

DUKANE

**Liquid Crystal Projector
Model 9060**



USER'S MANUAL

Important Information

Precautions

Please read this manual carefully before using your 9060 Projector. And keep this manual handy for future reference.

Your serial number is located on the bottom of your 9060. Record it here:

CAUTION



To turn off main power, be sure to remove the plug from power outlet. The power outlet socket should be installed as near to the equipment as possible, and should be easily accessible.

CAUTION



TO PREVENT SHOCK, DO NOT OPEN THE CABINET. NO USER-SERVICEABLE PARTS INSIDE. REFER SERVICING TO QUALIFIED NEC SERVICE PERSONNEL.



This symbol warns the user that uninsulated voltage within the unit may be sufficient to cause electrical shock. Therefore, it is dangerous to make any kind of contact with any part inside of the unit.



This symbol alerts the user that important information concerning the operation and maintenance of this unit has been provided. The information should be read carefully to avoid problems.

WARNING

TO PREVENT FIRE OR SHOCK, DO NOT EXPOSE THIS UNIT TO RAIN OR MOISTURE.

DO NOT USE THIS UNIT'S GROUNDED PLUG WITH AN EXTENSION CORD OR IN AN OUTLET UNLESS ALL THREE PRONGS CAN BE FULLY INSERTED.

DO NOT OPEN THE CABINET. THERE ARE HIGH-VOLTAGE COMPONENTS INSIDE. ALL SERVICING MUST BE DONE BY QUALIFIED NEC SERVICE PERSONNEL.

DOC Compliance Notice

This Class B digital apparatus meets all requirements of the Canadian Interference-Causing Equipment Regulations.

3. GSGV Acoustic Noise Information Ordinance:

The sound pressure level is less than 70 dB (A) according to ISO 3744 or ISO 7779.

In UK, a BS approved power cable with moulded plug has a Black (five Amps) fuse installed for use with this equipment. If a power cable is not supplied with this equipment please contact your supplier.

- IBM is a registered trademark of International Business Machines Corporation.
- Macintosh and PowerBook are registered trademarks of Apple Computer, Inc.
- Other product and company names mentioned in this user's manual may be the trademarks of their respective holders.

RF Interference

WARNING

The Federal Communications Commission does not allow any modifications or changes to the unit EXCEPT those specified by NEC Solutions, Inc. in this manual. Failure to comply with this government regulation could void your right to operate this equipment.

This equipment has been tested and found to comply with the limits for a Class B digital device, pursuant to Part 15 of the FCC Rules. These limits are designed to provide reasonable protection against harmful interference in a residential installation. This equipment generates, uses, and can radiate radio frequency energy and, if not installed and used in accordance with the instructions, may cause harmful interference to radio communications. However, there is no guarantee that interference will not occur in a particular installation. If this equipment does cause harmful interference to radio or television reception, which can be determined by turning the equipment off and on, the user is encouraged to try to correct the interference by one or more of the following measures:

- Reorient or relocate the receiving antenna.
- Increase the separation between the equipment and receiver.
- Connect the equipment into an outlet on a circuit different from that to which the receiver is connected.
- Consult the dealer or an experienced radio / TV technician for help.

Important Safeguards

These safety instructions are to ensure the long life of your projector and to prevent fire and shock. Please read them carefully and heed all warnings.

Installation

1. For best results, use your projector in a darkened room.
2. Place the projector on a flat, level surface in a dry area away from dust and moisture. Tilting the front of the projector up or down by more than 45° from level could reduce lamp life by up to 20%.
3. Do not place your projector in direct sunlight, near heaters or heat radiating appliances.
4. Exposure to direct sunlight, smoke or steam can harm internal components.
5. Handle your projector carefully. Do not hold the lens hood and the terminal covers. Dropping or jarring can damage internal components.
6. Do not place heavy objects on top of the projector.
7. If you wish to have the projector installed on the ceiling:
 - a. Do not attempt to install the projector yourself.
 - b. The projector must be installed by qualified technicians in order to ensure proper operation and reduce the risk of bodily injury.
 - c. In addition, the ceiling must be strong enough to support the projector and the installation must be in accordance with any local building codes.
 - d. Please consult your dealer for more information.

To Dealer or Installer:

To prevent the projector from falling, install it in a place and fasten it in a way with sufficient strength to support the combined weight (24.0 kg/53.0 lbs) of the projector (18.4 kg/40.6 lbs), the lens (2.0 kg/4.4 lbs) and the ceiling mount(3.2 kg/7.1 lbs) for an extended period of time as well as to withstand earthquakes.

Power Supply

1. The projector is designed to operate on a power supply of 100-120 or 200-240 V 50/60 Hz AC. Ensure that your power supply fits this requirement before attempting to use your projector.
2. Handle the power cable carefully and avoid excessive bending. A damaged cord can cause electric shock or fire.
3. If the projector is not to be used for an extended period of time, disconnect the plug from the power outlet.
4. Do not touch the power plug with wet hand. Doing so can cause electrical shock or fire.
5. Do not touch the power plug during a thunder storm. Doing so can cause electrical shock or fire.

Cleaning

1. Unplug the projector before cleaning.
2. Clean the cabinet periodically with a damp cloth. If heavily soiled, use a mild detergent. Never use strong detergents or solvents such as alcohol or thinner.
3. Use a blower or lens paper to clean the lens, and be careful not to scratch or mar the lens.

CAUTION

Do not unplug the power cable from the wall outlet under any one of the following circumstances. Doing so can cause damage to the projector:

- While the message "Please wait a moment." appears. This message will be displayed after the projector is turned off.
- Immediately after the power cable is plugged into the wall outlet (the POWER indicator has not changed to a steady orange glow).
- Immediately after the cooling fan stops working (The cooling fan continues to work for 90 seconds (2 minutes in the optional extended life lamp) after the projector is turned off with the POWER button).

CAUTION

- Do not try to touch the ventilation outlets as they can become heated while the projector is turned on.
- Do not put the projector on its side when the lamp is turned on. Doing so may cause damage to the projector.
- Before shipping this projector, remove the lens and attach the lens hood cap.
The Lens Shift mechanism may encounter damage caused by improper handling during transportation.
- Do not eject a PC card or LAN card while its data is being accessed. Doing so can damage your PC card or LAN card.

Lamp Replacement

- To replace the lamp, follow all instructions provided on page 9-2.
- Be sure to replace the lamp when the message "The Lamp has reached the end of its usable life. Please replace the lamp." appears. If you continue to use the lamp after the lamp has reached the end of its usable life, the lamp bulb may shatter, and pieces of glass may be scattered in the lamp case. Do not touch them as the pieces of glass may cause injury. If this happens, contact your NEC dealer for lamp replacement.
- Allow a minimum of 90 seconds (2 minutes in the optional extended life lamp) to elapse after turning off the projector. Then turn off the main power and disconnect the power cable and allow 60 minutes to cool the projector before replacing the lamp.

- The projector must be operated with two lamp housings installed regardless of whether or not the lamp is active. Failure to do so may degrade the performance of the projector such as screen flicker or loss of lamp life. If one lamp has reached the end of its usable life, replace it with a new one as soon as possible.

Fire and Shock Precautions

1. Ensure that there is sufficient ventilation and that vents are unobstructed to prevent the build-up of heat inside your projector. Allow at least 3 inches (10 cm) of space between your projector and a wall. Allow at least 12 inches (30cm) of space between the outlets on the left side (when viewed from the front) and the wall.
2. Prevent foreign objects such as paper clips and bits of paper from falling into your projector. Do not attempt to retrieve any objects that might fall into your projector. Do not insert any metal objects such as a wire or screwdriver into your projector. If something should fall into your projector, disconnect it immediately and have the object removed by a qualified service personnel.
3. Do not place any liquids on top of your projector.
4. When using a LAN cable:

For safety, do not connect to the connector for peripheral device wiring that might have excessive Voltage.

CAUTION

- Do not look into the lens while the projector is on. Serious damage to your eyes could result.
- Keep any items such as magnifying glass out of the light path of the projector. The light being projected from the lens is extensive, therefore any kind of abnormal objects that can redirect light coming out of the lens, can cause unpredictable outcome such as fire or injury to the eyes.
- Do not cover the lens with the supplied lens hood cap or equivalent while the projector is on. Doing so can lead to melting of the cap and possibly burning your hands due to the heat emitted from the light output.

Table of Contents

1. Introduction

1 What's in the Box?	1-2
2 Introduction to the Projector	1-3
3 Getting to Know Your Projector	1-4
Attaching the lens hood cap to the lens hood with the supplied string and rivet	1-6
Carrying the Projector	1-6
Top Features	1-7
Terminal Panel Features	1-8
4 Remote Control Features	1-10
Remote Control Precautions	1-12
Remote Control Battery Installation	1-12
Operating Range for Wireless Remote Control	1-12
Using the Remote Control in Wired Operation	1-13

2. Installation

1 Setting Up Your Projector	2-2
Screen Size and Projection Distance	2-2
2 Lens Shift Adjustable Range	2-4
3 Optional Lens Installation	2-6
4 Making Connections	2-8
Connecting Your PC or Macintosh	2-8
To connect Scart Output	2-9
Connecting an External Monitor	2-9
Connecting Your DVD Player	2-10
Connecting Your VCR or Laser Disc Player	2-11
Connecting to a Network	2-12
Connecting the Supplied Power Cable	2-13

3. Projecting an Image (Basic Operation)

1 Turning on the Projector	3-2
2 Selecting a Source	3-3
3 Adjusting the Picture Size and Position	3-3
4 Correcting the Horizontal and Vertical Keystone Distortion (3D Reform)	3-4
5 Optimizing RGB Picture Automatically	3-6
6 Turning Up or Down Volume	3-6
7 Turning off the Projector	3-7

4. Convenient Features

1 Turning Off the Image and Sound	4-2
2 Enlarging and Moving a Picture	4-2
3 Getting the On-line Help and Information	4-2
4 Using a USB Mouse	4-3
5 Using a USB HUB Function	4-3
6 Changing Background Logo	4-4
7 Making Freehand Drawings on	
8 Projected Image (ChalkBoard)	4-4
9 Lens Memory	4-5

5. Using the Viewer

1 Making the Most out of the Viewer Function	5-2
2 Operating the Viewer Function from the Projector (playback)	5-3

6. Using the Projector in a Network

1 End User License Agreement	6-2
2 Introduction	6-3
3 Supported Projectors	6-4
4 Equipment Connections and Settings	6-5
5 Software Installation	6-6
6 Starting/Exiting the Software	6-7
7 Troubleshooting	6-8

7. Setting Up for Double Stacking in Link Mode

1 Stacking and Connecting the Projectors	7-2
2 Adjusting and Registering Signals to Be Projected	7-5
3 Adjusting the Lens Shift, Zoom and Focus to Clearly Display all projected patterns	7-5
4 Link Mode Setting	7-5
5 List of Menu Items Available in Link Mode	7-6

8. Using On-Screen Menu

1 Basic Menu Operation	8-2
2 List of Direct Button Combinations	8-3
3 Menu tree	8-4
4 Menu Descriptions & Functions	8-7
Adjust (Source)	8-8
Picture	8-8
Video Adjust	8-8
Picture Management	8-9
Image Options	8-10
Option Adjust	8-10
Lens Memory	8-11
Signal Type	8-11
Sound	8-11
Ref. Adjust	8-12
Using 3D Reform	8-12
Screen Type	8-12
Reference White Balance	8-12
Reference Color Correction	8-12
Reference Lens Memory	8-13
Factory Default	8-13
Projector Options	8-13
Menu	8-13
Setup	8-15
Lamp Settings	8-18
Link Mode	8-18
LAN Mode	8-19
Setting a Password	8-23
Security	8-24
Tools	8-25
Timer	8-25
Using Capture (GT5000 only)	8-27
Using PC Card Files	8-27
Using ChalkBoard	8-27
Help	8-27
Contents	8-27
Source Information	8-27
Projector Information	8-28
Test Pattern	8-28

9. Maintenance Replacing the Lamp 9-2

1 Replacing or Cleaning the Filter	9-3
2 Cleaning the Cabinet and the Lens	9-4

10. Appendix

1 USB Memory Device or USB Memory Card Reader Support	10-2
2 Troubleshooting	10-3
3 Specifications	10-5
4 Cabinet Dimensions	10-7
5 Pin Assignments of D-Sub RGB Input Connector	10-7
6 Compatible Input Signal List	10-8
7 REMOTE 1 Connector	10-9
8 PC Control Codes and Cable Connection	10-10
Cable Connection	10-10
PC Control Connector (D-SUB 9P)	10-10
9 Using Software Keyboard	10-10
10 Operation Using an HTTP Browser	10-11

1

Introduction

.....

1	What's in the Box?	1-2
2	Introduction to the Projector	1-3
3	Getting to Know Your Projector	1-4
	Attaching the lens hood cap to the lens hood with the supplied string and rivet .	1-6
	Carrying the Projector	1-6
	Top Features	1-7
	Terminal Panel Features	1-8
4	Remote Control Features	1-10
	Remote Control Precautions	1-12
	Remote Control Battery Installation	1-12
	Operating Range for Wireless Remote Control	1-12
	Using the Remote Control in Wired Operation	1-13

What's in the Box?

Make sure your box contains everything listed. If any pieces are missing, contact your dealer. Please save the original box and packing materials if you ever need to ship your Projector.

NOTE: Lenses are optional. Order lenses from your Dukane dealer.

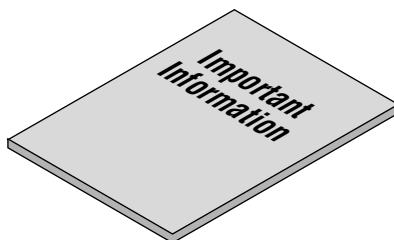
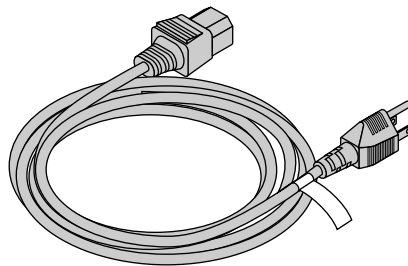
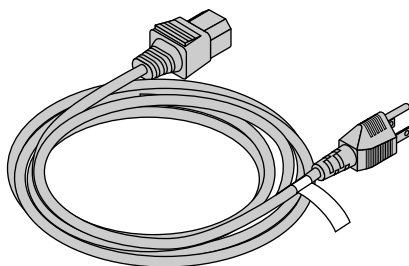
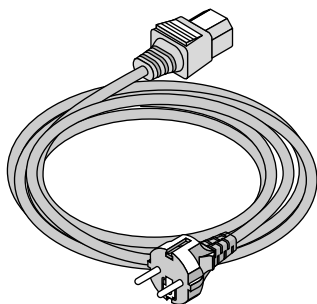
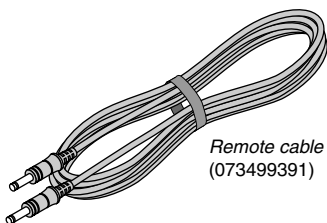
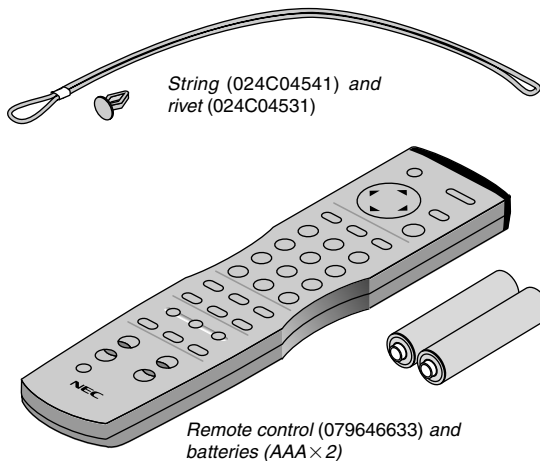
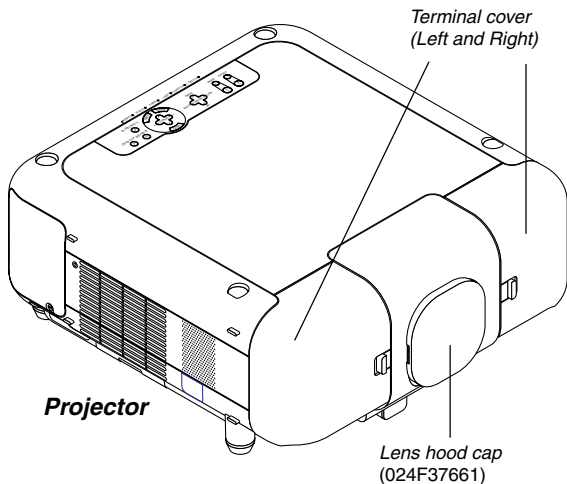

Document
User's Manual

2 Introduction to the Projector

This chapter introduces you to the 9060 high end fixed installation projector and describes key features and controls.

Congratulations on Your Purchase of the projector

The 9060 is a sophisticated three panel, dual lamp XGA LCD projector. With the 9060 you will be able to project images up to 500" (measured diagonally) from your DVD player, VCR, satellite hookup, HDTV source, PC, Workstation or Macintosh computer (desktop or notebook) and images from your digital camera PC Card or compact flash memory. The Dukane 9060 incorporates integrated networking access through the RJ45 input or provides for wireless network connectivity from an optional wireless network PC card. With extensive input and output panels, optional long life lamp, full suite of quick-change lenses and a full function remote, the 9060 will let you immerse yourself in large screen viewing.

Features you'll enjoy on the 9060:

- Integrated RJ45 connector for wired networking ability
 - Two optional modular card slots allow for future projector growth with the ability to add additional input cards
 - Dual PC card slots provide for optional wireless/wired network connectivity or PC Card usage
 - Email projector error status information to selected individuals
 - Power Horizontal and Vertical lens shift for optical display corrections
 - Lens memory controls lens attributes (zoom, focus, shift) depending on input resolution and input selected for fast and easy source transitions
 - Designed and developed SweetVision™ technology for enhanced video image display, more vibrant colors and blacks richer with detail
 - 3D Reform enhanced image technology for increased projector versatility that provides for horizontal, vertical and diagonal keystone correction (allows for positioning the projector in off center locations in the room and still get aligned images)
 - Display 16:9 or 4:3 information and fill the screen
 - HDTV (1080p, 1080i, 720p) and SDTV (576p, 576i, 480p, 480i) compatibility
 - 9060 supports a native resolution of XGA (1024 × 768) and
 - Intelligent lamp technology offers up to six user lamp settings to maximize light output or lamp life and provide for built in redundancy
 - Smart security settings for password protection, control panel lock, menu lock and PC card protection key to help prevent unauthorized access and adjustments to the projector
 - ADA508 and Executive Order 13221 Federal Government compliance *1
 - NEC 3D 10-bit video decoder for expanded black levels and adaptive gamma correction
 - High performance optional long life lamp for low total operating costs
 - Digital photo viewer to display larger than life images from your digital cameras PC card or compact flash card
- Double stackable for built in redundancy and high light output requirements
 - Built in 5W × 2 speakers for an integrated audio solution
 - Two timer settings - On/Off with programming or Sleep timer that counts down at selected intervals
 - 12V low voltage Screen Trigger output
 - Easy set up and operation
 - Eco-mode™ lamp technology for increased lamp life and energy savings
 - VORTEX Technology Plus™ for uncompromising display of video and data. Improves white level, color accuracy, dynamic range, and display of varying levels of black in an image
 - Wireless remote control operation
 - External control via RS232, USB or Network
 - Advanced AccuBlend intelligent pixel blending technology provides for extremely accurate image compression and HDTV (1920 × 1080) display resolution*2.
 - Supports most IBM VGA, SVGA, XGA, Macintosh, component signal (YCbCr/YPbPr) or other RGB signals within a horizontal frequency range of 15 to 100 kHz and a vertical frequency range of 48 to 120 Hz. This includes NTSC, NTSC4.43, PAL, PAL-M, PAL-N, PAL60 and SECAM standard video signals

*NOTE: Composite video standards are as follows:
NTSC: U.S. TV standard for video in U.S. and Canada.
NTSC4.43: TV standard used in Middle East countries.
PAL: TV standard used in Western Europe.
PAL-M: TV standard used in Brazil.
PAL-N: TV standard used in Argentina, Paraguay and Uruguay.
PAL60: TV standard used for NTSC playback on PAL TVs.
SECAM: TV standard used in France and Eastern Europe.*

*1 The 9060 meets ADA508 compliance, the latest American government regulation which provides for closed captioning, including a menu system that can be viewed by colorblind users. This model also meets Executive Order 13221 requirement for standby operation, which consumes less than 1 watt.

*2 HDTV 1080P (1920 × 1080), HDTV 1080i (1920 × 1080), HDTV 720 p (1280 × 720) and 1600 × 1200 are displayed with Advanced AccuBlend technology on the 9060.

3 Getting to Know Your Projector

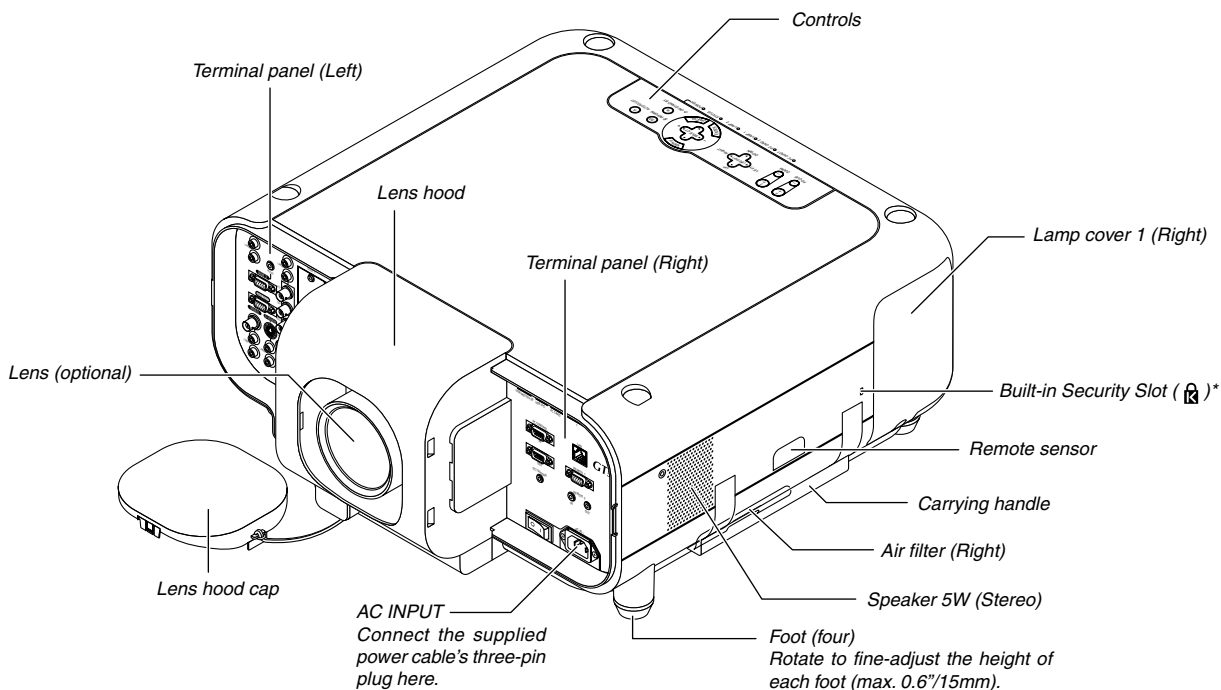

*NOTE: Slot for Kensington MicroSaver Security System
 This security slot supports the MicroSaver® Security System.
 MicroSaver® is a registered trademark of Kensington Microware Inc. The logo is trademarked and owned by Kensington Microware Inc.

Attaching and Removing the Terminal Covers

To remove the terminal cover, push and hold the latch.
 To attach the terminal cover, align the protrusions inside and push it until you feel it click into place.

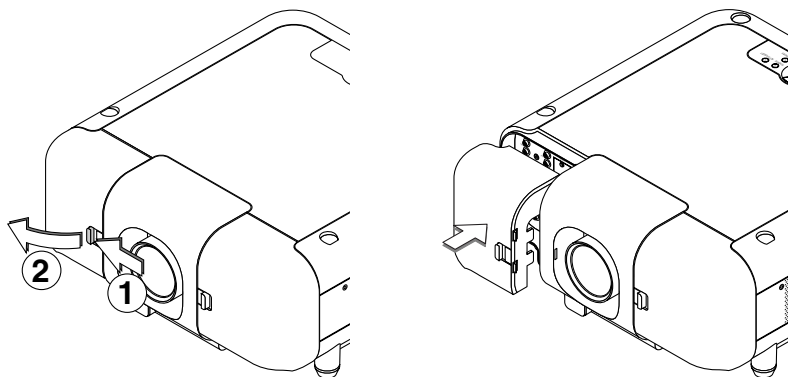

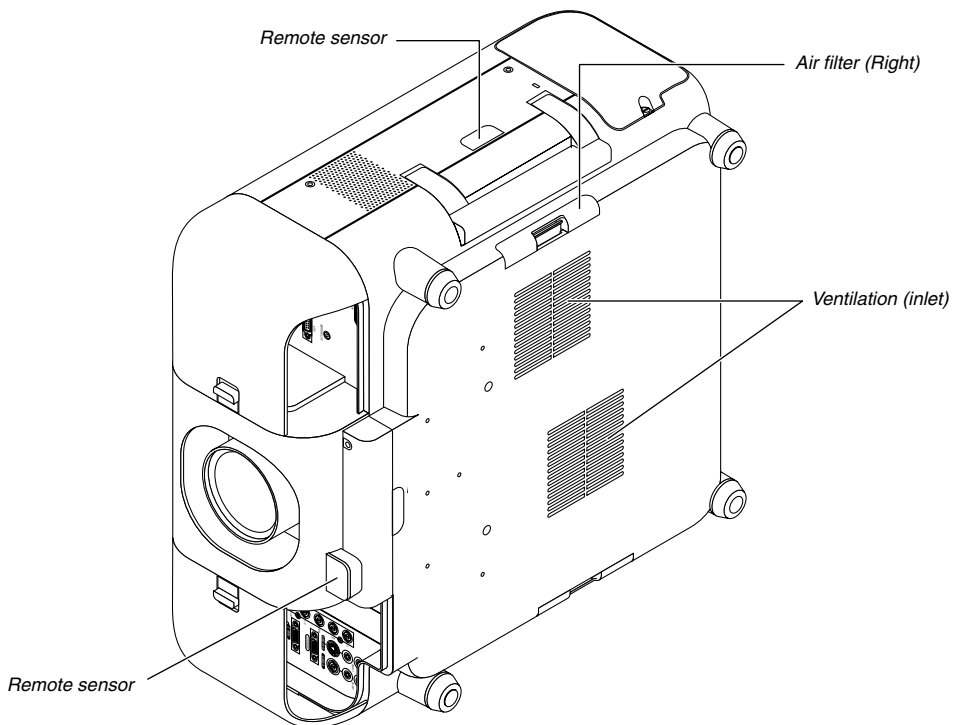
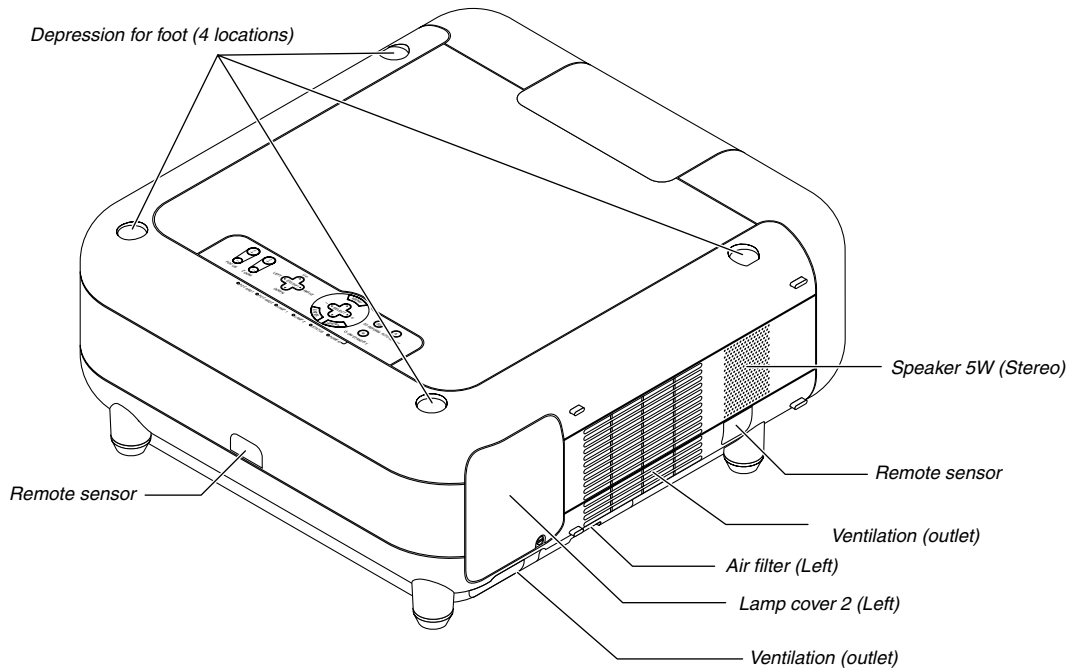

Attaching the lens hood cap to the lens hood with the supplied string and rivet

1. Thread the string through the hole on the lens hood cap.

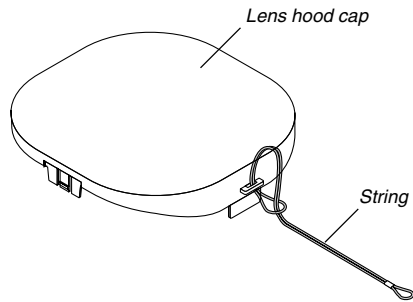

2. Use the rivet to attach the string to the bottom of the projector.

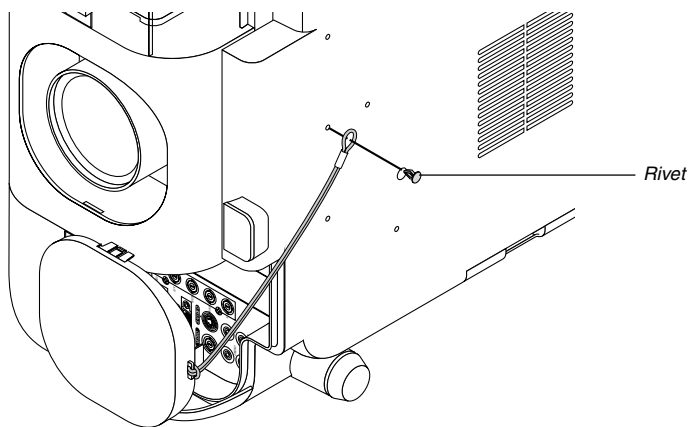

Carrying the Projector

Always carry your projector by the handle.

Ensure that the power cable and any other cables connecting to video sources are disconnected before moving the projector.

When moving the projector or when it is not in use, cover the lens with the lens hood cap.

CAUTION: Do not put the projector on its side when the lamp is on.
Doing so may cause damage to the projector.

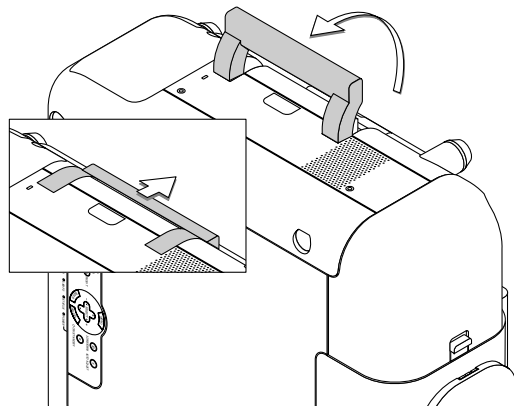

Top Features

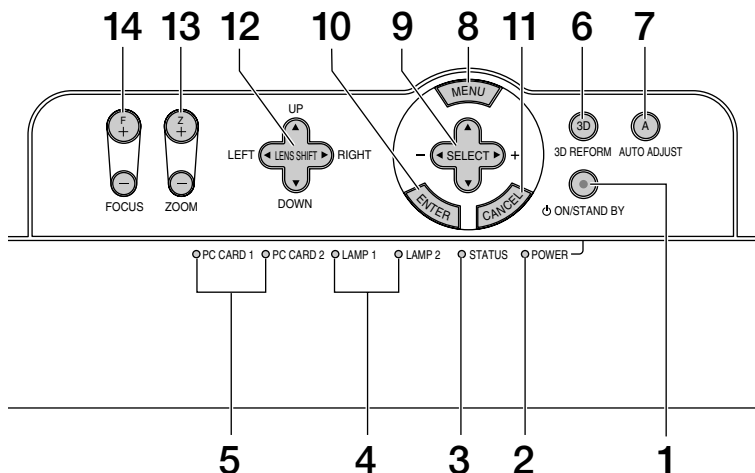

1. POWER Button (ON / STAND BY)(⏻)
 Use this button to turn the power on and off when the main power is supplied and the projector is in standby mode or idle mode.

NOTE: To turn on or off the projector, press and hold this button for a minimum of two seconds.

2. POWER Indicator
 When this indicator is green, the projector is on; when this indicator is orange, it is in standby or idle mode. See the Power Indicator section on page 10-3 for more details.

3. STATUS Indicator
 If this light blinks red rapidly, it indicates that an error has occurred, the lamp cover is not attached properly or the projector has overheated. If this light remains orange, it indicates that you have pressed a cabinet key while the Control Panel Key Lock is enabled. See the Status Indicator section on page 10-3 for more details.

4. LAMP Indicator 1/2
 If this light blinks red rapidly, it's warning you that the lamp has reached the end of its usable life. After this light appears, replace the lamp as soon as possible (See page 9-2). See the Lamp Indicator section on page 10-3 for more details.

5. PC CARD Access Indicator 1/2
 Lights while accessing a PC card.

6. 3D REFORM Button
 Press this button to enter 3D Reform mode to correct the keystone (trapezoidal) distortion, and make the image square. Press to toggle between Cornerstone and Keystone adjustment mode.

NOTE: Pressing and holding this button for a minimum of 2 seconds will reset 3D Reform correction setting values to zero.

7. AUTO ADJUST Button
 Use this button to adjust Position-H/V and Pixel Clock/Phase for an optimal picture. See page 3-6.

8. MENU Button
 Displays the menu.

9. SELECT ▲▼◀▶ (+) (-) / Volume Buttons
 ▲▼ : Use these buttons to select the menu of the item you wish to adjust. When no menus appear, these buttons work as a volume control.
 ◀▶ : Use these buttons to change the level of a selected menu item. A press of the ▶ button executes the selection. When the menus or the Viewer tool bar is not displayed, these buttons can be used to select a slide, or to move the cursor in Folder List or Slide List.

10. ENTER Button
 Executes your menu selection and activates items selected from the menu.

11. CANCEL Button
 Press this button to exit "Menus". Press this button to return the adjustments to the last condition while you are in the adjustment or setting menu.

12. LENS SHIFT ▲▼◀▶ Button
 Adjust the lens offset by shifting the projected image position horizontally and / or vertically.

13. ZOOM Button (+/-)
 Zoom the lens in and out.

14. FOCUS Button (+/-)
 Adjust the lens focus.

Terminal Panel Features

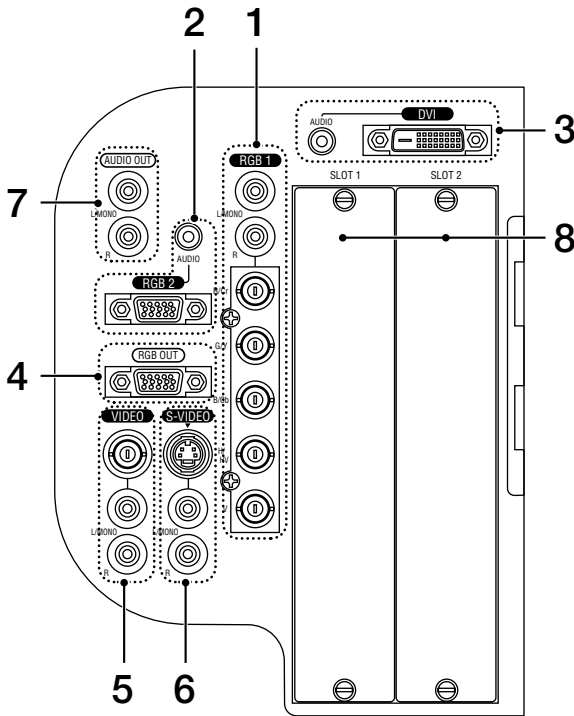

1. RGB 1 Connectors [R/Cr, G/Y, B/Cb, H/V, V] (BNC)
Connect R,G,B,H (Horizontal sync) and V (Vertical sync) outputs of external equipment.
If using a component with a combined sync (SYNC) output, connect it to the H/V terminal. When using luminance and color-difference signals of HDTV and DVD, connect Pr/Cr to the R, Y to the G and Pb/Cb to the B input of the projector.

RGB 1 Audio Input Jacks (RCA)

L/MONO: This is your left channel audio input for stereo sound coming from the RGB Input 1 source.
This also serves as your monaural audio input.

R: This is your right channel audio input for stereo sound from the RGB Input 1 source.

2. RGB 2 Connector (Mini D-sub 15 Pin)
Connect your computer or other analog RGB equipment such as IBM compatible or Macintosh computers. This also serves as a component input connector that allows you to connect a component video output of component equipment such as a DVD player. This connector also supports SCART output signal. See page 2-9 for more details.

RGB 2 Audio Input Mini Jack (Stereo Mini)

This is where you connect audio output from your computer or DVD player connected to the RGB2 input. A commercially available audio cable is required.

3. DVI IN Connector (DVI-D 24 Pin)
This connector can be used to accept digital signal output from a computer with a DVI connector.

DVI AUDIO Input Mini Jack (Stereo Mini)

This is where you connect the audio output from your computer when connected to the DVI input. A commercially available audio cable is required.

4. RGB OUT Connector (Mini D-Sub 15 Pin)
You can use this connector to loop your computer image to an external monitor from the RGB 1 or 2 input source.
5. VIDEO IN Connector (BNC)
Connect a VCR, DVD player, laser disc player, or document camera here to project video.

VIDEO AUDIO Input Jacks R/L (RCA)

These are your left and right channel audio inputs for stereo sound from a Video source.

6. S-VIDEO IN Connector (Mini DIN 4 Pin)
Here is where you connect the S-Video input from an external source like a VCR.

NOTE: S-Video provides more vivid color and higher resolution than the traditional composite video format.

S-VIDEO AUDIO Input Jacks R/L (RCA)

These are your left and right channel audio inputs for stereo sound from an S-Video source.

7. AUDIO OUT Jacks R/L (RCA)
You can use this connector to output sound from the currently selected input source (RGB 1, RGB 2, DVI (DIGITAL), Video or S-Video).
Output sound level can be adjusted in accordance with the sound level of the internal speaker.
8. Slot 1/2
For optional RGB, SDI or DVI board.

Terminal Panel Features

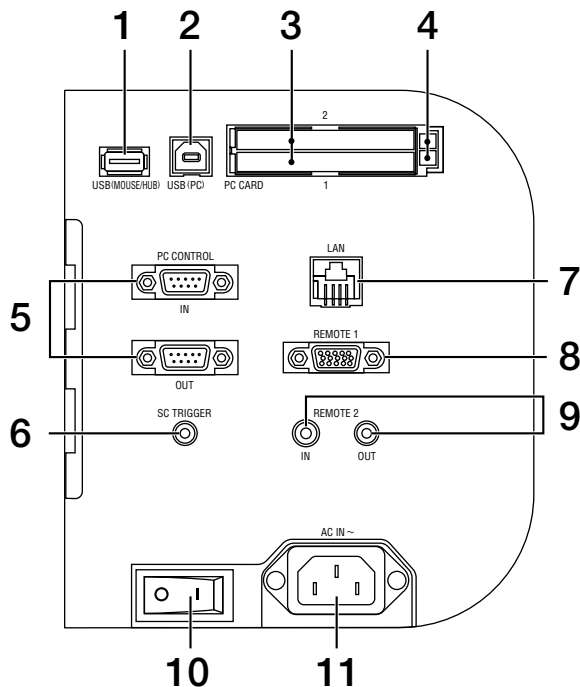

1. **USB Port [MOUSE/HUB] (Type A)**
Connect a USB mouse. You can operate the menu or Viewer with a USB mouse via this port.
• A USB-supported scanner or PC peripheral can be connected to this port. (USB Hub Function. See page 4-3)
2. **USB Port [PC] (Type B)**
Connect this port to the USB port (type A) of your PC using a USB cable. This port also serves as a PC Control port by using Dynamic Image Utility 2.0 included on the supplied CD-ROM.
3. **PC CARD Slot 1/2**
Insert a PC card, commercially available flash memory card or optional wireless LAN card here.
There are two slots: Slot 1 and Slot 2.
4. **PC CARD Eject Button 1/2**
Press to eject a PC card partially. Each slot has its own eject button: 1 and 2.
5. **PC CONTROL Connectors (Mini D-Sub 9 pin)**
For system expansion such as PC-Control using Dynamic Image Utility included on the supplied User Supportware CD-ROM or RS232C control from an external control system.

IN: connect to the external equipment such as a PC or control system.

OUT: for daisy-chaining multiple projectors and operating them with the same external equipment. To do so, connect to a second projector's IN terminal to relay the input at the IN terminal of the first projector until all the projectors are connected.

6. SC. TRIGGER Mini Jack

When the projector is powered ON the screen trigger output sends a low voltage trigger to the screen controller and the screen will go down. When the projector is powered OFF the screen trigger stops sending a low voltage trigger to the screen controller and the screen will go up.

NOTE: To use this feature, you must turn on the Screen Trigger function. See page 8-17.

Stereo mini cable (not supplied)

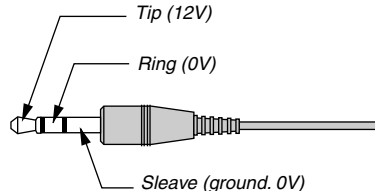

NOTE: Screen controllers are supplied and supported by screen manufacturers.

NOTE: Do not use this jack for anything other than intended use. Connecting wired remote control to the SC. TRIGGER Mini Jack causes damage to the remote control.

7. LAN Port (RJ-45)

This port is typically used for UTP Ethernet/Fast Ethernet. Use this connector to control the projector on a LAN. See page 2-12.

8. REMOTE 1 (Mini D-Sub 15 Pin)

This terminal allows external control of the projector by use of contact closure. See page 10-9.

9. REMOTE 2 Mini Jacks (IN/OUT)

IN: wired remote control input.

OUT: for daisy-chaining multiple projectors and operating them with the same remote control. To do so, connect to a second projector's IN terminal to relay the input at the IN terminal of the first projector until all the projectors are connected.

10. Main Power Switch

When you plug the supplied power cable into an active wall outlet and turn on the Main Power switch, the POWER indicator turns orange and the projector is in standby mode. See page 3-2.

11. AC IN

Connect the supplied power cable's three-pin plug here. Three types of power cable are supplied with this projector: three-pin type for U. S. A. and Canada. Two-pin type for Europe and Japan.

4 Remote Control Features

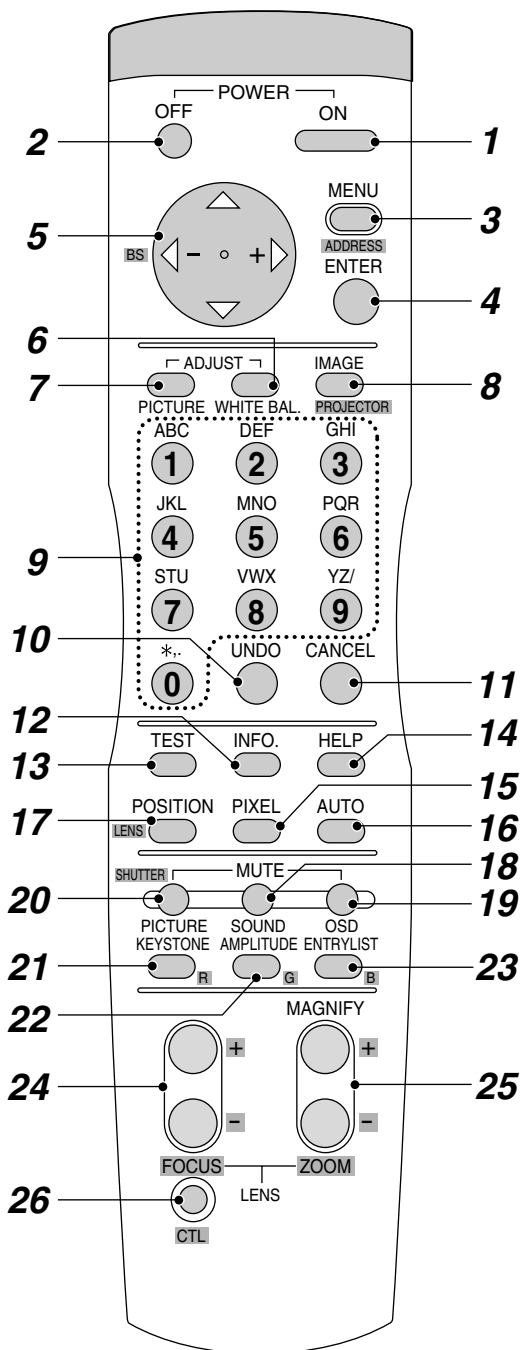

1. POWER ON
Press and hold this button for a minimum of two seconds to turn on the projector when the main power is supplied and the projector is in standby mode or idle mode.
2. POWER OFF
Press and hold this button for a minimum of two seconds to turn off the projector.
3. MENU
Press to display the main menu.
While pressing and holding CTL, press this button to display the Remote Control ID dialog box to specify the remote control ID. See page 7-2.
4. ENTER
Executes the menu selection and activates items selected from the menu. When the slider or dialog box is displayed: Pressing this button confirms adjustments/setting and returns to the previous menu display.
5. Select (Up/Down/Left/Right)
▲▼: Use these buttons to select the menu of the item you wish to adjust.
When no menus appear, these buttons work as a volume control.
◀▶: Use these buttons to change the level of a selected menu item.
A press of the ▶ button executes the selection.
Pressing and holding CTL, then pressing ◀ button works as a Back Space key in the entry screen.
Pressing and holding CTL, then pressing this button moves the menu, slider, toolbar or dialog box.
6. ADJUST WHITE BAL.
Press to display the Picture Management screen.
7. ADJUST PICTURE
Press to display the Picture adjustment screen. Pressing this button sequentially selects adjustment screens.
8. IMAGE/PROJECTOR
Press to display the Image Option screen. Pressing this button sequentially selects Image Options screens.
While pressing and holding CTL, pressing this button rotates Projector Options screens.
9. Source / Input
Press to select input or to name a signal.

- 1 Selects RGB 1 input.
 - 2 Selects RGB 2 input.
 - 3 Selects DVI (DIGITAL) input.
 - 4 Selects VIDEO input.
 - 5 Selects S-VIDEO input.
 - 6 Selects Viewer input
 - 7 Selects LAN input
 - 8 Selects OPTION SLOT 1* (available for optional SDI board)
 - 9 Selects OPTION SLOT 2* (available for optional SDI board)
 - 0 Sequentially selects: RGB1 (VIDEO) → RGB1 (S-VIDEO).
- * This button toggles between input 1 and 2.

NOTE: While pressing and holding CTL, pressing this button switches to the selected signal found in the Entry List.

10. UNDO

Press to return the adjustments and settings to the previous condition. While pressing and holding CTL, pressing this button clears the entire menus or adjustment/setting screen. At this time the adjustments/settings are stored in memory except the items on the setting screen with "OK" and "Cancel" buttons such as the Menu and the Setup screen.

11. CANCEL

Press to exit the menu.
Press this button with CTL to return to the previous menu without closing adjustment/setting screen while the menus appear. This feature allows you to adjust or set several items concurrently.

12. INFO

Displays the "Source Information" or "Projector Information" window. This button toggles between these two windows.
While pressing and holding CTL, pressing this button stores lens position settings.

13. TEST

Press to display the test pattern. Pressing this button sequentially selects test patterns.

14. HELP

Provides online help.

15. PIXEL

Displays the Position/Clock screen to adjust the clock and phase.

16. AUTO (RGB only)

Press to adjust Position-H/V and Pixel Clock for an optimal picture.

17. POSITION

Press to display the Position screen; press again to display the Blanking screen.
While pressing and holding CTL, pressing this button displays the Lens Shift adjustment screen.

18. MUTE SOUND

Turns off the sound for a short period of time. Press again to restore the sound.

19. MUTE OSD

Press to turn off the on-screen display. Press again to restore the on-screen display.

NOTE: You can also turn off the on-screen display forcibly by pressing and holding CTL and then pressing MUTE OSD (Forced On-Screen Mute Mode); doing this again restores it. In this case any adjustment will still change the projector's memory settings. This mode is available even when input is switched to another or the power is turned off the main power.

20. MUTE PICTURE

Press to turn off the picture for a short period of time. Press again to restore the picture.

21. KEYSTONE (R)

Press to display the Keystone Correction (3D Reform) screen. This button toggles between "Cornerstone" and "Keystone".
When the test pattern is displayed, while pressing and holding CTL, pressing this button displays a red test pattern.

NOTE: Pressing and holding this button for a minimum of two seconds will reset 3D Reform correction setting values to zero.

22. AMPLITUDE (G)

Service personnel only.
When the test pattern is displayed, while pressing and holding CTL, pressing this button displays a green test pattern.

23. ENTRY LIST (B)

Press to display the Entry List screen.
Pressing and holding CTL and then ENTRY LIST buttons simultaneously, enters a signal in the Entry List when you are not displaying a test pattern.
When the test pattern is displayed, while pressing and holding CTL, pressing this button displays a blue test pattern.

24. FOCUS (+/-)

While pressing and holding CTL, pressing this button allows you to adjust the lens focus.

25. MAGNIFY/ZOOM (+/-)

Magnify the size of a target portion.
While pressing and holding CTL, pressing this button allows you to zoom the lens in and out.

26. CTL

Used in conjunction with other buttons, similar to a shift key on a computer.

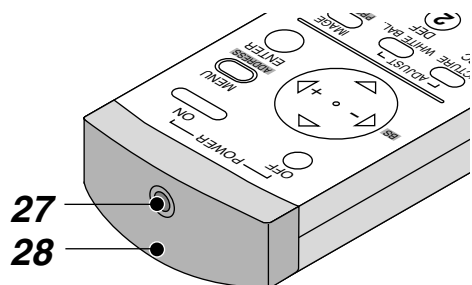

27. Remote Jack

Connect your remote cable here for wired operation.

28. Infrared Transmitter

Direct the remote control toward the remote sensor on the projector cabinet.

Remote Control Precautions

- The remote control system may not function when direct sunlight or strong illumination strikes the remote control sensor of the main unit, or when there is an obstacle in the path.
- When remote control buttons are pressed and held, projector's function keys may not operate.
- Do not subject to strong shock.
- Do not allow water or other liquid to splash on the remote control. If the remote control gets wet, wipe it dry immediately.
- Avoid exposure to heat and steam.
- Remove the batteries from the remote control when the remote control is not going to be used for a long period.

Remote Control Battery Installation

Installing the Remote Control Batteries

When it comes time to replace the batteries, two "AAA" type will be required.

1. Press and open the cover.

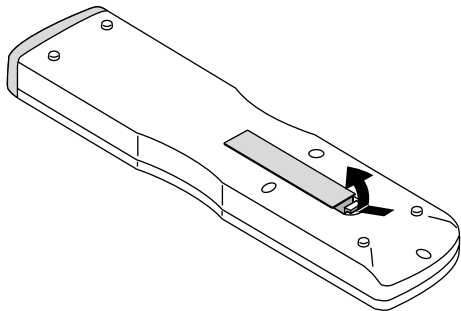

2. Align and insert the batteries according to the (+) and (-) indications inside the case.

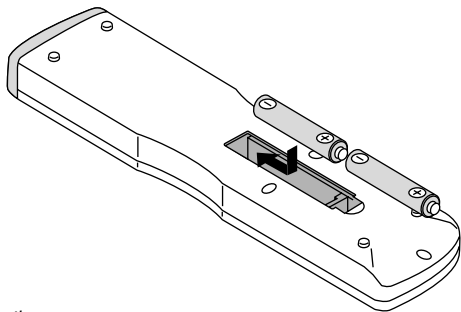

3. Replace the cover.

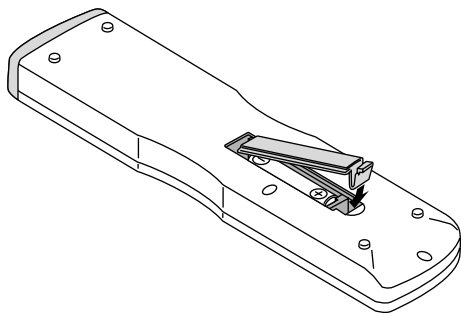

Operating Range for Wireless Remote Control

The infrared signal operates by line-of-sight up to a distance of approximately 7m (20 feet) and a 60 degree angle of the remote sensor.

The projector will not function if there are objects between the remote sensor and the remote control or if strong light falls on the remote sensor. Weak batteries will also prevent the projector from operating properly.

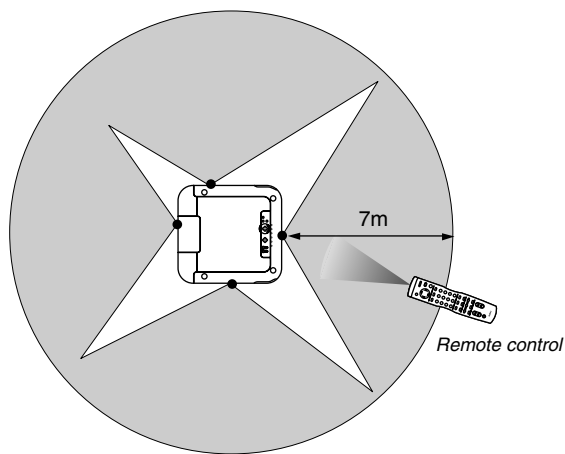
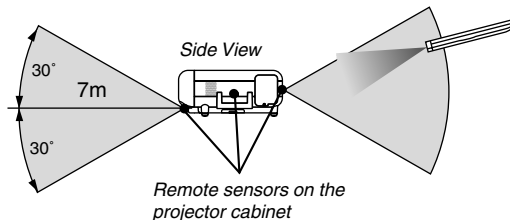

NOTE: You cannot operate the projector using the remote control if:

- The remote control ID is not set to [None].
- The remote ID is not the same as the projector ID.

See page 7-2 for setting remote ID and projector ID.

Using the Remote Control in Wired Operation

Connect one end of the supplied remote cable to the REMOTE 2 IN mini jack and the other end to the remote jack on the remote control.

NOTE: Do not use this jack for anything other than intended use. Connecting the wired remote control to the SC. TRIGGER Mini Jack causes damage to the remote control.

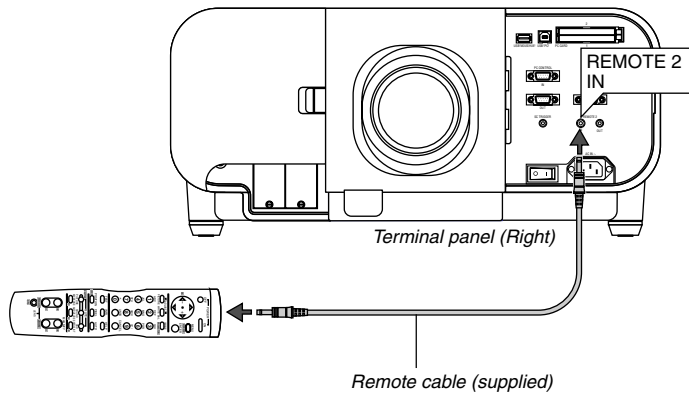

2

Installation

.....

1	Setting Up Your Projector	2-2
	Screen Size and Projection Distance	2-2
2	Lens Shift Adjustable Range	2-4
3	Optional Lens Installation	2-6
4	Making Connections	2-8
	Connecting Your PC or Macintosh	2-8
	To connect Scart Output	2-9
	Connecting an External Monitor	2-9
	Connecting Your DVD Player	2-10
	Connecting Your VCR or Laser Disc Player	2-11
	Connecting to a Network	2-12
	Connecting the Supplied Power Cable	2-13

This chapter describes how to set up your projector and how to connect video and audio sources.

■ Setting Up Your Projector

Your Projector is simple to set up and use. But before you get started, you must first:

1. Determine the image size
2. Set up a screen or select a non-glossy white wall onto which you can project your image.
3. Install the optional lens to the projector.
4. Connect the supplied power cable.
5. Set up the projector.
6. Connect a PC, VCR, DVD player, or other equipment.
7. Make settings or adjustments on the projector.

Screen Size and Projection Distance

Applicable lens and throw distance/ List of screen sizes

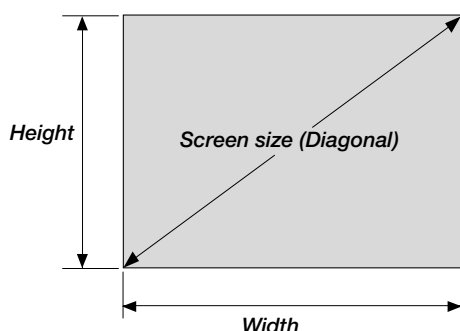

List of Screen Sizes

Screen size	Width (H)		Height (V)	
	m	inch	m	inch
40"	0.8	31.5	0.6	23.6
60"	1.2	47.2	0.9	35.4
80"	1.6	63.0	1.2	47.2
100"	2.0	78.7	1.5	59.1
120"	2.4	94.5	1.8	70.9
150"	3.0	118.1	2.3	90.6
200"	4.1	161.4	3.0	118.1
250"	5.1	200.8	3.8	149.6
300"	6.1	240.2	4.6	181.1
400"	8.1	318.9	6.1	240.2
500"	10.2	401.6	7.6	299.2

Formulas:
 Screen width H (m)= Screen size × 4/5 × 0.0254
 Screen height V (m)= Screen size × 3/5 × 0.0254
 Screen width H (inch)= Screen size × 4/5
 Screen height V (inch)= Screen size × 3/5

Table of Throw Distances and Screen Sizes for Optional Lenses

	GT10RLB		GT13ZLB		GT19ZL		GT20ZL		GT24ZLB		GT34ZLB	
	1.0		1.2-1.5		1.7-2.2		2.0-2.6		2.2-3.2		3.2-4.8	
	(m)	(inches)	(m)	(inches)	(m)	(inches)	(m)	(inches)	(m)	(inches)	(m)	(inches)
40"	0.76	30.0	0.91 - 1.15	36.0 - 45.2	1.30 - 1.74	51.0 - 68.4	1.53 - 2.03	60.1 - 80.0	—	—	—	—
60"	1.17	46.1	1.40 - 1.75	55.2 - 69.0	1.99 - 2.65	78.3 - 104.2	2.34 - 3.10	92.1 - 122.0	2.58 - 3.86	101.6 - 152.0	—	—
67"	1.31	51.7	1.57 - 1.97	62.0 - 77.4	2.23 - 2.97	87.8 - 116.7	2.62 - 3.47	103.3 - 136.7	2.90 - 4.32	114.0 - 170.3	—	—
72"	1.41	55.7	1.70 - 2.12	66.8 - 83.3	2.40 - 3.19	94.6 - 125.7	2.83 - 3.74	111.3 - 147.2	3.12 - 4.66	122.9 - 183.3	—	—
80"	1.58	62.1	1.89 - 2.36	74.5 - 92.9	2.68 - 3.56	105.5 - 140.0	3.15 - 4.16	124.1 - 164.0	3.48 - 5.19	137.1 - 204.3	5.10 - 7.81	200.6 - 307.6
84"	1.66	65.3	1.99 - 2.48	78.3 - 97.6	2.82 - 3.74	110.9 - 147.2	3.32 - 4.38	130.6 - 172.4	3.66 - 5.45	144.2 - 214.7	5.36 - 8.21	211.0 - 323.3
90"	1.78	70.2	2.14 - 2.66	84.1 - 104.8	3.02 - 4.01	119.1 - 158.0	3.56 - 4.70	140.2 - 185.0	3.93 - 5.85	154.8 - 230.4	5.76 - 8.81	226.6 - 346.9
100"	1.99	78.2	2.38 - 2.96	93.7 - 116.7	3.37 - 4.47	132.7 - 175.9	3.97 - 5.23	156.2 - 205.9	4.38 - 6.52	172.6 - 256.5	6.41 - 9.81	252.5 - 386.2
120"	2.39	94.2	2.87 - 3.57	112.9 - 140.5	4.06 - 5.38	159.9 - 211.7	4.78 - 6.30	188.2 - 247.9	5.28 - 7.84	208.0 - 308.8	7.73 - 11.81	304.5 - 464.8
150"	3.01	118.3	3.60 - 4.48	141.8 - 176.2	5.10 - 6.74	200.7 - 265.4	6.00 - 7.90	236.3 - 310.9	6.64 - 9.83	261.3 - 387.2	9.71 - 14.80	382.3 - 582.7
180"	3.62	142.4	4.33 - 5.38	170.6 - 212.0	6.14 - 8.11	241.6 - 319.2	7.22 - 9.50	284.3 - 373.9	7.99 - 11.83	314.5 - 465.6	11.69 - 17.80	460.2 - 700.6
200"	4.02	158.5	4.82 - 5.99	189.9 - 235.8	6.83 - 9.02	268.8 - 355.0	8.04 - 10.56	316.3 - 415.8	8.89 - 13.15	350.0 - 517.9	13.01 - 19.79	512.1 - 779.2
210"	4.23	166.5	5.07 - 6.29	199.5 - 247.7	7.17 - 9.47	282.4 - 372.9	8.44 - 11.10	332.4 - 436.8	9.34 - 13.82	367.7 - 544.0	13.67 - 20.79	538.1 - 818.5
240"	4.84	190.6	5.80 - 7.20	228.4 - 283.4	8.21 - 10.84	323.2 - 426.7	9.66 - 12.69	380.4 - 499.8	10.69 - 15.81	421.0 - 622.4	15.64 - 23.79	615.9 - 936.5
250"	5.04	198.6	6.04 - 7.50	238.0 - 295.4	8.56 - 11.29	336.8 - 444.6	10.07 - 13.23	396.4 - 520.8	11.14 - 16.47	438.7 - 648.6	16.30 - 24.78	641.9 - 975.8
270"	—	—	6.53 - 8.11	257.2 - 319.2	9.25 - 12.20	364.0 - 480.4	10.88 - 14.29	428.5 - 562.8	12.04 - 17.80	474.2 - 700.8	17.62 - 26.78	693.8 - 1,054.4
300"	—	—	7.27 - 9.01	286.1 - 354.9	10.28 - 13.57	404.9 - 534.1	12.10 - 15.89	476.5 - 625.7	13.40 - 19.79	527.4 - 779.2	19.60 - 29.78	771.7 - 1,172.3
400"	—	—	—	—	—	—	—	—	17.90 - 26.43	704.9 - 1,040.6	26.19 - 39.76	1,031.2 - 1,565.3
500"	—	—	—	—	—	—	—	—	—	—	32.79 - 49.74	1,290.8 - 1,958.4

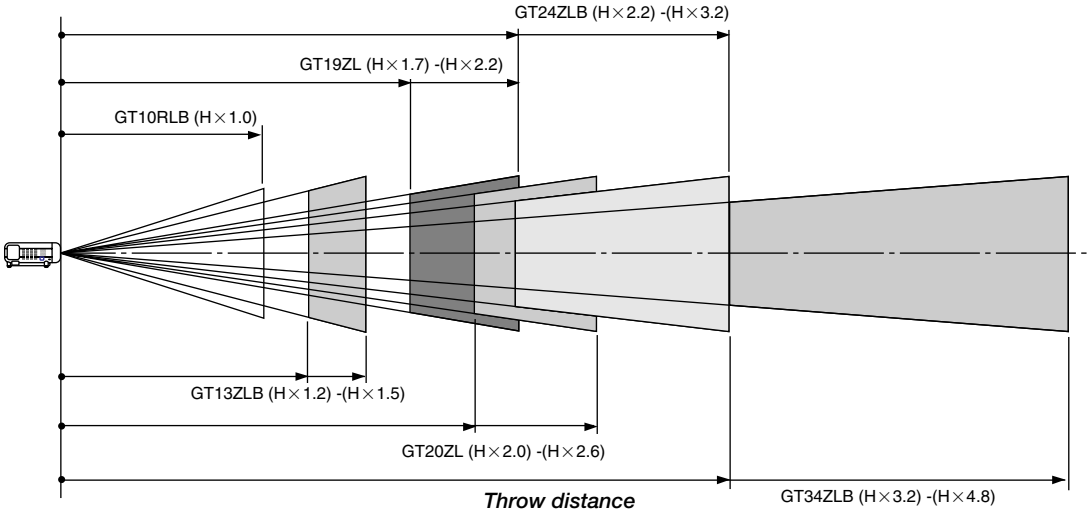

For screen sizes between 40" and 500" not indicated on the above table, use formulas below.
Projection Distance= Screen Width (H) × Lens Magnification
Throw distance for GT10RLB (m/inch)=H × 1.0 Distance from 0.8m to 5.0m/31.5" to 196.9"
Throw distance for GT13ZLB (m/inch)=H × 1.2 through H × 1.5 Distance from 1.0m to 9.0m/39.37" to 354.3"
Throw distance for GT19ZL (m/inch)=H × 1.7 through H × 2.2 Distance from 1.4m to 13.5m/55.12" to 531.5"
Throw distance for GT20ZL (m/inch)=H × 2.0 through H × 2.6 Distance from 1.7m to 15.8m/66.93" to 622"
Throw distance for GT24ZLB (m/inch)=H × 2.2 through H × 3.2 Distance from 2.6m to 26.4m/102.4" to 1039"
Throw distance for GT34ZLB (m/inch)=H × 3.2 through H × 4.8 Distance from 5.1m to 49.7m/200.8" to 1957"

NOTE: Distances may vary +/-5%.

NOTE: GT10RLB should be used only for "zero degree/no-offset" applications.
To set zero degree/no-offset, reset the lens position by using "Return to Factory Default" in "Ref. Lens Memory."
See page 8-13 for using "Return to Factory Default" to reset the lens position.
After resetting, perform fine adjustment on the lens position by using the LENS SHIFT button ▲▼◀▶.

NOTE: When using the projector with either the GT13ZLB or GT13ZL lens, it is recommended to select "Dual" in the Lamp Settings menu. This will provide the best performance when operating the projector.

2 Lens Shift Adjustable Range

The top right diagram shows the location of the image position in the lens. The lens can be shifted within the shaded area as shown using the normal projection position as a starting point.

Maximum Possible Range for GT20ZL:

- Up: 0.5 V (V: height of projected image)
- Down: 0.5 V
- Right: 0.32 H (H: width of projected image)
- Left: 0.32 H

NOTE: Lens shift is not available on the GT10RLB rear lens. The GT10RLB should be used only for "zero degree/no-offset" applications.

NOTE: If lens is shifted in two directions combined, maximum range in either direction cannot be obtained due to rounded off area of lens. (example: shift up and right) See top right diagram.

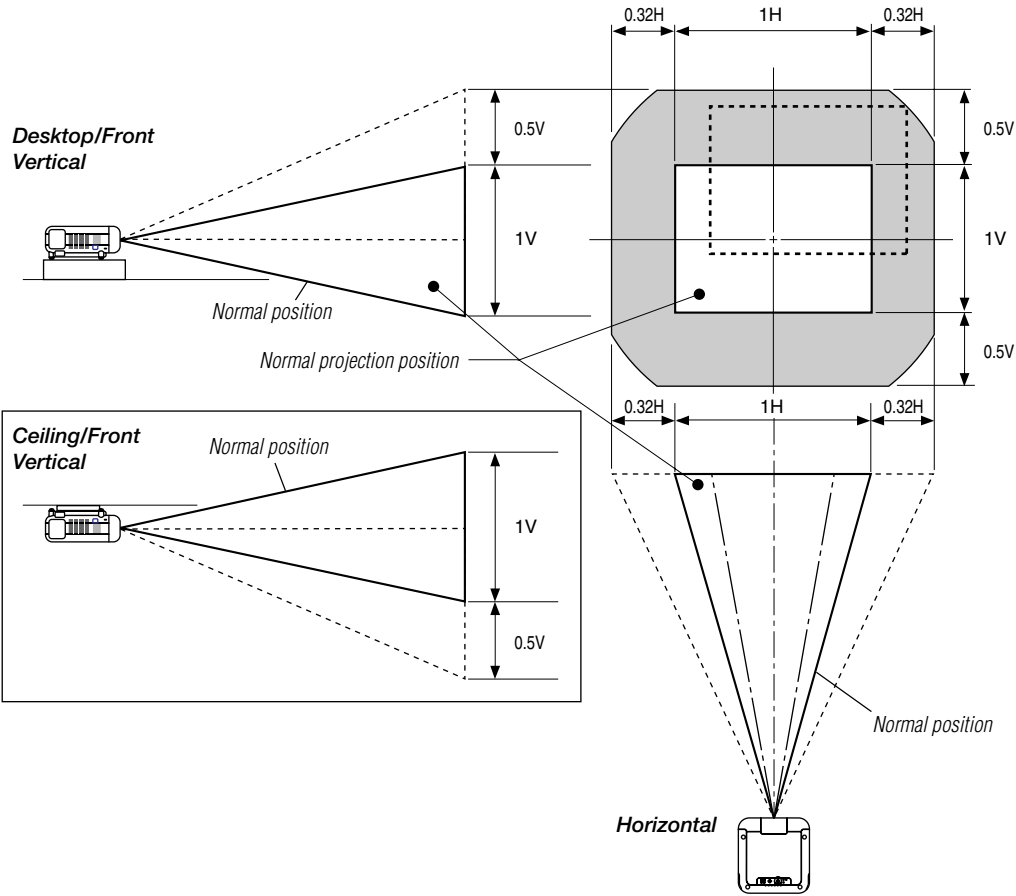

WARNING

- * Installing the projector on the ceiling must be done by a qualified technician.
- Tilting the front of the projector up or down by more than 45° from level could reduce lamp life by up to 20%.
- Only use your projector on a solid, level surface. If the projector falls, you could be injured and the projector severely damaged.
- Do not use the projector where temperatures vary greatly. The projector must be used at temperatures between 32°F (0°C) and 95°F (35°C).
- Do not expose the projector to moisture, dust, or smoke. This will reduce the quality of the image.
- Ensure that you have adequate ventilation around your projector so heat can dissipate. Do not cover the vents on the projector.

Lens Shift Adjustable Range (continued)

The top right diagram shows the location of the image position in the lens. The lens can be shifted within the shaded area as shown using the normal projection position as a starting point.

Maximum Possible Range for GT13ZLB/GT19ZL/GT24ZLB/GT34ZLB:

- Values in parentheses for GT13ZLB.
- Up: 0.39V (0.32V) (V: height of projected image)
- Down: 0.39V (0.32V)
- Right: 0.24H (0.19H) (H: height of projected image)
- Left: 0.24H (0.19H)

NOTE: Lens shift is not available on the GT10RLB rear lens. The GT10RLB should be used only for "zero degree/no-offset" applications.

NOTE: If lens is shifted in two directions combined, maximum range in either direction cannot be obtained due to rounded off area of lens. (example: shift up and right) See top right diagram.

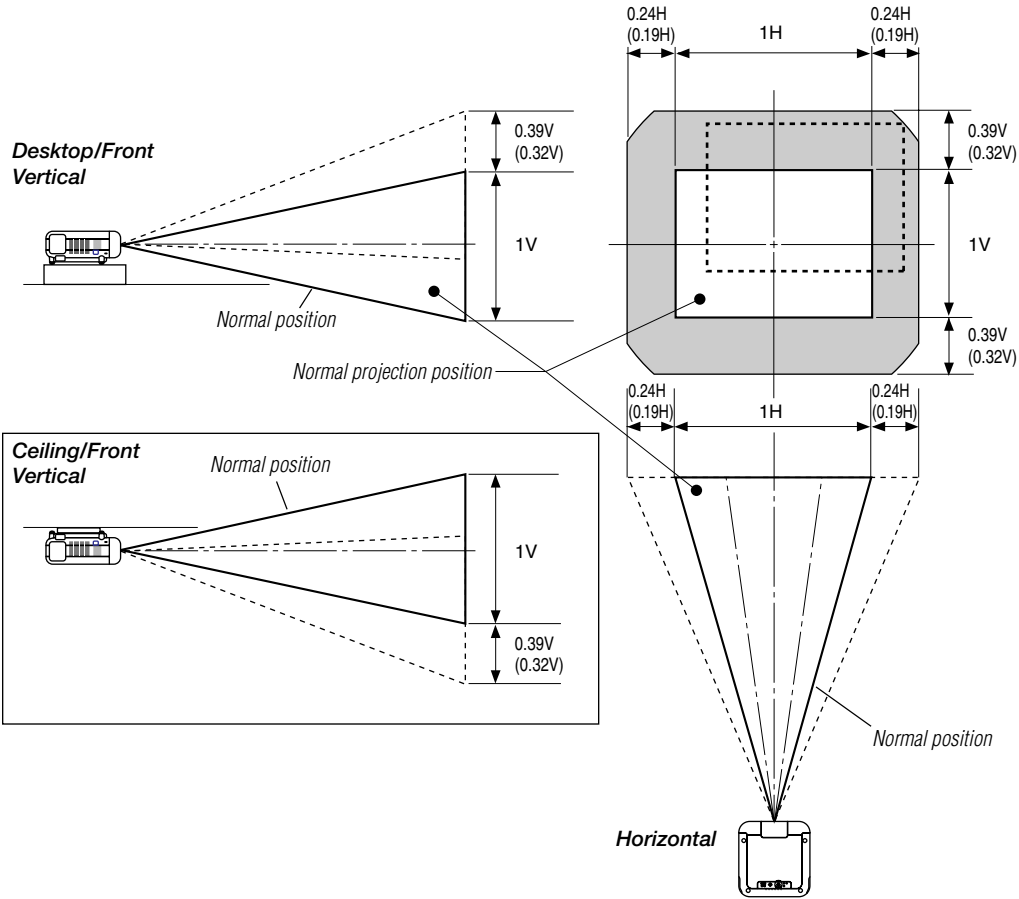

WARNING

- * Installing the projector on the ceiling must be done by a qualified technician.
- Tilting the front of the projector up or down by more than 45° from level could reduce lamp life by up to 20%.
- Only use your projector on a solid, level surface. If the projector falls, you could be injured and the projector severely damaged.
- Do not use the projector where temperatures vary greatly. The projector must be used at temperatures between 32°F (0°C) and 95°F (35°C).
- Do not expose the projector to moisture, dust, or smoke. This will reduce the quality of the image.
- Ensure that you have adequate ventilation around your projector so heat can dissipate. Do not cover the vents on the projector.

3 Optional Lens Installation

This section describes how to install the lens.

Before installation

- * Determine the optional lens to be used to obtain a desired projection distance. There are six optional lenses available:
GT13ZLB, GT19ZL, GT20ZL, GT24ZLB and GT34ZLB (Zoom lens)
GT10RLB (Short throw fixed-focus lens)
 - * Press the power button (ON/STAND BY) on the projector or POWER OFF button on the remote control for a minimum of two seconds to turn off the power, wait 90 seconds (2 minutes in the optional extended life lamp) for the cooling fan to stop, turn off the main power switch then disconnect the power cable.
- Check that the projector has cooled off sufficiently before proceeding.

CAUTION

- * The projector and lens contain high-precision parts. Do not induce shock to the projector or the lens.
- * Do not touch the lens surface. Doing so can degrade the optical performance.

Preparation: Tools needed for installation:

A hexagonal driver and dust-protective sheets are supplied with the optional lens.

1. Remove the lens hood cap and lens hood.

- ① Remove the lens hood cap.
- ② Loosen and remove the 2 screws on the lens hood using the hexagonal driver.
- ③ Remove the lens hood by pushing down and pulling the top toward you.

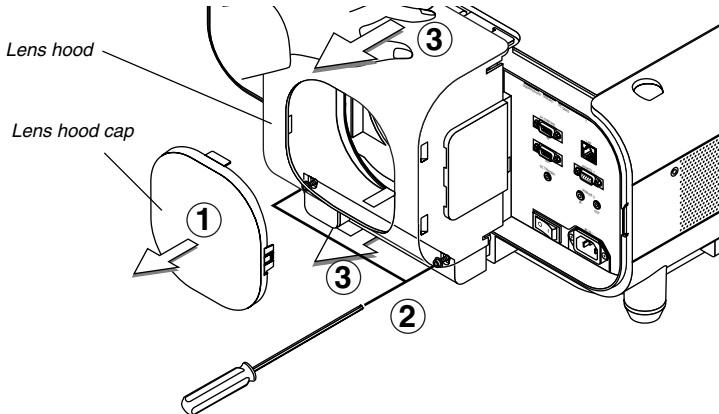

2. Attach a dust-protective sheet.

- ① Remove the shipping tape on the back of the lens hood.
- ② Insert the dust-protective sheet included with your optional lens. Be careful not to fold the sheet.

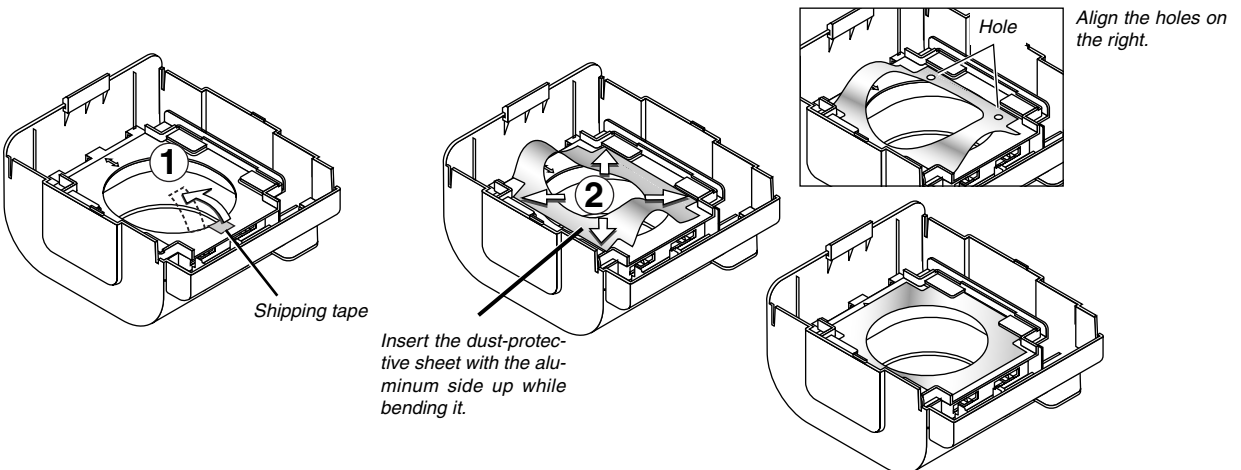

3. Mount the lens unit on the projector and connect the extension cable attached to the projector.

- ① Remove the lens cap from the rear end of the lens unit.

NOTE: Leave the front lens cap for protection while mounting the lens unit.

- ② Insert the lens unit so that the 4 screws on the lens unit are properly lined up with the 4 holes on the lens mount.
- ③ Secure the 4 screws using the hexagonal driver.
- ④ Insert the connector of the lens unit fully into the socket of the extension cable attached to the projector.

*NOTE: The GT13ZL, GT19ZL, GT24ZL and GT34ZL optional lenses have one connector. The B type lenses (GT13ZLB, GT24ZLB and GT34ZLB) and GT20ZL have two connectors.
To insert the connector into the 4-pin socket on the right side.*

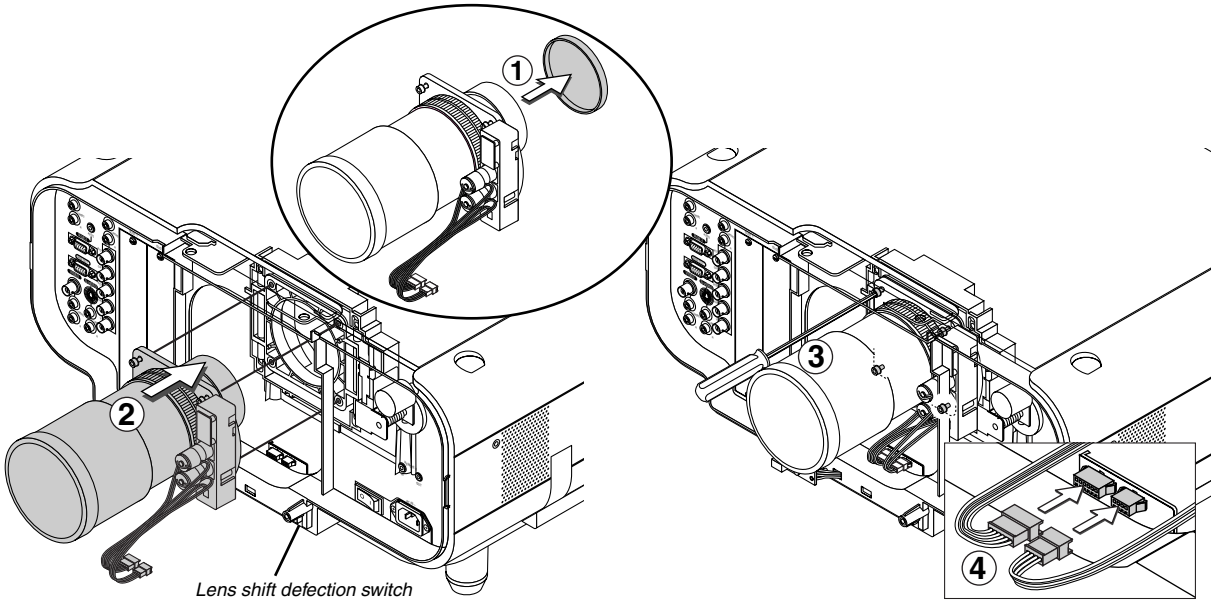

CAUTION: There is a lens shift detection switch for the moving gears of the lens shift motors used to reduce the risk of pinching fingers. Do not defeat this feature.

4. Reinstall the lens hood.

- ① Remove the front lens cap from the lens unit.
- ② Insert the lens hood so that the grooves on the 4 corners of the lens hood are properly lined up with the 4 catches on the projector.
- ③ Secure the 2 screws using the hexagonal driver.

This completes installation. If necessary, put the lens hood cap on the lens hood.

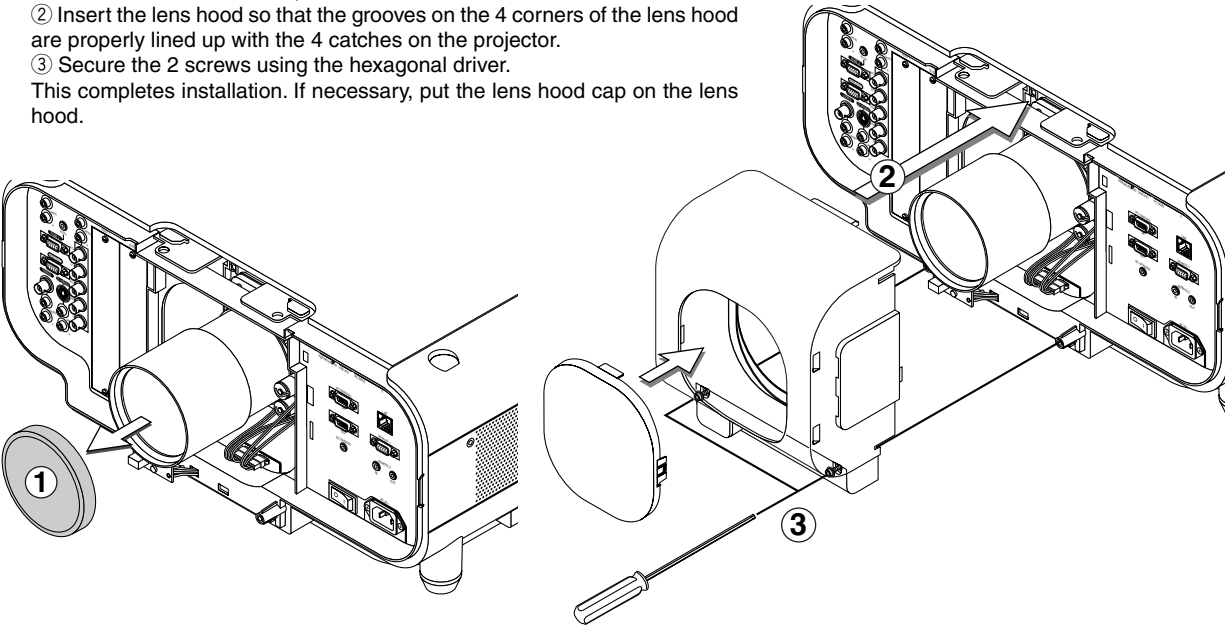

4 Making Connections

NOTE: When using with a notebook PC, be sure to connect between the projector and the notebook PC before turning on the power to the notebook PC. In most cases signal cannot be output from RGB output unless the notebook PC is turned on after connecting with the projector.

** If the screen goes blank while using your remote control, it may be the result of the computer's screen-saver or power management software.*

** If you accidentally hit the POWER button on the remote control, wait 90 seconds (2 minutes in the optional extended life lamp) and then press the POWER button again to resume.*

When Viewing a DVI Digital Signal:

To project a DVI digital signal, be sure to connect the PC and the projector using a DVI-D signal cable (not supplied) before turning on your PC or projector. Turn on the projector first and select DVI (DIGITAL) from the source menu before turning on your PC.

Failure to do so may not activate the digital output of the graphics card resulting in no picture being displayed. Should this happen, restart your PC. Do not disconnect the DVI-D signal cable while the projector is running. If the signal cable has been disconnected and then re-connected, an image may not be correctly displayed. Should this happen, restart your PC.

NOTE:

- Use the DVI-D cable compliant with DDWG (Digital Display Working Group) DVI (Digital Visual Interface) revision 1.0 standard. The DVI-D cable should be within 5 m (196") long.
- The DVI (DIGITAL) connector accepts VGA (640x480), SVGA (800x600), 1152x864, XGA (1024x768) and SXGA (1280x1024 @ up to 60Hz).

Connecting Your PC or Macintosh Computer

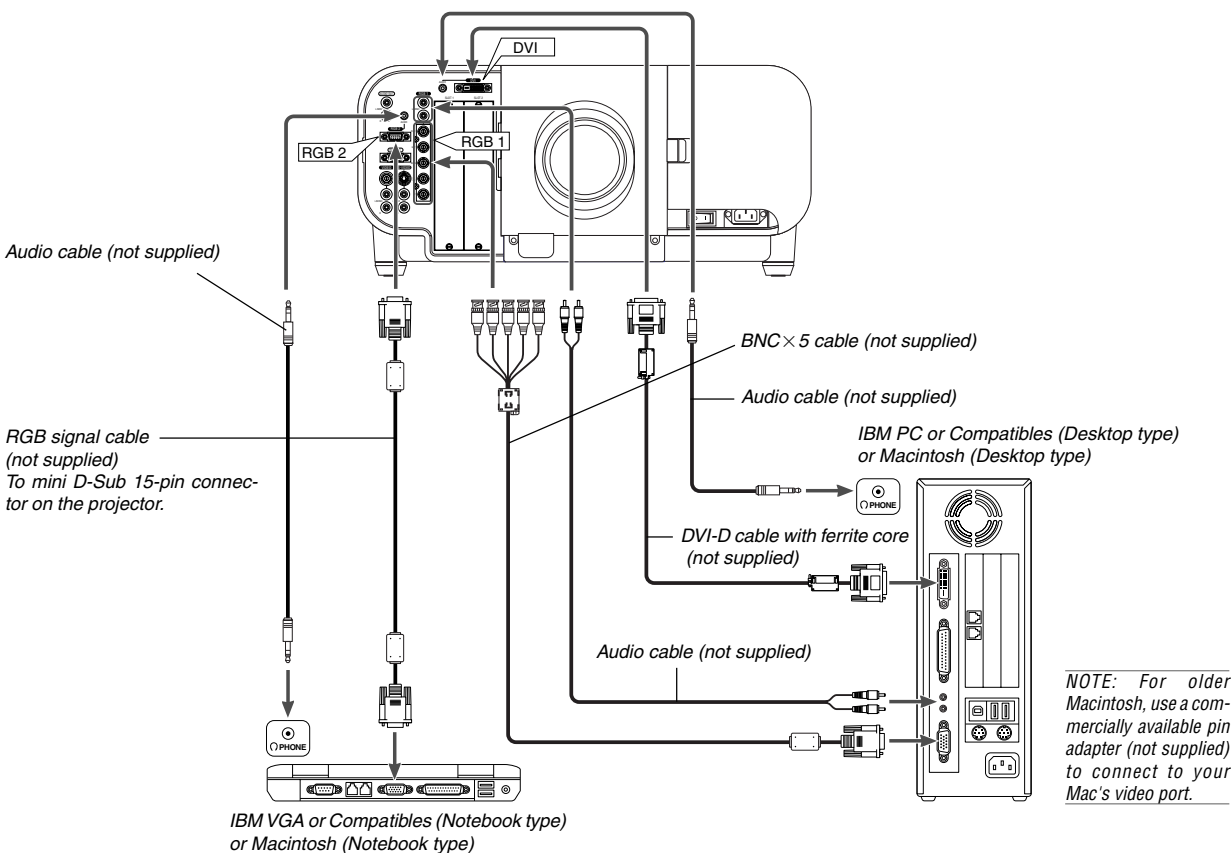

Connecting your PC or Macintosh computer to your projector will enable you to project your computer's screen image for an impressive presentation.

To connect to a PC or Macintosh, simply:

1. Turn off the power to your projector and computer.
2. Use a commercially available signal cable to connect your PC or Macintosh to the projector.
3. Turn on the projector and the computer.
4. If the projector goes blank after a period of inactivity, it may be caused by a screen saver installed on the computer you've connected to the projector.

Connecting to RGB 1 IN connectors (BNC)

Use a BNC x 5 cable (not supplied) to connect your PC and the RGB 1 IN connectors on your projector.

Connecting to RGB2 IN connector (D-Sub 15 Pin)

Use an RGB signal cable (not supplied) to connect your PC and the RGB2 IN connector on your projector.

Connecting Your PC with a DVI Connector

Use a DVI-D signal cable (not supplied) to connect a DVI connector of your PC to the projector.

To connect SCART output (RGB)

Before connections: An exclusive SCART adapter (ADP-SC1) and a commercially available SCART cable are required for this connection.

NOTE:

- Audio signal is not available for this connection.
- The RGB 1 IN connector does not support Plug & Play.

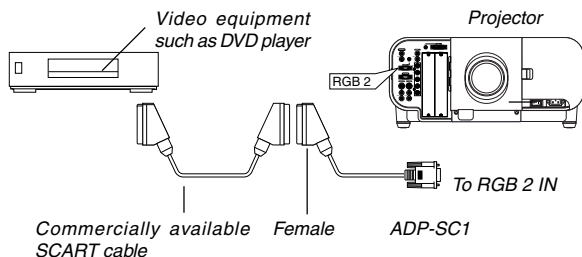

1. Turn off the power to the projector and your video equipment.
2. Use the ADP-SC1 SCART adapter and a commercially available SCART cable to connect the RGB 2 input of your projector and a SCART output (RGB) of your video equipment.
3. Turn on the power to the projector and your video equipment.
4. Use the RGB 2 button on the remote control to select the RGB 2 input.
5. Press the MENU button on the remote control to display the menu.
6. From the Advanced menu, select [Projector Options] → [Setup] → [Page 3] → [Signal Select RGB2] → [Scart]. SCART is a standard European audio-visual connector for TVs, VCRs and DVD players. It is also referred to as Euro-connector.

NOTE: The ADP-SC1 SCART adapter is obtainable from your dealer in Europe. Contact your dealer in Europe for more information.

Connecting an External Monitor

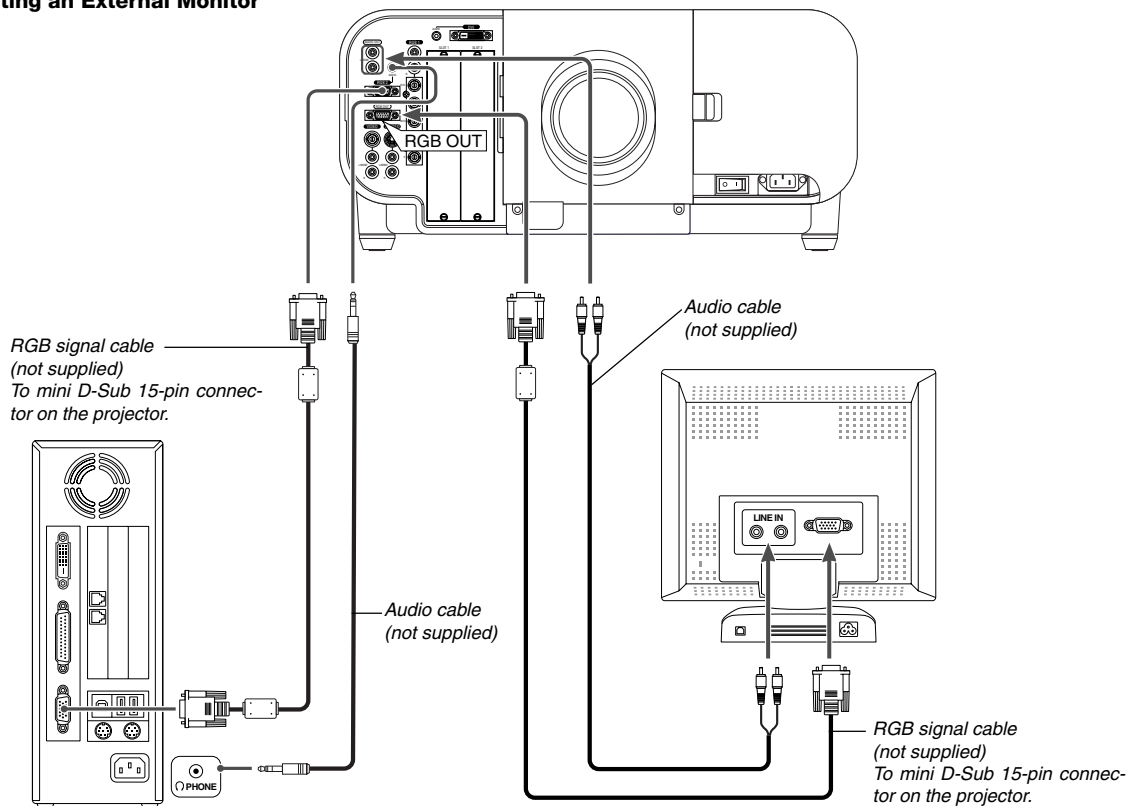

You can connect a separate, external monitor to your projector to simultaneously view on a monitor the RGB analog image you're projecting. To do so:

1. Turn off the power to your projector, monitor and computer.
2. Use a 15-pin cable to connect your monitor to the RGB OUT (Mini D-Sub 15 pin) connector on your projector.
3. Turn on the projector, monitor and the computer.

NOTE:

- The RGB OUT connector outputs RGB signal during idle mode (See page 8-15). When the projector goes into idle mode, the image on an external monitor disappears for a moment. Note that the RGB OUT connector will not output RGB signal during Standby mode.
- When the projector is in the Idle mode, the image may not be correctly displayed while the cooling fans are running immediately after turning on or off the power. Note that the RGB OUT connector will not output RGB signal during Standby mode.
- Daisy chain connection is not possible.

Connecting Your DVD Player

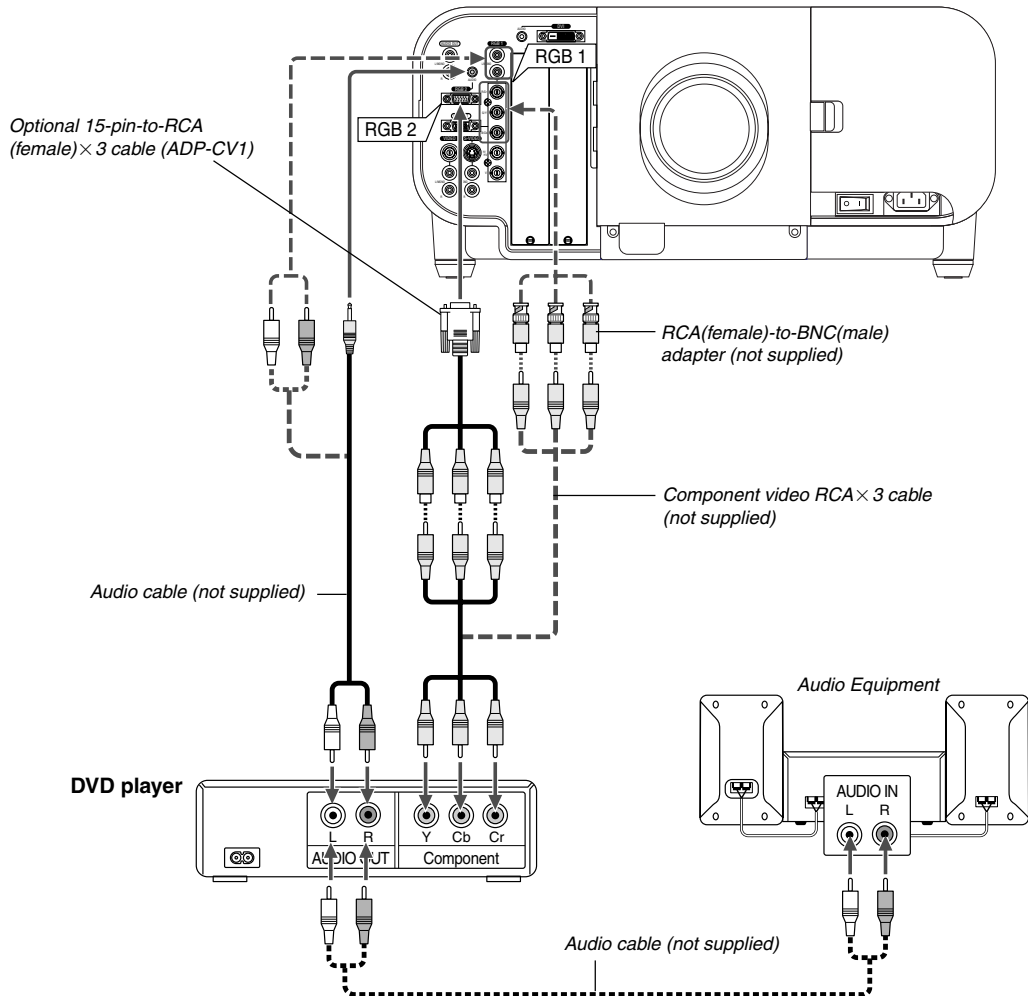

You can connect your projector to a DVD player with component output or Video output. To do so, simply:

1. Turn off the power to your projector and DVD player.
2. If your DVD player has the component video (Y,Cb,Cr) output, use a commercially available component video cable (RCAX3) and the optional 15-pin-to-RCA (female) × 3 cable to connect your DVD player to the RGB 1 IN or 2 IN connector on the projector.

For a DVD player without a component video (Y,Cb,Cr) output, use an S-Video cable (not supplied) to connect an S-Video output of the DVD player to the S-Video input of the projector. Use an appropriate type of audio cable (not supplied) to connect the desired type of audio from your DVD player to your audio equipment.

3. Turn on the projector and DVD player.

NOTE: Refer to your DVD player's owner's manual for more information about your DVD player's video output requirements.

Connecting Your VCR or Laser Disc Player

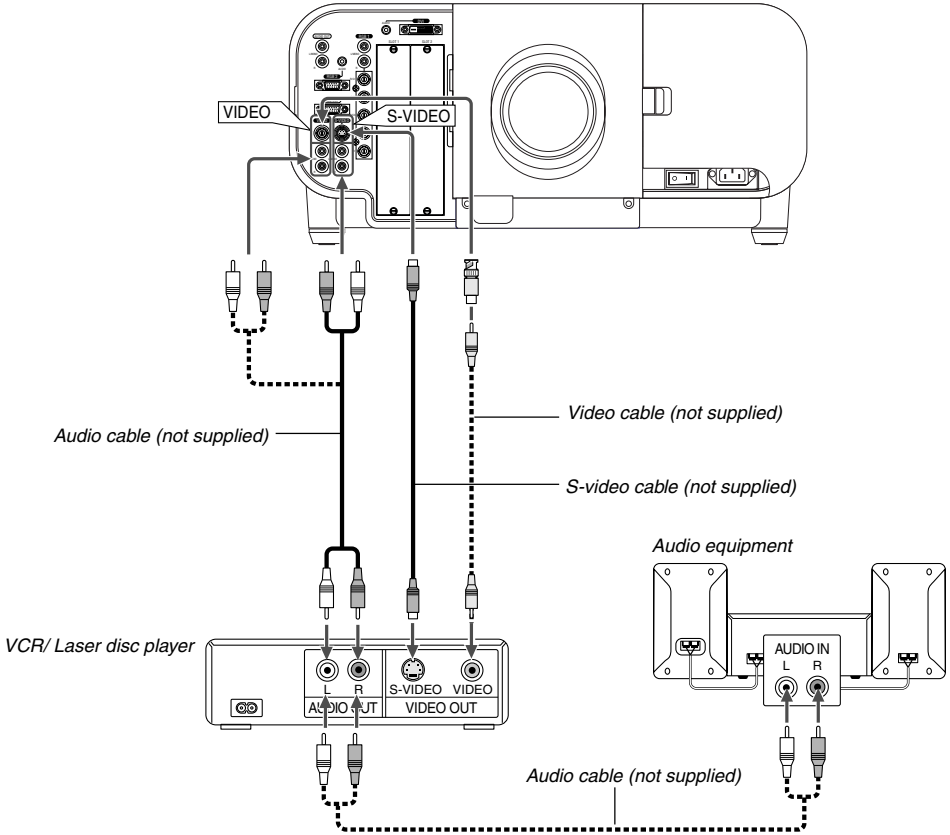

Use common RCA cables (not provided) to connect your VCR, laser disc player or document camera to your projector. To make these connections, simply:

1. Turn off the power to the projector and VCR, laser disc player or document camera.
2. Connect one end of an RCA cable (not supplied) to the video output connector on the back of your VCR or laser disc player, connect the other end to the Video input on your projector (an RCA to BNC adapter is necessary). Use an audio cable (not supplied) to connect the audio from your VCR or laser disc player to your audio equipment (if your VCR or laser disc player has this capability). Be careful to keep your right and left channel connections correct for stereo sound.
3. Turn on the projector and the VCR or laser disc player.

NOTE: Refer to your VCR or laser disc player owner's manual for more information about your equipment's video output requirements.

NOTE: An image may not be displayed correctly when a Video or S-Video source is played back in fast-forward or fast-rewind via a scan converter.

Connecting to a Network

With the LAN connection, you can control the projector over the network using a computer to switch the unit on/off, select the input and others.

- * To control the projector over the network using a computer, use the Dynamic Image Utility 2.0 contained on the User Supportware CD-ROM or the HTTP Server feature.
- * With the Image Express Utility 1.0 contained on the supplied User Supportware CD-ROM, you can project your PC screen image to the projector over the network.
- * With a use of the supplied User Supportware CD-ROM and the optional wireless LAN card (SWL-2100-N*), you can control the projector wirelessly or send your PC screen image to the projector over the network using a computer.

Example of LAN connection

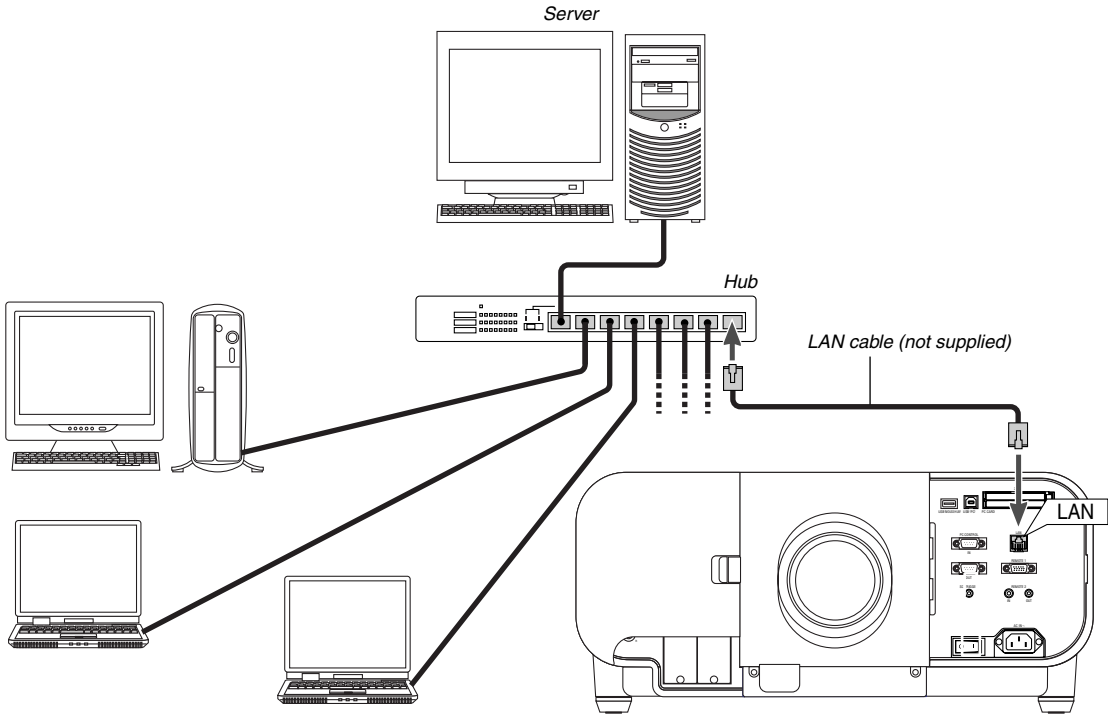

- Using the HTTP Server function
1. Configure your LAN settings such as IP address on the projector. (See "LAN Mode" on page 8-19)
 2. Start the Web browser on the computer connected to the network and execute HTTP server functions. (See "Operation Using an HTTP Browser" on page 10-11)

- Using the User Supportware
1. Configure your LAN settings such as IP address on the projector. (See "LAN Mode" on page 8-19)
 2. Install the software contained on the User Supportware CD-ROM into the computer connected to the network. See "6 Using the Projector in a Network" on page 6-1.

Connecting the Supplied Power Cable

Connect the supplied power cable to the projector.
First connect the supplied power cable's three-pin plug to the AC IN of the projector, and then connect the other plug of the supplied power cable in the wall outlet.

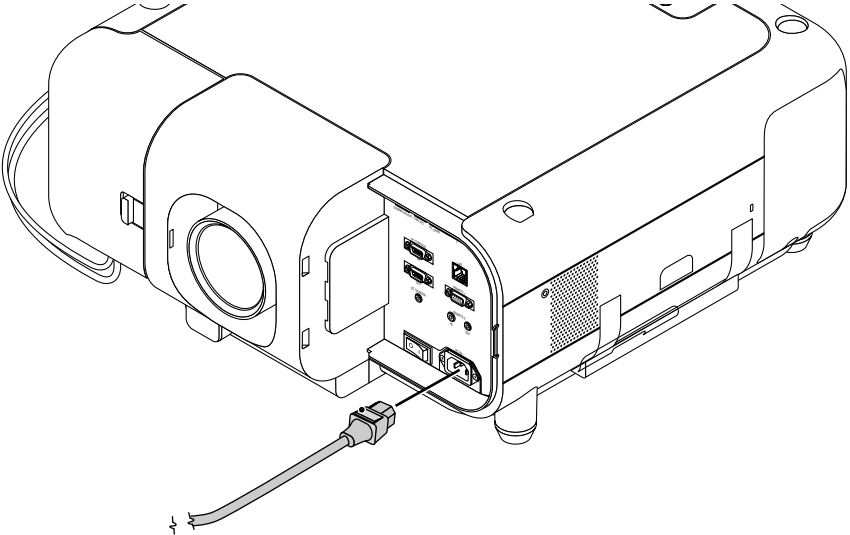

3

Projecting an Image (Basic Operation)

.....

1 Turning on the Projector.....	3-2
2 Selecting a Source	3-3
3 Adjusting the Picture Size and Position	3-3
4 Correcting the Horizontal and Vertical Keystone Distortion (3D Reform)	3-4
5 Optimizing RGB Picture Automatically	3-6
6 Turning Up or Down Volume	3-6
7 Turning off the Projector.....	3-7

This chapter describes how to turn on the projector and to project a picture onto the screen.

Turning on the Projector

NOTE:

- When plugging in or unplugging the supplied power cable, make sure that the main power switch is pushed to the off [O] position. Failure to do so may cause damage to the projector.
- The projector has two power switches: main power switch and POWER button (POWER ON and OFF on the remote control)
- The projector has a feature to prevent itself from being used by unauthorized individuals. To use this feature, register your PC card as a protect key. See "Security" in "Projector Options" on page 8-23 for more details.

To turn on the main power to the projector, press the Main Power switch to the ON position (1).

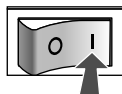

Standby or Idle



Steady orange light



Flashing for 1 minute.



Flashing green light

Steady light



Steady green light

Before you turn on your projector, ensure that the computer or video source is turned on and that your lens hood cap is removed. Only after you press the ON/STAND BY button on the projector cabinet or POWER ON button on the remote control for a minimum of 2 seconds will the power indicator turn to green and the projector become ready to use.

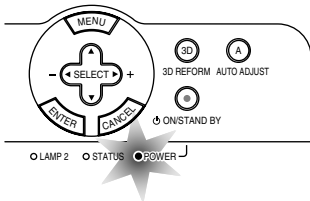

NOTE: You cannot turn off the projector for 60 seconds immediately after turning on the projector.

Note on Startup screen (Menu Language Select screen)

When you first turn on the projector, you will get the Startup screen. This screen gives you the opportunity to select one of the seven menu languages: English, German, French, Italian, Spanish, Swedish and Japanese.

To select a menu language, follow these steps:

- Use the SELECT ▲ or ▼ button to select one of the seven languages for the menu.

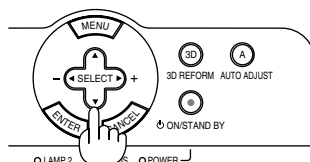

- Press the ENTER button to execute the selection.

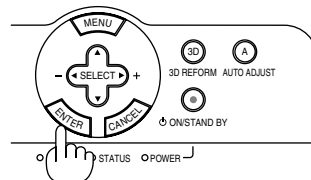

- The Basic menu will be displayed in the language you have selected.



To close the menu, press the CANCEL button.

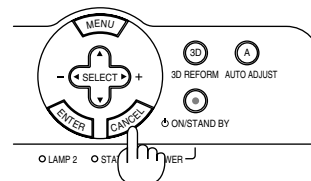

After this has been done, you can proceed to the advanced menu operation.

If you want, you can select the menu language later. See "Language" on page 8-13.

NOTE: To turn the projector on by plugging in the power cable, first turn on the Main Power switch to ON and use the menu and enable the "Auto Start" feature. (See page 8-16.) Immediately after turning on the projector, screen flicker may occur. This is not a fault. Wait 3 to 5 minutes until the lamp lighting is stabilized.

- If one of the following things happens, the projector will not turn on.
 - If the internal temperature of the projector is too high, the projector detects abnormal high temperature. In this condition the projector will not turn on to protect the internal system. If this happens, wait for the projector's internal components to cool down.
 - When the lamp reaches its end of usable life, the projector will not turn on. If this happens, replace the lamp.
 - If the lamp fails to light, and if the LAMP indicator 1 or 2 flashes on and off in a cycle of six times, wait a full minute and then turn on the power.

2 Selecting a Source

Selecting the computer or video source

Using the Remote Control

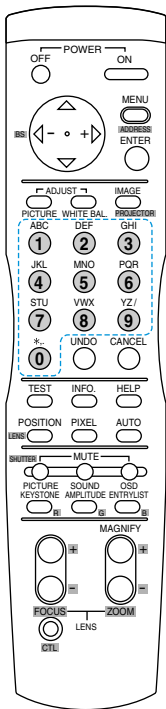

Press the Source/Number button (0-9) to select input.

- 1 RGB 1 input
- 2 RGB 2 input
- 3 DVI (DIGITAL) input
- 4 VIDEO input
- 5 S-VIDEO input
- 6 Viewer
- 7 LAN
- 8 SLOT 1
- 9 SLOT 2
- 0 Sequentially selects:
RGB1 (VIDEO) → RGB2 (S-VIDEO) →
RGB1 (VIDEO)

NOTE: If no input signal is available, the projector will display a blue background (factory preset).

Using the menu

You can also select the computer or video source using the menu.

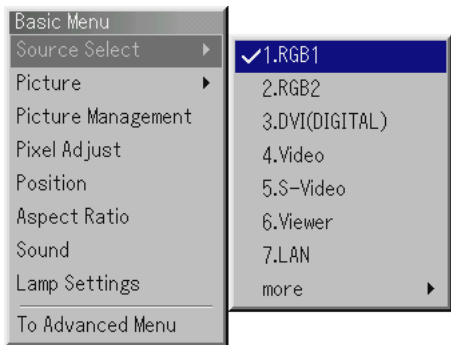
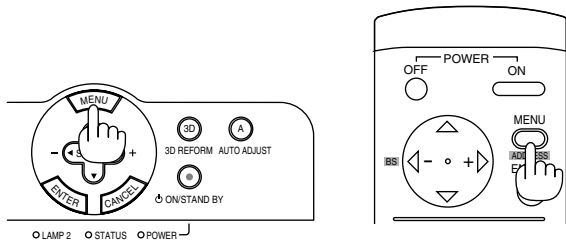

3 Adjusting the Picture Size and Position

1. Turn on the projector
2. Select your type of projector orientation.
Desktop front, ceiling rear, desktop rear, and ceiling front.

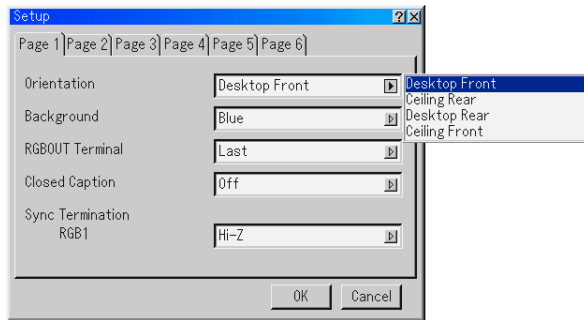

3. Display the test pattern by pressing the TEST button on the remote control or using the menu.

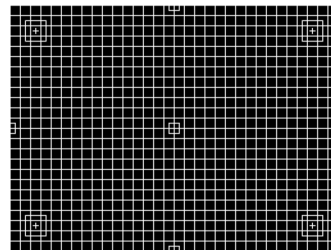

4. Adjust the image position and the image size.

- (1) Press and hold the CTL button and press the POSITION button to display the Lens Shift adjustment screen.

Use the SELECT button on the remote control or the LENS SHIFT button on the projector cabinet to move the image horizontally and vertically.

To close the Lens Shift adjustment screen, press the CANCEL button. See pages 2-4 and 2-5 for "Lens Shift Adjustable Range".

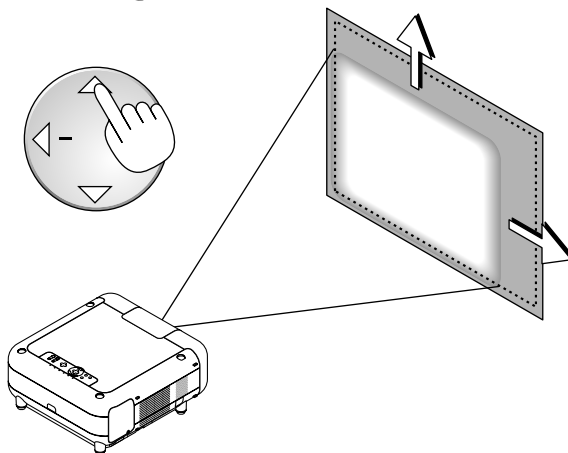
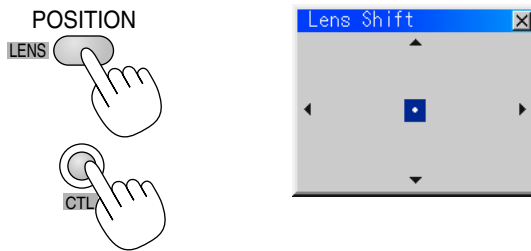

(2) Press and hold the CTL and press the ZOOM + or - button to adjust the image size. You can also adjust the image size by using the ZOOM + or - button on the projector cabinet.

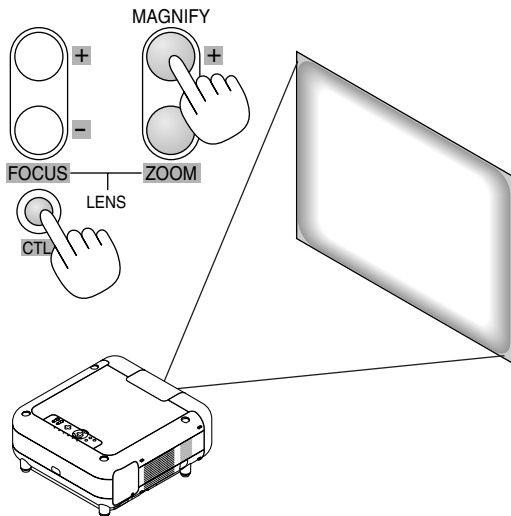

(3) Press and hold the CTL button and press the FOCUS + or - button to obtain the best focus. You can also adjust the focus by using the FOCUS + or - button on the projector cabinet.

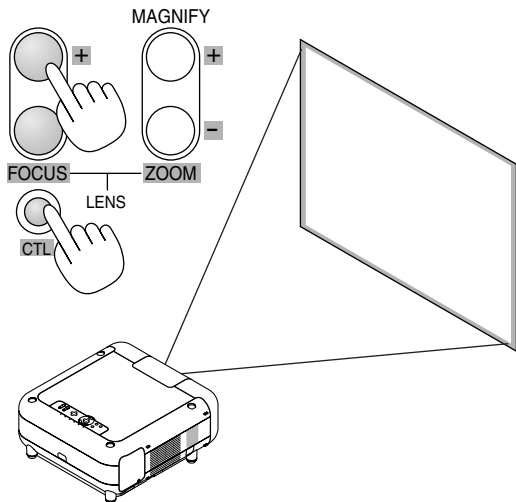

Preparation (Recommended):
Warm up the projector for about 60 minutes.

Adjusting the Focus

1. Practice focusing
Use the FOCUS (+) or (-) button on the projector or the remote control to increase or decrease the focus values to verify the accuracy of focusing.
2. Try optimizing defocus
Use the FOCUS button (-) to decrease the focus values until pixel patterns are too blurry to be visible.
3. Obtain correct focus
Use the FOCUS button (+) to obtain the best focus. Do not use the FOCUS (-) button at this time. Finally store the adjustments in memory.
If you adjust beyond the best focus point, go back to step 2 and repeat the procedures. Always adjust the focus from the negative direction towards the positive direction.

Geometric Correction Tool

If you use a special shaped screen such as a cylindrical or spherical screen, a downloadable program, Geometric Correction Tool is available. This program (Geometric Correction Tool) enables the geometrical distortion correction of an image when projected onto a special shaped screen with a projector. Additionally, this program allows control of the projector via a computer.

For additional information visit:
US : <http://www.necvisualsystems.com>
Europe : <http://www.nec-europe.com/>
Global : <http://www.nec-pj.com/>

4 Correcting the Horizontal and Vertical Keystone Distortion (3D Reform)

Use the 3D Reform feature to correct keystone (trapezoidal) distortion to make the top or bottom and the left or right side of the screen longer or shorter so that the projected image is rectangular. In the following description, 3D Reform (Cornerstone) correction can be done with the USB mouse, remote control or cabinet buttons.

When using the USB mouse connected to the projector

Preparation: Connect the USB mouse to the projector. See page 4-3.

1. Project an image so that the screen is smaller than the area of the raster.
2. Pick up any one of the corners and align the corner of the screen with the one of the image. (The drawing shows the upper right corner.)

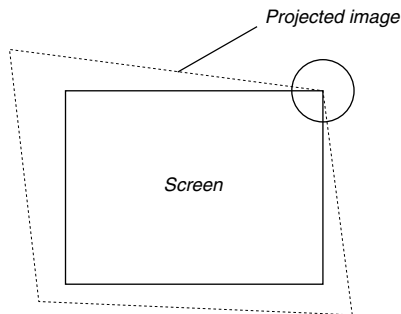

Tips on Adjusting Focus

Optimum focus adjustments can be achieved on the projector by paying special attention in a few areas.

Focus adjustment after the projector has warmed up to normal operating temperature is better than doing so when the projector is cold.

Lens mechanism interacts differently when adjusting focus from one direction to the other.

For this reason final focus adjustments should be done in a specific direction.

For optimum focus, follow the steps below.

For the zoom and the lens shift adjustment, perform the normal procedures.

3. Projecting an Image

3. Press the 3D REFORM button on the remote control.
The Cornerstone adjustment screen is displayed.
The Cornerstone adjustment screen will disappear when you move the USB mouse cursor.
4. Point to one of the remaining 3 corners and left-click on it.

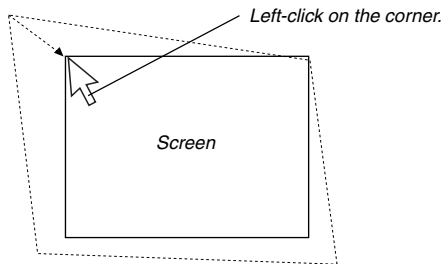

5. Do the above step 4 for the other two corners so that the projected area becomes smaller than the screen.

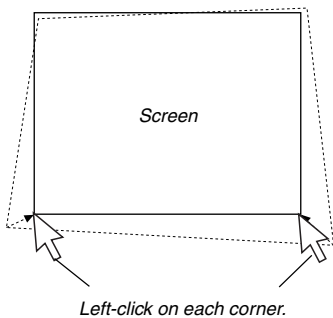

6. To complete the procedure, right-click anywhere on the screen.
The confirmation screen is displayed.
7. Left-click on "OK".
This completes the Cornerstone adjustment.
- * To return the Cornerstone adjustment to the default settings, left-click on "Reset" in Step 7.

You can save your Cornerstone changes. The changes are saved when you turn off the projector. To do so, select [Projector Options] → [Setup] → [Page 4]. Select the 3D Reform Save check box. This is not selected at the time of shipment.

* There are limitations of shapes which can be corrected using the Cornerstone adjustment. When adjusting the Cornerstone beyond these limits, you will get the message "Out of adjustment range!" and no correction can be done. Should this happen, do the Cornerstone adjustment again within the allowable range.

* Due to limitations of accuracy within internal processes, there may be some discrepancy of positions between the mouse cursor and corrected shape or one corner and the other 3 corners.

When using the remote control or cabinet buttons:

1. Project an image so that the screen is smaller than the area of the raster.
2. Pick up any one of the corners and align the corner of the screen with the one of the image.

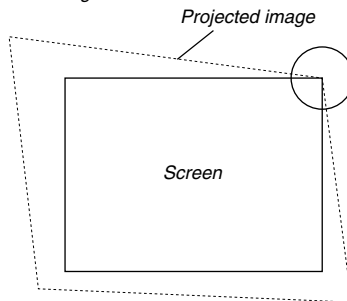

(The drawing shows the upper right corner.)

3. Press the 3D REFORM button on the projector or the KEYSTONE button on the remote control.



The Cornerstone adjustment screen is displayed.

NOTE: Press the 3D REFORM button to toggle between "Cornerstone" and "Keystone."

4. Use the SELECT ▲▼◀▶ button to select one icon which points in the direction you wish to move the projected image frame.

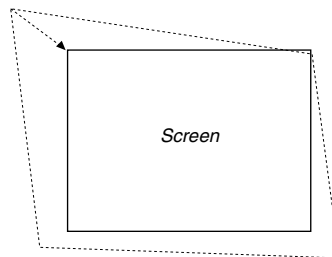

5. Press the ENTER button.
6. Use the SELECT ▲▼◀▶ button to move the projected image frame as shown on the example.
7. Press the ENTER button.

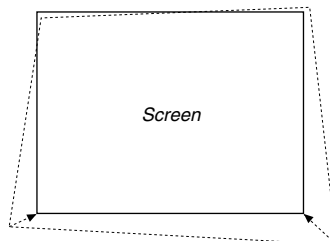

8. Use the SELECT \blacktriangle \blacktriangledown \blacktriangleleft \blacktriangleright button to select another icon which points in the direction.

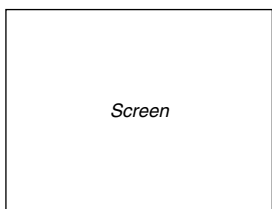

On the Cornerstone adjustment screen, select "Exit" and then "OK", or press the CANCEL button on the remote control.

The confirmation screen is displayed.

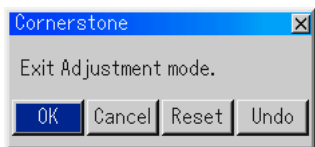

9. Press the SELECT \blacktriangleleft or \blacktriangleright button to highlight the [OK] and press the ENTER button.

This completes the keystone correction.

Selecting "Cancel" will return to the adjustment screen without saving changes (Step 3).

Selecting "Reset" will return to the factory default.

Selecting "Undo" will exit without saving changes.

NOTE: To return the 3D Reform correction setting values to the factory default, press and hold the 3D REFORM button on the projector cabinet or the KEYSTONE button on the remote control for a minimum of 2 seconds.

NOTE: During 3D Reform adjustment, "Aspect Ratio" and "Screen" may not be available. Should this happen, first reset the 3D Reform data and then do each setting. Second repeat the 3D Reform adjustment. Changing Aspect Ratio and/or Screen setting can limit 3D Reform in its adjustable range.

The adjustable ranges for 3D Reform are as follows:

Horizontal Max $\pm 30^\circ$ approx.

Vertical Max $\pm 40^\circ$ approx.

* The following are conditions at the above maximum angle when all of the following are met

- Image is projected in Wide (Zoom)
- The lens is positioned at the center (when not, adjustable range increases or decreases)
- Resolution is XGA
Higher resolution than XGA limits 3D Reform in its adjustable range.
- Menu items should be set as follows:
Aspect Ratio 1.33:1 (4:3)
Screen Type 1.33:1 (4:3)
- Horizontal and Vertical are adjusted separately.
A combination of both adjustments limits 3D Reform in its adjustable range.
- When "Native" is selected in "Resolution", "3D Reform" is not available.

5 Optimizing RGB Picture Automatically

Adjusting the Image Using Auto Adjust

Optimizing RGB image automatically

Press the Auto Adjust button to optimize an RGB image automatically.

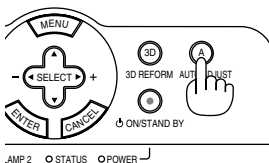

[Poor picture]

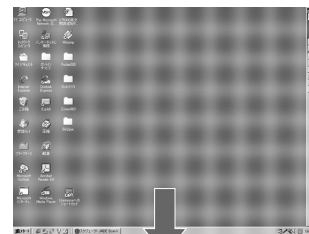

[Normal picture]

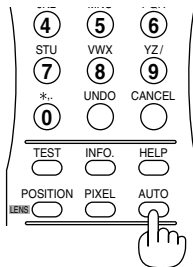
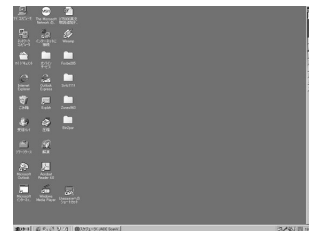

Press the AUTO ADJUST or AUTO button to fine-tune the computer image or to remove any vertical banding that might appear and to reduce video noise, dot interference or cross talk (this is evident when part of your image appears to be shimmering). This function adjusts the clock frequencies that eliminate the horizontal banding in the image. This function also adjusts the clock phase to reduce video noise, dot interference or cross talk. (This is evident when part of your image appears to be shimmering.) This adjustment may be necessary when you connect your computer for the first time.

NOTE:

- Some signals may not be displayed correctly or take time.
- The Auto Adjust function does not work for component and video signal.
- If the Auto Adjust operation cannot optimize the RGB signal, try to adjust Clock and Phase manually. See page 8-10.

6 Turning Up or Down Volume

Sound level from the speaker and the AUDIO OUT jack (RCA) on the projector can be adjusted.

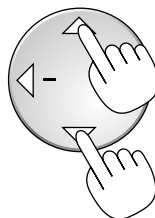

increase volume

decrease volume

NOTE: The SELECT \blacktriangle or \blacktriangledown button works as a volume control only when no menu appears.

Volume bar

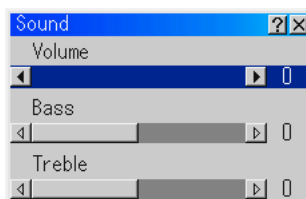

NOTE: The volume bar can be displayed by selecting "Sound" from "Basic Menu" or "Advanced Menu".

7 Turning off the Projector

To turn off the projector:

First press the POWER (ON/STAND BY) button on the projector cabinet or the POWER OFF button on the remote control for a minimum of two seconds. The POWER indicator will glow orange. After the projector turns off, the cooling fans keep operating for 90 seconds (2 minutes in the optional extended life lamp) (Cooling-off time).

Second, turn off the Main Power switch. The power indicator will go out. Last unplug the power cable.

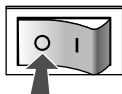
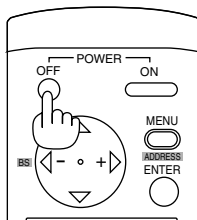

Power on



Steady green light



Fan working



Flashing orange light

Standby or Idle



Steady orange light

NOTE: You cannot turn off the projector for 1 minute immediately after turning on the projector.

CAUTION

Do not unplug the power cable from the wall outlet or do not turn off the main power under any one of the following circumstances. Doing so can cause damage to the projector:

- While the Hour Glass icon appears.
- While the message "Please wait a moment." appears. This message will be displayed after the projector is turned off.
- While the cooling fans are running. (The cooling fans continue to work for 90 seconds (2 minutes in the optional extended life lamp) after the projector is turned off).
- While accessing a PC card or LAN card. (The PC Card Access indicator lights.)

4

Convenient Features

.....

1	Turning Off the Image and Sound	4-2
2	Enlarging and Moving a Picture	4-2
3	Getting the On-line Help and Information	4-2
4	Using a USB Mouse	4-3
5	Using a USB HUB Function	4-3
6	Changing Background Logo	4-4
7	Making Freehand Drawings on a Projected Image (ChalkBoard)	4-4
8	Lens Memory	4-5

1 Turning Off the Image and Sound

Press the MUTE PICTURE button to turn off the image and sound for a short period of time. Press again to restore the image and sound.

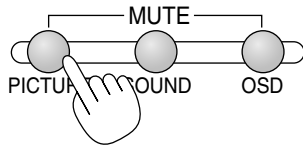

Press the MUTE SOUND button to turn off the sound for a short period of time. Press again to restore the sound.

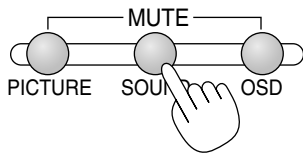

Press the MUTE OSD button to turn off the on-screen display. Press again to restore the on-screen display.

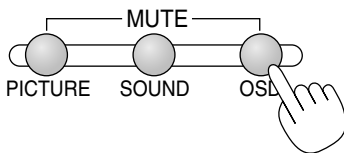

NOTE: You can also turn off the on-screen display forcibly by pressing and holding CTL and then pressing MUTE OSD (Forced On-Screen Mute Mode) ; doing this again restores it. In this case any adjustment will still change the projector's memory settings. This mode is available even when input is switched to another or the main power is turned off.

2 Enlarging and Moving a Picture

You can enlarge the area you want up to 400 percent. To do so:

Press the MAGNIFY button.

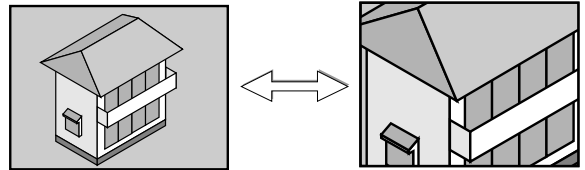

Enlarge the selected area. When the MAGNIFY (+) button is pressed, the image is magnified. To move the magnified image, use the SELECT button.

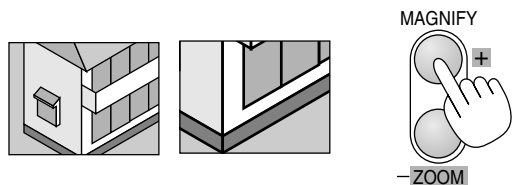

Return the image to the original size.

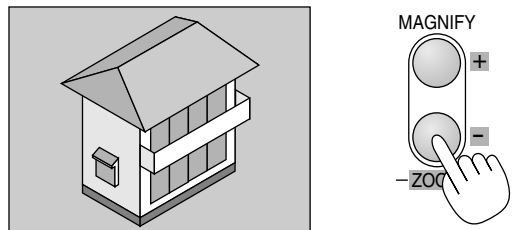

3 Getting the On-line Help and Information

You get the contents about Help.



Display Help

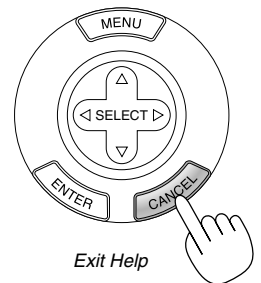

Exit Help

You get the source and projector information.



Press this button once to display "Source Information" and press twice to display "Projector Information". Press third time to close it.

4 Using the USB Mouse

Using a commercially available USB mouse gives you smooth operation.

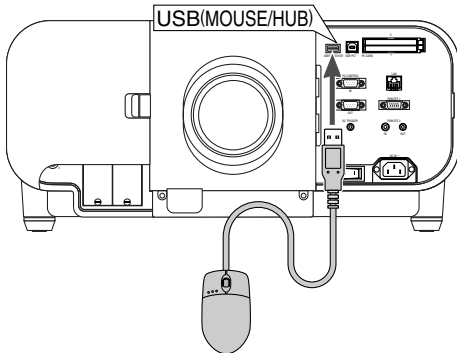

NOTE: There may be some brands of USB mouse that the projector does not support.

Operate the Projector Menus using the USB mouse

Mouse Cursor

When connecting a USB mouse to the projector, you get a mouse cursor on the screen.

Unless you use your USB mouse within 10 seconds, the mouse cursor disappears.

Menu Display

Clicking with a mouse button displays the menu.

Clicking ► displays the pull-down menu. To close the menu, click anywhere in the background.

Adjusting and Setting Display

You can select a menu item and click with a mouse button to make adjustments and setting.

Examples

Click (or press and hold) the mouse button ◀ or ▶ to adjust the brightness. Or click and drag the mouse button on the slide bar horizontally to adjust it.

To save the adjustments, click . This closes the menu. If you click anywhere in the background while displaying an adjustment and setting menu or dialog box, you will go to the main menu after clicking with the mouse.

Clicking displays help.

Using the Middle Button/Wheel on a Mouse (when available)

The projector supports the middle button/wheel on a mouse. With the middle button/wheel you can use a scroll bar or click the middle button/wheel to display or hide the Chalkboard toolbar.

Operate the PC mouse using the USB mouse

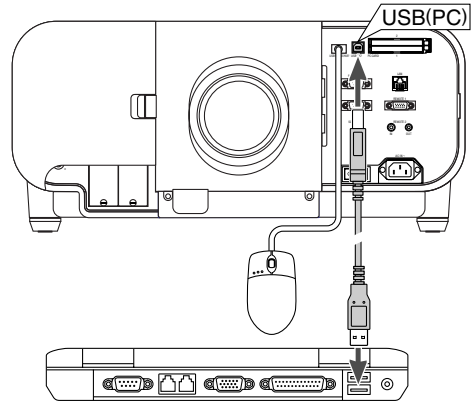

NOTE: You can select the operation mode of the USB mouse connected to the USB port of the projector.

5 Using the USB HUB Function

When using the projector with a PC via the supplied USB cable, both the USB port(type A) on the projector can be connected to a USB-supported scanner or other USB-supported device. (USB Hub Function)

Example: When connecting a PC and a scanner to each USB port respectively

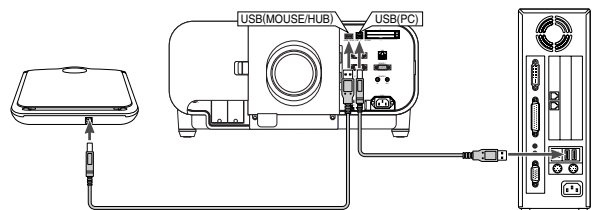

An example of how a scanned image is projected

1. Install the Dynamic Image Utility on your PC.

NOTE: The Dynamic Image Utility is contained on the supplied CD-ROM. See "6-5 Software Installation" for the installation procedure.

2. Use your scanner to scan an image.

NOTE: A scanner driver must be installed on your PC before use.

3. Load the scanned image on your PC using the Dynamic Image Utility.
4. Transmit the scanned image from your PC to the projector via the USB cable and project the image on the screen.

NOTE:

- The USB HUB function is effective only when "Auto" is selected in Operation Mode Select.
- The PCs using the USB Host Controller may not be available.
- When connecting a USB hub to the USB port (type B) on the projector, be sure to use a USB hub capable of supplying 500mA per port of downstream current.

6 Changing Background Logo

You can change the default background logo using the PC Card Files feature.

NOTE: File size must be 256KB or less. Other file formats than JPEG and BMP are not available.

1. From the menu, select [Tools] → [PC Card Files] to display a list of all the files stored in the PC card so that you can select a file you want to use as a background logo.

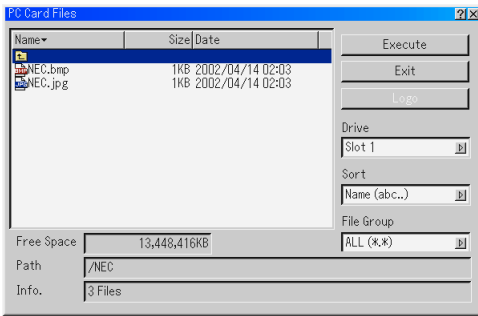

2. The Logo button allows you to select a background logo from graphic files on a PC card and change to it as the background logo.
3. Use the SELECT ▲ or ▼ button to select a JPEG or BMP file for your background logo.
4. Use the SELECT ► and then ▼ button to select "Logo".
5. Press the ENTER button on the remote control or the cabinet. You will get the confirmation dialog box.
6. Select "OK" and press the ENTER button. This completes changing a logo for the background.

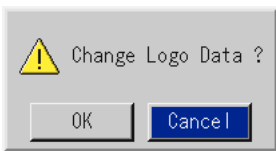

- * Once you have changed the background from the logo to another, you cannot return the logo to background even by using Factory Default. To do so, repeat the above steps. The logo file is included on the supplied CD-ROM Projector User Supportware ("Logo/nec_bb_x.jpg" for 9060).

7 Making Freehand Drawings on a Projected Image (ChalkBoard)

The ChalkBoard feature allows you to write and draw messages on a projected image.

NOTE: The ChalkBoard feature is available only when a USB mouse is used.

From the menu, select [Tools] → [ChalkBoard] to display the ChalkBoard tool bar that contains the following icons.

NOTE: You can also display the ChalkBoard tool bar by clicking the scroll button on your USB mouse.

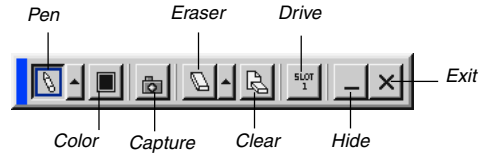

- Pen Left-click and drag to draw. Left-click [▲] or right-click the pen icon to display the pen palette containing four lines of different thickness from which you can select a line you prefer by left-clicking.
- Color Selects a color. Left-click to display the color palette from which you can select a color you prefer by left-clicking.
- Capture Left click to capture and save freehand drawings in the PC card. (GT5000 only)
- Eraser Left-click and drag to erase part of a drawing. Left-click [▲] or right-click the eraser icon to display the eraser palette containing four eraser of different thickness from which you can select an eraser you prefer by left-clicking.
- Clear Left-click to clear the drawing completely from the ChalkBoard screen.
- Drive Switches between PC Card slot. (GT5000 only)
- Hide Hides the tool bar by left-clicking. Right-clicking anywhere on the screen displays the ChalkBoard tool bar again.
- Exit Clears the complete drawing and exits the ChalkBoard.

NOTE:

- The menu is not available while you display the ChalkBoard screen.
- Switching slides clears a drawing completely.

8 Lens Memory

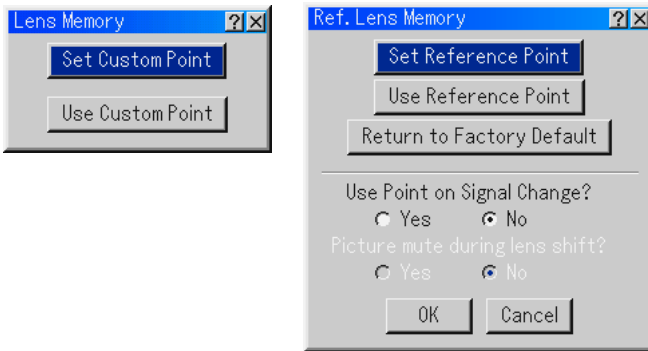

This function serves to store the adjusted value when using the Shift, Focus, and Zoom buttons of the projector or the remote control.

Reference memory:

Reference Point Adjusted settings are stored in memory as a reference common to all the input sources. If no setting is stored in Custom Point, the adjusted settings in Reference Point will be applied.

Custom memory:

Custom Point Adjusted settings are stored in memory for each input signal.

Usage Example

When you wish to display on a screen having a 4:3 aspect ratio an NTSC or other 4:3 aspect ratio signal and an SXGA or other 5:4 aspect ratio signal:

Perform shift, focus, and zoom adjustments to set the vertical screen size of the vertically tall 5:4 aspect ratio signal to standard.

Both 4:3 aspect ratio signals and 5:4 aspect ratio signals can now be displayed.

Note that with these shift, focus, and zoom adjustments, the 4:3 aspect ratio signal will become smaller on the screen.

To eliminate this size reduction, adjust the shift, focus and zoom to the optimum condition for each of the 4:3 aspect ratio signal and the 5:4 aspect ratio signal. Memory (storage) of each of these values will permit projection at an optimum condition upon signal switching.

1. Perform Zoom, Focus and Lens Shift adjustments and store them in memory using "Set Custom Point".
Another way to store your adjustments is to use the CTL and INFO buttons on the remote control.
2. When "Yes" is selected for "Use Point on Signal Change", the adjustment is applied to the signal you switched.
3. Select "OK" and press the ENTER button for the change to take effect.

NOTE: The Lens Memory function is not available in Link mode.

*NOTE: The other optional lenses than GT10RLB, GT13ZLB, GT20ZL, GT24ZLB and GT34ZLB do not support Lens Memory function. (On GT10RLB focus can be stored in memory)
You cannot store settings for zoom and focus on the following lenses:
GT13ZL, GT19ZL, GT24ZL and GT34ZL.*

Picture Mute during Lens Shift?

To turn off the image and sound during lens shift, select "Yes".

NOTE: This option is only available when "Yes" is selected for "Use Point on Signal Change?".

5

Using the Viewer

.....

1	Making the Most out of the Viewer Function	5-2
2	Operating the Viewer Function from the Projector (playback)	5-3

NOTE:

- To use the Viewer, first you need to create presentation materials on your PC using the Dynamic Image Utility 2.0 contained on the supplied Projector User Supportware CD-ROM. For installation, see “6- 5 Software Installation”. For creating presentation materials, see the Slide show function on the on-line manual of the Dynamic Image Utility 2.0.
- Selecting Viewer sets the audio input for DVI input.

1 Making the Most out of the Viewer Function

Features

You can view presentation data, capture (9060), and play images on the projector. A PC card is used to view presentation data prepared on the computer and to capture and play images projected with the projector.

The Viewer feature allows you to view slides stored on a PC memory card (referred to as PC card in this manual) on the projector. Even if no computer is available, presentations can be conducted simply with the projector. This feature is convenient for holding presentations at meetings and in offices, as well as for playing images taken on digital cameras.

Easy to use

- Presentations can be started immediately simply by inserting a PC card (not supplied)
- Easy slide switching
- Remote control operation
- Jumping to list of slides or any specific slide

High quality images

- High resolution up to 1024 x 768 dots
- 24-bit full color playback
- Viewing of digital camera images

Simple utility software (for computer)

- Dynamic Image Utility 2.0 operable on Windows 98/Me/XP/2000
- Slides can be created by capturing the currently displayed image
- Control screen for displaying lists of slides and editing
- * Microsoft, Windows and PowerPoint are registered trademarks of Microsoft Corporation.

Inserting and Removing a PC Card

NOTE:

- Do not try to force the PC card into the slot.

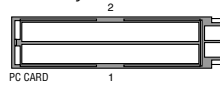

NOTE: When using two PC cards, do not insert both PC cards into the two PC card slots simultaneously. Doing so may cause projector malfunction such as shutting down. Each PC card must be inserted slowly one at a time.

Inserting the PC Card

- Hold the PC card horizontally and insert it slowly into PC card slot 1 or 2 with its top facing up.

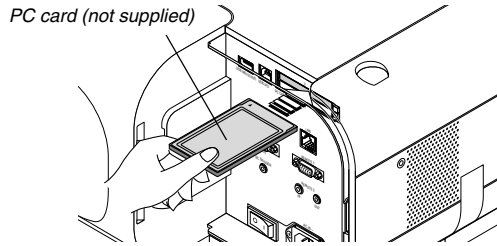

Removing the PC Card

Press the eject button slowly. The eject button card pops out a little. Press the eject button slowly again. Grasp the edges of the PC card and pull it out. Push and insert the eject button fully until it stops.

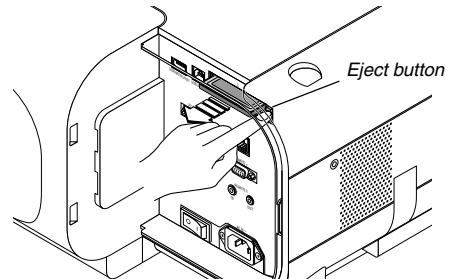

NOTE: Do not eject the PC card while its data is being accessed.

CAUTION: Make sure that the PC card or LAN card is removed during Standby mode (NOT Idle mode) or with the main power off. Failure to do so may cause damage to the data on your PC card or LAN card, or may cause the projector to malfunction. Should a malfunction occur, turn off the main power and turn it back on.

Direction for Inserting the PC Card

The PC card has a top and bottom and must be inserted into the PC card slot in a specific direction. It cannot be inserted backwards or upside-down. Attempting to force it into the slot in the wrong direction may break the internal pin and damage the card slot. Refer to the PC card's operating instructions for the proper direction of insertion.

PC Card Type

The PC Card slot accepts PCMCIA Type II only.

2 Operating the Viewer Function from the Projector (playback)

This section describes the operation for showing slides of presentation documents created using the Viewer function with the projector. It is also possible to make slides directly from the images projected with the projector.

Projecting slides (Viewer)

1. Insert a PC card into the PC card slot.

Insert the PC card so that the end with the insertion direction arrow on the top goes in first.

* Press the eject button to eject the card.

2. Select the "Viewer" from the Source Select menu.
3. Project slides.

Checking "Show Folder List", means that selecting Viewer input displays a list of the folders in the PC card and if "Auto Play" is checked the projector automatically starts to play slides at the first slide of the folder you have selected.

A tool bar will appear when you press the MENU button on the remote control or the projector cabinet or clicking with the right button of a mouse.

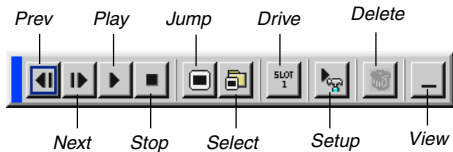

The tool bar includes the following buttons:

- Prev Returns to the previous slide or folder. Or this lets you play slides back in reverse.
- Next Advances to the next slide or folder. Or this lets you play slides back.
- Play Plays back automatically or manually depending on the setting on Viewer Options of the menu. This allows you to move on to the next slide when "Manual Play" is selected.
- Stop This allows you to stop Auto Play while you are playing back and to resume playing from the selected slide or folder when "Auto Play" is selected.
- Jump Displays a list of slides while you are playing back.
- Select Displays a list of folders while you are playing back.
- Drive Switches between PC Card slot.
- Setup Displays the Viewer Options dialog box on Page 2 of the Setup dialog box.
- Delete Deletes a captured slide(s) or all the captured slides in the Capture - specific folder. (9060)
- View Hides the tool bar while you are playing back. Pressing the MENU button or clicking with the right button of a mouse shows it again.

NOTE: If no memory card is inserted in the PC CARD slot, there is no signal, and a black, blue or logo background is displayed, depending on the setting. Playback is stopped when ◀▶ button on the cabinet is pressed in Auto Play mode. Up to 12 indexes can be displayed on the list of folders. The folder in the right bottom is always a folder exclusively for captured images, but is only displayed when images have been captured. (9060 only)

When the tool bar is not displayed:

You can use the ◀ and ▶ button on the cabinet to select folders or slides.

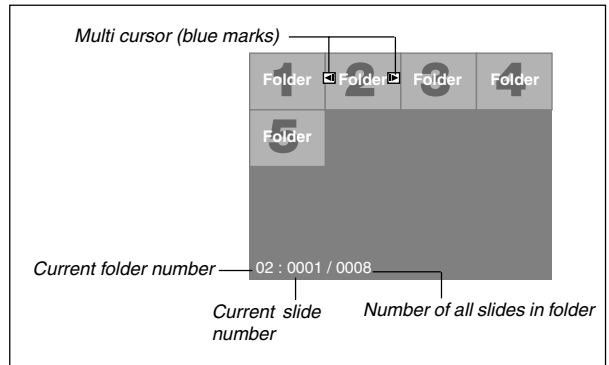
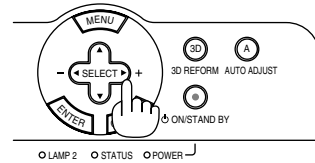

Use the SELECT ◀ or ▶ button to advance to the next folder or return to the previous folder.

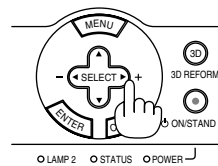

Use the SELECT ◀ or ▶ button to advance to the next slide or return to the previous slide.

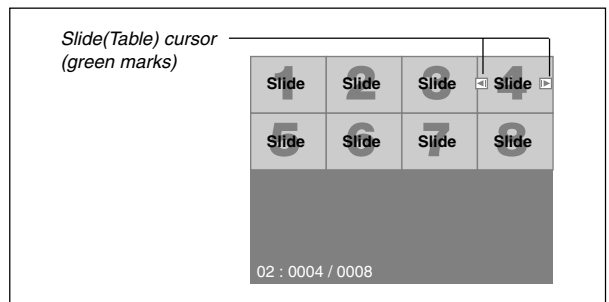

Auto Play Mode

If the "Auto Play" option is selected in "Viewer Options" of the menu, any given slide will start to play automatically. You can also specify Auto Play Interval between 5 and 300 seconds.

Switching to Slides Directly from Other Input Modes

With this function it is possible to switch directly to a slide when the picture of a VCR or computer is being projected. Example: When conducting presentations using a combination of slides and moving pictures from a VCR, etc., it is possible to switch from a Viewer slide to the video picture then back to the Viewer slide simply by using the SELECT button.

NOTE: Even if you switch the current Viewer source to another source, the current slide is retained. When you return back to the Viewer, you will get the slide that has been retained.

The PC card editing operation cannot be performed from the projector. Do so using the Dynamic Image Utility 2.0 software.

Viewing Digital Images

Digital images can be played with the Viewer if the following conditions are met:

- If the image can be stored on an MS-DOS format PC card
- If the image can be stored in a format supported by the Viewer. With the Viewer, images on the card are searched for in directories and images in JPEG or BMP format are recognized as slides. Searchable directories are directories within two steps from the root directory, and searchable images are images within the first 12 files in the directory. Only file and slide switching are possible.

NOTE: The maximum number of images recognized as slides within one directory is 128.

Storing Images Displayed on the Projector on the PC card (Capture)

The Capture features allows you to capture an image from a source that is currently being displayed. The image is saved as JPEG in the PC card. When you select Capture from the menu, you will get a tool bar. You can capture an image directly using the tool bar when the menu is not displayed.

NOTE:

* Unless a PC card is inserted into the PC Card slot of the projector, the Capture feature is not available.

* The "Card Error" display means that the free space of the PC card is insufficient for saving images. Make more space available on the card by erasing unwanted images with your PC. The number of images that can be captured depends on the size of the PC card.

CAUTION: Make sure that the PC card is removed during Standby mode (NOT Idle mode) or with the main power off.

Failure to do so may cause damage to the data on your PC card, or may cause the projector to malfunction.

Should a malfunction occur, turn off the main power and turn it back on.

Preparations:

Insert the PC card into the card slot.

Insert the PC card so that the end with the insertion direction arrow on the top goes in first.

* Press the eject button to eject the card.

1. Project the image you wish to store on the projector.

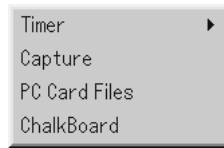

2. Select the "Capture" from the Tools menu.

3. A tool bar will appear.

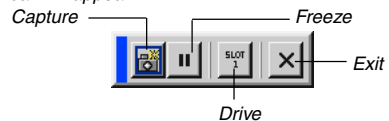

The tool bar includes the following buttons:

Capture Captures an image and save it as a JPEG file on a PC card.

Freeze Freezes and unfreezes images.

Drive Switches between PC Card slot.

Exit Exits the Capture function. Another option to exit the Capture function is to press MENU or CANCEL button on the remote control or projector cabinet.

NOTE:

You can compress a captured file (JPEG) using the Capture Options in the Setup dialog. See page 8-15.

Captured images with higher resolution than the projector's native resolution cannot be displayed correctly.



- File size of the captured image varies depending on the resolution of an input signal.
- An hourglass indicating that an image is being captured appears on the projector's display. Do not eject the PC card or turn off the projector's power while this icon is displayed. Doing so will damage the PC card data. If the PC card data is damaged, use a computer to repair the data.

Deleting Captured Images

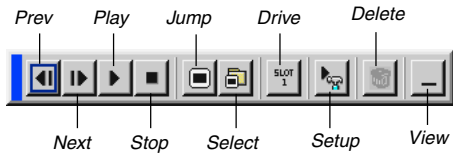
Using the Delete button on the tool bar for Viewer can delete captured images.



To delete captured images:

1. Select Viewer and display a folder list of captured images.
2. Use  button to select the Capture folder "Cap" in the right bottom of the screen.
3. Press the MENU button to display the tool bar.
4. Use the  or  button to select the Delete icon and press the ENTER button or click with a mouse button.

Using the PC Card Files Function (PC Card Files)

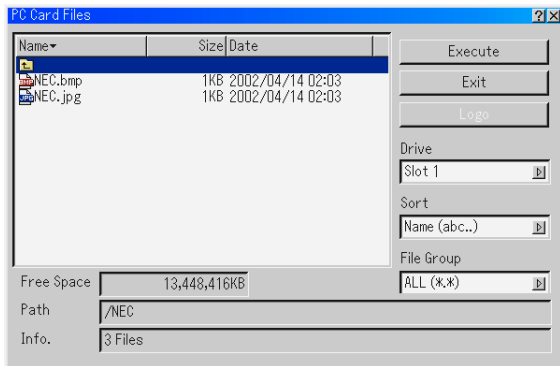

The PC Card Files function allows you to display a list of all the files stored in the PC card so that you can select a file you want to display. You can also sort files by file name or date, or display the file. Although a list of all the files in the PC card is displayed, you can view files in idx, text, HTML, JPEG and BMP format only. Selecting BMP and JPEG files automatically switches to the Viewer source. See also page 5-3.

NOTE: This option is not available for selection unless a PC card is inserted properly.

Selecting "Execute" displays the file you selected. When you select a JPEG or BMP file and press the ENTER button on the remote or the cabinet, or "Execute" on the above, you will get a toolbar. This toolbar is used to return to the PC Card Files screen.

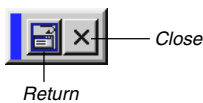

- Return Returns to the PC Card Files screen.
- Close Close the toolbar.

6

Using the Projector in a Network

.....

1 End User License Agreement.....	6-2
2 Introduction	6-3
3 Supported Projectors	6-4
4 Equipment Connections and Settings	6-5
5 Software Installation	6-6
6 Starting/Exiting the Software	6-7
7 Troubleshooting	6-8

Be sure to read this before using the accompanying software.

END USER LICENSE AGREEMENT

PLEASE READ THIS SOFTWARE LICENSE AGREEMENT ("LICENSE") CAREFULLY BEFORE PRESSING THE "Yes" BUTTON BELOW. BY PRESSING "Yes", YOU ARE AGREEING TO BE BOUND BY THE TERMS OF THIS LICENSE. IF YOU DO NOT AGREE TO THE TERMS OF THIS LICENSE, PRESS "No" AND (IF APPLICABLE) RETURN THIS SOFTWARE TO THE PLACE WHERE YOU OBTAINED IT FOR A REFUND.

NEC Viewtechnology, Ltd. ("NECVT") grants you ("User") a license to use the PROJECTOR USER SUPPORTWARE ("Software") provided with this End User License Agreement ("EULA"). User assumes responsibility for the selection, adoption use and the result of use of the Software to achieve its intended result.

1. Term

- 1) *EULA will become effective upon User's agreement to the terms of EULA and shall remain in force until User terminates it by returning or destroying the Software and its related documents.*
- 2) *Notwithstanding the foregoing NECVT may terminate EULA at any time upon User failing to abide by any terms of EULA. Upon the termination of the EULA by NECVT, the license granted to User shall be terminated automatically. User agrees to destroy the Software together with all copies of it upon such termination.*

2. License

User use the Software on personal computers only for operating NECVT's projector supplied with the Software or other projector to be specified by NECVT ("Projector")

3. Replication, modification and merger of the Software

- 1) *User may make copies of the Software and related documentation to the extent necessary for using the Projector. User agrees to reproduce the NECVT's copyright notice and other notice on any such copies.*
- 2) *User may not use, copy, modify, or otherwise dispose of the Software, except as expressly permitted in EULA.*
- 3) *No provision in EULA shall be construed to assign and/or transfer any intellectual property right in the Software to User.*

4. Transfer of the Software

- 1) *User may transfer the Software to any third party, provided always that:*
 - a) *User must transfer, with the Software, to such third party EULA and all the related documentation with all copies thereof, and must not retain any copy thereof.*
 - b) *Such third party has agreed to the terms and conditions of EULA.*
- 2) *Except as otherwise expressly permitted above, User may not sublicense, assign, transfer or otherwise dispose of the license for the Software.*

5. Reverse Engineering

User may not reverse engineer, decompile, and/or disassemble the Software, except and only to the extent that such activity is expressly permitted by applicable law notwithstanding this limitation.

6. Limitations of Warranty

- 1) *Except as expressly specified herein, the Software is provided "as is" without warranty of any kind, including but not limited to implied warranties for fitness for a particular purpose, merchantability, title and non-infringement of any third party rights.*
- 2) *If User finds a material defect, which effects to the proper operation of the Software, in the media of the Software, NECVT will replace such defective media at no charge, if such media is returned to distributor from which such User purchased it within 1 month from such purchase and if NECVT determines that such defect is due to NECVT.*

7. Limitations of Liability

In no event shall NECVT be responsible for any indirect, consequential or special damages or lost profits even if NECVT has been advised of the possibility of such damages, and/or for any claim for compensation or damage by any third party to User.

8. Others

- 1) *The validity, interpretation, construction and performance of EULA shall be governed by the laws of Japan.*
- 2) *User shall not export the Software to any country to which such export would be prohibited by any applicable laws.*

2 Introduction

Thank you for your purchase of the Dukane portable projector (here-after referred to as "unit" or "projector").

This projector is connected to a personal computer or other equipment and clearly projects text or graphics to a screen.

This projector is supplied with convenient software that allows presentations to be made more simply and effectively. This guide gives an overview and describes the use of the accompanying software (contained in the CD-ROM that is supplied with this projector). Look over this guide in conjunction with the Help functions of the software programs.

Contents of the Supplied CD-ROM

The supplied CD-ROM contains the following software programs:

- *Dynamic Image Utility 2.0*
- *Viewer PPT Converter 2.0*
- *Image Express Utility 1.0*

Please see the Help functions of the software programs for information about their functions and operation.

What Can Be Accomplished with the Supplied Software

Dynamic Image Utility 2.0

- *Converts PowerPoint files, JPEG images, and other files and creates slides that can be displayed with the viewer function of the projector.*
- *Captures portions of the image from the screens of word processors, spreadsheets, browsers, and other programs for use in presentations.*
- *By saving the created slides on a flash memory card (*1) and inserting the card into the PC Card slot of the projector, the slides can be projected to the screen without connecting a personal computer.*
- *The connection of personal computers and projectors by means of a network environment (*2) or connection with USB cable (*3) or serial cable allows the following uses. (In a network environment or USB cable connection (*3), support of multiple units is permitted.)*

(1) *Images and slides can be sent from the personal computer to the projector and then projected to the screen. When using Microsoft PowerPoint 2000/2002, slides can be sent synchronized with the slide show page feed.*

(2) *A personal computer can be used to switch the projector power on/off, control the adjustment of image quality and other settings, and to display the remaining lamp life.*

Viewer PPT Converter 2.0

- *Converts files created with Microsoft PowerPoint 95/97/2000/2002 to an independent index format with a simple operation to enable direct playback with the viewer function of the projector.*
- *When using Microsoft PowerPoint 2000/2002, Viewer PPT Converter 2.0 can be started from PowerPoint (by means of add-in registration to PowerPoint).*

Image Express Utility 1.0

- *Using a network environment (*2), this program enables the screen image displayed by the personal computer to be sent to the projector and then projected to a screen.*
- *Two methods are available for sending the screen image to the projector. "Continuous Transmit" automatically sends the screen image of the personal computer at a fixed interval. "Single Frame Transmit" sends the screen image by clicking the screen button (or pressing a key).*

*1: *Please purchase a commercially available PCMCIA Type 2 (ATA specification) flash memory card.*

*2: *Please check the network environment on the next page.*

*3: *USB cable connection is not supported by the LT260/LT240/LT220.*

Information about Upgrading this Software

Please see the service page for projectors (<http://www.nec-pj.com/>) for information about software upgrades of Projector User Supportware (i.e., Dynamic Image Utility, Viewer PPT Converter, and Image Express Utility).

Projector "Easy Connection" Settings

The "Easy Connection" option is a mode that can abbreviate the troublesome LAN settings when using the Image Express Utility and connecting the PC and projector via a wireless LAN.

- From the Advanced menu, select [Projector Options] → [LAN Mode] → [Status] → [Advanced] → [Network Type] → [Mode] → [Easy Connection] on the projector. (No setting for IP address, SSID and channel are required.)
- After you have installed the software from the supplied CD-ROM to your PC, before executing "Easy Connection" using Image Express Utility, visit our website to update the information about Image Express Utility and its related software.

Software can be downloaded from our website at no charge.

- Easy Connection is available on Windows 2000 Professional, Windows XP Professional and Windows XP Home Edition (not available on Windows XP Tablet PC Edition [with Image Express Utility 1.0 version 1.01.0003]).
- Easy Connection is available only when both PC and projector use the NEC optional wireless cards.
- Easy Connection is not available on Dynamic Image Utility included on the supplied CD-ROM.

3 Supported Projectors

Operating Environment

Supported Equipment	IBM PC/AT compatible computers <ul style="list-style-type: none"> • CD-ROM drive a requirement (at time of installation)
CPU	Pentium MMX processor or higher a requirement Pentium III 800 MHz or higher recommended
Memory	For Windows XP <ul style="list-style-type: none"> • 128 MB or more a requirement • 192 MB or more recommended For other operating systems <ul style="list-style-type: none"> • 64 MB or more a requirement • 128 MB or more recommended ※ More memory may be necessary when other applications are run at the same time.
Network Environment (when used)	A LAN that supports TCP/IP or a wireless LAN environment is a requirement. <ul style="list-style-type: none"> • For information on supported LAN cards, visit: http://www.nec-pj.com/ (In US: http://www.necvisualsystems.com) • For wireless LAN connection, use NEC optional wireless LAN card (SWL-2100N-N*). * Last digit of the model code varies depending on which country you live in. For more information, visit the above Website.
Supported OS	Windows 98 Windows 98 Second Edition Windows Me Windows 2000 Professional Windows XP Home Edition Windows XP Professional/Windows XP Tablet PC Edition * Microsoft Internet Explorer 5.01 or higher is required for the aforementioned environments. * Does not support Windows power-saving function.
Resolution	1024 dots x 768 lines recommended
Screen Colors	High Color (15 bit, 16 bit) True Color (24 bit, 32 bit)

4 Equipment Connections and Settings

[For Connections with USB Cable]

Equipment to Be Prepared

- Projector (This unit)
- Personal computer
- USB cable (included with the projector)

Connection at the Projector Side

Plug the B type connector of the USB cable to the USB port [PC] (type B).

NOTE: When switching the power of the projector on/off with the projector control function, please set [Projector Options] → [Setup] → [Page 4] → [Idle Mode] to "On".

Connection at the Personal Computer Side

Plug the A type connector of the USB cable to the USB port [PC] (type A).

[For Connections with Serial Cable]

Equipment to Be Prepared

- Projector (This unit)
- Personal computer
- Serial cable,
A commercially available RS-232C cross cable for 9060

Connection at the Projector Side

Plug the serial cable into the PC CONTROL connector. ("Terminal Panel Features" and "PC Control Connector" on pages 1-9 and 10-10)

Connection at the Personal Computer Side

Plug the serial cable into the (RS-232C) serial connector.

When Using a Network Environment

What Can Be Accomplished

- Using Image Express Utility 1.0, the screen image displayed by the personal computer can be sent to the projector and then projected to a screen.
- Using Dynamic Image Utility 2.0, a picture or slide can be sent to the projector and then projected to a screen.
- Using the projector control function of Dynamic Image Utility 2.0 allows operations to be performed from the personal computer which include switching the projector power on/off, signal selection, and adjustment of the picture quality.

Equipment to Be Prepared

- Projector (This unit) • Personal computer (with LAN card)
- LAN cable (not supplied) or wireless LAN card (optional)

Settings at the Projector Side

Preparation:

- (1) Connect a LAN cable (not supplied) to the LAN port (RJ-45) of the projector.

(For the use of an optional wireless LAN card, insert the wireless LAN card into the PC CARD slot 1 or 2 of the projector.)

- (2) Switch on the projector power and project to the screen. (chapter 3)
- (3) Switch to the advanced menu.

1. Press the MENU button.

The menu will be displayed.

2. Use the SELECT ▼ button to align the cursor with [Projector Options], then press the ENTER button.

The sub menu will be displayed.

3. Use the SELECT ▼ button to align the cursor with [LAN Mode], then press the ENTER button.

The LAN mode setting screen will be displayed.

4. Set the various items.

See "Setting LAN Mode" on page 8-19 for information about the various items.

NOTE: When switching the power of the projector on/off with the projector control function, please set [Projector Options] → [Setup] → [Page 4] → [Idle Mode] to "On".

Settings at the Personal Computer Side

Perform the regular LAN connections settings according to the instruction manual of the LAN card (adapter).

There are no special settings to be made in the connections with the projector.

When Making Connections with Serial Cable or USB Cable(*)

- * USB cable connection is not supported.

What Can Be Accomplished

- Using Dynamic Image Utility 2.0, a picture or slide can be sent to the projector and then projected to a screen.
- Using the projector control function of Dynamic Image Utility 2.0 allows operations to be performed from the personal computer which include switching the projector power on/off, signal selection, and adjustment of the picture quality.

5 Software Installation

NOTE

- Windows 98 operations will be described in examples given here.
- When using Windows 2000, please perform software installation/uninstalling with "Administrators" authority. When using Windows XP, perform with "Computer Administrator" authority.

Installation

Dynamic Image Utility 2.0, Viewer PPT Converter 2.0, and Image Express Utility 1.0 will all be installed together. The various programs cannot be installed individually.

Preparation:

Start Windows.

If Windows has already been started, please exit all running application software. The installation may not be completed properly unless all software has been exited.

1. Place the supplied CD-ROM in the CD-ROM drive.
The "Welcome" screen will appear.

Reference

Should the "Welcome" screen not appear...

- 1) Click [Start].
 - 2) Click [Run (R)]. The [Run] screen will appear.
 - 3) Enter the CD-ROM drive name (e.g., "Q:\") and then "SETUPEXE" to [Open (O)].
 - 4) Click [OK]. The "Welcome" screen will appear.
2. Click [Next >] at the "Welcome" screen.
The "End User License Agreement" screen will appear.
 - Please carefully read the contents of the "End User License Agreement".
 3. If you agree, click [Yes].
 - If you do not agree, please click [No] and exit the installer.
 4. Now, follow the operations described in the screen messages.
 - Please remove the CD-ROM from the CD-ROM drive when the installation is completed.

Reference

- To cancel the installation of the supplied software part way through the installation, click [Cancel] and follow the instructions of the dialog box.

Uninstalling

Dynamic Image Utility 2.0, Viewer PPT Converter 2.0, and Image Express Utility 1.0 will all be uninstalled together. The various programs cannot be uninstalled individually.

1. Click [Start].
2. Click [Settings] R [Control Panel].
The "Control Panel" screen will be displayed.
3. Double click [Add/Remove Programs].
The "Add/Remove Programs Properties" screen will appear.
4. Click "NEC Projector User Supportware" from the list.
5. Click [Add/Remove. . .].
The "Confirm File Deletion" screen will appear.
6. Check the message and click [Yes].

7. Now, follow the operations described in the screen messages.
When the uninstall procedure is completed, there will be a return to the "Add/Remove Programs Properties" screen.
8. Click [OK].
There will be a return to the "Control Panel" screen

6 Starting/Exiting the Software

Dynamic Image Utility 2.0

Start the Software

Preparation:

Install the software on the personal computer from the supplied CD-ROM. (Page 6-6)

The software cannot be started from the supplied CD-ROM.

From the [Start] menu click [Program] → [NEC Projector User Supportware] → [Dynamic Image Utility 2.0].

Dynamic Image Utility 2.0 will start.

Reference

- By selecting a PowerPoint file with Dynamic Image Utility 2.0 and clicking [Tools] → [Converting PowerPoint file], the function equivalent to Viewer PPT Converter 2.0 can be executed.
- Image Express Utility 1.0 can be started by clicking [Tools] → [Image Express Utility 1.0 Start] of Dynamic Image Utility 2.0.

Display Help

Preparation:

Please start Dynamic Image Utility 2.0.

1. Click [Help].
The [Help] menu will appear.
2. Click [Help].
The [Help] screen will appear.

Exit the Software

1. Click [File].
The [File] menu will appear.
2. Click [Exit].
Dynamic Image Utility 2.0 will close.

Viewer PPT Converter 2.0

Start the Software

Preparation:

(1) Check that Microsoft PowerPoint has been installed. Viewer PPT Converter 2.0 cannot be used unless PowerPoint has been installed.

(2) Install the software on the personal computer from the supplied CD-ROM. (Page 6-6)

The software cannot be started from the supplied CD-ROM.

1. From the [Start] menu click [Program] → [NEC Projector User Supportware] → [Viewer PPT Converter 2.0].
Dynamic Image Utility 2.0 will start.

Reference

- A function equivalent to Viewer PPT Converter 2.0 can also be executed from the Dynamic Image Utility 2.0 [Tools] → [Converting PowerPoint file] menu.
- Viewer PPT Converter 2.0 can also be started from the Microsoft PowerPoint 2000/2002 [Tools] → [NEC Projector User Supportware] → [Output Viewer] menu.

Display Help

Preparation:

Please start Viewer PPT Converter 2.0.

1. Click [Help].
The [Help] menu will appear.

Exit the Software

1. Click [Exit].
Viewer PPT Converter 2.0 will close.

Image Express Utility 1.0

Start the Software

Preparation:

Install the software on the personal computer from the supplied CD-ROM. (Page 6-6)

The software cannot be started from the supplied CD-ROM.

1. From the [Start] menu click [Program] → [NEC Projector User Supportware] → [Image Express Utility 1.0].
Image Express Utility 1.0 will start.

Reference

- Image Express Utility 1.0 can also be started from the [Tools] R [Image Express Utility 1.0 Start] menu of Dynamic Image Utility 2.0.

Display Help

Preparation:

Please start Image Express Utility 1.0.

1. Click the [] or [] icon of the Windows screen task tray.
The main menu of Image Express Utility 1.0 will appear.
2. Click [Help].
The Help screen will appear.

Exit the Software

1. Click the [] or [] icon of the Windows screen task tray.
The main menu of Image Express Utility 1.0 will appear.
2. Click [Exit].
Image Express Utility 1.0 will close.

7 Troubleshooting

In this section, the software names have been abbreviated as follows:

Dynamic Image Utility 2.0 to DIU 2.0, Viewer PPT Converter 2.0 to PPTC 2.0, and Image Express Utility 1.0 to IEU 1.0.

<Problem> Installation does not complete normally.

Check Points	Countermeasures
When using Windows 2000, did you log on with "Administrators" authority? When using Windows XP, did you log on with "Computer Administrator" authority?	When using Windows 2000 or Windows XP, log on with the authority described at the left and then install.
Has Microsoft PowerPoint 2000/2002 been installed on the personal computer to which this projector software is being installed? When this projector software is installed on a personal computer that does not have PowerPoint 2000/2002 installed, a message to the effect of "Error in the automatic registration of PPTViewer2.dll" will appear part way through the installation.	When the message described at the left appears part way through the installation, add-in registration will not be made to PowerPoint; however, the installation of this projector software will be completed normally. To have add-in registration made to PowerPoint, please install this projector software to a personal computer on which PowerPoint 2000/2002 has been installed.

<Problem> Viewer PPT Converter 2.0 does not function. (PPTC 2.0)

Check Points	Countermeasures
Has Microsoft PowerPoint been installed on the personal computer?	Install PowerPoint on the personal computer. Or, install Viewer PPT Converter 2.0 on a personal computer on which PowerPoint has been installed.

<Problem> When using the projector control function, the projector power does not switch on. (DIU 2.0)

Check Points	Countermeasures
Are the personal computer and the projector connected by a serial cable? Or, are the personal computer and the projector connected by a LAN?	Connect the personal computer and the projector with an serial cable or USB cable. Or, check the LAN port (RJ-45) of the projector. Purchase the optional wireless LAN card for wireless LAN connection.
When the personal computer and the projector are connected with a LAN, is the projector in the idle mode?	In the [Projector Options]→[Setup] menu of the projector, place checkmark in "Idle Mode". Connect a power cable to the power outlet and set the main power switch to "I (On)".

<Problem> You want to delete the PowerPoint add-in registration. (PPTC 2.0)

Check Points	Countermeasures
Installing this projector software when Microsoft PowerPoint 2000/2002 has already been installed on the personal computer, will result in the automatic registration of the add-in to PowerPoint.	Please see the PowerPoint Help function for the method of deleting PowerPoint add-in registrations. The PowerPoint add-in registration will not be deleted even when this projector software is uninstalled.

<Problem> Projection to the screen is not possible when using the LAN environment. (DIU 2.0, IEU 1.0)

Check Points	Countermeasures
Have LAN cards (i.e., adapters) been put into both the personal computer and the projector?	Put LAN cards (i.e., adapters) into both the personal computer and the projector.
Have the LAN settings (for both the personal computer and the projector) been completed?	Perform the LAN settings for both the personal computer and the projector.
Are a wired LAN and a wireless LAN being used simultaneously with the same personal computer?	Please cancel either one of the LAN connections. When a built-in type is used, set it to "not used" under Properties.
Image Express Utility 1.0 does not support the following: (1) Software using Direct X (2) MS-DOS screens (3) Microsoft Office assistant (4) IME (5) Moving pictures	_____
On the LT260K and LT240K, images cannot be sent from the "Dynamic Image Utility 2.0" on a PC to the projector on the Continuous Transmit of the Image Express Utility 1.0.	Quit the Continuous Transmit in the Image Express Utility 1.0 and then send the image from Dynamic Image Utility 2.0.

<Problem> Operation of this projector software becomes unstable. (DIU 2.0, IEU 1.0)

Check Points	Countermeasures
When the network settings of the projector or personal computer are changed while this projector software (i.e., Dynamic Image Utility 2.0 or Image Express Utility 1.0) is starting or running, the operation of the projector software may become unstable.	Please restart the projector and the personal computer. When changes are to be made to the network settings, exit the projector software before making the changes.
An application error occurs under Image Express Utility 1.0 when the screen resolution is changed during Continuous Transmit.	When changes are to be made to the screen resolution, exit Image Express Utility 1.0 before making the changes.

<Problem> The colors become strange when Windows is set to 256 colors. (IEU 1.0)

Check Points	Countermeasures
Image Express Utility 1.0 does not support 256 colors.	Please set the Windows number of colors setting to High Color (15 bit) or higher.

6. Using the Projector in a Network

<Problem> The projector cannot be found with "General search". (IEU 1.0)

Check Points	Countermeasures
<p>Are the wireless LAN settings appropriate? Are the channel numbers for the personal computer and the projector set to the same number? When WEP (encryption) has been set, has the same value been set for both the personal computer and the projector?</p>	<p>Please check the access points, the personal computer setting values and the projector [LAN Mode] setting values. When using the infrastructure or 802.11 Ad Hoc, please set to the same character string since SSID distinguishes between upper and lower case characters.</p>
<p>Are radio communication conditions satisfactory?</p>	<p>Check whether there are obstacles located between the access point and the personal computer. Try moving the personal computer closer to the access point.</p>
<p>Are the TCP/IP settings (e.g., IP address, sub net mask, etc.) of the personal computer and the projector correct?</p>	<p>Check whether the network settings are within the same segment.</p>
<p>Are more than one network interface cards (NIC) being used with the same computer?</p>	<p>Set only the network interface card (NIC) that is connected to the projector to "Valid". For a network card that is not connected to the projector, click the network card name under "Control Panel" → "System" → "Device Manager" → "Network Adapter" and then click [Properties (R)] and set the device usage to "Not used".</p>

<Problem> Sometimes it takes a long time for screen transmission from the personal computer to the projector. (IEU 1.0)

Check Points	Countermeasures
<ul style="list-style-type: none"> • Transmission time may be long depending on the image pattern. • When screens are sent to multiple projectors simultaneously, a larger number of projectors will result in longer transmission times. • The transmission time may vary depending on the network environment. • The transmission time may vary depending on the performance of the personal computer as well as other application software that is running at the same time. 	<p>_____</p>
<p>Transmission time will be longer when the resolution of the personal computer and that of the projector differ since there will be an increase in resolution conversion processing.</p>	<p>We recommend that the resolution of the personal computer and that of the projector be set to the same setting value (except GT6000).</p>

<Problem> Cannot follow the screen switching processing of the PowerPoint slide show, etc. (IEU 1.0)

Check Points	Countermeasures
<p>Smooth screen switching processing or animation effects cannot be followed because in Image Express Utility 1.0, the screen condition of the personal computer is sent to the projector at a fixed time interval.</p>	<p>Use the software with " the PowerPoint screen switching effects, animation effects, and other settings set to "None".</p>

7

Setting Up for Double Stacking in Link Mode

.....

1 Stacking and Connecting the Projectors	7-2
2 Adjusting and Registering Signals to Be Projected	7-5
3 Adjusting the Lens Shift, Zoom and Focus to Clearly Display all projected patterns	7-5
4 Link Mode Setting	7-5
5 List of Menu Items Available in Link Mode	7-6

1 Stacking and Connecting the Projectors

NOTE: Up to two units can be gravity stacked without external support. In some cases, however, two images will not align on the screen correctly. This will become more apparent when displaying small text and detailed graphics.

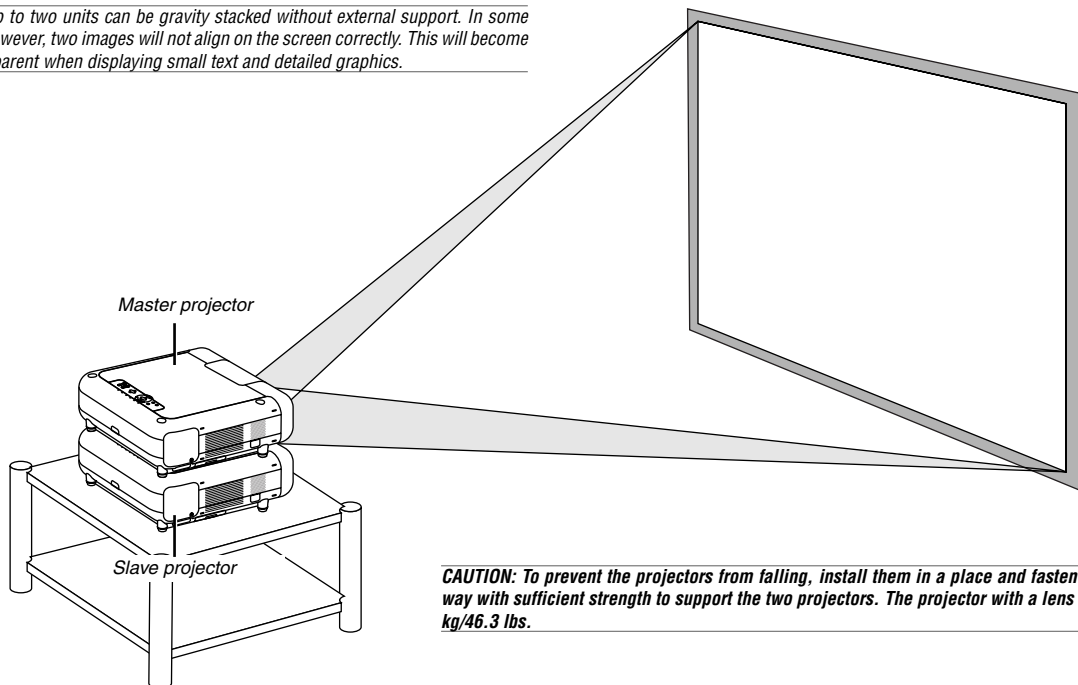

1-1. Assigning Projector IDs

You can operate multiple projectors with the same remote control.

To do so:

- 1-1-1. Select [Projector Options] → [Link Mode] → [Settings] → [Projector ID] and assign an ID number to each projector. See also page 8-18.

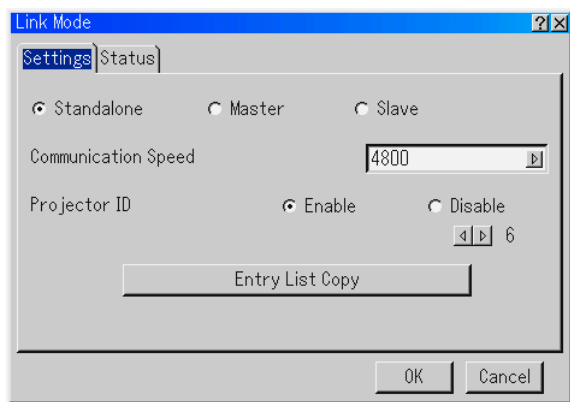

- 1-1-2. Select the same communication speed for both the projector.

NOTE: Do not turn on [Master] or [Slave] at this time.

- 1-1-3. On the remote control specify the ID number of the projector to be adjusted. Press and hold the CTL and press MENU (ADDRESS) button to enter the ID number. You can operate the projector assigned the same ID number as the remote control.

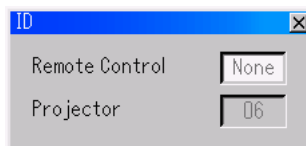

NOTE: Specifying "None" for projector ID allows you to operate multiple projectors concurrently. However, some projectors may not synchronize to the other projectors.

7. Setting Up for Double Stacking in Link Mode

Throw Distances for Optional Lenses

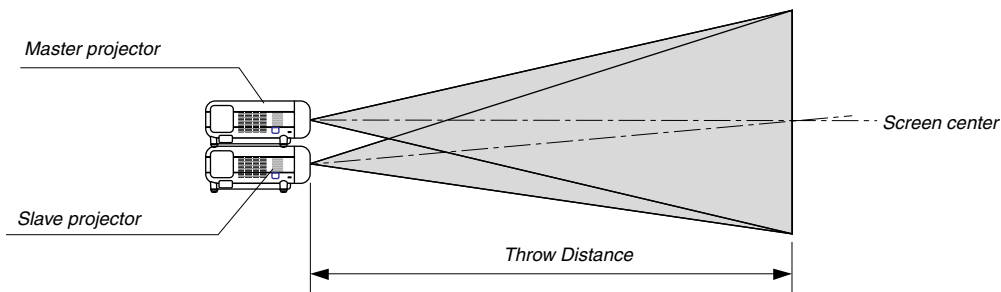

Recommended Throw Distances for Double Stack

Screen Size (inch)	Throw Distance (m)				
	GT13ZLB	GT19ZL	GT20ZL	GT24ZLB	GT34ZLB
40	0.94	1.61	2.03	-	-
60	1.43	2.44	3.05	2.92	-
80	1.92	3.27	4.07	3.93	6.21
100	2.40	4.10	5.09	4.93	7.78
120	2.89	4.93	6.11	5.93	9.35
150	3.62	6.18	7.63	7.44	11.70
200	4.84	8.25	10.18	9.95	15.62
240	5.82	9.91	12.21	11.96	18.76
300	7.28	12.40	15.27	14.97	23.46
350	-	-	-	17.48	27.38
400	-	-	-	19.99	31.30
450	-	-	-	-	35.22
500	-	-	-	-	39.14

Screen Size (inch)	Throw Distance (inch)				
	GT13ZLB	GT19ZL	GT20ZL	GT24ZLB	GT34ZLB
40	37.0	63.6	80.1	-	-
60	56.2	96.2	120.2	115.0	-
80	75.4	128.9	160.2	154.5	244.6
100	94.6	161.6	200.3	194.1	306.3
120	113.9	194.3	240.4	233.6	368.0
150	142.7	243.3	300.5	292.9	460.6
200	190.7	325.0	400.7	391.7	615.0
240	229.1	390.3	480.9	470.8	738.4
300	286.8	488.4	601.1	589.3	923.6
350	-	-	-	688.2	1078.0
400	-	-	-	787.0	1232.3
450	-	-	-	-	1386.6
500	-	-	-	-	1541.0

NOTE:

- The optional lenses for 9060 have different geometrical distortions in wide zoom and tele. Select the best zoom position for stacking where the geometrical distortion is as small as possible.
- The optional lens GT10RLB does not support stacking.

For double stacking, follow the instructions described below.

1-2. Stacking the Projectors

Place the projectors at the proper height for best screen to projector relationship. Make sure that all projectors have the same display orientation.

7. Setting Up for Double Stacking in Link Mode

1-3. Hookup

1-3-1. Use commercially available RGB signal cables to connect the RGB output of the master projector to the RGB input of the slave projector until all the projectors are connected.

1-3-2. Next, using a commercially available, bi-directional RS-232C cable connect the PC CONTROL OUT terminal of the master projector to the PC CONTROL IN terminal of the slave projector until all the projectors are connected.

1-3-3. Turn all the projectors on and roughly make some optical adjustments to each projector.

Example: Composite signal

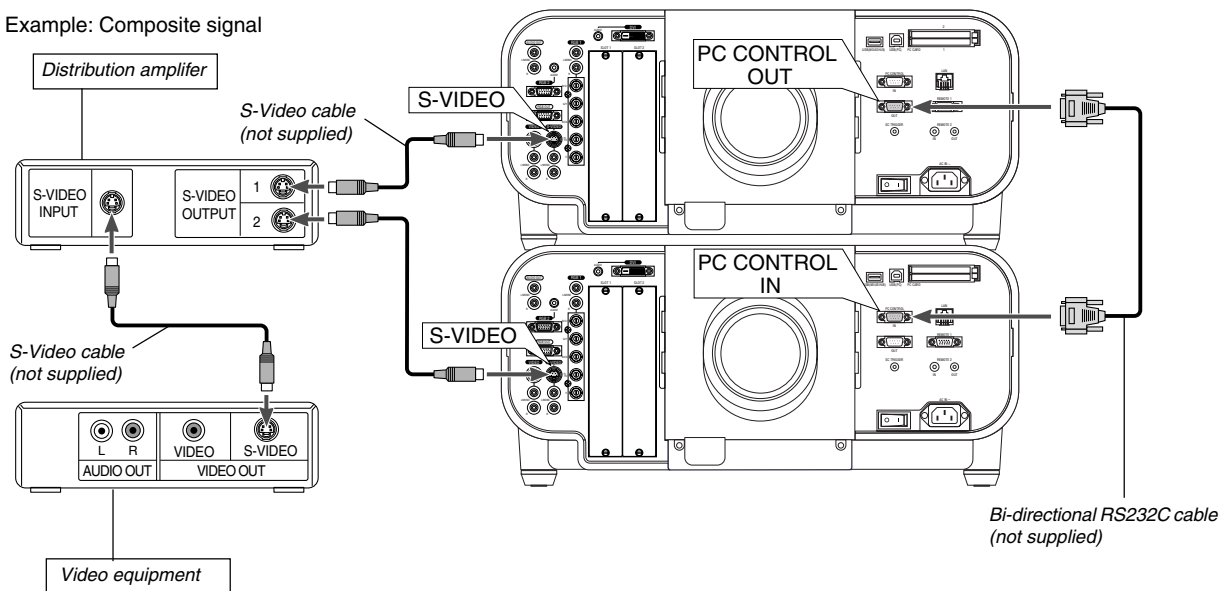

NOTE: Connect a commercially available distribution amplifier to both the master and the slave projectors to distribute signal to two outputs of the master and the slave projectors.

2 Adjusting and Registering Signals to Be Projected

- 2-1. Display a desired input signal on the master projector.
- 2-2. Make adjustment to the signal, then save (register) adjustments on the master projector by pressing and holding CTL and pressing ENTRY LIST button on the remote control.
- 2-3. Repeat steps 2-1 and 2-2 for all signals you want to project. Display all the signals you registered and check. To check, select [Source Select] → [Entry List].
- 2-4 Transferring Signal Data in the Entry List

- 2-4-1. Transfer the data from the master projector to the slave projector so that both the projectors have the same data in memory.

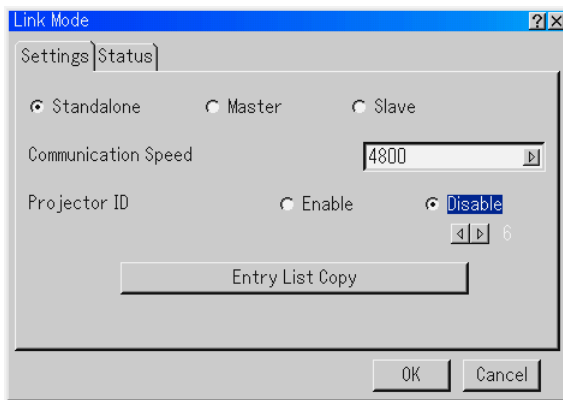

- 2-4-2. Select [Projector Options] → [Link Mode] on the master projector.
- 2-4-3. Select [Entry List Copy] and press the ENTER button. The following will be displayed.

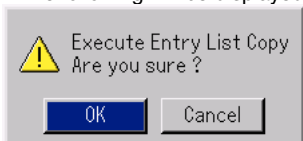

- 2-4-4. Select [OK] and press the ENTER button. The data has been transferred from the master projector to the slave projector.

2-5. Making Adjustments to the Slave Projector

- 2-5-1. Display a desired input signal on the slave projector.
- 2-5-2. Make adjustment to the signal, then save (register) adjustments on the slave projector by pressing and holding CTL and pressing ENTRY LIST button on the remote control.
- 2-5-3. Repeat steps 2-2 and 2-2 for all signals you want to project. Display all the signals you registered and check. To check, select [Source Select] → [Entry List].

3 Adjusting the Lens Shift, Zoom and Focus to Clearly Display all projected patterns

- 3-1. Display the internal crosshatch test pattern.

NOTE: Use a different single color for each projector. Example: Turn on Green of master projector, then Red of the slave projector.

- 3-2. Adjust the Lens Shift by pressing and holding CTL and pressing the POSITION button on the remote control. For lens shift adjustable range, see page 2-4 and 2-5. Lens Shift Adjustable Range.

- 3-3. Zoom the lens in and out by pressing and holding CTL and pressing the MAGNIFY(ZOOM)+/- button on the remote control.

- 3-4. Adjust the lens focus by pressing and holding CTL and pressing the FOCUS +/- button on the remote control.

NOTE: If the physical (vertical) alignment of the projector is not correct, adjust the height of the feet. If there is any keystone distortion, use 3D-Reform (Keystone) adjustment to correct and save the settings on each projector. See page 3-4 for 3D-Reform correction.

4 Link Mode Setting

- 4-1. Set the Link Mode on each projector.

NOTE: Be sure to set the Link Mode on the slave projector before the master projector. If you do this first on the master projector, you will not be able to set the Link Mode on the slave projector.

- 4-1-1. Select [Projector Options] → [Link Mode] → [Settings].

- 4-1-2. First select [Slave] on the slave projector.

- 4-1-3. Select [Master] on the master projector.

- 4-2. Projecting a Source Image from both the Projectors.

- 4-3. Display any signal onto the screen.

- 4-4. Check to see if the images on the master projector are displayed in synchronization with the ones on the slave projector while the projectors are in Link Mode.

NOTE: Registering signals is not possible in the Link mode. To register a signal, first set "Link Mode" to "Standalone" on the menu and then repeat the steps from "2 Adjusting and Registering Signals to Be Projected". If you select an unregistered signal, the master projector displays the image, but the slave projector doesn't. To view the information on the currently displayed signal, select [Help] → [Source Information].

5 List of Menu Items Available in Link Mode

Available Menu Items		NOTE
Source Select		*1
Sound		
Menu		
Link Mode		
On/Off Timer		
Sleep Timer		
Source Information		
Projector Information		

Direct Button		NOTE
LENS SHIFT	Projector	*2
FOCUS	Projector	*2
	Remote Control	*2
ZOOM	Projector	*2
	Remote Control	*2
"MENU/SELECT/ ENTER/CANCEL"	Projector	
	Remote Control	
POWER	Projector	*3
POWER ON	Remote Control	*3
POWER OFF	Remote Control	*3
INPUT	Remote Control	*1
MUTE(PICTURE)	Remote Control	
MUTE(SOUND)	Remote Control	
MUTE(OSD)	Remote Control	

*1: Unregistered signal is displayed on the master projector only and the picture is muted on the slave projector.

*2: Adjustment is possible on each projector independently.

*3: You can also turn on the slave projector only.

8

Using On-Screen Menu

1 Basic Menu Operation	8-2	Projector Options	8-13
2 List of Direct Button Combinations	8-3	Menu	8-13
3 Menu tree	8-4	Setup	8-15
4 Menu Descriptions & Functions	8-7	Lamp Settings	8-18
Adjust (Source)	8-8	Link Mode	8-18
Picture	8-8	LAN Mode	8-19
Video Adjust	8-8	Setting a Password	8-23
Picture Management	8-9	Security	8-24
Image Options	8-10	Tools	8-25
Option Adjust	8-10	Timer	8-25
Lens Memory	8-11	Using Capture	8-27
Signal Type	8-11	Using PC Card Files	8-27
Sound	8-11	Using ChalkBoard	8-27
Ref. Adjust	8-12	Help	8-27
Using 3D Reform	8-12	Contents	8-27
Screen Type	8-12	Source Information	8-27
Reference White Balance	8-12	Projector Information	8-28
Reference Color Correction	8-12	Test Pattern	8-28
Reference Lens Memory	8-13		
Factory Default	8-13		

1 Basic Menu Operation

Using the Menus

NOTE: The on-screen menu may not be displayed correctly while interlaced motion video image is projected.

1. Press the MENU button on the remote control or projector cabinet to display the Basic, Advanced or Custom Menu.



NOTE: When using a USB mouse, click the mouse button to display the menu. For other operations, do the same way as you use your PC mouse.

2. Press the SELECT ▲▼ buttons on the remote control or the projector cabinet to highlight the menu for the item you want to adjust or set.

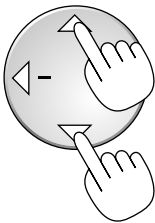

3. Press the SELECT ► button or the ENTER button on the remote control or the projector cabinet to select a submenu or item.

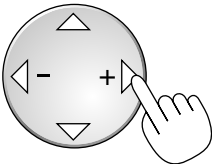

4. Adjust the level or turn the selected item on or off by using SELECT ◀ or ▶ buttons on the remote control or the projector cabinet.

The on-screen slide bar will show you the amount of increase or decrease.

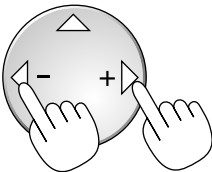

5. Changes are stored until you adjust it again.

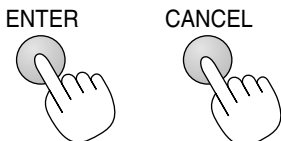

ENTER Stores the setting or adjustments.

CANCEL Return to the previous screen without storing settings or adjustments.

6. Repeat steps 2-5 to adjust an additional item, or press the CANCEL button on the projector cabinet or the remote control to quit the menu display.

Customizing the Menu

The Custom menu can be customized to meet your requirements. Selecting a menu item from the "Custom Menu Edit" list, allows you to custom tailor the menu items to your needs.

1. Select "Custom Menu Edit" to display the "Custom Menu Edit" screen.
2. Use the SELECT ▲ or ▼ buttons to highlight your selection and press the ENTER button to place a check mark next to an option.

This action enables that feature. Press the ENTER button again to clear the check box.

If you select an item with a solid triangle ► and press the ENTER button on the remote control or the projector cabinet, you can enable all the items within that submenu. Also you can turn on an item within the submenu without placing a check mark on the main menu item.

NOTE: Up to 12 main menu items (within Custom Menu Edit, not including submenu items) can be selected.

3. In order for the changes to take effect, use the SELECT ◀ or ▶ button on the remote control or the projector cabinet to highlight "OK", then press the ENTER button. To cancel the changes, use the SELECT ▲ or ▼ buttons to highlight "Cancel" and press the ENTER button. To return to the factory default, select "Reset" then press the ENTER button.

NOTE: Once you have selected OK on the Custom Menu Edit screen, you cannot cancel the changes on the Menu screen. However, you can reedit the menu items over again as described in the steps above.

NOTE: If the "Advanced Menu" item has been selected on the Menu mode, you get the "Change Custom menu now?" upon completion of "Custom Menu" editing. In this case, selecting "Yes" then "ENTER" will close all the menus and apply the changes from the Advanced menu to the Custom Menu. If you select "No" then "ENTER" functions, then all menu items will return to the Advanced menu, but your changes will still be available within the "Custom Menu" selection. To display the previously tailored Custom Menu, select "Custom Menu" from the "Menu Mode".

An item "To Advanced Menu" will be added to the bottom of the Custom Menu.

Selecting this item and pressing the ENTER button will display the "Advanced Menu" features.

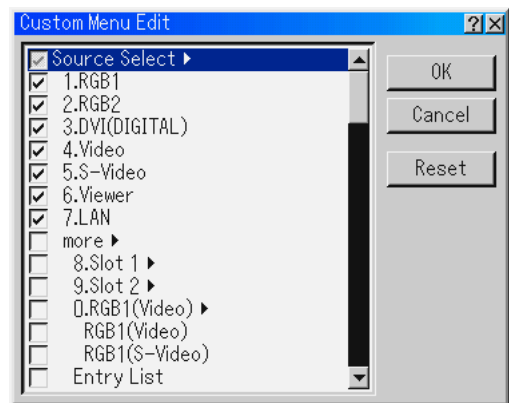

2 List of Direct Button Combinations

CTL+ Input (1-10)	Switches to any selected signal found in the Entry List. To enable this combination, you must first assign specific remote buttons for direct input selection in the Entry Edit window.
CTL+ ENTER (While displaying Entry list)	Displays the selected signal.
CTL+ CANCEL	Returns to the previous menu without closing the sidebar or dialog.
CTL+ UNDO	Clears all menus or adjustment/setting screens. All adjustments are saved automatically.
CTL+ ▲▼◀▶	Moves the sidebar or dialog box horizontally or vertically.
While using zoom on remote control:	Displays the magnifying glass icon.
CTL+ ◀ (BS)	Deletes one letter or numeral in the entry screen.
CTL+MUTE OSD	Turns off the on-screen display forcibly.
CTL+ MENU (ADDRESS)	Displays the remote ID entry window.
CTL+ IMAGE (PROJECTOR)	Sequentially selects the Projector Options sub menu.
CTL+ POSITION (LENS)	Displays the Lens Shift adjustment window.
CTL+ KEYSTONE (R)	Turns on red. Available only when the projector is in the test pattern mode.
CTL+ AMPLITUDE (G)	Turns on green. Available only when the projector is in the test pattern mode.
CTL+ ENTRY LIST (B)	Turns on blue. Available only when the projector is in the test pattern mode. Stores a signal in the Entry List when you are not displaying a test pattern.
CTL+ MAGNIFY (ZOOM)	Zooms the lens in and out
CTL+ (FOCUS)	Adjusts the lens focus.
CTL+ INFO.	Stores lens position settings.

3 Menu tree

NOTE: The item appears dimmed on the menu, it is unavailable.

Advanced Menu	1. RGB1			
Source Select ▶	2. RGB2			
Adjust (Source) ▶	3. DVI(DIGITAL)			
Sound	4. Video			
Ref. Adjust ▶	5. S-Video			
Factory Default	6. Viewer			
Projector Options ▶	7. LAN			
Tools ▶	8. Slot 1	Input Terminal 1/Input Terminal 2(available only when option board is installed)		
Help ▶	9. Slot 2	Input Terminal 1/Input Terminal 2(available only when option board is installed)		
Test Pattern	0. RGB1(Video)	RGB1(Video)/RGB1(S-Video)		
	Entry List	Load/Cut/Copy/Paste/Store/Edit/All Delete		
	Picture	Brightness/Contrast/Saturation/Color/Hue/Sharpness		
	Video Adjust	Noise Reduction	Off/Low/Medium/High	
		Color Matrix	HDTV/SDTV	
		Y/C Delay	0 to 15	
		YTR Adjustment	Gain/Tap	
		CTR Adjustment	Gain/Tap	
		SweetVision	Off/Low/Medium/High Split Mode (Off/On)	
		Deinterlace	Off/On	
		Telecine	Auto/Off	
		Black Expansion	0 to 5	
		Contrast Enhancement	-3 to +3	
	3D Y/C Separation	Off/On		
	Picture Management	Presentation/sRGB/Graphic/Video/Movie		
		User	Gamma Correction	Dynamic/Natural/Black Detail
			Color Correction	Red/Green/Blue/Yellow/Magenta/ Cyan/Color Gain
			Color Temperature	6 Steps
			White Balance	Brightness R/G/B, Contrast R/G/B
		Base Setting	Presentation/sRGB/Graphic/Video/Movie	
	Image Options	Pixel Adjust	Clock/Phase	
		Position	Horizontal/Vertical	
		Aspect Ratio	1.25:1(5:4)/1.33:1(4:3)/1.78:1(16:9)/1.85:1/2.35:1	
		Resolution	Auto/Native	
		Overscan	0%/5%/10%/25%	
		Video Filter	Off/Less/More	
		Blanking	Top/Bottom/Left/Right	
	Option Adjust	Clamp Timing	Mode 0-4/ Adjust	
		Sync Protection	Upper/Lower	
		VD Delay	Adjustment/Field Invert (On/Off)	
		Signal Level	Red/Green/Blue, Y/Cb/Cr, Y/Pb/Pr	
	Lens Memory	Set Custom Point/Use Custom Point		
	Signal Type	RGB/Component		
	Sound	Volume/Bass/Treble		

8. Using On-Screen Menu

NOTE: The shaded item indicates the default setting.

Advanced Menu	3D Reform	Conerstone			
Source Select ▶		Keystone	Horizontal/Vertical		
Adjust (Source) ▶		Screen	Screen Type	1.25:1(5:4)/1.33:1(4:3)/1.78:1(16:9)/1.85:1/2.35:1	
Sound			Position		
Ref. Adjust ▶		Ref. White Balance	Brightness R/G/B, Contrast R/G/B		
Factory Default		Ref. Color Correction	Red/Green/Blue/Yellow/Magenta/Cyan/Color Gain		
Projector Options ▶		Ref. Lens Memory	Set Reference Point/Use Reference Point/Return to Factory Default/ Use Point on Signal Change? Yes/No Picture Mute during Lens Shift? Yes/No		
Tools ▶	Factory Default	All Data (Including Entry List)/Current Signal			
Help ▶	Menu	Page 1	Language	English/Deutsch/Français/Italiano/Español/Svenska/日本語	
Test Pattern				Menu Mode	Basic/Custom/Advanced
				Custom Menu Edit	
				Menu Display Time	Manual/Auto 5 sec./Auto 15 sec./Auto 45 sec.
				Date Format	MM/DD/YYYY, MM/DD/YYYY ddd, DD/MM/YYYY, DD/MM/YYYY ddd, YYYY/MM/DD, YYYY/MM/DD ddd, Month DD, YYYY, Month DD, YYYY ddd
				Date, Time Preset	Date Month/Day/Year (Day of the week), Time (H/M)
	Page 2	Display Select	Date/Time/Input Terminal/Source Name/Projector ID/Message		
	Page 3	Menu Color	Color/Monochrome		
		Mouse Pointer	Pointer 1-9		
	Setup	Page 1	Orientation	Desktop Front/Ceiling Rear/Desktop Rear/Ceiling Front	
			Background	Blue/Black/Logo	
			RGBOUT Terminal	Last/RGB 1/RGB 2	
			Closed Caption	Off/Caption 1-4/Text 1-4	
			Sync Termination	RGB 1(Hi-Z/75Ω)	
	Page 2	Viewer Options	Show Folder List, Auto Play/Manual Play, Interval (5-300 sec)		
		Capture Options*	High Quality/Normal/High Compression		
		Mouse	Button (Right Hand/Left Hand), Sensitivity (Fast/Medium/Slow) Operation Mode Select (Auto/Projector)		
	Page 3	Signal Select	RGB 1 (RGB/Component, RGB, Component, Scart)		
			RGB2 (RGB/Component, RGB, Component, Scart)		
			Video (Auto/NTSC3.58/NTSC4.43/PAL/PAL-M/PAL-N/PAL60/SECAM)		
			S-Video (Auto/NTSC3.58/NTSC4.43/PAL/PAL-M/PAL-N/PAL60/SECAM)		
			RGB1 (Video) (Auto/NTSC3.58/NTSC4.43/PAL/PAL-M/PAL-N/PAL60/SECAM) RGB1(S-Video) (Auto/NTSC3.58/NTSC4.43/PAL/PAL-M/PAL-N/PAL60/SECAM)		
	Page 4	Auto Adjust (On/Off), Auto Start (On/Off), Power Management (On/Off), Power Off Confirmation (On/Off), 3D Reform Save (On/Off), Built-in Speaker (On/Off), Last Memory (On/Off), Idle Mode (On/Off), Back Light (On/Off), Screen Trigger (On/Off)			
	Page 5	Remote Sensor	Front/Back/Left/Right		
		S-Video Mode Select	Off/S2		
		Clear Filter Usage Meter			
	Page 6	Communication Speed	4800/9600/19200/38400		
		Projector ID	Enable (1-64)/Disable		
		Default Source Select	Last/Auto/Select Select: RGB1/RGB2/DVI(DIGITAL)/Video/S-Video/ Viewer/LAN/Solt-1-1(None)/Solt-1-2(None) Solt-2-1(None)/Solt-2-2(None)/RGB1(Video)/ RGB1(S-Video)		
		Control Panel Key Lock	Enable/Disable		

* GT5000 only

8. Using On-Screen Menu

Advanced Menu Source Select ▶ Adjust (Source) ▶ Sound Ref. Adjust ▶ Factory Default Projector Options ▶ Tools ▶ Help ▶ Test Pattern	Lamp Settings	Lamp Mode	Normal/Eco			
		Lamp Select	Dual/Lamp 1/Lamp 2			
		Interval	Auto/1 week/4 weeks/1300H/1800H/3000H/4000H			
		Lamp Type	Lamp1, Lamp2			
	Link Mode	Settings	Mode	Standalone/Master/Slave		
			Communication Speed	4800/9600/19200/38400		
			Projector ID	Enable (1 - 64)/Disable		
			Entry List Copy			
		Status	Link Mode(Master/Slave, ID, Status, Connected PJ) Reconnect			
	LAN Mode	Status	LAN Card	Build-in/PC Card*		
			Projector Name			
			IP Address			
			Subnet Mask			
			MAC Address			
			Advanced			
			Reconnect			
			IP Address	Automatic/Manual		
			IP Address			
			Subnet Mask			
			Gateway	On/Of		
			DNS Configuration			
			Domain Name			
			Network Type	Mode	Infrastructure/802.11 Ad Hoc/ Ad Hoc/Easy Connection	
			SSID			
			Channel	1-14		
			TX Rate	Automatic/11M/5.5M/2M/1M/ 1M-2M-Automatic		
	WEP	WEP	Disable/64 bit/128 bit			
Key Select		Key 1-4				
Key 1-4						
DHCP	Host Name option	None/Request/ Discover/Request				
	Client-Identifer option	None/Request/ Discover/Request				
Mail	Alert Mail	On/Off				
	Sender's Address					
	SMTP Server Name					
	Recipient's Addresss 1-3					
	Test Mail					
Password	Menu, Logo					
Security	Enable/Disable, Keyword, Use Protect Key, Drive/Read/Register/Delete					
Timer	On/Off Timer	Execute Switch (Active/Inactive), Edit, Delete				
	Sleep Timer	Preset Time (Off/0:30/1:00/2:00/4:00/8:00/12:00/16:00)				
Capture (GT5000 only), PC Card Files, ChalkBoard						
Contents						
Source Information	Page 1	Source Name/Input Terminal/Entry No./Horizontal Frequency/ Vertical Frequency/Sync Polarity				
	Page 2	Signal Type/Video Type/Sync Type/Interlace/Direct Key				
Projector Information	Page 1	Remaining Lamp 1Time/Remaining Lamp 2 Time/ Lamp 1 Hour Meter/Lamp 2 Hour Meter				
	Page 2	Filter Usage/Projector Usage/Projector ID				
	Page 3	Version (BIOS/Firmware/Data/FPGA)				
Test Pattern	Cross Hatch/Gray Bars/Raster (0%)/Raster(25%)/Raster(50%)/Focus Raster(100%)/Raster Blue/Gray Raster 10/Gray Raster 30					
	Red (On/Off), Green (On/Off), Blue (On/Off)					

* When selecting "PC Card", the "Network Type" and the "WEP" setting screens appear.

Entering Alphanumeric Characters by Using the Menu

Alphabet or numeric characters are used for your IP address or projector name. To enter IP Address or projector name, use the software keyboard.

For using the software keyboard, see page 10-10.

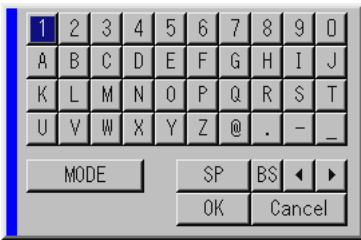

Entering Alphanumeric Characters by Using the Remote Control Numeric Buttons

Input alphanumeric characters by selecting one character at a time with the numeric (Source/Input) buttons 1 through 10(0) and by moving the cursor with the SELECT button. After finishing the selection of the characters, press the ENTER button. Whenever one of the Source/Input buttons on the remote control is pressed, characters will be rotated.

For example: A → B → C → 1 → A → ...

NOTE: When holding and pressing the CTL button and pressing one of the Source/Input buttons, another group of characters will be rotated.

For example: a → b → c → ! → a → ...

The alphanumeric characters corresponding to these Source/Input buttons are as follows:

Numeric buttons	Press	Press with CTL
1	A → B → C → 1	a → b → c → !
2	D → E → F → 2	d → e → f → ”
3	G → H → I → 3	g → h → i → #
4	J → K → L → 4	j → k → l → \$
5	M → N → O → 5	m → n → o → %
6	P → Q → R → 6	p → q → r → &
7	S → T → U → 7	s → t → u → '
8	V → W → X → 8	v → w → x → (
9	Y → Z → / → 9	y → z → ? →)
0	* → , → . → 0	; → : → + → -

* If you have made an error in the input of a character, use the SELECT button and enter the correct letter or number.

NOTE: Only numbers can be entered when you use the remote control Source/Input buttons while displaying the Software Keyboard.

4 Menu Descriptions & Functions

Source Select

Enables you to select a video source such as a VCR, DVD player, laser disc player, computer or document camera depending on what is connected to your inputs.

Press the up/down buttons on your remote control or the projector cabinet to highlight the menu for the item you want to project.

- * RGB1,2
- * DVI DIGITAL
- * Video
- * S-Video
- * Viewer
- * LAN
- * RGB 1 (Video)
- * RGB 1 (S-Video)

Entry List

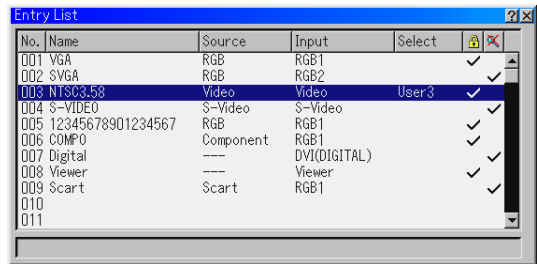

Displays the list of the entry signals. Use the SELECT buttons on your remote control or the projector cabinet to select the signal and press the ENTER button on the remote control or the projector cabinet to display the Entry Edit Command screen.

Using the Entry List

Making any adjustments to the current picture will automatically register its adjustments to the Entry List. The registered signal can be loaded any time from the Entry List.

NOTE: Up to 100 presets can be registered.

Entry Edit Command

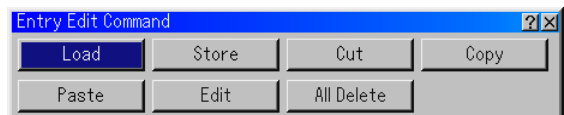

You can edit signals on the Entry List.

Load Enables you to select a signal from the list.

NOTE: This can be done by pressing CTL and ENTER buttons.

Store Enables you to store the currently projected signal.

NOTE: This can be done by pressing CTL and ENTRY LIST buttons.

Cut Enables you to remove a selected signal from the list and place it on the "clipboard" in the projector.

Copy Enables you to copy a selected signal from the list and place it on the "clipboard" in the projector.

Paste Enables you to paste the signal placed on the "clipboard" to any other line of the list. To do this, select "Paste" and then select the line number you want to paste to. Last press ENTER.

Edit Enables you to change source names or assign the direct key.

Source Name

Enter a signal name. Up to 18 alphanumeric characters can be used.

Input Terminal

Change the input terminal. RGB1 and RGB2 are available for RGB signal; Video and S-Video are available for composite signal.

Direct key

You can assign specific remote keys for direct signal input selection.

Lock

Set so that the selected signal cannot be deleted when "All Delete" is executed. The changes cannot be saved.

Skip

Set so that the selected signal will be skipped during auto search.

When complete, select OK and press ENTER. To exit without storing setting, select Cancel. Select "Source Name" and press ENTER to display the Source Name Edit window. You can change source name on this window. Press [▼] to display the software keyboard, which you can enter alphanumeric characters. See page 10-10 for the key function of the software keyboard.

All Delete This feature enables you to delete all the registered signals in the Entry List.

Video Adjust (not available for RGB)

Noise Reduction



Select one of the three levels for reducing video noise: Low, Medium or High.

NOTE: The lower the Noise Reduction level, the better the image quality by way of higher video bandwidth.

Color Matrix

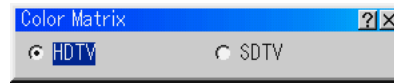

Select an appropriate color matrix for your input signal, either HDTV or SDTV.

Y/C Delay



Adjusts Y/C delay level.

YTR Adjustment

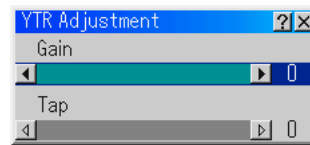

Adjusts luminance transient time.

CTR Adjustment

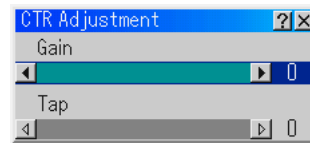

Adjusts chroma transient time.

The following buttons are not available for the currently projecting signals:

- 1) The Cut and Paste buttons on the Entry Edit Command screen
- 2) The Input Terminal button on the Entry Edit screen

Adjust (Source)

Picture

Brightness

Adjusts the brightness level or the back raster intensity.

Contrast

Adjusts the intensity of the image according to the incoming signal.

Saturation

Adjust saturation at the white peak.

Color

Increases or decreases the color saturation level (not available for RGB).

Hue

Varies the color level from +/- green to +/-blue. The red level is used as reference. This adjustment is only valid for Video and Component inputs (not available for RGB).

Sharpness

Controls the detail of the image for Video (not available for RGB).

SweetVision

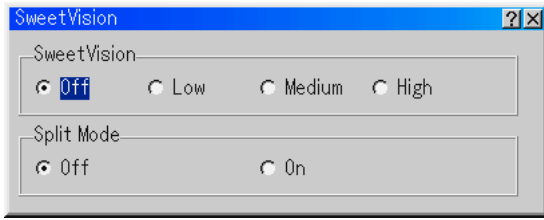

The SweetVision feature provides improvement of contrast using a proprietary detail enhancement technology.

NOTE: This feature is not available for 480p, 576p and HDTV signals.

- Off Turns off the SweetVision feature
- Low Selects low level
- Medium Selects medium level
- High Selects high level

Split Mode

This feature turns on or off to show the effect of the Sweet Vision.

NOTE: When the projector is turned off, the Split Mode will return to Off.

Deinterlace

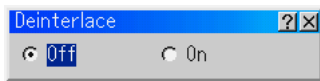

Turns on or off the deinterlace function for a telecine signal.

- On Default standard setting.
- Off Select this option if there is any jitter or artifacts in video.

NOTE: This feature is not available for 480p, 576p and HDTV signals.

Telecine

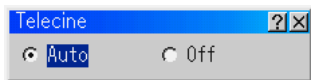

Use 3:2 pull down correction to eliminate jitter and artifacts in video.

- Auto For film source such as a DVD player
- Off For signals other than film sources

NOTE:
 • This feature is not available for 480p, 576p and HDTV signals.
 • When "Off" is selected in Deinterlace, this feature is not available.

Black Expansion

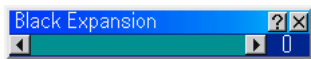

Minimizes blacks that appear more like shades of gray to provide a true black and white image at high contrast.

NOTE: This feature is not available for 480p, 576p and HDTV signals.

Contrast Enhancement

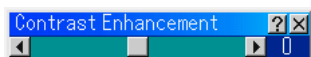

This option allows you to provide a high contrast image in a bright scene.

NOTE: This feature is not available for 480p, 576p and HDTV signals.

3D Y/C Separation

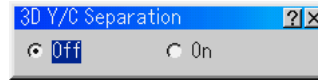

This option turns on or off the 3 dimension separation feature.

NOTE: This feature is available for NTSC3.58 of Video signal only.

Picture Management

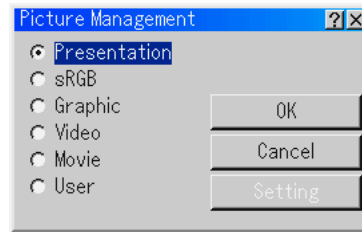

This option allows you to adjust neutral tint for yellow, cyan or magenta.

There are 5 factory presets optimized for various types of images, or you can set a user adjustable setting.

- Presentation .. Recommended for making a presentation using a PowerPoint file.
- sRGB Standard color values
- Graphic Recommended for graphics
- Video Recommended for regular picture such as TV program
- Movie Recommended for movies
- User User adjustable

NOTE: When "sRGB", "Graphic", "Video" or "Movie" is selected, the brightness decreases slightly when compared to "Presentation". This is not a malfunction.

User Adjust

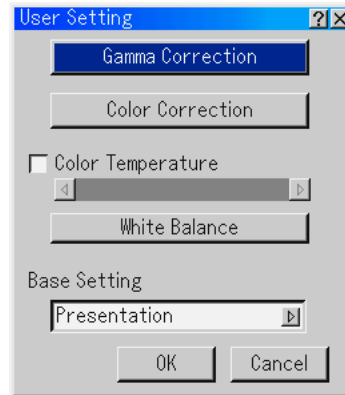

When selecting the user adjustable presetting (User), the submenu will be displayed. You can customize each gamma or color. To do so, first select [Setting] and press the ENTER button, and then proceed the following steps.

Selecting Gamma Correction Mode

Use the ◀ or ▶ buttons to choose one mode from three options. Each mode is recommended for :

- Dynamic For true color reproduction of natural tones
- Natural Normal settings
- Black Detail . For dark portions of a picture

Selecting Color Correction

Adjusts red, green, blue, yellow, magenta, cyan and color gain each independently to correct the tint on whole screen.

Adjusting Color Temperature

This feature adjusts the color temperature using the slide bar. Checking "Color Temperature" enables the color temperature slide bar.

Adjusting White Balance

Press the White Balance button to access the Contrast/Brightness adjustment for each R, G, and B.

NOTE: The White Balance is not available for Viewer and LAN.

Selecting Base Setting

This feature allows you to use color correction or gamma values as reference data to optimize for various types of images. You can select one of the following five settings.

- Presentation
- Graphic
- Movie
- sRGB
- Video

Image Options

Pixel Adjust

Displays the Clock and Phase adjustments.

- Clock Use this item to fine tune the computer image or to remove any vertical banding that might appear.
- Phase Use this item to adjust the clock phase or to reduce video noise, dot interference or cross talk. (This is evident when part of your image appears to be shimmering.) Use the ◀ and ▶ buttons to adjust the image.

Use "Phase" only after the "Clock" is complete.

Position

Adjusts the image location horizontally and vertically using the SELECT ◀ and ▶ buttons.

Aspect Ratio

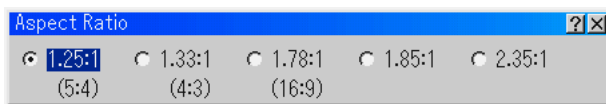

You can select the aspect ratio for input signal. Select the appropriate aspect ratio using the SELECT ◀ or ▶ button.

NOTE: When "Resolution" is set to "Native", this feature is not available, and the aspect ratio is set to "1.33:1 (4:3)".

NOTE: When "S2" is selected in "S-Video Mode Select" and the S2 signal is detected, this feature is not available.

Resolution

This allows you to activate or deactivate the Advanced AccuBlend feature.

- Auto Turns on the Advanced AccuBlend feature. The projector automatically reduces or enlarges the current image to fit the full screen.
- Native Turns off the Advanced AccuBlend feature. The projector displays the current image in its true resolution.

NOTE:

* When "Resolution" is set to "Native", "3D Reform", "Aspect Ratio", "Screen" and "Overscan" are not available.

* While you are displaying an image with higher resolution than the projector's native resolution (GT6000: SXGA+ and GT5000: XGA), "Resolution" is not available.

Overscan

Select overscan percentage (0%, 5%, 10% and 25%) for signal.

NOTE: When "Resolution" is set to "Native", this feature is not available, and the stored settings and adjustments are invalid.

NOTE: The "0%" option may not be available depending upon the input signal.

Video Filter (not available for Video, Component, Viewer and LAN)

This function reduces video noise.

- Off The filter is removed.
- Less The low-pass filter is applied partially.
- More The low-pass filter is applied fully.

Blanking

This feature allows you to mask any unwanted area of the screen image.

Adjust the Top, Bottom, Left or Right blanking with the SELECT ◀ or ▶ button.

Option Adjust

Clamp Timing

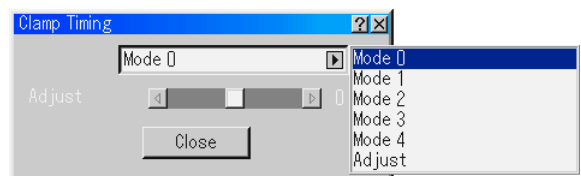

According to the signal, this function sets the detection position (i.e., clamp position) of the black level reproduction of the analog input signal. Normally this is not used.

- Mode 0-4 Select the appropriate one.
- Adjust This permits the video clamp position for each signal to be set. Use "Adjust" when a clamp timing error occurs at the time of special analog signal reception such as 1080P. Note that "Adjust" is not valid for doubler signals such as NTSC and PAL.

To delete the "Clamp Timing" setting screen, select the SELECT ▼ button and press the ENTER button, or press the remote control CANCEL button.

Sync Protection

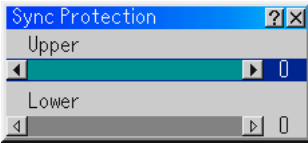

When a VCR, DVD, or some other equipment that supports Copyguard (a copy prevention system) is played back, the screen may be displayed in a curved manner. Adjustments are made in such circumstances. Use the SELECT ◀ or ▶ button to adjust the VD level.

VD Delay

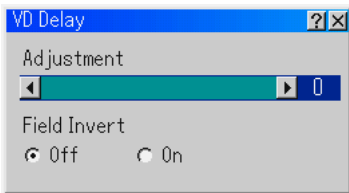

Adjustment:
This feature is used to correct vertical jitter of a signal.

*NOTE: When connecting with a scan converter:
If an image from the scan converter is not correctly displayed, adjust to select the best level point so that the image is displayed correctly.*

Field Invert:
This feature is used to correct diagonal lines of a non-standard interlaced signal when they appear jaggy. Invert the odd or even field of a video signal.

Signal Level

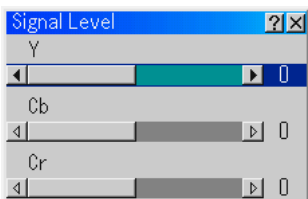

R/G/B, Y/Cb/Cr or Y/Pb/Pr Gain:
Adjust RGB, Component or HDTV Gain to match multiple projector color uniformity.

Lens Memory

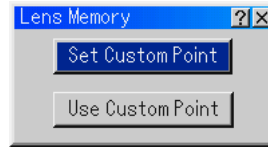

This function serves to store or apply the adjusted value when using the Shift, Focus and Zoom buttons on the projector or the remote control.

Set Custom Point Store the current adjusted values in memory.

Use Custom Point Apply the adjusted values to the current signal.

NOTE:

- To enable the Lens Memory feature, select [Ref. Adjust] → [Ref. Lens Memory] and place a check mark next to "Yes" for [Use Point on Signal Change?].
- The Lens Memory feature is not available in the Link Mode.
- To store adjusted values common to all the input sources, use the Ref. Lens Memory. See page 8-13.

Signal Type

RGB/Component



Select either the RGB signal type or the Component signal type.

RGB RGB signal

Component .. Component signals such as Y/Cb/Cr, Y/Pb/Pr

NOTE: This feature is available on RGB 1 and 2 only. If you do not get a better picture even when you set "Signal Select" to "Component" in Setup, set this to "Component".

Sound

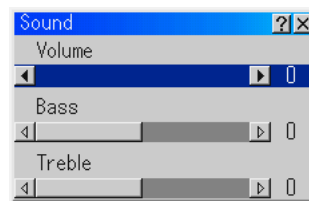

Volume/Bass/Treble

Controlling Volume, Bass and Treble.

Adjusts the sound, bass and treble level of the projector speaker and AUDIO OUT (RCA).

Ref. Adjust

Using 3D Reform

This feature corrects trapezoidal distortion so that the projected image is rectangular.

Two options are available for correcting procedures.

You can save adjustment settings by using the 3D Reform Save option on Setup (See page 8-16).

Cornerstone



See page 3-4.

* When "Resolution" is set to "Native", "Cornerstone" and "Keystone" are not available.

Keystone

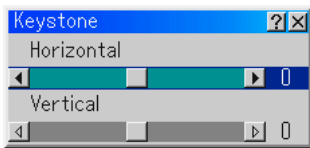

1. Press the SELECT ◀ or ▶ button to adjust the horizontal keystone.
2. Press the SELECT ▲ or ▼ button to select "Vertical".
3. Press the SELECT ◀ or ▶ button to adjust the vertical keystone.
4. After completing, press the ENTER button. This will return to the menu screen.

Screen

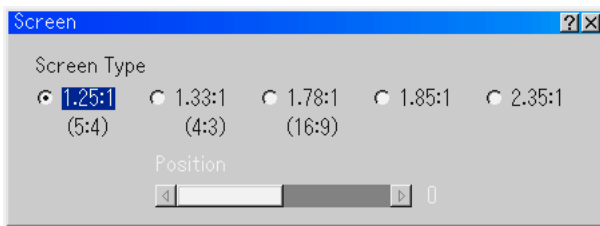

Screen Type

Select the correct aspect ratio for the screen to be used. See also "Aspect Ratio" on page 8-10.

NOTE: When "Resolution" is set to "Native", this selection is inactive.

Position

This feature adjusts the vertical position of the image when viewing video with an aspect ratio selected.

When some aspect ratios are selected in Image Options, the image is displayed with black borders on the top and bottom.

You can adjust the vertical position between top and bottom.

NOTE: This option is available only when "1.78:1 (16:9)", "1.85:1" and "2.35:1" are selected in Screen Type and Aspect Ratio.

NOTE: During 3D Reform adjustment, "Screen Type" and "Screen Position" may not be available. To make available, first reset the 3D Reform data and then do settings again. Secondly repeat the 3D Reform adjustment. Changing "Screen Type" and "Screen Position" can limit 3D Reform in its adjustable range.

Reference White Balance [Ref. White Balance]



Brightness R/G/B, Contrast R/G/B

This feature adjusts the white balance that is used as a reference. This adjustment affects all sources.

Reference Color Correction [Ref. Color Correction]



Red/Green/Blue/Yellow/Magenta/Cyan/Color Gain

This option allows you to adjust red, green, blue, yellow, cyan, magenta or color gain.

Reference Lens Memory [Ref. Lens Memmory]

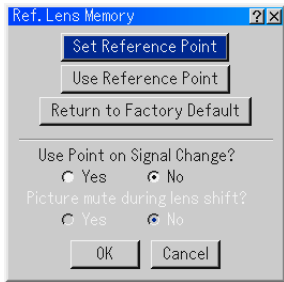

This function serves to store the adjusted value common to all input sources when using the Shift, Focus, and Zoom buttons of the main unit or the remote control.

- Set Reference Point Stores the current adjusted values in memory as a reference.
- Use Reference Point Applies the adjusted values stored in Set Reference Point to the current signal.
- Return to Factory Default Returns the adjusted values to the factory default setting.
- Use Point on Signal Change? For change to take effect at the time of source selection, select "Yes".
- Picture Mute during Lens Shift? ... To turn off the image and sound during lens shift, select "Yes".

NOTE: This option is only available when "Yes" is selected for "Use Point on Signal Change?".

Even if "CANCEL" is executed, changes to "Set Reference Point", "Use Reference Point" and "Return to Factory Default" will not be canceled.

* See "Tips on Adjusting Focus" on page 3-4 for more information.

NOTE:

- Adjusted values in Ref. Lens Memory will not be returned to default by using the Factory Default.
- To store adjusted values for each input source, use the Lens Memory.

NOTE: In the Link mode the Lens Memory feature is not available.

Factory Default

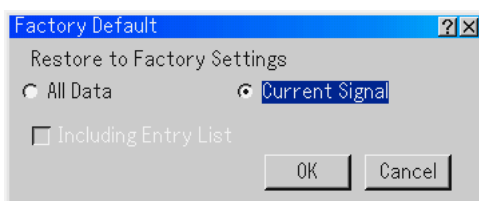

All Data /Current Signal

The Factory Default feature allows you to change adjustments and setting to the factory preset for source.

- All Data Reset all the adjustments and settings for all the signals to the factory preset except Ref. Lens Memory, Language, Background Logo, Communication Speed, Projector ID, Lamp Settings, LAN Mode, Password, Security, Remaining Lamp1/2 Time, Lamp 1/2 Hour Meter, Filter Usage and Projector Usage.

Including Entry List:

Also deletes all the signals in the Entry List and returns to the factory preset.

NOTE: Locked signals in Entry List cannot be deleted.

Current Signal

..... Resets the adjustments for the current signal to the factory preset levels.

All the items in "Adjust (Source)" and "Sound" can be reset.

NOTE: Locked signals in Entry List cannot be reset.

Projector Options

Menu

[Page 1]

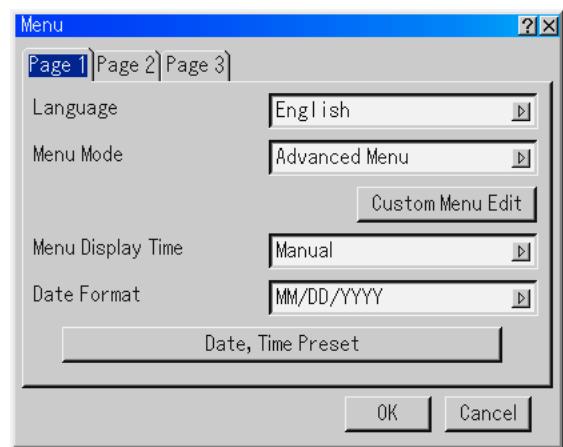

Selecting Menu Language [Language]

You can choose one of seven languages for on-screen instructions. The options are: English, German, French, Italian, Spanish, Swedish and Japanese.

Selecting Menu Mode [Menu Mode]

This feature allows you to select 4 menu modes: Advanced, Custom, Basic and Service Menu.

Advanced Menu This is the menu that contains all the available menus and commands.

Basic Menu This is the basic menu that contains minimum essentials of menus and commands.

Custom Menu This is the menu that you can customize using the Custom Menu Edit to fit your needs.

Service Menu For service personnel only.

Customizing the Menu [Custom Menu Edit]

See page 8-2 for instructions about how to customize the Menu.

Selecting Menu Display Time

This option allows you to select how long the projector waits after the last touch of a button to turn off the menu. The preset choices are "Manual", "Auto 5 sec", "Auto 15 sec", and "Auto 45 sec". The "Auto 45 sec" is the factory preset.

Manual The menu can be turned off manually.

Auto 5 sec ... The menu will automatically be turned off in 5 seconds if no buttons are pressed within 5 seconds.

Auto 15 sec . The menu will automatically be turned off in 15 seconds if no buttons are pressed within 15 seconds.

Auto 45 sec . The menu will automatically be turned off in 45 seconds if no buttons are pressed within 45 seconds.

Selecting Date Format

Eight display formats can be selected. This date format sets the current date that appears on the upper left corner of the screen.

Setting the Current Date and Time [Date, Time Preset]

You can set the current time, month, date, and year.

1. Type in date.

Enter month, date and year in this order using Source/Input buttons on the remote control.

Month and date must be entered in two digits. For example, to display "February", press "0" and "2".

2. Type in time.

Time is expressed in the 24-hour format. For example, 6:00 p.m. is entered as 18:00.

3. Select "OK" and press ENTER.

Closing the window allows the clock to start.

The current year, month, date and time are displayed on the top of the screen.

NOTE: The projector has a built-in clock. The clock will keep working for about 3 days after the main power is turned off. If the main power is off for 3 days or more, the built-in clock will cease. If the built-in clock ceases, set the date and time again. The built-in clock will not cease while in the standby or idle condition.

[Page 2]

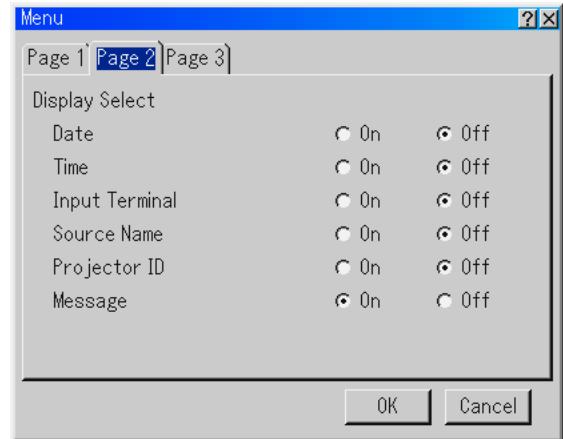

Display Select

You can choose the desired status information to be displayed on the screen.

The information selections are:

Date, Time, Input Terminal, Source Name, Projector ID and Message.

The Message selections are:

Lamp life warning, lamp error, 3-minute before power off time, clean filter, lock in Security and "Wait a moment".

[Page 3]

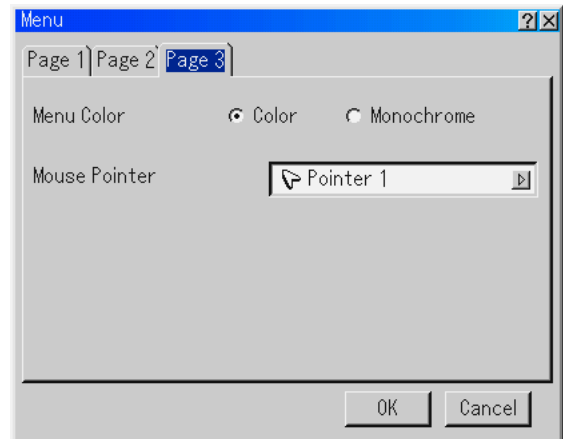

Selecting Menu Color [Menu Color Select]

You can choose between two color modes for menu color: color and monochrome.

Selecting Mouse Pointer Icon [Mouse Pointer]

This enables you to select from nine different mouse icons when using a USB mouse.

NOTE: There may be cases where the Pointer function is not available (ex. a non-interlace signal at 15kHz such as video game.)

Setup

[Page 1]

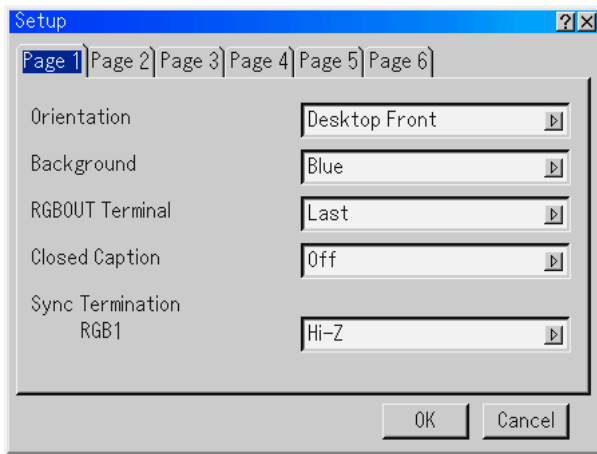

Selecting Projector Orientation [Orientation]

This reorients your image for your type of projection. The options are: desktop front projection, ceiling rear projection, desktop rear projection, and ceiling front projection.

Selecting a Color or Logo for Background [Background]

Use this feature to display a blue/ black screen or logo when no signal is available. The default background is "Blue". You can change the logo screen using the PC Card Files feature. See pages 4-4.

Setting RGB 1 or 2 for RGB OUT [RGBOUT Terminal]

This option allows you to determine which RGB source is output from the RGBOUT connector during Idle mode.

- Last The signal from the last RGB input will be output to the RGBOUT connector.
- RGB 1 The signal from RGB1 will be output to the RGBOUT connector.
- RGB 2 The signal from RGB2 will be output to the RGBOUT connector.

NOTE:

- The AUDIO OUT jack (RCA) will not output sound during the Idle mode.
- The RGB signal can be output even when Video, S-Video, Viewer and LAN is selected.
- When the DVI (DIGITAL) input is selected, the RGB OUTPUT terminal will not output signal.

Setting Closed Caption

This option sets several closed caption modes that allows text to be superimposed on the projected image of Video or S-Video.

- CAPTION 1-4 ... Text is superimposed.
- TEXT 1-4 Text is displayed in full screen.
- OFF This exits the closed caption mode.

Sync Termination (RGB1)

This function is used to select the impedance of the sync signal. Select " 75Ω" or "Hi-Z".

NOTE: This should be "75Ω" for normal use. Select the "Hi-Z" when inputting a TTL signal.

[Page 2]

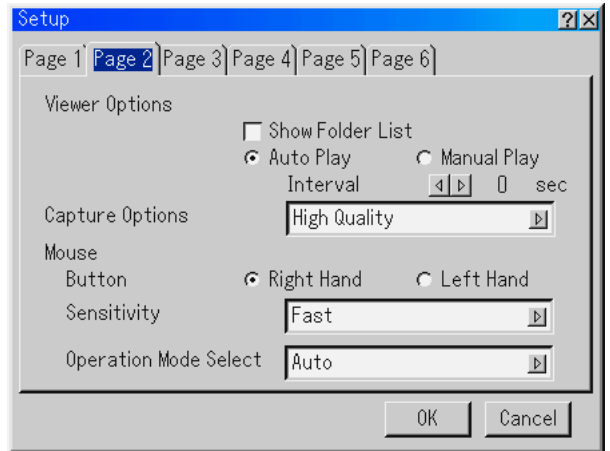

Setting Viewer Options [Viewer Options]

Show Folder List:

If this option is checked, when the Viewer source is selected on the projector, the folder lists will be displayed and allows you to select the presentation from a PC card.

Auto Play:

If this option is checked, when the Viewer source is selected on the projector any given slide will start to play automatically.

Auto Play Interval:

You can specify interval time between 5 and 300 seconds.

NOTE: The Auto Play Interval time set on "Slide Show Settings" of the Dynamic Image Utility 2.0 overrides the one set here.

Manual Play:

Views a slide manually when the Viewer source is selected.

Selecting Capture Options [Capture Option] (GT5000 only) (available for JPEG only)

These options are used for the Capture function that you can select from Tools. You have three options for JPEG compression quality: High quality, Normal and High Compression.

- High Quality Gives quality of JPEG a priority.
- Normal Gives normal JPEG quality.
- High Compression ... Gives compression a priority.

Setting Mouse Button and Sensitivity [Mouse]

This option lets you to change your USB mouse settings. The mouse settings feature is available for USB mouse only. Choose the settings you want:

- Mouse Button "Right Hand" or "Left Hand"
- Mouse Sensitivity "Fast", "Medium" or "Slow"

Selecting Operation Mode [Operation Mode Select]

Set the operation mode of the USB mouse connected to the USB port (MOUSE/HUB) on the projector

Auto Depending on connection of the USB port (PC) on the projector and a USB port (type A) on your PC, the USB mouse is operated in the following way:

- * When connecting the projector to your PC
The USB mouse connected to the projector can be used as a PC mouse.
- * When not connecting the projector to your PC
The USB mouse connected to the projector can perform menu operation of the projector.

Projector The USB mouse connected to the projector can perform menu operation of the projector.

[Page 4]

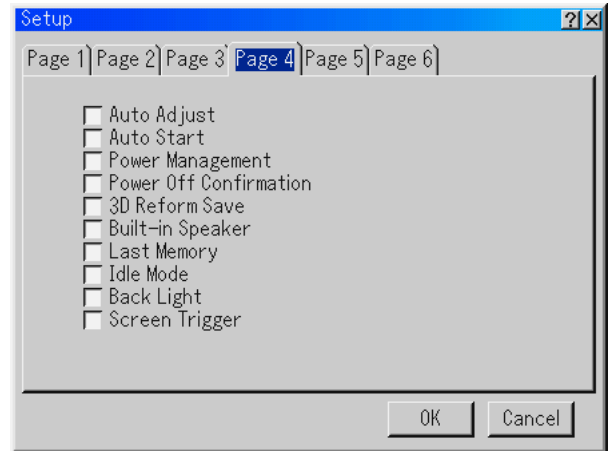

[Page 3]

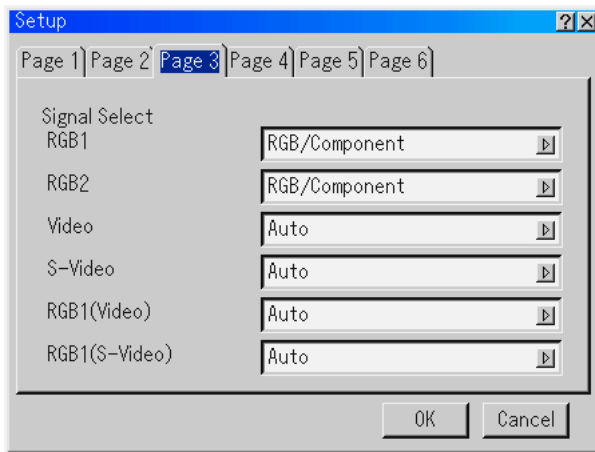

Selecting Signal Format [Signal Select]

RGB1/2

Allows you to choose "RGB" for an RGB source such as a computer, or "Component" for a component video source such as a DVD player.

Normally select "RGB/Component" and the projector automatically detects an either incoming signal. However there may be some component signals that the projector is unable to detect. If this is the case, select "Component". Select "Scart" in RGB 1 or 2 for the European Scart.

VIDEO, S-VIDEO and RGB1 (Video and S-Video)

This feature enables you to select composite video standards manually.

Normally select "Auto". Select the video standard from the pulldown menu. This must be done for Video and S-Video separately and "VIDEO" or "S-VIDEO" for RGB1 connector.

Enabling Auto Adjust [Auto Adjust]

When "Auto Adjust" is set to "On", the projector automatically determines the best resolution for the current RGB input signal to project an image using NEC's Advanced AccuBlend Intelligent Pixel Blending Technology.

The image can be automatically adjusted for position and stability; "Horizontal Position", "Vertical Position", "Clock", "Phase", and "Resolution".

On Automatically adjusts image "Horizontal Position", "Vertical Position", "Clock", "Phase" and "Resolution".

Off User can adjust the image display functions ("Horizontal Position", "Vertical Position", "Clock", "Phase" and "Resolution") manually.

Enabling Auto Start [Auto Start]

Turns the projector on automatically when the power cable is inserted into an active power outlet and the main power switch is turned on.

This eliminates the need to always use the "Power" button on the remote control or projector cabinet.

Enabling Power Management [Power Management]

When this option is on and there is no input for five minutes or more, the projector will automatically turn itself off.

Enabling Power Off Confirmation [Power Off Confirmation]

This option determines whether a confirmation dialog for turning off the projector will appear or not.

Enabling Horizontal and Vertical Keystone Correction Save [3D Reform Save]

This option enables you to save your current 3D Reform settings. Saving your change once affects all sources. The changes are saved when you turn off the projector.

Selecting Built-in Speakers [Built-in Speaker]

This option allows you to mute the built-in speakers.

Enabling Last Memory [Last Memory]

The projector stores the last signal data in memory for each input (RGB1, RGB2, DVI DIGITAL, Video, S-Video and Slot 1/2).

This feature will reduce switching time between sources. If a commercially available switcher is connected, turning on this feature may cause the image to appear incorrectly. Should this happen, turn this feature off to mute the screen during switching.

Enabling Idle Mode [Idle Mode]

The projector has two standby modes: Standby and Idle.

Standby is the mode that allows you to put the projector in the standby condition which consumes less power than the idle mode. The projector is preset for Standby at the factory.

When this check box is turned on, you allow the RGB OUT connector to output RGB signal during Idle mode.

NOTE:

* The RGB OUT connector will not output signal during the Standby mode.

* Via the USB interface the projector can be turned on from your PC using Dynamic Image Utility 2.0 during the Standby or Idle mode. On the LAN connection the projector can be controlled or monitored from your PC using Dynamic Image Utility 2.0 only in the Idle mode.

* The HTTP server functions are not available during Standby mode. See page 10-11.

Turning on or off the Back Light [Back Light]

This function turns on or off the backlight of the buttons on the cabinet.

NOTE: The Back Light feature is available in the normal operating mode or the idle mode only.

Enabling Screen Trigger [Screen Trigger]

When "Screen Trigger" is selected and the projector is powered ON, the screen trigger output sends a low voltage trigger to the screen controller and the screen will go down. When the projector is powered OFF the screen trigger stops sending a low voltage trigger to the screen controller and the screen will go up. Use a commercially available stereo mini cable.

[Page 5]

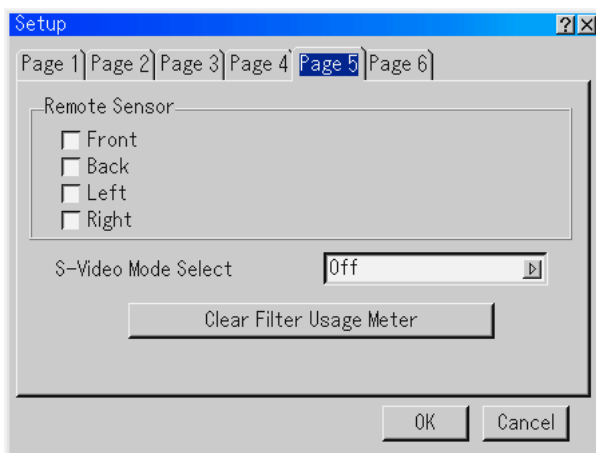

Remote Sensor

This option determines which remote sensors on the projector are enabled in wireless mode.

The options are: front, rear, right, or left. All checked boxes indicate that they can accept the infrared signal from the supplied remote control.

S-Video Mode Select:

This feature is used to select the S-Video signal detection mode. This allows identifying of the S-Video signals with different aspect ratio (16:9 and 4:3).

Off Does not identify any S-video signal.

S2 Identifies the 16:9 or 4:3 signal.

NOTE: The Aspect Ration is not available when S2 signal is detected.

Resetting the Filter Usage Hours [Clear Filter Usage Meter]

Resets the filter usage back to zero. Pressing this button appears a confirmation dialog box. To reset the filter usage hours, press "OK".

[Page 6]

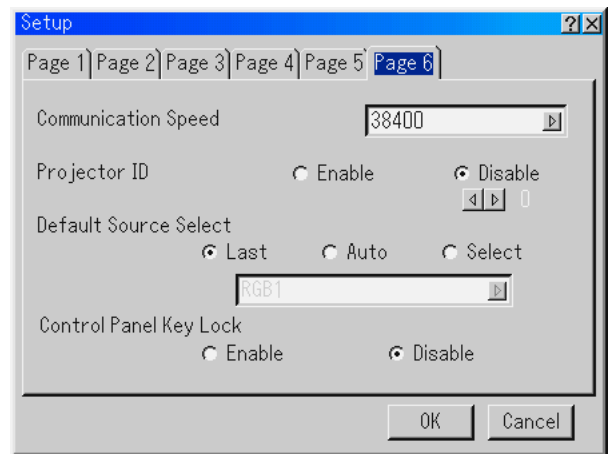

Selecting Communication Speed [Communication Speed]

This feature sets the baud rate of the PC CONTROL port (D-Sub 9 Pin). It supports data rates from 4800 to 38400 bps.

The default is 38400 bps. Select the appropriate baud rate for your equipment to be connected (depending on the equipment, a lower baud rate may be recommended for long cable runs).

Enabling and Disabling Projector ID

Each projector needs its own unique addresses when used in serial communication mode. You can choose one of 64 unique address using the spin box. First select Enable. Keep pressing ► button increases the number. To make your setting available, select OK.

Selecting Default Source [Default Source Select]

You can set the projector to default to any one of its inputs each time the projector is turned on.

Last Sets the projector to default to the previous or last active input each time the projector is turned on.

Auto Searches for an active source in order of RGB1 → RGB2 → DVI(DIGITAL) → Video → S-Video → Viewer → Slot 1 → Slot 2 → RGB1(Video) → RGB1(S-Video) → RGB1 and displays the first found source.

Select Displays the selected source input every time the projector is started up. Select an input from the pull-down menu.

Disabling the Cabinet Buttons [Control Panel Key Lock]

This option turns on or off the Control Panel Key Lock function.

NOTE:

* This Control Panel Key Lock does not affect the remote control functions.

* When the cabinet buttons are disabled, pressing and holding the CANCEL button for about 10 seconds will change the setting to enable.

Lamp Settings

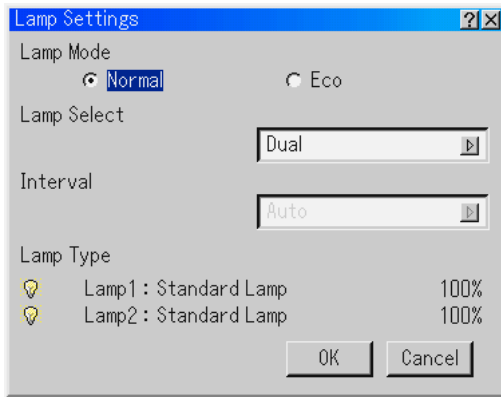

The projector is designed to accept two lamps (dual lamp system). This dual lamp system provides prolong lamp life or high brightness or extra lamp (Extended life lamp).

NOTE: Be sure to use the same lamp type for both lamp 1 and 2.

Lamp Mode

This feature enables you to select two modes of the lamp: Normal and Eco. The lamp life can be extended by using the Eco mode.

Normal Mode . This is the default setting (100% Brightness).

Eco Mode Select this mode to increase the lamp life (80% Brightness).

NOTE: When the optional Extended life lamp is used, the Lamp Mode is fixed to Eco mode.

Lamp Select

This feature allows you to select which lamp to be used.

NOTE: This option is not displayed in the Basic menu.

* Changes to these options will not take effect for 90 seconds immediately after the lamp is turned off (120 seconds for the extended life lamp).

* The lamp cannot be turned off for 60 seconds immediately after the lamp is turned on. Changes to these options cannot take effect until then.

Dual Select to use the two lamps at the same time to increase brightness.

Lamp1/2 Select to use one lamp of the two lamps. (Lamp 1 on the right side and Lamp 2 on the left side when viewed from the front)

Interval

This allows you to specify the time for switching between the two lamps alternately. This option is available only when "Lamp1" or "Lamp2" is selected. When Auto is selected and one lamp has reached the end of its usable life, the other lamp is turned on. The lamp cannot be turned off for 60 seconds immediately after the lamp is turned on.

NOTE: This option is not displayed in the Basic menu.

Lamp Type:

The lamp type you use and its information are displayed here.

The information displayed here are:

Light on or off, standard lamp or extended life lamp and remaining hours.

Link Mode

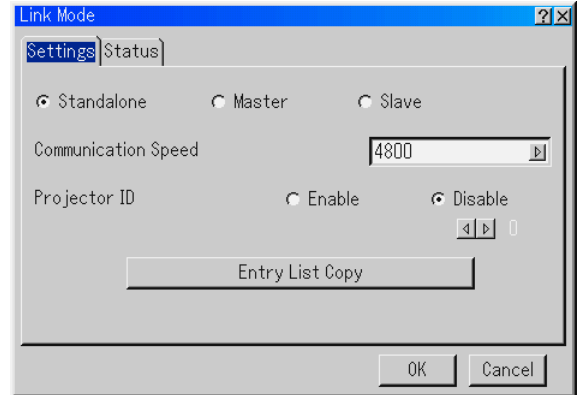

Settings

Selecting Standalone/Master/Slave

This feature is used for multiple projector connection. The master projector is set to Master. The other slave projectors are set to Slave. When not using Link mode, set to Standalone. See page 7-5 for setting up for double stacking in link mode.

Selecting Communication Speed [Communication Speed]

This feature sets the baud rate of the PC CONTROL port (D-Sub 9 Pin). This is the same procedure as in "Page 6" of "Setup".

Enabling and Disabling Projector ID:

Each projector needs its own unique addresses when used in serial communication mode. This is the same procedure as in "Page 6" of "Setup".

Copying Signals in the Entry List

Press the Entry List Copy button to copy all of the signals recorded in the Entry List from one projector to another.

Status

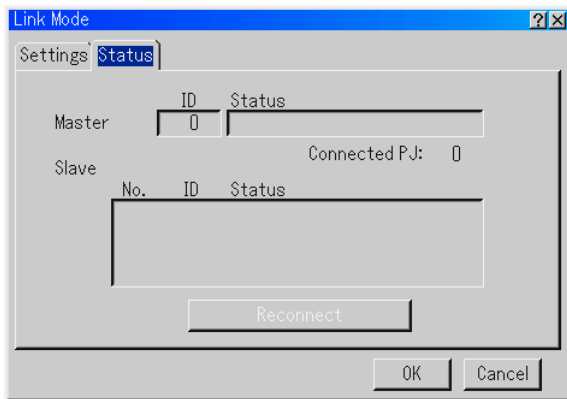

Displaying Current Status of Link Mode

When selecting the tab "Status", you will get the following dialog box.

Master ID	Indicates the Master projector
Status	Indicates the status of the master projector
Connected PJ	Indicates number of connected slave projectors
Slave No	Indicates serial number of the slave projector
ID	Indicates ID of a slave projector
Status	Indicates the status of the slave projector
Reconnect button	Confirms connection of all linked projectors

Status items

Running	The projector is now working
Cooling Lamp	The fan is now cooling the lamp
Standby	The projector is in stand-by or idle.
Communication Error ...	A communication error has occurred
Connecting	The projector is now verifying for connection
Error Standby	An error caused the projector to enter the stand-by mode.

LAN Mode

This feature allows you to set various setting items when the projector is used on your network.

Consult with your network administrator about these settings.

NOTE:

- Connect an Ethernet LAN cable to the LAN port (RJ-45) of the projector for network connection.
- NEC's optional wireless LAN card is available. For more information on inserting or ejecting a LAN card, see page 5-2.
- Either PC Card Slots 1 or 2 can accept LAN card. If two LAN cards are inserted into both PC card slots, the first inserted one is effective.
- The standard built-in LAN feature and a commercially LAN card are available for network connection, but only one can be used at a time (mutual exclusion).

CAUTION: Make sure that the LAN card is removed during Standby mode (NOT Idle mode) or with the main power off. Failure to do so may cause damage to the LAN card, or may cause the projector to malfunction. Should a malfunction occur, turn off the main power and turn it back on.

Status

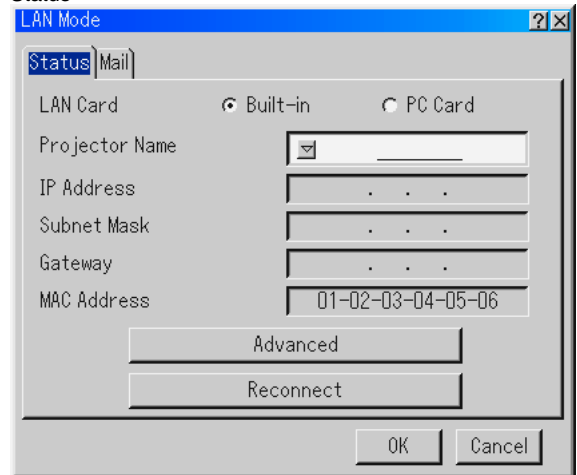

LAN Card

This option selects to use either LAN feature between the standard LAN port (RJ-45) and an optional LAN card inserted in the PC CARD slot.

Projector Name

Specify a unique projector name. Press ▼ to display the software keyboard and type in. Up to 16 alphanumeric characters can be used.

IP Address

Indicates the IP address of the projector.

Subnet Mask

Indicates the subnet mask of the projector.

Gateway

Indicates the gateway of network connected to the projector.

MAC Address

Indicates the MAC address of the LAN card.

Advanced

Displays the IP Address setting window.

Reconnect

Use this button to connect the projector to a network.

NOTE: Once you have selected "OK" on the Advanced screen, you cannot cancel the changes using "Cancel" on the LAN Mode screen.

Advanced

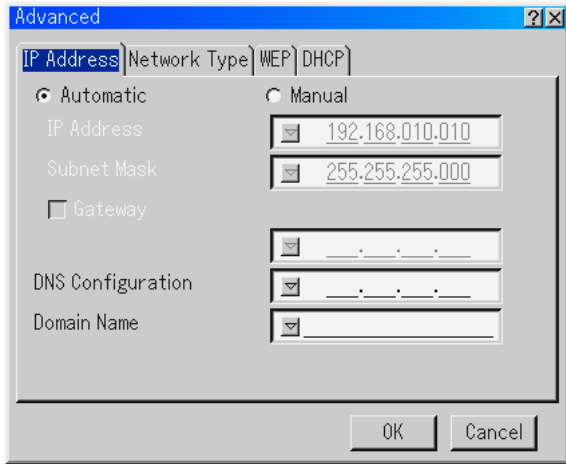

Network Type (required for wireless only)

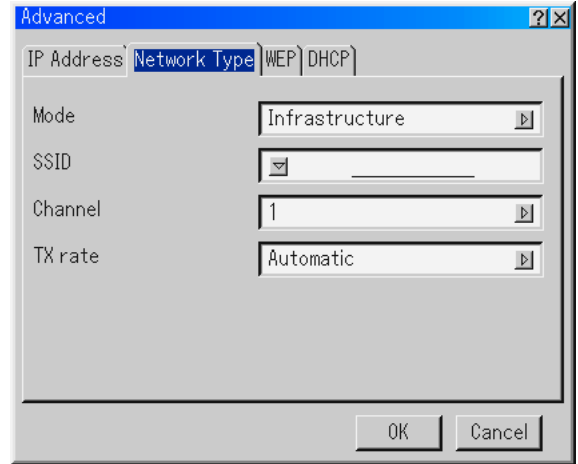

IP Address

An IP address can be automatically assigned to this projector by your DHCP server. If your network does not automatically assign IP address, ask your network administrator for an address, and then register it manually.

Automatic Automatically assigns an IP address to the projector from a DHCP server.

Manual Provides a space for you to register the IP address or subnet mask number obtained from your network administrator.

IP Address ... Set your IP address. Press ▼ to display the software keyboard and type in 12 numeric characters.

Subnet Mask Set your subnet mask number. Press ▼ to display the software keyboard and type in 12 numeric characters.

Gateway Set the default gateway of the network connected to the projector. Press ▼ to display the software keyboard and type in 12 numeric characters.

Checking this box will make the set default route valid.

When data is sent from the LAN card, the transfer location will be searched according to the previously set routing information; however, when the transfer location has not been found as a result of the search, the data will be sent to the device that holds the IP address set here. The IP address that is set here must be one that can be identified by a search of the routing information.

DNS Configuration

..... Type in the IP address of DNS server on the network connected to the projector.
12 numeric characters are used.

Domain Name

..... Type in domain name of the network connected to the projector. Up to 60 alphanumeric characters can be used.

Mode:

Select communication method when using wireless LAN.

Infrastructure

..... Select this option when communicating with one or more equipment connected to the wireless or wired LAN network via an access point.

802.11 Ad Hoc

..... Select this option when using the wireless LAN to communicate with a computer in a one-to-one correspondence. This is a method that meets the IEEE802.11 wireless standard.

Ad Hoc Select this option when using the wireless LAN to communicate with a computer in a one-to-one correspondence.

Easy Connection

..... This allows you to easily set up wireless LAN connection. See the Software Utility Installation section for more information.

See chapter 6 "Using the Projector in a Network".

SSID (Network name):

Enter an identifier (SSID) for wireless LAN. Communication can be done only with equipment whose SSID matches SSID for your wireless LAN. Up to 32 alphanumeric characters can be used (Case sensitive).

NOTE: To disable SSID, select a space (null) or "ANY"(All caps).

Channel:

Set this option when selecting [802.11 Ad Hoc] or [Ad Hoc] in [Mode].

Select a channel number from the pull-down list. The channel must match for all wireless devices communicating on your wireless LAN.

NOTE: Channels in the pull-down list are different depending on which country you live in.

TX rate:

Select a wireless transmission speed. Normally leave it as Automatic.

Try another transmission speed when the connection fails.

WEP (for Wireless only)

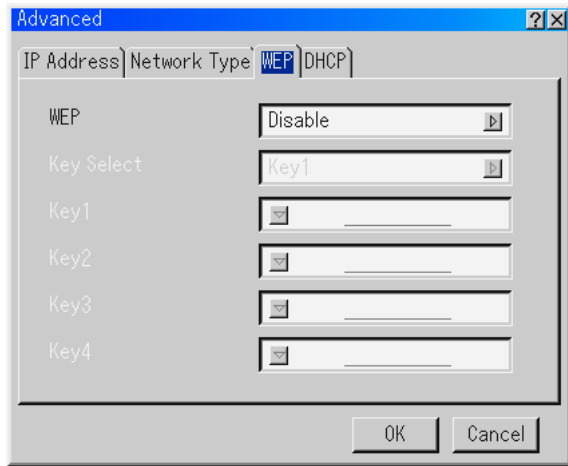

Select this option whether using the WEP (Wired Equivalent Privacy) key for encryption or not. To use encryption, specify WEP key.

- Disable Will not turn on the encryption feature. Your communications may be monitored by someone.
- 64bit Uses 64-bit datalength for secure transmission.
- 128bit Uses 128-bit datalength for secure transmission. This option will increase privacy and security when compared to use of 64bit datalength encryption.

NOTE: The WEP settings must be the same as communication devices such as PC or access point in your wireless network. When you use WEP, your image transmission speed will slow down.

Key Select:
Selects one key from the four keys below when selecting [64bit] or [128bit] in [WEP].

Key1-4:
Enter encryption key when selecting [64bit] or [128bit] in [WEP]. Up to 5 characters can be set in 64 bit and up to 13 characters in 128 bit. Press the "HEX" button to change to "ASCII" to set the key in ASCII digit. You can toggle this button between "ASCII" and "HEX".

The key can also be set in hexadecimal digit.
 * Hexadecimal uses 0 to 9 and A to F.
 * Up to 10 characters can be set in 64 bit and up to 26 characters in 128 bit.

NOTE: Only numbers can be entered when you use the remote control Source/ Input buttons.

DHCP

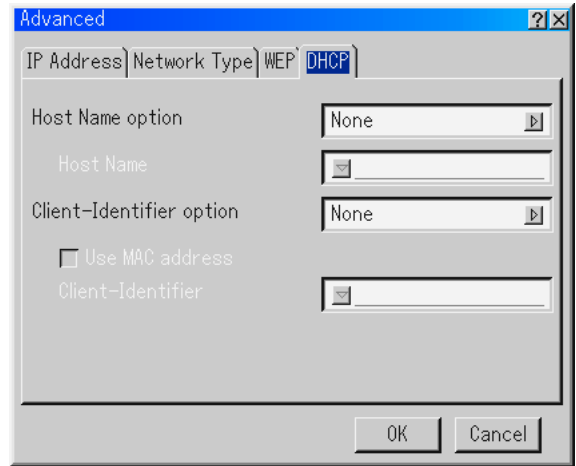

Depending on your network environment, acquiring an IP address from a DHCP server may not be possible. Should this happen, consult your network administrator to make changes to the following settings.

- Host Name option**
Select whether or not to add option hostname for DHCP.
None Not add
Request Add at the time of DHCP_REQUEST.
Discover/Request Add at the time of DHCP_DISCOVER and DHCP_REQUEST.

Host Name
Type in a hostname. This field is available only when "Request" or "Discover/Request."

- Client-identifier option**
Select whether or not to add option client identifier for DHCP.
None Not add
Request Add at the time of DHCP_REQUEST.
Discover/Request Add at the time of DHCP_DISCOVER and DHCP_REQUEST.

Use MAC address
Turn on to use MAC address for Client-identifier.

Client-identifier
Type in a client identifier.

Mail

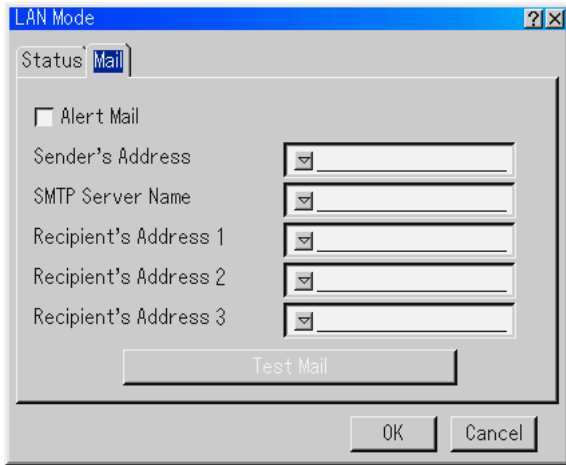

NOTE: To the Mail Alert feature on wireless LAN connection, select "Infrastructure" for "Mode" in "Network Type".

Alert Mail:

Checking this box enables Alert Mail feature.

This option notifies your computer of an error message via e-mail when using wireless or wired LAN. The error message will be notified when the projector lamp has reached the end of its usable life or an error occurs in the projector.

Sample of a message sent from the projector:

The lamp is at the end of its usable life. Please replace the lamp.

Projector Name: X X X X

Lamp 1 Hour Meter: xxxx [H]

Lamp 2 Hour Meter: xxxx [H]

Projector Usage: xxxxxx [H]

Sender's Address:

Specify the sender's address. Use the Software keyboard. Up to 60 alphanumeric and symbols characters can be used. See "Using Software Keyboard" in Appendix for more details.

SMTP Server Name:

Type in the SMTP server name to be connected to the projector. Up to 60 alphanumeric characters can be used.

Recipient's Address 1 to 3:

Type in your recipient's address. Up to 60 alphanumeric and symbols characters can be used.

Test Mail:

Send a test mail to check if your settings are correct.

NOTE: If you entered an incorrect address in a test, you may not receive an Alert mail. Should this happen, check if the Recipient's Address is correctly set.

NOTE: Unless any one of the "Sender's Address", "SMTP Server's Name" or "Recipient's Address 1-3" is selected, "Test Mail" is not available.

NOTE: Be sure to highlight "OK" and press the ENTER button before executing "Test Mail".

Setting a Password

A password can be set for your projector to avoid operation by an unauthorized person.

There are two password options: one for menu and the other for logo.

When a password is set, doing any one of the following four operations will display the Password input screen.

For Menu:

- * Changing the menu to *Advanced*
- * Editing the custom menu

For Logo:

- * Changing the background
- * Changing the logo data in *PC Card Files*

Procedures for Password setting apply to both Menu and Logo.

Entry

To assign your password:



NOTE: Up to 15 alphanumeric characters can be assigned.

- Only numbers can be entered when you use the remote control Source/Input buttons.

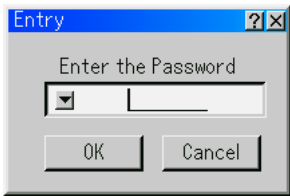

1. Type a password.
Highlight "Entry" and press the ENTER button.
The "Enter the Password screen" will be displayed.

Make sure that "▼" is highlighted and then press the ENTER button.
The Software keyboard appears. Use the Software keyboard to type a password and then highlight "OK" on the "Enter the Password" screen and press the ENTER button.
The [Confirm Password] screen will be displayed.

2. Type the same password again. Highlight "OK" on the "Enter the Password" screen and press the ENTER button.

Your password will be assigned.

Delete

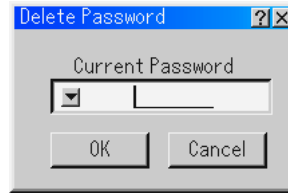

To delete your password:

1. Highlight [Delete] and press the ENTER button. The "Current Password" screen will be displayed.
2. Use the Software keyboard to type your password. Highlight "OK" on the "Current Password" screen and then press the ENTER button.

Your password will be deleted.

In case you forget your password, follow the steps below to delete it.

1. Select the *Advanced* menu from the *Basic* menu. The "Password" entry screen will be displayed.
2. Use the Software keyboard to type "1111".
Highlight "OK" on the "Password" entry screen and then press the ENTER button.
The "Password Warning!!" message will be displayed.
3. Use the Software keyboard to type "3333".
Highlight "OK" on the "Password" entry screen and then press the ENTER button.
The "Password Warning!!" message will be displayed.
4. Use the Software keyboard to type "5555".
Highlight "OK" on the "Password" entry screen and then press the ENTER button.
The "Delete Password. Are you sure? Yes/No" dialog box will be displayed.
5. Use the SELECT ◀ or ▶ button to highlight "Yes" and press the ENTER button.

Your password will be deleted.

Security

The Security function enables you to protect your projector so that the projector will not project a signal unless you enter a keyword. There is also an option to lock the projector by using a registered PC card as a protect key. Once you have registered your PC card as a protect key, you are required to insert the registered PC card into the PC card slot of the projector each time you turn on the projector. You can enable the Security function by using a keyword only.

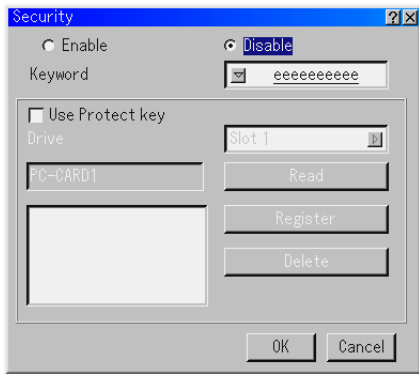

- Enable/Disable This turns the Security function on or off.
- Keyword Enter an appropriate keyword when you use the Security function.
(Up to 10 characters can be used.)
The Security function is available only when your keyword is entered.
- Use Protect key Check this box to lock your projector when using a PC card. To use a keyword without a PC card, do not check this box.
- Drive Switches between PC Card slots.
- Read Reads data of a PC card.
- Register Registers data of the PC card.
The Security function is not available unless at least one PC card is registered. (if the "Use Protect key" check box is selected)
Up to 5 PC cards can be registered.
- Delete Deletes data of a registered PC card.

To set up a keyword to enable the Security function without using a registered PC card.

NOTE: Only numbers can be entered when you use the remote control Source/ Input buttons.

1. Use the SELECT ▲▼ button to select "Keyword" and use the software keyboard to enter a keyword.

NOTE: Please make a note of your keyword.

2. Use the SELECT ▲▼ button to select "Enable" and use the SELECT ▲▼ button to select "OK", then the Security function will be enabled. An "Are you sure?" message will appear. Use the SELECT ◀▶ button and press the ENTER button.
The Security function takes effect.

To register a PC card as a protect key.

1. Insert a PC card into the PC card slot of the projector.
2. Use the SELECT ▲▼ button to select "Use Protect key" and press the ENTER button. A check mark will be placed.
3. Use the SELECT ▲▼ button to select "Read" and press the ENTER button.
Data of the PC card will be read into the projector.
4. Use the SELECT ▲▼ button to select "Register" and press the ENTER button.
Downloaded data will be registered and be displayed in the list window.
5. Use the SELECT ▲▼ button to select "Keyword" and use the software keyboard to enter a keyword.

NOTE: To use a PC card as a protect key, you must also set up a keyword. Please make a note of your keyword.

This completes registration of your PC card.

To enable Security, use the SELECT ▲▼ button to select "Enable" and use the SELECT ▲▼ button to select "OK" and "Security function will be enabled. An "Are you sure?" message will appear. Use the SELECT ◀▶ button and press the ENTER button.

The Security function takes effect.

To turn on the projector when Security is enabled (when using your keyword only).

NOTE: Only numbers can be entered when you use the remote control Source/ Input buttons.

1. Press and hold the POWER button for a minimum of two seconds.
The projector will be turned on and display a message to the effect that the projector is security-protected.
2. Select [Projector Options] → [Security] from the menu and press the ENTER button.
The Release Code input screen will be displayed.
3. Enter your keyword in the Release Code input screen.
You can view the projected image.

NOTE: Do not forget your keyword. However, if you forget your keyword, NEC or your dealer will provide you with your Release Code. See more information at the end of this section.

To turn on the projector when Security is enabled (when using a PC card as a protect key).

1. Insert your registered PC card into the PC card slot.
2. Press and hold the POWER button for a minimum of two seconds.
The projector will turn on and then recognize the PC card. Once the image has been projected, it will stay on without the PC card.

- The security disable mode is maintained until the main power is turned off (by setting the main power switch to "O" or unplugging the power cable).

In the following cases you will be asked to check the protect key or input the keyword:

- (1) When "OK" is selected at an image for which security is set and the power is turned off then back on
- (2) When the main power is turned off then back on while the security function is enabled
- (3) When you attempt to display an image for which security is set while the security function is enabled

- Blanks (spaces) cannot be used in the Keyword section.

To delete PC card data you registered.

1. Use the **SELECT ▲▼** button to select "Delete" and use the **SELECT ◀** button to select the list window.
2. Use the **SELECT ▲▼** button to select the PC card data you wish to delete.
3. Press the **SELECT ▶** button to select "Delete" and press the **ENTER** button.
The PC card data will be deleted.

If you've lost your registered PC card, proceed as follows:

NOTE: Your dealer will provide you with your Release Code in exchange for your registered keyword and Request Code. See URLs at the end of this section.

1. Press and hold the **POWER** button for a minimum of two seconds.
The projector will be turned on and display a message to the effect that the projector is security-protected.
 2. Select [Projector Options] → [Security] from the menu and press the **ENTER** button.
The Release Code input screen will be displayed as well as your Request Code (24 alphanumeric characters).
 3. Enter your Release Code in the Release Code Input screen.
- * If the projector is turned on by entering the Release Code, your Security will be disabled.

NOTE:

- * Some types of PC cards cannot be registered as your protect key.
- * It is recommended that you register two or more PC cards in case you lose or damage your registered PC card.
- * Formatting your registered PC card will disable your protect key function.

NOTE:

For additional information visit:
 US : <http://www.necvisualsystems.com>
 Europe : <http://www.nec-europe.com/>
 Global : <http://www.nec-pj.com/>

Tools

Provides tools for setting On/Off timer, sleep timer, capturing images, displaying files or changing your background logo in a PC Card and drawing.

Timer

Enables you to turn on or off your projector automatically at a specified time. Two timer functions are available: On/Off Timer and Sleep Timer.

NOTE: The projector has a built-in clock. The clock will keep working for about three days after the main power is turned off. If the main power is not supplied to the projector for three days or more, the built-in clock stops working.

On/Off Timer

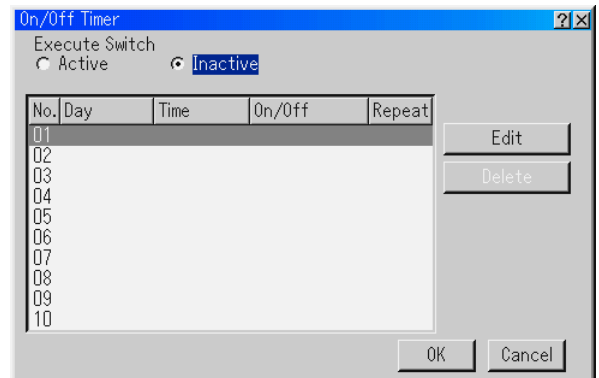

Up to 10 settings can be programmed.

- Before setting On/Off Timer, make sure that Date, Time Preset feature is set.
- Even after setting On/Off Timer, turning the projector on or off with the remote control is possible.

Setting the On or Off Timer

1. Open the On/Off Timer window.

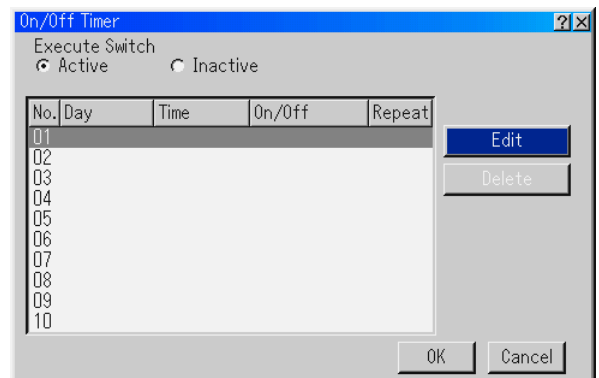

2. Select a program number (No. 1 to 10) by using the **SELECT ▲** or **▼** button.

3. Select "Edit" and press the ENTER button to open the Edit window.

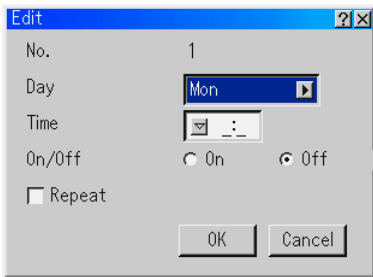

4. Set the Day, Time (24 hours format), On-Time and Off-Time using the SELECT buttons and the Software keyboard (1 thru 10).

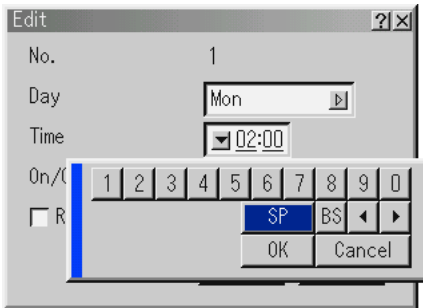

5. Select On Timer or Off Timer

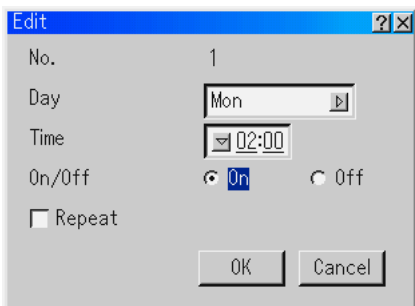

6. Repeat the Timer

To repeat the On Timer or Off Timer program every week, place a check mark in "Repeat".

7. Select "OK" and press the ENTER button on the remote control to complete the setting. To cancel this and return to its previous screen, select "Cancel".

NOTE: If there is no operation for 4 hours or more after the projector is turned on with On-Timer function, the projector will enter the standby or idle mode.

Enabling the On or Off Timer

1. To execute the setting, select "Active".

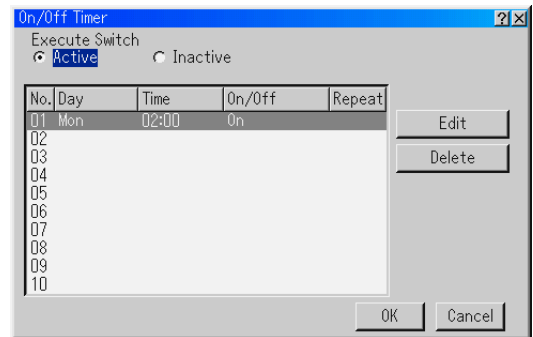

2. Select "OK" and press the ENTER button.

NOTE: When one program or more are specified, all the settings are active.

NOTE: The settings will be executed in numerical order. Finished settings will be automatically deleted.

NOTE: The On/Off Timer will not work while the cooling fans are running or an error message appears. Do not turn off the main power switch in this condition.

Disabling the On or Off Timer

To disable the setting, select "Inactive". Select "OK" and press the ENTER button.

Deleting the On or Off Timer settings

1. Select the setting you want to delete.

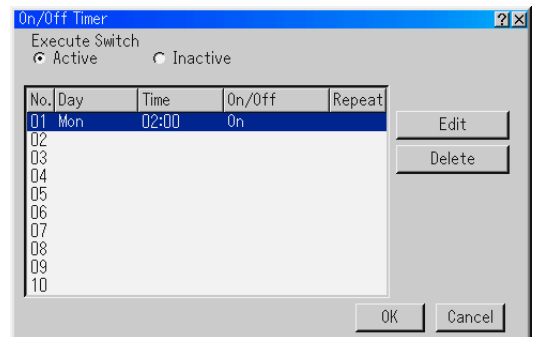

2. Select "Delete" and press the ENTER button.

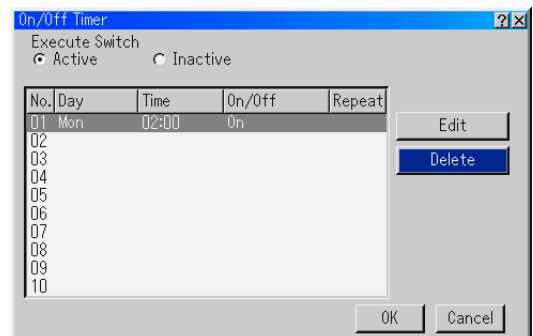

3. Select "OK" and press the ENTER button to complete the deletion.

4. Select "Delete" again and press the ENTER button to return to the previous screen.

Enabling Sleep Timer

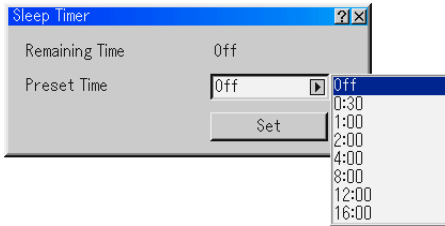

1. Select your desired time between 30 minutes and 16 hours: Off, 0:30, 1:00, 2:00, 4:00, 8:00, 12:00, 16:00.
2. Select "Set" and press the ENTER button on the remote control.
3. The remaining time starts counting down.
4. The projector will turn off after the countdown is complete.

NOTE:

- To cancel the preset time, set "Off" for the preset time or turn off the power.
- When the remaining time reaches 3 minutes before the projector is turned off, the "Projector will turn off in 3 minutes" message will be displayed on the bottom of the screen.

Using Capture



Allows you to capture an image from a source that is currently being displayed. The image is saved as JPEG in the PC card. When you select Capture from the menu, you will get a tool bar. You can capture an image directly using the tool bar when the menu is not displayed. See page 5-4.

Using PC Card Files

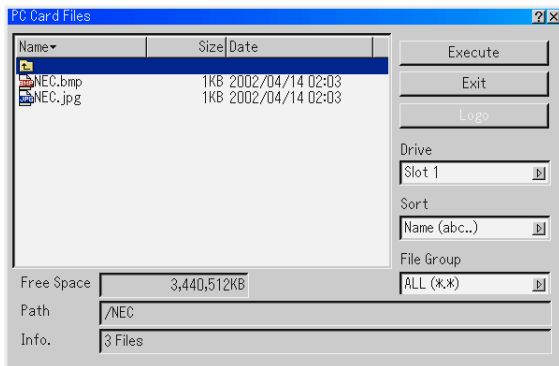

The PC Card Files feature allows you to display a list of all the files stored in the PC card so that you can select a file you want to display. You can also sort files by file name or date, or display the file. See page 4-4.

Changing Background Logo:

You can change the default background logo using the PC Card Files feature. See page 4-4.

NOTE: File size must be 256KB or less. Other file formats than JPEG and BMP are not available. See page 4-4.

Using ChalkBoard



The ChalkBoard feature allows you to write and draw messages on a projected image. See page 4-4.

NOTE: This feature is available only when using with USB mouse.

Help

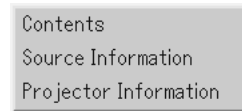

Contents



Provides an online help about how to use the menus. An underlined link means that you can move to an adjustment item directly.

Selecting the underlined link and pressing ENTER moves to the corresponding adjustment item.

NOTE: The Help menu may not be displayed correctly when an image is overscanned.

Source Information

Information

Displays the status of the current signal. This dialog box has two pages.

Page 1

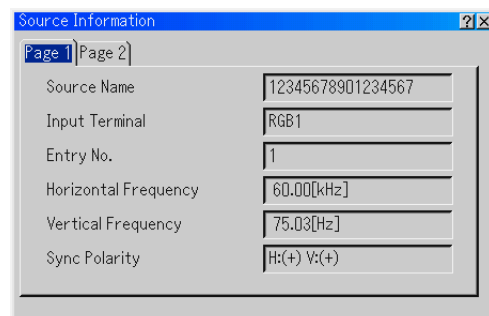

Source Name, Input Terminal, Entry No., Horizontal Frequency, Vertical Frequency, Sync Polarity

Page 2

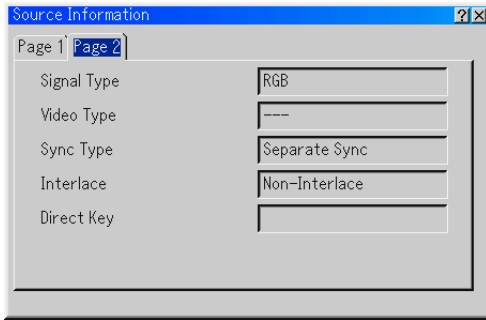

Signal Type, Video Type, Sync Type, Interlace, Direct Key

Projector Information

Displays the information for your projector such as lamp usage, filter usage, version number and others. This dialog box has three pages.

Page 1

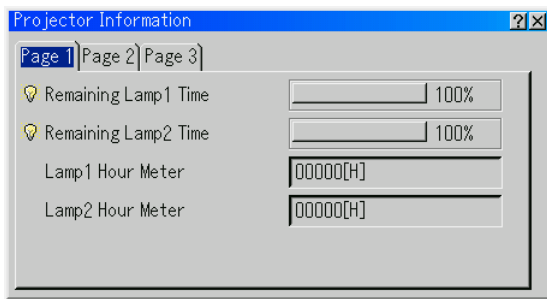

Remaining Lamp 1 Time, Remaining Lamp 2 Time, Lamp 1 Hour Meter, Lamp 2 Hour Meter

NOTE: The progress indicator shows the percentage of remaining bulb life. The value informs you of the amount of lamp 1 and 2 respectively.

- When the remaining lamp time reaches 0, the Remaining Lamp Time bar indicator changes from 0% to 100 hours and starts counting down. If the remaining lamp time reaches 0 hour, the projector will not turn on.

Type	Lamp life (H)		Model
	Normal	Eco	
Standard lamp	2000H	3000H	463-9060
Extended life lamp	4500H		463-9060E

NOTE: The Standard lamp life is typically 2000 hours in Normal mode (3000 hours in Eco mode).

The lamp life, however, may be decreased under certain conditions and the lamp could reach end of life within the specified time.

Page 2

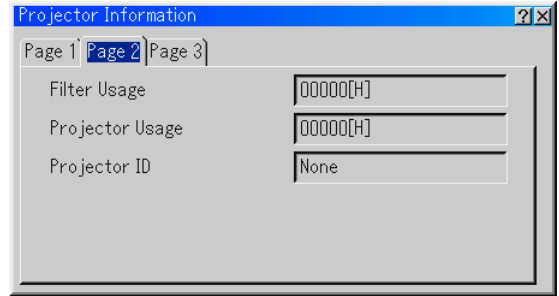

Filter Usage, Projector Usage, Projector ID

Page 3

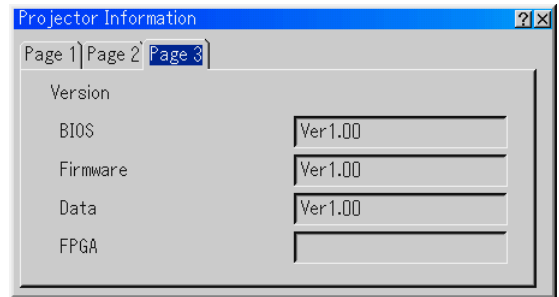

Version (BIOS/Firmware/Data/FPGA)

Test Pattern

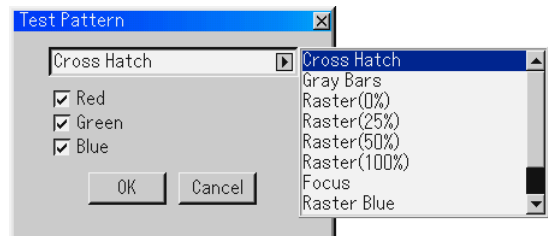

Press to display the test pattern. Pressing this button sequentially selects 10 test patterns for each red, green and blue.

9

Maintenance

.....

1 Replacing the Lamp	9-2
2 Replacing or Cleaning the Filter	9-3
3 Cleaning the Cabinet and the Lens	9-4

This chapter describes the simple maintenance procedures you should follow to replace the lamp and the filter, and to clean the filter and the cabinet.

■ Replacing the Lamp

The projector has two lamps. The lamp replacement procedure applies to both lamps. After your lamp 1 and 2 has been operating for 2000 hours (Normal mode on the standard life lamp) or longer, the "Lamp" indicator in the cabinet will blink red and the message will appear. Even though the lamp may still be working, replace it as soon as possible to maintain optimal projector performance.

NOTE: Be sure to use the same lamp type for both lamp 1 and 2.

CAUTION

- DO NOT TOUCH THE LAMP immediately after it has been used. It will be extremely hot. Turn the projector off, wait 90 seconds (2 minutes in the optional extended life lamp), turn off the main power switch, and then disconnect the power cable. Allow at least one hour for the lamp to cool before handling.
- DO NOT REMOVE ANY SCREWS except the lamp cover screw and the two lamp case screws. You could receive an electric shock.
- The projector will turn off and go into stand by mode after 2100 hours (Normal mode on the standard life lamp) of service. If this happens, be sure to replace the lamp. If you continue to use the lamp after 2000 hours (Normal mode on the standard life lamp) of use, the lamp bulb may shatter, and pieces of glass may be scattered in the lamp housing. Do not touch them as the pieces of glass may cause injury. If this happens, contact your dealer for lamp replacement.
- When "Dual" is selected in "Lamp Select" of "Lamp Settings", replace both lamp 1 and 2 at the same time so that the projector can keep the color of projected image even.

To replace the lamp:

1. Loosen the lamp cover screw until the screwdriver goes into a free-wheeling condition and remove the lamp cover. The lamp cover screw is not removable.

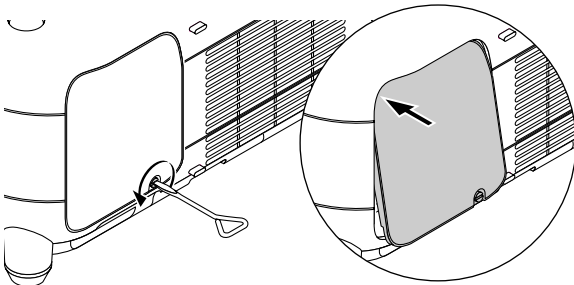

2. Loosen the two screws securing the lamp housing until the screwdriver goes into a free-wheeling condition. The two screws are not removable. Remove the lamp housing by pulling out the handle.

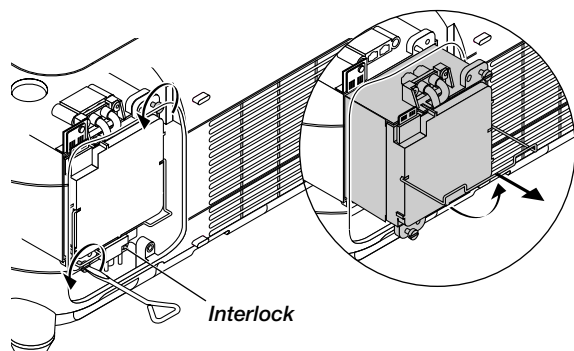

NOTE: There is an interlock on this case to prevent the risk of electrical shock. Do not attempt to circumvent this interlock.

3. Insert a new lamp housing until the lamp housing is plugged into the socket.

CAUTION: Do not use a lamp other than the replacement lamp (Standard life lamp: 463-9060 or Extended life lamp: 463-9060E).

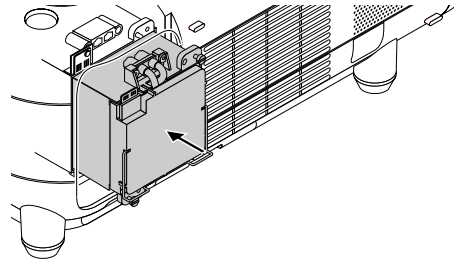

4. Secure it in place with the two screws. Be sure to tighten the screws.

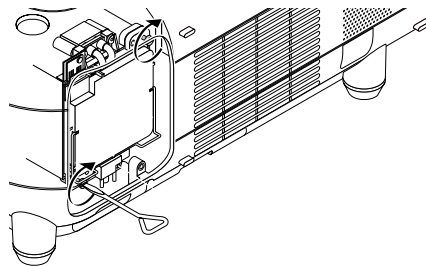

5. Reattach the lamp cover.

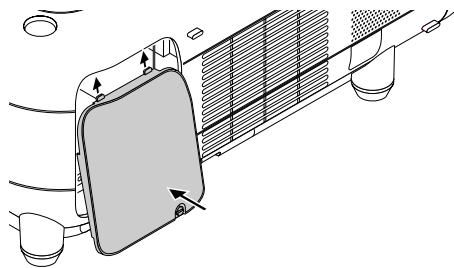

6. Tighten the lamp cover screw. Be sure to tighten the screw.

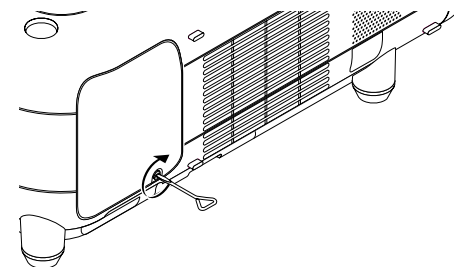

NOTE: Replacing a new lamp automatically clears the lamp usage hours.

NOTE: The lamp housing has an EEPROM chip memorizing its amount of usage hours. You can check the amount usage hours in Information of the menu. (The standard lamp and the optional lamp have an EEPROM chip in it so that when you remove it, your lamp usage hours are saved in its own memory. The projector reads the lamp usage hours from the EEPROM chip to display them in Information of the menu.)

2 Replacing or Cleaning the Filter

To replace the filter:

- Replace both filters at the same time.
- Before replacing the filters, remove dust and dirt from the projector cabinet.
- The projector contains high-precision parts. Keep out dust and dirt during filter replacement.
- Do not wash the filter with water. Water will damage the filter membrane.
- Reattach the filter cover correctly. Failure to do so may cause projector malfunction.

Preparation: Replace the lamp before replacing the filters.

1. Pull out the filter cover by pushing up on the catch.

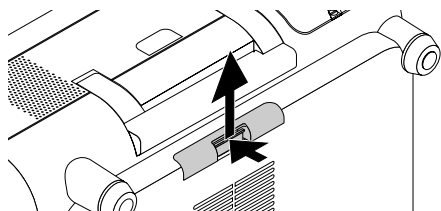

(This must be done to the filters on both left and right.)

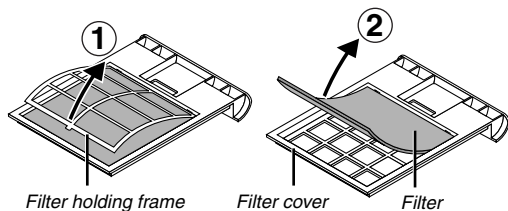

2. Replace both filters.

1. Remove the filter and clean the filter cover.

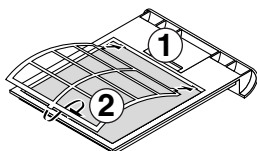

2. Place the new filter on the filter cover in the correct direction.

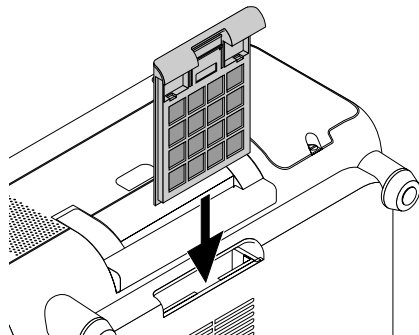

3. Reinstall the filter cover. (This must be done to both left and right)

4. Plug the power cable into a wall outlet and turn on the projector.

5. Reset the filter usage hours to zero.

Select [Menu] → [Projector Options] → [Setup] → [Page 5] → [Clear Filter Usage Meter] → [OK]. Press the ENTER button.

The air-filter sponge prevents dust or dirt from getting the inside of the projector and should be cleaned after every 100 hours of operation (more often in dusty conditions). If the filter is dirty or clogged, your projector may overheat.

CAUTION

- Turn off the power, wait for 90 seconds (2 minutes in the optional extended life lamp GT60LPS), turn off the main power and unplug the projector before replacing the filter.
- Do not attempt to operate the projector without filter.
- Your projector will not operate unless the filter cover is installed correctly.

To clean the filter:

Pull out the filter by pushing up on the catch. Vacuum the filter through the filter.

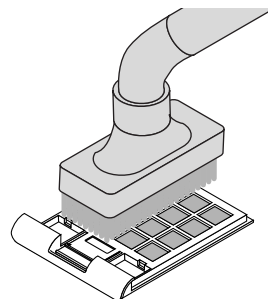

The "Please clean the filters" message will be displayed each time the projector is turned on after it has been used in excess of 168 hours. Should this message appear, clean the filters.

NOTE:

* The message can be turned on or off using the "Message" option on the Setup menu. See page 8-14.

* After cleaning the filters and resetting the filter usage time back to zero, the message will not be displayed.

See page 8-17 for resetting the filter usage time.

3 Cleaning the Cabinet and the Lens

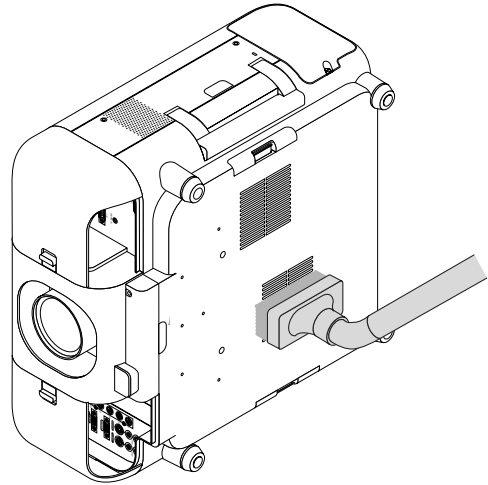
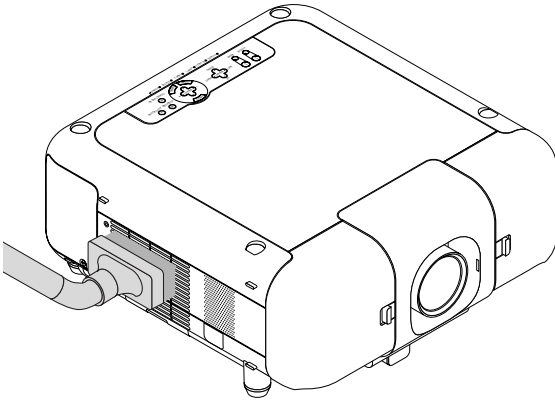

1. Turn off the projector before cleaning.
2. Clean the cabinet periodically with a damp cloth. If heavily soiled, use a mild detergent. Never use strong detergents or solvents such as alcohol or thinner.
3. Use a blower or lens paper to clean the lens, and be careful not to scratch or mar the lens.

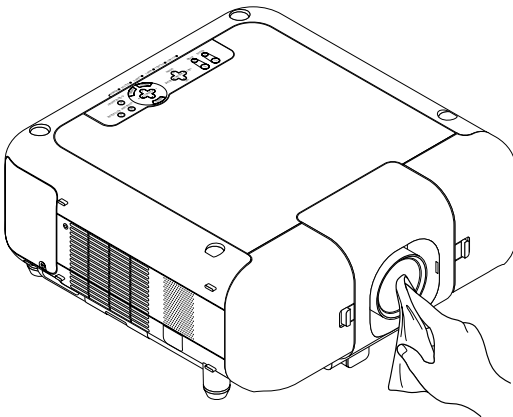

10

Appendix

.....

1	USB Memory Device or USB Memory Card Reader Support	10-2
2	Troubleshooting	10-3
3	Specifications	10-5
4	Cabinet Dimensions	10-7
5	Pin Assignments of D-Sub RGB Input Connector ..	10-7
6	Compatible Input Signal List	10-8
7	REMOTE 1 Connector	10-9
8	PC Control Codes and Cable Connection	10-10
	Cable Connection	10-10
	PC Control Connector (D-SUB 9P)	10-10
9	Using Software Keyboard	10-10
10	Operation Using an HTTP Browser	10-11

1 USB Memory Device or USB Memory Card Reader Support

The projector is compatible with either a USB memory device or USB memory card reader which supports the viewer and security features.

- To use a USB memory device or USB memory card reader, connect the device to the USB port (type A).
- Select one of the Drive icons in the Viewer toolbar, Capture toolbar and PC Card File setting screen. Up to four drives can be accepted.
- To use a USB memory device as a Protect key for Security function, select one from the Drive icons in the Security setting screen.

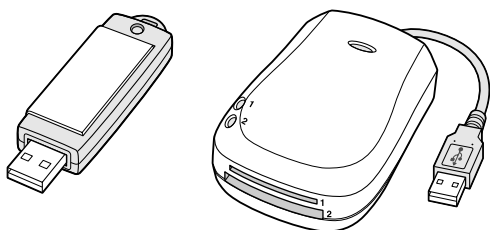

NOTE:

- Some USB memory devices (brands) or USB memory card readers may not work.
 - You cannot use a USB memory device and a USB memory card reader when connecting a USB mouse to the projector.
Using a USB HUB that allows multiple USB memory devices or card readers is not supported either.
 - Do not do the following while the USB memory device or USB memory card reader's access indicator is lit or flashing (while data is being accessed.) Doing so can damage your USB memory device or USB memory card in the reader. Back up your data in case it will need to be restored.
 - * Pulling out the USB memory device or USB memory card reader from the USB port of the projector.
 - * Pulling out the memory card from the USB memory card reader
 - * Turning off the main power switch or unplugging the power cable.
 - The drive for "USB 1-4" is displayed only when the USB memory device or USB memory card reader is connected to the projector. The drive for "USB 1-4" may be displayed differently from the one in the USB memory card reader.
 - Some USB memory devices (brands) or USB memory cards cannot be used as Protect key for the projector's Security function.
-

2 Troubleshooting

This section helps you resolve problems you may encounter while setting up or using the projector.

Power Indicator

Indicator Condition			Projector Condition	Note
Off			The main power is off	–
Blinking light	Green blinking	0.5 sec ON, 0.5 sec OFF	The projector is getting ready to turn on.	Wait for a moment.
		2.5 sec ON, 0.5 sec OFF	Off Timer or Sleep Timer is active.	–
	Orange blinking	0.5 sec ON, 0.5 sec OFF	The projector is cooling down.	Wait for a moment.
		2.5 sec ON, 0.5 sec OFF	On Timer is active.	–
Steady light	Green		The projector is turned on.	–
	Orange		The projector is in Standby or Idle.	–

Status Indicator

Indicator Condition			Projector Condition	Note
Off			Normal	–
Blinking light	Red blinking	1 cycle (0.5 sec ON, 2.5 sec OFF)	Lens hood or lamp cover error	Replace the lens hood or the lamp cover correctly.
		2 cycle (0.5 sec ON, 0.5 sec OFF)	Temperature error	The projector is overheated. Move the projector to a cooler location.
		3 cycle (0.5 sec ON, 0.5 sec OFF)	Power error	Power unit will not work correctly.
		4 cycle (0.5 sec ON, 0.5 sec OFF)	Fan error	Cooling fan has stopped. Contact your dealer.
Steady light	Red (GT6000 only)		Circuit error	An error occurs in the circuit. Consult your dealer.
	Orange		Control key locked	You have pressed control panel key when Control Key Lock is enabled.
	Green		Idle condition	–

Lamp 1/2 Indicator

Indicator Condition			Projector Condition	Note
Off			Light off	–
Blinking light	Red blinking	2.5 sec ON, 0.5 sec OFF	Lamp has reached its end of life. Lamp replacement message will be displayed.	Replace the lamp.
		1 cycle (0.5 sec ON, 2.5 sec OFF)	No lamp	Lamp is not installed. Turn off the power and install lamp.
		6 cycle (0.5 sec ON, 0.5 sec OFF)	Lamp error	Lamp fails to light. Wait a full minute and turn on the power again. If this will not solve the problem, consult your dealer.
		7 cycle (0.5 sec ON, 0.5 sec OFF)	Lamp data error	Fails to read lamp data. Consult your dealer.
	Green blinking		Re-firing the lamp	Wait for a moment.
	Orange blinking		Switching from Lamp 1 to 2	Wait for a moment.
Steady light	Red		Lamp has been used beyond its limit. The projector will not turn on until the lamp is replaced.	Replace the lamp.
	Green		Lamp mode is set to Normal mode	–
	Orange		Lamp mode is set to Eco mode.	–

Common Problems & Solutions

Problem	Check These Items
Does not turn on	<ul style="list-style-type: none"> • Check that the power cable is plugged in and that the main power switch on the projector is on. See pages 1-9 and 2-11. • Ensure that the lens hood or the lamp cover is installed correctly. See pages 1-4 and 9-2. • Check to see if the projector has overheated or the lamp has reached the end of its usable life. If there is insufficient ventilation around the projector or if the room where you're presenting is particularly warm, move the projector to a cooler location.
No picture	<ul style="list-style-type: none"> • Use the menu or Source/Input button to select your source (RGB 1/2, DVI, Video, S-Video, Viewer or LAN). See page 3-3 or 8-7. • Ensure your cables are connected properly. • Use menus to adjust the brightness and contrast. See page 8-8. • Select correct option in the Signal Select for current signal. See page 8-16. • Select RGB/Component when connecting DVD player to RGB connector of the projector. See page 8-11. • Apply a standard RGB signal when using RGB connector. • Adjust picture for RGB signal. • Make sure each setting is correct. • If the problem still persists, reset the settings or adjustments to factory preset levels using the Factory Default in the Adjustment Menu. See page 8-13. • If Security is enabled, a keyword or PC card as a protect key is required. • Remove the lens cap.
Image isn't square to the screen	<ul style="list-style-type: none"> • Reposition the projector to improve its angle to the screen. See page 3-3. • Use the 3DReform function to correct the trapezoid distortion. See page 3-4.
Picture is blurred	<ul style="list-style-type: none"> • Adjust the focus. See page 3-4. • Reposition the projector to improve its angle to the screen. See page 3-3. • Ensure that the distance between the projector and screen is within the adjustment range of the lens. See page 2-2. • Condensation may form on the lens if the projector is cold, brought into a warm place and is then turned on. Should this happen, let the projector stand until there is no condensation on the lens.
Image is scrolling vertically, horizontally or both	<ul style="list-style-type: none"> • Use the menus or Source/Input button on the remote control or the cabinet to select the source you want to input. See page 3-3 or 8-7.
Remote control does not work	<ul style="list-style-type: none"> • Install new batteries. See page 1-12. • Make sure there are no obstacles between you and the projector. See page 1-12. • Stand within 22 feet (7 m) of the projector. See page 1-12. • Check if one or more remote sensors are enabled. Select [Projector Options] → [Setup] → [Page 5] → [Remote Sensor] from the menu. See page 8-17. • If the remote control cable plug is inserted into the REMOTE 2 IN jack, the remote control does not function wirelessly. See page 1-13. • Make sure that the remote control's ID corresponds with the projector's ID. See page 7-2.
Indicator is lit or blinking	<ul style="list-style-type: none"> • See the Power/Status/Lamp Indicator on page 10-3.
Cross color in RGB mode	<ul style="list-style-type: none"> • If Auto Adjust is off, turn it on or adjust the image manually with the Position/Clock in the Image Options. See page 8-16.
USB mouse does not work	<ul style="list-style-type: none"> • Make sure that your USB mouse is properly connected to the projector. The projector may not support some brands of a USB mouse.
No on-screen menu	<ul style="list-style-type: none"> • Press MUTE OSD if the image is muted. Or press and hold CTL and press MUTE OSD button. See page 4-2.

3 Specifications

This section provides technical information about the Projector's performance.

Optical

LCD Panel	1.4" p-Si TFT active-matrix with Micro Lens Array, 1024×768 (GT5000)/1400×1050(GT6000) native resolution* up to 1600×1200 with Advanced AccuBlend Technology
Lamp	275 W DC lamp×2
Lamp Life	Eco-mode 3000 hours/Normal mode 2000 hours
Lens Options	Motorized zoom and Motorized focus GT10RLB : F2.4 f=28.9mm GT19ZL : F2.0-2.7 f=48.9-63.7mm GT13ZLB : F2.3-2.8 f=34.5-42.5mm GT20ZL : F1.8-2.5 f=57.4-74.7mm GT24ZLB : F2.5-3.2 f=64.0-93.8mm GT34ZLB : F2.5-3.3 f=93.5-140.3mm
Lens Shift	GT20ZL: Vertical +/- 0.5V, Horizontal +/- 0.32H GT13ZLB: Vertical +/-0.32V, Horizontal +/-0.19H GT19ZL/GT24ZLB/GT34ZLB: Vertical +/- 0.39V, Horizontal +/- 0.24H
Image Size	GT10RLB: 40-250 inches (1016-6350mm) diagonal GT20ZL/GT19ZL/GT13ZLB: 40 - 300 inches (1016 - 7620 mm) diagonal GT24ZLB: 60 - 400 inches (1524 - 10160 mm) diagonal GT34ZLB : 80-500 inches (2032-12700 mm) diagonal
Projection Distance	GT10RLB lens: 0.8 - 5.0 m / 31.5" - 196.9" GT13ZLB lens: 1.0 - 9.0 m / 39.37"- 354.3" GT19ZL lens: 1.4 - 13.5 m / 55.12"- 531.5" GT20ZL lens: 1.7 - 15.8 m / 66.93"- 622" GT24ZLB lens: 2.6 - 26.4 m / 102.4"- 1039" GT34ZLB lens: 5.1 - 49.7 m / 200.8"- 1957"

Electrical

Input Connections	RGB/YCr/Cb/H(HV)V 5 BNC×1, Audio: RCA (L/MONO, R)×1 RGB D-Sub 15 pin×1, Audio: Stereo Mini Audio×1 DVI DIGITAL DVI-D (Max resolution : XGA@60Hz) x 1, Audio: Stereo Mini Audio×1 Video BNC×1, Audio: RCA (L/MONO, R)×1 S-Video Mini DIN 4×1, Audio: RCA (L/MONO, R)×1 PC Card Slot×2 Option Board Slot×2
Output Connections	RGB D-Sub 15 pin×1 Audio Out RCA (L/MONO, R)×1
Other Input/Output	Remote Control Stereo mini jack ;IN x 1; OUT×1 PC Control D-Sub 9 pin; IN×1, OUT×1 Ex. Control D-Sub 15 Din×1 SC. TRIGGER Stereo mini jack×1 LAN Port RJ-45×1 USB Port A Type×1, B Type×1
Input Compatibility	NTSC / PAL / PAL60 / SECAM / NTSC4.43, YCbCr Component, HDTV-1080I, 1080p, 720p, 480p, 480I, VGA, SVGA, XGA, SXGA / UXGA (with Advanced AccuBlend)
Synchronization	Horizontal Frequency : 15 - 100 kHz (RGB : 24 kHz or over)
Range	Vertical Frequency : 48 - 120 Hz
Video Bandwidth	RGB: 100 MHz
Color Reproduction	Full color, 16.7 million colors simultaneously
Horizontal Resolution	550 TV lines : NTSC / PAL / NTSC4.43 / YCbCr 350 TV lines : SECAM RGB: 1024 dots horizontal, 768 dots vertical

* Effective pixels are more than 99.99%.

Built-in Speakers	5W × 2
Power Requirement	100 - 120VAC / 200 - 240 VAC, 50 / 60 Hz
Input Current	8.0 A (100 - 120 VAC) / 4.0A (200 - 240 VAC)
Power Consumption (2 lamps)	800W (Lamp Normal mode) 660W (Lamp Eco mode) 1W on GT5000 / 1.5W on GT6000 (Standby)

Mechanical

Dimensions	20.4" (W) × 9.5" (H) × 21.6" (D) / 518 mm (W) × 242 mm (H) × 548 mm (D) (not including protrusions)
Net Weight	40.6 lbs / 18.4 kg (not including lens)
Environment	Operational Temperatures: 32° - 95°F (0° to 35°C), 20 - 80% humidity Storage Temperatures: 14° - 122°F (-10° to 50°C), 20 - 80% humidity
Regulations	UL Approved (UL 60950, CSA 60950) Meets DOC Canada Class B requirements Meets FCC Class B requirements Meets AS/NZS3548 Class B Meets EMC Directive (EN55022, EN55024, EN61000-3-2, EN61000-3-3) Meets Low Voltage Directive (EN60950, TUV GS Approved)



For additional information visit:

US: <http://www.dukcorp.com/av>

The specifications are subject to change without notice.

4 Cabinet Dimensions

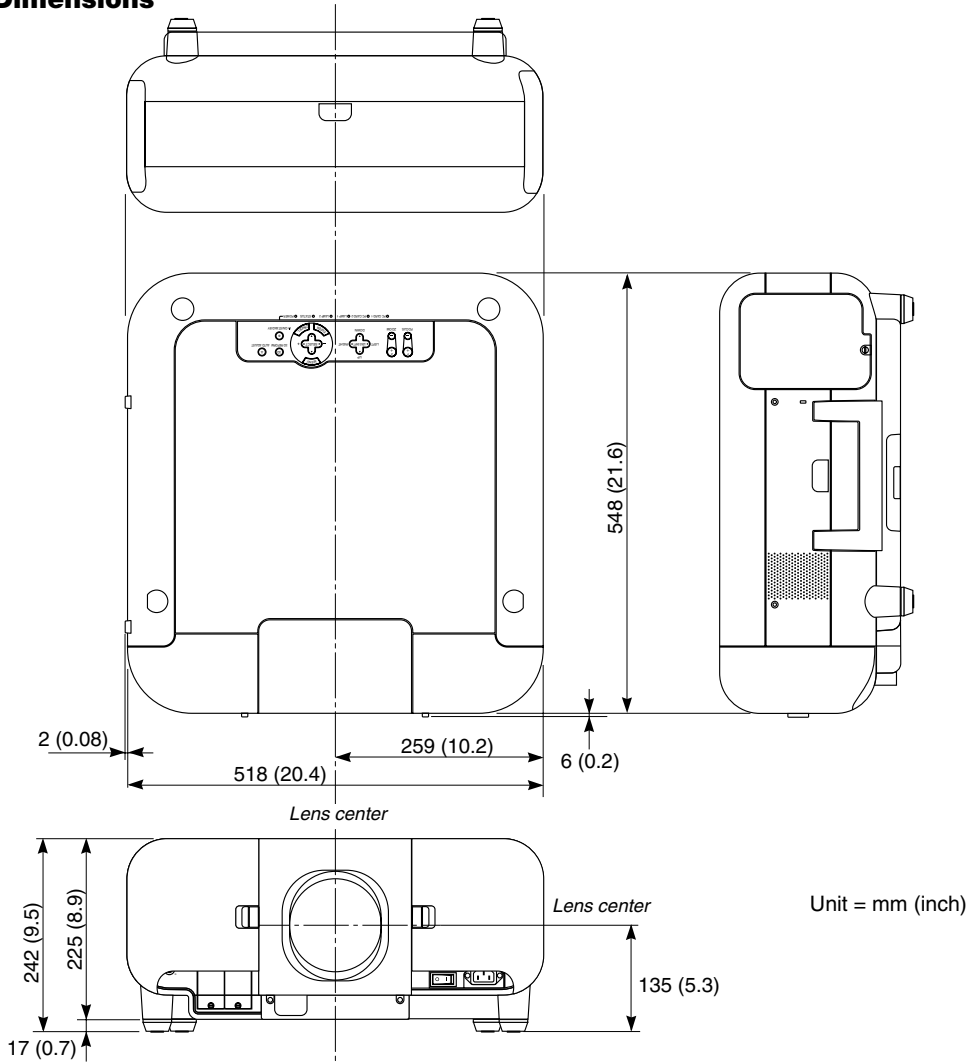

5 Pin Assignments of D-Sub RGB Input Connector

Mini D-Sub 15 Pin Connector

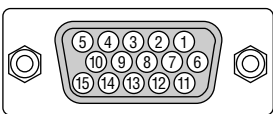

Signal Level
 Video signal : 0.7Vp-p (Analog)
 Sync signal : TTL level
 * RGB 2 Input only

Pin No.	RGB Signal (Analog)	YCbCr Signal
1	Red	Cr
2	Green or Sync on Green	Y
3	Blue	Cb
4	Ground	
5	Ground	
6	Red Ground	Cr Ground
7	Green Ground	Y Ground
8	Blue Ground	Cb Ground
9	No Connection	
10	Sync Signal Ground	
11	SCART Sync	Sync
12	Bi-directional DATA (SDA)*	
13	Horizontal Sync or Composite Sync	
14	Vertical Sync	
15	Data Clock*	

6 Compatible Input Signal List

Signal	Resolution (Dots)	Frequency H. (kHz)	Refresh Rate (Hz)
NTSC	–	15.734	60
PAL	–	15.625	50
SECAM	–	15.625	50
VESA	640 × 480	31.47	59.94
IBM	640 × 480	31.47	60
MAC	640 × 480	31.47	60
MAC	640 × 480	34.97	66.67
MAC	640 × 480	35	66.67
VESA	640 × 480	37.86	72.81
VESA	640 × 480	37.5	75
IBM	640 × 480	39.375	75
VESA	640 × 480	43.269	85.01
IBM	720 × 350	31.469	70.09
VESA	720 × 400	37.927	85.04
IBM	720 × 350	39.44	87.85
IBM	720 × 400	39.44	87.85
VESA	800 × 600	35.16	56.25
VESA	800 × 600	37.879	60.32
VESA	800 × 600	48.077	72.19
VESA	800 × 600	46.88	75
VESA	800 × 600	53.674	85.06
MAC	832 × 624	49.725	74.55
VESA	1024 × 768	35.5	43 Interlaced
VESA	1024 × 768	48.363	60
VESA	1024 × 768	56.476	70.07
MAC	1024 × 768	60.241	74.93
VESA	1024 × 768	60.023	75.03
VESA	1024 × 768	68.677	85
# VESA	1152 × 864	67.5	75
# MAC	1152 × 870	68.681	75.06
# SUN	1152 × 900	61.796	65.95
# SGI	1152 × 900	71.736	76.05
# VESA	1280 × 960	60	60
# VESA	1280 × 1024	63.981	60.02
# MAC	1280 × 1024	69.89	65.2
# HP	1280 × 1024	78.125	72.01
# SUN	1280 × 1024	81.13	76.11
# VESA	1280 × 1024	79.976	75.03
# VESA	1280 × 1024	91.146	85.02
# SXGA+	1400 × 1050	–	–
# HDTV (1080p)	1920 × 1080	67.5	60
SDTV(576i)(625i)	–	15.6	50
SDTV(576p)(625p)	–	31.5	50
# HDTV (1080i)(1125i)	1920 × 1080	33.75	60 Interlace
# HDTV (1080i)(1125i)	1920 × 1080	28.13	50 Interlace
# HDTV (720p)(750p)	1280 × 720	45	60 Progressive
SDTV (480p)(525p)	–	31.47	59.94 Progressive
# VESA	1600 × 1200	75.0	60
# VESA	1600 × 1200	81.3	65
# VESA	1600 × 1200	87.5	70
# VESA	1600 × 1200	93.75	75
DVD YCbCr	–	15.734	59.94 Interlaced
DVD YCbCr	–	15.625	50 Interlaced

#: Images in above flagged with # are compressed with Advanced AccuBlend on 9060.

NOTE: Some composite sync signals may not be displayed correctly.

Signals other than those specified in the table above may not be displayed correctly. If this should happen, change the refresh rate or resolution on your PC. Refer to Display Properties help section of your PC for procedures.

UXGA (1600×1200) is supported for separate sync signal only.

7 REMOTE 1 Connector

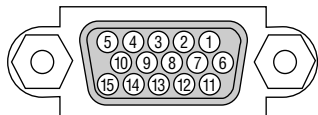

This connector is used for a third party external control device.

Pin No.	SHORT/OPEN				FUNCTION
14	SHORT OPEN				External control mode ON External control mode OFF
5	SHORT OPEN				POWER ON POWER OFF
10	SHORT OPEN				PICTURE MUTE ON PICTURE MUTE OFF
3	SHORT OPEN				MUTE SOUND ON MUTE SOUND OFF
4,8,12,11	11pin	12pin	8pin	4pin	
	OPEN	OPEN	OPEN	OPEN	RGB 1
	OPEN	OPEN	OPEN	SHORT	VIDEO
	OPEN	OPEN	SHORT	OPEN	S-VIDEO
	OPEN	SHORT	OPEN	OPEN	Slot 1-1
	OPEN	SHORT	OPEN	SHORT	RGB 2
	OPEN	SHORT	SHORT	OPEN	Slot 1-2
	OPEN	SHORT	SHORT	SHORT	RGB1 (S-VIDEO)
	SHORT	OPEN	OPEN	OPEN	DVI (DIGITAL)
	SHORT	OPEN	OPEN	SHORT	VIEWER
	SHORT	OPEN	SHORT	SHORT	RGB1 (VIDEO)
	SHORT	SHORT	OPEN	OPEN	Slot 2-1
	SHORT	SHORT	OPEN	SHORT	Slot 2-2
	SHORT	SHORT	SHORT	OPEN	LAN

* When combinations other than specified in the above table are selected or when no optional board is inserted in the Slot 1 and 2, the input will be switched to RGB 1 by default.

* The term "SHORT" means to connect with pin 15

* When in the external control mode, the POWER, Source/Input, PICTURE MUTE and SOUND MUTE buttons on the remote control will not function.

* When the External control mode is set to ON, the following settings are not effective: Source Select, Auto Start, Power Management, Power off Confirmation, Idle mode, Default Source Select, Timer and Test Pattern.

NOTE: When turning off the power to the projector using the external control, do not disconnect the plug from the power outlet. These procedures are to protect your projector and the connected equipment.

8 PC Control Codes and Cable Connection

9 Using Software Keyboard

PC Control Codes

Function	Code Data
POWER ON	02H 00H 00H 00H 00H 02H
POWER OFF	02H 01H 00H 00H 00H 03H
INPUT SELECT RGB 1	02H 03H 00H 00H 02H 01H 01H 09H
INPUT SELECT RGB 2	02H 03H 00H 00H 02H 01H 02H 0AH
INPUT SELECT VIDEO	02H 03H 00H 00H 02H 01H 06H 0EH
INPUT SELECT S-VIDEO	02H 03H 00H 00H 02H 01H 0BH 13H
INPUT SELECT DVI (DIGITAL)	02H 03H 00H 00H 02H 01H 1AH 22H
INPUT SELECT VIEWER	02H 03H 00H 00H 02H 01H 1FH 27H
LAN	02H 03H 00H 00H 02H 01H 20H 28H
SLOT1-1	02H 03H 00H 00H 02H 01H 24H 2CH
SLOT1-2	02H 03H 00H 00H 02H 01H 25H 2DH
SLOT2-1	02H 03H 00H 00H 02H 01H 29H 31H
SLOT2-2	02H 03H 00H 00H 02H 01H 2AH 32H
RGB1(VIDEO)	02H 03H 00H 00H 02H 01H 07H 0FH
RGB1(S-VIDEO)	02H 03H 00H 00H 02H 01H 0CH 14H
PICTURE MUTE ON	02H 10H 00H 00H 00H 12H
PICTURE MUTE OFF	02H 11H 00H 00H 00H 13H
SOUND MUTE ON	02H 12H 00H 00H 00H 14H
SOUND MUTE OFF	02H 13H 00H 00H 00H 15H
ON SCREEN MUTE ON	02H 14H 00H 00H 00H 16H
ON SCREEN MUTE OFF	02H 15H 00H 00H 00H 17H

NOTE: Contact your local dealer for a full list of PC Control Codes if needed.

Cable Connection

Communication Protocol

- Baud rate 38400 bps
- Data length 8 bits
- Parity No parity
- Stop bit One bit
- X on/off None
- Communications procedure Full duplex

NOTE: Depending on the equipment, a lower baud rate may be recommended for long cable runs.

PC Control Connector (D-SUB 9P)

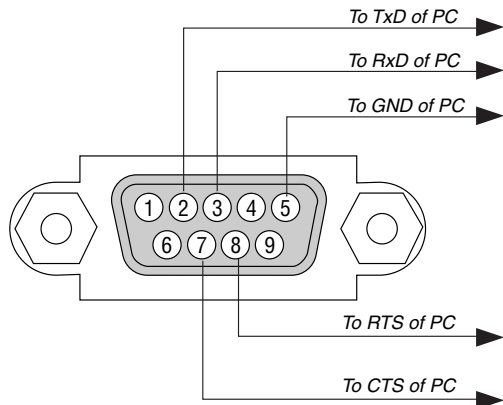

NOTE: Pins 1, 4, 6 and 9 are no used.

NOTE: Jumper "Request to Send" and "Clear to Send" together on both ends of the cable to simplify cable connection.

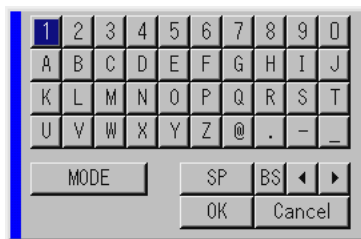

1 to 0 and Characters

- Use to type in IP address or projector name
- MODE Selects one of three modes for alphabet and special characters.
- SP Inserts a space
- BS Deletes one character backward
- ◀ Returns to the previous
- ▶ Advances to the next
- OK Executes the selection
- Cancel Cancels the selection

10 Operation Using an HTTP Browser

Overview

The use of HTTP server functions will allow control of the projector from a web browser without the installation of special software. Please be sure to use "Microsoft Internet Explorer 4.x" or a higher version for the web browser. (This device uses "JavaScript" and "Cookies" and the browser should be set to accept these functions. The setting method will vary depending on the version of browser. Please refer to the help files and the other information provided in your software.)

NOTE:

- * The use of HTTP server functions is not available during Standby mode.
- * The display's or button's response can be slowed down or operation may not be accepted depending the settings of your network. Should this happen, consult your network administrator.
- * The projector may not respond if its buttons are repeatedly pressed in rapid intervals. Should this happen, wait a moment and repeat. If you still can't get any response, pull out and then re-insert the LAN card.
- * Do not use the HTTP Server functions and the Dynamic Image Utility included on the supplied CD-ROM. Using both at the same time may result in a connection failure or slow response.

Access is gained to the HTTP server functions by specifying `http://<the projector's IP address>/index.html` in the entry column of the URL.

Preparation Before Use

Make network connections and set up the projector and confirm that it is complete before engaging in browser operations. (See "LAN Mode" on page 8-19.)

Operation with a browser that uses a proxy server may not be possible depending on the type of proxy server and the setting method. Although the type of proxy server will be a factor, it is possible that items that have actually been set will not be displayed depending on the effectiveness of the cache, and the contents set from the browser may not be reflected in operation. It is recommended that a proxy server not be used unless it is unavoidable.

Handling of the Address for Operation via a Browser

Regarding the actual address that is entered for the address or entered to the URL column when operation of the projector is via a browser, the host name can be used as it is when the host name corresponding to the IP address of the projector has been registered to the domain name server by a network administrator, or the host name corresponding to the IP address of the projector has been set in the "HOSTS" file of the computer being used.

Example 1: When the host name of the projector has been set to "pj.nec.co.jp", `http://pj.nec.co.jp/index.html` is specified for the address or the entry column of the URL.

Example 2: When the IP address of the projector is "192.168.73.1", access is gained to the HTTP server functions by specifying `http://192.168.73.1/index.html` for the address or the entry column of the URL.

Structure of the HTTP Server

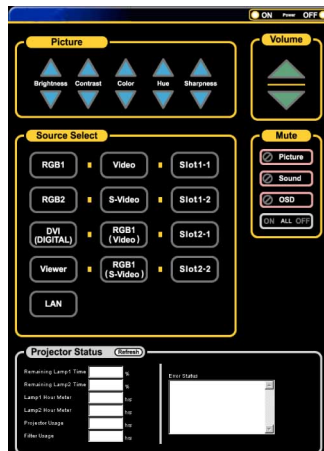

Power: This controls the power of the projector.

- On Power is switched on.
- Off Power is switched off.

Volume: This controls the volume of the projector.

- ▲ Increments the volume adjustment value.
- ▼ Decrements the volume adjustment value.

Mute: This controls the mute function of the projector.

- All On Mutes each of the video, audio, and on-screen display functions.
- All Off Cancels the muting of each of the video, audio, and on-screen display functions.
- Picture On ... Mutes the video.
- Picture Off ... Cancels the video muting.
- Sound On Mutes the audio.
- Sound Off Cancels the audio muting.
- OSD On Mutes the on-screen display.
- OSD Off Cancels the muting of the on-screen display.

Picture: Controls the video adjustment of the projector.

- Brightness ▲ Increments the brightness adjustment value.
- Brightness ▼ Decrements the brightness adjustment value.
- Contrast ▲ ... Increments the contrast adjustment value.
- Contrast ▼ ... Decrements the contrast adjustment value.
- Color ▲ Increments the color adjustment value.
- Color ▼ Decrements the color adjustment value.
- Hue ▲ Increments the hue adjustment value.
- Hue ▼ Decrements the hue adjustment value.
- Sharpness ▲ Increments the sharpness adjustment value.
- Sharpness ▼ Decrements the sharpness adjustment value.

* The functions that can be controlled will vary depending on the signal being input to the projector.

Source Select: This switches the input connector of the projector.

- RGB1 Switches to the RGB 1 connector.
- RGB2 Switches to the RGB 2 connector.
- DVI(DIGITAL) Switches to the DVI connector.
- Video Switches to the Video connector.
- S-Video Switches to the S-Video connector.
- Viewer Switches to the Viewer.
- LAN Switches to a LAN signal.
- Slot 1-1 Switches to input 1 of the Slot 1.
- Slot 1-2 Switches to input 2 of the Slot 1.
- Slot 2-1 Switches to input 1 of the Slot 2.
- Slot 2-2 Switches to input 2 of the Slot 2.
- RGB1 (VIDEO) Switches to Video of the RGB1 connector.
- RGB1 (S-VIDEO) Switches to S-Video of the RGB1 connector.

Projector Status: This displays the condition of the projector.

- Remaining Lamp 1/2 Time
 - Displays the remaining life of the lamp 1/2 as a percentage.
- Lamp 1/2 Hour Meter... Displays how many hours the lamp 1/2 has been used.
- Projector Usage Displays how many hours the projector has been used.
- Filter Usage Displays how many hours the filter has been used.
- Error Status Displays the status of errors occurring within the projector.
- Refresh Updates the display of the following conditions.

Audio Visual Products

Dukane Corporation
Audio Visual Products Division
2900 Dukane Drive
St. Charles, IL 60174-3395
E-mail: avsales@dukcorp.com

Phone: (630) 762-4040
Orders: (800) 676-2485
Information: (800) 676-2486
Fax: (630) 584-5156
Parts & Service: (800) 676-2487
Fax: (630) 584-0984

DUKANE

401-9060-00