

Model 362/382 Controller Systems
Hardware Configuration Guide

HP 9000 Series 300 Controllers



HP Part No. A1473-90020
Printed in USA October, 1991

Edition 1
E1091

Notices

Information in this document is subject to change without notice.

Hewlett-Packard makes no warranty of any kind about this manual, including, but not limited to, the implied warranties of merchantability and fitness for a particular purpose. Hewlett-Packard shall not be liable for errors contained herein or direct, indirect, special, incidental or consequential damages about the furnishing, performance, or use of this material.

Warranty. Please carefully read the enclosed *Hewlett-Packard Software Product License Agreement and Limited Warranty* before operating this product. Rights in the software are offered only on the condition that the customer accepts all terms and conditions of the License Agreement.

Operating the product indicates your acceptance of these terms and conditions. If you do not agree to the License Agreement, you may return the unused product for a full refund.

A copy of the specific warranty terms applicable to your Hewlett-Packard product and replacement parts can be obtained from your local Sales and Service Office.

Copyright © Hewlett-Packard Company 1991 This document contains information which has been protected by copyright. All rights are reserved. Reproduction, adaptation, or translation without prior written permission is prohibited, except as allowed under the copyright laws.

Copyright © AT&T, Inc. 1980, 1984, 1986

Copyright © The Regents of the University of California 1979, 1980, 1983, 1985.

Software mentioned and documentation is based in part on the Fourth Berkeley Software Distribution under license from the Regents of the University of California.

Restricted Rights Legend

Use, duplication or disclosure by the United States Government is subject to restrictions as set forth in subparagraph (c) (1) (ii) of the Rights in Technical Data and Computer Software clause at FARs 52.227.7013.

Hewlett-Packard Company
Fort Collins Systems Division
3404 East Harmony Road
Fort Collins, Colorado 80525

Printing History

This manual's printing date and part number show its current edition. The printing date will change when a new edition gets printed. Minor changes may be made at reprint without changing the printing date. The manual part number will change when extensive changes occur.

Manual updates may be issued between editions to correct errors or document product changes. To ensure that you receive these updates or new editions, you should subscribe to the appropriate product support service. See your Hewlett-Packard Sales Representative for details.

October, 1991 Edition 1

Safety and Information Symbols and Conventions

The following conventions are used throughout this manual:

SKIP?	SKIP messages in configuration procedures tell you that you can skip some information if conditions permit.
--------------	---

Note	Notes contain important information set off from the text.
-------------	--

Caution	Caution messages indicate procedures which, if not observed, could result in damage to equipment. Do not proceed beyond a CAUTION sign until the indicated conditions are fully understood and met.
----------------	---

Warning	Warning messages indicate procedures or practices which, if not observed, could result in personal injury. Do not proceed beyond a WARNING sign until the indicated conditions are fully understood and met.
----------------	--

FCC Regulations (U. S. A. Only)

The Federal Communications Commission (in Subpart J of Part 15, Docket 20780) has specified that the following notice be brought to the attention of the users of this product.

Warning. This equipment generates, uses, and can radiate radio frequency energy and if not installed and used in accordance with the instructions manual, may cause interference to radio communications. It has been tested and found to comply with the limits for a Class A computing device pursuant to Subpart J of Part 15 of FCC rules, which are designed to provide reasonable protection against such interference when operated in a commercial environment. Operation of this equipment in a residential area is likely to cause interference in which case the user at his own expense will be required to take whatever measures may be required to correct the interference.

VCCI Statement (Japan Only)

この装置は、第一種情報装置（商工業地域において使用されるべき情報装置）で商工業地域での電波障害防止を目的とした情報処理装置等電波障害自主規制協議会（VCCI）基準に適合しております。

従って、住宅地域またはその隣接した地域で使用すると、ラジオ、テレビジョン受信機等に受信障害を与えることがあります。

取扱説明書に従って正しい取り扱いをして下さい。

VCCI基準に適合する為に、シールドされたケーブルをご使用下さい。

Manufacturers Declaration (Germany Only)

Herstellerbescheinigung

Hiermit wird bescheinigt, daß dieses Gerät in Übereinstimmung mit den Bestimmungen der Postverfügung 1046/84 funkentstört ist. Der Deutschen Bundespost wurde das Inverkehrbringen dieses Gerätes angezeigt und die Berechtigung zur Überprüfung der Serie auf Einhaltung der Bestimmungen eingeräumt.

Turvallisuusyhteenveto (Finland Only)

Laserturvallisuus

Luokan 1 Laserlaite

Klass 1 Laser Apparat

HP 9000 Model 382 tietokoneeseen voidaan asentaa muistilaitteeksi laitteensisäinen CD-ROM-levyasema, joka on laserlaite. Tällöin myös päälaitteena toimiva tietokone katsotaan laserlaitteeksi.

Kyseinen CD-ROM-levyasema on käyttäjän kannalta turvallinen luokan 1 laserlaite. Normaalisissa käytössä levyaseman suojakotelo estää lasersäteiden pääsyn laitteen ulkopuolelle.

HP 9000 Model 382 tietokoneen on tyyppi hyväksynyt Suomessa laserturvallisuuden osalta Työsuojeluhallitus, Työsuojeluhallituksen hyväksyntänumero TSH 222/6019/90. Laitteiden turvallisuusluokka on määritetty valtioneuvoston päätöksen N:o 472/1985 ja standardin SFS-IEC 825 mukaisesti. Tiedot CD-ROM-levyasemassa käytettävän laserdiodin säteilyominaisuuksista:

Aallonpituus 780 nm

Teho 0,4 mW

Luokan 1 laser

Laser Safety Statement (For U.S.A. Only)

(For controllers with a CD ROM disk drive installed.)

The CD ROM mass storage system is certified as a Class 1 laser product under the U.S. Department of Health and Human services (DHHS) Radiation Performance Standard according to the *Radiation Control for Health and Safety Act* of 1968.

This means that the mass storage system does not produce hazardous laser radiation. Since laser light emitted inside the mass storage system is completely confined within protective housings and external covers, the laser beam cannot escape from the machine during any phase of user operation.

Warning

- **Use of controls, adjustments, or performing procedures different from those specified in this manual may result in hazardous invisible laser radiation exposure. None of the mechanisms within the mass storage system contain customer or field-replaceable parts.**
 - **The CD ROM drive becomes a Class 3B laser mechanism when disassembled. If the CD ROM drive is disassembled, exposure to the invisible laser beam and hazardous invisible laser radiation could result in blindness. Do NOT disassemble the CD ROM drive for any reason.**
-

Contents

1. Using This Manual	
Chapter Contents	1-1
How to Use This Manual	1-2
Finding Configuration Information	1-4
2. Finding Your Controller's Existing Configuration	
Chapter Contents	2-1
Using the Power-Up Display	2-2
Existing RAM	2-3
Existing Mass Storage Devices	2-3
Existing LAN Type	2-4
Floating-Point Accelerator Chip Presence	2-5
Determining Internal Interface Configurations	2-5
Checking the Rear Panel	2-9
3. Configuring Internal Interfaces and Boot Modes	
Chapter Contents	3-1
Changing Internal Interface Configurations	3-2
Changing Boot Modes	3-8
Configuring for Automatic Operating System Selection	3-8
4. Accessing Your Controller's Internal Assemblies	
Chapter Contents	4-1
Shutting Down Your System	4-2
Accessing the Controller's Internal Assemblies	4-4

5. Memory Configurations	
Chapter Contents	5-1
Model 362 Controller	5-2
Supported RAM Boards	5-2
RAM Board Installation Requirements	5-2
Performing the RAM Upgrade	5-3
Preliminary Requirements	5-3
Verifying the Upgrade	5-9
Model 382 Controller	5-10
Determining Existing Memory	5-10
RAM Board Installation Requirements	5-12
Supported Memory Configurations	5-12
Your New RAM Configuration	5-13
Example: Upgrading 8 Mbytes to 16 Mbytes	5-14
Example: Upgrading 8 Mbytes to 24 Mbytes	5-16
Performing the RAM Upgrade	5-19
Verifying the Upgrade	5-30
6. Configuring Mass Storage Devices	
Chapter Contents	6-1
Accessing a Hard Disk Drive	6-2
Removing the Hard Disk Drive	6-2
52 Mbyte Hard Disk Drives	6-6
Setting Configuration Jumpers	6-6
SCSI Bus Address Jumpers	6-7
Configuring the Operating System	6-7
210 or 420 Mbyte Hard Disk Drives	6-8
Setting Configuration Jumpers	6-8
SCSI Bus Address Jumpers	6-9
Configuring the Operating System	6-9
3.5-in. Flexible Disk Drive	6-10
Preliminary Requirements	6-10
Setting the Configuration Jumpers	6-10
Function Jumpers	6-12
SCSI Bus Address Jumpers	6-12
SCSI Bus Address Jumpers	6-13
Configuring the Operating System	6-13
CD ROM Disk Drive	6-14

Preliminary Requirements	6-14
Setting the Configuration Jumpers	6-14
SCSI Bus Address Jumpers	6-15
Parity Jumper	6-16
Audio Use	6-16
Configuring the Operating System	6-16
DDS Tape Drive	6-17
Configuring the Operating System	6-17
Configuring the Hardware	6-17
7. Configuring Graphics Mode	
Chapter Contents	7-1
Preliminary Requirements	7-2
Model 362 Controllers	7-2
Model 382 Controllers	7-3
Medium-Resolution System Board	7-3
High-Resolution System Board	7-4
8. Changing the LAN Type	
Chapter Contents	8-1
Preliminary Requirements	8-2
LAN Jumper Location	8-2
Changing the LAN Type	8-2
9. Configuring Bus Expanders	
Chapter Contents	9-1
HP A2246A 4-Slot DIO-I Bus Expander	9-2
Physical Location	9-2
Supported Accessory Cards	9-2
HP A2247A 2-Slot DIO-II Bus Expander	9-3
Physical Location	9-3
Supported Accessory Cards	9-3

10. Configuring Popular Accessory Cards	
Chapter Contents	10-1
Supported Accessory Cards in Controllers	10-2
Configuring Popular Accessory Cards	10-3
HP 98622A GPIO Interface Card	10-4
Operating System Support	10-4
Setting the Configuration Switches and Jumpers	10-4
Setting the Select Code	10-5
Setting the Interrupt Level	10-6
Setting the Data-in Clock Source Clock Switches	10-6
Setting the Option Select Switches	10-7
Setting the Data Jumpers	10-8
Adjusting the PCTL Delay	10-8
Reinstalling the GPIO Card	10-8
Verification Test	10-8
Filling Out the Worksheets	10-9
BASIC System Worksheet Entry	10-9
Pascal System Worksheet Entry	10-10
HP-UX System Worksheet Entry	10-10
HP 98624A HP-IB (IEEE 488) Interface Card	10-11
Operating System Support	10-11
Preliminary Requirements	10-11
Setting the Configuration Switches	10-11
Setting the Select Code Switches	10-12
Setting the Interrupt Level	10-13
Setting the Address and System Controller Switches	10-14
Reinstalling the HP-IB Card	10-14
Verification Test	10-14
Making Worksheet Entries	10-15
BASIC System Worksheet Entry	10-15
Pascal System Worksheet Entry	10-15
HP-UX System Worksheet Entry	10-16
HP 98625B High-Speed HP-IB (IEEE 488) Interface Card	10-17
Preliminary Requirements	10-17
Operating System Support	10-17
Setting the Configuration Switches	10-17
Setting the Select Code	10-18
Setting the Interrupt Level	10-19

Setting the System Controller Switch	10-20
Setting the Low/High Speed Switch	10-20
Reinstalling the High-Speed HP-IB Card	10-21
Verification Test	10-21
Filling Out the Worksheets	10-21
BASIC System Worksheet Entry	10-22
Pascal System Worksheet Entry	10-22
HP-UX System Worksheet Entry	10-22
HP 98642A 4-Port Multiplexer Card	10-23
Operating System Support	10-23
Preliminary Requirements	10-23
Setting the Configuration Switches	10-23
Setting the Select Code	10-24
Setting the Interrupt Level	10-26
Setting the Remote Switch	10-26
Reinstalling the 4-Port Multiplexer Card	10-27
Verification Test	10-27
Filling Out the Worksheets	10-28
HP-UX System Worksheet Entry	10-28
HP 98643A Local Area Network (IEEE 802.3) Interface Card	10-29
Operating System Support	10-29
Preliminary Requirements	10-29
Setting the Configuration Switches	10-29
Setting the Select Code	10-31
Setting the Interrupt Level	10-31
Setting the Interface Type	10-32
Reinstalling the LAN Interface Card	10-32
Verification Test	10-32
Filling Out the Worksheets	10-33
HP-UX System Worksheet Entry	10-33
HP 98644A RS-232-C Serial Interface Card	10-34
Operating System Support	10-34
Preliminary Requirements	10-34
Setting the Configuration Switches	10-34
Setting the Select Code	10-35
Setting the Interrupt Level	10-36
Setting the MODEM ENable Switch	10-37
Setting the 626 Switch	10-37

Set the REMOTE Switch	10-37
Reinstalling the RS-232 Card	10-38
Verification Test	10-38
Filling Out the Worksheets	10-38
BASIC System Worksheet Entry	10-39
Pascal System Worksheet Entry	10-39
HP-UX System Worksheet Entry	10-39
HP 98658A Small Controller Systems Interface Card	10-40
Operating System Support	10-40
Preliminary Requirements	10-40
Setting the Configuration Switches	10-40
Setting the Select Code	10-42
Setting the Interrupt Level	10-42
Setting the Bus Address Switches	10-43
Setting the Parity Switch	10-43
Reinstalling the SCSI Card	10-43
Verification Test	10-44
Filling Out the Worksheets	10-44
HP-UX System Worksheet Entry	10-45

Index

Figures

2-1. Power-Up Display	2-2
2-2. Controller Rear Panel	2-9
5-1. Typical Power-Up Display	5-11
6-1. 52 Megabyte Hard Disk Drive Configuration Jumper Locations	6-6
6-2. Hard Disk Drive Configuration Jumper Locations	6-8
6-3. Flexible Disk Drive Configuration Jumper Locations	6-11
6-4. CD ROM Configuration Jumper Locations	6-14
7-1. Model 362 System Board Graphics Jumper	7-2
7-2. Model 382 Medium-Resolution System Board Graphics Jumpers	7-3
7-3. Model 382 High-Resolution System Board Graphics Jumper	7-4
8-1. LAN Board Jumper Positions	8-2
10-1. HP 98622A GPIO Interface Card Switches and Jumpers	10-5
10-2. GPIO Interface Card Select Code Settings	10-6
10-3. HP 98624A HP-IB Interface Switch Locations	10-12
10-4. HP-IB Interface Card Select Code Settings	10-13
10-5. HP 98625B High-Speed HP-IB Interface Card Switch Locations	10-18
10-6. High-Speed HP-IB Interface Card Select Code Switch Settings	10-19
10-7. HP 98642A 4-Port Multiplexer Interface Card Switch Locations	10-24
10-8. 4-Port Multiplexer Interface Card Select Codes	10-25
10-9. HP 98643A Local Area Network Interface Switch Locations	10-30
10-10. HP 98644A RS-232-C Interface Switch Locations	10-35
10-11. HP 98644A RS-232-C Interface Select Code Switch Settings	10-36
10-12. HP 98658A SCSI Interface Card Configuration Switch Locations	10-41

Tables

1-1. Configuration Task Procedures	1-3
1-2. Configuration Information in this Manual	1-4
2-1. Total RAM vs. Displayed RAM in Bytes	2-3
2-2. Built-In Interface Default Values	2-8
4-1. Configurations Possible With Only Top Cover Removed	4-8
5-1. Model 382: Total RAM vs. Slot Numbers and Board Sizes	5-12
5-2. Model 382: Existing Memory vs. Upgraded Memory	5-13
5-3. Model 382: RAM Board Configurations for 8 Mbytes	5-14
6-1. Hard Disk Drive Configuration Jumper Functions	6-7
6-2. Hard Disk Drive Configuration Jumper Functions	6-9
6-3. Flexible Disk Drive Configuration Bottom Jumper Functions	6-12
6-4. CD ROM Drive Configuration Jumper Functions	6-15
6-5. CD ROM SCSI ID Addresses and Switch Settings	6-15
9-1. Supported DIO-I Accessory Cards in HP A2246A 4-Slot DIO-I Bus Expander	9-2
9-2. Supported DIO-II Accessory Cards in HP A2247A 2-Slot DIO-II Bus Expander	9-3
10-1. Supported DIO-I Accessory Cards in Model 362 and 382 Controllers	10-2
10-2.	10-6
10-3.	10-7
10-4.	10-9
10-5.	10-10
10-6.	10-10
10-7.	10-13
10-8.	10-15
10-9.	10-15
10-10.	10-16
10-11.	10-22
10-12.	10-22

10-13.	10-22
10-14.	10-26
10-15.	10-28
10-16.	LAN Card Select Code Switch Settings	10-31
10-17.	10-32
10-18.	10-33
10-19.	10-37
10-20.	10-39
10-21.	10-39
10-22.	10-39
10-23.	SCSI Card Select Code Switch Settings	10-42
10-24.	10-43
10-25.	10-45

Using This Manual

Chapter Contents

- **How to Use This Manual** and check or change your controller system's hardware configuration.
- **Finding Configuration Information** in this manual and its organization.

Note Your controller system may include mass storage or other products not covered in this manual. Refer to that device's manuals for configuration information.

How to Use This Manual

If you already know how your controller system is configured for:

- Mass storage devices,
- Internal interfaces,
- LAN type,
- Graphics type, and
- Accessory cards,

you can skip chapter 2.

If you need to know how your controller system is configured, you should:

1. Go to chapter 2,
2. Read and follow its instructions and
3. Find out how your controller system is configured.

If you need to reconfigure your controller system, you should refer to Table 1-1 below and find out what procedures to follow.

Table 1-1. Configuration Task Procedures

To Change This Configuration,	Refer to chapter and do these tasks:
Internal interface values,	<ol style="list-style-type: none"> 1. Chapter 2; Learn how to use Configure Mode. 2. Chapter 3; Change the internal interface configuration.
Boot mode or system select,	<ol style="list-style-type: none"> 1. Chapter 2; Learn how to use Configure Mode. 2. Chapter 3; Change the boot mode.
LAN type,	<ol style="list-style-type: none"> 1. Chapter 4; Access your controller's internal assemblies. 2. Chapter 8; Change the LAN type.
Add more memory,	<ol style="list-style-type: none"> 1. Chapter 2; Determine existing memory. 2. Chapter 4; Access your controller's internal assemblies. 3. Chapter 5; Add more memory.
Mass storage device configuration,	<ol style="list-style-type: none"> 1. Chapter 4; Access your controller's internal assemblies. 2. Chapter 6; Change the device configuration.
Graphics mode,	<ol style="list-style-type: none"> 1. Chapter 4; Access your controller's internal assemblies. 2. Chapter 7; Change the graphics mode.
LAN type,	<ol style="list-style-type: none"> 1. Chapter 4; Access your controller's internal assemblies. 2. Chapter 8; Change the LAN type.
Bus expander,	<ol style="list-style-type: none"> 1. Chapter 4; Access your controller's internal assemblies. 2. Chapter 9; Change the bus expander.
Accessory cards	<ol style="list-style-type: none"> 1. Chapter 10; Determine supported cards. 2. Chapter 10; Change the card's configuration.

Finding Configuration Information

You'll find configuration task information in this manual organized as shown in Table 1-2.

Table 1-2. Configuration Information in this Manual

Configuration Information	Refer To
Finding Your Controller's Existing Configuration	Chapter 2
Configuring Internal Interfaces and Boot Modes	Chapter 3
Accessing Your Controller's Internal Assemblies	Chapter 4
Memory Configurations	Chapter 5
Configuring Mass Storage Devices	Chapter 6
Configuring Graphics Mode	Chapter 7
Changing the LAN Type	Chapter 8
Configuring Bus Expanders	Chapter 9
Configuring Accessory Cards	Chapter 10

Finding Your Controller's Existing Configuration

Chapter Contents

- **Using the Power-Up Display** explains how to:
 - Find out how much memory is in your controller.
 - Determine what mass storage devices are already installed.
 - See what LAN type your controller is set to.
 - See if a floating-point accelerator chip is installed.
 - Determine the internal interface configuration settings by using Configure Mode.
- **Checking the Rear Panel** shows you how to find out what optional interfaces your controller has.

Note Your controller system may include mass storage or other products not covered in this manual. Refer to that device's manuals for configuration information.

Using the Power-Up Display

Follow these steps to determine your controller's hardware configuration:

1. If your controller is operating, shut down the operating system following normal procedures. Refer to your controller's *Owner's Guide* for instructions.
2. Turn off your controller, then turn it ON.
3. When the power-up display shown in Figure 2-1 lists the line:

HP-HIL.Keyboard

and before the operating system boots, press the **Space bar**.

```
Copyright 1991
Hewlett-Packard Company
All Rights Reserved

BOOTROM Rev. 3.01 2 MAY 91
Bit-Mapped Video
MC68030 Processor
Configuration EEPROM
Utility Chip at 41
HP-HIL.Keyboard
DMA-CO
RAM xxxxxxx Bytes
Digital Audio at 8
HP Parallel at 12
HP98265 (SCSI S 32) at 14
HP98643 (LAN) at 21, THIN, 0800091595F3

System Search Mode
RESET To Restart
```

Figure 2-1. Power-Up Display

Existing RAM

Note the amount of RAM in bytes listed in the line that reads:

RAM xxxxxxxx Bytes

Write the amount here: RAM _____ Bytes.

Note that the actual amount of RAM will be about 4.9% higher than the amount commonly stated. Refer to Table 2-1 for the actual number of bytes for each amount of RAM.

Table 2-1. Total RAM vs. Displayed RAM in Bytes

Total RAM in Mbytes	Displayed RAM in Bytes
2	2097152
4	4194304
6	6291452
8	8388688
10	10485760
12	12582912
16	16777216
20	20971520
24	25165824
28	29360128
32	33554432

Existing Mass Storage Devices

Internal mass storage devices with operating systems will be listed on the right side. Note the line in the upper right-hand corner that reads something like this:

:QUANTUM PD 420S, 1406, 0

Each part of this line is explained below.

QUANTUM PD 420S, 1406, 0

Unit 0

Bus address 6 (range = 0 - 7)

Select Code 14

SCSI interface

Unformatted size in Mbytes

Drive manufacturer

Existing LAN Type

Note the line that reads something like:

HP98643 (LAN) at 21, THIN, 0800091595F3

or

HP98643 (LAN) at 21, AUI, 0800091595F3

If, after HP98643 (LAN) at 21,, the word:

- THIN appears, ThinLAN is the type and the BNC connector must be used.
- AUI appears, AUI LAN is the type and the D-sub connector must be used.

Write in the LAN type here: _____.

Refer to chapter n, 'Setting the LAN Type' to learn how change the LAN configuration jumper.

Your controller's LAN ID is the number at the end of that line. For example:

0800091595F3

Your system administrator uses that number for networking configuration.

Floating-Point Accelerator Chip Presence

Note This section applies to Model 362 controllers only.

Look for a line on the left side that reads:

MC68882 Coprocessor

If that line appears, your Model 362 controller has the floating-point accelerator coprocessor chip installed.

Determining Internal Interface Configurations

The Boot ROM configuration mode is used for internal interface configurations or Auto System Selection for your controller.

Configure Mode is run and controlled by the Boot ROM. You do not need to have an operating system installed to use Configure Mode.

If the operating system is installed and you want to enter Configure Mode, you must prevent the operating system from booting. Instructions are provided in this chapter.

- 1** With the power-up display shown on your monitor, press these keys to enter Configuration Mode:

C **Return**

- 2** You should see this menu appear in the upper right-hand corner of the power-up display:

```
Configuration Control
Keys    Control Class
-----
1 I/O Configuration
2 Auto System Selection

A Abort without changes
-----
Type [key] RETURN ?
```

The ? prompt below the menu indicates your controller is waiting for an input. To respond, press an appropriate number or letter key, followed by **Return**.

If you now want to see the I/O configuration of your controller, press:

1 **Return**/**Enter**

then skip now to the section titled 'Internal Interface Configurations.'

This Configurable Interfaces menu replaces the Configuration Control menu:

```
Configurable Interfaces
Keys  Interface Select Code
-----
  1   LAN                21
  2   HP-IB
  3   SCSI                14
  4   HP Parallel        12
  5   RS-232             9

N store New values
D store Default values
  (then cycle SPU power)
A Abort without changes
-----
Type [key] RETURN ?
```

If you want to leave Configuration Control without making any changes, type:

(A) **Return**/**Enter**

and the power-up display will reappear.

Table 2-2 lists the factory-set default configurations for your EEPROM.

Table 2-2. Built-In Interface Default Values

Built-In Interface	Function	Default Configuration	Options
SCSI	Select Code	14	0 to 31
	Interrupt Level	4	3 to 6
	Bus Address	7	0 to 7
	Parity	Yes	Yes/No
LAN	Select Code	21	0 to 31
	Interrupt Level	5	3 to 6
HP Parallel	Select Code	12	0 to 31
	Interrupt Level	3	3 to 6
HP-IB	System-Controller option	yes	yes/no
RS-232	Select Code	9	0 to 31
	interrupt level	5	3 to 6
	Remote/Local	L	R or L
	Modem Enable	yes	yes/no

Checking the Rear Panel

To find out what optional interfaces your controller has, refer to Figure 2-2.

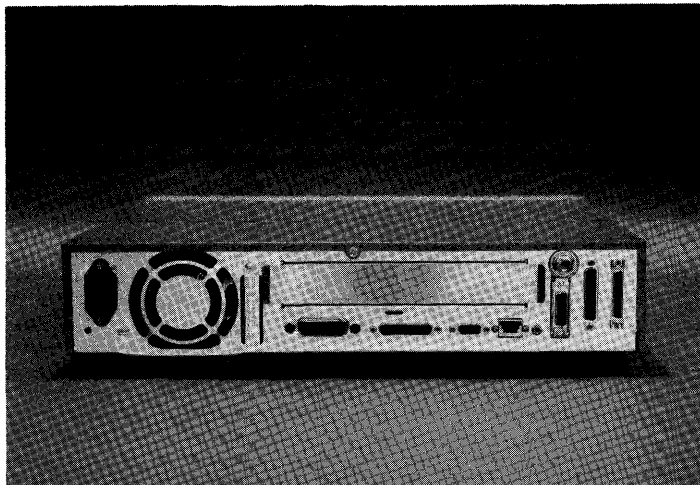

Figure 2-2. Controller Rear Panel

Configuring Internal Interfaces and Boot Modes

Chapter Contents

- **Changing Internal Interface Configurations** tells you how to use Configure Mode's I/O Control mode to change internal interface parameters.
- **Changing Boot Modes** explains how you can change the operating system your controller boots.

Note Your controller system may include mass storage or other products not covered in this manual. Refer to that device's manuals for configuration information.

Changing Internal Interface Configurations

Configuration settings are stored in a part of memory called an EEPROM (“Electronically-Erasable Programmable Read-Only Memory”). Information stored in the EEPROM remains intact even when your controller is turned off.

Follow these instructions to enter and use I/O Configuration Mode.

1 With this power-up display on your monitor, type:

C **Return**

Copyright 1991
Hewlett-Packard Company
All Rights Reserved

BOOTROM Rev. 3.01 2 MAY 91
MC68040 Processor
Configuration EEPROM
Utility Chip at 41
HP-HIL.Keyboard
DMA-CO

2 This Configuration Control menu will appear.

Enter the I/O Configuration Mode by typing:

1 **Return**/**Enter**

Configuration Control
Keys Control Class

1 I/O Configuration
2 Auto System Selection

A Abort without changes

Type [key] RETURN ?

3 This Configurable Interfaces menu replaces the Configuration Control menu:

```
Configurable Interfaces
Keys Interface Select Code
-----
1 LAN 21
2 HP-IB
3 SCSI 14
4 HP Parallel 12
5 RS-232 9

N store New values
D store Default values
(then cycle SPU power)
A Abort without changes
-----
Type [key] RETURN ?
```

The order that interface identifiers appear and their respective number keys may be different on your controller. Only interfaces that are configurable from the Boot ROM's Configuration Control Mode will be listed. The Select Code currently assigned to the interfaces is shown in the column marked "Select Code".

Each of the number and letter key commands is explained below. Note that the **Return**/**Enter** key must be pressed after pressing the command key.

Possible Response	Function and Meaning
① ② ③ ④ ⑤	Selects the respective internal interface to configure.
Ⓝ	Stores all the listed new values you entered in the EEPROM. You can turn OFF your controller, then turn it back ON and the new values will be used. Then the self-test will run.
ⓓ	Exits the Configuration Mode and stores the factory default values in the EEPROM. You must cycle controller power to reconfigure the interfaces to these default values.
Ⓐ	Causes the Boot ROM to reset and run the power-up self-test without saving any changes you may have made to the interface values. The pre-existing values will be used.

Enter your response followed by **Return** after the ? prompt.

If you decide to use the default configurations, exit the menu by pressing **ⓓ** followed by **Return**.

<p>4 Select the interface to reconfigure by pressing the key for that interface.</p> <p>For example, to select SCSI, press:</p> <p>③</p>	<pre> Configurable Interfaces Keys Interface Select Code ----- 1 LAN 21 2 HP-IB 12 3 SCSI 14 4 HP Parallel 12 5 RS-232 9 N store New values D store Default values (then cycle SPU power) A Abort without changes ----- Type [key] RETURN ? </pre>
---	--

5 This SCSI configuration menu will appear.

```
          SCSI
Key Feature      Value
-----
1 Select Code    14
2 Interrupt Level 3
3 Parity         Y
4 Bus Address    7

X to eXit menu
-----
Type [key] RETURN ?
```

6 Press the key for the interface function you want to change.

For example, to change the select code, press:

1

and the SCSI menu changes to the screen at the right. Note the command line has changed and used select codes are listed.

```
          SCSI
Key Feature      Value
-----
1 Select Code    14
2 Interrupt Level 3
3 Parity         Y
4 Bus Address    7

X to eXit menu
-----
1 Select Code    14
  used select codes are :
12 14 15 21
Type 0.. 31 except used RETURN ?
```

7 Type the keys for the SCSI select code you want to use.

For example, to change the select code to 17, press:

1 **7** **Return**/**Enter**

and the SCSI menu changes to the screen at the right. Note the command line has changed and used select codes are listed.

```
SCSI
Key Feature      Value
-----
1  Select Code   14
2  Interrupt Level 3
3  Parity        Y
4  Bus Address   7
```

X to eXit menu

```
-----
1  Select Code   17
used select codes are :
12 14 15 21
Type 0.. 31 except used RETURN ?
```

8 Exit the select code menu by pressing:

X **Return**/**Enter**

and the SCSI menu changes to the screen at the right. Note the Select Code line has changed to reflect the new value.

```
SCSI
Key Feature      Value
-----
1  Select Code   14
2  Interrupt Level 3
3  Parity        Y
4  Bus Address   7
```

X to eXit menu

```
-----
Type [key] RETURN ?
```

9 Make other SCSI interface feature value changes as needed. When you are finished, you can:

- Select another interface to reconfigure by typing:

X **Return**/**Enter**

from the SCSI menu.

- Store new interface values in the EEPROM by typing:

N **Return**/**Enter**

from the Configurable Interfaces menu. Then the Configuration Control menu will appear.

```
SCSI
Key Feature      Value
-----
1 Select Code    14
2 Interrupt Level 3
3 Parity         Y
4 Bus Address    7

X to exit menu
-----
Type [key] RETURN ?
```

Changing Boot Modes

Configuring for Automatic Operating System Selection

3 You will probably want to leave this feature in its default setting unless any of the following obtains:

- Two or more operating systems are available on your controller
- Your controller system is connected to a network that contains multiple operating systems.
- You need to be able to auto boot from a different operating system than that used by other nodes.

If any of these conditions are true, follow these steps to enter and use Auto System Selection:

- 1 With Configuration Control menu in the upper-right corner of the screen, enter
- 2 **(Return)**.

```

Configuration Control
Keys      Control Class
-----
 1 I/O Configuration
 2 Auto System Selection

A Abort without changes
-----
Type [key] RETURN ?

```

- 2 This menu appears:

```

Auto System Selection
Keys Option          Status
-----
 1 Scan for System   Y
 2 Selected System   N
 3 Store Selected Sys. N

E Execute
A Abort without changes
-----
Type [key] RETURN ?

```

- 3 The prompt ? indicates that your controller is waiting for a letter or number input.

The Auto System Selection menu indicates the way your system is currently set. Toggling the "Status" options by entering one of the numbers under "Keys" on the left will result in a new configuration which will be executed as soon as you press E.

For example, if your disks contain more than one operating system, you could choose one as the Selected System by pressing 2, followed by **(Return)**.

- 4** The Auto System Selection menu changes to indicate **Selected System**, **Scan for System**, and **Store Selected Sys.** are all Y ("yes").

Auto System Selection

Keys	Option	Status
1	Scan for System	Y
2	Selected System	Y
3	Store Selected Sys.	Y
E	Execute	
A	Abort without changes	

Type [key] RETURN ?

- 5** To execute the menu as it appears in the previous step, press E, followed by **Return**. The system will give you the opportunity to identify the "Selected System" in the next step.

If you decide *not* to change the Auto System Selection configuration, press A to leave the configuration unchanged.

- 6** If you pressed E, your power-up display would change, and the available operating systems would be listed in the upper right-hand corner like this:

Copyright 1991	:(device, select code/address, unit)
Hewlett-Packard Company	1H SYSTEM_HPUX
All Rights Reserved	(other systems)
BOOTROM Rev. 3.01 2 MAY 91	
MC68040 Processor	
Configuration EEPROM	
HP-HIL Keyboard	

7 The number-letter designation for the operating system you will select is 1H.

Enter that prefix by typing 1H **(Return)**. That operating system will boot.

If you do not enter this information, the boot ROM will designate the first system it scans as the “Selected System”.

If you previously set the **Store Selected Sys.** option to “yes,” the operating system selected will be the one to automatically boot each time you turn on your controller.

This completes the selection process, and the system will now proceed with booting the selected system for this and future sessions.

Accessing Your Controller's Internal Assemblies

Chapter Contents

- **Shutting Down Your System** tells you to shut down your application program and operating system and turn off your controller.
- **Accessing the Controller's Internal Assemblies** tells you how to remove any expanders and top covers.

Shutting Down Your System

- 1 Save any important data, then stop your application program.

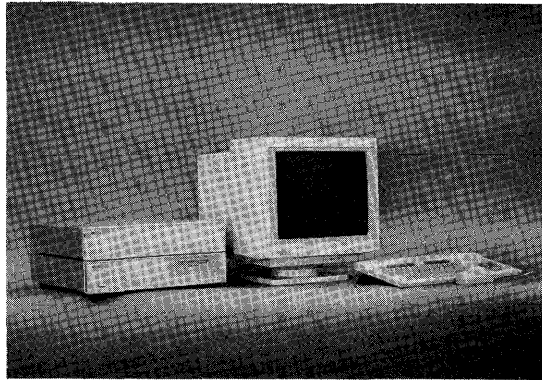

- 2 Shut down your controller's operating system.

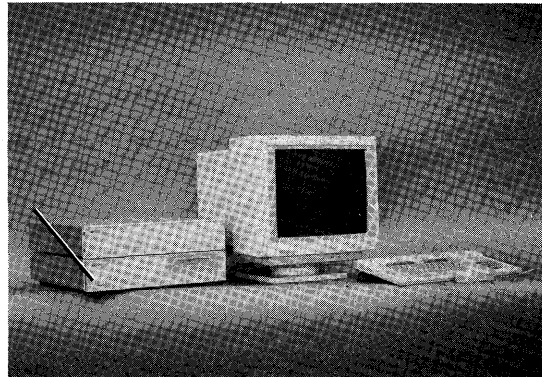

3 Turn OFF your controller.

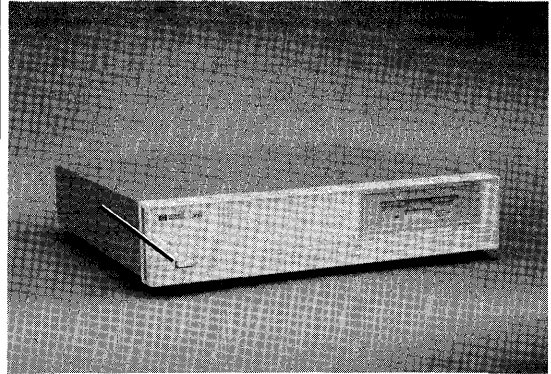

4

4 Go on to the next section, 'Accessing the Controller's Internal Assemblies.'

Accessing the Controller's Internal Assemblies

5 Unplug all cables and cords from the:

- Controller.
- Expanders, if attached.

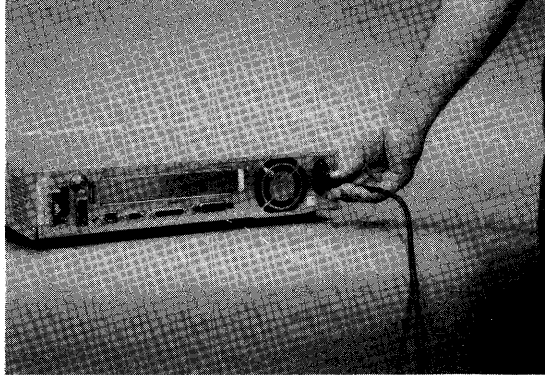

6 If your controller is not rack mounted, skip now to step 7.

If rack mounted, remove the controller and attached expanders from the rack.

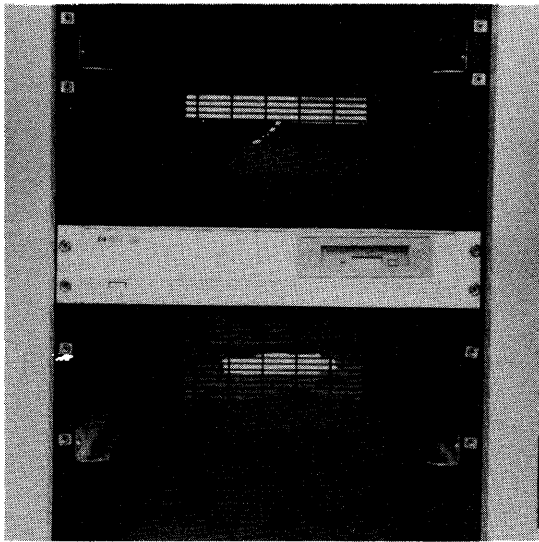

7 If your system does not have an expander, skip now to step 5.

If your system has an expander attached, use a #1 Phillips screwdriver to remove the expander's top cover screw, then slide the expander's top cover back off the expander.

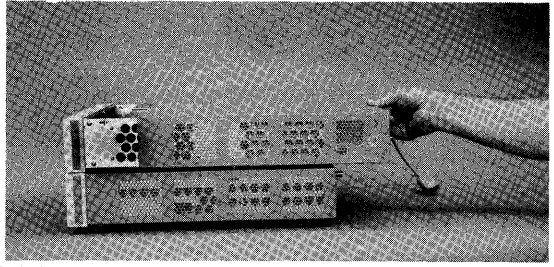
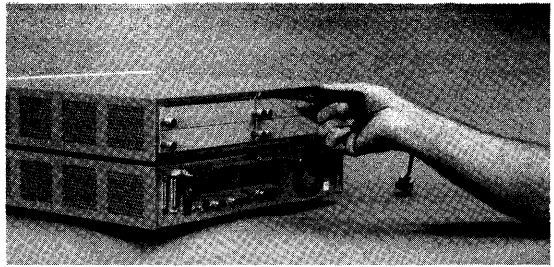

4

8 Remove the two expander attaching standoffs using an 8 mm (5/16-in.) nutdriver.

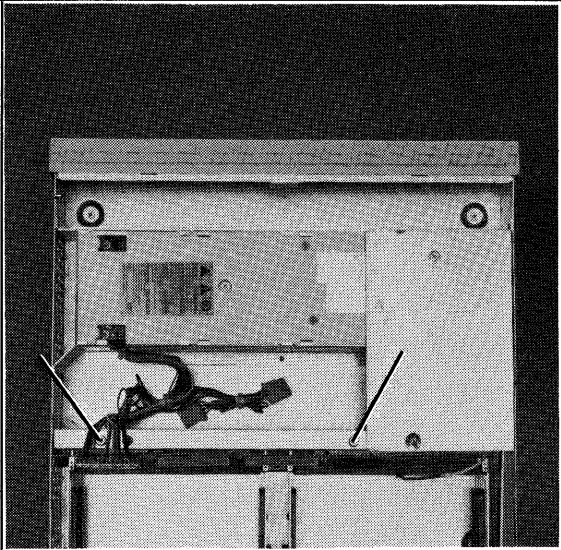

- 9** Remove the two expander attaching screws from the front-bottom of the expander using a #1 Phillips screwdriver.

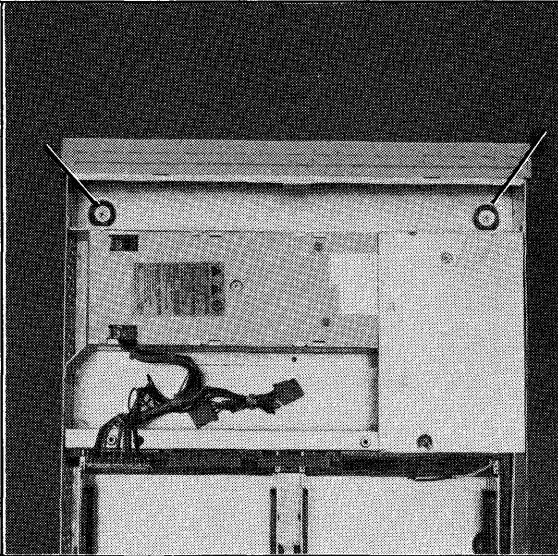

- 10** If a second expander is not installed, skip now to step 11.

If a second expander is installed, remove its top cover, standoffs and attaching screws the same as you removed those from the upper expander.

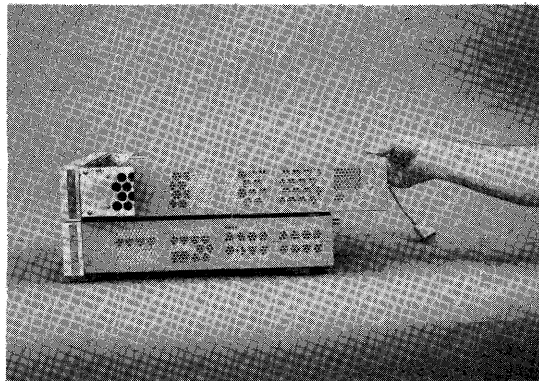

- 11** Remove the controller's top cover screw with a #1 Phillips screwdriver, then slide the top cover off towards the back.

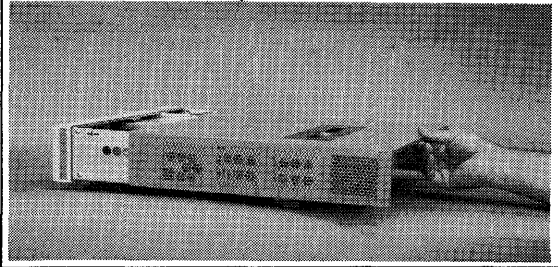
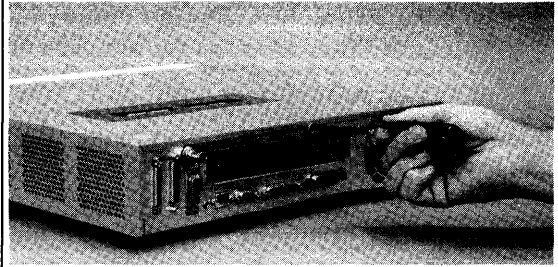

- 12** Open the grounding wrist strap kit, unfold the strap and attach its copper end to your controller's chassis.

The sticky black end attaches to your wrist.

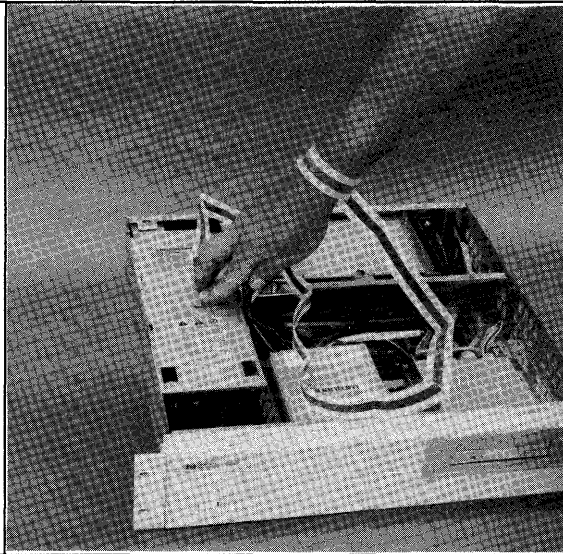

Table 4-1 lists the functions you can configure with the controller's top cover removed. Chapters that explain how to configure that function are to the right of the function.

Table 4-1.
Configurations Possible With Only Top Cover Removed

To configure this function,	skip now to this chapter.
Memory	Chapter 5
Flexible, CD ROM and tape drives	Chapter 6
Graphics type jumpers.	Chapter 7
LAN type; ThinLAN or AUI LAN	Chapter 8

Memory Configurations

Chapter Contents

- **Model 362 Controllers** explains how to:
 - Find out how much memory is already in your controller.
 - Install more memory.
 - Verify the memory change.
- **Model 382 Controllers** explains how to:
 - Find out how much memory is already in your controller.
 - Install more memory.
 - Verify the memory change.

Model 362 Controller

Supported RAM Boards

Three RAM boards are supported in Model 362 controllers:

- HP D2381A; one 2 Mbyte RAM board.
- HP D2156A; one 4 Mbyte RAM board.
- HP D2152A; one 8 Mbyte RAM board.

RAM Board Installation Requirements

- Board may be installed in either slot.
- Any size RAM board may go in either slot.

Performing the RAM Upgrade

Caution

A static charge of almost *40,000 volts* can be generated on a carpeted floor. This exceeds the limits of these RAM boards and can cause unsuccessful operation or damage.

Integrated circuits on printed circuit boards can be damaged by electrostatic discharge. Use the following precautions:

- Use the grounding wrist strap supplied with the upgrade. Follow the instructions printed on the strap's package.
- Do not wear clothing subject to static charge buildup, such as wool or synthetic materials.
- Do not handle integrated circuits in carpeted areas.
- Do not remove the device from its anti-static bag until you are ready to install it.
- Avoid touching circuit leads as much as possible.

5

Caution

RAM boards must be removed from the highest-numbered slots first.

Preliminary Requirements

Before you go inside the controller, refer to Chapter 1 and:

1. Shut down the application program and operating system.
2. Turn OFF the controller.
3. Remove all cables and cords attached to the controller and attached expander(s).
4. If rack mounted, remove the controller and expanders, if attached, from the rack.
5. Remove the controller's top cover.

Go on to the next page and begin.

- 1** Open the grounding wrist strap kit, unfold the strap and attach its copper end to your controller's chassis.

The sticky black end attaches to your wrist.

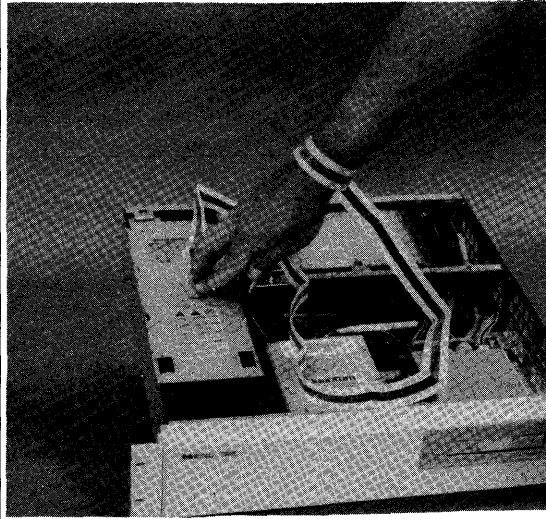

- 2** If you must remove a smaller size RAM board, remove the board by prying the clips apart and tilting the RAM board vertical, then removing it.

Otherwise, skip to step 6.

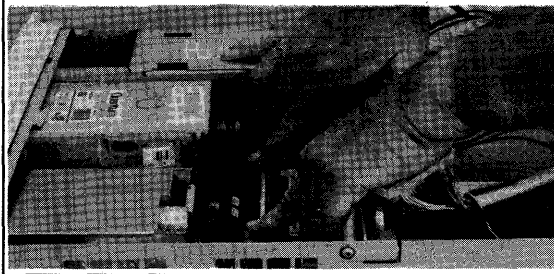

- 3** Note the RAM board is notched on one end to fit the keyed connector.

Install the RAM board in the slot vertically, seat the board completely in its socket, then tilt it down and snap it in place.

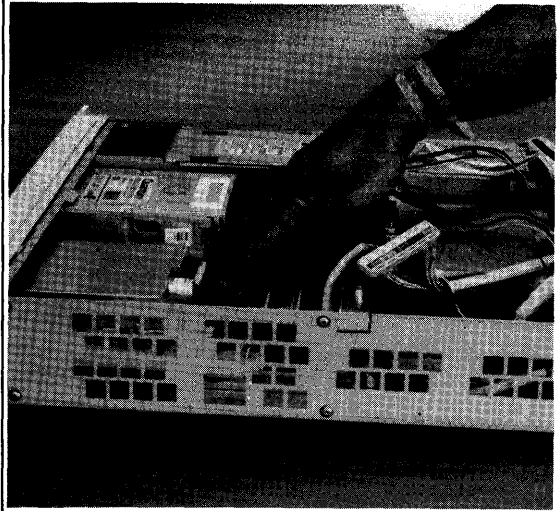

- 4** Remove the grounding strap from the controller and replace the top cover.

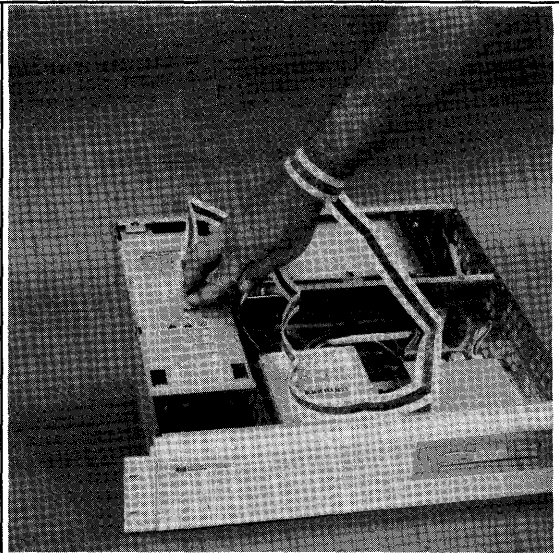

- 5** Replace the controller's top cover.

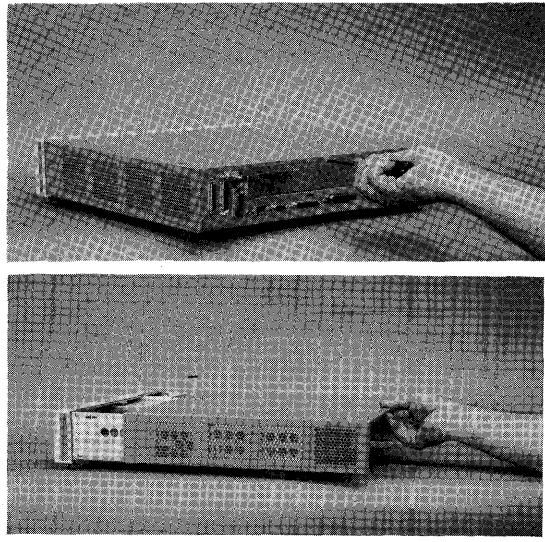

- 6** Connect your controller's power cord and video cable, then turn on your monitor and controller. Note the amount of RAM displayed. If the amount displayed is what you upgraded to, your RAM installation was correct. Otherwise, turn OFF and unplug your controller and check the RAM board installation in their sockets.

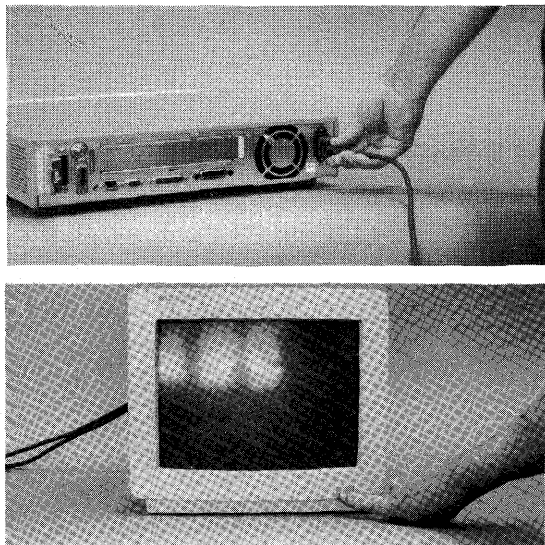

7 If you do not have an expander attached, skip now to step 15.

If you have an expander:

- a. Position the expander that was attached to your controller squarely over the controller.
- b. Align its backplane bottom connectors with the controller/expander backplane connectors.
- c. Lower the expander into place mating the backplane connectors.

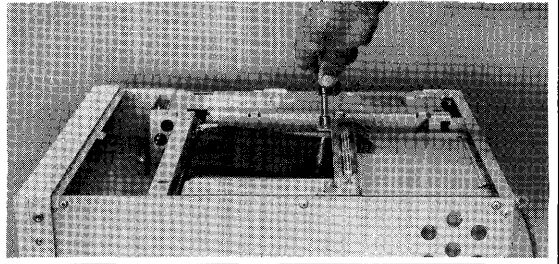
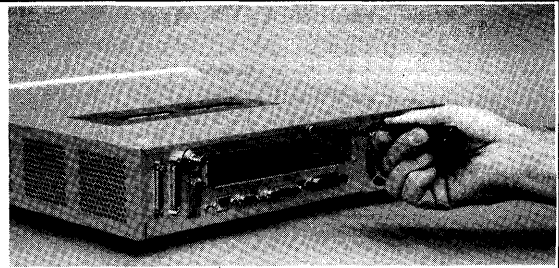

8 Replace the expander's top cover.

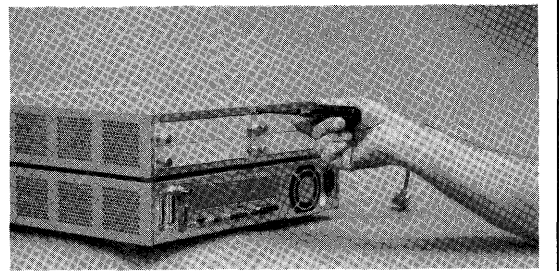
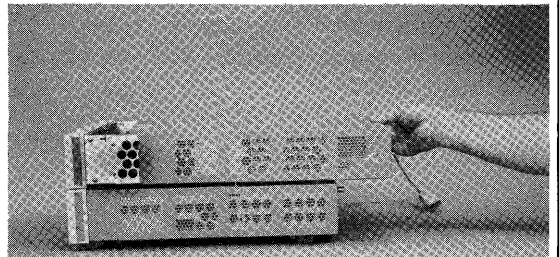

- 9** If a second expander was attached, install that expander and its top cover like you did the first expander.

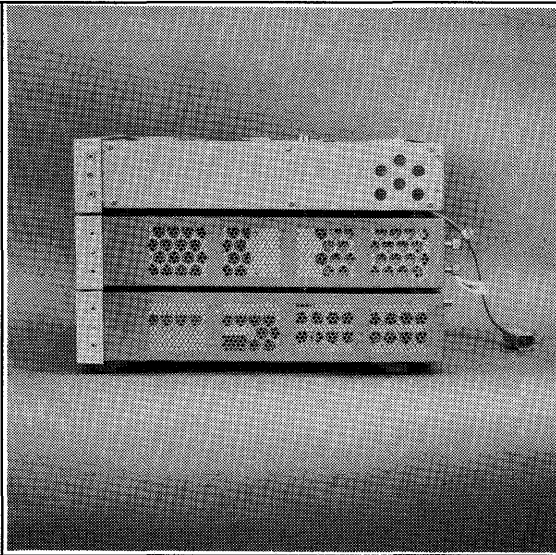

- 10** If your controller/expanders were rack mounted, reinstall them in the rack.

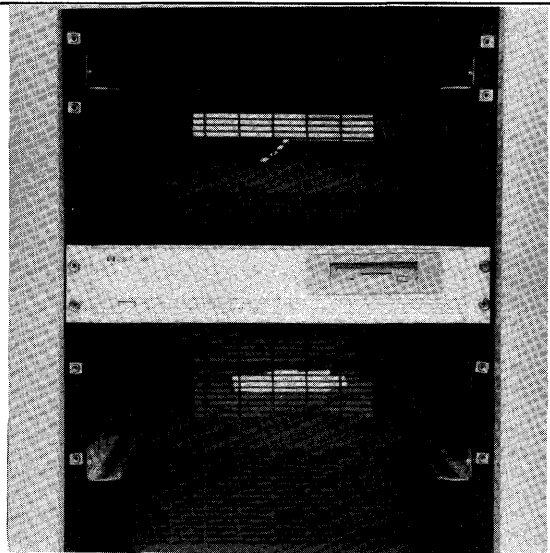

- 11** Reconnect the video cable and power cord to their rear panel connectors on the controller.

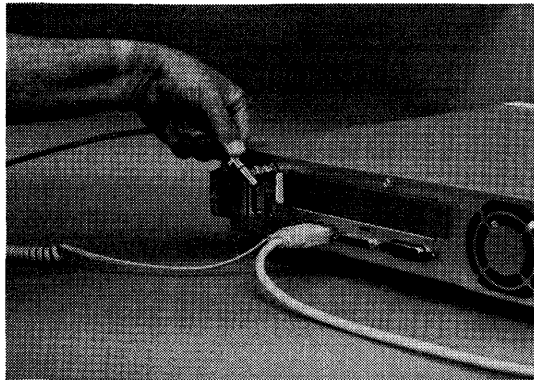

Verifying the Upgrade

Follow these steps to verify your memory upgrade:

1. Turn ON your controller.
2. Enter attended mode by pressing **Space Bar** when the keyboard line appears in the power-up display.
3. Note the amount of RAM in bytes listed in the power-up display. The amount should be what you upgraded to. If the amount is correct, turn off your controller and reinstall in its normal position.

If it is not, check your RAM board installation.

Model 382 Controller

Determining Existing Memory

Follow these steps to determine how much memory your controller already has:

1. If your controller is operating, shut down the operating system following normal procedures. Refer to your controller's *Owner's Guide* for instructions.
2. Turn off your controller, then turn it ON.
3. When the power-up display shown in Figure 5-1 lists the line:

HP-HIL.Keyboard

press the Space bar.

4. Note the amount of Random Access Memory (RAM) in bytes listed in the line that reads:

RAM xxxxxxxx Bytes

5. Write the amount here: RAM _____ Bytes.

Note that the actual amount of RAM will be about 4.9% higher than the amount commonly stated. For example, '8 000 000' bytes (8 megabytes) is actually 8 388 308 bytes.

Copyright 1991
Hewlett-Packard Company
All Rights Reserved

BOOTROM Rev. 3.01
MC68040
Configuration EEPROM
Utility Chip at 41
HP-HIL.Keyboard
HP-IB
DMA-CO
RAM xxxxxxx Bytes
Digital Audio at 8
HP98644 (RS-232) at 9
HP PARALLEL at 12
HP98265 (SCSI S 32) at 14
HP98643 (LAN) at 21, THIN, 0800091595F3
Bit Mapped Video at 132 (Console)

System Search Mode
RESET To Restart

Figure 5-1. Typical Power-Up Display

RAM Board Installation Requirements

- Boards must be installed in pairs; each board must be the same size.
- Slot pair labeled RAM PAIR 0 must have the largest size RAM board pair.
- Slots pair labeled RAM PAIR 1 boards must be equal to, or smaller than boards in slot pair labeled RAM PAIR 0.

Supported Memory Configurations

Table 5-1 lists all supported RAM board configurations for HP 9000 Series 300 Model 382 controllers that use HP A2202A, HP A2201A, and HP A2202A RAM boards. Your controller has one of these configurations. After you upgrade your controller with more memory, a larger configuration will be used.

Table 5-1.
Model 382: Total RAM vs. Slot Numbers and Board Sizes

Total Memory	RAM PAIR 0	RAM PAIR 1
4 MBytes	(2 MB) (2 MB)	
8 MBytes	(4 MB) (4 MB)	
8 MBytes	(2 MB) (2 MB)	(2 MB) (2 MB)
12 MBytes	(4 MB) (4 MB)	(2 MB) (2 MB)
16 MBytes	(8 MB) (8 MB)	
16 MBytes	(4 MB) (4 MB)	(4 MB) (4 MB)
20 MBytes	(8 MB) (8 MB)	(2 MB) (2 MB)
24 MBytes	(8 MB) (8 MB)	(4 MB) (4 MB)
32 MBytes	(8 MB) (8 MB)	(8 MB) (8 MB)

Your New RAM Configuration

You should refer to the sections explaining examples to help you learn about your new RAM configuration.

Follow these steps to determine your new RAM configuration:

1. Write the existing RAM board sizes in Table 5-2's 'Existing' row for each slot.
2. In Table 5-2, fill in the upgraded RAM board configurations as follows:
 - a. RAM boards must be installed in pairs; each board in the pair must be the same size.
 - b. Slot pair 'RAM Pair 0' must have the largest size RAM board pair.
 - c. Slot pair 1RAM Pair 1' must have boards equal to, or smaller than boards in slot pair 'RAM Pair 0.'
3. Add up the Upgraded RAM board sizes and write the total in the 'Upgraded, Total' block of Table 5-2.
4. Remove and/or replace RAM boards to match the configuration in Table 5-2's 'Upgraded' row.

Table 5-2. Model 382: Existing Memory vs. Upgraded Memory

	Total	RAM PAIR 0	RAM PAIR 1
Existing			
Upgraded			

Example: Upgrading 8 Mbytes to 16 Mbytes

To upgrade a Model 382 controller with 8 Mbytes (two existing 4 Mbyte RAM boards) to 16 Mbytes with the HP A2201A 8 Mbyte RAM Board Set, you would follow these steps:

1. The amount of RAM existing is 8 Mbytes. You would write that amount in Table 5-2's 'Existing, Total' block as shown below:

Example Existing Memory vs. Upgraded Memory

	Total	RAM PAIR 0	RAM PAIR 1
Existing	8 MB		
Upgraded			

5

2. Refer to your controller's memory and determine the size of the RAM boards already in the slots. One of these configurations in Table 5-3 will exist:

**Table 5-3.
Model 382: RAM Board Configurations for 8 Mbytes**

Total Memory	RAM PAIR 0	RAM PAIR 1
8 MBytes	4 MB 4 MB	
8 MBytes	2 MB 2 MB	2 MB 2 MB

If two slots have boards, the boards are each 4 Mbytes. This condition is used in this example.

You would write '4 MB' in Table 5-2's 'Existing' block for RAM PAIR 1 slots as shown below:

Example Existing Memory vs. Upgraded Memory

	Total	RAM PAIR 0	RAM PAIR 1
Existing	8 MB	4 MB 4 MB	
Upgraded			

3. Add up the new RAM board sizes to the existing RAM board sizes and write the total in Table 5-2's 'Upgraded-Total' block. In this example, adding 8 Mbytes to 8 Mbytes equals 16 Mbytes. You would write in '16 MB' as shown below:

Example Existing Memory vs. Upgraded Memory

	Total	RAM PAIR 0	RAM PAIR 1
Existing	8 MB	4 MB 4 MB	
Upgraded	16 MB		

5

4. In Table 5-2, you would write in the upgraded RAM board configurations as follows:
- RAM PAIR 0 would have the largest size board PAIR, or a 4 Mbyte board in each slot. The existing boards can remain in slots 'RAM PAIR 0.'
 - RAM PAIR 1 slots would have a new 4 Mbyte board in each one: the new 8 Mbytes.

The example table below shows how you would write in the new RAM boards.

Example Existing Memory vs. Upgraded Memory

	Total	RAM PAIR 0	RAM PAIR 1
Existing	8 MB	4 MB 4 MB	
Upgraded	16 MB	4 MB	4 MB

5. You would install the new 4 Mbyte boards in **RAM PAIR 1** slots
6. When you turned on your controller, the amount of RAM listed would be about 16 776 916 bytes.

Example: Upgrading 8 Mbytes to 24 Mbytes

To upgrade a Model 382 Controller with 8 Mbytes (two 4 Mbyte RAM boards) to 24 Mbytes with the HP A2202 16 Mbytes Board Set, you would follow these steps:

1. The amount of RAM existing is 8 Mbytes. You would write that amount in Table 5-2's 'Existing, Total' block as the example shows below.

Example Existing Memory vs. Upgraded Memory

	Total	RAM PAIR 0	RAM PAIR 1
Existing	8 MB		
Upgraded			

2. Refer to your controller/controller's memory and determine the size of the RAM boards already in the slots. One of these configurations in Table 5-3 will exist.

Model 382: RAM Board Configurations for 8 Mbytes

Total Memory	RAM PAIR 0	RAM PAIR 1
8 MBytes	(4 MB) (4 MB)	
8 MBytes	(2 MB) (2 MB)	(2 MB) (2 MB)

If two slots have boards, the boards are 4 Mbytes. This condition is used in this example.

You would write '4 MB' in Table 5-2's 'Existing' block for 'RAM PAIR 0' shown below:

Example Existing Memory vs. Upgraded Memory

	Total	RAM PAIR 0	RAM PAIR 1
Existing	8 MB	4 MB 4 MB	
Upgraded			

3. Add up the new RAM board sizes to the existing RAM board sizes and write the total in Table 5-2's 'Upgraded-Total' block. In this example, adding 16 Mbytes to 8 Mbytes equals 24 Mbytes. You would write in '24 MB' as shown below:

Example Existing Memory vs. Upgraded Memory

	Total	RAM PAIR 0	RAM PAIR 1
Existing	8 MB	4 MB 4 MB	
Upgraded	24 MB		

4. In Table 5-2, you would fill in the upgraded board configurations as follows:
 - a. RAM PAIR 0 would have the largest size board pair, or an 8 Mbyte board in each slot totaling 16 Mbytes.
 - b. RAM PAIR 1 slots would have an existing 4 Mbyte board reinstalled in each slot; the original 8 Mbytes.
5. You would remove the existing 4 Mbyte boards from 'RAM PAIR 0 and install them in RAM PAIR 1 slots.

6. You would install the new 8 Mbyte boards in RAM PAIR 0 slots. Enter this information in Table 5-2's 'Upgraded, RAM PAIR 0 and RAM PAIR 1' blocks as shown below:

Example Existing Memory vs. Upgraded Memory

	Total	RAM PAIR 0	RAM PAIR 1
Existing	8 MB	4 MB 4 MB	
Upgraded	24 MB	8 MB 8 MB	4 MB 4 MB

7. When you turned on your controller, the amount of RAM listed would be about 25 165 524 bytes.

Performing the RAM Upgrade

Caution

A static charge of almost *40,000 volts* can be generated on a carpeted floor. This exceeds the limits of these RAM boards and can cause unsuccessful operation or damage.

Integrated circuits on printed circuit boards can be damaged by electrostatic discharge. Use the following precautions:

- Use the grounding wrist strap supplied with this upgrade. Follow the instructions printed on the strap's package.
- Do not wear clothing subject to static charge buildup, such as wool or synthetic materials.
- Do not handle integrated circuits in carpeted areas.
- Do not remove the device from its anti-static bag until you are ready to install it.
- Avoid touching circuit leads as much as possible.

Caution

RAM boards must be removed from the highest-numbered slots first.

- 1** Before you go inside the controller:
1. Shut down the operating system.
 2. Turn OFF the controller.
 3. Remove all cables and cords attached to the controller and attached expander(s)

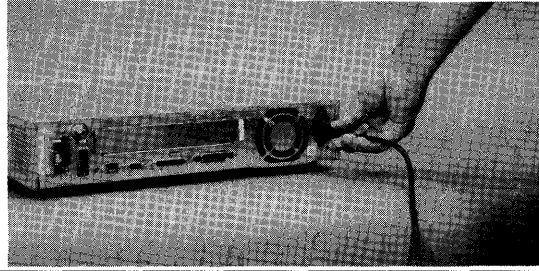
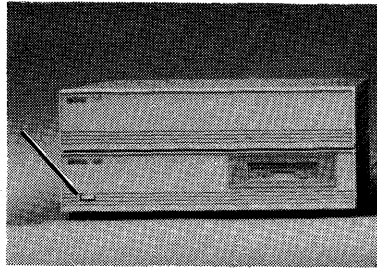

- 2** Use a #1 Phillips® screwdriver and remove the:
- Controller's top cover screw if it does not have an expander.
 - Existing expander's top cover screw if attached to your controller.

and slide the cover backwards and off the controller/expander.

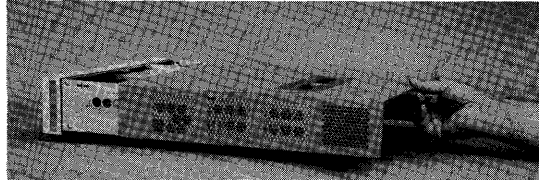
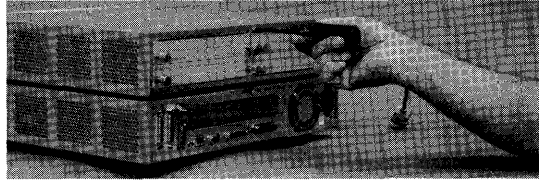
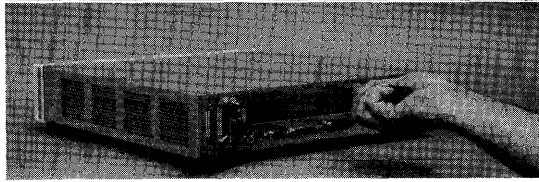

- 3** Use an 8 mm (5/16-in.) nutdriver to remove the two expander attaching standoffs.

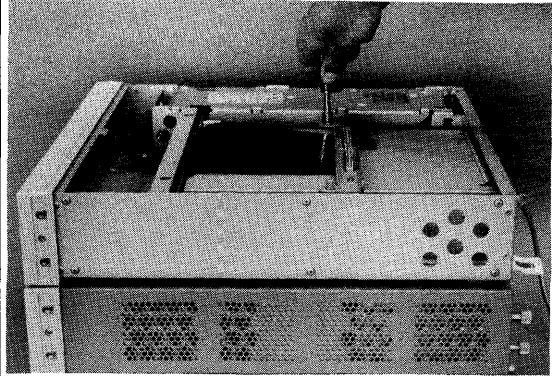

- 4** Use the #1 Phillips® screwdriver to remove the two expander attaching screws from the front-bottom of the expander.

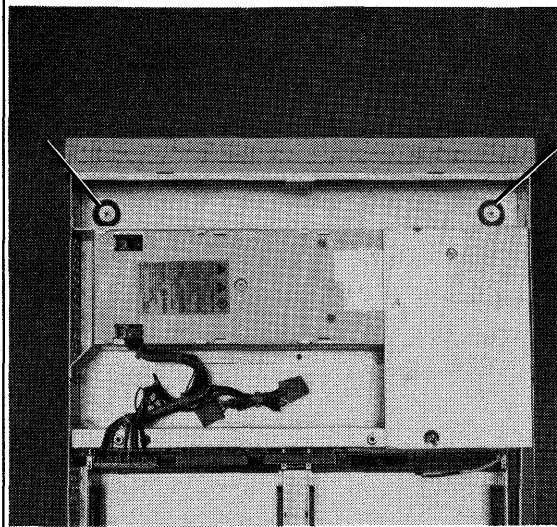

- 5** If a second expander is installed, remove its top cover, standoffs and attaching screws the same as you removed those from the upper expander.

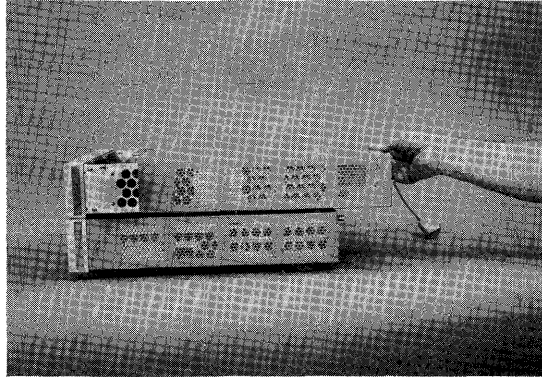

- 6** Remove the controller's top cover screw and top cover like you did the expander's.

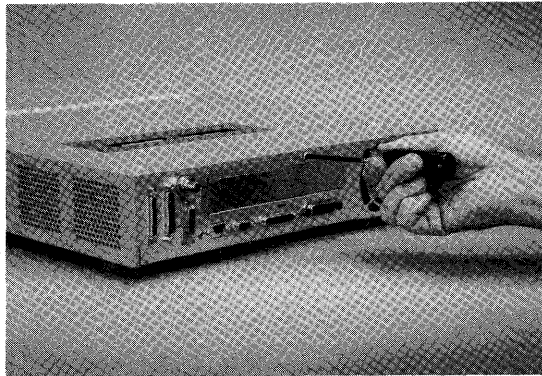

- 7** Open the grounding wrist strap kit, unfold the strap and attach its copper end to your controller's chassis.

The sticky black end attaches to your wrist.

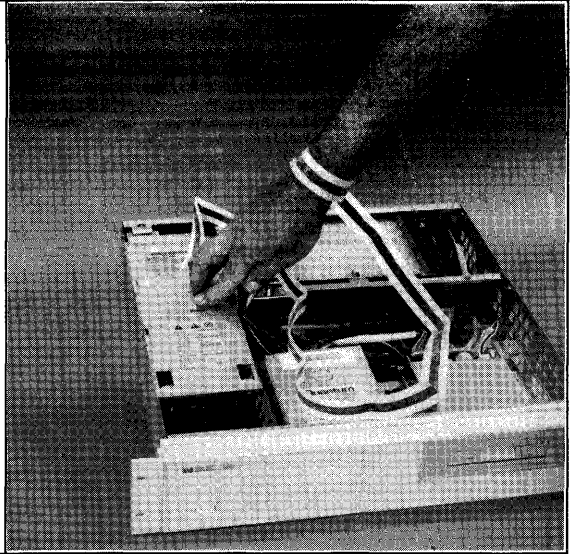

- 8** If you do not need to remove RAM boards, skip to step 9. If you need to remove RAM boards:

- a. Remove the highest-numbered (towards the front) RAM board first. Pushing its two slot clips out, then tilt its top away from the board next to it.
- b. Remove the next lower-numbered RAM board next to the one just removed.
- c. Remove the remaining RAM boards you need to remove.

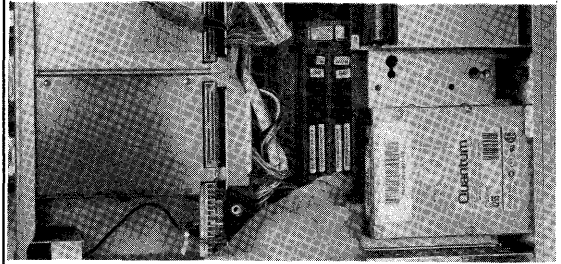
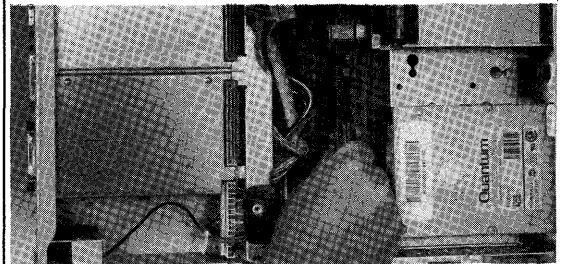

- 9** Place the first RAM board you will install in the lowest numbered empty slot. Install the board with its top edge tilted towards slot 1B.

Note the RAM board is notched on one end to fit the keyed connector.

Snap the RAM board in place by moving it to a vertical position. Its ends will snap into the slot's spring clips.

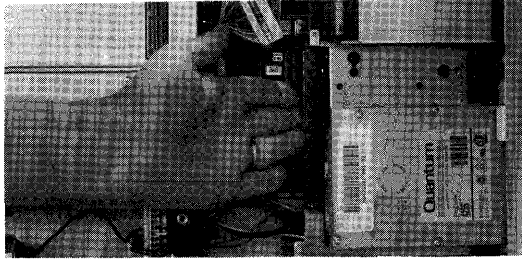
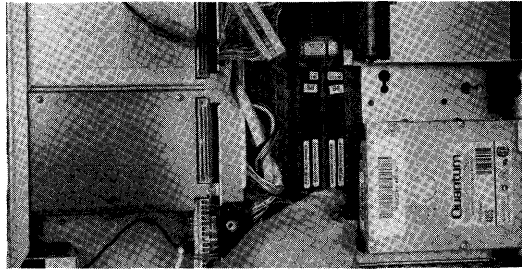

- 10** Install the second RAM board next to the previous one.

Repeat this step for the other RAM boards to be installed.

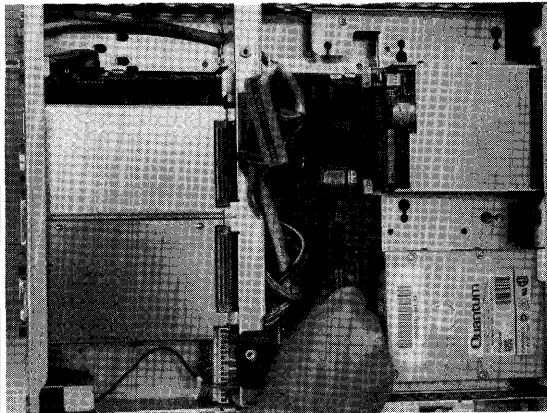

11 Verify that:

- a. Slots labeled RAM PAIR 0 have the largest size RAM boards.
- b. Slots labeled RAM PAIR 1 have RAM boards equal in size to, or smaller than those in slots labeled RAM PAIR 1.

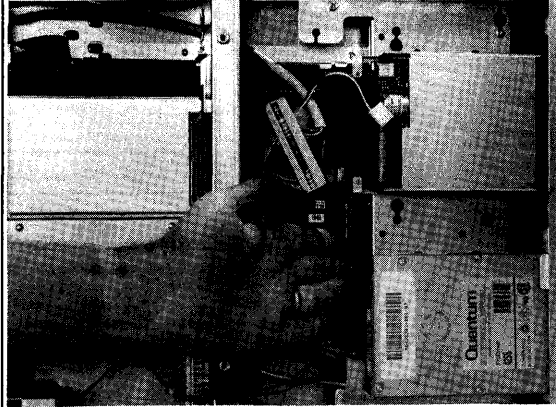

- 12** Remove the grounding strap from the controller and replace the top cover.

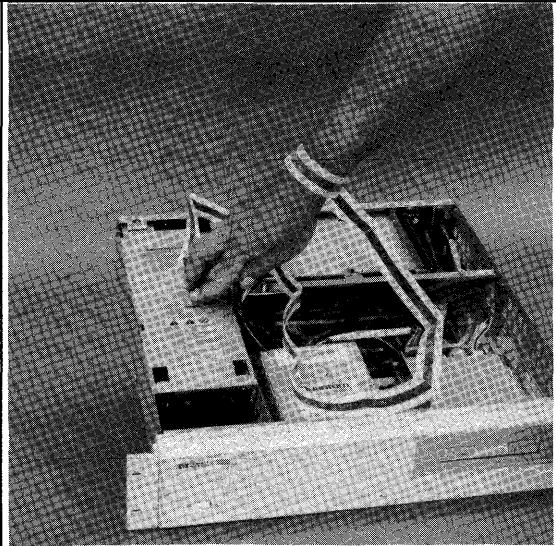

- 13** Replace the controller's top cover.

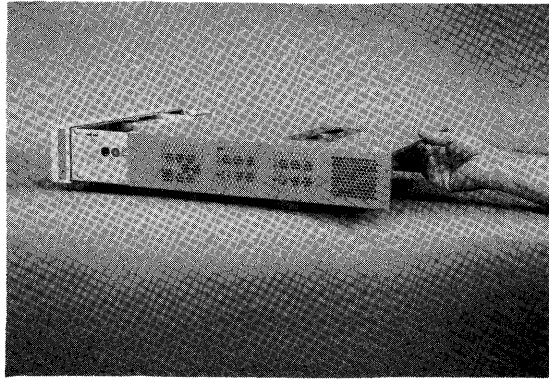

- 14** a. Position the expander that was attached to your controller squarely over the controller.
- b. Align its backplane bottom connectors with the controller/expander backplane connectors.
- c. Lower the expander into place mating the backplane connectors.

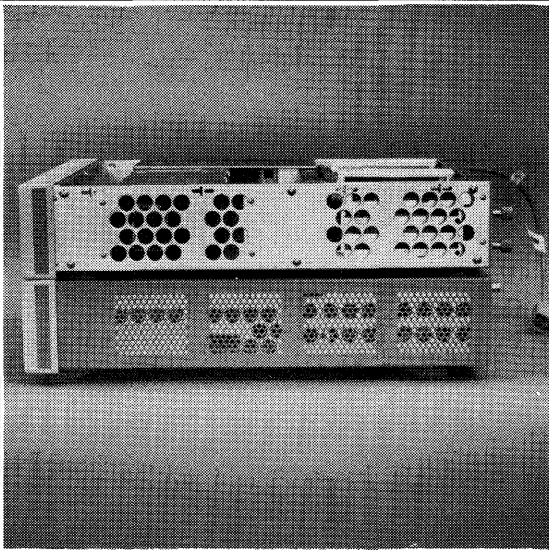

15 Replace the expander's two front bottom screws.

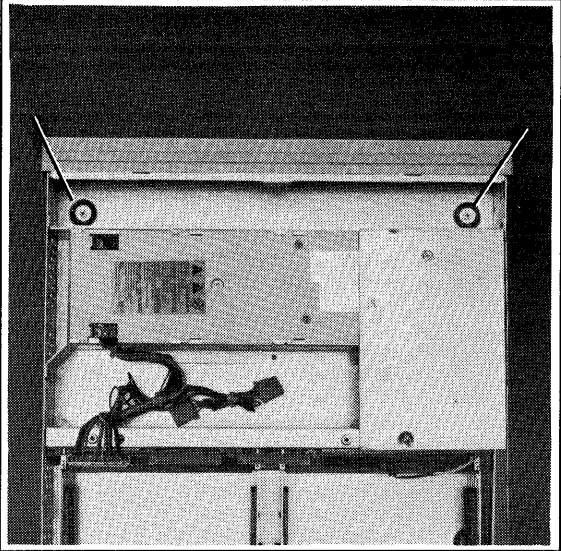

16 Replace the expander's standoffs.

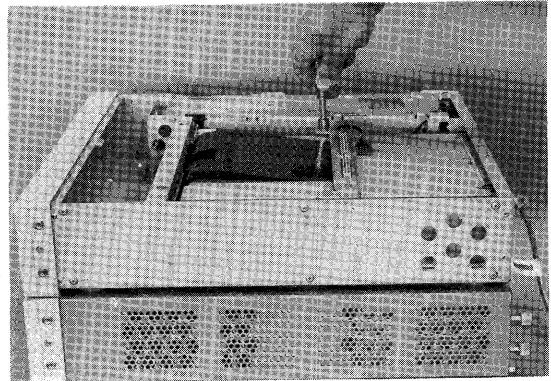

17 Replace the expander's top cover.

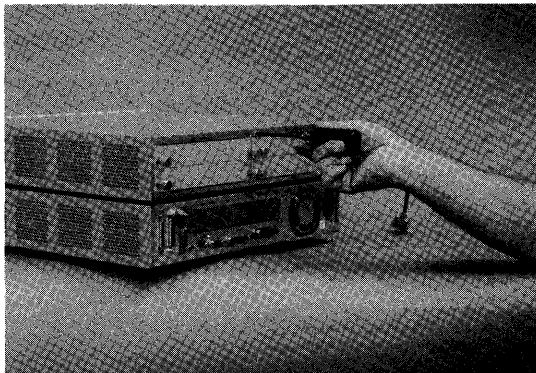

18 If a second expander was attached, install that expander and its top cover like you did the first expander.

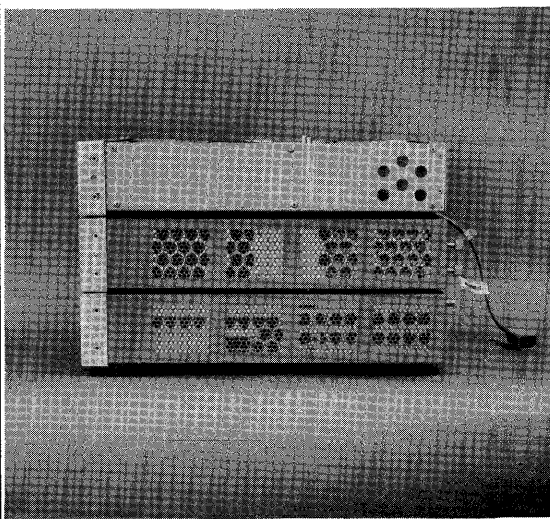

19 If your controller/expanders were rack mounted, reinstall them in the rack.

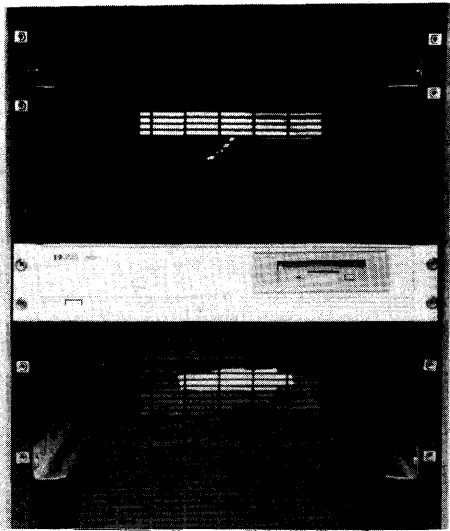

20 Reconnect the cables and power cord to their rear panel connectors on the controller and expanders.

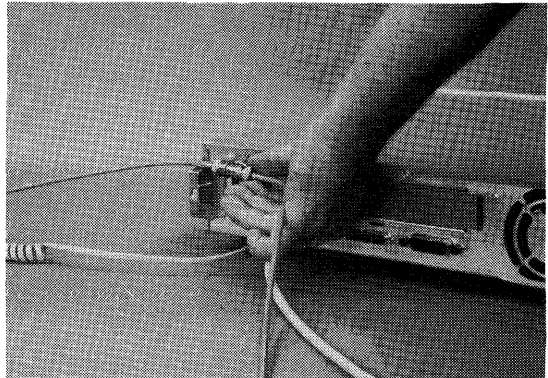

Verifying the Upgrade

Follow these steps to verify your memory upgrade for your Model 382 controller:

1. Turn ON your expander(s), then turn on your controller.
2. Enter attended mode by pressing **Space Bar** when the keyboard line appears in the power-up display.
3. Note the amount of RAM in bytes listed in the power-up display. The upgraded amount should be displayed. If it is not, check your board installation.

Configuring Mass Storage Devices

Chapter Contents

- **Accessing a Hard Disk Drive** shows you how to remove a hard disk drive from the controller. Their configuration jumpers are on the bottom.
- **Jumper or switch settings for the:**
 - **52 Mbyte Hard Disk Drive**
 - **210 and 420 Mbyte Hard Disk Drives**
 - **CD ROM Disk Drive**
 - **3.5-in. Flexible Disk Drive**
 - **DDS Tape Drive**

Note Your controller system may include mass storage or other products not covered in this manual. Refer to that device's manuals for configuration information.

Accessing a Hard Disk Drive

Before you start to reconfigure your 210 or 420 Mbyte hard disk drive, refer to Chapter 3 and 4 to:

1. Shut down your controller's application program and operating system.
2. Turn OFF your controller and unplug all cords and cables from it and any attached expanders.
3. Access the controller's internal assemblies.

Removing the Hard Disk Drive

Before you can change a hard disk drive's configuration, you need to remove the drive from the controller. Follow these steps to remove the drive.

Caution Hard disk drives are vulnerable to physical shock. *Dropping a hard disk drive from even a small height will damage its heads and platters.*

Always handle hard disk drives with extreme caution.

Do not set a hard disk drive upside down on any surface.

- 1** Unplug the power and SCSI cables from all drives.
- Note the SCSI cable connectors as they are connected to the drives.

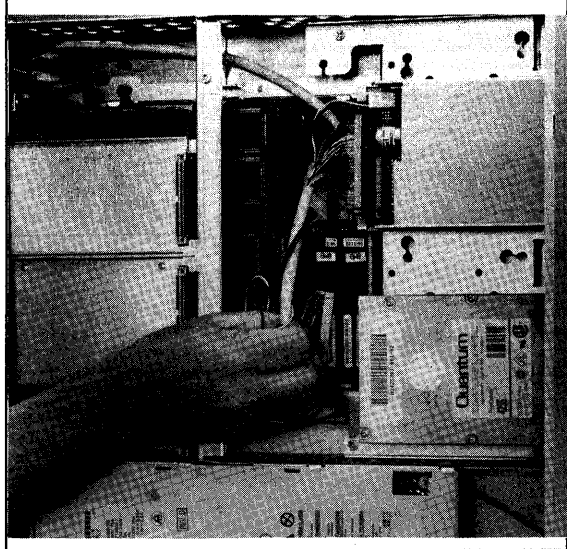

- 2** Remove the two screws at the rear of the drive tray, one on each rear corner.

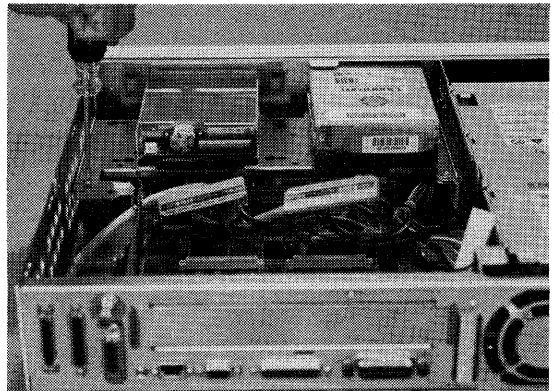

3 Slide the drive tray to the rear about 12 mm (0.5-in.) until the three tabs are free from the chassis and lift the drive assembly out of the unit.

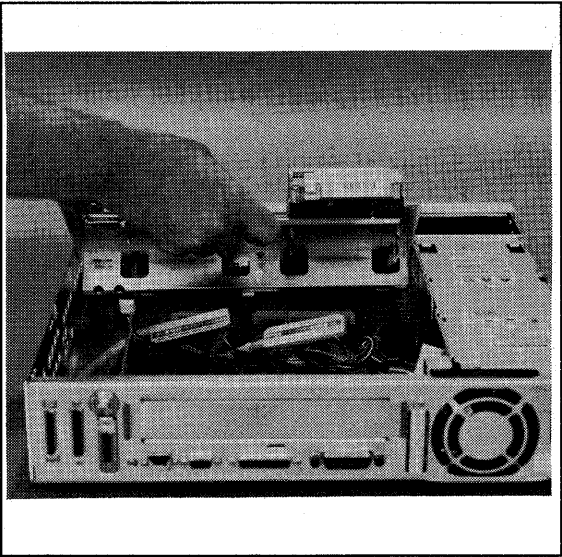

Caution

Although mass storage devices are well-protected from physical shock when installed in the controller, it is very easily damaged when removed. Avoid dropping or striking the device. Handle it gently at all times.

6

- 4** Remove the four screws from the bottom of the tray holding the drive and remove the drive from the tray.

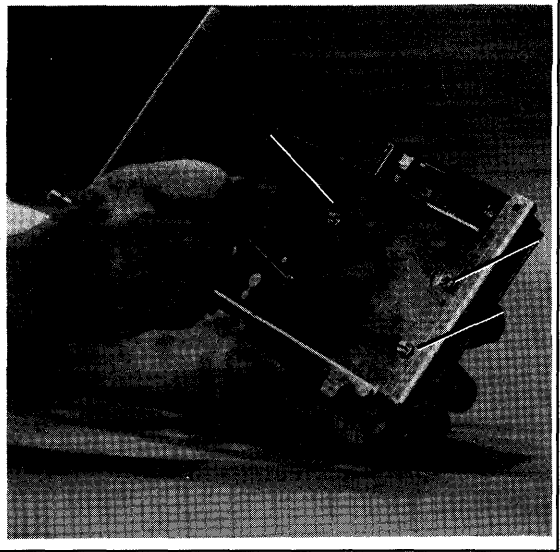

52 Mbyte Hard Disk Drives

Setting Configuration Jumpers

Caution Although the device is well-protected from physical shock when installed in the controller, it is very easily damaged when separate. Avoid dropping or striking the device. Handle it gently at all times.

Figure 6-2 shows you the configuration jumper locations. Jumpers and their settings are explained in Table 6-1.

Note the jumpers in the back of the drive are installed as follows:

- Jumpers installed on pins = “in.”
- Jumpers removed from pins = “out.”

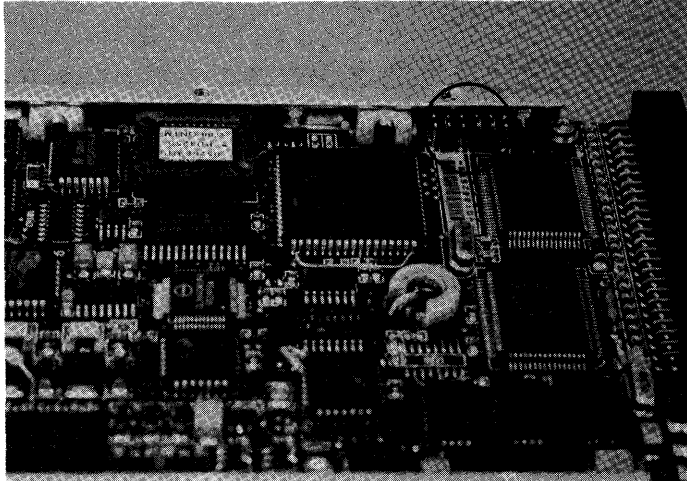

Figure 6-1. 52 Megabyte Hard Disk Drive Configuration Jumper Locations

Table 6-1. Hard Disk Drive Configuration Jumper Functions

Jumper Label	Function
SS	Self-Seek; In = disabled. Out = enabled. (Default) Drive self-tests at turn-on. LED is ON during test, OFF after self-test passes. Flashes if an error is detected.
EP	Enable Parity In = enabled. Out = disabled. (Default) Controls parity checking of data on SCSI bus.
WS	Wait/Spin In = enabled. Requires a stop/start unit command to spin drive motor. Out = disabled. (Default) Drive motor starts automatically at turn-on and is ready within 20 seconds.
A0, A1, A2	SCSI Bus Address; A0 is least significant bit. Shipped with address 6 set (jumpers on A1 and A2).

SCSI Bus Address Jumpers

The hard disk drive must be set to a unique SCSI bus address. Use a pair of needle-nose pliers to set the drive's SCSI address. The address is binary (jumper in = 1, out = 0) with jumper A0 the least significant bit.

Configuring the Operating System

Refer to your *Owner's Guide* or other operating system documentation to configure your operating system for the drive.

210 or 420 Mbyte Hard Disk Drives

Setting Configuration Jumpers

Caution Although the device is well-protected from physical shock when installed in the controller, it is very easily damaged when separate. Avoid dropping or striking the device. Handle it gently at all times.

Note the jumpers in the back of the drive are installed as follows:

- Jumpers installed on pins = “in.”
- Jumpers removed from pins = “out.”

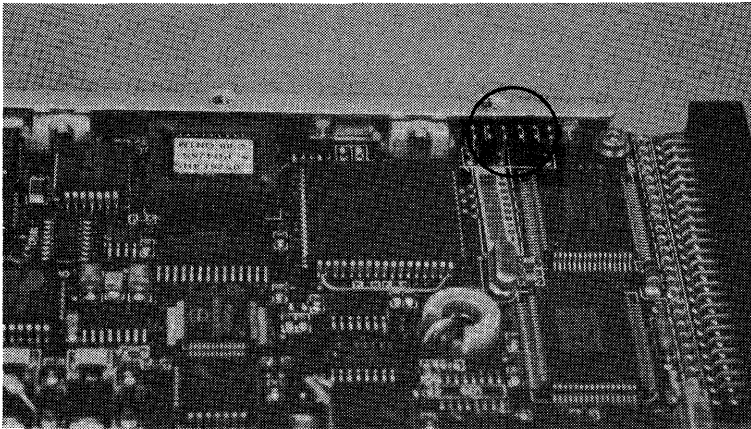

Figure 6-2. Hard Disk Drive Configuration Jumper Locations

Table 6-2. Hard Disk Drive Configuration Jumper Functions

Jumper Label	Function
SS	Self-Seek; In = disabled. Out = enabled. (Default) Drive self-tests at turn-on. LED is ON during test, OFF after self-test passes. Flashes if an error is detected.
EP	Enable Parity In = enabled. Out = disabled. (Default) Controls parity checking of data on SCSI bus.
WS	Wait/Spin In = enabled. Requires a stop/start unit command to spin drive motor. Out = disabled. (Default) Drive motor starts automatically at turn-on and is ready within 20 seconds.
A0, A1, A2	SCSI Bus Address; A0 is least significant bit. Shipped with address 6 set (jumpers on A1 and A2).

SCSI Bus Address Jumpers

The hard disk drive must be set to a unique SCSI bus address. Use a pair of needle-nose pliers to set the drive's SCSI address. The address is binary (jumper in = 1, out = 0) with jumper A0 the least significant bit.

Configuring the Operating System

Refer to your *Owner's Guide* or other operating system documentation to configure your operating system for the drive.

3.5-in. Flexible Disk Drive

Preliminary Requirements

Before you start to reconfigure your 3.5-in. flexible disk drive, refer to Chapter 3 and 4 and:

1. Shut down your controller's application program and operating system.
2. Turn OFF your controller and unplug all cords and cables from it and any attached expanders.
3. Access the controller's internal assemblies.

Setting the Configuration Jumpers

Caution Although the device is well-protected from physical shock when installed in the controller, it is very easily damaged when separate. Avoid dropping or striking the device. Handle it gently at all times.

6

Figure 6-3 shows you the configuration jumper locations. Jumpers and their settings are explained in Table 6-3.

Note the flexible disk drive jumpers are installed as follows:

- Jumpers installed on pins = "in."
- Jumpers removed from pins = "out."

Caution Your flexible disk drive jumpers are used opposite to jumpers in your hard disk drives. For example, the three flexible disk drive bus address jumpers when set to bus address 0 are all 'in.' The same hard disk drive address jumpers set to bus address 0 are all 'out.'

Note Jumpers 0, 2DS and A through F are factory set and must not be changed.

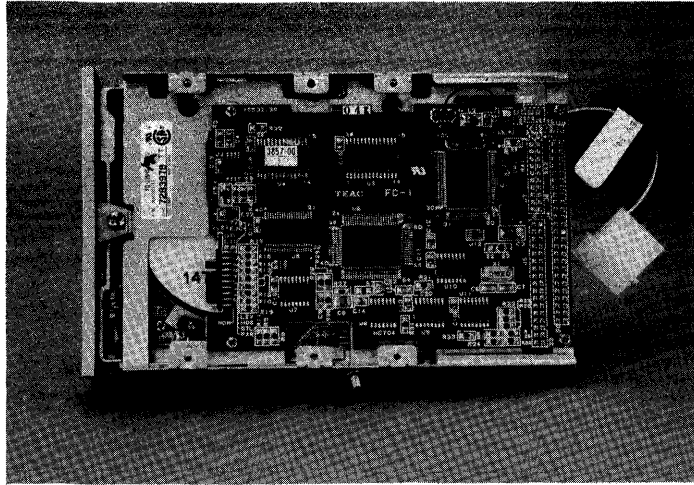

Figure 6-3. Flexible Disk Drive Configuration Jumper Locations

Table 6-3.
Flexible Disk Drive Configuration Bottom Jumper Functions

Jumper Label	Function
ID2, ID1, ID0	SCSI Bus Address jumpers. ID2 is most significant bit. Default settings: Address 3. ID2 = out; ID1 = in; ID0 = in.
EJC	Eject mode In = Electrical eject mode (not used). Out = (default) Manual eject mode.
LEV	Pin 2 output of the density is enabled. In = enabled. (Default) Out = disabled.
HDS	In = enabled. (Default) Out = disabled.
STL	In = enabled. (Default) Out = disabled.
PAR	Enable Parity In = enabled. (Default) Controls parity checking of data on SCSI bus. Out = disabled.
MON	Motor ON In = disabled. Out = enabled. (Default) Drive motor is not turned on when the controller is turned on.

Function Jumpers

Only the SCSI address jumpers should be changed. You should not have to change the function jumpers. They should be left in their default condition.

SCSI Bus Address Jumpers

Your flexible disk drive must be set to a bus address that is different from other SCSI device bus addresses already used. The factory default setting is address 3. Use a pair of needle-nose pliers to remove and install the

configuration jumpers. Set your drive's SCSI configuration jumpers for the SCSI bus address it will use.

Note that jumper ID 0 is next to the edge of the printed circuit board. For example, if you want to set your hard disk drive's address jumpers to address 5, you would set:

- Jumper ID 0 out.
- Jumper ID 1 in.
- Jumper ID 2 out.

SCSI Bus Address Jumpers

The hard disk drive must be set to a unique SCSI bus address. Use a pair of needle-nose pliers to set the drive's SCSI address. The address is binary (jumper in = 1, out = 0) with jumper A0 the least significant bit.

Configuring the Operating System

Refer to your *Owner's Guide* or other operating system documentation to configure your operating system for the drive.

CD ROM Disk Drive

Preliminary Requirements

Before you start to reconfigure your CD ROM drive, refer to Chapter 3 and 4 to

1. Shut down your controller's application program and operating system.
2. Turn OFF your controller and unplug all cords and cables from it and any attached expanders.
3. Access the controller's internal assemblies.

Setting the Configuration Jumpers

Figure 6-4 shows you the configuration jumper locations. Jumpers and their settings are explained in Table 6-4. Note the jumper positions that represent an 'out' and 'in.'

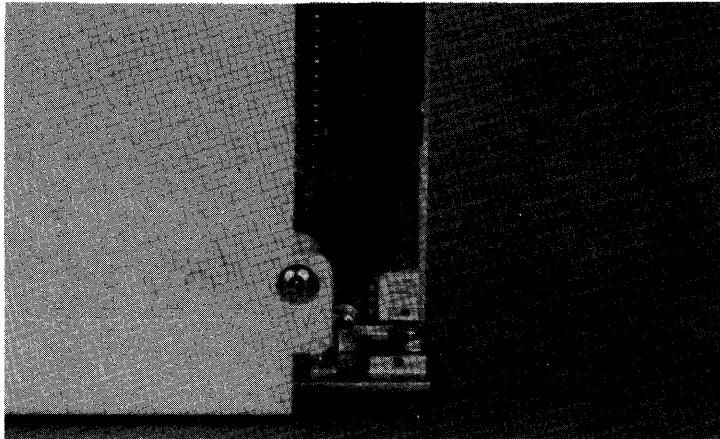

Figure 6-4. CD ROM Configuration Jumper Locations

Table 6-4. CD ROM Drive Configuration Jumper Functions

Jumper Label	Function
ID1,ID2,ID4	SCSI ID Address; Jumper ID1 is least significant bit. Shipped with address 2 set (default); jumper only on ID2
PRTY	Parity checking; Out = Disabled, In = Enabled.
PRV/ALW	Media removal; Out = eject button enabled, In = eject button ignored.
TEST	Test; for factory use only.
TERM	Termination power source; In = from drive, Out = from bus

SCSI Bus Address Jumpers

Your CD ROM drive's SCSI ID jumpers must be set to the bus address it will use. Your CD ROM has bus address 2 factory set. Set your CD ROM's SCSI ID configuration jumpers for SCSI bus address you will use in the range of 0 through 6. Refer to Table 6-5 for bus address settings

Table 6-5. CD ROM SCSI ID Addresses and Switch Settings

SCSI Address	ID1	ID2	ID4
0	0	0	0
1	1	0	0
2	0	1	0
3	1	1	0
4	0	0	1
5	1	0	1
6	0	1	1
7	1	1	1

Parity Jumper

You should leave the PRTY jumper in to enable parity checking of data.

Audio Use

'Audio Only Mode' is not supported.

Configuring the Operating System

Refer to your *Owner's Guide* or other operating system documentation to configure your operating system for the drive.

DDS Tape Drive

Before you start to reconfigure your DDS tape drive, refer to Chapter 3 and 4 to:

1. Shut down your controller's application program and operating system.
2. Turn OFF your controller and unplug all cords and cables from it and any attached expanders.
3. Access the controller's internal assemblies.

Configuring the Operating System

Refer to your *Owner's Guide* or other operating system documentation to configure your operating system for the drive.

Configuring the Hardware

You now have access to the mounting location for the new drive. This section contains instructions for configuring the new drive and installing it in the workstation.

1. Choose the Device Address. It can be any unused number from 0 to 6. If you have no preference, use 2 unless it has been taken.

2. Locate the SCSI address jumpers on the drive. They are located directly behind the power connector.

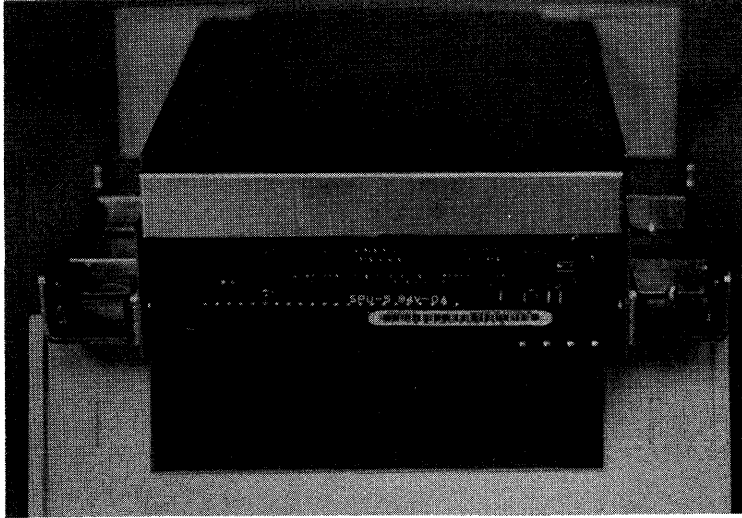

SCSI Address Jumpers

- The address jumpers are the three in the middle. There are two pins to the left and one pin and an empty space to the right. The address jumpers have the values shown in Figure 6-5.

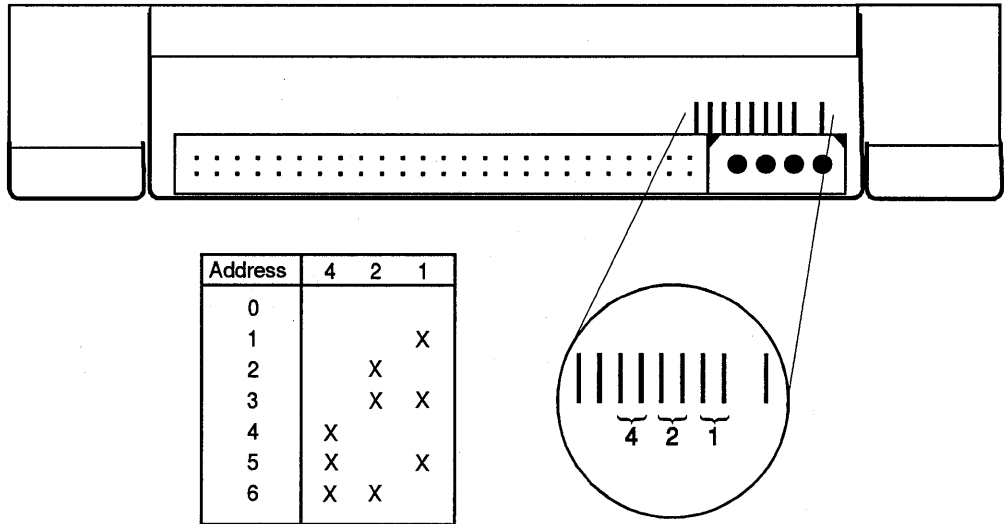

Figure 6-5. Setting the Address Jumpers

- Move the jumpers to obtain the desired address.

Note Do not change the setting of the other two positions. Removing the jumper from the first position will result in no parity checking, and installing a jumper in the second position will result in a non-functional drive.

- Write the Device Address here: _____
- SCSI circuits must be terminated properly. The new drive must be terminated unless there is an external SCSI connector on the rear panel.

7. Check to make sure that the termination resistors are correctly configured.
Here is how to check that the termination is correctly configured:

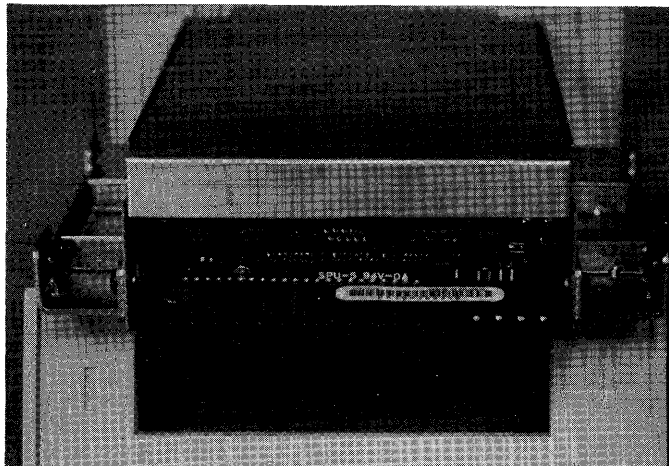

Terminator Location

6

If you see a row of pin sockets, the termination resistors have been removed. The resistors are still present if you see resistors installed in the sockets. If the device should be unterminated and the resistors are present, remove them with a pair of long-nose pliers. If they are removed but should be present, contact your Sales and Service Office.

8. There are two mass storage locations in the unit. The one on the right as you face the front panel is called the Removeable-media Bay, and the other is called the Non-removeable-media Bay. The new drive must go in the Removeable-media Bay.

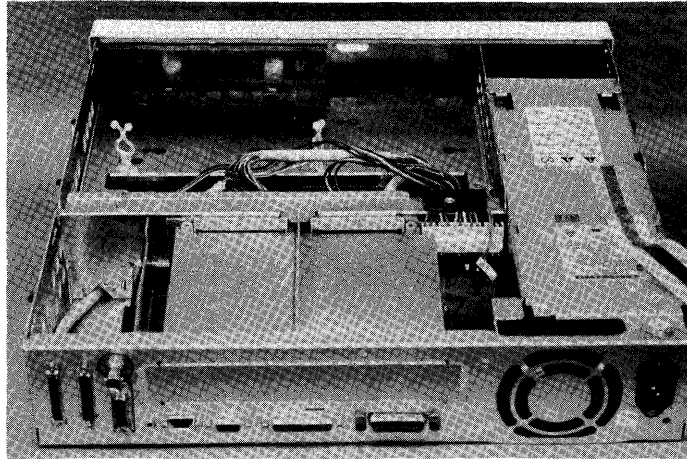

Mass Storage Locations

6

9. If a drive is already installed in that location, it must be moved to the other location or removed from the unit.

Note

If there is no external SCSI connector on the rear panel, the termination must be removed from any drive located in the Non-removeable-media Bay. It must be removed both in drives which have just been moved there as well as those installed there at the factory.

10. Install the isolation grommets on the drive bracket. Use the holes marked "DDS". Put the grommet through the large hole, then roll it into the small hole.

Configuring Graphics Mode

Chapter Contents

- **Model 362 Controllers** explains how to set its graphics mode jumpers.
- **Model 382 Controllers** explains how to set its graphics mode jumpers.

Preliminary Requirements

Before you start to reconfigure your CD ROM drive, refer to Chapter 3 and 4 to

1. Shut down your controller's application program and operating system.
2. Turn OFF your controller and unplug all cords and cables from it and any attached expanders.
3. Access the controller's internal assemblies.

Model 362 Controllers

There is one jumper on the low-resolution system board for on-board graphics configuration. The jumper is marked **ENABLE**. The default condition is nearest the marking. Moving the **ENABLE** jumper causes the on-board graphics circuitry to be disabled, allowing a supported graphics board to be used in the DIO slot.

Refer to Figure 7-1 for jumper positions.

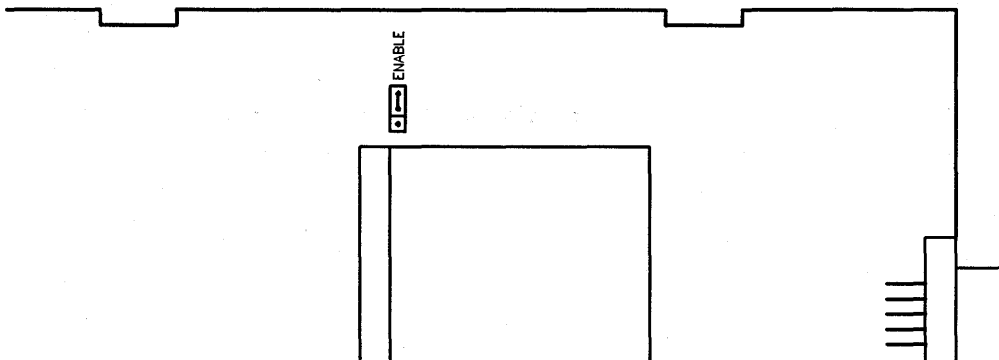

Figure 7-1. Model 362 System Board Graphics Jumper

Model 382 Controllers

Medium-Resolution System Board

There are two jumpers on the Model 382 controller's medium-resolution system board for on-board graphics configuration. The jumpers are marked **COLOR** and **ENABLE**. The default condition is with both jumpers nearest the markings. Moving the **ENABLE** jumper causes the on-board graphics circuitry to be disabled, allowing a supported graphics board to be used in the DIO slot. Only the **COLOR** graphics type is supported on Model 362 and 382 controllers. Refer to Figure 7-2 for jumper positions.

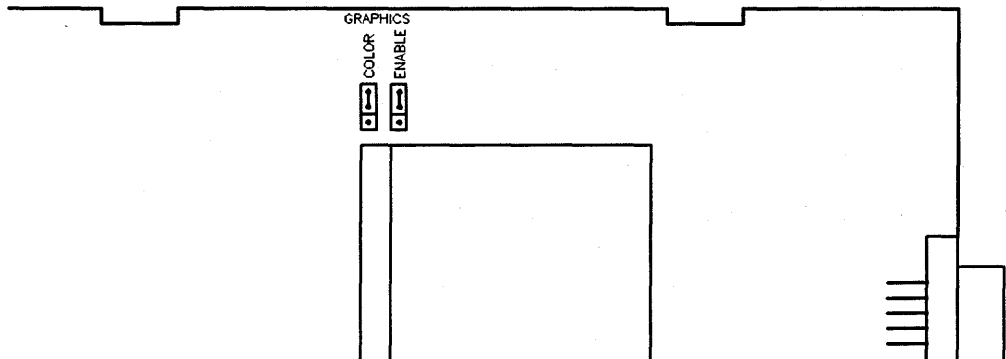

Figure 7-2. Model 382 Medium-Resolution System Board Graphics Jumpers

High-Resolution System Board

Model 382 controller's high-resolution system boards have one jumper for enabling on-board graphics. It is labeled **ENABLE**. Moving the **ENABLE** jumper causes the on-board graphics circuits to be disabled, allowing a supported graphics board to be used in the DIO slot.

Refer to Figure 7-3 for jumper positions.

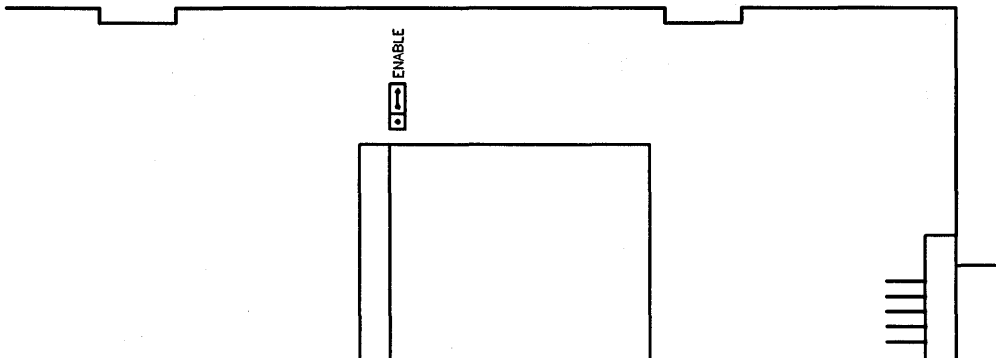

Figure 7-3. Model 382 High-Resolution System Board Graphics Jumper

Changing the LAN Type

Chapter Contents

This chapter tells you how to change the LAN type between ThinLAN and AUI LAN.

Preliminary Requirements

Before you start to reconfigure your LAN type, refer to Chapter 3 and 4 to

1. Shut down your controller's application program and operating system.
2. Turn OFF your controller and unplug all cords and cables from it and any attached expanders.
3. Access the controller's internal assemblies.

LAN Jumper Location

A jumper on the top of the LAN board selects the LAN type. Figure 8-1 shows the two positions.

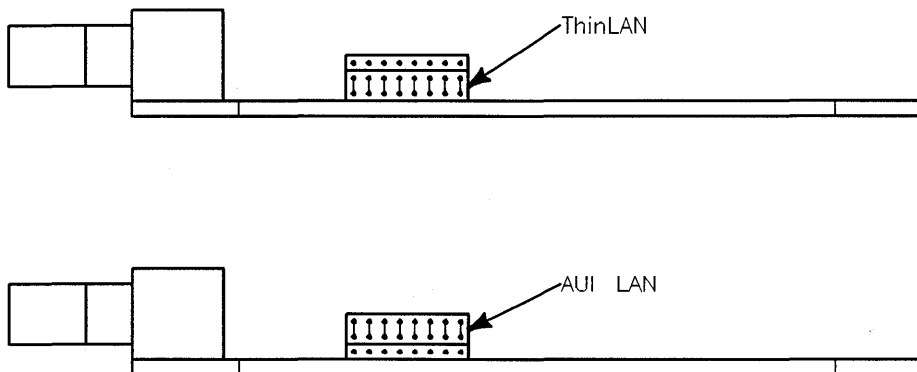

Figure 8-1. LAN Board Jumper Positions

Changing the LAN Type

Use a pair of needlenose pliers to lift the jumper up and place on the other position.

Configuring Bus Expanders

Chapter Contents

- **HP A2246A 4-Slot DIO-I Bus Expander** tells you where expanders can be installed and lists their supported accessory cards.
- **HP A2247A 2-Slot DIO-II Bus Expander** tells you where expanders can be installed and lists their supported accessory cards.

HP A2246A 4-Slot DIO-I Bus Expander

Physical Location

Up to two bus expanders may be placed on one controller.

Supported Accessory Cards

HP A2246A 4-slot bus expanders accept DIO-I accessory cards. These cards are also used in other Series 300 computers and controllers. Refer to Table 9-1 for the supported accessory cards.

Table 9-1.
Supported DIO-I Accessory Cards in HP A2246A 4-Slot DIO-I
Bus Expander

Accessory Card	HP-UX Support?	BASIC Support?
HP 98622A 16-Bit Parallel (GPIO) Interface Card	Yes	Yes
HP 98624A HP-IB (IEEE 488) Interface Card	Yes	Yes
HP 98625B High-Speed HP-IB (IEEE 488) Interface Card	Yes	Yes
HP 98626A RS-232-C Serial Interface Card	Yes	Yes
HP 98642A 4-Port Multiplexer Card	Yes	No
HP 98643A Local Area Network (IEEE 802.3) Interface Card	Yes	Yes
HP 98644A RS-232-C Serial Interface Card	Yes	Yes
HP 98658A Small Controller Systems Interface Card	Yes	Yes

HP A2247A 2-Slot DIO-II Bus Expander

Physical Location

Up to two bus expanders may be placed on one controller.

Supported Accessory Cards

The HP A2247A 4-slot bus expander accepts DIO-II accessory cards. These cards are also used in other Series 300 controllers and computers. Refer to Table 9-2 for the supported accessory cards.

Table 9-2.
Supported DIO-II Accessory Cards in
HP A2247A 2-Slot DIO-II Bus Expander

Accessory Card	HP-UX Support?	BASIC Support?
HP 98297A Real Time Interface Card	Yes	No
HP 98638A 8-Port Multiplexer Card	Yes	No
HP 98641A RJE 2780/3780 Interface Card	Yes	No

10

Configuring Popular Accessory Cards

Chapter Contents

- **Supported Accessory Cards in Controllers** lists the DIO-I accessory cards supported in Model 362 and 382 controllers.
- **Configuring Popular Accessory Cards** explains how to configure commonly used accessory cards.

Note Your controller system may include mass storage or other products not covered in this manual. Refer to that device's manuals for configuration information.

Supported Accessory Cards in Controllers

Model 362 and 382 controllers accept DIO-I accessory cards. These cards are also used in other Series 300 controllers and computers. Refer to Table 10-1 for the supported accessory cards.

Table 10-1.
Supported DIO-I Accessory Cards in Model 362 and 382
Controllers

Accessory Card	HP-UX Support?	BASIC Support?
HP 98622A 16-Bit Parallel (GPIO) Interface Card	Yes	Yes
HP 98624A HP-IB (IEEE 488) Interface Card	Yes	Yes
HP 98625B High-Speed HP-IB (IEEE 488) Interface Card	Yes	Yes
HP 98626A RS-232-C Serial Interface Card	Yes	Yes
HP 98642A 4-Port Multiplexer Card	Yes	No
HP 98643A Local Area Network (IEEE 802.3) Interface Card	Yes	Yes
HP 98644A RS-232-C Serial Interface Card	Yes	Yes
HP 98658A Small Controller Systems Interface Card	Yes	Yes

Configuring Popular Accessory Cards

Several accessory cards are supported in controllers and bus expanders. Only the more commonly used ones have configuration information in this manual. Refer to the installation manual supplied with your accessory card for complete or additional information.

Accessory card's configuration information in this manual are:

- HP 98622A 16-Bit Parallel (GPIO) Interface Card
- HP 98624A HP-IB (IEEE 488) Interface Card
- HP 98625B High-Speed HP-IB (IEEE 488) Interface Card
- HP 98642A 4-Port Multiplexer Card
- HP 98643A Local Area Network (IEEE 802.3) Interface Card
- HP 98644A RS-232-C Serial Interface Card
- HP 98658A Small Controller Systems Interface Card

Caution

Before reconfiguring any accessory card:

1. Shut down your controller's application program and operating system.
 2. Turn OFF the controller
-

HP 98622A GPIO Interface Card

Operating System Support

Operating/language system support is as follows:

- *BASIC*: supported on revision 4.0 or later with Series 300 controllers.
- *Pascal System*: supported on revision 3.1 or later with Series 300 controllers.
- *HP-UX Operating System*: supported on revision 5.0 or later with Series 300 controllers.

Setting the Configuration Switches and Jumpers

The GPIO Interface may be configured in any number of ways depending on the requirements of your application. Abbreviated instructions are provided here; refer to the installation manual that came with the interface if you need more information.

Refer to Figure 10-1 for switch and jumper positions.

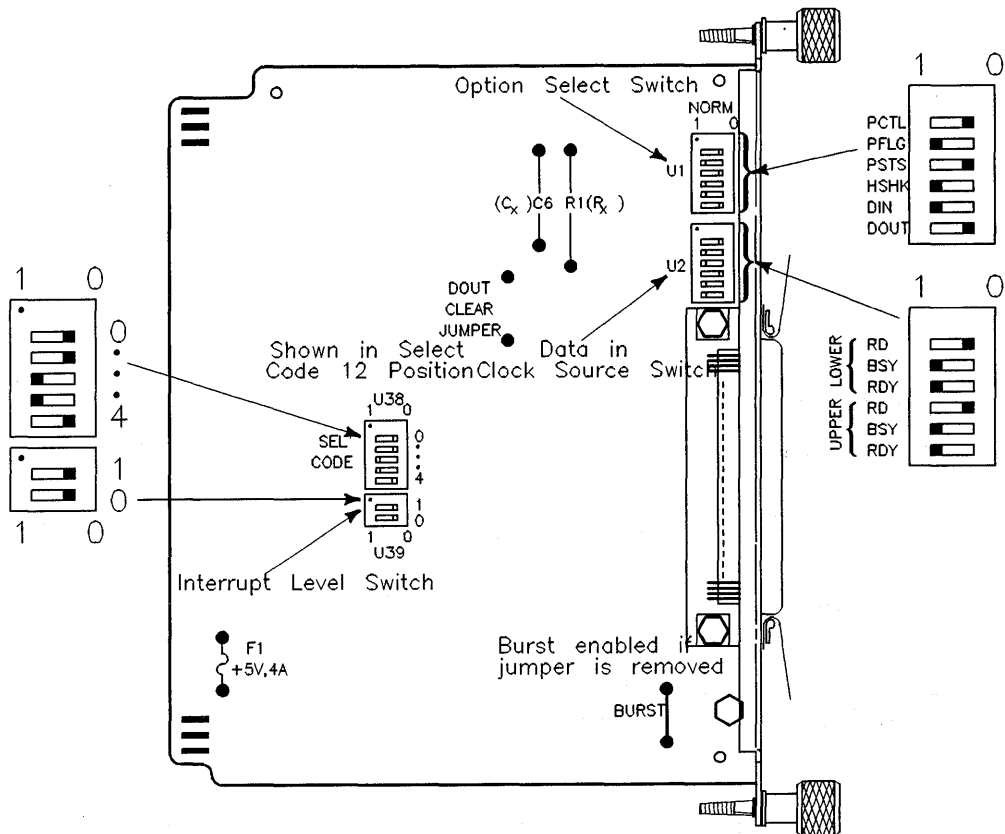

Figure 10-1. HP 98622A GPIO Interface Card Switches and Jumpers
Setting the Select Code.

1. Remove the GPIO card from the controller or expander and place it on a static-free surface.
2. Find the set of five switches labeled U38 on the GPIO Interface as shown in Figure 10-1. This group of switches determines the select code.
3. Set these switches to one of the four select codes given in Figure 10-2, unless you have used them elsewhere. Refer to the installation note that came with the interface if you need additional switch settings.

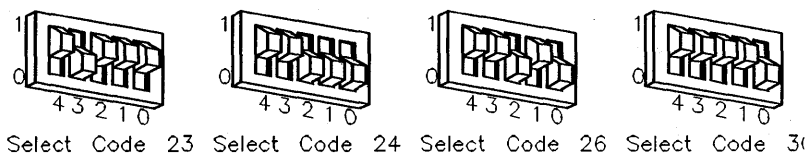

Figure 10-2. GPIO Interface Card Select Code Settings

4. Make a note that the select code has been used and is no longer available.
5. Find the new select code's number in the set of select code labels supplied with the interface. Replace the card's select code label with this new label. If a number is not available, make a label that looks like the one removed and stick it on the GPIO card.

Setting the Interrupt Level. Set Interrupt Level switch, labeled U39 on the card, to interrupt level 3 (00) as shown in Table 10-2 (interrupt level 3 is required for HP-UX). If your application requires a different setting, refer to Table 10-2.

Table 10-2.

Interrupt Level	Switch	
	1	0
3	0	0
4	0	1
5	1	0
6	1	1

Setting the Data-in Clock Source Clock Switches. The Data-in Clock Source switches are labeled U2. If you are connecting an HP 9884A Paper Tape Punch to this interface, set these switches as shown in Figure 10-1.

The right-hand 3 switches set the clock source for the data input lines DI0 through DI7. The left-hand 3 switches set the clock source for the data input lines DI8 through DI15. Select only one clock source (logic 0) for each group of input lines. The three clock sources are:

- **RD.** This mode causes the data to be clocked into the input register when the register is read. It accomplishes this by clocking the leading edge of the output enable signal of the register.
- **BSY.** This mode clocks the data into the data input register by a ready-to-busy transition of the PFLG line. This transition also clears the PCTL line.
- **RDY.** This mode clocks the data into the data input register by a busy-to-ready transition of the PFLG line.

Setting the Option Select Switches. Refer to Table 10-3 and find the Option Select switches labeled U1. If you will be connecting an HP 9884A Paper Tape Punch to this interface, set all of these switches to 1.

Table 10-3.

Switch Position Name	Function	Logic 1 (Switch Open)	Logic 0 (Switch Closed)
DOUT	Invert Data Out	Low = 1 High = 0	Low = 0 High = 1
DIN	Invert Data In	Low = 1 High = 0	Low = 0 High = 1
HSHK	Full/Pulse Handshake	Full	Pulse
PSTS	Invert PSTS	Low = \overline{OK} High = OK	Low = OK High = \overline{OK}
PFLG	Invert PFLG	Low = Rdy High = Bsy	Low = Bsy High = Rdy
PCTL	Invert PCTL	Low = set High = Clr	Low = Clr High = Set

Setting the Data Jumpers.

1. Refer to Figure 10-1 and find the DOUT CLEAR and BURST jumpers.
2. Install or remove the jumpers on your HP 98622A GPIO card as required by the peripheral it will be connected to. Refer to the peripheral's manuals for this information.

■ DOUT CLEAR Jumper.

With the jumper installed, both data output registers are cleared at power up and after an interface reset. With the jumper removed, contents of the register are undefined. The card is shipped without the jumper. If you intend to use the HP 9884A Paper Tape Punch with this interface, the jumper should be in.

■ BURST Jumper.

With the jumper installed, there is better overall system performance, but slightly slower GPIO performance on high-speed transfers. With the removed, there is slightly degraded overall system performance, but better GPIO performance for transfers greater than 100K transfers/second. The card is shipped with the jumper. If you intend to use the HP 9884A Paper Tape Punch with this interface, the jumper should be removed.

Adjusting the PCTL Delay. Adjust the PCTL Delay if required. The PCTL line has a built in delay of 250ns. Capacitor C6 and resistor R1 can be changed to adjust the delay:

- To increase the delay, increase the value of C6 40pF per 100ns of additional delay.
- To decrease the delay, decrease the value of R1 1.47k ohms per 100ns of decreased delay.

Reinstalling the GPIO Card

Insert the GPIO Interface, component side up, into its slot. Tighten the thumb screws on the metal end plate until the end plate is flush with the back of the controller.

Verification Test

1. Plug in your controller's power cord and video cable, then turn on your monitor and controller.
2. When the keyboard line appears, press space bar a few times to go into attended mode.
3. Check the interfaces listed on the left-hand side of the screen:
 - If the message, HP98622, is listed, you have correctly installed the GPIO Interface.
 - If the message above does not appear, check the installation procedure and configuration settings, making sure there are no select code conflicts and that the card is firmly seated in an even-numbered slot. If the message still does not appear, call your HP Service Representative for assistance.

Filling Out the Worksheets

The following "Worksheet Entries" contain information needed to use the GPIO Interface with various language/operating systems. Refer to the table for the system you'll be using.

Copy this information to a worksheet or simply remember to refer here when you need it. *If you changed the select code, write in your new select code instead of 12.*

When finished, you'll be ready to install your next peripheral or interface.

BASIC System Worksheet Entry.

Table 10-4.

Interface Name	Select Code	Driver Name
HP 98622A	12	GPIO

Pascal System Worksheet Entry.

Table 10-5.

Interface Name	Select Code	Module Name
HP 98622A	12	GPIO
NOTE: Before you can access the HP 98622A GPIO Interface from the Pascal System, you must make a few modifications. See the Special Configurations chapter of the <i>Pascal Workstation System</i> manual for details.		

HP-UX System Worksheet Entry.

Table 10-6.

Interface Name	Select Code
HP 98622A	12

- The character-mode major number for the Device I/O Library GPIO Interface driver is 22.
- The minor number for a GPIO Interface at select code 12 is 0x0c0000.
- A typical **mknod** for a GPIO Interface at select code 12 is:

```
# mknod /dev/gpio c 22 0x0c0000
```

The 0c in the minor number represents select code 12 (0c is hexadecimal for 12).

HP 98624A HP-IB (IEEE 488) Interface Card

The HP 98624A HP-IB Interface card implements the IEEE 488-1978 Standard Digital Interface for Programmable Instrumentation. The interface can communicate with as many as 14 HP-IB compatible instruments, connected with a maximum of 20 metres of cable (65.6 ft.). It has interrupt capabilities and can carry out DMA transfers via the optional DMA Controller card.

It is a “normal” or “standard” speed HP-IB interface.

Operating System Support

Operating/language system support is as follows:

- *BASIC*: supported on revision 4.0 or later with Series 300 controllers.
- *Pascal System*: supported on revision 3.1 or later with Series 300 controllers.
- *HP-UX Operating System*: supported on revision 5.0 or later with Series 300 controllers.

Preliminary Requirements

Find out what your application’s accessory HP-IB interface function values need to be set to. These functions are:

- Select Code.
- Interrupt level.
- Address and System Controller.

Your HP 98624A HP-IB Interface Card must be set to the values your application requires.

Setting the Configuration Switches

The HP-IB Interface may be configured in any number of ways depending on the requirements of your application. Abbreviated instructions are provided here; refer to the installation manual that came with the interface if you need more information.

Refer to Figure 10-3 for switch locations.

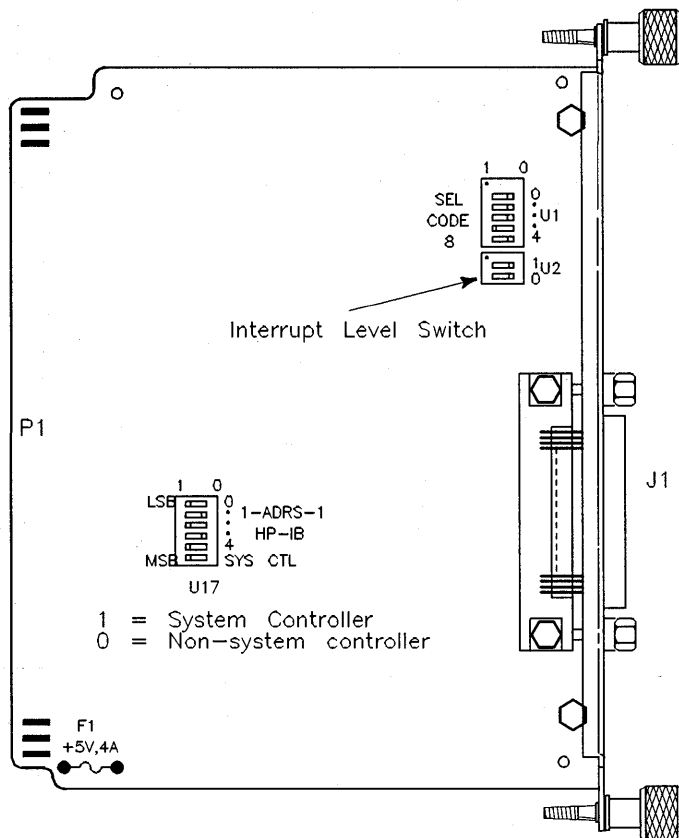

Figure 10-3. HP 98624A HP-IB Interface Switch Locations

Setting the Select Code Switches.

1. Find the set of five switches labeled U1 on the HP-IB Interface (see Figure 10-3). This group of switches determine the interface's select code.
2. Set these switches to one of the four select codes given in Figure 10-4, unless you have used them elsewhere. Refer to the installation note that came with the interface if you need additional switch settings.

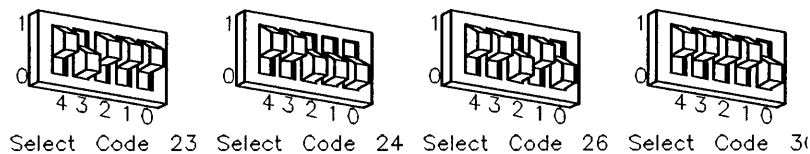

Figure 10-4. HP-IB Interface Card Select Code Settings

3. Make a note that the select code has been used and is no longer available.
4. Find the new select code's number in the set of select code labels supplied with the HP-IB interface. Replace the card's select code label with this new label. If a number is not available, make a label that looks like the one removed and stick it on the HP-IB card's end plate.

Setting the Interrupt Level.

SKIP?

The HP 98624A HP-IB interface is factory set to interrupt level 3. Unless you are certain that interrupt level 3 is inappropriate for your application, leave the interrupt level setting alone and skip now to the next function.

Refer to Figure 10-3 and set the switches labeled U2 according to Table 10-7.

Table 10-7.

Interrupt Level	Switch 1	Switch 0
3	0	0
4	0	1
5	1	0
6	1	1

Setting the Address and System Controller Switches.

SKIP? Unless you intend to connect two controllers together with this interface, you can skip now to the next function. The interface is factory configured to be system controller at address 21 and need not be changed.

1. If connecting two controllers together via HP-IB, only one of them may be set to address 21. To change the address of this interface, reset switches 0 through 4 in the group of switches labeled U17 as shown in Figure 10-3.

As an example, to change the address from the default setting of 21 to a new setting of 20, just change switch 0 in this group to 0 (the opposite of that shown).

2. If connecting two controllers together via HP-IB, only one of them may be set to system controller. To change this interface to non-system controller, move the SYS CTL switch shown in Figure 10-3 to the 0 position (the opposite of that shown).

Note: If you will be connecting a disk drive, printer, plotter or other peripheral to this interface, *and* you will be using an HP Series 300 operating system, *do not* set this switch to non-system controller.

Reinstalling the HP-IB Card

Insert the HP-IB card, component side up, into its slot. Tighten the thumb screws on the metal end plate until the end plate is flush with the back of the controller.

Verification Test

1. Plug in your controller's power cord and video cable, then turn on your monitor and controller.
2. When the keyboard line appears, press space bar a few times to go into attended mode.

3. Check the interfaces listed on the left-hand side of the screen:
 - If the message, HP98624, is listed, you have correctly installed the HP-IB Interface.
 - If the message above does not appear, check the installation procedure and configuration settings, making sure there are no select code conflicts and that the card is firmly seated in an even-numbered slot. If the message still does not appear, call your HP Service Representative for assistance.

Making Worksheet Entries

The following “Worksheet Entries” contain information needed to use the HP-IB Interface with various language/operating systems. Refer to the table for the system you’ll be using.

Copy this information to a worksheet or simply remember to refer here when you need it. *If you changed the select code, write in your new select code instead of 8.*

When finished, you’ll be ready to install your next peripheral or interface.

BASIC System Worksheet Entry.

Table 10-8.

Interface Name	Select Code	Driver Name
HP 98624A	8	HPIB

Pascal System Worksheet Entry.

Table 10-9.

Interface Name	Select Code	Module Name
HP 98624A	8	HPIB

HP-UX System Worksheet Entry.**Table 10-10.**

Interface Name	Select Code
HP 98624A	8

HP 98625B High-Speed HP-IB (IEEE 488) Interface Card

The HP 98625B High-Speed Interface provides a high-speed HP-IB interface to Command Set 80 (CS/80) disks. It is capable of handling up to four disks on one interface card. A DMA Controller card is required for the high-speed HP-IB interface to achieve optimum performance.

Preliminary Requirements

Find out what your application's accessory high-speed HP-IB interface function values need to be set to. These functions are:

- Select Code.
- Interrupt level.
- Low/High Speed.
- System Controller.

Your HP 98625B High-Speed HP-IB Interface Card must be set to the values your application requires.

Operating System Support

Operating/language system support is as follows:

- *BASIC*: supported on revision 4.0 or later with Series 300 controllers.
- *Pascal System*: supported on revision 3.1 or later with Series 300 controllers.
- *HP-UX Operating System*: supported on revision 5.0 or later with Series 300 controllers.

Setting the Configuration Switches

The high-speed HP-IB interface card may be configured in any number of ways depending on the requirements of your application. Abbreviated instructions are provided here; refer to the installation manual that came with the interface if you need more information.

Refer to Figure 10-5 for switch and jumper positions.

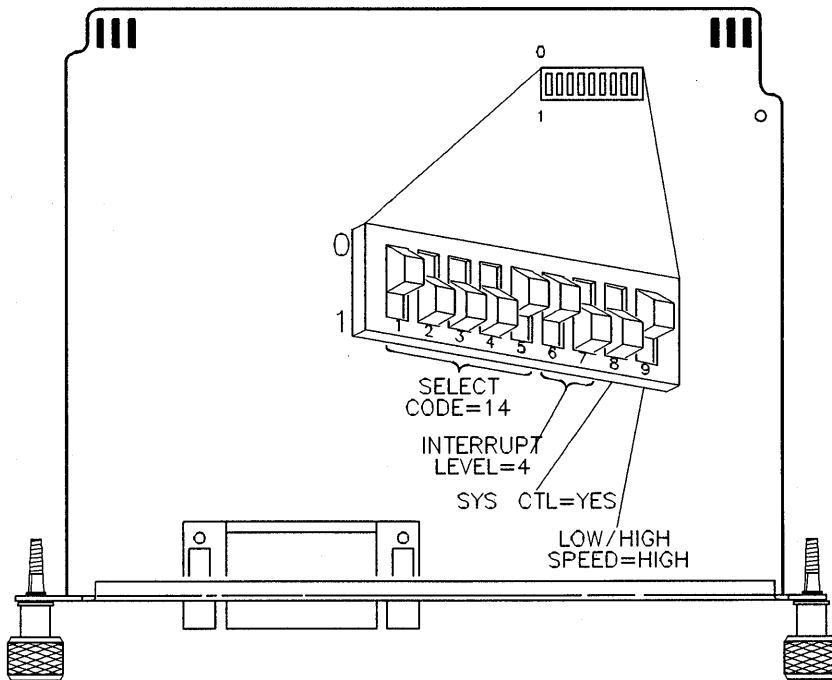

Figure 10-5.

**HP 98625B High-Speed HP-IB Interface Card Switch Locations
Setting the Select Code.**

1. Remove the high-speed HP-IB card from the controller or expander and place it on a static-free surface.
2. Find the set of nine switches by referring to Figure 10-5. Switches 1 through 5 in this group determine the select code.

- Set these switches to one of the four select codes given in Figure 10-6, unless you have used them elsewhere. Refer to the installation note that came with the interface if you need additional switch settings.

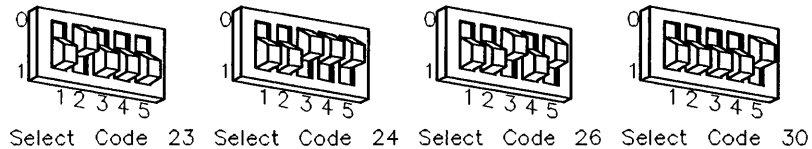

Figure 10-6.

High-Speed HP-IB Interface Card Select Code Switch Settings

- Make a note that the select code has been used and is no longer available.
- Find the new select code's number in the set of select code labels supplied with the interface. Replace the card's select code label with this new label. If a number is not available, make a label that looks like the one removed and stick it on the high-speed HP-IB card.

Setting the Interrupt Level.

SKIP? If you are not using HP-UX, the interrupt level is preset to 6 and need not be changed. If you will be using HP-UX continue with this section.

- Find the set of nine switches by referring to Figure 10-5. Switches 6 and 7 in this group determine the interrupt level.
- If using HP-UX, set these switches to interrupt level 4 as shown in Figure 10-5. To get interrupt level 4, set the left switch to 0 and the right switch to 1. *Do not set any other interface to interrupt level 4.*

Setting the System Controller Switch.

SKIP? Unless you intend to connect two controllers together with this interface, you can skip to the next set of configuration switches. The interface is configured to be system controller and need not be changed.

1. Find the set of nine switches by referring to Figure 10-5. Switch 8 in this group determines the system controller setting.
2. If connecting two controllers together via HP-IB, only one of them may be set to system controller. To change this interface to non-system controller, move the system controller switch shown in Figure 10-5 to the 0 position (the opposite of that shown).

Note: If you will be connecting a disk drive, printer, plotter or other peripheral to this interface, *and* you will be using an HP Series 200/300 operating system, *do not* set this switch to non-system controller.

Setting the Low/High Speed Switch.

SKIP? The Low/High Speed switch is preset to 0, "high speed," as shown in Figure 10-5. This setting is appropriate for most applications. If you want to change this setting, continue with this section.

Otherwise skip now to the next configuration switch settings.

1. Find the set of nine switches by referring to Figure 10-5. Switch 9 in this group is the Low/High Speed switch.
2. Set this switch as follows:
 - To set this switch to "low speed," set switch 9 to 1, which is opposite of that shown in Figure 10-5.
 - To set this switch to "high speed," set switch 9 to 0 as shown in Figure 10-5.

Reinstalling the High-Speed HP-IB Card

Insert the high-speed HP-IB card, component side up, into its slot. Tighten the thumb screws on the metal end plate until the end plate is flush with the back of the controller.

Verification Test

1. Plug in your controller's power cord and video cable, then turn on your monitor and controller.
2. When the keyboard line appears, press space bar a few times to go into attended mode.
3. Check the interfaces listed on the left-hand side of the screen:
 - If the message, HP98625, is listed, you have correctly installed the HP-IB Interface.
 - If the message above does not appear, check the installation procedure and configuration settings, making sure there are no select code conflicts and that the card is firmly seated in an even-numbered slot. If the message still does not appear, call your HP Service Representative for assistance.

Filling Out the Worksheets

The following "Worksheet Entries" contain information needed to use the high-speed HP-IB interface with various language/operating systems. Refer to the table for the system you'll be using.

Copy this information to a worksheet found later in this section and remember to refer here when you need it. *If you changed the select code, write in your new select code instead of 14.*

When finished, you'll be ready to install your next peripheral or interface.

BASIC System Worksheet Entry.**Table 10-11.**

Interface Name	Select Code	Driver Name
HP 98625B	14	FHPIB

Pascal System Worksheet Entry.**Table 10-12.**

Interface Name	Select Code	Module Name
HP 98625B	14	DISC_INTF & DMA
<p>NOTE: Before you can access the HP 98625B Interface from the Pascal System, you must make a few modifications. See the Special Configurations chapter of the <i>Pascal Workstation System</i> manual for details.</p>		

HP-UX System Worksheet Entry.**Table 10-13.**

Interface Name	Select Code
HP 98625B	14

HP 98642A 4-Port Multiplexer Card

The HP 98642A 4-Channel Multiplexer Interface has three direct-connect ports and one port with full modem control. The buffering of this interface makes it suitable for nearly all applications, including graphics terminals.

Operating System Support

Operating/language system support is as follows:

- *BASIC*: not supported.
- *Pascal System*: not supported.
- *HP-UX Operating System*: supported on revision 5.0 or later with Series 300 controllers.

Preliminary Requirements

Find out what your application's accessory HP 98642A 4-Port Multiplexer Card function values need to be set to. These functions are:

- Select Code.
- Interrupt level.
- Remote/Local.

Your 4-port multiplexer card must be set to the values your application requires.

Setting the Configuration Switches

Refer to Figure 10-7 for switch and jumper positions.

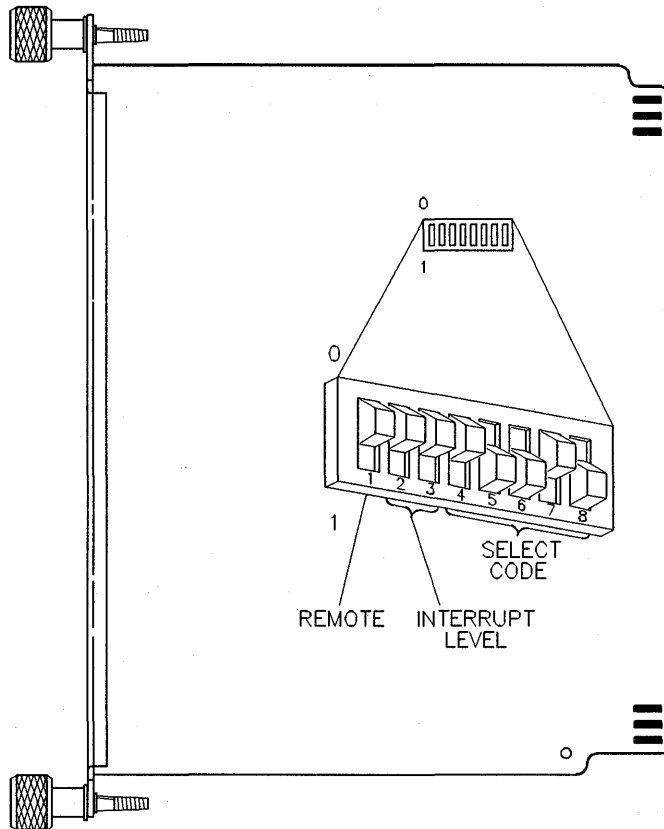

Figure 10-7.

**HP 98642A 4-Port Multiplexer Interface Card Switch Locations
Setting the Select Code.**

1. Remove the multiplexer card from the controller or expander and place it on a static-free surface.

SKIP?

If this is the *first* (or only) 4-Channel Multiplexer Interface you are installing, you can skip now to the next configuration function. The select code is preset to 13 and need not be changed.

2. Find the group of eight switches on the interface by referring to Figure 10-7. Switches 4 through 8 in this group determine the select code.

10-24 Configuring Popular Accessory Cards

- Set these switches to one of the five select codes given in Figure 10-8, unless you have used them elsewhere (check the Select Code Record on the Step 5 tab to see which ones you have used). Refer to the installation note that came with the interface if you need additional switch settings.

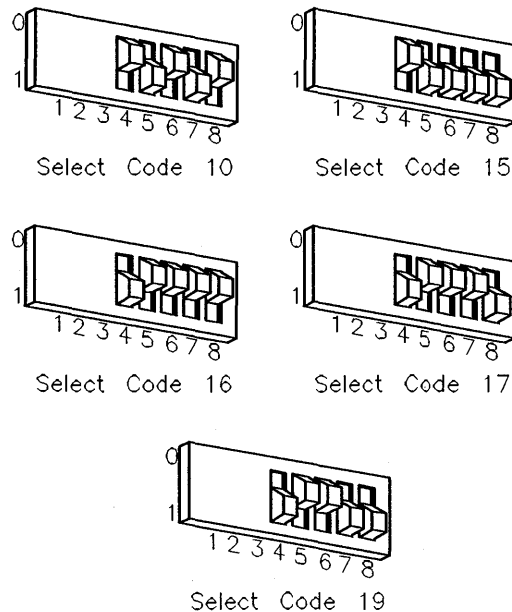

Figure 10-8. 4-Port Multiplexer Interface Card Select Codes

- Make a note that the select code has been used and is no longer available.
- Find the new select code's number in the set of select code labels supplied with the interface. Replace the card's select code label with this new label. If a number is not available, make a label that looks like the one removed and stick it on the multiplexer card.

Setting the Interrupt Level.

SKIP?

The interface is preset to interrupt level 3. Unless you are certain that interrupt level 3 is inappropriate for your application, leave the interrupt level setting alone and skip to the next configuration function.

1. Find the group of eight switches on the interface by referring to Figure 10-7. Switches 2 and 3 in this group determine the interrupt level.
2. Set the interrupt level to the desired value by referring to Table 10-14:

Table 10-14.

Interrupt Level	Switch 2	Switch 3
3	0	0
4	0	1
5	1	0
6	1	1

Setting the Remote Switch.

SKIP?

If you are *not* connecting your system console to port 1 of this interface, skip to step 5. The Remote switch is preset to “local,” which does *not* configure port 1 to be the system console.

1. Find the group of eight switches on the interface by referring to Figure 10-7. Switch 1 in this group is the Remote switch.

2. Set the Remote switch as follows:

- If you are connecting a terminal to port 1 of this interface and want the terminal on port 1 to be the system console, set this switch to *1* (remote), which is *opposite* that shown in Figure 10-7.

Be aware that the boot ROM will not recognize this terminal as the system console, even though HP-UX will. No boot ROM messages will appear on the associated terminal; therefore, do not use the HP 98642A as a system console until after HP-UX is installed.

- If you are connecting a terminal to port 1 of this interface but *do not* want the terminal on port 1 to be the system console, set this switch to *0* (local) as shown in Figure 10-7.

Reinstalling the 4-Port Multiplexer Card

Insert the multiplexer interface, component side up, into its slot. Tighten the thumb screws on the metal end plate until the end plate is flush with the back of the controller.

Verification Test

1. Plug in your controller's power cord and video cable, then turn on your monitor and controller.
2. When the keyboard line appears, press **space bar** a few times to go into attended mode.
3. Check the interfaces listed on the left-hand side of the screen:
 - If the message, HP98642, is listed, you have correctly installed the multiplexer interface card.
 - If the message above does not appear, check the installation procedure and configuration settings, making sure there are no select code conflicts and that the card is firmly seated in an even-numbered slot. If the message still does not appear, call your HP Service Representative for assistance.

Filling Out the Worksheets

The following “Worksheet Entry” contains information needed to use the 4-Channel Multiplexer Interface with HP-UX.

Copy this information to a worksheet or simply remember to refer here when you need it.

If you changed the select code, write in your new select code instead of 13.

When finished, you’ll be ready to install your next peripheral or interface.

HP-UX System Worksheet Entry.**Table 10-15.**

Interface Name	Select Code
HP 98642A	13

HP 98643A Local Area Network (IEEE 802.3) Interface Card

The HP 98643A Local Area Network (LAN) Interface is used to connect a controller to a local area network.

Operating System Support

Operating/language system support is as follows:

- *BASIC*: not supported.
- *Pascal System*: not supported.
- *HP-UX Operating System*: supported on revision 5.0 or later with Series 300 controllers.

Preliminary Requirements

Find out what your application's accessory HP 98643A Local Area Network (LAN) Interface Card function values need to be set to. The LAN card's functions that can be configured are:

- Select code.
- Interrupt level.
- Interface type.

Your Local Area Network (LAN) Interface Card must be set to the select code your networking application requires.

Setting the Configuration Switches

Refer to Figure 10-9 for switch locations.

Note that switch 8 on SW1 is not used.

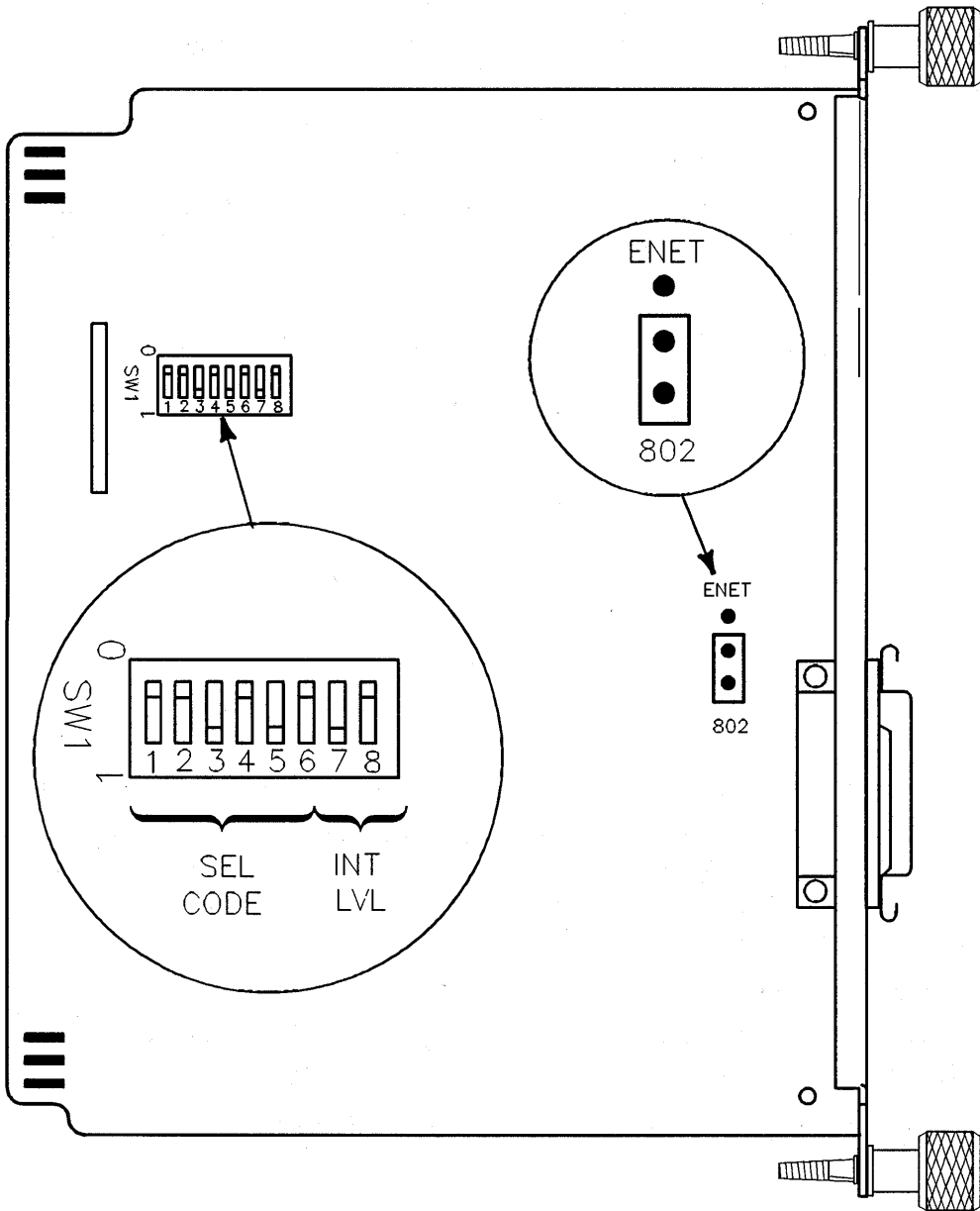

Figure 10-9. HP 98643A Local Area Network Interface Switch Locations

Setting the Select Code.

1. Remove the LAN card from the controller or expander and place it on a static-free surface.
2. Find the group of switches labeled SW1 by referring to Figure 10-9. Switches 3 through 8 in this group determine the select code.
3. Set these switches to one of the five select codes given in Table 10-16, unless you have used them elsewhere. Refer to the installation note that came with the interface if you need additional switch settings.

Table 10-16. LAN Card Select Code Switch Settings

Switch 5	Switch 4	Switch 3	Switch 2	Switch 1	Select Code
1	0	1	0	1	21
0	1	1	0	1	22
1	1	1	0	1	23
0	0	0	1	1	24
1	0	0	1	1	25

4. Make a note that the select code has been used and is no longer available.
5. Find the new select code's number in the set of select code labels supplied with the interface. Replace the card's select code label with this new label. If a number is not available, make a label that looks like the one removed and stick it on the LAN card.

Setting the Interrupt Level.

1. Find the group of switches labeled SW1 by referring to Figure 10-9. Switches 6 and 7 in this group determine the interrupt level.
2. Set the interrupt level to the desired value by referring to Table 10-17.

Table 10-17.

Interrupt Level	Switch 6	Switch 7
3	0	0
4	0	1
5	1	0
6	1	1

Setting the Interface Type. Refer to Figure 10-9 to find the interface type jumper.

That jumper selects either LAN Ethernet or IEEE 802.3 interface type. Most applications require the IEEE 802.3 LAN interface type. If your application requires the Ethernet type, change the jumper to the two pins next to the ENET label next to the jumpers.

Reinstalling the LAN Interface Card

Insert the LAN interface card, component side up, into its slot. Tighten the thumb screws on the metal end plate until the end plate is flush with the back of the controller.

Verification Test

1. Plug in your controller's power cord and video cable, then turn on your monitor and controller.
2. When the keyboard line appears, press a few times to go into attended mode.
3. Check the interfaces listed on the left-hand side of the screen:
 - If the message, HP98643, is listed, you have correctly installed the LAN Interface.

- If the message above does not appear, check the installation procedure and configuration settings, making sure there are no select code conflicts and that the card is firmly seated in an even-numbered slot. If the message still does not appear, call your HP Service Representative for assistance.

Filling Out the Worksheets

The following “Worksheet Entry” contains information needed to use the LAN Interface with HP-UX.

Copy this information to a worksheet or simply remember to refer here when you need it. *If you changed the select code, write in your new select code instead of 21.*

When finished, you’ll be ready to install your next peripheral or interface.

HP-UX System Worksheet Entry.

Table 10-18.

Interface Name	Select Code
HP 98643A	21

Note this information regarding HP-UX operating systems:

- The character-mode major number for an IEEE-802 network is 18. The character-mode major number for an Ethernet™ is 19. (Ethernet™ is a trademark of the Xerox Corporation.)
- A typical mknod for a LAN Interface at select code 21 on an IEEE-802 (major number 18) Local Area Network is:

```
# mknod /dev/lan 18 c 0x150000
```

The 15 in the minor number represents the select code (15 is the hexadecimal value for 21).

HP 98644A RS-232-C Serial Interface Card

The HP 98644A RS-232 Interface connects to a terminal, modem, serial peripheral, or controller and supports the RS-232C standard. One interface is required for each device, and each interface must be set to a unique select code.

Operating System Support

Operating/language system support is as follows:

- *BASIC*: supported on revision 4.0 or later with Series 300 controllers. Earlier revisions can access this interface if it is set to emulate the HP 98626A RS-232-C Interface.
- *Pascal System*: supported on revision 3.1 or later with Series 300 controllers. Earlier revisions can access this interface if it is set to emulate the HP 98626A RS-232-C Interface.
- *HP-UX Operating System*: supported on revision 5.0 or later with Series 300 controllers.

Preliminary Requirements

Find out what your application's accessory RS-232 interface function values need to be set to. These functions are:

- Select Code.
- Interrupt level.
- Remote/Local.
- Modem Enable.

Your HP 98644A RS-232 Interface Card must be set to the values your application requires.

Setting the Configuration Switches

Refer to Figure 10-10 for switch locations.

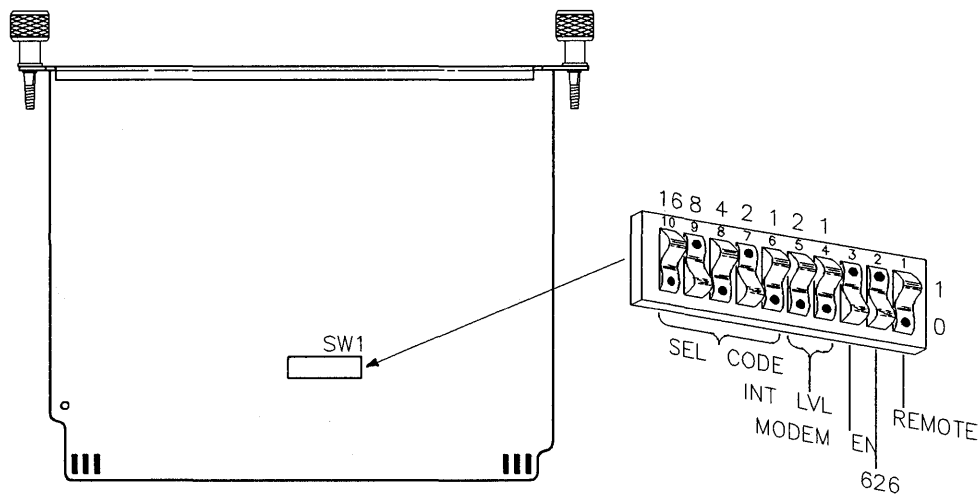

Figure 10-10. HP 98644A RS-232-C Interface Switch Locations

Setting the Select Code.

1. Remove the RS-232 card from the controller or expander and place it on a static-free surface.
2. Find the group of switches labeled SW1 by referring to Figure 10-10. Switches 6 through 10 in this group determine the select code.
3. Set these switches to one of the five select codes given in Figure 10-11, unless you have used them elsewhere. Refer to the installation note that came with the interface if you need additional switch settings.

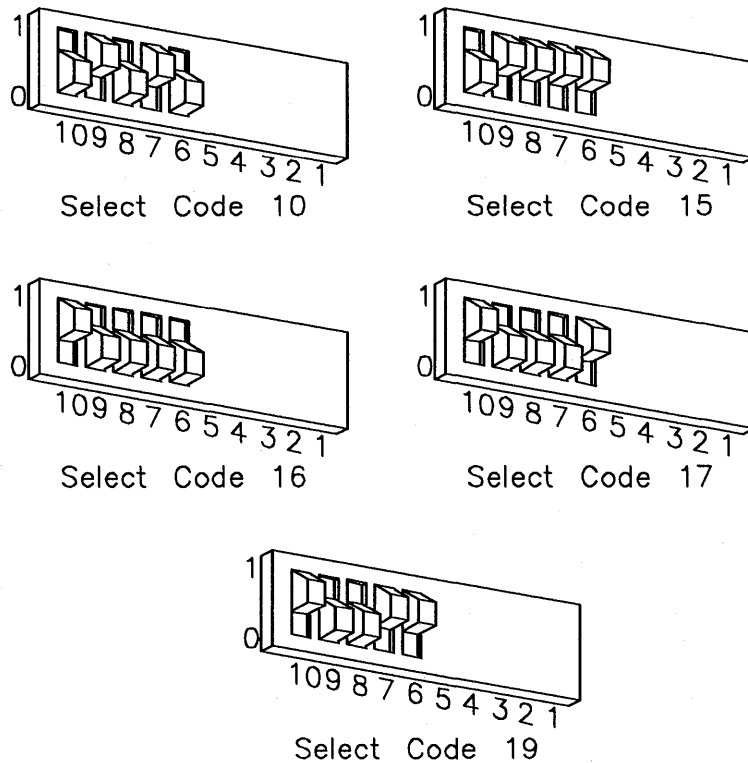

Figure 10-11.
HP 98644A RS-232-C Interface Select Code Switch Settings

4. Make a note that the select code has been used and is no longer available.
5. Find the new select code's number in the set of select code labels supplied with the interface. Replace the card's select code label with this new label. If a number is not available, make a label that looks like the one removed and stick it on the RS-232 card.

Setting the Interrupt Level.

SKIP?

The interface is preset to interrupt level 3. Unless you are certain that interrupt level 3 is inappropriate for your application, leave the interrupt level setting alone.

1. Find the group of switches labeled SW1 by referring to Figure 10-10. Switches 4 and 5 in this group determine the interrupt level.
2. Set the interrupt level to the desired value by referring to Table 10-19:

Table 10-19.

Interrupt Level	Switch 5	Switch 4
3	0	0
4	0	1
5	1	0
6	1	1

Setting the MODEM ENable Switch.

1. Find the group of switches labeled SW1 by referring to Figure 10-10. Switch 3 in this group is the MODEM ENable switch.
2. Set the MODEM ENable switch as follows:
 - If you intend to connect an HP 2601A printer, an HP 2686A Laserjet printer, an HP 92205A/C Hayes Smartmodem, or a controller, set this switch to *1* as shown in Figure 10-10.
 - If you intend to connect a terminal or the HP 39800/01A bar code reader, set this switch to *0*, which is *opposite* that shown in Figure 10-10.

Setting the 626 Switch.

1. Find the group of switches labeled SW1 by referring to Figure 10-10. Switch 2 in this group is the 626 switch.
2. Set the 626 switch to *1* as shown in Figure 10-10.

Set the REMOTE Switch.

1. Find the group of switches labeled SW1 by referring to Figure 10-10. Switch 1 in this group is the Remote switch.
2. Set the Remote switch as follows:

- If you are connecting a terminal to this interface and want this terminal to be the system console, set this switch to *1*, which is *opposite* that shown in Figure 10-10.
- If you are connecting a terminal to this interface but *do not* want this terminal to be the system console, or if you are connecting any other device, set this switch to *0* as shown in Figure 10-10.

Reinstalling the RS-232 Card

Insert the RS-232 Interface, component side up, into its slot. Tighten the thumb screws on the metal end plate until the end plate is flush with the back of the controller.

Verification Test

1. Plug in your controller's power cord and video cable, then turn on your monitor and controller.
2. When the keyboard line appears, press space bar a few times to go into attended mode.
3. Check the interfaces listed on the left-hand side of the screen:
 - If the message, HP98644, is listed, you have correctly installed the RS-232 Interface.
 - If the message above does not appear, check the installation procedure and configuration settings, making sure there are no select code conflicts and that the card is firmly seated in an even-numbered slot. If the message still does not appear, call your HP Service Representative for assistance.

Filling Out the Worksheets

The following "Worksheet Entries" contain information needed to use the RS-232 Interface with various language/operating systems. Refer to the table for the system you'll be using.

Copy this information to a worksheet or simply remember to refer here when you need it.

If you changed the select code, write in your new select code instead of 9.

10-38 Configuring Popular Accessory Cards

When finished, you'll be ready to install your next peripheral or interface.

BASIC System Worksheet Entry.

Table 10-20.

Interface Name	Select Code	Driver Name
HP 98644A	9	SERIAL

Pascal System Worksheet Entry.

Table 10-21.

Interface Name	Select Code	Module Name
HP 98644A	9	RS232
NOTE: Before you can access the HP 98644A Asynchronous Serial Interface from the Pascal System, you must make a few modifications. See the Special Configurations chapter of the <i>Pascal Workstation System</i> manual for details.		

HP-UX System Worksheet Entry.

Table 10-22.

Interface Name	Select Code
HP 98644A	9

HP 98658A Small Controller Systems Interface Card

Operating System Support

Operating/language system support is as follows:

- *BASIC*: supported on revision 4.0 or later with Series 300 controllers.
- *Pascal System*: supported on revision 3.1 or later with Series 300 controllers.
- *HP-UX Operating System*: supported on revision 5.0 or later with Series 300 controllers.

Preliminary Requirements

Find out what your application's accessory SCSI interface function values need to be set to. These functions are:

- Select Code.
- Interrupt level.
- Bus address.
- Parity.

Your HP 98658A SCSI Interface Card must be set to the values your application requires.

Setting the Configuration Switches

The HP 98658A SCSI Interface Card's configuration switches are shown in Figure 10-12.

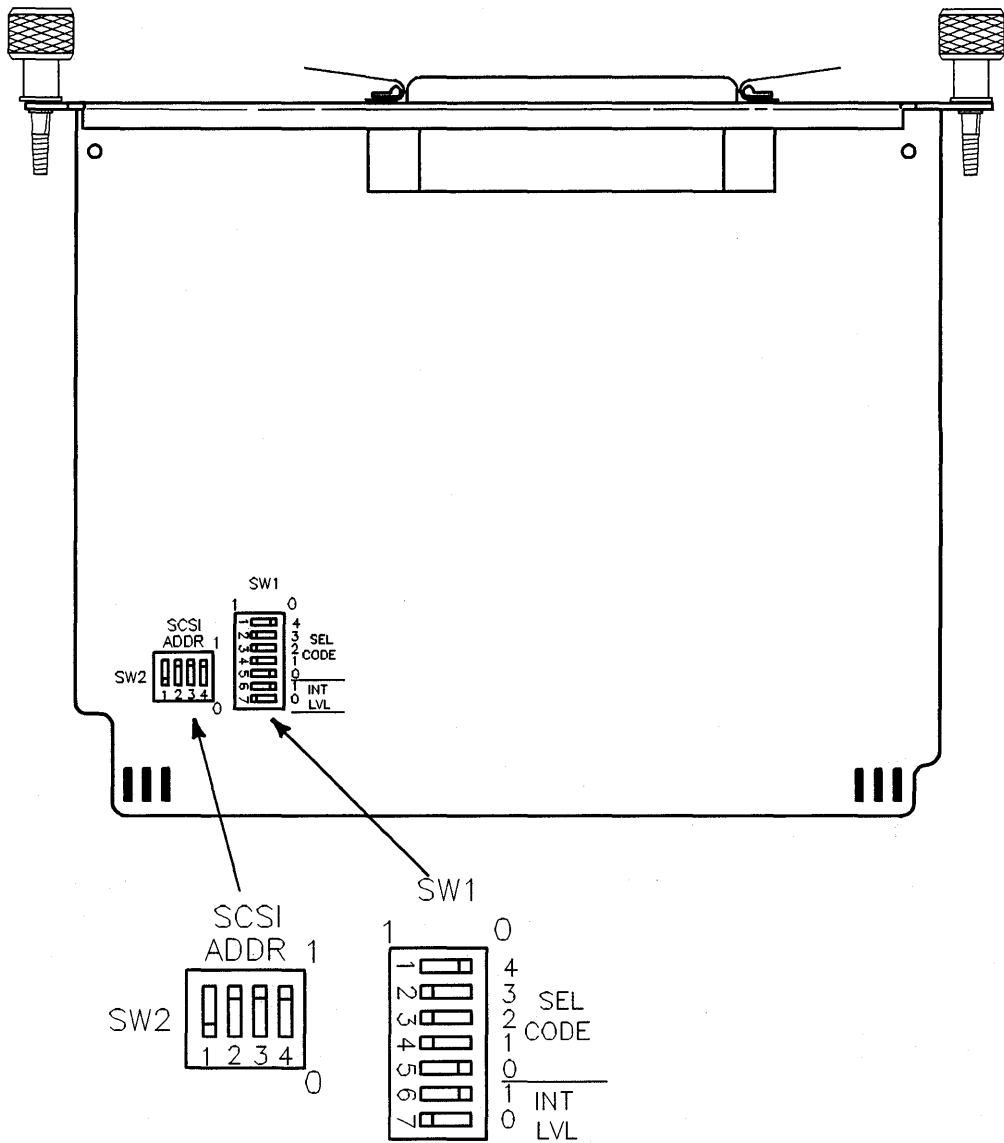

Figure 10-12. HP 98658A SCSI Interface Card Configuration Switch Locations

Setting the Select Code.

1. Remove the SCSI card from the controller or expander and place it on a static-free surface.
2. Find the group of switches labeled SW1 by referring to Figure 10-12. Switches 1 through 5 in this group determine the select code.
3. Set these switches to one of the five select codes given in Table 10-23, unless you have used them elsewhere (check the Select Code for other interfaces to see which ones you have used). Refer to the installation note that came with the interface if you need additional switch settings.

Table 10-23. SCSI Card Select Code Switch Settings

Select Code	Switch 1 Labeled 4	Switch 2 Labeled 3	Switch 3 Labeled 2	Switch 4 Labeled 1	Switch 5 Labeled 0
14	0	1	1	1	0
15	1	1	1	1	0
16	0	0	0	0	1
17	1	0	0	0	1
18	0	1	0	0	1

4. Make a note that the select code has been used and is no longer available.
5. Find the new select code's number in the set of select code labels supplied with the interface. Replace the card's select code label with this new label. If a number is not available, make a label that looks like the one removed and stick it on the SCSI card.

Setting the Interrupt Level.

SKIP?

The interface is preset to interrupt level 3. Unless you are certain that interrupt level 3 is inappropriate for your application, leave the interrupt level setting alone and skip now to the next configuration function.

1. Find the group of switches labeled SW1 by referring to Figure 10-12. Switches 6 and 7 in this group determine the interrupt level.
2. Set the interrupt level to the desired value by referring to Table 10-24:

Table 10-24.

Interrupt Level	Switch 6	Switch 7
3	0	0
4	0	1
5	1	0
6	1	1

Setting the Bus Address Switches.

1. Find the group of switches labeled SW2 by referring to Figure 10-12. Switches 2, 3, and 4 set the bus address.
2. Set the bus address switches as follows:
 - first step
 - second step.

Setting the Parity Switch.

1. Find the group of switches labeled SW1 by referring to Figure 10-12. Switch 1 in this group is the PARity switch.
2. Set the parity switch as follows:
 - a. To enable parity checking, set the switch to 1.
 - b. To disable parity checking, set the switch to 0.

Reinstalling the SCSI Card

Insert the SCSI interface, component side up, into its slot. Tighten the thumb screws on the metal end plate until the end plate is flush with the back of the controller.

Verification Test

1. Plug in your controller's power cord and video cable, then turn on your monitor and controller.
2. When the keyboard line appears, press **space bar** a few times to go into attended mode.
3. Check the interfaces listed on the left-hand side of the screen:
 - If the message, HP98658, is listed, you have correctly installed the Interface.
 - If the message above does not appear, check the installation procedure and configuration settings, making sure there are no select code conflicts and that the card is firmly seated in an even-numbered slot. If the message still does not appear, call your HP Service Representative for assistance.

Filling Out the Worksheets

The following "Worksheet Entries" contain information needed to use the SCSI Interface with various language/operating systems. Refer to the table for the system you'll be using.

Copy this information to a worksheet or simply remember to refer here when you need it.

If you changed the select code, write in your new select code instead of 14.

When finished, you'll be ready to install your next peripheral or interface.

HP-UX System Worksheet Entry.**Table 10-25.**

Interface Name	Select Code
HP 98658A	21

Note this information regarding HP-UX operating systems:

- The character-mode major number for an IEEE-802 network is 18. The character-mode major number for an EthernetTM is 19. (EthernetTM is a trademark of the Xerox Corporation.)
- A typical `mknod` for a LAN Interface at select code 21 on an IEEE-802 (major number 18) Local Area Network is:

```
# mknod /dev/lan 18 c 0x150000
```

The 15 in the minor number represents the select code (15 is the hexadecimal value for 21).

Index

B

- Boot ROM configuration, 3-2
- Boot ROM interfaces
 - menu , 3-8

C

- configuration
 - 210 and 420 Mbyte hard disk drive configuration jumpers explained, 6-8
 - 210 and 420 Mbyte hard disk drive jumpers, 6-8
 - 52 Mbyte hard disk drive jumpers, 6-6
 - Boot ROM, 3-2
 - bus expander locations , 9-1
 - CD ROM disk drive jumpers, 6-14
 - control menu , 2-6
 - HP 98622A GPIO Interface Card, 10-4
 - HP 98624A HP-IB Interface Card, 10-11
 - HP 98625B High-Speed HP-IB Interface Card, 10-17
 - HP 98642A 4-Port Multiplexer Card, 10-23
 - HP 98643A LAN Interface Card, 10-29
 - HP 98644A RS-232-C Interface Card, 10-34
 - HP 98658A SCSI Interface Card, 10-40

- popular accessory cards, 10-3
- setting CD ROM PRY jumper, 6-16
- setting CD ROM SCSI bus address jumpers, 6-15
- setting flexible drive bus address jumpers, 6-12
- setting flexible drive function jumpers, 6-12
- setting the flexible disk drive jumpers, 6-10
- supported accessory cards in 2-slot expander, 9-3
- supported accessory cards in 4-slot expander, 9-2
- supported accessory cards in controllers , 10-2
- configure mode menu, 3-3

I

- internal interfaces
 - default configurations, 2-7

O

- operating system mode
 - using auto system select, 3-8

S

- safety
 - mechanical, 6-2
- Static discharge precautions, 5-3



Manual Part No.
A1473-90020

Copyright ©1991
Hewlett-Packard Company
Printed in USA E1091

**Manufacturing
Part No.
A1473-90020**



A1473-90020