

ML2430A SERIES POWER METER

OPERATION MANUAL

The Anritsu logo is displayed in a bold, black, sans-serif font. It is centered horizontally and is flanked by two horizontal lines on each side, which extend towards the left and right margins of the page.

ANRITSU LTD (EMD)
RUTHERFORD CLOSE
STEVENAGE
HERTS
SG1 2EF

P/N: 10585-00001
REVISION: K
PRINTED: MARCH, 2000
COPYRIGHT 2000 ANRITSU

WARRANTY

The ANRITSU product(s) listed on the title page is (are) warranted against defects in materials and workmanship for one year from the date of shipment.

ANRITSU's obligation covers repairing or replacing products which prove to be defective during the warranty period. Buyers shall prepay transportation charges for equipment returned to ANRITSU for warranty repairs. Obligation is limited to the original purchaser. ANRITSU is not liable for consequential damages.

LIMITATION OF WARRANTY

The foregoing warranty does not apply to ANRITSU connectors that have failed due to normal wear. Also, the warranty does not apply to defects resulting from improper or inadequate maintenance by the Buyer, unauthorized modification or misuse, or operation outside of the environmental specifications of the product. No other warranty is expressed or implied, and the remedies provided herein are the Buyer's sole and exclusive remedies.

TRADEMARK ACKNOWLEDGMENTS

V Connector and K Connector are registered trademarks of ANRITSU Company. HP 436A, HP 437B, HP 438A, Deskjet, and HP 340 Deskjet are registered trademarks of Hewlett-Packard Company. Adobe Acrobat and Acrobat Reader are trademarks of Adobe Systems Incorporated.

NOTICE

ANRITSU Company has prepared this manual for use by ANRITSU Company personnel and customers as a guide for the proper installation, operation and maintenance of ANRITSU Company equipment and computer programs. The drawings, specifications, and information contained herein are the property of ANRITSU Company, and any unauthorized use or disclosure of these drawings, specifications, and information is prohibited; they shall not be reproduced, copied, or used in whole or in part as the basis for manufacture or sale of the equipment or software programs without the prior written consent of ANRITSU Company.

Safety Symbols

To prevent the risk of personal injury or loss related to equipment malfunction, ANRITSU Company uses the following symbols to indicate safety-related information. For your own safety, please read this information carefully BEFORE operating the equipment.

Symbols used in manuals

DANGER	Indicates a very dangerous procedure that could result in serious injury or death if not performed properly.
WARNING	Indicates a hazardous procedure that could result in serious injury or death if not performed properly.
CAUTION	Indicates a hazardous procedure or danger that could result in light-to-severe injury, or loss related to equipment malfunction, if proper precautions are not taken.

Safety Symbols Used on Equipment and in Manuals

(Some or all of the following five symbols may or may not be used on all ANRITSU equipment. In addition, there may be other labels attached to products that are not shown in the diagrams in this manual.)

The following safety symbols are used inside or on the equipment near operation locations to provide information about safety items and operation precautions. Ensure that you clearly understand the meanings of the symbols and take the necessary precautions BEFORE operating the equipment.



This symbol indicates a prohibited operation. The prohibited operation is indicated symbolically in or near the barred circle.



This symbol indicates a compulsory safety precaution. The required operation is indicated symbolically in or near the circle.



This symbol indicates warning or caution. The contents are indicated symbolically in or near the triangle.



This symbol indicates a note. The contents are described in the box.



These symbols indicate that the marked part should be recycled.

For Safety

WARNING



Always refer to the operation manual when working near locations at which the alert mark, shown on the left, is attached. If the operation, etc., is performed without heeding the advice in the operation manual, there is a risk of personal injury. In addition, the equipment performance may be reduced.

Moreover, this alert mark is sometimes used with other marks and descriptions indicating other dangers.

WARNING



When supplying AC power to this equipment, connect the accessory 3-pin power cord to a 3-pin grounded power outlet. If a grounded 3-pin outlet is not available, use a conversion adapter and ground the green wire, or connect the frame ground on the rear panel of the equipment to ground. If power is supplied without grounding the equipment, there is a risk of receiving a severe or fatal electric shock.

WARNING

Repair



This equipment cannot be repaired by the operator. DO NOT attempt to remove the equipment covers or to disassemble internal components. Only qualified service technicians with a knowledge of electrical fire and shock hazards should service this equipment. There are high-voltage parts in this equipment presenting a risk of severe injury or fatal electric shock to untrained personnel. In addition, there is a risk of damage to precision components.

WARNING

If this equipment is used in a manner not specified by the manufacturer, the protection provided by the equipment may be impaired.

DECLARATION OF CONFORMITY

Manufacturer's Name: ANRITSU COMPANY

Manufacturer's Address: Anritsu Limited
Rutherford Close
Stevenage, Hertfordshire
United Kingdom

declares that the product specified below:

Product Name: Power Meter

Model Number: ML2437A, ML2438A

conforms to the requirement of:

EMC Directive 89/336/EEC as amended by Council Directive 92/31/EEC & 93/68/EEC
Low Voltage Directive 73/23/EEC as amended by Council directive 93/68/EEC

Electromagnetic Interference:

Emissions: CISPR 11:1990/EN55011:1991 Group 1 Class A

Immunity: EN50082 -1:1992 Generic Immunity Standard
IEC801-2 Electrostatic Discharge - 4kV CD, 8kV AD
IEC801-3 RF Radiated Field Immunity - 3V/m
IEC801-4 Electrical Fast Transients - 0.5kV SL, 1kV PL

Electrical Safety Requirement:

Product Safety: IEC 1010-1:1990 + A1/EN61010-1:1993

Morgan Hill, CA

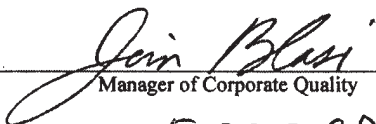

Manager of Corporate Quality
5-SEPT-97
Date

European Contact: For Anritsu product EMC & LVD information, contact Anritsu LTD, Rutherford Close,
Stevenage Herts, SG1 2EF UK, (FAX 44-1438-740202)

Table of Contents

Chapter 1 - General Information

1-1	Scope of This Manual	1-1
1-2	Introduction	1-1
1-3	Related Manuals	1-1
1-4	Identification Number	1-2
1-5	Power Meter Models, Options, and Accessories	1-2
1-6	Sensors.	1-3/1-4

Chapter 2 - Installation

2-1	Introduction	2-1
2-2	Initial Inspection	2-1
2-3	Sensor Handling	2-1
2-4	Power Requirements	2-1
2-5	Environmental Requirements.	2-3
2-6	Rack Mounting	2-3
2-7	Battery Charging, Removal and Replacement	2-9
2-8	Storage and Shipment	2-11

Chapter 3 - Connections

3-1	Introduction	3-1
3-2	Front Panel Connectors	3-1
3-3	Rear Panel Connectors.	3-2

Chapter 4 - Front Panel Operation

4-1	Introduction	4-1
4-2	Front Panel Controls	4-1
4-3	Power-on Procedure	4-3
4-4	Sensor Menu4-5	
4-5	Channel Menu.	4-12
4-6	Trigger Menu 4-15	
4-7	System Menu	4-20
4-8	Cal/Zero Menu	4-34

Chapter 5 - Procedures

5-1	Introduction	5-1
5-2	Power Measurement	5-1
5-3	Zeroing the Sensor	5-1
5-4	Sensor Calibration	5-2
5-5	Sensor Zero/Cal	5-3
5-6	Performance Verification	5-4
5-7	Printer Connection	5-4
5-8	GPIB Remote Operation	5-4
5-9	Serial Remote Operation	5-5
5-10	RS232 Modem Support	5-6
5-11	Profile Operation Mode	5-11
5-12	Source Sweep Mode	5-17
5-13	Power vs. Time Mode	5-19
5-14	User Cal Factors	5-19
5-15	Optimizing Readings	5-21
5-16	Operator Maintenance	5-25

Chapter 6 - GPIB Operation

6-1	Introduction	6-1
6-2	Typographic Conventions	6-1
6-3	Data I/O Formats	6-1
6-4	Query Commands	6-4
6-5	GPIB PC Card Setup	6-5
6-6	Using 488.1 GPIB	6-6
6-7	Using 488.2 GPIB	6-7
6-8	Service Request Status (SRQ)	6-9
6-9	Functional Groups	6-10
6-10	ML24XXA Native Commands	6-12
6-11	GPIB Emulation Modes	6-84
6-12	ML4803A Emulation Commands	6-85
6-13	HP 436A Emulation Commands	6-96
6-14	HP 437B Emulation Commands	6-101
6-15	HP 438A Emulation Commands	6-118
6-16	Programming Examples	6-129

Appendix A - Specifications

A-1	Introduction	A-1
A-2	System Specifications	A-1
A-3	System Defaults	A-6
A-4	System Error Messages	A-11

Appendix B - GPIB Quick Reference

B-1	Introduction	B-1
B-2	ML24XXA Quick Reference	B-1
B-3	ML4803A Quick Reference	B-9
B-4	HP 436A Quick Reference	B-10
B-5	HP 437B Quick Reference	B-11
B-6	HP 438A Quick Reference	B-14
B-7	HP-IB Support	B-16

Appendix C - Menu Maps

C-1	Introduction	C-1
C-2	Sensor Menu	C-1
C-3	Channel Menu	C-6
C-4	Trigger Menu	C-8
C-5	System Menu	C-9
C-6	Cal/Zero Menu	C-15

Index

Chapter 1

General Information

1-1 SCOPE OF THIS MANUAL

This manual provides installation and operation information for the Model ML2430A Series of ANRITSU Power Meters (Figure 1-1).



Figure 1-1. ML2430A Series Power Meters

1-2 INTRODUCTION

This chapter provides information to familiarize the user with the basic ML2430A Series Power Meter. Included is information about the equipment identification number, models, options, and sensors.

1-3 RELATED MANUALS

This manual is one of a two manual set consisting of this Operation Manual, and the *ML2430A Series Maintenance Manual* (Anritsu part number 10585-00003).

These manuals are available on CD ROM as Adobe Acrobat™ (*.pdf) files. The files can be viewed using Acrobat Reader™, a freeware program provided on the CD ROM. For price and availability, contact the nearest Anritsu Customer Service Center or visit our web site at: www.global.anritsu.com.

**1-4 IDENTIFICATION
NUMBER**

The ML2430A Series ID number is affixed to the rear panel (see Figure 3-2). Please use the complete ID number when ordering parts or corresponding with the Anritsu Customer Service department.

**1-5 POWER METER
MODELS, OPTIONS, AND
ACCESSORIES**

The ML2430A Series Power Meter is available with either one or two sensor inputs, and is delivered with a 1.5m sensor cable (ML2400A-20) for each input. Model numbers, options, and accessories are listed below.

Models

<u>Model No.</u>	<u>Number of Sensor Channels</u>
ML2437A	Single Channel
ML2438A	Dual Channel

Options

<u>Model No.</u>	<u>Option</u>
ML2400A-01	Rack Mount, single unit
ML2400A-03	Rack Mount, side-by-side
ML2400A-05	Front Bail Handle (Options -01 thru -05 are mutually exclusive.)
ML2400A-06	Rear Panel Mounted Input A
ML2400A-07	Rear Panel Mounted Input A & Reference
ML2400A-08	Rear Panel Mounted Inputs A, B, & Reference
ML2400A-09	Rear Panel Mounted Inputs A & B (Options -06 thru -09 are mutually exclusive.)
ML2400A-11	3000 mA-h, NiMH Battery
ML2400A-12	Front Panel Cover (Can not be used with rack mounted units.)
ML2400A-13	External Battery Charger

Accessories

<u>Part No.</u>	<u>Item</u>
760-206	Hard Sided Transit Case
D41310	Soft Sided Carry Case with shoulder strap
ML2419A	Range Calibrator
B41323	Serial Interface Cable
MA2418A	50 MHz, 0 dBm Reference Source

1-6 SENSORS

The following sensors, sensor options, and sensor accessories are available for use with the ML2430A Series Power Meters:

Power Sensors (–70 to + 20 dBm)

<u>Model No.</u>	<u>Range</u>
MA2468A	10 MHz – 6 GHz
MA2469B	10 MHz – 18 GHz (–60 to +20 dBm, nominal bw 1.2 MHz)
MA2472A	10 MHz – 18 GHz
MA2473A	10 MHz – 32 GHz
MA2474A	10 MHz – 40 GHz
MA2475A	10 MHz – 50 GHz

Thermal Sensors (–30 to + 20 dBm)

<u>Model No.</u>	<u>Range</u>
MA2421A	100 KHz to 18 GHz
MA2422A/B	10 MHz – 18 GHz
MA2423A/B	10 MHz – 32 GHz
MA2424A/B	10 MHz – 40 GHz
MA2425A/B	10 MHz – 50 GHz

High Accuracy Sensors (–64 to +20 dBm)

<u>Model No.</u>	<u>Range</u>
MA2442A	10 MHz – 18 GHz
MA2444A	10 MHz – 40 GHz
MA2445A	10 MHz – 50 GHz

Universal Power Sensor

<u>Model No.</u>	<u>Range</u>
MA2481A	10 MHz – 6 GHz
MA2480/01	Add Fast CW

Sensor Options

MA2400A-10	Extra Cal Factor Freq., 0.01 – 40 GHz
------------	---------------------------------------

Sensor Accessories

ML2400A-20	1.5m Sensor Cable
ML2400A-21	0.3m Sensor Cable
ML2400A-22	3m Sensor Cable
ML2400A-23	5m Sensor Cable
ML2400A-24	10m Sensor Cable
ML2400A-25	30m Sensor Cable
ML2400A-26	50m Sensor Cable
ML2400A-27	100m Sensor Cable
ML2400A-29	Bulkhead Adapter
ML2400A-30	Extra Operation Manual ML2437/38A
ML2400A-33	Printer
MA2499B	Anritsu Sensor Adapter
MA2497A	HP Sensor Adapter
1N75C	5W Limiter, 0.01 – 3 GHz, Nm-f, 75W
1N50C	5W Limiter, 0.01 – 18 GHz, Nm-f, 50W
1K50A	5W Limiter, 0.01 – 20 GHz, Km-f, 50W
1K50B	3W Limiter, 0.01 – 26 GHz, Km-f, 50W
42N75-20	5 Watt Attenuator, Nm-f, 75Ω
42N50-20	5 Watt Attenuator, Nm-f, 50Ω
42N50-30	50 Watt Attenuator, Nm-f, 50Ω
42KC-20	5 Watt Attenuator, Km-f, 50Ω

NOTE

The use of sensor cables greater than 10 meters in length is not recommended when measuring pulses of less than 10 μ s.

Chapter 2

Installation

2-1 INTRODUCTION

This chapter provides information for the initial inspection and preparation for use of the ML2430A Series Power Meter. Shipping and storage information is also included.

2-2 INITIAL INSPECTION

Inspect the shipping container for damage. If the container or cushioning material is damaged, retain until the contents of the shipment have been checked against the packing list and the instrument has been checked for mechanical and electrical operation.

If the power meter is damaged mechanically, notify your local sales representative or Anritsu Customer Service Center. If either the shipping container is damaged or the cushioning material shows signs of stress, notify the carrier as well as Anritsu. Retain the shipping materials for the carrier's inspection.

2-3 SENSOR HANDLING

The sensors are enclosed in a polycarbonate case to help prevent damage. The sensor connectors, however, are exposed and are a critical part of the microwave instrument. Refer to the MA24XXA Series Power Sensor manual (10585-00004) for detailed information on proper connector care.

2-4 POWER REQUIREMENTS

The ML2430A Series Power Meter can be operated from either AC line power, external DC power, or from the optional internal battery. The ML2430A Series Power Meter is intended as an Installation (Overvoltage) Category II, Insulation Category I device.

At power-on, the power meter will perform a brief power-on self test (POST). If a POST error occurs, information and available options will be displayed on the screen (See Chapter 4, page 4-3). If the POST is successful, the instrument will load the last used configuration, unless Secure mode has been selected (see Chapter 4, page 4-34, or Chapter 6, page 6-68).

AC Line Power The ML2430A Series Power Meter can operate on AC input power of 85-264V, 50-440 Hz, 40 VA maximum. The Power Meter automatically configures itself for the voltage applied. The AC line input is protected by an internal fuse.

DC Power The ML2430A Series Power Meter can also operate from a nominal external 12-24 VDC input in the absence of AC line power. DC line power is protected by

a fuse mounted inside the unit, on the main board. A grounding terminal is provided on the rear panel to ground the unit during operation from a DC supply.

Battery Power

The ML2430A Series Power Meter can be operated using the optional internal battery pack. During battery operation, an icon will be displayed on measurement screens indicating the state of charge. When the remaining capacity reaches less than 10%, the icon will flash, indicating that charging will soon be required. When running from battery power, an estimate of typical-use running time remaining can be viewed using the System menu (see Chapter 4, Front Panel Operation). Note that, due to power consumption considerations, GPIB and serial remote operation are not available when the power meter is running from the battery.

The AUTO POWER OFF feature is also available through the System menu, and can be used to automatically switch the unit to standby after a specified period of inactivity to save battery power. The timer can be set for 10 to 240 minutes, and any key press will restart the timer. This same feature will automatically switch the unit to standby when the battery is fully discharged in order to minimize the risk of over-discharge.

NOTE

The ML2430A Series Power Meter uses a high-capacity Ni-MH battery (option ML2400A-11). Over-discharge can result in a permanent loss of battery capacity of as much as 20%. If the unit is to be stored for an extended period (longer than one week), remove the optional battery pack so as to preclude over-discharge.

For optimum battery life, store the battery pack at -20 to $+50^{\circ}$ C (-4 to $+122^{\circ}$ F) for short periods and -20 to $+35^{\circ}$ C (-4 to $+95^{\circ}$ F) for long term storage.

The ML2430A Series Power Meter will operate from AC or DC main power with this battery removed. This battery is not used for the retention of nonvolatile memory functions. Refer to Section 2-7, Battery Charging, Removal and Replacement, for further information.

Fuses

The ML2430A Series Power Meter AC and DC input lines are protected by internally mounted fuses. These fuses should only be changed by qualified service personnel. Replace only with fuses of the same type and rating (AC fuse is 2A, 250V, slow-blow; DC fuse is 3A, 125V, slow-blow).

Grounding

The ML2430A Series Power Meter must be properly grounded. Failure to ground the instrument could be hazardous to operating personnel. The meter is supplied with a three-conductor power cord. The instrument is properly grounded during AC line operation when the plug is connected to a properly installed three-prong receptacle. A grounding terminal is provided on the rear panel to ground the unit during operation from a DC supply.

2-5 ENVIRONMENTAL REQUIREMENTS

The ML2430A Series Power Meter is designed to operate within the temperature range of 0 to 50° C (32 to 122° F) with a maximum humidity of 90% at 40° C (104° F), non-condensing. Full accuracy is specified at 5 to 35° C (23 to 95° F).

Although not recommended, operation in temperatures to –20° C (–4° F) is possible. At these temperatures, however, the liquid crystal display may exhibit excessively slow response. The soft sided carry case (part number D41310) and optional front panel cover (option ML2400A-12) can be used to help retain internally generated heat and may improve response.

2-6 RACK MOUNTING

The ML2430A Series Power Meter can be ordered with rack mounting hardware that allows the unit to be mounted into a standard 19-inch equipment rack. There are two rack mount option kits available:

- The ML2400A-01 Rack Mount option allows the installation of a single ML2430A in either the left or right side rack position.
- The ML2400A-03 Rack Mount option allows side-by-side mounting of two ML2430A Power Meters.

The Power Meter itself must be ordered from the factory as a rack mount-ready unit. As such, it will be fitted with rack mount top and bottom cases. These cases have extra mounting holes so that the rack mount kits can be installed. Instructions for installing the rack mount kits follow.

ML2400A-01 Rack Mount Installation

This section describes the assembly procedure for fitting a single ML2430A Power Meter (PM) unit into an instrument rack. The PM must be fitted with rack mount top and bottom covers before the rack mount kit can be fitted. The procedure involves fitting the support bracket to the PM. The PM can then be loaded and secured in the rack position desired.

The required parts and tools are listed below:

Quantity (each)	Description	Anritsu Part Number	Max. Torque Setting
2	HANDLE, PULL, CHASSIS, PLASTIC, HARDWARE	783-1055	
4	SPEED NUT	790-319	
8	6-32, SST, WASHER, FLAT	900-345	
4	M4, 8.00 MM, PHH, SCREW, FLAT HEAD	900-795	
4	DECORATIVE SCREW	900-821	
8	M3X8, POS, SST, PATCHLOCK, SCREW, METRIC, PAN HEAD	905-68	.4lbf.in [45cN m]
6	M3X5, POS, SST, PATCHLOCK, SCREW, METRIC, PAN HEAD	905-72	.4lbf.in [45cN m]
6	SNAP RIVET, PLASTIC	788-575	
1	RACK MOUNT, SIDE, BRACKET	C37276	
1	REAR SUPPORT, BRACKET, RACK MOUNT	C41449	
1	RACK MOUNT, SUPPORT, BRACKET	D41473	
1	BRACKET SUPPORT, BASE PANEL	49361	
1	FRONT FACE PLATE	49362	
1	POWER METER FITTED WITH RACK MOUNT TOP AND BOTTOM COVERS	ML2430A	

Table 2-1 ML2430A-01 Rack Mount Kit Parts List

Tools Required: Small Phillips screw driver
 Large Phillips screw driver
 Small Phillips torque screw driver 10cNm to 120cNm
 Assembly drawing “ML2400A/01 RACK MOUNTED LEFT OR RIGHT OPTION”

- Assembly Procedure**
1. Confirm the correct tools are available and the parts listed above are present. Refer to diagram on page 2-5 throughout this procedure.
 2. Fit the two handles 783-1055 to front plate 49362 and the front rack bracket C37376 using 4 screws 900-795.
 3. Lay the large support bracket D41473 next to the Power Meter as per the assembly drawing. Note if the PM needs to be mounted on the left hand side of the rack, simply lay the bracket on the PM's right side. i.e. a mirror image of the assembly drawing.
 - 4.

Locate the support bracket on the four PM case pillars. Secure with 4 screws 905-68 and 4 washers 900-345. (See max. torque settings page 2-4.)

5. Locate the front rack mounting bracket C37276 at the front of the PM on the other side to the large support bracket with two screws 905-68 and two washers 900-345. (See max. torque settings page 2-4).
6. Locate the rear bracket C41449 at the back of the PM on the other side to the large support bracket with two screws 905-68 and two washers 900-345. See maximum torque settings above. Locate the rear bracket C41449 at the back of the PM on the other side to the large support bracket with two screws 905-68 and two washers 900-345. (See max. torque settings page 2-4).
7. Fit the front plate 49362 with 6 screws 905-72. (See max. torque settings page 2-4).
8. Position the base panel 49361 as shown in the drawing, and secure with 6 snap rivets 788-575.
9. Fit the four speed nut 790-319 to the rack in the correct place to allow mounting of the PM in the rack.
10. Slide the PM into the rack and secure with 4 decorative screws 900-821.

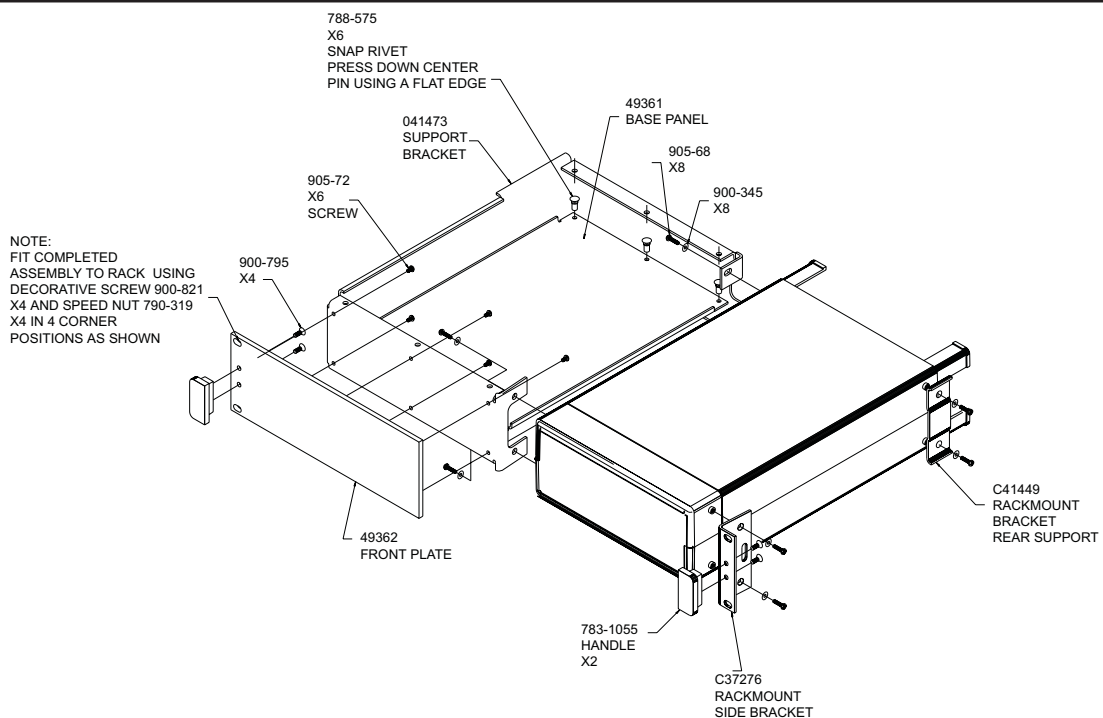

ML2400A-03 Rack Mount Installation

This section describes the assembly procedure for fitting two ML2430A Power Meters (PM) into a instrument rack. The PM's must be fitted with rack mount top and bottom covers for the rack mount kit to be fitted. The procedure involves fitting support brackets, two front handles, and two rear support brackets, one to each PM. The two PM,s which are locked together can then be loaded and secured in the rack position desired. This assembly procedure also provides assembly instructions for fitting a ML2430A to a HP34401A Multimeter and a MF2412A Microwave Frequency Counter.

The required parts and tools are listed below:

Quantity (each)	Description	Anritsu Part Number	Max. Torque Setting
2	HANDLE, PULL, CHASSIS, PLASTIC, HARDWARE	783-1055	
4	SPEED NUT	790-319	
16	WASHER, 6-32UNC, OVERSIZE	900-345	
4	M4, 8.00 MM, PHH, SCREW, FLAT HEAD	900-795	
4	DECORATIVE SCREW	900-821	
16	M3X8, POS, SST, PATCHLOCK, SCREW, METRIC, PAN HEAD	905-68	.4lbf.in [45cN m]
4	M3X6, POS, SST, PATCHLOCK, SCREW, METRIC, FLAT HEAD	905-69	
4	WASHER, M4 SPLIT.	900-807	
2	M4X12MM, SCREW, PAN HD	900-806	
2	M3.5X8MM, SCREW, PAN HD	905-103	
4	M4X10MM, SCREW, FLT HD	905-63	
1	RACK MOUNT, SIDE BRACKET	49415	
1	RACK MOUNT, CENTRE, FRT, BRACKET	49413	
1	SPACER PLATE	49439	
1	RACK MOUNT, CENTER, FRONT, BRACKET	C37275	
2	RACK MOUNT, SIDE, BRACKET	C37276	
1	RACK MOUNT, CENTER, BRACKET	C37277	
1	RACK MOUNT, CENTER, BRACKET	C37279	
2	REAR SUPPORT, BRACKET, RACK MOUNT	C41449	
2	POWER METER FITTED WITH RACK MOUNT TOP		

Table 2-2 ML2430A-03 Rack Mount Kit Parts List

Tools Required: 1 Small Phillips screw driver
1 Large Phillips screw driver
1 Small Phillips torque screw driver 10cNm to 120cNm.
1 Assembly drawing "ML2400/03 SIDE BY SIDE OPTION"

- Assembly Procedure**
1. Confirm the correct tools are available and the parts listed above are present. Refer to diagram on page 2-8 throughout this procedure.
 2. On the two sides of the power meter to be joined together, fit the two rear brackets 49413, C37279, and two front brackets C37275, C37277 using 8 screws 905-68 and 8 washers 900-345. (See max. torque settings page 2-6).
 3. Slide the two PM units together and secure using 4 counter sink screws 905-69.
 4. Fit the two handles 783-1055 to the front rack brackets using 4 screws 900-795.
 5. Locate the two front rack brackets C37276 and 49415 at the front of each of the PM's, one on each side with four screws 905-68 and four washers 900-345. See max, torque setting above.
 6. Locate the two rear rack brackets C41449 at the back of each of the PM's one on each side with four screws 905-68 and four washers 900-345. (See max. torque settings page 2-6).
 7. Fit the four speed nuts 790-319 to the rack in the correct place to allow mounting of the two PM's in the rack.
 8. Slide the instruments into the rack and secure with the four decorative screws (900-821) provided.

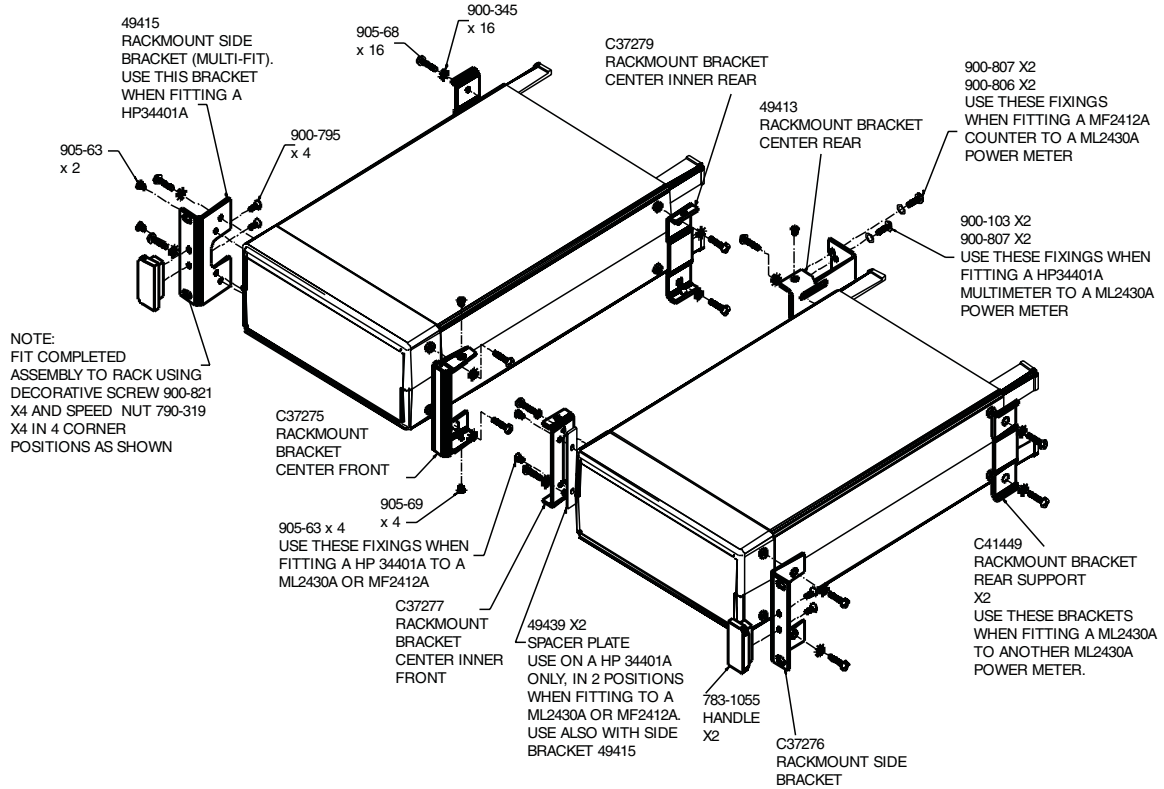

The procedure for fitting a ML2430A to a HP34401A Multimeter is as follows:

1. Fit to the ML2430A Power Meter front brackets C37276, C37275 and rear bracket C41449 using 6 screws 905-68 and 6 washers 900-345. Do not tighten fully at this stage, only enough to allow the bracket to slide to its maximum position.
2. Fit the center rear bracket 49413 using 2 screws 905-63. (See max. torque settings page 2-6).
3. Fit to the HP34401A spacer plate 49439 in 2 positions with front brackets C37277 and 49415 using 4 screws 905-63. (See max. torque settings page 2-6).
4. Offer up the HP34401A to the ML2430A unit ensuring the front bracket fixing holes of both units are in line. Slide the center rear bracket 49413 forward till it makes contact with the rear face of the HP34401A.
5. Gently remove the HP34401A unit and tighten the 49413 bracket fixings in its new position. (See max. torque settings page 2-6).

2-7 BATTERY CHARGING, REMOVAL AND REPLACEMENT

The optional ML2430A Series Power Meter battery is a 12 Volt, 3000 mA-h nickel-metal hydride (Ni-MH) multi-cell pack, located in a compartment on the bottom of the housing. The compartment cover is secured by fractional turn fasteners, as shown in Figure 2-1. Rotate the fasteners approximately ¼-turn counterclockwise to release the cover.

NOTE

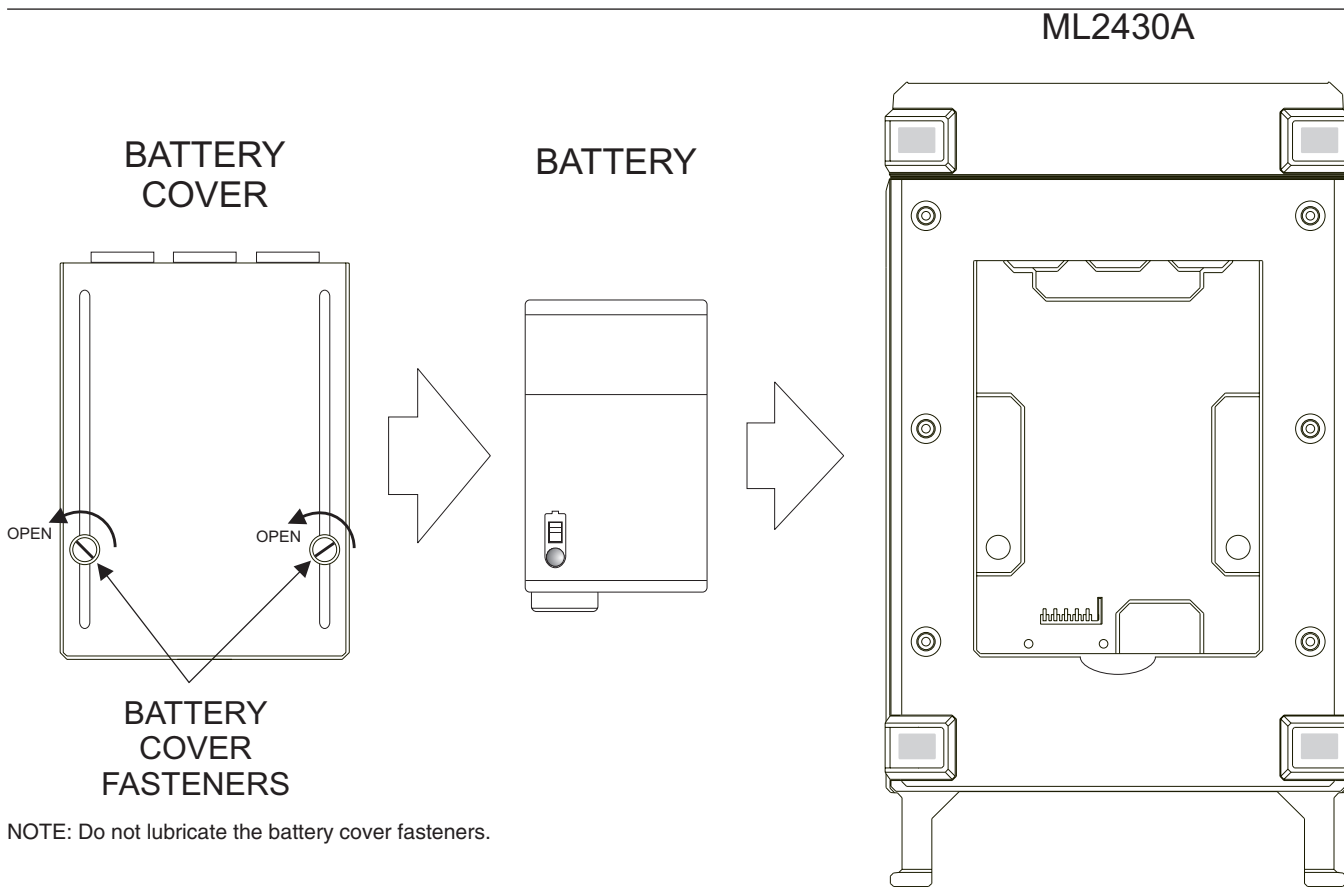

NOTE: Do not lubricate the battery cover fasteners.

Figure 2-1. Model ML2430A Series Battery Compartment

The battery is shipped with a partial charge only, and should be fully charged before use.

The battery can be completely charged in about two hours with the power meter in standby mode by selecting CHARGE from the System menu (page 4-30). This selection is available only when the instrument is being powered by AC line power or external DC power greater than 21 volts. Note that the instrument will shut down during the charging cycle, and restart automatically when the charging is completed. A series of 10 beeps signals completion of the charge cycle.

The external battery charger (option ML2400A-13) can completely charge the battery in 2.5 hours.

INSTALLATION BATTERY CHARGING, REMOVAL AND REPLACEMENT

CAUTION

- To avoid excessive heat build up, always remove the ML2430A from the optional soft sided carrying case (D41310) before selecting fast charging.

For optimal battery life, the battery should be fully discharged before re-charging. Repeated partial charge/discharge cycles can result in a loss of battery capacity, recoverable by applying several “conditioning” (full charge/discharge) cycles. If the power meter determines that a battery conditioning cycle is required, a message stating this requirement will be displayed on the front panel, and will remain until the battery is fully conditioned or replaced. A number of complete conditioning cycles may be necessary to fully condition a battery.

The ideal battery temperature ranges are:

- Discharging: -20 to $+50^{\circ}$ C (-4 to $+122^{\circ}$ F)
- Charging: $+10$ to $+45^{\circ}$ C ($+50$ to $+113^{\circ}$ F)

Note that charging will be inhibited if the temperature falls outside these limits.

To remove the battery, first disconnect any AC or DC input line power. Open the battery compartment as illustrated and remove the battery. Replace the battery only with an identical battery or an equivalent as recommended by an Anritsu Service Center. Ensure that the battery is correctly connected and that the battery compartment cover is securely fastened.

Note that the battery is an optional component that is not used for the retention of nonvolatile memory functions, and is not required for the Power Meter to operate from either AC or DC line sources. Serial and GPIB remote operation, however, are not available when the power meter is running from battery power.

CAUTION

- The ML2430A battery pack can leak, explode, or catch on fire if it is opened, disassembled, or exposed to fire or very high temperatures. No attempt should be made to open, repair, or modify the battery package.
- When a battery pack has reached the end of its functional life, it should be returned to the nearest Anritsu Service Center for proper recycling or disposal. Do not treat a used battery as normal waste.

2-8 STORAGE AND SHIPMENT

The following paragraphs describe preparing the power meter for storage and shipment.

Preparation for Storage

Preparing the power meter for storage consists of cleaning the unit and packing it with moisture-absorbing desiccant crystals. Whenever the unit is to be stored for an extended period (longer than one week), it is advisable to remove the optional battery pack. Refer to Section 2-7, "Battery Charging, Removal and Replacement," for instructions.

Environmental Requirements

Store the unit in a temperature controlled environment that is maintained between -40 and $+70^{\circ}\text{C}$ (-40 to $+156^{\circ}\text{F}$), with a maximum humidity of 90% at 40°C (104°F), non-condensing. For optimum battery life, store the battery pack at -20 to $+50^{\circ}\text{C}$ (-4 to $+122^{\circ}\text{F}$) for short periods and -20 to $+35^{\circ}\text{C}$ (-4 to $+95^{\circ}\text{F}$) for long term storage.

Preparation for Shipment

To provide maximum protection against damage in transit, the power meter should be repackaged in the original shipping container. If this container is no longer available and the power meter is being returned to Anritsu for repair, advise Anritsu Customer Service Center; they will send a new shipping container free of charge. In the event neither of these two options is possible, follow the packaging instructions below.

Use a Suitable Container

Obtain a corrugated cardboard carton with a 275-pound test strength. This carton should have inside dimensions of no less than six inches larger than the instrument dimensions to allow for cushioning.

Protect the Instrument

Wrap the instrument to protect the finish.

Cushion the Instrument

Cushion the instrument on all sides by tightly packing dunnage or urethane foam between the carton and the instrument. Provide at least three inches of dunnage on all sides.

Seal the Container

Seal the carton using either shipping tape or an industrial stapler.

Address the Container

When the instrument is being returned to Anritsu for service, mark the address of the appropriate Anritsu service center (Table 2-1), the Return Materials Authorization (RMA) number, and your return address on the carton in a prominent location.

Table 2-3. ANRITSU Service Centers**UNITED STATES**

ANRITSU SALES COMPANY
685 Jarvis Drive
Morgan Hill, CA 95037-2809
Telephone: (408) 776-8300
FAX: (408) 776-1744

ANRITSU SALES COMPANY
10 Kingsbridge Road
Fairfield, NJ 07004
Telephone: (201) 227-8999
FAX: (201) 575-0092

AUSTRALIA

ANRITSU PTY. LTD.
Unit 3, 170 Foster Road
Mt Waverley, VIC 3149
Australia
Telephone: 03--9558--8177
FAX: 03--9558--8255

BRAZIL

ANRITSU ELETRONICA LTD
Praia de Botafogo 440, Sala 2401
CEP 22250-040
Rio de Janeiro, RJ, Brasil
Telephone: 021-527-6922
FAX: 021-53-71-456

CANADA

ANRITSU INSTRUMENTS LTD.
215 Stafford Road, Unit 102
Nepean, Ontario K2H 9C1
Telephone: (613) 828-4090
FAX: (613) 828-5400

CHINA

ANRITSU BEIJING SERVICE CENTER
416W Beijing Fortune Building
5 Dong San Huan Bei Lu
Chao Yang Qu, Beijing 1000004, China
Telephone: 011861065909237
FAX: 011861065909236

FRANCE

ANRITSU S.A
9 Avenue du Quebec
Zone de Courtaboeuf
91951 Les Ulis Cedex
Telephone: 016-44-66-546
FAX: 016-44-61-065

GERMANY

ANRITSU GmbH
Grafenberger Allee 54-56
D-40237 Dusseldorf, Germany
Telephone: 0211-67-97-60
FAX: 0211-68-33-53

INDIA

MEERA AGENCIES (P) LTD.
Head Office
A-23 Hauz Khas
New Delhi 110 016
Telephone: 011-685-3959
FAX: 011-686-6720

ISRAEL

TECH-CENT, LTD
Haarad Street No. 7
Ramat Haahayal
Tel Aviv 69701
Telephone: 03-64-78-563
FAX: 03-64-78-334

ITALY

ANRITSU Sp.A
Roma Office
Via E. Vittorini, 129
00144 Roma EUR
Telephone: 06-50-22-666
FAX: 06-50-22-4252

JAPAN

ANRITSU CORPORATION
1800 Onna Atsugi-shi
Kanagawa-Prf. 243 Japan
Telephone: 0462-23-1111
FAX: 0462-25-8379

KOREA

ANRITSU KOREA
#901 Daeo building 26-5
Yeoido Dong, Youngdeungpo
Seoul, Korea 150010
Telephone: 02-782-7156
FAX: 02-782-4590

SINGAPORE

ANRITSU (SINGAPORE)
PTE LTD
3 Shenton Way
#24-03 Shenton House
Singapore 068805
Telephone: 226-5206
FAX: 226-5207

SOUTH AFRICA

ETESCSA
1st Floor Montrose Place
Waterfall Park
Becker Road
Midrand, South Africa
Telephone: 011-315-1366
FAX: 011-315-2175

SWEDEN

ANRITSU AB
Box 247
S-127 25 Skarholmen
Telephone: 08-74-05-840
FAX: 08-71-09-960

TAIWAN

ANRITSU CO., LTD.
8F, No. 96, Section 3
Chien Kuo N. Road
Taipei, Taiwan, R.O.C.
Telephone: 02-515-6050
FAX: 02-509-5519

UNITED KINGDOM

ANRITSU EUROPE LTD.
200 Capability Green
Luton, Bedfordshire
LU1 3LU, England
Telephone: 015-82-41-88-53
FAX: 015-82-31-303

Chapter 3

Connections

3-1 INTRODUCTION

This chapter describes physical connections to the power meter on both the front and rear panels.

3-2 FRONT PANEL CONNECTORS

The front panel connectors are illustrated in Figure 3-1. Detailed descriptions of each connector follow.

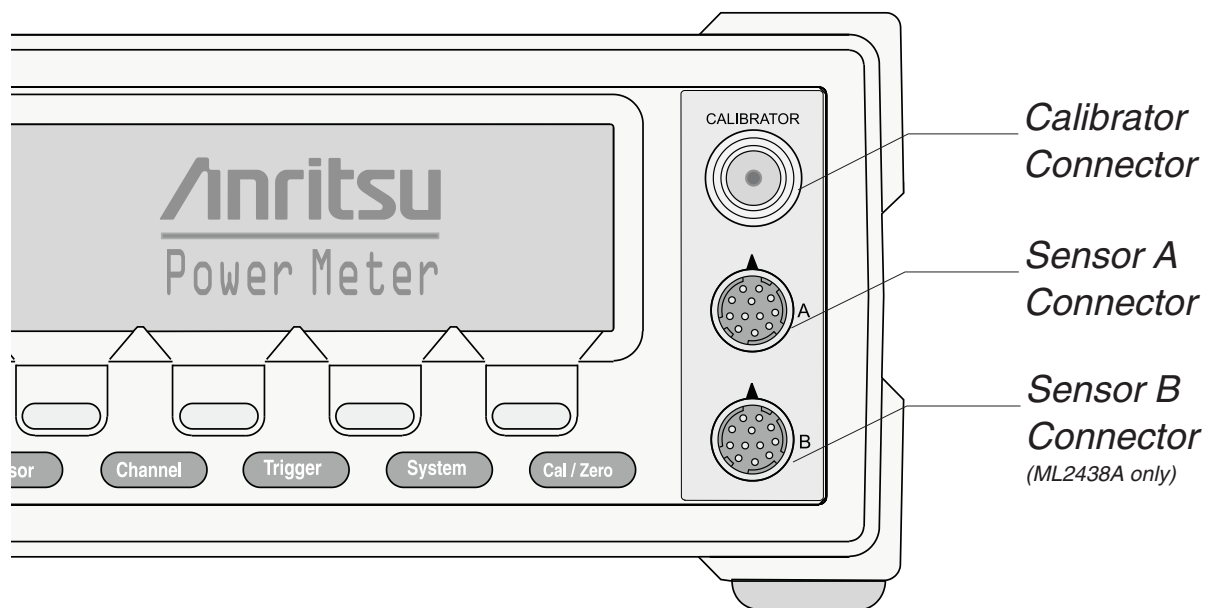

Figure 3-1. Model ML2430A Series Power Meter Front Panel Connectors

Calibrator 0.0 dBm Reference

This connector is a precision female N-Type, 50 Ohm connector that provides a precision, traceable 0.0 dBm, 50 MHz reference signal for absolute calibration of the sensors. The calibration signal can be turned on or off through the Cal/Zero menus (see Chapter 4, Front Panel Operation). Use only compatible 50 Ohm N-Type connectors.

An optional rear panel Calibrator connector is offered as an alternative (see Figure 3-2). If the rear panel connector option is installed, the front panel connector is not installed. Refer to Chapter 5, Procedures, for information on using the Calibrator output.

**Sensor A
Connector**

This connector is a 12-pin circular precision connector to be used in conjunction with power sensor cables. An optional rear panel Channel A connector is offered as an alternative (see Figure 3-2). If the rear panel connector option is installed, the front panel connector is not installed.

**Sensor B
Connector
(ML2438A only)**

This connector is a 12-pin circular precision connector to be used in conjunction with power sensor cables. An optional rear panel Channel B connector is offered as an alternative (see Figure 3-2). If the rear panel connector option is installed, the front panel connector is not installed.

NOTE

Only MA2400A Series sensors can be connected directly to the ML2430A Series Power Meters. MA4700A and MA4600A Series sensors require the MA2499A or MA2499B Anritsu Sensor Adapter. MP-Series (10-pin) sensors require an MA4001A or MA4002B adapter and an MA2499B.

**3-3 REAR PANEL
CONNECTORS**

The Rear Panel connectors are illustrated and described in Figure 3-2.

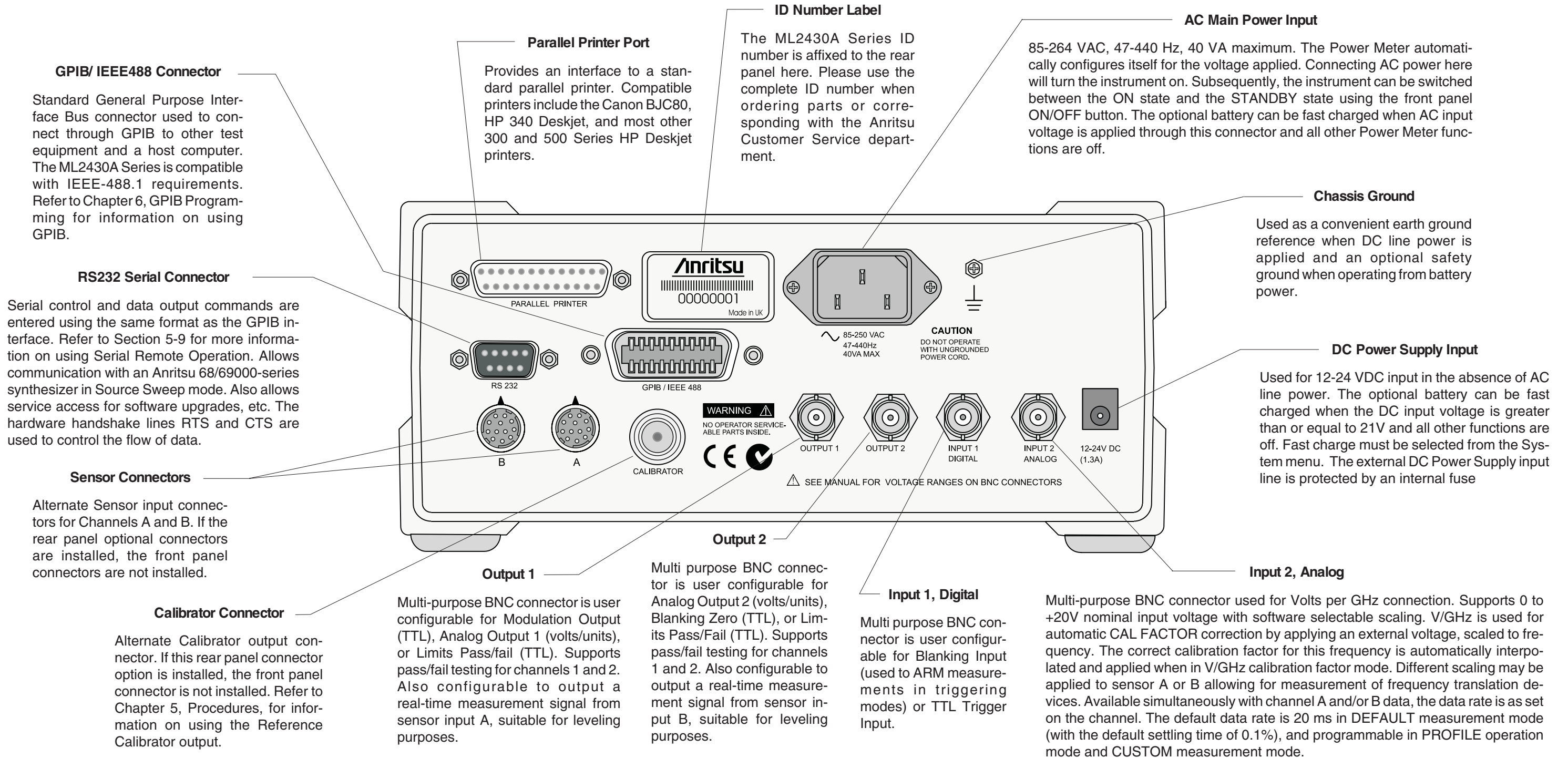

Figure 3-2. ML2430A Series Rear Panel

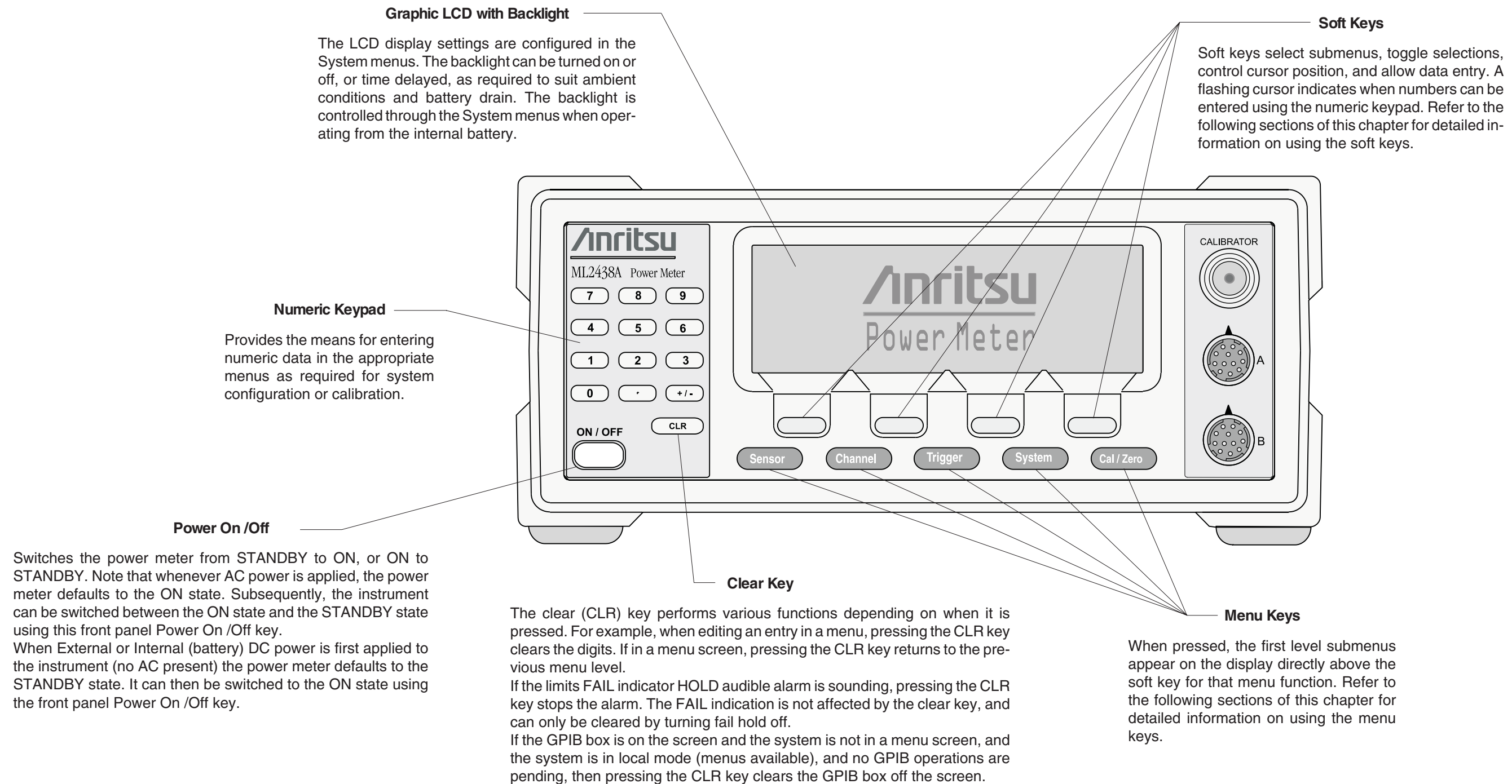

Figure 4-1. ML2430A Series Front Panel Controls

4-3 POWER-ON PROCEDURE

At power-on, the power meter performs a brief power-on self test (POST). After the POST, the instrument loads the last used configuration and display settings. If a POST error occurs, information and available options will be displayed on the screen.

The following tests are performed during the power-on self test, and also when the GPIB *TST? command is sent:

Table 4-1 Power-on Self Test

TEST SEQUENCE	POSSIBLE STATUS
Flash EPROM code checksum	Pass or Fail
Flash EPROM personality data checksum	Pass or Fail
Flash EPROM calibration data checksum	Pass or Fail
Volatile RAM tests	Pass or Fail
Non-volatile RAM checksums	Pass, Fail WARNING - Software version changed - all non-vol stores reset Current store failed - current store reset Saved store(s) failed - failed store status changed to not saved WARNING - Secure mode clear memory - all non-vol stores reset
Display	Pass or Fail
Keyboard	Pass or Fail

During the power-on self test, only failures and warnings will be displayed on the front panel. If all tests pass successfully, no self test information is displayed.

Failure and warning messages that can be displayed on the front panel are:

- Flash code csum
- Personality csum
- Volatile RAM
- Cal data csum
- Non-Vol RAM
- Software version - this is only a warning
- Current Setup
- Saved Setups
- Secure - Mem clear - this is only a warning
- Display
- Keyboard
- DSP error # - followed by a 4-digit hexadecimal error code

If any error, other than a DSP error, is encountered, the text:

"Press ANY key to continue"

will be displayed at the bottom of the screen. If only warnings are encountered, nothing will be displayed at the bottom of the screen, and the unit will continue to initialize.

If a DSP error occurs, the text:

"Restart unit. If error persists, contact Service Center."

is displayed and the unit will halt the self test. Make note of the hexadecimal error code displayed and contact your nearest Anritsu Service Center (see Chapter 2, Table 2-1).

Self test error messages are also available over the GPIB, as a self test status string (see STERR command, page 6-74).

4-4 *SENSOR MENU*

The Sensor menu has controls for sensor data processing.

NOTE

When editing an entry in a menu, pressing the CLR key clears the digits. If in a menu screen, pressing the CLR key returns to the previous menu level.

Setup

Selects the data acquisition controls for the sensor. The following submenus are displayed.

SENSOR Model ML2438A (dual channel) only. Select the sensor to be configured. Toggles between Channel A and Channel B for all submenu functions.

OPTION Only displayed if a Universal Power Sensor with Option 01 is connected to selected input channel. This key selects between True RMS sensor operation (for WCDMA measurements) and Fast CW (for TDMA/Pulse measurements).

MODE Select either Default, Modulated Average, or Custom.
[SENMM]

NOTE

The MODE selection is not available in Profile or Source Sweep modes.

Default is the sensor mode setting following system preset. It is the ML2430A Series simplest operating mode. Measurement speed is automatically adjusted according to sensor response times and the user-adjustable Settling %. Triggering controls, except for GPIB trigger, are disabled when the sensor mode is set to Default. This is intended to simplify basic power measurement by avoiding the necessity of specific trigger settings.

Modulated Average mode is used to stabilize the front panel digital readout. It is a specialized sensor mode for either MA2440A or MA2470A Series power sensors. These sensors are fast enough to demodulate the amplitude modulation of many RF test signals. The Mod Average sensor mode is unnecessary for thermal power sensors.

The Custom sensor mode permits the highest measurement rates. Trigger controls are available with this sensor mode. Trigger Delay (the time between the ML2430A Series receipt of a valid trigger event and the start of sample integration) and Gate Width (the duration of sample integration) controls are located in the Trigger menus.

When using universal power sensors only default mode is available unless OPTION is set to Fast CW. Fast CW can only be selected for sensors supplied with option 01.

NOTE

When measuring modulated signals with a diode sensor, ensure Modulated Average is selected or measurement errors may result.

NOTE

The HOLD selection is not available when System/Setup/mode is set to Source Sweep. In this mode, AUTO ranging is used.

HOLD
[RGH]

Allows the operating range of the selected sensor to be set to the desired range. Select a Range Hold value of 1 to 5, or Auto. When in Auto, the range changes to take the best measurement automatically. Auto is the default setting following system preset.

Typical Range Hold values for diode sensors are:

Range 1	above approximately -12 dBm
Range 2	-10 to -27 dBm
Range 3	-25 to -42 dBm
Range 4	-40 to -57 dBm
Range 5	below -55 dBm

NOTE

SETTLE% affects GPIB speed. Consider this when optimizing GPIB performance.

SETTLE %
[SENSTL]

Settle % per reading is available when the sensor mode is set to Default. The settling time allows some control over the tradeoff between speed and the extent to which a measurement has settled to its final value. A 1% settling value relates to approximately 0.04 dB, 0.5% relates to 0.02 dB and 0.25% to 0.01 dB. The default value after a system preset is 0.1%, or about 0.004 dB. Increasing the Settle percent to 1% or more will substantially increase measurement speed.

Calfactor

Allows entry of the calibration correction factor. The calibration factor compensates for mismatch losses and effective efficiency over the frequency range of the power sensor.

SENSOR

Model ML2438A (dual channel) only. Select the sensor to be configured. Toggles between Sensor A and Sensor B for all submenu functions.

SOURCE
[CFSRC
CFVAL]

Three selections are available, Frequency, Manual, and V/GHz.

Frequency

In this mode, correction data is read from the EEPROM in the sensor and applied automatically to the measurement based on the user's input frequency. The EEPROM correction data value nearest to the entered frequency is used to calculate the correction applied to the signal.

NOTE

Frequency or V/GHz are preferred methods as the sensors have internal linearity correction which varies with frequency.

NOTE

When the MA2499B Anritsu Sensor Adapter or the MA2497A HP Sensor Adapter are used, the input frequency should be set to 50 MHz irrespective of the measurement frequency. Linearity correction factors are not applied when the adapters are being used.

NOTE

You will see a live update of the Current Cal Factor only if that sensor is being used on a channel. For example: If you are editing the Cal Factor Frequency on Sensor B, but you only have channel 1 set to A and channel 2 off, you will not see the "Current Cal Factor" being updated.

NOTE

User defined Cal Factor tables are available for applications where user-supplied calibration points are required. Additional cal factor frequencies can be entered in a user table and used in conjunction with the factory table.

For greater accuracy, calibration factors are interpolated for settings that are between the calibration factor data provided in the sensor EEPROM. For example, if calibration factors exist for 1 and 2 GHz, then the calibration factor applied for 1.5 GHz will be a value midway between the two.

Sensor linearity adjustments for temperature are also interpolated; If the correction factor for 1.5 GHz at 25° C is 1 dB, and for 35° C is 1.1 dB, then at 30° C a value of 1.05 dB will be used.

Manual Set

Allows manual correction of sensor data either as a percentage or a fixed dB value. An input frequency is also required to allow the correct linearity correction factors to be applied.

V/GHz

Most modern synthesized sources have a rear panel BNC connector which outputs a voltage proportional to the synthesized frequency. The V/GHz is supplied to the rear panel input connector of the ML2430A Series. The SETUP submenu has controls for customizing the voltage and frequency relationship.

FREQ
[CFFRQ]

When the Cal Factor source is set to Frequency or manual, enter the input signal frequency in GHz or MHz. The correct sensor calibration factor is automatically interpolated and applied to the displayed power reading.

USE TABLE
[CFUSEL
CFUTBL
CFUUSE
CFUVLD]

Defines which calibration factor table is to be used. Can be set to Factory, table number 1-10, or Factory + table number. The maximum number of tables available is displayed on the screen, and is never greater than 10. If a selected table has not been used before, the user will be prompted to CLEAR or PRESET the table, or cancel the selection. If a table is CLEARED, all entries are cleared except for a single entry of 100% @ 50 MHz. If a table is PRESET - the factory defined calibration factor table is copied into the specified user calibration factor table. The CLEARED or PRESET table is saved directly to the sensor. PRESET clears the ID string, while CLEAR leaves the ID string as currently set.

The number of tables available is defined by the frequency range of the sensor and the amount of factory calibration data stored.

Delete

Deletes the currently displayed table number.

NOTE

Whichever set, or sets, of cal factors are used, the linearity and temperature correction remains active at all times. Ensure the power meter is programmed with the frequency of the signal being measured.

Factory

Selects the Factory calibration factor table. Pressing Factory and the +/- key on the numeric keypad allows selection of a user-defined table in addition to the factory table. This allows full factory calibration to be active, and allows adjustments or corrections to be entered in the user-defined table. If user table 1 was selected, the menu would show 'Factory+1' and the Status box on the readout display would show a warning "*" sign on the Cal Factor line (bottom text line in the box) to show that non-standard calibration is being applied (CAL *F or CAL *V).

Enter

Confirms the selection.

%/dB
[CFUNITS]

Toggles the Current Cal factor display format from percentage to dB, and back.

EDIT
[CFUADD
CFUSAV
CFUCT
CFUPT
CFULD
CFURD
CFUID]

Edit any of the available user calibration factor tables in the sensor. Options available are CLEAR or PRESET the table, enter a new table identity string, change or delete existing frequency/cal factor data pairs, or enter new frequency/cal factor data pairs. All frequency/cal factor data pairs can have both frequency and calibration factor value modified, except for the data pair at 50 MHz, which can only have its cal factor value changed. All frequency/cal factor data pairs can be deleted, but there must always be one data pair remaining. If there is a data pair at 50 MHz, this will be the data pair that will remain.

The user must ensure that the maximum number of cal factor data pairs entered into a table is not exceeded. Sensors with a maximum frequency of up to 40 GHz will hold 90 pairs, while sensors with a maximum frequency of 50 GHz will hold 110 pairs.

Once all changes have been made, the SAVE soft key saves the changed data to the sensor. If any user cal factor data is changed and not saved, any attempt to exit the cal factor menu or select a new table will result in a prompt to discard or save the changes.

FACTOR
[CFCAL]

When the Cal Factor Source is set to Manual, the operator is expected to enter the calibration factor value in dB or % terms.

**CAL
ADJUST**
[CFADJ]

Sets a calibration factor to be used when performing a 0 dBm calibration and the calibration factor source is set to 'Manual.' This value is the only factor applied when performing a 0 dBm reference calibration. If the sensor calibration factor source is set to V/GHz or Frequency, the sensor internal EEPROM correction value at 50 MHz is used.

NOTE

Manual Cal Factor method only.

SETUP Sets up the Start and Stop frequencies and voltages when Source
[CVSTF is set to V/GHz. This tells the ML2430A how to determine the fre-
CVSPF quency of the swept signal based on the applied rear panel voltage.
CVSTV
CVSPV]

Averaging

Sensor data averaging. The available soft keys depend upon the operating mode selected.

In Readout and Power vs. Time modes, the following soft keys appear:

SENSOR Model ML2438A (dual channel) only. Select sensor A or B, in Power vs. Time or Readout modes.

MODE Select OFF, AUTO, MOVING or REPEAT, in Power vs. Time or
[AVG Readout modes.
AVGM]

NOTE

Automatic averaging also applies an algorithm to enhance settling at low power levels (e.g., signal sources).

AUTOMATIC averaging uses a MOVING type of average and increases the amount of averaging as the noise level increases. The display updates at approximately 100 ms intervals, however the data is available at the full rate. The display is slowed down to prevent jitter and allow the user to follow the update.

MOVING average allows the user to manually select the amount of averaging regardless of the signal level. The display is continually updated while averaging.

When selected, the following soft key becomes available:

NUMBER Sweep averaging number (1 to 512).
[AVG
AVGM]

NOTE

GPIB trigger commands automatically apply REPEAT averaging after TR2 commands to ensure 'old' samples are excluded from the measurement. However, the user should be aware that due to the high speed of the meter, other instruments in the ATE system may not be settled.

REPEAT averaging also allows the user to manually select the amount of averaging regardless of the signal level, however the display is updated only when the NUMBER of readings specified have been taken (1-512).

NOTE

Due to the nature of this method of operation, if the power level changes between updates, the display update will not reflect the true input power for one measurement only. When a channel is set to a ratio, e.g., A-B or A/B etc., the repeat method described above only operates if all sensors are set to the REPEAT mode.

**LOW
LEVEL**
[AVGLL]

Select OFF, LOW, MEDIUM, or HIGH, Low Level Averaging, in Power vs. Time or Readout modes. Sets the low level averaging window for the sensor. At resolution settings of 0.01 and 0.001 dB, digital readouts may flicker due to the high reading rate of the power meter. Low level averaging applies a low pass filter to post-average data readings to achieve a more stable front panel display without slowing down the response of the meter to larger changes in level. The three windows for LOW, MEDIUM and HIGH low level averaging are ± 0.01, 0.02, and 0.05 dB.

For example: When a LOW setting of low level averaging is applied while stepping from 0 dBm to -1 dBm, the meter displays the final reading within 0.01 dB with no delay. The final settling of 0.01 dB will settle over a short subsequent period of time, leading to a stable high resolution readout.

With a HIGH setting of low level averaging, the settling window is increased (up to approximately 0.05 dB) and the settling time is longer.

With low level averaging OFF, the meter displays the final reading instantly with no further settling observed. Any jitter due to noise is reflected in the displayed reading, which may be inconvenient for high resolution readings.

In Profile and Source sweep modes, the following soft keys appear:

STATE
[GRSWS]

Graph averaging state, ON or OFF. When set to ON, the following additional soft keys appear:

A NUMBER [GRSWP]

B NUMBER (ML2438A only) [GRSWP]

Sweep averaging number (1 to 512).

RESET

Sweep average reset. If the graph sweep averaging state is ON, this key resets the data points and restarts the sweep to sweep mode.

CURSOR
[GRSWR]

Between cursor averaging ON or OFF. When ON, a digital readout of the average power between the two cursors is displayed in the readout area of the PROFILE display.

Offset

Allows an offset, in dB, to be applied to sensor data for the selected sensor.

SENSOR

Model ML2438A (dual channel) only. Used to select the sensor to be configured. Toggles between Channel A and Channel B for all submenu functions.

TYPE
[OFFTYP]

Selects the type of offset to be applied:

Off

No offset applied.

Fixed

A fixed dB offset VALUE is applied to the sensor data.

Table

The tables are a set of frequency-against-dB offsets. The offset value used from the table depends on the setting of the frequency correction source. If the source is FREQUENCY, the entered frequency is used to calculate the offset from the table. If the frequency correction source is V/GHz, the frequency value calculated from the supplied ramp input is used to calculate the offset from the table.

If the frequency does not match any frequency in the table, interpolation is used to calculate the correct offset.

NOTE

Use Fixed or Table to compensate for a fixed attenuator on a sensor for measuring higher power levels. A better method is to apply a Fixed cal factor in the User tables as this is then taken into account in the Zero/Cal process.

NOTE

If the frequency is greater than the maximum frequency in the table, the offset value from the maximum table frequency is used. If the frequency is less than the minimum frequency in the table, the offset from the minimum table frequency is used.

VALUE
[OFFFIX
OFFVAL]

Enter the offset value (dB) when Offset TYPE is set to Fixed. Valid range is -99.99 to +99.99.

TABLE
[OFFTBL
OFFTBR
OFFTBU
OFFVAL]

Select the offset table number (1-5) when Offset TYPE is set to Table. When a table is selected, additional soft keys become available:

EDIT

This will bring up all of the selected offset table's entries, with their associated frequencies and offsets. Select an entry and enter the frequency and offset using the keypad.

CLEAR [OFFCLR]

When an offset table is selected, CLEAR will set all of the table's elements to zero.

Duty cycle

Applies a duty cycle to the selected sensor. An offset will be applied based on the entered value.

SENSOR

Model ML2438A (dual channel) only. Used to select the sensor to be configured. Toggles between sensor A and sensor B for all sub-menu functions.

STATE
[DUTYS]

ON or OFF

DUTY
[DUTYS]

Delete, Enter, or Cancel. An offset will be applied based on the entered value. For example, specifying a duty cycle of 50% will alter the displayed readings by approximately +3.01 dB.

Rng Hold
[RGH]

This function will toggle the sensor between holding the present operating range and Auto Ranging. Auto Ranging automatically selects the best range to take the measurement.

NOTE

Rng Hold is not available when System|Setup|mode is set to Source Sweep. In this mode, AUTO ranging is

If either sensor is auto ranging, this key will force both sensors to hold their present operating ranges. If either sensor is held within an operation range, this key will force both sensors to Auto Range.

4-5 CHANNEL MENU

The Channel menu controls the operation of a display channel. There are two display channels, Channel 1 and Channel 2. Channel 1 appears at the top of the readout display and channel 2 at the bottom. If a channel input configuration is turned off, the remaining channel appears in the center of the screen.

NOTE

When editing an entry in a menu, pressing the CLR key clears the digits. If in a menu screen, pressing the CLR key returns to the previous menu level.

The Channel submenus are as follows:

Setup

The setup menu allows the user to set up the configuration of the display channels. The setup parameters are:

- CHANNEL** Selects the channel to be configured. Toggles between Channel 1 and Channel 2.
- INPUT**
[CHCFG] This is the sensor, combination of sensors, or rear panel BNC input that is used to calculate the measured and processed value for this channel. For the Model ML2437A (single input) power meter, the available options are A, External Volts, or OFF. For the ML2438A (dual input) power meter, the options are A, B, A – B, B – A, A/B, B/A, External Volts, or OFF.
- UNITS**
[CHUNIT] The units can be dB(m), Watts, dB μ V, or dBmV. If the External Volts input is selected, the units are fixed to Volts.
- RESOLUTION**
[CHRES] The number of decimal places in which the results are displayed in Readout mode, with certain limitations. If the units selected are in Watts or Volts, and the value goes down to pW or μ V, the number of decimal places is forced to zero. If the number to be displayed is too large for the number of decimal places selected, the decimal places displayed will be reduced.
- MIN/MAX**
[MNMXS
GMNMX] This selection turns on the Min/Max Tracking for the display channel selected. On the top line of the data display, when not in menu mode, the min and max of the channel data (after combination and unit conversion calculations) is displayed. The left hand set of data is for display channel 1 and the right hand set for display channel 2.

NOTE

Use MIN/MAX to track variations in a measurement over time, or while adjusting external devices or tuning over frequency.

In Profile mode, the Min/Max is between cursors only, as controlled by selecting SINGLE or INFINITE through the System|Graphics|TRACKING menu. SINGLE (default) is the most useful as it provides a continuously updated readout of the Min/Max points within the cursor window. The INFINITE setting is used when the results needs to be collated over a large number of samples.

- RESET** [MMRST] This function resets the Min/Max (when ON) for the channel selected.
- Rel 1** [REL] After the relative power level is set by the operator, the Relative mode subtracts that value from the current measured power. If selected when in Relative mode, the relative operation for channel one is turned off.
- Pressing the Rel 1 soft key when in Readout mode will subtract the last used relative value. Hold down the key to retake this value. The readout will display 0.00 dBr. This relative value will be used thereafter until it is replaced by another one in the same manner. This allows the user to refer to a previously referenced value, without the meter resetting itself back to a 0.00 display.
- Rel 2** [REL] Relative mode control for Channel 2 is labeled Rel 2.
- Limits** Pressing the Limits menu soft key displays the test limits for the selected channel. This menu sets individual high and low pass/fail limits for the two display channels. These limits drive the PASS/FAIL display flags and the PASS/FAIL TTL output if selected.
- In Power vs. Time graphic mode and Readout digital mode, each fail of the limits produce a separate fail flag and fail beep (if ON) and also drive the rear panel BNC (if enabled) for each pass or fail reading. In PROFILE mode, each fail of the limits produce a fail beep (if ON) and hold the fail output if any point in a sweep fails. If FAIL indicator HOLD is ON, both the screen FAIL indicator and the BNC output are held in the fail state whenever the limits specified for the channel have been exceeded, regardless of whether the reading subsequently goes into pass or not. This state remains until FAIL indicator HOLD is turned OFF.
- CHANNEL** The limits are set for the selected display channel unit type. The display channel units selected when the limit was originally set or turned on become the limit units. If the display channel units are changed, and the limits not altered, limit checking is turned off for that channel. If the display channel units are subsequently returned to the same units selected when the limit was entered or turned on, limit checking is turned on again.
- Whenever the limit units are active, limit checking is applied as follows: If the channel value is greater than the high limit, and the high limit is turned ON, a FAIL is indicated. If the channel value is below the low limit, and the low limit is ON, a FAIL is indicated. Otherwise, if any limit is ON and a FAIL is not detected, PASS is indicated.
- HIGH Limit** [HLIM] Sets the high limit. It is not necessary to enter the units as the limit value is checked against the displayed value. Therefore, if the limits

NOTE

In Profile mode, the limit value is only checked against dB values as Profile mode only works in dB.

have been set for -10 dBm and the display units are subsequently changed from dBm to Watts, the system still checks for the reading to rise above -10, even though the display units type has been changed. Enter a value from:

Units	Min	Max
dBm	-99.99	+99.99
dBmV	-53.00	147.00
dB μ V	7.00	207.00
Watts	0.0	50.0

Setting a limit value automatically turns on the limit state, except when done via GPIB.

LOW Limit
[LLIM] Sets the low limit. It is not necessary to enter the units as the limit value is checked against the displayed value.

HIGH State
[HLIMS] Select ON or OFF to enable or disable high limit checking.

LOW State
[LLIMS] Select ON or OFF to enable or disable low limit checking.

FAIL HOLD
[FHOLD] If FAIL HOLD is ON, both the screen FAIL indicator and the BNC output are held in the fail state whenever the limits specified for the channel have been exceeded, regardless of whether the reading subsequently goes into pass or not. This state remains until FAIL HOLD is turned OFF.

BEEP
[FBEEP] If BEEP is ON, and FAIL HOLD is OFF, whenever the limits specified for the channel have been exceeded, a single beep sounds.

If fail BEEP is ON and FAIL HOLD is ON, whenever the limits specified for the channel have been exceeded, a beep will sound once every second until FAIL HOLD is turned OFF, or the CLEAR key (CLR) is pressed.

The FAIL indication is not affected by the CLEAR key, and can only be cleared by turning FAIL HOLD off. If a limit fail happens again, the alarm will sound again.

4-6 TRIGGER MENU

The Trigger function in the ML2430A allows the user to define under what conditions measurements are taken, and the time period they are taken over. For instance, the READOUT mode can be configured to display the average power of the ON period of a square wave, or an individual slot in a GSM burst.

The Trigger menus are always available in PROFILE operation mode, as selected from the System menu. If PROFILE cannot be selected within the System|Setup submenu, change the GPIB mode to ML24XX in the System|Rear Panel submenu.

In READOUT or POWER vs. TIME modes, the trigger setup menus are available if the channel input configuration SENSOR|Setup|MODE is set to CUSTOM. A display channel using more than one sensor (A–B for example) where either sensor is in CUSTOM mode, is assumed to be in custom mode and can use triggering. Trigger setup is available only for the display channels that meet the above criteria.

In PROFILE mode, the display shows an 'x' marking the trigger point plus the display trigger delay time, updated for each new set of data. This trigger point mark rotates as the profile data is updated, changing between 'x' and '+' on each data update. On rapid updates, the trigger point mark may appear like a star (*), as it is rotating so quickly. In manual, external or GPIB triggered displays, the mark rotates at a slower rate and each true data update can be seen.

This point can be moved across the x axis by the pre trigger percentage. If the trigger source is either default, mod average or custom continuous, the trigger point has no meaning since the system is continuously triggering. The mark does not appear in the Power vs. Time or Source Sweep modes, as it is not applicable.

Trigger icons indicate the type of triggering selected and appear level with the related channel on the far left of the screen. Trigger icons are not displayed if the system is in Profile, Power vs. Time, or Source Sweep operation modes, if all sensors used in a channel input configuration are in the DEFAULT measurement mode, or if the peakmeter is displayed.

NOTE

When editing an entry in a menu, pressing the CLR key clears the digits. If in a menu screen, pressing the CLR key returns to the previous menu level.

The trigger icons appear as shown in Figure 4-2.

NOTE
External trigger is only effective at 800 KHz or lower.

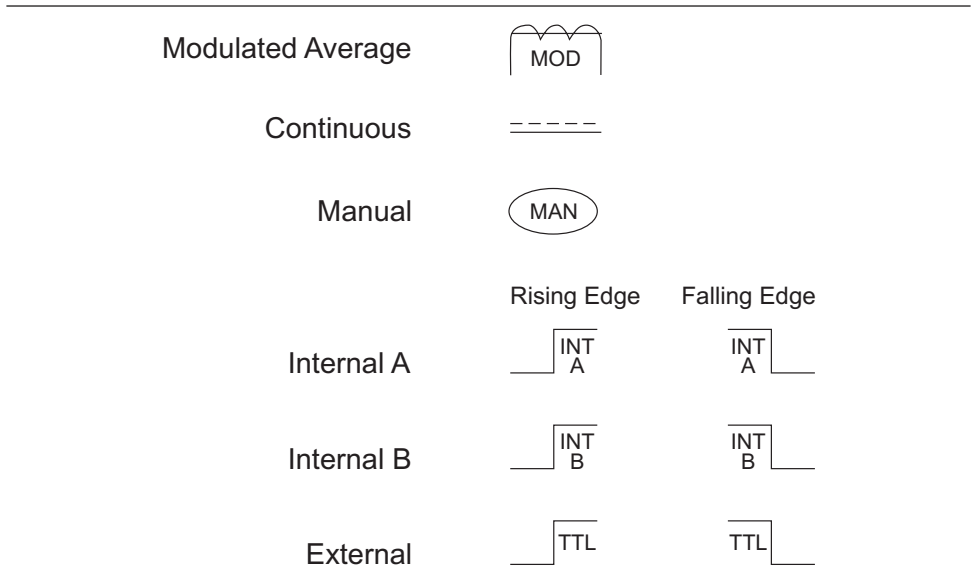

Figure 4-2. Trigger Icons

Only when a channel input configuration includes a sensor with a measurement mode that requires an icon, will an icon be displayed.

Setup

This menu is used to set up the trigger conditions for the display channels. In readout display mode with sensor mode set to custom, the trigger can be set to display channel 1 and 2 separately, or together as channel 1 & 2.

The channels are triggered simultaneously if the trigger conditions are set to 1 & 2. This guarantees the trigger conditions are the same, and therefore the readings are taken at the same time. In Readout and Power vs. Time modes, if the menu is exited with the trigger selection at channel 1 & 2, this setup is used for trigger control. Otherwise, if the trigger setup display is left with channel 1 or channel 2 displayed, the individual trigger settings are used for trigger control.

NOTE
Simultaneous trigger channels guarantee identical sampling for both channels, essential for accurate ratio (A/B) measurements.

CHANNEL [TRGMODE] Select display channel 1 or 2 (or 1&2 when setting trigger conditions in Readout or Power vs. Time modes).

SOURCE [TRGSRC GTSRC] The trigger sources are CONTINUOUS, Internal A, Internal B (ML2438A only), EXTTTL, or MANUAL . When the trigger source is set to INT A or INT B (Internal A or B) the power meter triggers on a rising or falling power level on the associated sensor. See LEVEL for the setting of the trigger power level.

DELAY
[TRGDLY
GTDLY]

In Profile mode, DELAY sets the time delay (after the display trigger delay) to when the system starts to take and display readings, represented by the left most cursor. Enter 0.0 to 1.0 seconds, in ms or μ S.

NOTE

Changing the left most cursor, or the trigger delay time, updates the cursor or the delay time value accordingly. In Profile mode, moving the cursor only allows updates to the pixel resolution of the display. In Power vs. Time mode, the delay and width can be used to alter the update rate.

In Readout mode (CUSTOM sensor mode), the value entered for DELAY is applied after a trigger event, and before samples are taken. Enter 0.0 to 1.0 seconds, in ms or μ s.

WIDTH
[TRGGW
GTGW]

Enter 100 ns to 7.0 seconds (the default is 20 ms). In Profile mode, WIDTH is the gate time the system uses to perform a cursor average measurement. The time interval is represented by the space between the left most cursor and the right most cursor. Changing either cursor, or the gate width value, updates both the cursors and the gate width value.

In Readout mode, this value defines the measurement gate width. A measurement is presented as the average of all data taken in this gate width.

In Power vs. Time mode, the delay and width can be used to alter the update rate or sample rate.

EDGE
[TRGX TTL
GTXTTL]

When set to External TTL, the power meter triggers on a TTL level rising or falling. This selection sets the trigger for either a rising or falling edge.

ARMING
[TRGARM
GTARM]

Sets the trigger arming, unless the trigger source is set to EXTTTL. When ARMING is set to Blanking ON, only samples taken when the rear panel Digital Input BNC is active will be averaged in the measurement. The polarity of the rear panel Digital Input BNC signal can be set (high or low) using the System|Rear Panel|BNC|TTL LEVEL menu setting.

When ARMING is set to Blanking OFF, all samples are read irrespective of the level on this BNC.

Figure 4-3 shows a typical arming diagram.

NOTE

The averaging function averages a number of gate WIDTHS, so for a given averaging number, larger WIDTHS will take longer to AVERAGE. Narrower widths will average faster (but may yield a less-settled measurement).

NOTE

Use Arming to synchronize to other equipment or modulation/burst synchronization. This is a simple way to inhibit measurements during user-defined periods without entering actual time periods.

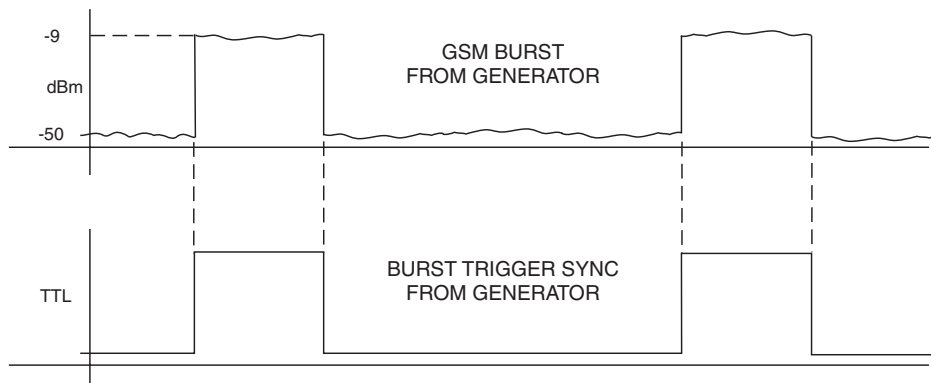

Figure 4-3. Typical Arming Diagram

1. Connect to the rear panel digital input.
2. Select Trigger|Setup|ARMING|Blanking ON.
3. Set the polarity of the blanking (System menu)

Example power meter reading: -9.16 dBm.

TYPE
[TRGTYP
GTTYP]

The Type selection (RISE or FALL) sets the trigger for a rising or falling edge. When the trigger source is set to INTA or INTB (Internal A or B) the power meter triggers on a power level which is rising or falling.

LEVEL
[TRGLVL
GTLVL]

The Level selection sets the internal trigger level. When the trigger source is set to either INTA or INTB (internal sensor A or B) the channel triggers on a power level (in dBm) given by the sensor. This value must not take any cal factors or offsets that the meter applies into account.

NOTE

Effective range is to approximately -30 dBm and is only active in DC ranges 1 and 2.

Trig 1

If Trigger Channel 1 SOURCE is set to Manual, this softkey initiates a measurement for channel 1.

Trig 2

If Trigger Channel 2 SOURCE is set to Manual, this softkey initiates a measurement for channel 2.

Trig 1&2

If Trigger Channels 1 and 2 SOURCE are set to Manual, this softkey triggers both channels simultaneously.

Figure 4-4 shows a typical trigger timing diagram. Note that the display trigger delay is only present when in Profile operation mode, and helps in setting the 'window' position along the signal.

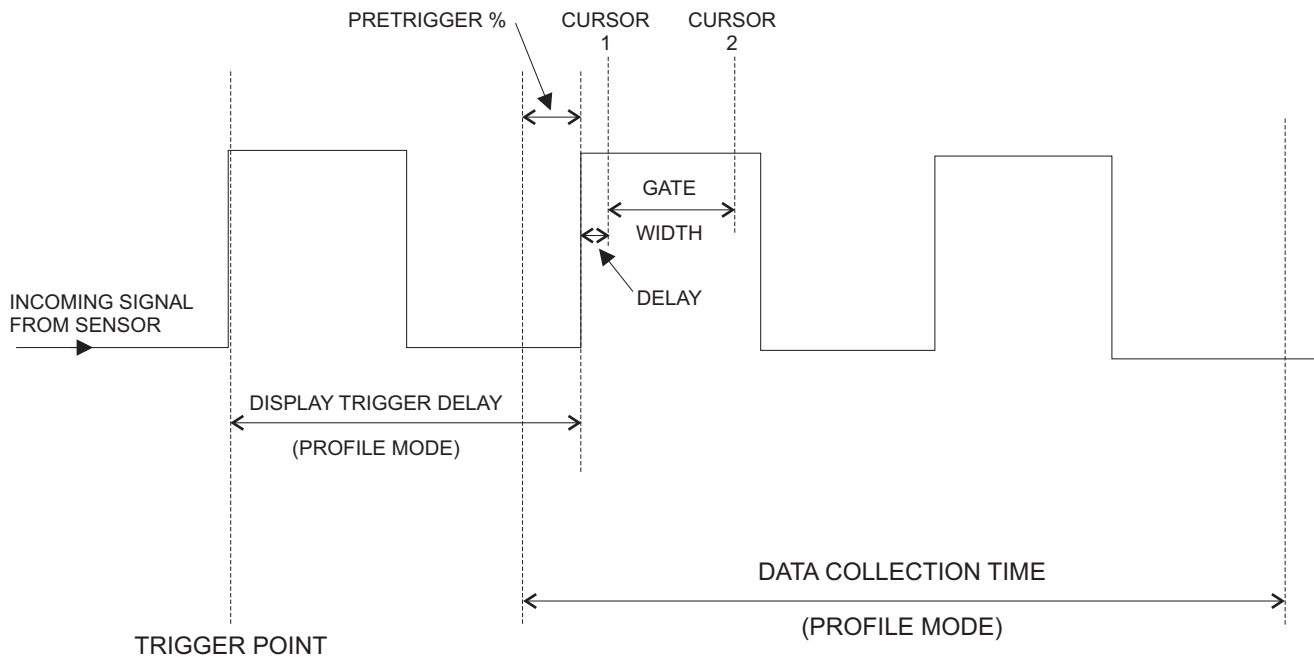

Figure 4-4. Sample Trigger in Graphic Mode

The Data Collection Time (collection period) is only present when in Profile operation mode (System|Profile|PERIOD), and is the period of time displayed on the profile graph.

The Gate Width is the section of the signal in which the measurements are performed. In Profile mode, this is the time between Cursor 1 and Cursor 2 and is used to provide the Between Cursor Average measurement.

Display Trigger Delay (System|Profile|DELAY) is the delay after the trigger point.

The Pretrigger % (System|Graphics|PRE TRG%) is only used in the Profile mode, and shows a percentage of the data collection time as Pretrigger information. If the display trigger delay is less than the pretrigger delay period, there will be no Pretrigger information as it will be before the trigger point itself.

Setting the display trigger delay to the length of the data pulse causes a trigger on the first pulse, but displays the second pulse with valid "pretrigger information." This is the best method for repetitive signals and can be used to verify signal repetition intervals.

NOTE

External trigger is only effective at 800 KHz or lower.

4-7 SYSTEM MENU

The System menus control the operating modes, display visibility, sound, rear panel functions, and battery state of the ML2430A Series Power Meter. Note that the soft keys will appear differently depending upon the operation mode selected with the Setup soft key below.

NOTE

When editing an entry in a menu, pressing the CLR key clears the digits. If in a menu screen, pressing the CLR key returns to the previous menu level.

Setup

This menu selects the operation mode, allows system setups to be saved or recalled, and provides two options to reset the system parameters to the default setup.

NOTE

When using the ML2430A Series Power Meter with an MA2499A or MA2499B Sensor Adapter, only Readout and Power vs. Time modes are allowed.

MODE
[OPMD] Select between Readout, Power vs. Time, Source Sweep and Profile operation modes. If only Readout is available, check the System|Rear Panel|GPIB|Mode setting. This setting must be ML24XX for Profile, Power vs. Time and Source Sweep modes to be available.

SAVE
[*SAV
SYSLD
SYSRD
SYSLNM] Save the current instrument setup in one of 10 memory locations.

RECALL
[*RCL
SYSLD
SYSRD
SYSLNM] Recall a saved instrument setup from one of 10 memory locations.

LINK
[LINK] There are two trigger conditions saved; one for Profile mode and one for Readout mode. Normally, Profile mode trigger conditions can be changed without affecting the trigger conditions used in Readout mode. With LINK set to ON, the Profile mode trigger conditions are used for both Profile and Readout modes.

In Profile mode, the user can view what is being measured with the selected trigger conditions, but only over a limited dynamic range, as it only uses the two DC ranges of the signal channel. Profile mode measurement rate is also limited by sweep speed.

NOTE

With LINK set to ON, Readout mode is temporarily forced to Custom mode, and the default and Mod Average modes are inhibited. To use these modes, de-select LINK.

With LINK readout/profile trigger set to ON, switching to Readout mode uses the same trigger conditions, but allows the full dynamic range of the meter to be used, as well as providing full GPIB speed on data acquisition.

When moving between Readout and Profile modes, with LINK enabled, the value used for "sample delay" is modified using the "display trigger delay." In Readout mode, the "sample delay" and "display trigger delay" values are combined as "sample delay," whereas in Profile mode they are both available separately.

FAST

Fast recall of a saved instrument setup from one of the 10 memory locations. In FAST system recall mode, a single key press recalls a saved setup. A message across the lower area of the screen will prompt for keypad keys 1-9, or 0, to be pressed to recall setups 1-10 (if saved setup data is available in the selected location). The -exit- softkey or any other menu key will exit fast recall mode.

PRESET

Resets the system parameters to the default setup (see Appendix A, Section A-3).

RESET [*RST]

This selection will reset the system setup. The offset tables and the GPIB interface will not be affected.

FACTORY [FRST]

This selection will reset the system setup, including the offset tables and GPIB interface.

Profile

This soft key becomes available when the System|Setup|MODE is set to Profile. Profile operation mode includes the following display controls:

CHANNEL
[GRMD]

Select Channel 1 or Channel 2. The channel selected will be displayed on the left of the screen, above the middle value of the y axis and is used for all Profile data displays.

PERIOD
[GRPRD]

Sets the time period over which the system collects data and scales the data into the profile graph after a trigger event. Enter the data collection period in ms or μ s. See System|Graphics|Pretrig % to move the t=0 (trigger event position) of the displayed waveform.

DELAY
[DTRGD]

Specifies the period of time after a trigger event to delay the start of the display window. For the trigger to line up with the marked trigger point on repetitive waveforms, the delay period should be either zero, or set to integer multiples of 1/PRF (Pulse Repetition Frequency). Enter the delay period in ms or μ s.

NOTE

PERIOD sets the x-axis time.

NOTE

This is Display Trigger Delay in Figure 4-4.

NOTE

Useful for tracking peak levels over a period of time, or detecting glitches.

DATA HOLD [GRPIX] This selects how the graph is displayed on the screen. Select from NORMAL, Min&Max, Min, or Max.

NOTE

If either Min&Max, Min, or Max is selected, the display will keep the "old" data and may appear stationary. The DATA HOLD mode in use is displayed on the left of the screen, below the middle value of the y axis.

With Min & Max selected, the minimum and maximum points for each sample are shown. If Connect Points is ON (default) (SYSTEM|Graphics|CONNECT), a vertical bar is drawn between these points. See CLEAR, under CONTROL to restart the process.

Min displays only the minimum for this sample position until reset by returning to NORMAL.

Max displays only the maximum for this sample position until reset by returning to NORMAL.

Power vs. Time

This soft key becomes available when the System|Setup|MODE is set to Power vs. Time mode. Power vs. Time mode displays measurements in a chart-like format showing history over a period of time. The measurements displayed are taken under the conditions of the Readout mode, and can therefore include all triggering and correction settings set up in that mode.

Power vs. Time operation mode includes the following display control:

CHANNEL [GRMD] Select Channel 1 or Channel 2. The channel selected will be displayed on the left of the screen, above the middle value of the y axis.

DATA HOLD [GRPIX] Selects how the graph is displayed on the screen. Select from NORMAL, AVG, Min&Max, Min, or Max.

TIME [GRDDT] Sets the data hold time, from 1 minute to 24 hours.

Source sweep

This soft key becomes available when the System|Setup|MODE is set to Source Sweep. The Source Sweep mode provides interconnection between a signal source/generator and the power meter. Using simple techniques, this can provide swept power-accurate measurements over any frequency range at very high speed. The sweep data is available over GPIB and can provide a simple low cost scalar analyzer function.

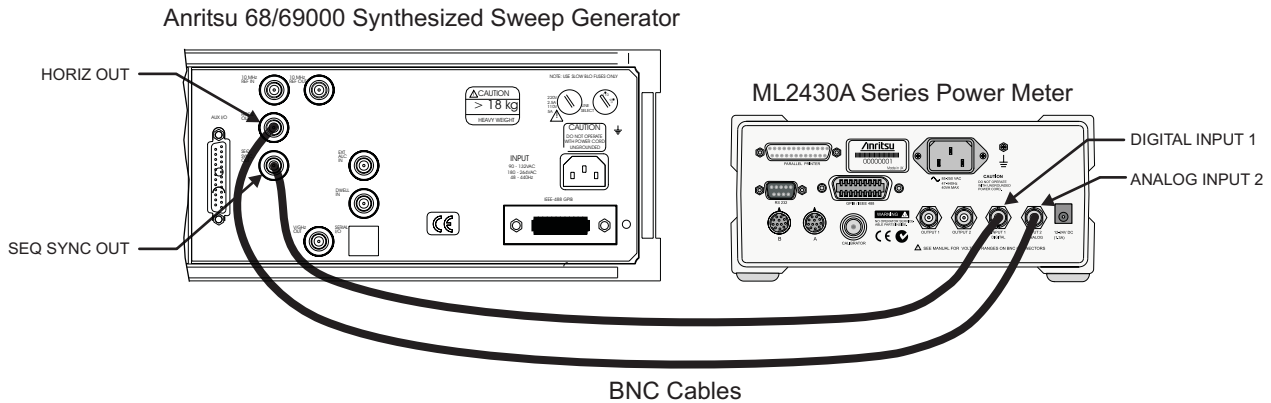

Figure 4-5. Source Sweep Mode Interconnection Example

If the source used does not provide a blanking output, the blanking signal may be disabled as follows: select System|Rear Panel|BNC. Select PORT until INPUT 1 (digital) is selected, then select TTL Level to alter the active state of the blanking signal expected. Setting the TTL Level to LOW will allow the Source sweep to progress without a Blanking signal. This is useful for third party sources or simple VTO systems. If a Source Sweep is later selected which does provide a blanking signal, remember to restore the polarity of this signal to HIGH or an incorrect display will result. Operating a source sweep which has BANDSWITCH blanking delays in it without an appropriate blanking signal may lead to glitches in the resulting measurement at the bandswitch points (simple VTO systems do not usually have bandswitch points).

Source sweep operation mode includes the following display controls:

CHANNEL [GRMD] Select Channel 1 or Channel 2. The channel selected will be displayed on the left of the screen, above the middle value of the y axis.

DATA HOLD [GRPIX] This selects how the graph is displayed on the screen. Select from NORMAL, Min&Max, Min, or Max.

MODE [SRCMOD] Source sweep mode: FREQUENCY or POWER.

START [SRCSTFRQ SRCSTPWR] Sweep start frequency (MHz or GHz) or power (dBm)

NOTE

If either Min&Max, Min, or Max is selected, the display will keep the “old” data and may appear stationary. The DATA HOLD mode in use is displayed on the left of the screen, below the middle value of the y axis.

With Min & Max selected, the minimum and maximum points for each sample are shown. If Connect Points is ON (SYSTEM|Graphics|CONNECT), a vertical bar is drawn between these points. Min displays only the minimum for this sample. Max displays only the maximum for this sample.

STOP Sweep stop frequency (MHz or GHz) or power (dBm)
 [SRCSPFRQ
 SRCSPWR]

NOTE

When the power meter is communicating with a signal source/generator over the serial interface, if the source frequency power level or the frequency itself is changed, the source sweep display will be updated where appropriate.

Control The Control menu adjusts cursor position and toggles the readout display in Profile, Power vs. Time and Source Sweep modes, and provides control over display scaling.

SWAP SWAP selects which cursor to move. The presently selected cursor is defined by a triangular marker at the top of the cursor line. Press the << soft key to move the selected cursor left, and the >> soft key to move the selected cursor right. Trigger delay and Gate Width are related to the cursor positions. This feature aids in measurement of pulsed signals. Changing either cursor, or adjusting the Gate width value, updates both the cursors and the gate width value.

When enabled through the System|Sound|CURSOR menu selection, if a cursor is moved into an illegal space such as the edge of the screen or the end of valid data (trigger point on the left of the screen) a warning beep will sound.

SCALE Adjust the Y-axis of the graph using TOP dB Value and BOTTOM dB Value parameters in the SCALE submenu. AUTO scale is based on the min and max of the previous sweep.

READOUT The supplemental data readout is displayed or removed with the READOUT soft key. The readout provides display data depending on the graph mode and the data hold type selected, as shown below.

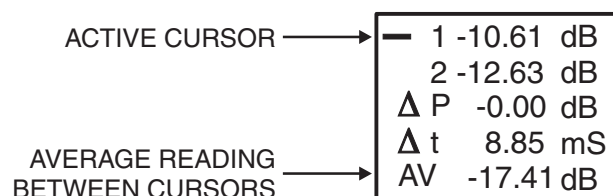

Figure 4-6. Sample Readout Display, Profile Mode, Data Hold = NORMAL

Profile Mode

Data hold = NORMAL:

- 1 cursor 1 reading
- 2 cursor 2 reading
- ΔP Power difference between cursor 1 and cursor 2
- Δt Time difference between cursor 1 and cursor 2
- AV Between cursor average if ON
- Data hold = MIN (or MAX) :**
- 1 cursor 1 minimum reading, or maximum if MAX mode
- 2 cursor 2 minimum reading, or maximum if MAX mode
- ΔP Power diff between cursor 1 and cursor 2 minimums
(or maximums if MAX mode)
- Δt Time difference between cursor 1 and cursor 2 minimums
(or maximums if MAX mode)
- Data hold = MIN&MAX:**
- 1 cursor 1 MIN reading
cursor 1 MAX reading
- 2 cursor 2 MIN reading
cursor 2 MAX reading
- Δt Time difference between cursor 1 and cursor 2

Power vs. Time Mode

- Data hold = NORMAL or AVERAGE:**
- 1 cursor 1 reading
- 2 cursor 2 reading
- ΔP Power difference between cursor 1 and cursor 2
- T1 Time at cursor 1
- T2 Time at cursor 2
- Data hold = MIN (or MAX) :**
- 1 cursor 1 minimum reading, or maximum if MAX mode
- 2 cursor 2 minimum reading, or maximum if MAX mode
- ΔP Power diff between cursor 1 and cursor 2 minimums
(or maximums if MAX mode)
- T1 Time at cursor 1
- T2 Time at cursor 2
- Data hold = MIN&MAX:**
- 1 cursor 1 MIN reading
cursor 1 MAX reading
- 2 cursor 2 MIN reading
cursor 2 MAX reading
- Δt Time difference between cursor 1 and cursor 2

Source Sweep mode

- Data hold = NORMAL or AVERAGE:**
- 1 cursor 1 reading

- 2 cursor 2 reading
- ΔP Power difference between cursor 1 and cursor 2
- X1 X axis at cursor 1
- X2 X axis at cursor 2

Data hold = MIN (or MAX) :

- 1 cursor 1 minimum reading, or maximum if MAX mode
- 2 cursor 2 minimum reading, or maximum if MAX mode
- ΔP Power diff between cursor 1 and cursor 2 minimums (or maximums if MAX mode)
- X1 X axis at cursor 1
- X2 X axis at cursor 2

Data hold = MIN&MAX:

- 1 cursor 1 MIN reading
cursor 1 MAX reading
- 2 cursor 2 MIN reading
cursor 2 MAX reading

CLEAR [GPRST] Available in Profile, Source Sweep and Power vs. Time modes when the DATA HOLD representation selection is not set to NORMAL (or AVERAGE for Power vs. Time). Pressing the CLEAR key restarts the min/max collection.

LINK CURSOR [CURLK] Links the screen cursors in Profile and Power vs. Time modes so that when one is moved, both are moved. When the cursors are linked, a horizontal bar is drawn between them on the screen. If one cursor is moved, the other cursor moves with it to maintain their relative positions and time interval between them. When the cursors are linked, the relative time positions are altered by adjusting the gate width in the TRIGGER|SETUP|WIDTH submenu.

HOLD [HOLD] In Profile, Power vs. Time, and Source Sweep modes the graph HOLD function allows a graph to be held and printed. The key action is a toggle action, with the warning message Graph Display HELD displayed at the top of the screen when HOLD is active. Whenever measurement setup parameters are changed, graph hold will automatically be released.

AUTO scale [GRAUTO] Auto scale for all graphic modes (Profile, Source Sweep and Power vs. Time). In Profile and Source Sweep modes, auto scale will be based on the min and max of the previous profile or sweep.

Display Controls the characteristics of the LCD display.

BACKLIGHT [DBLGHT] Controls the LCD backlight during internal battery operation. Can be ON, OFF, or timed to go off after a specified period to save battery life. The backlight is always on during AC or external DC power operation.

Contrast DOWN [DCONTD DCONT]	Reduces the display contrast. Adjust to suit ambient conditions.
Contrast UP [DCONTU DCONT]	Increases the display contrast. Adjust to suit ambient conditions.
TIMED [DBLTIM]	Sets the time limit when the backlight will turn off if the BACKLIGHT setting is set to TIMED. Enter a value from 0.0 to 100.0 minutes.
PEAKMETER [DPEAK]	Turns on the peakmeter display for Sensor A, Sensor B, or both Sensors A and B. The peakmeter display will eclipse any trigger icons. The peak meter display range covers 12 dB. When above the displayed maximum or below the displayed minimum, the range is switched by 10 dB in the appropriate direction. Note that in the event that the channel is displaying an alternative measurement (for example, external volts from the rear panel BNC) the peak meter will continue to represent the Sensor A and/or B data. This is useful for monitoring an external voltage on the meter, while peaking up a response being monitored by a sensor, such as RF output.
FREQ [FROFF]	Turns FREQUENCY offset display ON or OFF. When ON, a continuous indication of the frequency (used for Cal Factor) is displayed in small text at the top of the display along with any sensor offset (if applied).
TEXT [TEXT TEXTS]	GPIB user TEXT display ON or OFF. When ON, a user-defined text string can be displayed at the top of the display area. The text string can only be defined over the GPIB.
Sound	Controls system sounds.
KEY [KEYCK]	Turns the audible key click on or off.
EDIT [ENTERR]	Turns the audible edit error tone on or off.
LIMIT 1 [FBEEP]	Limit Fail beep on channel 1 on or off.
LIMIT 2 [FBEEP]	Limit Fail beep on channel 2 on or off.
CURSOR	CURSOR out of screen beep. If a cursor is moved into an illegal space, such as the edge of the screen or the end of valid data, a warning beep is sounded.

Print This selection prints the screen and various operational settings through the rear
[PRINT] panel printer port.

```

ANRITSU Power Meter ML2437A s/n: 97180010

Firmware: 2.02

Sensor A: NOT FITTED

Sensor Measurement Setup
Measurement mode           A: Default
Cal factor                 Frequency (50.00MHz)
Averaging mode & number    Auto
Low level averaging        Low
Offset type & value        Off
Settle % per reading       0.10%
Range hold                 Off
Sensor zeroed              No

Measurement Channel Setup
Trigger source             1: (A)                2: OFF
Trigger sample delay       1.00ms
Trigger gate width         20.00ms
Trigger arm                 Blanking OFF

High limit                 Off
Low limit                  Off
Limits test                Off

Readout                    1:
Measured value             -----
    
```

Figure 4-7. Sample ML2430A Series Printout

Battery Controls battery setup when the optional battery pack is installed.

AUTO Enables or disables the automatic power off feature. Automatic
[BAUTS] power off can be used to conserve battery power when operating from the internal battery.

TIME When operating from the internal battery, Time sets the number of
[BAUTT] minutes that the instrument will run before powering off in absence of any key activity. Enter a value of 10 to 240 minutes.

STATUS Displays the installed battery type, remaining capacity (%), esti-
 mated operating time remaining (minutes), and the battery's full charge capacity (mAh).

NOTE

Immediately after power-on, the “estimated operating time remaining” displayed may not be genuine, as the battery requires a few minutes to calculate the present rate of discharge. An accurate indication will be displayed only after a few minutes of continuous operation.

CHARGE

Available only when the instrument is being powered by AC line power or external DC power greater than 21 volts. This selection starts the battery charging cycle. Note that the instrument will shut down during the charging cycle, and restart automatically when the charging is completed. A series of 10 beeps signals completion of the charge cycle.

Rear Panel

Controls for rear panel connections are located in the Rear Panel submenu.

GPIB

Sets the GPIB address and emulation modes.

ADDRESS [ADDR]

Set the GPIB address for the power meter. The default is 13.

MODE [EMUL]

Selects the power meter emulation mode. Select from ML24XX (native), HP 436A, HP 437B, HP 438A, or ML4803A modes.

BUFFER [BUFF]

If BUFFER Enabled is TRUE (default): In the ML243X native mode, 488.2 GPIB operation, when a request for data is made the response is put in an output buffer ready to be read by the controller. If another data request is made and the previous data has not been read out of the output buffer; the new data is queued after the original request. In this mode of operation the GPIB response buffering enable is TRUE, and following the 488.2 specifications, the response should be read when ever a request for data is made.

If BUFFER Enabled is FALSE: In this mode when ever a request for data is made, (except by serial poll) the output buffer is cleared and the only data in the output queue will be the response to the last data request made. The output buffer is cleared once a valid GPIB data request command has been recognized.

NOTE

BUFFER Enabled TRUE is the default. Use FALSE when programming simple command sequences to read data, and you do not want to bother with decoding status or keeping track of multiple results or readings.

RS232

Sets the serial communication parameters.

MODE [RSMODE]

Selects External Communication or Source IF. External Communication allows GPIB type commands to be sent to the power meter over the serial interface from a local computer or a remote computer via a modem.

NOTE

For the power meter to communicate with Anritsu 68/69000-series synthesizers using Source IF, the synthesizer firmware must be later than the levels shown for the various models below:

Model - firmware level

680xxB - 3.39

681xxB - 3.44

682xxB - 2.41

683xxB - 2.50

680x5B - 1.26

681x5B - 1.32

682x5B - 1.30

683x5B - 1.34

690xxA - 1.21

691xxA - 1.26

692xxA - 1.26

693xxA - 1.35

690x5A - 1.21

691x5A - 1.24

692x5A - 1.24

693x5A - 1.31

Contact your nearest Anritsu Service Center for a firmware upgrade if necessary.

Source IF allows the power meter to communicate with an Anritsu 68/69000-series synthesizer when the operation mode is set to Source Sweep.

BAUD [RSBAUD]

Sets the serial port BAUD rate. Select from 1200, 2400, 4800, 9600 (default), 19200, or 38400. The other RS232 serial parameters are fixed at 8 bits, 1 stop bit, and no parity.

MODEM

This menu controls how a modem will react when the power meter attempts to connect to a remote computer. It allows entry of a PHONE number, redial COUNT and redial DELAY, and permits INITialisation of a connected modem.

PHONE number [MODPH] – The phone number can be up to 40 digits. When the number is being dialed, a dot (.) will be interpreted as a 2-second delay in the dialing sequence; a minus sign (–) will be interpreted as wait for another dialing tone.

Redial COUNT [MODRED] – If the dialed number does not connect, because it was not answered or was engaged, then the power meter will try to redial the same number according to the count specified. This has a minimum value of 0, maximum value of 10 and default value of 5.

Redial DELAY [MODDEL] – If the dialed number does not connect, and is to be redialed, this value specifies the delay in minutes before redialing. This has a minimum value of 1 minute, maximum value of 10 minutes and a default value of 5 minutes.

INITialize Modem [MODINIT] – This is a single shot command to reinitialize a connected modem. As at power on, if this command is executed with a PC connected directly to the power meter, then a string of modem commands will be seen by the PC.

AUTO

Sets up the power meter to autodial if there is a LIMITS test failure, sensor RANGE error, or the instrument POWER is cycled.

LIMITS [MODLIM] – If this is set, and the limits fail, then the number specified in the “phone number” field will be dialed. Remote communications can then continue as normal.

RANGE [MODRNG] – If this is set, and there is a signal channel range error, then the number specified in the “phone number” field will be dialed. Remote communications can then continue as normal.

POWER [MODPWR] – If this is set, and the power cycles on the meter, then the number specified in the “phone number” field will be dialed. When a connection is established, an SRQ will be sent to the host PC. Remote communications can then continue as normal.

BNC Configures the input and output rear panel BNC connectors.
[OBMD, OBCH,
OBVST, OBVSP,
OBDST, OBDSP,
OBCH, OBPL,
OBACM, OBCH,
OBZL, IBBLP]

PORT

Output 1 or 2: Select the output port to configure (see MODE below).

Input 1: Select what type of Blanking input you are providing (see TTL LEVEL below) on Input 1.

Input 2: Selects input 2 for V/GHz or External volts input. You cannot configure the V/GHz or External volts input port here. To configure V/GHz set Sensor|CalFactor|Source to V/GHz. To use the External Volts Input set Channel|Setup|Input to EXT V.

MODE (output ports only)

OFF (output set to ground) port 1 or 2

Analog OUT (analog scaled output) port 1 or 2 provides an output voltage proportional to the measurement.

RF Blanking (output 2 only) provides a logic level output during the ZERO process. This can be used to switch off RF from external sources.

PASS/FAIL port 1 or 2 logic level output

Signal channel A or B (port 1 or port 2) provides a real time output from the signal channel. Being real time, it shows modulation, etc., and is taken after the signal has been through range amplifiers. It is not directly proportional to the measurement.

Leveling A or B (range 1 or 2) (port 1 or 2). This is similar to the signal channel A or B outputs, except it connects to range 1 or 2 only of the signal channel. See below for more information on leveling.

ACMod output (port 1 only) is a TTL signal synchronized to the internal chopper (when used) of the signal channel. This signal can be used for synchronization with external sources or when viewing AC range (chopped) signals.

Leveling outputs - To allow the power meter to be used in a leveling loop, the signal channel output is available on the rear panel. The leveling loop will be broken every time the signal channel autoranges. To overcome this, the outputs of ranges 1 and 2 can be made directly available on the rear panel BNC connector. This feature is only available as a NON DRAWN option. It can be selected from the System|Rear Panel|BNC menu - PORT 1 for sensor A and PORT 2 for sensor B. Leveling A(1) selects range 1 on sensor A. If the hardware is not available, 0 volts will be set on the appropriate output when selected.

For signal levels below -25 dBm on a diode sensor, the leveling outputs will not be valid as the signal channel operates in chopping mode below this level.

TTL LEVEL (Input port 1 only)

When in Readout or Pwr vs. Time operation mode, this selects the blanking input type, HIGH active or LOW active, you are providing. The blanking input will be used if the Trigger|Setup|ARMING is set to Blanking ON and the Sensor|Setup|Mode is set to Custom.

When in Profile operation Mode, the blanking input is ignored.

When in Source Sweep operation Mode, if the Blanking input is set to HIGH, the ML24xxA uses the digital input to sync to. Your sweeper must provide a Sequential Sync output which is connected to the digital input of the meter.

If Blanking input is set to LOW, the ML24xxA does not use the digital input and therefore can be connected to a sweeper which does not provide a Sequential Sync output. The ML24xxA will use the Horizontal Ramp input only.

Printer
[PRNSEL]

Configures the rear panel printer port. Select from the listed compatible printers which include, but are not limited to, the following:

HP DeskJet 340
Canon BJC80

Other 300, 500, 600 Series and later HP printers are typically compatible.

For proper operation with the ML2430A, the Canon BJC80 printer must be set to the EPSON LQ emulation mode. Refer to the printer manual for instructions on setting the emulation mode.

Graphics

This menu presents additional graphic display controls:

CONNECT [GRCP] This control is normally ON and causes the data between samples to be interpolated and lines drawn between sample points. When OFF, the sample points only are displayed as pixels.

TRACKING [GRTMM] The number of scans of graph data between resetting the tracked min and max when in graph mode. Select SINGLE or INFINITE.

REF LINE [GRFS] Causes a dotted horizontal line to be drawn at the reference point on the graph screen; normally OFF.

PRE TRG% [GRPTP] Percentage of the screen that displays pretrigger information at the best resolution available. The display shows an 'x' marking the trigger point on the time axis.

Data before the actual trigger event is not available. The trigger reference point (x) indicates the active trigger point after the DELAY setting in the System|Profile menu. Providing sufficient delay has been set, the PRE TRG% can be used to move this reference to anywhere on the screen. The amount of valid data displayed before the trigger reference point is dependent on the System|Profile|DELAY setting. Also see Figure 4-4, page 4-20.

NOTE

These options allow either the min/max of each sweep to be displayed (single) or the conventional method for tracking variation of levels over an extended period of time (infinite).

Secure
[SECURE]

Normally OFF. When the system is powered on the ML2430A Series returns to the state it was in when it was powered off. This includes all the offset tables, calibration adjust values, etc.

If Secure is set to Clear memory, non-volatile memory is disabled and all stored values are reset to the factory defaults when the system is powered on. As long as this selection is set to Clear memory, the system will load the presets (see Appendix A, Section A-3) every time it is turned on.

Identity
[*IDN, OI]

This selection will display the installed firmware version, the instrument serial number, and the instrument type (model number).

4-8 CAL/ZERO MENU

The Cal/Zero menu establishes the 0.0 dBm reference calibration and zeroing of the sensors. Refer to Chapter 5 for specific procedures.

Zero/Cal

This function zeros and then sets the 50 MHz, 0.0 dBm reference of the connected sensor. In dual sensor systems with both sensors connected, sensor A or B must be selected.

Cal 0 dBm
[CAL]

References the connected sensor to 0.0 dBm at 50 MHz. In dual sensor systems with both sensors connected, sensor A or B must be selected.

Zero
[ZERO]

Zeros the connected sensor. Zeroing a power sensor compensates for noise and thermal EMF of the device under test. It is recommended prior to taking important power readings in the bottom 20 dB of a power sensor's dynamic range. In dual sensor systems with both sensors connected, sensor A or B must be selected.

RF ON/OFF
[RFCAL]

Turns the RF calibrator ON or OFF.

Ext V
[VZERO]

Zeros the rear panel multi-purpose BNC connector used for Volts per GHz connection (Analog Input). This will calibrate the units to read zero volts on this BNC. During this operation the connector should either not be connected to anything, or should be connected to a 0 Volt source.

The rear panel voltage can be viewed by selecting CHANNEL|INPUT|VOLTS, although this does not have to be selected in order for the function to operate.

This calibration is non-volatile and does not normally need to be performed. In the case of offsets being introduced by the user's setup, it is possible to leave the BNC cable connected to zero out system offsets, however the offset zero range is limited to approximately 100 mV.

Chapter 5

Procedures

5-1 INTRODUCTION

This chapter presents some common procedures for use with the ML2430A Series Power Meter. These procedures refer to the ML2430A Series front and rear panel connectors and front panel keys and menus as explained in Chapter 3, Connections, and Chapter 4, Front Panel Operation. The operator should be familiar with the front and rear panel layouts and with the use of the keys and menus before attempting these procedures.

5-2 POWER MEASUREMENT

To perform a power measurement, follow these steps:

- ❑ Connect the sensor(s) as described in Chapter 3, Connections.
- ❑ Configure the meter for the application. Refer to Chapter 4, Front Panel Operation, for specific configuration options. The simplest operation is obtained with SENSOR|SETUP|MODE set to DEFAULT. Power readings are continuous with the default setting.
- ❑ Zero the sensor(s) as described in Section 5-3 (optional).
- ❑ Calibrate the sensor(s) as described in Section 5-4 (optional).
- ❑ Measure power.

5-3 ZEROING THE SENSOR

Zero the sensor before making power measurements, particularly when operating within the lower 20 dB dynamic range of the power sensor. If frequent low level measurements are being made, it is advisable to check the sensor zeroing often and repeat as necessary.

To zero the sensor, connect it to the UUT (Unit Under Test) test port, and remove RF power from the connection to a level 20 dB below the tangential noise floor of the power sensor. For -70 to $+20$ dB dual-diode power sensors, this level is less than -100 dBm.

It is preferable to leave the sensor connected to the UUT test port so that ground noise and thermal EMF are zeroed out of the measurement. Alternately, in order of preference, the sensor can be connected to:

- ❑ A grounded connector on the UUT,
- ❑ the ML2430A Series Calibrator connector,
- ❑ disconnected from any signal source.

When a new sensor is attached, the message SENSOR x NOT ZEROED (where $x = A$ or B as appropriate) is displayed. If a sensor is removed and then reconnected, the message is not displayed.

The sensor can either be zeroed, or zeroed and calibrated in the same operation.

To zero the sensor without calibration, press the Cal/Zero front panel key and the Zero soft key, then select the appropriate sensor.

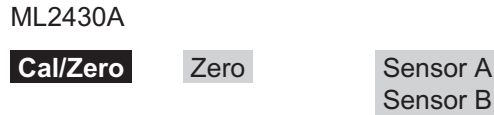

Figure 5-1. Sensor Zeroing Key Sequence

Note that if only one sensor is connected, the A-B selection is not displayed and the zeroing process begins immediately.

The message changes to SENSOR x ZERO On successful completion of the zeroing operation, the buzzer sounds. Sensor calibration should be performed next.

If the sensor fails the zeroing operation, the message SENSOR x ZERO fail *nxnnn* is displayed. The hexadecimal error code '*nxnnn*' indicates the detailed reason for the failure, which is usually due to excessive RF noise.

The sensors can also be zeroed using the GPIB ZERO command (see Chapter 6, "GPIB Operation").

5-4 SENSOR CALIBRATION

NOTE

When a Universal Power Sensor with option 1 fitted is changed from T-RMS mode to F-CW mode the user should perform a new zero/cal

Referencing power sensors to the ML2430A Series 50 MHz, 0.0 dBm calibrator is recommended. Sensors should be zeroed before being calibrated, either as a separate operation (Section 5-3) or in conjunction with calibration (Section 5-5).

To reference the sensor, connect the sensor to the ML2430A Series 50 MHz, 0.0 dBm reference output connector labeled CALIBRATOR or another 50 MHz, 0.0 dBm reference.

When the sensor is first attached, the message SENSOR x NOT ZEROED (where x = A or B as appropriate) is displayed. Perform the sensor zeroing procedure described in Section 5-3 to zero the sensor.

To calibrate the sensor after zeroing, press the Cal/Zero front panel key and the Cal 0 dBm soft key, then select the appropriate sensor.

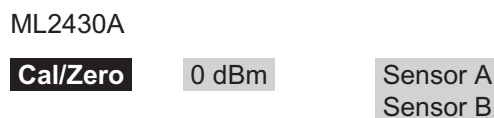

Figure 5-2. Sensor Calibration Key Sequence

Note that if only one sensor is connected, the A-B selection is not displayed and the zeroing process begins immediately.

On successful completion of the calibration operation, the buzzer sounds.

If the sensor fails the calibration operation, the message SENSOR x CAL 0 dBm invalid is displayed.

Any error conditions encountered during calibration, for example the presence of extraneous noise or RF signals, will result in an error message on the front panel display.

The sensors can also be calibrated using the GPIB CAL command (see Chapter 6, GPIB Operation).

5-5 *SENSOR ZERO/CAL*

Sensors must be zeroed before being calibrated. The Zero/Cal function completes both operations in sequence.

To zero and calibrate the sensor, connect the sensor to the ML2430A Series 50 MHz, 0.0 dBm reference output connector labeled CALIBRATOR.

When the sensor is first attached, the message SENSOR x NOT ZEROED (where x = A or B as appropriate) is displayed.

Press the Cal/Zero front panel key and the Zero/Cal function key, then select the appropriate sensor. The message changes to SENSOR x ZERO . . . Note that the power meter automatically switches the reference calibrator OFF during the zeroing operation.

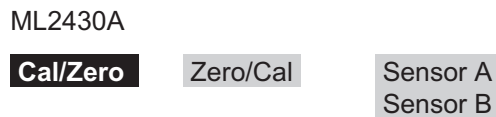

Figure 5-3. *Sensor Zero/Cal Key Sequence*

If only one sensor is connected, the A-B selection is not displayed and the zeroing process begins immediately.

On successful completion of the zeroing operation, the calibration process begins.

On successful completion of the calibration operation, the buzzer sounds and the message is cleared.

If the sensor fails either operation, the message SENSOR x ZERO fail *nxnnn* or Sensor x Cal fail *nxnnn* is displayed. The hexadecimal error code '*nxnnn*' indicates the reason for the failure.

The sensors can also be zeroed and calibrated using GPIB commands (see Chapter 6, "GPIB Operation").

5-6 *PERFORMANCE VERIFICATION*

The performance of the Power Meter's individual signal channel inputs can be verified using an Anritsu ML2419A Range Calibrator. Refer to the *ML2419A Range Calibrator Operation and Maintenance Manual* (10585-00007) for specific instructions.

5-7 **PRINTER CONNECTION**

See Chapter 3, Connectors, for the location of the parallel port connector on the rear panel. Connect a parallel printer cable from the ML2430A Series rear panel 25-pin D-sub connector to the printer.

Select System|Print to begin printing. See Chapter 4, Front Panel Operation, for specific printer connector configuration options.

Printing can also be initiated in ML24XXA (native) mode using the GPIB PRINT command (page 6-65).

5-8 **GPIB REMOTE OPERATION**

The ML2430A Series Power Meter can be operated remotely through a General Purpose Interface Bus (GPIB) connection to a host computer/controller. See Chapter 3, Connectors, for the location of the GPIB connector. The GPIB connector is configured through the System|Rear Panel|GPIB submenu. See Chapter 4, Front Panel Operation, for specific GPIB connector configuration options that can be set from the front panel. Refer to Chapter 6, GPIB Operation, for a listing of the available GPIB commands.

NOTE

GPIB remote operation is not available when the ML2430A Series Power Meter is operating from the internal battery.

If the ML2430A Series is addressed, and the Remote Enable and Local Lockout (REM and LLO) lines are not set, the front panel menus are still available, even if the unit is communicating. As long as the ML2430A Series is GPIB addressed, the GPIB status box will be displayed on the front panel whether the remote line is set or not.

If the GPIB box is on the screen and the system is not in a menu screen, and the system is in local mode (menus available), and no GPIB operations are pending, then pressing the CLR key clears the GPIB box off the screen.

5-9 SERIAL REMOTE OPERATION

The ML2430A Series Power Meter can be operated remotely through the rear panel serial connector (See Chapter 3, Connectors, for the location of the serial connector). Whereas GPIB has restrictions on total cable length and cable length between instruments, RS232 serial communication is not as limited. The GPIB can also be prone to electrical interference and is not easily electrically isolated, while RS232 can be isolated using optical couplers. Serial interface remote operation can be useful if the testing is to be done in the presence of high electrical fields and like environments.

NOTE

Serial interface remote operation is not available when the ML2430A Series Power Meter is operating from the internal battery.

While most standard serial cables will suffice, a 9-pin null-modem serial interface cable is available from Anritsu as an optional accessory (part number B41323). Note that the hardware handshake CTS and RTS lines are used to control the flow of data in and out of the power meter and must be available in the cable as hardware handshaking is always enabled. The DTR and DSR lines are connected together within the meter.

The ML2430A Series Power Meter serial connector pinouts are:

PIN	SIGNAL
1	NOT USED
2	RX data
3	TX data
4	DTR handshake signal
5	signal ground
6	DSR handshake signal
7	RTS handshake signal
8	CTS handshake signal
9	NOT USED

The serial interface baud rate can be set using the System|Rear panel|RS232 menu selection or the RSBAUD command (page 6-67). Available baud rates are: 1200, 2400, 4800, 9600 (default), 19200, and 38400. Other parameters are pre-defined as: 8 bits, no parity and 1 stop bit and cannot be changed.

Commands are entered as with the GPIB interface, conforming to the command format for the operation (emulation) mode selected. All GPIB commands are supported. There are some additional commands, specific to the serial interface, that are prefixed with an exclamation mark (!). In the emulation modes, when running under GPIB, the measured data is always available when the meter has been addressed to talk. In serial mode, the meter cannot be addressed to talk, but measurement data can still be obtained by using the GPIB trigger commands TR1 and TR2 in the HP 437 and HP 438 emulation modes, and T and I in the HP 436 emulation mode. All GPIB type commands and command strings should be terminated with a new line character (0A hex). The special serial mode commands do NOT require a termination character.

Connected Device	Character Sequence
Computer connected directly	"+++at\r\rS\n"
Modem offline from phone network Sequence will be seen if remote connection established	modem status data followed by "S\n"
Modem connected through to remote computer	"+++S\n"

GPIB/RS232 Modem Commands

The following table lists the GPIB/RS232 Modem Commands and the special serial interface only commands:

Command	Parameter	Definition
!BYE		RS232-type command only, allows the remote PC to instruct the power meter to tell its local modem to hang-up. This ensures that when communication is completed, the modems at both ends of the line can be disconnected and the telephone line released.
!DCL		RS232 type command only. Clears all buffered GPIB/RS232 messages waiting to be processed. Clears all buffered GPIB/RS232 data waiting to be output. Stops any pending actions.
!SPL		RS232 type command only. Allows a GPIB type serial poll to be requested in response to an SRQ from the power meter. This will return the instrument status register and clear the SRQ bit within that register. The *CLS command should be used to clear the rest of the register.
MODDEL	<value>	Modem redial delay time, 1 to 10 minutes (default = 5 min.)
MODINIT		Initialize connected modem
MODLIM	<TRUE FALSE>	Autodial enable for limits failure
MODPH	<string>	Phone number - up to 40 characters
MODPWR	<TRUE FALSE>	Autodial enable for power on
MODRED	<value>	Modem redial count, 0 to 10 (default = 5)
MODRNG	<TRUE FALSE>	Autodial enable for range failure

The RS232-type commands (!BYE, !SPL and !DCL) do NOT require terminating. All other commands or command strings require a new line character to terminate.

Refer to Section 4-7, System Menu, for information on using the front panel menus to configure modem operation. Refer to Section 6-10, ML24XX Native GPIB Commands, for information on using GPIB commands to configure modem operation.

a. Read the status register using the equivalent of a GPIB serial poll. Send the message:

```
!SPL
```

Note: There is NO terminator to this message.

The power meter will respond:

```
Px\n
```

x is the ASCII character determined by the value in the meter status register.

x = "B" gives a status register value of 01000010 binary. Comparing this with the status byte description in Section 6-7 of the manual will show that the SRQ and limits error bits are both set.

b. Alternatively the status register can be read directly using the command:

```
*STB?\n
```

This will respond:

```
Ry\n
```

y can be up to 3 digits and is the decimal representation of the status register.

y="66" gives a status register value of 01000010 binary. Comparing this with the status byte description in section 6-7 of the manual will show that the SRQ and limits error bits are both set.

8. Once the status register has been read, it must be cleared to allow further SRQ messages to be sent. Before the status register is cleared, further autodial actions (limits failure or sensor range error) should be disabled to prevent any unnecessary autodial attempts by the meter when already connected to a remote PC. To clear the status register, use the command:

```
*CLS\n
```

5-11 **PROFILE OPERATION MODE**

The ML2430A Series Power Meter can be used to view signals in Profile, Read-out, Power vs. Time and Source Sweep modes. This section describes setting up and viewing signals in the Profile mode. Profile mode allows the viewing of a single channel (1 or 2 as set up in the Channel menu) plotted against time.

NOTE

To operate the Universal power sensors in profile mode Option 1 must be fitted. Activate option 1 mode before selecting profile mode under the SENSOR | Setup OPTION FAST CW menu.

NOTE

Dynamic range is limited in Profile mode to DC ranges only. For maximum dynamic range, measured signals need to be repetitive (not single-shot) when profiling over less than 30ms width. Above this, single-shot profiles can be measured over the full dynamic range.

To view the time profile of a signal, enter the PROFILE mode via SYSTEM|SETUP|MODE (toggles through READOUT, PROFILE and POWER vs. TIME). Parameters needed to set up a PROFILE display are:

1. TRIGGER|SETUP provides access to a special TRIGGER configuration options. The default mode is CONTINUOUS which provides for a non-synchronized, oscilloscope type display. This type of display is useful for general monitoring of a signal and showing its variation over time. The settings for the DELAY and gate WIDTH provide the points at which the measurement is triggered and read out of the cursor. The other options are similar to other triggering modes.
2. SYSTEM|PROFILE sets up the channel (1 or 2) to be displayed and the time-axis, as well as the way that the data is displayed (for example, monitoring the minimum or maximum data over time). Note that in all cases, the PROFILE|CHANNEL selection (1 or 2) relates to a measurement channel set up in the CHANNEL menu, not directly to the A or B sensors.

NOTE

If the DATA HOLD mode is set to display min or max data, as opposed to the default (NORMAL), the display will continue to track the min/max until the DATA HOLD mode is returned to NORMAL.

3. SYSTEM|CONTROL provides control over the readout and CURSORS as well as the scaling of the display. From the CURSOR menu (using the << and >> arrows) the positions of the readout cursors can be adjusted. The cursors directly relate to the DELAY and gate WIDTH parameters in the TRIGGER|SETUP menu, but allow for visual movement of the parameters on the display itself. The TRIGGER|SETUP menu requires direct entry of the actual parameters when the timing criteria is known.

TYPICAL SETUP

A typical situation with no triggering (CONTINUOUS):

1. Select SYSTEM|SETUP|PRESET to reset the instrument to the standard default conditions (see Appendix A, Section A-3 for a listing of the system defaults).
2. Connect sensor A to the signal source.
3. Select SYSTEM|SETUP and press MODE to select PROFILE.
4. Press CLR or any other menu key to return to the display screen. The display now shows a power profile of sensor A on channel 1.
5. Press SYSTEM|CONTROL to get access to the cursor. Press << and >> to move the selected cursor, and SWAP to select the other cursor.

NOTE

With a CONTINUOUS trigger such as this, there will most likely not be specific points of interest, so the movement of the cursors is rather arbitrary.

If modulation is applied to the signal, or its power level altered, the signal should change on the display. The signal may not be visible if it is not in the default range which covers +20 to -50 dBm.

SCALING

In the example above, if the measured power signal is not visible because the power is too high or low, the scaling can be altered as follows:

1. Press SYSTEM|CONTROL|more|SCALE. There are now soft keys for TOP and BOTTOM dB levels, referring to the top and bottom of the screen, and AUTO SCALE, which will optimize the displayed graph.
2. Enter new values so that the measured power signal is visible. The TOP value must always be higher than the BOTTOM value.
3. When finished, press another soft key or CLR to return to the display.

CURSOR READOUT

To display the CURSOR READOUT box on the screen, press SYSTEM|CONTROL|more|READOUT (see page 4-25). This is a toggle action and will display or remove the cursor data readout box from the display.

The readout shows a digital representation of data at the two cursor positions on the currently displayed channel, along with the differences in power (Δp) and time (Δt). The value of Δp represents the selected cursor reading minus the other cursor reading, and Δt represents the time difference between the two cursors. If SENSOR|AVERAGING|between CURSOR averaging is on, the average reading between the cursors is displayed at the bottom of the readout.

NOTE

If continuous trigger is selected, or the display is changing while trying to read the readout, select TRIGGER|MANUAL to stop the display update.

The readouts are updated whenever the signal trace is updated, or if the cursors are moved. It is possible to link the movement of the cursors so they move at the same time. This is useful if measurements need to be taken at specific times between the cursors, as with channeled signals.

To link the cursors, select SYSTEM|CONTROL|more|more|LINK CURSR. When the cursors are linked, a line is drawn on the display connecting the two cursors and they will move together as one. This is dis-

cussed more fully in the Triggered Measurements section below.

Range Hold may be selected (see page 4-6) to limit dynamic range and prevent small range change disturbances on very high speed signals. Use Range Hold 1 for measurements down to -25 dBm, and Range Hold 2 up to -25 . If the display update is turned off via GPIB, only the average is updated.

Triggered Measurements

Since non-triggered measurements are of limited use in the PROFILE mode, most applications require triggering. For example:

1. Provide a 1 kHz square wave modulated signal to sensor A, and set TRIGGER|SETUP|MODE to Internal A (Int A). This causes the PROFILE sweep to wait until a certain power level is present on the sensor before starting the sweep.

2. The DELAY and WIDTH parameters, as discussed above, are the positions of the two CURSORS. These can be set to specific locations; for example, if the signal is a 1 kHz square wave, setting the DELAY to 250 μ s places the cursor in the first cycle at the midpoint of one of the phases. Setting the WIDTH to 500 μ s sets the other CURSOR to exactly one half-cycle later, thus allowing display of the power levels in the two phases of the signal.

NOTE

If the modulation is turned off, then the trigger conditions will not be met and the sweep will not continue to be updated. This is useful to 'freeze' a display. To display a CW signal again, re-select CONTINUOUS trigger in TRIGGER|SETUP|MODE.

In some conditions, it is useful to view triggered signals independent of signal levels. In these cases, provide an external trigger source into the rear panel TRIGGER input to trigger such a measurement.

3. The dynamic range in PROFILE mode should extend to the maximum specification of the meter, to approximately -40 dBm (diode sensors only). If the displayed range is restricted, check that RANGE HOLD is not applied.

NOTE

If RANGE HOLD 1 is applied, the lower limit will be approximately -30 dBm. If RANGE HOLD 2 is applied, the maximum level will be limited to approximately -10 dBm. In most triggered situations, range hold should be set to AUTO.

The unique method of range changing applied in this mode means that the change between range 1 and 2 is effected in less than $2 \mu\text{s}$. In most cases it is not noticeable, although there may be a slight discontinuity.

Due to the range-change method, if a triggered signal is not repetitive the range change may not settle instantly, and the displayed result may be in error. This is generally true for x-axis times of less than 6 ms where it takes more than one pass to completely update the display.

Control of x-axis - Width of Profile - Sample Time

The control of the time-frames over which the PROFILE is gathered is very precise, but there are certain restrictions. With care it can be used to display the profile of signals down to typically $100 \mu\text{s}$ or better.

1. Select SYSTEM|PROFILE. The first two items in the menus have already been covered (selection of channel 1 or 2, and the method of display, min max). The last two selections control the data collection PERIOD (the time span of the window). The default period is 10 ms, and it can be adjusted down to $100 \mu\text{s}$ and below. If you are still displaying the 1 kHz square wave, enter a period of 3 ms. The display will zoom in to show more detail of the pulses.

NOTE

Thermal sensors have rise and fall times of $<4 \text{ ms}$. Do not use a thermal sensor for fast signal profiles.

Typical MA2470A and MA2440A Series sensors have rise times of $<4 \mu\text{s}$. Fall time is typically $<10 \mu\text{s}$, except at low power levels. Consider this when looking at fast signals.

2. Note that the cursors have remained at their set positions in time, that is, when altering the time axis the cursors stay at their set positions in terms of time - NOT POSITION ON THE SCREEN. This is very important when measuring specific points or peaks in a signal.

3. By altering the DELAY parameter, the PROFILE can be made to look at a segment of time long after or very close to the trigger point. That is, by setting the DELAY to 100 ms, the PROFILE will show the 100th pulse (and onwards) of a 1 kHz square wave. By setting to ZERO, the profile will show data immediately after the trigger has occurred. This is the DISPLAY TRIGGER DELAY and is denoted by a small 'x' on the PROFILE display. This marks the point on the display where data is taken at the time DISPLAY TRIGGER DELAY is placed. For example, for the 1 kHz square wave, the pulse edge would occur at the 'x' point whenever the DISPLAY TRIGGER DELAY is a multiple of 1 ms. The x-axis nomenclature always denotes this point with a time of ZERO ($t=0$), this allows the user to always consider time intervals relative to the display trigger which is usually the point of interest.

NOTE

For smaller values of display trigger delay, it is possible that the display will cover time intervals (on the left of the display) for which there is no data. In these conditions, the cursors are normally prevented from displaying data taken there as it will be in error (there is no data). The position of 'x' is nominally 10% of the screen. This can be altered to any percentage the user requires in the SYSTEM|more|more|GRAPHICS preferences menu as the PRETRIGGER percentage. It can also be set to ZERO to remove pretrigger data and prevent confusion in cases of small display trigger delays. Profile can display A, B, or A-B measurements. Note that in the case of a ratioed measurement (A-B), the data is calculated as a straight dB difference (not a LINEAR mw difference). This is not the same as a MODULATED POWER AVERAGE measurement.

4. As well as the CURSOR readouts described above, the POWER AVERAGE method can be used to display the average power between the two cursors. This is performed as a TRUE AVERAGE and is the actual average of all the data points between and including the cursors. By placing the cursors on the top of a pulse, the flat top power can be measured. By placing the cursors with a period of the pulse, the average power of the pulse is calculated. This is more accurate than a simple duty cycle calculation which makes assumptions about the pulse shape. Use the SENSOR|AVERAGE menu to enable this readout method.

NOTE

The display resolution is 200 pixels. Consider this effect on the resolution of timing data. For example, a 1 millisecond PROFILE window would have a cursor resolution on the display of 5 microseconds. The LIMITS test functions on PROFILE data, and can be configured to BEEP on fail conditions.

**Advanced Triggering
and Setup Options**

The other aspects of triggering allow for fine tuning of the trigger conditions. This includes:

1. Selection of HIGH or LOW going edge in External TTL.
2. Level setting on Internal A or B trigger, as well as polarity - HIGH or LOW going.
3. ARMING via an External BLANKING input. When ARMING is set to Blanking ON, only samples taken when the rear panel Digital Input BNC is active will be averaged in the measurement. The polarity of the rear panel Digital Input BNC signal can be set (high or low) using the System|Rear Panel|BNC|TTL LEVEL menu setting. When ARMING is set to Blanking OFF, all samples are read.
4. In the SYSTEM|more|more|GRAPHICS menu, there are options for:

(a) **CONNECT** points. With this **ON** (default) the data points are connected with vectors to resemble a real time trace. When **OFF**, the data points are displayed as data points only, with no connecting line. This can give a faster display update, however, it may be confusing as near vertical lines will have very few points defined within them.

(b) If Tracking min/max is selected for the **CHANNEL** being used for the **PROFILE**, it is possible to configure the tracking min/max to display the min and max values for all the data **BETWEEN THE CURSORS**. This provides easy access to peak values within a time-window; for example, the top of a pulse.

When set to **SINGLE** it is updated **EACH SWEEP** and reflects the min and max values only within that sweep.

When set to **INFINITE**, it maintains the min/max from the point it is started until it is reset, updating the **MAX** if it sees a **HIGHER** measurement within the **CURSOR** window, and updating the **MIN** readout if or when it sees a lower value than that which it has already. This option, in the **SYSTEM** menu, is only a preferences option and not the main control for the feature.

The control for the min/max remains in the **CHANNEL** menu (**CHANNEL|SETUP|-more-|MIN/MAX |RESET**). The user should select the way he wants to work and leave it. In most cases the **SINGLE** (default) is the most useful as it provides a continuously updated readout of the min and max points within the cursor window. The **INFINITE** setting is used when the results need to be collated over a large number of samples. In order to **RESET** the **INFINITE** configuration, use the **CHANNEL** menu.

NOTE

In the triggered modes, such as Internal A or B and External TTL, the **SENSOR|SETUP|Range HOLD** feature can still be applied to restrict dynamic range if required.

5-12 SOURCE SWEEP MODE

This feature allows the ML2430A Series Power Meter to be synchronized to an RF source using the Horizontal ramp (to Analog Input) output on the RF source. The ML2430A Series can also optionally use a Sequential Sync (to Digital Input) output on the RF source.

To enable the Seq Sync input for RF sources that do provide this output (the default), set the **System|Rear Panel|BNC|Input Port 1|TTL LEVEL** to **HIGH**. This way the device will use both the Horizontal Ramp and Seq Sync inputs to sync to the sweep.

To disable the Seq Sync input for RF sources that do not provide this output, set the **System|Rear Panel|BNC|Input Port 1|TTL LEVEL** to **LOW**. This way the device will only use the Horizontal Ramp to sync to the sweep.

Frequency Sweep Mode

When the sensor/cal factor source is set to V/GHz in Source Sweep mode, the start and stop voltages are assumed to be 0 and 10V, and the start and stop frequencies are taken from the System|Source sweep menu.

Calibrate the V/GHz setup by setting 0 and 10v and the frequencies (F1 and F2) that these voltages correspond to (sweep width). This method activates real-time cal factor correction on a swept basis (including any user cal factor tables) providing swept power measurements. Note that V/GHz output should not be used, as this limits the range of the signal applied to the meter when sweeping narrow widths. The fixed 0-10V ramp should be used to ensure correct sweep operation.

In normal operation, leave the CalFactor|SOURCE set to V/GHz as this instructs the meter to apply cal factor correction proportional to the input ramp, and ensures that the whole sweep of data is cal factor corrected in real time at every data point. If the CalFactor|Source is set to Manual or Frequency, a single frequency cal factor will be applied through the sweep (or a manually entered value). This may be useful for some applications where the sweep signal is used for others purposes (for example, power sweep, etc.).

Power Sweep Mode

In this mode the Ramp input is scaled to Start and Stop power settings. The start and stop voltages are assumed to be 0 and 10V, and the start and stop power settings are taken from the System|Source sweep menu.

Make sure the Sensor|CalFactor|SOURCE is set to Frequency or Manual. In power sweep mode V/GHZ is not used.

Source Sweep Graph

The annotation at the bottom of the screen is manually entered (there is currently no digital connection between the power meter and the source), and these can be entered through the SYSTEM|Source sweep|more- Start and Stop softkeys. Note that the scaling for the 10V ramp input is not directly applied to the bottom of the screen; the user is able to enter this directly and may include effects of frequency translation devices.

The other controls remain similar to the Profile graphic mode. SYSTEM|Control provides access to most other functions used during measurement, such as CURSOR movement and control, SCALING, and READOUT from the cursor. Note that the “between cursor average” has no meaning in Source Sweep mode, and in place of this the frequency of the measurement is indicated instead (x1 and x2). The readout is only updated while the system is sweeping.

Averaging may be applied by selecting SENSOR|Averaging and setting the STATE to ON. An averaging number may then be applied for either sensor independently. Averaging is ‘EXPONENTIAL’ in character so changes in response (for example, adjusting tuning of a filter) will gradually settle to their final measurement value over a period of time. A larger number will take longer to settle. Good measurements may be achieved down to -45 dBm (65 dB dynamic range) with an average value as low as 4. Values up to 64 and higher produce significantly lower noise readings. All averaging is performed on a true linear basis.

System|Source Sweep|Data Hold can be used to select the way in which data is plotted. Using Min/Max variation (both minimum and maximum) can be shown on the display. Using Max effectively provides a peak hold. If the display of swept power is not what is expected, check the setting of AVERAGE and the DATA HOLD mode in case it is affecting the data processing.

NOTE

As with other graphic modes, improved speed can be achieved in ATE systems by disabling the graphic draw function for the LCD through the menus using SYSTEM|-more-|-more-|Graphics|CONNECT. Setting CONNECT to OFF displaces the line-drawing between samples, and improves update rate. Similarly, for ATE systems, the READOUT should be disabled for fastest throughput as this can all be handled within the controller (PC). Sensor range hold is not available in this mode of operation as auto ranging is selected.

Using the Anritsu 68/69000 Synthesizer

The ML2430A Series can be connected directly to the Anritsu 68/69000-Series Synthesized Signal Generators (models 68XXXB and 69XXXA) using a special RS232 cable (Anritsu part number C37399). To use this remote connection, the System|Setup mode must be set to Source sweep, and the System|Rear panel|RS232 mode must be set to SOURCE IF. The RS232 mode can also be changed using the GPIB command RSMODE (page 6-68).

When set up in this manner, all sweep frequency and power parameters will be communicated from the source to the meter. If the source frequency power level or the frequency itself is changed, the source sweep display will be updated where appropriate.

To communicate with an Anritsu 68/69000-series synthesizers, the synthesizer firmware must be later than the levels shown below for each model:
680xxB - 3.39, 681xxB - 3.44, 682xxB - 2.41, 683xxB - 2.50, 680x5B - 1.26,
681x5B - 1.32, 682x5B - 1.30, 683x5B - 1.34, 690xxA - 1.21, 691xxA - 1.26,
692xxA - 1.26, 693xxA - 1.35, 690x5A - 1.21, 691x5A - 1.24, 692x5A - 1.24,
693x5A - 1.31

Contact your nearest Anritsu Service Center for a firmware upgrade if necessary.

5-13 POWER vs. TIME MODE

The ML2430A Series Power vs. Time mode is a graphical chart display of one of the display channels, as selected in the SYSTEM|PWRvsTIME menu. The triggering setup is as set for Readout mode operation.

Power vs. Time mode provides a chart display on a timed basis where the x-axis of the graph is defined in units of time. The user specifies the sweep period and, within this sweep period, each pixel depicts all the measurements taken within a 200th of the sweep period.

The data can be displayed as a maximum value only, a minimum value only, maximum and minimum values, the average of all the readings during the time slot period, or the latest measured value. These display modes are selected in the SYSTEM|PwrVsTime menu, DATA HOLD representation. Measurement setup, i.e., trigger, etc., is selected the same way as in Readout mode. The minimum sweep time is 1 minute, and the maximum sweep time is 24 hours.

5-14 USER CAL FACTORS

NOTE

This feature is also available when using Anritsu MA4700A/MA4600A sensors with the Anritsu MA2499B Sensor Adapter. Since the MA4700A/MA4600A sensors do not contain an EEPROM, the user cal factors are stored in the MA2499B adapter EEPROM.

NOTE

A * in the displayed status box by the Cal Factor indicator, signifies User Cal Factors are active.

User Cal Factors are maintained in the sensor.

All MA24XXA Power Sensors have an internal EEPROM containing correction and calibration factors programmed into the sensor at the factory. This “cal factor” data is used when the power meter is set up to use frequency or volts per GHz calibration factors. The correction is in linearity (across the dynamic range) and sensitivity (across frequency).

The ML2430A Series has the capability to define sets of calibration factor data and store them in the sensor. A user-defined cal factor table can be used on its own, or in conjunction with the factory-defined cal factor table. Linearity correction is not affected provided the meter cal factor frequency is set correctly.

Depending on the amount of factory calibration data stored in the sensor, there can be up to 10 user-defined cal factor tables. A “user” cal factor table consists of up to 90 frequency/cal factor data pairs for sensors up to 40 GHz or 110 frequency/cal factor data pairs for sensors up to 50 GHz, plus a 7-character identity text string. User cal factor tables are fully interpolated, and can be used to apply correction for attenuators placed in front of the sensor. In this situation, determine the attenuation factors and use them in addition to the Factory cal factors. The number of frequency/cal factor data pairs in the factory defined table depends on the sensor being used.

The cal factor tables for a particular sensor are not maintained by the meter, but are held in the sensor. This means that when moving a sensor (perhaps with an associated attenuator or calibration record) from one meter to another, the calibration stays valid. It is not necessary to re-setup the new meter.

The first time a sensor is used with the ML2430A Series, a slight delay may be experienced when the sensor is first plugged in. This is caused by the firmware preparing the sensor to accept user cal factor tables. After first initialization, user cal factor tables will have only a single entry at 50 MHz, 100%.

Cal factor tables are accessed through the Sensor|CalFactor|USE TABLE front panel menus (Chapter 4), or through GPIB commands (Chapter 6).

ML2430A

Sensor

CalFactor

-more-

USE TABLE

%/dB

EDIT

Figure 5-4. Cal Factor Table Key Sequence

Example Procedure

Use the key sequence Sensor|Cal Factor|EDIT to get to the table edit menu. Use the TABLE key to select the table, then the EDIT key to edit that table. Press the INSERT key to enter frequency and cal factor data pairs.

For example, in order to enter the frequency/cal factor pairs 1 GHz @ 100%, 2 GHz @ 101%, 3 GHz @ 98% and 4 GHz @ 98%, step through the keys in the following sequence:

```
FREQ, 1, GHz. Entr
FACTOR, 100, %
FREQ, 2, GHz. Entr
FACTOR, 101, %
FREQ, 3, GHz. Entr
FACTOR, 98, %
FREQ, 4, GHz. Entr
DONE
```

The frequency/cal factor pairs can be entered in any order. Each time a new frequency is entered, a new data pair is formed. As the data pairs are entered, they are sorted into frequency ascending order.

Readout Mode

In Readout mode, the bottom text line in the Status box indicates what type of calibration factors are being used. At any time, if anything other than the factory supplied cal data is applied, the Status box display shows a warning "*" sign on the Cal Factor line to show that non-standard calibration is being applied. For example:

```
CAL F = frequency cal factors using factory defined table
CAL V = volts per GHz cal factors using factory defined table
CAL M = manual cal factor
CAL *F = frequency cal factors employing a user defined table
CAL *V = volts per GHz cal factors employing a user defined table
```

This is because the application of user cal factors can completely change the calibrated response of the Sensor.

5-15 OPTIMIZING READINGS

This section presents information on how to get the fastest readings from the ML2430A Series power meter when operating under GPIB control. Refer to Chapter 6, GPIB Operation, for specific command descriptions.

Measurement speed depends greatly on the type of measurements being taken, the power level, and the amount of settling used.

NOTES

All results shown in this section are from DOS programs running on a 200 MHz controller using IEEE 488.2 GPIB function calls. The timings (readings/second) presented in this section are for illustrative purposes only.

Using the default system set up (system preset), the "O 1" (page 6-57) command is used to retrieve one reading from channel 1 ten times (channel 1 = Sensor A).

C code example:

```

/* Reset the unit */
Send(0, 13, "**RST", 4L, NLEnd);

/* Ask for 10 readings */
for(i=0; i<10; i++)
{
    Send(0, 13, "O 1", 3L, NLEnd);
    Receive(0, 13, buffer[i], 20, STOPend);
}
    
```

Settling (%)	Power Level (dBm)	Readings/Second
0.1	0	150
0.1	-30	150
10.0	-30	150

There are, however, methods of improving the speed of the measurement without having to change the power level or settling time.

DISP ON/OFF command

Using the DISP command (page 6-33), the readout display can be turned OFF, yet data can still be acquired from the readout channels.

C code example:

```

/* turn display off */
Send(0, 13, "DISP OFF", 8L, NLEnd);

/*Ask for 10 readings */
for(i=0; i<10; i++)
{
    
```

```

Send(0, 13, "O 1", 3L, NLEnd);
Receive(0, 13, buffer[i], 20, STOPend);
}
    
```

Settling (%)	Power Level (dBm)	Readings/Second
0.1	0	160
0.1	-30	160
10.0	-30	160

The 0.1% settling on -30 dBm power level results were not improved because of the amount of time needed to settle to 0.1% on -30 dBm.

**FAST
ON/OFF
command**

Using the FAST command (page 6-37) limits the types of measurements that can be taken. As some processes are turned off, higher measurement speeds can be achieved. FAST will not operate when sent via RS232. When THE FAST ON command is selected, the readout display is also turned OFF.

NOTE

Using FAST mode only increases speed when asking for one measurement at a time, using the 'Receive' command.

C code example:

```

/* send fast mode ON*/
Send(0, 13, "FAST ON", 7L, NLEnd);

/* Setup the power meter into talk addressed. In this mode */
/* we can read from power meter without readdressing each */
/* time. */

Receivesetup(0,13);

/* Now read 10 readings */
for (loop = 0; loop < 10; loop++)
{
    RcvRespMsg(0,buffer,STOPend);
}
    
```

Settling (%)	Power Level (dBm)	Readings/Second
0.1	0	150
0.1	-30	150
10.0	0	610
10.0	-30	250

The 0.1% settling on -30 dBm power level results were not improved because of the time needed to settle to 0.1% at -30 dBm.

Using Buffered Requests

Using the buffered Output channel ON command (page 6-64), even faster measurement speeds can be achieved. By using the ON command instead of the O command *x* number of times, extra processing is removed, resulting in improved speed.

NOTE

Using FAST mode here will not increase the speed as this mode only works when asking for one measurement at a time (i.e., the 'O' command only.)

C code example:

```
/* Reset unit and ask for 200 buffered readings n channel 1 */
Send(0, 13, "**RST; ON 1, 200", 15L, NLEnd);

/* use a large buffer size (4K for 200 readings) */
Receive(0, 13, buffer, 4096, STOPend);
```

Settling (%)	Power Level (dBm)	Readings/Second
0.1	0	216
0.1	-30	202

Changing measurement modes

By changing the sensor measurement mode to Custom, the ML2430A Series can be precisely configured to meet the needs of the specific application.

In this example, the Trigger Gate Width (page 6-79) has been reduced to 1 ms, Channel 1 is set to Sensor A, and Channel 2 is off.

C code example:

```
/* reset unit. Custom measurement mode, 1 ms TRGGW */
/* Auto averaging Sensor A Channel 2 off*/
/* Use FAST mode*/
Send(0, 13, "**RST; FAST ON; SENMM A,
CUSTOM; TRGGW 1ms", 51L, NLEnd);

Receivesetup(0,13);

/* Fast mode, therefore do not send 'O 1' for data, just read.*/
for(i=0; i<10; i++)
    RcvRespMsg(0,buffer,STOPend);
```

Power Level (dBm)	Readings/Second
0	240
-30	240

**AN EXAMPLE
PROGRAM IN C**

```
#include <stdio.h>

/* include the NI 488.2 GPIB include file */
#include "DECL.H"

/* LINK with MCIB.LIB */
/* Compiled with BorlandC++ 2.0 */

void main()
{
    int i;
    char buffer[10][20];

    /* clear buffer */
    memset(buffer,0,200);

    SendIFC(0);
    if ( ibsta & ERR )
    {
        printf("GPIB error\nibsta: %0x\niberr: %i\n\n", ibsta,
            iberr);
        exit(1);
    }

    /* Setup ML2430A at address 13 */
    /* FAST mode (output readout channel 1)
    Send(0, 13, "**RST; FAST ON", 13L, NLEnd);

    /* Loop 10 times and store readings */
    for(i=0; i<10; i++)
        Receive(0, 13, buffer[i], 20, STOPend);

    /* display readings.. */
    for(i=0; i<10; i++)
        printf("Reading %i = %s", i+1, buffer[i]);
}
```

**5-16 OPERATOR
MAINTENANCE**

The ML2430A Series does not require any operator maintenance. All repairs must be performed by qualified service personnel only. Refer to Table 2-1 for the nearest Anritsu Service Center.

Chapter 6

GPIB Operation

6-1 INTRODUCTION

This chapter provides alphabetically-ordered listings and descriptions of all ML2430A Series GPIB programming commands. The majority of the GPIB commands have equivalents in the front panel menu settings. Note that GPIB operation is not available when the power meter is running from the internal battery (option ML2400A-11). The ML2430A Series Power Meter supports the IEEE 488.2–1992 GPIB standard in ML24XXA (native) mode (HP emulation commands are not GPIB 488.2 compliant). For further information about GPIB programming, refer to the IEEE 488.1/2 Standards documents.

6-2 TYPOGRAPHIC CONVENTIONS

The typographic conventions, abbreviations, and syntax legend used throughout this chapter to define the GPIB commands are described in Figure 6-1.

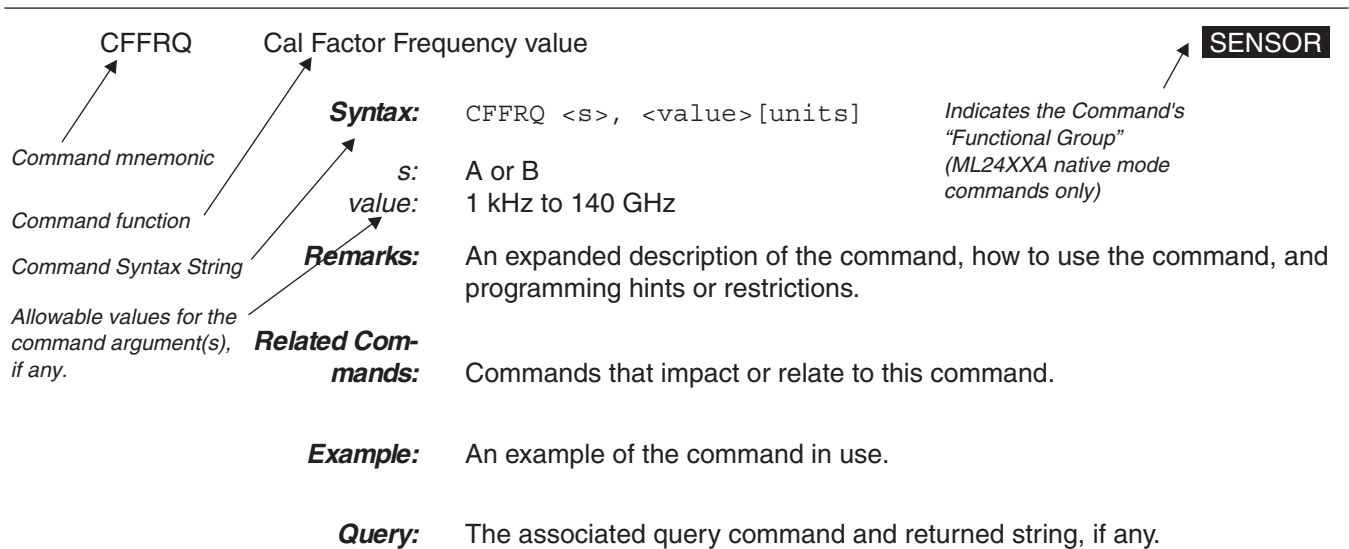

Figure 6-1. Typographic Conventions for Command Listings

6-3 DATA I/O FORMATS

All ML24XXA (native) GPIB 488.2 commands that use parameters must have a space between the command header and the first parameter, and all subsequent parameters must be separated by a comma (.). Multiple commands may be sent on the same line, but must be separated by a semicolon (;).

The format for ML2430A Series (native) GPIB commands is:

<command header><space><parameter 1>,<parameter n>,...

HP and ML4803 emulation commands on the other hand, do not have to have a space between the command header and the parameter, or commas between the parameters.

The format for HP emulation commands is:

<command header><parameter 1><parameter *n*>...

The end of the command text must be terminated with either a line feed character (0Ah, decimal 10) or a GPIB End of Transmission State (EOI), or both.

Data input and output formats and templates referred to throughout this chapter are delimited with the less-than and greater-than characters (< >). Optional parameters and suffix characters are delimited with brackets ([]). These characters are not part of the data and are only used in this text to distinguish the data elements they represent.

All the commands which allow a level to be set as a value argument are floating point values which can use the E-0x convention or a suffix multiplier. The GPIB standard [units] convention (i.e., MS for milliseconds, etc.) IEEE codes and formats have been implemented for the suffix units and multipliers. The suffix unit is always allowed but is not required and is shown in brackets where appropriate.

Table 6-1 lists the numeric data suffix mnemonics for the ML2430A Series Power Meter. These mnemonics are used when entering numeric data with GPIB commands (use of these codes is optional).

Commands which are not floating point, but integer, are:

Suffix Multipliers		Suffix Units	
Definition	Mnemonic	Definition	Mnemonic
1E18	EX	Decibels	DB
1E15	PE	dB ref to 1 mW	DBM
1E12	T	dB ref to 1 μ V	DBUV
1E9	G	Mega Hertz	MHZ
1E6	MA	Percent	PCT
1E3	K	Seconds	SEC
1E-3	M	Seconds	S
1E-6	U	Volts	V
1E-9	N	Watts	W
1E-12	P	Hertz	HZ
1E-15	F		
1E-18	A		

Table 6-1. Numeric Data Suffix Mnemonics

All of the Status enable type commands (*SRE for example)
Stored numbers (i.e., 0, 1, 2, 3, 4, 5)
Offset table numbers (i.e., 1, 2, 3, 4, 5, 6...)
GPIB addresses (1 to 30)
User Averaging number in the AVG command (1 to 512)
Display contrast number (1 to 12).

The ML2430A Series data formats are summarized below:

- <NR1>** This notation represents ASCII integer values. A comma (,) is used to separate multiple values sent in a single command input or output string. Examples of values that can be represented by <NR1> notation:
1
0
-29,179
- <NR2>** This notation represents ASCII floating point values in decimal point format. A comma (,) is used to separate multiple values sent in a single command's input or output string. Examples of values that can be represented by <NR2> notation:
1.0
-0.00015
12.743, -180.07
- <NR3>** This notation represents ASCII floating point values in exponential format (scientific notation). A comma (,) is used to separate multiple values sent in a single command's input or output string. Examples of values that can be represented by <NR3> notation:
1.0E9
7.056E3
9.0E2,3.42E2
- <NRf>** This notation is used to signify that data can be in either <NR1>, <NR2>, or <NR3> format as described above. Examples of values that can be represented by <NRf> notation:
1.0E9
10.005
83,4.5E2,234.9901
- <String>** This notation represents a string of 7-bit ASCII characters (including non printable characters) that is delimited (surrounded) with either single quotes (' ') or double quotes (" "). The string can include text formatting characters such as line-feed, space, or carriage return. Note that if a double quote character must be sent as part of the string, then it must be followed by an additional double quote. Alternatively, the string can be sent using single quotes as shown in the "cal_file" example below. Examples of data represented by <String> notation are:

"1/15/98"
"Save ""cal_file"" now."
'Save "cal_file" now.'

<Arbitrary ASCII>

This notation represents undelimited 7-bit ASCII text. The end of the text must be terminated with the line feed character (0Ah, decimal 10) or a GPIB End of Transmission State (EOI), or both. This requirement makes it necessary for <Arbitrary ASCII> text to be transmitted only at the end of a program or response message, that is, at the end of a multiple input or output statement.

Example of data represented by <Arbitrary ASCII> notation:

Anritsu,2410A,123456,1.0<0A^EOI> The example shows a sample response from the *IDN?, 488.2 common query. In the example, the instrument identifies itself as an Anritsu 2410A, with serial number 123456, and software version 1.0 installed. Note that decimal 10 (0Ah character) must be sent with the EOI to signal end of transmission.

<Arbitrary Block>

This notation represents data transmitted as 8-bit data bytes (00-FF hex, 0-255 decimal, notation is <DAB>). Useful for transmitting large blocks of formatted ASCII or binary data or unformatted binary data. The data stream is immediately preceded by a variable length ASCII header that is encoded with the number of data bytes to be sent. The header always starts with the (#) character.

6-4 QUERY COMMANDS Many ML24XXA (native) GPIB commands have an equivalent query command that will return a current value or setting. Query commands and their returned strings are provided with each command where applicable.

A complete listing of valid query commands and returned strings is provided in Appendix B, Section B-2.

6-5 GPIB PC CARD SETUP

The following GPIB driver configuration set up is recommended for reliable GPIB communication with the ML2430A Series power meter. The set up is expressed in the terms used by the National Instruments GPIB ISA and PCI cards and drivers for WIN95 and DOS.

GPIB Device Template

The ML2430A Series default primary address is 13. Separate device templates for the primary address of each device can usually be set up separately. The settings for the device template for the ML2430A Series are:

Terminate read on EOS	NO
Set EOI with EOS on write	YES
Type of compare on EOS	8 bit
EOS byte	0x0A (10 decimal)
Send EOI at end of write	YES
Readdressing	YES
Secondary address	NONE

GPIB Card Settings

The recommended GPIB card settings for use with the ML2430A Series are:

Terminate read on EOS	NO
Set EOI with EOS on writes	YES
Type of compare on EOS	8 bit
EOS byte	0x0A (10 decimal)
Send EOI at end of write	YES
System controller	YES
Assert REN when SC	YES
Enable Auto Serial polling	NO
NI card. Cable length for HS488	OFF

6-6 USING 488.1 GPIB

IEEE 488.1 level commands are in the form of data byte codes with the attention (ATN) line set. A separate function is normally provided to drive these commands from a GPIB program. A typical GPIB driver library call for 488.1 and 488.2 is given for each of the following commands. Refer to the IEEE 488.1 and IEEE488.2 device driver manuals for full definitions of the responses, and to find the actual command format for your GPIB driver library.

Commands

Device Clear (DCL) and Selected Device Clear (SDC)

These commands clear the GPIB device interface and have the following effects:

- ❑ All buffered messages waiting to be processed are cleared.
- ❑ All buffered data waiting to be read from the device is cleared.
- ❑ Stop any pending actions.

For example, if a request for data has been sent, and the system is waiting for the reading to be triggered, the system would wait until the reading has been provided before any further GPIB commands can be processed. The device clear will clear the data request so further GPIB commands after the device clear has completed can be actioned.

Typical device library calls are 488.1 'ibclr' and 488.2 'DevClear'.

Device trigger (GET)

This command triggers a GPIB device. An action predefined by the setup of the device being triggered will take place. On the ML2430A Series, the device trigger provides a trigger of the type defined by the GTn commands previously sent and a reading put into the output buffer for each display channel that is not OFF. In Profile mode, the profile display for the selected channel only is output.

Typical device library calls are 488.1 'ibtrg' and 488.2 'Trigger'.

Goto local (GTL)

This command forces the device out of remote mode and into local operation mode. The local operation keys and menus are now available.

Typical device library calls are 488.1 'ibloc' and 488.2 'EnableLocal'.

Interface clear (IFC)

This is part of the GPIB initialization and forces the board to the controller in charge.

Typical device library calls are 488.1 'ibsic' and 488.2 'SendIFC'.

Local lockout (LLO)

Sends the local lockout to all devices. The local lockout disables the 'LOCAL' key on all the devices.

Typical device library calls are 488.1 'ibconfig' plus correct option and 488.2 'SendLLO'.

Serial poll

This command will clear any SRQ's and read the status byte of the device.

Typical device library calls are 488.1 'ibrsp' and 488.2 'ReadStatusByte'.

6-7 USING 488.2 GPIB

The IEEE 488.1 GPIB standard was updated in 1987 to 488.2 to better enforce standardization of GPIB communication. This section explains the fundamentals of 488.2 GPIB operation and how it is implemented in the ML2430A Series Power Meter. Refer to the full IEEE 488.2 standard for more detailed information.

488.2 Command Format

All commands should follow the basic format:

<MNEMONIC><white space><comma separated message parameters><terminator>

<white space> = Normally a space character, but can be any of the white space characters listed in the 488.2 manual.

<terminator> = A line feed character (for example, \n in 'C' or VBLF in Visual Basic). An EOI (End Of transmission Interrupt) can be used as the last character instead of the line feed.

Example: AVG A,MOV,64

A number of commands can be put into one program message by separating the commands with semicolons. Example:

CHCFG 1,A;CHCFG 2,B-A;CHUNIT 1,W;CHUNIT 2,DBM;OPMD DIGIT

Status Byte

The 488.2 standard added two extra predefined bits to the status byte, these bits are the Event Status Bit (ESB) and the Message AVailable bit (MAV).

Event Status Bit (ESB) In 488.2 there is an event status register (ESR) that allows the state of the GPIB interface to be monitored. All the bits in this register are defined. These bits are:

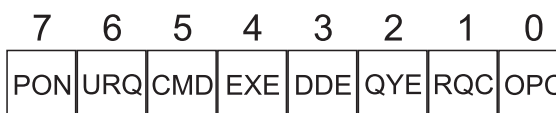

Event Status Register (ESR)

PON	Power On bit. This bit is set on power up of the device only.
URQ	Not used in the ML2430A Series
CMD	Command error. Received an illegal command.
EXE	Execution error. Could not execute a command. For example, a parameter is out of the allowable range, or requesting graph data while in readout mode.
DDE	Device Dependent Error. The specific error can be found by using the ERRLLST command.
QYE	Query Error.
RQC	Request Control. GPIB controllers only.

<p>OPC</p>	<p>Operation Complete. When a program message that includes the *OPC command has been completed, and the GPIB interface is idle, with any responses read out of the output buffer this bit is set. For example, if the last command in a configuration sequence is *OPC, the OPC bit in the event status register will be set when that configuration list has been completed.</p>
------------	--

Also refer to Figure 6-2, page 6-13, *IEEE 488.2 Standard Status Structures*.

If an event causes a bit in the ESR to be set and the corresponding bit in the Event Status Enable byte (ESE) is set, the ESB bit in the status byte will be set. This can cause an SRQ (see Section 6-8) if the ESB bit in the Status Register Enable byte (SRE) is set. For example, to get an SRQ on an unrecognized command do the following:

1. Set the CMD bit in the event status enable byte, and set the ESB bit in the status register enable byte. Send:

```
*ESE 32;*SRE 32
```

2. Now if an unrecognized command is sent to the ML2430A, an SRQ will be given. Send:

```
asdf
```

An SRQ will be indicated.

3. To clear the SRQ do a serial poll, this should return the decimal value 96, bit 6 for the SRQ and bit 5 for the ESB. The SRQ will be cleared.
4. To read the Event Status Register (ESR), send:

```
*ESR?
```

This will put 32 (or 160 if PON is set) in the output buffer to be read.

Message Available Bit (MAV)

This bit is set if there is any data in the output buffer waiting to be read, and can be used to ensure that only the latest reading is used. Upon receiving a request for data, the next reading taken is put in the output buffer. The data in the output buffer should always be read when data is available to ensure that old data is never left behind. The advantage of this method is that if the MAV bit is not set, the controller can not read old data, therefore data can only be read after it has been requested. Example:

1. In Readout display with the output buffer empty and the MAV bit not set, configure the ML2430A to give an SRQ on data becoming available by setting bit 4 in the Status Register Enable byte (SRE):

```
*SRE 16
```

2. Request data from display channel 1 by sending:

0 1

The SRQ will be set with the new reading which will now be in the output buffer ready to be read. The data should now be read so that the MAV bit will be cleared. If the data is not read, or the output buffer not cleared, and another request for data is made this data will be buffered after the previous data.

Getting a Reading

The 488.2 standard requires that the data can only be read from the device after it has been requested. Any data requested from the device is made available to be read, and is stored in an output buffer.

As long as there is data in the output buffer to be read, the Message Available (MAV) bit in the status byte is set. This bit allows data to be requested and, as soon as the data is available, the MAV bit is set, from which a service request can be produced (SRQ).

The ML243X allows this output buffer to be turned off using the BUFF OFF command. In this mode of operation, if a number of data requests are made with out reading the data after each request, only the last data requested is available. Note that this does not include the serial poll request which is handled independently.

6-8 SERVICE REQUEST STATUS (SRQ)

The System Service Request Status byte available over GPIB by a serial poll is defined as follows:

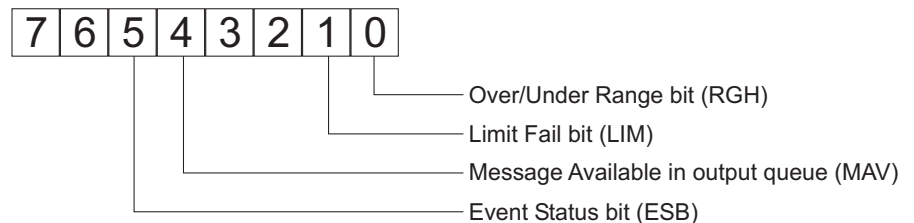

RGH If a sensor goes over or under the operating range, this bit is set. This bit can be used to set an SRQ by setting the same bit in the SRE register using the *SRE command (page 6-102). For more detail, see the STATUS command (page 6-72). This bit can only be cleared by sending a *CLS command (pages 6-12, 6-100).

LIM If a channel pass/fail limit fails, this bit will be set. This bit can be used to set an SRQ by setting the same bit in the SRE register using the *SRE command. For more detail, see the STATUS command. This bit can only be cleared by sending a *CLS command.

MAV If data is available in the output queue, this bit is set. This bit can be used to set an SRQ by setting the same bit in the SRE register using the *SRE command. This bit is only cleared when there is no data waiting to be transmitted.

ESB If any of the event register bits are set and the corresponding event status enable bits are set the ESB bit in the status byte will be set. This bit can be used to set an SRQ by setting the same bit in the SRE register using the *SRE command. The ESB bit is cleared when the ESR is read by using the *ESR? command (pages 6-14, 6-54, 6-101).

6-9 FUNCTIONAL GROUPS

Throughout the ML24XXA (native) mode section of this chapter, the distinctive, white on black text, in the upper corner of each command description area, indicates the Functional Group to which the command belongs (Figure 6-1). All ML24XXA (native) commands are presented by Functional Group in Appendix B, GPIB Quick Reference.

The Functional Groups are:

BNC Commands in this group are used to configure the rear panel BNC inputs and outputs.

CALIBRATION The CALIBRATION group commands are used for the 0.0 dBm reference calibration and zeroing of the power sensors.

CHANNEL The CHANNEL command group controls the configuration of the two channels. When both channels are activated, Channel 1 appears at the top of the display and Channel 2 at the bottom. If one channel is turned off, the remaining channel appears in the center of the screen.

**DATA
OUTPUT** Commands in this function group are used to place data on the GPIB to be read by the controller.

DISPLAY These commands control characteristics of the display, including the peakmeter reading display and contrast adjustments.

GPIB 488.2 This group contains the GPIB 488.2 mandatory commands. Refer to the IEEE 488.2-1987 Standards documents for further information.

GPIB SETUP The commands in this group control the GPIB Address, GPIB command set emulation mode (ML24XXA, ML4803A or HP Emulation), and other parameters.

**GPIB
TRIGGER** Commands in this group are used to configure GPIB triggering and setup the GPIB Group Execute Trigger (GET) and TR commands (TR0, TR1, TR2, TR3). Note that these commands are exclusive to GPIB, and do not have equivalent front panel operations.

**PROFILE
SETUP** The PROFILE SETUP function group commands change how the profile is displayed on the screen. Note that the Display Trigger configuration commands (DTRGD and GRPRD) in this group do not change how the system triggers, only where the graph is drawn after a trigger has occurred. Refer to the TRIGGER group functions to configure the measurement triggering.

- SENSOR** The SENSOR group commands select the data acquisition controls for the selected sensor.
- SYSTEM** The SYSTEM group commands control the overall functionality of the ML2430A Series Power Meter, including the system operation mode, cursor control, display configuration, sound, printing, battery control and status, rear panel configuration, graphics, system security, and system identity.
- TRIGGER** The TRIGGER group functions are used to program the triggering of measurement data. TRIGGER group commands are available in PROFILE operation mode, and in READOUT mode if the SENSOR|SETUP|MODE submenu is set to CUSTOM.

In CUSTOM, the channels are triggered simultaneously if the trigger conditions are set to 1 and 2. This guarantees the trigger conditions are the same, and therefore the readings are valid if taken at the same time.

Changes to the trigger configurations can be made using these GPIB commands regardless of the power meter operating mode, but will not come into play until the unit is configured to use triggers.

6-10 **ML24XXA NATIVE COMMANDS** This section provides an alphabetical listing of the GPIB commands (mnemonics) used to program the Model ML2430A Series Power Meter in ML24XXA (native) mode. The emulation mode can be set through the front panel SYSTEM|more|more|Rear panel|GPIB|MODE menu (see Chapter 4, Operation) or through the GPIB command EMUL (page 6-35).

All ML24XXA (native) GPIB commands that use parameters must have a space between the command header and the first parameter, and all subsequent parameters must be separated by a comma (,). Multiple commands may be sent on the same line, but must be separated by a semicolon (;).

The format for ML24XXA (native) GPIB commands is:

<command header><space><parameter 1>,<parameter n>,...

The end of the command text must be terminated with a line feed character (0Ah, decimal 10) or a GPIB End of Transmission State (EOI), or both.

*CLS Clear GPIB status bytes

GPIB 488.2

Syntax: *CLS

Remarks: This command performs a status data structure clear command. The event status register and the status register are cleared except for the MAV bit. *CLS does not clear the output buffer.

*ESE Event Status byte Enable

GPIB 488.2

Syntax: *ESE <val>

val: 8-bit mask

Remarks: Sets the Standard Event Status Enable Register bits (see Figure 6-2):
 Bit 7: Power ON, when there has been a transition from a power OFF state to a power ON state.
 Bit 5: Command Error. This bit is set when an incorrect GPIB code is sent to the power meter.
 Bit 4: Execution Error. This bit is set when incorrect data is sent to the power meter, e.g., ADDR 57 would result in an Execution Error as the allowable address value range is 1 to 30.
 Bit 3: Device Dependent Error (DDE). This bit is set true whenever a measurement error occurs. Device Dependent Errors are:
 ZERO fail - Zero attempted for a sensor and failed.
 CAL 0 dBm fail - 0 dBm value to far out.
 Display channel number goes out of displayable range -
 Displayable range is +99.999 to -99.999 dBm.
 Illegal log calculation for a channel - When a channel input

configuration combines sensors, the combination is done in linear units. If the result of the combination produces a negative linear value and the displayed units are log (i.e., dB) this would be an illegal logarithmic operation.
 Printer error - A print was requested and this error was returned.
 Request for data from a channel with no sensor connected.

Bit 0: Operation Complete. This bit is set when the *OPC command completes and can be used to tell the controller the unit has completed those commands just sent. See *OPC and *OPC? for more details.

All other bits are not used. The bits above are 488.2 common bits. The ERRLLST command will return an error list giving the state of the DDE causes.

Related Commands: *ESR?, *ESE?, ERRLLST

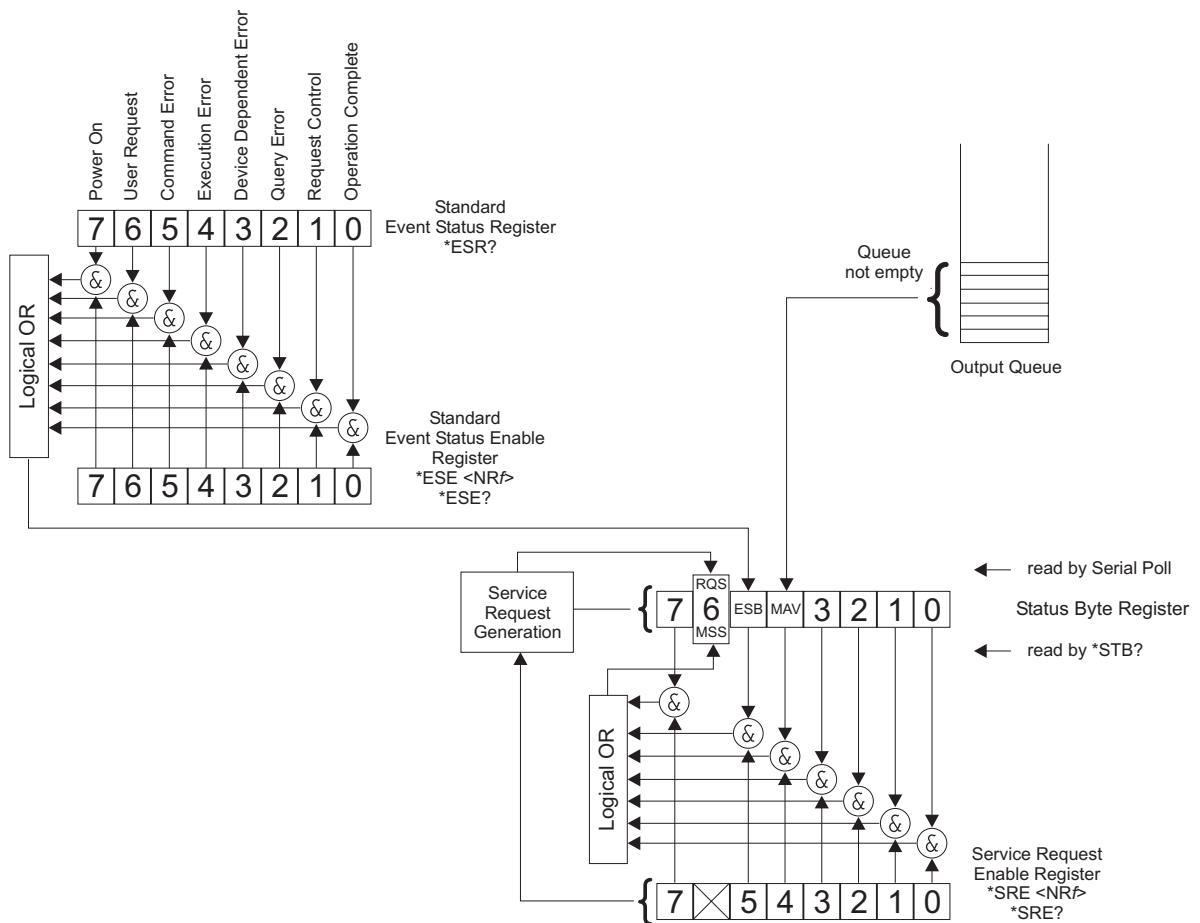

Figure 6-2. IEEE 488.2 Standard Status Structures

*ESE?	Return Event status register enable mask	GPIB 488.2
	Syntax: *ESE?	
	Remarks: Returned format: <unsigned character> When converted to an 8-bit binary number, this byte yields the bit settings of the register.	
*ESR?	Event status register request	GPIB 488.2
	Syntax: *ESR?	
	Remarks: Return the value of the standard event status register. Afterwards the event status register are cleared. The returned format is: <unsigned character>. When converted to a 8-bit binary number, this byte yields the bit settings of the register.	
*IDN?	Request device identification	GPIB 488.2
	Syntax: *IDN?	
	Remarks: Returned format: <Company name>,<model>,<serial>,<firmware version>	
*OPC	Operations complete	GPIB 488.2
	Syntax: *OPC	
	Remarks: The ML2430A Series generates the OPC event in the standard event status register when all pending operations have finished. An operation is complete when all input messages before the command have been completed and any responses have been read out of the output buffer.	
	Example: RGH A, 1; RGH B, 3; *OPC	
	Will set the Operations Complete bit in the Event Status Register once the Range Hold commands have completed.	
*OPC?	Operations complete Output '1'	GPIB 488.2
	Syntax: *OPC?	

Remarks: Places a single ASCII character '1' on the GPIB output queue when the conditions for the *OPC command are met. An operation is complete when all input messages before the command have been completed and any responses have been read out of the output buffer.

Example: RGH A, 1; RGH B, 2; *OPC?

Returns a '1' on the GPIB output when it has finished setting the range hold commands.

*RCL Recall a stored setup **SYSTEM**

Syntax: *RCL <val>

val: 1 to 10

Remarks: The ML2430A Series can store up to 10 instrument configurations for convenient recall. The configuration parameters stored are: Sensor Setup, Channel Setup, and Trigger Setup. This command sets the ML2430A Series to a configuration previously stored in memory locations 1 through 10. Trying to recall a setup that has not been saved will set the execution bit in the event register (EXE in ESR).

**Related
Commands:** *SAV

*RST Reset Device **GPIB 488.2**

Syntax: *RST

Remarks: Resets the ML2430A Series to the default configuration (see Appendix A, Section A-3). Offset tables are not cleared. The GPIB address and emulation settings are not changed, and the input queue, output queue, and status registers on the GPIB are not cleared. This command produces the same result as the front panel key sequence System|Setup|PRE-SET|RESET.

*SAV Save configuration **SYSTEM**

Syntax: *SAV <val>

val: 1 to 10

Remarks: Saves the configuration of the power meter into the memory location specified. Sensor Setup, Channel Setup, and Trigger Setup are saved along with all other instrument parameters.

**Related
Commands:** *RCL

*SRE Setup service request enable register **GPIB 488.2**

Syntax: *SRE <val>

val: 8-bit mask

Remarks: Sets the Service request enable register bits.

*SRE? Return Service Request Enable register **GPIB 488.2**

Syntax: *SRE?

Remarks: Returns the Service Request Enable register.

*STB? Return Status Byte register **GPIB 488.2**

Syntax: *STB?

Remarks: Returns the status byte value with bit 6 replaced with the MSS value. MSS is the GPIB Master Summary Status, and indicates that the device has at least one reason for requesting service. Although the MSS message is sent in bit position 6 of the device's response to the *STB? query, it is not sent in response to a serial poll and should not be considered part of the IEEE 488.1/2 status byte. MSS = the Status Byte (STB) OR'ed with the Service Request Enable register (SRE). Unlike the *ESR? Command, this command does not clear the register afterwards.

*TRG Perform the GPIB 'Group Execute Trigger' command **GPIB 488.2**

Syntax: *TRG

Remarks: Performs a 'GET' command. The GT0, GT1 and GT2 commands set the response to the GET or *TRG commands. When the ML2430 Series is triggered using this command or the 488.1 hardware trigger, a trigger and output for each display channel that is not OFF gives a response in the output queue. If both display channels are displayed, there will be two messages in the output queue to be read out.

**Related
Commands:** GT0, GT1, GT2

*TST? Self Test GPIB 488.2

Syntax: *TST?

Remarks: Performs a self test and returns 'PASSED' or 'FAILED.'
NOTE: This command will restart the sweep in Power vs. Time mode.

**Related
Commands:** STERR

ADDR Change GPIB address GPIB SETUP

Syntax: ADDR <val>

val: 1 to 30

Remarks: Once the address has been changed, the ML2430A Series will no longer respond to the old address. The power meter default address is 13.

Query: ADDR?

**Returned
String:** ADDR <val>

AVG Sets up averaging for a sensor. SENSOR

Syntax: AVG <s>, [<mode>], [<val>]

s: A or B
mode: OFF
MOV Moving
RPT Repeat
AUTO Automatic

val: ASCII string representing an integer, 1 to 512.

Remarks: MOVING average gives an update to the meter every sample/gate (normally 20 ms).

REPEAT averaging only returns a reading when the number of readings specified by <val> have been taken (1-512).

AUTOMATIC averaging uses a MOVING type of average. The display updates at approximately 100 ms intervals, however the data is available at the full rate. The display is slowed down to prevent jitter and allow the user to follow the update. Since AUTOMATIC averaging automatically chooses an average number with the averaging mode set internally to MOVING, the USER averaging number is not used. However, if a value is entered in the

same command as the one which changes to AUTO averaging, it will also update the USER averaging number.

Example: AVG A, AUTO, 64

This command will set the system to AUTO averaging and the USER averaging number to 64. But, the Auto Averaging measurement system does not use the USER averaging number.

NOTE

The AVG mnemonic can be sent to just change the <mode> of averaging (MOV, REPEAT etc.) without sending a number, but there must be a following COMMA to indicate the <val> parameter is not being sent. See the first example below.

The AVG mnemonic can also be sent to just change the User Average Number <val> (1 to 512) without changing the averaging mode, but there must be a COMMA to indicate the <mode> parameter is not being sent. See the last example below.

Examples: AVG A, AUTO,

Change Sensor A to Auto Averaging (note following comma to indicate the <val> parameter is not being sent).

AVG A, AUTO, 64

Change Sensor A to AUTO and the User Average Number to 64.

AVG A, MOV, 32

Change sensor A to MOVing average and the User Average number to 32.

AVG A, RPT,

Change sensor A to RePeaT average and keep the User Average number as 32.

AVG A, , 128

Change sensor A User Average number to 128, but keep the previously set averaging mode (note comma to indicate the <mode> parameter is not being sent).

Query: AVG? <S>

Returned

String: AVG <S>,<MODE>,<VAL>

AVGLL	Auto low level averaging	SENSOR
	<p>Syntax: AVGLL <s> , <mode></p> <p style="margin-left: 20px;">s: A or B</p> <p style="margin-left: 20px;">mode: OFF LOW MEDIUM HIGH</p> <p>Remarks: Sets the low level averaging window for the sensor. At resolution settings of 0.01 and 0.001dB, digital readouts may flicker due to the high reading rate of the ML2430A Series. Low level averaging applies a low pass filter to post-average data readings to achieve a more stable front panel display without slowing down the response of the meter to larger changes in level. The three windows for LOW, MEDIUM and HIGH low level averaging are ± 0.01, 0.02, and 0.05 dB.</p> <p>For example: When a LOW setting of low level averaging is applied while stepping from 0 dBm to -1 dBm, the meter displays the final reading within 0.01dB with no delay. The final settling of 0.01dB will settle over a short subsequent period of time, leading to a stable high resolution readout.</p> <p>With a HIGH setting of low level averaging, the settling window is increased (up to approximately 0.05 dB) and the settling time is longer.</p> <p>With low level averaging OFF, the meter displays the final reading instantly with no further settling observed. Any jitter due to noise is reflected in the displayed reading, which may be inconvenient for high resolution readings.</p> <p>Example: AVGLL A,HIGH</p> <p>Query: AVGLL? <S></p> <p><i>Returned String:</i> AVGLL <S>,<MODE></p>	
AVGM	Manual Averaging	SENSOR
	<p>Syntax: AVGM <s></p> <p style="margin-left: 20px;">s: A or B</p> <p>Remarks: Changes the averaging of the sensor to 'Moving' averaging mode from 'Auto' Averaging. The average number is set to the same value that the 'Auto' averaging mode was using internally. If the sensor is not presently in auto averaging mode, this command is ignored.</p>	
BAUTS	Battery Auto Turn OFF	SYSTEM

Syntax: BAUTS <state>

state: ENABLE or DISABLE

Remarks: Enable/disable the battery auto power shut off.
NOTE: Although GPIB is not available under battery operation, the state of this parameter can be changed for later use.

Query: BAUTS?

Returned

String: BAUTS <state>

BAUTT Battery Auto shut off after x minutes

SYSTEM

Syntax: BAUTT <val>

val: 10 to 240 minutes

Remarks: Automatically turns the unit off after x minutes when operating on battery power.
NOTE: Although GPIB is not available under battery operation, the state of this parameter can be changed for later use.

Query: BAUTT?

Returned

String: BAUT <val>

BUFF GPIB response buffering enabled

SYSTEM

Syntax: BUFF <s>

s: ON
OFF

Remarks: If BUFF is ON: In the ML243X native mode, 488.2 GPIB operation, when a request for data is made the response is put in an output buffer ready to be read by the controller. If another data request is made and the previous data has not been read out of the output buffer; the new data is queued after the original request. In this mode of operation the GPIB response buffering enable is ON, and following the 488.2 specifications when ever a request for data is made the response should be read.

If BUFF is OFF: In this mode when ever a request for data is made, (except by serial poll) the output buffer is cleared and the only data in the output queue will be the response to the last data request made. The output buffer is cleared once a valid GPIB data request command has been recognised.

NOTE

If the buffering enabled is set to OFF and '*OPC?' is used, the '*OPC?' will clear the output buffer of any previous response data so only the '1' will appear.

CAL	Cal sensor to 0 dBm reference	CALIBRATION
	<p>Syntax: CAL <s></p> <p>s: A or B</p> <p>Remarks: Performs a 0dBm calibration when the sensor is attached to the reference 0 dBm source on the ML2430A Series (or another 0 dBm reference source). If the calibration fails, the 'execution error' bit in the Event Status Register is set.</p>	
CFADJ	Cal Adjust	SENSOR
	<p>Syntax: CFADJ <s>, <units>, <val></p> <p>s: A or B</p> <p>units: %, PCT, DB, or DBM</p> <p>val: .07 to 150% +31.55 to -1.76dB</p> <p>Remarks: Sets a calibration factor to be used when performing a 0 dBm calibration and the calibration factor source is set to 'Manual.' This value is the only factor applied when performing a 0 dBm calibration. If the sensor calibration factor source is set to V/GHz or Frequency, the sensor internal EEPROM correction value at 50 MHz is used.</p> <p>Examples: CFADJ A, %, 99 Sets the calibration factor to 99% for sensor A.</p> <p>CFADJ A, DB, 0.2 Sets the calibration factor to 0.2dB for sensor A.</p> <p>Query: CFADJ? <s></p> <p><i>Returned String:</i> CFADJ <s>,<units>,<val></p>	
CFCAL	Cal factor manual setting	SENSOR
	<p>Syntax: CFCAL <s>, <units>, <val></p> <p>s: A or B</p> <p>units: %, PCT, DB, or DBM</p>	

val: .07 to 150%
+31.55 to -1.76dB

Remarks: If the Cal factor source is set to manual, this is the calibration factor number used.

Example: CFCAL A, %, 99
Sets the calibration factor to 99% for sensor A.
CFCAL A, DB, 0.2
Sets the calibration factor to .2 dB for sensor A.

Query: CFCAL? <s>

Returned

String: CFCAL <s>,<units>,<val>

CFFRQ Cal Factor Frequency value

SENSOR

Syntax: CFFRQ <s>, <value>[units]

s: A or B
value: 10 kHz to 122 GHz

Remarks: Sets the frequency used to look up the correction data from the sensor's internal table.

Examples: Both of the following examples set the frequency for cal source frequency to 25 GHz for sensor A.

CFFRQ A,25E9
CFFRQ A,25GHZ

Query: CFFRQ? <s>

Returned

String: CFFRQ <s>,<value>

CFSRC Cal factor source

SENSOR

Syntax: CFSRC <s>, <source>

s: A or B
source: FREQ
MAN
VGHZ

Remarks: Sets the source of the calibration factor. Frequency uses the internal EE-PROM calibration factor value in the sensor, from the frequency set by the CFFRQ number. Frequencies between Cal Factor data points are interpolated linearly to 0.01 dB resolution.

Manual uses the CFCAL number itself.
 VGHz takes the frequency from the V/GHz input and uses it to look up the calibration factor from the EEPROM in the sensor.

Related

Commands: CFVAL

Query: CFSRC? <s>

Returned

String: CFSRC <s>,<source>

CFUADD Add an entry pair to a cal factor table

SENSOR

Syntax: CFUADD <s>,<table number>,<frequency value>[units],
 <cal factor>,<cal factor units>

s: A or B

table

number: 1 to number of tables supported by the sensor type

frequency

value: 10 kHz to 122 GHz

cal factor: 0.07 to 150%

31.55 to -1.76 dB

cal factor

units: %, PCT, DB, or DBM

Remarks: Adds an entry pair to a cal factor table. This only affects the copy of the cal factor table stored in the memory of the power meter. Cal factors entered with this command will be available for use by the DSP, but will NOT be saved to the sensor until a save command (CFUSAV) is executed. If the sensor is changed or power is lost before saving, all changes made since the last CFUSAV will be lost.

The user must ensure that the maximum number of cal factor data pairs entered into a table is not exceeded. Sensors with a maximum frequency of up to 40 GHz will hold 90 pairs, while sensors with a maximum frequency of 50 GHz will hold 110 pairs.

Related

Commands: CFUSAV

CFUCT Clear cal factor table

SENSOR

Syntax: CFUCT <s>,<table number>

s: A or B

table

number: 1 to number of tables supported by the sensor type

Remarks: Clears the cal factor table to one entry for 50 MHz at 100%, but does not clear the identity of the table. The cleared table is automatically saved to the sensor.

CFUID Cal factor table identity update

SENSOR

Syntax: CFUID <s>,<table number>,<identity>

s: A or B

table

number: 1 to number of tables supported by the sensor type

identity: Seven characters or until a message terminator will be read as the identity.

Remarks: Updates the seven character identity string. This only affects the copy of the cal factor table stored in the memory of the power meter. To take affect and not be lost, the table must be saved to the sensor using the CFUSAV command.

Query: CFUID? <s>,<table number>

Returned

String: CFUID <s>,<table number>,<identity>

CFUNITS Cal factor display units

SENSOR

Syntax: CFUNITS <s>,<units>

s: A or B

units: % or PCT

dB or dBm

Remarks: This command changes the display units of the cal factors between either dB or percentage. Note that this will also set the form the data is output over the GPIB (or RS232) when requested.

Query: CFUNITS? <s>

Returned

String: CFUNITS <s>,<units>

CFULD Cal factor table binary load

SENSOR

Syntax: CFULD <s>,<table number>,<length>,<binary data>

s: A or B

table

number: 1 to number of tables supported by the sensor type

length: Length of message in bytes

binary data:

Same data as that received by CFURD

Remarks: Loads binary data into the cal factor table. This command will automatically save the data to the sensor.

CFUPT Preset cal factor table

SENSOR

Syntax: CFUPT <s>,<table number>

s: A or B

table

number: 1 to number of tables supported by the sensor type

Remarks: Presets the cal factor table to the factory settings. The preset table is automatically saved to the sensor. For a universal sensor, separate cal factor tables exist for option 1 (when fitted) and normal operation. This function will preset the table relating to the currently selected mode.

CFURD Cal factor table binary read

SENSOR

Syntax: CFURD <s>,<table number>

s: A or B

table

number: 1 to number of tables supported by the sensor type
F for the factory default table

Remarks: This command outputs the cal factor table in binary mode in the following form:

CFURD<space><length of binary data>,<binary data>

<length of binary data>: Total length of the binary data message, in bytes, after the comma.

<binary data>: Made up of :

- a. 8 bytes; 7 for the identity, plus a NULL terminator
- b. 2 bytes representing the number of table pair entries
- c. The cal factor table data in binary form. The binary data is output in entries which are frequency/factor pairs of six bytes. The frequency is held in 32768e-6LONG format and the cal factor in 1024INT format.

To convert these into real numbers the first four bytes of an entry are read into a LONG variable, cast to a float and then divided by 32768e-6 to give a frequency. The last two bytes are then read into the low bytes of a LONG then cast to a float and divided by 1024. The C programming example 'Binary output decoding' on page 6-133 shows how to extract the binary data.

This message can be manipulated to program a different table using the CFULD command.

CFUSAV Cal factor table save

SENSOR

Syntax: CFUSAV

Remarks: This command saves the cal factor table currently being edited to the appropriate sensor. Processing may take a couple of seconds. Any command that can select a new sensor and/or cal factor table for changing, will not automatically save any previous changes made. It is the users responsibility to issue a CFUSAV command.

CFUSEL Select cal factor table

SENSOR

Syntax: CFUSEL <s>,<table number>

s: A or B

table

number: table number or combination to use

0 = factory default table

1 to 10 = user table being used

11 to 20 = factory table + user table being used

Remarks: Selects the cal factor table or combination of tables to be used and automatically updates the sensor.

Example: CFUSEL A,13

Selects the factory table plus user table 3 in sensor A.

CFUTBL Number of cal factor tables in the sensor

SENSOR

Syntax: CFUTBL <s>

s: A or B

Remarks: Returns the number of cal factor tables available in the selected sensor.

CFUUSE Number of cal factor table being used

SENSOR

Syntax: CFUUSE <s>

s: A or B

Remarks: Returns a number indicating the cal factor table, or combination of tables, being used by the selected sensor. Possible returned values are:

- 0 = factory default table
- 1 to 10 = user table being used
- 11 to 20 = factory table + user table being used

CFUULD Valid cal factor table check **SENSOR**

Syntax: CFUULD <s>,<table number>

s: A or B

table

number: 1 to number of tables supported by the sensor type

Remarks: Returns a TRUE if the table number passed is a valid initialized table for the selected sensor. Returns a FALSE if it is not.

CFVAL Current cal factor value **SENSOR**

Syntax: CFVAL <s>

s: A or B

Remarks: Returns the cal factor value currently being used for the specified sensor. This will be a fixed value only when in MANUAL cal factor mode, otherwise the value will depend on the frequency entered when cal source is FREQUENCY and the scaled frequency when the cal source is V/GHz.

CFVAL will not return the updated Cal Factor Value if the system is in TR0 Trigger Hold mode. That is, if you change the Cal Factor Frequency and want to read back what the unit has set the Cal Factor to when the system is in TR0 mode, the system will return the last Cal Factor value before you went into TR0 mode.

Also, you may have to wait for approximately 0.25 seconds after you change the Cal Factor Frequency to read back the Cal Factor Value even when not in TR0, as CFVAL is not updated instantly after you change the Cal Factor Frequency.

This restriction only applies to the CFVAL GPIB command and does not effect any measurement taken. If you are in TR0 mode, change the Cal Factor Frequency, and then take a measurement the Cal factor will be calculated correctly.

Related

Commands: CFSRC, CFFRQ

CHCFG Channel input configuration

CHANNEL

Syntax: CHCFG <c>, <config>

c: 1 or 2
config: OFF,
A, B, V
A-B, B-A
A/B, B/A

Remarks: A, B, V = Sensor A, Sensor B, or External Volts
(If V is sent when in Profile or Source Sweep mode, an execution error will occur.)
A-B, B-A = Sensor A minus Sensor B, Sensor B minus Sensor A
A/B, B/A = Sensor A divided by Sensor B, Sensor B divided by Sensor A

Example: To set channel 2 to A-B:

CHCFG 1,A-B

Query: CHCFG? <c>*Returned**String:* CHCFG <c>,<config>

CHRES Set channel decimal point resolution

CHANNEL

Syntax: CHRES <c>, <val>

c: 1 or 2
val: 1 to 3

Remarks: Set the number of decimal places displayed for the specified channel. For example, specifying CHRES 1, 1 would yield a display of 1.5 dBm; CHRES 1, 2 would yield 1.47 dBm; CHRES 1, 3 would yield 1.468 dBm. If the number to be displayed is too large for the number of decimal places selected, the decimal places displayed will be reduced so that the display value can be shown.

Query: CHRES? <c>*Returned**String:* CHRES <c>,<val>

CHUNIT Set Channel units

CHANNEL

Syntax: CHUNIT <c>, <units>

c: 1 or 2

units: W (Watts)
 DBM (dB)
 DBUV (dB μ V)
 DBMV (dBmV)

Remarks: DBM 0dB is equal to 1mW readout mode
 W = Watts readout mode
 V = Volts readout mode. This selection is automatically made when the channel input configuration is set to External volts (EXT V).
 DBUV = dB μ V, 0dB is equal to 1 μ V in readout mode.

Query: CHUNIT? <c>

Returned

String: CHUNIT <c>,<units>

When the channel input configuration is set to External volts (EXT V), the returned units are always volts, irrespective of what units have been set.

CONT Continue

GPIB SETUP

Syntax: CONT

Remarks: This command will allow the system to continue the startup sequence if there are self test failures other than DSP errors.

Related

Commands: STERR, START

CUR Cursor in Power vs. Time and Source Sweep modes

SYSTEM

Syntax: CUR <cursor>,<fval>

cursor: 1 or 2

fval: 0.0 to 1440 minutes (24 hours) in Power vs. Time mode

In Source Sweep mode, Power sweep : -120.0 dB to 30.0 dB

In Source Sweep mode, Frequency sweep : 10.0 KHz to 122.0 GHz

Remarks: In Power vs. Time mode, the fval parameter is in minutes. In Source Sweep mode, the fval parameter is in dB or Hz for a power sweep or frequency sweep respectively.

Examples:

Power vs. Time:

Set cursor 1 to 30 seconds: CUR 1,0.5

Set cursor 2 to 12.5 hours: CUR 2,750

Source sweep:

Power Sweep, set cursor 1 to 11.5 dB: CUR 1,11.5

Frequency Sweep, set cursor 2 to 15.6 GHz: CUR 2,15.6GHz

Related**Commands:** GRDDT, SRCSPFRQ, SRCSTFRQ, SRCSTPWR, SRCSPWR

CURLK Link cursors in all graphic modes

PROFILE SETUP

Syntax: CURLK <state>**state:** ON
OFF**Remarks:** Links the two cursors together on the graph. When either cursor moves left or right, the other cursor follows. Subsequent changes to delay will move both cursors.**Query:** CURLK?**Returned****String:** CURLK <state>

CVSPF V/GHz calibration factor stop frequency

SENSOR

Syntax: CVSPF <s>, <val> [units]**s:** A or B
val: 10 kHz to 122 GHz**Remarks:** Sets the stop frequency of the V/GHz calibration factor settings.**Example:** CVSPF A, 20 GHz**Related****Commands:** CVSPV, CVSTF, CVSTV**Query:** CVSPF? <s>**Returned****String:** CVSPF <s>, <val>

CVSPV V/GHz calibration factor stop voltage

SENSOR

Syntax: CVSPV <s>, <val> [units]**s:** A or B
val: -0.5 to 20.5**Remarks:** Sets the stop voltage of the V/GHz calibration factor settings

Related
Commands: CVSPF, CVSTF, CVSTV
Query: CVSPV? <s>
Returned
String: CVSPV <s>,<val>

CVSTF V/GHz calibration factor start frequency **SENSOR**

Syntax: CVSTF <s>,<val>[units]
s: A or B
val: 10 kHz to 122 GHz

Remarks: Sets the start frequency of the V/GHz calibration factor settings.

Related
Commands: CVSPV, CVSPF, CVSTV
Query: CVSTF? <s>
Returned
String: CVSTF <s>,<val>

CVSTV V/GHz calibration factor start voltage **SENSOR**

Syntax: CVSTV <s>,<val>[units]
s: A or B
val: -0.5 to 20.5

Remarks: Sets the start voltage of the V/GHz calibration factor settings.

Related
Commands: CVSPV, CVSPF, CVSTF
Query: CVSTV? <s>
Returned
String: CVSTV <s>,<val>

DBLGHT Battery LCD Back light mode **SYSTEM**

Syntax: DBLGHT <mode>
mode: ON
OFF
TIMED

Remarks: Sets the mode of the LCD backlight when under Battery power.
 ON = back light is ON all the time
 OFF = back light is OFF all the time
 TIMED = back light is on for a limited time period set by the DBLTIM command.

NOTE

Although GPIB is not available under battery operation, the state of this battery-specific parameter can be changed through this GPIB command.

Related

Commands: DBLTIM

Query: DBLGHT?

Returned

String: DBLGHT <mode>

DBLTIM Auto Backlight OFF timer setting

SYSTEM

Syntax: DBLTIM <val>

val: 1.0 to 100.0 minutes

Remarks: Sets the time limit when the backlight will turn off if the DBLGHT setting is set to TIMED.

NOTE

Although GPIB is not available under battery operation, the state of this battery-specific parameter can be changed through this GPIB command.

Query: DBLTIM?

Returned

String: DBLTIM <val>

DCONT Set Display Contrast

DISPLAY

Syntax: DCONT <val>

val: 1 to 10

Remarks: One is the lightest setting, ten the darkest. The default is five.

Query: DCONT?

	<i>Returned</i> <i>String:</i> DCONT <val>	
DCONTD	Set display contrast down by one	DISPLAY
	Syntax: DCONTD	
	Remarks: Make the display lighter by lowering the contrast by one level.	
DCONTU	Set display contrast up by one	DISPLAY
	Syntax: DCONTU	
	Remarks: Make the display darker by increasing the contrast by one level.	
DISP	Display On or OFF	DISPLAY
	Syntax: DISP <state>	
	<i>state:</i> ON or OFF	
	Remarks: When using GPIB measurement, speed can be increased by not updating the display. This command turns off the display and writes REMOTE across the screen. If the LOCAL soft key is pressed, the system reverts to DISP ON. The restrictions of this mode are: 1. Min max values read via the GPIB are not updated. 2. Relative operation is ignored so that the normal value is given. 3. DISP will not operate when sent via RS232.	
	Query: DISP?	
	<i>Returned</i> <i>String:</i> DISP <state>	
DPEAK	Peak meter display	DISPLAY
	Syntax: DPEAK <mode>	
	<i>mode:</i> A B A&B OFF	
	Remarks: Turns the peak meter display on or off for each channel. A = Sensor A only	

B = Sensor B only
 A&B = Sensors A and B displayed at the same time
 OFF = Turns the peak meter display off.

The peak meter display range covers 12 dB. When above the displayed maximum or below the displayed minimum, the range is switched by 10 dB in the appropriate direction.

Note that in the event that the channel is displaying an alternative measurement (e.g., external volts from the rear panel BNC) the peak meter continues to represent the Sensor A and/or B data. This is very useful for monitoring an external voltage on the meter, while peaking up a response being monitored by a sensor (e.g., RF output).

Query: DPEAK?

Returned

String: DPEAK <mode>

DTRGD Display Trigger Delay

PROFILE SETUP

Syntax: DTRGD <val>

val: 0.0 to 7.0 seconds

Remarks: The delay time from the trigger point to when the profile starts to be drawn (refer to Figure 4-4, page 4-20).

Example: DTRGD 1.25MS Sets the display trigger delay to 1.25 ms.

Query: DTRGD?

Returned

String: DTRGD <val>

DUTY Duty cycle

SENSOR

Syntax: DUTY <s>, <duty_cycle>

s: A or B

duty cycle: 0.1 to 100%

Remarks: Applies a duty cycle to the selected sensor. An offset will be applied based on the entered value.

Example: DUTY A,50

Specifies a duty cycle of 50% that will alter the displayed readings by approximately +3.01 dB.

Related**Commands:** DUTYS**Query:** DUTY? <s>**Returned****String:** DUTY <s>,<duty cycle>

DUTYS Duty cycle state

SENSOR**Syntax:** DUTYS <s>,<state>**s:** A or B**state:** ON or OFF**Remarks:** Turns on or off the duty cycle for the selected sensor.**Related****Commands:** DUTY**Query:** DUTYS? <s>**Returned****String:** DUTYS <s>,<state>

EMUL GPIB emulation mode

GPIB SETUP**Syntax:** EMUL <mode>**mode:** ML24XX (Anritsu ML2430A Series native mode)
HP436A (Hewlett-Packard)
HP437B (Hewlett-Packard)
HP438A (Hewlett-Packard)
ML4803 (Anritsu ML4803A Series)**Remarks:** Set the GPIB emulation to emulate other types of power meters. This command is available in any emulation mode, and resets the whole GPIB interface when the emulation mode is changed.

When selecting GPIB emulation modes, the instrument configures itself to the preset conditions of the instrument to be emulated. For example, when selecting HP 438A emulation, the front panel menus pass through the presets for the HP 437B (which presets sensor A to dBm) then selects HP 438A emulation (which presets sensor A to Watts).

ENTERR Entry Error beep

SYSTEM

Syntax: ENTERR <state>

state: ON or OFF

Remarks: Turns the user entry error warning beep On or Off.

Query: ENTERR?

Returned

String: ENTERR <state>

ERRLST Returns the DDE error list

DATA OUTPUT

Syntax: ERRLST

Remarks: On detecting a DDE event, this command returns the error list giving the state of the DDE causes. When the error list is read all parts of the list are cleared and will be updated by any further occurrence of the listed events. The ERRLST response is:

ABCDEFGHIJKLMNO!PPPPPP!QQQQQQ!

A = Sensor A Zero state: 0 - ZERO done, 1 - Not done, 2 - Zero failed. (HP error 01)

B = Sensor B Zero state: 0 - ZERO done, 1 - Not done, 2 - Zero failed. (HP error 02)

C = Sensor A CAL state: 0 - Done, 1 - Failed. (HP error 05)

D = Sensor B CAL state, 0 - Done, 1 - Failed. (HP error 06)

E = Sensor A range hold: 0 - OK, 1 - Over range, 2 - Under range. (HP error 17)

F = Sensor B range hold: 0 - OK, 1 - Over range, 2 - Under range. (HP error 18)

G = Display channel 1 reading out of range; 0 - OK, 1 - Over range, 2 - Under range. (HP error 25)

H = Display channel 2 reading out of range: 0 - OK, 1 - Over range, 2 - Under range. (HP error 25)

I = Display channel 1 illegal log operation: 0 - OK, 1 - Error. (HP error 27)

J = Display channel 2 illegal log operation: 0 - OK, 1 - Error. (HP error 27)

K = Printer error: 0 - OK, 1 - Print error, 2 - Buffer full. 3 - Paper out

L = Sensor A fitted and used state: 0 - Fitted, 1 - Not fitted and used

M = Sensor B fitted and used state: 0 - Fitted, 1 - Not fitted and used

N = Display channel 1 limits state: 0 - Passed, 1 - High limit failed, 2 - Low limit failed

O = Display channel 2 limits state: 0 - Passed, 1 - High limit failed, 2 - Low limit failed.

PPPPPP = Last cause of a GPIB command error

QQQQQQ = Last cause of a GPIB execution error.

NOTES

The GPIB command error and GPIB execution error are always enclosed within exclamation marks (!). If no errors have been produced since the last ERRLLST was read, the ERRLLST will end with '!!!'.

When read for the first time after startup, a sensor may be reported as not fitted even though it is. This is because the error condition of a sensor used in a channel configuration was recorded before the sensor initialization was completed.

If a sensor is not used in a channel configuration, it will be reported as Zeroed, although it may not have been. If the sensor is then used in a channel configuration, its zero status will be correctly reported.

Related

Commands: *ESE?, *ESR?

FAST Operate in non-488.2 compliant mode

GPIB SETUP

Syntax: FAST <state>

state: ON or OFF

Remarks: This command allows the system, for speed purposes, to send the present system readings directly to the output, with no buffering at all (obeying the rules sent earlier when talk addressed). GPIB 488.2 rules specify that data should only be given after a request. FAST mode allows data to be read without requesting it first (like the HP 437/8). The following conditions and restrictions apply:

- a. REMOTE is written across the screen, and no screen updates are done.
- b. Sensor data for a single sensor only can be output from display channel 1, according to the following rules:

If the input configuration for display channel 1 is set to either OFF or EXT VOLTS, it is set to 'A' and sensor A data is output if a sensor is connected to input A.

If the input configuration for display channel 1 is set to a sensor combination (A-B, A/B, etc.), the configuration is left as is but only the sensor A data is output.

If the input configuration of display channel 1 is set to 'B', sensor B data is output.

- c. Output from display channel 2 is set to OFF.
- d. Output is in dB only.

- e. Sensor OFFSETS are applied.
- f. Relative is applied if it is set to on before switching to FAST mode, and if display channel 1 is configured for a single sensor and dB units.
- g. No other data output requests are processed while in FAST mode, except for serial poll. FAST mode must be turned off, for example, to ask for the identity data.
- h. FAST mode will not operate when sent via RS232.

FBEEP Fail Beep On/Off

SYSTEM

Syntax: FBEEP <c>, <state>

c: 1 or 2
state: ON or OFF

Remarks: When ON, causes an audio beep every time the limits for the selected channel fail. If FBEEP is ON, and FHOLD is ON, whenever the limits specified for the channel have been exceeded, a beep sounds once every second until FHOLD is turned OFF, or the CLEAR key (CLR) is pressed. The FAIL indication is not affected by the CLEAR key, and can only be cleared by turning FHOLD off. If a limit fail happens again, the alarm sounds again.

**Related
Commands:** FHOLD

Query: FBEEP? <c>

**Returned
String:** FBEEP <c>, <state>

FHOLD Fail indicator Hold

CHANNEL

Syntax: FHOLD <c>, <state>

c: 1 or 2
state: ON or OFF

Remarks: If the high or low limits fail, and this setting is turned on, the fail status continues until the command is turned off. All BNC outputs, beeps and displays continue to be in the 'fail' state until after the OFF is received.

**Related
Commands:** FBEEP

Query: FHOLD? <c>

**Returned
String:** FHOLD <c>, <state>

FROFF Frequency/Offset Display **SYSTEM**

Syntax: FROFF <state>

state: ON or OFF

Remarks: This command turns on the top line information text displaying the frequency and offset for the sensors used, similar to the min-max data display except the left hand data is for sensor A and the right hand is for sensor B. This command is only valid if the sensor cal factor source is set to either frequency or V/GHz, and the sensor is used in a displayed channel.

The display is 'FQ nn.nnGHz OS nnn.nnn' for each sensor.

The frequency (FQ) is the entered frequency if the cal factor source is set to frequency, or the calculated frequency if the cal factor source is V/GHz.

The offset (OS) is the fixed offset if set to fixed, or the offset table interpolated offset value depending on the frequency if the offset for the sensor is set to table. If the offset for that sensor is OFF, dashes are displayed in the OS part of the top line data.

Query: FROFF?

Returned

String: FROFF <state>

FRST Factory Reset **SYSTEM**

Syntax: FRST

Remarks: Resets the ML2430A Series to the factory default configuration (see Appendix A). Unlike the *RST command, the offset tables are cleared and all external interfaces are reset. Note that any settings in the *ESE and *SRE registers prior to this command will be reset. The equivalent front panel key sequence is System|Setup|PRESET|FACTORY.

GMNMX Return the minimum and maximum values **DATA OUTPUT**

Syntax: GMNMX <c>

c: 1 or 2

Remarks: When min/max tracking is turned on, this command is used to read the values. The format returned is:
<min_value>,<max_value>

GPRST Reset min/max graph

PROFILE SETUP

Syntax: GPRST

Remarks: When profile DATA HOLD mode is set to Min/Max points, this command is used to reset the min/max values for each data point.

**Related
Commands:** GRPIX

GRAUTO Auto scaling

SYSTEM

Syntax: GRAUTO

Remarks: Auto scale for all graphic modes (Profile, Source Sweep and Power vs. Time). This command auto scales the y axis only based on the currently displayed data.

GRAVG Average between profile cursors

PROFILE SETUP

Syntax: GRAVG <state>

state: ON or OFF

Remarks: Turns on or off averaging between cursors. The data returned by the GRDRQ command includes the average of all data points between the cursors if GRAVG is turned ON.

**Related
Commands:** GRDRQ

Query: GRAVG?

*Returned
String:* GRAVG <state>

GRCP Connect points on profile

PROFILE SETUP

Syntax: GRCP <state>

state: ON or OFF

Remarks: When set to ON, creates a line graph by connecting the profile data points together. The default is ON.

Query: GRCP?

Returned
String: GRCP <state>

GRDATA Display Graph Cursor Data

PROFILE SETUP

Syntax: GRDATA <state>

state: ON or OFF

Remarks: Display the graph cursor data readout box. GRDATA must be turned on before attempting to execute the GRDRQ command to send the data over the GPIB. If GRDATA is not on, GRDRQ will produce an execution error in the event status register (ESR).

Related
Commands: GRDRQ

Query: GRDATA?

Returned
String: GRDATA <state>

GRDDT Power vs. Time data display time

SYSTEM

Syntax: GRDDT <time>,<units>

time: 1 minute to 24 hours (1440 minutes)

units: MIN (minutes)

HR (hours)

Remarks: Sets the time period of the x axis in minutes or hours. For example, either of the following statements may be used to set the time period to 2.5 hours:
GRDDT 2.5,HR
GRDDT 150,MIN

Query: GRDDT?

Returned
String: GRDDT <time>,<units>

GRDRQ Return Graph Data readout

DATA OUTPUT

Syntax: GRDRQ

Remarks: Returns the values in the graph data box. GRDATA must be turned on before attempting to execute GRDRQ. The result string is:

GRDRQ <channel_number>,<Cursor_1_dB>,<Cursor_2_dB>,<Delta_power>,<Delta_time>[,<Average>]

<Delta_power> and <Delta_time> are absolute values. <Average> is only present when between cursor averaging is turned ON with the GRAVG command.

If no data is available, that is, a sensor is not fitted, the profile is not triggered, or the Power vs. Time graph has not reached to the cursor, the output for the relevant readout value is 999 output as 9.99e2.

Example result strings might look like:

GRDRQ 1, -10.000, -5.000, 5, 1E-03 (cursor average off)

GRDRQ 1, -10.000, -5.000, 5, 1E-03, -7.5 (cursor average on)

Related

Commands: GRAVG, GRDATA

GRFS Profile Reference line state

PROFILE SETUP

Syntax: GRFS <state>

state: ON or OFF

Remarks: Turn the profile reference line ON or OFF. The profile reference line is centered between the top and bottom of the display.

Query: GRFS?

Returned

String: GRFS <state>

GRMD Profile, Power vs. Time and Source Sweep Mode Channel Selection

PROFILE SETUP

Syntax: GRMD <c>

c: 1 or 2

Remarks: Selects the channel displayed on the Profile, Power vs. Time and Source Sweep graphs.

Query: GRMD?

Returned

String: GRMD <c>

GRPIX Profile type

PROFILE SETUP

Syntax: GRPIX <mode>

mode NORM
 MINMAX
 MIN
 MAX
 AVG

Remarks: Changes the type of graph displayed:
 NORM: Profiles the sensor readings vs. time from the triggered point.
 MINMAX: Plots both the MIN and MAX values for each point on the graph. If connect points (GRCP) is ON, a vertical bar is drawn between the min and max points.
 MIN: Same as NORM, but each point is the minimum value that point has achieved.
 MAX: Same as NORM, but each point is the maximum value that point has achieved.
 AVG: This position plotted on the chart for an x-axis time slot is the average of all the readings during that x-axis time slot period, and is only available in Power vs. Time mode.

Query: GRPIX?

Returned

String: GRPIX <mode> (Mode can be AVG in Power vs. Time mode.)

GRPRD Profile data collection period

PROFILE SETUP

Syntax: GRPRD <val>[units]

val: 100 ns to 7 seconds

Remarks: Sets the time the system will collect data for and scale into the profile graph after a trigger event.

Example: GRPRD 20US sets the data collection period to 20 microseconds.

Query: GRPRD?

Returned

String: GRPRD <val>

GRPTP Graph Pretrigger Percentage

PROFILE SETUP

Syntax: GRPTP <val>[units]

val: 0 to 100

units: PCT

Remarks: Sets the pre trigger percentage of the profile screen. The percentage of the data collection period that shows pretrigger information if the display trigger delay is 1/PRF.

Query: GRPTP?

Returned

String: GRPTP <val>

GRSWP Graph Averaging Number for Profile or Source Sweep

PROFILE SETUP

Syntax: GRSWP <s>, <val>

s: A or B

val: 1 to 512

Remarks: If GRSWS is set to ON, the points on the graph represent the averaged value of that point against its averaged value since either the graph averaging was reset, or since it was turned on.

Related

Commands: GRSWR, GRSWS

Query: GRSWP? <s>

Returned

String: GRSWP <s>, <val>

GRSWR Reset Graph Averaging for Profile or Source Sweep

PROFILE SETUP

Syntax: GRSWR

Remarks: If the Graph averaging mode in ON, this command resets the data points and restarts the averaging.

Related

Commands: GRSWP
GRSWS

GRSWS Graph Average State for Profile or Source Sweep

PROFILE SETUP

Syntax: GRSWS <state>

state: ON or OFF

Remarks: Turns Graph Averaging on or off.

Related Commands: GRSWP
GRSWR

Query: GRSWS?

Returned String: GRSWS <state>

GRTMM Profile Min/Max tracking mode

PROFILE SETUP

Syntax: GRTMM <mode>

mode: SINGLE
INFINITE

Remarks: Set Minimum and maximum tracking mode between the cursors.
SINGLE: Resets min and max values after each sweep.
INFINITE: Never resets the min and max values. The min & max values are updated after each sweep.
NOTE: The INFINITE tracking mode can be reset using the MMRST command.

Related Commands: MMRST

Query: GRTMM?

Returned String: GRTMM <mode>

GRYB Set graph Y-axis bottom scale

PROFILE SETUP

Syntax: GRYB <val>

val: -150.0 to +250.0

Remarks: It is not necessary to specify units as the displayed units are always assumed. Profile and Source Sweep modes always use dBm, but Power vs. Time mode can also use dB μ V or dBmV.

Query: GRYB?

Returned String: GRYB <val>

GRYT Set graph Y-axis top scale

PROFILE SETUP

Syntax: GRYT <val>

val: -150.0 to +250.0

Remarks: It is not necessary to specify units as the displayed units are always assumed. Profile and Source Sweep modes always use dBm, but Power vs. Time mode can also use dB μ V or dBmV.

Query: GRYT?

Returned

String: GRYT <val>

GT0 Set to ignore the Group Execute Trigger (GET) GPIB common command

GPIB TRIGGER

Syntax: GT0

Remarks: The ML2430A Series will ignore the GET command or a *TRG.

Related

Commands: *TRG, Group Execute Trigger (GET), GT1, GT2

GT1 Set 'GET' command to TR1 type (immediate) trigger

GPIB TRIGGER

Syntax: GT1

Remarks: When the ML2430A Series receives a GET or *TRG command, the system will perform a TR1-type trigger command.

Related

Commands: *TRG, Group Execute Trigger (GET), GT0, GT2

GT2 Set 'GET' command to TR2 type (settling delay) trigger

GPIB TRIGGER

Syntax: GT2

Remarks: When the ML2430A Series receives a GET or *TRG command, the system will perform a TR2-type trigger command.

Related

Commands: *TRG, Group Execute Trigger (GET), GT0, GT1

GTARM Set profile trigger arming

TRIGGER

Syntax: GTARM <state>

state: ON or OFF

Remarks: Sets the profile trigger arming ON or OFF. If set to ON, the system first checks to see if the BNC sweep blanking input is TRUE before it starts to trigger. If set to OFF, the system triggers on whatever trigger source it has been set up for.

Query: GTARM?

Returned

String: GTARM <state>

GTDLY Set profile trigger sample delay

TRIGGER

Syntax: GTDLY <val> [units]

val: 0.0 to 1.0 seconds

Remarks: Sets the time delay after the display trigger delay to when the system starts to take readings and displaying them. This point is represented by the left most cursor.

NOTE

Changing the left most cursor or trigger delay time updates either the cursor or the delay time value.

Query: GTDLY?

Returned

String: GTDLY <val>

GTGW Set profile trigger gate width

TRIGGER

Syntax: GTGW <val> [units]

val: 100ns to 7.0 seconds

Remarks: Sets the time the system uses to perform whatever calculations are set up. The time interval is represented by the space between the left most cursor and the right most cursor. Changing either cursor, or the Gate width value, will update both the cursors and the gate width value. The default gate width value is 20 ms.

Query: GTGW?

Returned

String: GTGW <val>

GTLVL Set profile trigger level

TRIGGER

Syntax: GTLVL <val>

val: -30 to +20 dBm

Remarks: When the system trigger in profile mode is set to either INTA or INTB (internal sensor A or B) it will trigger on a power level given by the sensor. This command sets the level.

Related

Commands: GTSRC, GTTYP

Query: GTLVL?

Returned

String: GTLVL <val>

GTSRC Set Profile Trigger source

TRIGGER

Syntax: GTSRC <source>

source: INTA
INTB
EXTTTL
MANUAL
CONT

Remarks: INTA = internal sensor A
INTB = internal sensor B
EXTTTL = external BNC TTL trigger input
MANUAL = manual push button trigger
CONT = continuous

MANUAL trigger only functions correctly on non-repetitive sampling, i.e., the PROFILE PERIOD needs to be 6ms or greater.

The display shows an 'x' marking the trigger point. This trigger point mark rotates as the profile data is updated, changing between 'x' and '+' on each data update. On rapid updates, the trigger point mark may appear like a star (*), as it is rotating so quickly. In manual, external or GPIB triggered displays, the mark rotates at a slower rate and each true data update can be seen.

The GTSRC setting is overridden by the Group Execute Trigger GPIB common command (GET), *TRG, TR0, TR1 and TR2 commands. The TR3 command will return the system to its previous state if the TR0 (Trigger hold) command has been used.

Query: GTSRC?

Returned

String: GTSRC <source>

GTTYP	Set profile trigger type	TRIGGER
	Syntax: GTTYP <type>	
	type: RISE FALL	
	Remarks: When the profile system trigger source is set to INTA or INTB (Internal A or B) the ML2430A Series triggers on a power level (GTLVL) rising or falling. This command sets the trigger for a rising or falling edge.	
	Related Commands: GTLVL, GTSRC	
	Query: GTTYP?	
	Returned String: GTTYP <type>	
GTXTTL	Set profile external trigger edge	TRIGGER
	Syntax: GTXTTL <type>	
	type: RISE FALL	
	Remarks: When the profile system trigger source is set to External TTL, the ML2430A Series triggers on a TTL level rising or falling. This command sets the trigger for either a rising or falling edge.	
	Related Commands: GTSRC	
	Query: GTXTTL?	
	Returned String: GTXTTL <type>	
HLIM	Set High limits	CHANNEL
	Syntax: HLIM <c>, <val>	
	c: 1 or 2	

<i>val:</i>	Units	Min	Max
	dBm	-99.99	+99.99
	dBmV	-53.00	147.00
	dB μ V	7.00	207.00
	Watts	0.0	50.0

Remarks: Sets the high limit. The HLIMS command turns the limits on and off. It is not necessary to enter the units as the limit value is checked against the displayed value. Therefore, if the limits have been set for -10 dBm (HLIM 1, -10) and the display units are subsequently changed from dBm to Watts, the system will still check for the reading to rise above -10, even though the display units type has been changed.

Example: The high limit is set to -10dBm and turned ON. The display is in dBm. A reading of -9.500dBm would pass. If the display is subsequently changed to Watts, a reading of 112.2 μ W would fail, because the DISPLAYED value is higher than -10. Limit checking only uses the displayed value and does not change its value even though the display units have changed.

Related Commands: HLIMS

Query: HLIM? <c>

Returned String: HLIM <c>,<val>

HLIMS Turn on/off High limits

CHANNEL

Syntax: HLIMS <c>,<state>

c: 1 or 2
state: ON or OFF

Remarks: The HLIMS command turns the limits on and off.

Related Commands: HLIM

Query: HLIMS? <c>

Returned String: HLIMS <c>,<state>

HOLD Graph hold

CHANNEL

Syntax: HOLD <state>

state: ON or OFF

Remarks: This command holds the present graph displayed on the screen and is available in all graph modes. In Profile and Power vs. Time modes, this command will not work when trigger source is set to MANUAL. The held graph can be requested over GPIB by using the OGD or OGBD commands. The same graph data will be held until HOLD is switched off.

Related

Commands: OGD, OGBD

Query: HOLD?

Returned

String: HOLD <state>

IBBLP Blanking active TTL level

BNC

Syntax: IBBLP <polarity>

polarity: POS (positive, for high TTL level)
NEG (negative, for low TTL level)

Remarks: Changes the expected polarity of the TTL Blanking input signal.

Query: IBBLP?

Returned

String: IBBLP <polarity>

KEYCK Turn key click sound on or off

SYSTEM

Syntax: KEYCK <state>

state: ON or OFF

Remarks: When ON, an audible annunciator produces a click corresponding to every key press.

Query: KEYCK?

Returned

String: KEYCK <state>

LINK Trigger linking

TRIGGER

Syntax: LINK <state>

state: ON or OFF

Remarks: This will link the trigger set-up between Profile mode and Readout mode so that the sample delay and the gate width will agree. A change to the trigger set-up in either Readout or Profile system set-up will affect either display mode.

Query: LINK?

Returned

String: LINK <state>

LLIM Set Low limits

CHANNEL

Syntax: LLIM <c>, <val>

c: 1 or 2

val:

Units	Min	Max
dBm	-99.99	+99.99
dBmV	-53.00	147.00
dB μ V	7.00	207.00
Watts	0.0	50.0
Volts	0.0	20.0

Remarks: Sets the low limit. The LLIMS command turns the limits on and off. It is not necessary to enter the units as the limit value is checked against the displayed value.

Therefore, if the limits have been set for -10 dBm (LLIM 1, -10) and the display units are subsequently changed from dBm to Watts, the system still checks for the reading to rise above -10, even though the display units type has been changed.

Related

Commands: LLIMS

Query: LLIM? <c>

Returned

String: LLIM <c>, <val>

LLIMS Turn on/off low limits

CHANNEL

Syntax: LLIMS <c>, <state>

c: 1 or 2

state: ON or OFF

Remarks: The LLIMS command turns the limits on and off.

Related

Commands: LLIM

Query: LLIMS? <c>

Returned

String: LLIMS <c>,<state>

MMRST Min Max Tracking reset **CHANNEL**

Syntax: MMRST <c>

c: 1 or 2

Remarks: This command resets the min/max values when in 'Readout' or 'Power vs. Time' mode. In profile mode, this command is used to reset the channels min/max values.

MNGDB Output Min Graph Binary Data **DATA OUTPUT**

Syntax: MNGDB

Remarks: Available in graph modes only. Outputs in binary form the min graph data to the GPIB in the long integer form of 1024 bits per dB as a definite length arbitrary block response data. The C programming example 'Binary output decoding' on page 6-133 shows how to extract the binary data. The response form is as follows :
MNGDB <#><length><number_of_bytes><data_byte_1><data_byte_2>
...<data_byte_n><\n>
<length> number of ASCII characters make up the number_of_bytes value
<number_of_bytes> number of bytes of data contained in rest of the string
<data_byte_n> four of these values makes up the long integer.
For example: FF FF D1 64 = -11932 As it is based on 1024 per dB, divide by 1024 to get the dB value (-11.652).

MNGD Output Min Graph Data **DATA OUTPUT**

Syntax: MNGD

Remarks: Available in graph modes only. Outputs in ASCII form the min graph data. The format is as follows:

MNGD <number_of_elements>,<element_1>,<element_2>,<element_n>...<\n>

The first number in the string is the number of elements to follow, and is always 200 for the ML2430A Series.

MNMXS Track min and max values

CHANNEL

Syntax: MNMXS <c>,<state>

c: 1 or 2
state: ON or OFF

Remarks: Turns ON or OFF the min/max tracking for the specified channel. The MMRST command resets the values.

**Related
Commands:** MMRST

Query: MNMXS? <c>

**Returned
String:** MNMXS <c>,<state>

MODDEL Modem redial delay time

SYSTEM

Syntax: MODDEL <value>

value: 1 to 10

Remarks: Sets the autodial delay between retries. The value is the number of minutes to delay between each autodial retry after a failure to connect. This interval can be set from 1 to 10 minutes. See Section 5-10 for more information on modem operation.

Query: MODDEL?

**Returned
String:** MODDEL <value>

MODINIT Initialize modem

SYSTEM

Syntax: MODINIT

Remarks: Initializes the modem connected to the ML2430A serial port. See Section 5-10 for more information on modem operation.

MODLIM Autodial enable for limits failure

SYSTEM

Syntax: MODLIM <state>

value: TRUE or FALSE

Remarks: When set to TRUE, produces an SRQ and autodial the phone number (set with MODPH) when a channel limits failure occurs. See Section 5-10 for more information on modem operation.

Query: MODLIM?

Returned

String: MODLIM <true> or <false>

MODPH Autodial phone number

SYSTEM

Syntax: MODPH <number_text>

number

text: the number to be dialed

Remarks: Enter the phone number to be dialed when autodialing is enabled. Reads in a string of up to 40 ASCII characters or the end of the message. When the number is being dialed, a dot (.) will be interpreted as a 2-second delay in the dialing sequence; a minus sign (-) will be interpreted as wait for another dialing tone. See Section 5-10 for more information on modem operation.

Query: MODPH?

Returned

String: MODPH <number text>

MODPWR Autodial enable for power on

SYSTEM

Syntax: MODPWR <state>

value: TRUE or FALSE

Remarks: When set to TRUE, produces an SRQ and autodial the phone number (set with MODPH) when the ML2430A is powered on. See Section 5-10 for more information on modem operation.

Query: MODPWR?

Returned

String: MODPWR <true> or <false>

MODRED Redial count

SYSTEM

Syntax: MODRED <count>

count: 0 to 10

Remarks: Sets the number of retrys after a failure to connect. The delay between retrys is set using MODDEL. See Section 5-10 for more information on modem operation.

Query: MODRED?

Returned

String: MODRED <count>

MODRNG Autodial enable for range error

SYSTEM

Syntax: MODRNG <state>

value: TRUE or FALSE

Remarks: When set to TRUE, produces an SRQ and autodial the phone number (set with MODPH) when a sensor range error occurs. See Section 5-10 for more information on modem operation.

Query: MODRNG?

Returned

String: MODRNG <state>

MXGDB Output Max Graph Binary Data

DATA OUTPUT

Syntax: MXGDB

Remarks: Available in graph modes only. Outputs in binary form the max graph data to the GPIB in the long integer form of 1024 bits per dB as a definite length arbitrary block response data. The C programming example 'Binary output decoding' on page 6-133 shows how to extract the binary data. The response form is as follows :

```
MXGDB <#><length><number_of_bytes><data_byte_1><data_byte_2>
...<data_byte_n><\n>
```

<length> number of ASCII characters that make up the number_of_bytes value

<number_of_bytes> number of bytes of data contained in rest of the string
<data_byte_n> four of these values make up the long integer.

For example: FF FF D1 64 = -11932 As it is based on 1024 per dB, divide by 1024 to get the dB value (-11.652).

MXGD Output Max Graph Data

DATA OUTPUT

Syntax: MXGD

Remarks: Available in graph modes only. Outputs in ASCII form the max graph data. The format is as follows:
MX

GD <number_of_elements>,<element_1>,<element_2>,<element_n>...<\n>

The first number in the string is the number of elements to follow, and is always 200 for the ML2430A Series.

O Return display channel reading

DATA OUTPUT

Syntax: O <c>

c: 1 or 2

Remarks: Readout and Power vs. Time modes only. Returns the next measured reading available in the output buffer from the selected channel. The reading will sit in the output buffer until it is read. If another reading is requested, that reading will be buffered after the previous reading. If the first reading requested is read before another request for data, the output buffer will be empty. The MAV bit in the status byte will always indicate the state of the buffer. The display is updated at a constant rate with available readings if the display is on.

If the selected channel is turned off, an execution error is returned. The returned string is the value plus a line feed (hex 0X0A), no terminators.

OBACM AC mod output polarity configuration

BNC

Syntax: OBACM <polarity>

polarity: POS (positive)
NEG (negative)

Remarks: Changes the polarity of the AC mod BNC output signal.

Query: OBACM?

Returned

String: OBACM <polarity>

OBCH BNC output port channel configuration

BNC

Syntax: OBCH <port>,<c>

port: 1 or 2
c: 1 or 2

Remarks: This command changes the channel represented by BNC output modes that can take data from either channel 1 or 2, such as “Analog Output” and “Pass/Fail” modes.

Query: OBCH? <port>

Returned

String: OBCH <port>,<c>

OBDSP BNC analog output display stop value

BNC

Syntax: OBDSP <port>,<units>,<val>

port: 1 or 2
units: W (Watts)
 DB (dB)
 DBM (dB)
 DBUV (dB μ V)
 DBMV (dBmV)
val: 0 to 50W
 -70 to 47dB
 -23 to 94 dBmV
 37 to 154 dB μ V

Remarks: Sets up the stop value for the analog out scale of the display.

Query: OBDSP? <port>

Returned

String: OBDSP <port>,<units>,<val>

OBDST BNC analog out display start value

BNC

Syntax: OBDST <port>,<units>,<val>

port: 1 or 2
units: W (Watts)
 DB (dB)
 DBM (dB)
 DBUV (dB μ V)
 DBMV (dBmV)
val: 0 to 50W
 -70 to 47dB
 -23 to 94 dBmV
 37 to 154 dB μ V

Remarks: Sets up the start value for the analog out scale of the display.

Query: OBDST? <port>

Returned

String: OBDST <port>,<units>,<val>

OBMD BNC output mode select

BNC

Syntax: OBMD <port>,<mode>

port: 1 or 2

mode: 'OFF' (output set to ground) port 1 or 2
 'AOUT' (analog scaled output) port 1 or 2
 'PASS/FAIL' (pass/fail) port 1 or 2
 'SIGA' (signal output sensor A) port 1 only
 'LVLA1' Signal channel range 1 amplifier output for sensor A
 'LVLA2' Signal channel range 2 amplifier output for sensor A
 'LVLB1' Signal channel range 1 amplifier output for sensor B
 'LVLB2' Signal channel range 2 amplifier output for sensor B
 'ACMOD' (AC mod output) port 1 only
 'RFB' (RF blanking while zeroing) port 2 only
 'SIGB' (signal output sensor B) port 2 only

Remarks: Changes the type of output selected for the BNC outputs.

Query: OBMD? <port>

Returned

String: OBMD <port>,<mode>

OBPL BNC pass/fail pass level

BNC

Syntax: OBPL <port>,<level>

port: 1 or 2

level: HIGH (TTL high is PASS)
 LOW (TTL low is PASS)

Remarks: Selects the PASS level for the Pass/fail type of output.

Query: OBPL? <port>

Returned

String: OBPL <port>,<level>

OBVSP BNC analog output stop voltage scale

BNC

Syntax: OBVSP <port>,<val>

port: 1 or 2
val: -5.00 to +5.00 Volts

Remarks: Sets up the stop value for the voltage output in analog output mode. Attempting to set the start value to a voltage greater than the stop value, or the stop value lower than the start value, will result in an execution error.

Query: OBVSP? <port>

Returned

String: OBVSP <port>,<val>

OBVST BNC analog output start voltage scale

BNC

Syntax: OBVST <port>,<val>

port: 1 or 2
val: -5.00 to +5.00 Volts

Remarks: Sets up the start value for the voltage output in analog output mode. Attempting to set the start value to a voltage greater than the stop value, or the stop value lower than the start value, will result in an execution error.

Query: OBVST? <port>

Returned

String: OBVST <port>,<val>

OBZL BNC RF blanking output level when zeroing

BNC

Syntax: OBZL <level>

level: HIGH (TTL high)
 LOW (TTL low)

Remarks: Sets the TTL level of the BNC RF blanking output.

Query: OBZL?

Returned

String: OBZL <level>

OFFCLR Clear an offset table

SENSOR

Syntax: OFFCLR <val>

val: 1 to 5

Remarks: Sets all the values in the table specified to 0 dB and 0.00 Hz.

OFFFIX Offset fixed value

SENSOR

Syntax: OFFFIX <s>, <val> [units]

s: A or B
val: -99.999 to +99.999
units: dB

Remarks: The value added to the sensor if the offset type is set to FIXED.

Example: To set the fixed offset for sensor A to -47 dBm:

OFFFIX A,-47DB

Query: OFFFIX? <s>

Returned

String: OFFFIX <s>,<val>

OFFTBL Specify the table used to apply offsets to the sensor

SENSOR

Syntax: OFFTBL <s>, <val>

s: A or B
val: 1 to 5

Remarks: If the Offset Type is set to TABLE, use this command to specify which of the five offset tables to apply to the sensor.

The tables are a set of frequency-against-dB offsets. The offset value used from the table depends on the setting of the frequency correction source. If the source is FREQUENCY, the entered frequency is used to calculate the offset from the table. If the frequency correction source is V/GHz, the frequency value calculated from the supplied ramp input is used to calculate the offset from the table.

If the frequency does not match any frequency in the table, interpolation is used to calculate the correct offset.

NOTE

If the frequency is greater than the maximum frequency in the table, the offset value from the maximum table frequency is used. If the frequency is less than the minimum frequency in the table, the offset from the minimum table frequency is used. The frequency comparisons start from the beginning of the table; if the entry is 0 Hz, this is counted as the end of the table.

Query: OFFTBL? <s>

Returned

String: OFFTBL <s>,<val>

OFFTBR Output an offset table

SENSOR

Syntax: OFFTBR <val>

val: 1 to 5

Remarks: Outputs the selected offset table. The returned string is constructed as follows:

OFFTBR #<length><number_of_bytes>,<element1<element2><elementn>

Where <length> is the character size of the <number_of_bytes> field and <number_of_bytes> is the number of bytes which make up the string after the comma (.). For example:

```
OFFTBR #41600,<data...>
```

4 = number of character to read next for the data length

1600 = One thousand and six hundred bytes of data to read in, representing 200 elements placed one after the other without commas. Each <element> is made up of 8 bytes; the first four bytes are the Frequency and the second four bytes are the corresponding dB value for the Frequency. For example:

<data_element1><data_element2><data_element3> is equal to:

<freq1><dB1><freq2><dB2><freq3><dB3>... is equal to:

<4bytes1><4bytes1><4bytes2><4bytes2><4bytes3><4bytes3>

The 4 byte binary values are 4 bytes single precision floating point binary data. The C programming example 'Binary output decoding' on page 6-133 shows how to extract the binary data.

OFFTBU Updates an offset table

SENSOR

Syntax: OFFTBU <val>,<bytes>,<binary_data...>

val: 1 to 5

bytes: number of bytes in the binary_data string

binary_

data: frequency and dB offset

Remarks: This command updates the offset table specified by <val>. <bytes> is the number of bytes in the binary_data string and <binary_data> is a string which represents the frequency and the dB offset to apply in the format of: <element1><element2><elementn...>, where <element> has four bytes to represent the frequency and four bytes to represent the dB value. The four byte value can be created by multiplying the floating point number by 1024 and converting the LONG number to an ASCII string. For example:

-10.234 becomes 10479, converted to hexadecimal FFFFD711. See the programming examples for more detail.

OFFTYP Offset type to use **SENSOR**

Syntax: OFFTYP <s>, <type>

 s: A or B
 type: OFF
 FIXED
 TABLE

Remarks: Selects the type of offset to use.
OFF = No offset to be used.
FIXED = Use the fixed value (OFFFIX) specified.
TABLE = Use the Offset table (OFFTBL) specified.

Query: OFFTYP? <s>

Returned

String: OFFTYP <s>, <type>

OFFVAL Sensor Offset Value **SENSOR**

Syntax: OFFVAL <s>

 s: A or B

Remarks: Returns the Offset value being applied to the specified sensor.

Related

Commands: OFFTBL, OFFTYP

OGBD Output Graph Binary Data **DATA OUTPUT**

Syntax: OGBD

Remarks: Output the next complete set of graph data to the GPIB in the long integer form of 1024 bits per dB as a definite length arbitrary block response data. The C programming example 'Binary output decoding' on page 6-133 shows how to extract the binary data. The response form is as follows :
OGBD <#><length><number_of_bytes><data_byte_1><data_byte_2>
...<data_byte_n><\n>
<length> number of ASCII characters that make up the number_of_bytes value
<number_of_bytes> number of bytes of data contained in rest of the string
<data_byte_n> four of these values makes up the long integer.

For example: FF FF D1 64 = -11932 As it is based on 1024 per dB, divide by 1024 to get the dB value (-11.652).

OGD Output Graph Data

DATA OUTPUT

Syntax: OGD

Remarks: Outputs the next complete set of graph data.

The format is as follows:

OGD <number_of_elements>,<element_1>,<element_2>,<element_n>...<\n>

The first number in the string is the number of elements to follow, and is always 200 for the ML2430A Series.

OGSD Output Valid Samples Array (power vs. time mode only)

DATA OUTPUT

Syntax: OGSD

Remarks: A power verses time chart plots the readings on a scrolling chart from left to right. If GRCP (connect points) is on and no new data has been received for a time slot, the graph is plotted with the same value as the previous time slot but the data for that sample position is not marked as valid. This command will read out an array of 1's and 0's that indicate whether the data for that time slot is valid. For example, '1' for valid and '0' for connecting data only.

Because the time between reading the data and reading the valid sample data may shift the valid samples out of sync with the graph read, it is recommended that a 'HOLD ON' be issued before reading the graph and sample data, and a 'HOLD OFF' after. This will make sure that the sample data and the graph data agree.

If not in Power vs. Time mode, this command will set an execution error.

OI Output device identification

GPIB 488.2

Syntax: OI

Remarks: Returned format:

<Company name>,<model>,<serial>,<firmware version>

ON Output number of channel readings

DATA OUTPUT

Syntax: ON <c>,<val>

c: 1 or 2

val: 1 to 1000

Remarks: Readout and Power vs. Time modes only. This command returns the specified number of readings for the specified channel. The readings are first assembled, and then passed to the GPIB as a whole, with a line feed character (hex 0x0a) marking the end of the string.

Example: ON 1, 9

This example will return:

-10.234, -10.234, -10.235, -10.238, -10.250, -10.270, -10.500, -10.934, -12.234<0x0a>

OPMD

ML2430A Series operation mode

SYSTEM

Syntax: OPMD <mode>

mode: DIGIT
PROFILE
PWRTIM
SRCSWP

Remarks: This command selects the ML2430A Series operation mode (data collection method).
DIGIT = digital read out of channel data
PROFILE = profile of graphic display
PWRTIM = graph of channel power versus time
SRCSWP = source sweep graphic display
To use Graph output commands, the ML2430A Series must be in Profile or Power vs. Time mode. To use the output channel data commands, the ML2430A Series must be in the digital readout mode.

Related

Commands: GRMD

Query: OPMD?

Returned

String: OPMD <mode>

PRINT

Send details to the connected printer.

SYSTEM

Syntax: PRINT

Remarks: The type of printout depends on the operation mode currently selected. In all modes, the printout includes a header with the current sensor settings

range 3 upper, range 3 lower, range 4 upper, range 4 lower, range 5 upper, range 5 lower.

REL Relative control

CHANNEL

Syntax: REL <c>, <mode>

c: 1 or 2

mode: 0 Turn OFF

1 Turn ON and reference

2 Turn ON, use old references if not first time.

Remarks: Turns relative ON or OFF, or references the zero point. REL1 and REL2 toggle between relative and absolute measurements. Sending the RELx command when in dB mode will make the meter apply the last used RELATIVE value. This relative value is used thereafter until it is replaced by another one in the same manner. This allows the user to refer to a previously referenced value, without the meter resetting itself back to a 0.00 display.

Query: REL? <c>

Returned

String: REL <c>,<mode>

RFCAL Turn RF reference calibrator ON or OFF

CALIBRATION

Syntax: RFCAL <state>

state: ON or OFF

Remarks: Turns on or off the RF reference calibrator.

Query: RFCAL?

Returned

String: RFCAL <state>

RGH Range Hold Sensor

SENSOR

Syntax: RGH <s> [, <val>]

s: A or B

val: 0 to 5 (0 to 6 for universal power sensor only)
(0 = AUTO)

Remarks: This function is used to toggle a sensor's range hold off or on, to set a specific range to be held, or to select AUTO ranging. RGH sent with only the sensor parameter will toggle the sensor between holding the present operating range and AUTO. If RGH is sent with sensor and value parameters, the sensor range mode will be set to the range value sent.

Query: RGH? <s>

Returned

String: RGH <s>,<val>

RSBAUD RS232 Baud Rate

SYSTEM

Syntax: RSBAUD <val>

val: 12,24,48,96,192 or 384 hundred bits per second

Remarks: Sets the RS232 Baud rate for the rear panel serial port.

Query: RSBAUD?

Returned

String: RSBAUD <val>

RSMODE RS232 Operating Mode

SYSTEM

Syntax: RSMODE <s>

s: EXTCOM
SRCSWP

Remarks: EXTCOM = External communication. GPIB commands are sent and received via an RS232 connection.

SRCSWP = Source sweep. Connected to a sweeper so updates to the sweepers power of frequencies etc. are automatically updated on the ML2430A Series also.

Query: RSMODE?

Returned

String: RSMODE <s>

SECURE Secure system state

SYSTEM

Syntax: SECURE <state>

state: ON or OFF

Remarks: Normally when the system is powered on the ML2430A Series returns to the state it was in when it was powered off. This includes all the offset tables, calibration adjust values, etc.
 If Secure is set to ON, non-volatile memory is disabled and all stored values are reset to the factory defaults when the system is powered on. As long as this command is ON, the system will load the presets (see Appendix A, Section A-3) every time it is turned ON.

Query: SECURE?

Returned

String: SECURE <s>

SENMM Sensor Measurement mode

SENSOR

Syntax: SENMM <s> , <mode>

s: A or B

mode: DEFAULT (carrier wave)
 MOD (modulated average)
 CUSTOM (user configurable trigger setup mode)

Remarks: Tells the sensor the type of signal it is expecting. This helps the sensor to take the best measurements.

Query: SENMM? <s>

Returned

String: SENMM <s>,<mode>

SENMO Universal Sensor Operation Mode

SENSOR

Syntax: SENMO <s> , <value>

s: A or B

value: TRMS / FCW

Remarks: Selects between using a universal power sensor in its normal operating mode (TRMS) and its option 1 mode (FCW). FCW can only be selected if this option is fitted in the power sensor.

Query: SENMO? <s>

Returned

String: SENMO <s>,<value>

SENSTL Set Sensor Settle Percentage

SENSOR

Syntax: SENSTL <s>, <val>

s: A or B
val: 0.01 to 10%

Remarks: Sets how long the system waits for the signal to settle. The value parameter is only used in DEFAULT measurement sensor mode. The settling time allows some control over the tradeoff between speed, and the extent to which a measurement has settled to its final value.

Query: SENSTL? <s>

Returned

String: SENSTL <s>, <mode>

SENTYP Return sensor information

SENSOR

Syntax: SENTYP <s>

s: A or B

Remarks: This command returns information on the selected sensor in string format: <sensor type>, <sensor serial>. For example: Dual Diode, PBD16.

SRCMOD Source Sweep Mode

SYSTEM

Syntax: SRCMOD <mode>

mode: FREQ
POWER

Remarks: Determines whether the voltage sweep applied to the V/GHz analog input on the rear panel is interpreted as a frequency or power sweep. The x axis of the graph on the display will be labeled appropriately.

Query: SRCMOD?

Returned

String: SRCMOD <mode>

SRCSPFRQ Source Sweep Stop Frequency

SYSTEM

Syntax: SRCSPFRQ <freq_value> [units]

freq value: 10 kHz to 122 GHz

Remarks: Determines the stop frequency when in frequency sweep mode.

Query: SRCSPFRQ?

Returned

String: SRCSPFRQ <frequency>

SRCSPWR Source Sweep Stop Power

SYSTEM

Syntax: SRCSPWR <power_value>

power

value: power

Remarks: Determines the stop power level of power sweep mode.

Query: SRCSPWR?

Returned

String: SRCSPWR <power>

SRCSTAT Source Sweep mode status request

SYSTEM

Syntax: SRCSTAT

Remarks: Requests the source sweep status, and returns the following message:

SRCSWP<ws><mode>,<start_power>,<stop_power>,<start_freq>,<stop_f
req>

SRCSTFRQ Source Sweep Start Frequency

SYSTEM

Syntax: SRCSTFRQ <freq_value> [units]

freq value: 10 kHz to 122 GHz

Remarks: Determines the start frequency when in frequency sweep mode.

Query: SRCSTFRQ?

Returned

String: SRCSTFRQ <frequency>

SRCSTPWR Source Sweep Start Power

SYSTEM

Syntax: SRCSTPWR <power_value>

power
value: power

Remarks: Determines the start power level of power sweep mode.

Query: SRCSTPWR?

Returned
String: SRCSTPWR <power>

START Initial startup self test command

GPIB SETUP

Syntax: START

Remarks: This is useful for ATE control. After the system has been given time to start up, this command can be used to find out what state the system is in. If the self test has failed, 'CONT' can be used to get the system running. This is an initial startup self test status command and will return one of the following:

- 0 - Passed self test and running.
- 1 - Startup self test running.
- 1 - Start up self test FAILED.

In this stage of the startup process, all commands except STERR, START, CONT and GPIB 488.2 event and status commands will produce a GPIB execution error. STERR will return the selftest result string.

Related
Commands: STERR, CONT

STATUS Status Message

DATA OUTPUT

Syntax: STATUS

Remarks: Replies with the power meter's current state code. In this format, the number of letters specifies the number of digits, with preceding zeroes for padding. The format is:

'ABCDEFGHIJKLMNNOOPQRRRRSSSTUVWXYZ12'

where: A = Operating mode: '0' = Digital readout, '1' = Profile mode channel 1, '2' = Profile mode channel 2, '3' = Power vs. Time channel 1, '4' = Power vs. Time channel 2, '5' = Source sweep chan. 1, '6' = Source sweep chan. 2..

B = Channel 1 input configuration: '0' = OFF, '1' = A, '2' = B, '3' = A-B, '4' = B-A, '5' = A/B, '6' = B/A, '7' = EXT Volts.

C = Channel 2 input configuration: '0' = OFF, '1' = A, '2' = B, '3' = A-B, '4' =

B–A, '5' = A/B, '6' = B/A, '7' = EXT Volts.

D = Channel 1 units: '0' = dBm, '1' = Watts, '2' = Volts, '3' = dB μ V, '4' = dBmV.

E = Channel 2 units: '0' = dBm, '1' = Watts, '2' = Volts, '3' = dB μ V, '4' = dBmV.

F = Channel 1 relative status: '0' = Rel OFF, '1' = Rel ON.

G = Channel 2 relative status: '0' = Rel OFF, '1' = Rel ON.

H = Channel 1 low limit state: '0' = OFF, '1' = ON.

I = Channel 1 high limit state: '0' = OFF, '1' = ON.

J = Channel 2 low limit state: '0' = OFF, '1' = ON.

K = Channel 2 high limit state: '0' = OFF, '1' = ON.

L = Sensor A measurement mode: '0' = Default, '1' = MOD average, '2' = Custom.

M = Sensor B measurement mode: '0' = Default, '1' = MOD average, '2' = Custom.

NN = Sensor A range hold: Manual = '01' to '05', AUTO = '11' to '15'.

OO = Sensor B range hold: Manual = '01' to '05', AUTO = '11' to '15'.

P = Sensor A averaging mode: '0' = OFF, '1' = AUTO, '2' = Moving, '3' = Repeat.

Q = Sensor B averaging mode: '0' = OFF, '1' = AUTO, '2' = Moving, '3' = Repeat.

RRRR = Sensor A average number. For Profile and Source Sweep modes, this number is between 1 and 512. For digital Readout or Power vs. Time modes, the values are either 1 to 512 or, if in AUTO averaging mode, 513 to 1024.

SSSS = Sensor B average number (0000 if ML2437A). For Profile and Source Sweep modes, this number is between 1 and 512. For digital Readout or Power vs. Time modes, the values are either 1 to 512 or, if in AUTO averaging mode, 513 to 1024.

T = Sensor A low level average: '0' = OFF, '1' = Low, '2' = Medium, '3' = High.

U = Sensor B low level average: '0' = OFF, '1' = Low, '2' = Medium, '3' = High.

V = Sensor A zeroed status: '0' = Not zeroed, '1' = Zeroed.

W = Sensor B Zeroed status: '0' = Not zeroed, '1' = Zeroed.

X = GPIB trigger mode: '0' = TR0 hold ON, '1' = Free run.

Y = GPIB group trigger mode: '0' = GTO, '1' = GT1, '2' = GT2.

Z = Calibrator state: '0' = OFF, '1' = ON.

1 = GPIB DISP command status: '0' = OFF, '1' = ON.

2 = GPIB FAST status: '0' = OFF, '1' = ON.

STERR Returns results of POST or *TST?

DATA OUTPUT

Syntax: STERR

Remarks: Returns (<sp> = space): 'FLASH<sp>0xnnnn,CALDAT<sp>0xnnnn,PERSON<sp>0xnnnn,RAM<sp>0xnnnn,NONVOL<sp>0xnnnn,LCD<sp>0xnnnn,KBD<sp>0xnnnn,DSP<sp>0xnnnn/n'

FLASH checksum test: 0x0000 = Passed, 0xffff = Failed

CALDAT checksum test: 0x0000 = Passed, 0xffff = Failed

PERSONality data: 0x0000 = Passed, 0xffff = Failed

RAM read/write test: 0x0000 = Passed, 0xffff = Failed

NONVOL RAM test: 0x0000 = Passed, 0x0001 = Software version fail, 0x0002 = Current store fail, 0x0004 = Saved store fail, 0x0008 = secure mode fail, 0xffff = read failure

LCD memory test: 0x0000 = Passed, 0xffff = Failed

KBD stuck key test: 0x0000 = Passed, 0xffff = Failed

DSP test: 0x0000 = Passed, else FATAL error

**Related
Commands:** START, CONT

SYSLD Load saved setup store over the GPIB

DATA OUTPUT

Syntax: SYSLD <store number>, <data length>, <binary data>

store

number: 1 to 10

data length:

number of bytes of binary data

binary data:

Saved data previously read from the meter using the SYSRD command

Remarks: Sets the passed store number to the setup contained in the binary data that was extracted using the SYSRD command.

**Related
Commands:** SYSRD

SYSLNM Saved set naming

SYSTEM

Syntax: SYSLNM <store number>,<text>

*store
number:* 1 to 10
text: text string

Remarks: This command allows the saved setups to have text associated with them rather than just the 'USED' and 'NOT USED' text.

Query: SYSLNM? <store number>

Returned

String: SYSLNM <store number>,<store name>

If a store number of 0 is used, then all the store titles will be output in the form:

SYSLNM 1,<store 1 name>,2,<store 2 name>, ... ,10,<store 10 name>

SYSRD Output the saved setup over the GPIB

DATA OUTPUT

Syntax: SYSRD <store number>

*store
number:* 0 (current setup) or 1 to 10 saved stores

Remarks: Requests that the saved stored setup is output over the GPIB. This is a BINARY output that allows the stored setup to be programmed into other ML2430A Series power meters and stores via the SYSLD command. If a request for a store number that has not had a setup stored into it is made, an execution error event will be set in the Event Status Register (ESR).

The output is in the form:

SYSRD<ws><#><num_digits><number num_digits long>, <binary data>

<num_digits> = Number of following digits giving the number of bytes of binary data.

<number num_digits long> = A number num_digits long giving the number of bytes of binary data.

<binary data> = Saved setup.

**Related
Commands:** SYSLD

TEXT User text command

SYSTEM

Syntax: TEXT <text string>

text string: Text string of up to 20 characters

Remarks: Defines the text string that will be displayed using the TEXTS command.

**Related
Commands:** TEXTS

Query: TEXT?

*Returned
String:* TEXT <text string>

TEXTS User text display command

SYSTEM

Syntax: TEXTS <state>

state: ON or OFF

Remarks: This command turns on or off the display of text entered using the TEXT command. Up to 20 characters of user text can be displayed on the top line of the data screen for READOUT, PROFILE and PWRvsTIME display modes.

**Related
Commands:** TEXT

Query: TEXTS?

*Returned
String:* TEXTS <state>

TR0 Trigger hold mode

GPIB TRIGGER

Syntax: TR0

Remarks: Sets both channels to trigger hold mode. It does not trigger until it receives a TR1 or TR2 or GET (group executive trigger), *TRG or TR3 command. If it receives a TR3 command it reverts back to the trigger mode it was in before the TR0 command was sent. If the REM line is low, this command has no effect.

Related

Commands: TR1, TR2, TR3, *TRG, Group Execute Trigger (GET), GT0, GT1, GT2

TR1 Trigger immediate

GPIB TRIGGER

Syntax: TR1 <c>

c: 1 or 2

Remarks: Triggers a single reading which is added to the internal digital filter and the updated filter power level is returned on the GPIB. The returned reading differs depending on the operation mode:

Readout:	'O' command response
Pwr vs. Time:	'O' command response
Profile:	'OGBD' command response (binary graph data for example)
Source Sweep:	'OGBD' command response (binary graph data for example)

After a TR1 command the instrument returns to either TR0 (trigger hold) or TR3 (trigger free run) mode depending on what it was previously set to.

Related

Commands: TR0, TR2, TR3, *TRG, Group Execute Trigger (GET), GT0, GT1, GT2

TR2 Trigger with a settling delay

GPIB TRIGGER

Syntax: TR2 <c>

c: 1 or 2

Remarks: Triggers a fully ranged and settled reading which is returned on the GPIB Bus. If averaging is set to ON, the average buffer will be cleared and filled before the result is returned. The returned reading differs depending on the operation mode:

Readout:	'O' command response
Pwr vs. Time:	'O' command response
Profile:	'OGBD' command response (binary graph data for example)
Source Sweep:	'OGBD' command response (binary graph data for example)

NOTE

TR2 in Profile and Source Sweep mode is not supported and will revert to a TR1 type measurement.

If the channel is set to External Volts, TR2 is not supported (as there is no averaging and settling) and will revert to a TR1 type measurement.

After a TR2 command the instrument returns to either TR0 (trigger hold) or TR3 (trigger free run) mode depending on what it was previously set to.

Related

Commands: TR0, TR1, TR3, *TRG, Group Execute Trigger (GET), GT0, GT1, GT2

TR3 Trigger free run

GPIB TRIGGER

Syntax: TR3

Remarks: Sets the ML2430A Series back into free run mode on both channels.

Related

Commands: TR0, TR1, TR2, *TRG, Group Execute Trigger (GET), GT0, GT1, GT2

TRGARM Trigger arming

TRIGGER

Syntax: TRGARM <c>, <state>

c: 1, 2 or 1&2

state: ON or OFF

Remarks: Sets the readout trigger arming ON or OFF when in READOUT or POWER vs. TIME mode. Select channel 1, 2 or 1&2. Selecting 1&2 allows both channels to trigger together on the same conditions without having to set up two sets of trigger data. If set to ON, the system first checks to see if the BNC sweep blanking input is TRUE before it starts to trigger. If set to OFF, the system uses the trigger source (TRSRC) to decide when to trigger. TRGARM will return an execution error if trying to set trigger arming ON when a display channel trigger source is already set to EXTTTL, as they both use the same BNC input.

Query: TRGARM? <c>

Returned

String: TRGARM <c>,<state>

The TRG type commands return the trigger state of the selected channel if the channel is ON. This depends on the settings of the “link triggers” flag and the current mode of the sensor on the selected channel. If the channel is OFF, the stored trigger state of the channel is returned.

TRGDLY Trigger sample delay

TRIGGER

Syntax: TRGDLY <c>, <val>[units]

c: 1, 2 or 1&2
val: 0.0 to 1.0 seconds

Remarks: The time the system waits after a trigger event has happened before taking measurements when in READOUT or POWER vs. TIME mode.
 Select channel 1, 2 or 1&2. Selecting 1&2 allows both channels to trigger together on the same conditions without having to set up two sets of trigger data.

Query: TRGDLY? <c>

Returned

String: TRGDLY <c>,<val>

The TRG type commands return the trigger state of the selected channel if the channel is ON. This depends on the settings of the “link triggers” flag and the current mode of the sensor on the selected channel. If the channel is OFF, the stored trigger state of the channel is returned.

TRGGW Set trigger gate width

TRIGGER

Syntax: TRGGW <c>,<val>[units]

c: 1, 2 or 1&2
val: 100 ns to 7.0 seconds

Remarks: The length of time the system uses to collect data when in READOUT or POWER vs. TIME mode. The default value is 20 ms.
 Select channel 1, 2 or 1&2. Selecting 1&2 allows both channels to trigger together on the same conditions without having to set up two sets of trigger data.

Query: TRGGW? <c>

Returned

String: TRGGW <c>,<val>

The TRG type commands return the trigger state of the selected channel if the channel is ON. This depends on the settings of the “link triggers” flag and the current mode of the sensor on the selected channel. If the channel is OFF, the stored trigger state of the channel is returned.

TRGLVL Set trigger level

TRIGGER

Syntax: TRGLVL <c>,<val>

c: 1, 2 or 1&2
val: -30 to +20 dBm

Remarks: If the Trigger source is set to INTA or INTB (internal A or B) the system triggers on a rising or falling power level edge. Use this command to set the level the channel must rise above or fall below before it triggers when in READOUT or POWER vs. TIME mode. Select channel 1, 2 or 1&2. Selecting 1&2 allows both channels to trigger together on the same conditions without having to set up two sets of trigger data.

Query: TRGLVL? <c>

Returned

String: TRGLVL <c>,<val>

The TRG type commands return the trigger state of the selected channel if the channel is ON. This depends on the settings of the “link triggers” flag and the current mode of the sensor on the selected channel. If the channel is OFF, the stored trigger state of the channel is returned.

TRGMODE Change trigger mode

TRIGGER

Syntax: TRGMODE <mode>

mode: IND
COMB

Remarks: Changes the trigger operating mode between INDividual channel trigger setups and COMBined trigger set ups. Individual set up is when the trigger conditions for each channel are setup separately. The combined setup allows both channels to trigger together on the same conditions.

If a channel is OFF or sensors used in both channel configurations do not include a sensor set to CUSTOM measurement mode, the COMBined trigger mode is not allowed, and sending the GPIB command TRGMODE COMB will produce an execution error.

Query: TRGMODE?

Returned

String: TRGMODE <mode>

TRGSRC Set trigger source

TRIGGER

Syntax: TRGSRC <c>,<source>

c: 1, 2 or 1&2
source: INTA (internal sensor A)
INTB (internal sensor B)
EXTTTL (external BNC TTL trigger input)

MANUAL (manual push button trigger)
 CONT (continuous)

Remarks: This command is overridden by the TR0, TR1 and TR2 commands when in READOUT or POWER vs. TIME mode. If TR3 is sent, the trigger source reverts back to the previously selected type of triggering. Select channel 1, 2 or 1&2. Selecting 1&2 allows both channels to trigger together on the same conditions without having to set up two sets of trigger data.

Query: TRGSRC? <c>

Returned

String: TRGSRC <c>,<source>

The TRG type commands return the trigger state of the selected channel if the channel is ON. This depends on the settings of the “link triggers” flag and the current mode of the sensor on the selected channel. If the channel is OFF, the stored trigger state of the channel is returned.

TRGTYP Set Trigger type

TRIGGER

Syntax: TRGTYP <c>,<type>

c: 1, 2 or 1&2
type: RISE
 FALL

Remarks: Sets the control type of the trigger used when the source is set to either INTA or INTB (internal A or B) in READOUT or POWER vs. TIME mode. Select channel 1, 2 or 1&2. Selecting 1&2 allows both channels to trigger together on the same conditions without having to set up two sets of trigger data.

Query: TRGTYP? <c>

Returned

String: TRGTYP <c>,<type>

The TRG type commands return the trigger state of the selected channel if the channel is ON. This depends on the settings of the “link triggers” flag and the current mode of the sensor on the selected channel. If the channel is OFF, the stored trigger state of the channel is returned.

TRGXTTL Set external trigger edge type

TRIGGER

Syntax: TRGXTTL <c>,<type>

c: 1, 2 or 1&2

type: RISE
FALL

Remarks: Sets the control type of the external trigger input used when the trigger source is set to EXTTTL in READOUT or POWER vs. TIME mode. Select channel 1, 2 or 1&2. Selecting 1&2 allows both channels to trigger together on the same conditions without having to set up two sets of trigger data. If external trigger is used on both trigger channels (1 and 2) the same TTL edge MUST be used on both channels.

Query: TRGXTTL? <c>

Returned

String: TRGXTTL <c>,<type>

The TRG type commands return the trigger state of the selected channel if the channel is ON. This depends on the settings of the “link triggers” flag and the current mode of the sensor on the selected channel. If the channel is OFF, the stored trigger state of the channel is returned.

VZERO Zero the BNC input connector

CALIBRATION

Syntax: VZERO

Remarks: Zeros the multipurpose BNC connector used for Volts per GHz connection (Analog Input 2). This will calibrate the units to read zero volts on this BNC. During this operation the connector should either not be connected to anything, or should be connected to a 0 Volt source. A settling time must be allowed after this command before reading any other commands.

ZERO Zero the selected sensor

CALIBRATION

Syntax: ZERO <s>

s: A or B

Remarks: Zero out the noise from the selected sensor.

6-11 GPIB EMULATION MODES

The ML2430 Anritsu power meter emulates the GPIB communication of other power meters. The emulation mode can be set through the front panel SYSTEM|more|more|Rear panel|GPIB|MODE menu (see Chapter 4, Operation) or through the GPIB command EMUL (page 6-86). The available emulation modes and command restrictions are:

Power Meter	Command Restrictions
Hewlett-Packard HP 436	All commands supported.
Hewlett-Packard HP 437	Commands not supported : DN, DU, ERR?, LP, LT, SP, UP and @2.
Hewlett-Packard HP 438	Commands not supported : DO, LP1 and LP2.
Anritsu ML4803	Commands not supported : PCT, VSW, RDB, DBV50, DBV75, VLT50 & VLT75.

In some cases, there are differences between the ML2430A in emulation mode and the actual meter being emulated. These differences are presented in the following sections.

Zeroing a Sensor

The time taken for an ML2430 to complete the ZEROing sequence for a sensor differs from the time taken by the emulated power meters. Any GPIB control programs that ZERO the power meter will have no problems with this time difference if the defined ZEROing controls and/or sequences for the device being emulated are followed.

- ❑ The HP 436 uses the 'Z1T' AUTO ZERO sequence described in the HP 436 manual.
- ❑ The HP 437 and HP 438 use bit 1 of the status byte to indicate ZERO or CAL completion.
- ❑ The ML4803 uses bit 0 of the status byte to indicate that the ZERO sequence is not complete.

Sensor Ranges

The sensor operating ranges for the ML2430 power meters are different from those of the meters being emulated. Refer to the specific range information for range commands in each emulation section.

Output Format

In the HP 437 and HP 438, the format of the readings agrees with the format specified in the manuals, which may differ from the output from some HP437 and HP 438's.

For example: -14.236 may be output by the HP437 or HP 438 as '-14.236e00' or '-1.4236e+01'. The ML2430A in HP 437 or HP 438 emulation modes will output as the manual specifies '-1.4236e+01'.

6-12 ML4803A EMULATION COMMANDS

This section provides an alphabetical listing of the GPIB commands (mnemonics) used to program the Model ML2430A Series Power Meter in ML4803A mode. The emulation mode can be set through the front panel SYSTEM|more|more|Rear panel|GPIB|MODE menu (see Chapter 4, Operation) or through the GPIB command EMUL (page 6-86).

All ML4803A GPIB commands that use parameters must not have a space between the command header and the parameter. Multiple parameters must be separated by semicolons.

Multiple commands may be sent on the same line, but must be separated by spaces.

The format for ML4803A GPIB commands is:

<command header><parameter 1>;<parameter *n*>;...

The end of the command text must be terminated with a line feed character (0Ah, decimal 10) or a GPIB End of Transmission State (EOI), or both.

The ML4803A has an array of memory addresses that each hold a structure of four values; Frequency, Cal factor, Offset, and Reference. The data held for an entered frequency is not automatically applied, but only applied if that memory address is called. The frequency value is only a reference to the operator for which the cal factor and other data is relevant. These memory address sets of data are only available via the GPIB in ML4803A emulation mode.

SRQ's

The startup and default mode of operation for the ML4803A is to set an SRQ off then on again for every reading when available. This has the affect of pulsing the SRQ line very quickly and would make it very difficult to use the ML4803A with other devices on the GPIB bus that wish to communicate via SRQ's. These SRQ's can be turned off temporarily by the 'SRQ0' command. The SRQs will start again as soon as any data is requested from the ML4803A.

Status Byte

The following table and diagram define the Status Byte.

Bit 0	Zero execution	Bit set during zeroing. When zeroing is complete the bit is cleared and the ODR bit and RQS bits are reset.
Bit 1	Cal execution	Bit is set during the Cal 0 dBm.
Bit 3	Output data ready	ODR bit is cleared and set for every reading when made. This is done in sync with the RQS bit giving an SRQ.
Bit 5	Command error	Set on receiving an unrecognized command. The bit is cleared by reading the status byte.
Bit 6	RQS bit	Indicates that the device is requiring service (SRQ).

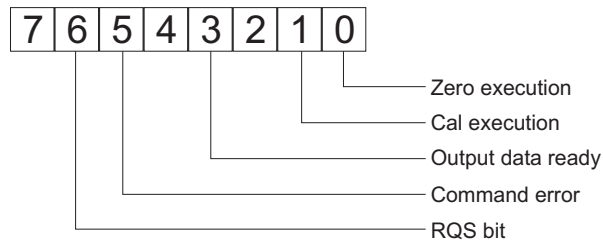

Output Requests

There are three commands to request output from the ML4803A: OPW for a reading, ODT for the cal factor, offset and reference values, and OMR for memory store settings. If these output requests are received simultaneously, only the data for the command received last will be available.

Unsupported Commands

The following ML4803A commands are not supported in the ML2430A Series Power Meter GPIB interface:

- PCT
- VSW
- RDB
- DBV50
- DBV75
- VLT50
- VLT75

These commands are read in without errors, but are ignored by the system.

AVE Sensor averaging setting.

Syntax: AVE<number>

- number:**
- 0 = Averaging OFF
 - 9 = HOLD. Holds the present averaged reading.
 - 1 = Average for 1 second (ML2430A Repeat average number of 25).
 - 2 = Average for 2 seconds (ML2430A Repeat average number of 70).
 - 3 = Average for 5 seconds (ML2430A Repeat average number of 128).
 - 4 = Average for 10 seconds (ML2430A Repeat average number of 256).

Remarks: The ML4803A averages for a period of time. The ML2430A sets the averaging to repeat averaging for a number of readings.

CAL Set the user cal factor value.

Syntax: CAL<value>

value: Cal factor value in dB

CCA Clear the calfactor value to zero.

CDJ Perform a CAL 0 dBm.

Remarks: During the cal 0 dBm sequence, the CAL execution bit in the status byte is set. When the CAL operation is completed, the CAL execution bit is cleared.

COF Clear the offset value to zero.

COS Turn ON the 50 MHz, 0 dBm RF calibrator output.

CRF Clear the reference value to zero.

CST Turn OFF the 50 MHz, 0 dBm RF calibrator output.

DBM Sets the display channel units to dBm.

DBR Sets the display channel units to dB's and takes the relative value.

Remarks: The relative value is stored as the reference data. The reference value can be independently changed with the GPIB command REF.

EMUL GPIB emulation mode

Syntax: EMUL <mode>

mode: ML24XX (Anritsu ML2430A Series native mode)
HP436A (Hewlett-Packard)
HP437B (Hewlett-Packard)
HP438A (Hewlett-Packard)
ML4803 (Anritsu ML4803A Series)

Remarks: Set the GPIB emulation to emulate other types of power meters. This command is available in any emulation mode, and resets the whole GPIB interface when the emulation mode is changed.

When selecting GPIB emulation modes, the instrument configures itself to the preset conditions of the instrument to be emulated. For example, when selecting HP 438A emulation, the front panel menus pass through the presets for the HP 437B (which presets sensor A to dBm) then selects HP 438A emulation (which presets sensor A to Watts).

NOTE

This command must be entered using the 488.2 format; that is, EMUL<ws><mode> (<ws> = white space).

- MCA** Set the cal factor value at the specified memory location in dBm.
- Syntax:** MCA<mem>< ; ><value>
- mem:* Memory location 1 to 30.
- value:* Cal factor value in dBm.
- Remarks:** Set the cal factor value at memory store address <mem> to <value> dBm.
-
- MCC** Clears the cal factor value at the specified memory location.
- Syntax:** MCC<mem>
- mem:* Memory location 1 to 30.
- Remarks:** Clears the cal factor value at memory store <mem> to 0.0 dBm.
-
- MCO** Clears the offset value at the specified memory location.
- Syntax:** MCO<mem>
- mem:* Memory location 1 to 30.
- Remarks:** Clears the offset value at memory store <mem> to 0.0 dBm.
-
- MCQ** Clears the frequency value at the specified memory location.
- Syntax:** MCQ<mem>
- mem:* Memory location 1 to 30.
- Remarks:** Clears the frequency value at memory store <mem> to 0.1MHz.

MCR Clears the reference value at the specified memory location.

Syntax: MCR<mem>

mem: Memory location 1 to 30.

Remarks: Clears the reference value at memory store <mem> to 0.0 dBm.

MCT Clears all the entries at the specified memory location.

Syntax: MCT<mem>

mem: Memory location 1 to 30.

Remarks: Clears frequency, cal factor, offset and reference values at memory store <mem>.

MDI Disable memory store setting and use.

MEN Enable setting of the memory stores. Also will apply the last memory store configured.

MFG Set the frequency value at the specified memory location in GHz.

Syntax: MFG<mem>< ; ><value>

mem: Memory location 1 to 30.

value: Frequency value in GHz.

Remarks: Set the frequency value at memory store address <mem> to <value> GHz.

MFM Set the frequency value at the specified memory location in MHz.

Syntax: MFM<mem>< ; ><value>

mem: Memory location 1 to 30

value: Frequency value in MHz

Remarks: Set the frequency value at memory store address <mem> to <value> MHz.

MOF

Set the offset value at the specified memory location in dBm.

Syntax: MOF<mem><;><value>

mem: Memory location 1 to 30.
value: Offset value in dBm.

Remarks: Set the offset value at memory store address <mem> to <value> dBm

MRF Set the reference value at the specified memory location in dBm.

Syntax: MRF<mem><;><value>

mem: Memory location 1 to 30.
value: Reference value in dBm.

Remarks: Set the reference value at memory store address <mem> to <value> dBm.

ODT Output the current calibration factor, offset value, and reference level.

Remarks: These are output as three separate messages in the output buffer, as shown below:

CAL factor: 18 ASCII characters + <CR><LF>
 OFFSET value: 18 ASCII characters + <CR><LF>
 REFERENCE level: 19 ASCII characters + <CR><LF>

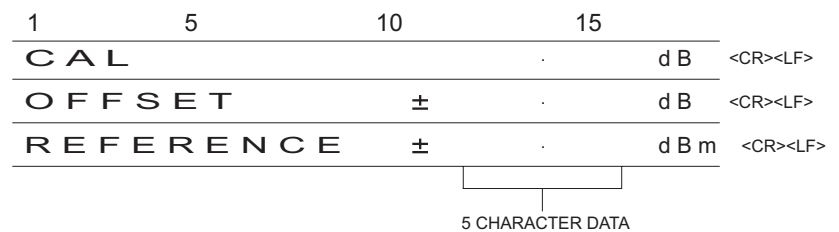

Figure 6-3. ODT Data Output Format

NOTE

When the ODT, OMR, and OPW data output commands are received simultaneously, only the command which is received last is valid.

OFF Set sensor offset value

Syntax: OFF<value>

value: Offset value to add to the sensor reading.

OI? Request identity

Syntax: OI?

Remarks: Response: <ML4803>

OMR Output a memory store set of data.

Syntax: OMR<mem>

mem: Memory location 1 to 30.

Remarks: Output a memory store set of data. The output format is as follows:

FREQUENCY: 19 ASCII characters + <CR><LF>
 CAL factor: 18 ASCII characters + <CR><LF>
 OFFSET value: 18 ASCII characters + <CR><LF>
 REFERENCE level: 19 ASCII characters + <CR><LF>

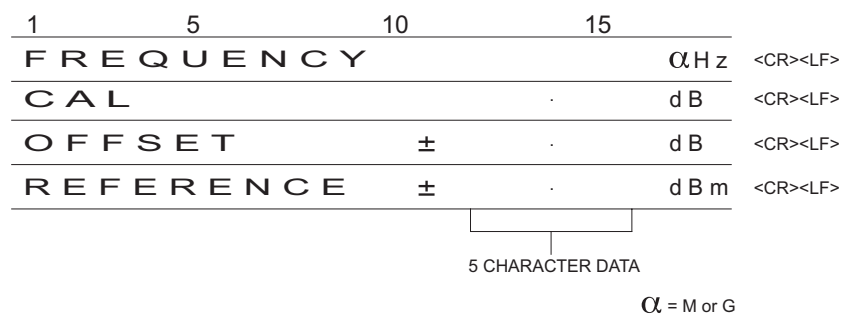

Figure 6-4. OMR Output Data Format

NOTE

When the ODT, OMR, and OPW data output commands are received simultaneously, only the command which is received last is valid.

OPW Request for channel reading.

Remarks: Outputs measuring condition, measured data, and status. CR and LF codes are automatically output and executed after each line of 22 ASCII characters when the OPW command is used. The format of the returned data is:

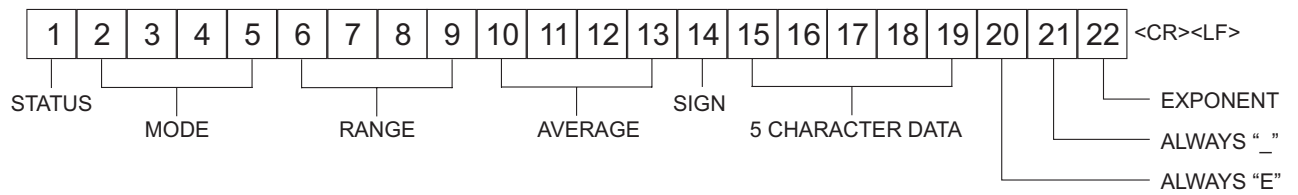

Figure 6-5. OPW Data Output Format

The data output codes are as shown in the table below. See the next page for measured data output examples.

Output Code	Contents	Function
V	Measured data valid	STATUS
D	Data range over	
U	Underrange (dBm and dBr)	
O	Overrange	
Z	Zero adjustment	
WATT	Watt	MODE
dBm	dBm	
dBr	dBr	
%	%	
VSWR	VSWR	
dB50	dBu, 50 Ω system	
dB75	dBu, 75 Ω system	
VL50	Volt, 50 Ω system	
VL75	Volt, 75 Ω system	
	HOLD	RANGE
MRG1	highest sensitivity 1	
MRG2	2	
MRG3	3	
MRG4	4	
MRG5	lowest sensitivity 5	

Output Code	Contents	Function
	AUTO	RANGE
ARG1	highest sensitivity 1	
ARG2	2	
ARG3	3	
ARG4	4	
ARG5	lowest sensitivity 5	
AVE0	OFF	AVERAGE
AVE9	HOLD	
AVE1	1 (1 second interval)	
AVE2	2 (2 second interval)	
AVE3	3 (5 second interval)	
AVE4	4 (10 second interval)	
Space	+	SIGN
-	-	
5 - 1	Numeric data (5 characters) × 10 ^{-(exponent value)}	DATA

NOTE

When the ODT, OMR, and OPW data output commands are received simultaneously, only the command which is received last is valid.

Examples:

dBm Mode:

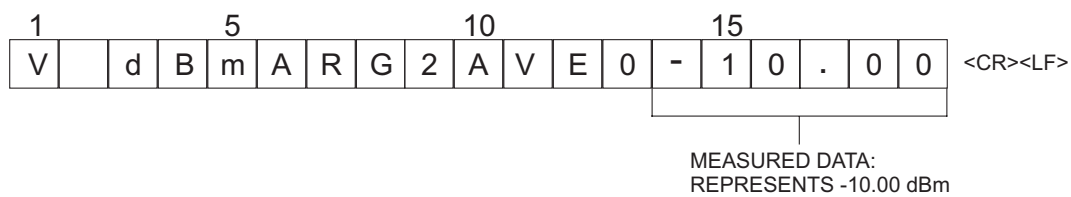

Watt Mode:

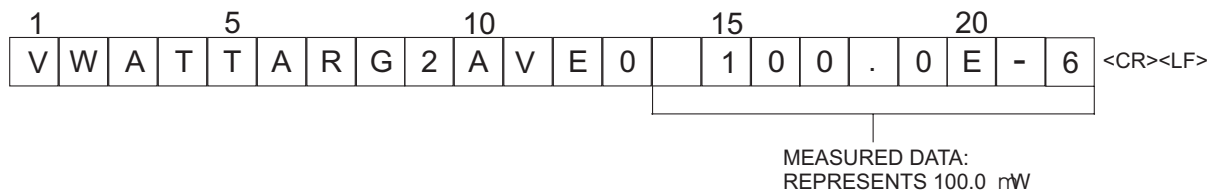

Figure 6-6. Examples, dBm Mode and Watt Mode

As shown in the examples above, the dBm data is output in fixed rotation, while the WATT data is output in scientific notation. The exponent may be converted as follows:

1.000W = 1.000E-0	1.000 μ W = 1.000E-6
1.000 mW = 1.000E-3	100.0 nW = 100.0E-9
100.0 μ W = 100.0E-6	10.00 nW = 10.00E-9
10.00 μ W = 10.00E-6	0.100 nW = 0.100E-9

For dB (rel), including % and VSWR data, the display data is output in fixed notation just as dBm data is.

REF Set the reference value.

Syntax: REF<value>

value: Reference value

Remarks: If the display channel is already in relative mode the display value will be updated to be relative to the new reference value set. When the display channel is put into relative mode the reference value will be over written with the correct relative value to make the display read 0 dB.

RNG Sensor measurement range hold.

Syntax: RNG<number>

<number>: 1 = Range 1 (ML2430A range 5)
 2 = Range 2 (ML2430A range 4)
 3 = Range 3 (ML2430A range 3)
 4 = Range 4 (ML2430A range 2)
 5 = Range 5 (ML2430A range 1)
 A = Auto ranging

Remarks: When the ML2430 is being used to emulate the ML4803, the ranges are reversed; that is, ML4803 range 1 (the lowest power range) is equivalent to the ML2430A range 5, and ML4803 range 5 (the highest power range) is equivalent to the ML2430A range 1. Refer to page 4-6 for more information on sensor ranges.

SRQ Turns on or off the SRQ on output data ready.

Syntax: SRQ<state>

state: 0 = OFF
 1 = ON

Remarks: When SRQ0 is issued, the SRQ will no longer turn off and on with each reading. The SRQ is set back on by the SRQ1 command or by requesting data.

STA Restart averaging reading.

WAT Sets the display channel units to Watts.

Remarks: Turns off relative mode. Relative is not available in this mode.

ZAJ Zero the sensor.

Remarks: During the zero operation, the zero bit in the status byte is set. When the zero operation is completed, the zero bit in the status byte is cleared.

When emulating the ML4803, the ML2430 may take longer to zero a sensor than the ML4803 itself. When performing a zero, the status byte should be used to identify when zeroing is complete.

6-13 *HP 436A
EMULATION
COMMANDS*

This section provides an alphabetical listing of the commands (mnemonics) used to program the Model ML2430A Series Power Meter when in HP 436A Emulation mode. The emulation mode is set through the front panel SYSTEM|Rear Panel|GPIB|MODE menu (see Chapter 4, Operation) or through the GPIB command EMUL (page 6-96).

HP Emulation commands must not have a space between the command header and the parameter, or commas between the parameters.

The format for HP Emulation commands is:

<command header><parameter 1><parameter *n*>...

The end of the command text must be terminated with a line feed character (0Ah, decimal 10) or a GPIB End of Transmission State (EOI), or both.

+ Disable cal factors

- Enable cal factors

1, 2, 3,
4 & 5 Set sensor operating range

Remarks: Range 5 is the highest power range, range 1 the lowest. (These are the opposite to the ML2430A native mode ranges; that is, HP 436 range 5 sets to ML2430A range 1, and HP 436 range 4 to ML2430A range 2, etc.)

When the ML2430A is being used to emulate the HP 436, the ranges are reversed; that is, HP 436 range 1 (the lowest power range) is equivalent to the ML2430A range 5, and HP 436 range 5 (the highest power range) is equivalent to the ML2430A range 1. Refer to page 4-6 for more information on sensor ranges.

9 Auto range

Remarks: Sets the ML2430A Series to automatically select the correct range for the measurement.

A Watt

Remarks: Set units to Watts. Turn relative mode off and do not allow relative.

B

dB (rel)

Remarks: Set to dB units in relative mode using the present relative reference value.

C dB (ref)

Remarks: Set to dB units in relative mode using the present relative reference value, and enable the application of the calfactor.

D dBm

Remarks: Set units to dBm.

EMUL Select emulation mode

Syntax: EMUL <mode>

mode: ML24XX (Anritsu ML2430A Series native mode)
HP436A (Hewlett-Packard)
HP437B (Hewlett-Packard)
HP438A (Hewlett-Packard)
ML4803 (Anritsu ML4803A Series)

Remarks: Sets the GPIB emulation to emulate other types of power meters. This command is available in any emulation mode, and resets the whole GPIB interface when the emulation mode is changed.

When selecting GPIB emulation modes, the instrument configures itself to the preset conditions of the instrument to be emulated. For example, when selecting HP 438A emulation, the front panel menus pass through the presets for the HP 437B (which presets sensor A to dBm) then selects HP 438A emulation (which presets sensor A to Watts).

NOTE

This command requires a white space between the command header (EMUL) and the parameter <mode>. This is an ML2430A-specific command that does not conform to the HP Emulation command format defined at the beginning of this section.

H Hold mode

Remarks: Sets both channels to trigger hold mode. The power meter does not trigger until it receives an I or T command. If it receives an R or V command, it reverts back to the trigger mode it was in before the H command was sent.

I Trigger without settling.

Remarks: Triggers a single reading which is added to the internal digital filter and the updated filter power level is returned on the GPIB. After an I command, the instrument returns to standby mode (H).

OI Identification

Remarks: Ask for identification of current operating mode. Responds with "HP436."

R Free run mode

Remarks: Sets the ML2430A Series back into free run mode to continuously take measurements and output data.

T Trigger with settling

Remarks: Triggers a new series of readings; enough to update the internal digital filter for a noise free reading at the current power level. The value is then returned on the GPIB and returns to standby mode (H).

V Free run mode with settling

Remarks: Sets the ML2430A Series back into free run mode to continuously take measurements and output data after running a settling routine.

Z Zero sensor

Remarks: Zero out the noise from the sensor. When zeroing the ML2430 in HP 436 emulation mode, the 'Z1T' sequence followed by the '9+DI' described in the HP 436 manual must be followed.

Output Format

The output data format for the HP 436A emulation mode is shown below.

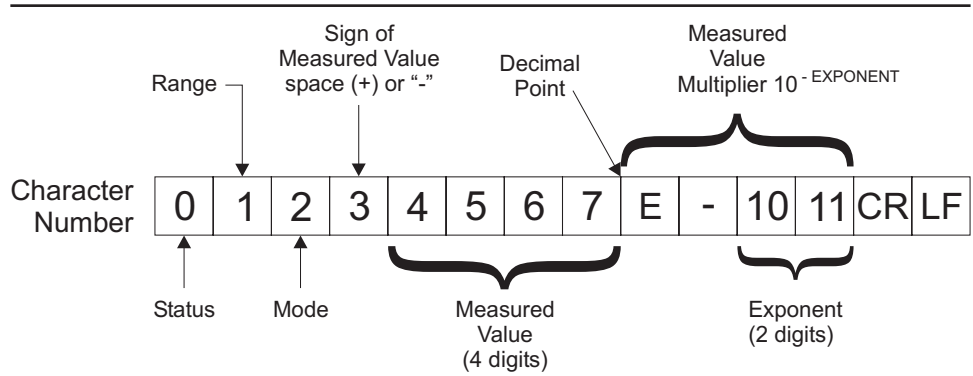

Figure 6-7 HP 436A Output Data Format

Table 6-2 (next page) describes the GPIB output data format.

Table 6-2 GPIB Output Data Format

Definition		Character	
		ASCII	Decimal
STATUS			
Measured value valid		P	80
Watts mode under range		Q	81
Over range		R	82
Under range dBm or dB (Rel) mode		S	83
Power Sensor Auto Zero loop enabled; range 1 under range		T	84
Power Sensor Auto Zero loop enabled; not range 1 under range		U	85
Power Sensor Auto Zero loop enabled; over range		V	86
RANGE			
most sensitive	1	I	73
	2	J	74
	3	K	75
	4	L	76
	5	M	77
least sensitive			
MODE			
Watt		A	65
dB Rel		B	66
dB Ref		C	67
dBm		D	68
SIGN OF MEASURED VALUE			
space (+)		SP	32
- (minus)		-	45
MEASURED VALUE DIGITS			
	0	0	48
	1	1	49
	2	2	50
	3	3	51
	4	4	52
	5	5	53
	6	6	54
	7	7	55
	8	8	56
	9	9	57

6-14 HP 437B EMULATION COMMANDS

This section provides an alphabetical listing of the commands (mnemonics) used to program the Model ML2430A Series Power Meter when in HP 437B Emulation mode. The emulation mode can be set through the front panel SYSTEM|Rear Panel|GPIB|MODE menu (see Chapter 4, Operation) or through the GPIB command EMUL (page 6-105).

HP Emulation commands must not have a space between the command header and the parameter, or commas between the parameters.

The format for HP Emulation commands is:

<command header><parameter 1><parameter n>...

The end of the command text must be terminated with a line feed character (0Ah, decimal 10) or a GPIB End of Transmission State (EOI), or both.

*CLS Clear GPIB status bytes

Syntax: *CLS

Remarks: This command performs a status structure clear command. The event status register and the status register are cleared except for the MAV bit.

*ESE Set the Event Status register enable mask

Syntax: *ESE<val>

val: 8-bit mask

Remarks: Event registers for the HP 437B (see Figure 6-8):

Bit 7: Power ON

Bit 6: N/A

Bit 5: Command error

Bit 4: Execution error

Bit 3: Device Dependent error

Bit 2: N/A

Bit 1: N/A

Bit 0: N/A

See the HP 437B manual for details about the HP status registers.

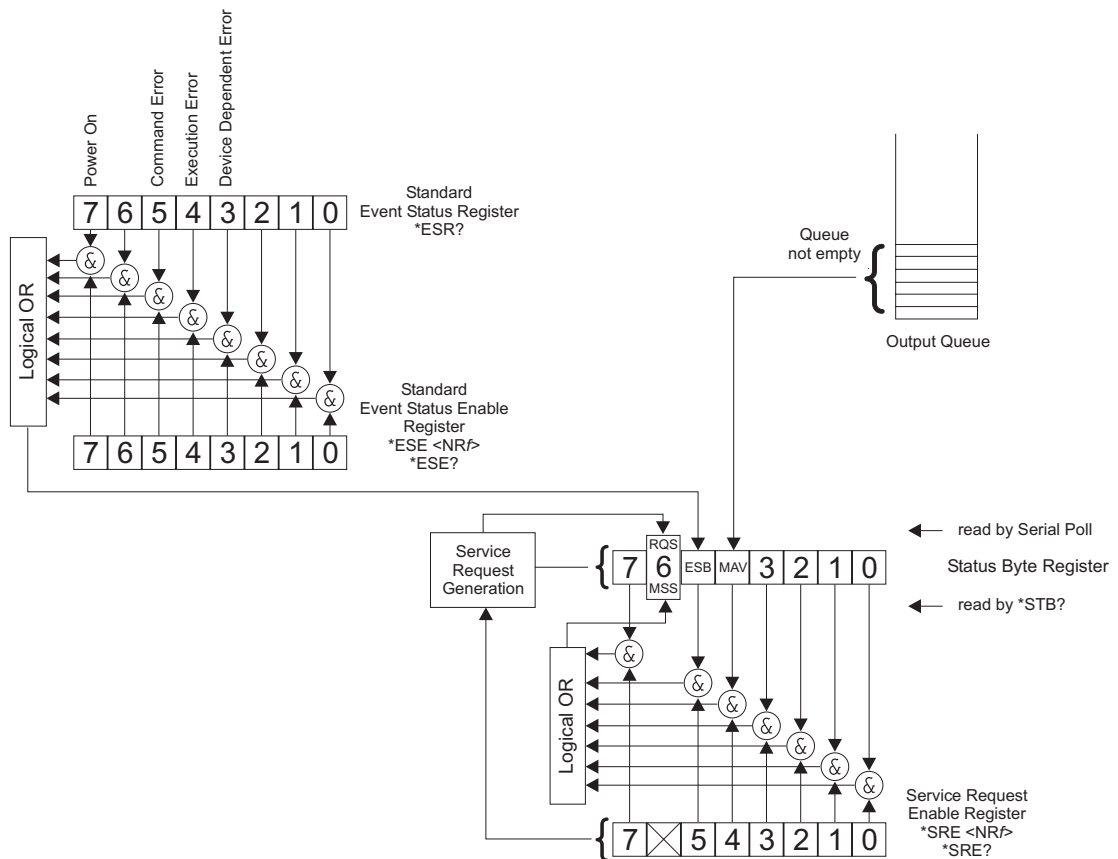

Figure 6-8. IEEE 488.2 Standard Status Structures

*ESE? Return Event status register enable mask

Syntax: *ESE?

Remarks: Returned format: <unsigned character>
 When converted to an 8-bit binary number, this byte yields the bit settings
 of the register.

*ESR? Event status register request

Syntax: *ESR?

Remarks: Return the value of the standard event status register. Afterwards the event
 status register are cleared. The returned format is: <unsigned character>.
 When converted to a 8-bit binary number, this byte yields the bit settings of
 the register.

*RST Reset Device

Syntax: *RST

Remarks: Resets the ML2430A Series to the default configuration (see Appendix A, Section A-3, or see the HP manual when in HP 437B emulation mode). Offset tables are not cleared. The GPIB ADDRESS and EMULATION settings are not changed, and the input queue, output queue, and status registers on the GPIB are not cleared. This command produces the same result as the front panel key sequence System|Setup|PRESET|RESET.

*SRE Setup service request enable register

Syntax: *SRE <val>

val: 8-bit mask

Remarks: Sets the Service request enable register bits.

*SRE? Return Service Request Enable register

Syntax: *SRE?

Remarks: Returns the Service Request Enable register.

*STB? Return Status Byte register

Syntax: *STB?

Remarks: Returns the status byte value with bit 6 replaced with the MSS value. MSS is the GPIB Master Summary Status, and indicates that the device has at least one reason for requesting service. Although the MSS message is sent in bit position 6 of the device's response to the *STB? query, it is not sent in response to a serial poll and should not be considered part of the IEEE 488.1/2 status byte. MSS = the Status Byte (STB) OR'ed with the Service Request Enable register (SRE). Unlike the *ESR? Command, this command does not clear the register afterwards.

*TST? Self Test

Syntax: *TST?

Remarks: Performs a self test and returns 000.'

Related

Commands: STERR

@1 Set SRE mask

Syntax: @1<val>

val: 8-bit mask

Remarks: Status Byte Structure:
 Bit 0: Data ready
 Bit 1: Cal/Zero complete
 Bit 2: Entry Error
 Bit 3: Measurement error
 Bit 4: Over/Under limit
 Bit 5: Event Status Register
 Bit 6: Request Service
 Bit 7: N/A

Related

Commands: RV

CL Cal Adjust

Syntax: CL<val><terminator>

val: 50.0 to 120.0

terminator: %
 PCT
 EN

Remarks: Same as the ML24XXA (native) CFADJ command. Sets a calibration factor to be used when performing a 0 dBm calibration.

Examples: CL98.5EN

CL98.5%

CL98.5PCT.

CS Clear all status bytes

Syntax: CS

Remarks: Same as the *CLS command. Resets all of the GPIB status registers and clears the input queue.

CT Clear the cal factor table

Syntax: CT<table_number>

table
number: 0 to 9

Remarks: Clears the specified cal factor table to a single 50mhz entry at 100%. Since the ML2430A stores the cal factor table information in the sensor, this data must be saved to the sensor by using the 'EX' command or an additional command 'SV', or the data could be lost. The saving of the cal factor table data to the sensor can be done at the end of all updates to a particular table.

DA Display All

Syntax: DA

Remarks: Turns on all the segments of the display to verify proper operation. The display is returned to normal when another command is sent.

DC Duty Cycle state

Syntax: DC<state>

state: 0 = OFF
1 = ON

Remarks: Turns on or off application of the duty cycle to the sensor data.

DD Display disable

Syntax: DD

Remarks: Turns the display off to allow faster measurements to be taken.

Related
Commands: DE, DF

DE display enable

Syntax: DE

Remarks: Return the display to normal operation after the display has been set in DD mode.

**Related
Commands:** DD, DF

DF Display disable

Syntax: DF

Remarks: Turns the display off to allow faster measurements to be taken.

**Related
Commands:** DD, DE

DR Set GPIB address

Syntax: DR<val><terminator>

val: 1 to 30
terminator: EN

Remarks: Changes the device address. The power meter default address is 13.

DY Duty Cycle

Syntax: DY<val><terminator>

val: duty cycle value in percent
terminator: %, PCT, or EN

Remarks: Sets the duty cycle to be applied to the input signal.

EMUL GPIB emulation mode

Syntax: EMUL <mode>

mode: ML24XX (Anritsu ML2430A Series native mode)
HP436A (Hewlett-Packard)
HP437B (Hewlett-Packard)

HP438A (Hewlett-Packard)
ML4803 (Anritsu ML4803A Series)

Remarks: Set the GPIB emulation to emulate other types of power meters. This command is available in any emulation mode, and resets the whole GPIB interface when the emulation mode is changed.

When selecting GPIB emulation modes, the instrument configures itself to the preset conditions of the instrument to be emulated. For example, when selecting HP 438A emulation, the front panel menus pass through the presets for the HP 437B (which presets sensor A to dBm) then selects HP 438A emulation (which presets sensor A to Watts).

EN Enter command

Syntax: EN

ET Enter data for a cal factor table

Syntax: ET<table_number><freq_value><cal factor><terminator>

table number: 0 to 9 (F for factory table allowed when using to read a table)

freq value: cal factor entry frequency value

cal factor: cal factor value in percentage

terminator: EN to terminate and entry
EX to terminate table entries

Remarks: Since the ML2430A stores the cal factor table information in the sensor, this data must be saved to the sensor by using the 'EX' command or an additional command 'SV', or the data could be lost. The saving of the cal factor table data to the sensor can be done at the end of all updates to a particular table.

EX Exit cal factor table mode

Syntax: EX

Remarks: Used on the ML2430A to force a save of the cal factor table to the sensor if the data has changed.

FA Auto average

Syntax: FA

Remarks: Automatic Filter on. Allows the system to automatically select the filter used to reduce the jitter in the display.

**Related
Commands:** FM, FH

FH average hold

Syntax: FH

Remarks: Hold filter sets the filter mode to Manual from Auto, but retains the auto filter setting. This function is the same as the AVGM command.

**Related
Commands:** FM, FH, FA

FM Set average value

Syntax: FM<val>EN

val: 1 to 512

Remarks: Sets the filter length for the averaging of sensor data. For HP 437B emulation, the command accepts 1 to 512 in 2-to-the-power steps. For example, 1, 2, 4, 8, 16,...256, 512.

**Related
Commands:** FH, FA

FR Frequency of the input signal

Syntax: FR<val><units>

val:
units: GZ (GHz)
MZ (MHz)
KZ (KHz)
HZ (Hz)
EN (Hz)

Remarks: Sets the frequency of the input signal so that the correct cal factor is used.

Example: To set the frequency of the input signal to 300 MHz:

FR300MZ

GT Set group trigger

Syntax: GT<mode>

mode: 0
1
2

Remarks: 0 = Ignore Group Execute Trigger (GET) command
1 = Trigger immediate response to 'GET' command
2 = Trigger with delayed response to 'GET' command
The GTn command configures what the device does when it receives the 'GET' command.
For example: GT1 sets the 'GET' (Group Execute Trigger) to perform a TR1 type trigger.

**Related
Commands:** TR

ID Return identification string

Syntax: ID

Remarks: Returned format:
<company name>,<model>,<firmware version>

IDN? HP 437B identity request

Syntax: IDN?

Remarks: Returned format:
<company name>,<model>,<firmware version>

KB Calibration factor

Syntax: KB<val><terminator>

val: 1.0 to 150.0%

terminator: %
PCT
EN

Remarks: The calibration factor compensates for mismatch losses and effective efficiency over the frequency range of the power sensor.

Example: KB99.9%

KB99.9PCT

KB99.9EN

LG Set log units

Syntax: LG

Remarks: Changes the display to log units (dBm).

LH Set high limit

Syntax: LH<val>EN

val: -99.999 to +99.999 (dBm only)

Remarks: Sets the high limit.

Example: LH30.00EN

LL Set low limit

Syntax: LL<val>EN

val: -99.999 to +99.999 (dBm only)

Remarks: Sets the low limit.

Example: LL20.00EN

LM limits check state

Syntax: LM<state>

state: 0 (off) or 1 (on)

Remarks: Turns limit checking on or off.

LN Set linear units

Syntax: LN

Remarks: Changes the display to linear units (Watts).

OC Set calibrator state

Syntax: OC<state>

state: 0 (OFF)
 1 (ON)

Remarks: For example: OC0 (reference calibrator state set to OFF).

OD Output the display

Syntax: OD

Remarks: Outputs a formatted display channel reading in either dBs or Watts. Will also output the cal factor tables, as described below.

The only way to read out the cal factor table data from the HP 437 is to send the commands to display each entry on the screen, and then ask for a text display output using the 'OD' command.

The ML2430A Series supports the 'OD' command to the extent that it will output a formatted display channel reading in either dBs or Watts, and will also output the cal factor tables. After sending the 'ETn' command (n = the cal factor table number) if an 'OD' is sent, the first frequency/cal factor entry of the cal factor table is output in the HP format. If this is then followed by an 'EN' the next cal factor entry pair is available for output, and can be read using the 'OD' command. When all the pairs are output, all further 'ENOD' combinations output a frequency of '00.00 MHz 100.0%'. The EX command terminates this action so that further 'OD' commands now output the display reading in a formatted mode.

If RFnOD (n = cal factor table number) is sent, the 50 MHz cal factor table entry is output.

OF Offset state

Syntax: OF<state>

state: 0 (OFF)
1 (ON)

Remarks: For example: OF1 (Turn offsets ON).

OI Return identification string

Syntax: OI

Remarks: Returned format:
<company name>,<model>,<firmware version>

OS Set offset value

Syntax: OS<val>EN

val: -99.99 to +99.99 dB

Remarks: Specifies the offset applied to the displayed value. Values can be entered in 0.01 dB increments.

Example: OS10.13EN

Set an offset of 10.13 to the displayed value.

PR Preset the unit

Syntax: PR

Remarks: Presets the unit to the HP factory defaults. This command does not effect the calibration factors stored in the sensor data tables.

RA Auto Range

Syntax: RA

Remarks: Sets the ML2430A Series to automatically select the correct range for the measurement.

RC Recall setup

Syntax: RC<val>EN

val: 1 to 10

Remarks: The ML2430A Series can store up to 10 instrument configurations for convenient recall. The configuration parameters stored are the same parameters the ML2430A Series stores in its own *SAV and *RCL native commands. Therefore, RC is equivalent to *RCL, and ST is equivalent to *SAV.

Selecting Register 0 always restores the previous power meter configuration, providing an expedient way to recover from an entry error.

RE Set decimal point resolution

Syntax: RE<number>EN

val: 1, 2, or 3

Remarks: Set the number of decimal places displayed.

Example: To set the display resolution to 2 decimal places:

RE2EN

RF Set the reference cal factor value for a table

Syntax: RF<table_number><cal_factor>%

table

number: 0 to 9

cal factor: 50 to 150

%: terminator

Remarks: Set the reference cal factor value for a table. Since the ML2430A stores the cal factor table information in the sensor, this data must be saved to the sensor by using the 'EX' command or an additional command 'SV', or the data could be lost. The saving of the cal factor table data to the sensor can be done at the end of all updates to a particular table.

RH Range hold

Syntax: RH

Remarks: Hold the power meter in the current range. The differences in sensor ranges must be taken into account when the ML2430 is being used to emulate the HP 437.

RL Relative mode

Syntax: RL<mode>

mode: 0
1
2

Remarks: Relative mode permits any measurement result to be compared in dB or percent to a reference value. Relative mode can be enabled using the current power reading (RL1) or the previous reference level (RL2). Successive measurements are displayed relative to this reference value. RL0 disables relative mode.

RM Range hold set

Syntax: RM<val>EN

val: 0 to 5

Remarks: Set the range to <val> and then sets range hold. A value of 0 selects Auto Ranging, so that the range will change to take the best measurement automatically.

Example: To set the range to 3:

RM3EN

**Related
Commands:** RH

RV Service request mask value.

Syntax: RV

Remarks: Read service request mask value. The returned string format is: <integer value>
Converting the integer value into an 8-bit binary number, each bit corresponds to the Service Request mask bits.

SE Select cal factor table

Syntax: SE<table_number>EN

*table
number:* 0 to 9

Remarks: Selects the cal factor table to be used.

SM status message

Syntax: SM

Remarks: Returns the status message in the format:
AAaaBBCCccDDddEFGHIJKLMNOP<cr><lf>
where:
AA: measurement error code
aa: entry error code
BB: operating mode
CC: sensor A range
cc: 0
DD: sensor A filter
dd: 0
E: linear/log units
F: A
G: pwr ref status
H: REL mode status
I: trigger mode
J: group trigger mode
K: limits checking status
L: sensor A limits status
M: 0
N: offset status
O: duty cycle status
P: measurement units

SN Cal table identity update

Syntax: SN<val>

val: up to seven characters

Remarks: Since the ML2430A stores the cal factor table information in the sensor, this data must be saved to the sensor by using the 'EX' command or an additional command 'SV', or the data could be lost. The saving of the cal factor table data to the sensor can be done at the end of all updates to a particular table.

ST Store setup

Syntax: ST<val>EN

val: 1 to 10

Remarks: Stores the present configuration to the selected register.

Example: To store the current instrument configuration in register 2:

ST2EN

Related

Commands: RC

SV Save cal factor table

Syntax: SV

Remarks: Since the ML2430A stores the cal factor tables in the sensors, this command forces the edits to a cal factor table to be saved to the sensor. The operation can take a couple of seconds to complete.

TR0 Trigger hold mode

Syntax: TR0

Remarks: Sets both channels to trigger hold mode. It does not trigger until it receives a TR1 or TR2 or GET (group executive trigger), *TRG or TR3 command. If it receives a TR3 command it reverts back to the trigger mode it was in before the TR0 command was sent. If the REM line is low, this command has no effect.

Related

Commands: TR1, TR2, TR3, *TRG, Group Execute Trigger (GET), GT0, GT1, GT2

TR1 Trigger immediate

Syntax: TR1

Remarks: Triggers a single reading which is added to the internal digital filter and the updated filter power level is returned on the GPIB. After a TR1 command, the instrument returns to TR0 standby mode.

Related

Commands: TR0, TR2, TR3, *TRG, Group Execute Trigger (GET), GT0, GT1, GT2

TR2 Trigger with a settling delay

Syntax: TR2

Remarks: Triggers a new series of readings; enough to update the internal digital filter for a noise free reading at the current power level. The value is then returned on the GPIB and returns to TR0 standby mode.

Related

Commands: TR0, TR1, TR3, *TRG, Group Execute Trigger (GET), GT0, GT1, GT2

TR3 Trigger free run

Syntax: TR3

Remarks: Sets the ML2430A Series back into free run mode on both channels.

Related

Commands: TR0, TR1, TR2, *TRG, Group Execute Trigger (GET), GT0, GT1, GT2

ZE Zero sensors

Syntax: ZE

Remarks: Zero all connected sensors. The ML2430, when emulating the HP 437, may take longer to Zero a sensor than the HP 437 itself. When performing a zero the status byte should be used to identify when ZEROing is complete.

**6-15 HP 438A
EMULATION
COMMANDS**

This section provides an alphabetical listing of the GPIB commands (mnemonics) used to program the Model ML2430A Series Power Meter when in HP 438A Emulation mode. The emulation mode can be set through the front panel SYSTEM|more|more|Rear panel|GPIB|MODE menu (see Chapter 4, Operation) or through the GPIB command EMUL (see page 6-120).

HP Emulation commands must not have a space between the command header and the parameter, or commas between the parameters.

The format for HP Emulation commands is:

<command header><parameter 1><parameter *n*>...

The end of the command text must be terminated with a line feed character (0Ah, decimal 10) or a GPIB End of Transmission State (EOI), or both.

The ML2430A Series in HP 438A emulation mode also supports the HP 437B cal factor table edit and read commands.

?ID HP Identity request

Syntax: ?ID

Remarks: The format of the returned string is:
<Company name>,<model>,<serial>,<firmware version>

@1 Set SRE mask

Syntax: @1<val>

val: 8-bit mask

Remarks: Status Byte Structure, HP 438A:
Bit 0: Data ready
Bit 1: Cal/Zero complete
Bit 2: Entry Error
Bit 3: Measurement error
Bit 4: Over/Under limit
Bit 5: Event Status Register (HP 437B only)
Bit 6: Request Service
Bit 7: N/A

AD Set display to A – B

Syntax: AD

Remarks: Display the Input A reading minus the Input B reading.

AP Set single sensor A display

Syntax: AP

Remarks: Set the display to output Input A readings.

AR Set display A / B

Syntax: AR

Remarks: Display the Input A reading divided by the Input B reading.

BD Set display B – A

Syntax: BD

Remarks: Display the Input B reading minus the Input A reading.

BP Set single sensor B display

Syntax: BP

Remarks: Display Input B readings.

BR Set display B / A

Syntax: BR

Remarks: Display the Input B reading divided by the Input A reading.

CL Cal Adjust

Syntax: CL<val><terminator>

val: 50.0 to 120.0

terminator: %
PCT
EN

Remarks: Same as the ML24XXA (native) CFADJ command. Sets a calibration factor to be used when performing a 0 dBm calibration.

Examples: CL98.5EN

CL98.5%

CL98.5PCT

CS Clear all status bytes

Syntax: CS

Remarks: Same as the *CLS command. Resets all of the GPIB status registers and clears the input queue.

DA Display All

Syntax: DA

Remarks: Turns on all the segments of the display to verify proper operation. The display is returned to normal when another command is sent.

DD Display disable

Syntax: DD

Remarks: Turns the display off to allow faster measurements to be taken.

**Related
Commands:** DE

DE Display enable

Syntax: DE

Remarks: Return the display to normal operation after the display has been set in DD mode.

**Related
Commands:** DD

DR Set GPIB address

Syntax: DR<val>

val: 1 to 30

Remarks: Changes the device address when operating in HP emulation mode. The power meter default address is 13.

EMUL GPIB emulation mode

Syntax: EMUL <mode>

mode: ML24XX (Anritsu ML2430A Series native mode)
HP436A (Hewlett-Packard)
HP437B (Hewlett-Packard)
HP438A (Hewlett-Packard)
ML4803 (Anritsu ML4803A Series)

Remarks: Set the GPIB emulation to emulate other types of power meters. This command is available in any emulation mode, and resets the whole GPIB interface when the emulation mode is changed.

When selecting GPIB emulation modes, the instrument configures itself to the preset conditions of the instrument to be emulated. For example, when selecting HP 438A emulation, the front panel menus pass through the presets for the HP 437B (which presets sensor A to dBm) then selects HP 438A emulation (which presets sensor A to Watts).

FA auto average

Syntax: FA

Remarks: Automatic Filter on. Allows the system to automatically select the filter used to reduce the jitter in the display.

**Related
Commands:** FM, FH

FH average hold

Syntax: FH

Remarks: Hold filter sets the filter mode to Manual from Auto, but retains the auto filter setting. This function is the same as the AVGM command.

Related

Commands: FM, FH, FA

FM Set average value

Syntax: FM<val>EN

val: 0 to 9

Remarks: Sets the filter length for the averaging of sensor data. For HP 438A emulation, the filter length is defined as the number 2 to the power of <val>. For example, the command FM5EN would be 2^5 , or 32.

Related

Commands: FH, FA

GT Set group trigger

Syntax: GT<mode>

mode: 0
1
2

Remarks: 0 = Ignore Group Execute Trigger (GET) command
1 = Trigger immediate response to 'GET' command
2 = Trigger with delayed response to 'GET' command
The GTn command configures what the device does when it receives the 'GET' command.
For example: GT1 sets the 'GET' (Group Execute Trigger) to perform a TR1 type trigger.

Related

Commands: TR

KB Calibration factor

Syntax: KB<val><terminator>

val: 1.0 to 150.0%
terminator: %
PCT
EN

Remarks: The calibration factor compensates for mismatch losses and effective efficiency over the frequency range of the power sensor.

Examples: KB99.9%

KB99.9PCT

KB99.9EN

LG Set log units

Syntax: LG

Remarks: Changes the display to log units (dBm).

LH Set high limit

Syntax: LH<val>EN

val: -99.999 to +99.999 (dBm only)

Remarks: Sets the high limit.

Example: LH30.00EN

LL Set low limit

Syntax: LL<val>EN

val: -99.999 to +99.999 (dBm only)

Remarks: Sets the low limit.

Example: LL20.00EN

LM limits check state

Syntax: LM<state>

state: 0 (off) or 1 (on)

Remarks: Turns limit checking on or off.

LN Set linear units

Syntax: LN

Remarks: Changes the display to linear units (Watts).

OC Set calibrator state

Syntax: OC<state>

state: 0 (OFF)
 1 (ON)

Remarks: For example: OC0 (reference calibrator state set to OFF).

OI HP Identity request

Syntax: OI

Remarks: The format of the returned string is:
<Company name>,<model>,<serial>,<firmware version>

OS Set offset value

Syntax: OS<val>EN

val: -99.99 to +99.99 dB

Remarks: Specifies the offset applied to the displayed value. Values can be entered in 0.01 dB increments.

Example: To set an offset of 10.13 to the displayed value:

OS10.13EN

PR Preset the unit

Syntax: PR

Remarks: Presets the unit to the HP factory defaults. This command does not effect the calibration factors stored in the sensor data tables. The defaults for the HP 438A are:

Measurement mode = Sensor A

Reference Oscillator = Off
Active entry channel = A
Measurement units = Watts
REL mode = off
Measurement parameters (set for Sensor A and Sensor B):
Cal Factor = 100.0%
Cal Adj = 100.0%
Offset = 0.00 dB

RA Auto Range

Syntax: RA

Remarks: Sets the ML2430A Series to automatically select the correct range for the measurement.

RC Recall setup

Syntax: RC<val>EN

val: 1 to 10

Remarks: The ML2430A Series can store up to 10 instrument configurations for convenient recall. The configuration parameters stored are the same parameters the ML2430A Series stores in its own *SAV and *RCL commands. Therefore, RC is equivalent to *RCL, and ST is equivalent to *SAV.

Selecting Register 0 always restores the previous power meter configuration, providing an expedient way to recover from an entry error.

RH Range hold

Syntax: RH

Remarks: Hold the power meter in the current range. The differences in sensor ranges must be taken into account when the ML2430 is being used to emulate the HP 438.

RL Relative mode

Syntax: RL<mode>

mode: 0
1
2

Remarks: Relative mode permits any measurement result to be compared in dB or percent to a reference value. Relative mode can be enabled using the current power reading (RL1) or the previous reference level (RL2). Successive measurements are displayed relative to this reference value. RL0 disables relative mode.

RM Range hold set

Syntax: RM<val>EN

val: 0 to 5

Remarks: Set the range to <val> and then sets range hold. A value of 0 selects Auto Ranging, where the range will change to take the best measurement automatically.

Example: To set the range to 3:

RM3EN

**Related
Commands:** RH

RV Service request mask value

Syntax: RV

Remarks: Read service request mask value. The returned string format is: <integer value>
Converting the integer value into an 8-bit binary number, each bit corresponds to the Service Request mask bits.

SM Status Message

Syntax: SM

Remarks: Returns the status message in the format:
AAaaBBCCccDDddEFGHIJKLMNOP<cr><lf>
where:
AA: measurement error code
aa: entry error code
BB: operating mode

CC: sensor A range
 cc: sensor B range
 DD: sensor A filter
 dd: sensor B filter
 E: measurement units
 F: active entry channel
 G: OSC status
 H: REL mode status
 I: trigger mode
 J: group trigger mode
 K: limits checking status
 L: sensor A limits status
 M: sensor B limits status
 others not used

ST Store setup

Syntax: ST<val>EN

val: 1 to 10

Remarks: Stores the present configuration to the selected register.

Example: To store the current instrument configuration in register 2:

ST2EN

**Related
 Commands:** RC

TR0 Trigger hold mode

Syntax: TR0

Remarks: Sets both channels to trigger hold mode. It does not trigger until it receives a TR1 or TR2 or GET (group executive trigger), *TRG or TR3 command. If it receives a TR3 command it reverts back to the trigger mode it was in before the TR0 command was sent. If the REM line is low, this command has no effect.

**Related
 Commands:** TR1, TR2, TR3, *TRG, Group Execute Trigger (GET), GT0, GT1, GT2

TR1 Trigger immediate

Syntax: TR1

Remarks: Triggers a single reading which is added to the internal digital filter and the updated filter power level is returned on the GPIB. After a TR1 command, the instrument returns to TR0 standby mode.

Related Commands: TR0, TR2, TR3, *TRG, Group Execute Trigger (GET), GT0, GT1, GT2

TR2 Trigger with a settling delay

Syntax: TR2

Remarks: Triggers a new series of readings; enough to update the internal digital filter for a noise free reading at the current power level. The value is then returned on the GPIB and returns to TR0 standby mode.

Related Commands: TR0, TR1, TR3, *TRG, Group Execute Trigger (GET), GT0, GT1, GT2

TR3 Trigger free run

Syntax: TR3

Remarks: Sets the ML2430A Series back into free run mode on both channels.

Related Commands: TR0, TR1, TR2, *TRG, Group Execute Trigger (GET), GT0, GT1, GT2

ZE Zero sensors

Syntax: ZE

Remarks: Zero all connected sensors. The ML2430, when emulating the HP 438, may take longer to Zero a sensor than the HP 438 itself. When performing a zero the status byte should be used to identify when ZEROing is complete.

**6-16 PROGRAMMING
EXAMPLES**

The following programming examples are provided as a general guideline on how to program the ML2430A Series Power Meters using GPIB commands. All examples are written in Visual Basic or C language. The GPIB-specific calls are for the National Instruments GPIB DLL.

Refer to the IEEE 488.2-1987 Programming Reference book for more information about how to use the 488.2 commands.

Output Data

Function GetReading (ByVal channel As Integer) As Single

' make space for the result

Dim result As String

result = String\$(10, 0)

' Set the command up

Cmd = "O " + Str(channel) : CmdLength = Len(Cmd)

' Send the command to the device at address 13

' (default address of the power meter)

Call DLLsend(0, 13, Cmd, CmdLength, NLen, ibsta%,

iberr%, ibcntl&)

' Receive the data from ML2430A at address 13

Call DLLreceive(0, 13, result, 10, STOPend, ibsta%,

iberr%, ibcntl&)

' Pass result back

GetReading = Val(result)

End Function

Get Graph Data

```
Function GetGraphData ()
    ' function assumes that you have the graph display
    ' setup and that there is a global array called
    ' Graph_Data().

    ' make space for the result
    Dim result As String
    result = String$(2048, 0)
    ' set up a 2K buffer for the data to put in.

    ' Set the command up
    Cmd = "OGD" : CmdLength = Len(Cmd)

    ' Send the command to the device at address 13
    ' (default address of the power meter)
    Call DLLsend(0, 13, Cmd, CmdLength, NLen, ibsta%,
    iberr%, ibcntl&)

    ' Receive the data from ML2430A at address 13
    Call DLLreceive(0, 13, result, 2048, STOPend, ibsta%, iberr%, ibcntl&)
    result = Left(result, ibcntl&) - 1

    ' Get number of elements
    Number_of_elements = Val(Mid(result, 5, InStr(5, result, ",") - 5))

    ' redimension our global array
    ReDim GraphData(1 To Number_of_elements) As Single

    ' format the result string so that we only have
    ' the elements.
    result = Right(result, Len(result) - InStr(5, result, ","))

    ' loop through elements and place into our global array
    For I = 1 To Number_of_elements

        next_place = InStr(result, ",") - 1
        If next_place = -1 Then next_place = Len(result)
        GraphData(I) = Val(Mid(result, 1, next_place))

        ' reduce the elements by one
        ' (the one we have just put in the array)
        result = Right(result, Len(result) - InStr
        (result, ","))

    Next I

End Function
```

**Status
Register
Control**

This function demonstrates how to use the Status Registers to provide synchronization.

Uses the TR2 (trigger with settling) command to make a reading.

Function GetTR2Reading (channel) As Single

```

' make space for the result
Dim result As String
result = String$(10, 0)

' Send Status Register setup command + TR0 hold trigger mode
Call DLLsend(0, 13, "**SRE 16; TR2 1", 14, NLen, ibsta%, iberr%, ibcntl&)

' Set loop flag
Value = -256

Do

    ' Loop until SRQ is asserted.
    Do
        Call DLLTestSRQ(0, SRQ%, ibsta%, iberr%, ibcntl&)
    Loop Until SRQ%=0

    ' SRQ asserted, read the ML2430As status register
    Call DLLReadStatusByte(0, 13, status_byte%, ibsta%,
        iberr%, ibcntl&)

    ' Check if it is the ML2430A which is requesting
    ' service (SRQ bit + MAV bit)

    If (status_byte% And 80) = 80 Then
        ' It is the ML2430A, read back value
        Call DLLreceive(0, 13, result, 10, STOPend,
            ibsta%, iberr%, ibcntl&)
        Value = Val(result)
    End If

Loop Until Value <> -256

GetTR2Reading = Value

End Function

```

**488.2
General Send/
Receive System**

This function uses the status registers to synchronize the GPIB commands and return data if a query command was used. The system waits until the command string has been completed and then checks to see if any data is on the GPIB output buffer. If so, the data is returned in the Result\$ argument and any error code generated in receiving the data is returned in the Result_Code% argument.

For example: Use 4882SendReceive(0, 13, "O 1", Result\$, Result_Code%) to return a reading from the ML2430A Series.

Note that this function is written in "pseudo code" and cannot be executed as is.

Function 4882SendReceive (Board%, Addr%, cmdstring\$, Result\$, Result_code%) as integer

```

' Set up SRE and ESE values first, then process User
' commands, then do *OPC
cmd$ = "**ESE 49; *SRE 48;" + cmdstring$ + "; *OPC"

' Send the command string
Call DLLsend(Board%, Addr%, cmd$, Len(cmd$), Nlend,
ibsta%, iberr%, ibcntl&)

' Wait for either the MAV_bit (Message Available)
' or/and the ESB_bit (*OPC)
WaitSRQ(Board, Address, MAV_bit + ESB_bit, stb)

If (stb And MAV_bit) Then
' Read the data string out from the ML2430A
Result_Code% = ReadML2430A(Board, Address, Result$)

' If we did not have the ESB_bit set, wait for
' it again (*OPC will set this)
If (stb And ESB_bit) = 0 Then WaitSRQ(Board, Address,
ESB_bit, stb)

End if

' Check if anything went wrong by asking for the ESB register
Call DLLsend(Board, Address, "**ESR?", 5, Nlend, ibsta%, iberr%, ibcntl&)

' Wait for it to return the data on the output queue.
WaitSRQ(Board, Address, MAV_bit, stb)

ReadML2430A(Board, Address, ESB)
' Read the ESB value

' Check the ESB for the OPC bit being set
' (pending commands complete).
If (Val(ESB) and 1) Then
4882SendReceive = True
' Everything sent
end if

' Now check if anything has gone wrong.
If (Val(ESB) And CMD_ERR_bit) Then
4882SendReceive = Command_Error
Elseif (Val(ESB) And EXEC_ERR_bit) Then

```

```
4882SendReceive= Execution_Error  
Elseif (Val(ESB) And DEVICE_ERR_bit) Then  
4882SendReceive = Device_dependent_Error  
  
End If  
  
End Function
```

**Binary Output
 Message Decoding**

The following program example may be used to decode the three types of binary output messages. The commands that reference this code example are OGBD, MXGDB and MNGDB for the GRAPH_BINARY_DATA decoding; OFFTBR for the OFFSET_TABLE_BINARY_DATA decoding; and CFURD for the CAL_FACTOR_BINARY_DATA decoding.

```

/*****
/* Decode binary outputs example */
/* This function expects the binary response from the command to be held in a global
/* character array buffer. The passed parameter 'decode type' will be one of the global
/* definitions */
/* GRAPH_BINARY_DATA */
/* OFFSET_TABLE_BINARY_DATA, CAL_FACTOR_BINARY_DATA */
/*****
void buffer_decode(int decode_type)
{
    int count;
    long *bin_value;
    char *cptr;
    char ch_val[6];
    int length;

    if (decode_type == GRAPH_BINARY_DATA)
    {
        /* FOR OGBD, MXGDB and MNGDB */
        /****** Decode header *****/
        /* Find # character. */
        cptr = strtok(&buffer[0], "#");
        cptr = strtok(NULL, "#");

        /* Get the number of characters for binary length */
        ch_val[0] = *cptr++;
        ch_val[1] = NULL;
        count = atoi(&ch_val[0]);

        /* Get length of binary data */
        for (loop = 0; loop < count; loop++)
        {
            ch_val[loop] = *cptr++;
        }
        ch_val[count] = NULL;
        length = atoi(&ch_val[0]);

        /* If reading in a binary graph the data will be in */
        /* 1024LONG format. In this format each of the graph */
        /* values are held as the dB value multiplied by 1024 */
        /* and held in LONG form. */
        /* */
        /* Each long is 4 byte in length. To read and transpose
        the values into real dB values each set of 4 bytes
        are read into a long variable and then cast into a
        float type and then divided by 1024.
        */
        count = 0;
        loop = 0;
        bin_value = (long *)cptr; /* Set the long pointer */
    }
}

```

```

/* Read and cast the data */
while (count < length)
{
    real_data1[loop++] = ((float)(*bin_value++))/1024.0;
    count += 4;
}
real1_entries = loop;
}
else if (decode_type == OFFSET_TABLE_BINARY_DATA)
{
    /* Decode header */
    /* Find # character. */
    cptr = strtok(&buffer[0], "#");
    cptr = strtok(NULL, "#");

    /* Get the number of characters for binary length */
    ch_val[0] = *cptr++;
    ch_val[1] = NULL;
    count = atoi(&ch_val[0]);

    /* Get length of binary data */
    for (loop = 0; loop < count; loop++)
    {
        ch_val[loop] = *cptr++;
    }
    ch_val[count] = NULL;
    length = atoi(&ch_val[0]);

    *cptr++; /* Read past comma for offset tables. */

    /* The binary offset table is 200 sets frequency and dB */
    /* These are held in single precision floating point. */
    /* To convert to the real values, re-order the bytes. */
    /*          */
    count = 0;
    loop = 0;

    while (count < length)
    {
        /* Frequency conversion */
        bin_data.cval[2] = *cptr++;
        bin_data.cval[3] = *cptr++;
        bin_data.cval[0] = *cptr++;
        bin_data.cval[1] = *cptr++;

        real_data1[loop] = bin_data.fval;

        /* dB conversion */
        bin_data.cval[2] = *cptr++;
        bin_data.cval[3] = *cptr++;
        bin_data.cval[0] = *cptr++;
        bin_data.cval[1] = *cptr++;

        real_data2[loop++] = bin_data.fval;
        count += 8;
    }
    real1_entries = loop;
    real2_entries = loop;
}

```

```

else if (decode_type == CAL_FACTOR_BINARY_DATA)
{
    /* Decode header */
    /* Read length of binary data*/
    ch_val[0] = buffer[6];
    ch_val[1] = buffer[7];
    ch_val[2] = NULL;
    length = atoi(ch_val);

    /* Point after the comma */
    cptr = &buffer[9];

    /* Read the table identity */
    count = 8;
    for (loop = 0; loop < count; loop++)
    {
        ident[loop] = *cptr++;
        length--;
    }
    ident[count] = NULL;

    /* Read number of entries*/
    bin_data.cval[0] = *cptr++;
    bin_data.cval[1] = *cptr++;
    bin_data.cval[2] = 0;
    bin_data.cval[3] = 0;
    table_entries = bin_data.ival;
    length -= 2;

    /* The cal factor table output is in frequency, dB order for */
    /* the whole table. The frequencies format is */
    /* 32768.0e-6LONG and the dBs are held in 1024INT format. */
    /*                                     */
    count = 0;
    loop = 0;

    while (count < length)
    {
        /* Frequency conversion */
        bin_data.cval[0] = *cptr++;
        bin_data.cval[1] = *cptr++;
        bin_data.cval[2] = *cptr++;
        bin_data.cval[3] = *cptr++;

        real_data1[loop] = ((float)(bin_data.lval))/32768e-6;

        /* dB conversion */
        bin_data.cval[0] = *cptr++;
        bin_data.cval[1] = *cptr++;
        bin_data.cval[2] = 0;
        bin_data.cval[3] = 0;

        real_data2[loop++] = ((float)(bin_data.ival))/1024.0;
        count += 6;
    }
    real1_entries = loop;
    real2_entries = loop;
}
}
}

```

Appendix A

Specifications

A-1 INTRODUCTION

This appendix provides system specifications for the ML2430A Series Power Meters along with listings of system defaults and error messages.

A-2 SYSTEM SPECIFICATIONS

This section provides overall system specifications.

Frequency Range:	10 MHz to 90 GHz (sensor dependent)
Power Sensors:	Meter specifications apply to MA2400A Series Power Sensors. Compatible with MA and MP Series sensors.
Sensor Dynamic Range:	MA2420A/B Series Fast Thermal Sensors: 50 dB MA2440A Series High Accuracy Power Sensors: 87 dB CW MA2470A Series Power Sensors: 90 dB CW MA2460A/B Series Fast diode sensors: 80dB MA2480A Series Universal Power Sensor: 80 dB
Power Measurement Range:	-70 to +47 dBm (0.1 nW to 50W), sensor/attenuator dependent. Use couplers for higher power levels.
Voltage Measurement Range:	0.00 to 20.00 V, nominal
Display Range:	-99.999 to +99.999 dB
Display Resolution:	Selectable from 0.1 dB to 0.001 dB limited to 0.01 dB in graphical display modes; Linear power units, 3 to 6 digit, 1 – 3 digits selectable to right of decimal nW – W; Voltage, 1 – 2 digits selectable to right of decimal.
Offset Range:	-99.99 to +99.99 dB. Fixed value or frequency dependent table.
Display Units:	dBm, dB, dBr, dBmV, dB μ V, W, %, Volts

Instrument Accuracy:	< 0.5 %
Zero Set and Drift:	< 0.5 % MA2420A; < 0.5 % MA2470A Series and MA2440A Series. Percent of full scale in most sensitive range, measured over one hour with maximum averaging after one hour warm up at constant temperature.
Noise:	< 0.5 % of full scale in most sensitive range, measured over a one minute interval with maximum averaging, two standard deviations at constant temperature after one hour warm up, typical. MA2470A Series, 20 pW typical.

1.00 mW Power Reference

Frequency:	50 MHz nominal
Output Level:	1.00 mW, $\pm 1.2\%$ /year, $\pm 0.9\%$ RSS, traceable to National Standards
VSWR:	< 1.04
Connector:	Type N female

SENSOR / CHANNEL CONTROL

Operating modes:	Readout: dual channel. RF power or voltage. Power vs. Time: single channel graphic of readout data over adjustable time interval. RF power or voltage. Profile: single channel RF peak power graphic display for analysis of repetitive pulse or transient waveforms. Source Sweep: Single channel graphic display synchronized to an RF source.
Range Hold:	Current range or selectable 1 through 5. (6 with Universal Power Sensor).
Averaging	Auto-averaging: Moving average increases averaging at low power ranges. Averaging Types: Auto, Manual (Moving, Repeat) Manual Average Range: 1, 2, 4, ..., 512 Low-Level Averaging: Low, Medium, and High settings apply post-average low pass filter to improve visibility at high display resolution settings.
Limit Lines:	Fixed value high and low limits with audible, rear panel TTL output, and/or visible Pass/Fail alarm indication. Failure indication can be set to latch until cleared so that a transient failure can be easily noticed.

Cursors: Two manually adjustable cursors with power, delta cursor power, between cursor power average, and delta time readout display.

Delta t Resolution: 0.5% of display period or 100 ns

TRIGGERING

Trigger Sources: Internal , External TTL, GPIB, Manual, Continuous

Delay Range: 0.01 to 1000.00 milliseconds

Delay Resolution: 0.5% of display period or 100 ns

Internal Trigger Range: –15 to + 20.0 dBm MA2470A Series Sensors. Selectable to –45 dBm

Internal Trigger Level Accuracy: 1.0 dB, typical

External Trigger Range: TTL rising or falling edge trigger. BNC input.

Manual Trigger: Front Panel soft key

SYSTEM CONFIGURATION

Display: LCD Graphic display with dual channel readout mode and dual peak meters. Backlight and adjustable contrast standard.

Save/Recall:

Setup Memory: 10 storage registers plus RESET default settings

Secure Mode: Erases memory information upon power ON. Default condition is Secure Mode OFF.

Rear Panel Inputs/Outputs

Cal Factor Voltage Input (BNC):	Operating Modes: Voltage: Display voltage reading on selected channel. Voltage proportional to frequency for sensor calibration factor compensation. Blanking Input: TTL levels only. Selectable positive or negative polarity.
Input Range: 0 to 20V	Resolution: 0.5 mV
Control:	Adjustable voltage to frequency relationship
Analog Output (BNC):	Two outputs configurable to Log or Lin
Operating Modes:	Analog Out: Selectable channel adjusted for calibration factors and other power reading correction settings. Pass/Fail: Selectable TTL High or Low Channel output: Near real time analog. Uncalibrated. AC Modulation Output: Output 1 only.
Output Range:	-5.0 to 5.0V
Resolution:	0.1 mV
Trigger Input:	
Operating Modes:	External TTL or RF Blanking.
 GPIB Interface:	IEEE-488.2 and IEC-625. Implements AH1, SH1, T6, LE0, SR1, RL1, PP0, DC1, DT1, C0 and E1.
RS232:	Supports software download and GPIB commands.
Parallel Printer Output:	Compatible with HP Deskjet 540 and 310 Models other 500 Series and 300 Series and later are typically compatible. Also Canon BJC 80. See printer manual for DIP switch settings.

General Specifications

General: MIL-T28800E, Type 3, class 5, Style E

Display:	Flat panel monochrome LCD graphic with backlight.
Operating Temperature Range:	0 to 50° C (32 to 122° F)
Storage Temperature Range:	−40 to +70° C (−40 to +156° F)
Moisture:	Splash and rain resistant, 90% humidity, non-condensing
Power Requirements:	AC: 90 to 250 VAC, 47 to 440 Hz, 40 VA Maximum DC: 12 to 24 VDC, reverse protected to −40 Maximum input 30V Battery: > 4 hours usable with 3000 mAh battery and display backlight on.
Replaceable Battery (optional):	Energizer model NJ1020 3000 mAh, Ni-MH (option ML2400A-11)
EMI:	Complies with requirements for CE marking.
Warranty:	1 year standard, additional available.
External Dimensions:	Depth: 15.310" (38.887 cm), Height: 4.060" (10.312 cm), Width: 8.540" (21.691 cm) (standard case with feet and no handle)
Weight:	<6.6 lbs (<3 kg) excluding optional battery
Accessories Furnished:	Operation and Programming Manual Sensor Cable: One per input Power cord plug that matches destination requirements.

A-3 SYSTEM DEFAULTS

The following default parameters are loaded whenever preset is selected from the front panel or through GPIB.

SENSOR - setup

settle % per reading	0.10%
measurement mode	default
range hold	auto

SENSOR - cal factor

Source	Frequency
source (HP 437B & HP 438A)	manual

source = frequency	
input signal frequency	50 MHz

source = manual	
cal factor	100%
cal adjust	100%
input signal frequency	50 MHz

source = volts/GHz	
start freq	10 MHz
stop freq	20 GHz
start voltage	0 volts
stop voltage	10 volts
units	percent

SENSOR - averaging

SYSTEM - setup = readout or power vs. time

mode	auto
mode (HP 437B & HP 438A)	auto

mode = moving	
mode = repeat	
averaging number	64

auto low level averaging	low
--------------------------	-----

SYSTEM - setup = profile

graph averaging state	off
between cursor average	on

SENSOR - offset

offset type	off
offset type (HP 437B)	off
offset type (HP 438A)	fixed
offset type = fixed	
offset value	0 dB
offset type = table	
table number	1

frequencies	0 Hz
offset values	0 dB
SENSOR - duty cycle	
duty cycle state	off
duty cycle	100%
CHANNEL - setup	
input config chan 1 = A, chan 2 = off	
input config (HP 437B & HP 438A)	chan 1 = A, chan 2 = off
meas units	dBm
meas units (HP 437B)	dBm
meas units (HP 438A)	watts
display resolution	2 decimal places
tracking min/max display	off
CHANNEL - relative	off
CHANNEL - limits	
high limit	0 dBm
high limit (HP 437B)	90 dBm
high limit (HP 438A)	0 dBm
low limit	0 dBm
low limit (HP 437B)	-90 dBm
low limit (HP 438A)	0 dBm
high limit enabled	off
low limit enabled	off
fail indicator hold	off
fail beep control	off
TRIGGER	
SYSTEM - setup = readout or power vs. time	
SENSOR - meas mode = default	std trigger mode
SENSOR - meas mode = mod average	std trigger mode
SENSOR - meas mode = custom	
TRIGGER - setup	
source	continuous
sample delay	1 ms
sample gate width	20 ms
source = continuous, manual	
trigger arming	blanking off
source = internal A, internal B	
trigger arming	blanking off
trigger type	rise
trigger level	> -15 dBm
source = external TTL	
trigger edge	rise

SYSTEM - setup = profile	
TRIGGER - setup	
source	continuous
sample delay	1 ms
sample gate width	20 ms
source = continuous, manual	
trigger arming	blanking off
source = internal A, internal B	
trigger arming	blanking off
trigger type	rise
trigger level	> -15 dBm
source = external TTL	
trigger edge	rise
SYSTEM - setup	
mode	readout
mode = profile	
SYSTEM - profile	
channel	1
data hold representation	normal
data collection period	10 ms
display trigger delay	0 ns
mode = power vs. Time	
SYSTEM - pwr vs. Time	
channel	1
data hold representation	normal
data display time	1 min
mode = source sweep	
SYSTEM - source sweep	
channel	1
data hold representation	normal
source sweep mode	frequency
mode = frequency	
sweep start	10 MHz
sweep stop	20 GHz
mode = power	
sweep start	-10 dB
sweep stop	+10 dB
mode = profile, power vs time, source sweep	
SYSTEM - control	
scale top dB value	20 dB
scale bottom dB value	-50 dB
readout	on
link cursor	off
hold	off

SYSTEM - display	
battery backlight	on
display contrast	5
peak meter display	off
frequency/offset display	off
GPIB user text display	off
backlight = timed	
time	5 minutes
SYSTEM - sound	
key click state	off
edit error beep	off
limits fail beep channel 1	off
limits fail beep channel 2	off
cursor off screen beep	off
SYSTEM - battery (if present)	
auto power off	enable
auto power off time	30 min
SYSTEM - rear panel - GPIB	
GPIB address	13 (factory preset only)
emulation mode	ML24xx (factory preset only)
SYSTEM - rear panel - RS232	
mode	EXT COMMS
baud rate	9600 (factory preset only)
modem	redial count 5
	delay 5 minutes
auto	limits false
	range false
	power false
SYSTEM - rear panel - BNC	
output 1 & 2	
mode	off
mode = analog out	
channel	1
start volts	0 volts
stop volts	5 volts
start display value	-10 dB
stop display value	0 dB
mode = pass/fail	
channel	1
pass level	high
output 1 only	
mode = AC MOD output	
output	off
polarity	positive

output 2 only	
mode = RF blanking	
channel	1
output TTL during zero	high
input 1	
blanking active TTL level	high
SYSTEM - rear panel - printer	
printer type	HP Deskjet 340 (factory preset only)
SYSTEM - graphics	
connect graph points	on
tracking min max	single sweep
graph ref line	off
pre-trigger percentage	10%
SYSTEM - secure	
secure state	off
CAL/ZERO	
RF calibrator	off

A-4 SYSTEM ERROR MESSAGES

This section details some of the front panel error messages that may appear. In most cases, the error condition can be easily corrected. If not, note the error message and contact the nearest Anritsu Service Center (see Chapter 2, Table 2-3). Errors shown here with xxxx in the display contain a numeric error code.

Error Message	Meaning
SAVE RECALL STORE 0	Attempting save to or recall from current store, i.e., 0.
RECALL EMPTY STORE	Attempted to recall empty store.
SAVE RECALL STORE NUMBER	Illegal store number. NOTE: Save Recall error messages will only be seen under the following two conditions: 1. While doing a save or recall over the GPIB with the measurement display active on the front panel. 2. While doing a save or recall from the front panel and quickly exiting to a measurement display when an error is reported.
SENSOR A over range SENSOR A under range	Range Hold is selected for Sensor A, but the measured value is too large or small for the range selected.
SENSOR B over range SENSOR B under range	Range Hold is selected for Sensor B, but the measured value is too large or small for the range selected.
CHAN 1 display range	Channel 1 display value is greater than +99.999 dBm or less than -99.999 dBm.
CHAN 2 display range	Channel 2 display value is greater than +99.999 dBm or less than -99.999 dBm.
CHAN 1 illegal LOG calc	Combination of sensor values results in an illegal calculation.
CHAN 2 illegal LOG calc	Combination of sensor values results in an illegal calculation.
SENSOR A CAL error (xxxx) SENSOR A CAL 0 dBm invalid	Sensor A Cal 0 failed, xxxx = error code Sensor A Cal 0 dBm failed.
SENSOR B CAL error (xxxx) SENSOR B CAL 0 dBm invalid	Sensor B Cal 0 failed, xxxx = error code Sensor B Cal 0 dBm failed.
SENSOR A NOT ZEROED SENSOR A ZERO . . . SENSOR A ZERO error (xxxx)	as per message ZERO in progress ZERO failed xxxx = 4 digit code
SENSOR B NOT ZEROED SENSOR B ZERO . . . SENSOR B ZERO error (xxxx)	as per message ZERO in progress ZERO failed xxxx = 4 digit code

Error Message	Meaning
SENSOR A not fitted	Sensor A is required for the current measurement, but is not fitted.
READING SENSOR A data	as per message
SENSOR B not fitted	Sensor B is required for the current measurement, but is not fitted.
READING SENSOR B data	as per message
Printer buffer full Printer - Check paper Printer Error	Try selecting print, when current job finished. Printer reporting "Out of paper." Printer communication error.
Chan 1 - NO trigger Chan 2 - NO trigger	Waiting for trigger on specified channel for more than 6 seconds
Increase PERIOD to > 6 ms	WARNING: In profile mode, when using manual or continuous trigger, the data collection period must be > 6 ms.
Graph Display HELD	warning message
Updating SENSOR data	Programming SENSOR EEPROM
Graph Channel Off	In any graph mode, the selected display channel is off.
Ext Volts ZERO in progress	as per message
Put sensor number limit	Attempt to read/write sensor B setup on ML2437A
Sensor A cal factor error	Cal factor out of range - sensor A
Sensor B cal factor error	Cal factor out of range - sensor B
PUT current mode limit	Present configuration will not allow requested change.
Internal error (P6)	Entered numeric value out of range
Internal error (P10)	Requested action NOT allowed
Internal error (P20)	Cal factor edit - duplicate frequency entered
Internal error (P21)	Cannot delete last cal factor data pair in selected table, or cannot add cal factor data pair in selected table
Internal error (P22)	Cannot delete 50 MHz cal factor in selected table
Internal error (P23)	Non valid cal factor table

Appendix B

GPIB Quick Reference

B-1 INTRODUCTION

This appendix contains quick reference tables for all supported commands. Native mode commands are sorted by functional group. For detailed command explanations, refer to the page references listed.

B-2 ML24XXA QUICK REFERENCE

The following tables reference ML24XXA (native) mode commands. A command followed by a (?) indicates that there is an equivalent query command for that function (see Table B-13).

Table B-1. BNC Functional Group Commands

Command	Function	Page
IBBLP	Blanking active TTL level	6-41
OBACM(?)	AC modulation output polarity	6-57
OBCH(?)	BNC output port channel configuration	6-57
OBDSP(?)	BNC analog output display stop value	6-45
OB DST(?)	BNC analog output display start value	6-58
OBMD(?)	BNC output mode select	6-59
OBPL(?)	BNC pass/fail pass level	6-59
OBVSP(?)	BNC analog output stop voltage scale	6-59
OBVST(?)	BNC analog output start voltage scale	6-60
OBZL(?)	BNC RF blanking output level	6-60

Table B-2. Calibration Functional Group Commands

Command	Function	Page
CAL	Calibrate the selected sensor to 0 dBm	6-21
RFCAL(?)	Turn RF reference calibrator ON or OFF	6-67
VZERO	Zero the BNC input connector	6-82
ZERO	Zero the sensor	6-82

Table B-3. Channel Functional Group Commands

Command	Function	Page
CHCFG(?)	Channel input configuration	6-28
CHRES(?)	Set channel decimal point resolution	6-28
CHUNIT(?)	Set Channel units	6-28
FHOLD(?)	Fail indicators Hold	6-38
HLIM(?)	Set High limits	6-49
HLIMS(?)	Turn on/off High limits	6-50
HOLD(?)	Graph hold	6-50
LLIM(?)	Set Low limits	6-52
LLIMS(?)	Turn on/off Low limits	6-52
MMRST	Minimum and maximum Tracking reset	6-53
MNMXS(?)	Track minimum and maximum values	6-53
REL(?)	Relative control	6-67

Table B-4. Data Output Functional Group Commands

Command	Function	Page
ERRLST	Returns the DDE error list	6-36
GMNMX	Return Graph minimum and maximum values	6-39
GRDRQ	Return Graph Data readout	6-41
MNGDB	Output Min Graph Binary Data	6-47
MNGD	Output Min Graph Data	6-53
MXGDB	Output Max Graph Binary Data	6-49
MXGD	Output Max Graph Data	6-56
O	Return display channel reading	6-57
OGBD	Output Graph binary data	6-63
OGD	Output Graph data	6-64
ON	Output number of channel readings	6-64
STATUS	Replies with the power meter's current state code	6-72
STERR	Returns the results of the POST or *TST? command	6-74
SYSLD	Sets the store number for the saved setup	6-74
SYSRD	Output the saved setup over the GPIB	6-75

Table B-5. Display Functional Group Commands

Command	Function	Page
DCONT(?)	Set display Contrast	6-32
DCONTD	Set display contrast down by one	6-33
DCONTU	Set display contrast up by one	6-33
DISP(?)	Display ON or OFF	6-33
DPEAK(?)	Peak meter display	6-33

Table B-6. GPIB 488.2 Functional Group Commands

Command	Function	Page
*CLS	Clear GPIB status bytes	6-12
*ESE	Event Status Byte enable	6-7, 6-12, 6-100
*ESE?	Return Event status register enable mask	6-14
*ESR?	Event status register request	6-14
*IDN?	Request device identification	6-14
*OPC	Operations complete	6-14
*OPC?	Operations complete Output '1'	6-14
*RST	Reset device	6-102
*SRE	Setup service request enable register	6-102
*SRE?	Return Service Request enable register	6-102
*STB?	Return status byte register	6-102
*TRG	Perform a trigger 'GET' command	6-16
*TST?	Self Test	6-102
OI	Request device identification	6-64, 6-97, 6-111, 6-123

Table B-7. GPIB Setup Functional Group Commands

Command	Function	Page
ADDR(?)	Change GPIB address	6-17
CONT	Continue	6-29
EMUL	GPIB emulation mode	6-35
FAST(?)	Operate in non-488.2 compliant mode	6-37
START	Initial startup self test command	6-72

Table B-8. GPIB Trigger Functional Group Commands

Command	Function	Page
GT0	Set to ignore GET command	6-46
GT1	Set 'GET' command to TR1 type trigger	6-46
GT2	Set 'GET' command to TR2 type trigger	6-46
TR0	Trigger hold mode	6-76, 6-115, 6-126
TR1	Trigger immediate	6-77, 6-115, 6-126
TR2	Trigger with a settling delay	6-77, 6-115, 6-127
TR3	Trigger free run	6-78, 6-116, 6-127

Table B-9. Profile Setup Functional Group Commands

Command	Function	Page
CURLK(?)	Link cursors in profile mode	6-30
DTRGD(?)	Display Trigger Delay	6-34
GRAVG(?)	Average between profile cursors	6-40
GPRST	Reset min/max graph	6-40
GRCP(?)	Connect points on profile	6-40
GRDATA(?)	Display Graph Data	6-41
GRFS(?)	Profile Reference line state	6-42
GRMD(?)	Profile and Power vs. Time Mode Channel Selection	6-42
GRPIX(?)	Profile type	6-42
GRPRD(?)	Profile data collection period	6-43
GRPTP(?)	Graph Pretrigger Percentage	6-43
GRSWP(?)	Sweep to Sweep averaging	6-44
GRSWR	Reset Profile Sweep to Sweep Averaging	6-44
GRTMM(?)	Profile Min/Max tracking mode	6-45
GRYB(?)	Set profile Y-axis bottom scale	6-45
GRYT(?)	Set profile Y-axis top scale	6-44

Table B-10. Sensor Functional Group Commands

Command	Function	Page
AVG(?)	Sets the averaging type for the sensor	6-17
AVGLL(?)	Auto low level averaging	6-19
AVGM	Manual Averaging	6-19
CFADJ(?)	Cal Adjust	6-21
CFCAL(?)	Cal factor manual setting	6-21
CFFRQ(?)	Cal Factor Frequency value	6-22
CFSRC(?)	Cal Factor Source	6-22
CFUADD	Add an entry pair to a cal factor table	6-23
CFUCT	Clear cal factor table	6-23
CFUID(?)	Cal factor table identity	6-24
CFULD	Cal factor table binary load	6-24
CFUPT	Preset cal factor table	6-25
CFURD	Cal factor table binary read	6-25
CFUSAV	Cal factor table save	6-26
CFUSEL	Cal factor table select	6-26
CFUTBL	Cal factor tables	6-26
CFUUSE	Cal factor tables used	6-26
CFUULD	Valid table check	6-27
CFVAL	Current cal factor value	6-27
CVSPF(?)	VGHz cal factor stop frequency	6-30
CVSPV(?)	VGHz cal factor stop voltage	6-30
CVSTF(?)	VGHz cal factor start frequency	6-31
CVSTV(?)	VGHz cal factor start voltage	6-31
DUTY(?)	Duty cycle	6-34
DUTYS(?)	Duty cycle state	6-35

Command	Function	Page
OFFCLR	Clear an offset table	6-60
OFFFIX(?)	Offset fixed value	6-61
OFFTBL(?)	Select an offset table	6-61
OFFTBR	Output an offset table	6-62
OFFTBU	Update an offset table	6-62
OFFTYP(?)	Offset type to use	6-63
OFFVAL	Sensor Offset Value	6-63
RGH(?)	Range Hold Sensor	6-67
SENMM(?)	Sensor Measuremet mode	6-69
SENMO(?)	Universal Sensor operation mode	6-69
SENSTL(?)	Set Sensor Settle Percentage	6-70
SENTYP	Return sensor information	6-70

Table B-11. System Functional Group Commands

Command	Function	Page
*RCL	Recall a stored setup	6-10
*SAV	Save configuration	6-15
BAUTS(?)	Battery Auto State	6-19
BAUTT(?)	Battery Auto shut off after x minutes	6-20
BUFF	GPIB response buffering enabled	6-20
CUR	Cursor movement in Power vs. Time and Source Sweep modes	6-29
DBLGHT(?)	Battery LCD Back light mode	6-31
DBLTIM(?)	Auto Backlight OFF timer setting	6-32
ENTERR(?)	Entry Error beep	6-36
FBEEP(?)	Fail Beep On/Off	6-38
FROFF(?)	Frequency/Offset display	6-39
FRST	Factory Reset	6-39
GRAUTO	Auto scaling	6-40
GRDDT(?)	Power vs. Time data display time	6-41
KEYCK(?)	Turn key click sound on or off	6-51
MODDEL	Modem redial delay time	6-54
MODINIT	Initialize modem	6-54
MODLIM	Autodial enable for limits failure	6-54
MODPH	Autodial phone number	6-55
MODPWR	Autodial enable for power on	6-55
MODRED	Redial count	6-55
MODRNG	Autodial enable for range error	6-56
OPMD(?)	Operation mode	6-65
PRINT	Send details to the connected printer	6-65
PRNSEL	Select the type of printer	6-66
RSBAUD(?)	Set the RS232 Baud rate	6-67
SECURE(?)	Secure system state	6-68
SRCMOD(?)	Source sweep mode	6-70
SRCSTRFQ(?)	Source sweep start frequency	6-71
SRCSPFRQ(?)	Source sweep stop frequency	6-70
SRCSTPWR(?)	Source sweep start power	6-71
SRCSPWR(?)	Source sweep stop power	6-71

SRCSTAT	Source sweep status request	6-71
SYSLNM	Saved set naming	6-75
TEXT(?)	User text command	6-76
TEXTS(?)	User text display command	6-76

Table B-12. Trigger Functional Group Commands

Command	Function	Page
GTARM(?)	Set profile trigger arming	6-46
GTDLY(?)	Set profile trigger sample delay	6-47
GTGW(?)	Set profile trigger gate width	6-47
GTLVL(?)	Set profile trigger level	6-47
GTSRC(?)	Set profile Trigger source	6-48
GTTYP(?)	Set profile trigger type	6-48
GXTTL(?)	Set profile external trigger edge	6-49
LINK(?)	Link graph and readout trigger	6-51
TRGARM(?)	Trigger arming	6-78
TRGDLY(?)	Trigger sample delay	6-78
TRGGW(?)	Set trigger gate width	6-79
TRGLVL(?)	Set trigger level	6-79
TRGMODE	Change trigger mode	6-80
TRGSRC(?)	Set trigger source	6-80
TRGTYP(?)	Set Trigger type	6-81
TRGXTTL(?)	Set external trigger edge type	6-81

Table B-13. ML24XXA Native Mode Query Commands

Query	Returned String	Page
ADDR?	ADDR <VAL>	6-17
AVG? <S>	AVG <S>,<MODE>,<VAL>	6-17
AVGLL? <S>	AVGLL <S>,<MODE>	6-19
BAUTS?	BAUTS <STATE>	6-20
BAUTT?	BAUTT <VAL>	6-20
CFADJ? <S>	CFADJ <S>,<UNITS>,<VAL>	6-21
CFCAL? <S>	CFCAL <S>,<UNITS>,<VAL>	6-21
CFFRQ? <S>	CFFRQ <S>,<VALUE>	6-22
CFSRC? <S>	CFSRC <S>,<SOURCE>	6-22
CFUID? <S>,<TABLE NO>	CFUID <S>,<TABLE NO>,<IDENTITY>	6-24
CFUNITS? <S>	CFUNITS <S>,<UNITS>	6-24
CHCFG? <C>	CHCFG <C>,<CONFIG>	6-28
CHRES? <C>	CHRES <C>,<VAL>	6-28
CHUNIT? <C>	CHUNIT <C>,<UNITS>	6-28
CURLK?	CURLK <STATE>	6-30
CVSPF? <S>	CVSPF <S>,<VAL>	6-30
CVSPV? <S>	CVSPV <S>,<VAL>	6-30
CVSTF? <S>	CVSTF <S>,<VAL>	6-31
CVSTV? <S>	CVSTV <S>,<VAL>	6-31
DBLGHT?	DBLGHT <MODE>	6-31

Query	Returned String	Page
DBLTIM?	DBLTIM <VAL>	6-32
DCONT?	DCONT <VAL>	6-32
DISP?	DISP <STATE>	6-33
DPEAK?	DPEAK <MODE>	6-33
DTRGD?	DTRGD <VAL>	6-34
DUTY? <S>	DUTY <S>,<DUTY CYCLE>	6-34
DUTYS? <S>	DUTYS <S>,<STATE>	6-35
ENTERR?	ENTERR <STATE>	6-36
FBEEP? <C>	FBEEP <C>,<STATE>	6-38
FHOLD? <C>	FHOLD <C>,<STATE>	6-38
FROFF?	FROFF <STATE>	6-39
GRAVG?	GRAVG <STATE>	6-40
GRCP?	GRCP <STATE>	6-40
GRDATA?	GRDATA <STATE>	6-41
GRDDT?	GRDDT <TIME>,<UNITS>	6-41
GRFS?	GRFS <STATE>	6-42
GRMD?	GRMD <C>	6-42
GRPIX?	GRPIX <MODE> (MODE can be AVG in power vs. time mode)	6-42
GRPTP?	GRPTP <VAL>	6-43
GRPRD?	GRPRD <VAL>	6-43
GRSWP? <S>	GRSWP <S>,<VAL>	6-44
GRSWS?	GRSWS <STATE>	6-44
GRTMM?	GRTMM <MODE>	6-45
GRYB?	GRYB <VAL>	6-45
GRYT?	GRYT <VAL>	6-45
GTARM?	GTARM <STATE>	6-46
GTDLY?	GTDLY <VAL>	6-47
GTGW?	GTGW <VAL>	6-47
GTLVL?	GTLVL <VAL>	6-47
GTSRC?	GTSRC <SOURCE>	6-48
GTTYP?	GTTYP <TYPE>	6-49
GTX TTL?	GTX TTL <TYPE>	6-49
HLIM? <C>	HLIM <C>,<VAL>	6-49
HLIMS? <C>	HLIMS <C>,<STATE>	6-50
HOLD?	HOLD <STATE>	6-50
IBBLP?	IBBLP <polarity>	6-41
KEYCK?	KEYCK <STATE>	6-51
LINK?	LINK <STATE>	6-51
LLIM? <C>	LLIM <C>,<VAL>	6-52
LLIMS? <C>	LLIMS <C>,<STATE>	6-52
MNMXS? <C>	MNMXS <C>,<STATE>	6-54
MODEL?	MODEL <value>	6-54
MODLIM?	MODLIM <>true> or <>false>	6-54
MODPH?	MODPH <phone_number>	6-55
MODPWR?	MODPWR <>true> or <>false>	6-55
MODRED?	MODRED <count>	6-55
MODRNG?	MODRNG <>true> or <>false>	6-56
OBACM?	OBACM <POLARITY>	6-57
OBCH? <PORT>	OBCH <PORT>,<C>	6-57

Query	Returned String	Page
OBDSP? <PORT>	OBDSP <PORT>,<UNITS>,<VAL>	6-45
OB DST? <PORT>	OB DST <PORT>,<UNITS>,<VAL>	6-58
OBMD? <PORT>	OBMD <PORT>,<MODE>	6-59
OBPL? <PORT>	OBPL <PORT>,<LEVEL>	6-59
OBVSP? <PORT>	OBVSP <PORT>,<VAL>	6-59
OBVST? <PORT>	OBVST <PORT>,<VAL>	6-60
OBZL?	OBZL <LEVEL>	6-60
OFFFIX? <S>	OFFFIX <S>,<VAL>	6-61
OFFTBL? <S>	OFFTBL <S>,<VAL>	6-61
OFFTYP? <S>	OFFTYP <S>,<TYPE>	6-63
OPMD?	OPMD <MODE>	6-65
PRNSEL?	PRNSEL <printer>	6-66
REL? <C>	REL <C>,<MODE>	6-67
RFCAL?	RFCAL <STATE>	6-67
RGH? <S>	RGH <S>,<VAL>	6-67
RSBAUD?	RSBAUD <VAL>	6-67
RSMODE?	RSMODE <state>	6-68
SECURE?	SECURE <STATE>	6-68
SENMM? <S>	SENMM <S>,<MODE>	6-69
SENMO?	SENMO <S>,<VAL>	6-69
SENSTL? <S>	SENSTL <S>,<MODE>	6-70
SRCMOD?	SRCMOD <MODE>	6-70
SRCSPFRQ?	SRCSPFRQ <FREQ>	6-70
SRCSTFRQ?	SRCSTFRQ <FREQ>	6-71
SRCSPWR?	SRCSPWR <POWER>	6-71
SRCSTPWR?	SRCSTPWR <POWER>	6-71
SYSLNM? <STORE NO>	SYSLNM <STORE NO>,<STORE NAME>	6-75
TEXT?	TEXT <TEXT STRING>	6-76
TEXTS?	TEXTS <STATE>	6-76
TRGARM? <C>*	TRGARM <C>,<STATE>	6-78
TRGDLY? <C>*	TRGDLY <C>,<VAL>	6-78
TRGGW? <C>*	TRGGW <C>,<VAL>	6-79
TRGLVL? <C>*	TRGLVL <C>,<VAL>	6-79
TRGMODE?	TRGMODE<MODE>	6-80
TRGSRC?<C>*	TRGSRC <C>,<SOURCE>	6-80
TRGTYP? <C>*	TRGTYP <C>,<TYPE>	6-81
TRGX TTL? <C>*	TRGX TTL <C>,<TYPE>	6-81

**B-3 ML4803A QUICK
REFERENCE**

The following tables reference ML4803A emulation mode commands.

Table B-14. ML4803A Emulation Mode Commands

Command	Function	Page
AVE	Sensor averaging setting	6-85
CAL	Set the user cal factor value	6-65
CCA	Clear the user cal factor to zero	6-86
CDJ	Perform a Cal 0 dBm	6-86
COF	Clear the offset value to zero	6-86
COS	Turn ON the 50 MHz, 0 dBm RF calibrator output	6-86
CRF	Clear the reference value to zero	6-86
CST	Turn OFF the 50 MHz, 0 dBm RF calibrator output	6-86
DBM	Sets the display channel units to dBm	6-86
DBR	Set the display channel units to dB and takes the relative value	6-86
EMUL	GPIB emulation mode	6-86
MCA	Set the cal factor value at the specified memory location in dBm	6-87
MCC	Clears the cal factor value at the specified memory location	6-87
MCO	Clears the offset value at the specified memory location	6-87
MCQ	Clears the frequency value at the specified memory location	6-87
MCR	Clears the reference value at the specified memory location	6-88
MCT	Clears all values at the specified memory location	6-88
MDI	Disable memory store setting and use	6-88
MEN	Enable setting of the memory stores and apply the last memory store configured	6-88
MFG	Set the frequency value at the specified memory location in GHz	6-88
MFM	Set the frequency value at the specified memory location in MHz	6-88
MOF	Set the offset value at the specified memory location in dBm	6-88
MRF	Set the reference value at the specified memory location in dBm	6-89
ODT	Output the current calibration factor, offset value, and reference level	6-89
OFF	Set sensor offset value	6-90
OI?	Request identity	6-90
OMR	Output a memory store set of data	6-90
OPW	Request for channel reading	6-91
REF	Set the reference value	6-93
RNG	Sensor measurement range hold	6-93
SRQ	Turns on or off the SRQ on output data ready	6-93
STA	Restart averaging reading	6-94
WAT	Set the display channel unit to Watts	6-94
ZAJ	Zero the sensor	6-94

B-4 HP 436A QUICK
REFERENCE

The following table references HP 436A emulation mode commands.

Table B-15. HP 436A Emulation Mode Commands

Command	Function	Page
+	Disable cal factors	6-95
-	Enable cal factors	6-95
1, 2, 3, 4 & 5	Set sensor operating range	6-95
9	Auto range	6-95
A	Watt	6-95
B	dB (rel)	6-95
C	dB (ref)	6-96
D	dBm	6-96
EMUL	Select emulation mode	6-96
H	Hold mode	6-96
I	Trigger without settling	6-97
OI	Identification	6-64, 6-97, 6-111, 6-123
R	Free run mode	6-97
T	Trigger with settling	6-97
V	Free run mode with settling	6-97
Z	Zero sensor	6-97

**B-5 HP 437B QUICK
REFERENCE**

The following table references HP 437B emulation mode commands.

Table B-16. HP 437B Emulation Commands

Command	Function	Page
*CLS	Clear GPIB status bytes	6-12, 6-100
*ESE	Event Status Byte enable	6-7, 6-12, 6-100
*ESE?	Return Event status register enable mask	6-14, 6-54, 6-101
*ESR?	Event status register request	6-14, 6-54, 6-101
*RST	Reset device	6-102
*SRE	Setup service request enable register	6-102
*SRE?	Return Service Request enable register	6-102
*STB?	Return status byte register	6-102
*TST?	Self Test	6-102
@ 1	Set SRE mask	6-103, 6-117
CL	Cal Adjust	6-103, 6-118
CS	Clear all status bytes	6-103, 6-119
CT	Clear cal factor table	6-104
DA	Display All	6-104, 6-119
DC	Duty cycle state	6-104
DD	Display disable	6-104, 6-119
DE	Display enable	6-105, 6-119
DF	Display disable	6-105
DR	Set GPIB address	6-105, 6-120
DY	Duty cycle	6-105
EMUL	GPIB emulation mode	6-105
EN	Enter command	6-106
ET	Enter cal factor table data	6-106
EX	Exit	6-106
FA	Auto average	6-107, 6-120
FH	Average hold	6-107, 6-120
FM	Set average value	6-107, 6-121
FR	Frequency of the input signal	6-107

Command	Function	Page
GT	Set group trigger	6-108, 6-121
ID	Return identification string	6-108
IDN?	HP437 identity request	6-108
KB	Calibration factor	6-108, 6-121
LG	Set log units	6-109, 6-122
LH	Set high limit	6-109, 6-122
LL	Set low limit	6-109, 6-122
LM	Limits check state	6-109, 6-122
LN	Set linear units	6-110, 6-123
OC	Set calibrator state	6-123
OD	Output display	6-110
OF	Offset state	6-110
OI	Identification	6-64, 6-97, 6-111, 6-123
OS	Set offset value	6-111, 6-123
PR	Preset the unit	6-111, 6-123
RA	Auto Range	6-111, 6-124
RC	Recall setup	6-111, 6-124
RE	Display decimal resolution	6-112
RF	Set reference cal factor for a table	6-112
RH	Range hold	6-112, 6-124
RL	Relative mode	6-113, 6-124
RM	Range hold set	6-113, 6-125
RV	Read service request mask value.	6-113, 6-125
SE	Select cal factor table	6-113
SM	Status message	6-114, 6-125
SN	Cal table identity update	6-114
ST	Store setup	6-72
SV	Save cal factor table	6-115
TR0	Trigger hold mode	6-76, 6-115, 6-126

Command	Function	Page
TR1	Trigger immediate	6-77, 6-115, 6-126
TR2	Trigger with a settling delay	6-77, 6-115, 6-127
TR3	Trigger free run	6-78, 6-116, 6-127
ZE	Zero sensors	6-116, 6-127

B-6 HP 438A QUICK
REFERENCE

The following table references HP 438A emulation mode commands.

Table B-17. HP 438A Emulation Commands

Command	Function	Page
?ID	Return ID string	6-117
@1	Set SRE mask	6-103
AD	Config to A-B	6-117
AP	Config to A	6-118
AR	Set display A / B	6-118
BD	Set display B – A	6-118
BP	Set single sensor B display	6-118
BR	Set display B / A	6-118
CL	Cal Adjust	6-103, 6-118
CS	Clear all status bytes	6-103, 6-119
DA	Display All	6-104, 6-119
DD	Display disable	6-104, 6-119
DE	Display enable	6-105, 6-119
DR	Set GPIB address	6-105, 6-120
EMUL	GPIB emulation mode	6-120
FA	Auto average	6-107, 6-120
FH	Average hold	6-107, 6-120
FM	Set average value	6-107, 6-121
GT	Set group trigger	6-108, 6-121
KB	Calibration factor	6-108, 6-121
LG	Set log units	6-109, 6-122
LH	Set high limit	6-109, 6-122
LL	Set low limit	6-109, 6-122
LM	Limits check state	6-109, 6-122
LN	Set linear units	6-110, 6-123
OC	Set calibrator state	6-123

Command	Function	Page
OI	Identification	6-64, 6-97, 6-111, 6-123
OS	Set offset value	6-111, 6-123
PR	Preset the unit	6-111, 6-123
RA	Auto Range	6-111, 6-124
RC	Recall setup	6-111, 6-124
RH	Range hold	6-112, 6-124
RL	Relative mode	6-113, 6-124
RM	Range hold set	6-113, 6-125
RV	Read service request mask value.	6-113, 6-125
SM	Status message	6-114, 6-125
ST	Store setup	6-72, 6-114, 6-126
TR0	Trigger hold mode	6-76, 6-115, 6-126
TR1	Trigger immediate	6-77, 6-115, 6-126
TR2	Trigger with a settling delay	6-77, 6-115, 6-127
TR3	Trigger free run	6-78, 6-116, 6-127
ZE	Zero sensors	6-116, 6-127

B-7 HP-IB SUPPORT

The following tables list HP-IB commands for the HP 437B and HP 438A power meters, and which commands are supported in the Anritsu ML2430A Series power meter. Restrictions, if any, are also listed. Commands that are not supported will be ignored.

HP 437B Commands

Mnemonic	Action	Supported?	Restrictions
CL	CAL 0 dBm	Yes	None
*CLS	Clear Status	Yes	None
CS	Clear status	Yes	None
CT0-CT9	Sensor data tables	Yes	None
DA	Set all screen pixels	Yes	None
DC0	Duty cycle OFF	Yes	None
DC1	Duty cycle ON	Yes	None
DD	Disable display	Yes	DISP OFF restrictions: Screen and min/max not updated, Relative not active
DE	Display enable	Yes	DISP ON. None.
DF	Disable Display	Yes	see DD
DN	Down arrow	No	Not supported
DU	User message	No	Not supported
DY	Duty cycle	Yes	None
EN	Enter msg terminator	Yes	None
ERR?	Error query	No	Not supported
*ESR?	Read event reg	Yes	None
*ESE	Set event enable reg	Yes	None
*ESE?	Read event enable reg	Yes	None
ET0-ET9	Edit cal factor table	Yes	None
EX	Exit	Yes	None
FA	Auto average	Yes	None
FH	Average hold	Yes	None
FM	Manual average	Yes	None
FR	Set frequency	Yes	Switch to frequency cal factor source.
GT0	Ignore GET	Yes	None
GT1	TR1 on GET	Yes	None
GT2	TR2 on GET	Yes	None
GZ	Terminator	Yes	None
HZ	Terminator	Yes	None
ID	Return ID string	Yes	None
IDN?	Return ID string	Yes	None
KB	Set cal factor	Yes	None
KZ	Terminator	Yes	None
LG	Units to dBm	Yes	None
LH	Set high limit	Yes	On channel not sensor.
LL	Set low limit	Yes	On channel not sensor
LM0	Limit check off	Yes	Both high and low off as HP 437B

Mnemonic	Action	Supported?	Restrictions
LM1	Limit check on	Yes	Both high and low on as HP 437B
LN	Units to Watts	Yes	None
LP	Learn mode 1	No	Not supported
LT	Left arrow	No	Not supported
MZ	Terminator	Yes	None
OC0	RF calibrator off	Yes	None
OC1	RF calibrator on	Yes	None
OD	Output display text	Yes	Supports reading output and Cal factor table output only. (F=Factory table.)
OF0	Offset off	Yes	None
OF1	Offset on	Yes	None
OS	Set offset value	Yes	OSDOEN not supported
PCT	Terminator	Yes	None
PR	Preset	Yes	None
RA	Auto range	Yes	None
RC	Recall setup	Yes	Limited to 10 stores
RE	Resolution	Yes	Set screen decimal places
RF0-RF9	Sensor cal factors	Yes	None
RH	Range hold	Yes	None
RL0	Relative mode off	Yes	None
RL1	New relative value	Yes	None
RL2	Use old relative value	Yes	None
RM	Set sensor range	Yes	ML2430A ranges
*RST	Reset	Yes	None
RT	Right arrow	No	Not supported
RV	Read SRE	Yes	None
SE	Select data table	Yes	None
SM	Status output	Yes	As much as has meaning for ML2430A. Set to 0 if not used
SN0-SN9	Serial number	Yes	None
SP	Special	No	Not supported
*SRE	Set SRQ enables	Yes	None
*SRE?	Read SRQ enables	Yes	None
ST	Store setup	Yes	Limited to 10 stores
*STB?	Read status byte	Yes	None
TR0	GPIB trigger hold	Yes	None
TR1	Immediate trigger	Yes	None
TR2	Settled trigger	Yes	None
TR3	Trigger hold off	Yes	None
*TST?	Selftest	Yes	Always returns 0
UP	Up arrow	No	Not supported
@1	Status mask	Yes	None
@2	Learn mode 2	No	Not supported
%	Terminator	Yes	None

HP 438A Commands

Mnemonic	Action	Supported?	Restrictions
AD	Config to A-B	Yes	None
AE	Select sensor A	Yes	None
AP	Config to A	Yes	None
AR	Config A/B	Yes	None
BD	Config to B-A	Yes	None
BE	Select sensor B	Yes	None
BP	Config to B	Yes	None
BR	Config to B/A	Yes	None
CL	CAL 0 dBm	Yes	None
CS	Clear status	Yes	None
DA	Set all screen pixels	Yes	None
DD	Disable display	Yes	DISP OFF restrictions: Screen and min/max not updated, Relative not active.
DE	Display enable	Yes	DISP ON. None.
DO	Display to offset	No	Not supported
EN	Enter msg terminator	Yes	None
FA	Auto average	Yes	None
FH	Average hold	Yes	None
FM	Manual average	Yes	None
GT0	Ignore GET	Yes	None
GT1	TR1 on GET	Yes	None
GT2	TR2 on GET	Yes	None
KB	Set cal factor	Yes	None
LG	Units to dBm	Yes	None
LH	Set high limit	Yes	On channel not sensor.
LL	Set low limit	Yes	On channel not sensor
LM0	Limit check off	Yes	Both high and low off as HP437B
LM1	Limit check on	Yes	Both high and low on as HP437B
LN	Units to Watts	Yes	None
LP1	Learn mode1	No	Not supported
LP2	Learn mode2	No	Not supported
OC0	RF calibrator off	Yes	None
OC1	RF calibrator on	Yes	None
OS	Set offset value	Yes	OSDOEN not supported
PR	Preset	Yes	None
RA	Auto range	Yes	None
RC	Recall setup	Yes	Limited to 10 stores
RH	Range hold	Yes	None
RL0	Relative mode off	Yes	None
RL1	New relative value	Yes	None
RM	Set sensor range	Yes	ML2430A ranges

Mnemonic	Action	Supported?	Restrictions
RV	Read SRE	Yes	None
SM	Status output	Yes	As much as has meaning for ML2430A. Set to 0 if not used
ST	Store setup	Yes	Limited to 10 stores
TR0	GPIB trigger hold	Yes	None
TR1	Immediate trigger	Yes	None
TR2	Settled trigger	Yes	None
TR3	Trigger hold off	Yes	None
@1	Status mask	Yes	None
?ID	Return ID string	Yes	None

NOTES

The Factory cal factor table can be read by sending an 'F' instead of the table number.

The HP 438 emulation mode supports the HP 437 cal factor table commands on the ML2430A Series. This allows the cal factor tables to be updated or read since the ML2430A Series supports cal factor tables.

Appendix C

Menu Maps

C-1 INTRODUCTION

The ML2430A Series Power Meter is driven by five main menus; Sensor, Channel, Trigger, System, and Cal/Zero, each accessed by a key on the front panel. This appendix contains menu listings representing the levels of the available menus. Each menu begins on the left with the front panel key for that menu, with each subsequent softkey level indented from there. Available choices, ranges, or limits are shown in italics where appropriate. GPIB commands that are related to the menu selections are shown on the far left in brackets. Refer to Chapter 6, GPIB Operation for information on using GPIB.

Note that many menu choices are conditional depending upon the meter's operation mode, so that some menu options may not always be available as shown. Refer to Chapter Four, Operation, for more detailed explanations of menu functions.

C-2 SENSOR MENU

The Sensor menu presents controls for sensor data processing.

Sensor

Setup

	SENSOR		NOT in ML2437A
		<i>A B</i>	
[SENMO]	OPTION	TRMS/FCW	} Only display when universal power sensor with option 01 data is connected to selected input.
[SENMM]	Measurement	MODE	} available in readout and power vs. time } system setup modes
		<i>Default mod average custom</i>	
[SENSTL]	SETTLE%	per reading	} available in readout and power vs. time system } setup modes with default measurement mode
		<i>0.01 to 10%</i>	
[RGH]	Range	HOLD	} not available in power vs. time system setup } mode
		<i>Auto 1 to 5</i>	

CalFactor

	SENSOR		} not in ML2437A
		<i>A B</i>	

[CFSRC, CFVAL] SOURCE
 Frequency | manual | vghz

 SETUP } if source = VGHz only

[CVSTF] START Freq
 10kHz to 122GHz

[CVSPF] STOP Freq
 10kHz to 122GHz

[CVSTV] START Volts
 -0.5V to 20.5V

[CVSPV] STOP Volts
 -0.5V to 20.5V

[CFFRQ] Input signal FREQUENCY } if source = FREQ or MANUAL
 10kHz to 122GHz

[CFUSL, CFUTBL,]
[CFUUSE, CFUULD] USE TABLE } if source = VGHz or FREQ

 Factory | 1 to max tables | factory + "1 to max tables"
 max tables = 10 but determined by space in sensor EEPROM

[CFUNITS] %/dB

[CFUADD, CFULD,]
[CFURD] EDIT table } if source = VGHz or FREQ

 TABLE
 1 to max tables

 EDIT values
 down
 up

 CHANGE
 FREQUENCY
 10kHz to 122GHz
 determined by fitted sensor

 FACTOR
 150% to 0.07%
 -1.76dB to 31.55dB

 DONE

 INSERT
 FREQUENCY

10kHz to 122GHz
determined by fitted sensor

FACTOR

150% to 0.07%
-1.76dB to 31.55dB

DONE

DELETE

[CFUSAV]

SAVE to sensor

NO

YES

[CFUCT]

CLEAR table

NO

YES

[CFUPT]

PRESET table

NO

YES

[CFUID]

IDENTITY

up to 7 characters

<<

>>

SELECT

ENTER

exit when values changed but NOT saved to sensor

DISCARD

CANCEL

SAVE

[CFCAL]

user cal FACTOR

} if source = MANUAL only

150% to 0.07%
-1.76dB to 31.55dB

[CFADJ]

CAL ADJUST

} if source = MANUAL only

150% to 0.07%
-1.76dB to 31.55dB

[AVG, AVGM]

Averaging (readout and power vs time modes)

SENSOR

} not in ML2437A

A | B

Averaging MODE
Auto | moving | repeat | off

[AVG] Averaging NUMBER } if mode = MOVING or REPEAT
1 to 512

[AVGLL] Auto LOW LEVEL averaging
Off \ low \ medium \ high

Averaging (profile and source sweep modes)

[AVG, GSWP] Sensor A average NUMBER
1 to 512

[AVG, GSWP] Sensor B average NUMBER
1 to 512

[GRSWR] Sweep average RESET } if state = ON

[GRAVG] Between CURSOR averaging
On | off

[GRSWS] Graph averaging STATE
on | off

Offset

SENSOR } not in ML2437A
A | B

[OFFTYP] offset TYPE
off | fixed | table

[OFFFIX, OFFVAL] offset VALUE } if type = FIXED
-99.99dB to +99.99dB

[OFFTBL, OFFTBR,] offset TABLE } if type = TABLE
[OFFTBU, OFFVAL]
1 to 5

EDIT } if type = TABLE

NEXT

Freq
10kHz to 122GHz

Offset
-99.99dB to +99.99dB

down

up
ENTRY
1 to 200
[OFFCLR] CLEAR selected table } if type = TABLE

Duty cycle

SENSOR } not in ML2437A
A | B
[DUTYS] Duty cycle STATE
On | off
[DUTY] DUTY cycle
100% to 0.1%

[RGH] **Rnge Hold**

C-3 CHANNEL MENU

The Channel menu controls the operation of a display channel. There are two display channels, Channel 1 and Channel 2. Channel 1 appears at the top of the readout display and channel 2 at the bottom.

Channel

Setup

CHANNEL

1 | 2

[CHCFG]

INPUT configuration

*Off | A | B | A-B | B-A | A/B | B/A | EXT V
dual sensor configs NOT in ML2437A
ExtV only available if system setup mode=Readout*

[CHUNIT]

Measurement UNITS

*dB(m) | W | dBuV | dBmV
V when input config = EXT V*

[CHRES]

Display decimal RESOLUTION

1 | 2 | 3

[MNMXS, GMNMX]

Tracking MIN/MAX display

On | off

[MMRST]

RESET tracked min/max } if MIN/MAX = ON

[REL]

Rel 1

} if channel 1 = ON

[REL]

Rel 2

} if channel 2 = ON

Limits

CHANNEL

1 | 2

[HLIM]

HIGH Limit

*-99.99dB to +99.99dB
7dBuV to 207dBuV
-53dBmV to 147dBmV
0 to 50W
0 to 20V*

[LLIM]

LOW Limit

*-99.99dB to +99.99dB
7dBuV to 207dBuV
-53dBmV to 147dBmV
0 to 50W
0 to 20V*

[HLIMS]	HIGH State <i>On off</i>
[LLIMS]	LOW State <i>On off</i>
[FHOLD]	Fail indicator HOLD <i>On off</i>
[FBEEP]	Fail BEEP control <i>On off</i>

C-4 TRIGGER MENU

The Trigger menus are always available in PROFILE operation mode, as selected from the System menu. In READOUT and POWER vs. TIME modes, the trigger setup menus are available if a sensor used on a display channel has its SENSOR|Setup|MODE set to CUSTOM. In READOUT mode, the trigger setup menus are available if the mode is set to Int A, Int B (ML2438A only), EXT TTL, Manual or Continuous.

Trigger		} only available if a sensor used on a display } channel is in "custom measurement mode" and } system setup mode = READOUT or Power } vs. TIME; or if system setup mode = } PROFILE; or link readout/profile trigger = ON } channels only available if ON
	Setup	
[TRGMODE]	CHANNEL	} only available if system setup mode = Readout or } Power vs. Time, both with "link triggers" OFF 1 2 1&2
[TRGSRC, GTSRC]	SOURCE	} int B not available in ML2437A Continuous int A int B EXT TTL manual
[TRGDLY, GTDLY]	Sample DELAY	0 to 1 second
[TRGGW, GTGW]	Sample gate WIDTH	100ns to 7 seconds
[TRGARM, GTARM]	Trigger ARMING	} if SOURCE = continuous or internal A } or internal B on ML2438A, or manual Blanking ON blanking OFF
[TRGTYP, GTTYP] ML2438A	Trigger TYPE and level menu	} if source = internal A or internal B on Trigger TYPE Rise fall
[TRGLVL, GTLVL]	Trigger LEVEL	-30 dB to +20 dB
[TRGXTTL, GTX TTL]	Trigger EDGE	} if source = EXT TTL Rise fall
	Trig 1	} if trig chan 1 = manual
	Trig 2	} if trig chan 2 = manual
	Trig 1&2	} if trig chan 1&2 = manual

C-5 SYSTEM MENU

The System menus control the operating modes, display visibility, sound, rear panel functions, and battery state of the ML2430A Series Power Meter. Note that the soft keys will appear differently depending upon the operation mode selected with the Setup soft key.

System

Setup

[OPMD]	MODE	
		<i>Readout profile power vs time source sweep</i>
[*SAV, SYSLD, SYSRD,] [SYSLNM]	SAVE instrument setup	
	Enter setup number	
		<i>1 to 10</i>
	LIST/SCROLL	
[*SAV, SYSLD, SYSRD,] [SYSLNM]	RECALL instrument setup	
	Enter setup number	} only if stores available for RECALL
		<i>1 to 10</i>
	LIST/SCROLL	} only if stores available for RECALL
[LINK]	LINK readout/profile trigger	
		<i>On off</i>
	FAST system recall mode	
	PRESET to default setup	
[*RST]	RESET	
[FRST]	FACTORY	
	CANCEL	

Profile

} if system setup mode = Profile

[GRMD]	CHANNEL	
		<i>1 2</i>
[GRPRD]	Data collection PERIOD	
		<i>100ns to 7 seconds</i>
[DTRGD]	Display trigger DELAY	
		<i>0 to 7 seconds</i>
[GRPIX]	DATA HOLD representation	
		<i>Normal min&max min max</i>

PwrVsTime } if system setup mode = Power vs. Time

[GRMD] CHANNEL
1 | 2

[GRPIX] DATA HOLD representation
Normal | average | min&max | min | max

[GRDDT] Data display TIME
1 min to 24 hours

Source Sweep } if system setup mode = Source Sweep

[GRMD] CHANNEL
1 | 2

[GRPIX] DATA HOLD representation
Normal | min&max | min | max

[SRCMOD] Source sweep MODE
Frequency | power

[SRCSTFRQ,]
[SRCSTPWR] Sweep START frequency or power
*10 kHz to 122 GHz
-120.00 dB to +30.00 dB*

[SRCSPFRQ,]
[SRCSPPPWR] Sweep STOP frequency or power
*10 kHz to 122 GHz
-120.00 dB to +30.00 dB*

Control } if system setup mode = Profile, Power vs.
} Time or Source Sweep

SWAP

[CUR] CURSOR LEFT

[CUR] CURSOR RIGHT

[GRAUTO] SCALE

[GRYT] TOP
-150.00 dB to +250.00 dB } Units are dBmV or dB μ V if
} display channel units are dBmV
} or dB μ V respectively.

[GRYB] BOTTOM
-150.00 dB to +250.00 dB

[GRAUTO] AUTOSCALE

[GRDATA, GRDRQ] READOUT
 [GPRST] CLEAR
 [CURLK] LINK CURSOR
 [HOLD] Graph HOLD
 [GRAUTO] AUTO scale

Display

[DBLGHT] Battery BACKLIGHT
On | timed | off

[DCONTD, DCONT] Set display contrast DOWN
 1 to 10

[DCONTU, DCONT] Set display contrast UP
 1 to 10

[DBLTIM] TIMED } only if BACKLIGHT = TIMED
1 to 100 minutes

[DPEAK] PEAKMETER display
Off | sensor A | sensor B | sensor A & B

[FROFF] FREQUENCY/offset display
On | off

[TEXT, TEXTS] GPIB user TEXT display
On | off

Sound

[KEYCK] KEY click state
On | off

[ENTERR] Beep on EDIT error
On | off

[FBEEP] LIMIT fail beep on channel 1
On | off

[FBEEP] LIMIT fail beep on channel 2
On | off

CURSOR out of screen beep
On | off

[PRINT] **Print**

Battery

[BAUTS]	AUTO power off	} if smart battery detected
	<i>On off</i>	
[BAUTT]	Auto power off TIME	} if smart battery detected
	<i>10 to 240 minutes</i>	
	STATUS	} if smart battery detected
	CHARGE	

Rear Panel

GPIB setup menu

[ADDR]	GPIB ADDRESS	
	<i>1 to 30</i>	
[EMUL]	EmulationMODE	
	<i>ML24xx HP436A HP437B HP438A ML4803</i>	
[BUFF]	output BUFFERing	} only in ML24xx mode
	<i>ON OFF</i>	

RS232 setup menu

[RSMODE]	RS232 MODE	
	<i>EXT COMMS SOURCE IF</i>	
[RSBAUD]	RS232 BAUD rate	
	<i>1200 2400 4800 9600 19200 38400</i>	
	MODEM setup	
[MODPH]	Phone	
	<i>Up to 40 characters</i>	
[MODRED]	Redial COUNT	
	<i>0 to 10</i>	
[MODDEL]	Redial DELAY	
	<i>1 to 10</i>	
[MODINIT]	INITialize modem	
	AUTODIAL setup	
[MODLIM]	LIMITS fail	
	<i>True false</i>	
[MODRNG]	RANGE fail	
	<i>True false</i>	

[MODPWR]	POWER on/off <i>True false</i>
	BNC setup
	PORT <i>Output 1, output 2, input 1, input 2</i>
[OBMD]	Operating MODE only if port = output 1 or output 2 o/p 1 <i>off analog out pass/fail sig chan A leveling A1 leveling A2 AC Mod output</i> o/p 2 <i>off analog out RF blanking pass/fail sig chan B leveling B1 leveling B2</i>
	if mode = ANALOG OUT and port = output 1 or output 2
[OBCH]	CHANNEL <i>1 2</i>
[OBVST]	Voltage START <i>-5V to +5V</i>
[OBVSP]	Voltage STOP <i>-5V to +5V</i>
[OBDST]	DISPlay START power <i>-70dB to +47dB 0 to 50W 37 to 154dBuV -23 to 94dBmV</i>
[OBDSP]	DISPlay STOP power <i>-70dB to +47dB 0 to 50W 37 to 154dBuV -23 to 94dBmV</i>
	if mode = PASS/FAIL and port = output 1 or output 2
[OBCH]	CHANNEL <i>1 2</i>
[OBPL]	PASS TTL LEVEL <i>High low</i>
	if mode = AC Mod Output and port = output 1
	ACModOUTPUT
[OBACM]	POLARITY <i>Positive negative</i>

	if mode = RF BLANKING and port = output 2
[OBCH]	CHANNEL 1 2
[OBZL]	Output TTL during zeroing Low high
	if port = input 1
[IBBLP]	Blanking active TTL LEVEL Low high
[PRNSEL]	PRINTER selection down up HP Deskjet 340 Canon BJC80

Graphics

[GRCP]	CONNECT graph points On off
[GRTMM]	TRACKING min max Single infinite
[GRFS]	REF LINE On off
[GRPTP]	PRE TRigger percentage 0 to 100%

[SECURE]	Secure System SECURE state Off clear memory
----------	--

Identity

C-6 CAL/ZERO MENU The Cal/Zero menu establishes the 0.0 dBm reference calibration and zeroing of the sensors. Refer to Chapter 5 for specific procedures.

NOTE

The single sensor channel ML2437A will not display the Sensor B selection option shown below. The Sensor B selection will only be displayed on the dual sensor channel ML2438A when both sensors are connected.

Cal/Zero

Zero/Cal

On ML2438A with both sensors connected:

SENSOR A

SENSOR B

[CAL]

Cal 0 dBm

On ML2438A with both sensors connected:

SENSOR A

SENSOR B

[ZERO]

Zero

On ML2438A with both sensors connected:

SENSOR A

SENSOR B

[RFCAL]

RF OFF

[VZERO]

Ext V

Index

A

AC 2-1, 3-3, 4-2
accessories
 power meter 1-2
 sensor 1-3
Adobe 1-1
alarm 4-2
ARMING 4-17
ASCII 6-3
attention 6-6
attenuator 1-3
auto power off 2-2, 4-28
Averaging 4-8, 5-12

B

backlight 4-26
battery 1-2, 2-2, 2-8 - 2-10, 4-28
 charging 2-2
 compartment 2-8
 conditioning 2-9
 cover 2-8
 recycling 2-9
BEEP 4-14
BLANKING 5-16
BNC 3-3, 4-13, 4-31, 4-34, 6-10

C

CD ROM 1-1
calfactor 4-6, 4-8
calibrator 3-2 - 3-3, 4-34, 5-2, 6-10, C-15
case 1-2 - 2-3, 2-9
channel 6-10
CHARGE 4-29
charger, battery 1-2, 2-8 - 2-9
Clear Key 4-14
commands
 formats 6-1 - 6-3
 GPIB 6-1
 HP 436 Emulation 6-96 - 6-100
 HP 437B Emulation 6-101 - 6-117
 HP 438A Emulation 6-118 - 6-128

ML24XXA (native) mode 6-12 - 6-83
ML4803 Emulation 6-85 - 6-95
 query 6-4, B-6
CONNECT 4-33, 5-16
connections 3-1
connectors
 front panel 3-1
 rear panel 3-2 - 3-4, 4-29
Contrast 4-27
Control 4-24
cover, front panel 1-2
cursor 4-2, 4-10, 4-17, 4-26, 5-11

D

DATA HOLD 4-22 - 4-23, 5-11
DC 2-2 - 3-3
defaults A-6
delay 4-30
DELAY 4-17, 4-21
device clear 5-6, 6-6
device trigger 6-6
Display 4-26, 6-10
DSP 4-3
Duty cycle 4-11

E

EDGE 4-17
EDIT 4-8
EEPROM 4-6
emulation 4-29, 6-1, 6-96 - 6-97, 6-101, 6-118
environmental requirements 2-3, 2-10
error code 5-4, A-11
error messages A-11 - A-12
Event Status Register 6-7
external DC 3-3

F

FACTOR 4-8
FAIL HOLD 4-14
FAST 4-21
FREQ 4-7, 4-27
front panel

controls 4-1 - 4-2
 operation 4-1
 functional group 6-10, B-1
 fuse 2-2 - 2-3

G

gate width . . . 4-17, 4-24, 5-11, 5-23, 6-47, 6-79 - 6-80
 GET 6-10
 GPIB 2-2, 4-2, 4-4, 4-15, 4-29, 5-3 - 5-4, 6-1
 Graphics. 4-33, 5-16
 ground
 chassis 3-3
 noise 5-1
 grounding 2-3

H

handle. 1-2
 HOLD 4-6
 humidity. 2-3, 2-10

I

icon
 battery 2-2
 trigger 4-15
 identification number 1-1 - 3-3
 initial inspection. 2-1
 installation 2-1
 ISA 6-5

K

Keypad 4-2

L

LCD. 4-2, 4-26
 LEVEL. 4-18
 leveling 4-32
 limiter 1-3
 Limits 4-13, 4-27
 LINK. 4-20, 4-26
 local lockout 5-4, 6-6
 Low Level Averaging 4-9

M

maintenance. 5-25
 Menu
 Cal/Zero. 4-34
 Channel 4-12 - 4-14
 Sensor. 4-5 - 4-11
 System 4-20 - 4-33
 Trigger 4-15 - 4-19
 menu maps. C-1
 mismatch 4-6
 MODE. 4-5
 models 1-2
 modem 4-30, 5-6, 6-54 - 6-56, A-9
 commands 5-7
 compatibility 5-8
 support 5-6 - 5-10

O

Offset 4-10
 options
 power meter 1-2
 sensor 1-3

P

PC card setup. 6-5
 PCI 6-5
 peakmeter. 4-15, 4-27, 6-10
 Performance Verification 5-4
 PERIOD 4-21
 phone number. 4-30
 POST 2-1, 4-3
 power cord 2-3
 power requirements 2-1 - 2-2
 PRESET. 4-21
 Pretrigger %. 4-19, 4-33
 printer 3-3, 4-28, 4-33, 5-4
 Procedures 5-1
 PROFILE 4-21, 5-11 - 5-16, 6-11

R

rack mount 1-2 - 2-7
RAM 4-3
range calibrator 1-2, 5-4
Range Hold 4-6, 4-11
READOUT. 4-24, 5-12
RECALL 4-20
REF LINE 4-33
related manuals. 1-1
Relative 4-13
RESET 4-10
resolution 4-12
RMA 2-10
RS232 3-3, 4-30, 5-5, 6-68

S

Safety 1-1 - 1-2
SAVE 4-20
SCALE 4-24, 5-12
Scope of the Manual 1-1
Security 6-11
sensor
 accessories. 1-3
 adapter 1-3, 3-2
 cable 1-3, 3-2
 connector. 3-2
 group commands 6-11
 handling 2-1
 high accuracy. 1-3
 options 1-3
 range 1-3
 thermal 1-3, 4-5, 5-14
serial
 cable 1-2
 connector 3-3, 5-5 - 5-6
 parameters 4-30, 5-5, 6-68
 remote operation. 2-2, 2-9, 3-3, 5-5
serial poll 6-7, 6-16, 6-38, 6-103
service center. 2-1, 2-10
Service Request Status (SRQ) 6-9
Settle % 4-5
SETUP 4-8

shipment 2-10 - 2-11
Sound 4-27
source 4-6, 4-16
Source sweep 4-22, 5-17 - 5-18
specifications A-1
SRQ 6-85
standby 4-2
STATUS 4-28
status byte 6-7, 6-9, 6-85, 6-101, 6-104
storage. 2-2, 2-10 - 2-11
SWAP 4-24, 5-12
syntax 6-1
SYSTEM. 6-11

T

TABLE 4-11
TEXT 4-27
TIME. 4-28
Tracking 4-12, 4-33
trigger 4-5, 4-15, 4-33, 5-11, 6-11
TTL 5-16
TYPE 4-10
typographic conventions 6-1

U

USE TABLE. 4-7
UUT. 5-1

W

WARRANTY 1-2
WIDTH. 4-17

Z

Zero. 4-34, 5-1