

ARM® Architecture Reference Manual

ARMv8, for ARMv8-A architecture profile

Beta

ARM®

ARM Architecture Reference Manual

ARMv8, for ARMv8-A architecture profile

Copyright © 2013 ARM Limited. All rights reserved.

Release Information

The following releases of this document have been made.

Release history

Date	Issue	Confidentiality	Change
30 April 2013	A.a-1	Confidential-Beta Draft	Beta draft of first issue, limited circulation
12 June 2013	A.a-2	Confidential-Beta Draft	Second beta draft of first issue, limited circulation
04 September 2013	A.a	Non-Confidential Beta	Beta release.

Proprietary Notice

This document is protected by copyright and other related rights and the practice or implementation of the information contained in this document may be protected by one or more patents or pending patent applications. No part of this document may be reproduced in any form by any means without the express prior written permission of ARM Limited (“ARM”). **No license, express or implied, by estoppel or otherwise to any intellectual property rights is granted by this document unless specifically stated.**

Your access to the information in this document is conditional upon your acceptance that you will not use or permit others to use the information for the purposes of determining whether implementations infringe any third party patents.

THIS DOCUMENT IS PROVIDED “AS IS”. ARM PROVIDES NO REPRESENTATIONS AND NO WARRANTIES, EXPRESS, IMPLIED OR STATUTORY, INCLUDING, WITHOUT LIMITATION, THE IMPLIED WARRANTIES OF MERCHANTABILITY, SATISFACTORY QUALITY, NON-INFRINGEMENT OR FITNESS FOR A PARTICULAR PURPOSE WITH RESPECT TO THE DOCUMENT. For the avoidance of doubt, ARM makes no representation with respect to, and has undertaken no analysis to identify or understand the scope and content of, third party patents, copyrights, trade secrets, or other rights.

This document may include technical inaccuracies or typographical errors.

TO THE EXTENT NOT PROHIBITED BY LAW, IN NO EVENT WILL ARM BE LIABLE FOR ANY DAMAGES, INCLUDING WITHOUT LIMITATION ANY DIRECT, INDIRECT, SPECIAL, INCIDENTAL, PUNITIVE, OR CONSEQUENTIAL DAMAGES, HOWEVER CAUSED AND REGARDLESS OF THE THEORY OF LIABILITY, ARISING OUT OF ANY USE OF THIS DOCUMENT, EVEN IF ARM HAS BEEN ADVISED OF THE POSSIBILITY OF SUCH DAMAGES.

This document consists solely of commercial items. You shall be responsible for ensuring that any use, duplication or disclosure of this document complies fully with any relevant export laws and regulations to assure that this document or any portion thereof is not exported, directly or indirectly, in violation of such export laws. Use of the word “partner” in reference to ARM’s customers is not intended to create or refer to any partnership relationship with any other company. ARM may make changes to this document at any time and without notice.

If any of the provisions contained in these terms conflict with any of the provisions of any signed written agreement specifically covering this document with ARM, then the signed written agreement prevails over and supersedes the conflicting provisions of these terms.

Words and logos marked with ® or ™ are registered trademarks or trademarks of ARM Limited or its affiliates in the EU and/or elsewhere. All rights reserved. Other brands and names mentioned in this document may be the trademarks of their respective owners. You must follow the ARM trademark usage guidelines, <http://www.arm.com/about/trademark-usage-guidelines.php>.

This document is Non-Confidential but any disclosure by you is subject to you providing the recipient the conditions set out in this notice and procuring the acceptance by the recipient of the conditions set out in this notice.

Copyright © 2013 ARM Limited or its affiliates. All rights reserved.

ARM Limited. Company 02557590 registered in England.

110 Fulbourn Road, Cambridge, England CB1 9NJ.

LES-PRE-20327

In this document, where the term ARM is used to refer to the company it means “ARM or any of its subsidiaries as appropriate”.

Note

The term ARM can refer to versions of the ARM architecture, for example ARMv7 refers to version 7 of the ARM architecture. The context makes it clear when the term is used in this way.

Web Address

<http://www.arm.com>

Contents

ARM Architecture Reference Manual ARMv8, for ARMv8-A architecture profile

Preface

About this manual	xvi
Using this manual	xviii
Conventions	xxiii
Additional reading	xxv
Feedback	xxvi

Part A

ARMv8 Architecture Introduction and Overview

Chapter A1

Introduction to the ARMv8 Architecture

A1.1	About the ARM architecture	A1-30
A1.2	Architecture profiles	A1-32
A1.3	ARMv8 architectural concepts	A1-33
A1.4	Supported data types	A1-36
A1.5	Floating-point and Advanced SIMD support	A1-46
A1.6	Cryptographic Extension	A1-52
A1.7	The ARM memory model	A1-53

Part B

The AArch64 Application Level Architecture

Chapter B1

The AArch64 Application Level Programmers' Model

B1.1	About the Application level programmers' model	B1-58
B1.2	Registers in AArch64 Execution state	B1-59
B1.3	Software control features and EL0	B1-65

Chapter B2	The AArch64 Application Level Memory Model	
B2.1	Address space	B2-68
B2.2	Memory type overview	B2-69
B2.3	Caches and memory hierarchy	B2-70
B2.4	Alignment support	B2-75
B2.5	Endian support	B2-76
B2.6	Atomicity in the ARM architecture	B2-79
B2.7	Memory ordering	B2-82
B2.8	Memory types and attributes	B2-89
B2.9	Mismatched memory attributes	B2-98
B2.10	Synchronization and semaphores	B2-100

Part C The AArch64 Instruction Set

Chapter C1	The A64 Instruction Set	
C1.1	Introduction	C1-112
C1.2	Structure of the A64 assembler language	C1-113
C1.3	Address generation	C1-118
C1.4	Instruction aliases	C1-121

Chapter C2	A64 Instruction Set Overview	
C2.1	Branches, Exception generating, and System instructions	C2-124
C2.2	Loads and stores	C2-129
C2.3	Data processing - immediate	C2-140
C2.4	Data processing - register	C2-145
C2.5	Data processing - SIMD and floating-point	C2-152

Chapter C3	A64 Instruction Set Encoding	
C3.1	A64 instruction index by encoding	C3-172
C3.2	Branches, exception generating and system instructions	C3-173
C3.3	Loads and stores	C3-176
C3.4	Data processing - immediate	C3-193
C3.5	Data processing - register	C3-196
C3.6	Data processing - SIMD and floating point	C3-203

Chapter C4	The AArch64 System Instruction Class	
C4.1	About the System instruction and System register descriptions	C4-230
C4.2	The System instruction class encoding space	C4-232
C4.3	PSTATE and special purpose registers	C4-251
C4.4	A64 system instructions for cache maintenance	C4-306
C4.5	A64 system instructions for address translation	C4-322
C4.6	A64 system instructions for TLB maintenance	C4-335

Chapter C5	A64 Base Instruction Descriptions	
C5.1	Introduction	C5-386
C5.2	Register size	C5-387
C5.3	Use of the PC	C5-388
C5.4	Use of the stack pointer	C5-389
C5.5	Condition flags and related instructions	C5-390
C5.6	Alphabetical list of instructions	C5-391

Chapter C6	A64 SIMD and Floating-point Instruction Descriptions	
C6.1	Introduction	C6-776
C6.2	About the SIMD and floating-point instructions	C6-777
C6.3	Alphabetical list of floating-point and Advanced SIMD instructions	C6-779

Part D

The AArch64 System Level Architecture

Chapter D1

The AArch64 System Level Programmers' Model

D1.1	Exception levels	D1-1408
D1.2	Exception terminology	D1-1409
D1.3	Execution state	D1-1411
D1.4	Security state	D1-1412
D1.5	Virtualization	D1-1414
D1.6	Registers for instruction processing and exception handling	D1-1416
D1.7	Process state, PSTATE	D1-1421
D1.8	Program counter and stack pointer alignment	D1-1423
D1.9	Reset	D1-1426
D1.10	Exception entry	D1-1429
D1.11	Exception return	D1-1439
D1.12	The Exception level hierarchy	D1-1443
D1.13	Synchronous exception types, routing and priorities	D1-1450
D1.14	Asynchronous exception types, routing, masking and priorities	D1-1456
D1.15	Trapping functionality to higher Exception levels	D1-1462
D1.16	System calls	D1-1511
D1.17	Use of the ESR_EL1, ESR_EL2, and ESR_EL3	D1-1512
D1.18	Mechanisms for entering a low-power state	D1-1533
D1.19	Self-hosted debug	D1-1539
D1.20	Performance Monitors extension	D1-1541
D1.21	Interprocessing	D1-1542
D1.22	Supported configurations	D1-1554

Chapter D2

Debug Exceptions

D2.1	Introduction to debug exceptions	D2-1560
D2.2	Legacy debug exceptions	D2-1564
D2.3	Understanding the descriptions for AArch64 state and AArch32 state	D2-1565
D2.4	Software Breakpoint Instruction exceptions	D2-1566
D2.5	Breakpoint exceptions	D2-1569
D2.6	Watchpoint exceptions	D2-1606
D2.7	Vector Catch exceptions	D2-1627
D2.8	Software Step exceptions	D2-1634
D2.9	Synchronization and debug exceptions	D2-1647

Chapter D3

The Debug Exception Model

D3.1	About debug exceptions	D3-1650
D3.2	The debug exceptions enable controls	D3-1651
D3.3	Routing debug exceptions	D3-1652
D3.4	Enabling debug exceptions from current Exception level and Security state ..	D3-1656
D3.5	The effect of powerdown on debug exceptions	D3-1661
D3.6	Summary of permitted routing and enabling of debug exceptions	D3-1662
D3.7	Debug exception behavior	D3-1665
D3.8	Pseudocode descriptions of debug exceptions	D3-1669

Chapter D4

The AArch64 System Level Memory Model

D4.1	About the memory system architecture	D4-1672
D4.2	Address space	D4-1673
D4.3	Mixed-endian support	D4-1674
D4.4	Cache support	D4-1675
D4.5	External aborts	D4-1694
D4.6	Memory barrier instructions	D4-1696
D4.7	Pseudocode details of general memory system instructions	D4-1697

Chapter D5

The AArch64 Virtual Memory System Architecture

D5.1	About the Virtual Memory System Architecture (VMSA)	D5-1708
------	---	---------

D5.2	The VMSAv8-64 address translation system	D5-1710
D5.3	Translation table walk examples	D5-1760
D5.4	VMSAv8-64 translation table format descriptors	D5-1772
D5.5	Access controls and memory region attributes	D5-1781
D5.6	MMU faults	D5-1796
D5.7	Translation Lookaside Buffers (TLBs)	D5-1804
D5.8	Caches in a VMSA implementation	D5-1818

Chapter D6

The Performance Monitors Extension

D6.1	About the Performance Monitors	D6-1822
D6.2	Accuracy of the Performance Monitors	D6-1824
D6.3	Behavior on overflow	D6-1826
D6.4	Attributability	D6-1828
D6.5	Effect of EL3 and EL2	D6-1829
D6.6	Event filtering	D6-1831
D6.7	Performance Monitors and Debug state	D6-1832
D6.8	Counter enables	D6-1833
D6.9	Counter access	D6-1834
D6.10	Event numbers and mnemonics	D6-1836
D6.11	Performance Monitors Extension registers	D6-1851
D6.12	Pseudocode details	D6-1854

Chapter D7

The Generic Timer

D7.1	About the Generic Timer	D7-1856
D7.2	About the Generic Timer registers	D7-1864

Chapter D8

AArch64 System Register Descriptions

D8.1	About the AArch64 System registers	D8-1866
D8.2	General system control registers	D8-1870
D8.3	Debug registers	D8-2077
D8.4	Performance Monitors registers	D8-2134
D8.5	Generic Timer registers	D8-2170
D8.6	Generic Interrupt Controller CPU interface registers	D8-2194

Part E

The AArch32 Application Level Architecture

Chapter E1

The AArch32 Application Level Programmers' Model

E1.1	About the Application level programmers' model	E1-2288
E1.2	Additional information about the programmers' model in AArch32 state	E1-2289
E1.3	Advanced SIMD and floating-point instructions	E1-2303
E1.4	Coprocessor support	E1-2331
E1.5	Exceptions and debug events	E1-2332

Chapter E2

The AArch32 Application Level Memory Model

E2.1	Address space	E2-2334
E2.2	Memory type overview	E2-2336
E2.3	Caches and memory hierarchy	E2-2337
E2.4	Alignment support	E2-2341
E2.5	Endian support	E2-2343
E2.6	Atomicity in the ARM architecture	E2-2346
E2.7	Memory ordering	E2-2350
E2.8	Memory types and attributes	E2-2357
E2.9	Mismatched memory attributes	E2-2366
E2.10	Synchronization and semaphores	E2-2369

Part F

The AArch32 Instruction Sets

Chapter F1

The AArch32 Instruction Sets Overview

F1.1	Unified Assembler Language	F1-2380
F1.2	Branch instructions	F1-2382
F1.3	Data-processing instructions	F1-2383
F1.4	Status register access instructions	F1-2391
F1.5	Load/store instructions	F1-2392
F1.6	Load/store multiple instructions	F1-2394
F1.7	Miscellaneous instructions	F1-2395
F1.8	Exception-generating and exception-handling instructions	F1-2396
F1.9	Coprocessor instructions	F1-2397
F1.10	Advanced SIMD and floating-point load/store instructions	F1-2398
F1.11	Advanced SIMD and floating-point register transfer instructions	F1-2400
F1.12	Advanced SIMD data-processing instructions	F1-2401
F1.13	Floating-point data-processing instructions	F1-2408

Chapter F2

About the T32 and A32 Instruction Descriptions

F2.1	Format of instruction descriptions	F2-2410
F2.2	Standard assembler syntax fields	F2-2415
F2.3	Conditional execution	F2-2416
F2.4	Shifts applied to a register	F2-2419
F2.5	Memory accesses	F2-2422
F2.6	Integer arithmetic in the T32 and A32 instruction sets	F2-2423
F2.7	Encoding of lists of general-purpose registers and the PC	F2-2426
F2.8	Additional pseudocode support for instruction descriptions	F2-2427

Chapter F3

T32 Base Instruction Set Encoding

F3.1	T32 instruction set encoding	F3-2432
F3.2	16-bit T32 instruction encoding	F3-2435
F3.3	32-bit T32 instruction encoding	F3-2442

Chapter F4

A32 Base Instruction Set Encoding

F4.1	A32 instruction set encoding	F4-2466
F4.2	Data-processing and miscellaneous instructions	F4-2468
F4.3	Load/store word and unsigned byte	F4-2480
F4.4	Media instructions	F4-2481
F4.5	Branch, branch with link, and block data transfer	F4-2486
F4.6	Coprocessor instructions, and Supervisor Call	F4-2487
F4.7	Unconditional instructions	F4-2488

Chapter F5

T32 and A32 Instruction Sets Advanced SIMD and floating-point Encodings

F5.1	Overview	F5-2492
F5.2	Advanced SIMD and floating-point instruction syntax	F5-2493
F5.3	Register encoding	F5-2497
F5.4	Advanced SIMD data-processing instructions	F5-2499
F5.5	Floating-point data-processing instructions	F5-2511
F5.6	Extension register load/store instructions	F5-2514
F5.7	Advanced SIMD element or structure load/store instructions	F5-2515
F5.8	8, 16, and 32-bit transfer between general-purpose and extension registers ..	F5-2518
F5.9	64-bit transfers between general-purpose and extension registers	F5-2519

Chapter F6

ARMv8 Changes to the T32 and A32 Instruction Sets

F6.1	The A32 and T32 instruction sets	F6-2522
F6.2	Partial Deprecation of IT	F6-2523
F6.3	New A32 and T32 Load-Acquire/Store-Release instructions	F6-2524

F6.4	New A32 and T32 scalar floating-point instructions	F6-2525
F6.5	New A32 and T32 Advanced SIMD floating-point instructions	F6-2528
F6.6	New A32 and T32 cryptography instructions	F6-2530
F6.7	New A32 and T32 System instructions	F6-2531

Chapter F7

T32 and A32 Base Instruction Set Instruction Descriptions

F7.1	Alphabetical list of T32 and A32 base instruction set instructions	F7-2534
F7.2	General restrictions on system instructions	F7-3028
F7.3	Encoding and use of Banked register transfer instructions	F7-3029
F7.4	Alphabetical list of system instructions	F7-3033

Chapter F8

T32 and A32 Advanced SIMD and floating-point Instruction Descriptions

F8.1	Alphabetical list of floating-point and Advanced SIMD instructions	F8-3076
------	--	---------

Part G

The AArch32 System Level Architecture

Chapter G1

The AArch32 System Level Programmers' Model

G1.1	About the AArch32 System level programmers' model	G1-3400
G1.2	Exception levels	G1-3401
G1.3	Exception terminology	G1-3402
G1.4	Execution state	G1-3404
G1.5	Instruction Set state	G1-3406
G1.6	Debug state	G1-3406
G1.7	Security state	G1-3407
G1.8	Virtualization	G1-3410
G1.9	AArch32 PE modes, general-purpose registers, and the PC	G1-3412
G1.10	Instruction set states	G1-3429
G1.11	Handling exceptions that are taken to an Exception level using AArch32	G1-3431
G1.12	Asynchronous exception behavior for exceptions taken from AArch32 state	G1-3465
G1.13	AArch32 state exception descriptions	G1-3475
G1.14	The conceptual coprocessor interface and system control	G1-3492
G1.15	Advanced SIMD and floating-point support	G1-3494
G1.16	AArch32 control of traps to the hypervisor	G1-3503

Chapter G2

The AArch32 System Level Memory Model

G2.1	About the memory system architecture	G2-3520
G2.2	Address space	G2-3521
G2.3	Mixed-endian support	G2-3522
G2.4	Cache support	G2-3524
G2.5	ARMv8 CP15 register support for IMPLEMENTATION DEFINED features	G2-3545
G2.6	External aborts	G2-3546
G2.7	Memory barrier instructions	G2-3548
G2.8	Pseudocode details of general memory system instructions	G2-3549

Chapter G3

The AArch32 Virtual Memory System Architecture

G3.1	Execution privilege, Exception levels, and AArch32 Privilege levels	G3-3560
G3.2	About VMSAv8-32	G3-3562
G3.3	The effects of disabling address translation stages on VMSAv8-32 behavior	G3-3569
G3.4	Translation tables	G3-3573
G3.5	The VMSAv8-32 Short-descriptor translation table format	G3-3578
G3.6	The VMSAv8-32 Long-descriptor translation table format	G3-3591
G3.7	Memory access control	G3-3609
G3.8	Memory region attributes	G3-3618
G3.9	Translation Lookaside Buffers (TLBs)	G3-3630
G3.10	TLB maintenance requirements	G3-3633
G3.11	Caches in VMSAv8-32	G3-3644
G3.12	VMSAv8-32 memory aborts	G3-3647

G3.13	Exception reporting in a VMSAv8-32 implementation	G3-3659
G3.14	Virtual Address to Physical Address translation operations	G3-3685
G3.15	About the System registers for VMSAv8-32	G3-3691
G3.16	Organization of the CP14 registers in VMSAv8-32	G3-3713
G3.17	Organization of the CP15 registers in VMSAv8-32	G3-3716
G3.18	Functional grouping of VMSAv8-32 System registers	G3-3735
G3.19	Pseudocode details of VMSAv8-32 memory system operations	G3-3755

Chapter G4

AArch32 System Register Descriptions

G4.1	About the AArch32 System registers	G4-3772
G4.2	General system control registers	G4-3773
G4.3	Debug registers	G4-4101
G4.4	Performance Monitors registers	G4-4170
G4.5	Generic Timer registers	G4-4208
G4.6	Generic Interrupt Controller CPU interface registers	G4-4230

Part H

External Debug

Chapter H1

Introduction to External Debug

H1.1	Introduction to external debug	H1-4324
H1.2	External debug	H1-4325

Chapter H2

Debug State

H2.1	About Debug state	H2-4328
H2.2	Halting the PE on debug events	H2-4329
H2.3	Entering Debug state	H2-4337
H2.4	Behavior in Debug state	H2-4341
H2.5	Exiting Debug state	H2-4361

Chapter H3

Halting Debug Events

H3.1	Introduction to Halting debug events	H3-4364
H3.2	Halting Step debug event	H3-4366
H3.3	Halt Instruction debug event	H3-4376
H3.4	Exception Catch debug event	H3-4377
H3.5	External Debug Request debug event	H3-4380
H3.6	OS Unlock Catch debug event	H3-4381
H3.7	Reset Catch debug event	H3-4382
H3.8	Software Access debug event	H3-4383
H3.9	Synchronization and Halting debug events	H3-4384

Chapter H4

The Debug Communication Channel and Instruction Transfer Register

H4.1	Introduction	H4-4388
H4.2	DCC and ITR registers	H4-4389
H4.3	DCC and ITR access modes	H4-4391
H4.4	Flow-control of the DCC and ITR registers	H4-4395
H4.5	Synchronization of DCC and ITR accesses	H4-4398
H4.6	Interrupt-driven use of the DCC	H4-4402
H4.7	Pseudocode details for the operation of the DCC and ITR registers	H4-4403

Chapter H5

The Embedded Cross Trigger Interface

H5.1	About the Embedded Cross Trigger (ECT)	H5-4408
H5.2	Basic operation on the ECT	H5-4410
H5.3	Cross-triggers on a PE in an ARMv8 implementation	H5-4414
H5.4	Description and allocation of CTI triggers	H5-4415
H5.5	CTI registers programmers' model	H5-4418
H5.6	Examples	H5-4419

Chapter H6	Debug Reset and Powerdown Support	
	H6.1 About Debug over powerdown	H6-4424
	H6.2 Power domains and debug	H6-4425
	H6.3 Core power domain power states	H6-4426
	H6.4 Emulating low-power states	H6-4428
	H6.5 Debug OS Save and Restore sequences	H6-4430
Chapter H7	The Sample-based Profiling Extension	
	H7.1 Sample-based profiling	H7-4436
Chapter H8	About the External Debug Registers	
	H8.1 Relationship between external debug and System registers	H8-4442
	H8.2 Supported access sizes	H8-4444
	H8.3 Synchronization of changes to the external debug registers	H8-4445
	H8.4 Memory-mapped accesses to the external debug interface	H8-4449
	H8.5 External debug interface register access permissions	H8-4451
	H8.6 External debug interface registers	H8-4456
	H8.7 Cross-trigger interface registers	H8-4461
	H8.8 Reset and debug	H8-4463
	H8.9 External debug register resets	H8-4465
Chapter H9	External Debug Register Descriptions	
	H9.1 Introduction	H9-4468
	H9.2 Debug registers	H9-4469
	H9.3 Cross-Trigger Interface registers	H9-4554
Part I	Memory-mapped Components of the ARMv8 Architecture	
Chapter I1	Memory-Mapped System Register Descriptions	
	I1.1 Introduction	I1-4598
	I1.2 Performance Monitors registers	I1-4599
	I1.3 Generic Timer registers	I1-4647
Chapter I2	System Level Implementation of the Generic Timer	
	I2.1 About the Generic Timer specification	I2-4680
	I2.2 Memory-mapped counter module	I2-4681
	I2.3 Counter module control and status register summary	I2-4684
	I2.4 About the memory-mapped view of the counter and timer	I2-4686
	I2.5 The CNTBaseN and CNTPL0BaseN frames	I2-4687
	I2.6 The CNTCTLBase frame	I2-4689
	I2.7 Providing a complete set of counter and timer features	I2-4690
	I2.8 Gray-count scheme for timer distribution scheme	I2-4692
Chapter I3	Recommended Memory-mapped Interfaces to the Performance Monitors	
	I3.1 About the memory-mapped views of the Performance Monitors registers	I3-4694
Part J	Appendixes	
Appendix A	Architectural Constraints on UNPREDICTABLE behaviors	
	A.1 AArch32 CONSTRAINED UNPREDICTABLE behaviors	AppxA-4702
	A.2 Constraints on AArch64 state UNPREDICTABLE behaviors	AppxA-4765
Appendix B	Recommended External Debug Interface	
	B.1 About the recommended external debug interface	AppxB-4774
	B.2 PMUEVENT bus	AppxB-4777

B.3	DBGCPUDONE	AppxB-4778
B.4	Recommended authentication interface	AppxB-4779
B.5	Management registers and CoreSight compliance	AppxB-4782

Appendix C

Recommendations for Performance Monitors Event Numbers for IMPLEMENTATION DEFINED Events

C.1	ARM recommendations for IMPLEMENTATION DEFINED event numbers	AppxC-4790
C.2	Summary of events taken to an Exception Level using AArch64	AppxC-4801

Appendix D

Example OS Save and Restore sequences

D.1	Save Debug registers	AppxD-4804
D.2	Restore Debug registers	AppxD-4806

Appendix E

Additional Guidance

E.1	Implementation guidance for multiple views of Debug registers	AppxE-4810
E.2	AArch32 equivalent Advanced SIMD Mnemonics	AppxE-4813
E.3	Identifying the cache resources in ARMv8	AppxE-4821
E.4	Memory access mode in Debug state	AppxE-4822

Appendix F

Barrier Litmus Tests

F.1	Introduction	AppxF-4828
F.2	Load-Acquire, Store-Release and barriers	AppxF-4831
F.3	Load-Acquire Exclusive, Store-Release Exclusive and barriers	AppxF-4839
F.4	Using a mailbox to send an interrupt	AppxF-4845
F.5	Cache and TLB maintenance operations and barriers	AppxF-4846
F.6	ARMv7 compatible approaches for ordering, using DMB and DSB barriers	AppxF-4859

Appendix G

ARMv8 Pseudocode Library

G.1	Library pseudocode for AArch64	AppxG-4878
G.2	Library pseudocode for AArch32	AppxG-4927
G.3	Common library pseudocode	AppxG-4986

Appendix H

ARM Pseudocode Definition

H.1	About the ARM pseudocode	AppxH-5060
H.2	Pseudocode for instruction descriptions	AppxH-5061
H.3	Data types	AppxH-5063
H.4	Expressions	AppxH-5067
H.5	Operators and built-in functions	AppxH-5069
H.6	Statements and program structure	AppxH-5074
H.7	Miscellaneous helper procedures and functions	AppxH-5078

Appendix I

Pseudocode Index

I.1	Pseudocode operators and keywords	AppxI-5082
I.2	Pseudocode indexes	AppxI-5085

Appendix J

Registers Index

J.1	Introduction and register disambiguation	AppxJ-5088
J.2	Alphabetical index of AArch64 registers and system instructions	AppxJ-5092
J.3	Functional index of AArch64 registers and system instructions	AppxJ-5102
J.4	Alphabetical index of AArch32 registers and system instructions	AppxJ-5113
J.5	Functional index of AArch32 registers and system instructions	AppxJ-5122
J.6	Alphabetical index of memory-mapped registers	AppxJ-5133
J.7	Functional index of memory-mapped registers	AppxJ-5138

Glossary

Preface

This preface introduces the *ARM Architecture Reference Manual, ARMv8, for ARMv8-A architecture profile*. It contains the following sections:

- *About this manual* on page xvi
- *Using this manual* on page xviii
- *Conventions* on page xxiii
- *Additional reading* on page xxv
- *Feedback* on page xxvi.

About this manual

This manual describes the ARM® architecture v8, ARMv8. The architecture describes the operation of an ARMv8-A *Processing element (PE)*, and this manual includes descriptions of:

- The two Execution states, AArch64 and AArch32.
- The instruction sets:
 - In AArch32 state, the A32 and T32 instruction sets, that are compatible with earlier versions of the ARM architecture.
 - In AArch64 state, the A64 instruction set.
- The states that determine how a PE operates, including the current Exception level and Security state, and in AArch32 state the PE mode.
- The Exception model.
- The interprocessing model, that supports transitions between AArch64 state and AArch32 state.
- The memory model, that defines memory ordering and memory management. This manual covers a single architecture profile, ARMv8-A, that defines a *Virtual Memory System Architecture (VMSA)*.
- The programmers' model, and its interfaces to System registers that control most PE and memory system features, and provide status information.
- The Advanced SIMD and floating-point instructions, that provide high-performance:
 - Single-precision and double-precision floating-point operations
 - Conversions between double-precision, single-precision, and half-precision floating-point values.
 - Integer, single-precision floating-point, and in A64, double-precision vector operations in all instruction sets.
 - Double-precision floating-point vector operations in the A64 instruction set.
- The security model, that provides two security states to support secure applications.
- The virtualization model, that support the virtualization of Non-secure operation.
- The Debug architecture, that provides software access to debug features.

This manual gives the assembler syntax for the instructions it describes, meaning that it describes instructions in textual form. However, this manual is not a tutorial for ARM assembler language, nor does it describe ARM assembler language, except at a very basic level. To make effective use of ARM assembler language, read the documentation supplied with the assembler being used.

This manual is organized into parts:

- Part A** Provides an introduction to the ARMv8-A architecture, and an overview of the AArch64 and AArch32 Execution states.
- Part B** Describes the application level view of the AArch64 Execution state, meaning the view from EL0. It describes the application level view of the programmers' model and the memory model.
- Part C** Describes the A64 instruction set, that is available in the AArch64 Execution state. The descriptions for each instruction also include the precise effects of each instruction when executed at EL0, described as *unprivileged* execution, including any restrictions on its use, and how the effects of the instruction differ at higher Exception levels. This information is of primary importance to authors and users of compilers, assemblers, and other programs that generate ARM machine code.
- Part D** Describes the system level view of the AArch64 Execution state. It includes details of the System registers, most of which are not accessible from EL0, and the system level view of the programmers' model and the memory model. This part includes the description of self-hosted debug.
- Part E** Describes the application level view of the AArch32 Execution state, meaning the view from the EL0. It describes the application level view of the programmers' model and the memory model.

———— **Note** —————

In AArch32 state, execution at EL0 is execution in User mode.

Part F Describes the T32 and A32 instruction sets, that are available in the AArch32 Execution state. These instruction sets are backwards-compatible with earlier versions of the ARM architecture. This part describes the precise effects of each instruction when executed in User mode, described as *unprivileged* execution or execution at EL0, including any restrictions on its use, and how the effects of the instruction differ at higher Exception levels. This information is of primary importance to authors and users of compilers, assemblers, and other programs that generate ARM machine code.

———— **Note** —————

User mode is the only mode where software execution is unprivileged.

Part G Describes the system level view of the AArch32 Execution state, that is generally compatible with earlier versions of the ARM architecture. This part includes details of the System registers, most of which are not accessible from EL0, and the conceptual coprocessor interface to those registers. It also describes the system level view of the programmers' model and the memory model.

Part H Describes the Debug architecture for external debug. This provides configuration, breakpoint and watchpoint support, and a *Debug Communications Channel* (DCC) to a debug host.

Part I Describes additional features of the architecture that are not closely coupled to a *processing element* (PE), and therefore are accessed through memory-mapped interfaces. Some of these features are OPTIONAL.

Appendixes Provide additional information that is not part of the ARMv8 architectural requirements.

Using this manual

The information in this manual is organized into parts, as described in this section.

Part A, Introduction and Architecture Overview

Part A gives an overview of the ARMv8-A architecture profile, including its relationship to the other ARM PE architectures. It introduces the terminology used to describe the architecture, and gives an overview of the Executions states, AArch64 and AArch32. It contains the following chapter:

Chapter A1 *Introduction to the ARMv8 Architecture*

Read this for an introduction to the ARMv8 architecture.

Part B, The AArch64 Application Level Architecture

Part B describes the application level view of the architecture in AArch64 state. It contains the following chapters:

Chapter B1 *The AArch64 Application Level Programmers' Model*

Read this for an application level description of the programmers' model for software executing in AArch64 state. It describes execution at EL0 when EL0 is using AArch64 state.

Chapter B2 *The AArch64 Application Level Memory Model*

Read this for an application level description of the memory model for software executing in AArch64 state. It describes the memory model for execution in EL0 when EL0 is using AArch64 state. It includes information about ARM memory types, attributes, and memory access controls.

Part C, The A64 Instruction Set

Part C describes the A64 instruction set, that is used in AArch64 state. It contains the following chapters:

Chapter C1 *The A64 Instruction Set*

Read this for a description of the A64 instruction set and common instruction operation details.

Chapter C2 *A64 Instruction Set Overview*

Read this for an overview of the individual A64 instructions, that are divided into five functional groups.

Chapter C3 *A64 Instruction Set Encoding*

Read this for a description of the A64 instruction set encoding.

Chapter C4 *The AArch64 System Instruction Class*

Read this for a description of the AArch64 system instructions and register descriptions, and the system instruction class encoding space.

Chapter C5 *A64 Base Instruction Descriptions*

Read this for information on key aspects of the A64 base instructions and for descriptions of the individual instructions, which are listed in alphabetical order.

Chapter C6 *A64 SIMD and Floating-point Instruction Descriptions*

Read this for information on key aspects of the A64 Advanced SIMD and floating-point instructions and for descriptions of the individual instructions, which are listed in alphabetical order.

Part D, The AArch64 System Level Architecture

Part D describes the AArch64 the system level view of the architecture. It contains the following chapters:

Chapter D1 *The AArch64 System Level Programmers' Model*

Read this for a description of the AArch64 system level view of the programmers' model.

Chapter D2 *Debug Exceptions*

Read this for an introduction to, and a description of, different software debug events.

Chapter D3 *The Debug Exception Model*

Read this for a description of debug exceptions.

Chapter D4 *The AArch64 System Level Memory Model*

Read this for a description of the AArch64 system level view of the general features of the memory system.

Chapter D5 *The AArch64 Virtual Memory System Architecture*

Read this for a system level view of the AArch64 Virtual Memory System Architecture (VMSA), the memory system architecture of an ARMv8 implementation that is executing in AArch64 state.

Chapter D6 *The Performance Monitors Extension*

Read this for a description of an implementation of the ARM Performance Monitors, that are an optional non-invasive debug component.

Chapter D7 *The Generic Timer*

Read this for a description of an implementation of the ARM Generic Timer, that is an extension to an ARMv8 PE implementation.

Chapter D8 *AArch64 System Register Descriptions*

Read this for an introduction to, and description of, each of the AArch64 system registers.

Part E, The AArch32 Application Level Architecture

Part E describes the AArch32 application level view of the architecture. It contains the following chapters:

Chapter E1 *The AArch32 Application Level Programmers' Model*

Read this for an application level description of the programmers' model for software executing in AArch32 state. It describes execution at EL0 when EL0 is using AArch32 state.

Chapter E2 *The AArch32 Application Level Memory Model*

Read this for an application level description of the memory model for software executing in AArch32 state. It describes the memory model for execution in EL0 when EL0 is using AArch32 state. It includes information about ARM memory types, attributes, and memory access controls.

Part F, The AArch32 Instruction Sets

Part F describes the T32 and A32 instruction sets, that are used in AArch32 state. It contains the following chapters:

Chapter F1 *The AArch32 Instruction Sets Overview*

Read this for an overview of the T32 and A32 instruction sets.

Chapter F2 *About the T32 and A32 Instruction Descriptions*

Read this for a description of the T32 and A32 instructions.

Chapter F3 *T32 Base Instruction Set Encoding*

Read this for an introduction to the T32 instruction set and a description of how the T32 instruction set uses the ARM programmers' model.

Chapter F4 *A32 Base Instruction Set Encoding*

Read this for a description of the A32 base instruction set encoding.

Chapter F5 *T32 and A32 Instruction Sets Advanced SIMD and floating-point Encodings*

Read this for an overview of the T32 and A32 Advanced SIMD and floating-point instruction sets.

Chapter F6 ARMv8 Changes to the T32 and A32 Instruction Sets

Read this for a summary of the changes that are introduced to the T32 and A32 instruction sets in ARMv8.

Chapter F7 T32 and A32 Base Instruction Set Instruction Descriptions

Read this for a description of each T32 and A32 base instruction.

Chapter F8 T32 and A32 Advanced SIMD and floating-point Instruction Descriptions

Read this for a description of each T32 and A32 Advanced SIMD and floating-point instruction.

Part G, The AArch32 System Level Architecture

Part G describes the AArch32 system level view of the architecture. It contains the following chapters:

Chapter G1 The AArch32 System Level Programmers' Model

Read this for a description of the AArch32 system level view of the programmers' model for execution in an Exception level that is using AArch32.

Chapter G2 The AArch32 System Level Memory Model

Read this for a system level view of the general features of the memory system.

Chapter G3 The AArch32 Virtual Memory System Architecture

Read this for a description of the AArch32 Virtual Memory System Architecture (VMSA).

Chapter G4 AArch32 System Register Descriptions

Read this for a description of each of the AArch32 system registers.

Part H, External Debug

Part H describes the architecture for external debug. It contains the following chapters:

Chapter H1 Introduction to External Debug

Read this for an introduction to external debug, and a definition of the scope of this part of the manual.

Chapter H2 Debug State

Read this for a description of debug state, which the PE might enter as the result of a Halting debug event.

Chapter H3 Halting Debug Events

Read this for a description of the external debug events referred to as Halting debug events.

Chapter H4 The Debug Communication Channel and Instruction Transfer Register

Read this for a description of the communication between a debugger and the PE debug logic using the Debug Communications Channel and the Instruction Transfer register.

Chapter H5 The Embedded Cross Trigger Interface

Read this for a description of the embedded cross-trigger interface.

Chapter H6 Debug Reset and Powerdown Support

Read this for a description of reset and powerdown support in the Debug architecture.

Chapter H7 The Sample-based Profiling Extension

Read this for a description of the Sample-based Profiling extension that is an optional extension to the ARMv8 architecture.

Chapter H8 *About the External Debug Registers*

Read this for some additional information about the external debug registers.

Chapter H9 *External Debug Register Descriptions*

Read this for a description of each external debug register.

Part I, Memory-mapped Components of the ARMv8 Architecture

Part I describes the memory-mapped components in the architecture. It contains the following chapters:

Chapter I1 *Memory-Mapped System Register Descriptions*

Read this for a description of each memory-mapped system register.

Chapter I2 *System Level Implementation of the Generic Timer*

Read this for a definition of a system level implementation of the Generic Timer.

Chapter I3 *Recommended Memory-mapped Interfaces to the Performance Monitors*

Read this for a description of the recommended memory-mapped and external debug interfaces to the Performance Monitors.

Part J, Appendixes

This manual contains the following appendixes:

Appendix A *Architectural Constraints on UNPREDICTABLE behaviors*

Read this for a description of the architecturally-required constraints on UNPREDICTABLE behaviors in the ARMv8 architecture, including AArch32 behaviors that were UNPREDICTABLE in previous versions of the architecture.

Appendix B *Recommended External Debug Interface*

Read this for a description of the recommended external debug interface.

———— **Note** —————

This description is not part of the ARM architecture specification. It is included here as supplementary information, for the convenience of developers and users who might require this information.

Appendix C *Recommendations for Performance Monitors Event Numbers for IMPLEMENTATION DEFINED Events*

Read this for a description of ARM recommendations for the use of the IMPLEMENTATION DEFINED event numbers.

———— **Note** —————

This description is not part of the ARM architecture specification. It is included here as supplementary information, for the convenience of developers and users who might require this information.

Appendix D *Example OS Save and Restore sequences*

Read this for software examples that perform the OS Save and Restore sequences for an ARMv8 debug implementation.

———— **Note** —————

Chapter H6 Debug Reset and Powerdown Support describes the OS Save and Restore mechanism.

Appendix E *Additional Guidance*

Read this for information about implementing and using the ARM architecture.

———— **Note** —————

This description is not part of the ARM architecture specification. It is included here as supplementary information, for the convenience of developers and users who might require this information.

Appendix F *Barrier Litmus Tests*

Read this for examples of the use of barrier instructions provided by the ARMv8 architecture.

———— **Note** —————

This description is not part of the ARM architecture specification. It is included here as supplementary information, for the convenience of developers and users who might require this information.

Appendix G *ARMv8 Pseudocode Library*

Read this for the pseudocode definitions that are shared between AArch32 and AArch64.

Appendix H *ARM Pseudocode Definition*

Read this for definitions of the AArch32 pseudocode.

Appendix I *Pseudocode Index*

Read this for an index of the pseudocode.

Appendix J *Registers Index*

Read this for an alphabetic and functional index of AArch32 and AArch64 registers, and memory-mapped registers.

Conventions

The following sections describe conventions that this book can use:

- *Typographic conventions.*
- *Signals.*
- *Numbers.*
- *Pseudocode descriptions.*
- *Assembler syntax descriptions on page xxiv.*

Typographic conventions

The typographical conventions are:

italic Introduces special terminology, and denotes citations.

bold Denotes signal names, and is used for terms in descriptive lists, where appropriate.

monospace Used for assembler syntax descriptions, pseudocode, and source code examples.
Also used in the main text for instruction mnemonics and for references to other items appearing in assembler syntax descriptions, pseudocode, and source code examples.

SMALL CAPITALS

Used in body text for a few terms that have specific technical meanings, and are defined in the *Glossary*.

Colored text Indicates a link. This can be:

- A URL, for example, <http://infocenter.arm.com>.
- A cross-reference, that includes the page number of the referenced information if it is not on the current page, for example, *Pseudocode descriptions*.
- A link, to a chapter or appendix, or to a glossary entry, or to the section of the document that defines the colored term, for example *Simple sequential execution* or **SCTLR**.

Signals

In general this specification does not define hardware signals, but it does include some signal examples and recommendations. The signal conventions are:

Signal level The level of an asserted signal depends on whether the signal is active-HIGH or active-LOW. Asserted means:

- HIGH for active-HIGH signals.
- LOW for active-LOW signals.

Lower-case n At the start or end of a signal name denotes an active-LOW signal.

Numbers

Numbers are normally written in decimal. Binary numbers are preceded by `0b`, and hexadecimal numbers by `0x`. In both cases, the prefix and the associated value are written in a monospace font, for example `0xFFFF0000`. To improve readability, long numbers can be written with an underscore separator between every four characters, for example `0xFFFF_0000_0000_0000`. Ignore any underscores when interpreting the value of a number.

Pseudocode descriptions

This manual uses a form of pseudocode to provide precise descriptions of the specified functionality. This pseudocode is written in monospace font, and is described in [Appendix H ARM Pseudocode Definition](#).

Assembler syntax descriptions

This manual contains numerous syntax descriptions for assembler instructions and for components of assembler instructions. These are shown in a monospace font, and use the conventions described in *Structure of the A64 assembler language* on page C1-113, Appendix H *ARM Pseudocode Definition*, and *Pseudocode operators and keywords* on page AppxI-5082.

Additional reading

This section lists relevant publications from ARM and third parties.

See the Infocenter, <http://infocenter.arm.com>, for access to ARM documentation.

ARM publications

- *ARM® Architecture Reference Manual, ARMv7-A and ARMv7-R edition* (ARM DDI 0406).
- *ARM® Debug Interface Architecture Specification, ADIv5.0 to ADIv5.2* (ARM IHI 0031).
- *CoreSight™ Program Flow Trace Architecture Specification* (ARM IHI 0035).
- *ARM® Embedded Trace Macrocell Architecture Specification, ETMv4* (ARM IHI 0064).
- *ARM® Generic Interrupt Controller Architecture Specification, GIC architecture version 3.0* (ARM IHI 0048).
- *CoreSight™ SoC Technical Reference Manual* (ARM DDI 0480).
- *ARM® Procedure Call Standard for the ARM 64-bit Architecture* (ARM IHI 0055).

Other publications

The following publications are referred to in this manual, or provide more information:

- *Announcing the Advanced Encryption Standard (AES)*, Federal Information Processing Standards Publication 197, November 2001.
- IEEE 754-2008, *IEEE Standard for Floating-point Arithmetic*, August 2008.
- *Secure Hash Standard (SHA)*, Federal Information Processing Standards Publication 180-2, August 2002.
- *The Galois/Counter Mode of Operation*, McGraw, D. and Viega, J., Submission to NIST Modes of Operation Process, January 2004.
- *Memory Consistency Models for Shared Memory-Multiprocessors*, Gharachorloo, Kourosh, 1995, Stanford University Technical Report CSL-TR-95-685.

Feedback

ARM welcomes feedback on its documentation.

Feedback on this manual

If you have comments on the content of this manual, send e-mail to errata@arm.com. Give:

- The title.
- The number, ARM DDI 0487A.a.
- The page numbers to which your comments apply.
- A concise explanation of your comments.

ARM also welcomes general suggestions for additions and improvements.

Part A

ARMv8 Architecture Introduction and Overview

Chapter A1

Introduction to the ARMv8 Architecture

This chapter introduces the ARM architecture and contains the following sections:

- *About the ARM architecture* on page A1-30.
- *Architecture profiles* on page A1-32.
- *ARMv8 architectural concepts* on page A1-33.
- *Supported data types* on page A1-36.
- *Floating-point and Advanced SIMD support* on page A1-46.
- *Cryptographic Extension* on page A1-52.
- *The ARM memory model* on page A1-53.

A1.1 About the ARM architecture

The ARM architecture—described in this Architecture Reference Manual—defines the behavior of an abstract machine, referred to as a *Processing Element*, often abbreviated to *PE*. Implementations compliant with the ARM architecture must conform to the described behavior of the Processing Element. It is not intended to describe how to build an implementation of the PE, nor to limit the scope of such implementations beyond the defined behaviors.

Except where the architecture specifies differently, the programmer-visible behavior of an implementation that is compliant with the ARM architecture must be the same as a simple sequential execution of the program on the processing element. This programmer-visible behavior does not include the execution time of the program.

The ARM Architecture Reference Manual also describes rules for software to use the Processing Element.

The ARM architecture includes definitions of:

- An associated debug architecture, see [Debug architecture versions on page A1-32](#) and Part H of this manual.
- Associated trace architectures, that define trace macrocells that implementers can implement with the associated processor hardware. For more information see the *Embedded Trace Macrocell Architecture Specification* and the *CoreSight Program Flow Trace Architecture Specification*.

The ARM architecture is a *Reduced Instruction Set Computer* (RISC) architecture with the following RISC architecture features:

- A large uniform register file.
- A *load/store* architecture, where data-processing operations only operate on register contents, not directly on memory contents.
- Simple addressing modes, with all load/store addresses determined from register contents and instruction fields only.

The architecture defines the interaction of the Processing Element with memory, including caches, and includes a memory translation system. It also describes how multiple Processing Elements interact with each other and with other observers in a system.

This document defines the ARMv8 version of the A profile. See [Architecture profiles on page A1-32](#) for more information on architecture profiles.

The ARM architecture supports implementations across a wide range of performance points. Implementation size, performance, and very low power consumption are key attributes of the ARM architecture.

An important feature of the ARMv8 architecture is backwards compatibility, combined with the freedom for optimal implementation in a wide range of standard and more specialized use cases. The ARMv8 architecture supports:

- A 64-bit Execution state, AArch64.
- A 32-bit Execution state, AArch32, that is compatible with previous versions of the ARM architecture.

———— **Note** —————

The AArch32 Execution state is compatible with the ARMv7-A architecture profile, and enhances that profile to support some features included in the AArch64 Execution state.

Both Execution states support SIMD and floating-point instructions.

Note

- AArch32 state provides both:
 - SIMD instructions in the base instruction sets, that operate on the 32-bit general-purpose registers.
 - SIMD instructions that operate on 64-bit SIMD and floating-point registers, and are identified as Advanced SIMD instructions.
 - AArch64 state provides only SIMD instructions that operate on 128-bit SIMD and floating-point registers. AArch64 state descriptions use SIMD as a synonym for Advanced SIMD.
 - See [Conventions on page xxiii](#) for information about conventions used in this manual, including the use of SMALL CAPITALS for the terms **CONSTRAINED UNPREDICTABLE**, **IMPLEMENTATION DEFINED**, **OPTIONAL**, **RES0**, **RES1**, **UNDEFINED**, **UNKNOWN**, and **UNPREDICTABLE**, that have ARM-specific meanings that are defined in the *Glossary*
-

A1.2 Architecture profiles

The ARM architecture has evolved significantly since its introduction, and ARM continues to develop it. Eight major versions of the architecture have been defined to date, denoted by the version numbers 1 to 8. Of these, the first three versions are now obsolete.

The generic names AArch64 and AArch32 describe the 64-bit and 32-bit Execution states:

- AArch64** Is the 64-bit Execution state, meaning addresses are held in 64-bit registers, and instructions in the base instruction set can use 64-bit registers for their processing. AArch64 state supports the A64 instruction set.
- AArch32** Is the 32-bit Execution state, meaning addresses are held in 32-bit registers, and instructions in the base instruction sets use 32-bit registers for their processing. AArch32 state supports the T32 and A32 instruction sets.

See sections [Execution state on page A1-33](#) and [The ARM instruction sets on page A1-34](#) for more information.

ARM defines three architecture profiles:

- A** Application profile, described in this manual:
- Supports a *Virtual Memory System Architecture (VMSA)* based on a *Memory Management Unit (MMU)*.
- **Note** —————
- An ARMv8-A implementation can be called an AArchv8-A implementation.
- Supports the A64, A32 and T32 instruction sets.
- R** Real-time profile:
- Supports a *Protected Memory System Architecture (PMSA)* based on a *Memory Protection Unit (MPU)*.
 - Supports the A32 and T32 instruction sets.
- M** Microcontroller profile:
- Implements a programmers' model designed for low-latency interrupt processing, with hardware stacking of registers and support for writing interrupt handlers in high-level languages.
 - Implements a variant of the R-profile PMSA.
 - Supports a variant of the T32 instruction set.

———— **Note** —————

This Architecture Reference Manual describes only the ARMv8-A profile.

For information about the R and M architecture profiles, and earlier ARM architecture versions see:

- The *ARM® Architecture Reference Manual, ARMv7-A and ARMv7-R edition*.
- The *ARM®v7-M Architecture Reference Manual*.
- The *ARM®v6-M Architecture Reference Manual*.

A1.2.1 Debug architecture versions

From ARMv7 the ARM debug architecture is fully integrated with the architecture version.

For information about earlier ARM debug architecture versions, see the *ARM® Architecture Reference Manual, ARMv7-A and ARMv7-R edition*.

For more information, see [Chapter H1 Introduction to External Debug](#).

A1.3 ARMv8 architectural concepts

ARMv8 introduces major changes to the ARM architecture, while maintaining a high level of consistency with previous versions of the architecture. The ARMv8 Architecture Reference Manual includes significant changes in the terminology used to describe the architecture, and this section introduces both the ARMv8 architectural concepts and the associated terminology.

The following subsections describe key ARMv8 architectural concepts. Each section introduces the corresponding terms that are used to describe the architecture:

- [Execution state](#).
- [The ARM instruction sets on page A1-34](#).
- [System registers on page A1-34](#).
- [ARMv8 Debug on page A1-35](#).

A1.3.1 Execution state

The Execution state defines the PE execution environment, including:

- The supported register widths.
- The supported instruction sets.
- Significant aspects of:
 - The exception model.
 - The *Virtual Memory System Architecture (VMSA)*.
 - The programmers' model.

The Execution states are:

- AArch64** The 64-bit Execution state. This Execution state:
- Provides 31 64-bit general-purpose registers, of which X30 is used as the procedure link register.
 - Provides a 64-bit *program counter (PC)*, *stack pointers (SPs)*, and *exception link registers (ELRs)*.
 - Provides 32 128-bit registers for SIMD vector and scalar floating-point support.
 - Provides a single instruction set, A64. For more information, see [The ARM instruction sets on page A1-34](#).
 - Defines the ARMv8 Exception model, with up to four Exception levels, EL0 - EL3, that provide an *execution privilege* hierarchy, see [Exception levels on page D1-1408](#).
 - Support for 64-bit *virtual addressing*. For more information, including the limits on address ranges, see [Chapter D5 The AArch64 Virtual Memory System Architecture](#).
 - Defines a number of PSTATE elements that hold PE state. The A64 instruction set includes instructions that operate directly on various PSTATE elements.
 - Names each system register using a suffix that indicates the lowest Exception level at which the register can be accessed.
- AArch32** The 32-bit Execution state. This Execution state:
- Provides 13 32-bit general-purpose registers, and a 32-bit PC, SP, and *link register (LR)*. The LR is used as both an ELR and a procedure link register. Some of these registers have multiple *banked* instances for use in different PE *modes*.
 - Provides a single ELR, for exception returns from Hyp mode.
 - Provides 32 64-bit registers for Advanced SIMD vector and scalar floating-point support.
 - Provides two instruction sets, A32 and T32. For more information, see [The ARM instruction sets on page A1-34](#).
 - Supports the ARMv7-A exception model, based on *PE modes*, and maps this onto the ARMv8 Exception model, that is based on the Exception levels, see [Exception levels on page G1-3401](#).

- Uses 32-bit virtual addresses.
- Uses a single *Current Program State Register* (CPSR) to hold the PE state.

Later subsections give more information about the different properties of the Execution states.

Making transitions between the AArch64 and AArch32 execution states is known as *interprocessing*. The PE can move between execution states only on a change of Exception level, and subject to the rules given in [Interprocessing on page D1-1542](#). This means different software layers, such as an application, an operating system kernel, and a hypervisor, executing at different Exception levels, can execute in different execution states.

A1.3.2 The ARM instruction sets

In ARMv8 the possible instruction sets depend on the execution state:

AArch64 AArch64 state supports only a single instruction set, called A64. This is a fixed-length instruction set that uses 32-bit instruction encodings.

For information on the A64 instruction set, see [Chapter C2 A64 Instruction Set Overview](#).

AArch32 AArch32 state supports the following instruction sets:

A32 This is a fixed-length instruction set that uses 32-bit instruction encodings. It is compatible with the ARMv7 ARM instruction set.

T32 This is a variable-length instruction set that uses both 16-bit and 32-bit instruction encodings. It is compatible with the ARMv7 Thumb® instruction set

In previous documentation, these instruction sets were called the ARM and Thumb instruction sets. ARMv8 extends each of these instruction sets. The PE Instruction set state determines the instruction set that the PE executes.

For information on the A32 and T32 instruction sets, see [Chapter F1 The AArch32 Instruction Sets Overview](#).

The ARMv8 instruction sets support SIMD and scalar floating-point instructions. See [Floating-point and Advanced SIMD support on page A1-46](#).

A1.3.3 System registers

System registers provide control and status information of architected features.

The System registers use a standard naming format: <register_name>.<bit_field_name> to identify specific registers as well as control and status bits within a register.

Bits can also be described by their numerical position in the form <register_name>[x:y] or the generic form bits[x:y].

In addition, in AArch64 state, most register names include the lowest Exception level that can access the register as a suffix to the register name:

- <register_name>_ELx, where x is 0, 1, 2, or 3.

For information about Exception levels, see [Exception levels on page D1-1408](#).

The System registers comprise:

- General system control registers.
- Debug registers.
- Generic Timer registers.
- Optionally, Performance Monitor registers.
- Optionally, Trace registers.
- Optionally, Generic Interrupt Controller (GIC) CPU interface registers.

The *Embedded Trace Macrocell Architecture Specification, ETMv4* defines the Trace registers. This ARMv8 reference manual describes all the other System registers.

For information about the AArch64 System registers, see [Chapter D8 AArch64 System Register Descriptions](#).

For information about the AArch32 System registers, see [Chapter G4 AArch32 System Register Descriptions](#).

The ARM Generic Interrupt Controller CPU interface

Version 3 of the ARM Generic Interrupt Controller architecture, GICv3, defines a system register interface to the GIC CPU interface. The System register descriptions in this ARMv8 manual include these registers, see [Generic Interrupt Controller CPU interface registers on page D8-2194](#).

———— **Note** —————

The programmers' model for earlier versions of the GIC architecture is wholly memory-mapped.

For more information about the ARM Generic Interrupt Controller, see the *ARM Generic Interrupt Controller Architecture Specification, GIC architecture version 3.0*.

A1.3.4 ARMv8 Debug

ARMv8 supports the following:

Self-hosted debug

In this model, the PE generates *debug exceptions*. Debug exceptions are part of the ARMv8 Exception model.

External debug

In this model, *debug events* cause the PE to enter *Debug state*. In Debug state the PE is controlled by an external debugger.

All ARMv8 implementations support both models. The model chosen by a particular user depends on the debug requirements during different stages of the design and development life cycle of the product. For example, external debug might be used during debugging of the hardware implementation and OS bring-up, and self-hosted debug might be used during application development.

For more information about self-hosted debug, see:

- [Chapter D2 Debug Exceptions](#).
- [Chapter D3 The Debug Exception Model](#).

For more information about external debug, see *Part H External Debug*.

A1.4 Supported data types

The ARMv8 architecture supports the following integer data types:

Byte	8 bits.
Halfword	16 bits.
Word	32 bits.
Doubleword	64 bits.
Quadword	128 bits.

The architecture also supports the following floating-point data types:

- Half-precision, see [Half-precision floating-point formats on page A1-40](#) for details.
- Single-precision, see [Single-precision floating-point format on page A1-42](#) for details.
- Double-precision, see [Double-precision floating-point format on page A1-43](#) for details.

It also supports:

- Fixed-point interpretation of words and doublewords. See [Fixed-point format on page A1-44](#).
- Vectors, where a register holds multiple elements, each of the same data type. See [Vector formats on page A1-37](#) for details.

The ARMv8 architecture provides two register files:

- A general-purpose register file.
- A SIMD and floating-point register file.

In each of these, the possible register widths depend on the Execution state.

In AArch64 state:

- A general-purpose register file contains 64-bit registers:
 - Many instructions can access these registers as 64-bit registers or as 32-bit registers, using only the bottom 32 bits.
- A SIMD and floating-point register file contains 128-bit registers:
 - The quadword integer data types only apply to the SIMD and floating-point register file.
 - The floating-point data types only apply to the SIMD and floating-point register file.
 - While the AArch64 vector registers support 128-bit vectors, the effective vector length can be 64-bits or 128-bits depending on the A64 instruction encoding used, see [Instruction Mnemonics on page C1-113](#)

For more information on the register files in AArch64, see [Registers in AArch64 Execution state on page B1-59](#).

In AArch32 state:

- A general-purpose register file contains 32-bit registers:
 - Two 32-bit registers can support a doubleword.
 - Vector formatting is supported, see [Figure A1-4 on page A1-40](#).
- A SIMD and floating-point register file contains 64-bit registers:
 - AArch32 state does not support quadword integer or floating-point data types.

———— **Note** —————

Two consecutive 64-bit registers can be used as a 128-bit register.

For more information on the register files in AArch32, see [The general-purpose registers, and the PC, in AArch32 state on page E1-2294](#)

A1.4.1 Vector formats

In an implementation that includes the SIMD instructions that operate on the SIMD and floating-point register file, a register can hold one or more packed elements, all of the same size and type. The combination of a register and a data type describes a vector of elements. The vector is considered to be an array of elements of the data type specified in the instruction. The number of elements in the vector is implied by the size of the data elements and the size of the register.

Vector indices are in the range 0 to (number of elements – 1). An index of 0 refers to the least significant end of the vector.

Vector formats in AArch64 state

In AArch64 state, the SIMD and floating-point registers are generically known by the name V_n , where n is a value from 0 to 31 that identifies 1 of 32 registers.

The SIMD and floating-point registers support three data formats for loads, stores and data processing operations:

- A single, scalar, element in the least significant bits of the register.
- A 64-bit vector of byte, halfword, or word elements.
- A 128-bit vector of byte, halfword, word or doubleword elements.

The element sizes are defined in [Table A1-1](#) with the vector format described as:

- For a 128-bit vector: $V_n\{.2D, .4S, .8H, .16B\}$.
- For a 64-bit vector: $V_n\{.1D, .2S, .4H, .8B\}$.

Table A1-1 SIMD elements

Mnemonic	Size
B	8 bits
H	16 bits
S	32 bits
D	64 bits

[Figure A1-1 on page A1-38](#) shows the SIMD vectors in AArch64 state.

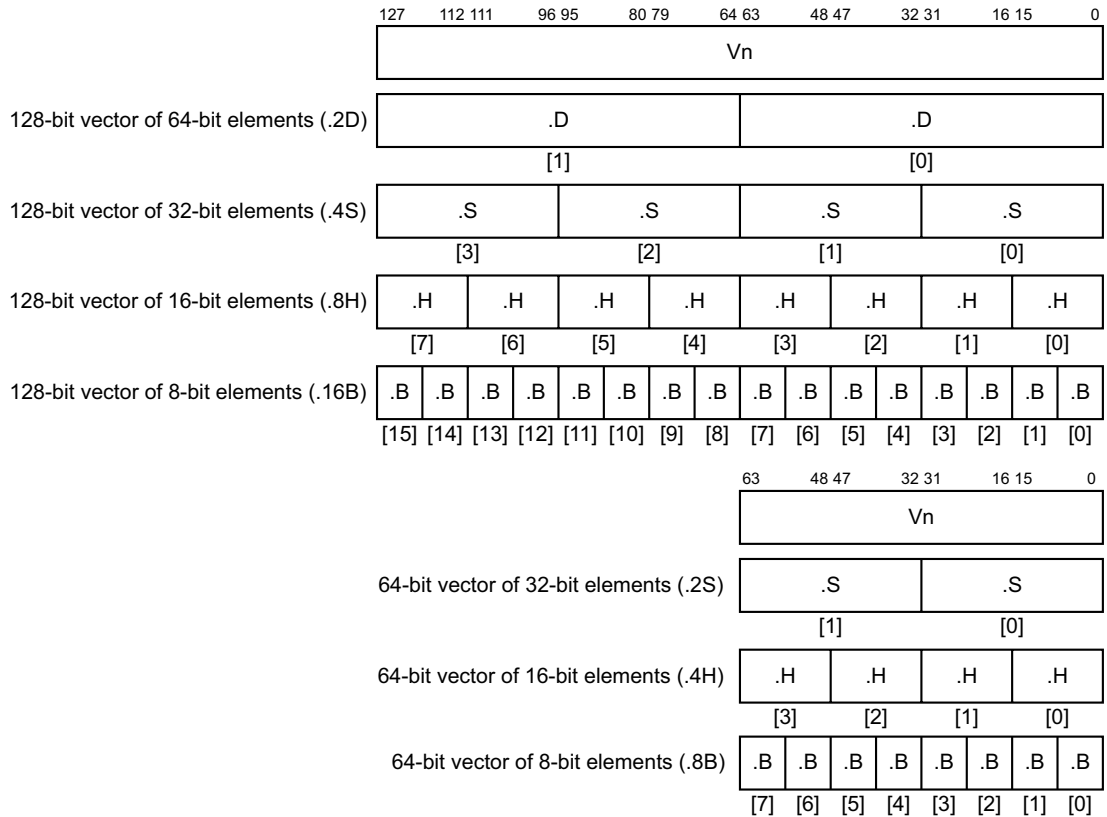

Figure A1-1 SIMD vectors in AArch64 state

Vector formats in AArch32 state

Table A1-2 shows the available formats. Each instruction description specifies the data types that the instruction supports.

Table A1-2 Advanced SIMD data types in AArch32

Data type specifier	Meaning
.<size>	Any element of <size> bits
.F<size>	Floating-point number of <size> bits
.I<size>	Signed or unsigned integer of <size> bits
.P<size>	Polynomial over {0, 1} of degree less than <size>
.S<size>	Signed integer of <size> bits
.U<size>	Unsigned integer of <size> bits

Polynomial arithmetic over {0, 1} on page A1-45 describes the polynomial data type.

The .F16 data type is the half-precision data type selected by the FPSCR.AHP bit.

The .F32 data type is the ARM standard single-precision floating-point data type, see *Single-precision floating-point format* on page A1-42.

The instruction definitions use a data type specifier to define the data types appropriate to the operation. Figure A1-2 on page A1-39 shows the hierarchy of the Advanced SIMD data types.

.8	.i8	.S8
		.U8
	.P8	
	-	
.16	.i16	.S16
		.U16
	.P16 †	
	.F16	
.32	.i32	.S32
		.U32
	-	
	.F32	
.64	.i64	.S64
		.U64
	.P64 ‡	
	-	

† Output format only. See VMULL instruction description.

‡ Available only if the Cryptographic Extension is implemented.
See VMULL instruction description.

Figure A1-2 Advanced SIMD data type hierarchy in AArch32

For example, a multiply instruction must distinguish between integer and floating-point data types.

An integer multiply instruction that generates a double-width (long) result must specify the input data types as signed or unsigned. However, some integer multiply instructions use modulo arithmetic, and therefore do not have to distinguish between signed and unsigned inputs.

Figure A1-3 on page A1-40 shows the Advanced SIMD vectors in AArch32 state.

Note

In AArch32 state, a pair of even and following odd numbered doubleword registers can be concatenated and treated as a single quadword register.

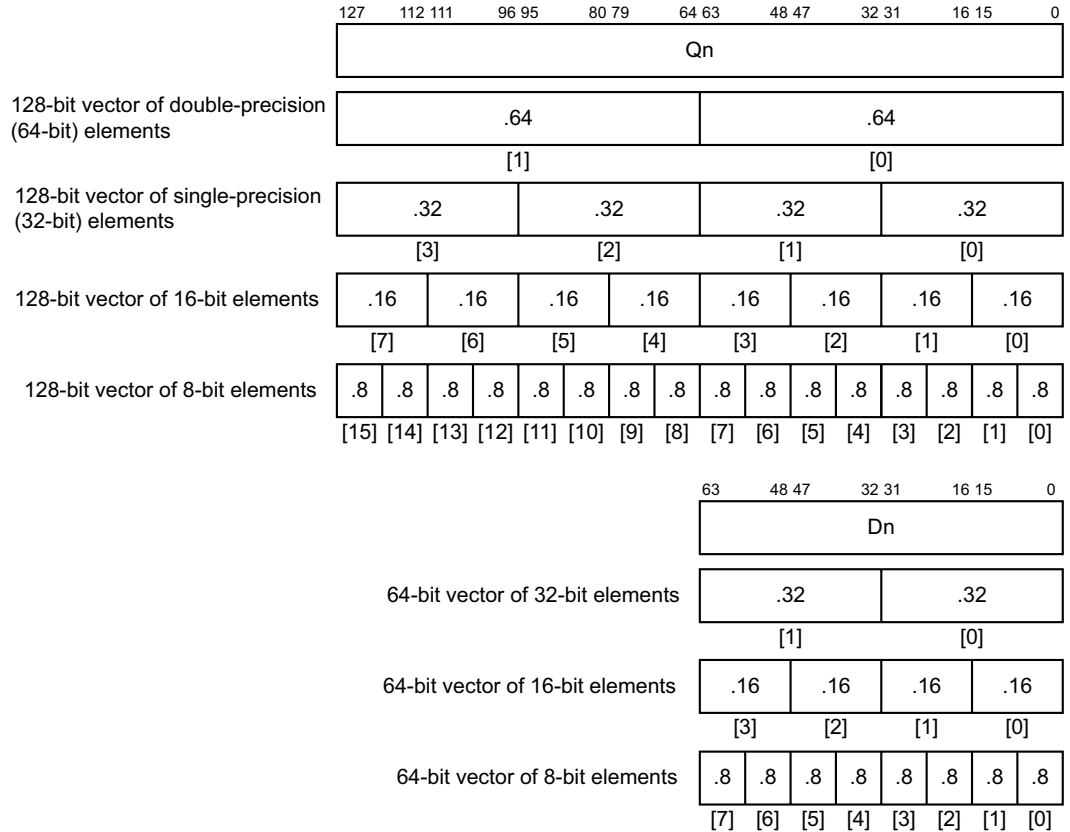

Figure A1-3 Advanced SIMD vectors in AArch32

The general-purpose registers support vector formatting in the AArch32 Execution state only, as shown in Figure A1-4.

This means that a general-purpose register can be treated as either a two halfwords or four bytes.

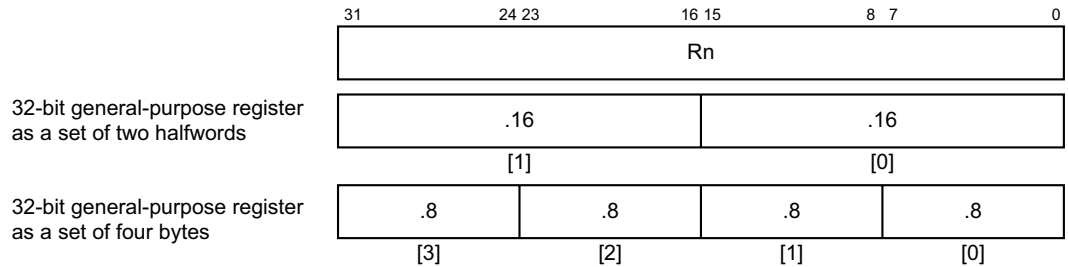

Figure A1-4 Vector formatting in AArch32

A1.4.2 Half-precision floating-point formats

ARMv8 supports two half-precision floating-point formats:

- IEEE half-precision, as described in the IEEE 754-2008 standard
- Alternative half-precision.

———— **Note** ————

Half-precision floating-point formats can only be converted to and from other floating-point formats. They cannot be used in any other data processing operations. This applies to both AArch32 state and AArch64 state.

The description of IEEE half-precision includes ARM-specific details that are left open by the standard, and is only an introduction to the formats and to the values they can contain. For more information, especially on the handling of infinities, NaNs and signed zeros, see the IEEE 754 standard.

For both half-precision floating-point formats, the layout of the 16-bit format is the same. The format is:

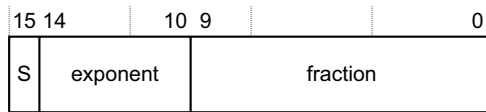

The interpretation of the format depends on the value of the exponent field, bits[14:10] and on which half-precision format is being used.

0 < exponent < 0x1F

The value is a normalized number and is equal to:

$$(-1)^S \times 2^{(\text{exponent}-15)} \times (1.\text{fraction})$$

The minimum positive normalized number is 2^{-14} , or approximately 6.104×10^{-5} .

The maximum positive normalized number is $(2 - 2^{-10}) \times 2^{15}$, or 65504.

Larger normalized numbers can be expressed using the alternative format when the exponent == 0x1F.

exponent == 0

The value is either a zero or a denormalized number, depending on the fraction bits:

fraction == 0

The value is a zero. There are two distinct zeros:

- +0** when S==0
- 0** when S==1.

fraction != 0

The value is a denormalized number and is equal to:

$$(-1)^S \times 2^{-14} \times (0.\text{fraction})$$

The minimum positive denormalized number is 2^{-24} , or approximately 5.960×10^{-8} .

exponent == 0x1F

The value depends on which half-precision format is being used:

IEEE half-precision

The value is either an infinity or a Not a Number (NaN), depending on the fraction bits:

fraction == 0

The value is an infinity. There are two distinct infinities:

- +infinity** When S==0. This represents all positive numbers that are too big to be represented accurately as a normalized number.
- infinity** When S==1. This represents all negative numbers with an absolute value that is too big to be represented accurately as a normalized number.

fraction != 0

The value is a NaN, and is either a *quiet NaN* or a *signaling NaN*.

The two types of NaN are distinguished by their most significant fraction bit, bit[9]:

- bit[9] == 0** The NaN is a signaling NaN. The sign bit can take any value, and the remaining fraction bits can take any value except all zeros.
- bit[9] == 1** The NaN is a quiet NaN. The sign bit and remaining fraction bits can take any value.

Alternative half-precision

The value is a normalized number and is equal to:

$$-1^S \times 2^{16} \times (1.\text{fraction})$$

The maximum positive normalized number is $(2-2^{-10}) \times 2^{16}$ or 131008.

A1.4.3 Single-precision floating-point format

The single-precision floating-point format is as defined by the IEEE 754 standard.

This description includes ARM-specific details that are left open by the standard. It is only intended as an introduction to the formats and to the values they can contain. For full details, especially of the handling of infinities, NaNs and signed zeros, see the IEEE 754 standard.

A single-precision value is a 32-bit word with the format:



The interpretation of the format depends on the value of the exponent field, bits[30:23]:

0 < exponent < 0xFF

The value is a *normalized number* and is equal to:

$$(-1)^S \times 2^{(\text{exponent} - 127)} \times (1.\text{fraction})$$

The minimum positive normalized number is 2^{-126} , or approximately 1.175×10^{-38} .

The maximum positive normalized number is $(2 - 2^{-23}) \times 2^{127}$, or approximately 3.403×10^{38} .

exponent == 0

The value is either a zero or a *denormalized number*, depending on the fraction bits:

fraction == 0

The value is a zero. There are two distinct zeros:

+0 When S==0.

-0 When S==1.

These usually behave identically. In particular, the result is *equal* if +0 and -0 are compared as floating-point numbers. However, they yield different results in some circumstances. For example, the sign of the infinity produced as the result of dividing by zero depends on the sign of the zero. The two zeros can be distinguished from each other by performing an integer comparison of the two words.

fraction != 0

The value is a denormalized number and is equal to:

$$(-1)^S \times 2^{-126} \times (0.\text{fraction})$$

The minimum positive denormalized number is 2^{-149} , or approximately 1.401×10^{-45} .

Denormalized numbers are always flushed to zero in AArch32 Advanced SIMD processing. They are optionally flushed to zero in floating-point processing and AArch64 SIMD. For details see [Flush-to-zero on page A1-49](#).

exponent == 0xFF

The value is either an *infinity* or a *Not a Number* (NaN), depending on the fraction bits:

fraction == 0

The value is an infinity. There are two distinct infinities:

+infinity When S==0. This represents all positive numbers that are too big to be represented accurately as a normalized number.

-infinity When S==1. This represents all negative numbers with an absolute value that is too big to be represented accurately as a normalized number.

fraction != 0

The value is a NaN, and is either a *quiet NaN* or a *signaling NaN*.

The two types of NaN are distinguished by their most significant fraction bit, bit[22]:

bit[22] == 0

The NaN is a signaling NaN. The sign bit can take any value, and the remaining fraction bits can take any value except all zeros.

bit[22] == 1

The NaN is a quiet NaN. The sign bit and remaining fraction bits can take any value.

For details of the *default NaN* see [NaN handling and the Default NaN](#) on page A1-50.

———— **Note** —————

NaNs with different sign or fraction bits are distinct NaNs, but this does not mean software can use floating-point comparison instructions to distinguish them. This is because the IEEE 754 standard specifies that a NaN compares as *unordered* with everything, including itself.

A1.4.4 Double-precision floating-point format

The double-precision floating-point format is as defined by the IEEE 754 standard. Double-precision floating-point is supported by both floating-point and SIMD instructions in AArch64 state, and only by floating-point instructions in AArch32 state.

This description includes implementation-specific details that are left open by the standard. It is only intended as an introduction to the formats and to the values they can contain. For full details, especially of the handling of infinities, NaNs and signed zeros, see the IEEE 754 standard.

A double-precision value is a 64-bit doubleword, with the format:

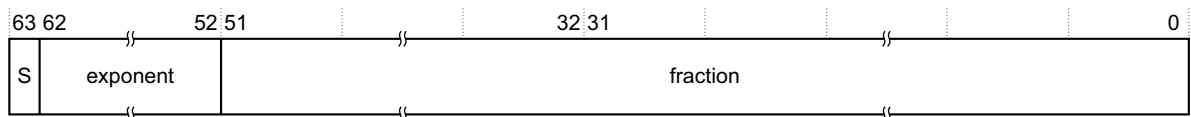

Double-precision values represent numbers, infinities and NaNs in a similar way to single-precision values, with the interpretation of the format depending on the value of the exponent:

0 < exponent < 0x7FF

The value is a normalized number and is equal to:

$$(-1)^S \times 2^{(\text{exponent}-1023)} \times (1.\text{fraction})$$

The minimum positive normalized number is 2^{-1022} , or approximately 2.225×10^{-308} .

The maximum positive normalized number is $(2 - 2^{-52}) \times 2^{1023}$, or approximately 1.798×10^{308} .

exponent == 0

The value is either a zero or a denormalized number, depending on the fraction bits:

fraction == 0

The value is a zero. There are two distinct zeros that behave in the same way as the two single-precision zeros:

+0 when S==0

-0 when S==1.

fraction != 0

The value is a denormalized number and is equal to:

$$(-1)^S \times 2^{-1022} \times (0.\text{fraction})$$

The minimum positive denormalized number is 2^{-1074} , or approximately 4.941×10^{-324} .

Optionally, denormalized numbers are flushed to zero in floating-point calculations. For details see [Flush-to-zero on page A1-49](#).

exponent == 0x7FF

The value is either an infinity or a NaN, depending on the fraction bits:

fraction == 0

the value is an infinity. As for single-precision, there are two infinities:

+infinity When $S==0$.

-infinity When $S==1$.

fraction != 0

The value is a NaN, and is either a *quiet NaN* or a *signaling NaN*.

The two types of NaN are distinguished by their most significant fraction bit, bit[19] of the most significant word:

bit[19] == 0

The NaN is a signaling NaN. The sign bit can take any value, and the remaining fraction bits can take any value except all zeros.

bit[19] == 1

The NaN is a quiet NaN. The sign bit and the remaining fraction bits can take any value.

For details of the *default NaN* see [NaN handling and the Default NaN on page A1-50](#).

———— **Note** —————

NaNs with different sign or fraction bits are distinct NaNs, but this does not mean software can use floating-point comparison instructions to distinguish them. This is because the IEEE 754 standard specifies that a NaN compares as *unordered* with everything, including itself.

A1.4.5 Fixed-point format

Fixed-point formats are used only for conversions between floating-point and fixed-point values. They apply to general-purpose registers.

Fixed-point values can be signed or unsigned, and can be 16-bit or 32-bit. Conversion instructions take an argument that specifies the number of fraction bits in the fixed-point number. That is, it specifies the position of the binary point.

A1.4.6 Conversion between floating-point and fixed-point values

ARMv8 supports the conversion of a scalar floating-point to or from a signed or unsigned fixed-point value in a general-purpose register.

The instruction argument *#fbits* indicates that the general-purpose register holds a fixed-point number with *fbits* bits after the binary point, where *fbits* is in the range 1 to 64 for a 64-bit general-purpose register, or 1 to 32 for a 32-bit general-purpose register.

More specifically:

- For a 64-bit register X_d :
 - The integer part is $X_d[63:\#fbits]$.
 - The fractional part is $X_d[(\#fbits-1):0]$.
- For a 32-bit register W_d or R_d :
 - The integer part is $W_d[31:\#fbits]$ or $R_d[31:\#fbits]$.
 - The fractional part is $W_d[(\#fbits-1):0]$ or $R_d[(\#fbits-1):0]$.

These instructions might generate the following exceptions:

- Invalid Operation** When the floating-point input is NaN or Infinity or when a numerical value cannot be represented within the destination register.
- Inexact** When the numeric result differs from the input.
- Input Denormal** When flush-to-zero mode is enabled and the denormal input is replaced by a zero.

———— **Note** —————

An out of range fixed-point result is saturated to the destination size.

A1.4.7 Polynomial arithmetic over {0, 1}

Some SIMD instructions that operate on SIMD and floating-point registers can operate on polynomials over {0, 1}, see [Supported data types on page A1-36](#). The polynomial data type represents a polynomial in x of the form $b_{n-1}x^{n-1} + \dots + b_1x + b_0$ where b_k is bit[k] of the value.

The coefficients 0 and 1 are manipulated using the rules of Boolean arithmetic:

- $0 + 0 = 1 + 1 = 0$
- $0 + 1 = 1 + 0 = 1$
- $0 \times 0 = 0 \times 1 = 1 \times 0 = 0$
- $1 \times 1 = 1$.

That is:

- Adding two polynomials over {0, 1} is the same as a bitwise exclusive OR.
- Multiplying two polynomials over {0, 1} is the same as integer multiplication except that partial products are exclusive-ORed instead of being added.

A64, A32 and T32 provide instructions for performing polynomial multiplication of 8-bit values. For AArch32, see [VMUL, VMULL \(integer and polynomial\) on page F8-3236](#). For AArch64 see [PMUL on page C6-1095](#) and [PMULL, PMULL2 on page C6-1096](#).

The Cryptographic Extension adds the ability to perform long polynomial multiplies of 64-bit values. See [PMULL, PMULL2 on page C6-1096](#).

Pseudocode details of polynomial multiplication

In pseudocode, polynomial addition is described by the EOR operation on bitstrings.

Polynomial multiplication is described by the PolynomialMult() function:

```
// PolynomialMult()
// =====

bits(M+N) PolynomialMult(bits(M) op1, bits(N) op2)
    result = Zeros(M+N);
    extended_op2 = ZeroExtend(op2, M+N);
    for i=0 to M-1
        if op1<i> == '1' then
            result = result EOR LSL(extended_op2, i);
    return result;
```

A1.5 Floating-point and Advanced SIMD support

Note

In AArch32 state, the SIMD instructions that operate on SIMD and floating-point registers are always described as the Advanced SIMD instructions, to distinguish them from the SIMD instructions in the base instruction sets, that operate on the 32-bit general-purpose registers. The A64 instruction set does not provide any SIMD instructions that operate on the general-purpose registers, and therefore some AArch64 state descriptions use SIMD as a synonym for Advanced SIMD. Unless the context clearly indicates otherwise, this section describes the support for SIMD instructions that operate on SIMD and floating-point registers.

ARMv8 can support the following levels of support for floating-point and Advanced SIMD instructions:

- Full floating-point and SIMD support without exception trapping.
- Full floating-point and SIMD support with exception trapping.
- No floating-point or SIMD support. This option is licensed only for implementations targeting specialised markets.

Note

All systems that support standard operating systems with rich application environments provide hardware support for floating-point and Advanced SIMD. It is a requirement of the ARM Procedure Call Standard for AArch64, see *Procedure Call Standard for the ARM 64-bit Architecture*.

ARMv8 supports single-precision (32-bit) and double-precision (64-bit) floating-point data types and arithmetic as defined by the IEEE 754 floating-point standard. It also supports the half-precision (16-bit) floating-point data type for data storage only, by supporting conversions between single-precision and half-precision data types and double-precision and half-precision data types.

The SIMD instructions provide packed *Single Instruction Multiple Data (SIMD)* and single-element scalar operations, and support:

- Single-precision and double-precision arithmetic in AArch64 state.
- Single-precision arithmetic only in AArch32 state.

Floating-point support in AArch64 state SIMD is IEEE 754-2008 compliant with:

- Configurable rounding modes.
- Configurable Default NaN behavior.
- Configurable Flush-to-zero behavior.

Floating-point computation using AArch32 Advanced SIMD instructions remains unchanged from ARMv7. A32 and T32 Advanced SIMD floating-point always uses ARM standard floating-point arithmetic and performs IEEE 754 floating-point arithmetic with the following restrictions:

- Denormalized numbers are flushed to zero, see [Flush-to-zero on page A1-49](#).
- Only default NaNs are supported, see [NaN handling and the Default NaN on page A1-50](#).
- The Round to Nearest rounding mode is used.
- Untrapped exception handling is used for all floating-point exceptions.

ARMv8 introduces new instructions for AArch32 state:

- Floating-point selection, see [VSEL on page F8-3336](#).
- Floating-point maximum and minimum numbers, see [VMAXNM, VMINNM on page F8-3206](#).
- Floating-point integer conversions with directed rounding modes, see [VCVTA, VCVTN, VCVTP, VCVTM \(between floating-point and integer, Advanced SIMD\) on page F8-3152](#) and [VCVTA, VCVTN, VCVTP, VCVTM \(between floating-point and integer, floating-point\) on page F8-3154](#).

- Floating-point round to integral floating-point, see [VRINTA](#), [VRINTN](#), [VRINTP](#), [VRINTM](#) (*Advanced SIMD*) on page F8-3310, [VRINTA](#), [VRINTN](#), [VRINTP](#), [VRINTM](#) (*floating-point*) on page F8-3312, [VRINTX](#) (*Advanced SIMD*) on page F8-3314, [VRINTX](#) (*floating-point*) on page F8-3316, [VRINTZ](#) (*Advanced SIMD*) on page F8-3318 and [VRINTZ](#), [VRINTR](#) (*floating-point*) on page F8-3320.
- Floating-point conversions between half-precision and double-precision, see [VCVTB](#), [VCVTT](#) on page F8-3156.

If trapping is supported, Floating-point exceptions, such as overflow or division by zero, can be handled without trapping. This applies to both floating-point and SIMD operations. When handled in this way, a Floating-point exception causes a cumulative status register bit to be set to 1 and a default result to be produced by the operation. For more information about Floating-point exceptions, see [Supported data types](#) on page A1-36.

In AArch64 state, the following registers control floating-point operation and return floating-point status information:

- The Floating-Point Control Register, [FPCR](#), controls:
 - The half-precision format where applicable, [FPCR.AHP](#) bit.
 - Default NaN behavior, [FPCR.DN](#) bit.
 - Flush to zero behavior, [FPCR.FZ](#) bit.
 - Rounding mode support, [FPCR.Rmode](#) field.
 - Optional LEN and STRIDE fields associated with AArch32 execution, only supported for a context save and restore in AArch64. These fields are obsolete in ARMv8 and are either RAZ/WI or, when nonzero, cause an UNDEFINED instruction trap when an affected AArch32 instruction is executed.
 - Optional exception trap controls, the [FPCR.{IDE, IXE, UFE, OFE, DZE, IOE}](#) bits, see [Floating-point Exception traps](#) on page D1-1454.
- The Floating-Point Status Register, [FPSR](#), provides:
 - Cumulative flags, [FPSR.{IDC, IXC, UFC, OFC, DZC, IOC and QC}](#).
 - The AArch32 floating-point comparison flags {N,Z,C,V}. These bits are RES0 if AArch32 floating-point is not supported.

———— **Note** —————

In AArch64, the process state flags, [PSTATE.{N,Z,C,V}](#) are used for all data processing compares and any associated conditional execution.

AArch32 state provides a single Floating-Point Status and Control Register, [FPSCR](#), combining the [FPCR](#) and [FPSR](#) fields.

For system level information about the SIMD and floating-point support, see [Advanced SIMD and floating-point support](#) on page G1-3494.

A1.5.1 Instruction support

The floating-point and SIMD support includes the following types of instructions:

- Load and store for single elements and vectors of multiple elements.

———— **Note** —————

Single elements are also referred to as scalar elements.

- Data processing on single and multiple elements for both integer and floating-point data types.
- Floating-point conversion:
 - Half-precision, single-precision, and double-precision conversions.
 - Single-precision, double-precision, and fixed point integer conversions.
 - Single-precision, double-precision, and integer conversions.

- Floating-point rounding.

For more information on the floating-point and SIMD instructions in AArch64 state, see [Chapter C2 A64 Instruction Set Overview](#).

For more information on the floating-point and Advanced SIMD instructions in AArch32 state, see [Chapter F5 T32 and A32 Instruction Sets Advanced SIMD and floating-point Encodings](#)

A1.5.2 Floating-point standards, and terminology

The ARM includes support for all the required features of ANSI/IEEE Std 754-2008, *IEEE Standard for Binary Floating-Point Arithmetic*, referred to as IEEE 754-2008. However, some terms in this manual are based on the 1985 version of this standard, referred to as IEEE 754-1985:

- ARM floating-point terminology generally uses the IEEE 754-1985 terms. This section summarizes how IEEE 754-2008 changes these terms.
- References to IEEE 754 that do not include the issue year apply to either issue of the standard.

[Table A1-3](#) shows how the terminology in this manual differs from that used in IEEE 754-2008.

Table A1-3 Floating-point terminology

This manual	IEEE 754-2008
Normalized ^a	Normal
Denormal, or denormalized	Subnormal
Round towards Minus Infinity (RM)	roundTowardsNegative
Round towards Plus Infinity (RP)	roundTowardsPositive
Round towards Zero (RZ)	roundTowardZero
Round to Nearest (RN)	roundTiesToEven
Round to Nearest with Ties to Away	roundTiesToAway
Rounding mode	Rounding-direction attribute

- a. *Normalized number* is used in preference to *normal number*, because of the other specific uses of *normal* in this manual.

A1.5.3 ARM standard floating-point input and output values

ARMv8 provides full IEEE 754 floating-point arithmetic support. In AArch32, floating-point operations performed using Advanced SIMD instructions are limited to *ARM standard floating-point operation*, regardless of the selected rounding mode in the [FPSCR](#). Unlike AArch32, AArch64 SIMD floating point arithmetic is performed using the rounding mode selected by the [FPCR](#).

ARM standard floating-point arithmetic supports the following input formats defined by the IEEE 754 floating-point standard:

- Zeros.
- Normalized numbers.
- Denormalized numbers are flushed to 0 before floating-point operations, see [Flush-to-zero on page A1-49](#).
- NaNs.
- Infinities.

ARM standard floating-point arithmetic supports the Round to Nearest rounding mode defined by the IEEE 754 standard.

ARM standard floating-point arithmetic supports the following output result formats defined by the IEEE 754 standard:

- Zeros.
- Normalized numbers.
- Results that are less than the minimum normalized number are flushed to zero, see *Flush-to-zero*.
- NaNs produced in floating-point operations are always the default NaN, see *NaN handling and the Default NaN on page A1-50*.
- Infinities.

A1.5.4 Flush-to-zero

The performance of floating-point processing can be reduced when doing calculations involving denormalized numbers and Underflow exceptions. In many algorithms, this performance can be recovered, without significantly affecting the accuracy of the final result, by replacing the denormalized operands and intermediate results with zeros. To permit this optimization, ARM floating-point implementations have a special processing mode called *Flush-to-zero* mode. AArch32 Advanced SIMD floating-point instructions always use Flush-to-zero mode.

Behavior in Flush-to-zero mode differs from normal IEEE 754 arithmetic in the following ways:

- All inputs to floating-point operations that are double-precision denormalized numbers or single-precision denormalized numbers are treated as though they were zero. This causes an Input Denormal exception, but does not cause an Inexact exception. The Input Denormal exception occurs only in Flush-to-zero mode.
In AArch32, the **FPSR** contains a cumulative exception bit **FPSR.IDC** and optional trap enable bit **FPSR.IDE** corresponding to Input Denormal exception.
In AArch64 the **FPSR** contains a cumulative exception bit **FPSR.IDC** and optional trap enable bit **FPCR.IDE** corresponding to the Input Denormal exception.
The occurrence of all exceptions except Input Denormal is determined using the input values after flush-to-zero processing has occurred.
- The result of a floating-point operation is flushed to zero if the result of the operation before rounding satisfies the condition:
 $0 < \text{Abs}(\text{result}) < \text{MinNorm}$, where:
 - **MinNorm** is 2^{-126} for single-precision
 - **MinNorm** is 2^{-1022} for double-precision.This causes the **FPSR.UFC** bit to be set to 1, and prevents any Inexact exception from occurring for the operation.
Underflow exceptions occur only when a result is flushed to zero.
In all implementations Underflow exceptions that occur in Flush-to-zero mode are always treated as untrapped, even when the Underflow trap enable bit, **FPCR.UFE**, is set to 1.
- An Inexact exception does not occur if the result is flushed to zero, even though the final result of zero is not equivalent to the value that would be produced if the operation were performed with unbounded precision and exponent range.

When an input or a result is flushed to zero the value of the sign bit of the zero is preserved. That is, the sign bit of the zero matches the sign bit of the input or result that is being flushed to zero.

Flush-to-zero mode has no effect on half-precision numbers that are inputs to floating-point operations, or results from floating-point operations.

Note

Flush-to-zero mode is incompatible with the IEEE 754 standard, and must not be used when IEEE 754 compatibility is a requirement. Flush-to-zero mode must be used with care. Although it can improve performance on some algorithms, there are significant limitations on its use. These are application dependent:

- On many algorithms, it has no noticeable effect, because the algorithm does not normally use denormalized numbers.
 - On other algorithms, it can cause exceptions to occur or seriously reduce the accuracy of the results of the algorithm.
-

A1.5.5 NaN handling and the Default NaN

The IEEE 754 standard specifies that:

- an operation that produces an Invalid Operation floating-point exception generates a quiet NaN as its result if that exception is untrapped
- an operation involving a quiet NaN operand, but not a signaling NaN operand, returns an input NaN as its result.

The floating-point processing behavior when Default NaN mode is disabled adheres to this, with the following additions:

- If an untrapped Invalid Operation floating-point exception is produced, the quiet NaN result is derived from:
 - the first signaling NaN operand, if the exception was produced because at least one of the operands is a signaling NaN
 - otherwise, the default NaN
- If an untrapped Invalid Operation floating-point exception is not produced, but at least one of the operands is a quiet NaN, the result is derived from the first quiet NaN operand.

Depending on the operation, the exact value of a derived quiet NaN result may differ in both sign and number of fraction bits from its source. For a quiet NaN result derived from signaling NaN operand, the most-significant fraction bit is set to 1.

Note

- In these descriptions, *first operand* relates to the left-to-right ordering of the arguments to the pseudocode function that describes the operation.
 - The IEEE 754 standard specifies that the sign bit of a NaN has no significance.
-

The floating-point and SIMD processing behavior when Default NaN mode is enabled is that the Default NaN is the result of all floating-point operations that either:

- generate untrapped Invalid Operation floating-point exceptions
- have one or more quiet NaN inputs, but no signaling NaN inputs.

[Table A1-4 on page A1-51](#) shows the format of the default NaN for ARM floating-point operations.

Default NaN mode is selected for the floating-point processing by setting the FPCR.DN bit to 1.

Other aspects of the functionality of the Invalid Operation exception are not affected by Default NaN mode. These are that:

- If untrapped, it causes the FPSR.IOC bit be set to 1.
- If trapped, it causes a user trap handler to be invoked.

Table A1-4 Default NaN encoding

	Half-precision, IEEE Format	Single-precision	Double-precision
Sign bit	0	0	0
Exponent	0x1F	0xFF	0x7FF
Fraction	Bit[9] == 1, bits[8:0] == 0	bit[22] == 1, bits[21:0] == 0	bit[51] == 1, bits[50:0] == 0

A1.6 Cryptographic Extension

The presence of this extension in an implementation is subject to export license controls. The Cryptographic Extension is an extension of the SIMD support and operates on the vector register file. It provides instructions for the acceleration of encryption and decryption to support the following:

- AES
- SHA1
- SHA2-256

Large polynomial multiplies are included as part of the Cryptographic Extension, see [PMULL](#), [PMULL2](#) on [page C6-1096](#).

A1.7 The ARM memory model

The ARM memory model supports:

- Generating an exception on an unaligned memory access.
- Restricting access by applications to specified areas of memory.
- Translating virtual addresses provided by executing instructions into physical addresses.
- Altering the interpretation of multi-byte data between big-endian and little-endian.
- Controlling the order of accesses to memory.
- Controlling caches and address translation structures.
- Synchronizing access to shared memory by multiple PEs.

Virtual address (VA) support depends on the Execution state, as follows:

AArch64 state

Supports 64-bit virtual addressing, with the Translation Control Register determining the supported VA range. Execution at EL1 and EL0 supports two independent VA ranges, each with its own translation controls.

AArch32 state

Supports 32-bit virtual addressing, with the Translation Control Register determining the supported VA range. For execution at EL1 and EL0, system software can split the VA range into two subranges, each with its own translation controls.

The supported physical address space is IMPLEMENTATION DEFINED, and can be discovered by system software.

Regardless of the Execution state, the *Virtual Memory System Architecture* (VMSA) can translate VAs to blocks or pages of memory anywhere within the supported physical address space.

For more information, see:

For execution in AArch64 state

- [Chapter B2 The AArch64 Application Level Memory Model.](#)
- [Chapter D4 The AArch64 System Level Memory Model.](#)
- [Chapter D5 The AArch64 Virtual Memory System Architecture.](#)

For execution in AArch32 state

- [Chapter E2 The AArch32 Application Level Memory Model.](#)
- [Chapter G2 The AArch32 System Level Memory Model.](#)
- [Chapter G3 The AArch32 Virtual Memory System Architecture.](#)

Part B

The AArch64 Application Level Architecture

Chapter B1

The AArch64 Application Level Programmers' Model

This chapter gives an application level view of the ARM programmers' model. It contains the following sections:

- *About the Application level programmers' model* on page B1-58.
- *Registers in AArch64 Execution state* on page B1-59.
- *Software control features and ELO* on page B1-65.

B1.1 About the Application level programmers' model

This chapter contains the programmers' model information required for application development.

The information in this chapter is distinct from the system information required to service and support application execution under an operating system, or higher level of system software. However, some knowledge of the system information is needed to put the Application level programmers' model into context.

Depending on the implementation choices, the architecture supports multiple levels of execution privilege, indicated by different *Exception levels* that number upwards from EL0 to EL3. EL0 corresponds to the lowest privilege level and is often described as unprivileged. The Application level programmers' model is the programmers' model for software executing at EL0. For more information see [Exception levels on page D1-1408](#).

System software determines the Exception level, and therefore the level of privilege, at which software runs. When an operating system supports execution at both EL1 and EL0, an application usually runs unprivileged at EL0. This:

- Permits the operating system to allocate system resources to an application in a unique or shared manner.
- Provides a degree of protection from other processes, and so helps protect the operating system from malfunctioning software.

This chapter indicates where some system level understanding is necessary, and where relevant it gives a reference to the system level description.

Execution at any Exception level above EL0 is often referred to as privileged execution.

For more information on the system level view of the architecture refer to [Chapter D1 The AArch64 System Level Programmers' Model](#).

B1.2 Registers in AArch64 Execution state

This section describes the registers and process state visible at EL0 when executing in the AArch64 state. It includes the following:

- [Registers in AArch64 state](#)
- [Process state, PSTATE on page B1-63](#)
- [System registers on page B1-63](#)

B1.2.1 Registers in AArch64 state

In the AArch64 application level view, an ARM Processing element has:

R0-R30 31 general-purpose registers, R0 to R30. Each register can be accessed as:

- A 64-bit general-purpose register named X0 to X30.
- A 32-bit general-purpose register named W0 to W30.

See the register name mapping in [Figure B1-1](#).

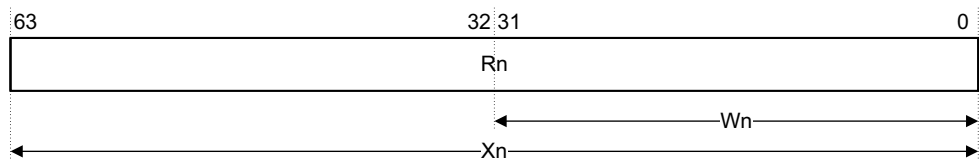

Figure B1-1 General-purpose register naming

The X30 general-purpose register is used as the procedure call link register.

———— **Note** ————

In instruction encodings, the value 0b11111 (31) is used to indicate the ZR (zero register). This indicates that the argument takes the value zero, but does not indicate that the ZR is implemented as a physical register.

SP A 64-bit dedicated Stack Pointer register. The least significant 32-bits of the stack-pointer can be accessed via the register name WSP.

The use of SP as an operand in an instruction, indicates the use of the current stack pointer.

———— **Note** ————

Stack pointer alignment to a 16-byte boundary is configurable at EL1. For more information see the *Procedure Call Standard for the ARM 64-bit Architecture*.

PC A 64-bit Program Counter holding the address of the current instruction.

Software cannot write directly to the PC. It can only be updated on a branch, exception entry or exception return.

———— **Note** ————

Attempting to execute an A64 instruction that is not word-aligned generates an Alignment fault, see [PC alignment checking on page D1-1423](#).

V0-V31 32 SIMD and floating-point registers, V0 to V31. Each register can be accessed as:

- A 128-bit register named Q0 to Q31.
- A 64-bit register named D0 to D31.
- A 32-bit register named S0 to S31.
- A 16-bit register named H0 to H31.
- An 8-bit register named B0 to B31.

- A 128-bit vector of elements.
- A 64-bit vector of elements.

Where the number of bits described by a register name does not occupy an entire SIMD and floating-point register, it refers to the least significant bits. See [Figure B1-2](#).

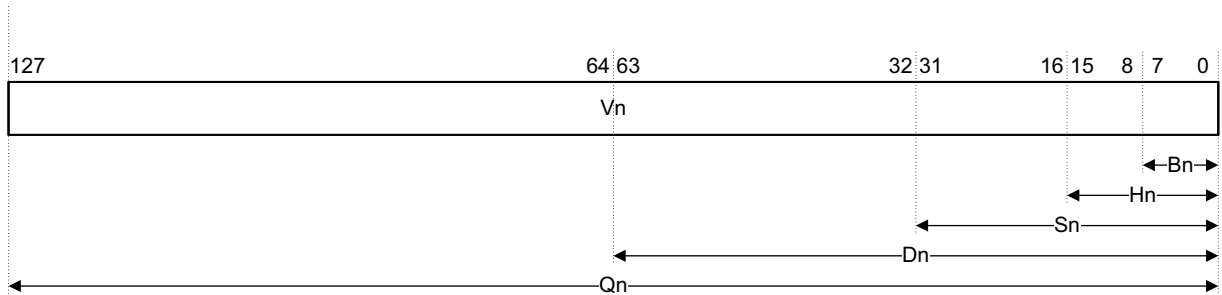

Figure B1-2 SIMD and floating-point register naming

For more information about data types and vector formats, see [Supported data types on page A1-36](#).

FPCR, FPSR Two SIMD and floating-point control and status registers, [FPCR](#) and [FPSR](#).

See [Registers for instruction processing and exception handling on page D1-1416](#) for more information on the registers.

Pseudocode details of registers in AArch64 state

In the pseudocode functions that access registers:

- The assignment form is used for register writes.
- The non-assignment for register reads.

The uses of the X[] function are:

- Reading or writing X0-X30, using n to index the required register.
- Reading the zero register ZR, accessed as X[31].

———— **Note** ————

The pseudocode use of X[31] to represent the zero register does not indicate that hardware must implement this register.

```
// X[] - assignment form
// =====
// Write to general-purpose register from either a 32-bit and 64-bit value.
```

```
X[integer n] = bits(width) value
    assert n >= 0 && n <= 31;
    assert width IN {32,64};
    if n != 31 then
        _R[n] = ZeroExtend(value);
    return;
```

```
// X[] - non-assignment form
```

```
// =====  
// Read from general-purpose register with implicit slice of 8, 16, 32 or 64 bits.
```

```
bits(width) X[integer n]  
    assert n >= 0 && n <= 31;  
    assert width IN {8,16,32,64};  
    if n != 31 then  
        return _R[n]<width-1:0>;  
    else  
        return Zeros(width);
```

The `_R[]` function provides a view of the physical array of the physical general-purpose registers.

```
array bits(64) _R[0..30];
```

The use of the `SP[]` function is reading or writing the current SP. This function has prototypes:

```
SP[] = bits(width) value;
```

```
bits(width) SP[];
```

The use of the `PC[]` function is reading the PC. This function has prototype:

```
bits(64) PC[];
```

The `_V[]` function provides a view of the physical array of the physical SIMD and floating-point registers.

```
array bits(128) _V[0..31];
```

The use of the `V[]` function is reading or writing V0-V31, using `n` to index the required register.

```
// V[] - assignment form
```

```
// =====
```

```
// Write to SIMD&FP register with implicit extension from
```

```
// 8, 16, 32, 64 or 128 bits.
```

```
V[integer n] = bits(width) value
```

```
    assert n >= 0 && n <= 31;
```

```
    assert width IN {8,16,32,64,128};
```

```
    _V[n] = ZeroExtend(value);
```

```
    return;
```

```
// V[] - non-assignment form
```

```
// =====
```

```
// Read from SIMD&FP register with implicit slice of 8, 16
```

```
// 32, 64 or 128 bits.
```

```
bits(width) V[integer n]
```

```
    assert n >= 0 && n <= 31;
    assert width IN {8,16,32,64,128};
    return _V[n]<width-1:0>;
```

The use of the `Vpart[]` function is reading or writing the lower or upper half of `V0-V31`, using `n` to index the required register, and `part` to indicate the required half.

```
// Vpart[] - non-assignment form
// =====
// Read lower half of a SIMD&FP register with implicit slice
// of 8, 16, 32 or 64 bits, or read upper half as 64 bits.
```

`bits(width) Vpart[integer n, integer part]`

```
    assert n >= 0 && n <= 31;
    assert part IN {0, 1};
    if part == 0 then
        assert width IN {8,16,32,64};
        return _V[n]<width-1:0>;
    else
        assert width == 64;
        return _V[n]<127:64>;
```

```
// Vpart[] - assignment form
// =====
// Write lower half of a SIMD&FP register with implicit extension
// from 8, 16, 32, or 64 bits, or write upper half from 64 bits.
```

`Vpart[integer n, integer part] = bits(width) value`

```
    assert n >= 0 && n <= 31;
    assert part IN {0, 1};
    if part == 0 then
        assert width IN {8,16,32,64};
        _V[n] = ZeroExtend(value);
    else
        assert width == 64;
        _V[n]<127:64> = value<63:0>;
```

B1.2.2 Process state, PSTATE

For AArch64, PSTATE holds process state related information. The following PSTATE information is accessible at EL0

The Data processing flags

- | | |
|----------|--|
| N | Negative condition flag. If the result is regarded as a two's complement signed integer, then the PE sets N to 1 if the result is negative, and sets N to 0 if it is positive or zero. |
| Z | Zero condition flag. Set to 1 if the result of the instruction is zero, and to 0 otherwise. A result of zero often indicates an equal result from a comparison. |
| C | Carry condition flag. Set to 1 if the instruction results in a carry condition, for example an unsigned overflow that is the result of an addition. |
| V | Overflow condition flag. Set to 1 if the instruction results in an overflow condition, for example a signed overflow that is the result of an addition. |

The Exception masking bits

- | | |
|----------|--|
| D | Debug exception mask bit. When EL0 is enabled to modify the mask bits, this bit is visible and can be modified. However, this bit is architecturally ignored at EL0. |
| A | System error mask bit, referred to as an external asynchronous abort bit in the earlier versions of the architecture. |
| I | IRQ mask bit. |
| F | FIQ mask bit. |

The possible values of each bit are:

- | | |
|----------|----------------------|
| 0 | Exception not masked |
| 1 | Exception masked |

See *Process state, PSTATE* on page D1-1421 for the system level view of PSTATE.

B1.2.3 System registers

System registers provide support for execution control, status and general system configuration. The majority of the System registers are not accessible at EL0.

However, some system registers can be configured to allow access from software executing at EL0. Any access from EL0 to a system register with the access right disabled causes the instruction to behave as an UNDEFINED instruction. The registers that can be accessed from EL0 are:

Cache ID registers The [CTR_EL0](#) and [DCZID_EL0](#) registers provide implementation parameters for EL0 cache management support.

Debug registers A debug communications channel is supported by the [MDCCSR_EL0](#), [DBGDTR_EL0](#), [DBGDTRRX_EL0](#) and [DBGDTRTX_EL0](#) registers.

Performance Monitors registers

See *Performance Monitors support* on page B1-64.

Thread registers The [TPIDR_EL0](#) and [TPIDRRO_EL0](#) registers are two thread ID registers with different access rights.

Timer registers In ARMv8 the following operations are performed:

- Read access to the system counter clock frequency using [CNTFRQ_EL0](#).
- Physical and virtual timer count registers, [CNTPCT_EL0](#) and [CNTVCT_EL0](#).
- Physical up-count comparison, down-count value and timer control registers, [CNTP_CVAL_EL0](#), [CNTP_TVAL_EL0](#), and [CNTP_CTL_EL0](#).
- Virtual up-count comparison, down-count value and timer control registers, [CNTV_CVAL_EL0](#), [CNTV_TVAL_EL0](#), and [CNTV_CTL_EL0](#).

Performance Monitors support

The ARMv8 architecture defines optional Performance Monitors.

The basic form of the Performance Monitors is:

- A 64-bit cycle counter.
- Up to a maximum of 32 IMPLEMENTATION DEFINED event counters, where the number is identified by the [PMCR_ELO.N](#) field.
- System register access to the cycle counter and event registers, and related controls for:
 - Enabling and resetting counters.
 - Flagging overflows.
 - Generating interrupts on overflow.

Software can enable the cycle counter independently of the event counters.

Software executing at EL1 or a higher Exception level, for example an operating system, can enable access to the counters from EL0. This allows an application to monitor its own performance with fine grain control without requiring operating system support. For example, an application might implement per-function performance monitoring.

For details on the features, configuration and control of the Performance Monitors, see [Chapter D6 The Performance Monitors Extension](#).

EL0 access to Performance Monitors

To allow application code to make use of the Performance Monitors, software executing at a higher Exception level must set the following bits in the [PMUSERENR_ELO](#) system register:

- | | |
|-----------|---|
| EN | When set to 1, access to all Performance Monitors registers is allowed at EL0, except for writes to PMUSERENR_ELO , and reads/writes of PMINTENSET_EL1 and PMINTENCLR_EL1 . |
| ER | When set to 1, read access to event counters is allowed at EL0. This includes read/write access to PMSELR_ELO , so that the event counter to read through PMXEVCNTR_ELO can be set. |
| CR | When set to 1, read access to PMCCNTR_ELO is allowed at EL0. |
| SW | When set to 1, write access to PMSWINC_ELO is allowed at EL0. |

———— **Note** —————

Register [PMUSERENR_ELO](#) is always read-only at EL0.

B1.3 Software control features and EL0

The following sections describe the EL0 view of the ARMv8 software control features:

- [Exception handling](#)
- [Wait for Interrupt and Wait for Event](#)
- [The YIELD instruction](#)
- [Application level cache management](#)
- [Debug events on page B1-66](#)

B1.3.1 Exception handling

In the ARM architecture, an *exception* causes a change of program flow. Execution of an exception handler starts, at an Exception level higher than EL0, from a defined vector that relates to the exception taken.

Exceptions include:

- Interrupts.
- Memory system aborts.
- Undefined instructions.
- System calls.
- Secure monitor or Hypervisor traps.

Most details of exception handling are not visible to application level software, and are described in [Chapter D1 The AArch64 System Level Programmers' Model](#).

The SVC instruction causes a Supervisor Call exception. This provides a mechanism for unprivileged software to make a system call to an operating system.

B1.3.2 Wait for Interrupt and Wait for Event

Issuing a WFI instruction indicates that no further execution is required until a WFI wake-up event occurs, see [Wait For Interrupt on page D1-1536](#). This permits entry to a low-power state.

Issuing a WFE instruction indicates that no further execution is required until a WFE wake-up event occurs, see [Wait for Event mechanism and Send event on page D1-1533](#). This permits entry to a low-power state.

B1.3.3 The YIELD instruction

The YIELD instruction provides a hint that the task performed by a thread is of low importance so that it could yield, see [YIELD on page C5-773](#). This mechanism can be used to improve overall performance in an *Symmetric Multi-Threading* (SMT) or *Symmetric Multi-Processing* (SMP) system.

Examples of when the YIELD instruction might be used include a thread that is sitting in a spin-lock, or where the arbitration priority of the snoop but in an SMP system is modified. The YIELD instruction permits binary compatibility between SMT and SMP systems.

The YIELD instruction is a NOP (No Operation) hint instruction.

The YIELD instruction has no effect in a single-threaded system, but developers of such systems can use the instruction to flag its intended use for future migration to a multiprocessor or multithreading system. Operating systems can use YIELD in places where a yield hint is wanted, knowing that it will be treated as a NOP if there is no implementation benefit.

B1.3.4 Application level cache management

A small number of cache management instructions can be enabled at EL0 from higher levels of privilege using the [SCTLR_ELI](#) system register. Any access from EL0 to an operation with the access right disabled causes the instruction to behave as an UNDEFINED instruction.

About the available operations, see [Application level cache instructions on page B2-72](#).

B1.3.5 Debug events

The debug logic is responsible for generating debug events. Most aspects of debug events are not visible to application level software, and are described in [Chapter H1 Introduction to External Debug](#). Aspects that are visible to application level software include:

- The BKPT instruction, which causes a BKPT instruction debug event to occur.
- The DBG instruction, which provides a hint to the debug system.
- The HLT instruction, which causes entry to Debug state.

Chapter B2

The AArch64 Application Level Memory Model

This chapter gives an application level view of the memory model. It contains the following sections:

- *Address space* on page B2-68.
- *Memory type overview* on page B2-69.
- *Caches and memory hierarchy* on page B2-70.
- *Alignment support* on page B2-75.
- *Endian support* on page B2-76.
- *Atomicity in the ARM architecture* on page B2-79.
- *Memory ordering* on page B2-82.
- *Memory types and attributes* on page B2-89.
- *Mismatched memory attributes* on page B2-98.
- *Synchronization and semaphores* on page B2-100.

Note

In this chapter, system register names usually link to the description of the register in [Chapter D8 AArch64 System Register Descriptions](#), for example [SCTLR_EL1](#).

B2.1 Address space

Address calculations are performed using 64-bit registers. However, supervisory software can configure the top eight address bits for use as a tag, as described in [Address tagging in AArch64 state on page D5-1708](#). If this is done, address bits[63:56]:

- Are not considered when determining whether the address is valid.
- Are never propagated to the program counter.

Supervisory software determines the valid address range. Attempting to access an address that is not valid generates an MMU fault.

Address calculations are performed modulo 2^{64} .

The result of an address calculation is UNKNOWN if it overflows or underflows:

- The 64-bit address range A[63:0], where tagged addressing is not used.
- The 56-bit address range A[55:0], where tagged addressing is used.

Memory accesses use the Mem[] function.

The Mem[] function makes an access of the required type. If supervisory software configures the top eight address bits for use as a tag, the top eight address bits are ignored.

```
bits(size*8) Mem[bits(64) address, integer size, AccType acctype]
```

```
    assert size IN {1, 2, 4, 8, 16};
```

```
Mem[bits(64) address, integer size, AccType acctype] = bits(size*8) value;
```

The AccType enumeration defines the different access types:

```
enumeration AccType {AccType_NORMAL, AccType_VEC,          // Normal loads and stores
                    AccType_STREAM, AccType_VECSTREAM,    // Streaming loads and stores
                    AccType_ATOMIC,                       // Atomic loads and stores
                    AccType_ORDERED,                     // Load-Acquire and Store-Release
                    AccType_UNPRIV,                      // Load and store unprivileged
                    AccType_IFETCH,                      // Instruction fetch
                    AccType_PTW,                         // Page table walk
                    // Other operations
                    AccType_DC,                          // Data cache maintenance
                    AccType_IC,                          // Instruction cache maintenance
                    AccType_AT};                         // Address translation
```

Note

- [Chapter D4 The AArch64 System Level Memory Model](#) and [Chapter D5 The AArch64 Virtual Memory System Architecture](#) include descriptions of memory system features that are transparent to the application, including memory access, address translation, memory maintenance instructions, and alignment checking and the associated fault handling. These chapters also include pseudocode descriptions of these operations.
- For information on the pseudocode that relates to memory accesses, see [Basic memory access on page D4-1698](#), [Unaligned memory access on page D4-1699](#), and [Aligned memory access on page D4-1698](#).

B2.2 Memory type overview

ARMv8 provides the following mutually-exclusive memory types:

- Normal** This is generally used for bulk memory operations, both read-write and read-only operations.
- Device** The ARM architecture forbids speculative reads of any type of Device memory. This means Device memory types are suitable attributes for read-sensitive locations.
- Locations of the memory map that are assigned to peripherals are usually assigned the Device memory attribute.
- Device memory has additional attributes that have the following effects:
- They prevent aggregation of reads and writes, maintaining the number and size of the specified memory accesses. See [Gathering on page B2-94](#).
 - They preserve the access order and synchronization requirements, both for accesses to a single peripheral and where there is a synchronization requirement on the observability of one or more memory write and read accesses. See [Reordering on page B2-95](#)
 - They indicate whether a write can be acknowledged other than at the end point. See [Early Write Acknowledgement on page B2-96](#).

For more information on Normal memory and Device memory, see [Memory types and attributes on page B2-89](#).

———— **Note** —————

Earlier versions of the ARM architecture defined a single Device memory type and a Strongly-Ordered memory type. A *Note* in [Device memory on page B2-92](#) describes how these memory types map onto the ARMv8 memory types.

—————

B2.3 Caches and memory hierarchy

The implementation of a memory system depends heavily on the microarchitecture and therefore many details of the memory system are IMPLEMENTATION DEFINED. ARMv8 defines the application level interface to the memory system, including a hierarchical memory system with multiple levels of cache. This section describes an application level view of this system. It contains the subsections:

- [Introduction to caches.](#)
- [Memory hierarchy.](#)
- [Application level cache instructions on page B2-72](#)
- [Implication of caches for the application programmer on page B2-72.](#)
- [Preloading caches on page B2-73.](#)

B2.3.1 Introduction to caches

A cache is a block of high-speed memory that contains a number of entries, each consisting of:

- Main memory address information, commonly known as a *tag*.
- The associated data.

Caches increase the average speed of a memory access. Caching takes account of two principles of locality:

Spatial locality

An access to one location is likely to be followed by accesses to adjacent locations. Examples of this principle are:

- Sequential instruction execution.
- Accessing a data structure.

Temporal locality

An access to an area of memory is likely to be repeated in a short time period. An example of this principle is the execution of a software loop.

To minimize the quantity of control information stored, the spatial locality property groups several locations together under the same tag. This logical block is commonly known as a *cache line*. When data is loaded into a cache, access times for subsequent loads and stores are reduced, resulting in overall performance benefits. An access to information already in a cache is known as a *cache hit*, and other accesses are called *cache misses*.

Normally, caches are self-managing, with the updates occurring automatically. Whenever the PE accesses a cacheable memory location, the cache is checked. If the access is a cache hit, the access occurs in the cache. Otherwise, the access is made to memory. Typically, when making this access, a cache location is allocated and the cache line loaded from memory. ARMv8 permits different cache topologies and access policies, provided they comply with the memory coherency model described in this manual.

Caches introduce a number of potential problems, mainly because:

- Memory accesses can occur at times other than when the programmer would expect them.
- A data item can be held in multiple physical locations.

B2.3.2 Memory hierarchy

Typically memory close to a PE has very low latency, but is limited in size and expensive to implement. Further from the PE it is common to implement larger blocks of memory but these have increased latency. To optimize overall performance, an ARMv8 memory system can include multiple levels of cache in a hierarchical memory system that exploits this trade-off between size and latency. [Figure B2-1 on page B2-71](#) shows an example of such a system in an ARMv8-A system that supports virtual addressing.

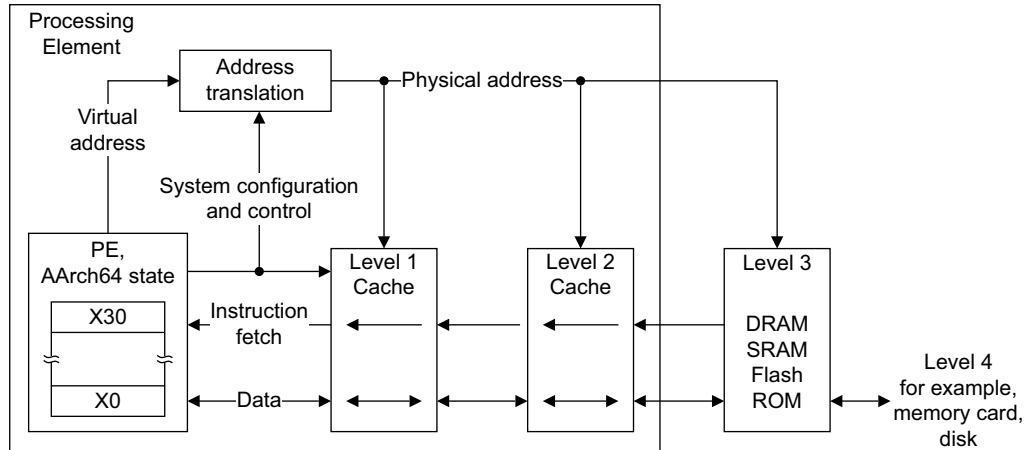

Figure B2-1 Multiple levels of cache in a memory hierarchy

Note

In this manual, in a hierarchical memory system, Level 1 refers to the level closest to the Processing Element, as shown in [Figure B2-1](#).

Instructions and data can be held in separate caches or in a unified cache. A cache hierarchy can have one or more levels of separate instruction and data caches, with one or more unified caches located at the levels closest to the main memory. Memory coherency for cache topologies can be defined by two conceptual points:

Point of Unification (PoU)

The point at which the instruction cache, data cache, and translation table walks of a particular PE are guaranteed to see the same copy of a memory location. In many cases, the point of unification is the point in a uniprocessor memory system by which the instruction and data caches and the translation table walks have merged. The point of unification might coincide with the point of coherency.

Point of Coherency (PoC)

The point at which all agents that can access memory are guaranteed to see the same copy of a memory location. In many cases this is effectively the main system memory, although the architecture does not prohibit the implementation of caches beyond the PoC that have no effect on the coherency between memory system agents.

See also [Cache maintenance operations](#) on page D4-1680.

The cacheability and shareability memory attributes

Cacheability and shareability are two attributes that describe the memory hierarchy in a multiprocessing system:

Cacheability This term defines whether memory locations are allowed to be allocated into a cache or not. Cacheability can be defined independently for Inner and Outer cacheability locations.

Shareability This term defines whether memory locations are shareable between different agents in a system. Marking a memory location as shareable for a particular domain requires hardware to ensure that the location is coherent for all agents in that domain. Shareability can be defined independently for Inner and Outer shareability domains.

For more information about cacheability and shareability see [Memory types and attributes](#) on page B2-89.

B2.3.3 Application level cache instructions

In the ARM architecture, the application level is defined as *Exception level 0* (EL0). The architecture defines a set of cache maintenance instructions that software can use to manage cache coherency. Software executing at a higher Exception level can enable EL0 access to the following:

- The data cache maintenance instructions, DC CVAU, DC CVAC, and DC CIVAC. See [Data cache maintenance instructions \(DC*\)](#) on page D4-1685.
- The instruction cache maintenance instruction, IC IVAU. See [Instruction cache maintenance instructions \(IC*\)](#) on page D4-1684.
- The cache type register. See [CTR_EL0](#).
- The data cache zero instruction, DC ZVA. See [Data cache zero instruction](#) on page D4-1690.

These instructions are UNDEFINED from EL0 unless software executing at a higher Exception level has enabled them. See [Cache maintenance instructions](#) on page D4-1684.

For all of these instructions, if the addresses do not have read access permission at EL0, executing these instructions at EL0 generates a Permission fault.

For more information about the system controls, see [Cache support](#) on page D4-1675.

B2.3.4 Implication of caches for the application programmer

In normal operation, the caches are largely invisible to the application programmer. However they can become visible when there is a breakdown in the coherency of the caches. Such a breakdown can occur:

- When memory locations are updated by other agents in the system that do not use hardware management of coherency.
- When memory updates made from the application software must be made visible to other agents in the system, without the use of hardware management of coherency.

For example:

- In the absence of hardware management of coherency of DMA accesses, in a system with a DMA controller that reads memory locations that are held in the data cache of a PE, a breakdown of coherency occurs when the PE has written new data in the data cache, but the DMA controller reads the old data held in memory.
- In a Harvard cache implementation, where there are separate instruction and data caches, a breakdown of coherency occurs when new instruction data has been written into the data cache, but the instruction cache still contains the old instruction data.

Data coherency issues

Software can ensure the data coherency of caches in the following ways:

- By not using the caches in situations where coherency issues can arise. This can be achieved by:
 - Using Non-cacheable or, in some cases, Write-Through Cacheable memory.
 - Not enabling caches in the system.
- By using cache maintenance instructions to manage the coherency issues in software. See [Application level cache instructions](#).
- By using hardware coherency mechanisms to ensure the coherency of data accesses to memory for cacheable locations by observers within the different shareability domains, see [Non-shareable Normal memory](#) on page B2-91 and [Shareable, Inner Shareable, and Outer Shareable Normal memory](#) on page B2-90.

———— **Note** ————

The performance of these hardware coherency mechanisms is highly implementation-specific. In some implementations the mechanism suppresses the ability to cache shareable locations. In other implementations, cache coherency hardware can hold data in caches while managing coherency between observers within the shareability domains.

———— **Note** ————

Not all these mechanisms are directly available to software operating at EL0 and might involve interaction with software operating at a higher Exception level.

Synchronization and coherency issues between data and instruction accesses

How far ahead of the current point of execution instructions are fetched from is IMPLEMENTATION DEFINED. Such prefetching can be either a fixed or a dynamically varying number of instructions, and can follow any or all possible future execution paths. For all types of memory:

- The PE might have fetched the instructions from memory at any time since the last *Context synchronization operation* on that PE.
- Any instructions fetched in this way might be executed multiple times, if this is required by the execution of the program, without being re-fetched from memory.

The ARM architecture does not require the hardware to ensure coherency between instruction caches and memory, even for locations of shared memory. This means that for cacheable locations of memory, an instruction cache can hold instructions that were fetched from memory before any *Context synchronization operation*.

If software requires coherency between instruction execution and memory, it must manage this coherency using the ISB and DSB memory barriers and cache maintenance instructions. The following code sequence can be used for this purpose:

; Coherency example for data and instruction accesses within the same Inner Shareable domain.

; Enter this code with <Wt> containing a new 32-bit instruction,

; to be held in non-cacheable space at a location pointed to by Xn.

```
STR    <Wt>, [Xn]
DC CVAU, Xn      ; Clean data cache by VA to point of unification (PoU)
DSB ISH          ; Ensure visibility of the data cleaned from cache
IC IVAU, Xn      ; Invalidate instruction cache by VA to PoU
DSB ISH          ; Ensure completion of the invalidations
ISB             ; Synchronize the fetched instruction stream
```

B2.3.5 Preloading caches

The ARM architecture provides memory system hints PRFM, LDNP, and STNP that software can use to communicate the expected use of memory locations to the hardware. The memory system can respond by taking actions that are expected to speed up the memory accesses if they occur. The effect of these memory system hints is IMPLEMENTATION DEFINED. Typically, implementations use this information to bring the data or instruction locations into caches.

The Preload instructions are hints, and so implementations can treat them as NOPs without affecting the functional behavior of the device. The instructions cannot generate synchronous Data Abort exceptions, but the resulting memory system operations might, under exceptional circumstances, generate an asynchronous external abort, which is taken using an SError interrupt exception. For more information, see *Exception from a Data abort on page D1-1525*.

PrefetchHint{} defines the prefetch hint types:

```
enumeration PrefetchHint {Prefetch_READ, Prefetch_WRITE, Prefetch_EXEC};
```

The Hint_Prefetch() function signals to the memory system that memory accesses of the type hint to or from the specified address are likely to occur in the near future. The memory system might take some action to speed-up the memory accesses when they do occur, such as preloading the specified address into one or more caches as indicated by the innermost cache level target and non-temporal hint stream.

```
Hint_Prefetch(bits(64) address, PrefetchHint hint, integer target, boolean stream);
```

For more information on PRFM and Load/Store instructions that provide hints to the memory system, see [Prefetch memory](#) on page C2-138 and [Load/Store SIMD and Floating-point Non-temporal pair](#) on page C2-136.

B2.4 Alignment support

This section describes alignment support. It contains the following subsections:

- [Instruction alignment](#).
- [Alignment of data accesses](#).
- [Unaligned data access restrictions](#).

B2.4.1 Instruction alignment

A64 instructions must be word-aligned.

Attempting to fetch an instruction from a misaligned location results in a Misaligned PC fault. See [PC alignment checking on page D1-1423](#).

B2.4.2 Alignment of data accesses

An unaligned access to any type of Device memory causes an Alignment fault.

The alignment requirements for accesses to Normal memory are as follows:

- For all instructions that load or store a single or multiple registers, other than Load-Exclusive/Store-Exclusive and Load-Acquire/Store-Release, if the address that is accessed is not aligned to the size of the data element being accessed, then one of the following occurs:

- An Alignment fault is generated.
- An unaligned access is performed.

[SCTLR_ELx.A](#) at the current Exception level can be configured to enable an alignment check, and thereby determine which of these two options is used.

———— **Note** —————

- The [SCTLR_EL1.A](#) bit that is applicable to software running at EL0, can only be accessed from EL1 or above.
- Alignment checks are based on element size, not overall access size. This affects SIMD element and structure loads and stores, and also Load/Store pair instructions.

- For all Load-Exclusive/Store-Exclusive and Load-Acquire/Store-Release memory accesses that access a single element or a pair of elements, an alignment fault is generated if the address being accessed is not aligned to the size of the data structure being accessed.

A failed alignment check results in an Alignment fault, which is taken as a Data Abort exception. These exceptions are taken at the lowest Exception level that can handle the exception, consistent with the basic requirement that the Exception level never decreases on an exception. Therefore:

- Alignment faults at EL0 or EL1 are taken at EL1 unless redirected by [HCR_EL2.TGE](#)
- Alignment faults at EL2 are taken at EL2.
- Alignment faults at EL3 are taken at EL3.

B2.4.3 Unaligned data access restrictions

The following points apply to unaligned data accesses in ARMv8:

- Accesses are not guaranteed to be single-copy atomic except at the byte access level, see [Atomicity in the ARM architecture on page B2-79](#).
- Unaligned accesses typically takes a number of additional cycles to complete compared to a naturally-aligned access.
- An operation that performs an unaligned access can abort on any memory access that it makes, and can abort on more than one access. This means that an unaligned access that occurs across a page boundary can generate an abort on either side of the boundary.

B2.5 Endian support

General description of endianness in the ARM architecture describes the relationship between endianness and memory addressing in the ARM architecture.

The following subsections then describe the endianness schemes supported by the architecture:

- [Instruction endianness on page B2-77](#).
- [Data endianness on page B2-77](#).

B2.5.1 General description of endianness in the ARM architecture

This section only describes memory addressing and the effects of endianness for data elements up to quadwords of 128 bits. However, this description can be extended to apply to larger data elements.

For an address A, [Figure B2-2](#) shows, for big-endian and little-endian memory systems, the relationship between:

- The quadword at address A.
- The doubleword at address A and A+8.
- The words at addresses A, A+4, A+8, and A+12.
- The halfwords at addresses A, A+2, A+4, A+6, A+8, A+10, A+12, and A+14.
- The bytes at addresses A, A+1, A+2, A+3, A+4, A+5, A+6, A+7, A+8, A+9, A+10, A+11, A+12, A+13, A+14, and A+15.

The terms in [Figure B2-2](#) have the following definitions:

- B_A** Byte at address A.
- HW_A** Halfword at address A.
- MSByte** Most-significant byte.
- LSByte** Least-significant byte.

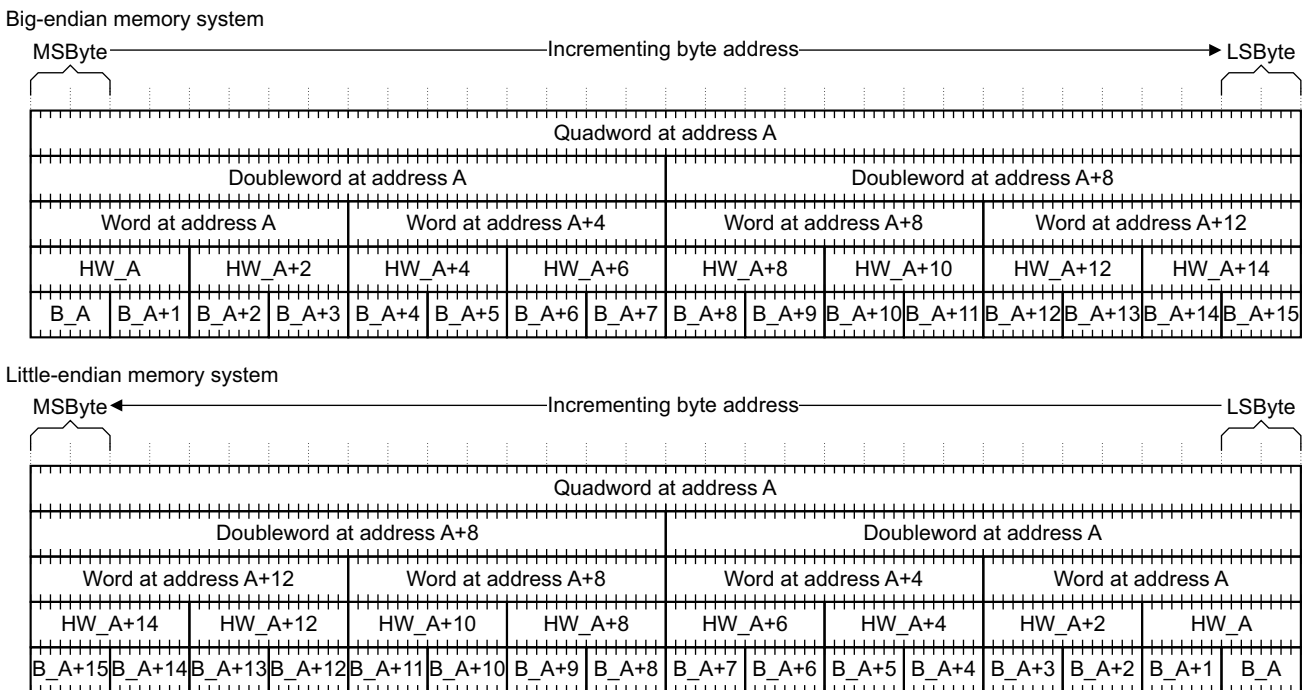

Figure B2-2 Endianness relationships

The big-endian and little-endian mapping schemes determine the order in which the bytes of a quadword, doubleword, word or halfword are interpreted. For example, a load of a word from address 0x1000 always results in an access to the bytes at memory locations 0x1000, 0x1001, 0x1002, and 0x1003. The endianness mapping scheme determines the significance of these four bytes.

B2.5.2 Instruction endianness

In ARMv8-A, A64 instructions have a fixed length of 32 bits and are always little-endian.

B2.5.3 Data endianness

[SCTLR_EL1.E0E](#), configurable at EL1 or higher, determines the data endianness for execution at EL0.

The data size used for endianness conversions:

- Is the size of the data value that is loaded or stored for SIMD and floating-point register and general-purpose register loads and stores.
- Is the size of the data element that is loaded or stored for SIMD element and data structure loads and stores. For more information see [Endianness in SIMD operations](#).

Instructions to reverse bytes in a general-purpose register or a SIMD and floating-point register

An application or device driver might have to interface to memory-mapped peripheral registers or shared memory structures that are not the same endianness as the internal data structures. Similarly, the endianness of the operating system might not match that of the peripheral registers or shared memory. In these cases, the PE requires an efficient method to transform explicitly the endianness of the data.

[Table B2-1](#) shows the instructions that provide this functionality:

Table B2-1 Byte reversal instructions

Function	Instructions	Notes
Reverse bytes in 32-bit word or words ^a	REV32	For use with general-purpose registers
Reverse bytes in whole register	REV	For use with general-purpose registers
Reverse bytes in 16-bit halfwords	REV16	For use with general-purpose registers
Reverse elements in doublewords, vector	REV64	For use with SIMD and floating-point registers
Reverse elements in words, vector	REV32	For use with SIMD and floating-point registers
Reverse elements in halfwords, vector	REV16	For use with SIMD and floating-point registers

a. Can operate on multiple words.

Endianness in SIMD operations

SIMD element Load/Store instructions transfer vectors of elements between memory and the SIMD and floating-point register file. An instruction specifies both the length of the transfer and the size of the data elements being transferred. This information is used to load and store data correctly in both big-endian and little-endian systems.

For example:

```
LD1 {V0.4H}, [X1]
```

This loads a 64-bit register with four 16-bit values. The four elements appear in the register in array order, with the lowest indexed element fetched from the lowest address. The order of bytes in the elements depends on the endianness configuration, as shown in Figure B2-3. Therefore, the order of the elements in the registers is the same regardless of the endianness configuration.

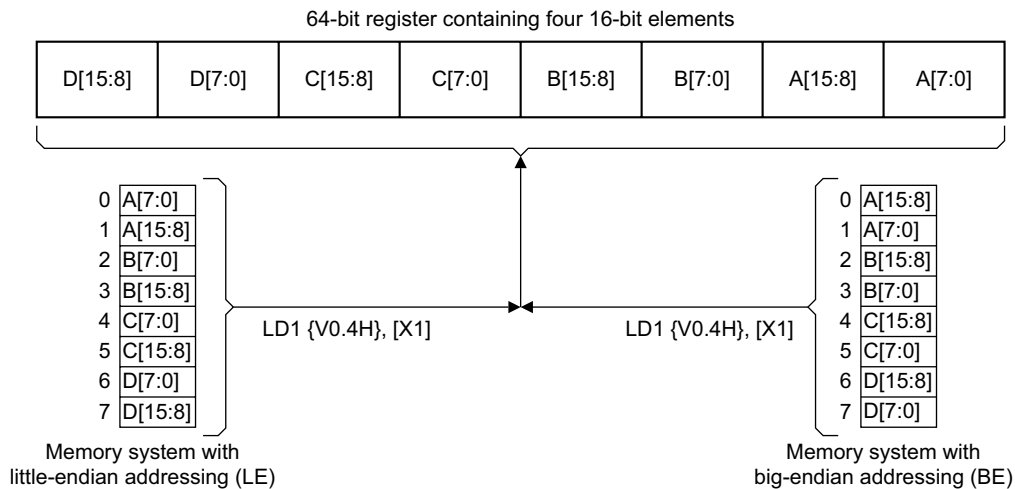

Figure B2-3 SIMD byte order example

The `BigEndian()` function determines the current endianness of the data:

```
boolean BigEndian();
```

The pseudocode function for `BigEndianReverse()` is as follows:

```
// BigEndianReverse()
// =====

bits(width) BigEndianReverse (bits(width) value)
    assert width IN {8, 16, 32, 64, 128};
    integer half = width DIV 2;
    if width == 8 then return value;
    return BigEndianReverse(value<half-1:0>) : BigEndianReverse(value<width-1:half>);
```

B2.6 Atomicity in the ARM architecture

Atomicity is a feature of memory accesses, described as *atomic* accesses. The ARM architecture description refers to two types of atomicity, defined in:

- [Single-copy atomicity](#).
- [Multi-copy atomicity](#).

In the ARMv8 architecture, the atomicity requirements for memory accesses depends on the memory type, and whether the access is explicit or implicit. For more information, see:

- [Memory type overview on page B2-69](#).
- [Requirements for single-copy atomicity](#).
- [Requirements for multi-copy atomicity on page B2-80](#).

B2.6.1 Single-copy atomicity

A read or write operation is *single-copy atomic* if the following conditions are both true:

- After any number of write operations to a memory location, the value of the memory location is the value written by one of the write operations. It is impossible for part of the value of the memory location to come from one write operation and another part of the value to come from a different write operation.
- When a read operation and a write operation are made to the same memory location, the value obtained by the read operation is either:
 - The value of the memory location before the write operation.
 - The value of the memory location after the write operation.

It is never the case that the value of the read operation is partly the value of the memory location before the write operation and partly the value of the memory location after the write operation.

B2.6.2 Multi-copy atomicity

In a multiprocessing system, writes to a memory location are *multi-copy atomic* if the following conditions are both true:

- All writes to the same location are *serialized*, meaning they are observed in the same order by all observers, although some observers might not observe all of the writes.
- A read of a location does not return the value of a write until all observers observe that write.

———— **Note** —————

Writes that are not coherent are not multi-copy atomic.

B2.6.3 Requirements for single-copy atomicity

For explicit memory accesses generated from an Exception level the following rules apply:

- All reads generated by load instructions that load a single general-purpose register and that are aligned to the size of the read in that instruction are single-copy atomic.
- All writes generated by store instructions that store a single general-purpose register and that are aligned to the size of the write in that instruction are single-copy atomic.
- Reads of general-purpose registers generated by Load Pair instructions that are aligned to the size of the load to each register are treated as two single-copy atomic reads, one for each register being loaded.
- Writes of general-purpose registers generated by Store pair instructions that are aligned to the size of the store of each register are treated as two single-copy atomic writes, one for each register being stored.
- Load-Exclusive Pair instructions of two 32-bit quantities and Store-Exclusive Pair instructions of 32-bit quantities are single-copy atomic.

- When the Store-Exclusive of a Load-Exclusive /Store-Exclusive pair instruction using two 64-bit quantities succeeds, it causes a single-copy atomic update of the entire memory location being updated.

———— **Note** ————

To atomically load two 64-bit quantities, perform a Load-Exclusive pair/Store-Exclusive pair sequence of reading and writing the same value for which the Store-Exclusive pair succeeds, and use the read values from the Load-Exclusive pair.

- Where translation table walks generate a read of a translation table entry, this read is single-copy atomic.
- When a store that, by the rules given in this section, would be single-copy atomic is made to a memory location at a time when there is at least one store to the same memory location that has not completed, and that would be single-copy atomic at a different size, then the architecture does not give any assurance of atomicity between accesses to the bytes of that location.
- For the atomicity of instruction fetches, see [Concurrent modification and execution of instructions on page B2-91](#).

All other memory accesses are regarded as streams of accesses to bytes, and no atomicity between accesses to different bytes is ensured by the architecture.

All accesses to any byte are single-copy atomic.

———— **Note** ————

No memory accesses involving SIMD and floating-point registers, or memory accesses from Data cache zero instructions, have single-copy atomicity of any quantity greater than individual bytes.

B2.6.4 Requirements for multi-copy atomicity

In a multiprocessing system, coherent writes to a memory location are multi-copy atomic if the read of a location returns the value of a write only when all observers have observed that write.

For Normal memory, writes are not required to be multi-copy atomic.

For Device memory with the non-Gathering attribute, writes that are single-copy atomic are also multi-copy atomic.

For Device memory with the Gathering attribute, writes are not required to be multi-copy atomic.

B2.6.5 Concurrent modification and execution of instructions

The ARMv8 architecture limits the set of instructions that can be executed by one thread of execution as they are being modified by another thread of execution without requiring explicit synchronization.

Concurrent modification and execution of instructions can lead to the resulting instruction performing any behavior that can be achieved by executing any sequence of instructions that can be executed from the same Exception level, except where the instruction before modification and the instruction after modification is a B, BL, NOP, BKPT, SVC, HVC, or SMC instruction.

For the B, BL, NOP, BKPT, SVC, HVC, and SMC instructions the architecture guarantees that, after modification of the instruction, behavior is consistent with execution of either:

- The instruction originally fetched.
- A fetch of the modified instruction.

For more information about the required synchronization operation, see [Synchronization and coherency issues between data and instruction accesses on page B2-73](#).

If one thread of execution changes a conditional branch instruction, such as B or BL, to another conditional instruction and the change affects both the condition field and the branch target, execution of the changed instruction by another thread of execution before the change is synchronized can lead to either:

- The old condition being associated with the new target address.

- The new condition being associated with the old target address.

These possibilities apply regardless of whether the condition, either before or after the change to the branch instruction, is the always condition.

———— **Note** —————

For information about memory accesses caused by instruction fetches, see [Ordering requirements on page B2-83](#).

B2.7 Memory ordering

This section describes observation ordering. It contains the following subsections:

- [Observability and completion.](#)
- [Ordering requirements on page B2-83.](#)
- [Memory barriers on page B2-85.](#)

For information on endpoint ordering of memory accesses, see [Reordering on page B2-95.](#)

In the ARMv8 memory model, the shareability memory attribute indicates whether hardware must ensure memory coherency.

The ARMv8 memory system architecture defines additional attributes and associated behaviors, defined in the system level section of this manual. See:

- [Chapter D4 The AArch64 System Level Memory Model.](#)
- [Chapter D5 The AArch64 Virtual Memory System Architecture.](#)

See also [Mismatched memory attributes on page B2-98.](#)

B2.7.1 Observability and completion

An *observer* is a master in the system that is capable of observing memory accesses. For a PE, the following mechanisms must be treated as independent observers:

- The mechanism that performs reads or writes to memory.
- A mechanism that causes an instruction cache to be filled from memory or that fetches instructions to be executed directly from memory. These are treated as reads.
- A mechanism that performs translation table walks. These are treated as reads.

The set of observers that can observe a memory access is defined by the system.

In the definitions in this subsection, *subsequent* means whichever of the following is appropriate to the context:

- After the point in time where the location is observed by that observer.
- After the point in time where the location is globally observed.

For all memory:

- A write to a location in memory is said to be *observed* by an observer when:
 - A subsequent read of the location by the same observer returns the value written by the observed write, or written by a write to that location by any observer that is sequenced in the *Coherence order* of the location after the observed write.
 - A subsequent write of the location by the same observer is sequenced in the *Coherence order* of the location after the observed write.
- A write to a location in memory is said to be *globally observed* for a shareability domain or set of observers when:
 - A subsequent read of the location by any observer in that shareability domain returns the value written by the globally observed write, or written by a write to that location by any observer that is sequenced in the *Coherence order* of the location after the globally observed write.
 - A subsequent write of the location by any observer in that shareability domain is sequenced in the *Coherence order* of the location after the globally observed write.
- A read of a location in memory is said to be observed by an observer when a subsequent write to the location by the same observer has no effect on the value returned by the read.
- A read of a location in memory is said to be globally observed for a shareability domain when a subsequent write to the location by any observer in that shareability domain has no effect on the value returned by the read.

Additionally, for Device-nGnRnE memory:

- A read or write of a memory-mapped location in a peripheral that exhibits side-effects is said to be observed, and globally observed, only when the read or write:
 - Meets the general conditions listed.
 - Can begin to affect the state of the memory-mapped peripheral.
 - Can trigger all associated side-effects, whether they affect other peripheral devices, PEs, or memory.

———— **Note** —————

————— This definition is consistent with the memory access having reached the peripheral. —————

For all memory, the completion rules are defined as:

- A read or write is complete for a shareability domain when all of the following are true:
 - The read or write is globally observed for that shareability domain.
 - Any translation table walks associated with the read or write are complete for that shareability domain.
- A translation table walk is complete for a shareability domain when the memory accesses associated with the translation table walk are globally observed for that shareability domain, and the TLB is updated.
- A cache or TLB maintenance instruction is complete for a shareability domain when the effects of the instruction are globally observed for that shareability domain, and any translation table walks that arise from the instruction are complete for that shareability domain.

The completion of any cache or TLB maintenance instruction includes its completion on all PEs that are affected by both the instruction and the DSB operation that is required to guarantee visibility of the maintenance instruction.

Completion of side-effects of accesses to Device memory

The completion of a memory access to Device memory other than Device-nGnRnE is not guaranteed to be sufficient to determine that the side-effects of the memory access are visible to all observers. The mechanism that ensures the visibility of side-effects of a memory access is IMPLEMENTATION DEFINED.

B2.7.2 Ordering requirements

ARMv8 defines restrictions for the permitted ordering of memory accesses. These restrictions depend on the memory locations that are being accessed. See [Memory types and attributes on page B2-89](#).

The following additional restrictions apply to the order in which accesses to Normal memory are observed:

- Reads and writes can be observed in any order provided the following constraints are met:
 - If an address dependency exists between two reads or between a read and a write, then those memory accesses are observed in program order by all observers within the shareability domain of the memory address being accessed.

The ARMv8 architecture relaxes this rule for execution where the second read is generated by a Load Non-Temporal Pair instruction. See [Load/Store Non-temporal Pair on page C2-132](#) and [Load/Store SIMD and Floating-point Non-temporal pair on page C2-136](#).
 - Writes that would not occur in a simple sequential execution of the program cannot be observed by other observers. This implies that where a control, address or data dependency exists between a read and a write, those memory accesses are observed in program order by all observers within the shareability domain of the memory addresses being accessed.
 - Ordering can be achieved by using a DMB or DSB barrier. For more information on DMB and DSB instructions, see [Memory barriers on page B2-85](#).
- Reads and writes to the same location are coherent within the shareability domain of the memory address being accessed.

- Two reads of the same location by the same observer are observed in program order by all observers within the shareability domain of the memory address being accessed.
- Writes are not required to be multi-copy atomic. This means that in the absence of barriers, the observation of a store by one observer does not imply the observation of the store by another observer.
- Instructions that access multiple elements have no defined ordering requirements for the memory accesses relative to each other.

Memory accesses caused by instruction fetches are not required to be observed in program order, unless they are separated by an ISB or other context synchronization event.

Address dependencies and order

In the ARMv8 architecture, a register data dependency creates order between a load instruction and a subsequent memory transaction, that is between the data value returned from the load and the address used by the subsequent memory transaction.

A register data dependency exists between a first data value and a second data value exists when either:

- The register, excluding the zero register (XZR or WZR), used to hold the first data value is used in the calculation of the second data value, and the calculation between the first data value and the second data value does not consist of either:
 - A conditional branch whose condition is determined by the first data value.
 - A conditional selection, move, or computation whose condition is determined by the first data value, where the input data values for the selection, move, or computation do not have a data dependency on the first data value.
- There is a register data dependency between the first data value and a third data value, and between the third data value and the second data value.

———— Note ————

A register data dependency can exist even if the value of the first data value is discarded as part of the calculation, as might be the case if it is ANDed with $0x0$ or if arithmetic using the first data value cancels out its contribution.

For example, each of the following code snippets exhibits order between the memory transactions:

1. LDR X1, [X2]
1. AND X1, X1, XZR
1. LDR X4, [X3, X1]
2. LDR X1, [X2]
3. ADD X3, X3, X1
4. SUB X3, X3, X1
5. STR X4, [X3]

Address dependencies of Load Non-temporal Pair instructions

Where an address dependency exists between two reads, and the second read was generated by a Load Non-temporal Pair instruction, then in the absence of any other barrier mechanism to achieve order, those memory accesses can be observed in any order by other observers within the shareability domain of the memory addresses being accessed.

This affects the following instruction:

- [LDNP on page C5-509](#).

B2.7.3 Memory barriers

The ARM architecture is a weakly ordered memory architecture that supports out of order completion. *Memory barrier* is the general term applied to an instruction, or sequence of instructions, that forces synchronization events by a PE with respect to retiring Load/Store instructions. The memory barriers defined by the ARMv8 architecture provide a range of functionality, including:

- Ordering of Load/Store instructions.
- Completion of Load/Store instructions.
- Context synchronization.

The following subsections describe the ARMv8 memory barrier instructions:

- [Instruction Synchronization Barrier \(ISB\)](#)
- [Data Memory Barrier \(DMB\)](#).
- [Data Synchronization Barrier \(DSB\) on page B2-86](#).
- [Shareability and access limitations on the data barrier operations on page B2-87](#).
- [Load-Acquire, Store-Release on page B2-87](#).

———— Note ————

Depending on the required synchronization, a program might use memory barriers on their own, or it might use them in conjunction with cache maintenance and memory management instructions that in general are only available when software execution is at EL1 or higher.

The DMB and DSB memory barriers affect reads and writes to the memory system generated by Load/Store instructions and data or unified cache maintenance instructions being executed by the PE. Instruction fetches or accesses caused by a hardware translation table access are not explicit accesses.

Instruction Synchronization Barrier (ISB)

An ISB instruction flushes the pipeline in the PE, so that all instructions that come after the ISB instruction in program order are fetched from the cache or memory only after the ISB instruction has completed. Using an ISB ensures that the effects of context-changing operations executed before the ISB are visible to the instructions fetched after the ISB instruction. Examples of context-changing operations that require the insertion of an ISB instruction to ensure the effects of the operation are visible to instructions fetched after the ISB instruction are:

- Completed cache and TLB maintenance instructions.
- Changes to system control registers.

Any context-changing operations appearing in program order after the ISB instruction only take effect after the ISB has been executed.

```
InstructionSynchronizationBarrier();
```

See also [Memory barriers on page D4-1705](#).

Data Memory Barrier (DMB)

The DMB instruction is a data memory barrier. The PE that executes the DMB instruction is referred to as the executing PE, PEe. The DMB instruction takes the *required shareability domain* and *required access types* as arguments:

```
DataMemoryBarrier(MBReqDomain domain, MBReqTypes types);
```

See [Shareability and access limitations on the data barrier operations on page B2-87](#).

If the required shareability is *Full system* then the operation applies to all observers within the system.

A DMB creates two groups of memory accesses, Group A and Group B:

Group A Contains:

- All explicit memory accesses of the required access types from observers in the same required shareability domain as PEe that are observed by PEe before the DMB instruction. These accesses include any accesses of the required access types performed by PEe.

- All loads of required access types from an observer PEx in the same required shareability domain as PEe that have been observed by any given different observer, PEy, in the same required shareability domain as PEe before PEy has performed a memory access that is a member of Group A.

Group B Contains:

- All explicit memory accesses of the required access types by PEe that occur in program order after the DMB instruction.
- All explicit memory accesses of the required access types by any given observer PEx in the same required shareability domain as PEe that can only occur after a load by PEx has returned the result of a store that is a member of Group B.

Any observer with the same required shareability domain as PEe observes all members of Group A before it observes any member of Group B to the extent that those group members are required to be observed, as determined by the shareability and cacheability of the memory locations accessed by the group members.

If members of Group A and members of Group B access the same memory-mapped peripheral of arbitrary system-defined size, then members of Group A that are accessing Device or Normal Non-cacheable memory arrive at that peripheral before members of Group B that are accessing Device or Normal Non-cacheable memory. Where the members of Group A and Group B that must be ordered are from the same PE, a DMB NSH is sufficient for this guarantee.

———— **Note** —————

- A memory access might be in neither Group A nor Group B. The DMB does not affect the order of observation of such a memory access.
- The second part of the definition of Group A is recursive. Ultimately, membership of Group A derives from the observation by PEy of a load before PEy performs an access that is a member of Group A as a result of the first part of the definition of Group A.
- The second part of the definition of Group B is recursive. Ultimately, membership of Group B derives from the observation by any observer of an access by PEe that is a member of Group B as a result of the first part of the definition of Group B.

DMB only affects memory accesses and the operation of data cache and unified cache maintenance instructions, see [Cache maintenance instructions on page D4-1684](#). It has no effect on the ordering of any other instructions executing on the PE.

See also [Memory barriers on page D4-1705](#).

Data Synchronization Barrier (DSB)

The DSB instruction is a special memory barrier, that synchronizes the execution stream with memory accesses.

The DSB instruction takes the *required shareability domain* and *required access types* as arguments:

```
DataSynchronizationBarrier(MBReqDomain domain, MBReqTypes types);
```

See [Shareability and access limitations on the data barrier operations on page B2-87](#).

If the required shareability is *Full system* then the operation applies to all observers within the system.

A DSB behaves as a DMB with the same arguments, and also has the additional properties defined in this section. The PE that executes the DSB instruction is referred to as the executing PE, PEe

A DSB completes when all of the following apply:

- All explicit memory accesses that are observed by PEe before the DSB is executed and are of the required access types, and are from observers in the same required shareability domain as PEe, are complete for the set of observers in the required shareability domain.

- All cache maintenance instructions issued by PEE before the DSB are complete for the required shareability domain.
- If the required access types of the DSB is *reads and writes*, all TLB maintenance instructions issued by PEE before the DSB are complete for the required shareability domain.

In addition, no instruction that appears in program order after the DSB instruction can execute until the DSB completes.

See also [Memory barriers on page D4-1705](#).

Shareability and access limitations on the data barrier operations

The DMB and DSB instructions can each take an optional limitation argument that specifies:

- The shareability domain over which the instruction must operate. This is one of:
 - Full system.
 - Outer Shareable.
 - Inner Shareable.
 - Non-shareable.
- The accesses for which the instruction operates. This is one of:
 - Read and write accesses in Group A and Group B.
 - Write accesses only in Group A and Group B.
 - Read access only in Group A.

———— **Note** —————

This is occasionally referred to as a Load-Load/Store barrier.

- Read and write accesses in Group B.

———— **Note** —————

This is occasionally referred to as a Load-Load/Store barrier.

If no specifiers are used then each instruction operates for read and write accesses, over the full system. See the instruction descriptions for more information about these arguments.

———— **Note** —————

ISB also supports an optional limitation argument that can only contain one value that corresponds to full system operation.

Load-Acquire, Store-Release

ARMv8 provides a set of instructions with Acquire semantics for loads, and Release semantics for stores. See [Load-Acquire/Store-Release on page C2-134](#).

For all memory types, these instructions have the following ordering requirements:

- A Store-Release followed by a Load-Acquire is observed in program order by each observer within the shareability domain of the memory address being accessed by the Store-Release and the memory address being accessed by the Load-Acquire.
- A Load-Acquire is a read that must be observed by all observers in the shareability domain of the accessed memory location before any other read or write that both:
 - Is caused by an instruction that appears in program order after the Load-Acquire.
 - Accesses memory in the shareability domain accessed by the Load-Acquire.
- A Load-Acquire places no additional ordering constraints on any loads or stores appearing before the Load-Acquire.

- Store-Release is a write:
 - Where the reads and writes generated by loads and stores appearing in program order before the Store-Release are observed as required by the shareability domains of the memory addresses being accessed by those loads and stores by each observer within the shareability domain of the memory address being accessed by the Store-Release, before that observer observes the write generated by the Store-Release.
 - Where any writes that have been observed before the Store-Release by the processing element executing the Store-Release are observed as required by the shareability domains of the memory addresses being accessed by those loads and store by each observer within the shareability domain of the memory address being accessed by the Store-Release, before that observer observes the write generated by the Store-Release.
- The Store-Release places no additional ordering constraints on any loads or stores appearing after the Store-Release instruction.
- All Store-Release instructions must be multi-copy atomic when they are observed with Load-Acquire instructions. This means that if one observer has seen the Store-Release, then all observers have seen the Store-Release.

Load-Acquire and Store-Release, other than Load-Acquire Exclusive Pair and Store-Release-Exclusive Pair, access only a single data element. This access is single-copy atomic. The address of the data object must be aligned to the size of the data element being accessed, otherwise the access generates an Alignment fault.

Load-Acquire Exclusive Pair and Store-Release Exclusive Pair access two data elements. The address supplied to the instructions must be aligned to twice the size of the element being loaded, otherwise the access generates an Alignment fault.

A Store-Release Exclusive instruction only has the release semantics if the store is successful.

———— **Note** —————

- Each Load-Acquire Exclusive and Store-Release Exclusive instruction is essentially a variant of the equivalent Load-Exclusive or Store-Exclusive instruction. All usage restrictions and single-copy atomicity properties that apply to the Load-Exclusive or Store-Exclusive instructions also apply to the Load-Acquire Exclusive or Store-Release Exclusive instructions.
- The Load-Acquire/Store-Release instructions can remove the requirement to use the explicit [DMB](#) memory barrier instruction.

B2.8 Memory types and attributes

In ARMv8 the ordering of accesses for locations of memory, referred to as the memory order model, is defined by the memory attributes. The following sections describe this model:

- [Normal memory](#).
- [Device memory on page B2-92](#).

B2.8.1 Normal memory

The Normal memory type attribute applies to most memory in a system. It indicates that the hardware might perform speculative data read accesses to these locations.

The Normal memory type has the following properties:

- A write to a memory location with the Normal attribute completes in finite time. This means that it is globally observed for the shareability domain of the memory location in finite time. For a Non-cacheable location, the location is observed by all observers in finite time.
- A completed write to a memory location with the Normal attribute is globally observed for the shareability domain of the memory location in finite time without the need for explicit cache maintenance instructions or barriers. For a Non-cacheable location, the completed write is globally observed for all observers in finite time without the need for explicit cache maintenance instructions or barriers.
- Writes to a memory location with the Normal memory attribute that are Non-cacheable must reach the endpoint for that location in the memory system in finite time.
- Unaligned memory accesses can access Normal memory if the system is configured to generate such accesses.
- There is no requirement for the memory system beyond the PE to be able to identify the elements accessed by multi-register Load/Store instructions. See [Multi-register loads and stores that access Normal memory on page B2-92](#).

Note

- The Normal memory attribute is appropriate for locations of memory that are idempotent, meaning that they exhibit all of the following properties:
 - Read accesses can be repeated with no side-effects.
 - Repeated read accesses return the last value written to the resource being read.
 - Read accesses can fetch additional memory locations with no side-effects.
 - Write accesses can be repeated with no side-effects if the contents of the location accessed are unchanged between the repeated writes or as the result of an exception, as described in this section.
 - Unaligned accesses can be supported.
 - Accesses can be merged before accessing the target memory system.
- An instruction that generates a sequence of accesses as described in [Atomicity in the ARM architecture on page B2-79](#) might be abandoned as a result of an exception being taken during the sequence of accesses. On return from the exception the instruction is restarted, and therefore one or more of the memory locations might be accessed multiple times. This can result in repeated write accesses to a location that has been changed between the write accesses.

The following sections describe the other attributes for Normal memory:

- [Shareable Normal memory on page B2-90](#).
- [Non-shareable Normal memory on page B2-91](#).

See also:

- [Atomicity in the ARM architecture on page B2-79.](#)
- [Memory barriers on page B2-85.](#) For accesses to Normal memory, a DMB instruction is required to ensure the required ordering.
- [Concurrent modification and execution of instructions on page B2-80.](#)

Shareable Normal memory

A Normal memory location has a Shareability attribute that is:

- Defined independently for the Inner Shareable and Outer Shareable shareability domains.
- Defined, for each shareability domain, as being either Shareable or Non-shareable.

The shareability attributes define the data coherency requirements of the location, that hardware must enforce. They do not affect the coherency requirements of instruction fetches, see [Synchronization and coherency issues between data and instruction accesses on page B2-73.](#)

Note

- System designers can use the shareability attribute to specify the locations in Normal memory for which coherency must be maintained. However, software developers must not assume that specifying a memory location as Non-shareable permits software to make assumptions about the incoherency of the location between different PEs in a shared memory system. Such assumptions are not portable between different multiprocessing implementations that might use the shareability attribute. Any multiprocessing implementation might implement caches that are shared, inherently, between different processing elements.
 - This architecture assumes that all PEs that use the same operating system or hypervisor are in the same Inner Shareable shareability domain.
-

Shareable, Inner Shareable, and Outer Shareable Normal memory

The ARM architecture abstracts the system as a series of Inner and Outer Shareability domains.

Each Inner Shareability domain contains a set of observers that are data coherent for each member of that set for data accesses with the Inner Shareable attribute made by any member of that set.

Each Outer Shareability domain contains a set of observers that are data coherent for each member of that set for data accesses with the Outer Shareable attribute made by any member of that set.

The following properties also hold:

- Each observer is only a member of a single Inner Shareability domain.
- Each observer is only a member of a single Outer Shareability domain.
- All observers in an Inner Shareability domain are always members of the same Outer Shareability domain. This means that an Inner Shareability domain is a subset of an Outer Shareability domain, although it is not required to be a proper subset.

Note

- Because all data accesses to Non-cacheable locations are data coherent to all observers, Non-cacheable locations are always treated as Outer Shareable.
 - The Inner Shareable domain is expected to be the set of PEs controlled by a single hypervisor or operating system.
-

The details of the use of the shareability attributes are system-specific. [Example B2-1](#) shows how they might be used.

Example B2-1 Use of shareability attributes

In an implementation, a particular subsystem with two clusters of PEs has the requirement that:

- In each cluster, the data caches or unified caches of the PEs in the cluster are transparent for all data accesses to memory locations with the Inner Shareable attribute.
- However, between the two clusters, the caches:
 - Are not required to be coherent for data accesses that have only the Inner Shareable attribute.
 - Are coherent for data accesses that have the Outer Shareable attribute.

In this system, each cluster is in a different shareability domain for the Inner Shareable attribute, but all components of the subsystem are in the same shareability domain for the Outer Shareable attribute.

A system might implement two such subsystems. If the data caches or unified caches of one subsystem are not transparent to the accesses from the other subsystem, this system has two Outer Shareable shareability domains.

Having two levels of shareability means system designers can reduce the performance and power overhead for shared memory locations that do not need to be part of the Outer Shareable shareability domain.

For Shareable Normal memory, the Load-Exclusive and Store-Exclusive synchronization primitives take account of the possibility of accesses by more than one observer in the same Shareability domain.

Non-shareable Normal memory

For Normal memory locations, the Non-shareable attribute identifies Normal memory that is likely to be accessed only by a single PE.

A location in Normal memory with the Non-shareable attribute does not require the hardware to make data accesses by different observers coherent, unless the memory is Non-cacheable. For a Non-shareable location, if other observers share the memory system, software must use cache maintenance instructions, if the presence of caches might lead to coherency issues when communicating between the observers. This cache maintenance requirement is in addition to the barrier operations that are required to ensure memory ordering.

For Non-shareable Normal memory, it is IMPLEMENTATION DEFINED whether the Load-Exclusive and Store-Exclusive synchronization primitives take account of the possibility of accesses by more than one observer.

Concurrent modification and execution of instructions

The ARMv8 architecture limits the set of instructions that can be executed by one thread of execution as they are being modified by another thread of execution without requiring explicit synchronization.

Except where the instruction before modification or the instruction after modification is explicitly identified in this section, concurrent modification and execution of instructions can lead to the resulting instruction performing any behavior that can be achieved by executing any sequence of instructions that can be executed from the same Exception level.

For the instructions explicitly identified in this section, the architecture guarantees that, after modification of the instruction, behavior is consistent with execution of either:

- The instruction originally fetched.
- A fetch of the modified instruction.

The instructions to which this applies are the B, BL, NOP, BKPT, SVC, HVC, and SMC instructions.

For all other instructions, to avoid UNPREDICTABLE behavior, instruction modifications must be explicitly synchronized before they are executed. The required synchronization is as follows:

1. To ensure that the modified instructions are observable, the thread of execution that is modifying the instructions must issue the following sequence of instructions and operations:

```
; Coherency example for self-modifying code
; Enter this code with Wt containing a new 32-bit instruction,
; to be held in non-cacheable space at a location pointed to by Xn.
STR    Wt, [Xn]
DSB ISH                ; Ensure visibility of the data stored
IC IVAU, Xn           ; Invalidate instruction cache by VA to PoU
DSB ISH                ; Ensure completion of the invalidations
```

2. Once the modified instructions are observable, the thread of execution that is executing the modified instructions must issue the following instruction to ensure execution of the modified instructions:

```
ISB SY                ; Synchronize fetched instruction stream
```

For both instruction sets, if one thread of execution changes a conditional branch instruction to another conditional branch instruction, and the change affects both the condition field and the branch target, execution of the changed instruction by another thread of execution before the change is synchronized can lead to either:

- The old condition being associated with the new target address.
- The new condition being associated with the old target address.

These possibilities apply regardless of whether the condition, either before or after the change to the branch instruction, is the always condition.

Multi-register loads and stores that access Normal memory

For all instructions that load or store more than one general-purpose register from an Exception level there is no requirement for the memory system beyond the PE to be able to identify the size of the elements accessed by these load or store instructions.

For all instructions that load or store more than one general-purpose register from an Exception level the order in which the registers are accessed is not defined by the architecture.

For all instructions that load or store one or more SIMD and floating-point register from an Exception level there is no requirement for the memory system beyond the PE to be able to identify the size of the element accessed by these load or store instructions.

B2.8.2 Device memory

The Device memory type attributes define memory locations where an access to the location can cause side-effects, or where the value returned for a load can vary depending on the number of loads performed. Typically, the Device memory attributes are used for memory-mapped peripherals and similar locations.

The attributes for ARMv8 Device memory are:

Gathering Identified as G or nG, see [Gathering on page B2-94](#).

Reordering Identified as R or nR, see [Reordering on page B2-95](#).

Early Write Acknowledgement hint

Identified as E or nE, see [Early Write Acknowledgement on page B2-96](#).

The ARMv8 Device memory types are:

Device-nGnRnE Device non-Gathering, non-Reordering, No Early write acknowledgement.

Equivalent to the Strongly-ordered memory type in earlier versions of the architecture.

Device-nGnRE	Device non-Gathering, non-Reordering, Early Write Acknowledgement. Equivalent to the Device memory type in earlier versions of the architecture.
Device-nGRE	Device non-Gathering, Reordering, Early Write Acknowledgement. ARMv8 adds this memory type to the translation table formats found in earlier versions of the architecture. The use of barriers is required to order accesses to Device-nGRE memory.
Device-GRE	Device Gathering, Reordering, Early Write Acknowledgement. ARMv8 adds this memory type to the translation table formats found in earlier versions of the architecture. Device-GRE memory has the fewest constraints. It behaves similar to Normal memory, with the restriction that speculative accesses to Device-GRE memory is forbidden.

Collectively these are referred to as *any Device memory type*. Going down the list, the memory types are described as getting *weaker*; conversely the going up the list the memory types are described as getting *stronger*.

Note

- As the list of types shows, these additional attributes are hierarchical. For example, a memory location that permits Gathering must also permit Reordering and Early Write Acknowledgement.
- The architecture does not require an implementation to distinguish between each of these memory types and ARM recognizes that not all implementations will do so. The subsection that describes each of the attributes, describes the implementation rules for the attribute.
- Earlier versions of the ARM architecture defined the following memory types:
 - Strongly-ordered memory. This is the equivalent of the Device-nGnRnE memory type.
 - Device memory. This is the equivalent of the Device-nGnRE memory type.

All of these memory types have the following properties:

- Speculative data accesses are not permitted to any memory location with any Device memory attribute. This means that each memory access to any Device memory type must be one that would be generated by a simple sequential execution of the program.

Three exceptions to this apply:

- Reads generated by the SIMD and floating-point instructions can access bytes that are not explicitly accessed by the instruction if the bytes accessed are in a 16-byte window, aligned to 16-bytes, that contains at least one byte that is explicitly accessed by the instruction.
- For Device memory with the Gathering attribute, reads generated by the LDNP instructions are permitted to access bytes that are not explicitly accessed by the instruction, provided that the bytes accessed are in a 128-byte window, aligned to 128-bytes, that contains at least one byte that is explicitly accessed by the instruction.
- Where a load or store instruction performs a sequence of memory accesses, as opposed to one single-copy atomic access as defined in the rules for single-copy atomicity, these accesses might occur multiple times as a result of executing the load or store instruction. See [Single-copy atomicity on page B2-79](#).

Note

- An instruction that generates a sequence of accesses as described in [Atomicity in the ARM architecture on page B2-79](#) might be abandoned as a result of an exception being taken during the sequence of accesses. On return from the exception the instruction is restarted, and therefore one or more of the memory locations might be accessed multiple times. This can result in repeated accesses to a location where the program only defines a single access. For this reason, ARM strongly recommends that no accesses to Device memory are performed from a single instruction that spans the boundary of a translation granule or which in some other way could lead to some of the accesses being aborted.
- Write speculation that is visible to other observers is prohibited for all memory types.

- A write to a memory location with any Device memory attribute completes in finite time. This means that it is globally observed for all observers in the system in finite time.
- If a location with any Device memory attribute changes without an explicit write by an observer, this change must also be globally observed for all observers in the system in finite time. Such a change might occur in a peripheral location that holds status information.
- A completed write to a memory location with any Device memory attribute is globally observed for all observers in finite time without the need for explicit maintenance.
- Data accesses to memory locations are coherent for all observers in the system, and correspondingly are treated as being Outer Shareable.
- A memory location with any Device memory attribute cannot be allocated into a cache.
- Writes to a memory location with any Device memory attribute must reach the endpoint for that address in the memory system in finite time. Typically, the endpoint is a peripheral or some physical memory.
- All accesses to memory with any Device memory attribute must be aligned. Any unaligned access generates an Alignment fault at the first stage of translation that defined the location as being Device.

———— **Note** ————

In the Non-secure EL1 translation regime in systems where `HCR_EL2.TGE == 1` and `HCR_EL2.DC == 0`, any Alignment fault that results from the fact that all locations are treated as Device is a fault at the first stage of translation. This causes `ESR_EL2.ISS.[24]` to be 0.

- Hardware does not prevent speculative instruction fetches from a memory location with any of the Device memory attributes unless the memory location is also marked as Execute-never for all Exception levels.

———— **Note** ————

This means that to prevent speculative instruction fetches from memory locations with Device memory attributes, any location that is assigned any Device memory type must also be marked as Execute-never for all Exception levels. Failure to mark a memory location with any Device memory attribute as Execute-never for all Exception levels is a programming error.

For instruction fetches, if branches cause the program counter to point to an area of memory with the Device attribute which is not marked as Execute-never for the current Exception level, an implementation can either:

- Treat the instruction fetch as if it were to a memory location with the Normal Non-cacheable attribute.
- Take a Permission fault.

Gathering

In the Device memory attribute:

- G** Indicates that the location has the Gathering attribute.
- nG** Indicates that the location does not have the Gathering attribute, meaning it is non-Gathering.

The Gathering attribute determines whether it is permissible for either:

- Multiple memory accesses of the same type, read or write, to the same memory location to be merged into a single transaction.
- Multiple memory accesses of the same type, read or write, to different memory locations to be merged into a single memory transaction on an interconnect.

———— **Note** ————

This also applies to writebacks from the cache, whether caused by a *Natural eviction* or as a result of a cache maintenance instruction.

For memory types with the Gathering attribute, either of these behaviors is permitted, provided that the ordering and coherency rules of the memory location are followed.

For memory types with the non-Gathering attribute, neither of these behaviors is permitted. As a result:

- The number of memory accesses that are made corresponds to the number that would be generated by a simple sequential execution of the program.
- All access occur at their programmed size, except that there is no requirement for the memory system beyond the PE to be able to identify the elements accessed by multi-register Load/Store instructions. See [Multi-register loads and stores that access Device memory on page B2-97](#).

Gathering between memory accesses separated by a memory barrier that affects those memory accesses is not permitted. This applies if one memory access is in Group A and one memory access is in Group B. That is, gathering is not permitted between a memory access in Group A and a memory access in Group B if the two accesses are separated by a barrier that affects at least one of the accesses.

Gathering between two memory accesses generated by a Load-Acquire/Store-Release is not permitted.

A read from a memory location with the non-Gathering attribute cannot come from a cache or a buffer, but must come from the endpoint for that address in the memory system. Typically this is a peripheral or physical memory.

Note

- A read from a memory location with the Gathering attribute can come from intermediate buffering of a previous write, provided that:
 - The accesses are not separated by a DMB or DSB barrier that affects both of the accesses, for example if one access is in Group A and the other is in Group B.
 - The accesses are not separated by other ordering constructions that require that the accesses are in order. Such a construction might be a combination of Load-Acquire and Store-Release.
 - The accesses are not generated by a Store-Release instruction.
- The ARM architecture only defines programmer visible behavior. Therefore, gathering can be performed if a programmer cannot tell whether gathering has occurred.

An implementation is permitted to perform an access with the Gathering attribute in a manner consistent with the requirements specified by the Non-gathering attribute.

An implementation is not permitted to perform an access with the Non-gathering attribute in a manner consistent with the relaxations allowed by the Gathering attribute.

Reordering

In the Device memory attribute:

- R** Indicates that the location has the Reordering attribute.
nR Indicates that the location does not have the Reordering attribute, meaning it is non-Reordering.

For all memory types with the non-Reordering attribute, the order of memory accesses arriving at a single peripheral of IMPLEMENTATION DEFINED size, as defined by the peripheral, must be the same order that occurs in a simple sequential execution of the program. That is, the accesses appear in program order. This ordering applies to all accesses using any of the memory types with the non-Reordering attribute. As a result, if there is a mixture of Device-nGnRE and Device-nGnRnE accesses to the same peripheral, these occur in program order. If the memory accesses are not to a peripheral, then this attribute imposes no restrictions.

Note

- The IMPLEMENTATION DEFINED size of the single peripheral is the same as applies for the ordering guarantee provided by the DMB instruction.
- The ARM architecture only defines programmer visible behavior. Therefore, reordering can be performed if a programmer cannot tell whether reordering has occurred.

An implementation is permitted to perform an access with the Reordering attribute in a manner consistent with the requirements specified by the non-Reordering attribute.

An additional relaxation is that an implementation is not permitted to perform an access with the non-Reordering attribute in a manner consistent with the relaxations allowed by the Reordering attribute.

The non-Reordering attribute does not require any additional ordering, other than that which applies to Normal memory, between:

- Accesses with the non-Reordering attribute and accesses with the Reordering attribute.
- Accesses with the non-Reordering attribute and accesses to Normal memory.
- Accesses with the non-Reordering attribute and accesses to different peripherals of IMPLEMENTATION DEFINED size.

The non-Reordering attribute has no effect on the ordering of cache maintenance instructions, even if the memory location specified in the instruction has the non-Reordering attribute.

Early Write Acknowledgement

In the Device memory attribute:

- E** Indicates that the location has the Early Write Acknowledgement attribute.
nE Indicates that the location has the No Early Write Acknowledgement attribute.

Early Write Acknowledgement is a hint to the platform memory system. Assigning the No Early Write Acknowledgement attribute to a Device memory location recommends that only the endpoint of the write access returns a write acknowledgement of the access, and that no earlier point in the memory system returns a write acknowledge. This means that a DSB barrier, executed by the PE that performed the write to the No Early Write Acknowledgement location, completes only after the write has reached its endpoint in the memory system. Typically, this endpoint is a peripheral or physical memory.

When the Early Write Acknowledgement attribute is assigned to a Device memory location, there is no such recommendation for the handling of accesses to that location.

————— Note —————

- The Early Write Acknowledgement hint has no effect on the ordering rules. The purpose of signalling no Early Write Acknowledgement is to signal to the interconnect that the peripheral requires the ability to signal the acknowledgement. The No Write Acknowledgement signal also provides an additional semantic that can be interpreted by the driver that is accessing the peripheral.
- This attribute is treated as a hint, as the exact nature of the interconnects accessed by a PE is outside the scope of the ARM architecture definition, and not all interconnects provide a mechanism to ensure that a write has reached the physical endpoint of the memory system.
- ARM recommends that writes with the No Early Write Acknowledgement hint are used for PCIe configuration writes. However, the mechanisms by which PCIe configuration writes are identified are IMPLEMENTATION DEFINED.
- ARM strongly recommends that the Early Write Acknowledgement hint is not ignored by a PE, but is made available for use by the system.

Because the No Early Write Acknowledgement attribute is a hint:

- An implementation is permitted to perform an access with the Early Write Acknowledgement attribute in a manner consistent with the requirements specified by the No Early Write Acknowledgement attribute.
- An implementation is permitted to perform an access with the No Early Write Acknowledgement attribute in a manner consistent with the relaxations allowed by the Early Write Acknowledgement attribute.

Multi-register loads and stores that access Device memory

For all instructions that load or store more than one general-purpose register from an Exception level there is no requirement for the memory system beyond the PE to be able to identify the size of the elements accessed by these load or store instructions.

For all instructions that load or store more than one general-purpose register from an Exception level the order in which the registers are accessed is not defined by the architecture. This applies even to accesses to any type of Device memory.

For all instructions that load or store one or more floating-point and SIMD register from an Exception level there is no requirement for the memory system beyond the PE to be able to identify the size of the element accessed by these load or store instructions, even for access to any type of Device memory.

B2.9 Mismatched memory attributes

Memory attributes are controlled by privileged software. For more information, see [Chapter D5 The AArch64 Virtual Memory System Architecture](#).

Physical memory locations are accessed with *mismatched attributes* if all accesses to the location do not use a common definition of all of the following attributes of that location:

- Memory type, Device or Normal.
- Shareability.
- Cacheability, for the same level of the inner or outer cache, but excluding any cache allocation hints.

Collectively these are referred to as memory attributes.

———— **Note** ————

The terms *location* and *memory location* refer to any byte within the current coherency granule and are used interchangeably.

The following rules apply when a physical memory location is accessed with mismatched attributes:

1. When a memory location is accessed with mismatched attributes the only software visible effects are one or more of the following:
 - Uniprocessor semantics for reads and writes to that memory location might be lost. This means:
 - A read of the memory location by one agent might not return the value most recently written to that memory location by the same agent.
 - Multiple writes to the memory location by one agent with different memory attributes might not be ordered in program order.
 - There might be a loss of coherency when multiple agents attempt to access a memory location.
 - There might be a loss of properties derived from the memory type, as described in later bullets in this section.
 - If all Load-Exclusive/Store-Exclusive instructions executed across all threads to access a given memory location do not use consistent memory attributes, the exclusive monitor state becomes UNKNOWN.
 - Bytes written without the Write-Back cacheable attribute within the same Write-Back granule as bytes written with the Write-Back cacheable attribute might have their values reverted to the old values as a result of cache Write-Back.
2. The loss of properties associated with mismatched memory type attributes refers only to the following properties of Device memory that are additional to the properties of Normal memory:
 - Prohibition of speculative read accesses.
 - Prohibition on Gathering.
 - Prohibition on Re-ordering.
 - The Write Acknowledgement guarantee with respect to the endpoint of the access.

If the only memory type mismatch associated with a memory location across all users of the memory location is between different types of Device memory, then all accesses might take the properties of the weakest Device memory type.
3. If all aliases of a memory location that permit write access to the location assign the same shareability and cacheability attributes to that location, and all these aliases use a definition of the shareability attribute that includes all the threads of execution that can access the location, then any agent that reads the memory location using these shareability and cacheability attributes accesses it coherently, to the extent required by that common definition of the memory attributes.
4. The possible loss of software-visible effects caused by mismatched attributes for a memory location are defined more precisely if all of the mismatched attributes define the memory location as one of:
 - Any Device memory type.
 - Normal Inner Non-cacheable, Outer Non-cacheable memory.

In these cases, the only permitted software-visible effects of the mismatched attributes are one or more of the following:

- Possible loss of properties described in point 2 [page B2-98](#), derived from the memory type when multiple agents attempt to access the memory location.
 - Possible reordering of memory transactions to the memory location with different memory attributes, potentially leading to a loss of coherency or uniprocessor semantics. Any possible loss of coherency or uniprocessor semantics can be avoided by inserting DMB barrier instructions between accesses to the same memory location that might use different attributes.
5. If the mismatched attributes for a memory location all assign the same shareability attribute to the location, any loss of uniprocessor semantics or coherency within a shareability domain can be avoided by use of software cache management. To do so, software must use the techniques that are required for the software management of the coherency of cacheable locations between agents in different shareability domains. This means:
- Before writing to a location not using the Write-Back attribute, software must invalidate, or clean, a location from the caches if any agent might have written to the location with the Write-Back attribute. This avoids the possibility of overwriting the location with stale data.
 - After writing to a location with the Write-Back attribute, software must clean the location from the caches, to make the write visible to external memory.
 - Before reading the location with a cacheable attribute, software must invalidate the location from the caches, to ensure that any value held in the caches reflects the last value made visible in external memory.

In all cases:

- Location refers to any byte within the current coherency granule.
- A clean and invalidate instruction can be used instead of a clean instruction, or instead of an invalidate instruction.
- In the sequences outlined in this section, all cache maintenance instructions and memory transactions must be completed, or ordered by the use of barrier operations, if they are not naturally ordered by the use of a common address, see [Ordering and completion of data and instruction cache instructions on page D4-1689](#).

———— **Note** —————

With software management of coherency, race conditions can cause loss of data. A race condition occurs when different agents write simultaneously to bytes that are in the same location, and the invalidate, write, clean sequence of one agent overlaps with the equivalent sequence of another agent. A race condition also occurs if the first operation of either sequence is a clean, rather than an invalidate.

6. If the mismatched attributes for a location mean that multiple cacheable accesses to the location might be made with different shareability attributes, then coherency is guaranteed only if processing elements that accesses the location with a cacheable attribute performs a clean and invalidate of the location before and after accessing that location.

———— **Note** —————

The Note in rule 5 on [page B2-99](#) about possible race conditions also applies to this rule.

In addition, if multiple agents attempt to use Load-Exclusive or Store-Exclusive instructions to access a location, and the accesses from the different agents have different memory attributes associated with the location, the exclusive monitor state becomes UNKNOWN.

ARM strongly recommends that software does not use mismatched attributes for aliases of the same location. An implementation might not optimize the performance of a system that uses mismatched aliases.

B2.10 Synchronization and semaphores

ARMv8 provides non-blocking synchronization of shared memory, using *synchronization primitives*. The information in this section about memory accesses by synchronization primitives applies to accesses to both Normal and Device memory.

———— **Note** —————

Use of the ARMv8 synchronization primitives scales for multiprocessing system designs.

Table B2-2 shows the synchronization primitives and the associated CLREX instruction.

Table B2-2 Synchronization primitives and associated instruction

Function	Instruction
Load-Exclusive	
Pair ^a	LDXP, LDAXP
Register ^a	LDXR, LDAXR
Halfword	LDXRH, LDAXRH
Byte	LDXRB, LDAXRB
Store-Exclusive	
Pair ^a	STXP, STLXP
Register ^a	STXR, STLXR
Halfword	STXRH, STLXRH
Byte	STXRB, STLXRB
Clear-Exclusive	CLREX

a. The instruction operates on a doubleword if accessing an X register, or on a word if accessing a W register.

The model for the use of a Load-Exclusive/Store-Exclusive instruction pair accessing a non-aborting memory address x is:

- The Load-Exclusive instruction reads a value from memory address x .
- The corresponding Store-Exclusive instruction succeeds in writing back to memory address x only if no other observer, process, or thread has performed a more recent store to address x . The Store-Exclusive instruction returns a status bit that indicates whether the memory write succeeded.

A Load-Exclusive instruction marks a small block of memory for exclusive access. The size of the marked block is IMPLEMENTATION DEFINED, see [Marking and the size of the marked memory block on page B2-105](#). A Store-Exclusive instruction to any address in the marked block clears the marking.

———— **Note** —————

In this section, the term PE includes any observer that can generate a Load-Exclusive or a Store-Exclusive instruction.

B2.10.1 Exclusive access instructions and Non-shareable memory locations

For memory locations that do not have the *Shareable* attribute, the exclusive access instructions rely on a *local monitor* that marks any address from which the PE executes a Load-Exclusive instruction. Any non-aborted attempt by the same PE to use a Store-Exclusive instruction to modify any address is guaranteed to clear the marking.

A Load-Exclusive instruction performs a load from memory, and:

- The executing PE marks the physical memory address for exclusive access.
- The local monitor of the executing PE transitions to the Exclusive Access state.

A Store-Exclusive instruction performs a conditional store to memory that depends on the state of the local monitor:

If the local monitor is in the Exclusive Access state

- If the address of the Store-Exclusive instruction is the same as the address that has been marked in the monitor by an earlier Load-Exclusive instruction, then the store occurs. Otherwise, it is IMPLEMENTATION DEFINED whether the store occurs.
- A status value is returned to a register:
 - If the store took place the status value is 0.
 - Otherwise, the status value is 1.
- The local monitor of the executing PE transitions to the Open Access state.

If the local monitor is in the Open Access state

- No store takes place.
- A status value of 1 is returned to a register.
- The local monitor remains in the Open Access state.

The Store-Exclusive instruction defines the register to which the status value is returned.

When a PE writes using any instruction other than a Store-Exclusive instruction:

- If the write is to a physical address that is not tagged by its local monitor it is IMPLEMENTATION DEFINED whether the write affects the state of the local monitor.
- If the write is to a physical address that is tagged by its local monitor it is IMPLEMENTATION DEFINED whether the write affects the state of the local monitor.

It is IMPLEMENTATION DEFINED whether a store to a marked physical address causes a mark in the local monitor to be cleared if that store is by an observer other than the one that caused the physical address to be marked.

Figure B2-4 shows the state machine for the local monitor and the effect of each of the operations shown in the figure.

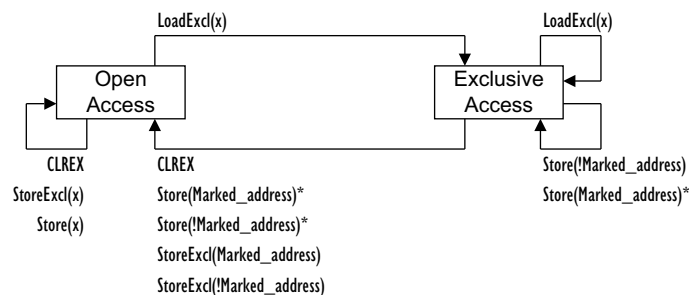

Operations marked * are possible alternative IMPLEMENTATION DEFINED options.

In the diagram: LoadExcl represents any Load-Exclusive instruction
 StoreExcl represents any Store-Exclusive instruction
 Store represents any other store instruction.

Any LoadExcl operation updates the marked address to the most significant bits of the address *x* used for the operation.

Figure B2-4 Local monitor state machine diagram

For more information about marking see [Marking and the size of the marked memory block on page B2-105](#).

———— **Note** —————

For the local monitor state machine, as shown in [Figure B2-4 on page B2-101](#):

- The IMPLEMENTATION DEFINED options for the local monitor are consistent with the local monitor being constructed so that it does not hold any physical address, but instead treats any access as matching the address of the previous Load-Exclusive instruction.
- A local monitor implementation can be unaware of Load-Exclusive and Store-Exclusive instructions from other PEs.
- The architecture does not require a load instruction by another PE, that is not a Load-Exclusive instruction, to have any effect on the local monitor.
- It is IMPLEMENTATION DEFINED whether the transition from Exclusive Access to Open Access state occurs when the Store or StoreExcl is from another observer.

Changes to the local monitor state resulting from speculative execution

The architecture permits a local monitor to transition to the Open Access state as a result of speculation, or from some other cause. This is in addition to the transitions to Open Access state caused by the architectural execution of an operation shown in [Figure B2-4 on page B2-101](#).

An implementation must ensure that:

- The local monitor cannot be seen to transition to the Exclusive Access state except as a result of the architectural execution of one of the operations shown in [Figure B2-4 on page B2-101](#).
- Any transition of the local monitor to the Open Access state not caused by the architectural execution of an operation shown in [Figure B2-4 on page B2-101](#) must not indefinitely delay forward progress of execution.

B2.10.2 Exclusive access instructions and Shareable memory locations

For memory locations that have the *Shareable* attribute, exclusive access instructions rely on:

- A *local monitor* for each PE in the system, that marks any address from which the PE executes a Load-Exclusive. The local monitor operates as described in [Exclusive access instructions and Non-shareable memory locations on page B2-101](#), except that for Shareable memory any Store-Exclusive is then subject to checking by the global monitor if it is described in that section as doing at least one of the following:
 - Updating memory.
 - Returning a status value of 0.

The local monitor can ignore accesses from other PEs in the system.

- A *global monitor* that marks a physical address as exclusive access for a particular PE. This marking is used later to determine whether a Store-Exclusive to that address that has not been failed by the local monitor can occur. Any successful write to the marked block by any other observer in the shareability domain of the memory location is guaranteed to clear the marking. For each PE in the system, the global monitor:
 - Can hold one marked block.
 - Maintains a state machine for each marked block it can hold.

———— **Note** —————

For each PE, the architecture only requires global monitor support for a single marked address. Any situation that might benefit from the use of multiple marked addresses on a single PE is UNPREDICTABLE, see [Load-Exclusive and Store-Exclusive instruction usage restrictions on page B2-106](#).

Note

The global monitor can either reside within the PE, or exist as a secondary monitor at the memory interfaces. The IMPLEMENTATION DEFINED aspects of the monitors mean that the global monitor and local monitor can be combined into a single unit, provided that the unit performs the global monitor and local monitor functions defined in this manual.

For Shareable locations of memory, in some implementations and for some memory types, the properties of the global monitor require functionality outside the PE. Some system implementations might not implement this functionality for all locations of memory. In particular, this can apply to:

- Any type of memory in the system implementation that does not support hardware cache coherency.
- Non-cacheable memory, or memory treated as Non-cacheable, in an implementation that does support hardware cache coherency.

In such a system, it is defined by the system:

- Whether the global monitor is implemented.
- If the global monitor is implemented, which address ranges or memory types it monitors.

Note

To support the use of the Load-Exclusive/Store-Exclusive mechanism when address translation is disabled, a system might define at least one location of memory, of at least the size of the translation granule, in the system memory map to support the global monitor for all ARM PEs within a common Inner Shareable domain. However, this is not an architectural requirement. Therefore, architecturally-compliant software that requires mutual exclusion must not rely on using the Load-Exclusive/Store-Exclusive mechanism, and must instead use a software algorithm such as Lamport's Bakery algorithm to achieve mutual exclusion.

If the global monitor is not implemented for an address range or memory type, then performing a Load-Exclusive/Store-Exclusive instruction to such a location has one or more of the following effects:

- The instruction generates an external abort.
- The instruction generates an IMPLEMENTATION DEFINED MMU fault. This is reported using the Fault Status code of `ESR_ELx.DFSC = 110101`.
- The instruction is treated as a NOP.
- The Load-Exclusive instruction is treated as if it were accessing a Non-shareable location, but the state of the local monitor becomes UNKNOWN.
- The Store-Exclusive instruction is treated as if it were accessing a Non-shareable location, but the state of the local monitor becomes UNKNOWN.
- The value held in the result register of the Store-Exclusive instruction becomes UNKNOWN.

In addition, for write transactions generated by non-PE observers that do not implement exclusive accesses or other atomic access mechanisms, the effect that writes have on the global and local monitors used by ARM PEs is IMPLEMENTATION DEFINED. The writes might not clear the global monitors of other PEs for:

- Some address ranges.
- Some memory types.

Operation of the global monitor

A Load-Exclusive instruction from Shareable memory performs a load from memory, and causes the physical address of the access to be marked as exclusive access for the requesting PE. This access also causes the exclusive access mark to be removed from any other physical address that has been marked by the requesting PE.

Note

The global monitor only supports a single outstanding exclusive access to Shareable memory per PE.

A Load-Exclusive instruction by one PE has no effect on the global monitor state for any other PE.

A Store-Exclusive instruction performs a conditional store to memory:

- The store is guaranteed to succeed only if the physical address accessed is marked as exclusive access for the requesting PE and both the local monitor and the global monitor state machines for the requesting PE are in the Exclusive Access state. In this case:
 - A status value of 0 is returned to a register to acknowledge the successful store.
 - The final state of the global monitor state machine for the requesting PE is IMPLEMENTATION DEFINED.
 - If the address accessed is marked for exclusive access in the global monitor state machine for any other PE then that state machine transitions to Open Access state.
- If no address is marked as exclusive access for the requesting PE, the store does not succeed:
 - A status value of 1 is returned to a register to indicate that the store failed.
 - The global monitor is not affected and remains in Open Access state for the requesting PE.
- If a different physical address is marked as exclusive access for the requesting PE, it is IMPLEMENTATION DEFINED whether the store succeeds or not:
 - If the store succeeds a status value of 0 is returned to a register, otherwise a value of 1 is returned.
 - If the global monitor state machine for the PE was in the Exclusive Access state before the Store-Exclusive instruction it is IMPLEMENTATION DEFINED whether that state machine transitions to the Open Access state.

The Store-Exclusive instruction defines the register to which the status value is returned.

In a shared memory system, the global monitor implements a separate state machine for each PE in the system. The state machine for accesses to Shareable memory by PE(n) can respond to all the Shareable memory accesses visible to it. This means it responds to:

- Accesses generated by PE(n).
- Accesses generated by the other observers in the shareability domain of the memory location. These accesses are identified as (!n).

In a shared memory system, the global monitor implements a separate state machine for each observer that can generate a Load-Exclusive or a Store-Exclusive instruction in the system.

Clear global monitor event

Whenever the global monitor state for a PE changes from Exclusive access to Open access, an event is generated and held in the Event register for that PE. This register is used by the Wait for Event mechanism, see [Mechanisms for entering a low-power state on page D1-1533](#).

[Figure B2-5 on page B2-105](#) shows the state machine for PE(n) in a global monitor.

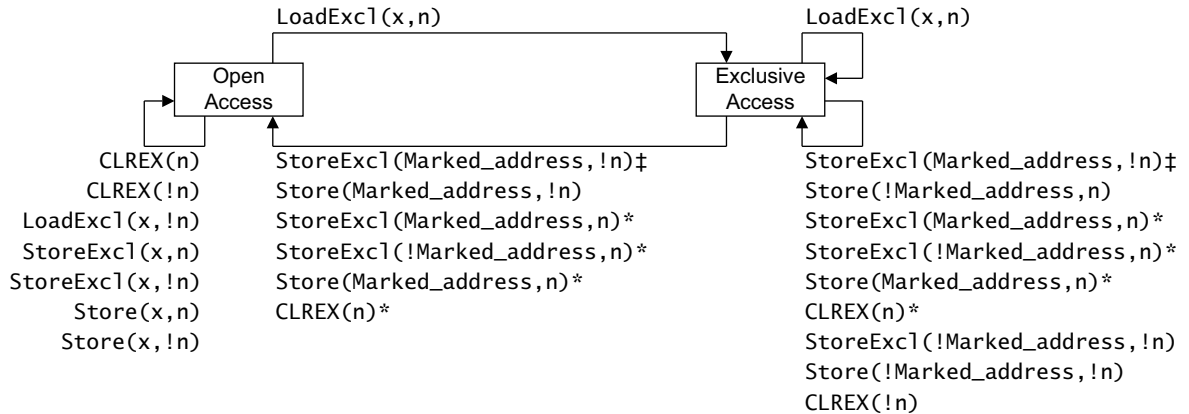

‡StoreExcl(Marked_address,!n) clears the monitor only if the StoreExcl updates memory

Operations marked * are possible alternative IMPLEMENTATION DEFINED options.

In the diagram: LoadExcl represents any Load-Exclusive instruction

StoreExcl represents any Store-Exclusive instruction

Store represents any other store instruction.

Any LoadExcl operation updates the marked address to the most significant bits of the address x used for the operation.

Figure B2-5 Global monitor state machine diagram for PE(n) in a multiprocessor system

For more information about marking see [Marking and the size of the marked memory block](#).

———— **Note** ————

For the global monitor state machine, as shown in [Figure B2-5](#):

- The architecture does not require a load instruction by another PE, that is not a Load-Exclusive instruction, to have any effect on the global monitor.
- Whether a Store-Exclusive instruction successfully updates memory or not depends on whether the address accessed matches the marked Shareable memory address for the PE issuing the Store-Exclusive instruction, and whether the local and global monitors are in the exclusive state. For this reason, [Figure B2-5](#) only shows how the operations by (!n) cause state transitions of the state machine for PE(n).
- A Load-Exclusive instruction can only update the marked Shareable memory address for the PE issuing the Load-Exclusive instruction.
- When the global monitor is in the Exclusive Access state, it is IMPLEMENTATION DEFINED whether a CLREX instruction causes the global monitor to transition from Exclusive Access to Open Access state.
- It is IMPLEMENTATION DEFINED:
 - Whether a modification to a Non-shareable memory location can cause a global monitor to transition from Exclusive Access to Open Access state.
 - Whether a Load-Exclusive instruction to a Non-shareable memory location can cause a global monitor to transition from Open Access to Exclusive Access state.

B2.10.3 Marking and the size of the marked memory block

When a Load-Exclusive instruction is executed, the resulting marked block ignores the least significant bits of the 64-bit memory address.

When a LDXR instruction is executed, a marked block of size 2^a is created by ignoring the least significant bits of the memory address. A marked address is any address within this marked block. For example, in an implementation where a is 4, a successful LDXRB of address 0x341B4 defines a marked block using bits[47:4] of the address. This means that the four words of memory from 0x341B0 to 0x341BF are marked for exclusive access.

The size of the marked memory block is called the *Exclusives Reservation Granule*. The Exclusives Reservation Granule is IMPLEMENTATION DEFINED in the range 2 - 512 words:

- 3 words in an implementation where a is 4.
- 512 words in an implementation where a is 11.

In some implementations the CTR identifies the Exclusives Reservation Granule, see [CTR_ELO](#). Otherwise, software must assume that the maximum Exclusives Reservation Granule, 512 words, is implemented.

B2.10.4 Context switch support

An exception return clears the local monitor. As a result, performing a CLREX instruction as part of a context switch is not required in most situations.

———— **Note** —————

Context switching is not an application level operation. However, this information is included here to complete the description of the exclusive operations.

B2.10.5 Load-Exclusive and Store-Exclusive instruction usage restrictions

The Load-Exclusive and Store-Exclusive instructions are intended to work together as a pair, for example a LDXP/STXP pair or a LDXR/STXR pair. To support different implementations of these functions, software must follow the notes and restrictions given here.

The following notes describe use of a Load-Exclusive/Store-Exclusive pair, LoadExcl/StoreExcl, to indicate the use of any of the Load-Exclusive/Store-Exclusive instruction pairs shown in [Table B2-2 on page B2-100](#):

- The exclusives support a single outstanding exclusive access for each PE thread that is executed. The architecture makes use of this by not requiring an address or size check as part of the IsExclusiveLocal() function. If the target virtual address of a StoreExcl is different from the virtual address of the preceding LoadExcl instruction in the same thread of execution, behavior can be UNPREDICTABLE. As a result, a LoadExcl/StoreExcl pair can only be relied upon to eventually succeed if the LoadExcl and the StoreExcl are executed with the same address.
- If two StoreExcl instructions are executed without an intervening LoadExcl instruction the second StoreExcl instruction returns a status value of 1. This means that:
 - ARM recommends that, in a given thread of execution, every StoreExcl instruction has a preceding LoadExcl instruction associated with it.

It is not necessary for every LoadExcl instruction to have a subsequent StoreExcl instruction.

- An implementation of the Load-Exclusive and Store-Exclusive instructions can require that, in any thread of execution, the transaction size of a Store-Exclusive instruction is the same as the transaction size of the preceding Load-Exclusive instruction executed in that thread. If the transaction size of a Store-Exclusive instruction is different from the preceding Load-Exclusive instruction in the same thread of execution, behavior can be UNPREDICTABLE. As a result, software can rely on an LoadExcl/StoreExcl pair to eventually succeed only if they have the same size.
- An implementation might clear an exclusive monitor between the LoadExcl instruction and the StoreExcl, instruction without any application-related cause. For example, this might happen because of cache evictions. Software must, in any single thread of execution, avoid having any explicit memory accesses or cache maintenance instructions between the LoadExcl instruction and the associated StoreExcl instruction.
- Implementations can benefit from keeping the LoadExcl and StoreExcl operations close together in a single thread of execution. This minimizes the likelihood of the exclusive monitor state being cleared between the LoadExcl instruction and the StoreExcl instruction. Therefore, for best performance, ARM strongly recommends a limit of 128 bytes between LoadExcl and StoreExcl instructions in a single thread of execution.

- The architecture sets an upper limit of 2048 bytes on the exclusive reservation granule that can be marked as exclusive. For performance reasons, ARM recommends that objects that are accessed by exclusive accesses are separated by the size of the exclusive reservations granule. This is a performance guideline rather than a functional requirement.
- After taking a Data Abort exception, the state of the exclusive monitors is UNKNOWN.
- If the memory attributes for the memory being accessed by a LoadExcl/StoreExcl pair are changed between the LoadExcl instruction and the StoreExcl instruction, behavior is UNPREDICTABLE.
- The effect of a cache invalidation instruction on a local or global exclusive monitor that is in the Exclusive Access state is UNPREDICTABLE. The instruction might clear the monitor, or it might leave it in the Exclusive Access state. For address-based invalidation this also applies to the monitors of other PEs in the same shareability domain as the PE executing the cache invalidation instruction, as determined by the shareability domain of the address being invalidated.

———— **Note** —————

ARM strongly recommends that implementations ensure that the use of such maintenance instructions by a PE in the Non-secure state cannot cause a denial of service on a PE in the Secure state.

———— **Note** —————

In the event of repeatedly-contending Load-Exclusive/Store-Exclusive instruction sequences from multiple PEs, an implementation must ensure that forward progress is made by at least one PE.

B2.10.6 Use of WFE and SEV instructions by spin-locks

ARMv8 provides Wait For Event, Send Event, and Send Event Local instructions, WFE, SEV, and SEVL, that can assist with reducing power consumption and bus contention caused by PEs repeatedly attempting to obtain a spin-lock. These instructions can be used at the application level, but a complete understanding of what they do depends on a system level understanding of exceptions. They are described in [Wait for Event mechanism and Send event on page D1-1533](#). However, in ARMv8, when the global monitor for a PE changes from Exclusive Access state to Open Access state, an event is generated.

———— **Note** —————

This is equivalent to issuing an SEV instruction on the PE for which the monitor state has changed. It removes the need for spinlock code to include an SEV instruction after clearing a spinlock.

Part C

The AArch64 Instruction Set

Chapter C1

The A64 Instruction Set

This chapter describes the A64 instruction set. It contains the following sections:

- *Introduction* on page C1-112.
- *Structure of the A64 assembler language* on page C1-113.
- *Address generation* on page C1-118.
- *Instruction aliases* on page C1-121.

C1.1 Introduction

The instruction set supported in the AArch64 execution state is known as A64.

All A64 instructions have a width of 32 bits. The A64 encoding structure breaks down into the following functional groups:

- A miscellaneous group of branch instructions, exception generating instructions, and system instructions.
- Data processing instructions associated with general-purpose registers. These instructions are supported by two *functional groups*, depending on whether the operands:
 - Are all held in registers.
 - Include an operand with a constant immediate value.
- Load and store instructions associated with the general-purpose register file and the SIMD and floating-point register file.
- SIMD and scalar floating-point data processing instructions that operate on the SIMD and floating-point registers.

The encoding hierarchy within a functional group breaks down as follows:

- A functional group consists of a set of related instruction classes. [A64 instruction index by encoding on page C3-172](#) provides an overview of the instruction encodings in the form of a list of instruction classes within their functional groups.
- An instruction class consists of a set of related instruction forms. Instruction forms are documented in one of two alphabetic lists:
 - The load, store, and data processing instructions associated with the general-purpose registers, together with those in the other instruction classes. See [Chapter C5 A64 Base Instruction Descriptions](#).
 - The load, store, and data processing instructions associated with the SIMD and floating-point support. See [Chapter C6 A64 SIMD and Floating-point Instruction Descriptions](#).
- An instruction form might support a single instruction syntax. Where an instruction supports more than one syntax, each syntax is an *instruction variant*. Instruction variants can occur because of differences in:
 - The size or format of the operands.
 - The register file used for the operands.
 - The addressing mode used for load/load/store memory operands.

Instruction variants might also arise as the result of other factors.

Instruction variants are described in the instruction description for the individual instructions.

A64 instructions have a regular bit encoding structure:

- 5-bit register operand fields at fixed positions within the instruction. For general-purpose register operands, the values 0-30 select one of 31 registers. The value 31 is used as a special case that can:
 - Indicate use of the current stack pointer, when identifying a load/store base register or in a limited set of data processing instructions. See [The stack pointer registers on page D1-1416](#).
 - Indicate the value zero when used as a source register operand.
 - Indicate discarding the result when used as a destination register operand.

For SIMD and floating-point register access, the value used selects one of 32 registers.

- Immediate bits that provide constant data processing values or address offsets are placed in contiguous bit fields. Some computed values in instruction variants use one or more immediate bit fields together with the secondary encoding bit fields.

All encodings that are not fully defined are described as UNALLOCATED. An attempt to execute an UNALLOCATED instruction results in an Undefined Instruction exception, unless otherwise defined in the Exception model.

C1.2 Structure of the A64 assembler language

The letter *W* denotes a general-purpose register holding a 32-bit word, and *X* denotes a general-purpose register holding a 64-bit doubleword.

An A64 assembler recognizes both upper-case and lower-case variants of the instruction mnemonics and register names, but not mixed case variants. An A64 disassembler can output either upper-case or lower-case mnemonics and register names. Program and data labels are case-sensitive.

The A64 assembly language does not require the # character to introduce constant immediate operands, but an assembler must allow immediate values introduced with or without the # character. ARM recommends that an A64 disassembler outputs a # before an immediate operand.

In [Example C1-1 on page C1-114](#) the sequence // is used as a comment leader and A64 assemblers are encouraged to accept this syntax.

C1.2.1 Common syntax terms

The following syntax terms are used frequently throughout the A64 instruction set description.

UPPER	Text in upper-case letters is fixed. Text in lower-case letters is variable. This means that register name X_n indicates that the X is required, followed by a variable register number, for example X_{29} .
< >	Any text enclosed by angle braces, < >, is a value that the user supplies. Subsequent text might supply additional information.
{ }	Any item enclosed by curly brackets, { }, is optional. A description of the item and how its presence or absence affects the instruction is normally supplied by subsequent text. In some cases curly braces are actual symbols in the syntax, for example when they surround a register list. These cases are called out in the surrounding text.
[]	Any items enclosed by square brackets, [], constitute a list of alternative characters. A single one of the characters can be used in that position and the subsequent text describes the meaning of the alternatives. In some case the square brackets are part of the syntax itself, such as addressing modes or vector elements. These cases are called out in the surrounding text.
a b	Alternative words are separated by a vertical bar, , and can be surrounded by parentheses to delimit them. For example, U(ADD SUB)W represents UADDW or USUBW.
±	This indicates an optional + or - sign. If neither is used then + is assumed.
uimmn	An <i>n</i> -bit unsigned, positive, immediate value.
simmn	An <i>n</i> -bit two's complement, signed immediate value, where <i>n</i> includes the sign bit.
SP	See Register names on page C1-114 .
Wn	See Register names on page C1-114 .
WSP	See Register names on page C1-114 .
WZR	See Register names on page C1-114 .
Xn	See Register names on page C1-114 .
XZR	See Register names on page C1-114 .

C1.2.2 Instruction Mnemonics

The A64 assembly language overloads instruction mnemonics and distinguishes between the different forms of an instruction based on the operand types. For example, the following ADD instructions all have different opcodes. However, the programmer must only remember one mnemonic, as the assembler automatically chooses the correct opcode based on the operands. The disassembler follows the same procedure in reverse.

Example C1-1 ADD instructions with different opcodes

```

ADD W0, W1, W2           // add 32-bit register
ADD X0, X1, X2           // add 64-bit register
ADD X0, X1, W2, SXTW    // add 64-bit extended register
ADD X0, X1, #42         // add 64-bit immediate
  
```

C1.2.3 Condition Code

The A64 ISA has some instructions that set condition flags or test condition codes or both. For information about instructions that set the condition flags or use the condition mnemonics, see [Condition flags and related instructions on page C5-390](#).

Table C1-1 shows the available condition codes.

Table C1-1 Condition codes

cond	Mnemonic	Meaning (integer)	Meaning (floating-point) ^a	Condition flags
0000	EQ	Equal	Equal	Z == 1
0001	NE	Not equal	Not equal or unordered	Z == 0
0010	CS or HS	Carry set	Greater than, equal, or unordered	C == 1
0011	CC or LO	Carry clear	Less than	C == 0
0100	MI	Minus, negative	Less than	N == 1
0101	PL	Plus, positive or zero	Greater than, equal, or unordered	N == 0
0110	VS	Overflow	Unordered	V == 1
0111	VC	No overflow	Ordered	V == 0
1000	HI	Unsigned higher	Greater than, or unordered	C == 1 && Z == 0
1001	LS	Unsigned lower or same	Less than or equal	!(C == 1 && Z == 0)
1010	GE	Signed greater than or equal	Greater than or equal	N == V
1011	LT	Signed less than	Less than, or unordered	N != V
1100	GT	Signed greater than	Greater than	Z == 0 && N == V
1101	LE	Signed less than or equal	Less than, equal, or unordered	!(Z == 0 && N == V)
1110	AL	Always	Always	Any
1111	NV ^b	Always	Always	Any

a. Unordered means at least one NaN operand.

b. The condition code NV exists only to provide a valid disassembly of the 0b1111 encoding, otherwise its behavior is identical to AL.

C1.2.4 Register names

This section describes the AArch64 registers. It contains the following subsections:

- [General-purpose register file and the stack pointer on page C1-115](#).
- [SIMD and floating-point register file on page C1-115](#).
- [SIMD and floating-point scalar register names on page C1-116](#).
- [SIMD vector register names on page C1-116](#).

- [SIMD vector element names on page C1-116.](#)

General-purpose register file and the stack pointer

The 31 general-purpose registers in the general-purpose register file are named R0-R30 and encoded in the instruction register fields with values 0-30. A general-purpose register field that encodes the value 31 represents either the current stack pointer or the zero register, depending on the instruction and the operand position.

When the registers are used in a specific instruction variant, they must be qualified to indicate the operand data size, 32 bits or 64 bits, and the data size of the instruction.

When the data size is 32 bits, the lower 32 bits of the register are used and the upper 32 bits are ignored on a read and cleared to zero on a write.

[Table C1-2](#) shows the qualified names for registers, where n is a register number 0-30.

Table C1-2 General-purpose register names

Name	Size	Encoding	Description
Wn	32 bits	0-30	General-purpose register 0-30
Xn	64 bits	0-30	General-purpose register 0-30
WZR	32 bits	31	Zero register
XZR	64 bits	31	Zero register
WSP	32 bits	31	Current stack pointer
SP	64 bits	31	Current stack pointer

The following list provides further details relating to [Table C1-2](#).

- The names Xn and Wn both refer to the same general-purpose register, Rn.
- There is no register named W31 or X31.
- The name SP represents the stack pointer for 64-bit operands where an encoding of the value 31 in the corresponding register field is interpreted as a read or write of the current stack pointer. When instructions do not interpret this operand encoding as the stack pointer, use of the name SP is an error.
- The name WSP represents the current stack pointer in a 32-bit context.
- The name XZR represents the zero register for 64-bit operands where an encoding of the value 31 in the corresponding register field is interpreted as returning zero when read or discarding the result when written. When instructions do not interpret this operand encoding as the zero register, use of the name XZR is an error.
- The name WZR represents the zero register in a 32-bit context.
- The architecture does not define a special name for general-purpose register R30 that reflects its special role as the link register on procedure calls. An A64 assembler must always use W30 and X30. Additional software names might be defined as part of the Procedure Call Standard, see *Procedure Call Standard for the ARM 64-bit Architecture*.

SIMD and floating-point register file

The 32 registers in the SIMD and floating-point register file, V0-V31, hold floating-point operands for the scalar floating-point instructions, and both scalar and vector operands for the SIMD instructions. When they are used in a specific instruction form, the names must be further qualified to indicate the data shape, that is the data element size and the number of elements or lanes within the register. A similar requirement is placed on the general-purpose registers. See [General-purpose register file and the stack pointer](#).

———— **Note** —————

The data type is described by the instruction mnemonics that operate on the data. The data type is not described by the register name. The data type is the interpretation of bits within each register or vector element, whether these are integers, floating-point values, polynomials or cryptographic hashes.

SIMD and floating-point scalar register names

SIMD and floating-point instructions that operate on scalar data only access the lower bits of a SIMD and floating-point register. The unused high bits are ignored on a read and cleared to 0 on a write.

Table C1-3 shows the qualified names for accessing scalar SIMD and floating-point registers. The letter *n* denotes a register number between 0 and 31.

Table C1-3 SIMD and floating-point scalar register names

Size	Name
8 bits	Bn
16 bits	Hn
32 bits	Sn
64 bits	Dn
128 bits	Qn

SIMD vector register names

If a register holds multiple data elements on which arithmetic is performed in a parallel, SIMD, manner, then a qualifier describes the vector shape. The vector shape is the element size and the number of elements or lanes. If the element size in bits multiplied by the number of lanes does not equal 128, then the upper 64 bits of the register are ignored on a read and cleared to zero on a write.

Table C1-4 shows the SIMD vector register names. The letter *n* denotes a register number between 0 and 31.

Table C1-4 SIMD vector register names

Shape	Name
8 bits × 8 lanes	Vn.8B
8 bits × 16 lanes	Vn.16B
16 bits × 4 lanes	Vn.4H
16 bits × 8 lanes	Vn.8H
32 bits × 2 lanes	Vn.2S
32 bits × 4 lanes	Vn.4S
64 bits × 1 lane	Vn.1D
64 bits × 2 lanes	Vn.2D

SIMD vector element names

Appending a constant, zero-based element index to the register name inside square brackets indicates that a single element from a SIMD and floating-point register is used as a scalar operand. The number of lanes is not represented, as it is not encoded in the instruction and can only be inferred from the index value.

Table C1-5 shows the vector register names and the element index. The letter *i* denotes the element index.

Table C1-5 Vector register names with element index

Size	Name
8 bits	Vn.B[i]
16 bits	Vn.H[i]
32 bits	Vn.S[i]
64 bits	Vn.D[i]

An assembler must accept a fully qualified SIMD register name, if the number of lanes is greater than the index value. See *SIMD vector register names* on page C1-116. For example, an assembler must accept all of the following forms as the name for the 32-bit element in bits [63:32] of the SIMD and floating-point register V9:

```
V9.S[1]    //standard disassembly
V9.2S[1]   //optional number of lanes
V9.4S[1]   //optional number of lanes
```

Note

The SIMD and floating-point register element name Vn.S[0] is not equivalent to the scalar SIMD and floating-point register name Sn. Although they represent the same bits in the register, they select different instruction encoding forms, either the vector element or the scalar form.

SIMD vector register list

Where an instruction operates on multiple SIMD and floating-point registers, for example vector Load/Store structure and table lookup operations, the registers are specified as a list enclosed by curly braces. This list consists of either a sequence of registers separated by commas, or a register range separated by a hyphen. The registers must be numbered in increasing order, modulo 32, in increments of one. The hyphenated form is preferred for disassembly if there are more than two registers in the list and the register number are increasing. The following examples are equivalent representations of a set of four registers V4 to V7, each holding four lanes of 32-bit elements:

```
{ V4.4S - V7.4S }           //standard disassembly
{ V4.4S, V5.4S, V6.4S, V7.4S } //alternative representation
```

SIMD vector element list

Registers in a list can also have a vector element form. For example, the LD4 instruction can load one element into each of four registers, and in this case the index is appended to the list as follows:

```
{ V4.S - V7.S }[3]           //standard disassembly
{ V4.4S, V5.4S, V6.4S, V7.4S }[3] //alternative with optional number of lanes
```

C1.3 Address generation

The A64 instruction set supports 64-bit addresses. The valid address range is determined by the following factors:

- The size of the implemented virtual address space.
- Memory Management Unit (MMU) configuration settings.

The top 8 bits of the 64-bit address can be used as a tag, see [Address tagging in AArch64 state on page D5-1708](#). For more information on memory management and address translation, see [Chapter D5 The AArch64 Virtual Memory System Architecture](#).

C1.3.1 Register indexed addressing

The A64 instruction set allows a 64-bit index register to be added to the 64-bit base register, with optional scaling of the index by the access size. Additionally it allows for sign-extension or zero-extension of a 32-bit value within an index register, followed by optional scaling.

C1.3.2 PC-relative addressing

The A64 instruction set has support for position-independent code and data addressing:

- PC-relative literal loads have an offset range of $\pm 1\text{MB}$.
- Process state flag and compare based conditional branches have a range of $\pm 1\text{MB}$. Test bit conditional branches have a restricted range of $\pm 32\text{KB}$.
- Unconditional branches, including branch and link, have a range of $\pm 128\text{MB}$.

PC-relative Load/Store operations, and address generation with a range of $\pm 4\text{GB}$ can be performed using two instructions.

C1.3.3 Load/Store addressing modes

Load/Store addressing modes in the A64 instruction set require a 64-bit base address from a general-purpose register X0-X30 or the current stack pointer, SP, with an optional immediate or register offset. [Table C1-6](#) shows the assembler syntax for the complete set of Load/Store addressing modes.

Table C1-6 A64 Load/Store addressing modes

Addressing Mode	Offset		
	Immediate	Register	Extended Register
Base register only (no offset)	[base{, #0}]	-	-
Base plus offset	[base{, #imm}]	[base, Xm{, LSL #imm}]	[base, Wm, (S U)XTW {#imm}]
Pre-indexed	[base, #imm]!	-	-
Post-indexed	[base], #imm	[base], Xm ^a	-
Literal (PC-relative)	label	-	-

a. The post-indexed by register offset mode can be used with the SIMD Load/Store structure instructions described in [Load/Store Vector on page C2-137](#). Otherwise the post-indexed by register offset mode is not available.

Some types of Load/Store instruction support only a subset of the Load/Store addressing modes listed in [Table C1-6](#) on page C1-118. Details of the supported modes are as follows:

- Base plus offset addressing means that the address is the value in the 64-bit base register plus an offset.
- Pre-indexed addressing means that the address is the sum of the value in the 64-bit base register and an offset, and the address is then written back to the base register.
- Post-indexed addressing means that the address is the value in the 64-bit base register, and the sum of the address and the offset is then written back to the base register.
- Literal addressing means that the address is the value of the 64-bit program counter for this instruction plus a 19-bit signed word offset. This means that it is a 4 byte aligned address within $\pm 1\text{MB}$ of the address of this instruction with no offset. Literal addressing can only be used for loads of at least 32 bits and for prefetch instructions. The PC cannot be referenced using any other addressing modes. The syntax for labels is specific to individual toolchains.
- An immediate offset can be unsigned or signed, and scaled or unscaled, depending on the type of Load/Store instruction. When the immediate offset is scaled it is encoded as a multiple of the transfer size, although the assembly language always uses a byte offset, and the assembler or disassembler performs the necessary conversion. The usable byte offsets therefore depend on the type of Load/Store instruction and the transfer size.

[Table C1-7](#) shows the offset and the type of Load/Store instruction.

Table C1-7 Immediate offsets and the type of Load/Store instruction

Offset bits	Sign	Scaling	Write-Back	Load/Store type
0	-	-	-	Exclusive/acquire/release
7	Signed	Scaled	Optional	Register pair
9	Signed	Unscaled	Optional	Single register
12	Unsigned	Scaled	No	Single register

- A register offset means that the offset is the 64 bits from a general-purpose register, X_m , optionally scaled by the transfer size, in bytes, if LSL $\#imm$ is present and where imm must be equal to $\log_2(\text{transfer_size})$.
- An extended register offset means that offset is the bottom 32 bits from a general-purpose register W_m , sign-extended or zero-extended to 64 bits, and then scaled by the transfer size if so indicated by $\#imm$, where imm must be equal to $\log_2(\text{transfer_size})$. An assembler must accept W_m or X_m as an extended register offset, but W_m is preferred for disassembly.
- Generating an address lower than the value in the base register requires a negative signed immediate offset or a register offset holding a negative value.
- When stack alignment checking is enabled by system software and the base register is the SP, the current stack pointer must be initially quadword aligned, that is aligned to 16 bytes. Misalignment generates a Stack Alignment fault. The offset does not have to be a multiple of 16 bytes unless the specific Load/Store instruction requires this. SP can not be used as a register offset.

Address calculation

General-purpose arithmetic instructions can calculate the result of most addressing modes and write the address to a general-purpose register or, in most cases, to the current stack pointer.

Table C1-8 shows the arithmetic instructions that can compute addressing modes.

Table C1-8 Arithmetic instructions to compute addressing modes

Addressing Form	Offset		
	Immediate	Register	Extended Register
Base register (no offset)	MOV Xd SP, base	-	-
Base plus offset	ADD Xd SP, base, #imm or SUB Xd SP, base, #imm	ADD <Xd SP>, base, Xm{,LSL#imm}	ADD <Xd SP>, base, Wm,(S U)XT(W H B) {#imm}
Pre-indexed	-	-	-
Post-indexed	-	-	-
Literal (PC-relative)	ADR Xd, label	-	-

Note

- To calculate a base plus immediate offset the ADD instructions defined in [Arithmetic \(immediate\) on page C2-140](#) accept an unsigned 12-bit immediate offset, with an optional left shift by 12. This means that a single ADD instruction cannot support the full range of byte offsets available to a single register Load/Store with a scaled 12-bit immediate offset. For example, a quadword LDR effectively has a 16-bit byte offset. To calculate an address with a byte offset that requires more than 12 bits it is necessary to use two ADD instructions. The following example shows this:

```
ADD Xd, base, #(imm & 0xFFF)
ADD Xd, Xd, #(imm>>12), LSL #12
```

- To calculate a base plus extended register offset, the ADD instructions defined in [Arithmetic \(extended register\) on page C2-145](#) provide a superset of the addressing mode that also supports sign-extension or zero-extension of a byte or halfword value with any shift amount between 0 and 4, for example:

```
ADD Xd, base, Wm, SXTW #3 // Xd = base + (SignExtend(Wm) LSL 3)
ADD Xd, base, Wm, UXTH #4 // Xd = base + (ZeroExtend(Wm<15:0>) LSL 4)
```

- If the same extended register offset is used by more than one Load/Store instruction, then, depending on the implementation, it might be more efficient to calculate the extended and scaled intermediate result just once, and then re-use it as a simple register offset. The extend and scale calculation can be performed using the SBFIZ and UBFIZ bitfield instructions defined in [Bitfield move on page C2-142](#), for example:

```
SBFIZ Xd, Xm, #3, #32 //Xd = "Wm, SXTW #3"
UBFIZ Xd, Xm, #4, #16 //Xd = "Wm, UXTH #4"
```

C1.4 Instruction aliases

Some instructions have an associated *architecture alias* that is used for disassembly of the encoding when the associated conditions are met. Architecture alias instructions are included in the alphabetic lists of instruction types and clearly presented as an alias form in descriptions for the individual instructions.

Chapter C2

A64 Instruction Set Overview

This chapter provides an overview of the A64 instruction set. It contains the following sections:

- *Branches, Exception generating, and System instructions* on page C2-124.
- *Loads and stores* on page C2-129.
- *Data processing - immediate* on page C2-140.
- *Data processing - register* on page C2-145.
- *Data processing - SIMD and floating-point* on page C2-152.

For a structured breakdown of instruction groups by encoding, see [Chapter C3 A64 Instruction Set Encoding](#).

C2.1 Branches, Exception generating, and System instructions

This section describes the branch, exception generating, and system instructions. It contains the following subsections:

- [Conditional branch](#).
- [Unconditional branch \(immediate\)](#).
- [Unconditional branch \(register\) on page C2-125](#).
- [Exception generation and return on page C2-125](#).
- [System register instructions on page C2-126](#).
- [System instructions on page C2-126](#).
- [Hint instructions on page C2-127](#).
- [Barriers and CLREX instructions on page C2-127](#).

For information about the encoding structure of the instructions in this instruction group, see [Branches, exception generating and system instructions on page C3-173](#).

———— Note —————

Software must:

- Use only BLR or BL to perform a nested subroutine call when that subroutine is expected to return to the immediately following instruction, that is, the instruction with the address of the BLR or BL instruction incremented by four.
- Use only RET to perform a subroutine return, when that subroutine is expected to have been entered by a BL or BLR instruction.
- Use only B, BR, or the instructions listed in [Table C2-1](#) to perform a control transfer that is not a subroutine call or subroutine return described in this *Note*.

C2.1.1 Conditional branch

Conditional branches change the flow of execution depending on the current state of the condition flags or the value in a general-purpose register. See [Table C1-1 on page C1-114](#) for a list of the condition codes that can be used for cond.

[Table C2-1](#) shows the Conditional branch instructions.

Table C2-1 Conditional branch instructions

Mnemonic	Instruction	Branch offset range from the PC	See
B.cond	Branch conditionally	±1MB	B.cond on page C5-420
CBNZ	Compare and branch if nonzero	±1MB	CBNZ on page C5-434
CBZ	Compare and branch if zero	±1MB	CBZ on page C5-435
TBNZ	Test bit and branch if nonzero	±32KB	TBNZ on page C5-754
TBZ	Test bit and branch if zero	±32KB	TBZ on page C5-755

C2.1.2 Unconditional branch (immediate)

Unconditional branch (immediate) instructions change the flow of execution unconditionally by adding an immediate offset with a range of ±128MB to the value of the program counter that fetched the instruction. The BL instruction also writes the address of the sequentially following instruction to general-purpose register, X30.

Table C2-2 shows the Unconditional branch instructions with an immediate branch offset.

Table C2-2 Unconditional branch instructions (immediate)

Mnemonic	Instruction	Immediate branch offset range from the PC	See
B	Branch unconditionally	±128MB	B on page C5-421
BL	Branch with link	±128MB	BL on page C5-430

C2.1.3 Unconditional branch (register)

Unconditional branch (register) instructions change the flow of execution unconditionally by setting the program counter to the value in a general-purpose register. The BLR instruction also writes the address of the sequentially following instruction to general-purpose register X30. The RET instruction behaves identically to BR, but provides an additional hint to the PE that this is a return from a subroutine. Table C2-3 shows Unconditional branch instructions that jump directly to an address held in a general-purpose register.

Table C2-3 Unconditional branch instructions (register)

Mnemonic	Instruction	See
BLR	Branch with link to register	BLR on page C5-431
BR	Branch to register	BR on page C5-432
RET	Return from subroutine	RET on page C5-642

C2.1.4 Exception generation and return

This section describes the following exceptions:

- [Exception generating.](#)
- [Exception return on page C2-126.](#)
- [Debug state on page C2-126.](#)

Exception generating

Table C2-4 shows the Exception generating instructions.

Table C2-4 Exception generating instructions

Mnemonic	Instruction	See
BRK	Software breakpoint instruction	BRK on page C5-433
HLT	Halting software breakpoint instruction	HLT on page C5-484
HVC	Generate exception targeting Exception level 2	HVC on page C5-485
SMC	Generate exception targeting Exception level 3	SMC on page C5-663
SVC	Generate exception targeting Exception level 1	SVC on page C5-748

Exception return

Table C2-5 shows the Exception return instructions.

Table C2-5 Exception return instructions

Mnemonic	Instruction	See
ERET	Exception return using current ELR and SPSR	ERET on page C5-479

Debug state

Table C2-6 shows the Debug state instructions.

Table C2-6 Debug state instructions

Mnemonic	Instruction	See
DCPS1	Debug switch to Exception level 1	DCPS1 on page C5-466
DCPS2	Debug switch to Exception level 2	DCPS2 on page C5-467
DCPS3	Debug switch to Exception level 3	DCPS3 on page C5-468
DRPS	Debug restore PE state	DRPS on page C5-471

C2.1.5 System register instructions

For detailed information about the System register instructions, see [Chapter C4 The AArch64 System Instruction Class](#). Table C2-7 shows the System register instructions.

Table C2-7 System register instructions

Mnemonic	Instruction	See
MRS	Move system register to general-purpose register	MRS on page C5-610
MSR	<ul style="list-style-type: none"> • Move general-purpose register to system register • Move immediate to PE state field 	<ul style="list-style-type: none"> • MSR (register) on page C5-613 • MSR (immediate) on page C5-611

C2.1.6 System instructions

For detailed information about the System instructions, see [Chapter C4 The AArch64 System Instruction Class](#).

Table C2-8 shows the System instructions.

Table C2-8 System instructions

Mnemonic	Instruction	See
SYS	System instruction	SYS on page C5-752
SYSL	System instruction with result	SYSL on page C5-753
IC	Instruction cache maintenance	IC on page C5-486 and Table C4-2 on page C4-237

Table C2-8 System instructions (continued)

Mnemonic	Instruction	See
DC	Data cache maintenance	DC on page C5-465 and Table C4-2 on page C4-237
AT	Address translation	AT on page C5-419 and Table C4-3 on page C4-238
TLBI	TLB Invalidate	TLBI on page C5-756 and Table C4-4 on page C4-239

C2.1.7 Hint instructions

[Table C2-9](#) shows the Hint instructions.

Table C2-9 Hint instructions

Mnemonic	Instruction	See
NOP	No operation	NOP on page C5-622
YIELD	Yield hint	YIELD on page C5-773.
WFE	Wait for event	WFE on page C5-771.
WFI	Wait for interrupt	WFI on page C5-772
SEV	Send event	SEV on page C5-660
SEVL	Send event local	SEVL on page C5-661
HINT	Unallocated hint	HINT on page C5-482

C2.1.8 Barriers and CLREX instructions

[Table C2-10](#) shows the barrier and CLREX instructions.

Table C2-10 Barriers and CLREX instructions

Mnemonic	Instruction	See
CLREX	Clear exclusive monitor	CLREX on page C5-442
DSB	Data synchronization barrier	DSB on page C5-472
DMB	Data memory barrier	DMB on page C5-469
ISB	Instruction synchronization barrier	ISB on page C5-487

[Table C2-11](#) shows the allocated options for the data barriers. UNALLOCATED values behave as SY, but might be allocated to other barrier functionality in future revisions of the architecture.

Table C2-11 Allocated values for the data barriers

Option	Shareability Domain	Ordered-accesses (before-after)
OSHL	Outer Shareable	Load-Load/Store
OSHS		Store-Store
OSH		Any-Any

Table C2-11 Allocated values for the data barriers (continued)

Option	Shareability Domain	Ordered-accesses (before-after)
NSHLD	Non-shareable	Load-Load/Store
NSHST		Store-Store
NSH		Any-Any
ISHLD	Inner Shareable	Load-Load/Store
ISHST		Store-Store
ISH		Any-Any
LD	Full System	Load-Load/Store
ST		Store-Store
SY		Any-Any

C2.2 Loads and stores

This section describes the Load/Store instructions. It contains the following subsections:

- [Load/Store register](#).
- [Load/Store register \(unscaled offset\)](#) on page C2-130.
- [Load/Store Pair](#) on page C2-131.
- [Load/Store Non-temporal Pair](#) on page C2-132.
- [Load/Store Unprivileged](#) on page C2-132.
- [Load-Exclusive/Store-Exclusive](#) on page C2-133.
- [Load-Acquire/Store-Release](#) on page C2-134.
- [Load/Store scalar SIMD and floating-point](#) on page C2-134.
- [Load/Store Vector](#) on page C2-137.
- [Prefetch memory](#) on page C2-138.

Apart from Load-Exclusive, Store-Exclusive, Load-Acquire, and Store-Release, addresses can have any alignment unless strict alignment checking is enabled, that is if `SCTLR_ELx.A == 1`.

The additional control bits `SCTLR_ELx.SA` and `SCTLR_EL1.SA0` control whether the stack pointer must be quadword aligned when used as a base register. See [Stack pointer alignment checking](#) on page D1-1424. Using a misaligned stack pointer generates a Stack Alignment exception.

For information about the encoding structure of the instructions in this instruction group, see [Loads and stores](#) on page C3-176.

———— Note ————

In some cases, Load/Store instructions can lead to CONSTRAINED UNPREDICTABLE behavior. See [Appendix A Constraints on AArch64 UNPREDICTABLE behavior](#).

C2.2.1 Load/Store register

The Load/Store register instructions support the following addressing modes:

- Base plus a scaled 12-bit unsigned immediate offset or base plus an unscaled 9-bit signed immediate offset.
- Base plus a 64-bit register offset, optionally scaled.
- Base plus a 32-bit extended register offset, optionally scaled.
- Pre-indexed by an unscaled 9-bit signed immediate offset.
- Post-indexed by an unscaled 9-bit signed immediate offset.
- PC-relative literal for loads of 32 bits or more.

See also [Load/Store addressing modes](#) on page C1-118.

If a Load instruction specifies writeback and the register being loaded is also the base register, then one of the following behaviors occurs:

- The instruction is UNALLOCATED.
- The instruction is treated as a NOP.
- The instruction performs the load using the specified addressing mode and the base register becomes UNKNOWN. In addition, if an exception occurs during the execution of such an instruction, the base address might be corrupted so that the instruction cannot be repeated.

If a Store instruction performs a writeback and the register that is stored is also the base register, then one of the following behaviors occurs:

- The instruction is UNALLOCATED.
- The instruction is treated as a NOP.

- The instruction performs the store to the designated register using the specified addressing mode, but the value stored is UNKNOWN.

Table C2-12 shows the Load/Store Register instructions.

Table C2-12 Load/Store register instructions

Mnemonic	Instruction	See
LDR	<ul style="list-style-type: none"> • Load register (register offset) • Load register (immediate offset) • Load register (PC-relative literal) 	<ul style="list-style-type: none"> • LDR (register) on page C5-521 • LDR (immediate) on page C5-517 • LDR (literal) on page C5-520
LDRB	<ul style="list-style-type: none"> • Load byte (register offset) • Load byte (immediate offset) 	<ul style="list-style-type: none"> • LDRB (register) on page C5-527 • LDRB (immediate) on page C5-524
LDRSB	<ul style="list-style-type: none"> • Load signed byte (register offset) • Load signed byte (immediate offset) 	<ul style="list-style-type: none"> • LDRSB (register) on page C5-539 • LDRSB (immediate) on page C5-536
LDRH	<ul style="list-style-type: none"> • Load halfword (register offset) • Load halfword (immediate offset) 	<ul style="list-style-type: none"> • LDRH (register) on page C5-533 • LDRH (immediate) on page C5-530
LDRSH	<ul style="list-style-type: none"> • Load signed halfword (register offset) • Load signed halfword (immediate offset) 	<ul style="list-style-type: none"> • LDRSH (register) on page C5-545 • LDRSH (immediate) on page C5-542
LDRSW	<ul style="list-style-type: none"> • Load signed word (register offset) • Load signed word (immediate offset) • Load signed word (PC-relative literal) 	<ul style="list-style-type: none"> • LDRSW (register) on page C5-552 • LDRSW (immediate) on page C5-548 • LDRSW (literal) on page C5-551
STR	<ul style="list-style-type: none"> • Store register (register offset) • Store register (immediate offset) 	<ul style="list-style-type: none"> • STR (register) on page C5-697 • STR (immediate) on page C5-694
STRB	<ul style="list-style-type: none"> • Store byte (register offset) • Store byte (immediate offset) 	<ul style="list-style-type: none"> • STRB (register) on page C5-703 • STRB (immediate) on page C5-700
STRH	<ul style="list-style-type: none"> • Store halfword (register offset) • Store halfword (immediate offset) 	<ul style="list-style-type: none"> • STRH (register) on page C5-709 • STRH (immediate) on page C5-706

C2.2.2 Load/Store register (unscaled offset)

The Load/Store register instructions with an unscaled offset support only one addressing mode:

- Base plus an unscaled 9-bit signed immediate offset.

See [Load/Store addressing modes on page C1-118](#).

The Load/Store register (unscaled offset) instructions are required to disambiguate this instruction class from the Load/Store register instruction forms that support an addressing mode of base plus a scaled, unsigned 12-bit immediate offset, because that can represent some offset values in the same range.

The ambiguous immediate offsets are byte offsets that are both:

- In the range 0-255, inclusive.
- Naturally aligned to the access size.

Other byte offsets in the range -256 to 255 inclusive are unambiguous. An assembler program translating a Load/Store instruction, for example LDR, is required to encode an unambiguous offset using the unscaled 9-bit offset form, and to encode an ambiguous offset using the scaled 12-bit offset form. A programmer might force the

generation of the unscaled 9-bit form by using one of the mnemonics in [Table C2-13](#). ARM recommends that a disassembler outputs all unscaled 9-bit offset forms using one of these mnemonics, but unambiguous offsets can be output using a Load/Store single register mnemonic, for example, LDR.

[Table C2-13](#) shows the Load/Store register instructions with an unscaled offset.

Table C2-13 Load/Store register (unscaled offset) instructions

Mnemonic	Instruction	See
LDUR	Load register (unscaled offset)	LDUR on page C5-567
LDURB	Load byte (unscaled offset)	LDURB on page C5-569
LDURSB	Load signed byte (unscaled offset)	LDURSB on page C5-573
LDURH	Load halfword (unscaled offset)	LDURH on page C5-571
LDURSH	Load signed halfword (unscaled offset)	LDURSH on page C5-575
LDURSW	Load signed word (unscaled offset)	LDURSW on page C5-577
STUR	Store register (unscaled offset)	STUR on page C5-718
STURB	Store byte (unscaled offset)	STURB on page C5-720
STURH	Store halfword (unscaled offset)	STURH on page C5-722

C2.2.3 Load/Store Pair

The Load/Store Pair instructions support the following addressing modes:

- Base plus a scaled 7-bit signed immediate offset.
- Pre-indexed by a scaled 7-bit signed immediate offset.
- Post-indexed by a scaled 7-bit signed immediate offset.

See also [Load/Store addressing modes on page C1-118](#).

If a Load Pair instruction specifies the same register for the two register that are being loaded, then one of the following behaviors occurs:

- The instruction is UNALLOCATED.
- The instruction is treated as a NOP.
- The instruction performs all the loads using the specified addressing mode and the register that is loaded takes an UNKNOWN value.

If a Load Pair instruction specifies writeback and one of the registers being loaded is also the base register, then one of the following behaviors occurs:

- The instruction is UNALLOCATED.
- The instruction is treated as a NOP.
- The instruction performs all of the loads using the specified addressing mode, and the base register becomes UNKNOWN. In addition, if an exception occurs during the instruction, the base address might be corrupted so that the instruction cannot be repeated.

If a Store Pair instruction performs a writeback and one of the registers being stored is also the base register, then one of the following behaviors occurs:

- The instruction is UNALLOCATED.
- The instruction is treated as a NOP.

- The instruction performs all the stores of the registers indicated by the specified addressing mode, but the value stored for the base register is UNKNOWN.

Table C2-14 shows the Load/Store Pair instructions.

Table C2-14 Load/Store Pair instructions

Mnemonic	Instruction	See
LDP	Load Pair	LDP on page C5-511
LDPSW	Load Pair signed words	LDPSW on page C5-514
STP	Store Pair	STP on page C5-691

C2.2.4 Load/Store Non-temporal Pair

The Load/Store Non-temporal Pair instructions support only one addressing mode:

- Base plus a scaled 7-bit signed immediate offset.

See [Load/Store addressing modes on page C1-118](#).

The Load/Store Non-temporal Pair instructions provide a hint to the memory system that an access is non-temporal or streaming, and unlikely to be repeated in the near future. This means that data caching is not required. However, depending on the memory type, the instructions might permit memory reads to be preloaded and memory writes to be gathered to accelerate bulk memory transfers.

In addition there is a special exception to the normal memory ordering rules. If an address dependency exists between two memory reads, and a Load Non-temporal Pair instruction generated the second read, then in the absence of any other barrier mechanism to achieve order, the memory accesses can be observed in any order by the other observers within the shareability domain of the memory addresses being accessed.

If a Load Non-Temporal Pair instruction specifies the same register for the two registers that are being loaded, then one of the following can occur:

- The instruction is UNALLOCATED.
- The instruction is treated as a NOP.
- The instruction performs all the loads using the specified addressing mode and the register that is loaded takes an UNKNOWN value.

Table C2-15 shows the Load/Store Non-temporal Pair instructions.

Table C2-15 Load/Store Non-temporal Pair instructions

Mnemonic	Instruction	See
LDNP	Load Non-temporal Pair	LDNP on page C5-509
STNP	Store Non-temporal Pair	STNP on page C5-689

C2.2.5 Load/Store Unprivileged

The Load/Store Unprivileged instructions support only one addressing mode:

- Base plus an unscaled 9-bit signed immediate offset.

See [Load/Store addressing modes on page C1-118](#).

The Load/Store Unprivileged instructions can be used when the PE is at EL1 to perform unprivileged memory accesses. If the PE is executing in any other Exception level, then a normal memory access for that level is performed.

Table C2-16 shows the Load/Store Unprivileged instructions.

Table C2-16 Load-Store Unprivileged instructions

Mnemonic	Instruction	See
LDTR	Load Unprivileged register	LDTR on page C5-555
LDTRB	Load Unprivileged byte	LDTRB on page C5-557
LDTRSB	Load Unprivileged signed byte	LDTRSB on page C5-561
LDTRH	Load Unprivileged halfword	LDTRH on page C5-559
LDTRSH	Load Unprivileged signed halfword	LDTRSH on page C5-563
LDTRSW	Load Unprivileged signed word	LDTRSW on page C5-565
STTR	Store Unprivileged register	STTR on page C5-712
STTR	Store Unprivileged register	STTR on page C5-712
STTRB	Store Unprivileged byte	STTRB on page C5-714
STTRH	Store Unprivileged halfword	STTRH on page C5-716

C2.2.6 Load-Exclusive/Store-Exclusive

The Load-Exclusive/Store-Exclusive instructions support only one addressing mode:

- Base register with no offset.

See [Load/Store addressing modes on page C1-118](#).

The Load-Exclusive instructions mark the physical address being accessed as an exclusive access. This exclusive access mark is checked by the Store-Exclusive instruction, permitting the construction of atomic read-modify-write operations on shared memory variables, semaphores, mutexes, and spinlocks. See [Load-Acquire Exclusive, Store-Release Exclusive and barriers on page AppxF-4839](#).

Natural alignment is required and an unaligned address generates an Alignment fault. Memory accesses generated by Load-Exclusive pair or Store-Exclusive pair instructions must be aligned to the size of the pair. When a Store-Exclusive pair succeeds, it causes a single-copy atomic update of the entire memory location.

Table C2-17 shows the Load-Exclusive/Store-Exclusive instructions.

Table C2-17 Load-Exclusive/Store-Exclusive instructions

Mnemonic	Instruction	See
LDXR	Load Exclusive register	LDXR on page C5-582
LDXRB	Load Exclusive byte	LDXRB on page C5-585
LDXRH	Load Exclusive halfword	LDXRH on page C5-588
LDXP	Load Exclusive pair	LDXP on page C5-579
STXR	Store Exclusive register	STXR on page C5-727
STXRB	Store Exclusive byte	STXRB on page C5-730
STXRH	Store Exclusive halfword	STXRH on page C5-733
STXP	Store Exclusive pair	STXP on page C5-724

C2.2.7 Load-Acquire/Store-Release

The Load-Acquire/Store-Release instructions support only one addressing mode:

- Base register with no offset.

See [Load/Store addressing modes on page C1-118](#).

The Load-Acquire/Store-Release instructions can remove the requirement to use the explicit **DMB** memory barrier instruction. For more information about the ordering of Load-Acquire/Store-Release, see [Load-Acquire, Store-Release on page B2-87](#).

[Table C2-18](#) shows the Non-exclusive Load-Acquire/Store-Release instructions.

Table C2-18 Non-exclusive Load-Acquire and Store-Release instructions

Mnemonic	Instruction	See
LDAR	Load-Acquire register	LDAR on page C5-488
LDARB	Load-Acquire byte	LDARB on page C5-491
LDARH	Load-Acquire halfword	LDARH on page C5-494
STLR	Store-Release register	STLR on page C5-668
STLRB	Store-Release byte	STLRB on page C5-671
STLRH	Store-Release halfword	STLRH on page C5-674

[Table C2-19](#) shows the Exclusive Load-Acquire/Store-Release instructions.

Table C2-19 Exclusive Load-Acquire and Store-Release instructions

Mnemonic	Instruction	See
LDAXR	Load-Acquire Exclusive register	LDAXR on page C5-500
LDAXRB	Load-Acquire Exclusive byte	LDAXRB on page C5-503
LDAXRH	Load-Acquire Exclusive halfword	LDAXRH on page C5-506
LDAXP	Load-Acquire Exclusive pair	LDAXP on page C5-497
STLXR	Store-Release Exclusive register	STLXR on page C5-680
STLXRB	Store-Release Exclusive byte	STLXRB on page C5-683
STLXRH	Store-Release Exclusive halfword	STLXRH on page C5-686
STLXP	Store-Release Exclusive pair	STLXP on page C5-677

C2.2.8 Load/Store scalar SIMD and floating-point

The Load/Store scalar SIMD and floating-point instructions operate on scalar values in the SIMD and floating-point register file as described in [SIMD and floating-point scalar register names on page C1-116](#). The memory addressing modes available, described in [Load/Store addressing modes on page C1-118](#), are identical to the general-purpose register Load/Store instructions, and like those instructions permit arbitrary address alignment unless strict alignment checking is enabled. However, unlike the Load/Store instructions that transfer general-purpose registers, Load/Store scalar SIMD and floating-point instructions make no guarantee of atomicity, even when the address is naturally aligned to the size of the data.

Load/Store scalar SIMD and floating-point register

The Load/Store scalar SIMD and floating-point register instructions support the following addressing modes:

- Base plus a scaled 12-bit unsigned immediate offset or base plus unscaled 9-bit signed immediate offset.
- Base plus 64-bit register offset, optionally scaled.
- Base plus 32-bit extended register offset, optionally scaled.
- Pre-indexed by an unscaled 9-bit signed immediate offset.
- Post-indexed by an unscaled 9-bit signed immediate offset.
- PC-relative literal for loads of 32 bits or more.

For more information on the addressing modes, see [Load/Store addressing modes](#) on page C1-118.

Note

The unscaled 9-bit signed immediate offset address mode requires its own instruction form, see [Load/Store scalar SIMD and floating-point register \(unscaled offset\)](#).

Table C2-20 shows the Load/Store instructions for a single SIMD and floating-point register.

Table C2-20 Load/Store single SIMD and floating-point register instructions

Mnemonic	Instruction	See
LDR	<ul style="list-style-type: none"> • Load scalar SIMD&FP register (register offset) • Load scalar SIMD&FP register (immediate offset) • Load scalar SIMD &FP register (PC-relative literal) 	<ul style="list-style-type: none"> • LDR (register, SIMD&FP) on page C6-1061 • LDR (immediate, SIMD&FP) on page C6-1057 • LDR (literal, SIMD&FP) on page C6-1060
STR	<ul style="list-style-type: none"> • Store scalar SIMD &FP register (register offset) • Store scalar SIMD &FP register (immediate offset) 	<ul style="list-style-type: none"> • STR (register, SIMD&FP) on page C6-1290 • STR (immediate, SIMD&FP) on page C6-1287

Load/Store scalar SIMD and floating-point register (unscaled offset)

The Load /Store scalar SIMD and floating-point register instructions support only one addressing mode:

- Base plus an unscaled 9-bit signed immediate offset.

See also [Load/Store addressing modes](#) on page C1-118.

The Load/Store scalar SIMD and floating-point register (unscaled offset) instructions are required to disambiguate this instruction class from the Load/Store single SIMD and floating-point instruction forms that support an addressing mode of base plus a scaled, unsigned 12-bit immediate offset. This is similar to the Load/Store register (unscaled offset) instructions, that disambiguate this instruction class from the Load/Store register instruction, see [Load/Store register \(unscaled offset\)](#) on page C2-130.

Table C2-21 shows the Load/Store SIMD and floating-point register instructions with an unscaled offset.

Table C2-21 Load/Store SIMD and floating-point register instructions

Mnemonic	Instruction	See
LDUR	Load scalar SIMD&FP register (unscaled offset)	LDUR (SIMD&FP) on page C6-1064
STUR	Store scalar SIMD&FP register (unscaled offset)	STUR (SIMD&FP) on page C6-1293

Load/Store SIMD and Floating-point register pair

The Load/Store SIMD and floating-point register pair instructions support the following addressing modes:

- Base plus a scaled 7-bit signed immediate offset.
- Pre-indexed by a scaled 7-bit signed immediate offset.
- Post-indexed by a scaled 7-bit signed immediate offset.

See also [Load/Store addressing modes on page C1-118](#).

If a Load pair instruction specifies the same register for the two registers that are being loaded, then one of the following occurs:

- The instruction is UNALLOCATED.
- The instruction is treated as a NOP.
- The instruction performs all of the loads using the specified addressing mode and the register being loaded takes an UNKNOWN value.

Table C2-22 shows the Load/Store SIMD and floating-point register pair instructions.

Table C2-22 Load/Store SIMD and floating-point register pair instructions

Mnemonic	Instruction	See
LDP	Load pair of scalar SIMD&FP registers	LDP (SIMD&FP) on page C6-1054
STP	Store pair of scalar SIMD&FP registers	STP (SIMD&FP) on page C6-1284

Load/Store SIMD and Floating-point Non-temporal pair

The Load/Store SIMD and Floating-point Non-temporal pair instructions support only one addressing mode:

- Base plus a scaled 7-bit signed immediate offset.

See also [Load/Store addressing modes on page C1-118](#).

The Load/Store Non-temporal pair instructions provide a hint to the memory system that an access is non-temporal or streaming, and unlikely to be repeated in the near future. This means that data caching is not required. However, depending on the memory type, the instructions might permit memory reads to be preloaded and memory writes to be gathered to accelerate bulk memory transfers.

In addition there is a special exception to the normal memory ordering rules. If an address dependency exists between two memory reads, and a Load non-temporal pair instruction generated the second read, then in the absence of any other barrier mechanism to achieve order, those memory accesses can be observed in any order by the other observers within the shareability domain of the memory addresses being accessed.

If a Load Non-temporal pair instruction specifies the same register for the two registers that are being loaded, then one of the following occurs:

- The instruction is UNALLOCATED.
- The instruction is treated as a NOP.
- The instruction performs all the loads using the specified addressing mode and the register that is loaded takes an UNKNOWN value.

Table C2-23 shows the Load/Store SIMD and floating-point Non-temporal pair instructions.

Table C2-23 Load/Store SIMD and floating-point Non-temporal pair instructions

Mnemonic	Instruction	See
LDNP	Load pair of scalar SIMD&FP registers	LDNP (SIMD&FP) on page C6-1052
STNP	Store pair of scalar SIMD&FP registers	STNP (SIMD&FP) on page C6-1282

C2.2.9 Load/Store Vector

The Vector Load/Store structure instructions support the following addressing modes:

- Base register only.
- Post-indexed by a 64-bit register.
- Post-indexed by an immediate, equal to the number of bytes transferred.

Load/Store vector instructions, like other Load/Store instructions, allow any address alignment, unless strict alignment checking is enabled. If strict alignment checking is enabled, then alignment checking to the size of the element is performed. However, unlike the Load/Store instructions that transfer general-purpose registers, the Load/Store vector instructions do not guarantee atomicity, even when the address is naturally aligned to the size of the element.

Load/Store structures

Table C2-24 shows the Load/Store structure instructions. A post-increment immediate offset, if present, must be 8, 16, 24, 32, 48, or 64, depending on the number of elements transferred.

Table C2-24 Load/Store multiple structures instructions

Mnemonic	Instruction	See
LD1	<ul style="list-style-type: none"> • Load single 1-element structure to one lane of one register • Load multiple 1-element structures to one register or to two, three or four consecutive registers 	<ul style="list-style-type: none"> • LD1 (single structure) on page C6-1019 • LD1 (multiple structures) on page C6-1016
LD2	<ul style="list-style-type: none"> • Load single 2-element structure to one lane of two consecutive registers • Load multiple 2-element structures to two consecutive registers 	<ul style="list-style-type: none"> • LD2 (single structure) on page C6-1028 • LD2 (multiple structures) on page C6-1025
LD3	<ul style="list-style-type: none"> • Load single 3-element structure to one lane of three consecutive registers • Load multiple 3-element structures to three consecutive registers 	<ul style="list-style-type: none"> • LD3 (single structure) on page C6-1037 • LD3 (multiple structures) on page C6-1034
LD4	<ul style="list-style-type: none"> • Load single 4-element structure to one lane of four consecutive registers • Load multiple 4-element structures to four consecutive registers 	<ul style="list-style-type: none"> • LD4 (single structure) on page C6-1046 • LD4 (multiple structures) on page C6-1043
ST1	<ul style="list-style-type: none"> • Store single 1-element structure from one lane of one register • Store multiple 1-element structures from one register, or from two, three or four consecutive registers 	<ul style="list-style-type: none"> • ST1 (single structure) on page C6-1261 • ST1 (multiple structures) on page C6-1258

Table C2-24 Load/Store multiple structures instructions (continued)

Mnemonic	Instruction	See
ST2	<ul style="list-style-type: none"> Store single 2-element structure from one lane of two consecutive registers Store multiple 2-element structures from two consecutive registers 	<ul style="list-style-type: none"> ST2 (single structure) on page C6-1267 ST2 (multiple structures) on page C6-1264
ST3	<ul style="list-style-type: none"> Store single 3-element structure from one lane of three consecutive registers Store multiple 3-element structures from three consecutive registers 	<ul style="list-style-type: none"> ST3 (single structure) on page C6-1273 ST3 (multiple structures) on page C6-1270
ST4	<ul style="list-style-type: none"> Store single 4-element structure from one lane of four consecutive registers Store multiple 4-element structures from four consecutive registers 	<ul style="list-style-type: none"> ST4 (single structure) on page C6-1279 ST4 (multiple structures) on page C6-1276

Load single structure and replicate

Table C2-25 shows the Load single structure and replicate instructions. A post-increment immediate offset, if present, must be 1, 2, 3, 4, 6, 8, 12, 16, 24, or 32, depending on the number of elements transferred.

Table C2-25 Load single structure and replicate instructions

Mnemonic	Instruction	See
LD1R	Load single 1-element structure and replicate to all lanes of one register	LD1R on page C6-1022
LD2R	Load single 2-element structure and replicate to all lanes of two registers	LD2R on page C6-1031
LD3R	Load single 3-element structure and replicate to all lanes of three registers	LD3R on page C6-1040
LD4R	Load single 4-element structure and replicate to all lanes of four registers	LD4R on page C6-1049

C2.2.10 Prefetch memory

The Prefetch memory instructions support the following addressing modes:

- Base plus a scaled 12-bit unsigned immediate offset or base plus an unscaled 9-bit signed immediate offset.
- Base plus a 64-bit register offset. This can be optionally scaled by 8-bits, for example LSL#3.
- Base plus a 32-bit extended register offset. This can be optionally scaled by 8-bits.
- PC-relative literal.

The prefetch memory instructions signal to the memory system that memory accesses from a specified address are likely to occur in the near future. The memory system can respond by taking actions that are expected to speed up the memory access when they do occur, such as pre-loading the specified address into one or more caches. Because these signals are only hints, it is valid for the PE to treat any or all prefetch instructions as a NOP.

Because they are hints to the memory system, the operation of a PRFM instruction cannot cause a synchronous exception. However, a memory operation performed as a result of one of these memory system hints might in exceptional cases trigger an asynchronous event, and thereby influence the execution of the PE. An example of an asynchronous event that might be triggered is a System error interrupt.

A PRFM instruction can only have an effect on software visible structures, such as caches and translation lookaside buffers associated with memory locations that can be accessed by reads, writes, or execution as defined in the translation regime of the current Exception level.

A PRFM instruction is guaranteed not to access Device memory.

A PRFM instruction using a PLI hint must not result in any access that could not be performed by the PE speculatively fetching an instruction. Therefore, if all associated MMUs are disabled, a PLI hint cannot access any memory location that cannot be accessed by instruction fetches.

The PRFM instructions require an additional <prfop> operand to be specified, which must be one of the following:

PLDL1KEEP, PLDL1STRM, PLDL2KEEP, PLDL2STRM, PLDL3KEEP, PLDL3STRM
 PSTL1KEEP, PSTL1STRM, PSTL2KEEP, PSTL2STRM, PSTL3KEEP, PSTL3STRM
 PLIL1KEEP, PLIL1STRM, PLIL2KEEP, PLIL2STRM, PLIL3KEEP, PLIL3STRM

<prfop> is defined as <type><target><policy>.

Here:

<type> Is one of:
 PLD Prefetch for load.
 PST Prefetch for store.
 PLI Preload instructions.
 <target> Is one of:
 L1 Level 1 cache.
 L2 Level 2 cache.
 L3 Level 3 cache.
 <policy> Is one of:
 KEEP Retained or temporal prefetch, allocated in the cache normally.
 STRM Streaming or non-temporal prefetch, for data that is used only once.

PRFUM explicitly uses the unscaled 9-bit signed immediate offset addressing mode, as described in *Load/Store register (unscaled offset)* on page C2-130.

Table C2-26 shows the Prefetch memory instructions.

Table C2-26 Prefetch memory instructions

Mnemonic	Instruction	See
PRFM	<ul style="list-style-type: none"> Prefetch memory (register offset) Prefetch memory (immediate offset) Prefetch memory (PC-relative offset) 	<ul style="list-style-type: none"> <i>PRFM (register)</i> on page C5-634 <i>PRFM (immediate)</i> on page C5-629 <i>PRFM (literal)</i> on page C5-632
PRFUM	Prefetch memory (unscaled offset)	<i>PRFUM</i> on page C5-637

C2.3 Data processing - immediate

This section describes the instruction groups for data processing with immediate operands. It contains the following subsections:

- [Arithmetic \(immediate\)](#).
- [Logical \(immediate\)](#).
- [Move \(wide immediate\)](#) on page C2-141.
- [Move \(immediate\)](#) on page C2-141.
- [PC-relative address calculation](#) on page C2-142.
- [Bitfield move](#) on page C2-142.
- [Bitfield insert and extract](#) on page C2-143
- [Extract register](#) on page C2-143.
- [Shift \(immediate\)](#) on page C2-143.
- [Sign-extend and Zero-extend](#) on page C2-143.

For information about the encoding structure of the instructions in this instruction group, see [Data processing - immediate](#) on page C3-193.

C2.3.1 Arithmetic (immediate)

The Arithmetic (immediate) instructions accept a 12-bit unsigned immediate value, optionally shifted left by 12 bits.

The Arithmetic (immediate) instructions that do not set condition flags can read from and write to the current stack pointer. The flag setting instructions can read from the stack pointer, but they cannot write to it.

[Table C2-27](#) shows the Arithmetic instructions with an immediate offset.

Table C2-27 Arithmetic instructions with an immediate

Mnemonic	Instruction	See
ADD	Add	ADD (immediate) on page C5-396
ADDS	Add and set flags	ADDS (immediate) on page C5-402
SUB	Subtract	SUB (immediate) on page C5-738
SUBS	Subtract and set flags	SUBS (immediate) on page C5-744
CMP	Compare	CMP (immediate) on page C5-451.
CMN	Compare negative	CMN (immediate) on page C5-447

C2.3.2 Logical (immediate)

The Logical (immediate) instructions accept a bitmask immediate value that is a 32-bit pattern or a 64-bit pattern viewed as a vector of identical elements of size $e = 2, 4, 8, 16, 32$ or 64 bits. Each element contains the same sub-pattern, that is a single run of 1 to $(e - 1)$ nonzero bits from bit 0 followed by zero bits, then rotated by 0 to $(e - 1)$ bits. This mechanism can generate 5334 unique 64-bit patterns as 2667 pairs of pattern and their bitwise inverse.

———— **Note** —————

Values that consist of only zeros or only ones cannot be described in this way.

The Logical (immediate) instructions that do not set the condition flags can write to the current stack pointer, for example to align the stack pointer in a function prologue.

Note

Apart from ANDS, and its TST alias, Logical (immediate) instructions do not set the condition flags. However, the final results of a bitwise operation can be tested by a CBZ, CBNZ, TBZ, or TBNZ conditional branch.

Table C2-28 shows the Logical immediate instructions.

Table C2-28 Logical immediate instructions

Mnemonic	Instruction	See
AND	Bitwise AND	AND (immediate) on page C5-408
ANDS	Bitwise AND and set flags	ANDS (immediate) on page C5-412
EOR	Bitwise exclusive OR	EOR (immediate) on page C5-476
ORR	Bitwise inclusive OR	ORR (immediate) on page C5-625
TST	Test bits	TST (immediate) on page C5-757

C2.3.3 Move (wide immediate)

The Move (wide immediate) instructions insert a 16-bit immediate, or inverted immediate, into a 16-bit aligned position in the destination register. The value of the other bits in the destination register depends on the variant used. The optional shift amount can be any multiple of 16 that is smaller than the register size.

Table C2-29 shows the Move (wide immediate) instructions.

Table C2-29 Move (wide immediate) instructions

Mnemonic	Instruction	See
MOVZ	Move wide with zero	MOVZ on page C5-608
MOVN	Move wide with NOT	MOVN on page C5-606
MOVK	Move wide with keep	MOVK on page C5-605

C2.3.4 Move (immediate)

The Move (immediate) instructions are aliases for a single MOVZ, MOVN, or ORR (immediate with zero register), instruction to load an immediate value into the destination register. An assembler must permit a signed or unsigned immediate, as long as its binary representation can be generated using one of these instructions, and an assembler error results if the immediate cannot be generated in this way. On disassembly it is unspecified whether the immediate is output as a signed or an unsigned value.

If there is a choice between the MOVZ, MOVN, and ORR instruction to encode the immediate, then an assembler must prefer MOVZ to MOVN, and MOVZ or MOVN to ORR, to ensure reversability. A disassembler must output ORR (immediate with zero register) MOVZ, and MOVN, as a MOV mnemonic except that the underlying instruction must be used when:

- ORR has an immediate that can be generated by a MOVZ or MOVN instruction.
- A MOVN instruction has an immediate that can be encoded by MOVZ.
- MOVZ #0 or MOVN #0 have a shift amount other than LSL #0.

Table C2-30 shows the Move (immediate) instructions.

Table C2-30 Move (immediate) instructions

Mnemonic	Instruction	See
MOV	<ul style="list-style-type: none"> Move (inverted wide immediate) Move (wide immediate) Move (bitmask immediate) 	<ul style="list-style-type: none"> <i>MOV (inverted wide immediate)</i> on page C5-601 <i>MOV (wide immediate)</i> on page C5-602 <i>MOV (bitmask immediate)</i> on page C5-603

C2.3.5 PC-relative address calculation

The ADR instruction adds a signed, 21-bit immediate to the value of the program counter that fetched this instruction, and then writes the result to a general-purpose register. This permits the calculation of any byte address within $\pm 1\text{MB}$ of the current PC.

The ADRP instruction shifts a signed, 21-bit immediate left by 12 bits, adds it to the value of the program counter with the bottom 12 bits cleared to zero, and then writes the result to a general-purpose register. This permits the calculation of the address at a 4KB aligned memory region. In conjunction with an ADD (immediate) instruction, or a Load/Store instruction with a 12-bit immediate offset, this allows for the calculation of, or access to, any address within $\pm 4\text{GB}$ of the current PC.

———— **Note** ————

The term *page* used in the ADRP description is short-hand for the 4KB memory region, and is not related to the virtual memory translation granule size.

Table C2-31 shows the instructions used for PC-relative address calculations are as follows:

Table C2-31 PC-relative address calculation instructions

Mnemonic	Instruction	See
ADRP	Compute address of 4KB page at a PC-relative offset	<i>ADRP</i> on page C5-407
ADR	Compute address of label at a PC-relative offset.	<i>ADR</i> on page C5-406

C2.3.6 Bitfield move

The Bitfield move instructions copy a bitfield of constant width from bit 0 in the source register to a constant bit position in the destination register, or from a constant bit position in the source register to bit 0 in the destination register. The remaining bits in the destination register are set as follows:

- For BFM the remaining bits are unchanged.
- For UBFM the lower bits, if any, and upper bits, if any, are set to zero.
- For SBFM the lower bits, if any, are set to zero, and the upper bits, if any, are set to a copy of the most-significant bit in the copied bitfield.

Table C2-32 shows the Bitfield move instructions.

Table C2-32 Bitfield move instructions

Mnemonic	Instruction	See
BFM	Bitfield move	<i>BFM</i> on page C5-423
SBFM	Signed bitfield move	<i>SBFM</i> on page C5-656
UBFM	Unsigned bitfield move (32-bit)	<i>UBFM</i> on page C5-760

C2.3.7 Bitfield insert and extract

The Bitfield insert and extract instructions are implemented as aliases of the Bitfield move instructions. [Table C2-33](#) shows the Bitfield insert and extract aliases.

Table C2-33 Bitfield insert and extract instructions

Mnemonic	Instruction	See
BFI	Bitfield insert	BFI on page C5-422
BFXIL	Bitfield extract and insert low	BFXIL on page C5-425
SBFIZ	Signed bitfield insert in zero	SBFIZ on page C5-655
SBFX	Signed bitfield extract	SBFX on page C5-658
UBFIZ	Unsigned bitfield insert in zero	UBFIZ on page C5-759
UBFX	Unsigned bitfield extract	UBFX on page C5-762

C2.3.8 Extract register

Depending on the register width of the operands, the Extract register instruction copies a 32-bit or 64-bit field from a constant bit position within a double-width value formed by the concatenation of a pair of source registers to a destination register.

[Table C2-34](#) shows the Extract (immediate) instructions.

Table C2-34 Extract register instructions

Mnemonic	Instruction	See
EXTR	Extract register from pair	EXTR on page C5-480

C2.3.9 Shift (immediate)

Shifts and rotates by a constant amount are implemented as aliases of the Bitfield move or Extract register instructions. The shift or rotate amount must be in the range 0 to one less than the register width of the instruction, inclusive.

[Table C2-35](#) shows the aliases that can be used as immediate shift and rotate instructions.

Table C2-35 Aliases for immediate shift and rotate instructions

Mnemonic	Instruction	See
ASR	Arithmetic shift right	ASR (immediate) on page C5-417
LSL	Logical shift left	LSL (immediate) on page C5-592
LSR	Logical shift right	LSR (immediate) on page C5-595
ROR	Rotate right	ROR (immediate) on page C5-648

C2.3.10 Sign-extend and Zero-extend

The Sign-extend and Zero-extend instructions are implemented as aliases of the Bitfield move instructions.

[Table C2-36 on page C2-144](#) shows the aliases that can be used as zero-extend and sign-extend instructions.

Table C2-36 Zero-extend and sign-extend instructions

Mnemonic	Instruction	See
SXTB	Sign-extend byte	SXTB on page C5-749
SXTH	Sign-extend halfword	SXTH on page C5-750
SXTW	Sign-extend word	SXTW on page C5-751
UXTB	Unsigned extend byte	UXTB on page C5-769
UXTH	Unsigned extend halfword	UXTH on page C5-770

C2.4 Data processing - register

This section describes the instruction groups for data processing with all register operands. It contains the following subsections:

- [Arithmetic \(shifted register\)](#).
- [Arithmetic \(extended register\)](#).
- [Arithmetic with carry](#) on page C2-146.
- [Logical \(shifted register\)](#) on page C2-147.
- [Move \(register\)](#) on page C2-148.
- [Shift \(register\)](#) on page C2-148.
- [Multiply and divide](#) on page C2-148.
- [CRC32](#) on page C2-150.
- [Bit operation](#) on page C2-150.
- [Conditional select](#) on page C2-150.
- [Conditional comparison](#) on page C2-151.

For information about the encoding structure of the instructions in this instruction group, see [Data processing - register](#) on page C3-196.

C2.4.1 Arithmetic (shifted register)

The Arithmetic (shifted register) instructions apply an optional shift operator to the second source register value before performing the arithmetic operation. The register width of the instruction controls whether the new bits are fed into the intermediate result on a right shift or rotate at bit[63] or bit[31].

The shift operators LSL, ASR and LSR accept an immediate shift amount in the range 0 to one less than the register width of the instruction, inclusive.

Omitting the shift operator implies LSL #0, which means that there is no shift. A disassembler must not output LSL #0. However, a disassembler must output all other shifts by zero.

The current stack pointer, SP or WSP, cannot be used with this class of instructions. See [Arithmetic \(extended register\)](#) for arithmetic instructions that can operate on the current stack pointer.

Table C2-37 shows the Arithmetic (shifted register) instructions.

Table C2-37 Arithmetic (shifted register) instructions

Mnemonic	Instruction	See
ADD	Add	ADD (shifted register) on page C5-398
ADDS	Add and set flags	ADDS (shifted register) on page C5-404
SUB	Subtract	SUB (shifted register) on page C5-740
SUBS	Subtract and set flags	SUBS (shifted register) on page C5-746
CMN	Compare negative	CMN (shifted register) on page C5-448
CMP	Compare	CMP (shifted register) on page C5-452
NEG	Negate	NEG on page C5-618
NEGS	Negate and set flags	NEGS on page C5-619

C2.4.2 Arithmetic (extended register)

The extended register instructions provide an optional sign-extension or zero-extension of a portion of the second source register value, followed by an optional left shift by a constant amount of 1-4, inclusive.

The extended shift is described by the mandatory extend operator SXTB, SXTL, SXTW, UXTB, UXTH, or UXTW. This is followed by an optional left shift amount. If the shift amount is not specified, the default shift amount is zero. A disassembler must not output a shift amount of zero.

For 64-bit instruction forms the additional operators UXTX and SXTX use all 64 bits of the second source register with an optional shift. In that case ARM recommends UXTX as the operator. If and only if at least one register is SP, ARM recommends use of the LSL operator name, rather than UXTX, and when the shift amount is also zero then both the operator and the shift amount can be omitted.

For 32-bit instruction forms the operators UXTW and SXTW both use all 32 bits of the second source register with an optional shift. In that case ARM recommends UXTW as the operator. If and only if at least one register is WSP, ARM recommends use of the LSL operator name, rather than UXTW, and when the shift amount is also zero then both the operator and the shift amount can be omitted.

The non-flag setting variants of the extended register instruction permit the use of the current stack pointer as either the destination register and the first source register. The flag setting variants only permit the stack pointer to be used as the first source register.

In the 64-bit form of these instructions the final register operand is written as *Wm* for all except the UXTX/LSL and SXTX extend operators. For example:

```
CMP X4, W5, SXTW
ADD X1, X2, W3, UXTB #2
SUB SP, SP, X1          // SUB SP, SP, X1, UXTX #0
```

Table C2-38 shows the Arithmetic (extended register) instructions.

Table C2-38 Arithmetic (extended register) instructions

Mnemonic	Instruction	See
ADD	Add	<i>ADD (extended register)</i> on page C5-394
ADDS	Add and set flags	<i>ADDS (extended register)</i> on page C5-400
SUB	Subtract	<i>SUB (extended register)</i> on page C5-736
SUBS	Subtract and set flags	<i>SUBS (extended register)</i> on page C5-742
CMN	Compare negative	<i>CMN (extended register)</i> on page C5-445
CMP	Compare	<i>CMP (extended register)</i> on page C5-449

C2.4.3 Arithmetic with carry

The Arithmetic with carry instructions accept two source registers, with the carry flag as an additional input to the calculation. They do not support shifting of the second source register.

Table C2-39 shows the Arithmetic with carry instructions

Table C2-39 Arithmetic with carry instructions

Mnemonic	Instruction	See
ADC	Add with carry	<i>ADC</i> on page C5-392
ADCS	Add with carry and set flags	<i>ADCS</i> on page C5-393
SBC	Subtract with carry	<i>SBC</i> on page C5-651

Table C2-39 Arithmetic with carry instructions (continued)

Mnemonic	Instruction	See
SBCS	Subtract with carry and set flags	SBCS on page C5-653
NGC	Negate with carry	NGC on page C5-620
NGCS	Negate with carry and set flags	NGCS on page C5-621

C2.4.4 Logical (shifted register)

The Logical (shifted register) instructions apply an optional shift operator to the second source register value before performing the main operation. The register width of the instruction controls whether the new bits are fed into the intermediate result on a right shift or rotate at bit[63] or bit[31].

The shift operators LSL, ASR, LSR and ROR accept a constant immediate shift amount in the range 0 to one less than the register width of the instruction, inclusive.

Omitting the shift operator and amount implies LSL #0, which means that there is no shift. A disassembler must not output LSL #0. However, a disassembler must output all other shifts by zero.

———— **Note** —————

Apart from ANDS, TST and BICS the logical instructions do not set the condition flags, but the final result of a bit operation can usually directly control a CBZ, CBNZ, TBZ, or TBNZ conditional branch.

[Table C2-40](#) shows the Logical (shifted register) instructions.

Table C2-40 Logical (shifted register) instructions

Mnemonic	Instruction	See
AND	Bitwise AND	AND (shifted register) on page C5-410
ANDS	Bitwise AND and set flags	ANDS (shifted register) on page C5-414
BIC	Bitwise bit clear	BIC (shifted register) on page C5-426
BICS	Bitwise bit clear and set flags	BICS (shifted register) on page C5-428
EON	Bitwise exclusive OR NOT	EON (shifted register) on page C5-474
EOR	Bitwise exclusive OR	EOR (shifted register) on page C5-477
ORR	Bitwise inclusive OR	ORR (shifted register) on page C5-627
MVN	Bitwise NOT	MVN on page C5-617
ORN	Bitwise inclusive OR NOT	ORN (shifted register) on page C5-623
TST	Test bits	TST (shifted register) on page C5-758

C2.4.5 Move (register)

The Move (register) instructions are aliases for other data processing instructions. They copy a value from a general-purpose register to another general-purpose register or the current stack pointer, or from the current stack pointer to a general-purpose register.

Table C2-41 MOV register instructions

Mnemonic	Instruction	See
MOV	<ul style="list-style-type: none"> Move register Move register to SP or move SP to register 	<ul style="list-style-type: none"> MOV (register) on page C5-604 MOV (to/from SP) on page C5-600

C2.4.6 Shift (register)

In the Shift (register) instructions, the shift amount is the positive value in the second source register modulo the register size. The register width of the instruction controls whether the new bits are fed into the result on a right shift or rotate at bit[63] or bit[31].

[Table C2-42](#) shows the Shift (register) instructions.

Table C2-42 Shift (register) instructions

Mnemonic	Instruction	See
ASRV	Arithmetic shift right variable	ASRV on page C5-418
LSLV	Logical shift left variable	LSLV on page C5-593
LSRV	Logical shift right variable	LSRV on page C5-596
RORV	Rotate right variable	RORV on page C5-650

However, the Shift (register) instructions have a preferred set of aliases that match the shift immediate aliases described in [Shift \(immediate\) on page C2-143](#).

[Table C2-43](#) shows the aliases for Shift (register) instructions.

Table C2-43 Aliases for Variable shift instructions

Mnemonic	Instruction	See
ASR	Arithmetic shift right	ASR (register) on page C5-416
LSL	Logical shift left	LSL (register) on page C5-591
LSR	Logical shift right	LSR (register) on page C5-594
ROR	Rotate right	ROR (register) on page C5-649

C2.4.7 Multiply and divide

This section describes the instructions used for integer multiplication and division. It contains the following subsections:

- [Multiply on page C2-149.](#)
- [Divide on page C2-149.](#)

Multiply

The Multiply instructions write to a single 32-bit or 64-bit destination register, and are built around the fundamental four operand multiply-add and multiply-subtract operation, together with 32-bit to 64-bit widening variants. A 64-bit to 128-bit widening multiple can be constructed with two instructions, using SMULH or UMULH to generate the upper 64 bits. [Table C2-44](#) shows the Multiply instructions.

Table C2-44 Multiply integer instructions

Mnemonic	Instruction	See
MADD	Multiply-add	MADD on page C5-597
MSUB	Multiply-subtract	MSUB on page C5-614
MNEG	Multiply-negate	MNEG on page C5-599
MUL	Multiply	MUL on page C5-616
SMADDL	Signed multiply-add long	SMADDL on page C5-662
SMSUBL	Signed multiply-subtract long	SMSUBL on page C5-665
SMNEGL	Signed multiply-negate long	SMNEGL on page C5-664
SMULL	Signed multiply long	SMULL on page C5-667
SMULH	Signed multiply high	SMULH on page C5-666
UMADDL	Unsigned multiply-add long	UMADDL on page C5-764.
UMSUBL	Unsigned multiply-subtract long	UMSUBL on page C5-766
UMNEGL	Unsigned multiply-negate long	UMNEGL on page C5-765
UMULL	Unsigned multiply long	UMULL on page C5-768
UMULH	Unsigned multiply high	UMULH on page C5-767

Divide

The Divide instructions compute the quotient of a division, rounded towards zero. The remainder can then be computed as (numerator - (quotient × denominator)), using the MSUB instruction.

If a signed integer division ($\text{INT_MIN} / -1$) is performed where INT_MIN is the most negative integer value representable in the selected register size, then the result overflows the signed integer range. No indication of this overflow is produced and the result that is written to the destination register is INT_MIN.

A division by zero results in a zero being written to the destination register, without any indication that the division by zero occurred.

[Table C2-45](#) shows the Divide instructions.

Table C2-45 Divide instructions

Mnemonic	Instruction	See
SDIV	Signed divide	SDIV on page C5-659
UDIV	Unsigned divide	UDIV on page C5-763

C2.4.8 CRC32

The optional CRC32 instructions operate on the general-purpose register file to update a 32-bit CRC value from an input value comprising 1, 2, 4, or 8 bytes. There are two different classes of CRC instructions, CRC32 and CRC32C, that support two commonly used 32-bit polynomials, known as CRC-32 and CRC-32C.

To fit with common usage, the bit order of the values is reversed as part of the operation.

When bits[19:16] of `ID_AA64ISAR0_EL1` are set to `0b0001` the CRC instructions are implemented.

[Table C2-46](#) shows the CRC instructions.

Table C2-46 CRC32 instructions

Mnemonic	Instruction	See
CRC32B	CRC-32 sum from byte	CRC32B , CRC32H , CRC32W , CRC32X on page C5-454
CRC32H	CRC-32 sum from halfword	CRC32B , CRC32H , CRC32W , CRC32X on page C5-454
CRC32W	CRC-32 sum from word	CRC32B , CRC32H , CRC32W , CRC32X on page C5-454
CRC32X	CRC-32 sum from doubleword	CRC32B , CRC32H , CRC32W , CRC32X on page C5-454
CRC32CB	CRC-32C sum from byte	CRC32CB , CRC32CH , CRC32CW , CRC32CX on page C5-455
CRC32CH	CRC-32C sum from halfword	CRC32CB , CRC32CH , CRC32CW , CRC32CX on page C5-455
CRC32CW	CRC-32C sum from word	CRC32CB , CRC32CH , CRC32CW , CRC32CX on page C5-455
CRC32CX	CRC-32C sum from doubleword	CRC32CB , CRC32CH , CRC32CW , CRC32CX on page C5-455

C2.4.9 Bit operation

[Table C2-47](#) shows the Bit operation instructions.

Table C2-47 Bit operation instructions

Mnemonic	Instruction	See
CLS	Count leading sign bits	CLS on page C5-443
CLZ	Count leading zero bits	CLZ on page C5-444
RBIT	Reverse bit order	RBIT on page C5-640
REV	Reverse bytes in register	REV on page C5-643.
REV16	Reverse bytes in halfwords	REV16 on page C5-645
REV32	Reverses bytes in words	REV32 on page C5-647

C2.4.10 Conditional select

The Conditional select instructions select between the first or second source register, depending on the current state of the condition flags. When the named condition is true, the first source register is selected and its value is copied without modification to the destination register. When the condition is false the second source register is selected and its value might not be optionally inverted, negated, or incremented by one, before writing to the destination register.

Other useful conditional set and conditional unary operations are implemented as aliases of the four Conditional select instructions.

Table C2-48 shows the Conditional select instructions.

Table C2-48 Conditional select instructions

Mnemonic	Instruction	See
CSEL	Conditional select	CSEL on page C5-456
CSINC	Conditional select increment	CSINC on page C5-459
CSINV	Conditional select inversion	CSINV on page C5-461
CSNEG	Conditional select negation	CSNEG on page C5-463
CSET	Conditional set	CSET on page C5-457
CSETM	Conditional set mask	CSETM on page C5-458
CINC	Conditional increment	CINC on page C5-440
CINV	Conditional invert	CINV on page C5-441
CNEG	Conditional negate	CNEG on page C5-453

C2.4.11 Conditional comparison

The Conditional comparison instructions provide a conditional select for the NZCV condition flags, setting the flags to the result of an arithmetic comparison of its two source register values if the named input condition is true, or to an immediate value if the input condition is false. There are register and immediate forms. The immediate form compares the source register to a small 5-bit unsigned value.

Table C2-49 shows the Conditional comparison instructions.

Table C2-49 Conditional comparison instructions

Mnemonic	Instruction	See
CCMN	Conditional compare negative (register)	CCMN (register) on page C5-437
CCMN	Conditional compare negative (immediate)	CCMN (immediate) on page C5-436
CCMP	Conditional compare (register)	CCMP (register) on page C5-439
CCMP	Conditional compare (immediate)	CCMP (immediate) on page C5-438

C2.5 Data processing - SIMD and floating-point

This section describes the instruction groups for data processing with SIMD and floating-point register operands.

It contains the following subsections that describe the scalar floating-point data processing instructions:

- [Floating-point move \(register\)](#) on page C2-153.
- [Floating-point move \(immediate\)](#) on page C2-153.
- [Floating-point conversion](#) on page C2-154.
- [Floating-point round to integral](#) on page C2-155.
- [Floating-point multiply-add](#) on page C2-156.
- [Floating-point arithmetic \(one source\)](#) on page C2-156.
- [Floating-point arithmetic \(two sources\)](#) on page C2-156.
- [Floating-point minimum and maximum](#) on page C2-156.
- [Floating-point comparison](#) on page C2-157.
- [Floating-point conditional select](#) on page C2-157.

It also contains the following subsections that describe the SIMD data processing instructions:

- [SIMD move](#) on page C2-158
- [SIMD arithmetic](#) on page C2-158.
- [SIMD compare](#) on page C2-160.
- [SIMD widening and narrowing arithmetic](#) on page C2-161.
- [SIMD unary arithmetic](#) on page C2-162.
- [SIMD by element arithmetic](#) on page C2-164.
- [SIMD permute](#) on page C2-165.
- [SIMD immediate](#) on page C2-165.
- [SIMD shift \(immediate\)](#) on page C2-166.
- [SIMD floating-point and integer conversion](#) on page C2-167.
- [SIMD reduce \(across vector lanes\)](#) on page C2-168.
- [SIMD pairwise arithmetic](#) on page C2-168.
- [SIMD table lookup](#) on page C2-169.
- [Cryptography extensions](#) on page C2-169.

For information about the encoding structure of the instructions in this instruction group, see [Data processing - SIMD and floating point](#) on page C3-203.

For information about the Floating-point exceptions, see [Floating-point Exception traps](#) on page D1-1454.

C2.5.1 Common features of SIMD instructions

A number of SIMD instructions come in three forms:

- **Wide:**
 - This is indicated by the suffix *W*. The element width of the destination register and the first source operand is double that of the second source operand.
- **Long:**
 - This is indicated by the suffix *L*. The element width of the destination register is double that of both source operands.
- **Narrow:**
 - This is indicated by the suffix *N*. The element width of the destination register is half that of both source operands.

Furthermore, each vector form of the instruction is part of a pair, with a second and upper half suffix of 2, to identify the variant of the instruction:

- Where a SIMD operation widens or lengthens a 64-bit vector to a 128-bit vector, the instruction provides a second part operation that can extract the source from the upper 64-bits of the source registers.
- Where a SIMD operation narrows a 128-bit vector to a 64-bit vector, the instruction provides a second-part operation that can pack the result of a second operation into the upper part of the same destination register.

———— **Note** —————

This is referred to as a *lane set specifier*.

C2.5.2 Floating-point move (register)

The Floating-point move (register) instructions copy a scalar floating-point value from one register to another register without performing any conversion.

Some of the Floating-point move (register) instructions overlap with the functionality provided by the Advanced SIMD instructions DUP, INS, and UMOV. However, ARM recommends using the FMOV instructions when operating on scalar floating-point data to avoid the creation of scalar floating-point code that depends on the availability of the Advanced SIMD instruction set.

Table C2-50 shows the Floating-point move (register) instructions.

Table C2-50 Floating-point move (register) instructions

Mnemonic	Instruction	See
FMOV	<ul style="list-style-type: none"> • Floating-point move register without conversion • Floating-point move to or from general-purpose register without conversion 	<ul style="list-style-type: none"> • FMOV (register) on page C6-962 • FMOV (general) on page C6-963

C2.5.3 Floating-point move (immediate)

The Floating-point move (immediate) instructions convert a small constant immediate floating-point value into a single-precision or double-precision scalar floating-point value in a SIMD and floating-point register.

The floating-point constant can be specified either in decimal notation, such as 12.0 or -1.2e1, or as a string beginning with 0x followed by a hexadecimal representation of the IEEE 754 single-precision or double-precision encoding. ARM recommends that a disassembler uses the decimal notation, provided that this displays the value precisely.

The floating-point value must be expressible as $(\pm n/16 \times 2^r)$, where n is an integer in the range $16 \leq n \leq 31$ and r is an integer in the range of $-3 \leq r \leq 4$, that is a normalized binary floating-point encoding with one sign bit, four bits of fraction, and a 3-bit exponent.

———— **Note** —————

This encoding does not include the floating-point constant 0.0. There are several instructions that can store zero in a SIMD and floating-point register, but ARM recommends that software uses FMOV Sd, WZR or FMOV Dd, XZR to provide consistency across a range of microarchitectures.

Table C2-51 shows the Floating-point move (immediate) instruction:

Table C2-51 Floating-point move (immediate) instruction

Mnemonic	Instruction	See
FMOV	Floating-point move immediate	FMOV (scalar, immediate) on page C6-965

C2.5.4 Floating-point conversion

The following subsections describe the conversion of floating-point values:

- [Convert floating-point precision.](#)
- [Convert between floating-point and integer or fixed-point.](#)

Convert floating-point precision

These instructions convert a floating-point scalar with one precision to a floating-point scalar with a different precision, using the current rounding mode as specified by [FPCR.RMode](#).

[Table C2-52](#) shows the Floating-point precision conversion instruction.

Table C2-52 Floating-point precision conversion instruction

Mnemonic	Instruction	See
FCVT	Floating-point convert precision (scalar)	FCVT on page C6-868

Convert between floating-point and integer or fixed-point

These instructions convert a floating-point scalar in a SIMD and floating-point register to or from a signed or unsigned integer or fixed-point in a general-purpose register. For a fixed-point value, a final immediate operand indicates that the general-purpose register holds a fixed-point number and *fbits* indicates the number of bits after the binary point. *fbits* is in the range 1- 32 inclusive for a 32-bit general-purpose register name, and 1-64 inclusive for a 64-bit general-purpose register name.

These instructions generate the Invalid Operation exception, in response to a floating-point input of NaN, infinity, or a numerical value that cannot be represented within the destination register. An out-of-range integer or fixed-point result is saturated to the size of the destination register. A numeric result that differs from the input generates an Inexact exception. When flush-to-zero mode is enabled, zero replaces a denormal input and generates an Input Denormal exception.

[Table C2-53](#) shows the Floating-point and fixed-point conversion instructions.

Table C2-53 Floating-point and integer or fixed-point conversion instructions

Mnemonic	Instruction	See
FCVTAS	Floating-point scalar convert to signed integer, rounding to nearest with ties to away (scalar form)	FCVTAS (scalar) on page C6-872
FCVTAU	Floating-point scalar convert to unsigned integer, rounding to nearest with ties to away (scalar form)	FCVTAU (scalar) on page C6-876
FCVTMS	Floating-point scalar convert to signed integer, rounding toward minus infinity (scalar form)	FCVTMS (scalar) on page C6-881.
FCVTMU	Floating-point scalar convert to unsigned integer, rounding toward minus infinity (scalar form)	FCVTMU (scalar) on page C6-885
FCVTNS	Floating-point scalar convert to signed integer, rounding to nearest with ties to even (scalar form)	FCVTNS (scalar) on page C6-890.
FCVTNU	Floating-point scalar convert to unsigned integer, rounding to nearest with ties to even (scalar form)	FCVTNU (scalar) on page C6-894
FCVTPS	Floating-point scalar convert to signed integer, rounding toward positive infinity (scalar form)	FCVTPS (scalar) on page C6-898

Table C2-53 Floating-point and integer or fixed-point conversion instructions (continued)

Mnemonic	Instruction	See
FCVTPU	Floating-point scalar convert to unsigned integer, rounding toward positive infinity (scalar form)	FCVTPU (scalar) on page C6-902
FCVTZS	<ul style="list-style-type: none"> Floating-point scalar convert to signed integer, rounding toward zero (scalar form) Floating-point convert to signed fixed-point, rounding toward zero (scalar form) 	<ul style="list-style-type: none"> FCVTZS (scalar, integer) on page C6-912 FCVTZS (scalar, fixed-point) on page C6-910
FCVTZU	<ul style="list-style-type: none"> Floating-point scalar convert to unsigned integer, rounding toward zero (scalar form) Floating-point scalar convert to unsigned fixed-point, rounding toward zero (scalar form) 	<ul style="list-style-type: none"> FCVTZU (scalar, integer) on page C6-920 FCVTZU (scalar, fixed-point) on page C6-918
SCVTF	<ul style="list-style-type: none"> Signed integer scalar convert to floating-point, using the current rounding mode (scalar form) Signed fixed-point convert to floating-point, using the current rounding mode (scalar form) 	<ul style="list-style-type: none"> SCVTF (vector, integer) on page C6-1128 SCVTF (scalar, fixed-point) on page C6-1130
UCVTF	<ul style="list-style-type: none"> Unsigned integer scalar convert to floating-point, using the current rounding mode (scalar form) Unsigned fixed-point convert to floating-point, using the current rounding mode (scalar form) 	<ul style="list-style-type: none"> UCVTF (vector, integer) on page C6-1325 UCVTF (scalar, fixed-point) on page C6-1327

C2.5.5 Floating-point round to integral

The Floating-point round to integral instructions round a floating-point value to an integral floating-point value of the same size.

These instructions generate the Invalid Operation exception in response to a signaling NaN input, or the Input Denormal exception in response to a denormal input when flush-to-zero mode is enabled. The FRINTX instruction can also generate the Inexact exception if the result is numeric and does not have the same numerical value as the input. A zero input gives a zero result with the same sign, an infinite input gives an infinite result with the same sign, and a NaN is propagated as in normal floating-point arithmetic.

[Table C2-54](#) shows the Floating-point round to integral instructions.

Table C2-54 Floating-point round to integral instructions

Mnemonic	Instruction	See
FRINTA	Floating-point round to integral, to nearest with ties to away	FRINTA (scalar) on page C6-991
FRINTI	Floating-point round to integral, using current rounding mode	FRINTI (scalar) on page C6-993.
FRINTM	Floating-point round to integral, toward minus infinity	FRINTM (scalar) on page C6-995
FRINTN	Floating-point round to integral, to nearest with ties to even	FRINTN (scalar) on page C6-997
FRINTP	Floating-point round to integral, toward positive infinity	FRINTP (scalar) on page C6-999
FRINTX	Floating-point round to integral exact, using current rounding mode	FRINTX (scalar) on page C6-1001.
FRINTZ	Floating-point round to integral, toward zero	FRINTZ (scalar) on page C6-1003

C2.5.6 Floating-point multiply-add

Table C2-55 shows the Floating-point multiply-add instructions that require three source register operands.

Table C2-55 Floating-point multiply-add instructions

Mnemonic	Instruction	See
FMADD	Floating-point scalar fused multiply-add	<i>FMADD</i> on page C6-924
FMSUB	Floating-point scalar fused multiply-subtract	<i>FMSUB</i> on page C6-966
FNMADD	Floating-point scalar negated fused multiply-add	<i>FNMADD</i> on page C6-980
FNMSUB	Floating-point scalar negated fused multiply-subtract	<i>FNMSUB</i> on page C6-982

C2.5.7 Floating-point arithmetic (one source)

Table C2-56 shows the Floating-point arithmetic instructions that require a single source register operand.

Table C2-56 Floating-point arithmetic instructions with one source register

Mnemonic	Instructions	See
FABS	Floating-point scalar absolute value	<i>FABS (scalar)</i> on page C6-838
FNEG	Floating-point scalar negate	<i>FNEG (scalar)</i> on page C6-979
FSQRT	Floating-point scalar square root	<i>FSQRT (scalar)</i> on page C6-1009

C2.5.8 Floating-point arithmetic (two sources)

Table C2-57 shows the Floating-point arithmetic instructions that require two source register operands.

Table C2-57 Floating-point arithmetic instructions with two source registers

Mnemonic	Instruction	See
FADD	Floating-point scalar add	<i>FADD (scalar)</i> on page C6-844
FDIV	Floating-point scalar divide	<i>FDIV (scalar)</i> on page C6-923
FMUL	Floating-point scalar multiply	<i>FMUL (scalar)</i> on page C6-972
FNMUL	Floating-point scalar multiply-negate	<i>FNMUL</i> on page C6-984
FSUB	Floating-point scalar subtract	<i>FSUB (scalar)</i> on page C6-1011

C2.5.9 Floating-point minimum and maximum

The $\min(x, y)$ and $\max(x, y)$ operations return a quiet NaN when either x or y is NaN. In flush-to-zero mode subnormal operands are flushed to zero before comparison, and if the result of the comparison is the flushed value, then a zero value is returned. Where both x and y are zero, or subnormal values flushed to zero, with different signs, then $+0.0$ is returned by $\max()$ and -0.0 by $\min()$.

The $\minNum(x, y)$ and $\maxNum(x, y)$ operations follow the IEEE 754-2008 standard and return the numerical operand when one operand is numerical and the other a quiet NaN. Apart from this additional handling of a single quiet NaN the result is then identical to $\min(x, y)$ and $\max(x, y)$.

Table C2-58 shows the Floating-point instructions that can perform floating-point minimum and maximum operations.

Table C2-58 Floating-point minimum and maximum instructions

Mnemonic	Instruction	See
FMAX	Floating-point scalar maximum	<i>FMAX (scalar)</i> on page C6-928.
FMAXNM	Floating-point scalar maximum number	<i>FMAXNM (scalar)</i> on page C6-931
FMIN	Floating-point scalar minimum	<i>FMIN (scalar)</i> on page C6-942
FMINNM	Floating-point scalar minimum number	<i>FMINNM (scalar)</i> on page C6-945

C2.5.10 Floating-point comparison

These instructions set the NZCV condition flags in PSTATE, based on the result of a comparison of two operands. If the floating-point comparisons are *unordered*, where one or both operands are a form of NaN, the C and V bits are set to 1 and the N and Z bits are cleared to 0.

———— **Note** —————

The NZCV flags in the [FPSR](#) are associated with AArch32 state. The A64 floating-point comparison instructions do not change the condition flags in the [FPSR](#).

For the conditional Floating-point comparison instructions, if the condition is TRUE, the flags are updated to the result of the comparison, otherwise the flags are updated to the immediate value that is defined in the instruction encoding.

The quiet compare instructions generate an Invalid Operation exception if either of the source operands is a signaling NaN. The signaling compare instructions generate an Invalid Operation exception if either of the source operands is any type of NaN.

Table C2-59 shows the Floating-point comparison instructions.

Table C2-59 Floating-point comparison instructions

Mnemonic	Instruction	See
FCMP	Floating-point quiet compare	<i>FCMP</i> on page C6-865.
FCMPE	Floating-point signaling compare	<i>FCMPE</i> on page C6-866.
FCCMP	Floating-point conditional quiet compare	<i>FCCMP</i> on page C6-847
FCCMPE	Floating-point conditional signaling compare	<i>FCCMPE</i> on page C6-848.

C2.5.11 Floating-point conditional select

Table C2-60 shows the Floating-point conditional select instructions.

Table C2-60 Floating-point conditional select instructions

Mnemonic	Instruction	See
FCSEL	Floating-point scalar conditional select	<i>FCSEL</i> on page C6-867

C2.5.12 SIMD move

The functionality of some data movement instructions overlaps with that provided by the scalar floating-point FMOV instructions described in *Floating-point move (register)* on page C2-153.

Table C2-61 shows the SIMD move instructions.

Table C2-61 SIMD move instructions

Mnemonic	Instruction	See
DUP	<ul style="list-style-type: none"> Duplicate vector element to vector or scalar Duplicate general-purpose register to vector 	<ul style="list-style-type: none"> <i>DUP (element)</i> on page C6-828 <i>DUP (general)</i> on page C6-830
INS	<ul style="list-style-type: none"> Insert vector element from another vector element Insert vector element from general-purpose register <p style="text-align: center;">————— Note ————— Normally disassembled as MOV.</p>	<ul style="list-style-type: none"> <i>INS (element)</i> on page C6-1012 <i>INS (general)</i> on page C6-1014
MOV	<ul style="list-style-type: none"> Move vector element to vector element Move general-purpose register to vector element Move vector element to scalar Move vector element to general-purpose register 	<ul style="list-style-type: none"> <i>MOV (element)</i> on page C6-1075 <i>MOV (from general)</i> on page C6-1076 <i>MOV (scalar)</i> on page C6-1074 <i>MOV (to general)</i> on page C6-1078
UMOV	Unsigned move vector element to general-purpose register	<i>UMOV</i> on page C6-1349
SMOV	Signed move vector element to general-purpose register	<i>SMOV</i> on page C6-1170

C2.5.13 SIMD arithmetic

Table C2-62 shows the SIMD arithmetic instructions.

Table C2-62 SIMD arithmetic instructions

Mnemonic	Instruction	See
ADD	Add (vector and scalar form)	<i>ADD (vector)</i> on page C6-782
AND	Bitwise AND (vector form)	<i>AND (vector)</i> on page C6-793
BIC	Bitwise bit clear (register) (vector form)	<i>BIC (vector, register)</i> on page C6-796
BIF	Bitwise insert if false (vector form)	<i>BIF</i> on page C6-797
BIT	Bitwise insert if true (vector form)	<i>BIT</i> on page C6-799
BSL	Bitwise select (vector form)	<i>BSL</i> on page C6-801
EOR	Bitwise exclusive OR (vector form)	<i>EOR (vector)</i> on page C6-832
FABD	Floating-point absolute difference (vector and scalar form)	<i>FABD</i> on page C6-835
FADD	Floating-point add (vector form)	<i>FADD (scalar)</i> on page C6-844
FDIV	Floating-point divide (vector form)	<i>FDIV (vector)</i> on page C6-922
FMAX	Floating-point maximum (vector form)	<i>FMAXP (vector)</i> on page C6-937
FMAXNM	Floating-point maximum number (vector form)	<i>FMAXNM (vector)</i> on page C6-929

Table C2-62 SIMD arithmetic instructions (continued)

Mnemonic	Instruction	See
FMIN	Floating-point minimum (vector form)	<i>FMIN (vector)</i> on page C6-940
FMINNM	Floating-point minimum number (vector form)	<i>FMINNM (vector)</i> on page C6-943
FMLA	Floating-point fused multiply-add (vector form)	<i>FMLA (vector)</i> on page C6-956
FMLS	Floating-point fused multiply-subtract (vector form)	<i>FMLS (vector)</i> on page C6-959
FMUL	Floating-point multiply (vector form)	<i>FMUL (vector)</i> on page C6-971
FMULX	Floating-point multiply extended (vector and scalar form)	<i>FMULX</i> on page C6-976
FRECPS	Floating-point reciprocal step (vector and scalar form)	<i>FRECPS</i> on page C6-987
FRSQRTS	Floating-point reciprocal square root step (vector and scalar form)	<i>FRSQRTS</i> on page C6-1006
FSUB	Floating-point subtract (vector form)	<i>FSUB (vector)</i> on page C6-1010
MLA	Multiply-add (vector form)	<i>MLA (vector)</i> on page C6-1068
MLS	Multiply-subtract (vector form)	<i>MLS (vector)</i> on page C6-1072
MUL	Multiply (vector form)	<i>MUL (vector)</i> on page C6-1083
MOV	Move vector register (vector form)	<i>MOV (vector)</i> on page C6-1077.
ORN	Bitwise inclusive OR NOT (vector form)	<i>ORN (vector)</i> on page C6-1091
ORR	Bitwise inclusive OR (register) (vector form)	<i>ORR (vector, register)</i> on page C6-1094
PMUL	Polynomial multiply (vector form)	<i>PMUL</i> on page C6-1095
SABA	Signed absolute difference and accumulate (vector form)	<i>SABA</i> on page C6-1111
SABD	Signed absolute difference (vector form)	<i>SABD</i> on page C6-1114
SHADD	Signed halving add (vector form)	<i>SHADD</i> on page C6-1144
SHSUB	Signed halving subtract (vector form)	<i>SHSUB</i> on page C6-1151
SMAX	Signed maximum (vector form)	<i>SMAX</i> on page C6-1154
SMIN	Signed minimum (vector form)	<i>SMIN</i> on page C6-1158
SQADD	Signed saturating add (vector and scalar form)	<i>SQADD</i> on page C6-1178
SQDMULH	Signed saturating doubling multiply returning high half (vector and scalar form)	<i>SQDMULH (vector)</i> on page C6-1195
SQRSHL	Signed saturating rounding shift left (register) (vector and scalar form)	<i>SQRSHL</i> on page C6-1209
SQRDMULH	Signed saturating rounding doubling multiply returning high half (vector and scalar form)	<i>SQRDMULH (vector)</i> on page C6-1207
SQSHL	Signed saturating shift left (register) (vector and scalar form)	<i>SQSHL (register)</i> on page C6-1220
SQSUB	Signed saturating subtract (vector and scalar form)	<i>SQSUB</i> on page C6-1231
SRHADD	Signed rounding halving add (vector form)	<i>SRHADD</i> on page C6-1237
SRSHL	Signed rounding shift left (register) (vector and scalar form)	<i>SRSHL</i> on page C6-1240
SSHL	Signed shift left (register) (vector and scalar form)	<i>SSHL</i> on page C6-1246

Table C2-62 SIMD arithmetic instructions (continued)

Mnemonic	Instruction	See
SUB	Subtract (vector and scalar form)	SUB (vector) on page C6-1295
UABA	Unsigned absolute difference and accumulate (vector form)	UABA on page C6-1308
UABD	Unsigned absolute difference (vector form)	UABD on page C6-1311
UHADD	Unsigned halving add (vector form)	UHADD on page C6-1331
UHSUB	Unsigned halving subtract (vector form)	UHSUB on page C6-1332
UMAX	Unsigned maximum (vector form)	UMAX on page C6-1333
UMIN	Unsigned minimum (vector form)	UMIN on page C6-1337
UQADD	Unsigned saturating add (vector and scalar form)	UQADD on page C6-1355
UQRSHL	Unsigned saturating rounding shift left (register) (vector and scalar form)	UQRSHL on page C6-1357
UQSHL	Unsigned saturating shift left (register) (vector and scalar form)	UQSHL (register) on page C6-1365
UQSUB	Unsigned saturating subtract (vector and scalar form)	UQSUB on page C6-1370
URHADD	Unsigned rounding halving add (vector form)	URHADD on page C6-1375
URSHL	Unsigned rounding shift left (register) (vector and scalar form)	URSHL on page C6-1376
USHL	Unsigned shift left (register) (vector and scalar form)	USHL on page C6-1383

C2.5.14 SIMD compare

The SIMD compare instructions compare vector or scalar elements according to the specified condition and set the destination vector element to all ones if the condition holds, or to zero if the condition does not hold.

———— **Note** —————

Some of the comparisons, such as LS, LE, LO, and LT, can be made by reversing the operands and using the opposite comparison, HS, GE, HI, or GT.

[Table C2-63](#) shows that SIMD compare instructions.

Table C2-63 SIMD compare instructions

Mnemonic	Instruction	See
CMEQ	<ul style="list-style-type: none"> Compare bitwise equal (vector and scalar form) Compare bitwise equal to zero (vector and scalar form) 	<ul style="list-style-type: none"> CMEQ (register) on page C6-805 CMEQ (zero) on page C6-807
CMHS	Compare unsigned higher or same (vector and scalar form)	CMHS (register) on page C6-819
CMGE	<ul style="list-style-type: none"> Compare signed greater than or equal (vector and scalar form) Compare signed greater than or equal to zero (vector and scalar form) 	<ul style="list-style-type: none"> CMGE (register) on page C6-809 CMGE (zero) on page C6-811
CMHI	Compare unsigned higher (vector and scalar form)	CMHI (register) on page C6-817
CMGT	<ul style="list-style-type: none"> Compare signed greater than (vector and scalar form) Compare signed greater than zero (vector and scalar form) 	<ul style="list-style-type: none"> CMGT (register) on page C6-813 CMGT (zero) on page C6-815

Table C2-63 SIMD compare instructions (continued)

Mnemonic	Instruction	See
CMLE	Compare signed less than or equal to zero (vector and scalar form)	CMLE (zero) on page C6-821
CMLT	Compare signed less than zero (vector and scalar form)	CMLT (zero) on page C6-823
CMTST	Compare bitwise test bits nonzero (vector and scalar form)	CMTST on page C6-825
FCMEQ	<ul style="list-style-type: none"> Floating-point compare equal (vector and scalar form) Floating-point compare equal to zero (vector and scalar form) 	<ul style="list-style-type: none"> FCMEQ (register) on page C6-849 FCMEQ (zero) on page C6-851
FCMGE	<ul style="list-style-type: none"> Floating-point compare greater than or equal (vector and scalar form) Floating-point compare greater than or equal to zero (vector and scalar form) 	<ul style="list-style-type: none"> FCMGE (register) on page C6-853 FCMGE (zero) on page C6-855
FCMGT	<ul style="list-style-type: none"> Floating-point compare greater than (vector and scalar form) Floating-point compare greater than zero (vector and scalar form) 	<ul style="list-style-type: none"> FCMGT (register) on page C6-857 FCMGT (zero) on page C6-859
FCMLE	Floating-point compare less than or equal to zero (vector and scalar form)	FCMLE (zero) on page C6-861
FCMLT	Floating-point compare less than zero (vector and scalar form)	FCMLT (zero) on page C6-863
FACGE	Floating-point absolute compare greater than or equal (vector and scalar form)	FACGE on page C6-839
FACGT	Floating-point absolute compare greater than (vector and scalar form)	FACGT on page C6-841

C2.5.15 SIMD widening and narrowing arithmetic

For information about the variants of these instructions, see [Common features of SIMD instructions](#) on page C2-152.

[Table C2-64](#) shows the SIMD widening and narrowing arithmetic instructions.

Table C2-64 SIMD widening and narrowing arithmetic instructions

Mnemonic	Instruction	See
ADDHN, ADDHN2	Add returning high, narrow (vector form)	ADDHN, ADDHN2 on page C6-784
PMULL, PMULL2	Polynomial multiply long (vector form)	PMULL, PMULL2 on page C6-1096 See also Cryptography extensions on page C2-169
RADDHN, RADDHN2	Rounding add returning high, narrow (vector form)	RADDHN, RADDHN2 on page C6-1098
RSUBHN, RSUBHN2	Rounding subtract returning high, narrow (vector form)	RSUBHN, RSUBHN2 on page C6-1109
SABAL, SABAL2	Signed absolute difference and accumulate long (vector form)	SABAL, SABAL2 on page C6-1112
SABDL, SABDL2	Signed absolute difference long (vector form)	SABDL, SABDL2 on page C6-1115
SADDL, SADDL2	Signed add long (vector form)	SADDL, SADDL2 on page C6-1119
SADDW, SADDW2	Signed add wide (vector form)	SADDW, SADDW2 on page C6-1124
SMLAL, SMLAL2	Signed multiply-add long (vector form)	SMLAL, SMLAL2 (vector) on page C6-1164

Table C2-64 SIMD widening and narrowing arithmetic instructions (continued)

Mnemonic	Instruction	See
SMLS, SMLS2	Signed multiply-subtract long (vector form)	SMLS, SMLS2 (vector) on page C6-1168
SMULL, SMULL2	Signed multiply long (vector form)	SMULL, SMULL2 (vector) on page C6-1174
SQDMLAL, SQDMLAL2	Signed saturating doubling multiply-add long (vector and scalar form)	SQDMLAL, SQDMLAL2 (vector) on page C6-1183
SQDMLSL, SQDMLSL2	Signed saturating doubling multiply-subtract long (vector and scalar form)	SQDMLSL, SQDMLSL2 (vector) on page C6-1189
SQDMULL, SQDMULL2	Signed saturating doubling multiply long (vector and scalar form)	SQDMULL, SQDMULL2 (vector) on page C6-1200
SSUBL, SSUBL2	Signed subtract long (vector form)	SSUBL, SSUBL2 on page C6-1254
SSUBW, SSUBW2	Signed subtract wide (vector form)	SSUBW, SSUBW2 on page C6-1256
SUBHN, SUBHN2	Subtract returning high, narrow (vector form)	SUBHN, SUBHN2 on page C6-1297
UABAL, UABAL2	Unsigned absolute difference and accumulate long (vector form)	UABAL, UABAL2 on page C6-1309
UABDL, UABDL2	Unsigned absolute difference long (vector form)	UABDL, UABDL2 on page C6-1312
UADDL, UADDL2	Unsigned add long (vector form)	UADDL, UADDL2 on page C6-1316
UADDW, UADDW2	Unsigned add wide (vector form)	UADDW, UADDW2 on page C6-1321
UMLAL, UMLAL2	Unsigned multiply-add long (vector form)	UMLAL, UMLAL2 (vector) on page C6-1343
UMLSL, UMLSL2	Unsigned multiply-subtract long (vector form)	UMLSL, UMLSL2 (vector) on page C6-1347
UMULL, UMULL2	Unsigned multiply long (vector form)	UMULL, UMULL2 (vector) on page C6-1353
USUBL, USUBL2	Unsigned subtract long (vector form)	USUBL, USUBL2 on page C6-1393
USUBW, USUBW2	Unsigned subtract wide (vector form)	USUBW, USUBW2 on page C6-1395

C2.5.16 SIMD unary arithmetic

For information about the variants of these instructions, see [Common features of SIMD instructions on page C2-152](#).

[Table C2-65](#) shows the SIMD unary arithmetic instructions.

Table C2-65 SIMD unary arithmetic instructions

Mnemonic	Instruction	See
ABS	Absolute value (vector and scalar form)	ABS on page C6-780
CLS	Count leading sign bits (vector form)	CLS (vector) on page C6-803
CLZ	Count leading zero bits (vector form)	CLZ (vector) on page C6-804
CNT	Population count per byte (vector form)	CNT on page C6-827
FABS	Floating-point absolute (vector form)	FABS (vector) on page C6-837
FCVTL, FCVTL2	Floating-point convert to higher precision long (vector form)	FCVTL, FCVTL2 on page C6-878
FCVTN, FCVTN2	Floating-point convert to lower precision narrow (vector form)	FCVTN, FCVTN2 on page C6-887

Table C2-65 SIMD unary arithmetic instructions (continued)

Mnemonic	Instruction	See
FCVTXN, FCVTXN2	Floating-point convert to lower precision narrow, rounding to odd (vector and scalar form)	FCVTXN, FCVTXN2 on page C6-904
FNEG	Floating-point negate (vector form)	FNEG (vector) on page C6-978
FRECPE	Floating-point reciprocal estimate (vector and scalar form)	FRECPE on page C6-985
FRECPX	Floating-point reciprocal square root (scalar form)	FRECPX on page C6-989
FRINTA	Floating-point round to integral, to nearest with ties to away (vector form)	FRINTA (scalar) on page C6-991
FRINTI	Floating-point round to integral, using current rounding mode (vector form)	FRINTI (vector) on page C6-992
FRINTM	Floating-point round to integral, toward minus infinity (vector form)	FRINTM (vector) on page C6-994
FRINTN	Floating-point round to integral, to nearest with ties to even (vector form)	FRINTN (vector) on page C6-996
FRINTP	Floating-point round to integral, toward positive infinity (vector form)	FRINTP (vector) on page C6-998
FRINTX	Floating-point round to integral exact, using current rounding mode (vector form)	FRINTX (vector) on page C6-1000
FRINTZ	Floating-point round to integral, toward zero (vector form)	FRINTZ (vector) on page C6-1002
FRSQRTE	Floating-point reciprocal square root estimate (vector and scalar form)	FRSQRTE on page C6-1004
FSQRT	Floating-point square root (vector form)	FSQRT (vector) on page C6-1008
MVN	Bitwise NOT (vector form)	MVN on page C6-1085
NEG	Negate (vector and scalar form)	NEG (vector) on page C6-1088
NOT	Bitwise NOT (vector form)	NOT on page C6-1090
RBIT	Bitwise reverse (vector form)	RBIT (vector) on page C6-1100
REV16	Reverse elements in 16-bit halfwords (vector form)	REV16 (vector) on page C6-1101
REV32	Reverse elements in 32-bit words (vector form)	REV32 (vector) on page C6-1103
REV64	Reverse elements in 64-bit doublewords (vector form)	REV64 on page C6-1105
SADALP	Signed add and accumulate long pairwise (vector form)	SADALP on page C6-1117
SADDLP	Signed add long pairwise (vector form)	SADDLP on page C6-1121
SQABS	Signed saturating absolute value (vector and scalar form)	SQABS on page C6-1176
SQNEG	Signed saturating negate (vector and scalar form)	SQNEG on page C6-1202
SQXTN, SQXTN2	Signed saturating extract narrow (vector form)	SQXTN, SQXTN2 on page C6-1233
SQXTUN, SQXTUN2	Signed saturating extract unsigned narrow (vector and scalar form)	SQXTUN, SQXTUN2 on page C6-1235
SUQADD	Signed saturating accumulate of unsigned value (vector and scalar form)	SUQADD on page C6-1299

Table C2-65 SIMD unary arithmetic instructions (continued)

Mnemonic	Instruction	See
SXTL, SXTL2	Signed extend long	SXTL on page C6-1301
UADALP	Unsigned add and accumulate long pairwise (vector form)	UADALP on page C6-1314
UADDLP	Unsigned add long pairwise (vector form)	UADDLP on page C6-1318
UQXTN, UQXTN2	Unsigned saturating extract narrow (vector form)	UQXTN , UQXTN2 on page C6-1372
URECPE	Unsigned reciprocal estimate (vector form)	URECPE on page C6-1374
URSQRTE	Unsigned reciprocal square root estimate (vector form)	URSQRTE on page C6-1380
USQADD	Unsigned saturating accumulate of signed value (vector and scalar form)	USQADD on page C6-1389
UXTL, UXTL2	Unsigned extend long	UXTL on page C6-1397
XTN, XTN2	Extract narrow (vector form)	XTN , XTN2 on page C6-1400

C2.5.17 SIMD by element arithmetic

For information about the variants of these instructions, see [Common features of SIMD instructions](#) on page C2-152.

[Table C2-66](#) shows the SIMD by element arithmetic instructions.

Table C2-66 SIMD by element arithmetic instructions

Mnemonic	Instruction	See
FMLA	Floating-point fused multiply-add (vector and scalar form)	FMLA (by element) on page C6-954
FMLS	Floating-point fused multiply-subtract (vector and scalar form)	FMLS (by element) on page C6-957.
FMUL	Floating-point multiply (vector and scalar form)	FMUL (by element) on page C6-968
FMULX	Floating-point multiply extended (vector and scalar form)	FMULX (by element) on page C6-973
MLA	Multiply-add (vector form)	MLA (by element) on page C6-1066
MLS	Multiply-subtract (vector form)	MLS (by element) on page C6-1070
MUL	Multiply (vector form)	MUL (by element) on page C6-1081
SMLAL, SMLAL2	Signed multiply-add long (vector form)	SMLAL , SMLAL2 (by element) on page C6-1162
SMLSL, SMLSL2	Signed multiply-subtract long (vector form)	SMLSL , SMLSL2 (by element) on page C6-1166
SMULL, SMULL2	Signed multiply long (vector form)	SMULL , SMULL2 (by element) on page C6-1172
SQDMLAL, SQDMLAL2	Signed saturating doubling multiply-add long (vector and scalar form)	SQDMLAL , SQDMLAL2 (by element) on page C6-1180
SQDMLSL, SQDMLSL2	Signed saturating doubling multiply-subtract long (vector form)	SQDMLSL , SQDMLSL2 (by element) on page C6-1186
SQDMULH	Signed saturating doubling multiply returning high half (vector and scalar form)	SQDMULH (by element) on page C6-1192

Table C2-66 SIMD by element arithmetic instructions (continued)

Mnemonic	Instruction	See
SQDMULL, SQDMULL2	Signed saturating doubling multiply long (vector and scalar form)	SQDMULL, SQDMULL2 (by element) on page C6-1197
SQRDMULH	Signed saturating rounding doubling multiply returning high half (vector and scalar form)	SQRDMULH (by element) on page C6-1204
UMLAL, UMLAL2	Unsigned multiply-add long (vector form)	UMLAL, UMLAL2 (by element) on page C6-1341
UMLSL, UMLSL2	Unsigned multiply-subtract long (vector form)	UMLSL, UMLSL2 (by element) on page C6-1345
UMULL, UMULL2	Unsigned multiply long (vector form)	UMULL, UMULL2 (by element) on page C6-1351

C2.5.18 SIMD permute

[Table C2-67](#) shows the SIMD permute instructions.

Table C2-67 SIMD permute instructions

Mnemonic	Instruction	See
EXT	Extract vector from a pair of vectors	EXT on page C6-834
TRN1	Transpose vectors (primary)	TRN1 on page C6-1306
TRN2	Transpose vectors (secondary)	TRN2 on page C6-1307
UZP1	Unzip vectors (primary)	UZP1 on page C6-1398
UZP2	Unzip vectors (secondary)	UZP2 on page C6-1399
ZIP1	Zip vectors (primary)	ZIP1 on page C6-1402
ZIP2	Zip vectors (secondary)	ZIP2 on page C6-1403

C2.5.19 SIMD immediate

[Table C2-68](#) shows the SIMD immediate instructions.

Table C2-68 SIMD immediate instructions

Mnemonic	Instruction	See
BIC	Bitwise bit clear immediate	BIC (vector, immediate) on page C6-794
FMOV	Floating-point move immediate	FMOV (vector, immediate) on page C6-960
MOVI	Move immediate	MOVI on page C6-1079
MVNI	Move inverted immediate	MVNI on page C6-1086
ORR	Bitwise inclusive OR immediate	ORR (vector, immediate) on page C6-1092

C2.5.20 SIMD shift (immediate)

For information about the variants of these instructions, see [Common features of SIMD instructions on page C2-152](#).

Table C2-69 shows the SIMD shift immediate instructions.

Table C2-69 SIMD shift (immediate) instructions

Mnemonic	Instruction	See
RSHRN, RSHRN2	Rounding shift right narrow immediate (vector form)	RSHRN, RSHRN2 on page C6-1107
SHL	Shift left immediate (vector and scalar form)	SHL on page C6-1145
SHLL, SHLL2	Shift left long (by element size) (vector form)	SHLL, SHLL2 on page C6-1147
SHRN, SHRN2	Shift right narrow immediate (vector form)	SHRN, SHRN2 on page C6-1149
SLI	Shift left and insert immediate (vector and scalar form)	SLI on page C6-1152
SQRSHRN, SQRSHRN2	Signed saturating rounded shift right narrow immediate (vector and scalar form)	SQRSHRN, SQRSHRN2 on page C6-1211
SQRSHRUN, SQRSHRUN2	Signed saturating shift right unsigned narrow immediate (vector and scalar form)	SQRSHRUN, SQRSHRUN2 on page C6-1214
SQSHL	Signed saturating shift left immediate (vector and scalar form)	SQSHL (immediate) on page C6-1217
SQSHLU	Signed saturating shift left unsigned immediate (vector and scalar form)	SQSHLU on page C6-1222
SQSHRN, SQSHRN2	Signed saturating shift right narrow immediate (vector and scalar form)	SQSHRN, SQSHRN2 on page C6-1225
SQSHRUN, SQSHRUN2	Signed saturating shift right unsigned narrow immediate (vector and scalar form)	SQSHRUN, SQSHRUN2 on page C6-1228
SRI	Shift right and insert immediate (vector and scalar form)	SRI on page C6-1238
SRSHR	Signed rounding shift right immediate (vector and scalar form)	SRSHR on page C6-1242
SRSRA	Signed rounding shift right and accumulate immediate (vector and scalar form)	SRSRA on page C6-1244.
SSHLL, SSHLL2	Signed shift left long immediate (vector form)	SSHLL, SSHLL2 on page C6-1248
SSHR	Signed shift right immediate (vector and scalar form)	SSHR on page C6-1250
SSRA	Signed integer shift right and accumulate immediate (vector and scalar form)	SSRA on page C6-1252
SXTL, SXTL2	Signed integer extend (vector only)	SXTL on page C6-1301
UQRSHRN, UQRSHRN2	Unsigned saturating rounded shift right narrow immediate (vector and scalar form)	UQRSHRN, UQRSHRN2 on page C6-1359
UQSHL	Unsigned saturating shift left immediate (vector and scalar form)	UQSHL (immediate) on page C6-1362
UQSHRN, UQSHRN2	Unsigned saturating shift right narrow immediate (vector and scalar form)	UQSHRN on page C6-1367
URSHR	Unsigned rounding shift right immediate (vector and scalar form)	URSHR on page C6-1378
URSRA	Unsigned integer rounding shift right and accumulate immediate (vector and scalar form)	URSRA on page C6-1381
USHLL, USHLL2	Unsigned shift left long immediate (vector form)	USHLL, USHLL2 on page C6-1385

Table C2-69 SIMD shift (immediate) instructions (continued)

Mnemonic	Instruction	See
USHR	Unsigned shift right immediate (vector and scalar form)	USHR on page C6-1387
USRA	Unsigned shift right and accumulate immediate (vector and scalar form)	USRA on page C6-1391
UXTL, UXTL2	Unsigned integer extend (vector only)	UXTL on page C6-1397

C2.5.21 SIMD floating-point and integer conversion

The SIMD floating-point and integer conversion instructions generate the Invalid Operation exception in response to a floating-point input of NaN, infinity, or a numerical value that cannot be represented within the destination register. An out-of-range integer or a fixed-point result is saturated to the size of the destination register. A numeric result that differs from the input raises the Inexact exception.

[Table C2-70](#) shows the SIMD floating-point and integer conversion instructions.

Table C2-70 SIMD floating-point and integer conversion instructions

Mnemonic	Instruction	See
FCVTAS	Floating-point convert to signed integer, rounding to nearest with ties to away (vector and scalar form)	FCVTAS (vector) on page C6-870
FCVTAU	Floating-point convert to unsigned integer, rounding to nearest with ties to away (vector and scalar form)	FCVTAU (vector) on page C6-874
FCVTMS	Floating-point convert to signed integer, rounding toward minus infinity (vector and scalar form)	FCVTMS (vector) on page C6-879
FCVTMU	Floating-point convert to unsigned integer, rounding toward minus infinity (vector and scalar form)	FCVTMU (vector) on page C6-883
FCVTNS	Floating-point convert to signed integer, rounding to nearest with ties to even (vector and scalar form)	FCVTNS (vector) on page C6-888
FCVTNU	Floating-point convert to unsigned integer, rounding to nearest with ties to even (vector and scalar form)	FCVTNU (vector) on page C6-892
FCVTPS	Floating-point convert to signed integer, rounding toward positive infinity (vector and scalar form)	FCVTPS (vector) on page C6-896
FCVTPU	Floating-point convert to unsigned integer, rounding toward positive infinity (vector and scalar form)	FCVTPU (vector) on page C6-900
FCVTZS	<ul style="list-style-type: none"> Floating-point convert to signed integer, rounding toward zero (vector and scalar form) Floating-point convert to signed fixed-point, rounding toward zero (vector and scalar form) 	<ul style="list-style-type: none"> FCVTZS (vector, integer) on page C6-908 FCVTZS (vector, fixed-point) on page C6-906

Table C2-70 SIMD floating-point and integer conversion instructions (continued)

Mnemonic	Instruction	See
FCVTZU	<ul style="list-style-type: none"> Floating-point convert to unsigned integer, rounding toward zero (vector and scalar form) Floating-point convert to unsigned fixed-point, rounding toward zero, (vector and scalar form) 	<ul style="list-style-type: none"> FCVTZU (vector, integer) on page C6-916 FCVTZU (vector, fixed-point) on page C6-914
SCVTF	<ul style="list-style-type: none"> Signed integer convert to floating-point (vector and scalar form) Signed fixed-point convert to floating-point (vector and scalar form) 	<ul style="list-style-type: none"> SCVTF (vector, integer) on page C6-1128 SCVTF (vector, fixed-point) on page C6-1126
UCVTF	<ul style="list-style-type: none"> Unsigned integer convert to floating-point (vector and scalar form) Unsigned fixed-point convert to floating-point (vector and scalar form) 	<ul style="list-style-type: none"> UCVTF (vector, integer) on page C6-1325 UCVTF (vector, fixed-point) on page C6-1323

C2.5.22 SIMD reduce (across vector lanes)

The SIMD reduce (across vector lanes) instructions perform arithmetic operations horizontally, that is across all lanes of the input vector. They deliver a single scalar result.

[Table C2-71](#) shows the SIMD reduce (across vector lanes) instructions.

Table C2-71 SIMD reduce (across vector lanes) instructions

Mnemonic	Instruction	See
ADDV	Add (across vector)	ADDV on page C6-788
FMAXNMV	Floating-point maximum number (across vector)	FMAXNMV on page C6-935
FMAXV	Floating-point maximum (across vector)	FMAXV on page C6-939
FMINNMV	Floating-point minimum number (across vector)	FMINNMV on page C6-949
FMINV	Floating-point minimum (across vector)	FMINV on page C6-953
SADDLV	Signed add long (across vector)	SADDLV on page C6-1123
SMAXV	Signed maximum (across vector)	SMAXV on page C6-1156
SMINV	Signed minimum (across vector)	SMINV on page C6-1160
UADDLV	Unsigned add long (across vector)	UADDLV on page C6-1320
UMAXV	Unsigned maximum (across vector)	UMAXV on page C6-1335
UMINV	Unsigned minimum (across vector)	UMINV on page C6-1339

C2.5.23 SIMD pairwise arithmetic

The SIMD pairwise arithmetic instructions perform operations on pairs of adjacent elements and deliver a vector result.

Table C2-72 shows the SIMD pairwise arithmetic instructions.

Table C2-72 SIMD pairwise arithmetic instructions

Mnemonic	Instruction	See
ADDP	Add pairwise (vector and scalar form)	<ul style="list-style-type: none"> • ADDP (vector) on page C6-787 • ADDP (scalar) on page C6-786
FADDP	Floating-point add pairwise (vector and scalar form)	<ul style="list-style-type: none"> • FADDP (vector) on page C6-846 • FADDP (scalar) on page C6-845
FMAXNMP	Floating-point maximum number pairwise (vector and scalar form)	<ul style="list-style-type: none"> • FMAXNMP (vector) on page C6-933 • FMAXNMP (scalar) on page C6-932
FMAXP	Floating-point maximum pairwise (vector and scalar form)	<ul style="list-style-type: none"> • FMAXP (vector) on page C6-937 • FMAXP (scalar) on page C6-936
FMINNMP	Floating-point minimum number pairwise (vector and scalar form)	<ul style="list-style-type: none"> • FMINNMP (vector) on page C6-947 • FMINNMP (scalar) on page C6-946
FMINP	Floating-point minimum pairwise (vector and scalar form)	<ul style="list-style-type: none"> • FMINP (vector) on page C6-951 • FMINP (scalar) on page C6-950
SMAXP	Signed maximum pairwise	SMAXP on page C6-1155
SMINP	Signed minimum pairwise	SMINP on page C6-1159
UMAXP	Unsigned maximum pairwise	UMAXP on page C6-1334
UMINP	Unsigned minimum pairwise	UMINP on page C6-1338

C2.5.24 SIMD table lookup

Table C2-73 shows the SIMD table lookup instructions.

Table C2-73 SIMD table lookup instructions

Mnemonic	Instruction	See
TBL	Table vector lookup	TBL on page C6-1302
TBX	Table vector lookup extension	TBX on page C6-1304

C2.5.25 Cryptography extensions

The optional Cryptography extension instructions share the SIMD and floating-point register file. For more information see:

- [Announcing the Advanced Encryption Standard.](#)
- [The Galois/Counter Mode of Operation.](#)
- [Announcing the Secure Hash Standard.](#)

Table C2-74 shows the Cryptography extension instructions.

Table C2-74 Cryptography extension instructions

Mnemonic	Instruction	See
AESD	AES single round decryption	AESD on page C6-789
AESE	AES single round encryption	AESE on page C6-790
AESIMC	AES inverse mix columns	AESIMC on page C6-791
AESMC	AES mix columns	AESMC on page C6-792
PMULL	Polynomial multiply long	PMULL , PMULL2 on page C6-1096
SHA1C	SHA1 hash update (choose)	SHA1C on page C6-1134
SHA1H	SHA1 fixed rotate	SHA1H on page C6-1135
SHA1M	SHA1 hash update (majority)	SHA1M on page C6-1136
SHA1P	SHA1 hash update (parity)	SHA1P on page C6-1137
SHA1SU0	SHA1 schedule update 0	SHA1SU0 on page C6-1138
SHA1SU1	SHA1 schedule update 1	SHA1SU1 on page C6-1139
SHA256H	SHA256 hash update (part 1)	SHA256H on page C6-1141
SHA256H2	SHA256 hash update (part 2)	SHA256H2 on page C6-1140
SHA256SU0	SHA256 schedule update 0	SHA256SU0 on page C6-1142
SHA256SU1	SHA256 schedule update 1	SHA256SU1 on page C6-1143

Chapter C3

A64 Instruction Set Encoding

This chapter describes the A64 instruction set encoding. It contains an encoding index followed by a set of functional groups. Each group contains an alphabetical list of instructions that have similar function within the instruction set.

It contains the following sections:

- *A64 instruction index by encoding on page C3-172.*
- *Branches, exception generating and system instructions on page C3-173*
- *Loads and stores on page C3-176*
- *Data processing - immediate on page C3-193*
- *Data processing - register on page C3-196*
- *Data processing - SIMD and floating point on page C3-203*

C3.1 A64 instruction index by encoding

Table C3-1 A64 main encoding table

Instruction bits																Encoding Group							
31	30	29	28	27	26	25	24	23	22	21	20	19	18	17	16	15	14	13	12	11	10		
-	-	-	0	0	-	-	-	-	-	-	-	-	-	-	-	-	-	-	-	-	-	-	UNALLOCATED
-	-	-	1	0	0	-	-	-	-	-	-	-	-	-	-	-	-	-	-	-	-	-	Data processing - immediate
-	-	-	1	0	1	-	-	-	-	-	-	-	-	-	-	-	-	-	-	-	-	-	Branch, exception generation and system instructions
-	-	-	-	1	-	0	-	-	-	-	-	-	-	-	-	-	-	-	-	-	-	-	Loads and stores
-	-	-	-	1	0	1	-	-	-	-	-	-	-	-	-	-	-	-	-	-	-	-	Data processing - register
-	-	-	0	1	1	1	-	-	-	-	-	-	-	-	-	-	-	-	-	-	-	-	Data processing - SIMD and floating point
-	-	-	1	1	1	1	-	-	-	-	-	-	-	-	-	-	-	-	-	-	-	-	Data processing - SIMD and floating point

C3.2 Branches, exception generating and system instructions

This section describes the encoding of the instruction classes in the Branch, exception generation and system instruction group, and shows how each instruction class encodes the different instruction forms. For additional information on this functional group of instructions, see [Branches, Exception generating, and System instructions](#) on page C2-124.

Table C3-2 Encoding table for the Branches, Exception Generating and System instructions functional group

Instruction bits																Instruction class							
31	30	29	28	27	26	25	24	23	22	21	20	19	18	17	16	15	14	13	12	11	10		
-	0	0	1	0	1	-	-	-	-	-	-	-	-	-	-	-	-	-	-	-	-	-	Unconditional branch (immediate)
-	0	1	1	0	1	0	-	-	-	-	-	-	-	-	-	-	-	-	-	-	-	-	Compare & branch (immediate)
-	0	1	1	0	1	1	-	-	-	-	-	-	-	-	-	-	-	-	-	-	-	-	Test & branch (immediate)
0	1	0	1	0	1	0	-	-	-	-	-	-	-	-	-	-	-	-	-	-	-	-	Conditional branch (immediate)
1	1	0	1	0	1	0	0	-	-	-	-	-	-	-	-	-	-	-	-	-	-	-	Exception generation
1	1	0	1	0	1	0	1	0	0	-	-	-	-	-	-	-	-	-	-	-	-	-	System
1	1	0	1	0	1	1	-	-	-	-	-	-	-	-	-	-	-	-	-	-	-	-	Unconditional branch (register)

C3.2.1 Compare & branch (immediate)

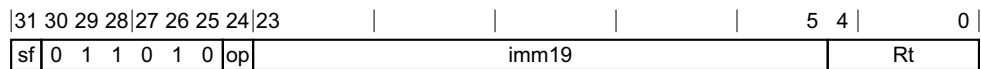

Decode fields		Instruction Page	Variant
sf	op		
0	0	CBZ	32-bit
0	1	CBNZ	32-bit
1	0	CBZ	64-bit
1	1	CBNZ	64-bit

C3.2.2 Conditional branch (immediate)

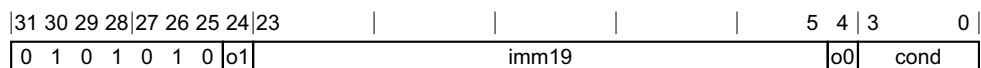

Decode fields		Instruction Page	Variant
o1	o0		
0	0	B.cond	-

C3.2.3 Exception generation

31	30	29	28	27	26	25	24	23	21	20					5	4	2	1	0
1	1	0	1	0	1	0	0	opc	imm16						op2	LL			

Decode fields			Instruction Page	Variant
opc	op2	LL		
000	000	01	SVC	-
000	000	10	HVC	-
000	000	11	SMC	-
001	000	00	BRK	-
010	000	00	HLT	-
101	000	01	DCPS1	-
101	000	10	DCPS2	-
101	000	11	DCPS3	-

C3.2.4 System

31	30	29	28	27	26	25	24	23	22	21	20	19	18	16	15	12	11	8	7	5	4	0
1	1	0	1	0	1	0	1	0	0	L	op0	op1	CRn	CRm	op2	Rt						

Decode fields						Instruction Page	Variant
L	op0	op1	CRn	op2	Rt		
0	00	-	0100	-	11111	MSR (immediate)	-
0	00	011	0010	-	11111	HINT	-
0	00	011	0011	010	11111	CLREX	-
0	00	011	0011	100	11111	DSB	-
0	00	011	0011	101	11111	DMB	-
0	00	011	0011	110	11111	ISB	-
0	01	-	-	-	-	SYS	-
0	1x	-	-	-	-	MSR (register)	-
1	01	-	-	-	-	SYSL	-
1	1x	-	-	-	-	MRS	-

C3.2.5 Test & branch (immediate)

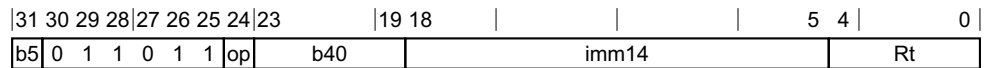

Decode fields	Instruction Page	Variant
op		
0	TBZ	-
1	TBNZ	-

C3.2.6 Unconditional branch (immediate)



Decode fields	Instruction Page	Variant
op		
0	B	-
1	BL	-

C3.2.7 Unconditional branch (register)

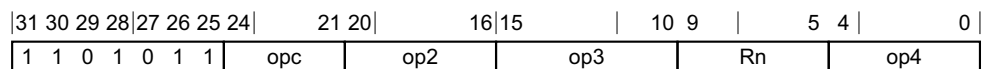

Decode fields					Instruction Page	Variant
opc	op2	op3	Rn	op4		
0000	11111	000000	-	00000	BR	-
0001	11111	000000	-	00000	BLR	-
0010	11111	000000	-	00000	RET	-
0100	11111	000000	11111	00000	ERET	-
0101	11111	000000	11111	00000	DRPS	-

C3.3 Loads and stores

This section describes the encoding of the instruction classes in the Loads and stores instruction group, and shows how each instruction class encodes the different instruction forms. For additional information on this functional group of instructions, see *Loads and stores* on page C2-129.

Table C3-3 Encoding table for the Loads and Stores functional group

Instruction bits																Instruction class								
31	30	29	28	27	26	25	24	23	22	21	20	19	18	17	16	15	14	13	12	11	10			
-	-	0	0	1	0	0	0	-	-	-	-	-	-	-	-	-	-	-	-	-	-	-	-	Load/store exclusive
-	-	0	1	1	-	0	0	-	-	-	-	-	-	-	-	-	-	-	-	-	-	-	-	Load register (literal)
-	-	1	0	1	-	0	0	0	-	-	-	-	-	-	-	-	-	-	-	-	-	-	-	Load/store no-allocate pair (offset)
-	-	1	0	1	-	0	0	1	-	-	-	-	-	-	-	-	-	-	-	-	-	-	-	Load/store register pair (post-indexed)
-	-	1	0	1	-	0	1	0	-	-	-	-	-	-	-	-	-	-	-	-	-	-	-	Load/store register pair (offset)
-	-	1	0	1	-	0	1	1	-	-	-	-	-	-	-	-	-	-	-	-	-	-	-	Load/store register pair (pre-indexed)
-	-	1	1	1	-	0	0	-	-	0	-	-	-	-	-	-	-	-	-	-	0	0	-	Load/store register (unscaled immediate)
-	-	1	1	1	-	0	0	-	-	0	-	-	-	-	-	-	-	-	-	-	0	1	-	Load/store register (immediate post-indexed)
-	-	1	1	1	-	0	0	-	-	0	-	-	-	-	-	-	-	-	-	-	1	0	-	Load/store register (unprivileged)
-	-	1	1	1	-	0	0	-	-	0	-	-	-	-	-	-	-	-	-	-	1	1	-	Load/store register (immediate pre-indexed)
-	-	1	1	1	-	0	0	-	-	1	-	-	-	-	-	-	-	-	-	-	1	0	-	Load/store register (register offset)
-	-	1	1	1	-	0	1	-	-	-	-	-	-	-	-	-	-	-	-	-	-	-	-	Load/store register (unsigned immediate)
0	-	0	0	1	1	0	0	0	-	0	0	0	0	0	0	-	-	-	-	-	-	-	-	AdvSIMD load/store multiple structures
0	-	0	0	1	1	0	0	1	-	0	-	-	-	-	-	-	-	-	-	-	-	-	-	AdvSIMD load/store multiple structures (post-indexed)
0	-	0	0	1	1	0	1	0	-	-	0	0	0	0	0	-	-	-	-	-	-	-	-	AdvSIMD load/store single structure
0	-	0	0	1	1	0	1	1	-	-	-	-	-	-	-	-	-	-	-	-	-	-	-	AdvSIMD load/store single structure (post-indexed)

C3.3.1 AdvSIMD load/store multiple structures

31	30	29	28	27	26	25	24	23	22	21	20	19	18	17	16	15	12	11	10	9	5	4	0
0	Q	0	0	1	1	0	0	0	L	0	0	0	0	0	0	opcode	size	Rn	Rt				

Decode fields	Instruction Page	Variant
L opcode		
0 0000	ST4 (multiple structures)	No offset
0 0010	ST1 (multiple structures)	Four registers
0 0100	ST3 (multiple structures)	No offset
0 0110	ST1 (multiple structures)	Three registers

Decode fields		Instruction Page	Variant
L	opcode		
0	0111	ST1 (multiple structures)	One register
0	1000	ST2 (multiple structures)	No offset
0	1010	ST1 (multiple structures)	Two registers
1	0000	LD4 (multiple structures)	No offset
1	0010	LD1 (multiple structures)	Four registers
1	0100	LD3 (multiple structures)	No offset
1	0110	LD1 (multiple structures)	Three registers
1	0111	LD1 (multiple structures)	One register
1	1000	LD2 (multiple structures)	No offset
1	1010	LD1 (multiple structures)	Two registers

C3.3.2 AdvSIMD load/store multiple structures (post-indexed)

31	30	29	28	27	26	25	24	23	22	21	20	16	15	12	11	10	9	5	4	0
0	Q	0	0	1	1	0	0	1	L	0	Rm	opcode	size	Rn	Rt					

Decode fields		Instruction Page	Variant
L	Rm	opcode	
0	!= 11111	0000	ST4 (multiple structures) Register offset
0	!= 11111	0010	ST1 (multiple structures) Four registers, register offset
0	!= 11111	0100	ST3 (multiple structures) Register offset
0	!= 11111	0110	ST1 (multiple structures) Three registers, register offset
0	!= 11111	0111	ST1 (multiple structures) One register, register offset
0	!= 11111	1000	ST2 (multiple structures) Register offset
0	!= 11111	1010	ST1 (multiple structures) Two registers, register offset
0	11111	0000	ST4 (multiple structures) Immediate offset
0	11111	0010	ST1 (multiple structures) Four registers, immediate offset
0	11111	0100	ST3 (multiple structures) Immediate offset
0	11111	0110	ST1 (multiple structures) Three registers, immediate offset
0	11111	0111	ST1 (multiple structures) One register, immediate offset
0	11111	1000	ST2 (multiple structures) Immediate offset
0	11111	1010	ST1 (multiple structures) Two registers, immediate offset

Decode fields			Instruction Page	Variant
L	Rm	opcode		
1	!= 11111	0000	LD4 (multiple structures)	Register offset
1	!= 11111	0010	LD1 (multiple structures)	Four registers, register offset
1	!= 11111	0100	LD3 (multiple structures)	Register offset
1	!= 11111	0110	LD1 (multiple structures)	Three registers, register offset
1	!= 11111	0111	LD1 (multiple structures)	One register, register offset
1	!= 11111	1000	LD2 (multiple structures)	Register offset
1	!= 11111	1010	LD1 (multiple structures)	Two registers, register offset
1	11111	0000	LD4 (multiple structures)	Immediate offset
1	11111	0010	LD1 (multiple structures)	Four registers, immediate offset
1	11111	0100	LD3 (multiple structures)	Immediate offset
1	11111	0110	LD1 (multiple structures)	Three registers, immediate offset
1	11111	0111	LD1 (multiple structures)	One register, immediate offset
1	11111	1000	LD2 (multiple structures)	Immediate offset
1	11111	1010	LD1 (multiple structures)	Two registers, immediate offset

C3.3.3 AdvSIMD load/store single structure

31	30	29	28	27	26	25	24	23	22	21	20	19	18	17	16	15	13	12	11	10	9	5	4	0
0	Q	0	0	1	1	0	1	0	L	R	0	0	0	0	0	opcode	S	size	Rn	Rt				

Decode fields					Instruction Page	Variant
L	R	opcode	S	size		
0	0	000	-	-	ST1 (single structure)	8-bit
0	0	001	-	-	ST3 (single structure)	8-bit
0	0	010	-	x0	ST1 (single structure)	16-bit
0	0	011	-	x0	ST3 (single structure)	16-bit
0	0	100	-	00	ST1 (single structure)	32-bit
0	0	100	0	01	ST1 (single structure)	64-bit
0	0	101	-	00	ST3 (single structure)	32-bit
0	0	101	0	01	ST3 (single structure)	64-bit
0	1	000	-	-	ST2 (single structure)	8-bit
0	1	001	-	-	ST4 (single structure)	8-bit

Decode fields					Instruction Page	Variant
L	R	opcode	S	size		
0	1	010	-	x0	ST2 (single structure)	16-bit
0	1	011	-	x0	ST4 (single structure)	16-bit
0	1	100	-	00	ST2 (single structure)	32-bit
0	1	100	0	01	ST2 (single structure)	64-bit
0	1	101	-	00	ST4 (single structure)	32-bit
0	1	101	0	01	ST4 (single structure)	64-bit
1	0	000	-	-	LD1 (single structure)	8-bit
1	0	001	-	-	LD3 (single structure)	8-bit
1	0	010	-	x0	LD1 (single structure)	16-bit
1	0	011	-	x0	LD3 (single structure)	16-bit
1	0	100	-	00	LD1 (single structure)	32-bit
1	0	100	0	01	LD1 (single structure)	64-bit
1	0	101	-	00	LD3 (single structure)	32-bit
1	0	101	0	01	LD3 (single structure)	64-bit
1	0	110	0	-	LD1R	No offset
1	0	111	0	-	LD3R	No offset
1	1	000	-	-	LD2 (single structure)	8-bit
1	1	001	-	-	LD4 (single structure)	8-bit
1	1	010	-	x0	LD2 (single structure)	16-bit
1	1	011	-	x0	LD4 (single structure)	16-bit
1	1	100	-	00	LD2 (single structure)	32-bit
1	1	100	0	01	LD2 (single structure)	64-bit
1	1	101	-	00	LD4 (single structure)	32-bit
1	1	101	0	01	LD4 (single structure)	64-bit
1	1	110	0	-	LD2R	No offset
1	1	111	0	-	LD4R	No offset

C3.3.4 AdvSIMD load/store single structure (post-indexed)

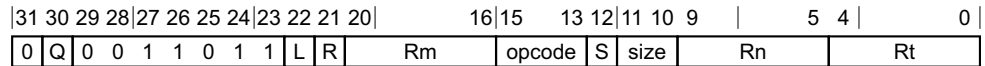

Decode fields						Instruction Page	Variant
L	R	Rm	opcode	S	size		
0	0	!= 11111	000	-	-	ST1 (single structure)	8-bit, register offset
0	0	!= 11111	001	-	-	ST3 (single structure)	8-bit, register offset
0	0	!= 11111	010	-	x0	ST1 (single structure)	16-bit, register offset
0	0	!= 11111	011	-	x0	ST3 (single structure)	16-bit, register offset
0	0	!= 11111	100	-	00	ST1 (single structure)	32-bit, register offset
0	0	!= 11111	100	0	01	ST1 (single structure)	64-bit, register offset
0	0	!= 11111	101	-	00	ST3 (single structure)	32-bit, register offset
0	0	!= 11111	101	0	01	ST3 (single structure)	64-bit, register offset
0	0	11111	000	-	-	ST1 (single structure)	8-bit, immediate offset
0	0	11111	001	-	-	ST3 (single structure)	8-bit, immediate offset
0	0	11111	010	-	x0	ST1 (single structure)	16-bit, immediate offset
0	0	11111	011	-	x0	ST3 (single structure)	16-bit, immediate offset
0	0	11111	100	-	00	ST1 (single structure)	32-bit, immediate offset
0	0	11111	100	0	01	ST1 (single structure)	64-bit, immediate offset
0	0	11111	101	-	00	ST3 (single structure)	32-bit, immediate offset
0	0	11111	101	0	01	ST3 (single structure)	64-bit, immediate offset
0	1	!= 11111	000	-	-	ST2 (single structure)	8-bit, register offset
0	1	!= 11111	001	-	-	ST4 (single structure)	8-bit, register offset
0	1	!= 11111	010	-	x0	ST2 (single structure)	16-bit, register offset
0	1	!= 11111	011	-	x0	ST4 (single structure)	16-bit, register offset
0	1	!= 11111	100	-	00	ST2 (single structure)	32-bit, register offset
0	1	!= 11111	100	0	01	ST2 (single structure)	64-bit, register offset
0	1	!= 11111	101	-	00	ST4 (single structure)	32-bit, register offset
0	1	!= 11111	101	0	01	ST4 (single structure)	64-bit, register offset
0	1	11111	000	-	-	ST2 (single structure)	8-bit, immediate offset
0	1	11111	001	-	-	ST4 (single structure)	8-bit, immediate offset
0	1	11111	010	-	x0	ST2 (single structure)	16-bit, immediate offset

Decode fields					Instruction Page	Variant
L	R	Rm	opcode	S	size	
0	1	11111	011	-	x0	ST4 (single structure) 16-bit, immediate offset
0	1	11111	100	-	00	ST2 (single structure) 32-bit, immediate offset
0	1	11111	100	0	01	ST2 (single structure) 64-bit, immediate offset
0	1	11111	101	-	00	ST4 (single structure) 32-bit, immediate offset
0	1	11111	101	0	01	ST4 (single structure) 64-bit, immediate offset
1	0	!= 11111	000	-	-	LD1 (single structure) 8-bit, register offset
1	0	!= 11111	001	-	-	LD3 (single structure) 8-bit, register offset
1	0	!= 11111	010	-	x0	LD1 (single structure) 16-bit, register offset
1	0	!= 11111	011	-	x0	LD3 (single structure) 16-bit, register offset
1	0	!= 11111	100	-	00	LD1 (single structure) 32-bit, register offset
1	0	!= 11111	100	0	01	LD1 (single structure) 64-bit, register offset
1	0	!= 11111	101	-	00	LD3 (single structure) 32-bit, register offset
1	0	!= 11111	101	0	01	LD3 (single structure) 64-bit, register offset
1	0	!= 11111	110	0	-	LD1R Register offset
1	0	!= 11111	111	0	-	LD3R Register offset
1	0	11111	000	-	-	LD1 (single structure) 8-bit, immediate offset
1	0	11111	001	-	-	LD3 (single structure) 8-bit, immediate offset
1	0	11111	010	-	x0	LD1 (single structure) 16-bit, immediate offset
1	0	11111	011	-	x0	LD3 (single structure) 16-bit, immediate offset
1	0	11111	100	-	00	LD1 (single structure) 32-bit, immediate offset
1	0	11111	100	0	01	LD1 (single structure) 64-bit, immediate offset
1	0	11111	101	-	00	LD3 (single structure) 32-bit, immediate offset
1	0	11111	101	0	01	LD3 (single structure) 64-bit, immediate offset
1	0	11111	110	0	-	LD1R Immediate offset
1	0	11111	111	0	-	LD3R Immediate offset
1	1	!= 11111	000	-	-	LD2 (single structure) 8-bit, register offset
1	1	!= 11111	001	-	-	LD4 (single structure) 8-bit, register offset
1	1	!= 11111	010	-	x0	LD2 (single structure) 16-bit, register offset
1	1	!= 11111	011	-	x0	LD4 (single structure) 16-bit, register offset
1	1	!= 11111	100	-	00	LD2 (single structure) 32-bit, register offset
1	1	!= 11111	100	0	01	LD2 (single structure) 64-bit, register offset
1	1	!= 11111	101	-	00	LD4 (single structure) 32-bit, register offset

Decode fields						Instruction Page	Variant
L	R	Rm	opcode	S	size		
1	1	!= 11111	101	0	01	LD4 (single structure)	64-bit, register offset
1	1	!= 11111	110	0	-	LD2R	Register offset
1	1	!= 11111	111	0	-	LD4R	Register offset
1	1	11111	000	-	-	LD2 (single structure)	8-bit, immediate offset
1	1	11111	001	-	-	LD4 (single structure)	8-bit, immediate offset
1	1	11111	010	-	x0	LD2 (single structure)	16-bit, immediate offset
1	1	11111	011	-	x0	LD4 (single structure)	16-bit, immediate offset
1	1	11111	100	-	00	LD2 (single structure)	32-bit, immediate offset
1	1	11111	100	0	01	LD2 (single structure)	64-bit, immediate offset
1	1	11111	101	-	00	LD4 (single structure)	32-bit, immediate offset
1	1	11111	101	0	01	LD4 (single structure)	64-bit, immediate offset
1	1	11111	110	0	-	LD2R	Immediate offset
1	1	11111	111	0	-	LD4R	Immediate offset

C3.3.5 Load register (literal)

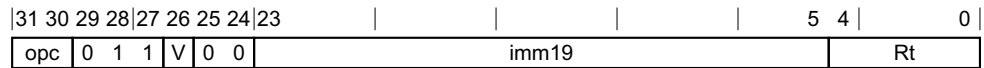

Decode fields		Instruction Page		Variant
opc	V			
00	0	LDR (literal)		32-bit
00	1	LDR (literal, SIMD&FP)		32-bit
01	0	LDR (literal)		64-bit
01	1	LDR (literal, SIMD&FP)		64-bit
10	0	LDRSW (literal)		-
10	1	LDR (literal, SIMD&FP)		128-bit
11	0	PRFM (literal)		-

C3.3.6 Load/store exclusive

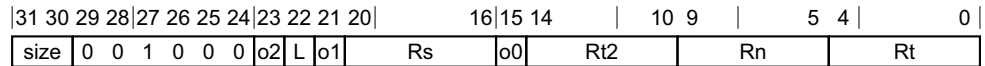

Decode fields					Instruction Page	Variant
size	o2	L	o1	o0		
00	0	0	0	0	STXRB	-
00	0	0	0	1	STLXRB	-
00	0	1	0	0	LDXRB	-
00	0	1	0	1	LDAXRB	-
00	1	0	0	1	STLRB	-
00	1	1	0	1	LDARB	-
01	0	0	0	0	STXRH	-
01	0	0	0	1	STLXRH	-
01	0	1	0	0	LDXRH	-
01	0	1	0	1	LDAXRH	-
01	1	0	0	1	STLRH	-
01	1	1	0	1	LDARH	-
10	0	0	0	0	STXR	32-bit
10	0	0	0	1	STLXR	32-bit
10	0	0	1	0	STXP	32-bit
10	0	0	1	1	STLXP	32-bit
10	0	1	0	0	LDXR	32-bit
10	0	1	0	1	LDAXR	32-bit
10	0	1	1	0	LDXP	32-bit
10	0	1	1	1	LDAXP	32-bit
10	1	0	0	1	STLR	32-bit
10	1	1	0	1	LDAR	32-bit
11	0	0	0	0	STXR	64-bit
11	0	0	0	1	STLXR	64-bit
11	0	0	1	0	STXP	64-bit
11	0	0	1	1	STLXP	64-bit
11	0	1	0	0	LDXR	64-bit

Decode fields					Instruction Page	Variant
size	o2	L	o1	o0		
11	0	1	0	1	LDAXR	64-bit
11	0	1	1	0	LDXP	64-bit
11	0	1	1	1	LDAXP	64-bit
11	1	0	0	1	STLR	64-bit
11	1	1	0	1	LDAR	64-bit

C3.3.7 Load/store no-allocate pair (offset)

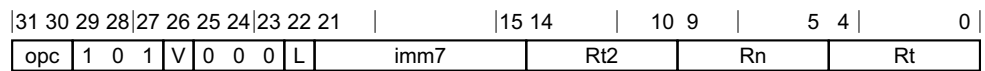

Decode fields			Instruction Page	Variant
opc	V	L		
00	0	0	STNP	32-bit
00	0	1	LDNP	32-bit
00	1	0	STNP (SIMD&FP)	32-bit
00	1	1	LDNP (SIMD&FP)	32-bit
01	1	0	STNP (SIMD&FP)	64-bit
01	1	1	LDNP (SIMD&FP)	64-bit
10	0	0	STNP	64-bit
10	0	1	LDNP	64-bit
10	1	0	STNP (SIMD&FP)	128-bit
10	1	1	LDNP (SIMD&FP)	128-bit

C3.3.8 Load/store register (immediate post-indexed)

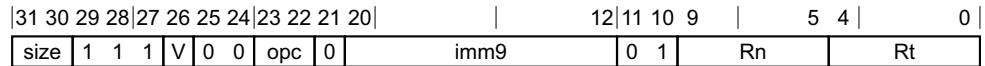

Decode fields			Instruction Page	Variant
size	V	opc		
00	0	00	STRB (immediate)	Post-index
00	0	01	LDRB (immediate)	Post-index
00	0	10	LDRSB (immediate)	64-bit
00	0	11	LDRSB (immediate)	32-bit
00	1	00	STR (immediate, SIMD&FP)	8-bit
00	1	01	LDR (immediate, SIMD&FP)	8-bit
00	1	10	STR (immediate, SIMD&FP)	128-bit
00	1	11	LDR (immediate, SIMD&FP)	128-bit
01	0	00	STRH (immediate)	Post-index
01	0	01	LDRH (immediate)	Post-index
01	0	10	LDRSH (immediate)	64-bit
01	0	11	LDRSH (immediate)	32-bit
01	1	00	STR (immediate, SIMD&FP)	16-bit
01	1	01	LDR (immediate, SIMD&FP)	16-bit
10	0	00	STR (immediate)	32-bit
10	0	01	LDR (immediate)	32-bit
10	0	10	LDRSW (immediate)	Post-index
10	1	00	STR (immediate, SIMD&FP)	32-bit
10	1	01	LDR (immediate, SIMD&FP)	32-bit
11	0	00	STR (immediate)	64-bit
11	0	01	LDR (immediate)	64-bit
11	1	00	STR (immediate, SIMD&FP)	64-bit
11	1	01	LDR (immediate, SIMD&FP)	64-bit

C3.3.9 Load/store register (immediate pre-indexed)

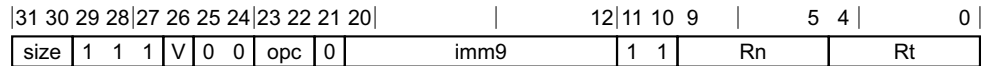

Decode fields			Instruction Page	Variant
size	V	opc		
00	0	00	STRB (immediate)	Pre-index
00	0	01	LDRB (immediate)	Pre-index
00	0	10	LDRSB (immediate)	64-bit
00	0	11	LDRSB (immediate)	32-bit
00	1	00	STR (immediate, SIMD&FP)	8-bit
00	1	01	LDR (immediate, SIMD&FP)	8-bit
00	1	10	STR (immediate, SIMD&FP)	128-bit
00	1	11	LDR (immediate, SIMD&FP)	128-bit
01	0	00	STRH (immediate)	Pre-index
01	0	01	LDRH (immediate)	Pre-index
01	0	10	LDRSH (immediate)	64-bit
01	0	11	LDRSH (immediate)	32-bit
01	1	00	STR (immediate, SIMD&FP)	16-bit
01	1	01	LDR (immediate, SIMD&FP)	16-bit
10	0	00	STR (immediate)	32-bit
10	0	01	LDR (immediate)	32-bit
10	0	10	LDRSW (immediate)	Pre-index
10	1	00	STR (immediate, SIMD&FP)	32-bit
10	1	01	LDR (immediate, SIMD&FP)	32-bit
11	0	00	STR (immediate)	64-bit
11	0	01	LDR (immediate)	64-bit
11	1	00	STR (immediate, SIMD&FP)	64-bit
11	1	01	LDR (immediate, SIMD&FP)	64-bit

C3.3.10 Load/store register (register offset)

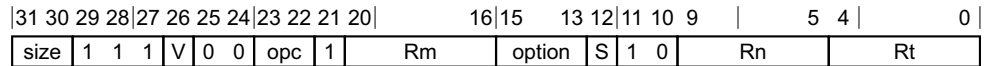

Decode fields				Instruction Page	Variant
size	V	opc	option		
00	0	00	-	STRB (register)	-
00	0	01	-	LDRB (register)	-
00	0	10	-	LDRSB (register)	64-bit
00	0	11	-	LDRSB (register)	32-bit
00	1	00	-	STR (register, SIMD&FP)	8-bit
00	1	01	-	LDR (register, SIMD&FP)	8-bit
00	1	10	-	STR (register, SIMD&FP)	128-bit
00	1	11	-	LDR (register, SIMD&FP)	128-bit
01	0	00	-	STRH (register)	-
01	0	01	-	LDRH (register)	-
01	0	10	-	LDRSH (register)	64-bit
01	0	11	-	LDRSH (register)	32-bit
01	1	00	-	STR (register, SIMD&FP)	16-bit
01	1	01	-	LDR (register, SIMD&FP)	16-bit
10	0	00	-	STR (register)	32-bit
10	0	01	-	LDR (register)	32-bit
10	0	10	-	LDRSW (register)	-
10	1	00	-	STR (register, SIMD&FP)	32-bit
10	1	01	-	LDR (register, SIMD&FP)	32-bit
11	0	00	-	STR (register)	64-bit
11	0	01	-	LDR (register)	64-bit
11	0	10	-	PRFM (register)	-
11	1	00	-	STR (register, SIMD&FP)	64-bit
11	1	01	-	LDR (register, SIMD&FP)	64-bit

C3.3.11 Load/store register (unprivileged)

31 30 29 28				27 26 25 24				23 22 21 20				12 11 10 9				5 4		0	
size	1	1	1	V	0	0	opc	0	imm9				1	0	Rn	Rt			

Decode fields			Instruction Page	Variant
size	V	opc		
00	0	00	STTRB	-
00	0	01	LDTRB	-
00	0	10	LDTRSB	64-bit
00	0	11	LDTRSB	32-bit
01	0	00	STTRH	-
01	0	01	LDTRH	-
01	0	10	LDTRSH	64-bit
01	0	11	LDTRSH	32-bit
10	0	00	STTR	32-bit
10	0	01	LDTR	32-bit
10	0	10	LDTRSW	-
11	0	00	STTR	64-bit
11	0	01	LDTR	64-bit

C3.3.12 Load/store register (unscaled immediate)

31 30 29 28				27 26 25 24				23 22 21 20				12 11 10 9				5 4		0	
size	1	1	1	V	0	0	opc	0	imm9				0	0	Rn	Rt			

Decode fields			Instruction Page	Variant
size	V	opc		
00	0	00	STURB	-
00	0	01	LDURB	-
00	0	10	LDURSB	64-bit
00	0	11	LDURSB	32-bit
00	1	00	STUR (SIMD&FP)	8-bit
00	1	01	LDUR (SIMD&FP)	8-bit
00	1	10	STUR (SIMD&FP)	128-bit

Decode fields			Instruction Page	Variant
size	V	opc		
00	1	11	LDUR (SIMD&FP)	128-bit
01	0	00	STURH	-
01	0	01	LDURH	-
01	0	10	LDURSH	64-bit
01	0	11	LDURSH	32-bit
01	1	00	STUR (SIMD&FP)	16-bit
01	1	01	LDUR (SIMD&FP)	16-bit
10	0	00	STUR	32-bit
10	0	01	LDUR	32-bit
10	0	10	LDURSW	-
10	1	00	STUR (SIMD&FP)	32-bit
10	1	01	LDUR (SIMD&FP)	32-bit
11	0	00	STUR	64-bit
11	0	01	LDUR	64-bit
11	0	10	PRFUM	-
11	1	00	STUR (SIMD&FP)	64-bit
11	1	01	LDUR (SIMD&FP)	64-bit

C3.3.13 Load/store register (unsigned immediate)

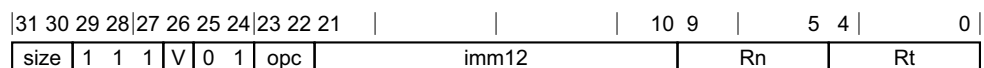

Decode fields			Instruction Page	Variant
size	V	opc		
00	0	00	STRB (immediate)	Unsigned offset
00	0	01	LDRB (immediate)	Unsigned offset
00	0	10	LDRSB (immediate)	64-bit
00	0	11	LDRSB (immediate)	32-bit
00	1	00	STR (immediate, SIMD&FP)	8-bit
00	1	01	LDR (immediate, SIMD&FP)	8-bit
00	1	10	STR (immediate, SIMD&FP)	128-bit

Decode fields			Instruction Page	Variant
size	V	opc		
00	1	11	LDR (immediate, SIMD&FP)	128-bit
01	0	00	STRH (immediate)	Unsigned offset
01	0	01	LDRH (immediate)	Unsigned offset
01	0	10	LDRSH (immediate)	64-bit
01	0	11	LDRSH (immediate)	32-bit
01	1	00	STR (immediate, SIMD&FP)	16-bit
01	1	01	LDR (immediate, SIMD&FP)	16-bit
10	0	00	STR (immediate)	32-bit
10	0	01	LDR (immediate)	32-bit
10	0	10	LDRSW (immediate)	Unsigned offset
10	1	00	STR (immediate, SIMD&FP)	32-bit
10	1	01	LDR (immediate, SIMD&FP)	32-bit
11	0	00	STR (immediate)	64-bit
11	0	01	LDR (immediate)	64-bit
11	0	10	PRFM (immediate)	-
11	1	00	STR (immediate, SIMD&FP)	64-bit
11	1	01	LDR (immediate, SIMD&FP)	64-bit

C3.3.14 Load/store register pair (offset)

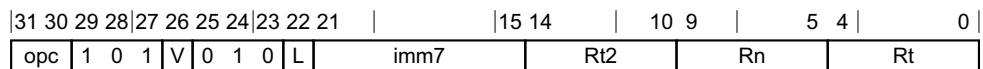

Decode fields			Instruction Page	Variant
opc	V	L		
00	0	0	STP	32-bit
00	0	1	LDP	32-bit
00	1	0	STP (SIMD&FP)	32-bit
00	1	1	LDP (SIMD&FP)	32-bit
01	0	1	LDPSW	Signed offset
01	1	0	STP (SIMD&FP)	64-bit
01	1	1	LDP (SIMD&FP)	64-bit

Decode fields			Instruction Page	Variant
opc	V	L		
10	0	0	STP	64-bit
10	0	1	LDP	64-bit
10	1	0	STP (SIMD&FP)	128-bit
10	1	1	LDP (SIMD&FP)	128-bit

C3.3.15 Load/store register pair (post-indexed)

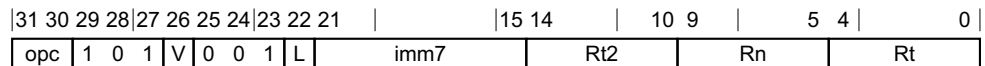

Decode fields			Instruction Page	Variant
opc	V	L		
00	0	0	STP	32-bit
00	0	1	LDP	32-bit
00	1	0	STP (SIMD&FP)	32-bit
00	1	1	LDP (SIMD&FP)	32-bit
01	0	1	LDPSW	Post-index
01	1	0	STP (SIMD&FP)	64-bit
01	1	1	LDP (SIMD&FP)	64-bit
10	0	0	STP	64-bit
10	0	1	LDP	64-bit
10	1	0	STP (SIMD&FP)	128-bit
10	1	1	LDP (SIMD&FP)	128-bit

C3.3.16 Load/store register pair (pre-indexed)

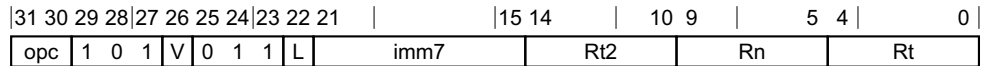

Decode fields			Instruction Page	Variant
opc	V	L		
00	0	0	STP	32-bit
00	0	1	LDP	32-bit
00	1	0	STP (SIMD&FP)	32-bit
00	1	1	LDP (SIMD&FP)	32-bit
01	0	1	LDPSW	Pre-index
01	1	0	STP (SIMD&FP)	64-bit
01	1	1	LDP (SIMD&FP)	64-bit
10	0	0	STP	64-bit
10	0	1	LDP	64-bit
10	1	0	STP (SIMD&FP)	128-bit
10	1	1	LDP (SIMD&FP)	128-bit

C3.4 Data processing - immediate

This section describes the encoding of the instruction classes in the Data processing (immediate) instruction group, and shows how each instruction class encodes the different instruction forms. For additional information on this functional group of instructions, see *Data processing - immediate* on page C2-140.

Table C3-4 Encoding table for the Data Processing - Immediate functional group

Instruction bits																Instruction class							
31	30	29	28	27	26	25	24	23	22	21	20	19	18	17	16	15	14	13	12	11	10		
-	-	-	1	0	0	0	0	-	-	-	-	-	-	-	-	-	-	-	-	-	-	-	PC-rel. addressing
-	-	-	1	0	0	0	1	-	-	-	-	-	-	-	-	-	-	-	-	-	-	-	Add/subtract (immediate)
-	-	-	1	0	0	1	0	0	-	-	-	-	-	-	-	-	-	-	-	-	-	-	Logical (immediate)
-	-	-	1	0	0	1	0	1	-	-	-	-	-	-	-	-	-	-	-	-	-	-	Move wide (immediate)
-	-	-	1	0	0	1	1	0	-	-	-	-	-	-	-	-	-	-	-	-	-	-	Bitfield
-	-	-	1	0	0	1	1	1	-	-	-	-	-	-	-	-	-	-	-	-	-	-	Extract

C3.4.1 Add/subtract (immediate)

31 30 29 28		27 26 25 24				23 22 21					10 9		5 4		0	
sf	op	S	1	0	0	0	1	shift			imm12				Rn	Rd

Decode fields				Instruction Page	Variant
sf	op	S	shift		
0	0	0	-	ADD (immediate)	32-bit
0	0	1	-	ADDS (immediate)	32-bit
0	1	0	-	SUB (immediate)	32-bit
0	1	1	-	SUBS (immediate)	32-bit
1	0	0	-	ADD (immediate)	64-bit
1	0	1	-	ADDS (immediate)	64-bit
1	1	0	-	SUB (immediate)	64-bit
1	1	1	-	SUBS (immediate)	64-bit

C3.4.2 Bitfield

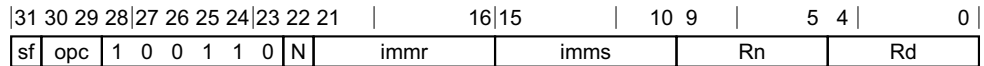

Decode fields			Instruction Page	Variant
sf	opc	N		
0	00	0	SBFM	32-bit
0	01	0	BFM	32-bit
0	10	0	UBFM	32-bit
1	00	1	SBFM	64-bit
1	01	1	BFM	64-bit
1	10	1	UBFM	64-bit

C3.4.3 Extract

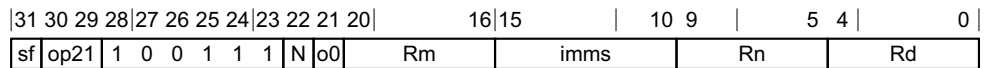

Decode fields					Instruction Page	Variant
sf	op21	N	o0	imms		
0	00	0	0	0xxxxx	EXTR	32-bit
1	00	1	0	-	EXTR	64-bit

C3.4.4 Logical (immediate)

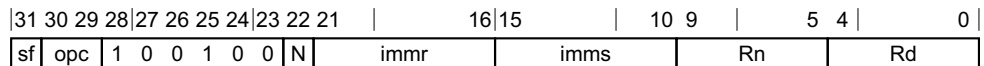

Decode fields			Instruction Page	Variant
sf	opc	N		
0	00	0	AND (immediate)	32-bit
0	01	0	ORR (immediate)	32-bit
0	10	0	EOR (immediate)	32-bit
0	11	0	ANDS (immediate)	32-bit

Decode fields			Instruction Page	Variant
sf	opc	N		
1	00	-	AND (immediate)	64-bit
1	01	-	ORR (immediate)	64-bit
1	10	-	EOR (immediate)	64-bit
1	11	-	ANDS (immediate)	64-bit

C3.4.5 Move wide (immediate)

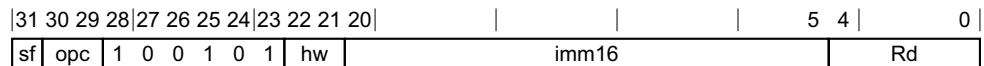

Decode fields			Instruction Page	Variant
sf	opc	hw		
0	00	-	MOVN	32-bit
0	10	-	MOVZ	32-bit
0	11	-	MOVK	32-bit
1	00	-	MOVN	64-bit
1	10	-	MOVZ	64-bit
1	11	-	MOVK	64-bit

C3.4.6 PC-rel. addressing

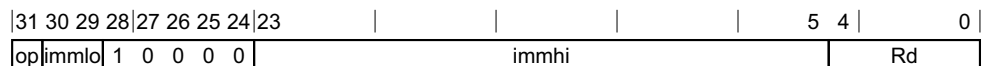

Decode fields		Instruction Page	Variant
op			
0		ADR	-
1		ADRP	-

C3.5 Data processing - register

This section describes the encoding of the instruction classes in the Data processing (register) instruction group, and shows how each instruction class encodes the different instruction forms. For additional information on this functional group of instructions, see *Data processing - register* on page C2-145.

Table C3-5 Encoding table for the Data Processing - Register functional group

Instruction bits																Instruction class							
31	30	29	28	27	26	25	24	23	22	21	20	19	18	17	16	15	14	13	12	11	10		
-	-	-	0	1	0	1	0	-	-	-	-	-	-	-	-	-	-	-	-	-	-	-	Logical (shifted register)
-	-	-	0	1	0	1	1	-	-	0	-	-	-	-	-	-	-	-	-	-	-	-	Add/subtract (shifted register)
-	-	-	0	1	0	1	1	-	-	1	-	-	-	-	-	-	-	-	-	-	-	-	Add/subtract (extended register)
-	-	-	1	1	0	1	0	0	0	0	-	-	-	-	-	-	-	-	-	-	-	-	Add/subtract (with carry)
-	-	-	1	1	0	1	0	0	1	0	-	-	-	-	-	-	-	-	-	0	-	-	Conditional compare (register)
-	-	-	1	1	0	1	0	0	1	0	-	-	-	-	-	-	-	-	-	1	-	-	Conditional compare (immediate)
-	-	-	1	1	0	1	0	1	0	0	-	-	-	-	-	-	-	-	-	-	-	-	Conditional select
-	-	-	1	1	0	1	1	-	-	-	-	-	-	-	-	-	-	-	-	-	-	-	Data-processing (3 source)
-	0	-	1	1	0	1	0	1	1	0	-	-	-	-	-	-	-	-	-	-	-	-	Data-processing (2 source)
-	1	-	1	1	0	1	0	1	1	0	-	-	-	-	-	-	-	-	-	-	-	-	Data-processing (1 source)

C3.5.1 Add/subtract (extended register)

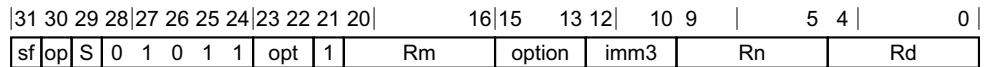

Decode fields					Instruction Page	Variant
sf	op	S	opt	imm3		
0	0	0	00	-	ADD (extended register)	32-bit
0	0	1	00	-	ADDS (extended register)	32-bit
0	1	0	00	-	SUB (extended register)	32-bit
0	1	1	00	-	SUBS (extended register)	32-bit
1	0	0	00	-	ADD (extended register)	64-bit
1	0	1	00	-	ADDS (extended register)	64-bit
1	1	0	00	-	SUB (extended register)	64-bit
1	1	1	00	-	SUBS (extended register)	64-bit

C3.5.2 Add/subtract (shifted register)

31 30 29 28			27 26 25 24			23 22 21 20			16 15		10 9		5 4		0
sf	op	S	0	1	0	1	1	shift	0	Rm	imm6		Rn	Rd	

Decode fields					Instruction Page	Variant
sf	op	S	shift	imm6		
0	0	0	-	-	ADD (shifted register)	32-bit
0	0	1	-	-	ADDS (shifted register)	32-bit
0	1	0	-	-	SUB (shifted register)	32-bit
0	1	1	-	-	SUBS (shifted register)	32-bit
1	0	0	-	-	ADD (shifted register)	64-bit
1	0	1	-	-	ADDS (shifted register)	64-bit
1	1	0	-	-	SUB (shifted register)	64-bit
1	1	1	-	-	SUBS (shifted register)	64-bit

C3.5.3 Add/subtract (with carry)

31 30 29 28			27 26 25 24			23 22 21 20			16 15		10 9		5 4		0
sf	op	S	1	1	0	1	0	0	0	0	Rm	opcode2	Rn	Rd	

Decode fields				Instruction Page	Variant
sf	op	S	opcode2		
0	0	0	000000	ADC	32-bit
0	0	1	000000	ADCS	32-bit
0	1	0	000000	SBC	32-bit
0	1	1	000000	SBCS	32-bit
1	0	0	000000	ADC	64-bit
1	0	1	000000	ADCS	64-bit
1	1	0	000000	SBC	64-bit
1	1	1	000000	SBCS	64-bit

C3.5.4 Conditional compare (immediate)

31 30 29 28 27 26 25 24 23 22 21 20										16 15		12 11 10 9			5 4 3		0			
sf	op	S	1	1	0	1	0	0	1	0	imm5		cond		1	o2	Rn		o3	nzcv

Decode fields					Instruction Page	Variant
sf	op	S	o2	o3		
0	0	1	0	0	CCMN (immediate)	32-bit
0	1	1	0	0	CCMP (immediate)	32-bit
1	0	1	0	0	CCMN (immediate)	64-bit
1	1	1	0	0	CCMP (immediate)	64-bit

C3.5.5 Conditional compare (register)

31 30 29 28 27 26 25 24 23 22 21 20										16 15		12 11 10 9			5 4 3		0			
sf	op	S	1	1	0	1	0	0	1	0	Rm		cond		0	o2	Rn		o3	nzcv

Decode fields					Instruction Page	Variant
sf	op	S	o2	o3		
0	0	1	0	0	CCMN (register)	32-bit
0	1	1	0	0	CCMP (register)	32-bit
1	0	1	0	0	CCMN (register)	64-bit
1	1	1	0	0	CCMP (register)	64-bit

C3.5.6 Conditional select

31 30 29 28 27 26 25 24 23 22 21 20										16 15		12 11 10 9			5 4		0		
sf	op	S	1	1	0	1	0	1	0	0	Rm		cond		op2	Rn		Rd	

Decode fields				Instruction Page	Variant
sf	op	S	op2		
0	0	0	00	CSEL	32-bit
0	0	0	01	CSINC	32-bit
0	1	0	00	CSINV	32-bit
0	1	0	01	CSNEG	32-bit

Decode fields				Instruction Page	Variant
sf	op	S	op2		
1	0	0	00	CSEL	64-bit
1	0	0	01	CSINC	64-bit
1	1	0	00	CSINV	64-bit
1	1	0	01	CSNEG	64-bit

C3.5.7 Data-processing (1 source)

31 30 29 28 27 26 25 24 23 22 21 20										16 15		10 9		5 4		0	
sf	1	S	1	1	0	1	0	1	1	0	opcode2	opcode	Rn	Rd			

Decode fields				Instruction Page	Variant
sf	S	opcode2	opcode		
0	0	00000	000000	RBIT	32-bit
0	0	00000	000001	REV16	32-bit
0	0	00000	000010	REV	32-bit
0	0	00000	000100	CLZ	32-bit
0	0	00000	000101	CLS	32-bit
1	0	00000	000000	RBIT	64-bit
1	0	00000	000001	REV16	64-bit
1	0	00000	000010	REV32	-
1	0	00000	000011	REV	64-bit
1	0	00000	000100	CLZ	64-bit
1	0	00000	000101	CLS	64-bit

C3.5.8 Data-processing (2 source)

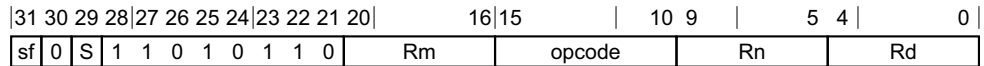

Decode fields			Instruction Page	Variant
sf	S	opcode		
0	0	000010	UDIV	32-bit
0	0	000011	SDIV	32-bit
0	0	001000	LSLV	32-bit
0	0	001001	LSRV	32-bit
0	0	001010	ASRV	32-bit
0	0	001011	RORV	32-bit
0	0	010000	CRC32B, CRC32H, CRC32W, CRC32X	CRC32B
0	0	010001	CRC32B, CRC32H, CRC32W, CRC32X	CRC32H
0	0	010010	CRC32B, CRC32H, CRC32W, CRC32X	CRC32W
0	0	010100	CRC32CB, CRC32CH, CRC32CW, CRC32CX	CRC32CB
0	0	010101	CRC32CB, CRC32CH, CRC32CW, CRC32CX	CRC32CH
0	0	010110	CRC32CB, CRC32CH, CRC32CW, CRC32CX	CRC32CW
1	0	000010	UDIV	64-bit
1	0	000011	SDIV	64-bit
1	0	001000	LSLV	64-bit
1	0	001001	LSRV	64-bit
1	0	001010	ASRV	64-bit
1	0	001011	RORV	64-bit
1	0	010011	CRC32B, CRC32H, CRC32W, CRC32X	CRC32X
1	0	010111	CRC32CB, CRC32CH, CRC32CW, CRC32CX	CRC32CX

C3.5.9 Data-processing (3 source)

31 30 29 28		27 26 25 24		23 21 20		16 15 14		10 9		5 4		0	
sf	op54	1	1	0	1	1	op31	Rm	o0	Ra	Rn	Rd	

Decode fields

sf	op54	op31	o0	Instruction Page	Variant
0	00	000	0	MADD	32-bit
0	00	000	1	MSUB	32-bit
1	00	000	0	MADD	64-bit
1	00	000	1	MSUB	64-bit
1	00	001	0	SMADDL	-
1	00	001	1	SMSUBL	-
1	00	010	0	SMULH	-
1	00	101	0	UMADDL	-
1	00	101	1	UMSUBL	-
1	00	110	0	UMULH	-

C3.5.10 Logical (shifted register)

31 30 29 28		27 26 25 24		23 22 21 20		16 15		10 9		5 4		0	
sf	opc	0	1	0	1	0	shift	N	Rm	imm6	Rn	Rd	

Decode fields

sf	opc	N	imm6	Instruction Page	Variant
0	00	0	-	AND (shifted register)	32-bit
0	00	1	-	BIC (shifted register)	32-bit
0	01	0	-	ORR (shifted register)	32-bit
0	01	1	-	ORN (shifted register)	32-bit
0	10	0	-	EOR (shifted register)	32-bit
0	10	1	-	EON (shifted register)	32-bit
0	11	0	-	ANDS (shifted register)	32-bit
0	11	1	-	BICS (shifted register)	32-bit
1	00	0	-	AND (shifted register)	64-bit
1	00	1	-	BIC (shifted register)	64-bit

Decode fields				Instruction Page	Variant
sf	opc	N	imm6		
1	01	0	-	ORR (shifted register)	64-bit
1	01	1	-	ORN (shifted register)	64-bit
1	10	0	-	EOR (shifted register)	64-bit
1	10	1	-	EON (shifted register)	64-bit
1	11	0	-	ANDS (shifted register)	64-bit
1	11	1	-	BICS (shifted register)	64-bit

C3.6 Data processing - SIMD and floating point

This section describes the encoding of the instruction classes in the Data processing (SIMD and floating-point) instruction group, and shows how each instruction class encodes the different instruction forms. For additional information on this functional group of instructions, see [Data processing - SIMD and floating-point](#) on page C2-152.

Table C3-6 Encoding table for the Data Processing - Scalar Floating-Point and Advanced SIMD functional group

Instruction bits																Instruction class							
31	30	29	28	27	26	25	24	23	22	21	20	19	18	17	16	15	14	13	12	11	10		
-	0	-	1	1	1	1	0	-	-	0	-	-	-	-	-	-	-	-	-	-	-	-	Floating-point<->fixed-point conversions
-	0	-	1	1	1	1	0	-	-	1	-	-	-	-	-	-	-	-	-	0	1		Floating-point conditional compare
-	0	-	1	1	1	1	0	-	-	1	-	-	-	-	-	-	-	-	-	1	0		Floating-point data-processing (2 source)
-	0	-	1	1	1	1	0	-	-	1	-	-	-	-	-	-	-	-	-	1	1		Floating-point conditional select
-	0	-	1	1	1	1	0	-	-	1	-	-	-	-	-	-	-	-	-	1	0	0	Floating-point immediate
-	0	-	1	1	1	1	0	-	-	1	-	-	-	-	-	-	-	-	1	0	0	0	Floating-point compare
-	0	-	1	1	1	1	0	-	-	1	-	-	-	-	-	-	1	0	0	0	0	0	Floating-point data-processing (1 source)
-	0	-	1	1	1	1	0	-	-	1	-	-	-	-	-	0	0	0	0	0	0	0	Floating-point<->integer conversions
-	0	-	1	1	1	1	1	-	-	-	-	-	-	-	-	-	-	-	-	-	-	-	Floating-point data-processing (3 source)
0	-	-	0	1	1	1	0	-	-	1	-	-	-	-	-	-	-	-	-	-	-	1	AdvSIMD three same
0	-	-	0	1	1	1	0	-	-	1	-	-	-	-	-	-	-	-	-	0	0		AdvSIMD three different
0	-	-	0	1	1	1	0	-	-	1	0	0	0	0	-	-	-	-	-	1	0		AdvSIMD two-reg misc
0	-	-	0	1	1	1	0	-	-	1	1	0	0	0	-	-	-	-	-	1	0		AdvSIMD across lanes
0	-	-	0	1	1	1	0	0	0	0	-	-	-	-	-	0	-	-	-	-	1		AdvSIMD copy
0	-	-	0	1	1	1	1	-	-	-	-	-	-	-	-	-	-	-	-	-	0		AdvSIMD vector x indexed element
0	-	-	0	1	1	1	1	0	0	0	0	0	-	-	-	-	-	-	-	-	-	1	AdvSIMD modified immediate
0	-	-	0	1	1	1	1	0	!= 0000				-	-	-	-	-	-	-	-	-	1	AdvSIMD shift by immediate
0	-	0	0	1	1	1	0	-	-	0	-	-	-	-	-	0	-	-	-	0	0		AdvSIMD TBL/TBX
0	-	0	0	1	1	1	0	-	-	0	-	-	-	-	-	0	-	-	-	1	0		AdvSIMD ZIP/UZP/TRN
0	-	1	0	1	1	1	0	-	-	0	-	-	-	-	-	0	-	-	-	-	0		AdvSIMD EXT
0	1	-	1	1	1	1	0	-	-	1	-	-	-	-	-	-	-	-	-	-	-	1	AdvSIMD scalar three same
0	1	-	1	1	1	1	0	-	-	1	-	-	-	-	-	-	-	-	-	-	0	0	AdvSIMD scalar three different
0	1	-	1	1	1	1	0	-	-	1	0	0	0	0	-	-	-	-	-	1	0		AdvSIMD scalar two-reg misc
0	1	-	1	1	1	1	0	-	-	1	1	0	0	0	-	-	-	-	-	1	0		AdvSIMD scalar pairwise
0	1	-	1	1	1	1	0	0	0	0	-	-	-	-	-	0	-	-	-	-	1		AdvSIMD scalar copy
0	1	-	1	1	1	1	1	-	-	-	-	-	-	-	-	-	-	-	-	-	-	0	AdvSIMD scalar x indexed element
0	1	-	1	1	1	1	1	0	-	-	-	-	-	-	-	-	-	-	-	-	-	1	AdvSIMD scalar shift by immediate
0	1	0	0	1	1	1	0	-	-	1	0	1	0	0	-	-	-	-	-	1	0		Crypto AES
0	1	0	1	1	1	1	0	-	-	0	-	-	-	-	-	0	-	-	-	0	0		Crypto three-reg SHA
0	1	0	1	1	1	1	0	-	-	1	0	1	0	0	-	-	-	-	-	1	0		Crypto two-reg SHA

C3.6.1 AdvSIMD EXT

31 30 29 28 27 26 25 24 23 22 21 20								16 15 14			11 10 9			5 4		0
0	Q	1	0	1	1	1	0	op2	0	Rm	0	imm4	0	Rn	Rd	

Decode fields	Instruction Page	Variant
op2		
00	EXT	-

C3.6.2 AdvSIMD TBL/TBX

31 30 29 28 27 26 25 24 23 22 21 20								16 15 14 13 12 11 10 9				5 4		0			
0	Q	0	0	1	1	1	0	op2	0	Rm	0	len	op	0	0	Rn	Rd

Decode fields			Instruction Page	Variant
op2	len	op		
00	00	0	TBL	Single register table
00	00	1	TBX	Single register table
00	01	0	TBL	Two register table
00	01	1	TBX	Two register table
00	10	0	TBL	Three register table
00	10	1	TBX	Three register table
00	11	0	TBL	Four register table
00	11	1	TBX	Four register table

C3.6.3 AdvSIMD ZIP/UZP/TRN

31 30 29 28 27 26 25 24 23 22 21 20								16 15 14			12 11 10 9			5 4		0
0	Q	0	0	1	1	1	0	size	0	Rm	0	opcode	1	0	Rn	Rd

Decode fields	Instruction Page	Variant
opcode		
001	UZP1	-
010	TRN1	-
011	ZIP1	-

Decode fields	Instruction Page	Variant
opcode		
101	UZP2	-
110	TRN2	-
111	ZIP2	-

C3.6.4 AdvSIMD across lanes

31	30	29	28	27	26	25	24	23	22	21	20	19	18	17	16	12	11	10	9	5	4	0	
0	Q	U	0	1	1	1	0	size	1	1	0	0	0	opcode	1	0	Rn					Rd	

Decode fields	Instruction Page	Variant
U	size	opcode
0	-	00011
0	-	01010
0	-	11010
0	-	11011
1	-	00011
1	-	01010
1	-	11010
1	0x	01100
1	0x	01111
1	1x	01100
1	1x	01111

C3.6.5 AdvSIMD copy

31	30	29	28	27	26	25	24	23	22	21	20	16	15	14	11	10	9	5	4	0	
0	Q	op	0	1	1	1	0	0	0	0	imm5	0	imm4	1	Rn					Rd	

Decode fields	Instruction Page	Variant
Q	op	imm5
		imm4
-	0	-
-	0	-
0	0	-

Decode fields				Instruction Page	Variant
Q	op	imm5	imm4		
0	0	-	0111	UMOV	32-bit
1	0	-	0011	INS (general)	-
1	0	-	0101	SMOV	64-bit
1	0	-	0111	UMOV	64-bit
1	1	-	-	INS (element)	-

C3.6.6 AdvSIMD modified immediate

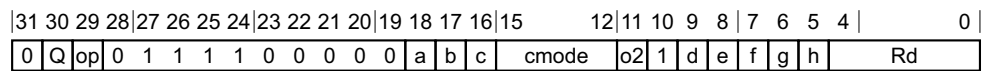

Decode fields				Instruction Page	Variant
Q	op	cmode	o2		
-	0	0xx0	0	MOVI	32-bit shifted immediate
-	0	0xx1	0	ORR (vector, immediate)	32-bit
-	0	10x0	0	MOVI	16-bit shifted immediate
-	0	10x1	0	ORR (vector, immediate)	16-bit
-	0	110x	0	MOVI	32-bit shifting ones
-	0	1110	0	MOVI	8-bit
-	0	1111	0	FMOV (vector, immediate)	Single-precision
-	1	0xx0	0	MVNI	32-bit shifted immediate
-	1	0xx1	0	BIC (vector, immediate)	32-bit
-	1	10x0	0	MVNI	16-bit shifted immediate
-	1	10x1	0	BIC (vector, immediate)	16-bit
-	1	110x	0	MVNI	32-bit shifting ones
0	1	1110	0	MOVI	64-bit scalar
1	1	1110	0	MOVI	64-bit vector
1	1	1111	0	FMOV (vector, immediate)	Double-precision

C3.6.7 AdvSIMD scalar copy

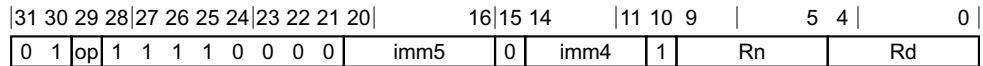

Decode fields			Instruction Page	Variant
op	imm5	imm4		
0	-	0000	DUP (element)	Scalar

C3.6.8 AdvSIMD scalar pairwise

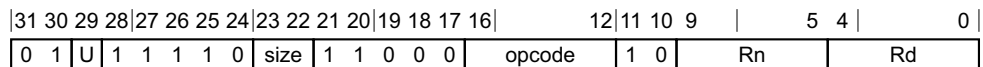

Decode fields			Instruction Page	Variant
U	size	opcode		
0	-	11011	ADDP (scalar)	-
1	0x	01100	FMAXNMP (scalar)	-
1	0x	01101	FADDP (scalar)	-
1	0x	01111	FMAXP (scalar)	-
1	1x	01100	FMINNMP (scalar)	-
1	1x	01111	FMINP (scalar)	-

C3.6.9 AdvSIMD scalar shift by immediate

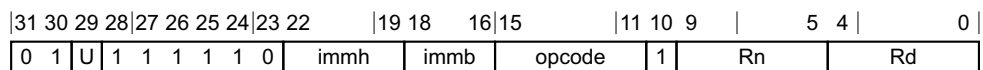

Decode fields			Instruction Page	Variant
U	immh	opcode		
0	!= 0000	00000	SSHR	Scalar
0	!= 0000	00010	SSRA	Scalar
0	!= 0000	00100	SRSR	Scalar
0	!= 0000	00110	SRSRA	Scalar
0	!= 0000	01010	SRL	Scalar

Decode fields			Instruction Page	Variant
U	immh	opcode		
0	!= 0000	01110	SQSHL (immediate)	Scalar
0	!= 0000	10010	SQSHRN, SQSHRN2	Scalar
0	!= 0000	10011	SQRSHRN, SQRSHRN2	Scalar
0	!= 0000	11100	SCVTF (vector, fixed-point)	Scalar
0	!= 0000	11111	FCVTZS (vector, fixed-point)	Scalar
1	!= 0000	00000	USHR	Scalar
1	!= 0000	00010	USRA	Scalar
1	!= 0000	00100	URSHR	Scalar
1	!= 0000	00110	URSRA	Scalar
1	!= 0000	01000	SRI	Scalar
1	!= 0000	01010	SLI	Scalar
1	!= 0000	01100	SQSHLU	Scalar
1	!= 0000	01110	UQSHL (immediate)	Scalar
1	!= 0000	10000	SQSHRUN, SQSHRUN2	Scalar
1	!= 0000	10001	SQRSHRUN, SQRSHRUN2	Scalar
1	!= 0000	10010	UQSHRN	Scalar
1	!= 0000	10011	UQRSHRN, UQRSHRN2	Scalar
1	!= 0000	11100	UCVTF (vector, fixed-point)	Scalar
1	!= 0000	11111	FCVTZU (vector, fixed-point)	Scalar

C3.6.10 AdvSIMD scalar three different

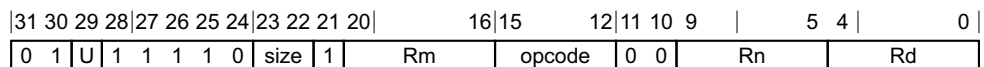

Decode fields		Instruction Page	Variant
U	opcode		
0	1001	SQDMLAL, SQDMLAL2 (vector)	Scalar
0	1011	SQDMLSL, SQDMLSL2 (vector)	Scalar
0	1101	SQDMULL, SQDMULL2 (vector)	Scalar

C3.6.11 AdvSIMD scalar three same

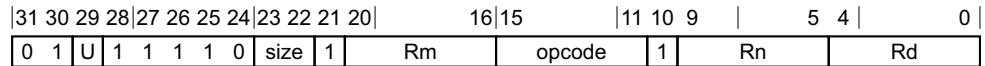

Decode fields			Instruction Page	Variant
U	size	opcode		
0	-	00001	SQADD	Scalar
0	-	00101	SQSUB	Scalar
0	-	00110	CMGT (register)	Scalar
0	-	00111	CMGE (register)	Scalar
0	-	01000	SSHL	Scalar
0	-	01001	SQSHL (register)	Scalar
0	-	01010	SRSHL	Scalar
0	-	01011	SQRSHL	Scalar
0	-	10000	ADD (vector)	Scalar
0	-	10001	CMTST	Scalar
0	-	10110	SQDMULH (vector)	Scalar
0	0x	11011	FMULX	Scalar
0	0x	11100	FCMEQ (register)	Scalar
0	0x	11111	FRECPS	Scalar
0	1x	11111	FRSQRTS	Scalar
1	-	00001	UQADD	Scalar
1	-	00101	UQSUB	Scalar
1	-	00110	CMHI (register)	Scalar
1	-	00111	CMHS (register)	Scalar
1	-	01000	USHL	Scalar
1	-	01001	UQSHL (register)	Scalar
1	-	01010	URSHL	Scalar
1	-	01011	UQRSHL	Scalar
1	-	10000	SUB (vector)	Scalar
1	-	10001	CMEQ (register)	Scalar
1	-	10110	SQRDMULH (vector)	Scalar
1	0x	11100	FCMGE (register)	Scalar

Decode fields			Instruction Page	Variant
U	size	opcode		
1	0x	11101	FACGE	Scalar
1	1x	11010	FABD	Scalar
1	1x	11100	FCMGT (register)	Scalar
1	1x	11101	FACGT	Scalar

C3.6.12 AdvSIMD scalar two-reg misc

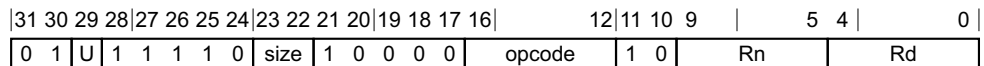

Decode fields			Instruction Page	Variant
U	size	opcode		
0	-	00011	SUQADD	Scalar
0	-	00111	SQABS	Scalar
0	-	01000	CMGT (zero)	Scalar
0	-	01001	CMEQ (zero)	Scalar
0	-	01010	CMLT (zero)	Scalar
0	-	01011	ABS	Scalar
0	-	10100	SQXTN, SQXTN2	Scalar
0	0x	11010	FCVTNS (vector)	Scalar
0	0x	11011	FCVTMS (vector)	Scalar
0	0x	11100	FCVTAS (vector)	Scalar
0	0x	11101	SCVTF (vector, integer)	Scalar
0	1x	01100	FCMGT (zero)	Scalar
0	1x	01101	FCMEQ (zero)	Scalar
0	1x	01110	FCMLT (zero)	Scalar
0	1x	11010	FCVTPS (vector)	Scalar
0	1x	11011	FCVTZS (vector, integer)	Scalar
0	1x	11101	FRECPE	Scalar
0	1x	11111	FRECPX	-
1	-	00011	USQADD	Scalar
1	-	00111	SQNEG	Scalar

Decode fields			Instruction Page	Variant
U	size	opcode		
1	-	01000	CMGE (zero)	Scalar
1	-	01001	CMLE (zero)	Scalar
1	-	01011	NEG (vector)	Scalar
1	-	10010	SQXTUN, SQXTUN2	Scalar
1	-	10100	UQXTN, UQXTN2	Scalar
1	0x	10110	FCVTXN, FCVTXN2	Scalar
1	0x	11010	FCVTNU (vector)	Scalar
1	0x	11011	FCVTMU (vector)	Scalar
1	0x	11100	FCVTAU (vector)	Scalar
1	0x	11101	UCVTF (vector, integer)	Scalar
1	1x	01100	FCMGE (zero)	Scalar
1	1x	01101	FCMLE (zero)	Scalar
1	1x	11010	FCVTPU (vector)	Scalar
1	1x	11011	FCVTZU (vector, integer)	Scalar
1	1x	11101	FRSQRTE	Scalar

C3.6.13 AdvSIMD scalar x indexed element

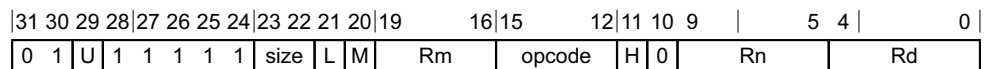

Decode fields			Instruction Page	Variant
U	size	opcode		
0	-	0011	SQDMLAL, SQDMLAL2 (by element)	Scalar
0	-	0111	SQDMLSL, SQDMLSL2 (by element)	Scalar
0	-	1011	SQDMULL, SQDMULL2 (by element)	Scalar
0	-	1100	SQDMULH (by element)	Scalar
0	-	1101	SQRDMULH (by element)	Scalar
0	1x	0001	FMLA (by element)	Scalar
0	1x	0101	FMLS (by element)	Scalar
0	1x	1001	FMUL (by element)	Scalar
1	1x	1001	FMULX (by element)	Scalar

C3.6.14 AdvSIMD shift by immediate

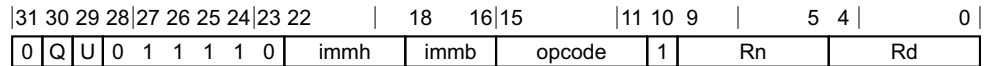

Decode fields		Instruction Page	Variant
U	opcode		
0	00000	SSHR	Vector
0	00010	SSRA	Vector
0	00100	SRSHR	Vector
0	00110	SRSRA	Vector
0	01010	SHL	Vector
0	01110	SQSHL (immediate)	Vector
0	10000	SHRN, SHRN2	-
0	10001	RSHRN, RSHRN2	-
0	10010	SQSHRN, SQSHRN2	Vector
0	10011	SQRSHRN, SQRSHRN2	Vector
0	10100	SSHLL, SSHLL2	-
0	11100	SCVTF (vector, fixed-point)	Vector
0	11111	FCVTZS (vector, fixed-point)	Vector
1	00000	USHR	Vector
1	00010	USRA	Vector
1	00100	URSHR	Vector
1	00110	URSRA	Vector
1	01000	SRI	Vector
1	01010	SLI	Vector
1	01100	SQSHLU	Vector
1	01110	UQSHL (immediate)	Vector
1	10000	SQSHRUN, SQSHRUN2	Vector
1	10001	SQRSHRUN, SQRSHRUN2	Vector
1	10010	UQSHRN	Vector
1	10011	UQRSHRN, UQRSHRN2	Vector

Decode fields		Instruction Page	Variant
U	opcode		
1	10100	USHLL, USHLL2	-
1	11100	UCVTF (vector, fixed-point)	Vector
1	11111	FCVTZU (vector, fixed-point)	Vector

C3.6.15 AdvSIMD three different

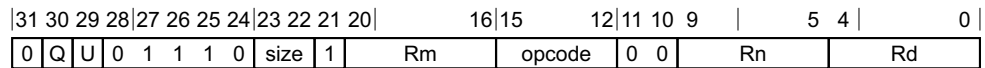

Decode fields		Instruction Page	Variant
U	opcode		
0	0000	SADDL, SADDL2	-
0	0001	SADDW, SADDW2	-
0	0010	SSUBL, SSUBL2	-
0	0011	SSUBW, SSUBW2	-
0	0100	ADDHN, ADDHN2	-
0	0101	SABAL, SABAL2	-
0	0110	SUBHN, SUBHN2	-
0	0111	SABDL, SABDL2	-
0	1000	SMLAL, SMLAL2 (vector)	-
0	1001	SQDMLAL, SQDMLAL2 (vector)	Vector
0	1010	SMLSL, SMLSL2 (vector)	-
0	1011	SQDMLSL, SQDMLSL2 (vector)	Vector
0	1100	SMULL, SMULL2 (vector)	-
0	1101	SQDMULL, SQDMULL2 (vector)	Vector
0	1110	PMULL, PMULL2	-
1	0000	UADDL, UADDL2	-
1	0001	UADDW, UADDW2	-
1	0010	USUBL, USUBL2	-
1	0011	USUBW, USUBW2	-
1	0100	RADDHN, RADDHN2	-
1	0101	UABAL, UABAL2	-

Decode fields		Instruction Page	Variant
U	opcode		
1	0110	RSUBHN, RSUBHN2	-
1	0111	UABDL, UABDL2	-
1	1000	UMLAL, UMLAL2 (vector)	-
1	1010	UMLSL, UMLSL2 (vector)	-
1	1100	UMULL, UMULL2 (vector)	-

C3.6.16 AdvSIMD three same

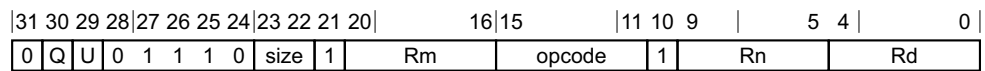

Decode fields			Instruction Page	Variant
U	size	opcode		
0	-	00000	SHADD	-
0	-	00001	SQADD	Vector
0	-	00010	SRHADD	-
0	-	00100	SHSUB	-
0	-	00101	SQSUB	Vector
0	-	00110	CMGT (register)	Vector
0	-	00111	CMGE (register)	Vector
0	-	01000	SSHL	Vector
0	-	01001	SQSHL (register)	Vector
0	-	01010	SRSHL	Vector
0	-	01011	SQRSHL	Vector
0	-	01100	SMAX	-
0	-	01101	SMIN	-
0	-	01110	SABD	-
0	-	01111	SABA	-
0	-	10000	ADD (vector)	Vector
0	-	10001	CMTST	Vector
0	-	10010	MLA (vector)	-
0	-	10011	MUL (vector)	-

Decode fields			Instruction Page	Variant
U	size	opcode		
0	-	10100	SMAXP	-
0	-	10101	SMINP	-
0	-	10110	SQDMULH (vector)	Vector
0	-	10111	ADDP (vector)	-
0	0x	11000	FMAXNM (vector)	-
0	0x	11001	FMLA (vector)	-
0	0x	11010	FADD (vector)	-
0	0x	11011	FMULX	Vector
0	0x	11100	FCMEQ (register)	Vector
0	0x	11110	FMAX (vector)	-
0	0x	11111	FRECPS	Vector
0	00	00011	AND (vector)	-
0	01	00011	BIC (vector, register)	-
0	1x	11000	FMINNM (vector)	-
0	1x	11001	FMLS (vector)	-
0	1x	11010	FSUB (vector)	-
0	1x	11110	FMIN (vector)	-
0	1x	11111	FRSQRTS	Vector
0	10	00011	ORR (vector, register)	-
0	11	00011	ORN (vector)	-
1	-	00000	UHADD	-
1	-	00001	UQADD	Vector
1	-	00010	URHADD	-
1	-	00100	UHSUB	-
1	-	00101	UQSUB	Vector
1	-	00110	CMHI (register)	Vector
1	-	00111	CMHS (register)	Vector
1	-	01000	USHL	Vector
1	-	01001	UQSHL (register)	Vector
1	-	01010	URSHL	Vector
1	-	01011	UQRSHL	Vector
1	-	01100	UMAX	-

Decode fields			Instruction Page	Variant
U	size	opcode		
1	-	01101	UMIN	-
1	-	01110	UABD	-
1	-	01111	UABA	-
1	-	10000	SUB (vector)	Vector
1	-	10001	CMEQ (register)	Vector
1	-	10010	MLS (vector)	-
1	-	10011	PMUL	-
1	-	10100	UMAXP	-
1	-	10101	UMINP	-
1	-	10110	SQRDMULH (vector)	Vector
1	0x	11000	FMAXNMP (vector)	-
1	0x	11010	FADDP (vector)	-
1	0x	11011	FMUL (vector)	-
1	0x	11100	FCMGE (register)	Vector
1	0x	11101	FACGE	Vector
1	0x	11110	FMAXP (vector)	-
1	0x	11111	FDIV (vector)	-
1	00	00011	EOR (vector)	-
1	01	00011	BSL	-
1	1x	11000	FMINNMP (vector)	-
1	1x	11010	FABD	Vector
1	1x	11100	FCMGT (register)	Vector
1	1x	11101	FACGT	Vector
1	1x	11110	FMINP (vector)	-
1	10	00011	BIT	-
1	11	00011	BIF	-

C3.6.17 AdvSIMD two-reg misc

31 30 29 28 27 26 25 24 23 22 21 20 19 18 17 16										12 11 10 9				5 4		0		
0	Q	U	0	1	1	1	0	size	1	0	0	0	0	opcode	1	0	Rn	Rd

Decode fields			Instruction Page	Variant
U	size	opcode		
0	-	00000	REV64	-
0	-	00001	REV16 (vector)	-
0	-	00010	SADDLP	-
0	-	00011	SUQADD	Vector
0	-	00100	CLS (vector)	-
0	-	00101	CNT	-
0	-	00110	SADALP	-
0	-	00111	SQABS	Vector
0	-	01000	CMGT (zero)	Vector
0	-	01001	CMEQ (zero)	Vector
0	-	01010	CMLT (zero)	Vector
0	-	01011	ABS	Vector
0	-	10010	XTN, XTN2	-
0	-	10100	SQXTN, SQXTN2	Vector
0	0x	10110	FCVTN, FCVTN2	-
0	0x	10111	FCVTL, FCVTL2	-
0	0x	11000	FRINTN (vector)	-
0	0x	11001	FRINTM (vector)	-
0	0x	11010	FCVTNS (vector)	Vector
0	0x	11011	FCVTMS (vector)	Vector
0	0x	11100	FCVTAS (vector)	Vector
0	0x	11101	SCVTF (vector, integer)	Vector
0	1x	01100	FCMGT (zero)	Vector
0	1x	01101	FCMEQ (zero)	Vector
0	1x	01110	FCMLT (zero)	Vector
0	1x	01111	FABS (vector)	-
0	1x	11000	FRINTP (vector)	-

Decode fields			Instruction Page	Variant
U	size	opcode		
0	1x	11001	FRINTZ (vector)	-
0	1x	11010	FCVTPS (vector)	Vector
0	1x	11011	FCVTZS (vector, integer)	Vector
0	1x	11100	URECPE	-
0	1x	11101	FRECPE	Vector
1	-	00000	REV32 (vector)	-
1	-	00010	UADDLP	-
1	-	00011	USQADD	Vector
1	-	00100	CLZ (vector)	-
1	-	00110	UADALP	-
1	-	00111	SQNEG	Vector
1	-	01000	CMGE (zero)	Vector
1	-	01001	CMLE (zero)	Vector
1	-	01011	NEG (vector)	Vector
1	-	10010	SQXTUN, SQXTUN2	Vector
1	-	10011	SHLL, SHLL2	-
1	-	10100	UQXTN, UQXTN2	Vector
1	0x	10110	FCVTXN, FCVTXN2	Vector
1	0x	11000	FRINTA (vector)	-
1	0x	11001	FRINTX (vector)	-
1	0x	11010	FCVTNU (vector)	Vector
1	0x	11011	FCVTMU (vector)	Vector
1	0x	11100	FCVTAU (vector)	Vector
1	0x	11101	UCVTF (vector, integer)	Vector
1	00	00101	NOT	-
1	01	00101	RBIT (vector)	-
1	1x	01100	FCMGE (zero)	Vector
1	1x	01101	FCMLE (zero)	Vector
1	1x	01111	FNEG (vector)	-
1	1x	11001	FRINTI (vector)	-
1	1x	11010	FCVTPU (vector)	Vector
1	1x	11011	FCVTZU (vector, integer)	Vector

Decode fields			Instruction Page	Variant
U	size	opcode		
1	1x	11100	URSQRTE	-
1	1x	11101	FRSQRTE	Vector
1	1x	11111	FSQRT (vector)	-

C3.6.18 AdvSIMD vector x indexed element

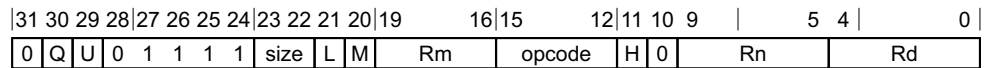

Decode fields			Instruction Page	Variant
U	size	opcode		
0	-	0010	SMLAL, SMLAL2 (by element)	-
0	-	0011	SQDMLAL, SQDMLAL2 (by element)	Vector
0	-	0110	SMLSL, SMLSL2 (by element)	-
0	-	0111	SQDMLSL, SQDMLSL2 (by element)	Vector
0	-	1000	MUL (by element)	-
0	-	1010	SMULL, SMULL2 (by element)	-
0	-	1011	SQDMULL, SQDMULL2 (by element)	Vector
0	-	1100	SQDMULH (by element)	Vector
0	-	1101	SQRDMULH (by element)	Vector
0	1x	0001	FMLA (by element)	Vector
0	1x	0101	FMLS (by element)	Vector
0	1x	1001	FMUL (by element)	Vector
1	-	0000	MLA (by element)	-
1	-	0010	UMLAL, UMLAL2 (by element)	-
1	-	0100	MLS (by element)	-
1	-	0110	UMLSL, UMLSL2 (by element)	-
1	-	1010	UMULL, UMULL2 (by element)	-
1	1x	1001	FMULX (by element)	Vector

C3.6.19 Crypto AES

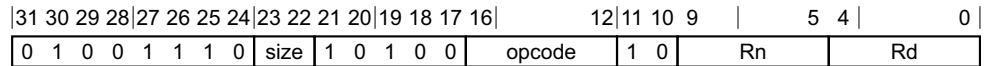

Decode fields

size	opcode	Instruction Page	Variant
00	00100	AESE	-
00	00101	AESD	-
00	00110	AESMC	-
00	00111	AESIMC	-

C3.6.20 Crypto three-reg SHA

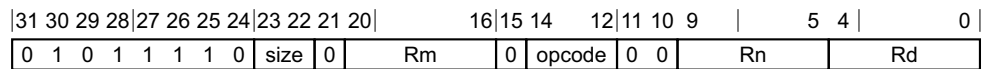

Decode fields

size	opcode	Instruction Page	Variant
00	000	SHA1C	-
00	001	SHA1P	-
00	010	SHA1M	-
00	011	SHA1SU0	-
00	100	SHA256H	-
00	101	SHA256H2	-
00	110	SHA256SU1	-

C3.6.21 Crypto two-reg SHA

31	30	29	28	27	26	25	24	23	22	21	20	19	18	17	16	12	11	10	9	5	4	0
0	1	0	1	1	1	1	0	size	1	0	1	0	0	opcode	1	0	Rn	Rd				

Decode fields

size	opcode	Instruction Page	Variant
00	00000	SHA1H	-
00	00001	SHA1SU1	-
00	00010	SHA256SU0	-

C3.6.22 Floating-point compare

31	30	29	28	27	26	25	24	23	22	21	20	16	15	14	13	12	11	10	9	5	4	0
M	0	S	1	1	1	1	0	type	1	Rm	op	1	0	0	0	Rn	opcode2					

Decode fields

M	S	type	op	opcode2	Instruction Page	Variant
0	0	00	00	00000	FCMP	Single-precision
0	0	00	00	01000	FCMP	Single-precision, zero
0	0	00	00	10000	FCMPE	Single-precision
0	0	00	00	11000	FCMPE	Single-precision, zero
0	0	01	00	00000	FCMP	Double-precision
0	0	01	00	01000	FCMP	Double-precision, zero
0	0	01	00	10000	FCMPE	Double-precision
0	0	01	00	11000	FCMPE	Double-precision, zero

C3.6.23 Floating-point conditional compare

31 30 29 28				27 26 25 24				23 22 21 20				16 15		12 11 10 9			5 4		3		0	
M	0	S	1	1	1	1	0	type	1	Rm			cond		0	1	Rn		op	nzcv		

Decode fields

Decode fields				Instruction Page	Variant
M	S	type	op		
0	0	00	0	FCCMP	Single-precision
0	0	00	1	FCCMPE	Single-precision
0	0	01	0	FCCMP	Double-precision
0	0	01	1	FCCMPE	Double-precision

C3.6.24 Floating-point conditional select

31 30 29 28				27 26 25 24				23 22 21 20				16 15		12 11 10 9			5 4		0	
M	0	S	1	1	1	1	0	type	1	Rm			cond		1	1	Rn		Rd	

Decode fields

Decode fields				Instruction Page	Variant
M	S	type			
0	0	00		FCSEL	Single-precision
0	0	01		FCSEL	Double-precision

C3.6.25 Floating-point data-processing (1 source)

31 30 29 28				27 26 25 24				23 22 21 20				15 14 13 12				11 10 9			5 4		0	
M	0	S	1	1	1	1	0	type	1	opcode			1	0	0	0	Rn		Rd			

Decode fields

Decode fields				Instruction Page	Variant
M	S	type	opcode		
0	0	00	000000	FMOV (register)	Single-precision
0	0	00	000001	FABS (scalar)	Single-precision
0	0	00	000010	FNEG (scalar)	Single-precision
0	0	00	000011	FSQRT (scalar)	Single-precision
0	0	00	000101	FCVT	Single-precision to double-precision
0	0	00	000111	FCVT	Single-precision to half-precision

Decode fields				Instruction Page	Variant
M	S	type	opcode		
0	0	00	001000	FRINTN (scalar)	Single-precision
0	0	00	001001	FRINTP (scalar)	Single-precision
0	0	00	001010	FRINTM (scalar)	Single-precision
0	0	00	001011	FRINTZ (scalar)	Single-precision
0	0	00	001100	FRINTA (scalar)	Single-precision
0	0	00	001110	FRINTX (scalar)	Single-precision
0	0	00	001111	FRINTI (scalar)	Single-precision
0	0	01	000000	FMOV (register)	Double-precision
0	0	01	000001	FABS (scalar)	Double-precision
0	0	01	000010	FNEG (scalar)	Double-precision
0	0	01	000011	FSQRT (scalar)	Double-precision
0	0	01	000100	FCVT	Double-precision to single-precision
0	0	01	000111	FCVT	Double-precision to half-precision
0	0	01	001000	FRINTN (scalar)	Double-precision
0	0	01	001001	FRINTP (scalar)	Double-precision
0	0	01	001010	FRINTM (scalar)	Double-precision
0	0	01	001011	FRINTZ (scalar)	Double-precision
0	0	01	001100	FRINTA (scalar)	Double-precision
0	0	01	001110	FRINTX (scalar)	Double-precision
0	0	01	001111	FRINTI (scalar)	Double-precision
0	0	11	000100	FCVT	Half-precision to single-precision
0	0	11	000101	FCVT	Half-precision to double-precision

C3.6.26 Floating-point data-processing (2 source)

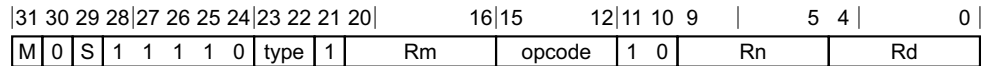

Decode fields				Instruction Page	Variant
M	S	type	opcode		
0	0	00	0000	FMUL (scalar)	Single-precision
0	0	00	0001	FDIV (scalar)	Single-precision
0	0	00	0010	FADD (scalar)	Single-precision
0	0	00	0011	FSUB (scalar)	Single-precision
0	0	00	0100	FMAX (scalar)	Single-precision
0	0	00	0101	FMIN (scalar)	Single-precision
0	0	00	0110	FMAXNM (scalar)	Single-precision
0	0	00	0111	FMINNM (scalar)	Single-precision
0	0	00	1000	FNMUL	Single-precision
0	0	01	0000	FMUL (scalar)	Double-precision
0	0	01	0001	FDIV (scalar)	Double-precision
0	0	01	0010	FADD (scalar)	Double-precision
0	0	01	0011	FSUB (scalar)	Double-precision
0	0	01	0100	FMAX (scalar)	Double-precision
0	0	01	0101	FMIN (scalar)	Double-precision
0	0	01	0110	FMAXNM (scalar)	Double-precision
0	0	01	0111	FMINNM (scalar)	Double-precision
0	0	01	1000	FNMUL	Double-precision

C3.6.27 Floating-point data-processing (3 source)

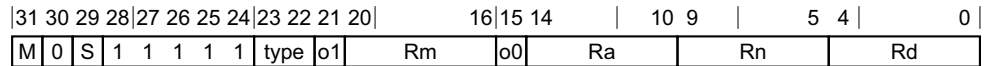

Decode fields					Instruction Page	Variant
M	S	type	o1	o0		
0	0	00	0	0	FMADD	Single-precision
0	0	00	0	1	FMSUB	Single-precision
0	0	00	1	0	FNMADD	Single-precision
0	0	00	1	1	FNMSUB	Single-precision
0	0	01	0	0	FMADD	Double-precision
0	0	01	0	1	FMSUB	Double-precision
0	0	01	1	0	FNMADD	Double-precision
0	0	01	1	1	FNMSUB	Double-precision

C3.6.28 Floating-point immediate

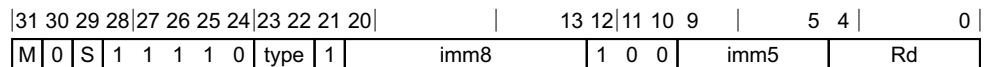

Decode fields				Instruction Page	Variant
M	S	type	imm5		
0	0	00	00000	FMOV (scalar, immediate)	Single-precision
0	0	01	00000	FMOV (scalar, immediate)	Double-precision

C3.6.29 Floating-point<->fixed-point conversions

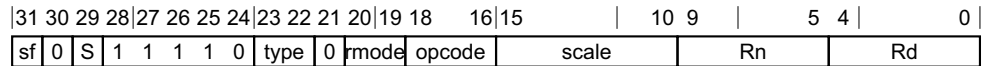

Decode fields						Instruction Page	Variant
sf	S	type	rmode	opcode	scale		
0	0	00	00	010	-	SCVTF (scalar, fixed-point)	32-bit to single-precision
0	0	00	00	011	-	UCVTF (scalar, fixed-point)	32-bit to single-precision
0	0	00	11	000	-	FCVTZS (scalar, fixed-point)	Single-precision to 32-bit
0	0	00	11	001	-	FCVTZU (scalar, fixed-point)	Single-precision to 32-bit
0	0	01	00	010	-	SCVTF (scalar, fixed-point)	32-bit to double-precision
0	0	01	00	011	-	UCVTF (scalar, fixed-point)	32-bit to double-precision
0	0	01	11	000	-	FCVTZS (scalar, fixed-point)	Double-precision to 32-bit
0	0	01	11	001	-	FCVTZU (scalar, fixed-point)	Double-precision to 32-bit
1	0	00	00	010	-	SCVTF (scalar, fixed-point)	64-bit to single-precision
1	0	00	00	011	-	UCVTF (scalar, fixed-point)	64-bit to single-precision
1	0	00	11	000	-	FCVTZS (scalar, fixed-point)	Single-precision to 64-bit
1	0	00	11	001	-	FCVTZU (scalar, fixed-point)	Single-precision to 64-bit
1	0	01	00	010	-	SCVTF (scalar, fixed-point)	64-bit to double-precision
1	0	01	00	011	-	UCVTF (scalar, fixed-point)	64-bit to double-precision
1	0	01	11	000	-	FCVTZS (scalar, fixed-point)	Double-precision to 64-bit
1	0	01	11	001	-	FCVTZU (scalar, fixed-point)	Double-precision to 64-bit

C3.6.30 Floating-point<->integer conversions

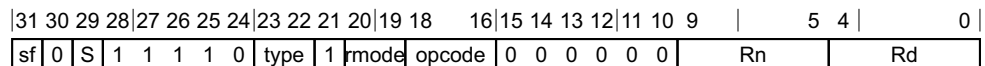

Decode fields						Instruction Page	Variant
sf	S	type	rmode	opcode			
0	0	00	00	000		FCVTNS (scalar)	Single-precision to 32-bit
0	0	00	00	001		FCVTNU (scalar)	Single-precision to 32-bit
0	0	00	00	010		SCVTF (scalar, integer)	32-bit to single-precision
0	0	00	00	011		UCVTF (scalar, integer)	32-bit to single-precision

Decode fields					Instruction Page	Variant
sf	S	type	rmode	opcode		
0	0	00	00	100	FCVTAS (scalar)	Single-precision to 32-bit
0	0	00	00	101	FCVTAU (scalar)	Single-precision to 32-bit
0	0	00	00	110	FMOV (general)	Single-precision to 32-bit
0	0	00	00	111	FMOV (general)	32-bit to single-precision
0	0	00	01	000	FCVTPS (scalar)	Single-precision to 32-bit
0	0	00	01	001	FCVTPU (scalar)	Single-precision to 32-bit
0	0	00	10	000	FCVTMS (scalar)	Single-precision to 32-bit
0	0	00	10	001	FCVTMU (scalar)	Single-precision to 32-bit
0	0	00	11	000	FCVTZS (scalar, integer)	Single-precision to 32-bit
0	0	00	11	001	FCVTZU (scalar, integer)	Single-precision to 32-bit
0	0	01	00	000	FCVTNS (scalar)	Double-precision to 32-bit
0	0	01	00	001	FCVTNU (scalar)	Double-precision to 32-bit
0	0	01	00	010	SCVTF (scalar, integer)	32-bit to double-precision
0	0	01	00	011	UCVTF (scalar, integer)	32-bit to double-precision
0	0	01	00	100	FCVTAS (scalar)	Double-precision to 32-bit
0	0	01	00	101	FCVTAU (scalar)	Double-precision to 32-bit
0	0	01	01	000	FCVTPS (scalar)	Double-precision to 32-bit
0	0	01	01	001	FCVTPU (scalar)	Double-precision to 32-bit
0	0	01	10	000	FCVTMS (scalar)	Double-precision to 32-bit
0	0	01	10	001	FCVTMU (scalar)	Double-precision to 32-bit
0	0	01	11	000	FCVTZS (scalar, integer)	Double-precision to 32-bit
0	0	01	11	001	FCVTZU (scalar, integer)	Double-precision to 32-bit
1	0	00	00	000	FCVTNS (scalar)	Single-precision to 64-bit
1	0	00	00	001	FCVTNU (scalar)	Single-precision to 64-bit
1	0	00	00	010	SCVTF (scalar, integer)	64-bit to single-precision
1	0	00	00	011	UCVTF (scalar, integer)	64-bit to single-precision
1	0	00	00	100	FCVTAS (scalar)	Single-precision to 64-bit
1	0	00	00	101	FCVTAU (scalar)	Single-precision to 64-bit
1	0	00	01	000	FCVTPS (scalar)	Single-precision to 64-bit
1	0	00	01	001	FCVTPU (scalar)	Single-precision to 64-bit
1	0	00	10	000	FCVTMS (scalar)	Single-precision to 64-bit
1	0	00	10	001	FCVTMU (scalar)	Single-precision to 64-bit

Decode fields					Instruction Page	Variant
sf	S	type	rmode	opcode		
1	0	00	11	000	FCVTZS (scalar, integer)	Single-precision to 64-bit
1	0	00	11	001	FCVTZU (scalar, integer)	Single-precision to 64-bit
1	0	01	00	000	FCVTNS (scalar)	Double-precision to 64-bit
1	0	01	00	001	FCVTNU (scalar)	Double-precision to 64-bit
1	0	01	00	010	SCVTF (scalar, integer)	64-bit to double-precision
1	0	01	00	011	UCVTF (scalar, integer)	64-bit to double-precision
1	0	01	00	100	FCVTAS (scalar)	Double-precision to 64-bit
1	0	01	00	101	FCVTAU (scalar)	Double-precision to 64-bit
1	0	01	00	110	FMOV (general)	Double-precision to 64-bit
1	0	01	00	111	FMOV (general)	64-bit to double-precision
1	0	01	01	000	FCVTPS (scalar)	Double-precision to 64-bit
1	0	01	01	001	FCVTPU (scalar)	Double-precision to 64-bit
1	0	01	10	000	FCVTMS (scalar)	Double-precision to 64-bit
1	0	01	10	001	FCVTMU (scalar)	Double-precision to 64-bit
1	0	01	11	000	FCVTZS (scalar, integer)	Double-precision to 64-bit
1	0	01	11	001	FCVTZU (scalar, integer)	Double-precision to 64-bit
1	0	10	01	110	FMOV (general)	Top half of 128-bit to 64-bit
1	0	10	01	111	FMOV (general)	64-bit to top half of 128-bit

Chapter C4

The AArch64 System Instruction Class

This chapter describes the AArch64 system instructions and registers, and the system instruction class encoding space. It contains the following sections:

- *About the System instruction and System register descriptions on page C4-230.*
- *The System instruction class encoding space on page C4-232.*
- *PSTATE and special purpose registers on page C4-251.*
- *A64 system instructions for cache maintenance on page C4-306.*
- *A64 system instructions for address translation on page C4-322.*
- *A64 system instructions for TLB maintenance on page C4-335.*

C4.1 About the System instruction and System register descriptions

This section provides general information about the System instructions and the System register descriptions.

The terms defined in *Fixed values in instruction and register descriptions* apply throughout this manual. That is, they are not restricted to the System instruction and the System register descriptions.

C4.1.1 Fixed values in instruction and register descriptions

In register descriptions, the meaning of some bits depends on the PE state. This affects the definitions of RES0 and RES1 given in this section. These definitions are more detailed than those given in the [Glossary](#).

The following terms are used to describe bits or fields with fixed values:

RAZ In any implementation:

- The field must read as zero.
- Writes to the field must be ignored.
- Software:
 - Can rely on the field reading as zero.
 - Must use an [SBZP](#) policy to write to the field.

In diagrams, a RAZ bit can be shown as 0.

RES0 In diagrams, and sometimes in other descriptions, a RES0 bit can be shown as (0). This notation can be expanded for bitfields, so a three-bit RES0 field can be shown as either (0)(0)(0) or as (000).

Within the architecture, there are a small number of cases where a register bit or bitfield:

- Is RES0 in some defined architectural context.
- Has different defined behavior in a different architectural context.

The definition of RES0 is modified for those bits.

This means the definition of RES0 is:

If a bit is RES0 in all contexts

- The bit must read as 0.
- Writes to the bit must be ignored.
- Software:
 - Must not rely on the bit reading as 0.
 - Must use an [SBZP](#) policy to write to the bit.

If a register bit is RES0 only in some contexts, when that bit is described as RES0

- A read of the bit must return the value last successfully written to the bit, regardless of the use of the register when the bit was written.
If the bit has not been successfully written since reset, then the read of the bit returns the reset value if there is one, or otherwise returns an UNKNOWN value.
- A write to the bit must update a storage location associated with the bit.
- While the use of the register is such that the bit is described as RES0, the value of the bit must have no effect on the operation of the PE, other than determining the value read back from that bit.
- Software:
 - Must not rely on the bit reading as 0.
 - Must use an [SBZP](#) policy to write to the bit.

The RES0 description can be applied to bits or bitfields that are read-only, or are write-only:

- For a read-only bit, RES0 indicates that the bit reads as 0, but software must treat the bit as UNKNOWN.
- For a write-only bit, RES0 indicates that software must treat the bit as SBZ.

RAO In any implementation:

- The field must read as all 1s.
- Writes to the field must be ignored.
- Software:
 - Can rely on the field reading as all 1s.

- Must use an **SBOP** policy to write to the field.
- In diagrams, a RAZ bit can be shown as 0.
- RES1** In diagrams, and sometimes in other descriptions, a RES1 bit can be shown as (1). This notation can be expanded for bitfields, so a three-bit RES1 field can be shown as either (1)(1)(1) or as (111).
- Within the architecture, there are a small number of cases where a register bit or bitfield:
- Is RES1 in some defined architectural context.
 - Has different defined behavior in a different architectural context.
- The definition of RES1 is modified for those bits.
- This means the definition of RES1 is:
- If a bit is RES1 in all contexts**
- The bit must read as 1.
 - Writes to the bit must be ignored.
 - Software:
 - Must not rely on the bit reading as 1.
 - Must use an **SBOP** policy to write to the bit.
- If a register bit is RES1 only in some contexts, when that bit is described as RES1**
- A read of the bit must return the value last successfully written to the bit, regardless of the use of the register when the bit was written.
If the bit has not been successfully written since reset, then the read of the bit returns the reset value if there is one, or otherwise returns an UNKNOWN value.
 - A write to the bit must update a storage location associated with the bit.
 - While the use of the register is such that the bit is described as RES1, the value of the bit must have no effect on the operation of the PE, other than determining the value read back from that bit.
 - Software:
 - Must not rely on the bit reading as 1.
 - Must use an **SBOP** policy to write to the bit.
- The RES1 description can be applied to bits or bitfields that are read-only, or are write-only:
- For a read-only bit, RES1 indicates that the bit reads as 1, but software must treat the bit as UNKNOWN.
 - For a write-only bit, RES1 indicates that software must treat the bit as SBO.

C4.2 The System instruction class encoding space

Part of the A64 instruction encoding space is assigned to instructions that access the system register space. These instructions provide:

- Access to *System registers*, including the debug registers, that provide system control, and system status information.
- Access to special-purpose registers such as *SPSR_ELx* on page AppxJ-5091, *ELR_ELx* on page AppxJ-5091, and the equivalent fields of the Process State.
- The cache and TLB maintenance instructions and address translation instructions.
- Barriers and the CLREX instruction.
- Architectural hint instructions.

This section describes the general model for accessing this functionality.

———— Note —————

In ARMv7 and earlier versions of the ARM architecture, this functionality is provided through conceptual coprocessors CP14 and CP15, and in part through CP10 and CP11. These are accessed through a generic coprocessor interface. For compatibility:

- ARMv8 AArch32 state retains this conceptual coprocessor model. However, it adds register and operation aliases, to simplify access to this functionality.
- In the instruction encoding descriptions, AArch64 state retains the naming of the instruction arguments as Op1, CRn, CRm, and Op2. However, there is no functional distinction between the *Opn* arguments and the CRx arguments.

Principles of the System instruction class encoding describes some general properties of these encodings. *System instruction class encoding overview* on page C4-233 then describes the top-level encoding of these instructions, and the following sections then describe the next level of the encoding hierarchy:

- *Op0=0b00, architectural hints, barriers and CLREX, and PSTATE access* on page C4-234.
- *Op0=0b01, cache maintenance, TLB maintenance, and address translation instructions* on page C4-237.
- *Op0=0b10, Moves to and from debug, trace, and Execution environment System registers* on page C4-240.
- *Op0=0b11, Moves to and from non-debug System registers and special-purpose registers* on page C4-242.
- *Reserved control space for IMPLEMENTATION DEFINED functionality* on page C4-250.

C4.2.1 Principles of the System instruction class encoding

In ARMv8, an encoding in the System instruction space is identified by a set of arguments, Op0, Op1, CRn, CRm, and Op2. These form an encoding hierarchy, where:

Op0	Defines the top-level division of the encoding space, see <i>System instruction class encoding overview</i> on page C4-233.
Op1	Identifies the lowest Exception level at which the encoding is accessible, as follows: Accessible at EL0 Op1 has the value 3. Accessible at EL1 Op1 has the value 0, 1, or 2. The value is the same as the Op1 value used to access the equivalent AArch32 register. Accessible at EL2 Op1 has the value 4. Accessible at EL3 Op1 has the value 6.

ARM strongly recommends that implementers adopt this use of Op1 when using the IMPLEMENTATION DEFINED regions of the encoding space described in *Reserved control space for IMPLEMENTATION DEFINED functionality* on page C4-250.

C4.2.2 System instruction class encoding overview

The encoding of the System instruction class describes each instruction as being either:

- A transfer to a System register. This is a System instruction with the semantics of a write.
- A transfer from a System register. This is a System instruction with the semantics of a read.

A System instruction that initiate an operation operates as if it was making a transfer to a register.

In the AArch64 instruction set, the decode structure for the System instruction class is:

31	30	29	28	27	26	25	24	23	22	21	20	19	18	16	15	12	11	8	7	5	4	0
1	1	0	1	0	1	0	1	0	0	L	Op0	Op1	CRn	CRm	Op2	Rt						

The value of L indicates the transfer direction:

- 0** Transfer to system register.
- 1** Transfer from system register.

The Op0 field is the top level encoding of the System instruction type. Its possible values are:

0b00 These encodings provide:

- Instructions with an immediate field for accessing [PSTATE](#), the current PE state.
- The architectural hint instructions.
- Barriers and the CLREX instruction.

For more information about these encodings, see [Op0==0b00, architectural hints, barriers and CLREX, and PSTATE access](#) on page C4-234.

0b01 These encodings provide the cache maintenance, TLB maintenance, and address translation operations.

———— **Note** ————

These are equivalent to operations in the AArch32 CP15 space.

For more information, see [Op0==0b01, cache maintenance, TLB maintenance, and address translation instructions](#) on page C4-237.

0b10 These encodings provide moves to and from:

- Legacy AArch32 System registers for execution environments, to provide access to these registers from higher exception levels that are using AArch64.
- Debug and trace registers.

———— **Note** ————

These are equivalent to the registers in the AArch32 CP14 space,.

For more information, see [Op0==0b10, Moves to and from debug, trace, and Execution environment System registers](#) on page C4-240.

0b11 These encodings provide:

- Moves to and from System registers for software execution in Non-debug state. These registers provide Non-debug state system control, and system status information.

———— **Note** ————

These are equivalent to the registers in the AArch32 CP15 space,.

- Instructions for accessing special-purpose registers.

For more information, see [Instructions for accessing special-purpose registers](#) on page C4-248 and [Instructions for accessing non-debug System registers](#) on page C4-242.

UNDEFINED behaviors

In the System register instruction encoding space, the following principles apply:

- All unallocated encodings are treated as UNDEFINED.
- All encodings with L==1 and Op0==0b0x are UNDEFINED, except for encodings in the area reserved for IMPLEMENTATION DEFINED use, see [Reserved control space for IMPLEMENTATION DEFINED functionality on page C4-250](#).

For registers and operations that are accessible from a particular Exception level, any attempt to access those registers from a lower Exception level is UNDEFINED.

If a particular Exception level:

- Defines a register to be RO then any attempt to write to that register, at that Exception level, is UNDEFINED. This means that any access to that register with L==0 is UNDEFINED.
- A register to be WO then any attempt to read from that register, at that Exception level, is UNDEFINED. This means that any access to that register with L==1 is UNDEFINED.

For IMPLEMENTATION DEFINED encoding spaces, the treatment of the encodings is IMPLEMENTATION DEFINED, but see the recommendation in [Principles of the System instruction class encoding on page C4-232](#).

C4.2.3 Op0==0b00, architectural hints, barriers and CLREX, and PSTATE access

The different groups of System register instructions with Op0==0b00:

- Are identified by the value of CRn.
- Are always encoded with a value of 0b11111 in the Rt field.

The encoding of these instructions is:

31	30	29	28	27	26	25	24	23	22	21	20	19	18	16	15	12	11	8	7	5	4	0
1	1	0	1	0	1	0	1	0	0	L	0	0	Op1	CRn	CRm	Op2	1	1	1	1	1	1
Op0														Rt								

The encoding of the CRn field is as follows:

- 0b0010** See [Architectural hint instructions](#).
- 0b0011** See [Barriers and CLREX on page C4-235](#).
- 0b0100** See [Instructions for accessing the PSTATE fields on page C4-236](#).

Architectural hint instructions

The architectural hint instructions are identified by CRn having the value 0b0010. The encoding of these instructions is:

31	30	29	28	27	26	25	24	23	22	21	20	19	18	16	15	12	11	5	4	0				
1	1	0	1	0	1	0	1	0	0	0	0	0	1	1	0	0	1	0	Op<6:0>	1	1	1	1	1
Op0											Op1			CRn			CRm			Op2		Rt		

The value of Op<6:0>, formed by concatenating the CRm and Op2 fields, determines the hint instruction as follows:

- 0b0000000 NOP instruction. This has no effect on architectural state other than to advance the PC.
- 0b0000001 YIELD instruction.
- 0b0000010 WFE instruction.
- 0b0000011 WFI instruction.
- 0b0000100 SEV instruction.
- 0b0000101 SEVL instruction.
- 0b0000110-0b1111111 Unallocated values. These behave as a NOP.

————— Note —————

- Instruction encodings with bits[4:0] not set to 0b11111 are UNDEFINED.

- The operation of the A64 instructions for architectural hints are identical to the corresponding A32 and T32 instructions.

For more information about:

- The WFE, WFI, SEV, and SEVL instructions, see [Mechanisms for entering a low-power state on page D1-1533](#).
- The YIELD instruction, see [Software control features and ELO on page B1-65](#).

Barriers and CLREX

The barriers and CLREX instructions are identified by CRn having the value 0b0011. The encoding of these instructions is:

31	30	29	28	27	26	25	24	23	22	21	20	19	18	16	15	12	11	8	7	5	4	0			
1	1	0	1	0	1	0	1	0	0	0	0	0	1	1	0	0	1	1	CRm	Op2	1	1	1	1	1
											Op0	Op1	CRn	CRm	Op2	Rt									

The value of Op2 determines the instruction, as follows. For the DSB and DMB instructions, CRm controls the instruction options.

0b010	CLREX instruction. The value of CRm is ignored.
0b100	DSB instruction. The value of CRm sets the option type, see Table C4-1 .
0b101	DMB instruction. The value of CRm sets the option type, see Table C4-1 .
0b110	ISB instruction. The value of CRm is ignored.
0b000, 0b001, 0b011, 0b111	UNDEFINED.

Note

Instruction encodings with bits[4:0] not set to 0b11111 are UNDEFINED.

[Table C4-1](#) shows the CRm encodings for the data barrier option types.

Table C4-1 CRm encoding for DMB and DSB instructions

CRm value	Option, for DMB and DSB	Meaning
0001	OSHL	Outer Shareable, load
0010	OSHS	Outer Shareable, store
0011	OSH	Outer Shareable, all
0101	NSHL	Non-shareable, load
0110	NSHS	Non-shareable, store
0111	NSH	Non-shareable, all
1001	ISHL	Inner Shareable, load
1010	ISHS	Inner Shareable, store
1011	ISH	Inner Shareable, all
1101	LD	Full system, load
1110	ST	Full system, store
0000, 0100, 1000, 1111	SYS	Full system, all

Note

The operation of the A64 instructions for barriers and CLREX are identical to the corresponding A32 and T32 instructions.

For more information about:

- The barrier instructions, see [Memory barriers on page B2-85](#).
- The CLREX instruction, see [Synchronization and semaphores on page B2-100](#).

Instructions for accessing the PSTATE fields

The A64 instruction set provides instructions that can be used to modify [PSTATE](#) fields directly. These instructions are:

- MSR DAIFSet, #Imm4 ; Used to set any or all of DAIF to 1
- MSR DAIFClr, #Imm4 ; Used to clear any or all of DAIF to 0
- MSR SPSEL, #Imm1 ; Used to select the Stack Pointer, between SP_ELO and SP_ELx

The [PSTATE](#) field update instructions are identified by CRn having the value 0b0100. The encoding of these instructions is:

31	30	29	28	27	26	25	24	23	22	21	20	19	18	16	15	12	11	8	7	5	4	0			
1	1	0	1	0	1	0	1	0	0	0	0	0	0	Op1	0	1	0	0	Imm4	Op2	1	1	1	1	1
											Op0	Op1	CRn		CRm	Op2	Rt								

The value of Op2 selects the instruction form, which defines the constraints on the values of the Op1 and Imm4 arguments, as follows:

- Op2==0b101 Selects the MSR SPSEL instruction.
 - Op1 must be 0b000.
 - This instruction is accessible at EL1 or higher.
 - Imm4<0> selects the accessed stack pointer, as follows:
 - 0 Selects [SP_ELO](#).
 - 1 Selects [SP_ELx on page AppxJ-5091](#), where x is the number of the current Exception level, 1, 2, or 3.
 - Imm4<3:1> are RES0.
- Op2==0b110 Selects the MSR DAIFSet instruction, that sets the specified [PSTATE](#).{D, A, I, F} bits to 1.
 - Op1 must be 0b011.
 - This instruction is accessible at EL1 or higher, and when the value of the [SCTLR_EL1.UMA](#) bit is 1 it is also accessible at EL0.
 - Imm4 determines which of the [PSTATE](#).{D, A, I, F} bits are set to 1, as follows:
 - Imm4<3> If this bit is set to 1 then the D bit is set to 1, otherwise the D bit is not changed.
 - Imm4<2> If this bit is set to 1 then the A bit is set to 1, otherwise the A bit is not changed.
 - Imm4<1> If this bit is set to 1 then the I bit is set to 1, otherwise the I bit is not changed.
 - Imm4<0> If this bit is set to 1 then the F bit is set to 1, otherwise the F bit is not changed.
- Op2==0b111 Selects the MSR DAIFClr instruction, that clears the specified [PSTATE](#).{D, A, I, F} bits to 0.
 - Op1 must be 0b011.
 - This instruction is accessible at EL1 or higher, and when the value of the [SCTLR_EL1.UMA](#) bit is 1 it is also accessible at EL0.
 - Imm4 determines which of the [PSTATE](#).{D, A, I, F} bits is cleared to 0, as follows:
 - Imm4<3> If this bit is set to 1 then the D bit is cleared to 0, otherwise the D bit is not changed.
 - Imm4<2> If this bit is set to 1 then the A bit is cleared to 0, otherwise the A bit is not changed.

- Imm4<1> If this bit is set to 1 then the I bit is cleared to 0, otherwise the I bit is not changed.
- Imm4<0> If this bit is set to 1 then the F bit is cleared to 0, otherwise the F bit is not changed.

All other combinations of Op1 and Op2 are reserved, and the corresponding instructions are UNDEFINED.

———— **Note** ————

For [PSTATE](#) updates, instruction encodings with bits[4:0] not set to 0b11111 are UNDEFINED.

Writes to [PSTATE](#).{D, A, I, F} occur in program order without the need for additional synchronization. Changing [PSTATE](#).SPSel to use EL0 synchronizes any updates to [SP_ELO](#) that have been written by an MSR to [SP_ELO](#), without the need for additional synchronization.

For more information about [PSTATE](#), see *Process state, PSTATE* on page D1-1421.

C4.2.4 Op0==0b01, cache maintenance, TLB maintenance, and address translation instructions

The System instructions are encoded with Op0==0b01. The different groups of System instructions are identified by the values of CRn and CRm, except that some of this encoding space is reserved for IMPLEMENTATION DEFINED functionality. The encoding of these instructions is:

31	30	29	28	27	26	25	24	23	22	21	20	19	18	16	15	12	11	8	7	5	4	0	
1	1	0	1	0	1	0	1	0	0	0	0	1	Op1	CRn	CRm	Op2	Xt						

Op0

The grouping of these instructions depending on the CRn and CRm fields is as follows:

- CRn==7 The instruction group is determined by the value of CRm, as follows:
 - CRm=={1, 5} Instruction cache maintenance operations.
 - CRm==4 Data cache zero operation.
 - CRm=={6, 10, 11, 14} Data cache maintenance operations.

See [Cache maintenance instructions, and data cache zero](#).
- CRm==8 See [Address translation instructions](#) on page C4-238.
- CRn==8 See [TLB maintenance instructions](#) on page C4-239.
- CRn=={11, 15} See [Reserved control space for IMPLEMENTATION DEFINED functionality](#) on page C4-250.

Cache maintenance instructions, and data cache zero

[Table C4-2](#) lists the Cache maintenance instructions and their encodings. Instructions that take an argument include Xt in the instruction syntax. For instructions that do not take an argument, the Xt field is encoded as 0b11111.

Table C4-2 Cache maintenance instructions

Instruction	Access instruction encoding				Notes
	Op1	CRn	CRm	Op2	
Instruction cache maintenance operations					
IC IALLUIS	0	7	1	0	Accessible from EL1 or higher.
IC IALLU			5	0	
IC IVAU , Xt	3	7	5	1	When SCTLR_EL1 .UCI == 1, accessible from EL0 or higher. Otherwise, accessible from EL1 or higher.

Data cache maintenance operations

Table C4-2 Cache maintenance instructions (continued)

Instruction	Access instruction encoding				Notes
	Op1	CRn	CRm	Op2	
DC IVAC , Xt	0	7	6	1	Accessible from EL1 or higher.
DC ISW , Xt				2	
DC CSW , Xt			10	2	
DC CISW , Xt			14	2	
DC CVAC , Xt	3	7	10	1	When SCTLR_EL1.UCI == 1, accessible from EL0 or higher. Otherwise, accessible from EL1 or higher.
DC CVAU , Xt			11	1	
DC CIVAC , Xt			14	1	
Data cache zero operation					
DC ZVA , Xt	3	7	4	1	When SCTLR_EL1.UCI == 1, accessible from EL0 or higher. Otherwise, accessible from EL1 or higher.

For more information about these instructions, see [Cache maintenance operations](#) on page D4-1680 and [Cache maintenance instructions](#) on page D4-1684.

Address translation instructions

[Table C4-3](#) lists the Address translation instructions and their encodings. The syntax of the instructions includes Xt, that provides the address to be translated.

Table C4-3 Address translation instructions

Instruction	Access instruction encoding				Notes	
	Op1	CRn	CRm	Op2		
AT S1E1R , Xt	0	7	8	0	Accessible from EL1 or higher.	
AT S1E1W , Xt				1		
AT S1E0R , Xt				2		
AT S1E0W , Xt				3		
AT S1E2R , Xt	4	7	8	0	Accessible from EL2 or higher.	
AT S1E2W , Xt				1		
AT S12E1R , Xt				4		
AT S12E1W , Xt				5		
AT S12E0R , Xt				6		
AT S12E0W , Xt				7		
AT S1E3R , Xt	6	7	8	0		Accessible only from EL3.
AT S1E3W , Xt				1		

For more information about these instructions, see [Address translation operations](#) on page D5-1756.

TLB maintenance instructions

Table C4-4 lists the TLB maintenance instructions and their encodings. Instructions that take an argument include Xt in the instruction syntax. For instructions that do not take an argument, the Xt field is encoded as 0b11111.

Table C4-4 TLB maintenance instructions

Instruction	Access instruction encoding				Notes
	Op1	CRn	CRm	Op2	
TLBI VMALLE1IS	0	8	3	0	Accessible from EL1 or higher.
TLBI VAE1IS, Xt				1	
TLBI ASIDE1IS, Xt				2	
TLBI VAAE1IS, Xt				3	
TLBI VALE1IS, Xt				5	
TLBI VAALE1IS, Xt				7	
TLBI VMALLE1			7	0	Accessible from EL1 or higher.
TLBI VAE1, Xt				1	
TLBI ASIDE1, Xt				2	
TLBI VAAE1, Xt				3	
TLBI VALE1, Xt				5	
TLBI VAALE1, Xt				7	
TLBI IPAS2E1IS, Xt	4	8	0	1	Accessible from EL2 or higher.
TLBI IPAS2LE1IS, Xt				5	
TLBI ALLE2IS			3	0	
TLBI VAE2IS, Xt				1	
TLBI ALLE1IS				4	
TLBI VALE2IS, Xt				5	
TLBI VMALLS12E1IS				6	
TLBI IPAS2E1, Xt			4	1	
TLBI IPAS2LE1, Xt				5	
TLBI ALLE2			7	0	
TLBI VAE2, Xt				1	
TLBI ALLE1				4	
TLBI VALE2, Xt				5	
TLBI VMALLS12E1				6	

Table C4-4 TLB maintenance instructions (continued)

Instruction	Access instruction encoding				Notes
	Op1	CRn	CRm	Op2	
TLBI ALLE3IS	6	8	3	0	Accessible only from EL3.
TLBI VAE3IS, Xt				1	
TLBI VALE3IS, Xt				5	
TLBI ALLE3			7	0	
TLBI VAE3, Xt				1	
TLBI VALE3, Xt				5	

For more information about these instructions, see *TLB maintenance instructions* on page D5-1808.

C4.2.5 Op0==0b10, Moves to and from debug, trace, and Execution environment System registers

The instructions that move data to and from the debug, Execution environment, and trace system registers are encoded with Op0==0b10. This means the encoding of these instructions is:

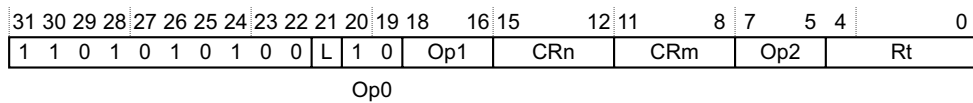

Note

These encodings access the registers that are equivalent to the AArch32 CP14 registers.

The value of Op1 provides the next level of decode of these instructions, as follows:

Op1 == {0, 3, 4}

Debug. See *Instructions for accessing debug System registers*

Op1 == 1 Trace. See the appropriate trace architecture specification.

Op1 == 2 Execution environment. See *Instructions for accessing AArch32 Execution environment registers* on page C4-241.

Instructions for accessing debug System registers

The instructions for accessing debug System registers are:

MSR <System register>, Xt ; Write to System register
 MRS Xt, <System register> ; Read from System register

Where <System_register> is the register name, for example MDCCSR_EL0.

This section includes only the System register access encodings for which both:

- Op0 is 0b10.
- The value of Op1 is one of {0, 3, 4}.

Note

These encodings access the registers that are equivalent to the AArch32 CP14 registers.

Table C4-5 shows the mapping of the System register encodings for debug System register access.

Table C4-5 System instruction encodings for debug System register access

Register	Access instruction encoding				Permitted accesses
	Op1	CRn	CRm	Op2	
OSDTRRX_EL1	0	0	0	2	RW
MDCCINT_EL1			2	0	RW
MDSCR_EL1				2	RW
OSDTRTX_EL1			3	2	RW
OSECRR_EL1			6	2	RW
DBGBVR<n>_EL1			0-15 ^a	4	RW
DBGBCR<n>_EL1			0-15 ^a	5	RW
DBGWVR<n>_EL1			0-15 ^a	6	RW
DBGWCR<n>_EL1			0-15 ^a	7	RW
MDRAR_EL1		1	0	0	RO
OSLAR_EL1				4	WO
OSLSR_EL1			1	4	RO
OSDLR_EL1			3	4	RW
DBGPRCR_EL1			4	4	RW
DBGCLAIMSET_EL1		7	8	6	RW
DBGCLAIMCLR_EL1			9	6	RW
DBGAUTHSTATUS_EL1			14	6	RO
MDCCSR_EL0	3	0	1	0	RO
DBGDTR_EL0			4	0	RW
DBGDTRRX_EL0			5	0	RO
DBGDTRTX_EL0					WO
DBGVCR32_EL2	4	0	7	0	RW

- a. Unimplemented breakpoint and watchpoint register access instructions are UNALLOCATED. If EL2 is not implemented or breakpoint *n* is not context-aware, `DBGBXRn_EL1` is unallocated. CRm encodes *n*, the breakpoint or watchpoint number.

For more information see [Mapping of the System registers between the Execution states](#) on page D1-1545.

Instructions for accessing AArch32 Execution environment registers

The instructions for accessing the deprecated and OPTIONAL AArch32 Execution environment registers are:

```
MSR <System register>, Xt    ; Write to System register
MRS Xt, <System register>    ; Read from System register
```

Where <System_register> is the register name, for example `TEECR32_EL1`.

This section includes only the System register access encodings for which both:

- Op0 is 0b10.
- The value of Op1 is 2.

———— **Note** —————

These encodings access the registers that are equivalent to the AArch32 CP14 registers.

Table C4-6 shows the mapping of the System register encodings for AArch32 Execution environment register access.

Table C4-6 System instruction encodings for AArch32 Execution environment register access

Register	Access instruction encoding				Notes
	Op1	CRn	CRm	Op2	
The following registers are defined to allow access from AArch64 state to registers that are only used in AArch32 state					
TEECR32_EL1	2	0	0	0	RW.
TEEHBR32_EL1		1	0	0	If EL0 cannot use AArch32, this register is UNDEFINED.

C4.2.6 Op0==0b11, Moves to and from non-debug System registers and special-purpose registers

The instructions that move data to and from non-debug system registers are encoded with Op0==0b11, except that some of this encoding space is reserved for IMPLEMENTATION DEFINED functionality. The encoding of these instructions is:

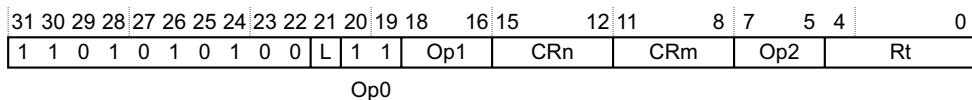

The value of CRn provides the next level of decode of these instructions, as follows:

CRn=={0, 1, 2, 3, 5, 6, 7, 9, 10, 12, 13, 14}

See *Instructions for accessing non-debug System registers*.

CRn==4 See *Instructions for accessing special-purpose registers on page C4-248*.

CRn=={11, 15} See *Reserved control space for IMPLEMENTATION DEFINED functionality on page C4-250*.

Instructions for accessing non-debug System registers

The A64 instructions for accessing System registers are:

```
MSR <System register>, Xt    ; Write to System register
MRS Xt, <System register>    ; Read from System register
```

Where <System_register> is the register name, for example MIDR_EL1.

This section includes only the System register access encodings for which both:

- Op0 is 0b11.
- The value of CRn is one of {0, 1, 2, 3, 5, 6, 7, 9, 10, 12, 13, 14}.

———— **Note** —————

These encodings access the registers that are equivalent to the AArch32 CP15 registers.

The instruction encoding for these accesses is:

31	30	29	28	27	26	25	24	23	22	21	20	19	18	16	15	12	11	8	7	5	4	0
1	1	0	1	0	1	0	1	0	0	L	1	1	Op1	CRn	CRm	Op2	Rt					

Op0

See text for permitted values of CRn

Table C4-7 shows the encodings of the register access instructions. For these registers, CRn often indicates register grouping, and therefore CRn is given as the first column of the encoding. Registers appended with [63:0] are 64-bit registers. All other registers are 32-bit registers for which bits [63:32] of the 64-bit register value are RES0.

Table C4-7 System instruction encodings for System register accesses

Register accessed	Access instruction encoding				Notes
	CRn	Op1	CRm	Op2	
MIDR_EL1	0	0	0	0	RO.
MPIDR_EL1[63:0]				5	RO.
REVIDR_EL1				6	RO.
ID_PFR0_EL1			1	0	RO, but RAZ if AArch32 is not implemented.
ID_PFR1_EL1				1	
ID_DFR0_EL1				2	
ID_AFR0_EL1				3	
ID_MMFR0_EL1				4	
ID_MMFR1_EL1				5	
ID_MMFR2_EL1				6	
ID_MMFR3_EL1				7	
ID_ISAR0_EL1	0	0	2	0	RO, but RAZ if AArch32 is not implemented.
ID_ISAR1_EL1				1	
ID_ISAR2_EL1				2	
ID_ISAR3_EL1				3	
ID_ISAR4_EL1				4	
ID_ISAR5_EL1				5	

Table C4-7 System instruction encodings for System register accesses (continued)

Register accessed	Access instruction encoding				Notes
	CRn	Op1	CRm	Op2	
MVFR0_EL1	0	0	3	0	RO.
MVFR1_EL1				1	
MVFR2_EL1				2	
Reserved, RAZ				<i>n</i>	For <i>n</i> =3-7.
ID_AA64PFR0_EL1			4	0	RO.
ID_AA64PFR1_EL1				1	RO.
Reserved, RAZ				<i>n</i>	For <i>n</i> =2-7.
ID_AA64DFR0_EL1			5	0	RO.
ID_AA64DFR1_EL1				1	RO.
ID_AA64AFR0_EL1				4	RO.
ID_AA64AFR1_EL1				5	RO.
Reserved, RAZ				<i>n</i>	For <i>n</i> ={2, 3, 6, 7}.
ID_AA64ISAR0_EL1			6	0	RO.
ID_AA64ISAR1_EL1				1	RO.
Reserved, RAZ				<i>n</i>	For <i>n</i> =2-7.
ID_AA64MMFR0_EL1			7	0	RO.
ID_AA64MMFR1_EL1				1	RO.
Reserved, RAZ				<i>n</i>	For <i>n</i> =2-7.
CCSIDR_EL1	0	1	0	0	RO.
CLIDR_EL1				1	
AIDR_EL1				7	
CSSELR_EL1	0	2	0	0	RW.
CTR_EL0	0	3	0	1	RO and configurable to enable access at EL0.
DCZID_EL0				7	RO.
VPIDR_EL2	0	4	0	0	RW.
VMPIDR_EL2[63:0]				5	
SCTLR_EL1	1	0	0	0	RW.
ACTLR_EL1				1	IMPLEMENTATION DEFINED.
CPACR_EL1				2	Floating-point and Advanced SIMD only.

Table C4-7 System instruction encodings for System register accesses (continued)

Register accessed	Access instruction encoding				Notes
	CRn	Op1	CRm	Op2	
SCTLR_EL2	1	4	0	0	RW.
ACTLR_EL2				1	IMPLEMENTATION DEFINED.
HCR_EL2[63:0]			1	0	RW.
MDCR_EL2				1	
CPTR_EL2				2	Floating-point and Advanced SIMD only.
HSTR_EL2				3	RW.
HACR_EL2				7	IMPLEMENTATION DEFINED.
SCTLR_EL3	1	6	0	0	RW.
ACTLR_EL3				1	IMPLEMENTATION DEFINED.
SCR_EL3			1	0	RW.
CPTR_EL3				2	Floating-point and Advanced SIMD only.
MDCR_EL3			3	1	RW.
TTBR0_EL1[63:0]	2	0	0	0	RW.
TTBR1_EL1[63:0]				1	
TCR_EL1[63:0]				2	
TTBR0_EL2[63:0]	2	4	0	0	RW.
TCR_EL2				2	
VTTBR_EL2[63:0]			1	0	RW.
VTCR_EL2				2	
TTBR0_EL3[63:0]	2	6	0	0	RW.
TCR_EL3				2	
AFSR0_EL1	5	0	1	0	IMPLEMENTATION DEFINED.
AFSR1_EL1				1	
ESR_EL1			2	0	RW.
AFSR0_EL2	5	4	1	0	IMPLEMENTATION DEFINED.
AFSR1_EL2				1	
ESR_EL2			2	0	RW.
AFSR0_EL3	5	6	1	0	IMPLEMENTATION DEFINED.
AFSR1_EL3				1	
ESR_EL3			2	0	RW.
FAR_EL1[63:0]	6	0	0	0	RW.

Table C4-7 System instruction encodings for System register accesses (continued)

Register accessed	Access instruction encoding				Notes
	CRn	Op1	CRm	Op2	
FAR_EL2[63:0]	6	4	0	0	RW.
HPFAR_EL2[63:0]				4	
FAR_EL3[63:0]	6	6	0	0	RW.
PAR_EL1[63:0]	7	0	4	0	RW.
PMINTENSET_EL1	9	0	14	1	RW
PMINTENCLR_EL1				2	RW
PMCR_ELO		3	12	0	Configurable whether accesses at EL0 are permitted.
PMCNTENSET_ELO				1	
PMCNTENCLR_ELO				2	
PMOVSCLR_ELO				3	
PMSWINC_ELO				4	WO. Configurable whether accesses at EL0 are permitted.
PMSELR_ELO				5	Configurable whether accesses at EL0 are permitted.
PMCEID0_ELO				6	RO. Configurable whether accesses at EL0 are permitted.
PMCEID1_ELO				7	
PMCCNTR_ELO			13	0	Configurable whether accesses at EL0 are permitted.
PMXEVTYPER_ELO				1	
PMXEVCNTR_ELO				2	
PMUSERENR_ELO			14	0	RO at EL0 but can be written at other Exception levels
PMOVSSET_ELO				3	Configurable whether accesses at EL0 are permitted.
PMEVCNTR<n>_ELO	14	3	{8-10}	{0-7}	CRm and op2 encode <i>n</i> , the counter number. Configurable whether accesses at EL0 are permitted.
			11	{0-6}	
PMEVTYPER<n>_ELO			{12-14}	{0-7}	
			15	{0-6}	
PMCCFILTR_ELO				7	Configurable whether accesses at EL0 are permitted.
MAIR_EL1[63:0]	10	0	2	0	RW.
AMAIR_EL1[63:0]			3	0	IMPLEMENTATION DEFINED.
MAIR_EL2[63:0]	10	4	2	0	RW.
AMAIR_EL2[63:0]			3	0	IMPLEMENTATION DEFINED.
MAIR_EL3[63:0]	10	6	2	0	RW.
AMAIR_EL3[63:0]			3	0	IMPLEMENTATION DEFINED.

Table C4-7 System instruction encodings for System register accesses (continued)

Register accessed	Access instruction encoding				Notes
	CRn	Op1	CRm	Op2	
VBAR_EL1[63:0]	12	0	0	0	RW.
RVBAR_EL1[63:0]				1	RO. Implemented only if EL2 and EL3 are not implemented.
RMR_EL1[63:0]				2	Implemented only if both of the following conditions apply: <ul style="list-style-type: none"> EL1 is capable of using AArch32 and AArch64 EL2 and EL3 are not implemented.
ISR_EL1			1	0	RO.
VBAR_EL2[63:0]	12	4	0	0	RW.
RVBAR_EL2[63:0]				1	RO. Implemented only if EL3 is not implemented.
RMR_EL2[63:0]				2	Implemented only if both of the following conditions apply: <ul style="list-style-type: none"> EL2 is capable of using AArch32 and AArch64 EL3 is not implemented.
VBAR_EL3[63:0]	12	6	0	0	RW.
RVBAR_EL3[63:0]				1	RO.
RMR_EL3[63:0]				2	Implemented only if EL3 can use both AArch32 and AArch64.
CONTEXTIDR_EL1	13	0	0	1	RW.
TPIDR_EL1[63:0]				4	
TPIDR_EL0[63:0]	13	3	0	2	RW.
TPIDRRO_EL0[63:0]				3	
TPIDR_EL2[63:0]	13	4	0	2	RW.
TPIDR_EL3[63:0]	13	6	0	2	RW.
Timer registers					
CNTKCTL_EL1	14	0	1	0	RW.

Table C4-7 System instruction encodings for System register accesses (continued)

Register accessed	Access instruction encoding				Notes
	CRn	Op1	CRm	Op2	
CNTRQ_EL0	14	3	0	0	RO at EL1 but can be written at the highest Exception Level implemented. Configurable to enable access at EL0.
CNTPCT_EL0[63:0]				1	RO. Configurable whether accesses at EL0 are permitted.
CNTVCT_EL0[63:0]				2	
CNTP_TVAL_EL0			2	0	Configurable whether accesses at EL0 are permitted.
CNTP_CTL_EL0				1	
CNTP_CVAL_EL0[63:0]				2	
CNTV_TVAL_EL0			3	0	Configurable whether accesses at EL0 are permitted.
CNTV_CTL_EL0				1	
CNTV_CVAL_EL0[63:0]				2	
CNTHCTL_EL2	14	4	1	0	RW.
CNTHP_TVAL_EL2	14	4	2	0	RW.
CNTHP_CTL_EL2				1	
CNTHP_CVAL_EL2[63:0]				2	
CNTPS_TVAL_EL1	14	7	2	0	Accessible at EL3. Configurable whether Secure accesses at EL1 are permitted.
CNTPS_CTL_EL1				1	
CNTPS_CVAL_EL1[63:0]				2	
The following registers are defined to allow access from AArch64 state to registers that are only used in AArch32 state					
SDER32_EL3	1	6	1	1	If EL1 cannot use AArch32, this register is UNDEFINED.
DACR32_EL2	3	4	0	0	If EL1 cannot use AArch32, this register is UNDEFINED.
IFSR32_EL2	5	4	0	1	If EL1 cannot use AArch32, this register is UNDEFINED.
FPEXC32_EL2			3	0	If EL1 cannot use AArch32, this register is UNDEFINED.

Instructions for accessing special-purpose registers

The A64 instructions for accessing special-purpose registers are:

MSR <special-purpose register>, Xt ; Write to special-purpose register
MRS Xt, <special-purpose register> ; Read from special-purpose register

For these accesses, CRn has the value 4. The encoding for special-purpose register accesses is:

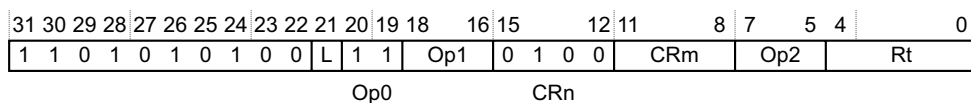

Table C4-8 lists the encodings for Op1, CRm, and Op2 fields for accesses to the special-purpose registers in AArch64.

Table C4-8 Special-purpose register accesses

Register	Access instruction encoding:			Notes
	Op1	CRm	Op2	
SPSR_EL1	0	0	0	Accessible from EL1 or higher.
ELR_EL1			1	
SP_ELO		1	0	Accessible from EL1 or higher. If SP_ELO is the current stack pointer then the access is UNDEFINED.
SPSel		2	0	Accessible from EL1 or higher.
CurrentEL			2	RO. Accessible from EL1 or higher.
DAIF	3	2	1	Configurable whether accesses at EL0 are permitted.
NZCV			0	Accessible from EL0 or higher.
FPCR		4	0	Accessible from EL0 or higher.
FPSR			1	
DSPSR_EL0		5	0	Accessible only in Debug state, from EL0 or higher.
DLR_EL0			1	
SPSR_EL2	4	0	0	Accessible from EL2 or higher.
ELR_EL2			1	
SP_EL1		1	0	
SPSR_irq		3	0	
SPSR_abt			1	
SPSR_und			2	
SPSR_fiq			3	
SPSR_EL3	6	0	0	Accessible from EL3 or higher.
ELR_EL3			1	
SP_EL2		1	0	

For the accesses to the special-purpose registers shown in Table C4-8:

- Any write to the FPCR must be synchronized, by a *Context synchronization operation*, before its effect on subsequent instructions can be relied upon.
- All other reads and writes to the registers appear to occur in program order relative to other instructions.

C4.3 PSTATE and special purpose registers

This section describes the following registers:

- [CurrentEL](#), that software can read to determine the current Exception level.
- [DAIF](#), that specifies the current interrupt mask bits.
- [dlr_el0](#), that holds the address to return to for a return from Debug state.
- [dpspr_el0](#), that holds process state on entry to Debug state.
- [ELR_EL1](#), that holds the address to return to for an exception return from EL1.
- [ELR_EL2](#), that holds the address to return to for an exception return from EL2.
- [ELR_EL3](#), that holds the address to return to for an exception return from EL3.
- [FPCR](#), that provides control of floating-point operation.
- [FPSR](#), that provides floating-point status information.
- [NZCV](#), that holds the condition flags.
- [SP_EL0](#), that holds the stack pointer for EL0.
- [SP_EL1](#), that holds the stack pointer for EL1.
- [SP_EL2](#), that holds the stack pointer for EL2.
- [SP_EL3](#), that holds the stack pointer for EL3.
- [SPSel](#), that at EL1 or higher selects between the SP for the current Exception level and [SP_EL0](#).
- [SPSR_abt](#), that holds process state on taking an exception to AArch32 Abort mode.
- [SPSR_EL1](#), that holds process state on taking an exception to AArch64 EL1.
- [SPSR_EL2](#), that holds process state on taking an exception to AArch64 EL2.
- [SPSR_EL3](#), that holds process state on taking an exception to AArch64 EL3.
- [SPSR_fiq](#), that holds process state on taking an exception to AArch32 FIQ mode.
- [SPSR_irq](#), that holds process state on taking an exception to AArch32 IRQ mode.
- [SPSR_und](#), that holds process state on taking an exception to AArch32 Undefined mode.

The PSRs hold the PE state from immediately before taking the exception or entering Debug state. This means they hold the state required for the return from Debug state, or for the exception return.

C4.3.1 CurrentEL, Current Exception Level

The CurrentEL characteristics are:

Purpose

Holds the current exception level.

This register is part of the Process state registers functional group.

Usage constraints

This register is accessible as shown below:

ELO	EL1 (NS)	EL1 (S)	EL2	EL3 (SCR.NS=1)	EL3 (SCR.NS=0)
-	RO	RO	RO	RO	RO

A write to the CurrentEL register is UNDEFINED.

Configurations

There are no configuration notes.

Attributes

CurrentEL is a 32-bit register.

The CurrentEL bit assignments are:

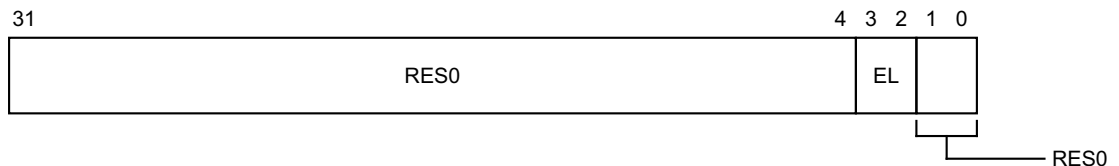

Bits [31:4]

Reserved, RES0.

EL, bits [3:2]

Current exception level. Possible values of this field are:

00	EL0
01	EL1
10	EL2
11	EL3

Resets to an IMPLEMENTATION DEFINED value.

Bits [1:0]

Reserved, RES0.

Accessing the CurrentEL:

To access the CurrentEL:

MRS <Xt>, CurrentEL ; Read CurrentEL into Xt

Register access is encoded as follows:

op0	op1	CRn	CRm	op2
11	000	0100	0010	010

C4.3.2 DAIF, Interrupt Mask Bits

The DAIF characteristics are:

Purpose

Allows access to the interrupt mask bits.

This register is part of the Process state registers functional group.

Usage constraints

This register is accessible as shown below:

EL0	EL1 (NS)	EL1 (S)	EL2	EL3 (SCR.NS=1)	EL3 (SCR.NS=0)
Config-RW	RW	RW	RW	RW	RW

This register is accessible at EL0 when [SCTLR_EL1.UMA](#) is set to 1.

Configurations

There are no configuration notes.

Attributes

DAIF is a 32-bit register.

The DAIF bit assignments are:

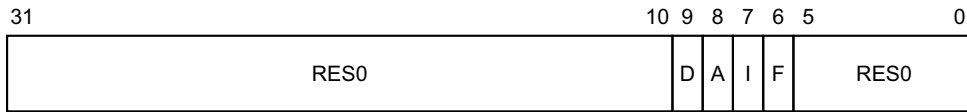

Bits [31:10]

Reserved, RES0.

D, bit [9]

Process state D mask. The possible values of this bit are:

- 0 Debug exceptions from Watchpoint, Breakpoint, and Software step debug events targeted at the current exception level are not masked.
- 1 Debug exceptions from Watchpoint, Breakpoint, and Software step debug events targeted at the current exception level are masked.

When the target exception level of the debug exception is not than the current exception level, the exception is not masked by this bit.

Resets to 1.

A, bit [8]

SError (System Error) mask bit. The possible values of this bit are:

- 0 Exception not masked.
- 1 Exception masked.

Resets to 1.

I, bit [7]

IRQ mask bit. The possible values of this bit are:

- 0 Exception not masked.
- 1 Exception masked.

Resets to 1.

F, bit [6]

FIQ mask bit. The possible values of this bit are:

0 Exception not masked.

1 Exception masked.

Resets to 1.

Bits [5:0]

Reserved, RES0.

Accessing the DAIF:

To access the DAIF:

MRS <Xt>, DAIF ; Read DAIF into Xt

MSR DAIF, <Xt> ; Write Xt to DAIF

Register access is encoded as follows:

op0	op1	CRn	CRm	op2
11	011	0100	0010	001

C4.3.3 DLR_EL0, Debug Link Register

The DLR_EL0 characteristics are:

Purpose

In Debug state, holds the address to restart from.

This register is part of:

- the Debug registers functional group
- the Special purpose registers functional group.

Usage constraints

This register is accessible as shown below:

EL0	EL1 (NS)	EL1 (S)	EL2	EL3 (SCR.NS=1)	EL3 (SCR.NS=0)
RW	RW	RW	RW	RW	RW

Access to this register is from Debug state only. During normal execution this register is UNALLOCATED.

Configurations

DLR_EL0[31:0] is architecturally mapped to AArch32 register [DLR](#).

Attributes

DLR_EL0 is a 64-bit register.

DLR_EL0 is a member of multiple register groups and is defined elsewhere. For the full definition, see [DLR_EL0, Debug Link Register](#) on page D8-2103.

C4.3.4 DSPSR_EL0, Debug Saved Program Status Register

The DSPSR_EL0 characteristics are:

Purpose

Holds the saved processor state on entry to Debug state.

This register is part of:

- the Debug registers functional group
- the Special purpose registers functional group.

Usage constraints

This register is accessible as shown below:

EL0	EL1 (NS)	EL1 (S)	EL2	EL3 (SCR.NS=1)	EL3 (SCR.NS=0)
RW	RW	RW	RW	RW	RW

Access to this register is from Debug state only. During normal execution this register is UNALLOCATED.

Configurations

DSPSR_EL0 is architecturally mapped to AArch32 register [DSPSR](#).

Attributes

DSPSR_EL0 is a 32-bit register.

DSPSR_EL0 is a member of multiple register groups and is defined elsewhere. For the full definition, see [DSPSR_EL0, Debug Saved Program Status Register](#) on page D8-2104.

C4.3.5 ELR_EL1, Exception Link Register (EL1)

The ELR_EL1 characteristics are:

Purpose

When taking an exception to EL1, holds the address to return to.

This register is part of the Special purpose registers functional group.

Usage constraints

This register is accessible as shown below:

ELO	EL1 (NS)	EL1 (S)	EL2	EL3 (SCR.NS=1)	EL3 (SCR.NS=0)
-	RW	RW	RW	RW	RW

Configurations

There are no configuration notes.

Attributes

ELR_EL1 is a 64-bit register.

The ELR_EL1 bit assignments are:

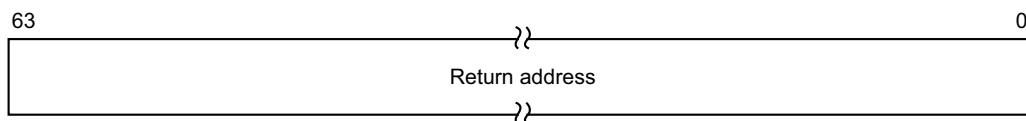

Bits [63:0]

Return address.

Accessing the ELR_EL1:

To access the ELR_EL1:

MRS <Xt>, ELR_EL1 ; Read ELR_EL1 into Xt

MSR ELR_EL1, <Xt> ; Write Xt to ELR_EL1

Register access is encoded as follows:

op0	op1	CRn	CRm	op2
11	000	0100	0000	001

C4.3.6 ELR_EL2, Exception Link Register (EL2)

The ELR_EL2 characteristics are:

Purpose

When taking an exception to EL2, holds the address to return to.

This register is part of the Special purpose registers functional group.

Usage constraints

This register is accessible as shown below:

EL0	EL1 (NS)	EL1 (S)	EL2	EL3 (SCR.NS=1)	EL3 (SCR.NS=0)
-	-	-	RW	RW	RW

When EL2 is using AArch32 and an exception is taken from EL0, EL1, or EL2 to EL3 and AArch64 execution, the upper 32-bits of ELR_EL2 are either set to 0 or hold the same value that they did before AArch32 execution. The choice between these two options is determined by an implementation, and might vary dynamically within an implementation. Correspondingly software must regard the value as being an UNKNOWN choice between the two values.

Configurations

ELR_EL2 is architecturally mapped to AArch32 register [ELR_hyp](#).

Attributes

ELR_EL2 is a 64-bit register.

The ELR_EL2 bit assignments are:

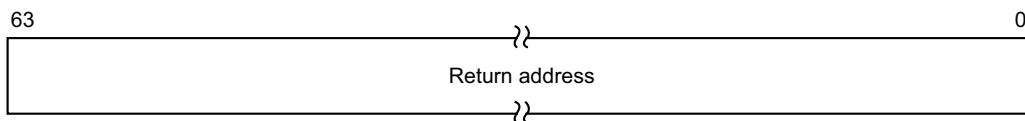

Bits [63:0]

Return address.

Accessing the ELR_EL2:

To access the ELR_EL2:

MRS <Xt>, ELR_EL2 ; Read ELR_EL2 into Xt
MSR ELR_EL2, <Xt> ; Write Xt to ELR_EL2

Register access is encoded as follows:

op0	op1	CRn	CRm	op2
11	100	0100	0000	001

C4.3.7 ELR_EL3, Exception Link Register (EL3)

The ELR_EL3 characteristics are:

Purpose

When taking an exception to EL3, holds the address to return to.
 This register is part of the Special purpose registers functional group.

Usage constraints

This register is accessible as shown below:

EL0	EL1 (NS)	EL1 (S)	EL2	EL3 (SCR.NS=1)	EL3 (SCR.NS=0)
-	-	-	-	RW	RW

Configurations

There are no configuration notes.

Attributes

ELR_EL3 is a 64-bit register.

The ELR_EL3 bit assignments are:

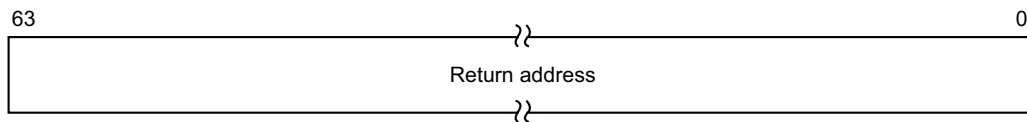

Bits [63:0]

Return address.

Accessing the ELR_EL3:

To access the ELR_EL3:

MRS <Xt>, ELR_EL3 ; Read ELR_EL3 into Xt
 MSR ELR_EL3, <Xt> ; Write Xt to ELR_EL3

Register access is encoded as follows:

op0	op1	CRn	CRm	op2
11	110	0100	0000	001

C4.3.8 FPCR, Floating-point Control Register

The FPCR characteristics are:

Purpose

Controls floating-point extension behavior.

This register is part of:

- the Special purpose registers functional group
- the Floating-point registers functional group.

Usage constraints

This register is accessible as shown below:

EL0	EL1 (NS)	EL1 (S)	EL2	EL3 (SCR.NS=1)	EL3 (SCR.NS=0)
RW	RW	RW	RW	RW	RW

Configurations

The named fields in this register map to the equivalent fields in the AArch32 [FPSCR](#).

It is IMPLEMENTATION DEFINED whether the Len and Stride fields can be programmed to non-zero values, which will cause some AArch32 floating-point instruction encodings to be UNDEFINED, or whether these fields are RAZ.

Attributes

FPCR is a 32-bit register.

The FPCR bit assignments are:

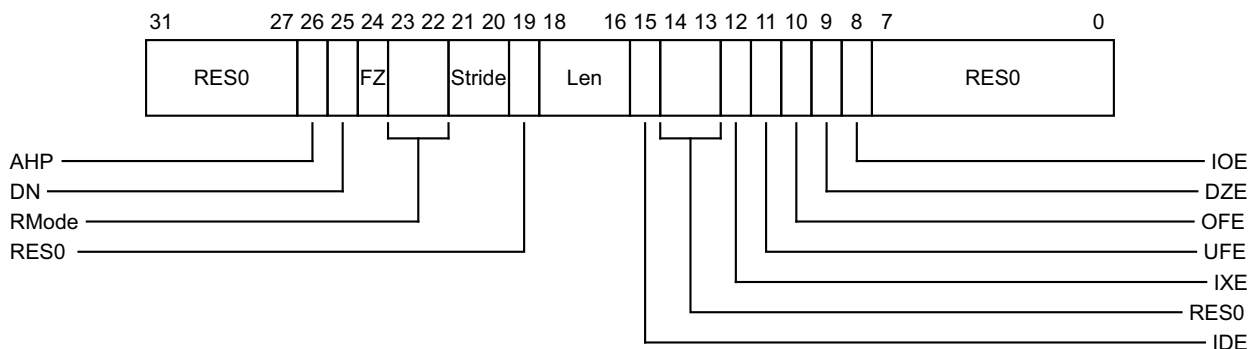

Bits [31:27]

Reserved, RES0.

AHP, bit [26]

Alternative half-precision control bit:

- 0 IEEE half-precision format selected.
- 1 Alternative half-precision format selected.

DN, bit [25]

Default NaN mode control bit:

- 0 NaN operands propagate through to the output of a floating-point operation.
- 1 Any operation involving one or more NaNs returns the Default NaN.

The value of this bit controls both scalar and Advanced SIMD floating-point arithmetic.

FZ, bit [24]

Flush-to-zero mode control bit:

- 0 Flush-to-zero mode disabled. Behavior of the floating-point system is fully compliant with the IEEE 754 standard.
- 1 Flush-to-zero mode enabled.

The value of this bit controls both scalar and Advanced SIMD floating-point arithmetic.

RMode, bits [23:22]

Rounding Mode control field. The encoding of this field is:

- 00 Round to Nearest (RN) mode
- 01 Round towards Plus Infinity (RP) mode
- 10 Round towards Minus Infinity (RM) mode
- 11 Round towards Zero (RZ) mode.

The specified rounding mode is used by both scalar and Advanced SIMD floating-point instructions.

Stride, bits [21:20]

This field is ignored during AArch64 execution.

Bit [19]

Reserved, RES0.

Len, bits [18:16]

This field is ignored during AArch64 execution.

IDE, bit [15]

Input Denormal exception trap enable. Possible values are:

- 0 Untrapped exception handling selected. If the floating-point exception occurs then the [FPSR.IDC](#) bit is set to 1.
- 1 Trapped exception handling selected. If the floating-point exception occurs, the PE does not update the [FPSR.IDC](#) bit. The trap handling software can decide whether to set the [FPSR.IDC](#) bit to 1.

The value of this bit controls both scalar and Advanced SIMD floating-point arithmetic.

If the implementation does not support this exception, this bit is RES0.

Bits [14:13]

Reserved, RES0.

IXE, bit [12]

Inexact exception trap enable. Possible values are:

- 0 Untrapped exception handling selected. If the floating-point exception occurs then the [FPSR.IXC](#) bit is set to 1.
- 1 Trapped exception handling selected. If the floating-point exception occurs, the PE does not update the [FPSR.IXC](#) bit. The trap handling software can decide whether to set the [FPSR.IXC](#) bit to 1.

The value of this bit controls both scalar and Advanced SIMD floating-point arithmetic.

If the implementation does not support this exception, this bit is RES0.

UFE, bit [11]

Underflow exception trap enable. Possible values are:

- 0 Untrapped exception handling selected. If the floating-point exception occurs then the [FPSR.UFC](#) bit is set to 1.

- 1 Trapped exception handling selected. If the floating-point exception occurs, the PE does not update the **FPSR.UFC** bit. The trap handling software can decide whether to set the **FPSR.UFC** bit to 1.

The value of this bit controls both scalar and Advanced SIMD floating-point arithmetic.

If the implementation does not support this exception, this bit is RES0.

OFE, bit [10]

Overflow exception trap enable. Possible values are:

- 0 Untrapped exception handling selected. If the floating-point exception occurs then the **FPSR.OFC** bit is set to 1.

- 1 Trapped exception handling selected. If the floating-point exception occurs, the PE does not update the **FPSR.OFC** bit. The trap handling software can decide whether to set the **FPSR.OFC** bit to 1.

The value of this bit controls both scalar and Advanced SIMD floating-point arithmetic.

If the implementation does not support this exception, this bit is RES0.

DZE, bit [9]

Division by Zero exception trap enable. Possible values are:

- 0 Untrapped exception handling selected. If the floating-point exception occurs then the **FPSR.DZC** bit is set to 1.

- 1 Trapped exception handling selected. If the floating-point exception occurs, the PE does not update the **FPSR.DZC** bit. The trap handling software can decide whether to set the **FPSR.DZC** bit to 1.

The value of this bit controls both scalar and Advanced SIMD floating-point arithmetic.

If the implementation does not support this exception, this bit is RES0.

IOE, bit [8]

Invalid Operation exception trap enable. Possible values are:

- 0 Untrapped exception handling selected. If the floating-point exception occurs then the **FPSR.IOC** bit is set to 1.

- 1 Trapped exception handling selected. If the floating-point exception occurs, the PE does not update the **FPSR.IOC** bit. The trap handling software can decide whether to set the **FPSR.IOC** bit to 1.

The value of this bit controls both scalar and Advanced SIMD floating-point arithmetic.

If the implementation does not support this exception, this bit is RES0.

Bits [7:0]

Reserved, RES0.

Accessing the FPCR:

To access the FPCR:

MRS <Xt>, FPCR ; Read FPCR into Xt

MSR FPCR, <Xt> ; Write Xt to FPCR

Register access is encoded as follows:

op0	op1	CRn	CRm	op2
11	011	0100	0100	000

C4.3.9 FPSR, Floating-point Status Register

The FPSR characteristics are:

Purpose

Provides floating-point system status information.

This register is part of:

- the Special purpose registers functional group
- the Floating-point registers functional group.

Usage constraints

This register is accessible as shown below:

EL0	EL1 (NS)	EL1 (S)	EL2	EL3 (SCR.NS=1)	EL3 (SCR.NS=0)
RW	RW	RW	RW	RW	RW

Configurations

The named fields in this register map to the equivalent fields in the AArch32 [FPSCR](#).

Attributes

FPSR is a 32-bit register.

The FPSR bit assignments are:

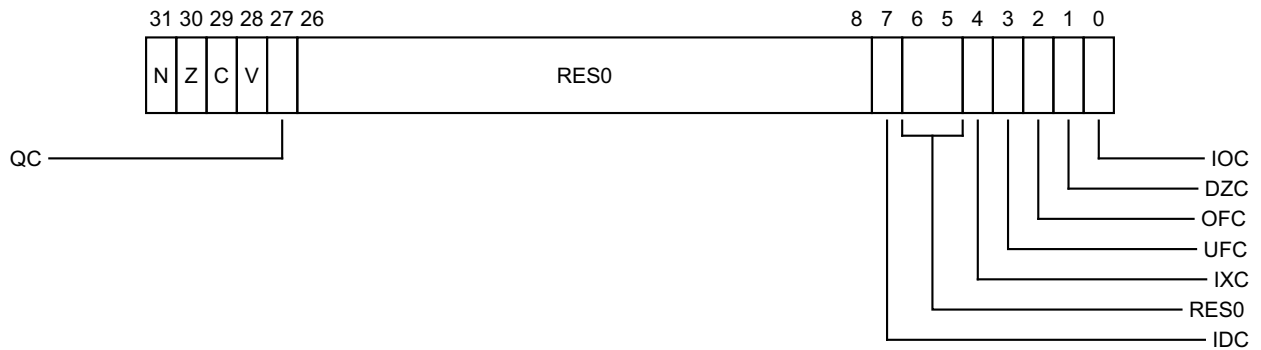

N, bit [31]

Negative condition flag for AArch32 floating-point comparison operations. AArch64 floating-point comparisons set the PSTATE.N flag instead.

Z, bit [30]

Zero condition flag for AArch32 floating-point comparison operations. AArch64 floating-point comparisons set the PSTATE.Z flag instead.

C, bit [29]

Carry condition flag for AArch32 floating-point comparison operations. AArch64 floating-point comparisons set the PSTATE.C flag instead.

V, bit [28]

Overflow condition flag for AArch32 floating-point comparison operations. AArch64 floating-point comparisons set the PSTATE.V flag instead.

QC, bit [27]

Cumulative saturation bit, Advanced SIMD only. This bit is set to 1 to indicate that an Advanced SIMD integer operation has saturated since 0 was last written to this bit.

Bits [26:8]

Reserved, RES0.

IDC, bit [7]

Input Denormal cumulative exception bit. This bit is set to 1 to indicate that the Input Denormal exception has occurred since 0 was last written to this bit.

How scalar and Advanced SIMD floating-point instructions update this bit depends on the value of the [FPCR.IDE](#) bit. This bit is only set to 1 to indicate an exception if [FPCR.IDE](#) is 0, or if trapping software sets it.

Bits [6:5]

Reserved, RES0.

IXC, bit [4]

Inexact cumulative exception bit. This bit is set to 1 to indicate that the Inexact exception has occurred since 0 was last written to this bit.

How scalar and Advanced SIMD floating-point instructions update this bit depends on the value of the [FPCR.IXE](#) bit. This bit is only set to 1 to indicate an exception if [FPCR.IXE](#) is 0, or if trapping software sets it.

UFC, bit [3]

Underflow cumulative exception bit. This bit is set to 1 to indicate that the Underflow exception has occurred since 0 was last written to this bit.

How scalar and Advanced SIMD floating-point instructions update this bit depends on the value of the [FPCR.UFE](#) bit. This bit is only set to 1 to indicate an exception if [FPCR.UFE](#) is 0, or if trapping software sets it.

OFC, bit [2]

Underflow cumulative exception bit. This bit is set to 1 to indicate that the Underflow exception has occurred since 0 was last written to this bit.

How scalar and Advanced SIMD floating-point instructions update this bit depends on the value of the [FPCR.OFE](#) bit. This bit is only set to 1 to indicate an exception if [FPCR.OFE](#) is 0, or if trapping software sets it.

DZC, bit [1]

Division by Zero cumulative exception bit. This bit is set to 1 to indicate that the Division by Zero exception has occurred since 0 was last written to this bit.

How scalar and Advanced SIMD floating-point instructions update this bit depends on the value of the [FPCR.DZE](#) bit. This bit is only set to 1 to indicate an exception if [FPCR.DZE](#) is 0, or if trapping software sets it.

IOC, bit [0]

Invalid Operation cumulative exception bit. This bit is set to 1 to indicate that the Invalid Operation exception has occurred since 0 was last written to this bit.

How scalar and Advanced SIMD floating-point instructions update this bit depends on the value of the [FPCR.IOE](#) bit. This bit is only set to 1 to indicate an exception if [FPCR.IOE](#) is 0, or if trapping software sets it.

Accessing the FPSR:

To access the FPSR:

MRS <Xt>, FPSR ; Read FPSR into Xt
MSR FPSR, <Xt> ; Write Xt to FPSR

Register access is encoded as follows:

op0	op1	CRn	CRm	op2
11	011	0100	0100	001

C4.3.10 NZCV, Condition Flags

The NZCV characteristics are:

Purpose

Allows access to the condition flags.

This register is part of the Process state registers functional group.

Usage constraints

This register is accessible as shown below:

EL0	EL1 (NS)	EL1 (S)	EL2	EL3 (SCR.NS=1)	EL3 (SCR.NS=0)
RW	RW	RW	RW	RW	RW

Configurations

There are no configuration notes.

Attributes

NZCV is a 32-bit register.

The NZCV bit assignments are:

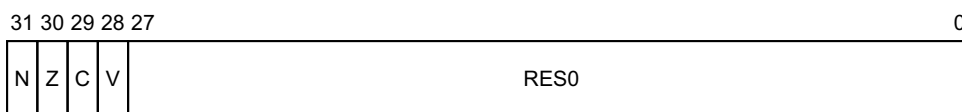

N, bit [31]

Negative condition flag. Set to bit[31] of the result of the last flag-setting instruction. If the result is regarded as a two's complement signed integer, then the processor sets N to 1 if the result was negative, and sets N to 0 if it was positive or zero.

Z, bit [30]

Zero condition flag. Set to 1 if the result of the last flag-setting instruction was zero, and to 0 otherwise. A result of zero often indicates an equal result from a comparison.

C, bit [29]

Carry condition flag. Set to 1 if the last flag-setting instruction resulted in a carry condition, for example an unsigned overflow on an addition.

V, bit [28]

Overflow condition flag. Set to 1 if the last flag-setting instruction resulted in an overflow condition, for example a signed overflow on an addition.

Bits [27:0]

Reserved, RES0.

Accessing the NZCV:

To access the NZCV:

MRS <Xt>, NZCV ; Read NZCV into Xt
MSR NZCV, <Xt> ; Write Xt to NZCV

Register access is encoded as follows:

op0	op1	CRn	CRm	op2
11	011	0100	0010	000

C4.3.11 SP_EL0, Stack Pointer (EL0)

The SP_EL0 characteristics are:

Purpose

Holds the stack pointer if *SPSel.SP* is 0, or the stack pointer for EL0 if *SPSel.SP* is 1.
This register is part of the Special purpose registers functional group.

Usage constraints

This register is accessible as shown below:

EL0	EL1 (NS)	EL1 (S)	EL2	EL3 (SCR.NS=1)	EL3 (SCR.NS=0)
-	RW	RW	RW	RW	RW

This register is also accessible at EL0 as the current stack pointer, and at any exception level as the current stack pointer when *SPSel.SP* is 0.

If *SPSel.SP* is 0 (the stack pointer selected is SP_EL0) then any access to SP_EL0 using the MSR or MRS instructions is UNDEFINED.

Configurations

There are no configuration notes.

Attributes

SP_EL0 is a 64-bit register.

The SP_EL0 bit assignments are:

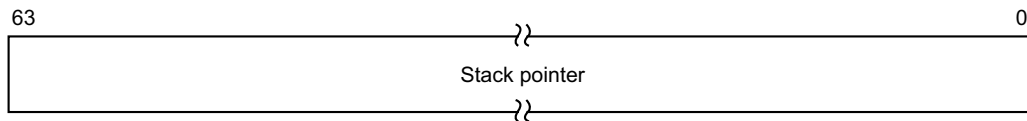

Bits [63:0]

Stack pointer.

Accessing the SP_EL0:

To access the SP_EL0:

MRS <Xt>, SP_EL0 ; Read SP_EL0 into Xt
MSR SP_EL0, <Xt> ; Write Xt to SP_EL0

Register access is encoded as follows:

op0	op1	CRn	CRm	op2
11	000	0100	0001	000

C4.3.12 SP_EL1, Stack Pointer (EL1)

The SP_EL1 characteristics are:

Purpose

Holds the stack pointer for EL1 if **SPSel.SP** is 1 (the stack pointer selected is SP_ELx).
 This register is part of the Special purpose registers functional group.

Usage constraints

This register is accessible as shown below:

EL0	EL1 (NS)	EL1 (S)	EL2	EL3 (SCR.NS=1)	EL3 (SCR.NS=0)
-	-	-	RW	RW	RW

This register is also accessible at EL1 as the current stack pointer when **SPSel.SP** is 1.

Configurations

There are no configuration notes.

Attributes

SP_EL1 is a 64-bit register.

The SP_EL1 bit assignments are:

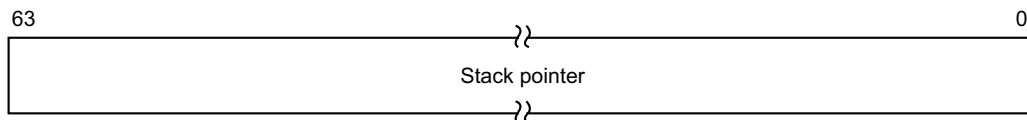

Bits [63:0]

Stack pointer.

Accessing the SP_EL1:

To access the SP_EL1:

MRS <Xt>, SP_EL1 ; Read SP_EL1 into Xt
 MSR SP_EL1, <Xt> ; Write Xt to SP_EL1

Register access is encoded as follows:

op0	op1	CRn	CRm	op2
11	100	0100	0001	000

C4.3.13 SP_EL2, Stack Pointer (EL2)

The SP_EL2 characteristics are:

Purpose

Holds the stack pointer for EL2 if **SPSel.SP** is 1 (the stack pointer selected is SP_ELx).
 This register is part of the Special purpose registers functional group.

Usage constraints

This register is accessible as shown below:

EL0	EL1 (NS)	EL1 (S)	EL2	EL3 (SCR.NS=1)	EL3 (SCR.NS=0)
-	-	-	-	RW	RW

This register is also accessible at EL2 as the current stack pointer when **SPSel.SP** is 1.

Configurations

There are no configuration notes.

Attributes

SP_EL2 is a 64-bit register.

The SP_EL2 bit assignments are:

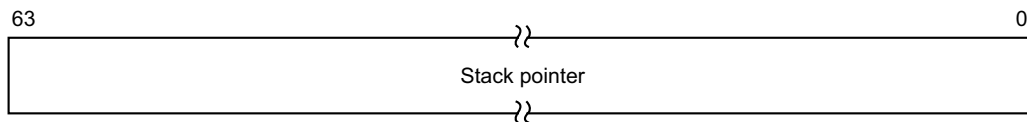

Bits [63:0]

Stack pointer.

Accessing the SP_EL2:

To access the SP_EL2:

MRS <Xt>, SP_EL2 ; Read SP_EL2 into Xt
 MSR SP_EL2, <Xt> ; Write Xt to SP_EL2

Register access is encoded as follows:

op0	op1	CRn	CRm	op2
11	110	0100	0001	000

C4.3.14 SP_EL3, Stack Pointer (EL3)

The SP_EL3 characteristics are:

Purpose

Holds the stack pointer for EL3 if [SPSel.SP](#) is 1 (the stack pointer selected is SP_ELx).

This register is part of the Special purpose registers functional group.

Usage constraints

Accessing this register depends on which field is being accessed; see the register field descriptions for the states that they are accessible in.

This register is only accessible at EL3 as the current stack pointer when [SPSel.SP](#) is 1.

Configurations

There are no configuration notes.

Attributes

SP_EL3 is a 64-bit register.

The SP_EL3 bit assignments are:

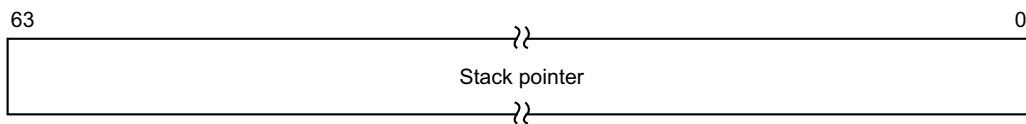

Bits [63:0]

Stack pointer.

C4.3.15 SPSel, Stack Pointer Select

The SPSel characteristics are:

Purpose

Allows the Stack Pointer to be selected between SP_EL0 and SP_ELx.
This register is part of the Process state registers functional group.

Usage constraints

This register is accessible as shown below:

EL0	EL1 (NS)	EL1 (S)	EL2	EL3 (SCR.NS=1)	EL3 (SCR.NS=0)
-	RW	RW	RW	RW	RW

Configurations

There are no configuration notes.

Attributes

SPSel is a 32-bit register.

The SPSel bit assignments are:

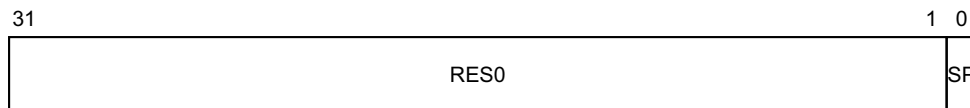

Bits [31:1]

Reserved, RES0.

SP, bit [0]

Stack pointer to use. Possible values of this bit are:

- 0 Use SP_EL0 at all exception levels.
- 1 Use SP_ELx for exception level ELx.

Resets to 1.

Accessing the SPSel:

To access the SPSel:

MRS <Xt>, SPSel ; Read SPSel into Xt
MSR SPSel, <Xt> ; Write Xt to SPSel

Register access is encoded as follows:

op0	op1	CRn	CRm	op2
11	000	0100	0010	000

C4.3.16 SPSR_abt, Saved Program Status Register (Abort mode)

The SPSR_abt characteristics are:

Purpose

Holds the saved processor state when an exception is taken to Abort mode.
 This register is part of the Special purpose registers functional group.

Usage constraints

This register is accessible as shown below:

EL0	EL1 (NS)	EL1 (S)	EL2	EL3 (SCR.NS=1)	EL3 (SCR.NS=0)
-	-	-	RW	RW	RW

Configurations

SPSR_abt is architecturally mapped to AArch32 register [SPSR_abt](#).
 If EL1 does not support execution in AArch32, this register is RES0.

Attributes

SPSR_abt is a 32-bit register.

The SPSR_abt bit assignments are:

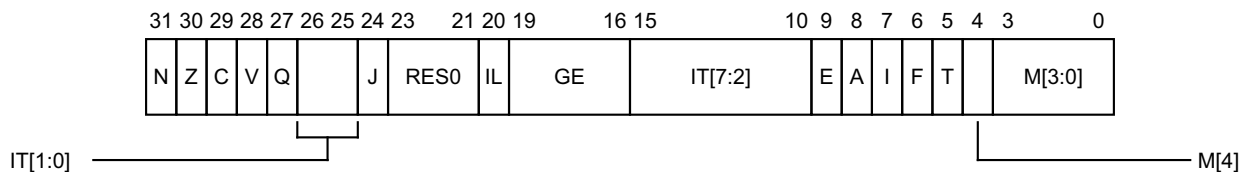

N, bit [31]

Set to the value of [CPSR.N](#) on taking an exception to Abort mode, and copied to [CPSR.N](#) on executing an exception return operation in Abort mode.

Z, bit [30]

Set to the value of [CPSR.Z](#) on taking an exception to Abort mode, and copied to [CPSR.Z](#) on executing an exception return operation in Abort mode.

C, bit [29]

Set to the value of [CPSR.C](#) on taking an exception to Abort mode, and copied to [CPSR.C](#) on executing an exception return operation in Abort mode.

V, bit [28]

Set to the value of [CPSR.V](#) on taking an exception to Abort mode, and copied to [CPSR.V](#) on executing an exception return operation in Abort mode.

Q, bit [27]

Cumulative saturation bit. Set to 1 to indicate that overflow or saturation occurred in some instructions.

IT[1:0], bits [26:25]

If-Then execution state bits for the T32 IT (If-Then) instruction. See IT[7:2] for explanation of this field.

J, bit [24]

Jazelle bit. Along with the T bit, determines the AArch32 instruction set state that the exception was taken from. Possible values of this bit are:

- 0 Processor in A32 state if T is 0, or T32 state if T is 1.
- 1 Processor in an invalid state (Jazelle state before ARMv8) if T is 0, or T32EE state if T is 1.

Since the Jazelle state is obsolete in ARMv8, J==1 and T==0 is an invalid combination, and attempting to perform an exception return with those values is an illegal exception return.

If T32EE is not implemented, this bit is RES0, so the possible values of the T bit signify either A32 or T32 state.

Bits [23:21]

Reserved, RES0.

IL, bit [20]

Illegal Execution State bit. Shows the value of PSTATE.IL immediately before the exception was taken.

GE, bits [19:16]

Greater than or Equal flags, for parallel addition and subtraction.

IT[7:2], bits [15:10]

If-Then execution state bits for the T32 IT (If-Then) instruction. This field must be interpreted in two parts.

- IT[7:5] holds the base condition for the IT block. The base condition is the top 3 bits of the condition code specified by the first condition field of the IT instruction.
- IT[4:0] encodes the size of the IT block, which is the number of instructions that are to be conditionally executed, by the position of the least significant 1 in this field. It also encodes the value of the least significant bit of the condition code for each instruction in the block.

The IT field is 0b00000000 when no IT block is active.

E, bit [9]

Endianness execution state bit. Controls the load and store endianness for data accesses:

- 0 Little-endian operation
- 1 Big-endian operation.

Instruction fetches ignore this bit.

When the reset value of the SCTL.R.EE bit is defined by a configuration input signal, that value also applies to the CPSR.E bit on reset, and therefore applies to software execution from reset.

If an implementation does not provide Big-endian support, this bit is RES0. If it does not provide Little-endian support, this bit is RES1.

If an implementation provides Big-endian support but only at EL0, this bit is RES0 for an exception return to any exception level other than EL0.

Likewise, if it provides Little-endian support only at EL0, this bit is RES1 for an exception return to any exception level other than EL0.

A, bit [8]

Asynchronous data abort mask bit. The possible values of this bit are:

- 0 Exception not masked.
- 1 Exception masked.

I, bit [7]

IRQ mask bit. The possible values of this bit are:

- 0 Exception not masked.
- 1 Exception masked.

F, bit [6]

FIQ mask bit. The possible values of this bit are:

- 0 Exception not masked.
- 1 Exception masked.

T, bit [5]

Thumb execution state bit. Along with the J bit, determines the AArch32 instruction set state that the exception was taken from. Possible values of this bit are:

- 0 Processor in A32 state if J is 0, or an invalid state (Jazelle state before ARMv8) if J is 1.
- 1 Processor in T32 state if J is 0, or T32EE state if J is 1.

Since the Jazelle state is obsolete in ARMv8, J==1 and T==0 is an invalid combination, and attempting to perform an exception return with those values is an illegal exception return.

If T32EE is not implemented, the J bit is RES0, so the possible values of this bit signify either A32 or T32 state.

M[4], bit [4]

Register width that the exception was taken from. Possible values of this bit are:

- 1 Exception taken from AArch32.

M[3:0], bits [3:0]

Mode that an exception was taken from. For exceptions taken from AArch32, the possible values are:

M[3:0]	Mode
0b0000	User
0b0001	FIQ
0b0010	IRQ
0b0011	Supervisor
0b0110	Monitor
0b0111	Abort
0b1010	Hyp
0b1011	Undefined
0b1111	System

Other values are reserved.

Accessing the SPSR_abt:

To access the SPSR_abt:

MRS <Xt>, SPSR_abt ; Read SPSR_abt into Xt
 MSR SPSR_abt, <Xt> ; Write Xt to SPSR_abt

Register access is encoded as follows:

op0	op1	CRn	CRm	op2
11	100	0100	0011	001

C4.3.17 SPSR_EL1, Saved Program Status Register (EL1)

The SPSR_EL1 characteristics are:

Purpose

Holds the saved processor state when an exception is taken to EL1.
 This register is part of the Special purpose registers functional group.

Usage constraints

This register is accessible as shown below:

EL0	EL1 (NS)	EL1 (S)	EL2	EL3 (SCR.NS=1)	EL3 (SCR.NS=0)
-	RW	RW	RW	RW	RW

Configurations

SPSR_EL1 is architecturally mapped to AArch32 register [SPSR_svc](#).

Attributes

SPSR_EL1 is a 32-bit register.

The SPSR_EL1 bit assignments are:

When exception taken from AArch32:

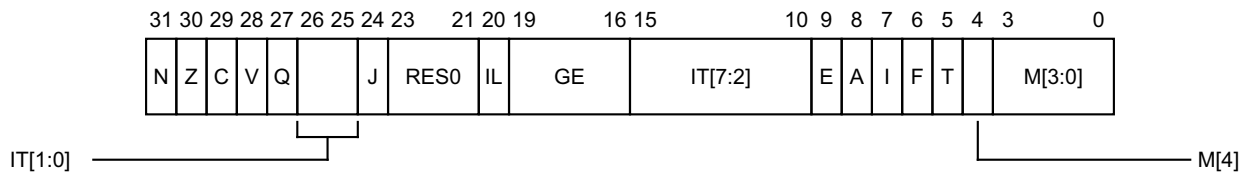

N, bit [31]

Set to the value of [CPSR.N](#) on taking an exception to Supervisor mode, and copied to [CPSR.N](#) on executing an exception return operation in Supervisor mode.

Z, bit [30]

Set to the value of [CPSR.Z](#) on taking an exception to Supervisor mode, and copied to [CPSR.Z](#) on executing an exception return operation in Supervisor mode.

C, bit [29]

Set to the value of [CPSR.C](#) on taking an exception to Supervisor mode, and copied to [CPSR.C](#) on executing an exception return operation in Supervisor mode.

V, bit [28]

Set to the value of [CPSR.V](#) on taking an exception to Supervisor mode, and copied to [CPSR.V](#) on executing an exception return operation in Supervisor mode.

Q, bit [27]

Cumulative saturation bit. Set to 1 to indicate that overflow or saturation occurred in some instructions.

IT[1:0], bits [26:25]

If-Then execution state bits for the T32 IT (If-Then) instruction. See IT[7:2] for explanation of this field.

J, bit [24]

Jazelle bit. Along with the T bit, determines the AArch32 instruction set state that the exception was taken from. Possible values of this bit are:

- 0 Processor in A32 state if T is 0, or T32 state if T is 1.
- 1 Processor in an invalid state (Jazelle state before ARMv8) if T is 0, or T32EE state if T is 1.

Since the Jazelle state is obsolete in ARMv8, J==1 and T==0 is an invalid combination, and attempting to perform an exception return with those values is an illegal exception return.

If T32EE is not implemented, this bit is RES0, so the possible values of the T bit signify either A32 or T32 state.

Bits [23:21]

Reserved, RES0.

IL, bit [20]

Illegal Execution State bit. Shows the value of PSTATE.IL immediately before the exception was taken.

GE, bits [19:16]

Greater than or Equal flags, for parallel addition and subtraction.

IT[7:2], bits [15:10]

If-Then execution state bits for the T32 IT (If-Then) instruction. This field must be interpreted in two parts.

- IT[7:5] holds the base condition for the IT block. The base condition is the top 3 bits of the condition code specified by the first condition field of the IT instruction.
- IT[4:0] encodes the size of the IT block, which is the number of instructions that are to be conditionally executed, by the position of the least significant 1 in this field. It also encodes the value of the least significant bit of the condition code for each instruction in the block.

The IT field is 0b00000000 when no IT block is active.

E, bit [9]

Endianness execution state bit. Controls the load and store endianness for data accesses:

- 0 Little-endian operation
- 1 Big-endian operation.

Instruction fetches ignore this bit.

When the reset value of the SCTL.R.EE bit is defined by a configuration input signal, that value also applies to the CPSR.E bit on reset, and therefore applies to software execution from reset.

If an implementation does not provide Big-endian support, this bit is RES0. If it does not provide Little-endian support, this bit is RES1.

If an implementation provides Big-endian support but only at EL0, this bit is RES0 for an exception return to any exception level other than EL0.

Likewise, if it provides Little-endian support only at EL0, this bit is RES1 for an exception return to any exception level other than EL0.

A, bit [8]

Asynchronous data abort mask bit. The possible values of this bit are:

- 0 Exception not masked.
- 1 Exception masked.

I, bit [7]

IRQ mask bit. The possible values of this bit are:

- 0 Exception not masked.
- 1 Exception masked.

F, bit [6]

FIQ mask bit. The possible values of this bit are:

- 0 Exception not masked.
- 1 Exception masked.

T, bit [5]

Thumb execution state bit. Along with the J bit, determines the AArch32 instruction set state that the exception was taken from. Possible values of this bit are:

- 0 Processor in A32 state if J is 0, or an invalid state (Jazelle state before ARMv8) if J is 1.
- 1 Processor in T32 state if J is 0, or T32EE state if J is 1.

Since the Jazelle state is obsolete in ARMv8, J==1 and T==0 is an invalid combination, and attempting to perform an exception return with those values is an illegal exception return.

If T32EE is not implemented, the J bit is RES0, so the possible values of this bit signify either A32 or T32 state.

M[4], bit [4]

Register width that the exception was taken from. Possible values of this bit are:

- 1 Exception taken from AArch32.

M[3:0], bits [3:0]

Mode that an exception was taken from. For exceptions taken from AArch32, the possible values are:

M[3:0]	Mode
0b0000	User
0b0001	FIQ
0b0010	IRQ
0b0011	Supervisor
0b0111	Abort
0b1011	Undefined
0b1111	System

Other values are reserved.

When exception taken from AArch64:

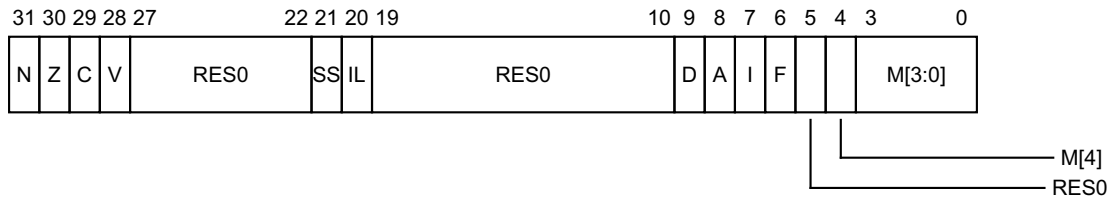

N, bit [31]

Set to the value of the N condition flag on taking an exception to EL1, and copied to the N condition flag on executing an exception return operation in EL1.

Z, bit [30]

Set to the value of the Z condition flag on taking an exception to EL1, and copied to the Z condition flag on executing an exception return operation in EL1.

C, bit [29]

Set to the value of the C condition flag on taking an exception to EL1, and copied to the C condition flag on executing an exception return operation in EL1.

V, bit [28]

Set to the value of the V condition flag on taking an exception to EL1, and copied to the V condition flag on executing an exception return operation in EL1.

Bits [27:22]

Reserved, RES0.

SS, bit [21]

Software step. Indicates whether software step was enabled when an exception was taken.

IL, bit [20]

Illegal Execution State bit. Shows the value of PSTATE.IL immediately before the exception was taken.

Bits [19:10]

Reserved, RES0.

D, bit [9]

Process state D mask. The possible values of this bit are:

- 0 Debug exceptions from Watchpoint, Breakpoint, and Software step debug events targeted at the current exception level are not masked.
- 1 Debug exceptions from Watchpoint, Breakpoint, and Software step debug events targeted at the current exception level are masked.

When the target exception level of the debug exception is not than the current exception level, the exception is not masked by this bit.

A, bit [8]

SError (System Error) mask bit. The possible values of this bit are:

- 0 Exception not masked.
- 1 Exception masked.

I, bit [7]

IRQ mask bit. The possible values of this bit are:

- 0 Exception not masked.
- 1 Exception masked.

F, bit [6]

FIQ mask bit. The possible values of this bit are:

- 0 Exception not masked.
- 1 Exception masked.

Bit [5]

Reserved, RES0.

M[4], bit [4]

Register width that the exception was taken from. Possible values of this bit are:

- 0 Exception taken from AArch64.

M[3:0], bits [3:0]

Mode that an exception was taken from. For exceptions taken from AArch64, the possible values are:

M[3:0]	Mode
0b0000	EL0t
0b0100	EL1t
0b0101	EL1h

Other values are reserved.

For exceptions from AArch64:

- M[3:2] holds the Exception Level.
- M[1] is unused, and returning to an exception level that is using AArch64 with this bit set is treated as an illegal exception return.
- M[0] is used to select the SP:
 - 0 means the SP is always SP0.
 - 1 means the exception SP is determined by the EL.

Accessing the SPSR_EL1:

To access the SPSR_EL1:

MRS <Xt>, SPSR_EL1 ; Read SPSR_EL1 into Xt
 MSR SPSR_EL1, <Xt> ; Write Xt to SPSR_EL1

Register access is encoded as follows:

op0	op1	CRn	CRm	op2
11	000	0100	0000	000

C4.3.18 SPSR_EL2, Saved Program Status Register (EL2)

The SPSR_EL2 characteristics are:

Purpose

Holds the saved processor state when an exception is taken to EL2.
This register is part of the Special purpose registers functional group.

Usage constraints

This register is accessible as shown below:

EL0	EL1 (NS)	EL1 (S)	EL2	EL3 (SCR.NS=1)	EL3 (SCR.NS=0)
-	-	-	RW	RW	RW

Configurations

SPSR_EL2 is architecturally mapped to AArch32 register [SPSR_hyp](#).

Attributes

SPSR_EL2 is a 32-bit register.

The SPSR_EL2 bit assignments are:

When exception taken from AArch32:

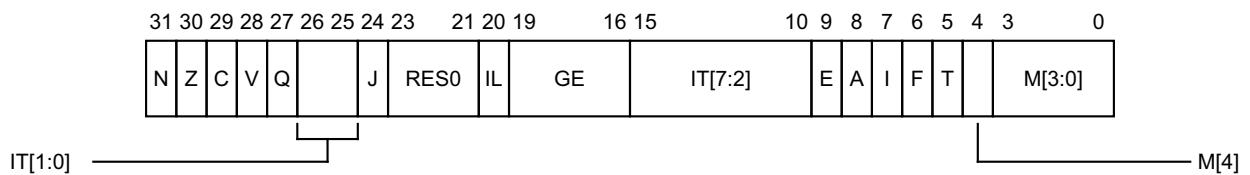

N, bit [31]

Set to the value of [CPSR.N](#) on taking an exception to Hyp mode, and copied to [CPSR.N](#) on executing an exception return operation in Hyp mode.

Z, bit [30]

Set to the value of [CPSR.Z](#) on taking an exception to Hyp mode, and copied to [CPSR.Z](#) on executing an exception return operation in Hyp mode.

C, bit [29]

Set to the value of [CPSR.C](#) on taking an exception to Hyp mode, and copied to [CPSR.C](#) on executing an exception return operation in Hyp mode.

V, bit [28]

Set to the value of [CPSR.V](#) on taking an exception to Hyp mode, and copied to [CPSR.V](#) on executing an exception return operation in Hyp mode.

Q, bit [27]

Cumulative saturation bit. Set to 1 to indicate that overflow or saturation occurred in some instructions.

IT[1:0], bits [26:25]

If-Then execution state bits for the T32 IT (If-Then) instruction. See IT[7:2] for explanation of this field.

J, bit [24]

Jazelle bit. Along with the T bit, determines the AArch32 instruction set state that the exception was taken from. Possible values of this bit are:

- 0 Processor in A32 state if T is 0, or T32 state if T is 1.
- 1 Processor in an invalid state (Jazelle state before ARMv8) if T is 0, or T32EE state if T is 1.

Since the Jazelle state is obsolete in ARMv8, J==1 and T==0 is an invalid combination, and attempting to perform an exception return with those values is an illegal exception return.

If T32EE is not implemented, this bit is RES0, so the possible values of the T bit signify either A32 or T32 state.

Bits [23:21]

Reserved, RES0.

IL, bit [20]

Illegal Execution State bit. Shows the value of PSTATE.IL immediately before the exception was taken.

GE, bits [19:16]

Greater than or Equal flags, for parallel addition and subtraction.

IT[7:2], bits [15:10]

If-Then execution state bits for the T32 IT (If-Then) instruction. This field must be interpreted in two parts.

- IT[7:5] holds the base condition for the IT block. The base condition is the top 3 bits of the condition code specified by the first condition field of the IT instruction.
- IT[4:0] encodes the size of the IT block, which is the number of instructions that are to be conditionally executed, by the position of the least significant 1 in this field. It also encodes the value of the least significant bit of the condition code for each instruction in the block.

The IT field is 0b00000000 when no IT block is active.

E, bit [9]

Endianness execution state bit. Controls the load and store endianness for data accesses:

- 0 Little-endian operation
- 1 Big-endian operation.

Instruction fetches ignore this bit.

When the reset value of the SCTLR.EE bit is defined by a configuration input signal, that value also applies to the CPSR.E bit on reset, and therefore applies to software execution from reset.

If an implementation does not provide Big-endian support, this bit is RES0. If it does not provide Little-endian support, this bit is RES1.

If an implementation provides Big-endian support but only at EL0, this bit is RES0 for an exception return to any exception level other than EL0.

Likewise, if it provides Little-endian support only at EL0, this bit is RES1 for an exception return to any exception level other than EL0.

A, bit [8]

Asynchronous data abort mask bit. The possible values of this bit are:

- 0 Exception not masked.
- 1 Exception masked.

I, bit [7]

IRQ mask bit. The possible values of this bit are:

- 0 Exception not masked.
- 1 Exception masked.

F, bit [6]

FIQ mask bit. The possible values of this bit are:

- 0 Exception not masked.
- 1 Exception masked.

T, bit [5]

Thumb execution state bit. Along with the J bit, determines the AArch32 instruction set state that the exception was taken from. Possible values of this bit are:

- 0 Processor in A32 state if J is 0, or an invalid state (Jazelle state before ARMv8) if J is 1.
- 1 Processor in T32 state if J is 0, or T32EE state if J is 1.

Since the Jazelle state is obsolete in ARMv8, J==1 and T==0 is an invalid combination, and attempting to perform an exception return with those values is an illegal exception return.

If T32EE is not implemented, the J bit is RES0, so the possible values of this bit signify either A32 or T32 state.

M[4], bit [4]

Register width that the exception was taken from. Possible values of this bit are:

- 1 Exception taken from AArch32.

M[3:0], bits [3:0]

Mode that an exception was taken from. For exceptions taken from AArch32, the possible values are:

M[3:0]	Mode
0b0000	User
0b0001	FIQ
0b0010	IRQ
0b0011	Supervisor
0b0111	Abort
0b1010	Hyp
0b1011	Undefined
0b1111	System

Other values are reserved.

When exception taken from AArch64:

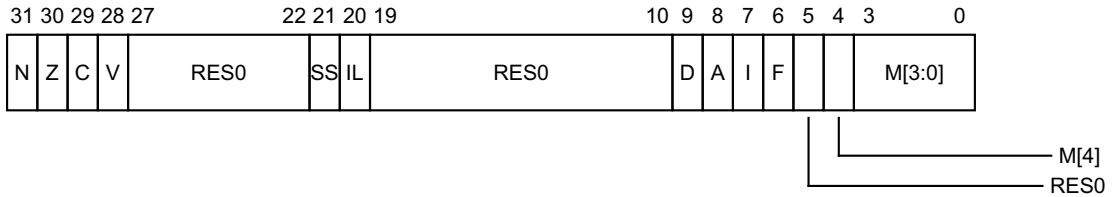

N, bit [31]

Set to the value of the N condition flag on taking an exception to EL2, and copied to the N condition flag on executing an exception return operation in EL2.

Z, bit [30]

Set to the value of the Z condition flag on taking an exception to EL2, and copied to the Z condition flag on executing an exception return operation in EL2.

C, bit [29]

Set to the value of the C condition flag on taking an exception to EL2, and copied to the C condition flag on executing an exception return operation in EL2.

V, bit [28]

Set to the value of the V condition flag on taking an exception to EL2, and copied to the V condition flag on executing an exception return operation in EL2.

Bits [27:22]

Reserved, RES0.

SS, bit [21]

Software step. Indicates whether software step was enabled when an exception was taken.

IL, bit [20]

Illegal Execution State bit. Shows the value of PSTATE.IL immediately before the exception was taken.

Bits [19:10]

Reserved, RES0.

D, bit [9]

Process state D mask. The possible values of this bit are:

- 0 Debug exceptions from Watchpoint, Breakpoint, and Software step debug events targeted at the current exception level are not masked.
- 1 Debug exceptions from Watchpoint, Breakpoint, and Software step debug events targeted at the current exception level are masked.

When the target exception level of the debug exception is not than the current exception level, the exception is not masked by this bit.

A, bit [8]

SError (System Error) mask bit. The possible values of this bit are:

- 0 Exception not masked.
- 1 Exception masked.

I, bit [7]

IRQ mask bit. The possible values of this bit are:

- 0 Exception not masked.
- 1 Exception masked.

F, bit [6]

FIQ mask bit. The possible values of this bit are:

- 0 Exception not masked.
- 1 Exception masked.

Bit [5]

Reserved, RES0.

M[4], bit [4]

Register width that the exception was taken from. Possible values of this bit are:

- 0 Exception taken from AArch64.

M[3:0], bits [3:0]

Mode that an exception was taken from. For exceptions taken from AArch64, the possible values are:

M[3:0]	Mode
0b0000	EL0t
0b0100	EL1t
0b0101	EL1h
0b1000	EL2t
0b1001	EL2h

Other values are reserved.

For exceptions from AArch64:

- M[3:2] holds the Exception Level.
- M[1] is unused, and returning to an exception level that is using AArch64 with this bit set is treated as an illegal exception return.
- M[0] is used to select the SP:
 - 0 means the SP is always SP0.
 - 1 means the exception SP is determined by the EL.

Accessing the SPSR_EL2:

To access the SPSR_EL2:

MRS <Xt>, SPSR_EL2 ; Read SPSR_EL2 into Xt
MSR SPSR_EL2, <Xt> ; Write Xt to SPSR_EL2

Register access is encoded as follows:

op0	op1	CRn	CRm	op2
11	100	0100	0000	000

C4.3.19 SPSR_EL3, Saved Program Status Register (EL3)

The SPSR_EL3 characteristics are:

Purpose

Holds the saved processor state when an exception is taken to EL3.
 This register is part of the Special purpose registers functional group.

Usage constraints

This register is accessible as shown below:

ELO	EL1 (NS)	EL1 (S)	EL2	EL3 (SCR.NS=1)	EL3 (SCR.NS=0)
-	-	-	-	RW	RW

Configurations

SPSR_EL3 can be mapped to AArch32 register [SPSR_mon](#), but this is not architecturally mandated.

Attributes

SPSR_EL3 is a 32-bit register.

The SPSR_EL3 bit assignments are:

When exception taken from AArch32:

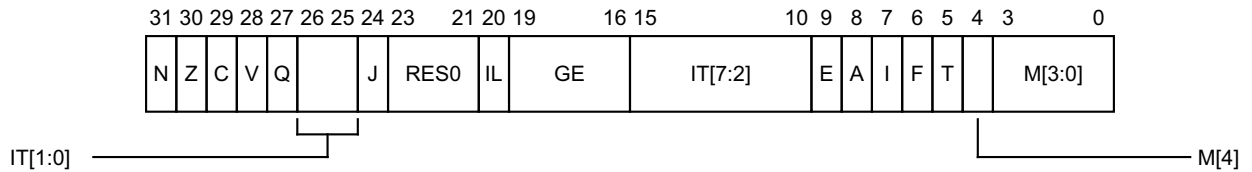

N, bit [31]

Set to the value of [CPSR.N](#) on taking an exception to Monitor mode, and copied to [CPSR.N](#) on executing an exception return operation in Monitor mode.

Z, bit [30]

Set to the value of [CPSR.Z](#) on taking an exception to Monitor mode, and copied to [CPSR.Z](#) on executing an exception return operation in Monitor mode.

C, bit [29]

Set to the value of [CPSR.C](#) on taking an exception to Monitor mode, and copied to [CPSR.C](#) on executing an exception return operation in Monitor mode.

V, bit [28]

Set to the value of [CPSR.V](#) on taking an exception to Monitor mode, and copied to [CPSR.V](#) on executing an exception return operation in Monitor mode.

Q, bit [27]

Cumulative saturation bit. Set to 1 to indicate that overflow or saturation occurred in some instructions.

IT[1:0], bits [26:25]

If-Then execution state bits for the T32 IT (If-Then) instruction. See IT[7:2] for explanation of this field.

J, bit [24]

Jazelle bit. Along with the T bit, determines the AArch32 instruction set state that the exception was taken from. Possible values of this bit are:

- | | |
|---|---|
| 0 | Processor in A32 state if T is 0, or T32 state if T is 1. |
| 1 | Processor in an invalid state (Jazelle state before ARMv8) if T is 0, or T32EE state if T is 1. |

Since the Jazelle state is obsolete in ARMv8, J==1 and T==0 is an invalid combination, and attempting to perform an exception return with those values is an illegal exception return.

If T32EE is not implemented, this bit is RES0, so the possible values of the T bit signify either A32 or T32 state.

Bits [23:21]

Reserved, RES0.

IL, bit [20]

Illegal Execution State bit. Shows the value of PSTATE.IL immediately before the exception was taken.

GE, bits [19:16]

Greater than or Equal flags, for parallel addition and subtraction.

IT[7:2], bits [15:10]

If-Then execution state bits for the T32 IT (If-Then) instruction. This field must be interpreted in two parts.

- IT[7:5] holds the base condition for the IT block. The base condition is the top 3 bits of the condition code specified by the first condition field of the IT instruction.
- IT[4:0] encodes the size of the IT block, which is the number of instructions that are to be conditionally executed, by the position of the least significant 1 in this field. It also encodes the value of the least significant bit of the condition code for each instruction in the block.

The IT field is 0b00000000 when no IT block is active.

E, bit [9]

Endianness execution state bit. Controls the load and store endianness for data accesses:

- | | |
|---|-------------------------|
| 0 | Little-endian operation |
| 1 | Big-endian operation. |

Instruction fetches ignore this bit.

When the reset value of the SCTL.R.EE bit is defined by a configuration input signal, that value also applies to the CPSR.E bit on reset, and therefore applies to software execution from reset.

If an implementation does not provide Big-endian support, this bit is RES0. If it does not provide Little-endian support, this bit is RES1.

If an implementation provides Big-endian support but only at EL0, this bit is RES0 for an exception return to any exception level other than EL0.

Likewise, if it provides Little-endian support only at EL0, this bit is RES1 for an exception return to any exception level other than EL0.

A, bit [8]

Asynchronous data abort mask bit. The possible values of this bit are:

- | | |
|---|-----------------------|
| 0 | Exception not masked. |
| 1 | Exception masked. |

I, bit [7]

IRQ mask bit. The possible values of this bit are:

- 0 Exception not masked.
- 1 Exception masked.

F, bit [6]

FIQ mask bit. The possible values of this bit are:

- 0 Exception not masked.
- 1 Exception masked.

T, bit [5]

Thumb execution state bit. Along with the J bit, determines the AArch32 instruction set state that the exception was taken from. Possible values of this bit are:

- 0 Processor in A32 state if J is 0, or an invalid state (Jazelle state before ARMv8) if J is 1.
- 1 Processor in T32 state if J is 0, or T32EE state if J is 1.

Since the Jazelle state is obsolete in ARMv8, J==1 and T==0 is an invalid combination, and attempting to perform an exception return with those values is an illegal exception return.

If T32EE is not implemented, the J bit is RES0, so the possible values of this bit signify either A32 or T32 state.

M[4], bit [4]

Register width that the exception was taken from. Possible values of this bit are:

- 1 Exception taken from AArch32.

M[3:0], bits [3:0]

Mode that an exception was taken from. For exceptions taken from AArch32, the possible values are:

M[3:0]	Mode
0b0000	User
0b0001	FIQ
0b0010	IRQ
0b0011	Supervisor
0b0110	Monitor
0b0111	Abort
0b1010	Hyp
0b1011	Undefined
0b1111	System

Other values are reserved.

When exception taken from AArch64:

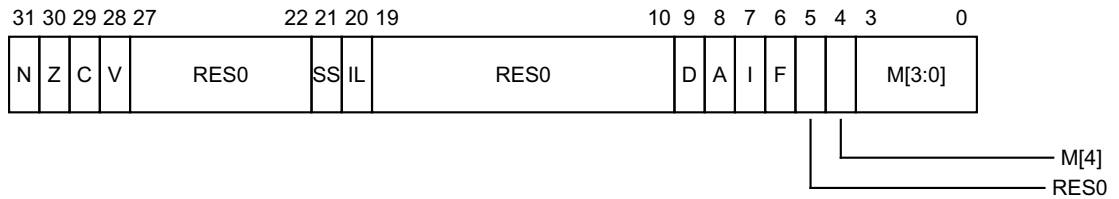

N, bit [31]

Set to the value of the N condition flag on taking an exception to EL3, and copied to the N condition flag on executing an exception return operation in EL3.

Z, bit [30]

Set to the value of the Z condition flag on taking an exception to EL3, and copied to the Z condition flag on executing an exception return operation in EL3.

C, bit [29]

Set to the value of the C condition flag on taking an exception to EL3, and copied to the C condition flag on executing an exception return operation in EL3.

V, bit [28]

Set to the value of the V condition flag on taking an exception to EL3, and copied to the V condition flag on executing an exception return operation in EL3.

Bits [27:22]

Reserved, RES0.

SS, bit [21]

Software step. Indicates whether software step was enabled when an exception was taken.

IL, bit [20]

Illegal Execution State bit. Shows the value of PSTATE.IL immediately before the exception was taken.

Bits [19:10]

Reserved, RES0.

D, bit [9]

Process state D mask. The possible values of this bit are:

- 0 Debug exceptions from Watchpoint, Breakpoint, and Software step debug events targeted at the current exception level are not masked.
- 1 Debug exceptions from Watchpoint, Breakpoint, and Software step debug events targeted at the current exception level are masked.

When the target exception level of the debug exception is not than the current exception level, the exception is not masked by this bit.

A, bit [8]

SError (System Error) mask bit. The possible values of this bit are:

- 0 Exception not masked.
- 1 Exception masked.

I, bit [7]

IRQ mask bit. The possible values of this bit are:

- 0 Exception not masked.
- 1 Exception masked.

F, bit [6]

FIQ mask bit. The possible values of this bit are:

- 0 Exception not masked.
- 1 Exception masked.

Bit [5]

Reserved, RES0.

M[4], bit [4]

Register width that the exception was taken from. Possible values of this bit are:

- 0 Exception taken from AArch64.

M[3:0], bits [3:0]

Mode that an exception was taken from. For exceptions taken from AArch64, the possible values are:

M[3:0]	Mode
0b0000	EL0t
0b0100	EL1t
0b0101	EL1h
0b1000	EL2t
0b1001	EL2h
0b1100	EL3t
0b1101	EL3h

Other values are reserved.

For exceptions from AArch64:

- M[3:2] holds the Exception Level.
- M[1] is unused, and returning to an exception level that is using AArch64 with this bit set is treated as an illegal exception return.
- M[0] is used to select the SP:
 - 0 means the SP is always SP0.
 - 1 means the exception SP is determined by the EL.

Accessing the SPSR_EL3:

To access the SPSR_EL3:

MRS <Xt>, SPSR_EL3 ; Read SPSR_EL3 into Xt
MSR SPSR_EL3, <Xt> ; Write Xt to SPSR_EL3

Register access is encoded as follows:

op0	op1	CRn	CRm	op2
11	110	0100	0000	000

C4.3.20 SPSR_fiq, Saved Program Status Register (FIQ mode)

The SPSR_fiq characteristics are:

Purpose

Holds the saved processor state when an exception is taken to FIQ mode.
 This register is part of the Special purpose registers functional group.

Usage constraints

This register is accessible as shown below:

EL0	EL1 (NS)	EL1 (S)	EL2	EL3 (SCR.NS=1)	EL3 (SCR.NS=0)
-	-	-	RW	RW	RW

Configurations

SPSR_fiq is architecturally mapped to AArch32 register [SPSR_fiq](#).
 If EL1 does not support execution in AArch32, this register is RES0.

Attributes

SPSR_fiq is a 32-bit register.

The SPSR_fiq bit assignments are:

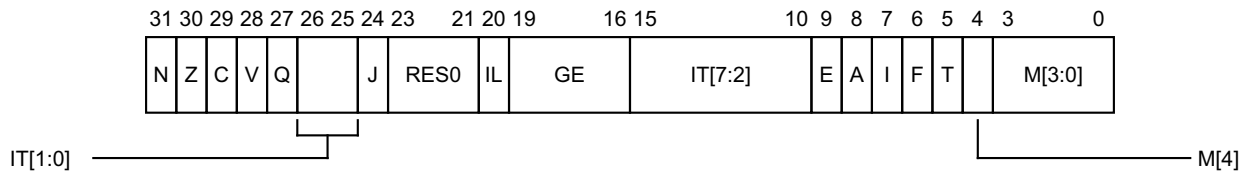

N, bit [31]

Set to the value of [CPSR.N](#) on taking an exception to FIQ mode, and copied to [CPSR.N](#) on executing an exception return operation in FIQ mode.

Z, bit [30]

Set to the value of [CPSR.Z](#) on taking an exception to FIQ mode, and copied to [CPSR.Z](#) on executing an exception return operation in FIQ mode.

C, bit [29]

Set to the value of [CPSR.C](#) on taking an exception to FIQ mode, and copied to [CPSR.C](#) on executing an exception return operation in FIQ mode.

V, bit [28]

Set to the value of [CPSR.V](#) on taking an exception to FIQ mode, and copied to [CPSR.V](#) on executing an exception return operation in FIQ mode.

Q, bit [27]

Cumulative saturation bit. Set to 1 to indicate that overflow or saturation occurred in some instructions.

IT[1:0], bits [26:25]

If-Then execution state bits for the T32 IT (If-Then) instruction. See IT[7:2] for explanation of this field.

J, bit [24]

Jazelle bit. Along with the T bit, determines the AArch32 instruction set state that the exception was taken from. Possible values of this bit are:

- 0 Processor in A32 state if T is 0, or T32 state if T is 1.
- 1 Processor in an invalid state (Jazelle state before ARMv8) if T is 0, or T32EE state if T is 1.

Since the Jazelle state is obsolete in ARMv8, J==1 and T==0 is an invalid combination, and attempting to perform an exception return with those values is an illegal exception return.

If T32EE is not implemented, this bit is RES0, so the possible values of the T bit signify either A32 or T32 state.

Bits [23:21]

Reserved, RES0.

IL, bit [20]

Illegal Execution State bit. Shows the value of PSTATE.IL immediately before the exception was taken.

GE, bits [19:16]

Greater than or Equal flags, for parallel addition and subtraction.

IT[7:2], bits [15:10]

If-Then execution state bits for the T32 IT (If-Then) instruction. This field must be interpreted in two parts.

- IT[7:5] holds the base condition for the IT block. The base condition is the top 3 bits of the condition code specified by the first condition field of the IT instruction.
- IT[4:0] encodes the size of the IT block, which is the number of instructions that are to be conditionally executed, by the position of the least significant 1 in this field. It also encodes the value of the least significant bit of the condition code for each instruction in the block.

The IT field is 0b00000000 when no IT block is active.

E, bit [9]

Endianness execution state bit. Controls the load and store endianness for data accesses:

- 0 Little-endian operation
- 1 Big-endian operation.

Instruction fetches ignore this bit.

When the reset value of the SCTL.R.EE bit is defined by a configuration input signal, that value also applies to the CPSR.E bit on reset, and therefore applies to software execution from reset.

If an implementation does not provide Big-endian support, this bit is RES0. If it does not provide Little-endian support, this bit is RES1.

If an implementation provides Big-endian support but only at EL0, this bit is RES0 for an exception return to any exception level other than EL0.

Likewise, if it provides Little-endian support only at EL0, this bit is RES1 for an exception return to any exception level other than EL0.

A, bit [8]

Asynchronous data abort mask bit. The possible values of this bit are:

- 0 Exception not masked.
- 1 Exception masked.

I, bit [7]

IRQ mask bit. The possible values of this bit are:

- 0 Exception not masked.
- 1 Exception masked.

F, bit [6]

FIQ mask bit. The possible values of this bit are:

- 0 Exception not masked.
- 1 Exception masked.

T, bit [5]

Thumb execution state bit. Along with the J bit, determines the AArch32 instruction set state that the exception was taken from. Possible values of this bit are:

- 0 Processor in A32 state if J is 0, or an invalid state (Jazelle state before ARMv8) if J is 1.
- 1 Processor in T32 state if J is 0, or T32EE state if J is 1.

Since the Jazelle state is obsolete in ARMv8, J=1 and T=0 is an invalid combination, and attempting to perform an exception return with those values is an illegal exception return.

If T32EE is not implemented, the J bit is RES0, so the possible values of this bit signify either A32 or T32 state.

M[4], bit [4]

Register width that the exception was taken from. Possible values of this bit are:

- 1 Exception taken from AArch32.

M[3:0], bits [3:0]

Mode that an exception was taken from. For exceptions taken from AArch32, the possible values are:

M[3:0]	Mode
0b0000	User
0b0001	FIQ
0b0010	IRQ
0b0011	Supervisor
0b0110	Monitor
0b0111	Abort
0b1010	Hyp
0b1011	Undefined
0b1111	System

Other values are reserved.

Accessing the SPSR_fiq:

To access the SPSR_fiq:

MRS <Xt>, SPSR_fiq ; Read SPSR_fiq into Xt
 MSR SPSR_fiq, <Xt> ; Write Xt to SPSR_fiq

Register access is encoded as follows:

op0	op1	CRn	CRm	op2
11	100	0100	0011	011

C4.3.21 SPSR_irq, Saved Program Status Register (IRQ mode)

The SPSR_irq characteristics are:

Purpose

Holds the saved processor state when an exception is taken to IRQ mode.
 This register is part of the Special purpose registers functional group.

Usage constraints

This register is accessible as shown below:

EL0	EL1 (NS)	EL1 (S)	EL2	EL3 (SCR.NS=1)	EL3 (SCR.NS=0)
-	-	-	RW	RW	RW

Configurations

SPSR_irq is architecturally mapped to AArch32 register [SPSR_irq](#).
 If EL1 does not support execution in AArch32, this register is RES0.

Attributes

SPSR_irq is a 32-bit register.

The SPSR_irq bit assignments are:

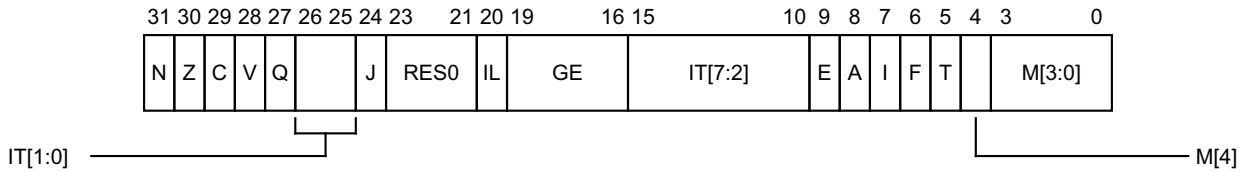

N, bit [31]

Set to the value of [CPSR.N](#) on taking an exception to IRQ mode, and copied to [CPSR.N](#) on executing an exception return operation in IRQ mode.

Z, bit [30]

Set to the value of [CPSR.Z](#) on taking an exception to IRQ mode, and copied to [CPSR.Z](#) on executing an exception return operation in IRQ mode.

C, bit [29]

Set to the value of [CPSR.C](#) on taking an exception to IRQ mode, and copied to [CPSR.C](#) on executing an exception return operation in IRQ mode.

V, bit [28]

Set to the value of [CPSR.V](#) on taking an exception to IRQ mode, and copied to [CPSR.V](#) on executing an exception return operation in IRQ mode.

Q, bit [27]

Cumulative saturation bit. Set to 1 to indicate that overflow or saturation occurred in some instructions.

IT[1:0], bits [26:25]

If-Then execution state bits for the T32 IT (If-Then) instruction. See IT[7:2] for explanation of this field.

J, bit [24]

Jazelle bit. Along with the T bit, determines the AArch32 instruction set state that the exception was taken from. Possible values of this bit are:

- 0 Processor in A32 state if T is 0, or T32 state if T is 1.
- 1 Processor in an invalid state (Jazelle state before ARMv8) if T is 0, or T32EE state if T is 1.

Since the Jazelle state is obsolete in ARMv8, J==1 and T==0 is an invalid combination, and attempting to perform an exception return with those values is an illegal exception return.

If T32EE is not implemented, this bit is RES0, so the possible values of the T bit signify either A32 or T32 state.

Bits [23:21]

Reserved, RES0.

IL, bit [20]

Illegal Execution State bit. Shows the value of PSTATE.IL immediately before the exception was taken.

GE, bits [19:16]

Greater than or Equal flags, for parallel addition and subtraction.

IT[7:2], bits [15:10]

If-Then execution state bits for the T32 IT (If-Then) instruction. This field must be interpreted in two parts.

- IT[7:5] holds the base condition for the IT block. The base condition is the top 3 bits of the condition code specified by the first condition field of the IT instruction.
- IT[4:0] encodes the size of the IT block, which is the number of instructions that are to be conditionally executed, by the position of the least significant 1 in this field. It also encodes the value of the least significant bit of the condition code for each instruction in the block.

The IT field is 0b00000000 when no IT block is active.

E, bit [9]

Endianness execution state bit. Controls the load and store endianness for data accesses:

- 0 Little-endian operation
- 1 Big-endian operation.

Instruction fetches ignore this bit.

When the reset value of the SCTL.R.EE bit is defined by a configuration input signal, that value also applies to the CPSR.E bit on reset, and therefore applies to software execution from reset.

If an implementation does not provide Big-endian support, this bit is RES0. If it does not provide Little-endian support, this bit is RES1.

If an implementation provides Big-endian support but only at EL0, this bit is RES0 for an exception return to any exception level other than EL0.

Likewise, if it provides Little-endian support only at EL0, this bit is RES1 for an exception return to any exception level other than EL0.

A, bit [8]

Asynchronous data abort mask bit. The possible values of this bit are:

- 0 Exception not masked.
- 1 Exception masked.

I, bit [7]

IRQ mask bit. The possible values of this bit are:

- 0 Exception not masked.
- 1 Exception masked.

F, bit [6]

FIQ mask bit. The possible values of this bit are:

- 0 Exception not masked.
- 1 Exception masked.

T, bit [5]

Thumb execution state bit. Along with the J bit, determines the AArch32 instruction set state that the exception was taken from. Possible values of this bit are:

- 0 Processor in A32 state if J is 0, or an invalid state (Jazelle state before ARMv8) if J is 1.
- 1 Processor in T32 state if J is 0, or T32EE state if J is 1.

Since the Jazelle state is obsolete in ARMv8, J==1 and T==0 is an invalid combination, and attempting to perform an exception return with those values is an illegal exception return.

If T32EE is not implemented, the J bit is RES0, so the possible values of this bit signify either A32 or T32 state.

M[4], bit [4]

Register width that the exception was taken from. Possible values of this bit are:

- 1 Exception taken from AArch32.

M[3:0], bits [3:0]

Mode that an exception was taken from. For exceptions taken from AArch32, the possible values are:

M[3:0]	Mode
0b0000	User
0b0001	FIQ
0b0010	IRQ
0b0011	Supervisor
0b0110	Monitor
0b0111	Abort
0b1010	Hyp
0b1011	Undefined
0b1111	System

Other values are reserved.

Accessing the SPSR_irq:

To access the SPSR_irq:

MRS <Xt>, SPSR_irq ; Read SPSR_irq into Xt
 MSR SPSR_irq, <Xt> ; Write Xt to SPSR_irq

Register access is encoded as follows:

op0	op1	CRn	CRm	op2
11	100	0100	0011	000

C4.3.22 SPSR_und, Saved Program Status Register (Undefined mode)

The SPSR_und characteristics are:

Purpose

Holds the saved processor state when an exception is taken to Undefined mode.
 This register is part of the Special purpose registers functional group.

Usage constraints

This register is accessible as shown below:

EL0	EL1 (NS)	EL1 (S)	EL2	EL3 (SCR.NS=1)	EL3 (SCR.NS=0)
-	-	-	RW	RW	RW

Configurations

SPSR_und is architecturally mapped to AArch32 register [SPSR_und](#).
 If EL1 does not support execution in AArch32, this register is RES0.

Attributes

SPSR_und is a 32-bit register.

The SPSR_und bit assignments are:

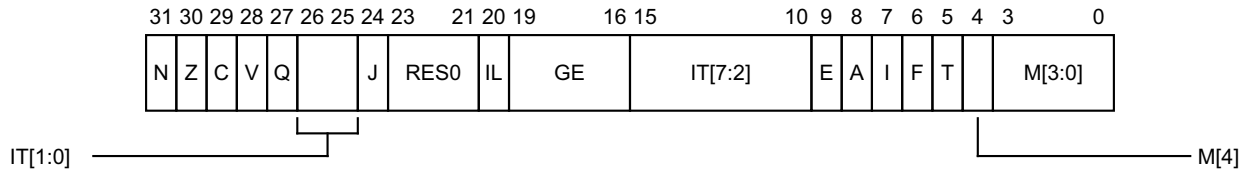

N, bit [31]

Set to the value of [CPSR.N](#) on taking an exception to Undefined mode, and copied to [CPSR.N](#) on executing an exception return operation in Undefined mode.

Z, bit [30]

Set to the value of [CPSR.Z](#) on taking an exception to Undefined mode, and copied to [CPSR.Z](#) on executing an exception return operation in Undefined mode.

C, bit [29]

Set to the value of [CPSR.C](#) on taking an exception to Undefined mode, and copied to [CPSR.C](#) on executing an exception return operation in Undefined mode.

V, bit [28]

Set to the value of [CPSR.V](#) on taking an exception to Undefined mode, and copied to [CPSR.V](#) on executing an exception return operation in Undefined mode.

Q, bit [27]

Cumulative saturation bit. Set to 1 to indicate that overflow or saturation occurred in some instructions.

IT[1:0], bits [26:25]

If-Then execution state bits for the T32 IT (If-Then) instruction. See IT[7:2] for explanation of this field.

J, bit [24]

Jazelle bit. Along with the T bit, determines the AArch32 instruction set state that the exception was taken from. Possible values of this bit are:

- 0 Processor in A32 state if T is 0, or T32 state if T is 1.
- 1 Processor in an invalid state (Jazelle state before ARMv8) if T is 0, or T32EE state if T is 1.

Since the Jazelle state is obsolete in ARMv8, J==1 and T==0 is an invalid combination, and attempting to perform an exception return with those values is an illegal exception return.

If T32EE is not implemented, this bit is RES0, so the possible values of the T bit signify either A32 or T32 state.

Bits [23:21]

Reserved, RES0.

IL, bit [20]

Illegal Execution State bit. Shows the value of PSTATE.IL immediately before the exception was taken.

GE, bits [19:16]

Greater than or Equal flags, for parallel addition and subtraction.

IT[7:2], bits [15:10]

If-Then execution state bits for the T32 IT (If-Then) instruction. This field must be interpreted in two parts.

- IT[7:5] holds the base condition for the IT block. The base condition is the top 3 bits of the condition code specified by the first condition field of the IT instruction.
- IT[4:0] encodes the size of the IT block, which is the number of instructions that are to be conditionally executed, by the position of the least significant 1 in this field. It also encodes the value of the least significant bit of the condition code for each instruction in the block.

The IT field is 0b00000000 when no IT block is active.

E, bit [9]

Endianness execution state bit. Controls the load and store endianness for data accesses:

- 0 Little-endian operation
- 1 Big-endian operation.

Instruction fetches ignore this bit.

When the reset value of the SCTL.R.EE bit is defined by a configuration input signal, that value also applies to the CPSR.E bit on reset, and therefore applies to software execution from reset.

If an implementation does not provide Big-endian support, this bit is RES0. If it does not provide Little-endian support, this bit is RES1.

If an implementation provides Big-endian support but only at EL0, this bit is RES0 for an exception return to any exception level other than EL0.

Likewise, if it provides Little-endian support only at EL0, this bit is RES1 for an exception return to any exception level other than EL0.

A, bit [8]

Asynchronous data abort mask bit. The possible values of this bit are:

- 0 Exception not masked.
- 1 Exception masked.

I, bit [7]

IRQ mask bit. The possible values of this bit are:

- 0 Exception not masked.
- 1 Exception masked.

F, bit [6]

FIQ mask bit. The possible values of this bit are:

- 0 Exception not masked.
- 1 Exception masked.

T, bit [5]

Thumb execution state bit. Along with the J bit, determines the AArch32 instruction set state that the exception was taken from. Possible values of this bit are:

- 0 Processor in A32 state if J is 0, or an invalid state (Jazelle state before ARMv8) if J is 1.
- 1 Processor in T32 state if J is 0, or T32EE state if J is 1.

Since the Jazelle state is obsolete in ARMv8, J==1 and T==0 is an invalid combination, and attempting to perform an exception return with those values is an illegal exception return.

If T32EE is not implemented, the J bit is RES0, so the possible values of this bit signify either A32 or T32 state.

M[4], bit [4]

Register width that the exception was taken from. Possible values of this bit are:

- 1 Exception taken from AArch32.

M[3:0], bits [3:0]

Mode that an exception was taken from. For exceptions taken from AArch32, the possible values are:

M[3:0]	Mode
0b0000	User
0b0001	FIQ
0b0010	IRQ
0b0011	Supervisor
0b0110	Monitor
0b0111	Abort
0b1010	Hyp
0b1011	Undefined
0b1111	System

Other values are reserved.

Accessing the SPSR_und:

To access the SPSR_und:

MRS <Xt>, SPSR_und ; Read SPSR_und into Xt
 MSR SPSR_und, <Xt> ; Write Xt to SPSR_und

Register access is encoded as follows:

op0	op1	CRn	CRm	op2
11	100	0100	0011	010

C4.4 A64 system instructions for cache maintenance

The following sections describe the cache maintenance system instructions in A64.

- *DC CISW, Data or unified Cache line Clean and Invalidate by Set/Way* on page C4-307
- *DC CIVAC, Data or unified Cache line Clean and Invalidate by VA to PoC* on page C4-309
- *DC CSW, Data or unified Cache line Clean by Set/Way* on page C4-310
- *DC CVAC, Data or unified Cache line Clean by VA to PoC* on page C4-312
- *DC CVAU, Data or unified Cache line Clean by VA to PoU* on page C4-313
- *DC ISW, Data or unified Cache line Invalidate by Set/Way* on page C4-314
- *DC IVAC, Data or unified Cache line Invalidate by VA to PoC* on page C4-316
- *DC ZVA, Data Cache Zero by VA* on page C4-317
- *IC IALLU, Instruction Cache Invalidate All to PoU* on page C4-319
- *IC IALLUIS, Instruction Cache Invalidate All to PoU, Inner Shareable* on page C4-320
- *IC IVAU, Instruction Cache line Invalidate by VA to PoU* on page C4-321

C4.4.1 DC CISW, Data or unified Cache line Clean and Invalidate by Set/Way

The DC CISW characteristics are:

Purpose

Clean and Invalidate data cache by set/way.

This register is part of the Cache maintenance operations functional group.

Usage constraints

This operation can be performed at the exception levels shown below:

ELO	EL1 (NS)	EL1 (S)	EL2	EL3 (SCR.NS=1)	EL3 (SCR.NS=0)
-	WO	WO	WO	WO	WO

Configurations

DC CISW performs the same function as AArch32 operation [DCCISW](#).

Attributes

DC CISW is a 64-bit system operation.

The DC CISW input value bit assignments are:

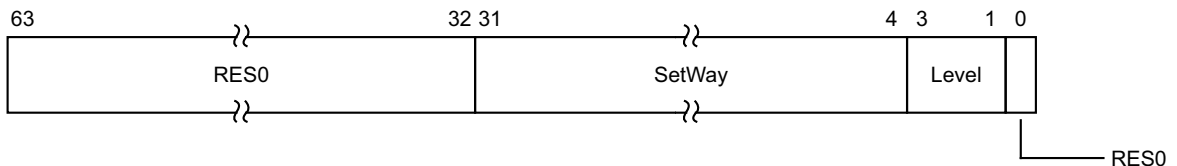

Bits [63:32]

Reserved, RES0.

SetWay, bits [31:4]

Contains two fields:

- Way, bits[31:32-A], the number of the way to operate on.
- Set, bits[B-1:L], the number of the set to operate on.

Bits[L-1:4] are RES0.

$A = \text{Log}_2(\text{ASSOCIATIVITY})$, $L = \text{Log}_2(\text{LINELEN})$, $B = (L + S)$, $S = \text{Log}_2(\text{NSETS})$.

ASSOCIATIVITY, LINELEN (line length, in bytes), and NSETS (number of sets) have their usual meanings and are the values for the cache level being operated on. The values of A and S are rounded up to the next integer.

Level, bits [3:1]

Cache level to operate on, minus 1. For example, this field is 0 for operations on L1 cache, or 1 for operations on L2 cache.

Bit [0]

Reserved, RES0.

Performing the DC CISW operation:

To perform the DC CISW operation:

DC CISW, <Xt>

The operation is encoded as follows:

op0	op1	CRn	CRm	op2
01	000	0111	1110	010

C4.4.2 DC CIVAC, Data or unified Cache line Clean and Invalidate by VA to PoC

The DC CIVAC characteristics are:

Purpose

Clean and Invalidate data cache by address to Point of Coherency.

This register is part of the Cache maintenance operations functional group.

Usage constraints

This operation can be performed at the exception levels shown below:

EL0	EL1 (NS)	EL1 (S)	EL2	EL3 (SCR.NS=1)	EL3 (SCR.NS=0)
Config-WO	WO	WO	WO	WO	WO

EL0 access is enabled when `SCTLR_EL1.UCI` is set to 1. When it is set to 0, this operation is UNDEFINED at EL0.

If EL0 access is enabled, this operation is available at EL0 when the VA has read access permission, otherwise it causes a Permission Fault.

Configurations

DC CIVAC performs the same function as AArch32 operation `DCCIMVAC`.

Attributes

DC CIVAC is a 64-bit system operation.

The DC CIVAC input value bit assignments are:

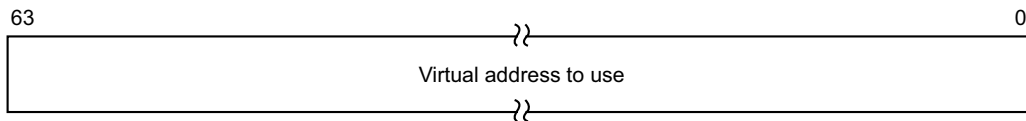

Bits [63:0]

Virtual address to use.

Performing the DC CIVAC operation:

To perform the DC CIVAC operation:

DC CIVAC, <Xt>

The operation is encoded as follows:

op0	op1	CRn	CRm	op2
01	011	0111	1110	001

C4.4.3 DC CSW, Data or unified Cache line Clean by Set/Way

The DC CSW characteristics are:

Purpose

Clean data cache by set/way.

This register is part of the Cache maintenance operations functional group.

Usage constraints

This operation can be performed at the exception levels shown below:

ELO	EL1 (NS)	EL1 (S)	EL2	EL3 (SCR.NS=1)	EL3 (SCR.NS=0)
-	WO	WO	WO	WO	WO

Configurations

DC CSW performs the same function as AArch32 operation [DCCSW](#).

Attributes

DC CSW is a 64-bit system operation.

The DC CSW input value bit assignments are:

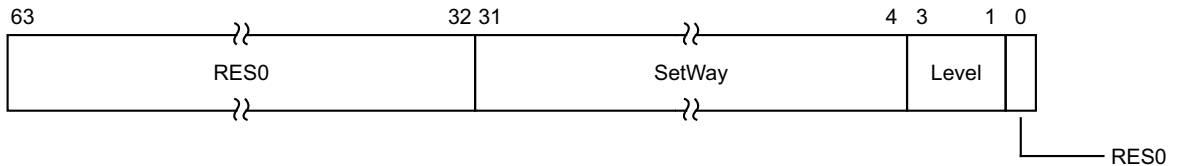

Bits [63:32]

Reserved, RES0.

SetWay, bits [31:4]

Contains two fields:

- Way, bits[31:32-A], the number of the way to operate on.
- Set, bits[B-1:L], the number of the set to operate on.

Bits[L-1:4] are RES0.

$A = \text{Log}_2(\text{ASSOCIATIVITY})$, $L = \text{Log}_2(\text{LINELEN})$, $B = (L + S)$, $S = \text{Log}_2(\text{NSETS})$.

ASSOCIATIVITY, LINELEN (line length, in bytes), and NSETS (number of sets) have their usual meanings and are the values for the cache level being operated on. The values of A and S are rounded up to the next integer.

Level, bits [3:1]

Cache level to operate on, minus 1. For example, this field is 0 for operations on L1 cache, or 1 for operations on L2 cache.

Bit [0]

Reserved, RES0.

Performing the DC CSW operation:

To perform the DC CSW operation:

DC CSW, <Xt>

The operation is encoded as follows:

op0	op1	CRn	CRm	op2
01	000	0111	1010	010

C4.4.4 DC CVAC, Data or unified Cache line Clean by VA to PoC

The DC CVAC characteristics are:

Purpose

Clean data cache by address to Point of Coherency.

This register is part of the Cache maintenance operations functional group.

Usage constraints

This operation can be performed at the exception levels shown below:

EL0	EL1 (NS)	EL1 (S)	EL2	EL3 (SCR.NS=1)	EL3 (SCR.NS=0)
Config-WO	WO	WO	WO	WO	WO

EL0 access is enabled when [SCTLR_EL1.UCI](#) is set to 1. When it is set to 0, this operation is UNDEFINED at EL0.

If EL0 access is enabled, this operation is available at EL0 when the VA has read access permission, otherwise it causes a Permission Fault.

Configurations

DC CVAC performs the same function as AArch32 operation [DCCMVAC](#).

Attributes

DC CVAC is a 64-bit system operation.

The DC CVAC input value bit assignments are:

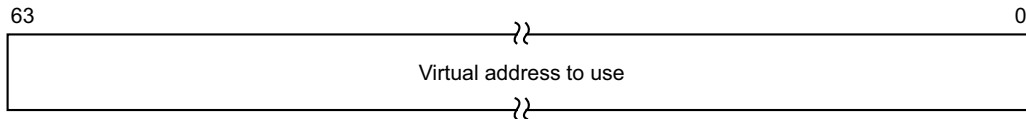

Bits [63:0]

Virtual address to use.

Performing the DC CVAC operation:

To perform the DC CVAC operation:

DC CVAC, <Xt>

The operation is encoded as follows:

op0	op1	CRn	CRm	op2
01	011	0111	1010	001

C4.4.5 DC CVAU, Data or unified Cache line Clean by VA to PoU

The DC CVAU characteristics are:

Purpose

Clean data cache by address to Point of Unification.

This register is part of the Cache maintenance operations functional group.

Usage constraints

This operation can be performed at the exception levels shown below:

EL0	EL1 (NS)	EL1 (S)	EL2	EL3 (SCR.NS=1)	EL3 (SCR.NS=0)
Config-WO	WO	WO	WO	WO	WO

EL0 access is enabled when [SCTLR_EL1.UCI](#) is set to 1. When it is set to 0, this operation is UNDEFINED at EL0.

If EL0 access is enabled, this operation is available at EL0 when the VA has read access permission, otherwise it causes a Permission Fault.

Configurations

DC CVAU performs the same function as AArch32 operation [DCCMVAU](#).

Attributes

DC CVAU is a 64-bit system operation.

The DC CVAU input value bit assignments are:

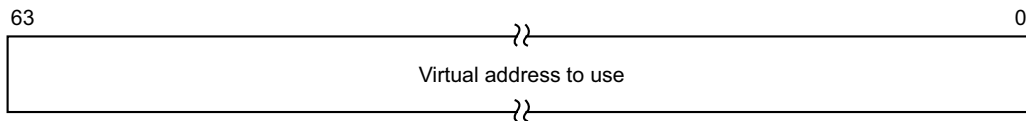

Bits [63:0]

Virtual address to use.

Performing the DC CVAU operation:

To perform the DC CVAU operation:

DC CVAU, <Xt>

The operation is encoded as follows:

op0	op1	CRn	CRm	op2
01	011	0111	1011	001

C4.4.6 DC ISW, Data or unified Cache line Invalidate by Set/Way

The DC ISW characteristics are:

Purpose

Invalidate data cache by set/way.

This register is part of the Cache maintenance operations functional group.

Usage constraints

This operation can be performed at the exception levels shown below:

ELO	EL1 (NS)	EL1 (S)	EL2	EL3 (SCR.NS=1)	EL3 (SCR.NS=0)
-	WO	WO	WO	WO	WO

At EL1, this operation must be performed as [DC CISW](#) if all of the following apply:

- EL2 is implemented
- [HCR_EL2.VM](#) is set to 1
- [SCR_EL3.NS](#) is set to 1 or EL3 is not implemented.

Configurations

DC ISW performs the same function as AArch32 operation [DCISW](#).

Attributes

DC ISW is a 64-bit system operation.

The DC ISW input value bit assignments are:

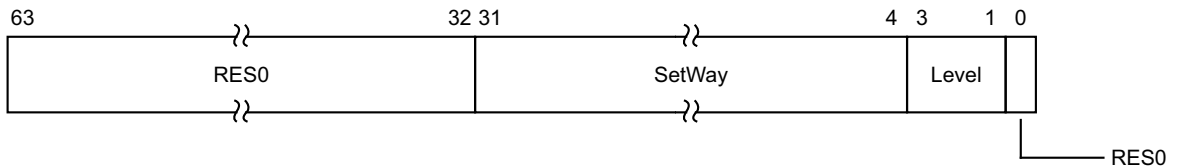

Bits [63:32]

Reserved, RES0.

SetWay, bits [31:4]

Contains two fields:

- Way, bits[31:32-A], the number of the way to operate on.
- Set, bits[B-1:L], the number of the set to operate on.

Bits[L-1:4] are RES0.

$A = \text{Log}_2(\text{ASSOCIATIVITY})$, $L = \text{Log}_2(\text{LINELEN})$, $B = (L + S)$, $S = \text{Log}_2(\text{NSETS})$.

ASSOCIATIVITY, LINELEN (line length, in bytes), and NSETS (number of sets) have their usual meanings and are the values for the cache level being operated on. The values of A and S are rounded up to the next integer.

Level, bits [3:1]

Cache level to operate on, minus 1. For example, this field is 0 for operations on L1 cache, or 1 for operations on L2 cache.

Bit [0]

Reserved, RES0.

Performing the DC ISW operation:

To perform the DC ISW operation:

DC ISW, <Xt>

The operation is encoded as follows:

op0	op1	CRn	CRm	op2
01	000	0111	0110	010

C4.4.7 DC IVAC, Data or unified Cache line Invalidate by VA to PoC

The DC IVAC characteristics are:

Purpose

Invalidate instruction cache by address to Point of Coherency.

This register is part of the Cache maintenance operations functional group.

Usage constraints

This operation can be performed at the exception levels shown below:

EL0	EL1 (NS)	EL1 (S)	EL2	EL3 (SCR.NS=1)	EL3 (SCR.NS=0)
-	WO	WO	WO	WO	WO

This operation requires write access permission to the VA, otherwise it causes a Permission Fault.

At EL1, this operation must be performed as [DC CIVAC](#) if all of the following apply:

- EL2 is implemented.
- [HCR_EL2.VM](#) is set to 1.
- [SCR_EL3.NS](#) is set to 1 or EL3 is not implemented.

Configurations

DC IVAC performs the same function as AArch32 operation [DCIMVAC](#).

Attributes

DC IVAC is a 64-bit system operation.

The DC IVAC input value bit assignments are:

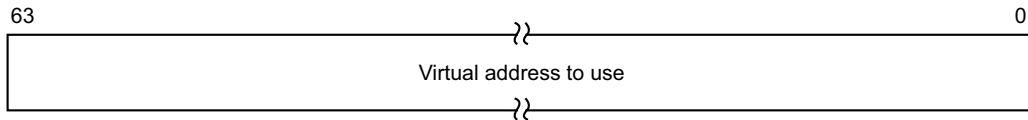

Bits [63:0]

Virtual address to use.

Performing the DC IVAC operation:

To perform the DC IVAC operation:

DC IVAC, <Xt>

The operation is encoded as follows:

op0	op1	CRn	CRm	op2
01	000	0111	0110	001

C4.4.8 DC ZVA, Data Cache Zero by VA

The DC ZVA characteristics are:

Purpose

Zero data cache by address. Zeroes a naturally aligned block of N bytes, where the size of N is identified in [DCZID_ELO](#).

This register is part of the Cache maintenance operations functional group.

Usage constraints

This operation can be performed at the exception levels shown below:

EL0	EL1 (NS)	EL1 (S)	EL2	EL3 (SCR.NS=1)	EL3 (SCR.NS=0)
Config-WO	WO	WO	WO	WO	WO

There are two control bits associated with this instruction: [SCTLR_EL1.DZE](#) and [HCR_EL2.TDZ](#).

- If execution at EL0 is disabled by the [SCTLR_EL1.DZE](#) bit being set to 0, the instruction is UNDEFINED at EL0.
- In the Non-secure state, [HCR_EL2.TDZ](#) controls whether the instruction executes at EL0 or EL1, or traps to EL2.

When UNDEFINED, the instruction always takes the EL1 UNDEFINED exception.

When the instruction is executed, it can generate memory faults or watchpoints which are prioritized in the same way as other memory related faults or watchpoints. If a synchronous data abort fault or a watchpoint is generated, the CM bit in the syndrome field is not set.

If the memory region being zeroed is any type of Device memory, these instructions give an alignment fault which is prioritized in the same way as other alignment faults that are determined by the memory type.

This instruction applies to Normal memory regardless of cacheability attributes.

The instruction behaves as a set of Stores to each byte within the block being accessed, and so it:

- Will cause a Permission Fault if the translation system does not permit writes to the locations.
- Requires the same considerations for ordering and the management of coherency as any other store instructions.

Configurations

There are no configuration notes.

Attributes

DC ZVA is a 64-bit system operation.

The DC ZVA input value bit assignments are:

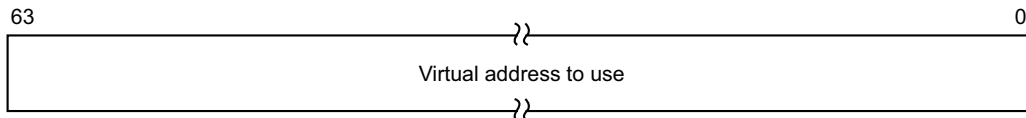

Bits [63:0]

Virtual address to use. There is no alignment restriction on the address within the block of N bytes that is used.

Performing the DC ZVA operation:

To perform the DC ZVA operation:

DC ZVA, <Xt>

The operation is encoded as follows:

op0	op1	CRn	CRm	op2
01	011	0111	0100	001

C4.4.9 IC IALLU, Instruction Cache Invalidate All to PoU

The IC IALLU characteristics are:

Purpose

Invalidate all instruction caches to Point of Unification.

This register is part of the Cache maintenance operations functional group.

Usage constraints

This operation can be performed at the exception levels shown below:

EL0	EL1 (NS)	EL1 (S)	EL2	EL3 (SCR.NS=1)	EL3 (SCR.NS=0)
-	WO	WO	WO	WO	WO

Configurations

IC IALLU performs the same function as AArch32 operation [ICIALLU](#).

Attributes

IC IALLU is a 64-bit system operation.

The IC IALLU operation ignores the value in the register specified by the instruction used to perform this operation. Software does not have to write a value to the register before issuing this instruction.

Performing the IC IALLU operation:

To perform the IC IALLU operation:

IC IALLU

The operation is encoded as follows:

op0	op1	CRn	CRm	op2
01	000	0111	0101	000

C4.4.10 IC IALLUIS, Instruction Cache Invalidate All to PoU, Inner Shareable

The IC IALLUIS characteristics are:

Purpose

Invalidate all instruction caches in Inner Shareable domain to Point of Unification.
This register is part of the Cache maintenance operations functional group.

Usage constraints

This operation can be performed at the exception levels shown below:

ELO	EL1 (NS)	EL1 (S)	EL2	EL3 (SCR.NS=1)	EL3 (SCR.NS=0)
-	WO	WO	WO	WO	WO

Configurations

IC IALLUIS performs the same function as AArch32 operation [ICIALLUIS](#).

Attributes

IC IALLUIS is a 64-bit system operation.

The IC IALLUIS operation ignores the value in the register specified by the instruction used to perform this operation. Software does not have to write a value to the register before issuing this instruction.

Performing the IC IALLUIS operation:

To perform the IC IALLUIS operation:

IC IALLUIS

The operation is encoded as follows:

op0	op1	CRn	CRm	op2
01	000	0111	0001	000

C4.4.11 IC IVAU, Instruction Cache line Invalidate by VA to PoU

The IC IVAU characteristics are:

Purpose

Invalidate instruction cache by address to Point of Unification.

This register is part of the Cache maintenance operations functional group.

Usage constraints

This operation can be performed at the exception levels shown below:

EL0	EL1 (NS)	EL1 (S)	EL2	EL3 (SCR.NS=1)	EL3 (SCR.NS=0)
Config-WO	WO	WO	WO	WO	WO

EL0 access is enabled when `SCTLR_EL1.UCI` is set to 1. When it is set to 0, this operation is UNDEFINED at EL0.

If EL0 access is enabled, this operation is available at EL0 when the VA has read access permission, otherwise it causes a Permission Fault.

Configurations

IC IVAU performs the same function as AArch32 operation `ICIMVAU`.

Attributes

IC IVAU is a 64-bit system operation.

The IC IVAU input value bit assignments are:

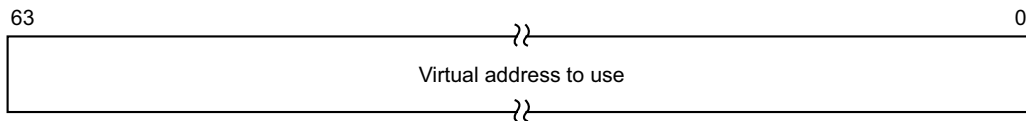

Bits [63:0]

Virtual address to use.

Performing the IC IVAU operation:

To perform the IC IVAU operation:

IC IVAU, <Xt>

The operation is encoded as follows:

op0	op1	CRn	CRm	op2
01	011	0111	0101	001

C4.5 A64 system instructions for address translation

The following sections describe the address translation instructions in A64.

- [AT S12E0R, Address Translate Stages 1 and 2 EL0 Read](#) on page C4-323
- [AT S12E0W, Address Translate Stages 1 and 2 EL0 Write](#) on page C4-324
- [AT S12E1R, Address Translate Stages 1 and 2 EL1 Read](#) on page C4-325
- [AT S12E1W, Address Translate Stages 1 and 2 EL1 Write](#) on page C4-326
- [AT S1E0R, Address Translate Stage 1 EL0 Read](#) on page C4-327
- [AT S1E0W, Address Translate Stage 1 EL0 Write](#) on page C4-328
- [AT S1E1R, Address Translate Stage 1 EL1 Read](#) on page C4-329
- [AT S1E1W, Address Translate Stage 1 EL1 Write](#) on page C4-330
- [AT S1E2R, Address Translate Stage 1 EL2 Read](#) on page C4-331
- [AT S1E2W, Address Translate Stage 1 EL2 Write](#) on page C4-332
- [AT S1E3R, Address Translate Stage 1 EL3 Read](#) on page C4-333
- [AT S1E3W, Address Translate Stage 1 EL3 Write](#) on page C4-334

C4.5.1 AT S12E0R, Address Translate Stages 1 and 2 EL0 Read

The AT S12E0R characteristics are:

Purpose

Performs stage 1 and 2 address translations as defined for EL0, with permissions as if reading from the given virtual address.

This register is part of the Address translation operations functional group.

Usage constraints

This operation can be performed at the exception levels shown below:

EL0	EL1 (NS)	EL1 (S)	EL2	EL3 (SCR.NS=1)	EL3 (SCR.NS=0)
-	-	-	WO	WO	WO

If EL2 does not exist, or stage 2 translation is disabled, this operation executes as [AT S1E0R](#).

Configurations

There are no configuration notes.

Attributes

AT S12E0R is a 64-bit system operation.

The AT S12E0R input value bit assignments are:

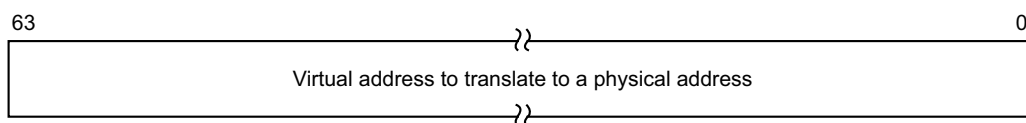

Bits [63:0]

Virtual address to translate to a physical address. The resulting physical address can be read from the [PAR_EL1](#).

If the address translation instructions are targeting a translation regime that is using AArch32, and so has a VA of only 32 bits, then VA[63:32] is RES0.

Performing the AT S12E0R operation:

To perform the AT S12E0R operation:

AT S12E0R, <Xt>

The operation is encoded as follows:

op0	op1	CRn	CRm	op2
01	100	0111	1000	110

C4.5.2 AT S12E0W, Address Translate Stages 1 and 2 EL0 Write

The AT S12E0W characteristics are:

Purpose

Performs stage 1 and 2 address translations as defined for EL0, with permissions as if writing to the given virtual address.

This register is part of the Address translation operations functional group.

Usage constraints

This operation can be performed at the exception levels shown below:

EL0	EL1 (NS)	EL1 (S)	EL2	EL3 (SCR.NS=1)	EL3 (SCR.NS=0)
-	-	-	WO	WO	WO

If EL2 does not exist, or stage 2 translation is disabled, this operation executes as [AT S1E0W](#).

Configurations

There are no configuration notes.

Attributes

AT S12E0W is a 64-bit system operation.

The AT S12E0W input value bit assignments are:

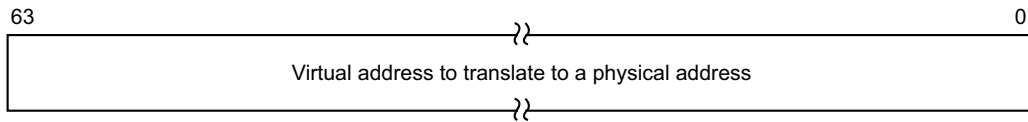

Bits [63:0]

Virtual address to translate to a physical address. The resulting physical address can be read from the [PAR_EL1](#).

If the address translation instructions are targeting a translation regime that is using AArch32, and so has a VA of only 32 bits, then VA[63:32] is RES0.

Performing the AT S12E0W operation:

To perform the AT S12E0W operation:

AT S12E0W, <Xt>

The operation is encoded as follows:

op0	op1	CRn	CRm	op2
01	100	0111	1000	111

C4.5.3 AT S12E1R, Address Translate Stages 1 and 2 EL1 Read

The AT S12E1R characteristics are:

Purpose

Performs stage 1 and 2 address translations as defined for EL1, with permissions as if reading from the given virtual address.

This register is part of the Address translation operations functional group.

Usage constraints

This operation can be performed at the exception levels shown below:

EL0	EL1 (NS)	EL1 (S)	EL2	EL3 (SCR.NS=1)	EL3 (SCR.NS=0)
-	-	-	WO	WO	WO

If EL2 does not exist, or stage 2 translation is disabled, this operation executes as [AT S1E1R](#).

Configurations

There are no configuration notes.

Attributes

AT S12E1R is a 64-bit system operation.

The AT S12E1R input value bit assignments are:

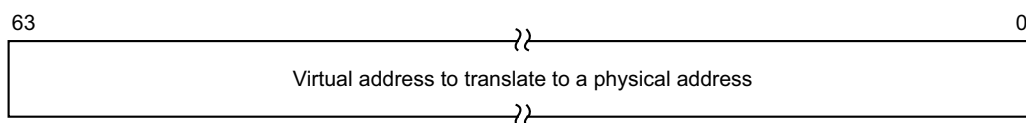

Bits [63:0]

Virtual address to translate to a physical address. The resulting physical address can be read from the [PAR_EL1](#).

If the address translation instructions are targeting a translation regime that is using AArch32, and so has a VA of only 32 bits, then VA[63:32] is RES0.

Performing the AT S12E1R operation:

To perform the AT S12E1R operation:

AT S12E1R, <Xt>

The operation is encoded as follows:

op0	op1	CRn	CRm	op2
01	100	0111	1000	100

C4.5.4 AT S12E1W, Address Translate Stages 1 and 2 EL1 Write

The AT S12E1W characteristics are:

Purpose

Performs stage 1 and 2 address translations as defined for EL1, with permissions as if writing to the given virtual address.

This register is part of the Address translation operations functional group.

Usage constraints

This operation can be performed at the exception levels shown below:

EL0	EL1 (NS)	EL1 (S)	EL2	EL3 (SCR.NS=1)	EL3 (SCR.NS=0)
-	-	-	WO	WO	WO

If EL2 does not exist, or stage 2 translation is disabled, this operation executes as [AT S1E1W](#).

Configurations

There are no configuration notes.

Attributes

AT S12E1W is a 64-bit system operation.

The AT S12E1W input value bit assignments are:

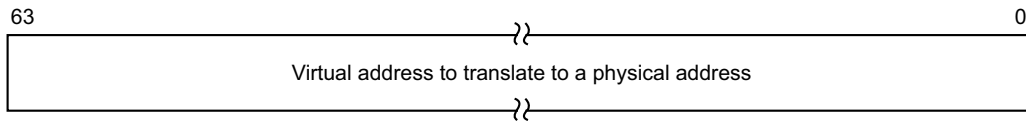

Bits [63:0]

Virtual address to translate to a physical address. The resulting physical address can be read from the [PAR_EL1](#).

If the address translation instructions are targeting a translation regime that is using AArch32, and so has a VA of only 32 bits, then VA[63:32] is RES0.

Performing the AT S12E1W operation:

To perform the AT S12E1W operation:

AT S12E1W, <Xt>

The operation is encoded as follows:

op0	op1	CRn	CRm	op2
01	100	0111	1000	101

C4.5.5 AT S1E0R, Address Translate Stage 1 EL0 Read

The AT S1E0R characteristics are:

Purpose

Performs stage 1 address translation as defined for EL0, with permissions as if reading from the given virtual address.

This register is part of the Address translation operations functional group.

Usage constraints

This operation can be performed at the exception levels shown below:

EL0	EL1 (NS)	EL1 (S)	EL2	EL3 (SCR.NS=1)	EL3 (SCR.NS=0)
-	WO	WO	WO	WO	WO

Configurations

There are no configuration notes.

Attributes

AT S1E0R is a 64-bit system operation.

The AT S1E0R input value bit assignments are:

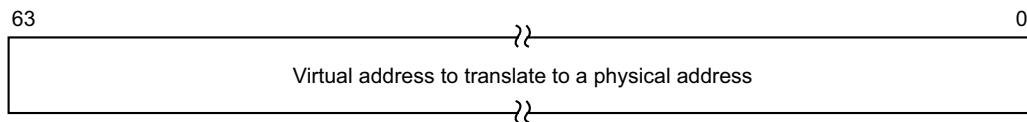

Bits [63:0]

Virtual address to translate to a physical address. The resulting physical address can be read from the [PAR_EL1](#).

If the address translation instructions are targeting a translation regime that is using AArch32, and so has a VA of only 32 bits, then VA[63:32] is RES0.

Performing the AT S1E0R operation:

To perform the AT S1E0R operation:

AT S1E0R, <Xt>

The operation is encoded as follows:

op0	op1	CRn	CRm	op2
01	000	0111	1000	010

C4.5.6 AT S1E0W, Address Translate Stage 1 EL0 Write

The AT S1E0W characteristics are:

Purpose

Performs stage 1 address translation as defined for EL0, with permissions as if writing to the given virtual address.

This register is part of the Address translation operations functional group.

Usage constraints

This operation can be performed at the exception levels shown below:

EL0	EL1 (NS)	EL1 (S)	EL2	EL3 (SCR.NS=1)	EL3 (SCR.NS=0)
-	WO	WO	WO	WO	WO

Configurations

There are no configuration notes.

Attributes

AT S1E0W is a 64-bit system operation.

The AT S1E0W input value bit assignments are:

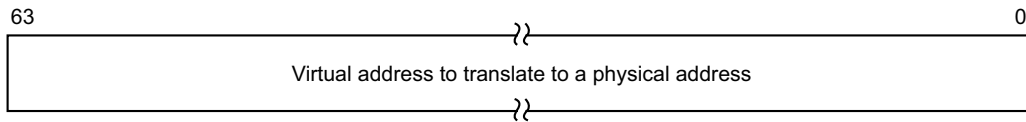

Bits [63:0]

Virtual address to translate to a physical address. The resulting physical address can be read from the [PAR_EL1](#).

If the address translation instructions are targeting a translation regime that is using AArch32, and so has a VA of only 32 bits, then VA[63:32] is RES0.

Performing the AT S1E0W operation:

To perform the AT S1E0W operation:

AT S1E0W, <Xt>

The operation is encoded as follows:

op0	op1	CRn	CRm	op2
01	000	0111	1000	011

C4.5.7 AT S1E1R, Address Translate Stage 1 EL1 Read

The AT S1E1R characteristics are:

Purpose

Performs stage 1 address translation as defined for EL1, with permissions as if reading from the given virtual address.

This register is part of the Address translation operations functional group.

Usage constraints

This operation can be performed at the exception levels shown below:

EL0	EL1 (NS)	EL1 (S)	EL2	EL3 (SCR.NS=1)	EL3 (SCR.NS=0)
-	WO	WO	WO	WO	WO

Configurations

There are no configuration notes.

Attributes

AT S1E1R is a 64-bit system operation.

The AT S1E1R input value bit assignments are:

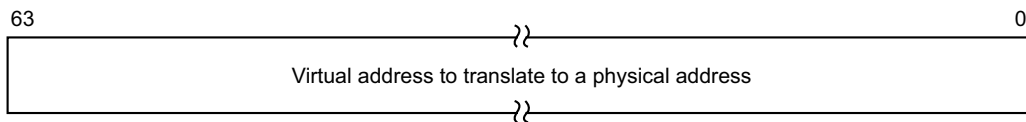

Bits [63:0]

Virtual address to translate to a physical address. The resulting physical address can be read from the [PAR_EL1](#).

If the address translation instructions are targeting a translation regime that is using AArch32, and so has a VA of only 32 bits, then VA[63:32] is RES0.

Performing the AT S1E1R operation:

To perform the AT S1E1R operation:

AT S1E1R, <Xt>

The operation is encoded as follows:

op0	op1	CRn	CRm	op2
01	000	0111	1000	000

C4.5.8 AT S1E1W, Address Translate Stage 1 EL1 Write

The AT S1E1W characteristics are:

Purpose

Performs stage 1 address translation as defined for EL1, with permissions as if writing to the given virtual address.

This register is part of the Address translation operations functional group.

Usage constraints

This operation can be performed at the exception levels shown below:

EL0	EL1 (NS)	EL1 (S)	EL2	EL3 (SCR.NS=1)	EL3 (SCR.NS=0)
-	WO	WO	WO	WO	WO

Configurations

There are no configuration notes.

Attributes

AT S1E1W is a 64-bit system operation.

The AT S1E1W input value bit assignments are:

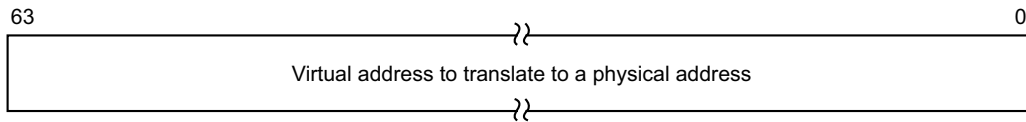

Bits [63:0]

Virtual address to translate to a physical address. The resulting physical address can be read from the [PAR_EL1](#).

If the address translation instructions are targeting a translation regime that is using AArch32, and so has a VA of only 32 bits, then VA[63:32] is RES0.

Performing the AT S1E1W operation:

To perform the AT S1E1W operation:

AT S1E1W, <Xt>

The operation is encoded as follows:

op0	op1	CRn	CRm	op2
01	000	0111	1000	001

C4.5.9 AT S1E2R, Address Translate Stage 1 EL2 Read

The AT S1E2R characteristics are:

Purpose

Performs stage 1 address translation as defined for EL2, with permissions as if reading from the given virtual address.

This register is part of the Address translation operations functional group.

Usage constraints

This operation can be performed at the exception levels shown below:

EL0	EL1 (NS)	EL1 (S)	EL2	EL3 (SCR.NS=1)	EL3 (SCR.NS=0)
-	-	-	WO	WO	-

Performing this operation from EL3 is UNDEFINED if EL2 does not exist.

Configurations

There are no configuration notes.

Attributes

AT S1E2R is a 64-bit system operation.

The AT S1E2R input value bit assignments are:

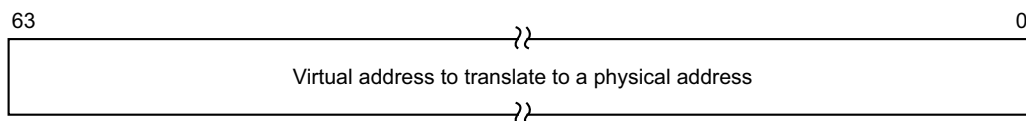

Bits [63:0]

Virtual address to translate to a physical address. The resulting physical address can be read from the [PAR_EL1](#).

If the address translation instructions are targeting a translation regime that is using AArch32, and so has a VA of only 32 bits, then VA[63:32] is RES0.

Performing the AT S1E2R operation:

To perform the AT S1E2R operation:

AT S1E2R, <Xt>

The operation is encoded as follows:

op0	op1	CRn	CRm	op2
01	100	0111	1000	000

C4.5.10 AT S1E2W, Address Translate Stage 1 EL2 Write

The AT S1E2W characteristics are:

Purpose

Performs stage 1 address translation as defined for EL2, with permissions as if writing to the given virtual address.

This register is part of the Address translation operations functional group.

Usage constraints

This operation can be performed at the exception levels shown below:

EL0	EL1 (NS)	EL1 (S)	EL2	EL3 (SCR.NS=1)	EL3 (SCR.NS=0)
-	-	-	WO	WO	-

Performing this operation from EL3 is UNDEFINED if EL2 does not exist.

Configurations

There are no configuration notes.

Attributes

AT S1E2W is a 64-bit system operation.

The AT S1E2W input value bit assignments are:

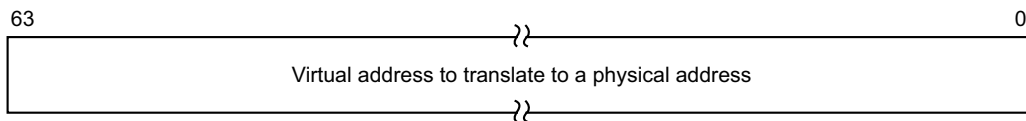

Bits [63:0]

Virtual address to translate to a physical address. The resulting physical address can be read from the [PAR_EL1](#).

If the address translation instructions are targeting a translation regime that is using AArch32, and so has a VA of only 32 bits, then VA[63:32] is RES0.

Performing the AT S1E2W operation:

To perform the AT S1E2W operation:

AT S1E2W, <Xt>

The operation is encoded as follows:

op0	op1	CRn	CRm	op2
01	100	0111	1000	001

C4.5.11 AT S1E3R, Address Translate Stage 1 EL3 Read

The AT S1E3R characteristics are:

Purpose

Performs stage 1 address translation as defined for EL3, with permissions as if reading from the given virtual address.

This register is part of the Address translation operations functional group.

Usage constraints

This operation can be performed at the exception levels shown below:

EL0	EL1 (NS)	EL1 (S)	EL2	EL3 (SCR.NS=1)	EL3 (SCR.NS=0)
-	-	-	-	WO	WO

Configurations

There are no configuration notes.

Attributes

AT S1E3R is a 64-bit system operation.

The AT S1E3R input value bit assignments are:

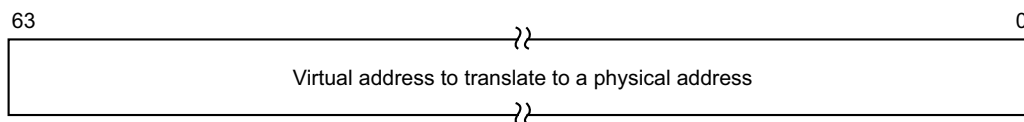

Bits [63:0]

Virtual address to translate to a physical address. The resulting physical address can be read from the [PAR_EL1](#).

If the address translation instructions are targeting a translation regime that is using AArch32, and so has a VA of only 32 bits, then VA[63:32] is RES0.

Performing the AT S1E3R operation:

To perform the AT S1E3R operation:

AT S1E3R, <Xt>

The operation is encoded as follows:

op0	op1	CRn	CRm	op2
01	110	0111	1000	000

C4.5.12 AT S1E3W, Address Translate Stage 1 EL3 Write

The AT S1E3W characteristics are:

Purpose

Performs stage 1 address translation as defined for EL3, with permissions as if writing to the given virtual address.

This register is part of the Address translation operations functional group.

Usage constraints

This operation can be performed at the exception levels shown below:

EL0	EL1 (NS)	EL1 (S)	EL2	EL3 (SCR.NS=1)	EL3 (SCR.NS=0)
-	-	-	-	WO	WO

Configurations

There are no configuration notes.

Attributes

AT S1E3W is a 64-bit system operation.

The AT S1E3W input value bit assignments are:

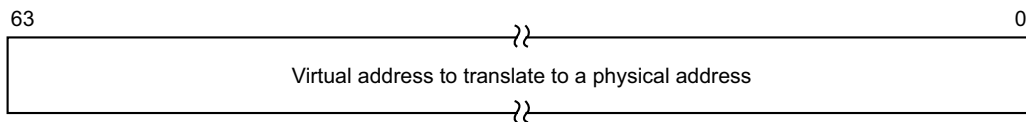

Bits [63:0]

Virtual address to translate to a physical address. The resulting physical address can be read from the [PAR_EL1](#).

If the address translation instructions are targeting a translation regime that is using AArch32, and so has a VA of only 32 bits, then VA[63:32] is RES0.

Performing the AT S1E3W operation:

To perform the AT S1E3W operation:

AT S1E3W, <Xt>

The operation is encoded as follows:

op0	op1	CRn	CRm	op2
01	110	0111	1000	001

C4.6 A64 system instructions for TLB maintenance

The following sections describe the TLB maintenance instructions in A64.

- *TLBI ALLE1, TLB Invalidate All entries, EL1* on page C4-336
- *TLBI ALLE1IS, TLB Invalidate All entries, EL1, Inner Shareable* on page C4-337
- *TLBI ALLE2, TLB Invalidate All entries, EL2* on page C4-338
- *TLBI ALLE2IS, TLB Invalidate All entries, EL2, Inner Shareable* on page C4-339
- *TLBI ALLE3, TLB Invalidate All entries, EL3* on page C4-340
- *TLBI ALLE3IS, TLB Invalidate All entries, EL3, Inner Shareable* on page C4-341
- *TLBI ASIDE1, TLB Invalidate by ASID, EL1* on page C4-342
- *TLBI ASIDE1IS, TLB Invalidate by ASID, EL1, Inner Shareable* on page C4-343
- *TLBI IPAS2E1, TLB Invalidate by Intermediate Physical Address, Stage 2, EL1* on page C4-344
- *TLBI IPAS2E1IS, TLB Invalidate by Intermediate Physical Address, Stage 2, EL1, Inner Shareable* on page C4-345
- *TLBI IPAS2LE1, TLB Invalidate by Intermediate Physical Address, Stage 2, Last level, EL1* on page C4-346
- *TLBI IPAS2LE1IS, TLB Invalidate by Intermediate Physical Address, Stage 2, Last level, EL1, Inner Shareable* on page C4-347
- *TLBI VAAE1, TLB Invalidate by VA, All ASID, EL1* on page C4-348
- *TLBI VAAE1IS, TLB Invalidate by VA, All ASID, EL1, Inner Shareable* on page C4-350
- *TLBI VAALE1, TLB Invalidate by VA, All ASID, Last level, EL1* on page C4-352
- *TLBI VAALE1IS, TLB Invalidate by VA, All ASID, EL1, Inner Shareable* on page C4-354
- *TLBI VAE1, TLB Invalidate by VA, EL1* on page C4-356
- *TLBI VAE1IS, TLB Invalidate by VA, EL1, Inner Shareable* on page C4-358
- *TLBI VAE2, TLB Invalidate by VA, EL2* on page C4-360
- *TLBI VAE2IS, TLB Invalidate by VA, EL2, Inner Shareable* on page C4-362
- *TLBI VAE3, TLB Invalidate by VA, EL3* on page C4-364
- *TLBI VAE3IS, TLB Invalidate by VA, EL3, Inner Shareable* on page C4-366
- *TLBI VALE1, TLB Invalidate by VA, Last level, EL1* on page C4-368
- *TLBI VALE1IS, TLB Invalidate by VA, Last level, EL1, Inner Shareable* on page C4-370
- *TLBI VALE2, TLB Invalidate by VA, Last level, EL2* on page C4-372
- *TLBI VALE2IS, TLB Invalidate by VA, Last level, EL2, Inner Shareable* on page C4-374
- *TLBI VALE3, TLB Invalidate by VA, Last level, EL3* on page C4-376
- *TLBI VALE3IS, TLB Invalidate by VA, Last level, EL3, Inner Shareable* on page C4-378
- *TLBI VMALLE1, TLB Invalidate by VMID, All entries at stage 1, EL1* on page C4-380
- *TLBI VMALLE1IS, TLB Invalidate by VMID, All entries at stage 1, EL1, Inner Shareable* on page C4-381
- *TLBI VMALLS12E1, TLB Invalidate by VMID, All entries at Stage 1 and 2, EL1* on page C4-382
- *TLBI VMALLS12E1IS, TLB Invalidate by VMID, All entries at Stage 1 and 2, EL1, Inner Shareable* on page C4-383

C4.6.1 TLBI ALLE1, TLB Invalidate All entries, EL1

The TLBI ALLE1 characteristics are:

Purpose

Invalidate all EL1&0 regime stage 1 and 2 TLB entries.

This register is part of the TLB maintenance operations functional group.

Usage constraints

This operation can be performed at the exception levels shown below:

EL0	EL1 (NS)	EL1 (S)	EL2	EL3 (SCR.NS=1)	EL3 (SCR.NS=0)
-	-	-	WO	WO	WO

If EL3 is implemented, the translations that are invalidated are those associated with either the Secure or Non-secure address space, depending on the value of [SCR_EL3.NS](#).

Configurations

There are no configuration notes.

Attributes

TLBI ALLE1 is a 64-bit system operation.

The TLBI ALLE1 operation ignores the value in the register specified by the instruction used to perform this operation. Software does not have to write a value to the register before issuing this instruction.

Performing the TLBI ALLE1 operation:

To perform the TLBI ALLE1 operation:

TLBI ALLE1

The operation is encoded as follows:

op0	op1	CRn	CRm	op2
01	100	1000	0111	100

C4.6.2 TLBI ALLE1IS, TLB Invalidate All entries, EL1, Inner Shareable

The TLBI ALLE1IS characteristics are:

Purpose

Invalidate all EL1&0 regime stage 1 and 2 TLB entries on all PEs in the same Inner Shareable domain.

This register is part of the TLB maintenance operations functional group.

Usage constraints

This operation can be performed at the exception levels shown below:

EL0	EL1 (NS)	EL1 (S)	EL2	EL3 (SCR.NS=1)	EL3 (SCR.NS=0)
-	-	-	WO	WO	WO

If EL3 is implemented, the translations that are invalidated are those associated with either the Secure or Non-secure address space, depending on the value of [SCR_EL3.NS](#).

Configurations

There are no configuration notes.

Attributes

TLBI ALLE1IS is a 64-bit system operation.

The TLBI ALLE1IS operation ignores the value in the register specified by the instruction used to perform this operation. Software does not have to write a value to the register before issuing this instruction.

Performing the TLBI ALLE1IS operation:

To perform the TLBI ALLE1IS operation:

TLBI ALLE1IS

The operation is encoded as follows:

op0	op1	CRn	CRm	op2
01	100	1000	0011	100

C4.6.3 TLBI ALLE2, TLB Invalidate All entries, EL2

The TLBI ALLE2 characteristics are:

Purpose

Invalidate all EL2 regime stage 1 TLB entries.

This register is part of the TLB maintenance operations functional group.

Usage constraints

This operation can be performed at the exception levels shown below:

EL0	EL1 (NS)	EL1 (S)	EL2	EL3 (SCR.NS=1)	EL3 (SCR.NS=0)
-	-	-	WO	WO	-

Performing this operation from EL3 is UNDEFINED if EL2 does not exist.

Configurations

There are no configuration notes.

Attributes

TLBI ALLE2 is a 64-bit system operation.

The TLBI ALLE2 operation ignores the value in the register specified by the instruction used to perform this operation. Software does not have to write a value to the register before issuing this instruction.

Performing the TLBI ALLE2 operation:

To perform the TLBI ALLE2 operation:

TLBI ALLE2

The operation is encoded as follows:

op0	op1	CRn	CRm	op2
01	100	1000	0111	000

C4.6.4 TLBI ALLE2IS, TLB Invalidate All entries, EL2, Inner Shareable

The TLBI ALLE2IS characteristics are:

Purpose

Invalidate all EL2 regime stage 1 TLB entries on all PEs in the same Inner Shareable domain.
This register is part of the TLB maintenance operations functional group.

Usage constraints

This operation can be performed at the exception levels shown below:

EL0	EL1 (NS)	EL1 (S)	EL2	EL3 (SCR.NS=1)	EL3 (SCR.NS=0)
-	-	-	WO	WO	-

Performing this operation from EL3 is UNDEFINED if EL2 does not exist.

Configurations

There are no configuration notes.

Attributes

TLBI ALLE2IS is a 64-bit system operation.

The TLBI ALLE2IS operation ignores the value in the register specified by the instruction used to perform this operation. Software does not have to write a value to the register before issuing this instruction.

Performing the TLBI ALLE2IS operation:

To perform the TLBI ALLE2IS operation:

TLBI ALLE2IS

The operation is encoded as follows:

op0	op1	CRn	CRm	op2
01	100	1000	0011	000

C4.6.5 TLBI ALLE3, TLB Invalidate All entries, EL3

The TLBI ALLE3 characteristics are:

Purpose

Invalidate all EL3 regime stage 1 TLB entries.

This register is part of the TLB maintenance operations functional group.

Usage constraints

This operation can be performed at the exception levels shown below:

EL0	EL1 (NS)	EL1 (S)	EL2	EL3 (SCR.NS=1)	EL3 (SCR.NS=0)
-	-	-	-	WO	WO

Configurations

There are no configuration notes.

Attributes

TLBI ALLE3 is a 64-bit system operation.

The TLBI ALLE3 operation ignores the value in the register specified by the instruction used to perform this operation. Software does not have to write a value to the register before issuing this instruction.

Performing the TLBI ALLE3 operation:

To perform the TLBI ALLE3 operation:

TLBI ALLE3

The operation is encoded as follows:

op0	op1	CRn	CRm	op2
01	110	1000	0111	000

C4.6.6 TLBI ALLE3IS, TLB Invalidate All entries, EL3, Inner Shareable

The TLBI ALLE3IS characteristics are:

Purpose

Invalidate all EL3 regime stage 1 TLB entries on all PEs in the same Inner Shareable domain.
This register is part of the TLB maintenance operations functional group.

Usage constraints

This operation can be performed at the exception levels shown below:

ELO	EL1 (NS)	EL1 (S)	EL2	EL3 (SCR.NS=1)	EL3 (SCR.NS=0)
-	-	-	-	WO	WO

Configurations

There are no configuration notes.

Attributes

TLBI ALLE3IS is a 64-bit system operation.

The TLBI ALLE3IS operation ignores the value in the register specified by the instruction used to perform this operation. Software does not have to write a value to the register before issuing this instruction.

Performing the TLBI ALLE3IS operation:

To perform the TLBI ALLE3IS operation:

TLBI ALLE3IS

The operation is encoded as follows:

op0	op1	CRn	CRm	op2
01	110	1000	0011	000

C4.6.7 TLBI ASIDE1, TLB Invalidate by ASID, EL1

The TLBI ASIDE1 characteristics are:

Purpose

Invalidate EL1&0 regime stage 1 TLB entries for the given ASID and the current VMID.
 This register is part of the TLB maintenance operations functional group.

Usage constraints

This operation can be performed at the exception levels shown below:

EL0	EL1 (NS)	EL1 (S)	EL2	EL3 (SCR.NS=1)	EL3 (SCR.NS=0)
-	WO	WO	WO	WO	WO

Configurations

There are no configuration notes.

Attributes

TLBI ASIDE1 is a 64-bit system operation.

The TLBI ASIDE1 input value bit assignments are:

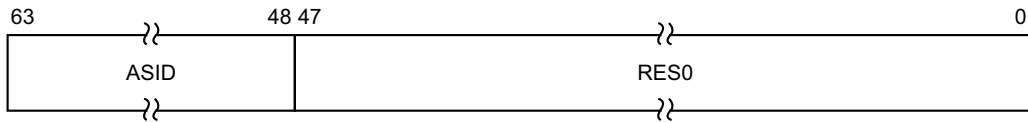

ASID, bits [63:48]

ASID value to match. Any appropriate TLB entries that match the ASID values will be affected by this operation.

If the implementation supports 16 bits of ASID, but only 8 bits are being used in the context being invalidated, the upper bits are considered RES0 and must be written to 0 by software performing the TLB maintenance.

Bits [47:0]

Reserved, RES0.

Performing the TLBI ASIDE1 operation:

To perform the TLBI ASIDE1 operation:

TLBI ASIDE1, <Xt>

The operation is encoded as follows:

op0	op1	CRn	CRm	op2
01	000	1000	0111	010

C4.6.8 TLBI ASIDE1IS, TLB Invalidate by ASID, EL1, Inner Shareable

The TLBI ASIDE1IS characteristics are:

Purpose

Invalidate EL1&0 regime stage 1 TLB entries for the given ASID and the current VMID on all PEs in the same Inner Shareable domain.

This register is part of the TLB maintenance operations functional group.

Usage constraints

This operation can be performed at the exception levels shown below:

EL0	EL1 (NS)	EL1 (S)	EL2	EL3 (SCR.NS=1)	EL3 (SCR.NS=0)
-	WO	WO	WO	WO	WO

Configurations

There are no configuration notes.

Attributes

TLBI ASIDE1IS is a 64-bit system operation.

The TLBI ASIDE1IS input value bit assignments are:

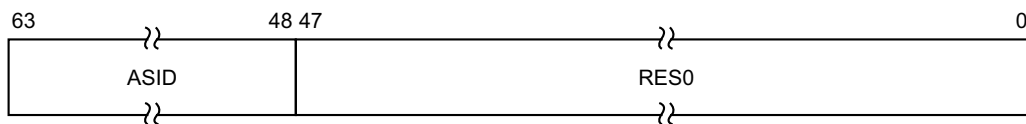

ASID, bits [63:48]

ASID value to match. Any appropriate TLB entries that match the ASID values will be affected by this operation.

If the implementation supports 16 bits of ASID, but only 8 bits are being used in the context being invalidated, the upper bits are considered RES0 and must be written to 0 by software performing the TLB maintenance.

Bits [47:0]

Reserved, RES0.

Performing the TLBI ASIDE1IS operation:

To perform the TLBI ASIDE1IS operation:

TLBI ASIDE1IS, <Xt>

The operation is encoded as follows:

op0	op1	CRn	CRm	op2
01	000	1000	0011	010

C4.6.9 TLBI IPAS2E1, TLB Invalidate by Intermediate Physical Address, Stage 2, EL1

The TLBI IPAS2E1 characteristics are:

Purpose

Invalidate EL1&0 regime stage 2 TLB entries for the given IPA and the current VMID.

This register is part of:

- the TLB maintenance operations functional group
- the Virtualization registers functional group.

Usage constraints

This operation can be performed at the exception levels shown below:

EL0	EL1 (NS)	EL1 (S)	EL2	EL3 (SCR.NS=1)	EL3 (SCR.NS=0)
-	-	-	WO	WO	WO

If SCR_EL3.NS==0, or EL2 is not implemented, this instruction is a NOP.

This instruction must apply to structures that contain only stage 2 translation information, but does not need to apply to structures that contain combined stage 1 and stage 2 translation information.

Configurations

There are no configuration notes.

Attributes

TLBI IPAS2E1 is a 64-bit system operation.

The TLBI IPAS2E1 input value bit assignments are:

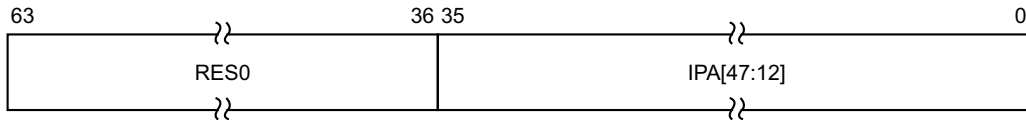

Bits [63:36]

Reserved, RES0.

IPA[47:12], bits [35:0]

Bits[47:12] of the intermediate physical address to match.

Performing the TLBI IPAS2E1 operation:

To perform the TLBI IPAS2E1 operation:

TLBI IPAS2E1, <Xt>

The operation is encoded as follows:

op0	op1	CRn	CRm	op2
01	100	1000	0100	001

C4.6.10 TLBI IPAS2E1IS, TLB Invalidate by Intermediate Physical Address, Stage 2, EL1, Inner Shareable

The TLBI IPAS2E1IS characteristics are:

Purpose

Invalidate EL1&0 regime stage 2 TLB entries for the given IPA and the current VMID on all PEs in the same Inner Shareable domain.

This register is part of:

- the TLB maintenance operations functional group
- the Virtualization registers functional group.

Usage constraints

This operation can be performed at the exception levels shown below:

EL0	EL1 (NS)	EL1 (S)	EL2	EL3 (SCR.NS=1)	EL3 (SCR.NS=0)
-	-	-	WO	WO	WO

If SCR_EL3.NS==0, or EL2 is not implemented, this instruction is a NOP.

This instruction must apply to structures that contain only stage 2 translation information, but does not need to apply to structures that contain combined stage 1 and stage 2 translation information.

Configurations

There are no configuration notes.

Attributes

TLBI IPAS2E1IS is a 64-bit system operation.

The TLBI IPAS2E1IS input value bit assignments are:

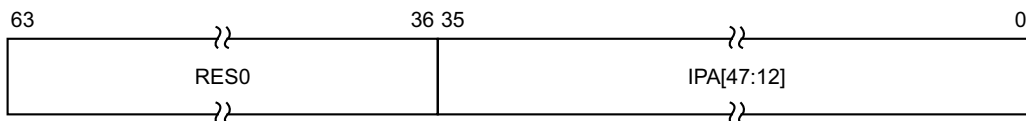

Bits [63:36]

Reserved, RES0.

IPA[47:12], bits [35:0]

Bits[47:12] of the intermediate physical address to match.

Performing the TLBI IPAS2E1IS operation:

To perform the TLBI IPAS2E1IS operation:

TLBI IPAS2E1IS, <Xt>

The operation is encoded as follows:

op0	op1	CRn	CRm	op2
01	100	1000	0000	001

C4.6.11 TLBI IPAS2LE1, TLB Invalidate by Intermediate Physical Address, Stage 2, Last level, EL1

The TLBI IPAS2LE1 characteristics are:

Purpose

Invalidate EL1&0 regime stage 2 TLB entries for the last level of translation, the given IPA, and the current VMID.

This register is part of:

- the TLB maintenance operations functional group
- the Virtualization registers functional group.

Usage constraints

This operation can be performed at the exception levels shown below:

EL0	EL1 (NS)	EL1 (S)	EL2	EL3 (SCR.NS=1)	EL3 (SCR.NS=0)
-	-	-	WO	WO	WO

If SCR_EL3.NS==0, or EL2 is not implemented, this instruction is a NOP.

This instruction must apply to structures that contain only stage 2 translation information, but does not need to apply to structures that contain combined stage 1 and stage 2 translation information.

Configurations

There are no configuration notes.

Attributes

TLBI IPAS2LE1 is a 64-bit system operation.

The TLBI IPAS2LE1 input value bit assignments are:

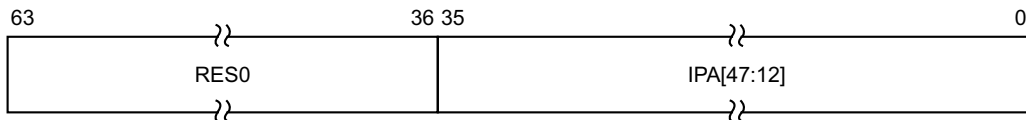

Bits [63:36]

Reserved, RES0.

IPA[47:12], bits [35:0]

Bits[47:12] of the intermediate physical address to match.

Performing the TLBI IPAS2LE1 operation:

To perform the TLBI IPAS2LE1 operation:

TLBI IPAS2LE1, <Xt>

The operation is encoded as follows:

op0	op1	CRn	CRm	op2
01	100	1000	0100	101

C4.6.12 TLBI IPAS2LE1IS, TLB Invalidate by Intermediate Physical Address, Stage 2, Last level, EL1, Inner Shareable

The TLBI IPAS2LE1IS characteristics are:

Purpose

Invalidate EL1&0 regime stage 2 TLB entries for the last level of translation, the given IPA, and the current VMID, on all PEs in the same Inner Shareable domain.

This register is part of:

- the TLB maintenance operations functional group
- the Virtualization registers functional group.

Usage constraints

This operation can be performed at the exception levels shown below:

EL0	EL1 (NS)	EL1 (S)	EL2	EL3 (SCR.NS=1)	EL3 (SCR.NS=0)
-	-	-	WO	WO	WO

If SCR_EL3.NS==0, or EL2 is not implemented, this instruction is a NOP.

This instruction must apply to structures that contain only stage 2 translation information, but does not need to apply to structures that contain combined stage 1 and stage 2 translation information.

Configurations

There are no configuration notes.

Attributes

TLBI IPAS2LE1IS is a 64-bit system operation.

The TLBI IPAS2LE1IS input value bit assignments are:

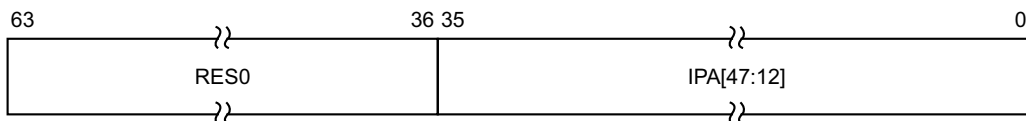

Bits [63:36]

Reserved, RES0.

IPA[47:12], bits [35:0]

Bits[47:12] of the intermediate physical address to match.

Performing the TLBI IPAS2LE1IS operation:

To perform the TLBI IPAS2LE1IS operation:

TLBI IPAS2LE1IS, <Xt>

The operation is encoded as follows:

op0	op1	CRn	CRm	op2
01	100	1000	0000	101

C4.6.13 TLBI VAAE1, TLB Invalidate by VA, All ASID, EL1

The TLBI VAAE1 characteristics are:

Purpose

Invalidate EL1&0 regime stage 1 TLB entries for the given VA and the current VMID.
 This register is part of the TLB maintenance operations functional group.

Usage constraints

This operation can be performed at the exception levels shown below:

EL0	EL1 (NS)	EL1 (S)	EL2	EL3 (SCR.NS=1)	EL3 (SCR.NS=0)
-	WO	WO	WO	WO	WO

If EL3 is implemented, the translations that are invalidated are those associated with either the Secure or Non-secure address space, depending on the value of [SCR_EL3.NS](#).

Configurations

There are no configuration notes.

Attributes

TLBI VAAE1 is a 64-bit system operation.

The TLBI VAAE1 input value bit assignments are:

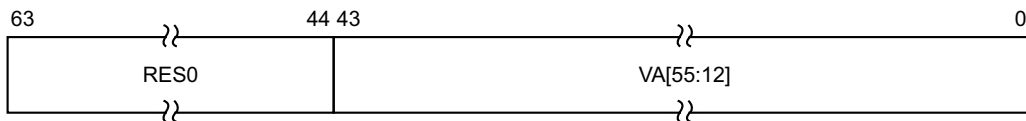

Bits [63:44]

Reserved, RES0.

VA[55:12], bits [43:0]

Bits[55:12] of the virtual address to match. Any appropriate TLB entries that match the VA will be affected by this operation, regardless of the ASID.

If the TLB maintenance instructions are targeting a translation regime that is using AArch32, and so has a VA of only 32 bits, then the software must treat bits[55:32] as RES0.

The treatment of the low-order bits of this field depends on the translation granule size, as follows:

- Where a 4KB translation granule is being used, all bits are valid and used for the invalidation.
- Where a 16KB translation granule is being used, bits [1:0] of this field are RES0 and ignored when the instruction is executed, because VA[13:12] have no effect on the operation of the instruction.
- Where a 64KB translation granule is being used, bits [3:0] of this field are RES0 and ignored when the instruction is executed, because VA[15:12] have no effect on the operation of the instruction.

Performing the TLBI VAAE1 operation:

To perform the TLBI VAAE1 operation:

TLBI VAAE1, <Xt>

The operation is encoded as follows:

op0	op1	CRn	CRm	op2
01	000	1000	0111	011

C4.6.14 TLBI VAAE1IS, TLB Invalidate by VA, All ASID, EL1, Inner Shareable

The TLBI VAAE1IS characteristics are:

Purpose

Invalidate EL1&0 regime stage 1 TLB entries for the given VA and the current VMID on all PEs in the same Inner Shareable domain.

This register is part of the TLB maintenance operations functional group.

Usage constraints

This operation can be performed at the exception levels shown below:

ELO	EL1 (NS)	EL1 (S)	EL2	EL3 (SCR.NS=1)	EL3 (SCR.NS=0)
-	WO	WO	WO	WO	WO

If EL3 is implemented, the translations that are invalidated are those associated with either the Secure or Non-secure address space, depending on the value of [SCR_EL3.NS](#).

Configurations

There are no configuration notes.

Attributes

TLBI VAAE1IS is a 64-bit system operation.

The TLBI VAAE1IS input value bit assignments are:

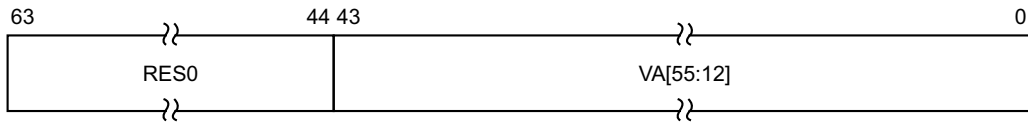

Bits [63:44]

Reserved, RES0.

VA[55:12], bits [43:0]

Bits[55:12] of the virtual address to match. Any appropriate TLB entries that match the VA will be affected by this operation, regardless of the ASID.

If the TLB maintenance instructions are targeting a translation regime that is using AArch32, and so has a VA of only 32 bits, then the software must treat bits[55:32] as RES0.

The treatment of the low-order bits of this field depends on the translation granule size, as follows:

- Where a 4KB translation granule is being used, all bits are valid and used for the invalidation.
- Where a 16KB translation granule is being used, bits [1:0] of this field are RES0 and ignored when the instruction is executed, because VA[13:12] have no effect on the operation of the instruction.
- Where a 64KB translation granule is being used, bits [3:0] of this field are RES0 and ignored when the instruction is executed, because VA[15:12] have no effect on the operation of the instruction.

Performing the TLBI VAAE1IS operation:

To perform the TLBI VAAE1IS operation:

TLBI VAAE1IS, <Xt>

The operation is encoded as follows:

op0	op1	CRn	CRm	op2
01	000	1000	0011	011

C4.6.15 TLBI VAALE1, TLB Invalidate by VA, All ASID, Last level, EL1

The TLBI VAALE1 characteristics are:

Purpose

Invalidate EL1&0 regime stage 1 TLB entries for the last level of translation table walk, the given VA, and the current VMID.

This register is part of the TLB maintenance operations functional group.

Usage constraints

This operation can be performed at the exception levels shown below:

EL0	EL1 (NS)	EL1 (S)	EL2	EL3 (SCR.NS=1)	EL3 (SCR.NS=0)
-	WO	WO	WO	WO	WO

If EL3 is implemented, the translations that are invalidated are those associated with either the Secure or Non-secure address space, depending on the value of [SCR_EL3.NS](#).

Configurations

There are no configuration notes.

Attributes

TLBI VAALE1 is a 64-bit system operation.

The TLBI VAALE1 input value bit assignments are:

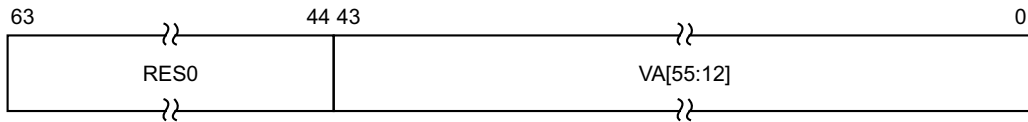

Bits [63:44]

Reserved, RES0.

VA[55:12], bits [43:0]

Bits[55:12] of the virtual address to match. Any appropriate TLB entries that match the VA will be affected by this operation, regardless of the ASID.

If the TLB maintenance instructions are targeting a translation regime that is using AArch32, and so has a VA of only 32 bits, then the software must treat bits[55:32] as RES0.

The treatment of the low-order bits of this field depends on the translation granule size, as follows:

- Where a 4KB translation granule is being used, all bits are valid and used for the invalidation.
- Where a 16KB translation granule is being used, bits [1:0] of this field are RES0 and ignored when the instruction is executed, because VA[13:12] have no effect on the operation of the instruction.
- Where a 64KB translation granule is being used, bits [3:0] of this field are RES0 and ignored when the instruction is executed, because VA[15:12] have no effect on the operation of the instruction.

Performing the TLBI VAALE1 operation:

To perform the TLBI VAALE1 operation:

TLBI VAALE1, <Xt>

The operation is encoded as follows:

op0	op1	CRn	CRm	op2
01	000	1000	0111	111

C4.6.16 TLBI VAALE1IS, TLB Invalidate by VA, All ASID, EL1, Inner Shareable

The TLBI VAALE1IS characteristics are:

Purpose

Invalidate EL1&0 regime stage 1 TLB entries for the last level of translation table walk, the given VA, and the current VMID, on all PEs in the same Inner Shareable domain.

This register is part of the TLB maintenance operations functional group.

Usage constraints

This operation can be performed at the exception levels shown below:

EL0	EL1 (NS)	EL1 (S)	EL2	EL3 (SCR.NS=1)	EL3 (SCR.NS=0)
-	WO	WO	WO	WO	WO

If EL3 is implemented, the translations that are invalidated are those associated with either the Secure or Non-secure address space, depending on the value of [SCR_EL3.NS](#).

Configurations

There are no configuration notes.

Attributes

TLBI VAALE1IS is a 64-bit system operation.

The TLBI VAALE1IS input value bit assignments are:

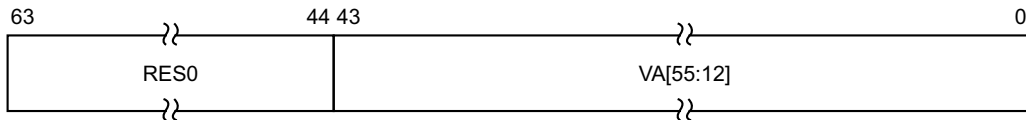

Bits [63:44]

Reserved, RES0.

VA[55:12], bits [43:0]

Bits[55:12] of the virtual address to match. Any appropriate TLB entries that match the VA will be affected by this operation, regardless of the ASID.

If the TLB maintenance instructions are targeting a translation regime that is using AArch32, and so has a VA of only 32 bits, then the software must treat bits[55:32] as RES0.

The treatment of the low-order bits of this field depends on the translation granule size, as follows:

- Where a 4KB translation granule is being used, all bits are valid and used for the invalidation.
- Where a 16KB translation granule is being used, bits [1:0] of this field are RES0 and ignored when the instruction is executed, because VA[13:12] have no effect on the operation of the instruction.
- Where a 64KB translation granule is being used, bits [3:0] of this field are RES0 and ignored when the instruction is executed, because VA[15:12] have no effect on the operation of the instruction.

Performing the TLBI VAALE1IS operation:

To perform the TLBI VAALE1IS operation:

TLBI VAALE1IS, <Xt>

The operation is encoded as follows:

op0	op1	CRn	CRm	op2
01	000	1000	0011	111

C4.6.17 TLBI VAE1, TLB Invalidate by VA, EL1

The TLBI VAE1 characteristics are:

Purpose

Invalidate EL1&0 regime stage 1 TLB entries for the given VA and ASID and the current VMID. This register is part of the TLB maintenance operations functional group.

Usage constraints

This operation can be performed at the exception levels shown below:

EL0	EL1 (NS)	EL1 (S)	EL2	EL3 (SCR.NS=1)	EL3 (SCR.NS=0)
-	WO	WO	WO	WO	WO

If EL3 is implemented, the translations that are invalidated are those associated with either the Secure or Non-secure address space, depending on the value of [SCR_EL3.NS](#).

Configurations

There are no configuration notes.

Attributes

TLBI VAE1 is a 64-bit system operation.

The TLBI VAE1 input value bit assignments are:

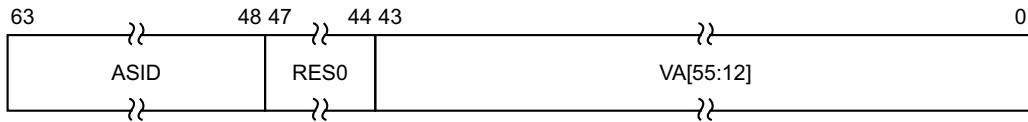

ASID, bits [63:48]

ASID value to match. Any TLB entries that match the ASID value and VA value will be affected by this operation.

Global TLB entries that match the VA value will be affected by this operation, regardless of the value of the ASID field.

If the implementation supports 16 bits of ASID, but only 8 bits are being used in the context being invalidated, the upper bits are considered RES0 and must be written to 0 by software performing the TLB maintenance.

Bits [47:44]

Reserved, RES0.

VA[55:12], bits [43:0]

Bits[55:12] of the virtual address to match. Any appropriate TLB entries that match the ASID value (if appropriate) and VA will be affected by this operation.

If the TLB maintenance instructions are targeting a translation regime that is using AArch32, and so has a VA of only 32 bits, then the software must treat bits[55:32] as RES0.

The treatment of the low-order bits of this field depends on the translation granule size, as follows:

- Where a 4KB translation granule is being used, all bits are valid and used for the invalidation.
- Where a 16KB translation granule is being used, bits [1:0] of this field are RES0 and ignored when the instruction is executed, because VA[13:12] have no effect on the operation of the instruction.

- Where a 64KB translation granule is being used, bits [3:0] of this field are RES0 and ignored when the instruction is executed, because VA[15:12] have no effect on the operation of the instruction.

Performing the TLBI VAE1 operation:

To perform the TLBI VAE1 operation:

TLBI VAE1, <Xt>

The operation is encoded as follows:

op0	op1	CRn	CRm	op2
01	000	1000	0111	001

C4.6.18 TLBI VAE1IS, TLB Invalidate by VA, EL1, Inner Shareable

The TLBI VAE1IS characteristics are:

Purpose

Invalidate EL1&0 regime stage 1 TLB entries for the given VA and ASID, and the current VMID, on all PEs in the same Inner Shareable domain.

This register is part of the TLB maintenance operations functional group.

Usage constraints

This operation can be performed at the exception levels shown below:

ELO	EL1 (NS)	EL1 (S)	EL2	EL3 (SCR.NS=1)	EL3 (SCR.NS=0)
-	WO	WO	WO	WO	WO

If EL3 is implemented, the translations that are invalidated are those associated with either the Secure or Non-secure address space, depending on the value of [SCR_EL3.NS](#).

Configurations

There are no configuration notes.

Attributes

TLBI VAE1IS is a 64-bit system operation.

The TLBI VAE1IS input value bit assignments are:

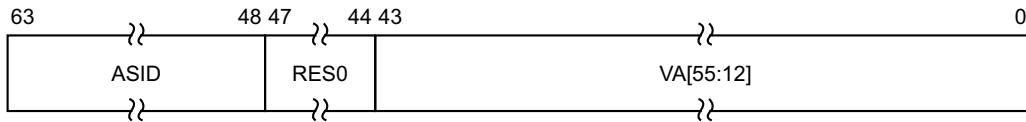

ASID, bits [63:48]

ASID value to match. Any TLB entries that match the ASID value and VA value will be affected by this operation.

Global TLB entries that match the VA value will be affected by this operation, regardless of the value of the ASID field.

If the implementation supports 16 bits of ASID, but only 8 bits are being used in the context being invalidated, the upper bits are considered RES0 and must be written to 0 by software performing the TLB maintenance.

Bits [47:44]

Reserved, RES0.

VA[55:12], bits [43:0]

Bits[55:12] of the virtual address to match. Any appropriate TLB entries that match the ASID value (if appropriate) and VA will be affected by this operation.

If the TLB maintenance instructions are targeting a translation regime that is using AArch32, and so has a VA of only 32 bits, then the software must treat bits[55:32] as RES0.

The treatment of the low-order bits of this field depends on the translation granule size, as follows:

- Where a 4KB translation granule is being used, all bits are valid and used for the invalidation.
- Where a 16KB translation granule is being used, bits [1:0] of this field are RES0 and ignored when the instruction is executed, because VA[13:12] have no effect on the operation of the instruction.

- Where a 64KB translation granule is being used, bits [3:0] of this field are RES0 and ignored when the instruction is executed, because VA[15:12] have no effect on the operation of the instruction.

Performing the TLBI VAE1IS operation:

To perform the TLBI VAE1IS operation:

TLBI VAE1IS, <Xt>

The operation is encoded as follows:

op0	op1	CRn	CRm	op2
01	000	1000	0011	001

C4.6.19 TLBI VAE2, TLB Invalidate by VA, EL2

The TLBI VAE2 characteristics are:

Purpose

Invalidate EL2 regime stage 1 TLB entries for the given VA.

This register is part of the TLB maintenance operations functional group.

Usage constraints

This operation can be performed at the exception levels shown below:

EL0	EL1 (NS)	EL1 (S)	EL2	EL3 (SCR.NS=1)	EL3 (SCR.NS=0)
-	-	-	WO	WO	-

Performing this operation from EL3 is UNDEFINED if EL2 does not exist.

Configurations

There are no configuration notes.

Attributes

TLBI VAE2 is a 64-bit system operation.

The TLBI VAE2 input value bit assignments are:

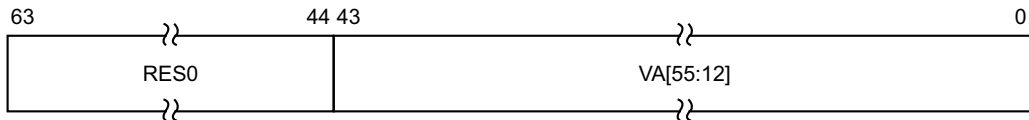

Bits [63:44]

Reserved, RES0.

VA[55:12], bits [43:0]

Bits[55:12] of the virtual address to match. Any appropriate TLB entries that match the ASID value (if appropriate) and VA will be affected by this operation.

If the TLB maintenance instructions are targeting a translation regime that is using AArch32, and so has a VA of only 32 bits, then the software must treat bits[55:32] as RES0.

The treatment of the low-order bits of this field depends on the translation granule size, as follows:

- Where a 4KB translation granule is being used, all bits are valid and used for the invalidation.
- Where a 16KB translation granule is being used, bits [1:0] of this field are RES0 and ignored when the instruction is executed, because VA[13:12] have no effect on the operation of the instruction.
- Where a 64KB translation granule is being used, bits [3:0] of this field are RES0 and ignored when the instruction is executed, because VA[15:12] have no effect on the operation of the instruction.

Performing the TLBI VAE2 operation:

To perform the TLBI VAE2 operation:

TLBI VAE2, <Xt>

The operation is encoded as follows:

op0	op1	CRn	CRm	op2
01	100	1000	0111	001

C4.6.20 TLBI VAE2IS, TLB Invalidate by VA, EL2, Inner Shareable

The TLBI VAE2IS characteristics are:

Purpose

Invalidate EL2 regime stage 1 TLB entries for the given VA on all PEs in the same Inner Shareable domain.

This register is part of the TLB maintenance operations functional group.

Usage constraints

This operation can be performed at the exception levels shown below:

ELO	EL1 (NS)	EL1 (S)	EL2	EL3 (SCR.NS=1)	EL3 (SCR.NS=0)
-	-	-	WO	WO	-

Performing this operation from EL3 is UNDEFINED if EL2 does not exist.

Configurations

There are no configuration notes.

Attributes

TLBI VAE2IS is a 64-bit system operation.

The TLBI VAE2IS input value bit assignments are:

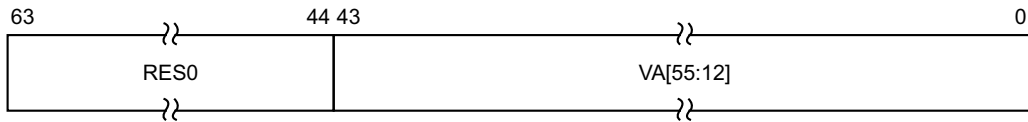

Bits [63:44]

Reserved, RES0.

VA[55:12], bits [43:0]

Bits[55:12] of the virtual address to match. Any appropriate TLB entries that match the ASID value (if appropriate) and VA will be affected by this operation.

If the TLB maintenance instructions are targeting a translation regime that is using AArch32, and so has a VA of only 32 bits, then the software must treat bits[55:32] as RES0.

The treatment of the low-order bits of this field depends on the translation granule size, as follows:

- Where a 4KB translation granule is being used, all bits are valid and used for the invalidation.
- Where a 16KB translation granule is being used, bits [1:0] of this field are RES0 and ignored when the instruction is executed, because VA[13:12] have no effect on the operation of the instruction.
- Where a 64KB translation granule is being used, bits [3:0] of this field are RES0 and ignored when the instruction is executed, because VA[15:12] have no effect on the operation of the instruction.

Performing the TLBI VAE2IS operation:

To perform the TLBI VAE2IS operation:

TLBI VAE2IS, <Xt>

The operation is encoded as follows:

op0	op1	CRn	CRm	op2
01	100	1000	0011	001

C4.6.21 TLBI VAE3, TLB Invalidate by VA, EL3

The TLBI VAE3 characteristics are:

Purpose

Invalidate EL3 regime stage 1 TLB entries for the given VA.

This register is part of the TLB maintenance operations functional group.

Usage constraints

This operation can be performed at the exception levels shown below:

EL0	EL1 (NS)	EL1 (S)	EL2	EL3 (SCR.NS=1)	EL3 (SCR.NS=0)
-	-	-	-	WO	WO

Configurations

There are no configuration notes.

Attributes

TLBI VAE3 is a 64-bit system operation.

The TLBI VAE3 input value bit assignments are:

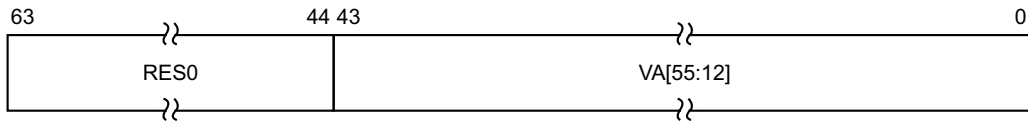

Bits [63:44]

Reserved, RES0.

VA[55:12], bits [43:0]

Bits[55:12] of the virtual address to match. Any appropriate TLB entries that match the ASID value (if appropriate) and VA will be affected by this operation.

If the TLB maintenance instructions are targeting a translation regime that is using AArch32, and so has a VA of only 32 bits, then the software must treat bits[55:32] as RES0.

The treatment of the low-order bits of this field depends on the translation granule size, as follows:

- Where a 4KB translation granule is being used, all bits are valid and used for the invalidation.
- Where a 16KB translation granule is being used, bits [1:0] of this field are RES0 and ignored when the instruction is executed, because VA[13:12] have no effect on the operation of the instruction.
- Where a 64KB translation granule is being used, bits [3:0] of this field are RES0 and ignored when the instruction is executed, because VA[15:12] have no effect on the operation of the instruction.

Performing the TLBI VAE3 operation:

To perform the TLBI VAE3 operation:

TLBI VAE3, <Xt>

The operation is encoded as follows:

op0	op1	CRn	CRm	op2
01	110	1000	0111	001

C4.6.22 TLBI VAE3IS, TLB Invalidate by VA, EL3, Inner Shareable

The TLBI VAE3IS characteristics are:

Purpose

Invalidate EL3 regime stage 1 TLB entries for the given VA on all PEs in the same Inner Shareable domain.

This register is part of the TLB maintenance operations functional group.

Usage constraints

This operation can be performed at the exception levels shown below:

EL0	EL1 (NS)	EL1 (S)	EL2	EL3 (SCR.NS=1)	EL3 (SCR.NS=0)
-	-	-	-	WO	WO

Configurations

There are no configuration notes.

Attributes

TLBI VAE3IS is a 64-bit system operation.

The TLBI VAE3IS input value bit assignments are:

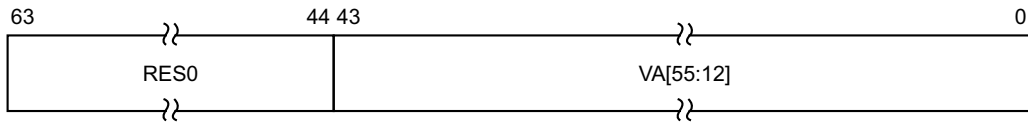

Bits [63:44]

Reserved, RES0.

VA[55:12], bits [43:0]

Bits[55:12] of the virtual address to match. Any appropriate TLB entries that match the ASID value (if appropriate) and VA will be affected by this operation.

If the TLB maintenance instructions are targeting a translation regime that is using AArch32, and so has a VA of only 32 bits, then the software must treat bits[55:32] as RES0.

The treatment of the low-order bits of this field depends on the translation granule size, as follows:

- Where a 4KB translation granule is being used, all bits are valid and used for the invalidation.
- Where a 16KB translation granule is being used, bits [1:0] of this field are RES0 and ignored when the instruction is executed, because VA[13:12] have no effect on the operation of the instruction.
- Where a 64KB translation granule is being used, bits [3:0] of this field are RES0 and ignored when the instruction is executed, because VA[15:12] have no effect on the operation of the instruction.

Performing the TLBI VAE3IS operation:

To perform the TLBI VAE3IS operation:

TLBI VAE3IS, <Xt>

The operation is encoded as follows:

op0	op1	CRn	CRm	op2
01	110	1000	0011	001

C4.6.23 TLBI VALE1, TLB Invalidate by VA, Last level, EL1

The TLBI VALE1 characteristics are:

Purpose

Invalidate EL1&0 regime stage 1 TLB entries for the last level of translation table walk, the given VA and ASID, and the current VMID.

This register is part of the TLB maintenance operations functional group.

Usage constraints

This operation can be performed at the exception levels shown below:

ELO	EL1 (NS)	EL1 (S)	EL2	EL3 (SCR.NS=1)	EL3 (SCR.NS=0)
-	WO	WO	WO	WO	WO

If EL3 is implemented, the translations that are invalidated are those associated with either the Secure or Non-secure address space, depending on the value of [SCR_EL3.NS](#).

Configurations

There are no configuration notes.

Attributes

TLBI VALE1 is a 64-bit system operation.

The TLBI VALE1 input value bit assignments are:

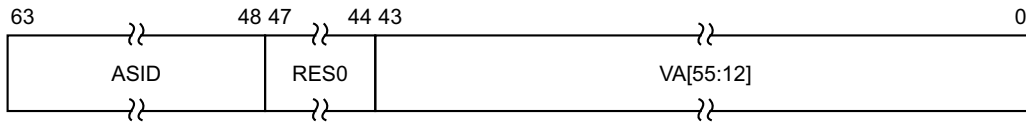

ASID, bits [63:48]

ASID value to match. Any TLB entries that match the ASID value and VA value will be affected by this operation.

Global TLB entries that match the VA value will be affected by this operation, regardless of the value of the ASID field.

If the implementation supports 16 bits of ASID, but only 8 bits are being used in the context being invalidated, the upper bits are considered RES0 and must be written to 0 by software performing the TLB maintenance.

Bits [47:44]

Reserved, RES0.

VA[55:12], bits [43:0]

Bits[55:12] of the virtual address to match. Any appropriate TLB entries that match the ASID value (if appropriate) and VA will be affected by this operation.

If the TLB maintenance instructions are targeting a translation regime that is using AArch32, and so has a VA of only 32 bits, then the software must treat bits[55:32] as RES0.

The treatment of the low-order bits of this field depends on the translation granule size, as follows:

- Where a 4KB translation granule is being used, all bits are valid and used for the invalidation.
- Where a 16KB translation granule is being used, bits [1:0] of this field are RES0 and ignored when the instruction is executed, because VA[13:12] have no effect on the operation of the instruction.

- Where a 64KB translation granule is being used, bits [3:0] of this field are RES0 and ignored when the instruction is executed, because VA[15:12] have no effect on the operation of the instruction.

Performing the TLBI VALE1 operation:

To perform the TLBI VALE1 operation:

TLBI VALE1, <Xt>

The operation is encoded as follows:

op0	op1	CRn	CRm	op2
01	000	1000	0111	101

C4.6.24 TLBI VALE1IS, TLB Invalidate by VA, Last level, EL1, Inner Shareable

The TLBI VALE1IS characteristics are:

Purpose

Invalidate EL1&0 regime stage 1 TLB entries for the last level of translation table walk, the given VA and ASID, and the current VMID, on all PEs in the same Inner Shareable domain.

This register is part of the TLB maintenance operations functional group.

Usage constraints

This operation can be performed at the exception levels shown below:

EL0	EL1 (NS)	EL1 (S)	EL2	EL3 (SCR.NS=1)	EL3 (SCR.NS=0)
-	WO	WO	WO	WO	WO

If EL3 is implemented, the translations that are invalidated are those associated with either the Secure or Non-secure address space, depending on the value of [SCR_EL3.NS](#).

Configurations

There are no configuration notes.

Attributes

TLBI VALE1IS is a 64-bit system operation.

The TLBI VALE1IS input value bit assignments are:

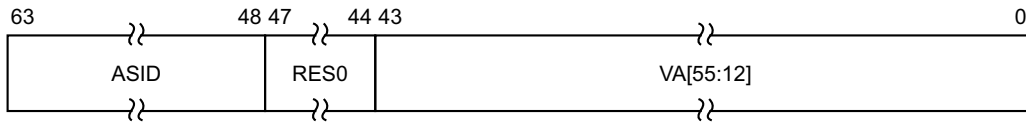

ASID, bits [63:48]

ASID value to match. Any TLB entries that match the ASID value and VA value will be affected by this operation.

Global TLB entries that match the VA value will be affected by this operation, regardless of the value of the ASID field.

If the implementation supports 16 bits of ASID, but only 8 bits are being used in the context being invalidated, the upper bits are considered RES0 and must be written to 0 by software performing the TLB maintenance.

Bits [47:44]

Reserved, RES0.

VA[55:12], bits [43:0]

Bits[55:12] of the virtual address to match. Any appropriate TLB entries that match the ASID value (if appropriate) and VA will be affected by this operation.

If the TLB maintenance instructions are targeting a translation regime that is using AArch32, and so has a VA of only 32 bits, then the software must treat bits[55:32] as RES0.

The treatment of the low-order bits of this field depends on the translation granule size, as follows:

- Where a 4KB translation granule is being used, all bits are valid and used for the invalidation.
- Where a 16KB translation granule is being used, bits [1:0] of this field are RES0 and ignored when the instruction is executed, because VA[13:12] have no effect on the operation of the instruction.

- Where a 64KB translation granule is being used, bits [3:0] of this field are RES0 and ignored when the instruction is executed, because VA[15:12] have no effect on the operation of the instruction.

Performing the TLBI VALE1IS operation:

To perform the TLBI VALE1IS operation:

TLBI VALE1IS, <Xt>

The operation is encoded as follows:

op0	op1	CRn	CRm	op2
01	000	1000	0011	101

C4.6.25 TLBI VALE2, TLB Invalidate by VA, Last level, EL2

The TLBI VALE2 characteristics are:

Purpose

Invalidate EL2 regime stage 1 TLB entries for the last level of translation table walk and the given VA.

This register is part of the TLB maintenance operations functional group.

Usage constraints

This operation can be performed at the exception levels shown below:

EL0	EL1 (NS)	EL1 (S)	EL2	EL3 (SCR.NS=1)	EL3 (SCR.NS=0)
-	-	-	WO	WO	-

Performing this operation from EL3 is UNDEFINED if EL2 does not exist.

Configurations

There are no configuration notes.

Attributes

TLBI VALE2 is a 64-bit system operation.

The TLBI VALE2 input value bit assignments are:

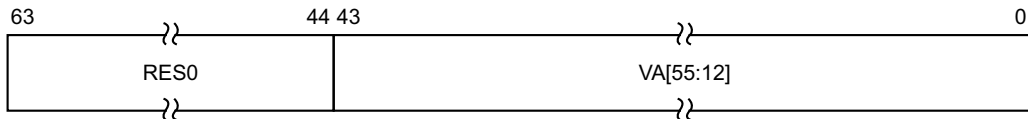

Bits [63:44]

Reserved, RES0.

VA[55:12], bits [43:0]

Bits[55:12] of the virtual address to match. Any appropriate TLB entries that match the ASID value (if appropriate) and VA will be affected by this operation.

If the TLB maintenance instructions are targeting a translation regime that is using AArch32, and so has a VA of only 32 bits, then the software must treat bits[55:32] as RES0.

The treatment of the low-order bits of this field depends on the translation granule size, as follows:

- Where a 4KB translation granule is being used, all bits are valid and used for the invalidation.
- Where a 16KB translation granule is being used, bits [1:0] of this field are RES0 and ignored when the instruction is executed, because VA[13:12] have no effect on the operation of the instruction.
- Where a 64KB translation granule is being used, bits [3:0] of this field are RES0 and ignored when the instruction is executed, because VA[15:12] have no effect on the operation of the instruction.

Performing the TLBI VALE2 operation:

To perform the TLBI VALE2 operation:

TLBI VALE2, <xt>

The operation is encoded as follows:

op0	op1	CRn	CRm	op2
01	100	1000	0111	101

C4.6.26 TLBI VALE2IS, TLB Invalidate by VA, Last level, EL2, Inner Shareable

The TLBI VALE2IS characteristics are:

Purpose

Invalidate EL2 regime stage 1 TLB entries for the last level of translation table walk and the given VA on all PEs in the same Inner Shareable domain.

This register is part of the TLB maintenance operations functional group.

Usage constraints

This operation can be performed at the exception levels shown below:

ELO	EL1 (NS)	EL1 (S)	EL2	EL3 (SCR.NS=1)	EL3 (SCR.NS=0)
-	-	-	WO	WO	-

Performing this operation from EL3 is UNDEFINED if EL2 does not exist.

Configurations

There are no configuration notes.

Attributes

TLBI VALE2IS is a 64-bit system operation.

The TLBI VALE2IS input value bit assignments are:

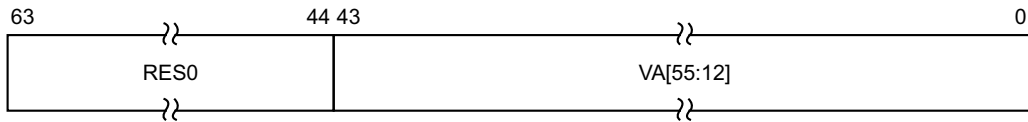

Bits [63:44]

Reserved, RES0.

VA[55:12], bits [43:0]

Bits[55:12] of the virtual address to match. Any appropriate TLB entries that match the ASID value (if appropriate) and VA will be affected by this operation.

If the TLB maintenance instructions are targeting a translation regime that is using AArch32, and so has a VA of only 32 bits, then the software must treat bits[55:32] as RES0.

The treatment of the low-order bits of this field depends on the translation granule size, as follows:

- Where a 4KB translation granule is being used, all bits are valid and used for the invalidation.
- Where a 16KB translation granule is being used, bits [1:0] of this field are RES0 and ignored when the instruction is executed, because VA[13:12] have no effect on the operation of the instruction.
- Where a 64KB translation granule is being used, bits [3:0] of this field are RES0 and ignored when the instruction is executed, because VA[15:12] have no effect on the operation of the instruction.

Performing the TLBI VALE2IS operation:

To perform the TLBI VALE2IS operation:

TLBI VALE2IS, <Xt>

The operation is encoded as follows:

op0	op1	CRn	CRm	op2
01	100	1000	0011	101

C4.6.27 TLBI VALE3, TLB Invalidate by VA, Last level, EL3

The TLBI VALE3 characteristics are:

Purpose

Invalidate EL3 regime stage 1 TLB entries for the last level of translation table walk and the given VA.

This register is part of the TLB maintenance operations functional group.

Usage constraints

This operation can be performed at the exception levels shown below:

EL0	EL1 (NS)	EL1 (S)	EL2	EL3 (SCR.NS=1)	EL3 (SCR.NS=0)
-	-	-	-	WO	WO

Configurations

There are no configuration notes.

Attributes

TLBI VALE3 is a 64-bit system operation.

The TLBI VALE3 input value bit assignments are:

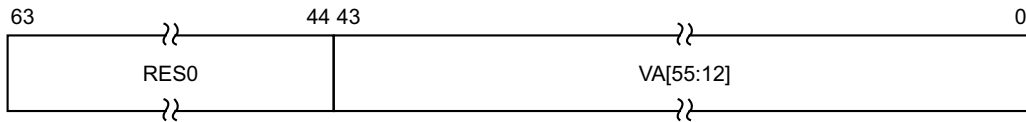

Bits [63:44]

Reserved, RES0.

VA[55:12], bits [43:0]

Bits[55:12] of the virtual address to match. Any appropriate TLB entries that match the ASID value (if appropriate) and VA will be affected by this operation.

If the TLB maintenance instructions are targeting a translation regime that is using AArch32, and so has a VA of only 32 bits, then the software must treat bits[55:32] as RES0.

The treatment of the low-order bits of this field depends on the translation granule size, as follows:

- Where a 4KB translation granule is being used, all bits are valid and used for the invalidation.
- Where a 16KB translation granule is being used, bits [1:0] of this field are RES0 and ignored when the instruction is executed, because VA[13:12] have no effect on the operation of the instruction.
- Where a 64KB translation granule is being used, bits [3:0] of this field are RES0 and ignored when the instruction is executed, because VA[15:12] have no effect on the operation of the instruction.

Performing the TLBI VALE3 operation:

To perform the TLBI VALE3 operation:

TLBI VALE3, <Xt>

The operation is encoded as follows:

op0	op1	CRn	CRm	op2
01	110	1000	0111	101

C4.6.28 TLBI VALE3IS, TLB Invalidate by VA, Last level, EL3, Inner Shareable

The TLBI VALE3IS characteristics are:

Purpose

Invalidate EL3 regime stage 1 TLB entries for the last level of translation table walk and the given VA on all PEs in the same Inner Shareable domain.

This register is part of the TLB maintenance operations functional group.

Usage constraints

This operation can be performed at the exception levels shown below:

EL0	EL1 (NS)	EL1 (S)	EL2	EL3 (SCR.NS=1)	EL3 (SCR.NS=0)
-	-	-	-	WO	WO

Configurations

There are no configuration notes.

Attributes

TLBI VALE3IS is a 64-bit system operation.

The TLBI VALE3IS input value bit assignments are:

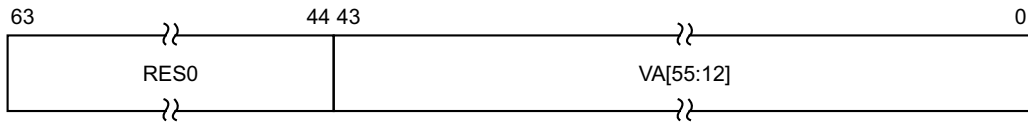

Bits [63:44]

Reserved, RES0.

VA[55:12], bits [43:0]

Bits[55:12] of the virtual address to match. Any appropriate TLB entries that match the ASID value (if appropriate) and VA will be affected by this operation.

If the TLB maintenance instructions are targeting a translation regime that is using AArch32, and so has a VA of only 32 bits, then the software must treat bits[55:32] as RES0.

The treatment of the low-order bits of this field depends on the translation granule size, as follows:

- Where a 4KB translation granule is being used, all bits are valid and used for the invalidation.
- Where a 16KB translation granule is being used, bits [1:0] of this field are RES0 and ignored when the instruction is executed, because VA[13:12] have no effect on the operation of the instruction.
- Where a 64KB translation granule is being used, bits [3:0] of this field are RES0 and ignored when the instruction is executed, because VA[15:12] have no effect on the operation of the instruction.

Performing the TLBI VALE3IS operation:

To perform the TLBI VALE3IS operation:

TLBI VALE3IS, <Xt>

The operation is encoded as follows:

op0	op1	CRn	CRm	op2
01	110	1000	0011	101

C4.6.29 TLBI VMALLE1, TLB Invalidate by VMID, All entries at stage 1, EL1

The TLBI VMALLE1 characteristics are:

Purpose

Invalidate all EL1&0 regime stage 1 TLB entries for the current VMID.
This register is part of the TLB maintenance operations functional group.

Usage constraints

This operation can be performed at the exception levels shown below:

EL0	EL1 (NS)	EL1 (S)	EL2	EL3 (SCR.NS=1)	EL3 (SCR.NS=0)
-	WO	WO	WO	WO	WO

If EL3 is implemented, the translations that are invalidated are those associated with either the Secure or Non-secure address space, depending on the value of [SCR_EL3.NS](#).

Configurations

There are no configuration notes.

Attributes

TLBI VMALLE1 is a 64-bit system operation.

The TLBI VMALLE1 operation ignores the value in the register specified by the instruction used to perform this operation. Software does not have to write a value to the register before issuing this instruction.

Performing the TLBI VMALLE1 operation:

To perform the TLBI VMALLE1 operation:

TLBI VMALLE1

The operation is encoded as follows:

op0	op1	CRn	CRm	op2
01	000	1000	0111	000

C4.6.30 TLBI VMALLE1IS, TLB Invalidate by VMID, All entries at stage 1, EL1, Inner Shareable

The TLBI VMALLE1IS characteristics are:

Purpose

Invalidate all EL1&0 regime stage 1 TLB entries for the current VMID on all PEs in the same Inner Shareable domain.

This register is part of the TLB maintenance operations functional group.

Usage constraints

This operation can be performed at the exception levels shown below:

EL0	EL1 (NS)	EL1 (S)	EL2	EL3 (SCR.NS=1)	EL3 (SCR.NS=0)
-	WO	WO	WO	WO	WO

If EL3 is implemented, the translations that are invalidated are those associated with either the Secure or Non-secure address space, depending on the value of [SCR_EL3.NS](#).

Configurations

There are no configuration notes.

Attributes

TLBI VMALLE1IS is a 64-bit system operation.

The TLBI VMALLE1IS operation ignores the value in the register specified by the instruction used to perform this operation. Software does not have to write a value to the register before issuing this instruction.

Performing the TLBI VMALLE1IS operation:

To perform the TLBI VMALLE1IS operation:

TLBI VMALLE1IS

The operation is encoded as follows:

op0	op1	CRn	CRm	op2
01	000	1000	0011	000

C4.6.31 TLBI VMALLS12E1, TLB Invalidate by VMID, All entries at Stage 1 and 2, EL1

The TLBI VMALLS12E1 characteristics are:

Purpose

Invalidate all EL1&0 regime stage 1 and 2 TLB entries for the current VMID.
This register is part of the TLB maintenance operations functional group.

Usage constraints

This operation can be performed at the exception levels shown below:

EL0	EL1 (NS)	EL1 (S)	EL2	EL3 (SCR.NS=1)	EL3 (SCR.NS=0)
-	-	-	WO	WO	WO

If EL3 is implemented, the translations that are invalidated are those associated with either the Secure or Non-secure address space, depending on the value of [SCR_EL3.NS](#).

Configurations

There are no configuration notes.

Attributes

TLBI VMALLS12E1 is a 64-bit system operation.

The TLBI VMALLS12E1 operation ignores the value in the register specified by the instruction used to perform this operation. Software does not have to write a value to the register before issuing this instruction.

Performing the TLBI VMALLS12E1 operation:

To perform the TLBI VMALLS12E1 operation:

TLBI VMALLS12E1

The operation is encoded as follows:

op0	op1	CRn	CRm	op2
01	100	1000	0111	110

C4.6.32 TLBI VMALLS12E1IS, TLB Invalidate by VMID, All entries at Stage 1 and 2, EL1, Inner Shareable

The TLBI VMALLS12E1IS characteristics are:

Purpose

Invalidate all EL1&0 regime stage 1 and 2 TLB entries for the current VMID on all PEs in the same Inner Shareable domain.

This register is part of the TLB maintenance operations functional group.

Usage constraints

This operation can be performed at the exception levels shown below:

EL0	EL1 (NS)	EL1 (S)	EL2	EL3 (SCR.NS=1)	EL3 (SCR.NS=0)
-	-	-	WO	WO	WO

If EL3 is implemented, the translations that are invalidated are those associated with either the Secure or Non-secure address space, depending on the value of [SCR_EL3.NS](#).

Configurations

There are no configuration notes.

Attributes

TLBI VMALLS12E1IS is a 64-bit system operation.

The TLBI VMALLS12E1IS operation ignores the value in the register specified by the instruction used to perform this operation. Software does not have to write a value to the register before issuing this instruction.

Performing the TLBI VMALLS12E1IS operation:

To perform the TLBI VMALLS12E1IS operation:

TLBI VMALLS12E1IS

The operation is encoded as follows:

op0	op1	CRn	CRm	op2
01	100	1000	0011	110

Chapter C5

A64 Base Instruction Descriptions

This chapter describes the A64 base instructions.

It contains the following sections:

- *Introduction on page C5-386.*
- *Register size on page C5-387.*
- *Use of the PC on page C5-388.*
- *Use of the stack pointer on page C5-389.*
- *Condition flags and related instructions on page C5-390.*
- *Alphabetical list of instructions on page C5-391.*

C5.1 Introduction

This chapter provides information on key aspects of the base instructions, and an alphabetic list of instructions from the following functional groups:

- Branch, Exception generation, and system instructions.
- Loads and stores associated with the general-purpose registers.
- Data processing (immediate).
- Data processing (register).

[A64 instruction index by encoding on page C3-172](#) provides an overview of the instruction encodings as well as of the instruction classes within their functional groups.

The base instruction descriptions include:

- [Register size on page C5-387](#).
- [Use of the PC on page C5-388](#).
- [Use of the stack pointer on page C5-389](#).
- [Condition flags and related instructions on page C5-390](#).

C5.2 Register size

Most data processing, comparison, and conversion instructions that use the general-purpose registers as the source or destination operand have two instruction variants that operate on either a 32-bit or a 64-bit value.

Where a 32-bit instruction form is selected, the following holds:

- The upper 32 bits of the source registers are ignored.
- The upper 32 bits of the destination register are set to zero.
- Right shifts and right rotates inject at bit[31], not at bit[63].
- The condition flags, where set by the instruction, are computed from the lower 32 bits.

This distinction applies even when the results of a 32-bit instruction form are indistinguishable from the lower 32 bits computed by the equivalent 64-bit instruction form. For example, a 32-bit bitwise ORR could be performed using a 64-bit ORR and simply ignoring the top 32 bits of the result. However, the A64 instruction set includes separate 32-bit and 64-bit forms of the ORR instruction.

As well as distinct sign-extend or zero-extend instructions, the A64 instruction set also provides the ability to extend and shift the final source register of an ADD, SUB, ADDS, or SUBS instruction and the index register of a Load/Store instruction. This enables array index calculations involving a 64-bit array pointer and a 32-bit array index to be implemented efficiently.

The assembly language notation enables the distinct identification of registers holding 32-bit values and registers holding 64-bit values. See [Register names](#) on page C1-114 and [Register indexed addressing](#) on page C1-118.

C5.3 Use of the PC

A64 instructions have limited access to the PC. The only instructions that can read the PC are those that generate a PC relative address:

- [ADR](#) and [ADRP](#).
- The Load register (literal) instruction class.
- Direct branches that use an immediate offset.
- The unconditional branch with link instructions, [BL](#) and [BLR](#), that use the PC to create the return link address.

Only explicit control flow instructions can modify the PC:

- Conditional and unconditional branch and return instructions.
- Exception generation and exception return instructions.

For more details on instructions that can modify the PC, see [Branches, Exception generating, and System instructions](#) on page C2-124.

C5.4 Use of the stack pointer

A64 instructions can use the stack pointer only in a limited number of cases:

- Load/Store instructions use the current stack pointer as the base address:
 - When stack alignment checking is enabled by system software and the base register is SP, the current stack pointer must be initially quadword aligned. That is, it must be aligned to 16 bytes. Misalignment generates a Stack Alignment fault. See [Stack pointer alignment checking on page D1-1424](#) for more information.
- Add and subtract data processing instructions in their immediate and extended register forms, use the current stack pointer as a source register or the destination register or both.
- Logical data processing instructions in their immediate form use the current stack pointer as the destination register.

C5.5 Condition flags and related instructions

The A64 base instructions that use the condition flags as an input are:

- Conditional branch. The conditional branch instruction is B.cond.
- Add or subtract with carry. These instruction types include instructions to perform multi-precision arithmetic and calculate checksums. The add or subtract with carry instructions are ADC, ADCS, SBC, and SBCS, or an architectural alias for these instructions.
- Conditional select with increment, negate, or invert. This instruction type conditionally selects between one source register and a second, incremented, negated, inverted, or unmodified source register. The conditional select with increment, negate, or invert instructions are CSINC, CSINV, and CSNEG.

These instructions also implement:

- Conditional select or move. The condition flags select one of two source registers as the destination register. Short conditional sequences can be replaced by unconditional instructions followed by a conditional select, CSEL.
- Conditional set. Conditionally selects between 0 and 1, or 0 and -1. This can be used to convert the condition flags to a Boolean value or mask in a general-purpose register, for example. These instructions include CSET and CSETM.
- Conditional compare. This instruction type sets the condition flags to the result of a comparison if the original condition is true, otherwise it sets the condition flags to an immediate value. It permits the flattening of nested conditional expressions without using conditional branches or performing Boolean arithmetic within the general-purpose registers. The conditional compare instructions are CCMP and CCMN.

The A64 base instructions that update the condition flags as an output are:

- Flag-setting data processing instructions, such as ADCS, ADDS, ANDS, BICS, SBCS, and SUBS, and the aliases CMN, CMP, and TST.
- Conditional compare instructions such as CCMN, CCMP.

The flags can be directly accessed for a read/write using the [NZCV, Condition Flags on page C4-267](#).

The A64 base instructions also include conditional branch instructions that do not use the condition flags as an input:

- Compare and branch if a register is zero or nonzero, CBZ and CBNZ.
- Test a single bit in a register and branch if the bit is zero or nonzero, TBZ and TBNZ.

C5.6 Alphabetical list of instructions

This section lists every instruction in the base category of the A64 instruction set. For details of the format used, see [Structure of the A64 assembler language on page C1-113](#).

C5.6.1 ADC

Add with carry: $Rd = Rn + Rm + C$

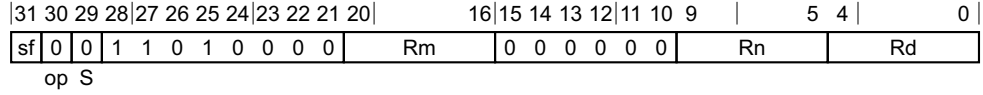

32-bit variant (sf = 0)

ADC <Wd>, <Wn>, <Wm>

64-bit variant (sf = 1)

ADC <Xd>, <Xn>, <Xm>

```
integer d = UInt(Rd);
integer n = UInt(Rn);
integer m = UInt(Rm);
integer datasize = if sf == '1' then 64 else 32;
boolean sub_op = (op == '1');
boolean setflags = (S == '1');
```

Assembler Symbols

- <Wd> Is the 32-bit name of the general-purpose destination register, encoded in the "Rd" field.
- <Wn> Is the 32-bit name of the first general-purpose source register, encoded in the "Rn" field.
- <Wm> Is the 32-bit name of the second general-purpose source register, encoded in the "Rm" field.
- <Xd> Is the 64-bit name of the general-purpose destination register, encoded in the "Rd" field.
- <Xn> Is the 64-bit name of the first general-purpose source register, encoded in the "Rn" field.
- <Xm> Is the 64-bit name of the second general-purpose source register, encoded in the "Rm" field.

Operation

```
bits(datasize) result;
bits(datasize) operand1 = X[n];
bits(datasize) operand2 = X[m];
bits(4) nzcvc;

if sub_op then
  operand2 = NOT(operand2);

(result, nzcvc) = AddWithCarry(operand1, operand2, PSTATE.C);

if setflags then
  PSTATE.<N,Z,C,V> = nzcvc;

X[d] = result;
```

C5.6.2 ADCS

Add with carry, setting the condition flags: $Rd = Rn + Rm + C$

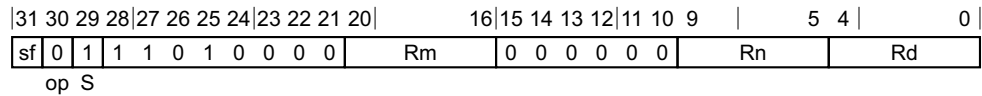

32-bit variant (sf = 0)

ADCS <Wd>, <Wn>, <Wm>

64-bit variant (sf = 1)

ADCS <Xd>, <Xn>, <Xm>

```
integer d = UInt(Rd);
integer n = UInt(Rn);
integer m = UInt(Rm);
integer datasize = if sf == '1' then 64 else 32;
boolean sub_op = (op == '1');
boolean setflags = (S == '1');
```

Assembler Symbols

<Wd>	Is the 32-bit name of the general-purpose destination register, encoded in the "Rd" field.
<Wn>	Is the 32-bit name of the first general-purpose source register, encoded in the "Rn" field.
<Wm>	Is the 32-bit name of the second general-purpose source register, encoded in the "Rm" field.
<Xd>	Is the 64-bit name of the general-purpose destination register, encoded in the "Rd" field.
<Xn>	Is the 64-bit name of the first general-purpose source register, encoded in the "Rn" field.
<Xm>	Is the 64-bit name of the second general-purpose source register, encoded in the "Rm" field.

Operation

```
bits(datasize) result;
bits(datasize) operand1 = X[n];
bits(datasize) operand2 = X[m];
bits(4) nzcvc;

if sub_op then
    operand2 = NOT(operand2);

(result, nzcvc) = AddWithCarry(operand1, operand2, PSTATE.C);

if setflags then
    PSTATE.<N,Z,C,V> = nzcvc;

X[d] = result;
```

C5.6.3 ADD (extended register)

Add (extended register): $Rd = Rn + LSL(\text{extend}(Rm), \text{amount})$

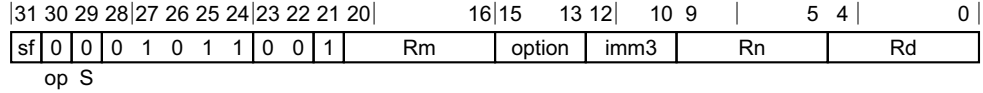

32-bit variant (sf = 0)

ADD <Wd|WSP>, <Wn|WSP>, <Wm>{, <extend> {#<amount>}}

64-bit variant (sf = 1)

ADD <Xd|SP>, <Xn|SP>, <R><m>{, <extend> {#<amount>}}

```
integer d = UInt(Rd);
integer n = UInt(Rn);
integer m = UInt(Rm);
integer datasize = if sf == '1' then 64 else 32;
boolean sub_op = (op == '1');
boolean setflags = (S == '1');
ExtendType extend_type = DecodeRegExtend(option);
integer shift = UInt(imm3);
if shift > 4 then ReservedValue();
```

Assembler Symbols

<Wd WSP>	Is the 32-bit name of the destination general-purpose register or stack pointer, encoded in the "Rd" field.
<Wn WSP>	Is the 32-bit name of the first source general-purpose register or stack pointer, encoded in the "Rn" field.
<Wm>	Is the 32-bit name of the second general-purpose source register, encoded in the "Rm" field.
<Xd SP>	Is the 64-bit name of the destination general-purpose register or stack pointer, encoded in the "Rd" field.
<Xn SP>	Is the 64-bit name of the first source general-purpose register or stack pointer, encoded in the "Rn" field.
<R>	Is a width specifier, W when option = 00x W when option = 010 X when option = x11 W when option = 10x W when option = 110
<m>	Is the number [0-30] of the second general-purpose source register or the name ZR (31), encoded in the "Rm" field.
<extend>	For the 32-bit variant: is the extension to be applied to the second source operand, UXTB when option = 000 UXTH when option = 001 LSL UXTW when option = 010 UXTX when option = 011

SXTB when option = 100

SXTH when option = 101

SXTW when option = 110

SXTX when option = 111

The LSL form can only be used when at least one of "Rd" or "Rn" is '11111' (i.e. WSP) and in that case is also the default. In all other cases <extend> must be present.

<extend> For the 64-bit variant: is the extension to be applied to the second source operand,

UXTB when option = 000

UXTH when option = 001

UXTW when option = 010

LSL|UXTX when option = 011

SXTB when option = 100

SXTH when option = 101

SXTW when option = 110

SXTX when option = 111

The LSL form can only be used when at least one of "Rd" or "Rn" is '11111' (i.e. SP) and in that case is also the default. In all other cases <extend> must be present.

<amount> Is the left shift amount in the range 0 to 4, which is optional with a default of 0 when <extend> is not LSL, encoded in the "imm3" field.

Operation

```

bits(datasize) result;
bits(datasize) operand1 = if n == 31 then SP[] else X[n];
bits(datasize) operand2 = ExtendReg(m, extend_type, shift);
bits(4) nzcvc;
bit carry_in;

if sub_op then
    operand2 = NOT(operand2);
    carry_in = '1';
else
    carry_in = '0';

(result, nzcvc) = AddWithCarry(operand1, operand2, carry_in);

if setflags then
    PSTATE.<N,Z,C,V> = nzcvc;

if d == 31 && !setflags then
    SP[] = result;
else
    X[d] = result;
  
```

C5.6.4 ADD (immediate)

Add (immediate): $Rd = Rn + \text{shift}(imm)$

This instruction is used by the alias [MOV \(to/from SP\)](#). See the *Alias conditions* table for details of when each alias is preferred.



32-bit variant (sf = 0)

ADD <Wd|WSP>, <Wn|WSP>, #<imm>{, <shift>}

64-bit variant (sf = 1)

ADD <Xd|SP>, <Xn|SP>, #<imm>{, <shift>}

```
integer d = UInt(Rd);
integer n = UInt(Rn);
integer datasize = if sf == '1' then 64 else 32;
boolean sub_op = (op == '1');
boolean setflags = (S == '1');
bits(datasize) imm;

case shift of
  when '00' imm = ZeroExtend(imm12, datasize);
  when '01' imm = ZeroExtend(imm12 : Zeros(12), datasize);
  when '1x' ReservedValue();
```

Alias conditions

Alias	is preferred when
MOV (to/from SP)	$(Rd == '11111' \ \ Rn == '11111')$ && IsZero (shift:imm12)

Assembler Symbols

- <Wd|WSP> Is the 32-bit name of the destination general-purpose register or stack pointer, encoded in the "Rd" field.
- <Wn|WSP> Is the 32-bit name of the source general-purpose register or stack pointer, encoded in the "Rn" field.
- <Xd|SP> Is the 64-bit name of the destination general-purpose register or stack pointer, encoded in the "Rd" field.
- <Xn|SP> Is the 64-bit name of the source general-purpose register or stack pointer, encoded in the "Rn" field.
- <imm> Is an unsigned immediate, in the range 0 to 4095, encoded in the "imm12" field.
- <shift> Is the optional left shift to apply to the immediate, defaulting to LSL #0 and
 - LSL #0** when shift = 00
 - LSL #12** when shift = 01
 - RESERVED** when shift = 1x

Operation

```
bits(datasize) result;
bits(datasize) operand1 = if n == 31 then SP[] else X[n];
bits(datasize) operand2 = imm;
bits(4) nzcvc;
bit carry_in;

if sub_op then
    operand2 = NOT(operand2);
    carry_in = '1';
else
    carry_in = '0';

(result, nzcvc) = AddWithCarry(operand1, operand2, carry_in);

if setflags then
    PSTATE.<N,Z,C,V> = nzcvc;

if d == 31 && !setflags then
    SP[] = result;
else
    X[d] = result;
```

C5.6.5 ADD (shifted register)

Add (shifted register): $Rd = Rn + \text{shift}(Rm, \text{amount})$

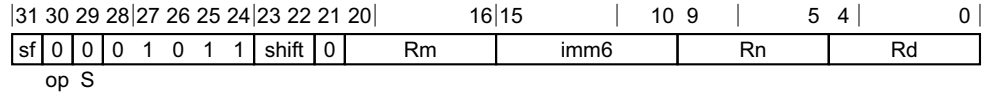

32-bit variant (sf = 0)

ADD <Wd>, <Wn>, <Wm>{, <shift> #<amount>}

64-bit variant (sf = 1)

ADD <Xd>, <Xn>, <Xm>{, <shift> #<amount>}

```
integer d = UInt(Rd);
integer n = UInt(Rn);
integer m = UInt(Rm);
integer datasize = if sf == '1' then 64 else 32;
boolean sub_op = (op == '1');
boolean setflags = (S == '1');

if shift == '11' then ReservedValue();
if sf == '0' && imm6<5> == '1' then ReservedValue();

ShiftType shift_type = DecodeShift(shift);
integer shift_amount = UInt(imm6);
```

Assembler Symbols

<Wd>	Is the 32-bit name of the general-purpose destination register, encoded in the "Rd" field.								
<Wn>	Is the 32-bit name of the first general-purpose source register, encoded in the "Rn" field.								
<Wm>	Is the 32-bit name of the second general-purpose source register, encoded in the "Rm" field.								
<Xd>	Is the 64-bit name of the general-purpose destination register, encoded in the "Rd" field.								
<Xn>	Is the 64-bit name of the first general-purpose source register, encoded in the "Rn" field.								
<Xm>	Is the 64-bit name of the second general-purpose source register, encoded in the "Rm" field.								
<shift>	Is the optional shift type to be applied to the second source operand, defaulting to LSL and <table style="margin-left: 20px; border-collapse: collapse;"> <tr><td>LSL</td><td>when shift = 00</td></tr> <tr><td>LSR</td><td>when shift = 01</td></tr> <tr><td>ASR</td><td>when shift = 10</td></tr> <tr><td>RESERVED</td><td>when shift = 11</td></tr> </table>	LSL	when shift = 00	LSR	when shift = 01	ASR	when shift = 10	RESERVED	when shift = 11
LSL	when shift = 00								
LSR	when shift = 01								
ASR	when shift = 10								
RESERVED	when shift = 11								
<amount>	For the 32-bit variant: is the shift amount, in the range 0 to 31, defaulting to 0 and encoded in the "imm6" field.								
<amount>	For the 64-bit variant: is the shift amount, in the range 0 to 63, defaulting to 0 and encoded in the "imm6" field.								

Operation

```
bits(datasize) result;  
bits(datasize) operand1 = X[n];  
bits(datasize) operand2 = ShiftReg(m, shift_type, shift_amount);  
bits(4) nzcvc;  
bit carry_in;  
  
if sub_op then  
    operand2 = NOT(operand2);  
    carry_in = '1';  
else  
    carry_in = '0';  
  
(result, nzcvc) = AddWithCarry(operand1, operand2, carry_in);  
  
if setflags then  
    PSTATE.<N,Z,C,V> = nzcvc;  
  
X[d] = result;
```

C5.6.6 ADDS (extended register)

Add (extended register), setting the condition flags: $Rd = Rn + LSL(\text{extend}(Rm), \text{amount})$

This instruction is used by the alias [CMN \(extended register\)](#). See the *Alias conditions* table for details of when each alias is preferred.

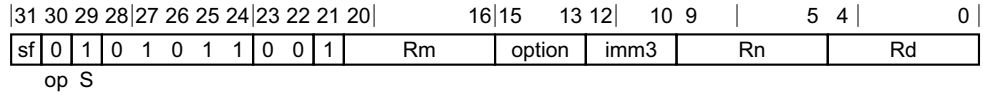

32-bit variant (sf = 0)

ADDS <Wd>, <Wn|WSP>, <Wm>{, <extend> {#<amount>}}

64-bit variant (sf = 1)

ADDS <Xd>, <Xn|SP>, <R><m>{, <extend> {#<amount>}}

```
integer d = UInt(Rd);
integer n = UInt(Rn);
integer m = UInt(Rm);
integer datasize = if sf == '1' then 64 else 32;
boolean sub_op = (op == '1');
boolean setflags = (S == '1');
ExtendType extend_type = DecodeRegExtend(option);
integer shift = UInt(imm3);
if shift > 4 then ReservedValue();
```

Alias conditions

Alias	is preferred when
CMN (extended register)	Rd == '11111'

Assembler Symbols

<Wd>	Is the 32-bit name of the general-purpose destination register, encoded in the "Rd" field.
<Wn WSP>	Is the 32-bit name of the first source general-purpose register or stack pointer, encoded in the "Rn" field.
<Wm>	Is the 32-bit name of the second general-purpose source register, encoded in the "Rm" field.
<Xd>	Is the 64-bit name of the general-purpose destination register, encoded in the "Rd" field.
<Xn SP>	Is the 64-bit name of the first source general-purpose register or stack pointer, encoded in the "Rn" field.
<R>	Is a width specifier, W when option = 00x W when option = 010 X when option = x11 W when option = 10x W when option = 110
<m>	Is the number [0-30] of the second general-purpose source register or the name ZR (31), encoded in the "Rm" field.

- <extend> For the 32-bit variant: is the extension to be applied to the second source operand,
- UXTB** when option = 000
 - UXTH** when option = 001
 - LSL|UXTW** when option = 010
 - UXTX** when option = 011
 - SXTB** when option = 100
 - SXTH** when option = 101
 - SXTW** when option = 110
 - SXTX** when option = 111
- The LSL form can only be used when "Rn" is '11111' (i.e. WSP) and in that case is also the default. In all other cases <extend> must be present.
- <extend> For the 64-bit variant: is the extension to be applied to the second source operand,
- UXTB** when option = 000
 - UXTH** when option = 001
 - UXTW** when option = 010
 - LSL|UXTX** when option = 011
 - SXTB** when option = 100
 - SXTH** when option = 101
 - SXTW** when option = 110
 - SXTX** when option = 111
- The LSL form can only be used when "Rn" is '11111' (i.e. SP) and in that case is also the default. In all other cases <extend> must be present.
- <amount> Is the left shift amount in the range 0 to 4, which is optional with a default of 0 when <extend> is not LSL, encoded in the "imm3" field.

Operation

```

bits(datasize) result;
bits(datasize) operand1 = if n == 31 then SP[] else X[n];
bits(datasize) operand2 = ExtendReg(m, extend_type, shift);
bits(4) nzcvc;
bit carry_in;

if sub_op then
    operand2 = NOT(operand2);
    carry_in = '1';
else
    carry_in = '0';

(result, nzcvc) = AddWithCarry(operand1, operand2, carry_in);

if setflags then
    PSTATE.<N,Z,C,V> = nzcvc;

if d == 31 && !setflags then
    SP[] = result;
else
    X[d] = result;
  
```

C5.6.7 ADDS (immediate)

Add (immediate), setting the condition flags: $Rd = Rn + \text{shift}(imm)$

This instruction is used by the alias [CMN \(immediate\)](#). See the [Alias conditions](#) table for details of when each alias is preferred.

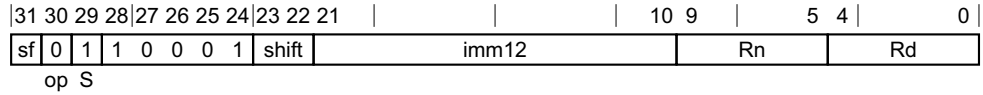

32-bit variant (sf = 0)

ADDS <Wd>, <Wn|WSP>, #<imm>{, <shift>}

64-bit variant (sf = 1)

ADDS <Xd>, <Xn|SP>, #<imm>{, <shift>}

```
integer d = UInt(Rd);
integer n = UInt(Rn);
integer datasize = if sf == '1' then 64 else 32;
boolean sub_op = (op == '1');
boolean setflags = (S == '1');
bits(datasize) imm;

case shift of
  when '00' imm = ZeroExtend(imm12, datasize);
  when '01' imm = ZeroExtend(imm12 : Zeros(12), datasize);
  when '1x' ReservedValue();
```

Alias conditions

Alias	is preferred when
CMN (immediate)	Rd == '11111'

Assembler Symbols

- <Wd> Is the 32-bit name of the general-purpose destination register, encoded in the "Rd" field.
- <Wn|WSP> Is the 32-bit name of the source general-purpose register or stack pointer, encoded in the "Rn" field.
- <Xd> Is the 64-bit name of the general-purpose destination register, encoded in the "Rd" field.
- <Xn|SP> Is the 64-bit name of the source general-purpose register or stack pointer, encoded in the "Rn" field.
- <imm> Is an unsigned immediate, in the range 0 to 4095, encoded in the "imm12" field.
- <shift> Is the optional left shift to apply to the immediate, defaulting to LSL #0 and
 - LSL #0** when shift = 00
 - LSL #12** when shift = 01
 - RESERVED** when shift = 1x

Operation

```
bits(datasize) result;  
bits(datasize) operand1 = if n == 31 then SP[] else X[n];  
bits(datasize) operand2 = imm;  
bits(4) nzcvc;  
bit carry_in;  
  
if sub_op then  
    operand2 = NOT(operand2);  
    carry_in = '1';  
else  
    carry_in = '0';  
  
(result, nzcvc) = AddWithCarry(operand1, operand2, carry_in);  
  
if setflags then  
    PSTATE.<N,Z,C,V> = nzcvc;  
  
if d == 31 && !setflags then  
    SP[] = result;  
else  
    X[d] = result;
```

C5.6.8 ADDS (shifted register)

Add (shifted register), setting the condition flags: $Rd = Rn + \text{shift}(Rm, \text{amount})$

This instruction is used by the alias [CMN \(shifted register\)](#). See the [Alias conditions](#) table for details of when each alias is preferred.

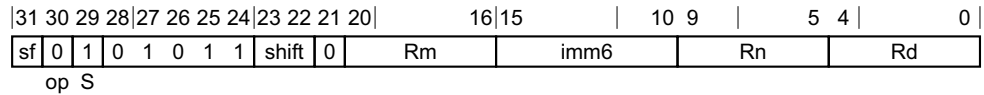

32-bit variant (sf = 0)

ADDS <Wd>, <Wn>, <Wm>{, <shift> #<amount>}

64-bit variant (sf = 1)

ADDS <Xd>, <Xn>, <Xm>{, <shift> #<amount>}

```

integer d = UInt(Rd);
integer n = UInt(Rn);
integer m = UInt(Rm);
integer datasize = if sf == '1' then 64 else 32;
boolean sub_op = (op == '1');
boolean setflags = (S == '1');

if shift == '11' then ReservedValue();
if sf == '0' && imm6<5> == '1' then ReservedValue();

ShiftType shift_type = DecodeShift(shift);
integer shift_amount = UInt(imm6);
  
```

Alias conditions

Alias	is preferred when
CMN (shifted register)	Rd == '11111'

Assembler Symbols

<Wd>	Is the 32-bit name of the general-purpose destination register, encoded in the "Rd" field.								
<Wn>	Is the 32-bit name of the first general-purpose source register, encoded in the "Rn" field.								
<Wm>	Is the 32-bit name of the second general-purpose source register, encoded in the "Rm" field.								
<Xd>	Is the 64-bit name of the general-purpose destination register, encoded in the "Rd" field.								
<Xn>	Is the 64-bit name of the first general-purpose source register, encoded in the "Rn" field.								
<Xm>	Is the 64-bit name of the second general-purpose source register, encoded in the "Rm" field.								
<shift>	Is the optional shift type to be applied to the second source operand, defaulting to LSL and <table style="margin-left: 20px;"> <tr> <td>LSL</td> <td>when shift = 00</td> </tr> <tr> <td>LSR</td> <td>when shift = 01</td> </tr> <tr> <td>ASR</td> <td>when shift = 10</td> </tr> <tr> <td>RESERVED</td> <td>when shift = 11</td> </tr> </table>	LSL	when shift = 00	LSR	when shift = 01	ASR	when shift = 10	RESERVED	when shift = 11
LSL	when shift = 00								
LSR	when shift = 01								
ASR	when shift = 10								
RESERVED	when shift = 11								
<amount>	For the 32-bit variant: is the shift amount, in the range 0 to 31, defaulting to 0 and encoded in the "imm6" field.								
<amount>	For the 64-bit variant: is the shift amount, in the range 0 to 63, defaulting to 0 and encoded in the "imm6" field.								

Operation

```

bits(datasize) result;
bits(datasize) operand1 = X[n];
bits(datasize) operand2 = ShiftReg(m, shift_type, shift_amount);
bits(4) nzcvc;
bit carry_in;

if sub_op then
    operand2 = NOT(operand2);
    carry_in = '1';
else
    carry_in = '0';

(result, nzcvc) = AddWithCarry(operand1, operand2, carry_in);

if setflags then
    PSTATE.<N,Z,C,V> = nzcvc;

X[d] = result;

```

C5.6.9 ADR

Address of label at a PC-relative offset



Literal variant

ADR <Xd>, <label>

```
integer d = UInt(Rd);
boolean page = (op == '1');
bits(64) imm;

if page then
    imm = SignExtend(immhi:immlo:Zeros(12), 64);
else
    imm = SignExtend(immhi:immlo, 64);
```

Assembler Symbols

- <Xd> Is the 64-bit name of the general-purpose destination register, encoded in the "Rd" field.
- <label> Is the program label whose address is to be calculated. Its offset from the address of this instruction, in the range +/-1MB, is encoded in "immhi:immlo".

Operation

```
bits(64) base = PC[];

if page then
    base<11:0> = Zeros(12);

X[d] = base + imm;
```

C5.6.10 ADRP

Address of 4KB page at a PC-relative offset



Literal variant

ADRP <Xd>, <label>

```
integer d = UInt(Rd);
boolean page = (op == '1');
bits(64) imm;

if page then
    imm = SignExtend(immhi:immlo:Zeros(12), 64);
else
    imm = SignExtend(immhi:immlo, 64);
```

Assembler Symbols

- <Xd> Is the 64-bit name of the general-purpose destination register, encoded in the "Rd" field.
- <label> Is the program label whose 4KB page address is to be calculated. Its offset from the page address of this instruction, in the range +/-4GB, is encoded as "immhi:immlo" times 4096.

Operation

```
bits(64) base = PC[];

if page then
    base<11:0> = Zeros(12);

X[d] = base + imm;
```

C5.6.11 AND (immediate)

Bitwise AND (immediate): Rd = Rn AND imm

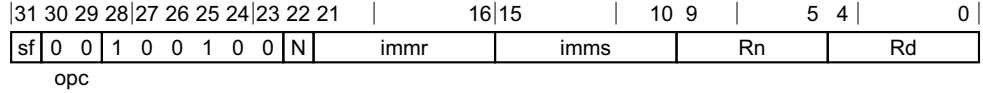

32-bit variant (sf = 0, N = 0)

AND <Wd|WSP>, <Wn>, #<imm>

64-bit variant (sf = 1)

AND <Xd|SP>, <Xn>, #<imm>

```

integer d = UInt(Rd);
integer n = UInt(Rn);
integer datasize = if sf == '1' then 64 else 32;
boolean setflags;
LogicalOp op;
case opc of
  when '00' op = LogicalOp_AND; setflags = FALSE;
  when '01' op = LogicalOp_ORR; setflags = FALSE;
  when '10' op = LogicalOp_EOR; setflags = FALSE;
  when '11' op = LogicalOp_AND; setflags = TRUE;

bits(datasize) imm;
if sf == '0' && N != '0' then ReservedValue();
(imm, -) = DecodeBitMasks(N, imms, immr, TRUE);

```

Assembler Symbols

- <Wd|WSP> Is the 32-bit name of the destination general-purpose register or stack pointer, encoded in the "Rd" field.
- <Wn> Is the 32-bit name of the general-purpose source register, encoded in the "Rn" field.
- <Xd|SP> Is the 64-bit name of the destination general-purpose register or stack pointer, encoded in the "Rd" field.
- <Xn> Is the 64-bit name of the general-purpose source register, encoded in the "Rn" field.
- <imm> Is the bitmask immediate, encoded in "N:imms:immr".

Operation

```
bits(datasize) result;
bits(datasize) operand1 = X[n];
bits(datasize) operand2 = imm;

case op of
  when LogicalOp_AND result = operand1 AND operand2;
  when LogicalOp_ORR result = operand1 OR operand2;
  when LogicalOp_EOR result = operand1 EOR operand2;

if setflags then
  PSTATE.<N,Z,C,V> = result<datasize-1>:IsZeroBit(result):'00';

if d == 31 && !setflags then
  SP[] = result;
else
  X[d] = result;
```

C5.6.12 AND (shifted register)

Bitwise AND (shifted register): $Rd = Rn \text{ AND } \text{shift}(Rm, \text{amount})$

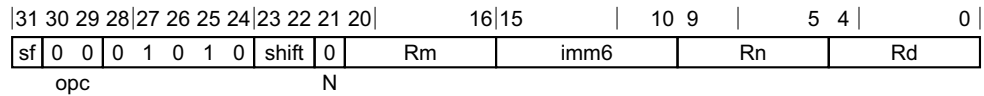

32-bit variant (sf = 0)

AND <Wd>, <Wn>, <Wm>{, <shift> #<amount>}

64-bit variant (sf = 1)

AND <Xd>, <Xn>, <Xm>{, <shift> #<amount>}

```
integer d = UInt(Rd);
integer n = UInt(Rn);
integer m = UInt(Rm);
integer datasize = if sf == '1' then 64 else 32;
boolean setflags;
LogicalOp op;
case opc of
  when '00' op = LogicalOp_AND; setflags = FALSE;
  when '01' op = LogicalOp_ORR; setflags = FALSE;
  when '10' op = LogicalOp_EOR; setflags = FALSE;
  when '11' op = LogicalOp_AND; setflags = TRUE;

if sf == '0' && imm6<5> == '1' then ReservedValue();

ShiftType shift_type = DecodeShift(shift);
integer shift_amount = UInt(imm6);
boolean invert = (N == '1');
```

Assembler Symbols

<Wd>	Is the 32-bit name of the general-purpose destination register, encoded in the "Rd" field.								
<Wn>	Is the 32-bit name of the first general-purpose source register, encoded in the "Rn" field.								
<Wm>	Is the 32-bit name of the second general-purpose source register, encoded in the "Rm" field.								
<Xd>	Is the 64-bit name of the general-purpose destination register, encoded in the "Rd" field.								
<Xn>	Is the 64-bit name of the first general-purpose source register, encoded in the "Rn" field.								
<Xm>	Is the 64-bit name of the second general-purpose source register, encoded in the "Rm" field.								
<shift>	Is the optional shift to be applied to the final source, defaulting to LSL and <table style="margin-left: 20px; border-collapse: collapse;"> <tr><td>LSL</td><td>when shift = 00</td></tr> <tr><td>LSR</td><td>when shift = 01</td></tr> <tr><td>ASR</td><td>when shift = 10</td></tr> <tr><td>ROR</td><td>when shift = 11</td></tr> </table>	LSL	when shift = 00	LSR	when shift = 01	ASR	when shift = 10	ROR	when shift = 11
LSL	when shift = 00								
LSR	when shift = 01								
ASR	when shift = 10								
ROR	when shift = 11								
<amount>	For the 32-bit variant: is the shift amount, in the range 0 to 31, defaulting to 0 and encoded in the "imm6" field.								
<amount>	For the 64-bit variant: is the shift amount, in the range 0 to 63, defaulting to 0 and encoded in the "imm6" field,.								

Operation

```
bits(datasize) operand1 = X[n];
bits(datasize) operand2 = ShiftReg(m, shift_type, shift_amount);

if invert then operand2 = NOT(operand2);

case op of
  when Logicalp_AND result = operand1 AND operand2;
  when Logicalp_ORR result = operand1 OR operand2;
  when Logicalp_EOR result = operand1 EOR operand2;

if setflags then
  PSTATE.<N,Z,C,V> = result<datasize-1>:IsZeroBit(result):'00';

X[d] = result;
```

C5.6.13 ANDS (immediate)

Bitwise AND (immediate), setting the condition flags: $Rd = Rn \text{ AND } imm$

This instruction is used by the alias [TST \(immediate\)](#). See the [Alias conditions](#) table for details of when each alias is preferred.

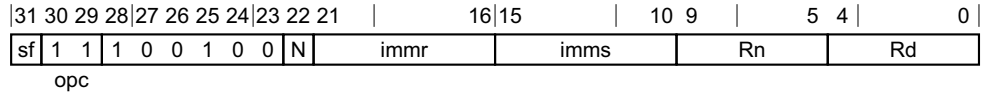

32-bit variant (sf = 0, N = 0)

ANDS <Wd>, <Wn>, #<imm>

64-bit variant (sf = 1)

ANDS <Xd>, <Xn>, #<imm>

```
integer d = UInt(Rd);
integer n = UInt(Rn);
integer datasize = if sf == '1' then 64 else 32;
boolean setflags;
LogicalOp op;
case opc of
  when '00' op = LogicalOp_AND; setflags = FALSE;
  when '01' op = LogicalOp_ORR; setflags = FALSE;
  when '10' op = LogicalOp_EOR; setflags = FALSE;
  when '11' op = LogicalOp_AND; setflags = TRUE;

bits(datasize) imm;
if sf == '0' && N != '0' then ReservedValue();
(imm, -) = DecodeBitMasks(N, imms, immr, TRUE);
```

Alias conditions

Alias	is preferred when
TST (immediate)	Rd == '11111'

Assembler Symbols

- <Wd> Is the 32-bit name of the general-purpose destination register, encoded in the "Rd" field.
- <Wn> Is the 32-bit name of the general-purpose source register, encoded in the "Rn" field.
- <Xd> Is the 64-bit name of the general-purpose destination register, encoded in the "Rd" field.
- <Xn> Is the 64-bit name of the general-purpose source register, encoded in the "Rn" field.
- <imm> Is the bitmask immediate, encoded in "N:imms:immr".

Operation

```
bits(datasize) result;
bits(datasize) operand1 = X[n];
bits(datasize) operand2 = imm;

case op of
  when LogicalOp_AND result = operand1 AND operand2;
```

```
when LogicalOp_ORR result = operand1 OR operand2;  
when LogicalOp_EOR result = operand1 EOR operand2;  
  
if setflags then  
    PSTATE.<N,Z,C,V> = result<datasize-1>:IsZeroBit(result):'00';  
  
if d == 31 && !setflags then  
    SP[] = result;  
else  
    X[d] = result;
```

C5.6.14 ANDS (shifted register)

Bitwise AND (shifted register), setting the condition flags: Rd = Rn AND shift(Rm, amount)

This instruction is used by the alias [TST \(shifted register\)](#). See the [Alias conditions](#) table for details of when each alias is preferred.

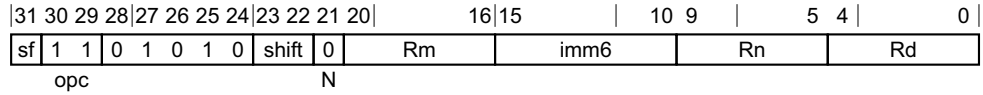

32-bit variant (sf = 0)

ANDS <Wd>, <Wn>, <Wm>{, <shift> #<amount>}

64-bit variant (sf = 1)

ANDS <Xd>, <Xn>, <Xm>{, <shift> #<amount>}

```
integer d = UInt(Rd);
integer n = UInt(Rn);
integer m = UInt(Rm);
integer datasize = if sf == '1' then 64 else 32;
boolean setflags;
LogicalOp op;
case opc of
    when '00' op = LogicalOp_AND; setflags = FALSE;
    when '01' op = LogicalOp_ORR; setflags = FALSE;
    when '10' op = LogicalOp_EOR; setflags = FALSE;
    when '11' op = LogicalOp_AND; setflags = TRUE;

if sf == '0' && imm6<5> == '1' then ReservedValue();

ShiftType shift_type = DecodeShift(shift);
integer shift_amount = UInt(imm6);
boolean invert = (N == '1');
```

Alias conditions

Alias	is preferred when
TST (shifted register)	Rd == '11111'

Assembler Symbols

- <Wd> Is the 32-bit name of the general-purpose destination register, encoded in the "Rd" field.
- <Wn> Is the 32-bit name of the first general-purpose source register, encoded in the "Rn" field.
- <Wm> Is the 32-bit name of the second general-purpose source register, encoded in the "Rm" field.
- <Xd> Is the 64-bit name of the general-purpose destination register, encoded in the "Rd" field.
- <Xn> Is the 64-bit name of the first general-purpose source register, encoded in the "Rn" field.
- <Xm> Is the 64-bit name of the second general-purpose source register, encoded in the "Rm" field.
- <shift> Is the optional shift to be applied to the final source, defaulting to LSL and
 - LSL** when shift = 00
 - LSR** when shift = 01

ASR when shift = 10

ROR when shift = 11

<amount> For the 32-bit variant: is the shift amount, in the range 0 to 31, defaulting to 0 and encoded in the "imm6" field.

<amount> For the 64-bit variant: is the shift amount, in the range 0 to 63, defaulting to 0 and encoded in the "imm6" field,.

Operation

```
bits(datasize) operand1 = X[n];
bits(datasize) operand2 = ShiftReg(m, shift_type, shift_amount);

if invert then operand2 = NOT(operand2);

case op of
  when Logicalp_AND result = operand1 AND operand2;
  when Logicalp_ORR result = operand1 OR operand2;
  when Logicalp_EOR result = operand1 EOR operand2;

if setflags then
  PSTATE.<N,Z,C,V> = result<datasize-1>:IsZeroBit(result):'00';

X[d] = result;
```

C5.6.15 ASR (register)

Arithmetic shift right (register): Rd = ASR(Rn, Rm)

This instruction is an alias of the [ASRV](#) instruction.

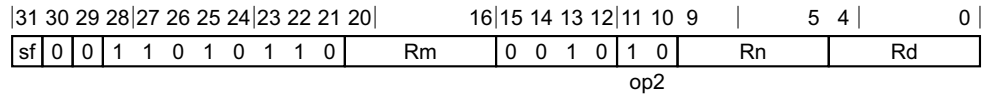

32-bit variant (sf = 0)

ASR <Wd>, <Wn>, <Wm>

is equivalent to

ASRV <Wd>, <Wn>, <Wm>

and is always the preferred disassembly.

64-bit variant (sf = 1)

ASR <Xd>, <Xn>, <Xm>

is equivalent to

ASRV <Xd>, <Xn>, <Xm>

and is always the preferred disassembly.

Assembler Symbols

- <Wd> Is the 32-bit name of the general-purpose destination register, encoded in the "Rd" field.
- <Wn> Is the 32-bit name of the first general-purpose source register, encoded in the "Rn" field.
- <Wm> Is the 32-bit name of the second general-purpose source register holding a shift amount from 0 to 31 in its bottom 5 bits, encoded in the "Rm" field.
- <Xd> Is the 64-bit name of the general-purpose destination register, encoded in the "Rd" field.
- <Xn> Is the 64-bit name of the first general-purpose source register, encoded in the "Rn" field.
- <Xm> Is the 64-bit name of the second general-purpose source register holding a shift amount from 0 to 63 in its bottom 6 bits, encoded in the "Rm" field.

C5.6.16 ASR (immediate)

Arithmetic shift right (immediate): $Rd = ASR(Rn, \text{shift})$

This instruction is an alias of the [SBFM](#) instruction.

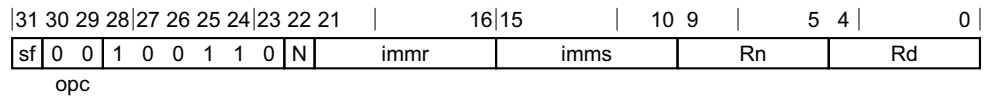

32-bit variant (sf = 0, N = 0)

ASR <Wd>, <Wn>, #<shift>

is equivalent to

SBFM <Wd>, <Wn>, #<shift>, #31

and is the preferred disassembly when `imms == '011111'`.

64-bit variant (sf = 1, N = 1)

ASR <Xd>, <Xn>, #<shift>

is equivalent to

SBFM <Xd>, <Xn>, #<shift>, #63

and is the preferred disassembly when `imms == '111111'`.

Assembler Symbols

- <Wd> Is the 32-bit name of the general-purpose destination register, encoded in the "Rd" field.
- <Wn> Is the 32-bit name of the general-purpose source register, encoded in the "Rn" field.
- <Xd> Is the 64-bit name of the general-purpose destination register, encoded in the "Rd" field.
- <Xn> Is the 64-bit name of the general-purpose source register, encoded in the "Rn" field.
- <shift> For the 32-bit variant: is the shift amount, in the range 0 to 31.
- <shift> For the 64-bit variant: is the shift amount, in the range 0 to 63.

C5.6.17 ASRV

Arithmetic shift right variable: Rd = ASR(Rn, Rm)

This instruction is used by the alias [ASR \(register\)](#). The alias is always the preferred disassembly.

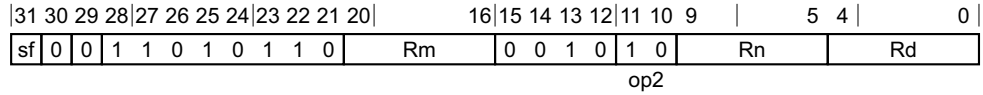

32-bit variant (sf = 0)

ASRV <Wd>, <Wn>, <Wm>

64-bit variant (sf = 1)

ASRV <Xd>, <Xn>, <Xm>

```
integer d = UInt(Rd);
integer n = UInt(Rn);
integer m = UInt(Rm);
integer datasize = if sf == '1' then 64 else 32;
ShiftType shift_type = DecodeShift(op2);
```

Assembler Symbols

- <Wd> Is the 32-bit name of the general-purpose destination register, encoded in the "Rd" field.
- <Wn> Is the 32-bit name of the first general-purpose source register, encoded in the "Rn" field.
- <Wm> Is the 32-bit name of the second general-purpose source register holding a shift amount from 0 to 31 in its bottom 5 bits, encoded in the "Rm" field.
- <Xd> Is the 64-bit name of the general-purpose destination register, encoded in the "Rd" field.
- <Xn> Is the 64-bit name of the first general-purpose source register, encoded in the "Rn" field.
- <Xm> Is the 64-bit name of the second general-purpose source register holding a shift amount from 0 to 63 in its bottom 6 bits, encoded in the "Rm" field.

Operation

```
bits(datasize) result;
bits(datasize) operand2 = X[m];

result = ShiftReg(n, shift_type, UInt(operand2) MOD datasize);
X[d] = result;
```

C5.6.18 AT

Address translate

This instruction is an alias of the [SYS](#) instruction.

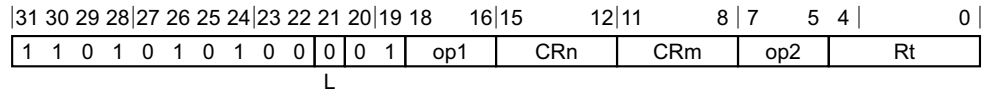

System variant

AT <at_op>, <Xt>

is equivalent to

SYS #<op1>, <Cn>, <Cm>, #<op2>, <Xt>

and is the preferred disassembly when SysOp(op1,CRn,CRm,op2) == Sys_AT.

Assembler Symbols

- <at_op> Is an AT operation name, as listed for the AT system operation group, encoded in the "op1:CRn:CRm:op2".
- <op1> Is a 3-bit unsigned immediate, in the range 0 to 7, encoded in the "op1" field.
- <Cn> Is a name 'Cn', with 'n' in the range 0 to 15, encoded in the "CRn" field.
- <Cm> Is a name 'Cm', with 'm' in the range 0 to 15, encoded in the "CRm" field.
- <op2> Is a 3-bit unsigned immediate, in the range 0 to 7, encoded in the "op2" field.
- <Xt> Is the 64-bit name of the general-purpose source register, encoded in the "Rt" field.

C5.6.19 B.cond

Branch conditionally to a label at a PC-relative offset, with a hint that this is not a subroutine call or return

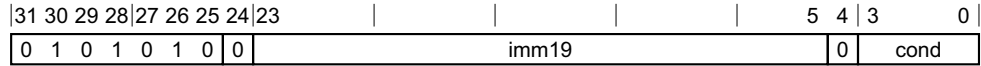

19-bit signed PC-relative branch offset variant

B.<cond> <label>

```
bits(64) offset = SignExtend(imm19:'00', 64);
bits(4) condition = cond;
```

Assembler Symbols

<cond> Is one of the standard conditions, encoded in the "cond" field in the standard way.

<label> Is the program label to be conditionally branched to. Its offset from the address of this instruction, in the range +/-1MB, is encoded as "imm19" times 4.

Operation

```
if ConditionHolds(condition) then
    BranchTo(PC[] + offset, BranchType_JMP);
```

C5.6.20 B

Branch unconditionally to a label at a PC-relative offset, with a hint that this is not a subroutine call or return

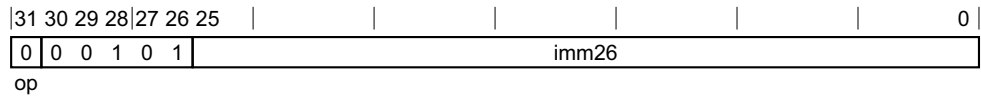

26-bit signed PC-relative branch offset variant

B <label>

```
BranchType branch_type = if op == '1' then BranchType_CALL else BranchType_JMP;
bits(64) offset = SignExtend(imm26:'00', 64);
```

Assembler Symbols

<label> Is the program label to be unconditionally branched to. Its offset from the address of this instruction, in the range +/-128MB, is encoded as "imm26" times 4.

Operation

```
if branch_type == BranchType_CALL then X[30] = PC[] + 4;
```

```
BranchTo(PC[] + offset, branch_type);
```

C5.6.21 BFI

Bitfield insert, leaving other bits unchanged

This instruction is an alias of the [BFM](#) instruction.

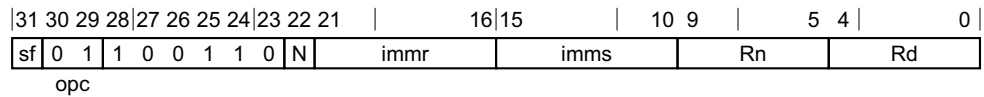

32-bit variant (sf = 0, N = 0)

BFI <Wd>, <Wn>, #<lsb>, #<width>

is equivalent to

BFM <Wd>, <Wn>, #(-<lsb> MOD 32), #(<width>-1)

and is the preferred disassembly when $\text{UInt}(\text{imms}) < \text{UInt}(\text{immr})$.

64-bit variant (sf = 1, N = 1)

BFI <Xd>, <Xn>, #<lsb>, #<width>

is equivalent to

BFM <Xd>, <Xn>, #(-<lsb> MOD 64), #(<width>-1)

and is the preferred disassembly when $\text{UInt}(\text{imms}) < \text{UInt}(\text{immr})$.

Assembler Symbols

- <Wd> Is the 32-bit name of the general-purpose destination register, encoded in the "Rd" field.
- <Wn> Is the 32-bit name of the general-purpose source register, encoded in the "Rn" field.
- <Xd> Is the 64-bit name of the general-purpose destination register, encoded in the "Rd" field.
- <Xn> Is the 64-bit name of the general-purpose source register, encoded in the "Rn" field.
- <lsb> For the 32-bit variant: is the bit number of the lsb of the source bitfield, in the range 0 to 31.
- <lsb> For the 64-bit variant: is the bit number of the lsb of the source bitfield, in the range 0 to 63.
- <width> For the 32-bit variant: is the width of the bitfield, in the range 1 to 32-<lsb>.
- <width> For the 64-bit variant: is the width of the bitfield, in the range 1 to 64-<lsb>.

C5.6.22 BFM

Bitfield move, leaving other bits unchanged

This instruction is used by the aliases [BFI](#) and [BFXIL](#). See the *Alias conditions* table for details of when each alias is preferred.

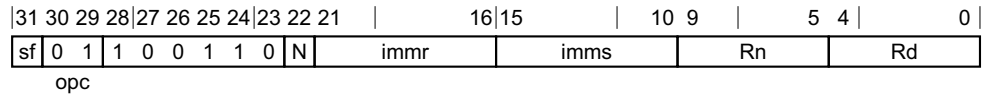

32-bit variant (sf = 0, N = 0)

BFM <Wd>, <Wn>, #<immr>, #<imms>

64-bit variant (sf = 1, N = 1)

BFM <Xd>, <Xn>, #<immr>, #<imms>

```

integer d = UInt(Rd);
integer n = UInt(Rn);
integer datasize = if sf == '1' then 64 else 32;

boolean inzero;
boolean extend;
integer R;
integer S;
bits(datasize) wmask;
bits(datasize) tmask;

case opc of
  when '00' inzero = TRUE; extend = TRUE; // SBFM
  when '01' inzero = FALSE; extend = FALSE; // BFM
  when '10' inzero = TRUE; extend = FALSE; // UBFM
  when '11' UnallocatedEncoding();

if sf == '1' && N != '1' then ReservedValue();
if sf == '0' && (N != '0' || immr<5> != '0' || imms<5> != '0') then ReservedValue();

R = UInt(immr);
S = UInt(imms);
(wmask, tmask) = DecodeBitMasks(N, imms, immr, FALSE);

```

Alias conditions

Alias	is preferred when
BFI	<code>UInt(imms) < UInt(immr)</code>
BFXIL	<code>UInt(imms) >= UInt(immr)</code>

Assembler Symbols

<Wd>	Is the 32-bit name of the general-purpose destination register, encoded in the "Rd" field.
<Wn>	Is the 32-bit name of the general-purpose source register, encoded in the "Rn" field.
<Xd>	Is the 64-bit name of the general-purpose destination register, encoded in the "Rd" field.
<Xn>	Is the 64-bit name of the general-purpose source register, encoded in the "Rn" field.

- <immr> For the 32-bit variant: is the right rotate amount, in the range 0 to 31, encoded in the "immr" field.
- <immr> For the 64-bit variant: is the right rotate amount, in the range 0 to 63, encoded in the "immr" field.
- <imms> For the 32-bit variant: is the leftmost bit number to be moved from the source, in the range 0 to 31, encoded in the "imms" field.
- <imms> For the 64-bit variant: is the leftmost bit number to be moved from the source, in the range 0 to 63, encoded in the "imms" field.

Operation

```
bits(datasize) dst = if inzero then Zeros() else X[d];
bits(datasize) src = X[n];

// perform bitfield move on low bits
bits(datasize) bot = (dst AND NOT(wmask)) OR (ROR(src, R) AND wmask);

// determine extension bits (sign, zero or dest register)
bits(datasize) top = if extend then Replicate(src<S>) else dst;

// combine extension bits and result bits
X[d] = (top AND NOT(tmash)) OR (bot AND tmash);
```

C5.6.23 BFXIL

Bitfield extract and insert at low end, leaving other bits unchanged

This instruction is an alias of the [BFM](#) instruction.

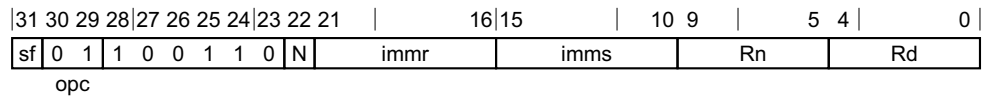

32-bit variant (sf = 0, N = 0)

BFXIL <Wd>, <Wn>, #<lsb>, #<width>

is equivalent to

BFM <Wd>, <Wn>, #<lsb>, #(<lsb>+<width>-1)

and is the preferred disassembly when $UInt(imms) \geq UInt(immr)$.

64-bit variant (sf = 1, N = 1)

BFXIL <Xd>, <Xn>, #<lsb>, #<width>

is equivalent to

BFM <Xd>, <Xn>, #<lsb>, #(<lsb>+<width>-1)

and is the preferred disassembly when $UInt(imms) \geq UInt(immr)$.

Assembler Symbols

- <Wd> Is the 32-bit name of the general-purpose destination register, encoded in the "Rd" field.
- <Wn> Is the 32-bit name of the general-purpose source register, encoded in the "Rn" field.
- <Xd> Is the 64-bit name of the general-purpose destination register, encoded in the "Rd" field.
- <Xn> Is the 64-bit name of the general-purpose source register, encoded in the "Rn" field.
- <lsb> For the 32-bit variant: is the bit number of the lsb of the source bitfield, in the range 0 to 31.
- <lsb> For the 64-bit variant: is the bit number of the lsb of the source bitfield, in the range 0 to 63.
- <width> For the 32-bit variant: is the width of the bitfield, in the range 1 to 32-<lsb>.
- <width> For the 64-bit variant: is the width of the bitfield, in the range 1 to 64-<lsb>.

C5.6.24 BIC (shifted register)

Bitwise bit clear (shifted register): $Rd = Rn \text{ AND NOT } \text{shift}(Rm, \text{amount})$

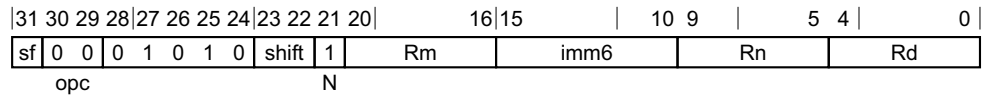

32-bit variant (sf = 0)

BIC <Wd>, <Wn>, <Wm>{, <shift> #<amount>}

64-bit variant (sf = 1)

BIC <Xd>, <Xn>, <Xm>{, <shift> #<amount>}

```
integer d = UInt(Rd);
integer n = UInt(Rn);
integer m = UInt(Rm);
integer datasize = if sf == '1' then 64 else 32;
boolean setflags;
LogicalOp op;
case opc of
  when '00' op = LogicalOp_AND; setflags = FALSE;
  when '01' op = LogicalOp_ORR; setflags = FALSE;
  when '10' op = LogicalOp_EOR; setflags = FALSE;
  when '11' op = LogicalOp_AND; setflags = TRUE;

if sf == '0' && imm6<5> == '1' then ReservedValue();

ShiftType shift_type = DecodeShift(shift);
integer shift_amount = UInt(imm6);
boolean invert = (N == '1');
```

Assembler Symbols

<Wd>	Is the 32-bit name of the general-purpose destination register, encoded in the "Rd" field.								
<Wn>	Is the 32-bit name of the first general-purpose source register, encoded in the "Rn" field.								
<Wm>	Is the 32-bit name of the second general-purpose source register, encoded in the "Rm" field.								
<Xd>	Is the 64-bit name of the general-purpose destination register, encoded in the "Rd" field.								
<Xn>	Is the 64-bit name of the first general-purpose source register, encoded in the "Rn" field.								
<Xm>	Is the 64-bit name of the second general-purpose source register, encoded in the "Rm" field.								
<shift>	Is the optional shift to be applied to the final source, defaulting to LSL and <table style="margin-left: 20px; border-collapse: collapse;"> <tr><td>LSL</td><td>when shift = 00</td></tr> <tr><td>LSR</td><td>when shift = 01</td></tr> <tr><td>ASR</td><td>when shift = 10</td></tr> <tr><td>ROR</td><td>when shift = 11</td></tr> </table>	LSL	when shift = 00	LSR	when shift = 01	ASR	when shift = 10	ROR	when shift = 11
LSL	when shift = 00								
LSR	when shift = 01								
ASR	when shift = 10								
ROR	when shift = 11								
<amount>	For the 32-bit variant: is the shift amount, in the range 0 to 31, defaulting to 0 and encoded in the "imm6" field.								
<amount>	For the 64-bit variant: is the shift amount, in the range 0 to 63, defaulting to 0 and encoded in the "imm6" field,.								

Operation

```
bits(datasize) operand1 = X[n];
bits(datasize) operand2 = ShiftReg(m, shift_type, shift_amount);

if invert then operand2 = NOT(operand2);

case op of
  when LogicalOp_AND result = operand1 AND operand2;
  when LogicalOp_ORR result = operand1 OR operand2;
  when LogicalOp_EOR result = operand1 EOR operand2;

if setflags then
  PSTATE.<N,Z,C,V> = result<datasize-1>:IsZeroBit(result):'00';

X[d] = result;
```

C5.6.25 BICS (shifted register)

Bitwise bit clear (shifted register), setting the condition flags: $Rd = Rn \text{ AND NOT } \text{shift}(Rm, \text{amount})$

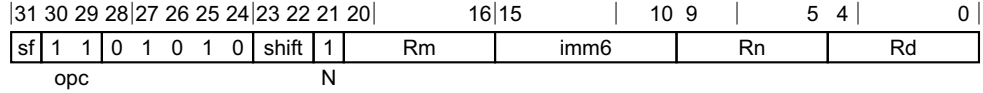

32-bit variant (sf = 0)

BICS <Wd>, <Wn>, <Wm>{, <shift> #<amount>}

64-bit variant (sf = 1)

BICS <Xd>, <Xn>, <Xm>{, <shift> #<amount>}

```

integer d = UInt(Rd);
integer n = UInt(Rn);
integer m = UInt(Rm);
integer datasize = if sf == '1' then 64 else 32;
boolean setflags;
LogicalOp op;
case opc of
    when '00' op = LogicalOp_AND; setflags = FALSE;
    when '01' op = LogicalOp_ORR; setflags = FALSE;
    when '10' op = LogicalOp_EOR; setflags = FALSE;
    when '11' op = LogicalOp_AND; setflags = TRUE;

if sf == '0' && imm6<5> == '1' then ReservedValue();

ShiftType shift_type = DecodeShift(shift);
integer shift_amount = UInt(imm6);
boolean invert = (N == '1');
```

Assembler Symbols

- <Wd> Is the 32-bit name of the general-purpose destination register, encoded in the "Rd" field.
- <Wn> Is the 32-bit name of the first general-purpose source register, encoded in the "Rn" field.
- <Wm> Is the 32-bit name of the second general-purpose source register, encoded in the "Rm" field.
- <Xd> Is the 64-bit name of the general-purpose destination register, encoded in the "Rd" field.
- <Xn> Is the 64-bit name of the first general-purpose source register, encoded in the "Rn" field.
- <Xm> Is the 64-bit name of the second general-purpose source register, encoded in the "Rm" field.
- <shift> Is the optional shift to be applied to the final source, defaulting to LSL and
 - LSL** when shift = 00
 - LSR** when shift = 01
 - ASR** when shift = 10
 - ROR** when shift = 11
- <amount> For the 32-bit variant: is the shift amount, in the range 0 to 31, defaulting to 0 and encoded in the "imm6" field.
- <amount> For the 64-bit variant: is the shift amount, in the range 0 to 63, defaulting to 0 and encoded in the "imm6" field,.

Operation

```
bits(datasize) operand1 = X[n];
bits(datasize) operand2 = ShiftReg(m, shift_type, shift_amount);

if invert then operand2 = NOT(operand2);

case op of
  when Logicalp_AND result = operand1 AND operand2;
  when Logicalp_ORR result = operand1 OR operand2;
  when Logicalp_EOR result = operand1 EOR operand2;

if setflags then
  PSTATE.<N,Z,C,V> = result<datasize-1>:IsZeroBit(result):'00';

X[d] = result;
```

C5.6.26 BL

Branch with link, calls a subroutine at a PC-relative offset, setting register X30 to PC + 4

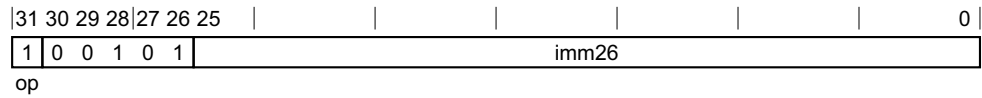

26-bit signed PC-relative branch offset variant

BL <label>

```
BranchType branch_type = if op == '1' then BranchType_CALL else BranchType_JMP;  
bits(64) offset = SignExtend(imm26:'00', 64);
```

Assembler Symbols

<label> Is the program label to be unconditionally branched to. Its offset from the address of this instruction, in the range +/-128MB, is encoded as "imm26" times 4.

Operation

```
if branch_type == BranchType_CALL then X[30] = PC[] + 4;
```

```
BranchTo(PC[] + offset, branch_type);
```

C5.6.27 BLR

Branch with link to register, calls a subroutine at an address in a register, setting register X30 to PC + 4

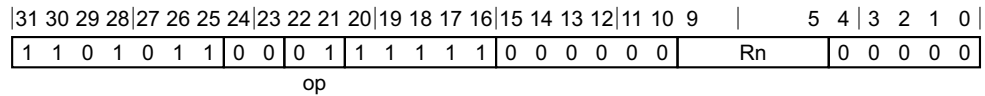

Integer variant

BLR <Xn>

```
integer n = UInt(Rn);
BranchType branch_type;
```

```
case op of
  when '00' branch_type = BranchType_JMP;
  when '01' branch_type = BranchType_CALL;
  when '10' branch_type = BranchType_RET;
  otherwise UnallocatedEncoding();
```

Assembler Symbols

<Xn> Is the 64-bit name of the general-purpose register holding the address to be branched to, encoded in the "Rn" field.

Operation

```
bits(64) target = X[n];
```

```
if branch_type == BranchType_CALL then X[30] = PC[] + 4;
BranchTo(target, branch_type);
```

C5.6.28 BR

Branch to register, branches unconditionally to an address in a register, with a hint that this is not a subroutine return

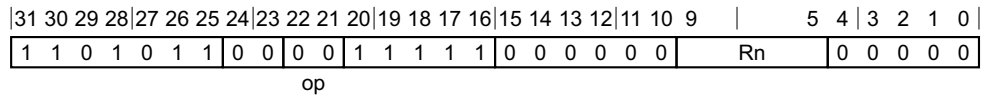

Integer variant

BR <Xn>

```
integer n = UInt(Rn);
BranchType branch_type;
```

```
case op of
  when '00' branch_type = BranchType_JMP;
  when '01' branch_type = BranchType_CALL;
  when '10' branch_type = BranchType_RET;
  otherwise UnallocatedEncoding();
```

Assembler Symbols

<Xn> Is the 64-bit name of the general-purpose register holding the address to be branched to, encoded in the "Rn" field.

Operation

```
bits(64) target = X[n];
```

```
if branch_type == BranchType_CALL then X[30] = PC[] + 4;
BranchTo(target, branch_type);
```

C5.6.29 BRK

Monitor debug-mode breakpoint

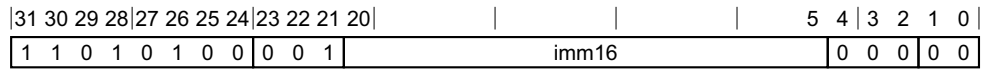

System variant

BRK #<imm>

bits(16) comment = imm16;

Assembler Symbols

<imm> Is a 16-bit unsigned immediate, in the range 0 to 65535, encoded in the "imm16" field.

Operation

[AArch64.SoftwareBreakpoint](#)(comment);

C5.6.30 CBNZ

Compare and branch if nonzero to a label at a PC-relative offset, without affecting the condition flags, and with a hint that this is not a subroutine call or return



32-bit variant (sf = 0)

CBNZ <Wt>, <label>

64-bit variant (sf = 1)

CBNZ <Xt>, <label>

```
integer t = UInt(Rt);
integer datasize = if sf == '1' then 64 else 32;
boolean iszero = (op == '0');
bits(64) offset = SignExtend(imm19:'00', 64);
```

Assembler Symbols

- <Wt> Is the 32-bit name of the general-purpose register to be tested, encoded in the "Rt" field.
- <Xt> Is the 64-bit name of the general-purpose register to be tested, encoded in the "Rt" field.
- <label> Is the program label to be conditionally branched to. Its offset from the address of this instruction, in the range +/-1MB, is encoded as "imm19" times 4.

Operation

```
bits(datasize) operand1 = X[t];
if IsZero(operand1) == iszero then
  BranchTo(PC[] + offset, BranchType_JMP);
```

C5.6.31 CBZ

Compare and branch if zero to a label at a PC-relative offset, without affecting the condition flags, and with a hint that this is not a subroutine call or return



32-bit variant (sf = 0)

CBZ <Wt>, <label>

64-bit variant (sf = 1)

CBZ <Xt>, <label>

```
integer t = UInt(Rt);
integer datasize = if sf == '1' then 64 else 32;
boolean iszero = (op == '0');
bits(64) offset = SignExtend(imm19:'00', 64);
```

Assembler Symbols

- <Wt> Is the 32-bit name of the general-purpose register to be tested, encoded in the "Rt" field.
- <Xt> Is the 64-bit name of the general-purpose register to be tested, encoded in the "Rt" field.
- <label> Is the program label to be conditionally branched to. Its offset from the address of this instruction, in the range +/-1MB, is encoded as "imm19" times 4.

Operation

```
bits(datasize) operand1 = X[t];
if IsZero(operand1) == iszero then
    BranchTo(PC[] + offset, BranchType_JMP);
```

C5.6.32 CCMN (immediate)

Conditional compare negative (immediate), setting condition flags to result of comparison or an immediate value:
 flags = if cond then compare(Rn, #-imm) else #nzcvc

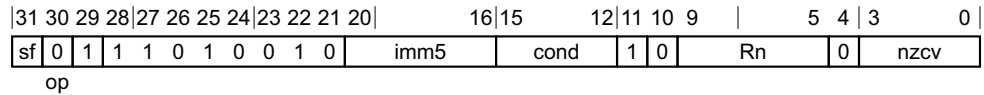

32-bit variant (sf = 0)

CCMN <Wn>, #<imm>, #<nzcvc>, <cond>

64-bit variant (sf = 1)

CCMN <Xn>, #<imm>, #<nzcvc>, <cond>

```
integer n = UInt(Rn);
integer datasize = if sf == '1' then 64 else 32;
boolean sub_op = (op == '1');
bits(4) condition = cond;
bits(4) flags = nzcvc;
bits(datasize) imm = ZeroExtend(imm5, datasize);
```

Assembler Symbols

- <Wn> Is the 32-bit name of the first general-purpose source register, encoded in the "Rn" field.
- <Xn> Is the 64-bit name of the first general-purpose source register, encoded in the "Rn" field.
- <imm> Is a five bit unsigned (positive) immediate encoded in the "imm5" field.
- <nzcvc> Is the flag bit specifier, an immediate in the range 0 to 15, giving the alternative state for the 4-bit NZCV condition flags, encoded in the "nzcvc" field.
- <cond> Is one of the standard conditions, encoded in the "cond" field in the standard way.

Operation

```
bits(datasize) operand1 = X[n];
bits(datasize) operand2 = imm;
bit carry_in = '0';

if ConditionHolds(condition) then
  if sub_op then
    operand2 = NOT(operand2);
    carry_in = '1';
  (-, flags) = AddWithCarry(operand1, operand2, carry_in);
PSTATE.<N,Z,C,V> = flags;
```

C5.6.33 CCMN (register)

Conditional compare negative (register), setting condition flags to result of comparison or an immediate value:
flags = if cond then compare(Rn, -Rm) else #nzcvc

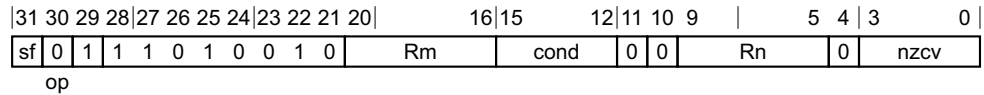

32-bit variant (sf = 0)

CCMN <Wn>, <Wm>, #<nzcvc>, <cond>

64-bit variant (sf = 1)

CCMN <Xn>, <Xm>, #<nzcvc>, <cond>

```
integer n = UInt(Rn);
integer m = UInt(Rm);
integer datasize = if sf == '1' then 64 else 32;
boolean sub_op = (op == '1');
bits(4) condition = cond;
bits(4) flags = nzcvc;
```

Assembler Symbols

- <Wn> Is the 32-bit name of the first general-purpose source register, encoded in the "Rn" field.
- <Wm> Is the 32-bit name of the second general-purpose source register, encoded in the "Rm" field.
- <Xn> Is the 64-bit name of the first general-purpose source register, encoded in the "Rn" field.
- <Xm> Is the 64-bit name of the second general-purpose source register, encoded in the "Rm" field.
- <nzcvc> Is the flag bit specifier, an immediate in the range 0 to 15, giving the alternative state for the 4-bit NZCV condition flags, encoded in the "nzcvc" field.
- <cond> Is one of the standard conditions, encoded in the "cond" field in the standard way.

Operation

```
bits(datasize) operand1 = X[n];
bits(datasize) operand2 = X[m];
bit carry_in = '0';

if ConditionHolds(condition) then
    if sub_op then
        operand2 = NOT(operand2);
        carry_in = '1';
    (-, flags) = AddWithCarry(operand1, operand2, carry_in);
PSTATE.<N,Z,C,V> = flags;
```

C5.6.34 CCMP (immediate)

Conditional compare (immediate), setting condition flags to result of comparison or an immediate value: flags = if cond then compare(Rn, #imm) else #nzcw

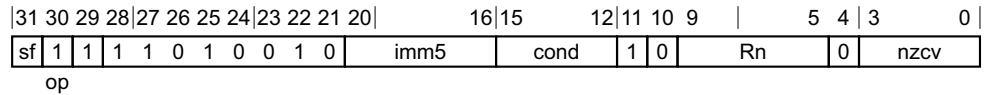

32-bit variant (sf = 0)

CCMP <Wn>, #<imm>, #<nzcw>, <cond>

64-bit variant (sf = 1)

CCMP <Xn>, #<imm>, #<nzcw>, <cond>

```
integer n = UInt(Rn);
integer datasize = if sf == '1' then 64 else 32;
boolean sub_op = (op == '1');
bits(4) condition = cond;
bits(4) flags = nzcw;
bits(datasize) imm = ZeroExtend(imm5, datasize);
```

Assembler Symbols

- <Wn> Is the 32-bit name of the first general-purpose source register, encoded in the "Rn" field.
- <Xn> Is the 64-bit name of the first general-purpose source register, encoded in the "Rn" field.
- <imm> Is a five bit unsigned (positive) immediate encoded in the "imm5" field.
- <nzcw> Is the flag bit specifier, an immediate in the range 0 to 15, giving the alternative state for the 4-bit NZCV condition flags, encoded in the "nzcw" field.
- <cond> Is one of the standard conditions, encoded in the "cond" field in the standard way.

Operation

```
bits(datasize) operand1 = X[n];
bits(datasize) operand2 = imm;
bit carry_in = '0';

if ConditionHolds(condition) then
    if sub_op then
        operand2 = NOT(operand2);
        carry_in = '1';
    (-, flags) = AddWithCarry(operand1, operand2, carry_in);
PSTATE.<N,Z,C,V> = flags;
```

C5.6.35 CCMP (register)

Conditional compare (register), setting condition flags to result of comparison or an immediate value: flags = if cond then compare(Rn, Rm) else #nzcvcv

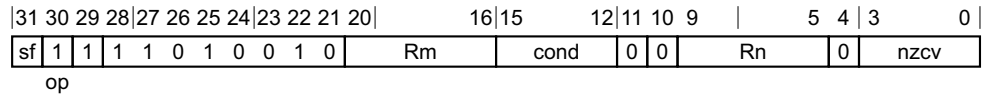

32-bit variant (sf = 0)

CCMP <Wn>, <Wm>, #<nzcvcv>, <cond>

64-bit variant (sf = 1)

CCMP <Xn>, <Xm>, #<nzcvcv>, <cond>

```
integer n = UInt(Rn);
integer m = UInt(Rm);
integer datasize = if sf == '1' then 64 else 32;
boolean sub_op = (op == '1');
bits(4) condition = cond;
bits(4) flags = nzcvcv;
```

Assembler Symbols

- <Wn> Is the 32-bit name of the first general-purpose source register, encoded in the "Rn" field.
- <Wm> Is the 32-bit name of the second general-purpose source register, encoded in the "Rm" field.
- <Xn> Is the 64-bit name of the first general-purpose source register, encoded in the "Rn" field.
- <Xm> Is the 64-bit name of the second general-purpose source register, encoded in the "Rm" field.
- <nzcvcv> Is the flag bit specifier, an immediate in the range 0 to 15, giving the alternative state for the 4-bit NZCV condition flags, encoded in the "nzcvcv" field.
- <cond> Is one of the standard conditions, encoded in the "cond" field in the standard way.

Operation

```
bits(datasize) operand1 = X[n];
bits(datasize) operand2 = X[m];
bit carry_in = '0';

if ConditionHolds(condition) then
    if sub_op then
        operand2 = NOT(operand2);
        carry_in = '1';
    (-, flags) = AddWithCarry(operand1, operand2, carry_in);
PSTATE.<N,Z,C,V> = flags;
```

C5.6.36 CINC

Conditional increment: Rd = if cond then Rn+1 else Rn

This instruction is an alias of the CSINC instruction.

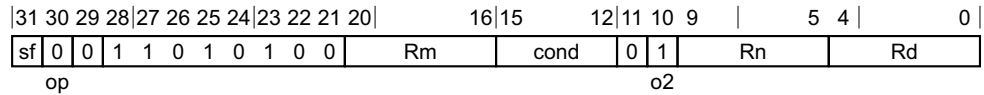

32-bit variant (sf = 0)

CINC <Wd>, <Wn>, <cond>

is equivalent to

CSINC <Wd>, <Wn>, <Wn>, invert(<cond>)

and is the preferred disassembly when Rn == Rm && Rn != '11111' && cond != '111x'.

64-bit variant (sf = 1)

CINC <Xd>, <Xn>, <cond>

is equivalent to

CSINC <Xd>, <Xn>, <Xn>, invert(<cond>)

and is the preferred disassembly when Rn == Rm && Rn != '11111' && cond != '111x'.

Assembler Symbols

- <Wd> Is the 32-bit name of the general-purpose destination register, encoded in the "Rd" field.
- <Wn> Is the 32-bit name of the general-purpose source register, encoded in the "Rn" and "Rm" fields.
- <Xd> Is the 64-bit name of the general-purpose destination register, encoded in the "Rd" field.
- <Xn> Is the 64-bit name of the general-purpose source register, encoded in the "Rn" and "Rm" fields.
- <cond> Is one of the standard conditions, excluding AL and NV, encoded in the "cond" field with its least significant bit inverted.

C5.6.37 CINV

Conditional invert: Rd = if cond then NOT(Rn) else Rn

This instruction is an alias of the [CSINV](#) instruction.

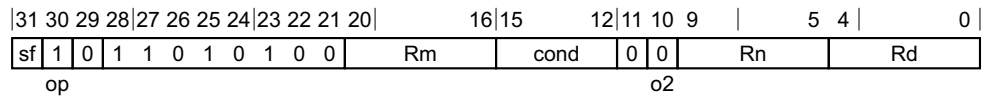

32-bit variant (sf = 0)

CINV <Wd>, <Wn>, <cond>

is equivalent to

CSINV <Wd>, <Wn>, <Wn>, invert(<cond>)

and is the preferred disassembly when Rn == Rm && Rn != '11111' && cond != '111x'.

64-bit variant (sf = 1)

CINV <Xd>, <Xn>, <cond>

is equivalent to

CSINV <Xd>, <Xn>, <Xn>, invert(<cond>)

and is the preferred disassembly when Rn == Rm && Rn != '11111' && cond != '111x'.

Assembler Symbols

- <Wd> Is the 32-bit name of the general-purpose destination register, encoded in the "Rd" field.
- <Wn> Is the 32-bit name of the general-purpose source register, encoded in the "Rn" and "Rm" fields.
- <Xd> Is the 64-bit name of the general-purpose destination register, encoded in the "Rd" field.
- <Xn> Is the 64-bit name of the general-purpose source register, encoded in the "Rn" and "Rm" fields.
- <cond> Is one of the standard conditions, excluding AL and NV, encoded in the "cond" field with its least significant bit inverted.

C5.6.38 CLREX

Clear exclusive monitor

31	30	29	28	27	26	25	24	23	22	21	20	19	18	17	16	15	14	13	12	11	8	7	6	5	4	3	2	1	0
1	1	0	1	0	1	0	1	0	0	0	0	0	0	1	1	0	0	1	1	CRm	0	1	0	1	1	1	1	1	1

System variant

CLREX {#<imm>}

// CRm field is ignored

Assembler Symbols

<imm> Is an optional 4-bit unsigned immediate, in the range 0 to 15, defaulting to 15 and encoded in the "CRm" field.

Operation

```
ClearExclusiveLocal(ProcessorID());
```

C5.6.39 CLS

Count leading sign bits: Rd = CLS(Rn)

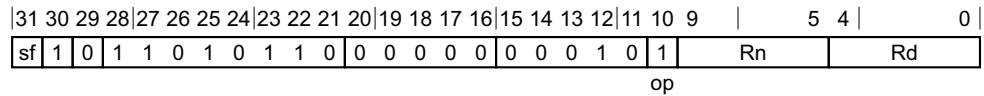

32-bit variant (sf = 0)

CLS <Wd>, <Wn>

64-bit variant (sf = 1)

CLS <Xd>, <Xn>

```
integer d = UInt(Rd);
integer n = UInt(Rn);
integer datasize = if sf == '1' then 64 else 32;
CountOp opcode = if op == '0' then CountOp_CLZ else CountOp_CLS;
```

Assembler Symbols

- <Wd> Is the 32-bit name of the general-purpose destination register, encoded in the "Rd" field.
- <Wn> Is the 32-bit name of the general-purpose source register, encoded in the "Rn" field.
- <Xd> Is the 64-bit name of the general-purpose destination register, encoded in the "Rd" field.
- <Xn> Is the 64-bit name of the general-purpose source register, encoded in the "Rn" field.

Operation

```
integer result;
bits(datasize) operand1 = X[n];

if opcode == CountOp_CLZ then
    result = CountLeadingZeroBits(operand1);
else
    result = CountLeadingSignBits(operand1);

X[d] = result<datasize-1:0>;
```

C5.6.40 CLZ

Count leading zero bits: Rd = CLZ(Rn)

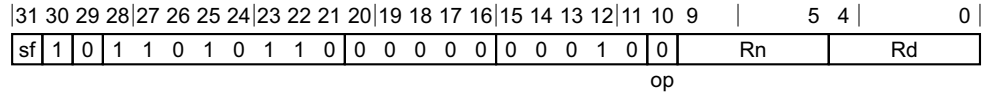

32-bit variant (sf = 0)

CLZ <Wd>, <Wn>

64-bit variant (sf = 1)

CLZ <Xd>, <Xn>

```
integer d = UInt(Rd);
integer n = UInt(Rn);
integer datasize = if sf == '1' then 64 else 32;
CountOp opcode = if op == '0' then CountOp_CLZ else CountOp_CLS;
```

Assembler Symbols

- <Wd> Is the 32-bit name of the general-purpose destination register, encoded in the "Rd" field.
- <Wn> Is the 32-bit name of the general-purpose source register, encoded in the "Rn" field.
- <Xd> Is the 64-bit name of the general-purpose destination register, encoded in the "Rd" field.
- <Xn> Is the 64-bit name of the general-purpose source register, encoded in the "Rn" field.

Operation

```
integer result;
bits(datasize) operand1 = X[n];

if opcode == CountOp_CLZ then
    result = CountLeadingZeroBits(operand1);
else
    result = CountLeadingSignBits(operand1);

X[d] = result<datasize-1:0>;
```

C5.6.41 CMN (extended register)

Compare negative (extended register), setting the condition flags and discarding the result: $Rn + LSL(\text{extend}(Rm), \text{amount})$

This instruction is an alias of the [ADDS \(extended register\)](#) instruction.

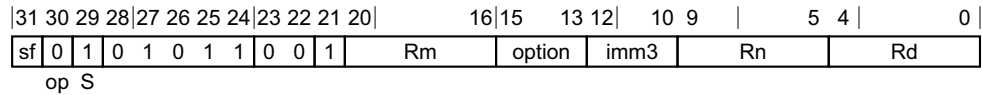

32-bit variant (sf = 0)

CMN <Wn|WSP>, <Wm>{, <extend> {#<amount>}}

is equivalent to

ADDS WZR, <Wn|WSP>, <Wm>{, <extend> {#<amount>}}

and is the preferred disassembly when $Rd == '11111'$.

64-bit variant (sf = 1)

CMN <Xn|SP>, <R><m>{, <extend> {#<amount>}}

is equivalent to

ADDS XZR, <Xn|SP>, <R><m>{, <extend> {#<amount>}}

and is the preferred disassembly when $Rd == '11111'$.

Assembler Symbols

<Wn WSP>	Is the 32-bit name of the first source general-purpose register or stack pointer, encoded in the "Rn" field.
<Wm>	Is the 32-bit name of the second general-purpose source register, encoded in the "Rm" field.
<Xn SP>	Is the 64-bit name of the first source general-purpose register or stack pointer, encoded in the "Rn" field.
<R>	Is a width specifier, encoded in "option", where x11->X, otherwise W.
<m>	Is the number [0-30] of the second general-purpose source register or the name ZR (31), encoded in the "Rm" field.
<extend>	For the 32-bit variant: is the extension to be applied to the second source operand, UXTB when option = 000 UXTH when option = 001 LSL UXTW when option = 010 UXTX when option = 011 SXTB when option = 100 SXTH when option = 101 SXTW when option = 110 SXTX when option = 111 The LSL form can only be used when "Rn" is '11111' (i.e. WSP) and in that case is also the default. In all other cases <extend> must be present.
<extend>	For the 64-bit variant: is the extension to be applied to the second source operand, UXTB when option = 000 UXTH when option = 001

UXTW when option = 010

LSL|UXTX when option = 011

SXTB when option = 100

SXTH when option = 101

SXTW when option = 110

SXTX when option = 111

The LSL form can only be used when "Rn" is '11111' (i.e. SP) and in that case is also the default. In all other cases <extend> must be present.

<amount> Is the left shift amount in the range 0 to 4, which is optional with a default of 0 when <extend> is not LSL, encoded in the "imm3" field.

C5.6.42 CMN (immediate)

Compare negative (immediate), setting the condition flags and discarding the result: $Rn + \text{shift}(\text{imm})$

This instruction is an alias of the [ADDS \(immediate\)](#) instruction.

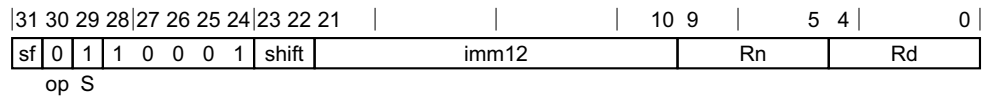

32-bit variant (sf = 0)

CMN <Wn|WSP>, #<imm>{, <shift>}

is equivalent to

ADDS WZR, <Wn|WSP>, #<imm> {, <shift>}

and is the preferred disassembly when $Rd == '11111'$.

64-bit variant (sf = 1)

CMN <Xn|SP>, #<imm>{, <shift>}

is equivalent to

ADDS XZR, <Xn|SP>, #<imm> {, <shift>}

and is the preferred disassembly when $Rd == '11111'$.

Assembler Symbols

- <Wn|WSP> Is the 32-bit name of the source general-purpose register or stack pointer, encoded in the "Rn" field.
- <Xn|SP> Is the 64-bit name of the source general-purpose register or stack pointer, encoded in the "Rn" field.
- <imm> Is an unsigned immediate, in the range 0 to 4095, encoded in the "imm12" field.
- <shift> Is the optional left shift to apply to the immediate, defaulting to LSL #0 and
 - LSL #0** when shift = 00
 - LSL #12** when shift = 01
 - RESERVED** when shift = 1x

C5.6.43 CMN (shifted register)

Compare negative (shifted register), setting the condition flags and discarding the result: $Rn + \text{shift}(Rm, \text{amount})$

This instruction is an alias of the [ADDS \(shifted register\)](#) instruction.

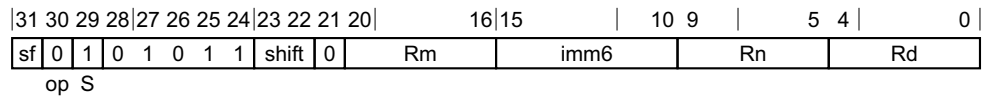

32-bit variant (sf = 0)

CMN <Wn>, <Wm>{, <shift> #<amount>}

is equivalent to

ADDS WZR, <Wn>, <Wm> {, <shift> #<amount>}

and is the preferred disassembly when Rd == '11111'.

64-bit variant (sf = 1)

CMN <Xn>, <Xm>{, <shift> #<amount>}

is equivalent to

ADDS XZR, <Xn>, <Xm> {, <shift> #<amount>}

and is the preferred disassembly when Rd == '11111'.

Assembler Symbols

- <Wn> Is the 32-bit name of the first general-purpose source register, encoded in the "Rn" field.
- <Wm> Is the 32-bit name of the second general-purpose source register, encoded in the "Rm" field.
- <Xn> Is the 64-bit name of the first general-purpose source register, encoded in the "Rn" field.
- <Xm> Is the 64-bit name of the second general-purpose source register, encoded in the "Rm" field.
- <shift> Is the optional shift type to be applied to the second source operand, defaulting to LSL and
 - LSL** when shift = 00
 - LSR** when shift = 01
 - ASR** when shift = 10
 - RESERVED** when shift = 11
- <amount> For the 32-bit variant: is the shift amount, in the range 0 to 31, defaulting to 0 and encoded in the "imm6" field.
- <amount> For the 64-bit variant: is the shift amount, in the range 0 to 63, defaulting to 0 and encoded in the "imm6" field.

C5.6.44 CMP (extended register)

Compare (extended register), setting the condition flags and discarding the result: $R_n - \text{LSL}(\text{extend}(R_m), \text{amount})$

This instruction is an alias of the [SUBS \(extended register\)](#) instruction.

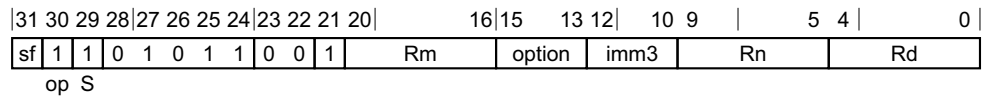

32-bit variant (sf = 0)

CMP <Wn|WSP>, <Wm>{, <extend> {#<amount>}}

is equivalent to

SUBS WZR, <Wn|WSP>, <Wm>{, <extend> {#<amount>}}

and is the preferred disassembly when $R_d == '11111'$.

64-bit variant (sf = 1)

CMP <Xn|SP>, <R><m>{, <extend> {#<amount>}}

is equivalent to

SUBS XZR, <Xn|SP>, <R><m>{, <extend> {#<amount>}}

and is the preferred disassembly when $R_d == '11111'$.

Assembler Symbols

- <Wn|WSP> Is the 32-bit name of the first source general-purpose register or stack pointer, encoded in the "Rn" field.
- <Wm> Is the 32-bit name of the second general-purpose source register, encoded in the "Rm" field.
- <Xn|SP> Is the 64-bit name of the first source general-purpose register or stack pointer, encoded in the "Rn" field.
- <R> Is a width specifier, encoded in "option", where x11->X, otherwise W.
- <m> Is the number [0-30] of the second general-purpose source register or the name ZR (31), encoded in the "Rm" field.
- <extend> For the 32-bit variant: is the extension to be applied to the second source operand,
 - UXTB** when option = 000
 - UXTH** when option = 001
 - LSL|UXTW** when option = 010
 - UXTX** when option = 011
 - SXTB** when option = 100
 - SXTH** when option = 101
 - SXTW** when option = 110
 - SXTX** when option = 111

The LSL form can only be used when "Rn" is '11111' (i.e. WSP) and in that case is also the default. In all other cases <extend> must be present.
- <extend> For the 64-bit variant: is the extension to be applied to the second source operand,
 - UXTB** when option = 000
 - UXTH** when option = 001
 - UXTW** when option = 010

LSL|UXTX when option = 011

SXTB when option = 100

SXTH when option = 101

SXTW when option = 110

SXTX when option = 111

The LSL form can only be used when "Rn" is '11111' (i.e. SP) and in that case is also the default. In all other cases <extend> must be present.

<amount> Is the left shift amount in the range 0 to 4, which is optional with a default of 0 when <extend> is not LSL, encoded in the "imm3" field.

C5.6.45 CMP (immediate)

Compare (immediate), setting the condition flags and discarding the result: Rn - shift(imm)

This instruction is an alias of the [SUBS \(immediate\)](#) instruction.

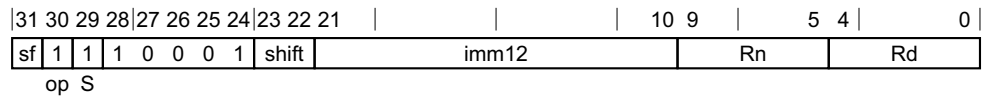

32-bit variant (sf = 0)

CMP <Wn|WSP>, #<imm>{, <shift>}

is equivalent to

SUBS WZR, <Wn|WSP>, #<imm> {, <shift>}

and is the preferred disassembly when Rd == '11111'.

64-bit variant (sf = 1)

CMP <Xn|SP>, #<imm>{, <shift>}

is equivalent to

SUBS XZR, <Xn|SP>, #<imm> {, <shift>}

and is the preferred disassembly when Rd == '11111'.

Assembler Symbols

- <Wn|WSP> Is the 32-bit name of the source general-purpose register or stack pointer, encoded in the "Rn" field.
- <Xn|SP> Is the 64-bit name of the source general-purpose register or stack pointer, encoded in the "Rn" field.
- <imm> Is an unsigned immediate, in the range 0 to 4095, encoded in the "imm12" field.
- <shift> Is the optional left shift to apply to the immediate, defaulting to LSL #0 and
 - LSL #0** when shift = 00
 - LSL #12** when shift = 01
 - RESERVED** when shift = 1x

C5.6.46 CMP (shifted register)

Compare (shifted register), setting the condition flags and discarding the result: $Rn - \text{shift}(Rm, \text{amount})$

This instruction is an alias of the [SUBS \(shifted register\)](#) instruction.

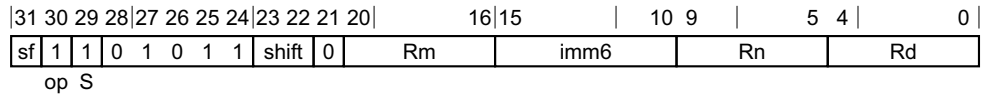

32-bit variant (sf = 0)

CMP <Wn>, <Wm>{, <shift> #<amount>}

is equivalent to

SUBS WZR, <Wn>, <Wm> {, <shift> #<amount>}

and is the preferred disassembly when $Rd == '11111'$.

64-bit variant (sf = 1)

CMP <Xn>, <Xm>{, <shift> #<amount>}

is equivalent to

SUBS XZR, <Xn>, <Xm> {, <shift> #<amount>}

and is the preferred disassembly when $Rd == '11111'$.

Assembler Symbols

- <Wn> Is the 32-bit name of the first general-purpose source register, encoded in the "Rn" field.
- <Wm> Is the 32-bit name of the second general-purpose source register, encoded in the "Rm" field.
- <Xn> Is the 64-bit name of the first general-purpose source register, encoded in the "Rn" field.
- <Xm> Is the 64-bit name of the second general-purpose source register, encoded in the "Rm" field.
- <shift> Is the optional shift type to be applied to the second source operand, defaulting to LSL and
 - LSL** when shift = 00
 - LSR** when shift = 01
 - ASR** when shift = 10
 - RESERVED** when shift = 11
- <amount> For the 32-bit variant: is the shift amount, in the range 0 to 31, defaulting to 0 and encoded in the "imm6" field.
- <amount> For the 64-bit variant: is the shift amount, in the range 0 to 63, defaulting to 0 and encoded in the "imm6" field.

C5.6.47 CNEG

Conditional negate: Rd = if cond then -Rn else Rn

This instruction is an alias of the [CSNEG](#) instruction.

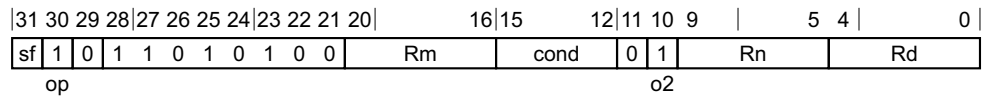

32-bit variant (sf = 0)

CNEG <Wd>, <Wn>, <cond>

is equivalent to

CSNEG <Wd>, <Wn>, <Wn>, invert(<cond>)

and is the preferred disassembly when Rn == Rm && cond != '111x'.

64-bit variant (sf = 1)

CNEG <Xd>, <Xn>, <cond>

is equivalent to

CSNEG <Xd>, <Xn>, <Xn>, invert(<cond>)

and is the preferred disassembly when Rn == Rm && cond != '111x'.

Assembler Symbols

<Wd>	Is the 32-bit name of the general-purpose destination register, encoded in the "Rd" field.
<Wn>	Is the 32-bit name of the general-purpose source register, encoded in the "Rn" and "Rm" fields.
<Xd>	Is the 64-bit name of the general-purpose destination register, encoded in the "Rd" field.
<Xn>	Is the 64-bit name of the general-purpose source register, encoded in the "Rn" and "Rm" fields.
<cond>	Is one of the standard conditions, excluding AL and NV, encoded in the "cond" field with its least significant bit inverted.

C5.6.48 CRC32B, CRC32H, CRC32W, CRC32X

CRC-32 checksum from byte, halfword, word or doubleword: $Wd = CRC32(Wn, Rm<n:0>) // n = 7, 15, 31, 63$

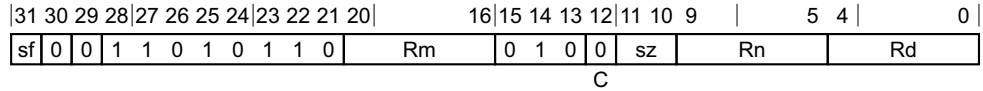

CRC32B variant (sf = 0, sz = 00)

CRC32B <Wd>, <Wn>, <Wm>

CRC32H variant (sf = 0, sz = 01)

CRC32H <Wd>, <Wn>, <Wm>

CRC32W variant (sf = 0, sz = 10)

CRC32W <Wd>, <Wn>, <Wm>

CRC32X variant (sf = 1, sz = 11)

CRC32X <Wd>, <Wn>, <Xm>

```
integer d = UInt(Rd);
integer n = UInt(Rn);
integer m = UInt(Rm);
if ! HaveCRCExt() then UnallocatedEncoding();
if sf == '1' && sz != '11' then UnallocatedEncoding();
if sf == '0' && sz == '11' then UnallocatedEncoding();
integer size = 8 << UInt(sz); // 2-bit size field -> 8, 16, 32, 64
boolean crc32c = (C == '1');
```

Assembler Symbols

- <Wd> Is the 32-bit name of the general-purpose accumulator output register, encoded in the "Rd" field.
- <Wn> Is the 32-bit name of the general-purpose accumulator input register, encoded in the "Rn" field.
- <Xm> Is the 64-bit name of the general-purpose data source register, encoded in the "Rm" field.
- <Wm> Is the 32-bit name of the general-purpose data source register, encoded in the "Rm" field.

Operation

```
bits(32)     acc     = X[n]; // accumulator
bits(size)   val     = X[m]; // input value
bits(32)     poly    = (if crc32c then 0x1EDC6F41 else 0x04C11DB7)<31:0>;

bits(32+size) tempacc = BitReverse(acc): Zeros(size);
bits(size+32) tempval = BitReverse(val): Zeros(32);

// Poly32Mod2 on a bitstring does a polynomial Modulus over {0,1} operation
X[d] = BitReverse(Poly32Mod2(tempacc EOR tempval, poly));
```

C5.6.49 CRC32CB, CRC32CH, CRC32CW, CRC32CX

CRC-32C checksum from byte, halfword, word, or doubleword: $Wd = \text{CRC32C}(Wn, Rm<n:0>) // n = 7, 15, 31, 63$

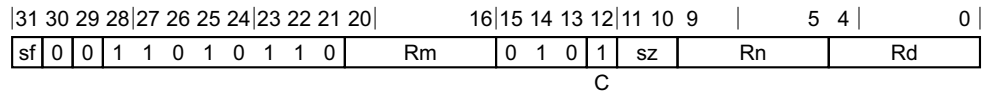

CRC32CB variant (sf = 0, sz = 00)

CRC32CB <Wd>, <Wn>, <Wm>

CRC32CH variant (sf = 0, sz = 01)

CRC32CH <Wd>, <Wn>, <Wm>

CRC32CW variant (sf = 0, sz = 10)

CRC32CW <Wd>, <Wn>, <Wm>

CRC32CX variant (sf = 1, sz = 11)

CRC32CX <Wd>, <Wn>, <Xm>

```
integer d = UInt(Rd);
integer n = UInt(Rn);
integer m = UInt(Rm);
if ! HaveCRCExt() then UnallocatedEncoding();
if sf == '1' && sz != '11' then UnallocatedEncoding();
if sf == '0' && sz == '11' then UnallocatedEncoding();
integer size = 8 << UInt(sz); // 2-bit size field -> 8, 16, 32, 64
boolean crc32c = (C == '1');
```

Assembler Symbols

<Wd> Is the 32-bit name of the general-purpose accumulator output register, encoded in the "Rd" field.

<Wn> Is the 32-bit name of the general-purpose accumulator input register, encoded in the "Rn" field.

<Xm> Is the 64-bit name of the general-purpose data source register, encoded in the "Rm" field.

<Wm> Is the 32-bit name of the general-purpose data source register, encoded in the "Rm" field.

Operation

```
bits(32) acc = X[n]; // accumulator
bits(size) val = X[m]; // input value
bits(32) poly = (if crc32c then 0x1EDC6F41 else 0x04C11DB7)<31:0>;

bits(32+size) tempacc = BitReverse(acc) : Zeros(size);
bits(size+32) tempval = BitReverse(val) : Zeros(32);

// Poly32Mod2 on a bitstring does a polynomial Modulus over {0,1} operation
X[d] = BitReverse(Poly32Mod2(tempacc EOR tempval, poly));
```

C5.6.50 CSEL

Conditional select, returning the first or second input: $Rd = \text{if cond then } Rn \text{ else } Rm$

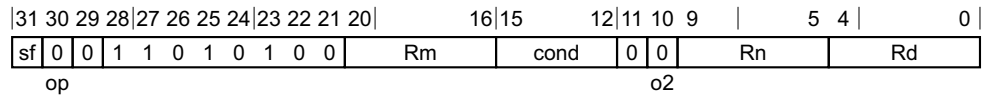

32-bit variant (sf = 0)

CSEL <Wd>, <Wn>, <Wm>, <cond>

64-bit variant (sf = 1)

CSEL <Xd>, <Xn>, <Xm>, <cond>

```
integer d = UInt(Rd);
integer n = UInt(Rn);
integer m = UInt(Rm);
integer datasize = if sf == '1' then 64 else 32;
bits(4) condition = cond;
boolean else_inv = (op == '1');
boolean else_inc = (o2 == '1');
```

Assembler Symbols

- <Wd> Is the 32-bit name of the general-purpose destination register, encoded in the "Rd" field.
- <Wn> Is the 32-bit name of the first general-purpose source register, encoded in the "Rn" field.
- <Wm> Is the 32-bit name of the second general-purpose source register, encoded in the "Rm" field.
- <Xd> Is the 64-bit name of the general-purpose destination register, encoded in the "Rd" field.
- <Xn> Is the 64-bit name of the first general-purpose source register, encoded in the "Rn" field.
- <Xm> Is the 64-bit name of the second general-purpose source register, encoded in the "Rm" field.
- <cond> Is one of the standard conditions, encoded in the "cond" field in the standard way.

Operation

```
bits(datasize) result;
bits(datasize) operand1 = X[n];
bits(datasize) operand2 = X[m];

if ConditionHolds(condition) then
  result = operand1;
else
  result = operand2;
  if else_inv then result = NOT(result);
  if else_inc then result = result + 1;

X[d] = result;
```

C5.6.51 CSET

Conditional set: Rd = if cond then 1 else 0

This instruction is an alias of the [CSINC](#) instruction.

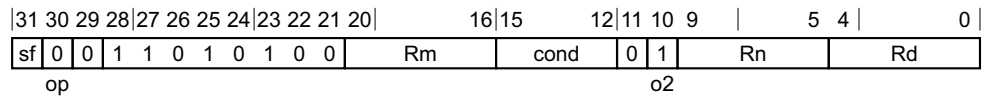

32-bit variant (sf = 0)

CSET <Wd>, <cond>

is equivalent to

CSINC <Wd>, WZR, WZR, invert(<cond>)

and is the preferred disassembly when Rn == Rm && Rn == '11111' && cond != '111x'.

64-bit variant (sf = 1)

CSET <Xd>, <cond>

is equivalent to

CSINC <Xd>, XZR, XZR, invert(<cond>)

and is the preferred disassembly when Rn == Rm && Rn == '11111' && cond != '111x'.

Assembler Symbols

- <Wd> Is the 32-bit name of the general-purpose destination register, encoded in the "Rd" field.
- <Xd> Is the 64-bit name of the general-purpose destination register, encoded in the "Rd" field.
- <cond> Is one of the standard conditions, excluding AL and NV, encoded in the "cond" field with its least significant bit inverted.

C5.6.52 CSETM

Conditional set mask: Rd = if cond then -1 else 0

This instruction is an alias of the [CSINV](#) instruction.

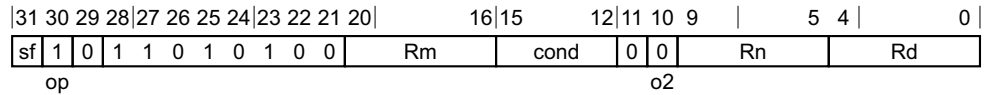

32-bit variant (sf = 0)

CSETM <Wd>, <cond>

is equivalent to

CSINV <Wd>, WZR, WZR, invert(<cond>)

and is the preferred disassembly when Rn == Rm && Rn == '11111' && cond != '111x'.

64-bit variant (sf = 1)

CSETM <Xd>, <cond>

is equivalent to

CSINV <Xd>, XZR, XZR, invert(<cond>)

and is the preferred disassembly when Rn == Rm && Rn == '11111' && cond != '111x'.

Assembler Symbols

- <Wd> Is the 32-bit name of the general-purpose destination register, encoded in the "Rd" field.
- <Xd> Is the 64-bit name of the general-purpose destination register, encoded in the "Rd" field.
- <cond> Is one of the standard conditions, excluding AL and NV, encoded in the "cond" field with its least significant bit inverted.

C5.6.53 CSINC

Conditional select increment, returning the first input or incremented second input: $Rd = \text{if cond then } Rn \text{ else } (Rm + 1)$

This instruction is used by the aliases [CINC](#) and [CSET](#). See the [Alias conditions](#) table for details of when each alias is preferred.

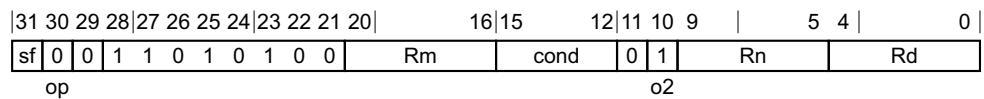

32-bit variant (sf = 0)

CSINC <Wd>, <Wn>, <Wm>, <cond>

64-bit variant (sf = 1)

CSINC <Xd>, <Xn>, <Xm>, <cond>

```
integer d = UInt(Rd);
integer n = UInt(Rn);
integer m = UInt(Rm);
integer datasize = if sf == '1' then 64 else 32;
bits(4) condition = cond;
boolean else_inv = (op == '1');
boolean else_inc = (o2 == '1');
```

Alias conditions

Alias	is preferred when
CINC	$Rn == Rm \ \&\& \ Rn \neq '11111' \ \&\& \ \text{cond} \neq '111x'$
CSET	$Rn == Rm \ \&\& \ Rn == '11111' \ \&\& \ \text{cond} \neq '111x'$

Assembler Symbols

<code><Wd></code>	Is the 32-bit name of the general-purpose destination register, encoded in the "Rd" field.
<code><Wn></code>	Is the 32-bit name of the first general-purpose source register, encoded in the "Rn" field.
<code><Wm></code>	Is the 32-bit name of the second general-purpose source register, encoded in the "Rm" field.
<code><Xd></code>	Is the 64-bit name of the general-purpose destination register, encoded in the "Rd" field.
<code><Xn></code>	Is the 64-bit name of the first general-purpose source register, encoded in the "Rn" field.
<code><Xm></code>	Is the 64-bit name of the second general-purpose source register, encoded in the "Rm" field.
<code><cond></code>	Is one of the standard conditions, encoded in the "cond" field in the standard way.

Operation

```
bits(datasize) result;
bits(datasize) operand1 = X[n];
bits(datasize) operand2 = X[m];

if ConditionHolds(condition) then
    result = operand1;
```

```
else  
    result = operand2;  
    if else_inv then result = NOT(result);  
    if else_inc then result = result + 1;  
  
X[d] = result;
```

C5.6.54 CSINV

Conditional select inversion, returning the first input or inverted second input: $Rd = \text{if cond then } Rn \text{ else NOT } (Rm)$

This instruction is used by the aliases [CINV](#) and [CSETM](#). See the [Alias conditions](#) table for details of when each alias is preferred.

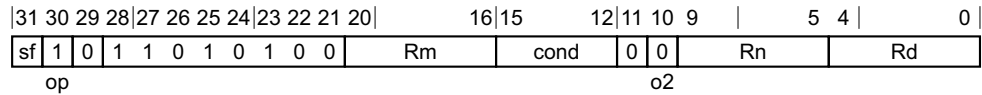

32-bit variant (sf = 0)

CSINV <Wd>, <Wn>, <Wm>, <cond>

64-bit variant (sf = 1)

CSINV <Xd>, <Xn>, <Xm>, <cond>

```
integer d = UInt(Rd);
integer n = UInt(Rn);
integer m = UInt(Rm);
integer datasize = if sf == '1' then 64 else 32;
bits(4) condition = cond;
boolean else_inv = (op == '1');
boolean else_inc = (o2 == '1');
```

Alias conditions

Alias	is preferred when
CINV	$Rn == Rm \ \&\& \ Rn \neq '11111' \ \&\& \ \text{cond} \neq '111x'$
CSETM	$Rn == Rm \ \&\& \ Rn == '11111' \ \&\& \ \text{cond} \neq '111x'$

Assembler Symbols

<Wd>	Is the 32-bit name of the general-purpose destination register, encoded in the "Rd" field.
<Wn>	Is the 32-bit name of the first general-purpose source register, encoded in the "Rn" field.
<Wm>	Is the 32-bit name of the second general-purpose source register, encoded in the "Rm" field.
<Xd>	Is the 64-bit name of the general-purpose destination register, encoded in the "Rd" field.
<Xn>	Is the 64-bit name of the first general-purpose source register, encoded in the "Rn" field.
<Xm>	Is the 64-bit name of the second general-purpose source register, encoded in the "Rm" field.
<cond>	Is one of the standard conditions, encoded in the "cond" field in the standard way.

Operation

```
bits(datasize) result;
bits(datasize) operand1 = X[n];
bits(datasize) operand2 = X[m];

if ConditionHolds(condition) then
    result = operand1;
else
```

```
    result = operand2;  
    if else_inv then result = NOT(result);  
    if else_inc then result = result + 1;  
  
X[d] = result;
```

C5.6.55 CSNEG

Conditional select negation, returning the first input or negated second input: $Rd = \text{if cond then } Rn \text{ else } -Rm$

This instruction is used by the alias [CNEG](#). See the [Alias conditions](#) table for details of when each alias is preferred.

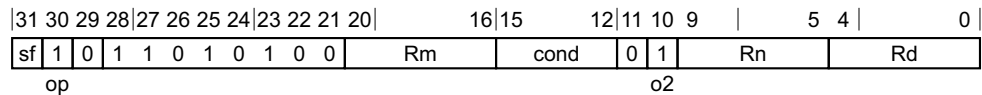

32-bit variant (sf = 0)

CSNEG <Wd>, <Wn>, <Wm>, <cond>

64-bit variant (sf = 1)

CSNEG <Xd>, <Xn>, <Xm>, <cond>

```
integer d = UInt(Rd);
integer n = UInt(Rn);
integer m = UInt(Rm);
integer datasize = if sf == '1' then 64 else 32;
bits(4) condition = cond;
boolean else_inv = (op == '1');
boolean else_inc = (o2 == '1');
```

Alias conditions

Alias	is preferred when
CNEG	$Rn == Rm \ \&\& \ \text{cond} \neq \text{'111x'}$

Assembler Symbols

<Wd>	Is the 32-bit name of the general-purpose destination register, encoded in the "Rd" field.
<Wn>	Is the 32-bit name of the first general-purpose source register, encoded in the "Rn" field.
<Wm>	Is the 32-bit name of the second general-purpose source register, encoded in the "Rm" field.
<Xd>	Is the 64-bit name of the general-purpose destination register, encoded in the "Rd" field.
<Xn>	Is the 64-bit name of the first general-purpose source register, encoded in the "Rn" field.
<Xm>	Is the 64-bit name of the second general-purpose source register, encoded in the "Rm" field.
<cond>	Is one of the standard conditions, encoded in the "cond" field in the standard way.

Operation

```
bits(datasize) result;
bits(datasize) operand1 = X[n];
bits(datasize) operand2 = X[m];

if ConditionHolds(condition) then
    result = operand1;
else
    result = operand2;
    if else_inv then result = NOT(result);
```

```
    if else_inc then result = result + 1;  
X[d] = result;
```

C5.6.56 DC

Data cache operation

This instruction is an alias of the [SYS](#) instruction.

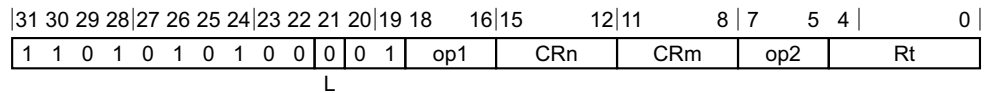

System variant

DC <dc_op>, <Xt>

is equivalent to

SYS #<op1>, <Cn>, <Cm>, #<op2>, <Xt>

and is the preferred disassembly when SysOp(op1,CRn,CRm,op2) == Sys_DC.

Assembler Symbols

- <dc_op> Is a DC operation name, as listed for the DC system operation group, encoded in "op1:CRn:CRm:op2".
- <op1> Is a 3-bit unsigned immediate, in the range 0 to 7, encoded in the "op1" field.
- <Cn> Is a name 'Cn', with 'n' in the range 0 to 15, encoded in the "CRn" field.
- <Cm> Is a name 'Cm', with 'm' in the range 0 to 15, encoded in the "CRm" field.
- <op2> Is a 3-bit unsigned immediate, in the range 0 to 7, encoded in the "op2" field.
- <Xt> Is the 64-bit name of the general-purpose source register, encoded in the "Rt" field.

C5.6.57 DCPS1

Debug switch to exception level 1

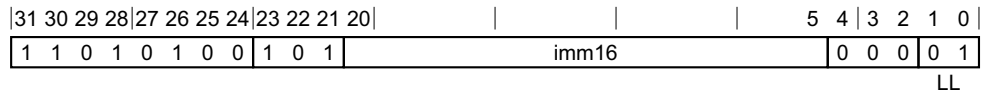

System variant

DCPS1 {#<imm>}

```
bits(2) target_level = LL;  
if !Halted() || LL == '00' then UnallocatedEncoding();
```

Assembler Symbols

<imm> Is an optional 16-bit unsigned immediate, in the range 0 to 65535, defaulting to 0 and encoded in the "imm16" field.

Operation

```
DCPSInstruction(target_level);
```

C5.6.58 DCPS2

Debug switch to exception level 2

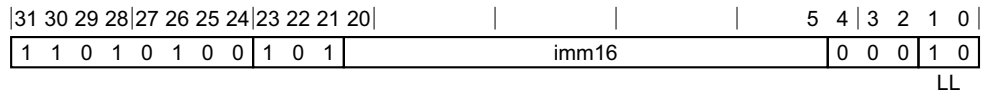

System variant

DCPS2 {#<imm>}

```
bits(2) target_level = LL;
if !Halted() || LL == '00' then UnallocatedEncoding();
```

Assembler Symbols

<imm> Is an optional 16-bit unsigned immediate, in the range 0 to 65535, defaulting to 0 and encoded in the "imm16" field.

Operation

```
DCPSInstruction(target_level);
```

C5.6.59 DCPS3

Debug switch to exception level 3

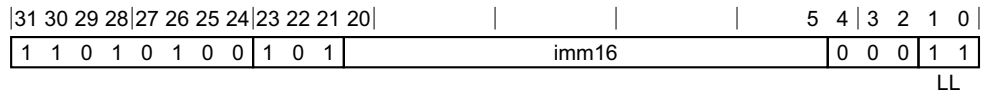

System variant

DCPS3 {#<imm>}

```
bits(2) target_level = LL;  
if !Halted() || LL == '00' then UnallocatedEncoding();
```

Assembler Symbols

<imm> Is an optional 16-bit unsigned immediate, in the range 0 to 65535, defaulting to 0 and encoded in the "imm16" field.

Operation

```
DCPSInstruction(target_level);
```

C5.6.60 DMB

Data memory barrier

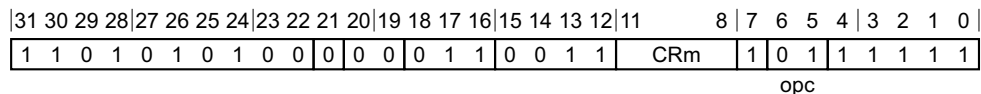

System variant

DMB <option>|<imm>

```
MemBarrierOp op;
MBReqDomain domain;
MBReqTypes types;

case opc of
  when '00' op = MemBarrierOp_DSB;
  when '01' op = MemBarrierOp_DMB;
  when '10' op = MemBarrierOp_ISB;
  otherwise UnallocatedEncoding();

case CRm<3:2> of
  when '00' domain = MBReqDomain_OuterShareable;
  when '01' domain = MBReqDomain_Nonshareable;
  when '10' domain = MBReqDomain_InnerShareable;
  when '11' domain = MBReqDomain_FullSystem;

case CRm<1:0> of
  when '01' types = MBReqTypes_Reads;
  when '10' types = MBReqTypes_Writes;
  when '11' types = MBReqTypes_All;
  otherwise
    types = MBReqTypes_All;
    domain = MBReqDomain_FullSystem;
```

Assembler Symbols

<option> Is a barrier option name,

OSHLD	when CRm = 0001
OSHST	when CRm = 0010
OSH	when CRm = 0011
NSHLD	when CRm = 0101
NSHST	when CRm = 0110
NSH	when CRm = 0111
#uimm4	when CRm = xx00
ISHLD	when CRm = 1001
ISHST	when CRm = 1010
ISH	when CRm = 1011
LD	when CRm = 1101
ST	when CRm = 1110
SY	when CRm = 1111

<imm> Is a 4-bit unsigned immediate, in the range 0 to 15, encoded in the "CRm" field.

Operation

```
case op of
  when MemBarrierOp_DSB
    DataSynchronizationBarrier(domain, types);
  when MemBarrierOp_DMB
    DataMemoryBarrier(domain, types);
  when MemBarrierOp_ISB
    InstructionSynchronizationBarrier();
```

C5.6.61 DRPS

Debug restore processor state

31	30	29	28	27	26	25	24	23	22	21	20	19	18	17	16	15	14	13	12	11	10	9	8	7	6	5	4	3	2	1	0	
1	1	0	1	0	1	1	0	1	0	1	1	1	1	1	1	0	0	0	0	0	0	0	1	1	1	1	1	0	0	0	0	0

System variant

DRPS

```
if !Halted() || PSTATE.EL == EL0 then UnallocatedEncoding();
```

Operation

```
DRPSInstruction();
```

C5.6.62 DSB

Data synchronization barrier

31	30	29	28	27	26	25	24	23	22	21	20	19	18	17	16	15	14	13	12	11	8	7	6	5	4	3	2	1	0
1	1	0	1	0	1	0	1	0	0	0	0	0	0	1	1	0	0	1	1	CRm	1	0	0	1	1	1	1	1	1

opc

System variant

DSB <option>|<imm>

```
MemBarrierOp op;
MBReqDomain domain;
MBReqTypes types;

case opc of
  when '00' op = MemBarrierOp_DSB;
  when '01' op = MemBarrierOp_DMB;
  when '10' op = MemBarrierOp_ISB;
  otherwise UnallocatedEncoding();

case CRm<3:2> of
  when '00' domain = MBReqDomain_OuterShareable;
  when '01' domain = MBReqDomain_Nonshareable;
  when '10' domain = MBReqDomain_InnerShareable;
  when '11' domain = MBReqDomain_FullSystem;

case CRm<1:0> of
  when '01' types = MBReqTypes_Reads;
  when '10' types = MBReqTypes_Writes;
  when '11' types = MBReqTypes_All;
  otherwise
    types = MBReqTypes_All;
    domain = MBReqDomain_FullSystem;
```

Assembler Symbols

<option> Is a barrier option name,

OSHLD	when CRm = 0001
OSHST	when CRm = 0010
OSH	when CRm = 0011
NSHLD	when CRm = 0101
NSHST	when CRm = 0110
NSH	when CRm = 0111
#uimm4	when CRm = xx00
ISHLD	when CRm = 1001
ISHST	when CRm = 1010
ISH	when CRm = 1011
LD	when CRm = 1101
ST	when CRm = 1110
SY	when CRm = 1111

<imm> Is a 4-bit unsigned immediate, in the range 0 to 15, encoded in the "CRm" field.

Operation

```
case op of
  when MemBarrierOp_DSB
    DataSynchronizationBarrier(domain, types);
  when MemBarrierOp_DMB
    DataMemoryBarrier(domain, types);
  when MemBarrierOp_ISB
    InstructionSynchronizationBarrier();
```

C5.6.63 EON (shifted register)

Bitwise exclusive OR NOT (shifted register): Rd = Rn EOR NOT shift(Rm, amount)

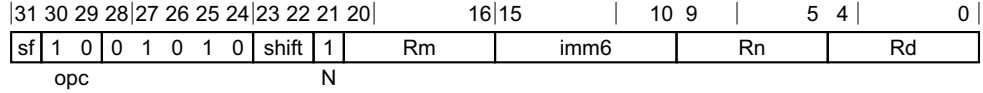

32-bit variant (sf = 0)

EON <Wd>, <Wn>, <Wm>{, <shift> #<amount>}

64-bit variant (sf = 1)

EON <Xd>, <Xn>, <Xm>{, <shift> #<amount>}

```
integer d = UInt(Rd);
integer n = UInt(Rn);
integer m = UInt(Rm);
integer datasize = if sf == '1' then 64 else 32;
boolean setflags;
LogicalOp op;
case opc of
    when '00' op = LogicalOp_AND; setflags = FALSE;
    when '01' op = LogicalOp_ORR; setflags = FALSE;
    when '10' op = LogicalOp_EOR; setflags = FALSE;
    when '11' op = LogicalOp_AND; setflags = TRUE;

if sf == '0' && imm6<5> == '1' then ReservedValue();

ShiftType shift_type = DecodeShift(shift);
integer shift_amount = UInt(imm6);
boolean invert = (N == '1');
```

Assembler Symbols

- <Wd> Is the 32-bit name of the general-purpose destination register, encoded in the "Rd" field.
- <Wn> Is the 32-bit name of the first general-purpose source register, encoded in the "Rn" field.
- <Wm> Is the 32-bit name of the second general-purpose source register, encoded in the "Rm" field.
- <Xd> Is the 64-bit name of the general-purpose destination register, encoded in the "Rd" field.
- <Xn> Is the 64-bit name of the first general-purpose source register, encoded in the "Rn" field.
- <Xm> Is the 64-bit name of the second general-purpose source register, encoded in the "Rm" field.
- <shift> Is the optional shift to be applied to the final source, defaulting to LSL and
 - LSL** when shift = 00
 - LSR** when shift = 01
 - ASR** when shift = 10
 - ROR** when shift = 11
- <amount> For the 32-bit variant: is the shift amount, in the range 0 to 31, defaulting to 0 and encoded in the "imm6" field.
- <amount> For the 64-bit variant: is the shift amount, in the range 0 to 63, defaulting to 0 and encoded in the "imm6" field,.

Operation

```
bits(datasize) operand1 = X[n];
bits(datasize) operand2 = ShiftReg(m, shift_type, shift_amount);

if invert then operand2 = NOT(operand2);

case op of
  when Logicalp_AND result = operand1 AND operand2;
  when Logicalp_ORR result = operand1 OR operand2;
  when Logicalp_EOR result = operand1 EOR operand2;

if setflags then
  PSTATE.<N,Z,C,V> = result<datasize-1>:IsZeroBit(result):'00';

X[d] = result;
```

C5.6.64 EOR (immediate)

Bitwise exclusive OR (immediate): Rd = Rn EOR imm

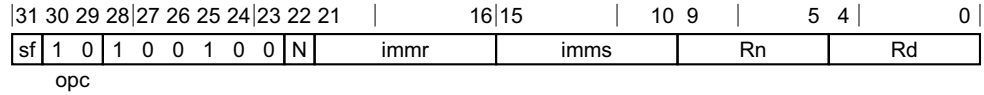

32-bit variant (sf = 0, N = 0)

EOR <Wd|WSP>, <Wn>, #<imm>

64-bit variant (sf = 1)

EOR <Xd|SP>, <Xn>, #<imm>

```
integer d = UInt(Rd);
integer n = UInt(Rn);
integer datasize = if sf == '1' then 64 else 32;
boolean setflags;
LogicalOp op;
case opc of
    when '00' op = LogicalOp_AND; setflags = FALSE;
    when '01' op = LogicalOp_ORR; setflags = FALSE;
    when '10' op = LogicalOp_EOR; setflags = FALSE;
    when '11' op = LogicalOp_AND; setflags = TRUE;

bits(datasize) imm;
if sf == '0' && N != '0' then ReservedValue();
(imm, -) = DecodeBitMasks(N, imms, immr, TRUE);
```

Assembler Symbols

<Wd WSP>	Is the 32-bit name of the destination general-purpose register or stack pointer, encoded in the "Rd" field.
<Wn>	Is the 32-bit name of the general-purpose source register, encoded in the "Rn" field.
<Xd SP>	Is the 64-bit name of the destination general-purpose register or stack pointer, encoded in the "Rd" field.
<Xn>	Is the 64-bit name of the general-purpose source register, encoded in the "Rn" field.
<imm>	Is the bitmask immediate, encoded in "N:imms:immr".

Operation

```
bits(datasize) result;
bits(datasize) operand1 = X[n];
bits(datasize) operand2 = imm;

case op of
    when LogicalOp_AND result = operand1 AND operand2;
    when LogicalOp_ORR result = operand1 OR operand2;
    when LogicalOp_EOR result = operand1 EOR operand2;

if setflags then
    PSTATE.<N,Z,C,V> = result<datasize-1>:IsZeroBit(result):'00';

if d == 31 && !setflags then
    SP[] = result;
else
    X[d] = result;
```

C5.6.65 EOR (shifted register)

Bitwise exclusive OR (shifted register): $Rd = Rn \text{ EOR } \text{shift}(Rm, \text{amount})$

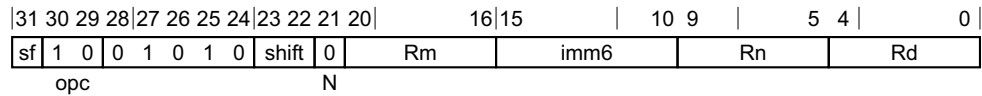

32-bit variant (sf = 0)

EOR <Wd>, <Wn>, <Wm>{, <shift> #<amount>}

64-bit variant (sf = 1)

EOR <Xd>, <Xn>, <Xm>{, <shift> #<amount>}

```
integer d = UInt(Rd);
integer n = UInt(Rn);
integer m = UInt(Rm);
integer datasize = if sf == '1' then 64 else 32;
boolean setflags;
LogicalOp op;
case opc of
  when '00' op = LogicalOp_AND; setflags = FALSE;
  when '01' op = LogicalOp_ORR; setflags = FALSE;
  when '10' op = LogicalOp_EOR; setflags = FALSE;
  when '11' op = LogicalOp_AND; setflags = TRUE;

if sf == '0' && imm6<5> == '1' then ReservedValue();

ShiftType shift_type = DecodeShift(shift);
integer shift_amount = UInt(imm6);
boolean invert = (N == '1');
```

Assembler Symbols

<Wd>	Is the 32-bit name of the general-purpose destination register, encoded in the "Rd" field.								
<Wn>	Is the 32-bit name of the first general-purpose source register, encoded in the "Rn" field.								
<Wm>	Is the 32-bit name of the second general-purpose source register, encoded in the "Rm" field.								
<Xd>	Is the 64-bit name of the general-purpose destination register, encoded in the "Rd" field.								
<Xn>	Is the 64-bit name of the first general-purpose source register, encoded in the "Rn" field.								
<Xm>	Is the 64-bit name of the second general-purpose source register, encoded in the "Rm" field.								
<shift>	Is the optional shift to be applied to the final source, defaulting to LSL and <table style="margin-left: 20px; border-collapse: collapse;"> <tr><td>LSL</td><td>when shift = 00</td></tr> <tr><td>LSR</td><td>when shift = 01</td></tr> <tr><td>ASR</td><td>when shift = 10</td></tr> <tr><td>ROR</td><td>when shift = 11</td></tr> </table>	LSL	when shift = 00	LSR	when shift = 01	ASR	when shift = 10	ROR	when shift = 11
LSL	when shift = 00								
LSR	when shift = 01								
ASR	when shift = 10								
ROR	when shift = 11								
<amount>	For the 32-bit variant: is the shift amount, in the range 0 to 31, defaulting to 0 and encoded in the "imm6" field.								
<amount>	For the 64-bit variant: is the shift amount, in the range 0 to 63, defaulting to 0 and encoded in the "imm6" field,.								

Operation

```
bits(datasize) operand1 = X[n];
bits(datasize) operand2 = ShiftReg(m, shift_type, shift_amount);

if invert then operand2 = NOT(operand2);

case op of
  when Logicalp_AND result = operand1 AND operand2;
  when Logicalp_ORR result = operand1 OR operand2;
  when Logicalp_EOR result = operand1 EOR operand2;

if setflags then
  PSTATE.<N,Z,C,V> = result<datasize-1>:IsZeroBit(result):'00';

X[d] = result;
```

C5.6.66 ERET

Exception return using current ELR and SPSR

31	30	29	28	27	26	25	24	23	22	21	20	19	18	17	16	15	14	13	12	11	10	9	8	7	6	5	4	3	2	1	0	
1	1	0	1	0	1	1	0	1	0	0	1	1	1	1	1	0	0	0	0	0	0	0	1	1	1	1	1	0	0	0	0	0

System variant

ERET

if PSTATE.EL == EL0 then [UnallocatedEncoding\(\)](#);

Operation

[AArch64.ExceptionReturn\(ELR\[\], SPSR\[\]\)](#);

C5.6.67 EXTR

Extract register from pair of registers

This instruction is used by the alias [ROR \(immediate\)](#). See the [Alias conditions](#) table for details of when each alias is preferred.

31	30	29	28	27	26	25	24	23	22	21	20	16	15	10	9	5	4	0
sf	0	0	1	0	0	1	1	1	N	0	Rm	imms	Rn	Rd				

32-bit variant (sf = 0, N = 0, imms = 0xxxxx)

EXTR <Wd>, <Wn>, <Wm>, #<lsb>

64-bit variant (sf = 1, N = 1)

EXTR <Xd>, <Xn>, <Xm>, #<lsb>

```
integer d = UInt(Rd);
integer n = UInt(Rn);
integer m = UInt(Rm);
integer datasize = if sf == '1' then 64 else 32;
integer lsb;

if N != sf then UnallocatedEncoding();
if sf == '0' && imms<5> == '1' then ReservedValue();
lsb = UInt(imms);
```

Alias conditions

Alias	is preferred when
ROR (immediate)	Rn == Rm

Assembler Symbols

<Wd>	Is the 32-bit name of the general-purpose destination register, encoded in the "Rd" field.
<Wn>	Is the 32-bit name of the first general-purpose source register, encoded in the "Rn" field.
<Wm>	Is the 32-bit name of the second general-purpose source register, encoded in the "Rm" field.
<Xd>	Is the 64-bit name of the general-purpose destination register, encoded in the "Rd" field.
<Xn>	Is the 64-bit name of the first general-purpose source register, encoded in the "Rn" field.
<Xm>	Is the 64-bit name of the second general-purpose source register, encoded in the "Rm" field.
<lsb>	For the 32-bit variant: is the least significant bit position from which to extract, in the range 0 to 31, encoded in the "imms" field.
<lsb>	For the 64-bit variant: is the least significant bit position from which to extract, in the range 0 to 63, encoded in the "imms" field.

Operation

```
bits(datasize) result;
bits(datasize) operand1 = X[n];
bits(datasize) operand2 = X[m];
```

```
bits(2*datasize) concat = operand1:operand2;  
result = concat<lsb+datasize-1:lsb>;  
X[d] = result;
```

C5.6.68 HINT

Hint instruction

This instruction is used by the aliases [NOP](#), [SEVL](#), [SEV](#), [WFE](#), [WFI](#), and [YIELD](#). See the *Alias conditions* table for details of when each alias is preferred.

31	30	29	28	27	26	25	24	23	22	21	20	19	18	17	16	15	14	13	12	11	8	7	5	4	3	2	1	0
1	1	0	1	0	1	0	1	0	0	0	0	0	1	1	0	0	1	0			CRm		op2	1	1	1	1	1

System variant

HINT #<imm>

[SystemHintOp](#) op;

```

case CRm:op2 of
  when '0000 000' op = SystemHintOp\_NOP;
  when '0000 001' op = SystemHintOp\_YIELD;
  when '0000 010' op = SystemHintOp\_WFE;
  when '0000 011' op = SystemHintOp\_WFI;
  when '0000 100' op = SystemHintOp\_SEV;
  when '0000 101' op = SystemHintOp\_SEVL;
  otherwise op = SystemHintOp\_NOP;

```

Alias conditions

Alias	is preferred when
NOP	<code>UInt(CRm:op2) == 0</code>
SEVL	<code>UInt(CRm:op2) == 5</code>
SEV	<code>UInt(CRm:op2) == 4</code>
WFE	<code>UInt(CRm:op2) == 2</code>
WFI	<code>UInt(CRm:op2) == 3</code>
YIELD	<code>UInt(CRm:op2) == 1</code>

Assembler Symbols

<imm> Is a 7-bit unsigned immediate, in the range 0 to 127, encoded in "CRm:op2".

Operation

```

case op of
  when SystemHintOp\_YIELD
    Hint\_Yield();

  when SystemHintOp\_WFE
    if EventRegistered() then
      ClearEventRegister();
    else
      if PSTATE.EL == EL0 && SCTLR_EL1.nTWE == '0' then
        AArch64.WFxTrap(EL1, TRUE);
      elseif HaveEL(EL2) && !IsSecure() && PSTATE.EL != EL2 && HCR_EL2.TWE == '1' then
        AArch64.WFxTrap(EL2, TRUE);

```



```
    elsif HaveEL(EL3) && PSTATE.EL != EL3 && SCR_EL3.TWE == '1' then
        AArch64.WFxTrap(EL3, TRUE);
    else
        WaitForEvent();

when SystemHintOp_WFI
    if !InterruptPending() then
        if PSTATE.EL == EL0 && SCTLR_EL1.nTWI == '0' then
            AArch64.WFxTrap(EL1, FALSE);
        elsif HaveEL(EL2) && !IsSecure() && PSTATE.EL != EL2 && HCR_EL2.TWI == '1' then
            AArch64.WFxTrap(EL2, FALSE);
        elsif HaveEL(EL3) && PSTATE.EL != EL3 && SCR_EL3.TWI == '1' then
            AArch64.WFxTrap(EL3, FALSE);
        else
            WaitForInterrupt();

when SystemHintOp_SEV
    SendEvent();

when SystemHintOp_SEVL
    EventRegisterSet();

otherwise // do nothing
```

C5.6.69 HLT

Halting debug-mode breakpoint

31	30	29	28	27	26	25	24	23	22	21	20					5	4	3	2	1	0	
1	1	0	1	0	1	0	0	0	1	0		imm16						0	0	0	0	0

System variant

HLT #<imm>

```
if EDSCR.HDE == '0' || !HaltingAllowed() then UnallocatedEncoding();
```

Assembler Symbols

<imm> Is a 16-bit unsigned immediate, in the range 0 to 65535, encoded in the "imm16" field.

Operation

```
Halt(DebugHalt_HaltInstruction);
```

C5.6.70 HVC

Generate exception targeting exception level 2

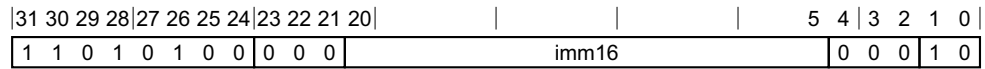

System variant

HVC #<imm>

bits(16) imm = imm16;

Assembler Symbols

<imm> Is a 16-bit unsigned immediate, in the range 0 to 65535, encoded in the "imm16" field.

Operation

```
if !HaveEL(EL2) || PSTATE.EL == EL0 || (PSTATE.EL == EL1 && IsSecure()) then
    UnallocatedEncoding();
```

```
hvc_enable = if HaveEL(EL3) then SCR_EL3.HCE else NOT(HCR_EL2.HCD);
```

```
if hvc_enable == '0' then
    UnallocatedEncoding();
```

```
else
    AArch64.CallHypervisor(imm);
```

C5.6.71 IC

Instruction cache operation

This instruction is an alias of the [SYS](#) instruction.

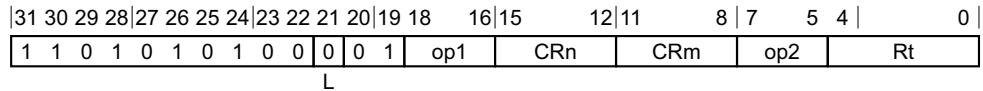

System variant

IC <ic_op>{, <Xt>}

is equivalent to

SYS #<op1>, <Cn>, <Cm>, #<op2>{, <Xt>}

and is the preferred disassembly when SysOp(op1,CRn,CRm,op2) == Sys_IC.

Assembler Symbols

- <ic_op> Is an IC operation name, as listed for the IC system operation pages, encoded in "op1:CRn:CRm:op2".
- <op1> Is a 3-bit unsigned immediate, in the range 0 to 7, encoded in the "op1" field.
- <Cn> Is a name 'Cn', with 'n' in the range 0 to 15, encoded in the "CRn" field.
- <Cm> Is a name 'Cm', with 'm' in the range 0 to 15, encoded in the "CRm" field.
- <op2> Is a 3-bit unsigned immediate, in the range 0 to 7, encoded in the "op2" field.
- <Xt> Is the 64-bit name of the optional general-purpose source register, defaulting to '11111', encoded in the "Rt" field.

C5.6.72 ISB

Instruction synchronization barrier

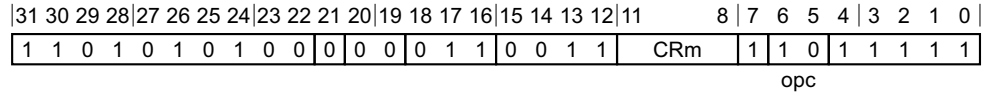

System variant

ISB {<option>|<imm>}

```

MemBarrierOp op;
MReqDomain domain;
MReqTypes types;

case opc of
  when '00' op = MemBarrierOp_DSB;
  when '01' op = MemBarrierOp_DMB;
  when '10' op = MemBarrierOp_ISB;
  otherwise UnallocatedEncoding();

case CRm<3:2> of
  when '00' domain = MReqDomain_OuterShareable;
  when '01' domain = MReqDomain_Nonshareable;
  when '10' domain = MReqDomain_InnerShareable;
  when '11' domain = MReqDomain_FullSystem;

case CRm<1:0> of
  when '01' types = MReqTypes_Reads;
  when '10' types = MReqTypes_Writes;
  when '11' types = MReqTypes_All;
  otherwise
    types = MReqTypes_All;
    domain = MReqDomain_FullSystem;

```

Assembler Symbols

- <option> Is the barrier option name SY, encoded as '1111' in the "CRm" field.
- <imm> Is an optional 4-bit unsigned immediate, in the range 0 to 15, defaulting to 15 and encoded in the "CRm" field.

Operation

```

case op of
  when MemBarrierOp_DSB
    DataSynchronizationBarrier(domain, types);
  when MemBarrierOp_DMB
    DataMemoryBarrier(domain, types);
  when MemBarrierOp_ISB
    InstructionSynchronizationBarrier();

```

C5.6.73 LDAR

Load-acquire register

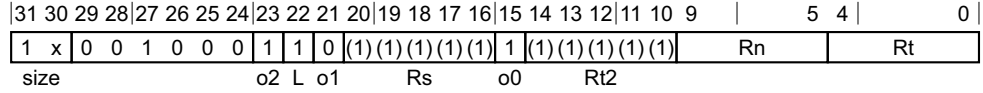

32-bit variant (size = 10)

LDAR <Wt>, [<Xn|SP>{,#0}]

64-bit variant (size = 11)

LDAR <Xt>, [<Xn|SP>{,#0}]

```
integer n = UInt(Rn);
integer t = UInt(Rt);
integer t2 = UInt(Rt2); // ignored by load/store single register
integer s = UInt(Rs); // ignored by all loads and store-release
```

```
if o2:o1:o0 == '100' || o2:o1:o0 == '11x' then UnallocatedEncoding();
if o1 == '1' && size<L> == '0' then UnallocatedEncoding();
```

```
AccType acctype = if o0 == '1' then AccType_ORDERED else AccType_ATOMIC;
boolean excl = (o2 == '0');
boolean pair = (o1 == '1');
MemOp memop = if L == '1' then MemOp_LOAD else MemOp_STORE;
integer elsize = 8 << UInt(size);
integer regsize = if elsize == 64 then 64 else 32;
integer datasize = if pair then elsize * 2 else elsize;
```

Assembler Symbols

- <Wt> Is the 32-bit name of the general-purpose register to be transferred, encoded in the "Rt" field.
- <Xt> Is the 64-bit name of the general-purpose register to be transferred, encoded in the "Rt" field.
- <Xn|SP> Is the 64-bit name of the general-purpose base register or stack pointer, encoded in the "Rn" field.

Operation

```
bits(64) address;
bits(datasize) data;
constant integer dbytes = datasize DIV 8;
boolean rt_unknown = FALSE;
boolean rn_unknown = FALSE;

if memop == MemOp_LOAD && pair && t == t2 then
    Constraint c = ConstrainUnpredictable();
    assert c IN {Constraint_UNKNOWN, Constraint_UNDEF, Constraint_NOP};
    case c of
        when Constraint_UNKNOWN    rt_unknown = TRUE; // result is UNKNOWN
        when Constraint_UNDEF      UnallocatedEncoding();
        when Constraint_NOP        EndOfInstruction();

if memop == MemOp_STORE && excl then
    if s == t || (pair && s == t2) then
        Constraint c = ConstrainUnpredictable();
        assert c IN {Constraint_UNKNOWN, Constraint_NONE, Constraint_UNDEF, Constraint_NOP};
        case c of
            when Constraint_UNKNOWN    rt_unknown = TRUE; // store UNKNOWN value
            when Constraint_NONE      rt_unknown = FALSE; // store original value
```

```

        when Constraint_UNDEF      UnallocatedEncoding();
        when Constraint_NOP        EndOfInstruction();
    if s == n && n != 31 then
        Constraint c = ConstrainUnpredictable();
        assert c IN {Constraint_UNKNOWN, Constraint_NONE, Constraint_UNDEF, Constraint_NOP};
        case c of
            when Constraint_UNKNOWN    rn_unknown = TRUE;    // address is UNKNOWN
            when Constraint_NONE        rn_unknown = FALSE;   // address is original base
            when Constraint_UNDEF      UnallocatedEncoding();
            when Constraint_NOP        EndOfInstruction();

    if n == 31 then
        CheckSPAlignment();
        address = SP[];
    elsif rn_unknown then
        address = bits(64) UNKNOWN;
    else
        address = X[n];

    case memop of
        when MemOp_STORE
            if rt_unknown then
                data = bits(datasize) UNKNOWN;
            elsif pair then
                assert excl;
                bits(datasize DIV 2) e11 = X[t];
                bits(datasize DIV 2) e12 = X[t2];
                data = if BigEndian() then e11 : e12 else e12 : e11;
            else
                data = X[t];

            if excl then
                // store {release} exclusive register|pair (atomic)
                bit status = '1';
                // Check whether the Exclusive Monitors are set to include the
                // physical memory locations corresponding to virtual address
                // range [address, address+dbytes-1].
                if AArch64.ExclusiveMonitorsPass(address, dbytes) then
                    // This atomic write will be rejected if it does not refer
                    // to the same physical locations after address translation.
                    Mem[address, dbytes, acctype] = data;
                    status = ExclusiveMonitorsStatus();
                    X[s] = ZeroExtend(status, 32);
                else
                    // store release register (atomic)
                    Mem[address, dbytes, acctype] = data;

        when MemOp_LOAD
            if excl then
                // Tell the Exclusive Monitors to record a sequence of one or more atomic
                // memory reads from virtual address range [address, address+dbytes-1].
                // The Exclusive Monitor will only be set if all the reads are from the
                // same dbytes-aligned physical address, to allow for the possibility of
                // an atomicity break if the translation is changed between reads.
                AArch64.SetExclusiveMonitors(address, dbytes);

            if pair then
                // load exclusive pair
                assert excl;
                if rt_unknown then
                    // ConstrainedUNPREDICTABLE case
                    X[t] = bits(datasize) UNKNOWN;
                elsif elsize == 32 then
                    // 32-bit load exclusive pair (atomic)
                    data = Mem[address, dbytes, acctype];
                    if BigEndian() then
                        X[t] = data<datasize-1:elsize>;
                        X[t2] = data<elsize-1:0>;

```

```
        else
            X[t] = data<elsize-1:0>;
            X[t2] = data<datasize-1:elsize>;
    else // elsize == 64
        // 64-bit load exclusive pair (not atomic),
        // but must be 128-bit aligned
        if address != Align(address, dbytes) then
            iswrite = FALSE;
            secondstage = FALSE;
            AArch64.Abort(address, AArch64.AlignmentFault(acctype, iswrite, secondstage));
        X[t] = Mem[address + 0, 8, acctype];
        X[t2] = Mem[address + 8, 8, acctype];
    else
        // load {acquire} {exclusive} single register
        data = Mem[address, dbytes, acctype];
        X[t] = ZeroExtend(data, regsize);
```

C5.6.74 LDARB

Load-acquire register byte

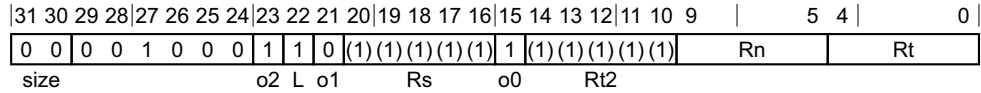

No offset variant

LDARB <Wt>, [<Xn|SP>{, #0}]

```
integer n = UInt(Rn);
integer t = UInt(Rt);
integer t2 = UInt(Rt2); // ignored by load/store single register
integer s = UInt(Rs); // ignored by all loads and store-release
```

```
if o2:o1:o0 == '100' || o2:o1:o0 == '11x' then UnallocatedEncoding();
if o1 == '1' && size<1> == '0' then UnallocatedEncoding();
```

```
AccType acctype = if o0 == '1' then AccType_ORDERED else AccType_ATOMIC;
boolean excl = (o2 == '0');
boolean pair = (o1 == '1');
MemOp memop = if L == '1' then MemOp_LOAD else MemOp_STORE;
integer elsize = 8 << UInt(size);
integer regsize = if elsize == 64 then 64 else 32;
integer datasize = if pair then elsize * 2 else elsize;
```

Assembler Symbols

<Wt> Is the 32-bit name of the general-purpose register to be transferred, encoded in the "Rt" field.

<Xn|SP> Is the 64-bit name of the general-purpose base register or stack pointer, encoded in the "Rn" field.

Operation

```
bits(64) address;
bits(datasize) data;
constant integer dbytes = datasize DIV 8;
boolean rt_unknown = FALSE;
boolean rn_unknown = FALSE;

if memop == MemOp_LOAD && pair && t == t2 then
    Constraint c = ConstrainUnpredictable();
    assert c IN {Constraint_UNKNOWN, Constraint_UNDEF, Constraint_NOP};
    case c of
        when Constraint_UNKNOWN    rt_unknown = TRUE; // result is UNKNOWN
        when Constraint_UNDEF      UnallocatedEncoding();
        when Constraint_NOP        EndOfInstruction();

if memop == MemOp_STORE && excl then
    if s == t || (pair && s == t2) then
        Constraint c = ConstrainUnpredictable();
        assert c IN {Constraint_UNKNOWN, Constraint_NONE, Constraint_UNDEF, Constraint_NOP};
        case c of
            when Constraint_UNKNOWN    rt_unknown = TRUE; // store UNKNOWN value
            when Constraint_NONE        rt_unknown = FALSE; // store original value
            when Constraint_UNDEF      UnallocatedEncoding();
            when Constraint_NOP        EndOfInstruction();
    if s == n && n != 31 then
        Constraint c = ConstrainUnpredictable();
        assert c IN {Constraint_UNKNOWN, Constraint_NONE, Constraint_UNDEF, Constraint_NOP};
```

```

        case c of
            when Constraint_UNKNOWN    rn_unknown = TRUE;    // address is UNKNOWN
            when Constraint_NONE       rn_unknown = FALSE;   // address is original base
            when Constraint_UNDEF     UnallocatedEncoding();
            when Constraint_NOP       EndOfInstruction();

if n == 31 then
    CheckSPAlignment();
    address = SP[];
elseif rn_unknown then
    address = bits(64) UNKNOWN;
else
    address = X[n];

case memop of
    when MemOp_STORE
        if rt_unknown then
            data = bits(datasize) UNKNOWN;
        elseif pair then
            assert excl;
            bits(datasize DIV 2) e11 = X[t];
            bits(datasize DIV 2) e12 = X[t2];
            data = if BigEndian() then e11 : e12 else e12 : e11;
        else
            data = X[t];

        if excl then
            // store {release} exclusive register|pair (atomic)
            bit status = '1';
            // Check whether the Exclusive Monitors are set to include the
            // physical memory locations corresponding to virtual address
            // range [address, address+dbytes-1].
            if AArch64.ExclusiveMonitorsPass(address, dbytes) then
                // This atomic write will be rejected if it does not refer
                // to the same physical locations after address translation.
                Mem[address, dbytes, acctype] = data;
                status = ExclusiveMonitorsStatus();
                X[s] = ZeroExtend(status, 32);
            else
                // store release register (atomic)
                Mem[address, dbytes, acctype] = data;

    when MemOp_LOAD
        if excl then
            // Tell the Exclusive Monitors to record a sequence of one or more atomic
            // memory reads from virtual address range [address, address+dbytes-1].
            // The Exclusive Monitor will only be set if all the reads are from the
            // same dbytes-aligned physical address, to allow for the possibility of
            // an atomicity break if the translation is changed between reads.
            AArch64.SetExclusiveMonitors(address, dbytes);

        if pair then
            // load exclusive pair
            assert excl;
            if rt_unknown then
                // ConstrainedUNPREDICTABLE case
                X[t] = bits(datasize) UNKNOWN;
            elseif elsize == 32 then
                // 32-bit load exclusive pair (atomic)
                data = Mem[address, dbytes, acctype];
                if BigEndian() then
                    X[t] = data<datasize-1:elsize>;
                    X[t2] = data<elsize-1:0>;
                else
                    X[t] = data<elsize-1:0>;
                    X[t2] = data<datasize-1:elsize>;
            else // elsize == 64
                // 64-bit load exclusive pair (not atomic),

```

```
// but must be 128-bit aligned
if address != Align(address, dbytes) then
    iswrite = FALSE;
    secondstage = FALSE;
    AArch64.Abort(address, AArch64.AlignmentFault(acctype, iswrite, secondstage));
X[t] = Mem[address + 0, 8, acctype];
X[t2] = Mem[address + 8, 8, acctype];
else
    // load {acquire} {exclusive} single register
    data = Mem[address, dbytes, acctype];
    X[t] = ZeroExtend(data, regsize);
```

C5.6.75 LDARH

Load-acquire register halfword

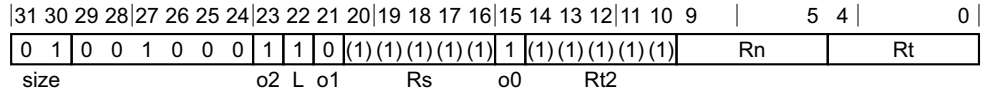

No offset variant

LDARH <Wt>, [<Xn|SP>{, #0}]

```
integer n = UInt(Rn);
integer t = UInt(Rt);
integer t2 = UInt(Rt2); // ignored by load/store single register
integer s = UInt(Rs); // ignored by all loads and store-release
```

```
if o2:o1:o0 == '100' || o2:o1:o0 == '11x' then UnallocatedEncoding();
if o1 == '1' && size<1> == '0' then UnallocatedEncoding();
```

```
AccType acctype = if o0 == '1' then AccType_ORDERED else AccType_ATOMIC;
boolean excl = (o2 == '0');
boolean pair = (o1 == '1');
MemOp memop = if L == '1' then MemOp_LOAD else MemOp_STORE;
integer elsize = 8 << UInt(size);
integer regsize = if elsize == 64 then 64 else 32;
integer datasize = if pair then elsize * 2 else elsize;
```

Assembler Symbols

- <Wt> Is the 32-bit name of the general-purpose register to be transferred, encoded in the "Rt" field.
- <Xn|SP> Is the 64-bit name of the general-purpose base register or stack pointer, encoded in the "Rn" field.

Operation

```
bits(64) address;
bits(datasize) data;
constant integer dbytes = datasize DIV 8;
boolean rt_unknown = FALSE;
boolean rn_unknown = FALSE;

if memop == MemOp_LOAD && pair && t == t2 then
  Constraint c = ConstrainUnpredictable();
  assert c IN {Constraint_UNKNOWN, Constraint_UNDEF, Constraint_NOP};
  case c of
    when Constraint_UNKNOWN rt_unknown = TRUE; // result is UNKNOWN
    when Constraint_UNDEF UnallocatedEncoding();
    when Constraint_NOP EndOfInstruction();

if memop == MemOp_STORE && excl then
  if s == t || (pair && s == t2) then
    Constraint c = ConstrainUnpredictable();
    assert c IN {Constraint_UNKNOWN, Constraint_NONE, Constraint_UNDEF, Constraint_NOP};
    case c of
      when Constraint_UNKNOWN rt_unknown = TRUE; // store UNKNOWN value
      when Constraint_NONE rt_unknown = FALSE; // store original value
      when Constraint_UNDEF UnallocatedEncoding();
      when Constraint_NOP EndOfInstruction();
  if s == n && n != 31 then
    Constraint c = ConstrainUnpredictable();
    assert c IN {Constraint_UNKNOWN, Constraint_NONE, Constraint_UNDEF, Constraint_NOP};
```

```

    case c of
        when Constraint_UNKNOWN    rn_unknown = TRUE;    // address is UNKNOWN
        when Constraint_NONE       rn_unknown = FALSE;   // address is original base
        when Constraint_UNDEF     UnallocatedEncoding();
        when Constraint_NOP       EndOfInstruction();

    if n == 31 then
        CheckSPAlignment();
        address = SP[];
    elsif rn_unknown then
        address = bits(64) UNKNOWN;
    else
        address = X[n];

    case memop of
        when MemOp_STORE
            if rt_unknown then
                data = bits(datasize) UNKNOWN;
            elsif pair then
                assert excl;
                bits(datasize DIV 2) e11 = X[t];
                bits(datasize DIV 2) e12 = X[t2];
                data = if BigEndian() then e11 : e12 else e12 : e11;
            else
                data = X[t];

            if excl then
                // store {release} exclusive register|pair (atomic)
                bit status = '1';
                // Check whether the Exclusive Monitors are set to include the
                // physical memory locations corresponding to virtual address
                // range [address, address+dbytes-1].
                if AArch64.ExclusiveMonitorsPass(address, dbytes) then
                    // This atomic write will be rejected if it does not refer
                    // to the same physical locations after address translation.
                    Mem[address, dbytes, acctype] = data;
                    status = ExclusiveMonitorsStatus();
                    X[s] = ZeroExtend(status, 32);
                else
                    // store release register (atomic)
                    Mem[address, dbytes, acctype] = data;

        when MemOp_LOAD
            if excl then
                // Tell the Exclusive Monitors to record a sequence of one or more atomic
                // memory reads from virtual address range [address, address+dbytes-1].
                // The Exclusive Monitor will only be set if all the reads are from the
                // same dbytes-aligned physical address, to allow for the possibility of
                // an atomicity break if the translation is changed between reads.
                AArch64.SetExclusiveMonitors(address, dbytes);

            if pair then
                // load exclusive pair
                assert excl;
                if rt_unknown then
                    // ConstrainedUNPREDICTABLE case
                    X[t] = bits(datasize) UNKNOWN;
                elsif elsize == 32 then
                    // 32-bit load exclusive pair (atomic)
                    data = Mem[address, dbytes, acctype];
                    if BigEndian() then
                        X[t] = data<datasize-1:elsize>;
                        X[t2] = data<elsize-1:0>;
                    else
                        X[t] = data<elsize-1:0>;
                        X[t2] = data<datasize-1:elsize>;
                else // elsize == 64
                    // 64-bit load exclusive pair (not atomic),

```

```
// but must be 128-bit aligned
if address != Align(address, dbytes) then
    iswrite = FALSE;
    secondstage = FALSE;
    AArch64.Abort(address, AArch64.AlignmentFault(acctype, iswrite, secondstage));
X[t] = Mem[address + 0, 8, acctype];
X[t2] = Mem[address + 8, 8, acctype];
else
    // load {acquire} {exclusive} single register
    data = Mem[address, dbytes, acctype];
    X[t] = ZeroExtend(data, regsize);
```

C5.6.76 LDAXP

Load-acquire exclusive pair of registers

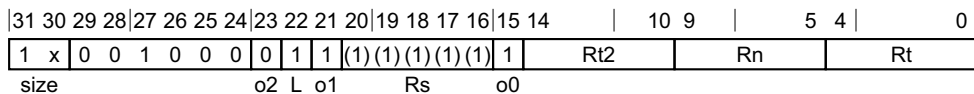

32-bit variant (size = 10)

LDAXP <Wt1>, <Wt2>, [<Xn|SP>{,#0}]

64-bit variant (size = 11)

LDAXP <Xt1>, <Xt2>, [<Xn|SP>{,#0}]

```
integer n = UInt(Rn);
integer t = UInt(Rt);
integer t2 = UInt(Rt2); // ignored by load/store single register
integer s = UInt(Rs); // ignored by all loads and store-release
```

```
if o2:o1:o0 == '100' || o2:o1:o0 == '11x' then UnallocatedEncoding();
if o1 == '1' && size<L> == '0' then UnallocatedEncoding();
```

```
AccType acctype = if o0 == '1' then AccType_ORDERED else AccType_ATOMIC;
boolean excl = (o2 == '0');
boolean pair = (o1 == '1');
MemOp memop = if L == '1' then MemOp_LOAD else MemOp_STORE;
integer elsize = 8 << UInt(size);
integer regsize = if elsize == 64 then 64 else 32;
integer datasize = if pair then elsize * 2 else elsize;
```

Assembler Symbols

- <Wt1> Is the 32-bit name of the first general-purpose register to be transferred, encoded in the "Rt" field.
- <Wt2> Is the 32-bit name of the second general-purpose register to be transferred, encoded in the "Rt2" field.
- <Xt1> Is the 64-bit name of the first general-purpose register to be transferred, encoded in the "Rt" field.
- <Xt2> Is the 64-bit name of the second general-purpose register to be transferred, encoded in the "Rt2" field.
- <Xn|SP> Is the 64-bit name of the general-purpose base register or stack pointer, encoded in the "Rn" field.

Operation

```
bits(64) address;
bits(datasize) data;
constant integer dbytes = datasize DIV 8;
boolean rt_unknown = FALSE;
boolean rn_unknown = FALSE;

if memop == MemOp_LOAD && pair && t == t2 then
    Constraint c = ConstrainUnpredictable();
    assert c IN {Constraint_UNKNOWN, Constraint_UNDEF, Constraint_NOP};
    case c of
        when Constraint_UNKNOWN    rt_unknown = TRUE; // result is UNKNOWN
        when Constraint_UNDEF       UnallocatedEncoding();
        when Constraint_NOP         EndOfInstruction();

if memop == MemOp_STORE && excl then
```

```

if s == t || (pair && s == t2) then
    Constraint c = ConstrainUnpredictable();
    assert c IN {Constraint_UNKNOWN, Constraint_NONE, Constraint_UNDEF, Constraint_NOP};
    case c of
        when Constraint_UNKNOWN    rt_unknown = TRUE;    // store UNKNOWN value
        when Constraint_NONE        rt_unknown = FALSE;    // store original value
        when Constraint_UNDEF        UnallocatedEncoding();
        when Constraint_NOP          EndOfInstruction();
if s == n && n != 31 then
    Constraint c = ConstrainUnpredictable();
    assert c IN {Constraint_UNKNOWN, Constraint_NONE, Constraint_UNDEF, Constraint_NOP};
    case c of
        when Constraint_UNKNOWN    rn_unknown = TRUE;    // address is UNKNOWN
        when Constraint_NONE        rn_unknown = FALSE;    // address is original base
        when Constraint_UNDEF        UnallocatedEncoding();
        when Constraint_NOP          EndOfInstruction();

if n == 31 then
    CheckSPAlignment();
    address = SP[];
elseif rn_unknown then
    address = bits(64) UNKNOWN;
else
    address = X[n];

case memop of
    when MemOp_STORE
        if rt_unknown then
            data = bits(datasize) UNKNOWN;
        elseif pair then
            assert excl;
            bits(datasize DIV 2) e11 = X[t];
            bits(datasize DIV 2) e12 = X[t2];
            data = if BigEndian() then e11 : e12 else e12 : e11;
        else
            data = X[t];

        if excl then
            // store {release} exclusive register|pair (atomic)
            bit status = '1';
            // Check whether the Exclusive Monitors are set to include the
            // physical memory locations corresponding to virtual address
            // range [address, address+dbytes-1].
            if AArch64.ExclusiveMonitorsPass(address, dbytes) then
                // This atomic write will be rejected if it does not refer
                // to the same physical locations after address translation.
                Mem[address, dbytes, acctype] = data;
                status = ExclusiveMonitorsStatus();
                X[s] = ZeroExtend(status, 32);
            else
                // store release register (atomic)
                Mem[address, dbytes, acctype] = data;

    when MemOp_LOAD
        if excl then
            // Tell the Exclusive Monitors to record a sequence of one or more atomic
            // memory reads from virtual address range [address, address+dbytes-1].
            // The Exclusive Monitor will only be set if all the reads are from the
            // same dbytes-aligned physical address, to allow for the possibility of
            // an atomicity break if the translation is changed between reads.
            AArch64.SetExclusiveMonitors(address, dbytes);

        if pair then
            // load exclusive pair
            assert excl;
            if rt_unknown then
                // ConstrainedUNPREDICTABLE case
                X[t] = bits(datasize) UNKNOWN;

```



```

elseif elsize == 32 then
    // 32-bit load exclusive pair (atomic)
    data = Mem[address, dbytes, acctype];
    if BigEndian() then
        X[t] = data<datasize-1:elsize>;
        X[t2] = data<elsize-1:0>;
    else
        X[t] = data<elsize-1:0>;
        X[t2] = data<datasize-1:elsize>;
else // elsize == 64
    // 64-bit load exclusive pair (not atomic),
    // but must be 128-bit aligned
    if address != Align(address, dbytes) then
        iswrite = FALSE;
        secondstage = FALSE;
        AArch64.Abort(address, AArch64.AlignmentFault(acctype, iswrite, secondstage));
    X[t] = Mem[address + 0, 8, acctype];
    X[t2] = Mem[address + 8, 8, acctype];
else
    // load {acquire} {exclusive} single register
    data = Mem[address, dbytes, acctype];
    X[t] = ZeroExtend(data, regsize);

```

C5.6.77 LDAXR

Load-acquire exclusive register

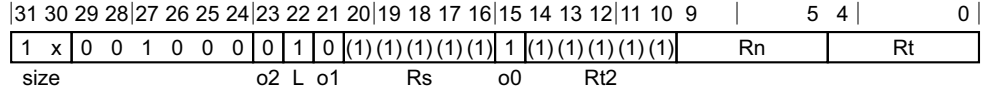

32-bit variant (size = 10)

LDAXR <Wt>, [<Xn|SP>{, #0}]

64-bit variant (size = 11)

LDAXR <Xt>, [<Xn|SP>{, #0}]

```
integer n = UInt(Rn);
integer t = UInt(Rt);
integer t2 = UInt(Rt2); // ignored by load/store single register
integer s = UInt(Rs); // ignored by all loads and store-release
```

```
if o2:o1:o0 == '100' || o2:o1:o0 == '11x' then UnallocatedEncoding();
if o1 == '1' && size<L> == '0' then UnallocatedEncoding();
```

```
AccType acctype = if o0 == '1' then AccType_ORDERED else AccType_ATOMIC;
boolean excl = (o2 == '0');
boolean pair = (o1 == '1');
MemOp memop = if L == '1' then MemOp_LOAD else MemOp_STORE;
integer elsize = 8 << UInt(size);
integer regsize = if elsize == 64 then 64 else 32;
integer datasize = if pair then elsize * 2 else elsize;
```

Assembler Symbols

- <Wt> Is the 32-bit name of the general-purpose register to be transferred, encoded in the "Rt" field.
- <Xt> Is the 64-bit name of the general-purpose register to be transferred, encoded in the "Rt" field.
- <Xn|SP> Is the 64-bit name of the general-purpose base register or stack pointer, encoded in the "Rn" field.

Operation

```
bits(64) address;
bits(datasize) data;
constant integer dbytes = datasize DIV 8;
boolean rt_unknown = FALSE;
boolean rn_unknown = FALSE;

if memop == MemOp_LOAD && pair && t == t2 then
    Constraint c = ConstrainUnpredictable();
    assert c IN {Constraint_UNKNOWN, Constraint_UNDEF, Constraint_NOP};
    case c of
        when Constraint_UNKNOWN    rt_unknown = TRUE; // result is UNKNOWN
        when Constraint_UNDEF      UnallocatedEncoding();
        when Constraint_NOP        EndOfInstruction();

if memop == MemOp_STORE && excl then
    if s == t || (pair && s == t2) then
        Constraint c = ConstrainUnpredictable();
        assert c IN {Constraint_UNKNOWN, Constraint_NONE, Constraint_UNDEF, Constraint_NOP};
        case c of
            when Constraint_UNKNOWN    rt_unknown = TRUE; // store UNKNOWN value
            when Constraint_NONE      rt_unknown = FALSE; // store original value
```

```

        when Constraint_UNDEF      UnallocatedEncoding();
        when Constraint_NOP        EndOfInstruction();
    if s == n && n != 31 then
        Constraint c = ConstrainUnpredictable();
        assert c IN {Constraint_UNKNOWN, Constraint_NONE, Constraint_UNDEF, Constraint_NOP};
        case c of
            when Constraint_UNKNOWN  rn_unknown = TRUE;    // address is UNKNOWN
            when Constraint_NONE      rn_unknown = FALSE;   // address is original base
            when Constraint_UNDEF     UnallocatedEncoding();
            when Constraint_NOP       EndOfInstruction();

    if n == 31 then
        CheckSPAlignment();
        address = SP[];
    elsif rn_unknown then
        address = bits(64) UNKNOWN;
    else
        address = X[n];

    case memop of
        when MemOp_STORE
            if rt_unknown then
                data = bits(datasize) UNKNOWN;
            elsif pair then
                assert excl;
                bits(datasize DIV 2) e11 = X[t];
                bits(datasize DIV 2) e12 = X[t2];
                data = if BigEndian() then e11 : e12 else e12 : e11;
            else
                data = X[t];

            if excl then
                // store {release} exclusive register|pair (atomic)
                bit status = '1';
                // Check whether the Exclusive Monitors are set to include the
                // physical memory locations corresponding to virtual address
                // range [address, address+dbytes-1].
                if AArch64.ExclusiveMonitorsPass(address, dbytes) then
                    // This atomic write will be rejected if it does not refer
                    // to the same physical locations after address translation.
                    Mem[address, dbytes, acctype] = data;
                    status = ExclusiveMonitorsStatus();
                    X[s] = ZeroExtend(status, 32);
                else
                    // store release register (atomic)
                    Mem[address, dbytes, acctype] = data;

        when MemOp_LOAD
            if excl then
                // Tell the Exclusive Monitors to record a sequence of one or more atomic
                // memory reads from virtual address range [address, address+dbytes-1].
                // The Exclusive Monitor will only be set if all the reads are from the
                // same dbytes-aligned physical address, to allow for the possibility of
                // an atomicity break if the translation is changed between reads.
                AArch64.SetExclusiveMonitors(address, dbytes);

            if pair then
                // load exclusive pair
                assert excl;
                if rt_unknown then
                    // ConstrainedUNPREDICTABLE case
                    X[t] = bits(datasize) UNKNOWN;
                elsif elsize == 32 then
                    // 32-bit load exclusive pair (atomic)
                    data = Mem[address, dbytes, acctype];
                    if BigEndian() then
                        X[t] = data<datasize-1:elsize>;
                        X[t2] = data<elsize-1:0>;

```

```
        else
            X[t] = data<elsize-1:0>;
            X[t2] = data<datasize-1:elsize>;
    else // elsize == 64
        // 64-bit load exclusive pair (not atomic),
        // but must be 128-bit aligned
        if address != Align(address, dbytes) then
            iswrite = FALSE;
            secondstage = FALSE;
            AArch64.Abort(address, AArch64.AlignmentFault(acctype, iswrite, secondstage));
        X[t] = Mem[address + 0, 8, acctype];
        X[t2] = Mem[address + 8, 8, acctype];
    else
        // load {acquire} {exclusive} single register
        data = Mem[address, dbytes, acctype];
        X[t] = ZeroExtend(data, regsize);
```

C5.6.78 LDAXRB

Load-acquire exclusive register byte

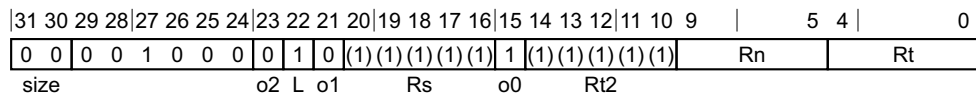

No offset variant

LDAXRB <Wt>, [<Xn|SP>{, #0}]

```
integer n = UInt(Rn);
integer t = UInt(Rt);
integer t2 = UInt(Rt2); // ignored by load/store single register
integer s = UInt(Rs); // ignored by all loads and store-release
```

```
if o2:o1:o0 == '100' || o2:o1:o0 == '11x' then UnallocatedEncoding();
if o1 == '1' && size<1> == '0' then UnallocatedEncoding();
```

```
AccType acctype = if o0 == '1' then AccType_ORDERED else AccType_ATOMIC;
boolean excl = (o2 == '0');
boolean pair = (o1 == '1');
MemOp memop = if L == '1' then MemOp_LOAD else MemOp_STORE;
integer elsize = 8 << UInt(size);
integer regsize = if elsize == 64 then 64 else 32;
integer datasize = if pair then elsize * 2 else elsize;
```

Assembler Symbols

<Wt> Is the 32-bit name of the general-purpose register to be transferred, encoded in the "Rt" field.

<Xn|SP> Is the 64-bit name of the general-purpose base register or stack pointer, encoded in the "Rn" field.

Operation

```
bits(64) address;
bits(datasize) data;
constant integer dbytes = datasize DIV 8;
boolean rt_unknown = FALSE;
boolean rn_unknown = FALSE;

if memop == MemOp_LOAD && pair && t == t2 then
    Constraint c = ConstrainUnpredictable();
    assert c IN {Constraint_UNKNOWN, Constraint_UNDEF, Constraint_NOP};
    case c of
        when Constraint_UNKNOWN    rt_unknown = TRUE; // result is UNKNOWN
        when Constraint_UNDEF      UnallocatedEncoding();
        when Constraint_NOP        EndOfInstruction();

if memop == MemOp_STORE && excl then
    if s == t || (pair && s == t2) then
        Constraint c = ConstrainUnpredictable();
        assert c IN {Constraint_UNKNOWN, Constraint_NONE, Constraint_UNDEF, Constraint_NOP};
        case c of
            when Constraint_UNKNOWN    rt_unknown = TRUE; // store UNKNOWN value
            when Constraint_NONE       rt_unknown = FALSE; // store original value
            when Constraint_UNDEF      UnallocatedEncoding();
            when Constraint_NOP        EndOfInstruction();
    if s == n && n != 31 then
        Constraint c = ConstrainUnpredictable();
        assert c IN {Constraint_UNKNOWN, Constraint_NONE, Constraint_UNDEF, Constraint_NOP};
```

```

        case c of
            when Constraint_UNKNOWN    rn_unknown = TRUE;    // address is UNKNOWN
            when Constraint_NONE        rn_unknown = FALSE;    // address is original base
            when Constraint_UNDEF      UnallocatedEncoding();
            when Constraint_NOP        EndOfInstruction();

if n == 31 then
    CheckSPAlignment();
    address = SP[];
elseif rn_unknown then
    address = bits(64) UNKNOWN;
else
    address = X[n];

case memop of
    when MemOp_STORE
        if rt_unknown then
            data = bits(datasize) UNKNOWN;
        elseif pair then
            assert excl;
            bits(datasize DIV 2) e11 = X[t];
            bits(datasize DIV 2) e12 = X[t2];
            data = if BigEndian() then e11 : e12 else e12 : e11;
        else
            data = X[t];

        if excl then
            // store {release} exclusive register|pair (atomic)
            bit status = '1';
            // Check whether the Exclusive Monitors are set to include the
            // physical memory locations corresponding to virtual address
            // range [address, address+dbytes-1].
            if AArch64.ExclusiveMonitorsPass(address, dbytes) then
                // This atomic write will be rejected if it does not refer
                // to the same physical locations after address translation.
                Mem[address, dbytes, acctype] = data;
                status = ExclusiveMonitorsStatus();
                X[s] = ZeroExtend(status, 32);
            else
                // store release register (atomic)
                Mem[address, dbytes, acctype] = data;

    when MemOp_LOAD
        if excl then
            // Tell the Exclusive Monitors to record a sequence of one or more atomic
            // memory reads from virtual address range [address, address+dbytes-1].
            // The Exclusive Monitor will only be set if all the reads are from the
            // same dbytes-aligned physical address, to allow for the possibility of
            // an atomicity break if the translation is changed between reads.
            AArch64.SetExclusiveMonitors(address, dbytes);

        if pair then
            // load exclusive pair
            assert excl;
            if rt_unknown then
                // ConstrainedUNPREDICTABLE case
                X[t] = bits(datasize) UNKNOWN;
            elseif elsize == 32 then
                // 32-bit load exclusive pair (atomic)
                data = Mem[address, dbytes, acctype];
                if BigEndian() then
                    X[t] = data<datasize-1:elsize>;
                    X[t2] = data<elsize-1:0>;
                else
                    X[t] = data<elsize-1:0>;
                    X[t2] = data<datasize-1:elsize>;
            else // elsize == 64
                // 64-bit load exclusive pair (not atomic),

```

```
// but must be 128-bit aligned
if address != Align(address, dbytes) then
    iswrite = FALSE;
    secondstage = FALSE;
    AArch64.Abort(address, AArch64.AlignmentFault(acctype, iswrite, secondstage));
X[t] = Mem[address + 0, 8, acctype];
X[t2] = Mem[address + 8, 8, acctype];
else
    // load {acquire} {exclusive} single register
    data = Mem[address, dbytes, acctype];
    X[t] = ZeroExtend(data, regsize);
```

C5.6.79 LDAXRH

Load-acquire exclusive register halfword

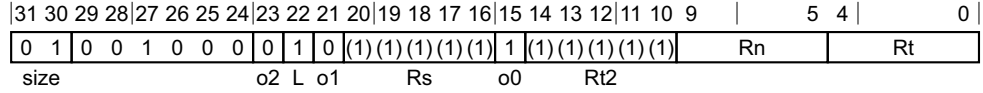

No offset variant

LDAXRH <Wt>, [<Xn|SP>{, #0}]

```
integer n = UInt(Rn);
integer t = UInt(Rt);
integer t2 = UInt(Rt2); // ignored by load/store single register
integer s = UInt(Rs); // ignored by all loads and store-release
```

```
if o2:o1:o0 == '100' || o2:o1:o0 == '11x' then UnallocatedEncoding();
if o1 == '1' && size<L> == '0' then UnallocatedEncoding();
```

```
AccType acctype = if o0 == '1' then AccType_ORDERED else AccType_ATOMIC;
boolean excl = (o2 == '0');
boolean pair = (o1 == '1');
MemOp memop = if L == '1' then MemOp_LOAD else MemOp_STORE;
integer elsize = 8 << UInt(size);
integer regsize = if elsize == 64 then 64 else 32;
integer datasize = if pair then elsize * 2 else elsize;
```

Assembler Symbols

<Wt> Is the 32-bit name of the general-purpose register to be transferred, encoded in the "Rt" field.
<Xn|SP> Is the 64-bit name of the general-purpose base register or stack pointer, encoded in the "Rn" field.

Operation

```
bits(64) address;
bits(datasize) data;
constant integer dbytes = datasize DIV 8;
boolean rt_unknown = FALSE;
boolean rn_unknown = FALSE;

if memop == MemOp_LOAD && pair && t == t2 then
    Constraint c = ConstrainUnpredictable();
    assert c IN {Constraint_UNKNOWN, Constraint_UNDEF, Constraint_NOP};
    case c of
        when Constraint_UNKNOWN    rt_unknown = TRUE; // result is UNKNOWN
        when Constraint_UNDEF      UnallocatedEncoding();
        when Constraint_NOP        EndOfInstruction();

if memop == MemOp_STORE && excl then
    if s == t || (pair && s == t2) then
        Constraint c = ConstrainUnpredictable();
        assert c IN {Constraint_UNKNOWN, Constraint_NONE, Constraint_UNDEF, Constraint_NOP};
        case c of
            when Constraint_UNKNOWN    rt_unknown = TRUE; // store UNKNOWN value
            when Constraint_NONE      rt_unknown = FALSE; // store original value
            when Constraint_UNDEF      UnallocatedEncoding();
            when Constraint_NOP        EndOfInstruction();
    if s == n && n != 31 then
        Constraint c = ConstrainUnpredictable();
        assert c IN {Constraint_UNKNOWN, Constraint_NONE, Constraint_UNDEF, Constraint_NOP};
```



```

    case c of
        when Constraint_UNKNOWN    rn_unknown = TRUE;    // address is UNKNOWN
        when Constraint_NONE       rn_unknown = FALSE;   // address is original base
        when Constraint_UNDEF     UnallocatedEncoding();
        when Constraint_NOP       EndOfInstruction();

    if n == 31 then
        CheckSPAlignment();
        address = SP[];
    elsif rn_unknown then
        address = bits(64) UNKNOWN;
    else
        address = X[n];

    case memop of
        when MemOp_STORE
            if rt_unknown then
                data = bits(datasize) UNKNOWN;
            elsif pair then
                assert excl;
                bits(datasize DIV 2) e11 = X[t];
                bits(datasize DIV 2) e12 = X[t2];
                data = if BigEndian() then e11 : e12 else e12 : e11;
            else
                data = X[t];

            if excl then
                // store {release} exclusive register|pair (atomic)
                bit status = '1';
                // Check whether the Exclusive Monitors are set to include the
                // physical memory locations corresponding to virtual address
                // range [address, address+dbytes-1].
                if AArch64.ExclusiveMonitorsPass(address, dbytes) then
                    // This atomic write will be rejected if it does not refer
                    // to the same physical locations after address translation.
                    Mem[address, dbytes, acctype] = data;
                    status = ExclusiveMonitorsStatus();
                    X[s] = ZeroExtend(status, 32);
                else
                    // store release register (atomic)
                    Mem[address, dbytes, acctype] = data;

        when MemOp_LOAD
            if excl then
                // Tell the Exclusive Monitors to record a sequence of one or more atomic
                // memory reads from virtual address range [address, address+dbytes-1].
                // The Exclusive Monitor will only be set if all the reads are from the
                // same dbytes-aligned physical address, to allow for the possibility of
                // an atomicity break if the translation is changed between reads.
                AArch64.SetExclusiveMonitors(address, dbytes);

            if pair then
                // load exclusive pair
                assert excl;
                if rt_unknown then
                    // ConstrainedUNPREDICTABLE case
                    X[t] = bits(datasize) UNKNOWN;
                elsif elsize == 32 then
                    // 32-bit load exclusive pair (atomic)
                    data = Mem[address, dbytes, acctype];
                    if BigEndian() then
                        X[t] = data<datasize-1:elsize>;
                        X[t2] = data<elsize-1:0>;
                    else
                        X[t] = data<elsize-1:0>;
                        X[t2] = data<datasize-1:elsize>;
                else // elsize == 64
                    // 64-bit load exclusive pair (not atomic),

```

```
// but must be 128-bit aligned
if address != Align(address, dbytes) then
    iswrite = FALSE;
    secondstage = FALSE;
    AArch64.Abort(address, AArch64.AlignmentFault(acctype, iswrite, secondstage));
X[t] = Mem[address + 0, 8, acctype];
X[t2] = Mem[address + 8, 8, acctype];
else
    // load {acquire} {exclusive} single register
    data = Mem[address, dbytes, acctype];
    X[t] = ZeroExtend(data, regsize);
```

C5.6.80 LDNP

Load pair of registers, with non-temporal hint

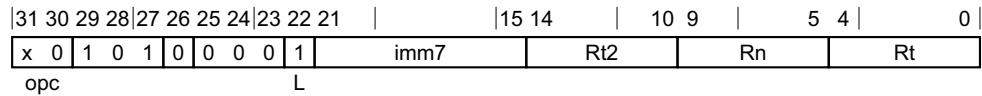

32-bit variant (opc = 00)

LDNP <Wt1>, <Wt2>, [<Xn|SP>{, #<imm>}]

64-bit variant (opc = 10)

LDNP <Xt1>, <Xt2>, [<Xn|SP>{, #<imm>}]

boolean wback = FALSE;
boolean postindex = FALSE;

Assembler Symbols

- <Wt1> Is the 32-bit name of the first general-purpose register to be transferred, encoded in the "Rt" field.
- <Wt2> Is the 32-bit name of the second general-purpose register to be transferred, encoded in the "Rt2" field.
- <Xt1> Is the 64-bit name of the first general-purpose register to be transferred, encoded in the "Rt" field.
- <Xt2> Is the 64-bit name of the second general-purpose register to be transferred, encoded in the "Rt2" field.
- <Xn|SP> Is the 64-bit name of the general-purpose base register or stack pointer, encoded in the "Rn" field.
- <imm> For the 32-bit variant: is the optional signed immediate byte offset, a multiple of 4 in the range -256 to 252, defaulting to 0 and encoded in the "imm7" field as <imm>/4.
- <imm> For the 64-bit variant: is the optional signed immediate byte offset, a multiple of 8 in the range -512 to 504, defaulting to 0 and encoded in the "imm7" field as <imm>/8.

Shared decode for all variants

```
integer n = UInt(Rn);
integer t = UInt(Rt);
integer t2 = UInt(Rt2);
AccType acctype = AccType_STREAM;
MemOp memop = if L == '1' then MemOp_LOAD else MemOp_STORE;
if opc<0> == '1' then UnallocatedEncoding();
integer scale = 2 + UInt(opc<1>);
integer datasize = 8 << scale;
bits(64) offset = LSL(SignExtend(imm7, 64), scale);
```

Operation

```
bits(64) address;
bits(datasize) data1;
bits(datasize) data2;
constant integer dbytes = datasize DIV 8;
boolean rt_unknown = FALSE;

if memop == MemOp_LOAD && t == t2 then
    Constraint c = ConstrainUnpredictable();
    assert c IN {Constraint_UNKNOWN, Constraint_UNDEF, Constraint_NOP};
```

```
    case c of
        when Constraint_UNKNOWN    rt_unknown = TRUE;    // result is UNKNOWN
        when Constraint_UNDEF      UnallocatedEncoding();
        when Constraint_NOP        EndOfInstruction();

    if n == 31 then
        CheckSPAlignment();
        address = SP[];
    else
        address = X[n];

    if ! postindex then
        address = address + offset;

    case memop of
        when MemOp_STORE
            if rt_unknown && t == n then
                data1 = bits(datasize) UNKNOWN;
            else
                data1 = X[t];
            if rt_unknown && t2 == n then
                data2 = bits(datasize) UNKNOWN;
            else
                data2 = X[t2];
            Mem[address + 0      , dbytes, acctype] = data1;
            Mem[address + dbytes, dbytes, acctype] = data2;

        when MemOp_LOAD
            data1 = Mem[address + 0      , dbytes, acctype];
            data2 = Mem[address + dbytes, dbytes, acctype];
            if rt_unknown then
                data1 = bits(datasize) UNKNOWN;
                data2 = bits(datasize) UNKNOWN;
            X[t] = data1;
            X[t2] = data2;

    if wback then
        if postindex then
            address = address + offset;
        if n == 31 then
            SP[] = address;
        else
            X[n] = address;
```

C5.6.81 LDP

Load pair of registers

It has encodings from 3 classes: *Post-index*, *Pre-index* and *Signed offset*

Post-index

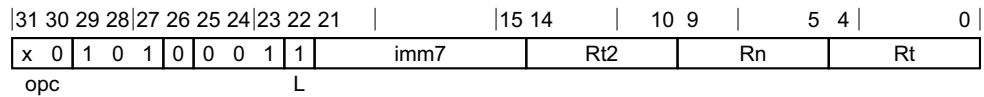

32-bit variant (opc = 00)

LDP <Wt1>, <Wt2>, [<Xn|SP>], #<imm>

64-bit variant (opc = 10)

LDP <Xt1>, <Xt2>, [<Xn|SP>], #<imm>

boolean wback = TRUE;
 boolean postindex = TRUE;

Pre-index

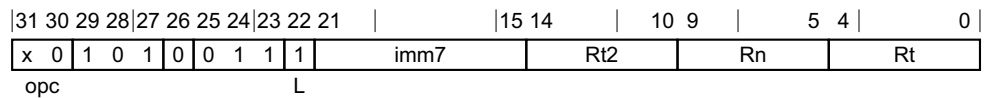

32-bit variant (opc = 00)

LDP <Wt1>, <Wt2>, [<Xn|SP>, #<imm>]!

64-bit variant (opc = 10)

LDP <Xt1>, <Xt2>, [<Xn|SP>, #<imm>]!

boolean wback = TRUE;
 boolean postindex = FALSE;

Signed offset

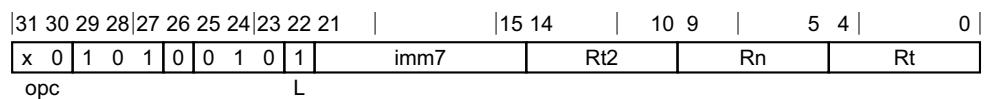

32-bit variant (opc = 00)

LDP <Wt1>, <Wt2>, [<Xn|SP>{, #<imm>}]

64-bit variant (opc = 10)

LDP <Xt1>, <Xt2>, [<Xn|SP>{, #<imm>}]

boolean wback = FALSE;
 boolean postindex = FALSE;

Assembler Symbols

- <Wt1> Is the 32-bit name of the first general-purpose register to be transferred, encoded in the "Rt" field.
- <Wt2> Is the 32-bit name of the second general-purpose register to be transferred, encoded in the "Rt2" field.

- <Xt1> Is the 64-bit name of the first general-purpose register to be transferred, encoded in the "Rt" field.
- <Xt2> Is the 64-bit name of the second general-purpose register to be transferred, encoded in the "Rt2" field.
- <Xn|SP> Is the 64-bit name of the general-purpose base register or stack pointer, encoded in the "Rn" field.
- <imm> For the 32-bit post-index and 32-bit pre-index variant: is the signed immediate byte offset, a multiple of 4 in the range -256 to 252, encoded in the "imm7" field as <imm>/4.
- <imm> For the 32-bit signed offset variant: is the optional signed immediate byte offset, a multiple of 4 in the range -256 to 252, defaulting to 0 and encoded in the "imm7" field as <imm>/4.
- <imm> For the 64-bit post-index and 64-bit pre-index variant: is the signed immediate byte offset, a multiple of 8 in the range -512 to 504, encoded in the "imm7" field as <imm>/8.
- <imm> For the 64-bit signed offset variant: is the optional signed immediate byte offset, a multiple of 8 in the range -512 to 504, defaulting to 0 and encoded in the "imm7" field as <imm>/8.

Shared decode for all variants

```
integer n = UInt(Rn);
integer t = UInt(Rt);
integer t2 = UInt(Rt2);
AccType acctype = AccType_NORMAL;
MemOp memop = if L == '1' then MemOp_LOAD else MemOp_STORE;
if L:opc<0> == '01' || opc == '11' then UnallocatedEncoding();
boolean signed = (opc<0> != '0');
integer scale = 2 + UInt(opc<1>);
integer datasize = 8 << scale;
bits(64) offset = LSL(SignExtend(imm7, 64), scale);
```

Operation for all classes

```
bits(64) address;
bits(datasize) data1;
bits(datasize) data2;
constant integer dbytes = datasize DIV 8;
boolean rt_unknown = FALSE;
boolean wb_unknown = FALSE;

if memop == MemOp_LOAD && wback && (t == n || t2 == n) && n != 31 then
  c = ConstrainUnpredictable();
  assert c IN {Constraint_WBSUPPRESS, Constraint_UNKNOWN, Constraint_UNDEF, Constraint_NOP};
  case c of
    when Constraint_WBSUPPRESS wback = FALSE; // writeback is suppressed
    when Constraint_UNKNOWN wb_unknown = TRUE; // writeback is UNKNOWN
    when Constraint_UNDEF UnallocatedEncoding();
    when Constraint_NOP EndOfInstruction();

if memop == MemOp_STORE && wback && (t == n || t2 == n) && n != 31 then
  c = ConstrainUnpredictable();
  assert c IN {Constraint_NONE, Constraint_UNKNOWN, Constraint_UNDEF, Constraint_NOP};
  case c of
    when Constraint_NONE rt_unknown = FALSE; // value stored is pre-writeback
    when Constraint_UNKNOWN rt_unknown = TRUE; // value stored is UNKNOWN
    when Constraint_UNDEF UnallocatedEncoding();
    when Constraint_NOP EndOfInstruction();

if memop == MemOp_LOAD && t == t2 then
  Constraint c = ConstrainUnpredictable();
  assert c IN {Constraint_UNKNOWN, Constraint_UNDEF, Constraint_NOP};
  case c of
    when Constraint_UNKNOWN rt_unknown = TRUE; // result is UNKNOWN
    when Constraint_UNDEF UnallocatedEncoding();
    when Constraint_NOP EndOfInstruction();
```

```

if n == 31 then
    CheckSPAAlignment();
    address = SP[];
else
    address = X[n];

if ! postindex then
    address = address + offset;

case memop of
when MemOp_STORE
    if rt_unknown && t == n then
        data1 = bits(datasize) UNKNOWN;
    else
        data1 = X[t];
    if rt_unknown && t2 == n then
        data2 = bits(datasize) UNKNOWN;
    else
        data2 = X[t2];
    Mem[address + 0, dbytes, acctype] = data1;
    Mem[address + dbytes, dbytes, acctype] = data2;

when MemOp_LOAD
    data1 = Mem[address + 0, dbytes, acctype];
    data2 = Mem[address + dbytes, dbytes, acctype];
    if rt_unknown then
        data1 = bits(datasize) UNKNOWN;
        data2 = bits(datasize) UNKNOWN;
    if signed then
        X[t] = SignExtend(data1, 64);
        X[t2] = SignExtend(data2, 64);
    else
        X[t] = data1;
        X[t2] = data2;

if wback then
    if wb_unknown then
        address = bits(64) UNKNOWN;
    elseif postindex then
        address = address + offset;
    if n == 31 then
        SP[] = address;
    else
        X[n] = address;

```

C5.6.82 LDPSW

Load pair of registers signed word

It has encodings from 3 classes: *Post-index*, *Pre-index* and *Signed offset*

Post-index

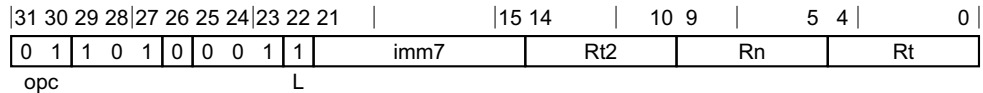

Post-index variant

LDPSW <Xt1>, <Xt2>, [<Xn|SP>], #<imm>

boolean wback = TRUE;
boolean postindex = TRUE;

Pre-index

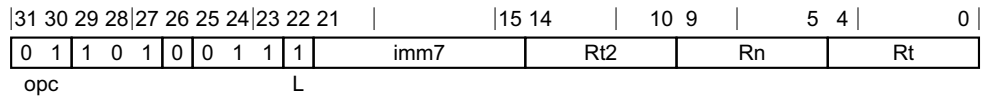

Pre-index variant

LDPSW <Xt1>, <Xt2>, [<Xn|SP>, #<imm>]!

boolean wback = TRUE;
boolean postindex = FALSE;

Signed offset

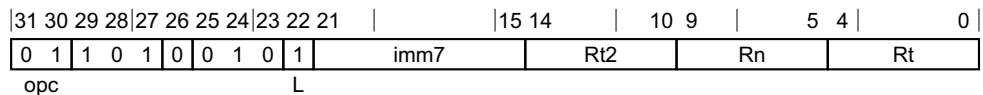

Signed offset variant

LDPSW <Xt1>, <Xt2>, [<Xn|SP>{, #<imm>}]

boolean wback = FALSE;
boolean postindex = FALSE;

Assembler Symbols

- <Xt1> Is the 64-bit name of the first general-purpose register to be transferred, encoded in the "Rt" field.
- <Xt2> Is the 64-bit name of the second general-purpose register to be transferred, encoded in the "Rt2" field.
- <Xn|SP> Is the 64-bit name of the general-purpose base register or stack pointer, encoded in the "Rn" field.
- <imm> For the post-index and pre-index variant: is the signed immediate byte offset, a multiple of 4 in the range -256 to 252, encoded in the "imm7" field as <imm>/4.
- <imm> For the signed offset variant: is the optional signed immediate byte offset, a multiple of 4 in the range -256 to 252, defaulting to 0 and encoded in the "imm7" field as <imm>/4.

Shared decode for all variants

```

integer n = UInt(Rn);
integer t = UInt(Rt);
integer t2 = UInt(Rt2);
AccType acctype = AccType_NORMAL;
MemOp memop = if L == '1' then MemOp_LOAD else MemOp_STORE;
if L:opc<0> == '01' || opc == '11' then UnallocatedEncoding();
boolean signed = (opc<0> != '0');
integer scale = 2 + UInt(opc<1>);
integer datasize = 8 << scale;
bits(64) offset = LSL(SignExtend(imm7, 64), scale);
  
```

Operation for all classes

```

bits(64) address;
bits(datasize) data1;
bits(datasize) data2;
constant integer dbytes = datasize DIV 8;
boolean rt_unknown = FALSE;
boolean wb_unknown = FALSE;

if memop == MemOp_LOAD && wback && (t == n || t2 == n) && n != 31 then
  c = ConstrainUnpredictable();
  assert c IN {Constraint_WBSUPPRESS, Constraint_UNKNOWN, Constraint_UNDEF, Constraint_NOP};
  case c of
    when Constraint_WBSUPPRESS wback = FALSE; // writeback is suppressed
    when Constraint_UNKNOWN wb_unknown = TRUE; // writeback is UNKNOWN
    when Constraint_UNDEF UnallocatedEncoding();
    when Constraint_NOP EndOfInstruction();

if memop == MemOp_STORE && wback && (t == n || t2 == n) && n != 31 then
  c = ConstrainUnpredictable();
  assert c IN {Constraint_NONE, Constraint_UNKNOWN, Constraint_UNDEF, Constraint_NOP};
  case c of
    when Constraint_NONE rt_unknown = FALSE; // value stored is pre-writeback
    when Constraint_UNKNOWN rt_unknown = TRUE; // value stored is UNKNOWN
    when Constraint_UNDEF UnallocatedEncoding();
    when Constraint_NOP EndOfInstruction();

if memop == MemOp_LOAD && t == t2 then
  Constraint c = ConstrainUnpredictable();
  assert c IN {Constraint_UNKNOWN, Constraint_UNDEF, Constraint_NOP};
  case c of
    when Constraint_UNKNOWN rt_unknown = TRUE; // result is UNKNOWN
    when Constraint_UNDEF UnallocatedEncoding();
    when Constraint_NOP EndOfInstruction();

if n == 31 then
  CheckSPAlignment();
  address = SP[];
else
  address = X[n];

if ! postindex then
  address = address + offset;

case memop of
  when MemOp_STORE
    if rt_unknown && t == n then
      data1 = bits(datasize) UNKNOWN;
    else
      data1 = X[t];
    if rt_unknown && t2 == n then
      data2 = bits(datasize) UNKNOWN;
    else
      data2 = X[t2];
  
```

```
Mem[address + 0      , dbytes, acctype] = data1;
Mem[address + dbytes, dbytes, acctype] = data2;

when MemOp_LOAD
  data1 = Mem[address + 0      , dbytes, acctype];
  data2 = Mem[address + dbytes, dbytes, acctype];
  if rt_unknown then
    data1 = bits(datasize) UNKNOWN;
    data2 = bits(datasize) UNKNOWN;
  if signed then
    X[t] = SignExtend(data1, 64);
    X[t2] = SignExtend(data2, 64);
  else
    X[t] = data1;
    X[t2] = data2;

if wback then
  if wb_unknown then
    address = bits(64) UNKNOWN;
  elsif postindex then
    address = address + offset;
  if n == 31 then
    SP[] = address;
  else
    X[n] = address;
```

C5.6.83 LDR (immediate)

Load register (immediate offset)

It has encodings from 3 classes: *Post-index*, *Pre-index* and *Unsigned offset*

Post-index



32-bit variant (size = 10)

LDR <Wt>, [<Xn|SP>], #<sim>

64-bit variant (size = 11)

LDR <Xt>, [<Xn|SP>], #<sim>

```
boolean wback = TRUE;
boolean postindex = TRUE;
integer scale = UInt(size);
bits(64) offset = SignExtend(imm9, 64);
```

Pre-index

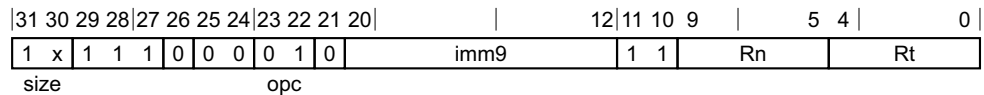

32-bit variant (size = 10)

LDR <Wt>, [<Xn|SP>, #<sim>]!

64-bit variant (size = 11)

LDR <Xt>, [<Xn|SP>, #<sim>]!

```
boolean wback = TRUE;
boolean postindex = FALSE;
integer scale = UInt(size);
bits(64) offset = SignExtend(imm9, 64);
```

Unsigned offset

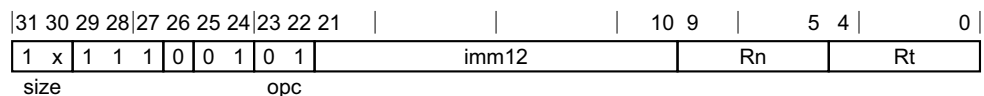

32-bit variant (size = 10)

LDR <Wt>, [<Xn|SP>{, #<pimm>}]

64-bit variant (size = 11)

LDR <Xt>, [<Xn|SP>{, #<pimm>}]

```
boolean wback = FALSE;
boolean postindex = FALSE;
integer scale = UInt(size);
bits(64) offset = LSL(ZeroExtend(imm12, 64), scale);
```

Assembler Symbols

<Wt>	Is the 32-bit name of the general-purpose register to be transferred, encoded in the "Rt" field.
<Xt>	Is the 64-bit name of the general-purpose register to be transferred, encoded in the "Rt" field.
<Xn SP>	Is the 64-bit name of the general-purpose base register or stack pointer, encoded in the "Rn" field.
<simm>	Is the signed immediate byte offset, in the range -256 to 255, encoded in the "imm9" field.
<pimm>	For the 32-bit variant: is the optional positive immediate byte offset, a multiple of 4 in the range 0 to 16380, defaulting to 0 and encoded in the "imm12" field as <pimm>/4.
<pimm>	For the 64-bit variant: is the optional positive immediate byte offset, a multiple of 8 in the range 0 to 32760, defaulting to 0 and encoded in the "imm12" field as <pimm>/8.

Shared decode for all variants

```

integer n = UInt(Rn);
integer t = UInt(Rt);
AccType acctype = AccType_NORMAL;
MemOp memop;
boolean signed;
integer regsize;

if opc<1> == '0' then
    // store or zero-extending load
    memop = if opc<0> == '1' then MemOp_LOAD else MemOp_STORE;
    regsize = if size == '11' then 64 else 32;
    signed = FALSE;
else
    if size == '11' then
        memop = MemOp_PREFETCH;
        if opc<0> == '1' then UnallocatedEncoding();
    else
        // sign-extending load
        memop = MemOp_LOAD;
        if size == '10' && opc<0> == '1' then UnallocatedEncoding();
        regsize = if opc<0> == '1' then 32 else 64;
        signed = TRUE;

integer datasize = 8 << scale;
  
```

Operation for all classes

```

bits(64) address;
bits(datasize) data;
boolean wb_unknown = FALSE;
boolean rt_unknown = FALSE;

if memop == MemOp_LOAD && wback && n == t && n != 31 then
    c = ConstrainUnpredictable();
    assert c IN {Constraint_WBSUPPRESS, Constraint_UNKNOWN, Constraint_UNDEF, Constraint_NOP};
    case c of
        when Constraint_WBSUPPRESS wback = FALSE; // writeback is suppressed
        when Constraint_UNKNOWN wb_unknown = TRUE; // writeback is UNKNOWN
        when Constraint_UNDEF UnallocatedEncoding();
        when Constraint_NOP EndOfInstruction();

if memop == MemOp_STORE && wback && n == t && n != 31 then
    c = ConstrainUnpredictable();
    assert c IN {Constraint_NONE, Constraint_UNKNOWN, Constraint_UNDEF, Constraint_NOP};
    case c of
        when Constraint_NONE rt_unknown = FALSE; // value stored is original value
        when Constraint_UNKNOWN rt_unknown = TRUE; // value stored is UNKNOWN
        when Constraint_UNDEF UnallocatedEncoding();
  
```

```

        when Constraint_NOP      EndOfInstruction();

if n == 31 then
    if memop != MemOp_PREFETCH then CheckSPAlignment();
    address = SP[];
else
    address = X[n];

if ! postindex then
    address = address + offset;

case memop of
    when MemOp_STORE
        if rt_unknown then
            data = bits(datasize) UNKNOWN;
        else
            data = X[t];
            Mem[address, datasize DIV 8, acctype] = data;

    when MemOp_LOAD
        data = Mem[address, datasize DIV 8, acctype];
        if signed then
            X[t] = SignExtend(data, regsize);
        else
            X[t] = ZeroExtend(data, regsize);

    when MemOp_PREFETCH
        Prefetch(address, t<4:0>);

if wback then
    if wb_unknown then
        address = bits(64) UNKNOWN;
    elsif postindex then
        address = address + offset;
    if n == 31 then
        SP[] = address;
    else
        X[n] = address;

```

C5.6.84 LDR (literal)

Load register (PC-relative literal)



32-bit variant (opc = 00)

LDR <Wt>, <label>

64-bit variant (opc = 01)

LDR <Xt>, <label>

```
integer t = UInt(Rt);
MemOp memop = MemOp_LOAD;
boolean signed = FALSE;
integer size;
bits(64) offset;

case opc of
  when '00'
    size = 4;
  when '01'
    size = 8;
  when '10'
    size = 4;
    signed = TRUE;
  when '11'
    memop = MemOp_PREFETCH;

offset = SignExtend(imm19:'00', 64);
```

Assembler Symbols

<Wt> Is the 32-bit name of the general-purpose register to be loaded, encoded in the "Rt" field.

<Xt> Is the 64-bit name of the general-purpose register to be loaded, encoded in the "Rt" field.

<label> Is the program label from which the data is to be loaded. Its offset from the address of this instruction, in the range +/-1MB, is encoded as "imm19" times 4.

Operation

```
bits(64) address = PC[] + offset;
bits(size*8) data;

case memop of
  when MemOp_LOAD
    data = Mem[address, size, AccType_NORMAL];
    if signed then
      X[t] = SignExtend(data, 64);
    else
      X[t] = data;

  when MemOp_PREFETCH
    Prefetch(address, t<4:0>);
```

C5.6.85 LDR (register)

Load register (register offset)

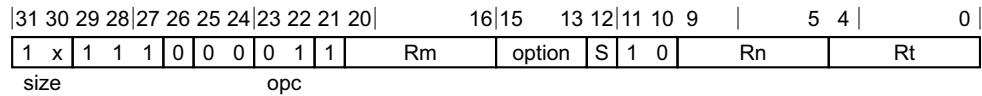

32-bit variant (size = 10)

LDR <Wt>, [<Xn|SP>, <R><m>{, <extend> {<amount>}}]

64-bit variant (size = 11)

LDR <Xt>, [<Xn|SP>, <R><m>{, <extend> {<amount>}}]

```
boolean wback = FALSE;
boolean postindex = FALSE;
integer scale = UInt(size);
if option<1> == '0' then UnallocatedEncoding(); // sub-word index
ExtendType extend_type = DecodeRegExtend(option);
integer shift = if S == '1' then scale else 0;
```

Assembler Symbols

<Wt>	Is the 32-bit name of the general-purpose register to be transferred, encoded in the "Rt" field.
<Xt>	Is the 64-bit name of the general-purpose register to be transferred, encoded in the "Rt" field.
<Xn SP>	Is the 64-bit name of the general-purpose base register or stack pointer, encoded in the "Rn" field.
<R>	Is the index width specifier, RESERVED when option = 00x W when option = x10 X when option = x11 RESERVED when option = 10x
<m>	Is the number [0-30] of the general-purpose index register or the name ZR (31), encoded in the "Rm" field.
<extend>	Is the index extend/shift specifier, defaulting to LSL and RESERVED when option = 00x UXTW when option = 010 LSL when option = 011 RESERVED when option = 10x SXTW when option = 110 SXTX when option = 111
<amount>	For the 32-bit variant: is the index shift amount, optional and defaulting to #0 when <extend> is not LSL, #0 when S = 0 #2 when S = 1
<amount>	For the 64-bit variant: is the index shift amount, optional and defaulting to #0 when <extend> is not LSL, #0 when S = 0

#3 when S = 1

Shared decode for all variants

```

integer n = UInt(Rn);
integer t = UInt(Rt);
integer m = UInt(Rm);
AccType acctype = AccType_NORMAL;
MemOp memop;
boolean signed;
integer regsize;

if opc<1> == '0' then
    // store or zero-extending load
    memop = if opc<0> == '1' then MemOp_LOAD else MemOp_STORE;
    regsize = if size == '11' then 64 else 32;
    signed = FALSE;
else
    if size == '11' then
        memop = MemOp_PREFETCH;
        if opc<0> == '1' then UnallocatedEncoding();
    else
        // sign-extending load
        memop = MemOp_LOAD;
        if size == '10' && opc<0> == '1' then UnallocatedEncoding();
        regsize = if opc<0> == '1' then 32 else 64;
        signed = TRUE;

integer datasize = 8 << scale;

```

Operation

```

bits(64) offset = ExtendReg(m, extend_type, shift);
bits(64) address;
bits(datasize) data;
boolean wb_unknown = FALSE;
boolean rt_unknown = FALSE;

if memop == MemOp_LOAD && wback && n == t && n != 31 then
    c = ConstrainUnpredictable();
    assert c IN {Constraint_WBSUPPRESS, Constraint_UNKNOWN, Constraint_UNDEF, Constraint_NOP};
    case c of
        when Constraint_WBSUPPRESS wback = FALSE; // writeback is suppressed
        when Constraint_UNKNOWN wb_unknown = TRUE; // writeback is UNKNOWN
        when Constraint_UNDEF UnallocatedEncoding();
        when Constraint_NOP EndOfInstruction();

if memop == MemOp_STORE && wback && n == t && n != 31 then
    c = ConstrainUnpredictable();
    assert c IN {Constraint_NONE, Constraint_UNKNOWN, Constraint_UNDEF, Constraint_NOP};
    case c of
        when Constraint_NONE rt_unknown = FALSE; // value stored is original value
        when Constraint_UNKNOWN rt_unknown = TRUE; // value stored is UNKNOWN
        when Constraint_UNDEF UnallocatedEncoding();
        when Constraint_NOP EndOfInstruction();

if n == 31 then
    if memop != MemOp_PREFETCH then CheckSPAlignment();
    address = SP[];
else
    address = X[n];

if ! postindex then
    address = address + offset;

case memop of

```



```
when MemOp_STORE      if rt_unknown then
    data = bits(datasize) UNKNOWN;
    else
        data = X[t];
        Mem[address, datasize DIV 8, acctype] = data;

when MemOp_LOAD
    data = Mem[address, datasize DIV 8, acctype];
    if signed then
        X[t] = SignExtend(data, regsize);
    else
        X[t] = ZeroExtend(data, regsize);

when MemOp_PREFETCH
    Prefetch(address, t<4:0>);

if wback then
    if wb_unknown then
        address = bits(64) UNKNOWN;
    elsif postindex then
        address = address + offset;
    if n == 31 then
        SP[] = address;
    else
        X[n] = address;
```

C5.6.86 LDRB (immediate)

Load register byte (immediate offset)

It has encodings from 3 classes: *Post-index*, *Pre-index* and *Unsigned offset*

Post-index

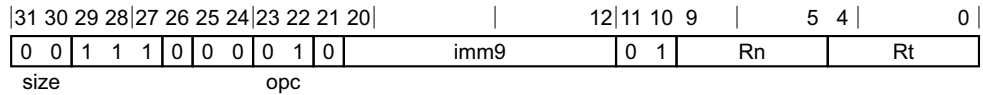

Post-index variant

LDRB <Wt>, [<Xn|SP>], #<simm>

```
boolean wback = TRUE;
boolean postindex = TRUE;
integer scale = UInt(size);
bits(64) offset = SignExtend(imm9, 64);
```

Pre-index

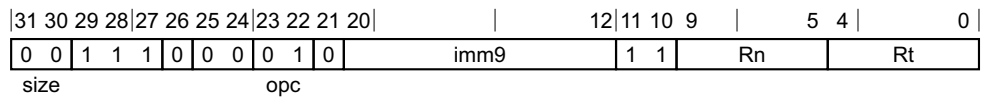

Pre-index variant

LDRB <Wt>, [<Xn|SP>, #<simm>]!

```
boolean wback = TRUE;
boolean postindex = FALSE;
integer scale = UInt(size);
bits(64) offset = SignExtend(imm9, 64);
```

Unsigned offset

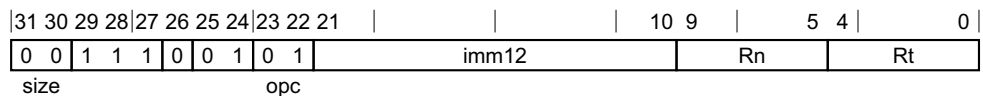

Unsigned offset variant

LDRB <Wt>, [<Xn|SP>{, #<pimm>}]

```
boolean wback = FALSE;
boolean postindex = FALSE;
integer scale = UInt(size);
bits(64) offset = LSL(ZeroExtend(imm12, 64), scale);
```

Assembler Symbols

- <Wt> Is the 32-bit name of the general-purpose register to be transferred, encoded in the "Rt" field.
- <Xn|SP> Is the 64-bit name of the general-purpose base register or stack pointer, encoded in the "Rn" field.
- <simm> Is the signed immediate byte offset, in the range -256 to 255, encoded in the "imm9" field.
- <pimm> Is the optional positive immediate byte offset, in the range 0 to 4095, defaulting to 0 and encoded in the "imm12" field.

Shared decode for all variants

```

integer n = UInt(Rn);
integer t = UInt(Rt);
AccType acctype = AccType_NORMAL;
MemOp memop;
boolean signed;
integer regsize;

if opc<1> == '0' then
    // store or zero-extending load
    memop = if opc<0> == '1' then MemOp_LOAD else MemOp_STORE;
    regsize = if size == '11' then 64 else 32;
    signed = FALSE;
else
    if size == '11' then
        memop = MemOp_PREFETCH;
        if opc<0> == '1' then UnallocatedEncoding();
    else
        // sign-extending load
        memop = MemOp_LOAD;
        if size == '10' && opc<0> == '1' then UnallocatedEncoding();
        regsize = if opc<0> == '1' then 32 else 64;
        signed = TRUE;

integer datasize = 8 << scale;

```

Operation for all classes

```

bits(64) address;
bits(datasize) data;
boolean wb_unknown = FALSE;
boolean rt_unknown = FALSE;

if memop == MemOp_LOAD && wback && n == t && n != 31 then
    c = ConstrainUnpredictable();
    assert c IN {Constraint_WBSUPPRESS, Constraint_UNKNOWN, Constraint_UNDEF, Constraint_NOP};
    case c of
        when Constraint_WBSUPPRESS wback = FALSE; // writeback is suppressed
        when Constraint_UNKNOWN wb_unknown = TRUE; // writeback is UNKNOWN
        when Constraint_UNDEF UnallocatedEncoding();
        when Constraint_NOP EndOfInstruction();

if memop == MemOp_STORE && wback && n == t && n != 31 then
    c = ConstrainUnpredictable();
    assert c IN {Constraint_NONE, Constraint_UNKNOWN, Constraint_UNDEF, Constraint_NOP};
    case c of
        when Constraint_NONE rt_unknown = FALSE; // value stored is original value
        when Constraint_UNKNOWN rt_unknown = TRUE; // value stored is UNKNOWN
        when Constraint_UNDEF UnallocatedEncoding();
        when Constraint_NOP EndOfInstruction();

if n == 31 then
    if memop != MemOp_PREFETCH then CheckSPAlignment();
    address = SP[];
else
    address = X[n];

if ! postindex then
    address = address + offset;

case memop of
    when MemOp_STORE
        if rt_unknown then
            data = bits(datasize) UNKNOWN;
        else
            data = X[t];

```

```
    Mem[address, datasize DIV 8, acctype] = data;

when MemOp_LOAD
    data = Mem[address, datasize DIV 8, acctype];
    if signed then
        X[t] = SignExtend(data, regsize);
    else
        X[t] = ZeroExtend(data, regsize);

when MemOp_PREFETCH
    Prefetch(address, t<4:0>);

if wback then
    if wb_unknown then
        address = bits(64) UNKNOWN;
    elsif postindex then
        address = address + offset;
    if n == 31 then
        SP[] = address;
    else
        X[n] = address;
```

C5.6.87 LDRB (register)

Load register byte (register offset)

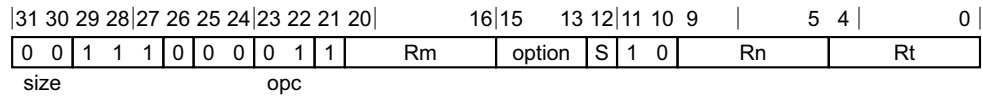

32-bit variant

LDRB <Wt>, [<Xn|SP>, <R><m>{, <extend> {<amount>}}]

```

boolean wback = FALSE;
boolean postindex = FALSE;
integer scale = UInt(size);
if option<1> == '0' then UnallocatedEncoding(); // sub-word index
ExtendType extend_type = DecodeRegExtend(option);
integer shift = if S == '1' then scale else 0;

```

Assembler Symbols

<Wt>	Is the 32-bit name of the general-purpose register to be transferred, encoded in the "Rt" field.
<Xn SP>	Is the 64-bit name of the general-purpose base register or stack pointer, encoded in the "Rn" field.
<R>	Is the index width specifier, RESERVED when option = 00x W when option = x10 X when option = x11 RESERVED when option = 10x
<m>	Is the number [0-30] of the general-purpose index register or the name ZR (31), encoded in the "Rm" field.
<extend>	Is the index extend/shift specifier, defaulting to LSL and RESERVED when option = 00x UXTW when option = 010 LSL when option = 011 RESERVED when option = 10x SXTW when option = 110 SXTX when option = 111
<amount>	Is the index shift amount, optional and defaulting to #0 when <extend> is not LSL, [absent] when S = 0 #0 when S = 1

Shared decode for all variants

```

integer n = UInt(Rn);
integer t = UInt(Rt);
integer m = UInt(Rm);
AccType acctype = AccType_NORMAL;
MemOp memop;
boolean signed;
integer regsize;

```

```

if opc<1> == '0' then
  // store or zero-extending load
  memop = if opc<0> == '1' then MemOp_LOAD else MemOp_STORE;
  regsize = if size == '11' then 64 else 32;
  signed = FALSE;
else
  if size == '11' then
    memop = MemOp_PREFETCH;
    if opc<0> == '1' then UnallocatedEncoding();
  else
    // sign-extending load
    memop = MemOp_LOAD;
    if size == '10' && opc<0> == '1' then UnallocatedEncoding();
    regsize = if opc<0> == '1' then 32 else 64;
    signed = TRUE;

integer datasize = 8 << scale;
  
```

Operation

```

bits(64) offset = ExtendReg(m, extend_type, shift);
bits(64) address;
bits(datasize) data;
boolean wb_unknown = FALSE;
boolean rt_unknown = FALSE;

if memop == MemOp_LOAD && wback && n == t && n != 31 then
  c = ConstrainUnpredictable();
  assert c IN {Constraint_WBSUPPRESS, Constraint_UNKNOWN, Constraint_UNDEF, Constraint_NOP};
  case c of
    when Constraint_WBSUPPRESS wback = FALSE; // writeback is suppressed
    when Constraint_UNKNOWN wb_unknown = TRUE; // writeback is UNKNOWN
    when Constraint_UNDEF UnallocatedEncoding();
    when Constraint_NOP EndOfInstruction();

if memop == MemOp_STORE && wback && n == t && n != 31 then
  c = ConstrainUnpredictable();
  assert c IN {Constraint_NONE, Constraint_UNKNOWN, Constraint_UNDEF, Constraint_NOP};
  case c of
    when Constraint_NONE rt_unknown = FALSE; // value stored is original value
    when Constraint_UNKNOWN rt_unknown = TRUE; // value stored is UNKNOWN
    when Constraint_UNDEF UnallocatedEncoding();
    when Constraint_NOP EndOfInstruction();

if n == 31 then
  if memop != MemOp_PREFETCH then CheckSPAlignment();
  address = SP[];
else
  address = X[n];

if ! postindex then
  address = address + offset;

case memop of
  when MemOp_STORE
    if rt_unknown then
      data = bits(datasize) UNKNOWN;
    else
      data = X[t];
      Mem[address, datasize DIV 8, acctype] = data;

  when MemOp_LOAD
    data = Mem[address, datasize DIV 8, acctype];
    if signed then
      X[t] = SignExtend(data, regsize);
    else
  
```

```
        X[t] = ZeroExtend(data, regsize);  
when MemOp_PREFETCH  
    Prefetch(address, t<4:0>);  
if wback then  
    if wb_unknown then  
        address = bits(64) UNKNOWN;  
    elsif postindex then  
        address = address + offset;  
    if n == 31 then  
        SP[] = address;  
    else  
        X[n] = address;
```

C5.6.88 LDRH (immediate)

Load register halfword (register offset)

It has encodings from 3 classes: *Post-index*, *Pre-index* and *Unsigned offset*

Post-index

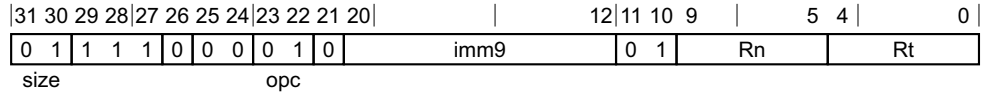

Post-index variant

LDRH <Wt>, [<Xn|SP>], #<simm>

```
boolean wback = TRUE;
boolean postindex = TRUE;
integer scale = UInt(size);
bits(64) offset = SignExtend(imm9, 64);
```

Pre-index

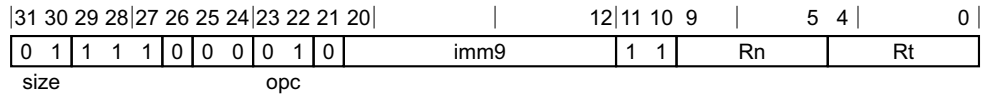

Pre-index variant

LDRH <Wt>, [<Xn|SP>, #<simm>]!

```
boolean wback = TRUE;
boolean postindex = FALSE;
integer scale = UInt(size);
bits(64) offset = SignExtend(imm9, 64);
```

Unsigned offset

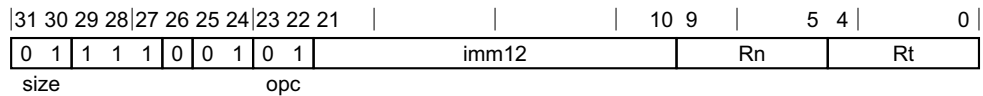

Unsigned offset variant

LDRH <Wt>, [<Xn|SP>{, #<pimm>}]

```
boolean wback = FALSE;
boolean postindex = FALSE;
integer scale = UInt(size);
bits(64) offset = LSL(ZeroExtend(imm12, 64), scale);
```

Assembler Symbols

- <Wt> Is the 32-bit name of the general-purpose register to be transferred, encoded in the "Rt" field.
- <Xn|SP> Is the 64-bit name of the general-purpose base register or stack pointer, encoded in the "Rn" field.
- <simm> Is the signed immediate byte offset, in the range -256 to 255, encoded in the "imm9" field.
- <pimm> Is the optional positive immediate byte offset, a multiple of 2 in the range 0 to 8190, defaulting to 0 and encoded in the "imm12" field as <pimm>/2.

Shared decode for all variants

```

integer n = UInt(Rn);
integer t = UInt(Rt);
AccType acctype = AccType_NORMAL;
MemOp memop;
boolean signed;
integer regsize;

if opc<1> == '0' then
    // store or zero-extending load
    memop = if opc<0> == '1' then MemOp_LOAD else MemOp_STORE;
    regsize = if size == '11' then 64 else 32;
    signed = FALSE;
else
    if size == '11' then
        memop = MemOp_PREFETCH;
        if opc<0> == '1' then UnallocatedEncoding();
    else
        // sign-extending load
        memop = MemOp_LOAD;
        if size == '10' && opc<0> == '1' then UnallocatedEncoding();
        regsize = if opc<0> == '1' then 32 else 64;
        signed = TRUE;

integer datasize = 8 << scale;

```

Operation for all classes

```

bits(64) address;
bits(datasize) data;
boolean wb_unknown = FALSE;
boolean rt_unknown = FALSE;

if memop == MemOp_LOAD && wback && n == t && n != 31 then
    c = ConstrainUnpredictable();
    assert c IN {Constraint_WBSUPPRESS, Constraint_UNKNOWN, Constraint_UNDEF, Constraint_NOP};
    case c of
        when Constraint_WBSUPPRESS wback = FALSE; // writeback is suppressed
        when Constraint_UNKNOWN wb_unknown = TRUE; // writeback is UNKNOWN
        when Constraint_UNDEF UnallocatedEncoding();
        when Constraint_NOP EndOfInstruction();

if memop == MemOp_STORE && wback && n == t && n != 31 then
    c = ConstrainUnpredictable();
    assert c IN {Constraint_NONE, Constraint_UNKNOWN, Constraint_UNDEF, Constraint_NOP};
    case c of
        when Constraint_NONE rt_unknown = FALSE; // value stored is original value
        when Constraint_UNKNOWN rt_unknown = TRUE; // value stored is UNKNOWN
        when Constraint_UNDEF UnallocatedEncoding();
        when Constraint_NOP EndOfInstruction();

if n == 31 then
    if memop != MemOp_PREFETCH then CheckSPAlignment();
    address = SP[];
else
    address = X[n];

if ! postindex then
    address = address + offset;

case memop of
    when MemOp_STORE
        if rt_unknown then
            data = bits(datasize) UNKNOWN;
        else
            data = X[t];

```

```
    Mem[address, datasize DIV 8, acctype] = data;

when MemOp_LOAD
    data = Mem[address, datasize DIV 8, acctype];
    if signed then
        X[t] = SignExtend(data, regsize);
    else
        X[t] = ZeroExtend(data, regsize);

when MemOp_PREFETCH
    Prefetch(address, t<4:0>);

if wback then
    if wb_unknown then
        address = bits(64) UNKNOWN;
    elsif postindex then
        address = address + offset;
    if n == 31 then
        SP[] = address;
    else
        X[n] = address;
```

C5.6.89 LDRH (register)

Load register halfword (register offset)

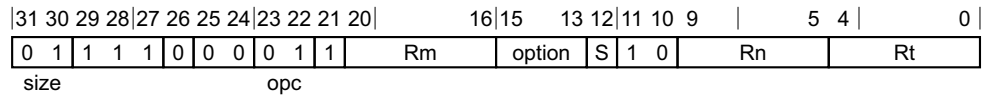

32-bit variant

LDRH <Wt>, [<Xn|SP>, <R><m>{, <extend> {<amount>}}]

```

boolean wback = FALSE;
boolean postindex = FALSE;
integer scale = UInt(size);
if option<1> == '0' then UnallocatedEncoding(); // sub-word index
ExtendType extend_type = DecodeRegExtend(option);
integer shift = if S == '1' then scale else 0;

```

Assembler Symbols

<Wt>	Is the 32-bit name of the general-purpose register to be transferred, encoded in the "Rt" field.
<Xn SP>	Is the 64-bit name of the general-purpose base register or stack pointer, encoded in the "Rn" field.
<R>	Is the index width specifier, RESERVED when option = 00x W when option = x10 X when option = x11 RESERVED when option = 10x
<m>	Is the number [0-30] of the general-purpose index register or the name ZR (31), encoded in the "Rm" field.
<extend>	Is the index extend/shift specifier, defaulting to LSL and RESERVED when option = 00x UXTW when option = 010 LSL when option = 011 RESERVED when option = 10x SXTW when option = 110 SXTX when option = 111
<amount>	Is the index shift amount, optional and defaulting to #0 when <extend> is not LSL, #0 when S = 0 #1 when S = 1

Shared decode for all variants

```

integer n = UInt(Rn);
integer t = UInt(Rt);
integer m = UInt(Rm);
AccType acctype = AccType_NORMAL;
MemOp memop;
boolean signed;
integer regsize;

```

```

if opc<1> == '0' then
    // store or zero-extending load
    memop = if opc<0> == '1' then MemOp_LOAD else MemOp_STORE;
    regsize = if size == '11' then 64 else 32;
    signed = FALSE;
else
    if size == '11' then
        memop = MemOp_PREFETCH;
        if opc<0> == '1' then UnallocatedEncoding();
    else
        // sign-extending load
        memop = MemOp_LOAD;
        if size == '10' && opc<0> == '1' then UnallocatedEncoding();
        regsize = if opc<0> == '1' then 32 else 64;
        signed = TRUE;

integer datasize = 8 << scale;

```

Operation

```

bits(64) offset = ExtendReg(m, extend_type, shift);
bits(64) address;
bits(datasize) data;
boolean wb_unknown = FALSE;
boolean rt_unknown = FALSE;

if memop == MemOp_LOAD && wback && n == t && n != 31 then
    c = ConstrainUnpredictable();
    assert c IN {Constraint_WBSUPPRESS, Constraint_UNKNOWN, Constraint_UNDEF, Constraint_NOP};
    case c of
        when Constraint_WBSUPPRESS wback = FALSE; // writeback is suppressed
        when Constraint_UNKNOWN wb_unknown = TRUE; // writeback is UNKNOWN
        when Constraint_UNDEF UnallocatedEncoding();
        when Constraint_NOP EndOfInstruction();

if memop == MemOp_STORE && wback && n == t && n != 31 then
    c = ConstrainUnpredictable();
    assert c IN {Constraint_NONE, Constraint_UNKNOWN, Constraint_UNDEF, Constraint_NOP};
    case c of
        when Constraint_NONE rt_unknown = FALSE; // value stored is original value
        when Constraint_UNKNOWN rt_unknown = TRUE; // value stored is UNKNOWN
        when Constraint_UNDEF UnallocatedEncoding();
        when Constraint_NOP EndOfInstruction();

if n == 31 then
    if memop != MemOp_PREFETCH then CheckSPAlignment();
    address = SP[];
else
    address = X[n];

if ! postindex then
    address = address + offset;

case memop of
    when MemOp_STORE
        if rt_unknown then
            data = bits(datasize) UNKNOWN;
        else
            data = X[t];
            Mem[address, datasize DIV 8, acctype] = data;

    when MemOp_LOAD
        data = Mem[address, datasize DIV 8, acctype];
        if signed then
            X[t] = SignExtend(data, regsize);
        else

```

```
        X[t] = ZeroExtend(data, regsize);  
when MemOp_PREFETCH  
    Prefetch(address, t<4:0>);  
if wback then  
    if wb_unknown then  
        address = bits(64) UNKNOWN;  
    elsif postindex then  
        address = address + offset;  
    if n == 31 then  
        SP[] = address;  
    else  
        X[n] = address;
```

C5.6.90 LDRSB (immediate)

Load register signed byte (immediate offset)

It has encodings from 3 classes: *Post-index*, *Pre-index* and *Unsigned offset*

Post-index



32-bit variant (opc = 11)

LDRSB <Wt>, [<Xn|SP>], #<sim>

64-bit variant (opc = 10)

LDRSB <Xt>, [<Xn|SP>], #<sim>

```
boolean wback = TRUE;
boolean postindex = TRUE;
integer scale = UInt(size);
bits(64) offset = SignExtend(imm9, 64);
```

Pre-index

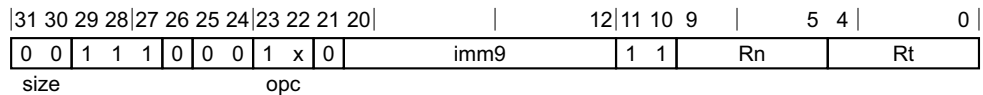

32-bit variant (opc = 11)

LDRSB <Wt>, [<Xn|SP>], #<sim>!

64-bit variant (opc = 10)

LDRSB <Xt>, [<Xn|SP>], #<sim>!

```
boolean wback = TRUE;
boolean postindex = FALSE;
integer scale = UInt(size);
bits(64) offset = SignExtend(imm9, 64);
```

Unsigned offset

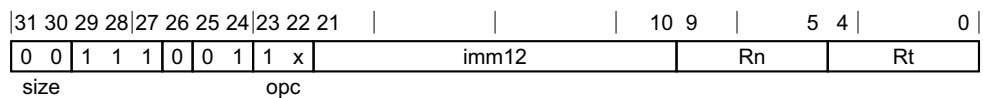

32-bit variant (opc = 11)

LDRSB <Wt>, [<Xn|SP>{, #<pimm>}]

64-bit variant (opc = 10)

LDRSB <Xt>, [<Xn|SP>{, #<pimm>}]

```
boolean wback = FALSE;
boolean postindex = FALSE;
integer scale = UInt(size);
bits(64) offset = LSL(ZeroExtend(imm12, 64), scale);
```

Assembler Symbols

<Wt>	Is the 32-bit name of the general-purpose register to be transferred, encoded in the "Rt" field.
<Xt>	Is the 64-bit name of the general-purpose register to be transferred, encoded in the "Rt" field.
<Xn SP>	Is the 64-bit name of the general-purpose base register or stack pointer, encoded in the "Rn" field.
<simm>	Is the signed immediate byte offset, in the range -256 to 255, encoded in the "imm9" field.
<pimm>	Is the optional positive immediate byte offset, in the range 0 to 4095, defaulting to 0 and encoded in the "imm12" field.

Shared decode for all variants

```

integer n = UInt(Rn);
integer t = UInt(Rt);
AccType acctype = AccType_NORMAL;
MemOp memop;
boolean signed;
integer regsize;

if opc<1> == '0' then
    // store or zero-extending load
    memop = if opc<0> == '1' then MemOp_LOAD else MemOp_STORE;
    regsize = if size == '11' then 64 else 32;
    signed = FALSE;
else
    if size == '11' then
        memop = MemOp_PREFETCH;
        if opc<0> == '1' then UnallocatedEncoding();
    else
        // sign-extending load
        memop = MemOp_LOAD;
        if size == '10' && opc<0> == '1' then UnallocatedEncoding();
        regsize = if opc<0> == '1' then 32 else 64;
        signed = TRUE;

integer datasize = 8 << scale;
  
```

Operation for all classes

```

bits(64) address;
bits(datasize) data;
boolean wb_unknown = FALSE;
boolean rt_unknown = FALSE;

if memop == MemOp_LOAD && wback && n == t && n != 31 then
    c = ConstrainUnpredictable();
    assert c IN {Constraint_WBSUPPRESS, Constraint_UNKNOWN, Constraint_UNDEF, Constraint_NOP};
    case c of
        when Constraint_WBSUPPRESS wback = FALSE; // writeback is suppressed
        when Constraint_UNKNOWN wb_unknown = TRUE; // writeback is UNKNOWN
        when Constraint_UNDEF UnallocatedEncoding();
        when Constraint_NOP EndOfInstruction();

if memop == MemOp_STORE && wback && n == t && n != 31 then
    c = ConstrainUnpredictable();
    assert c IN {Constraint_NONE, Constraint_UNKNOWN, Constraint_UNDEF, Constraint_NOP};
    case c of
        when Constraint_NONE rt_unknown = FALSE; // value stored is original value
        when Constraint_UNKNOWN rt_unknown = TRUE; // value stored is UNKNOWN
        when Constraint_UNDEF UnallocatedEncoding();
        when Constraint_NOP EndOfInstruction();

if n == 31 then
  
```

```
    if memop != MemOp_PREFETCH then CheckSPAlignment();
    address = SP[];
else
    address = X[n];

if ! postindex then
    address = address + offset;

case memop of
when MemOp_STORE
    if rt_unknown then
        data = bits(datasize) UNKNOWN;
    else
        data = X[t];
        Mem[address, datasize DIV 8, acctype] = data;

when MemOp_LOAD
    data = Mem[address, datasize DIV 8, acctype];
    if signed then
        X[t] = SignExtend(data, regsize);
    else
        X[t] = ZeroExtend(data, regsize);

when MemOp_PREFETCH
    Prefetch(address, t<4:0>);

if wback then
    if wb_unknown then
        address = bits(64) UNKNOWN;
    elsif postindex then
        address = address + offset;
    if n == 31 then
        SP[] = address;
    else
        X[n] = address;
```

C5.6.91 LDRSB (register)

Load register signed byte (register offset)

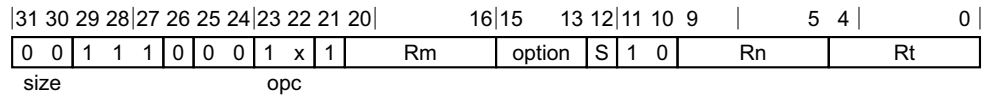

32-bit variant (opc = 11)

LDRSB <Wt>, [<Xn|SP>, <R><m>{, <extend> {<amount>}}

64-bit variant (opc = 10)

LDRSB <Xt>, [<Xn|SP>, <R><m>{, <extend> {<amount>}}

```
boolean wback = FALSE;
boolean postindex = FALSE;
integer scale = UInt(size);
if option<1> == '0' then UnallocatedEncoding(); // sub-word index
ExtendType extend_type = DecodeRegExtend(option);
integer shift = if S == '1' then scale else 0;
```

Assembler Symbols

<Wt>	Is the 32-bit name of the general-purpose register to be transferred, encoded in the "Rt" field.
<Xt>	Is the 64-bit name of the general-purpose register to be transferred, encoded in the "Rt" field.
<Xn SP>	Is the 64-bit name of the general-purpose base register or stack pointer, encoded in the "Rn" field.
<R>	Is the index width specifier, RESERVED when option = 00x W when option = x10 X when option = x11 RESERVED when option = 10x
<m>	Is the number [0-30] of the general-purpose index register or the name ZR (31), encoded in the "Rm" field.
<extend>	Is the index extend/shift specifier, defaulting to LSL and RESERVED when option = 00x UXTW when option = 010 LSL when option = 011 RESERVED when option = 10x SXTW when option = 110 SXTX when option = 111
<amount>	Is the index shift amount, optional and defaulting to #0 when <extend> is not LSL, [absent] when S = 0 #0 when S = 1

Shared decode for all variants

```

integer n = UInt(Rn);
integer t = UInt(Rt);
integer m = UInt(Rm);
AccType acctype = AccType_NORMAL;
MemOp memop;
boolean signed;
integer regsize;

if opc<1> == '0' then
    // store or zero-extending load
    memop = if opc<0> == '1' then MemOp_LOAD else MemOp_STORE;
    regsize = if size == '11' then 64 else 32;
    signed = FALSE;
else
    if size == '11' then
        memop = MemOp_PREFETCH;
        if opc<0> == '1' then UnallocatedEncoding();
    else
        // sign-extending load
        memop = MemOp_LOAD;
        if size == '10' && opc<0> == '1' then UnallocatedEncoding();
        regsize = if opc<0> == '1' then 32 else 64;
        signed = TRUE;

integer datasize = 8 << scale;

```

Operation

```

bits(64) offset = ExtendReg(m, extend_type, shift);
bits(64) address;
bits(datasize) data;
boolean wb_unknown = FALSE;
boolean rt_unknown = FALSE;

if memop == MemOp_LOAD && wback && n == t && n != 31 then
    c = ConstrainUnpredictable();
    assert c IN {Constraint_WBSUPPRESS, Constraint_UNKNOWN, Constraint_UNDEF, Constraint_NOP};
    case c of
        when Constraint_WBSUPPRESS wback = FALSE; // writeback is suppressed
        when Constraint_UNKNOWN wb_unknown = TRUE; // writeback is UNKNOWN
        when Constraint_UNDEF UnallocatedEncoding();
        when Constraint_NOP EndOfInstruction();

if memop == MemOp_STORE && wback && n == t && n != 31 then
    c = ConstrainUnpredictable();
    assert c IN {Constraint_NONE, Constraint_UNKNOWN, Constraint_UNDEF, Constraint_NOP};
    case c of
        when Constraint_NONE rt_unknown = FALSE; // value stored is original value
        when Constraint_UNKNOWN rt_unknown = TRUE; // value stored is UNKNOWN
        when Constraint_UNDEF UnallocatedEncoding();
        when Constraint_NOP EndOfInstruction();

if n == 31 then
    if memop != MemOp_PREFETCH then CheckSPAlignment();
    address = SP[];
else
    address = X[n];

if ! postindex then
    address = address + offset;

case memop of
    when MemOp_STORE

```

```
if rt_unknown then
    data = bits(datasize) UNKNOWN;
else
    data = X[t];
Mem[address, datasize DIV 8, acctype] = data;

when MemOp_LOAD
    data = Mem[address, datasize DIV 8, acctype];
    if signed then
        X[t] = SignExtend(data, regsize);
    else
        X[t] = ZeroExtend(data, regsize);

when MemOp_PREFETCH
    Prefetch(address, t<4:0>);

if wback then
    if wb_unknown then
        address = bits(64) UNKNOWN;
    elsif postindex then
        address = address + offset;
    if n == 31 then
        SP[] = address;
    else
        X[n] = address;
```

C5.6.92 LDRSH (immediate)

Load register signed halfword (immediate offset)

It has encodings from 3 classes: *Post-index*, *Pre-index* and *Unsigned offset*

Post-index



32-bit variant (opc = 11)

LDRSH <Wt>, [<Xn|SP>], #<sim>

64-bit variant (opc = 10)

LDRSH <Xt>, [<Xn|SP>], #<sim>

```
boolean wback = TRUE;
boolean postindex = TRUE;
integer scale = UInt(size);
bits(64) offset = SignExtend(imm9, 64);
```

Pre-index

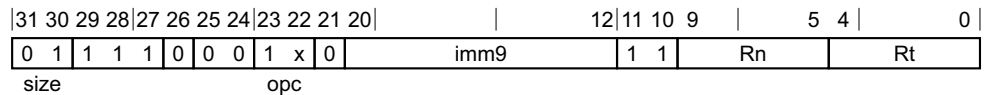

32-bit variant (opc = 11)

LDRSH <Wt>, [<Xn|SP>], #<sim>!

64-bit variant (opc = 10)

LDRSH <Xt>, [<Xn|SP>], #<sim>!

```
boolean wback = TRUE;
boolean postindex = FALSE;
integer scale = UInt(size);
bits(64) offset = SignExtend(imm9, 64);
```

Unsigned offset

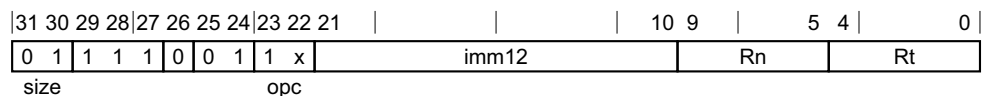

32-bit variant (opc = 11)

LDRSH <Wt>, [<Xn|SP>{, #<pimm>}]

64-bit variant (opc = 10)

LDRSH <Xt>, [<Xn|SP>{, #<pimm>}]

```
boolean wback = FALSE;
boolean postindex = FALSE;
integer scale = UInt(size);
bits(64) offset = LSL(ZeroExtend(imm12, 64), scale);
```

Assembler Symbols

<Wt>	Is the 32-bit name of the general-purpose register to be transferred, encoded in the "Rt" field.
<Xt>	Is the 64-bit name of the general-purpose register to be transferred, encoded in the "Rt" field.
<Xn SP>	Is the 64-bit name of the general-purpose base register or stack pointer, encoded in the "Rn" field.
<simm>	Is the signed immediate byte offset, in the range -256 to 255, encoded in the "imm9" field.
<pimm>	Is the optional positive immediate byte offset, a multiple of 2 in the range 0 to 8190, defaulting to 0 and encoded in the "imm12" field as <pimm>/2.

Shared decode for all variants

```

integer n = UInt(Rn);
integer t = UInt(Rt);
AccType acctype = AccType_NORMAL;
MemOp memop;
boolean signed;
integer regsize;

if opc<1> == '0' then
    // store or zero-extending load
    memop = if opc<0> == '1' then MemOp_LOAD else MemOp_STORE;
    regsize = if size == '11' then 64 else 32;
    signed = FALSE;
else
    if size == '11' then
        memop = MemOp_PREFETCH;
        if opc<0> == '1' then UnallocatedEncoding();
    else
        // sign-extending load
        memop = MemOp_LOAD;
        if size == '10' && opc<0> == '1' then UnallocatedEncoding();
        regsize = if opc<0> == '1' then 32 else 64;
        signed = TRUE;

integer datasize = 8 << scale;
  
```

Operation for all classes

```

bits(64) address;
bits(datasize) data;
boolean wb_unknown = FALSE;
boolean rt_unknown = FALSE;

if memop == MemOp_LOAD && wback && n == t && n != 31 then
    c = ConstrainUnpredictable();
    assert c IN {Constraint_WBSUPPRESS, Constraint_UNKNOWN, Constraint_UNDEF, Constraint_NOP};
    case c of
        when Constraint_WBSUPPRESS wback = FALSE; // writeback is suppressed
        when Constraint_UNKNOWN wb_unknown = TRUE; // writeback is UNKNOWN
        when Constraint_UNDEF UnallocatedEncoding();
        when Constraint_NOP EndOfInstruction();

if memop == MemOp_STORE && wback && n == t && n != 31 then
    c = ConstrainUnpredictable();
    assert c IN {Constraint_NONE, Constraint_UNKNOWN, Constraint_UNDEF, Constraint_NOP};
    case c of
        when Constraint_NONE rt_unknown = FALSE; // value stored is original value
        when Constraint_UNKNOWN rt_unknown = TRUE; // value stored is UNKNOWN
        when Constraint_UNDEF UnallocatedEncoding();
        when Constraint_NOP EndOfInstruction();

if n == 31 then
  
```

```
    if memop != MemOp_PREFETCH then CheckSPAlignment();
    address = SP[];
else
    address = X[n];

if ! postindex then
    address = address + offset;

case memop of
when MemOp_STORE
    if rt_unknown then
        data = bits(datasize) UNKNOWN;
    else
        data = X[t];
        Mem[address, datasize DIV 8, acctype] = data;

when MemOp_LOAD
    data = Mem[address, datasize DIV 8, acctype];
    if signed then
        X[t] = SignExtend(data, regsize);
    else
        X[t] = ZeroExtend(data, regsize);

when MemOp_PREFETCH
    Prefetch(address, t<4:0>);

if wback then
    if wb_unknown then
        address = bits(64) UNKNOWN;
    elsif postindex then
        address = address + offset;
    if n == 31 then
        SP[] = address;
    else
        X[n] = address;
```

C5.6.93 LDRSH (register)

Load register signed halfword (register offset)

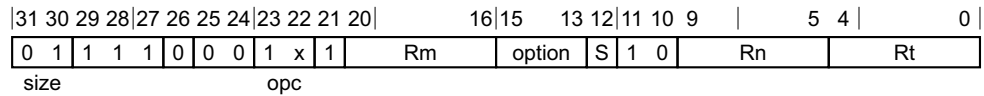

32-bit variant (opc = 11)

LDRSH <Wt>, [<Xn|SP>, <R><m>{, <extend> {<amount>}}

64-bit variant (opc = 10)

LDRSH <Xt>, [<Xn|SP>, <R><m>{, <extend> {<amount>}}

```
boolean wback = FALSE;
boolean postindex = FALSE;
integer scale = UInt(size);
if option<1> == '0' then UnallocatedEncoding(); // sub-word index
ExtendType extend_type = DecodeRegExtend(option);
integer shift = if S == '1' then scale else 0;
```

Assembler Symbols

<Wt>	Is the 32-bit name of the general-purpose register to be transferred, encoded in the "Rt" field.
<Xt>	Is the 64-bit name of the general-purpose register to be transferred, encoded in the "Rt" field.
<Xn SP>	Is the 64-bit name of the general-purpose base register or stack pointer, encoded in the "Rn" field.
<R>	Is the index width specifier, RESERVED when option = 00x W when option = x10 X when option = x11 RESERVED when option = 10x
<m>	Is the number [0-30] of the general-purpose index register or the name ZR (31), encoded in the "Rm" field.
<extend>	Is the index extend/shift specifier, defaulting to LSL and RESERVED when option = 00x UXTW when option = 010 LSL when option = 011 RESERVED when option = 10x SXTW when option = 110 SXTX when option = 111
<amount>	Is the index shift amount, optional and defaulting to #0 when <extend> is not LSL, #0 when S = 0 #1 when S = 1

Shared decode for all variants

```
integer n = UInt(Rn);
integer t = UInt(Rt);
integer m = UInt(Rm);
AccType acctype = AccType_NORMAL;
MemOp memop;
boolean signed;
integer regsize;

if opc<1> == '0' then
    // store or zero-extending load
    memop = if opc<0> == '1' then MemOp_LOAD else MemOp_STORE;
    regsize = if size == '11' then 64 else 32;
    signed = FALSE;
else
    if size == '11' then
        memop = MemOp_PREFETCH;
        if opc<0> == '1' then UnallocatedEncoding();
    else
        // sign-extending load
        memop = MemOp_LOAD;
        if size == '10' && opc<0> == '1' then UnallocatedEncoding();
        regsize = if opc<0> == '1' then 32 else 64;
        signed = TRUE;

integer datasize = 8 << scale;
```

Operation

```
bits(64) offset = ExtendReg(m, extend_type, shift);
bits(64) address;
bits(datasize) data;
boolean wb_unknown = FALSE;
boolean rt_unknown = FALSE;

if memop == MemOp_LOAD && wback && n == t && n != 31 then
    c = ConstrainUnpredictable();
    assert c IN {Constraint_WBSUPPRESS, Constraint_UNKNOWN, Constraint_UNDEF, Constraint_NOP};
    case c of
        when Constraint_WBSUPPRESS wback = FALSE; // writeback is suppressed
        when Constraint_UNKNOWN wb_unknown = TRUE; // writeback is UNKNOWN
        when Constraint_UNDEF UnallocatedEncoding();
        when Constraint_NOP EndOfInstruction();

if memop == MemOp_STORE && wback && n == t && n != 31 then
    c = ConstrainUnpredictable();
    assert c IN {Constraint_NONE, Constraint_UNKNOWN, Constraint_UNDEF, Constraint_NOP};
    case c of
        when Constraint_NONE rt_unknown = FALSE; // value stored is original value
        when Constraint_UNKNOWN rt_unknown = TRUE; // value stored is UNKNOWN
        when Constraint_UNDEF UnallocatedEncoding();
        when Constraint_NOP EndOfInstruction();

if n == 31 then
    if memop != MemOp_PREFETCH then CheckSPAlignment();
    address = SP[];
else
    address = X[n];

if ! postindex then
    address = address + offset;

case memop of
    when MemOp_STORE
```



```
if rt_unknown then
    data = bits(datasize) UNKNOWN;
else
    data = X[t];
Mem[address, datasize DIV 8, acctype] = data;

when MemOp_LOAD
    data = Mem[address, datasize DIV 8, acctype];
    if signed then
        X[t] = SignExtend(data, regsize);
    else
        X[t] = ZeroExtend(data, regsize);

when MemOp_PREFETCH
    Prefetch(address, t<4:0>);

if wback then
    if wb_unknown then
        address = bits(64) UNKNOWN;
    elsif postindex then
        address = address + offset;
    if n == 31 then
        SP[] = address;
    else
        X[n] = address;
```

C5.6.94 LDRSW (immediate)

Load register signed word (immediate offset)

It has encodings from 3 classes: *Post-index*, *Pre-index* and *Unsigned offset*

Post-index

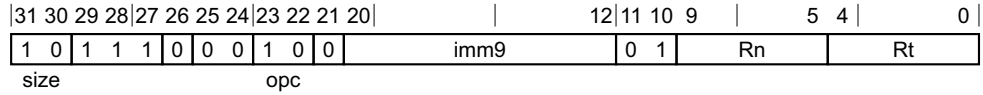

Post-index variant

LDRSW <Xt>, [<Xn|SP>], #<simm>

```
boolean wback = TRUE;
boolean postindex = TRUE;
integer scale = UInt(size);
bits(64) offset = SignExtend(imm9, 64);
```

Pre-index

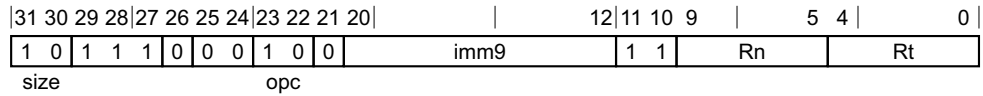

Pre-index variant

LDRSW <Xt>, [<Xn|SP>, #<simm>]!

```
boolean wback = TRUE;
boolean postindex = FALSE;
integer scale = UInt(size);
bits(64) offset = SignExtend(imm9, 64);
```

Unsigned offset

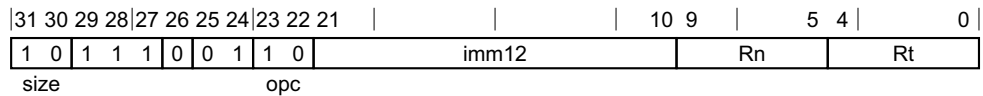

Unsigned offset variant

LDRSW <Xt>, [<Xn|SP>{, #<pimm>}]

```
boolean wback = FALSE;
boolean postindex = FALSE;
integer scale = UInt(size);
bits(64) offset = LSL(ZeroExtend(imm12, 64), scale);
```

Assembler Symbols

- <Xt> Is the 64-bit name of the general-purpose register to be transferred, encoded in the "Rt" field.
- <Xn|SP> Is the 64-bit name of the general-purpose base register or stack pointer, encoded in the "Rn" field.
- <simm> Is the signed immediate byte offset, in the range -256 to 255, encoded in the "imm9" field.
- <pimm> Is the optional positive immediate byte offset, a multiple of 4 in the range 0 to 16380, defaulting to 0 and encoded in the "imm12" field as <pimm>/4.

Shared decode for all variants

```

integer n = UInt(Rn);
integer t = UInt(Rt);
AccType acctype = AccType_NORMAL;
MemOp memop;
boolean signed;
integer regsize;

if opc<1> == '0' then
  // store or zero-extending load
  memop = if opc<0> == '1' then MemOp_LOAD else MemOp_STORE;
  regsize = if size == '11' then 64 else 32;
  signed = FALSE;
else
  if size == '11' then
    memop = MemOp_PREFETCH;
    if opc<0> == '1' then UnallocatedEncoding();
  else
    // sign-extending load
    memop = MemOp_LOAD;
    if size == '10' && opc<0> == '1' then UnallocatedEncoding();
    regsize = if opc<0> == '1' then 32 else 64;
    signed = TRUE;

integer datasize = 8 << scale;
  
```

Operation for all classes

```

bits(64) address;
bits(datasize) data;
boolean wb_unknown = FALSE;
boolean rt_unknown = FALSE;

if memop == MemOp_LOAD && wback && n == t && n != 31 then
  c = ConstrainUnpredictable();
  assert c IN {Constraint_WBSUPPRESS, Constraint_UNKNOWN, Constraint_UNDEF, Constraint_NOP};
  case c of
    when Constraint_WBSUPPRESS wback = FALSE; // writeback is suppressed
    when Constraint_UNKNOWN wb_unknown = TRUE; // writeback is UNKNOWN
    when Constraint_UNDEF UnallocatedEncoding();
    when Constraint_NOP EndOfInstruction();

if memop == MemOp_STORE && wback && n == t && n != 31 then
  c = ConstrainUnpredictable();
  assert c IN {Constraint_NONE, Constraint_UNKNOWN, Constraint_UNDEF, Constraint_NOP};
  case c of
    when Constraint_NONE rt_unknown = FALSE; // value stored is original value
    when Constraint_UNKNOWN rt_unknown = TRUE; // value stored is UNKNOWN
    when Constraint_UNDEF UnallocatedEncoding();
    when Constraint_NOP EndOfInstruction();

if n == 31 then
  if memop != MemOp_PREFETCH then CheckSPAlignment();
  address = SP[];
else
  address = X[n];

if ! postindex then
  address = address + offset;

case memop of
  when MemOp_STORE
    if rt_unknown then
      data = bits(datasize) UNKNOWN;
    else
      data = X[t];
  
```

```
Mem[address, datasize DIV 8, acctype] = data;

when MemOp_LOAD
  data = Mem[address, datasize DIV 8, acctype];
  if signed then
    X[t] = SignExtend(data, regsize);
  else
    X[t] = ZeroExtend(data, regsize);

when MemOp_PREFETCH
  Prefetch(address, t<4:0>);

if wback then
  if wb_unknown then
    address = bits(64) UNKNOWN;
  elsif postindex then
    address = address + offset;
  if n == 31 then
    SP[] = address;
  else
    X[n] = address;
```

C5.6.95 LDRSW (literal)

Load register signed word (PC-relative literal)



Literal variant

LDRSW <Xt>, <label>

```
integer t = UInt(Rt);
MemOp memop = MemOp_LOAD;
boolean signed = FALSE;
integer size;
bits(64) offset;

case opc of
  when '00'
    size = 4;
  when '01'
    size = 8;
  when '10'
    size = 4;
    signed = TRUE;
  when '11'
    memop = MemOp_PREFETCH;

offset = SignExtend(imm19:'00', 64);
```

Assembler Symbols

<Xt> Is the 64-bit name of the general-purpose register to be loaded, encoded in the "Rt" field.

<label> Is the program label from which the data is to be loaded. Its offset from the address of this instruction, in the range +/-1MB, is encoded as "imm19" times 4.

Operation

```
bits(64) address = PC[] + offset;
bits(size*8) data;

case memop of
  when MemOp_LOAD
    data = Mem[address, size, AccType_NORMAL];
    if signed then
      X[t] = SignExtend(data, 64);
    else
      X[t] = data;

  when MemOp_PREFETCH
    Prefetch(address, t<4:0>);
```

C5.6.96 LDRSW (register)

Load register signed word (register offset)

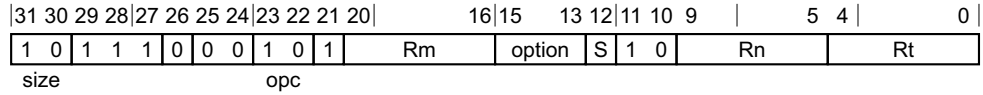

64-bit variant

LDRSW <Xt>, [<Xn|SP>, <R><m>{, <extend> {<amount>}}]

```
boolean wback = FALSE;
boolean postindex = FALSE;
integer scale = UInt(size);
if option<1> == '0' then UnallocatedEncoding(); // sub-word index
ExtendType extend_type = DecodeRegExtend(option);
integer shift = if S == '1' then scale else 0;
```

Assembler Symbols

- <Xt> Is the 64-bit name of the general-purpose register to be transferred, encoded in the "Rt" field.
- <Xn|SP> Is the 64-bit name of the general-purpose base register or stack pointer, encoded in the "Rn" field.
- <R> Is the index width specifier,
 - RESERVED** when option = 00x
 - W** when option = x10
 - X** when option = x11
 - RESERVED** when option = 10x
- <m> Is the number [0-30] of the general-purpose index register or the name ZR (31), encoded in the "Rm" field.
- <extend> Is the index extend/shift specifier, defaulting to LSL and
 - RESERVED** when option = 00x
 - UXTW** when option = 010
 - LSL** when option = 011
 - RESERVED** when option = 10x
 - SXTW** when option = 110
 - SXTX** when option = 111
- <amount> Is the index shift amount, optional and defaulting to #0 when <extend> is not LSL,
 - #0** when S = 0
 - #2** when S = 1

Shared decode for all variants

```
integer n = UInt(Rn);
integer t = UInt(Rt);
integer m = UInt(Rm);
AccType acctype = AccType_NORMAL;
MemOp memop;
boolean signed;
integer regsize;
```

```

if opc<1> == '0' then
    // store or zero-extending load
    memop = if opc<0> == '1' then MemOp_LOAD else MemOp_STORE;
    regsize = if size == '11' then 64 else 32;
    signed = FALSE;
else
    if size == '11' then
        memop = MemOp_PREFETCH;
        if opc<0> == '1' then UnallocatedEncoding();
    else
        // sign-extending load
        memop = MemOp_LOAD;
        if size == '10' && opc<0> == '1' then UnallocatedEncoding();
        regsize = if opc<0> == '1' then 32 else 64;
        signed = TRUE;

integer datasize = 8 << scale;

```

Operation

```

bits(64) offset = ExtendReg(m, extend_type, shift);
bits(64) address;
bits(datasize) data;
boolean wb_unknown = FALSE;
boolean rt_unknown = FALSE;

if memop == MemOp_LOAD && wback && n == t && n != 31 then
    c = ConstrainUnpredictable();
    assert c IN {Constraint_WBSUPPRESS, Constraint_UNKNOWN, Constraint_UNDEF, Constraint_NOP};
    case c of
        when Constraint_WBSUPPRESS wback = FALSE; // writeback is suppressed
        when Constraint_UNKNOWN wb_unknown = TRUE; // writeback is UNKNOWN
        when Constraint_UNDEF UnallocatedEncoding();
        when Constraint_NOP EndOfInstruction();

if memop == MemOp_STORE && wback && n == t && n != 31 then
    c = ConstrainUnpredictable();
    assert c IN {Constraint_NONE, Constraint_UNKNOWN, Constraint_UNDEF, Constraint_NOP};
    case c of
        when Constraint_NONE rt_unknown = FALSE; // value stored is original value
        when Constraint_UNKNOWN rt_unknown = TRUE; // value stored is UNKNOWN
        when Constraint_UNDEF UnallocatedEncoding();
        when Constraint_NOP EndOfInstruction();

if n == 31 then
    if memop != MemOp_PREFETCH then CheckSPAlignment();
    address = SP[];
else
    address = X[n];

if ! postindex then
    address = address + offset;

case memop of
    when MemOp_STORE
        if rt_unknown then
            data = bits(datasize) UNKNOWN;
        else
            data = X[t];
            Mem[address, datasize DIV 8, acctype] = data;

    when MemOp_LOAD
        data = Mem[address, datasize DIV 8, acctype];
        if signed then
            X[t] = SignExtend(data, regsize);
        else

```

```
        X[t] = ZeroExtend(data, regsize);

when MemOp_PREFETCH
    Prefetch(address, t<4:0>);

if wback then
    if wb_unknown then
        address = bits(64) UNKNOWN;
    elsif postindex then
        address = address + offset;
    if n == 31 then
        SP[] = address;
    else
        X[n] = address;
```

C5.6.97 LDTR

Load register (unprivileged)

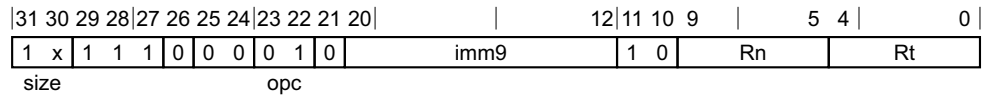

32-bit variant (size = 10)

LDTR <Wt>, [<Xn|SP>{, #<sim>}]

64-bit variant (size = 11)

LDTR <Xt>, [<Xn|SP>{, #<sim>}]

```
boolean wback = FALSE;
boolean postindex = FALSE;
integer scale = UInt(size);
bits(64) offset = SignExtend(imm9, 64);
```

Assembler Symbols

- <Wt> Is the 32-bit name of the general-purpose register to be transferred, encoded in the "Rt" field.
- <Xt> Is the 64-bit name of the general-purpose register to be transferred, encoded in the "Rt" field.
- <Xn|SP> Is the 64-bit name of the general-purpose base register or stack pointer, encoded in the "Rn" field.
- <sim> Is the optional signed immediate byte offset, in the range -256 to 255, defaulting to 0 and encoded in the "imm9" field.

Shared decode for all variants

```
integer n = UInt(Rn);
integer t = UInt(Rt);
AccType acctype = AccType_UNPRIV;
MemOp memop;
boolean signed;
integer regsize;

if opc<1> == '0' then
    // store or zero-extending load
    memop = if opc<0> == '1' then MemOp_LOAD else MemOp_STORE;
    regsize = if size == '11' then 64 else 32;
    signed = FALSE;
else
    if size == '11' then
        // no unprivileged prefetch
        UnallocatedEncoding();
    else
        // sign-extending load
        memop = MemOp_LOAD;
        if size == '10' && opc<0> == '1' then UnallocatedEncoding();
        regsize = if opc<0> == '1' then 32 else 64;
        signed = TRUE;

integer datasize = 8 << scale;
```

Operation

```

bits(64) address;
bits(datasize) data;
boolean wb_unknown = FALSE;
boolean rt_unknown = FALSE;

if memop == MemOp_LOAD && wback && n == t && n != 31 then
    c = ConstrainUnpredictable();
    assert c IN {Constraint_WBSUPPRESS, Constraint_UNKNOWN, Constraint_UNDEF, Constraint_NOP};
    case c of
        when Constraint_WBSUPPRESS wback = FALSE; // writeback is suppressed
        when Constraint_UNKNOWN wb_unknown = TRUE; // writeback is UNKNOWN
        when Constraint_UNDEF UnallocatedEncoding();
        when Constraint_NOP EndOfInstruction();

if memop == MemOp_STORE && wback && n == t && n != 31 then
    c = ConstrainUnpredictable();
    assert c IN {Constraint_NONE, Constraint_UNKNOWN, Constraint_UNDEF, Constraint_NOP};
    case c of
        when Constraint_NONE rt_unknown = FALSE; // value stored is original value
        when Constraint_UNKNOWN rt_unknown = TRUE; // value stored is UNKNOWN
        when Constraint_UNDEF UnallocatedEncoding();
        when Constraint_NOP EndOfInstruction();

if n == 31 then
    if memop != MemOp_PREFETCH then CheckSPAlignment();
    address = SP[];
else
    address = X[n];

if ! postindex then
    address = address + offset;

case memop of
    when MemOp_STORE
        if rt_unknown then
            data = bits(datasize) UNKNOWN;
        else
            data = X[t];
            Mem[address, datasize DIV 8, acctype] = data;

    when MemOp_LOAD
        data = Mem[address, datasize DIV 8, acctype];
        if signed then
            X[t] = SignExtend(data, regsize);
        else
            X[t] = ZeroExtend(data, regsize);

    when MemOp_PREFETCH
        Prefetch(address, t<4:0>);

if wback then
    if wb_unknown then
        address = bits(64) UNKNOWN;
    elsif postindex then
        address = address + offset;
    if n == 31 then
        SP[] = address;
    else
        X[n] = address;

```

C5.6.98 LDTRB

Load register byte (unprivileged)

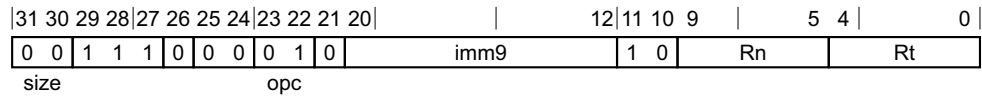

Unsigned offset variant

LDTRB <Wt>, [<Xn|SP>{, #<sim>}]

```
boolean wback = FALSE;
boolean postindex = FALSE;
integer scale = UInt(size);
bits(64) offset = SignExtend(imm9, 64);
```

Assembler Symbols

- <Wt> Is the 32-bit name of the general-purpose register to be transferred, encoded in the "Rt" field.
- <Xn|SP> Is the 64-bit name of the general-purpose base register or stack pointer, encoded in the "Rn" field.
- <sim> Is the optional signed immediate byte offset, in the range -256 to 255, defaulting to 0 and encoded in the "imm9" field.

Shared decode for all variants

```
integer n = UInt(Rn);
integer t = UInt(Rt);
AccType acctype = AccType_UNPRIV;
MemOp memop;
boolean signed;
integer regsize;

if opc<1> == '0' then
    // store or zero-extending load
    memop = if opc<0> == '1' then MemOp_LOAD else MemOp_STORE;
    regsize = if size == '11' then 64 else 32;
    signed = FALSE;
else
    if size == '11' then
        // no unprivileged prefetch
        UnallocatedEncoding();
    else
        // sign-extending load
        memop = MemOp_LOAD;
        if size == '10' && opc<0> == '1' then UnallocatedEncoding();
        regsize = if opc<0> == '1' then 32 else 64;
        signed = TRUE;

integer datasize = 8 << scale;
```

Operation

```
bits(64) address;
bits(datasize) data;
boolean wb_unknown = FALSE;
boolean rt_unknown = FALSE;

if memop == MemOp_LOAD && wback && n == t && n != 31 then
```

```
c = ConstrainUnpredictable();
assert c IN {Constraint_WBSUPPRESS, Constraint_UNKNOWN, Constraint_UNDEF, Constraint_NOP};
case c of
  when Constraint_WBSUPPRESS wback = FALSE; // writeback is suppressed
  when Constraint_UNKNOWN wb_unknown = TRUE; // writeback is UNKNOWN
  when Constraint_UNDEF UnallocatedEncoding();
  when Constraint_NOP EndOfInstruction();

if memop == MemOp_STORE && wback && n == t && n != 31 then
  c = ConstrainUnpredictable();
  assert c IN {Constraint_NONE, Constraint_UNKNOWN, Constraint_UNDEF, Constraint_NOP};
  case c of
    when Constraint_NONE rt_unknown = FALSE; // value stored is original value
    when Constraint_UNKNOWN rt_unknown = TRUE; // value stored is UNKNOWN
    when Constraint_UNDEF UnallocatedEncoding();
    when Constraint_NOP EndOfInstruction();

if n == 31 then
  if memop != MemOp_PREFETCH then CheckSPAlignment();
  address = SP[];
else
  address = X[n];

if ! postindex then
  address = address + offset;

case memop of
  when MemOp_STORE
    if rt_unknown then
      data = bits(datasize) UNKNOWN;
    else
      data = X[t];
    Mem[address, datasize DIV 8, acctype] = data;

  when MemOp_LOAD
    data = Mem[address, datasize DIV 8, acctype];
    if signed then
      X[t] = SignExtend(data, regsize);
    else
      X[t] = ZeroExtend(data, regsize);

  when MemOp_PREFETCH
    Prefetch(address, t<4:0>);

if wback then
  if wb_unknown then
    address = bits(64) UNKNOWN;
  elsif postindex then
    address = address + offset;
  if n == 31 then
    SP[] = address;
  else
    X[n] = address;
```

C5.6.99 LDTRH

Load register halfword (unprivileged)

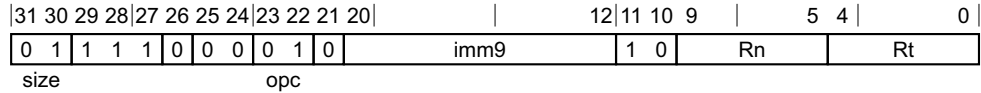

Unsigned offset variant

LDTRH <Wt>, [<Xn|SP>{, #<sim>}]

```
boolean wback = FALSE;
boolean postindex = FALSE;
integer scale = UInt(size);
bits(64) offset = SignExtend(imm9, 64);
```

Assembler Symbols

- <Wt> Is the 32-bit name of the general-purpose register to be transferred, encoded in the "Rt" field.
- <Xn|SP> Is the 64-bit name of the general-purpose base register or stack pointer, encoded in the "Rn" field.
- <sim> Is the optional signed immediate byte offset, in the range -256 to 255, defaulting to 0 and encoded in the "imm9" field.

Shared decode for all variants

```
integer n = UInt(Rn);
integer t = UInt(Rt);
AccType acctype = AccType_UNPRIV;
MemOp memop;
boolean signed;
integer regsize;

if opc<1> == '0' then
  // store or zero-extending load
  memop = if opc<0> == '1' then MemOp_LOAD else MemOp_STORE;
  regsize = if size == '11' then 64 else 32;
  signed = FALSE;
else
  if size == '11' then
    // no unprivileged prefetch
    UnallocatedEncoding();
  else
    // sign-extending load
    memop = MemOp_LOAD;
    if size == '10' && opc<0> == '1' then UnallocatedEncoding();
    regsize = if opc<0> == '1' then 32 else 64;
    signed = TRUE;

integer datasize = 8 << scale;
```

Operation

```
bits(64) address;
bits(datasize) data;
boolean wb_unknown = FALSE;
boolean rt_unknown = FALSE;

if memop == MemOp_LOAD && wback && n == t && n != 31 then
```

```
c = ConstrainUnpredictable();
assert c IN {Constraint_WBSUPPRESS, Constraint_UNKNOWN, Constraint_UNDEF, Constraint_NOP};
case c of
  when Constraint_WBSUPPRESS wback = FALSE; // writeback is suppressed
  when Constraint_UNKNOWN wb_unknown = TRUE; // writeback is UNKNOWN
  when Constraint_UNDEF UnallocatedEncoding();
  when Constraint_NOP EndOfInstruction();

if memop == MemOp_STORE && wback && n == t && n != 31 then
  c = ConstrainUnpredictable();
  assert c IN {Constraint_NONE, Constraint_UNKNOWN, Constraint_UNDEF, Constraint_NOP};
  case c of
    when Constraint_NONE rt_unknown = FALSE; // value stored is original value
    when Constraint_UNKNOWN rt_unknown = TRUE; // value stored is UNKNOWN
    when Constraint_UNDEF UnallocatedEncoding();
    when Constraint_NOP EndOfInstruction();

if n == 31 then
  if memop != MemOp_PREFETCH then CheckSPAlignment();
  address = SP[];
else
  address = X[n];

if ! postindex then
  address = address + offset;

case memop of
  when MemOp_STORE
    if rt_unknown then
      data = bits(datasize) UNKNOWN;
    else
      data = X[t];
    Mem[address, datasize DIV 8, acctype] = data;

  when MemOp_LOAD
    data = Mem[address, datasize DIV 8, acctype];
    if signed then
      X[t] = SignExtend(data, regsize);
    else
      X[t] = ZeroExtend(data, regsize);

  when MemOp_PREFETCH
    Prefetch(address, t<4:0>);

if wback then
  if wb_unknown then
    address = bits(64) UNKNOWN;
  elsif postindex then
    address = address + offset;
  if n == 31 then
    SP[] = address;
  else
    X[n] = address;
```

C5.6.100 LDTRSB

Load register signed byte (unprivileged)

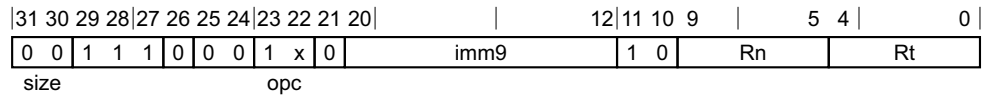

32-bit variant (opc = 11)

LDTRSB <Wt>, [<Xn|SP>{, #<simmm>}]

64-bit variant (opc = 10)

LDTRSB <Xt>, [<Xn|SP>{, #<simmm>}]

```
boolean wback = FALSE;
boolean postindex = FALSE;
integer scale = UInt(size);
bits(64) offset = SignExtend(imm9, 64);
```

Assembler Symbols

- <Wt> Is the 32-bit name of the general-purpose register to be transferred, encoded in the "Rt" field.
- <Xt> Is the 64-bit name of the general-purpose register to be transferred, encoded in the "Rt" field.
- <Xn|SP> Is the 64-bit name of the general-purpose base register or stack pointer, encoded in the "Rn" field.
- <simmm> Is the optional signed immediate byte offset, in the range -256 to 255, defaulting to 0 and encoded in the "imm9" field.

Shared decode for all variants

```
integer n = UInt(Rn);
integer t = UInt(Rt);
AccType acctype = AccType_UNPRIV;
MemOp memop;
boolean signed;
integer regsize;

if opc<1> == '0' then
    // store or zero-extending load
    memop = if opc<0> == '1' then MemOp_LOAD else MemOp_STORE;
    regsize = if size == '11' then 64 else 32;
    signed = FALSE;
else
    if size == '11' then
        // no unprivileged prefetch
        UnallocatedEncoding();
    else
        // sign-extending load
        memop = MemOp_LOAD;
        if size == '10' && opc<0> == '1' then UnallocatedEncoding();
        regsize = if opc<0> == '1' then 32 else 64;
        signed = TRUE;

integer datasize = 8 << scale;
```

Operation

```

bits(64) address;
bits(datasize) data;
boolean wb_unknown = FALSE;
boolean rt_unknown = FALSE;

if memop == MemOp_LOAD && wback && n == t && n != 31 then
    c = ConstrainUnpredictable();
    assert c IN {Constraint_WBSUPPRESS, Constraint_UNKNOWN, Constraint_UNDEF, Constraint_NOP};
    case c of
        when Constraint_WBSUPPRESS wback = FALSE; // writeback is suppressed
        when Constraint_UNKNOWN wb_unknown = TRUE; // writeback is UNKNOWN
        when Constraint_UNDEF UnallocatedEncoding();
        when Constraint_NOP EndOfInstruction();

if memop == MemOp_STORE && wback && n == t && n != 31 then
    c = ConstrainUnpredictable();
    assert c IN {Constraint_NONE, Constraint_UNKNOWN, Constraint_UNDEF, Constraint_NOP};
    case c of
        when Constraint_NONE rt_unknown = FALSE; // value stored is original value
        when Constraint_UNKNOWN rt_unknown = TRUE; // value stored is UNKNOWN
        when Constraint_UNDEF UnallocatedEncoding();
        when Constraint_NOP EndOfInstruction();

if n == 31 then
    if memop != MemOp_PREFETCH then CheckSPAlignment();
    address = SP[];
else
    address = X[n];

if ! postindex then
    address = address + offset;

case memop of
    when MemOp_STORE
        if rt_unknown then
            data = bits(datasize) UNKNOWN;
        else
            data = X[t];
            Mem[address, datasize DIV 8, acctype] = data;

    when MemOp_LOAD
        data = Mem[address, datasize DIV 8, acctype];
        if signed then
            X[t] = SignExtend(data, regsize);
        else
            X[t] = ZeroExtend(data, regsize);

    when MemOp_PREFETCH
        Prefetch(address, t<4:0>);

if wback then
    if wb_unknown then
        address = bits(64) UNKNOWN;
    elsif postindex then
        address = address + offset;
    if n == 31 then
        SP[] = address;
    else
        X[n] = address;

```

C5.6.101 LDTRSH

Load register signed halfword (unprivileged)

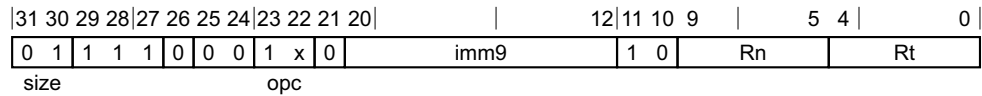

32-bit variant (opc = 11)

LDTRSH <Wt>, [<Xn|SP>{, #<sim>}]

64-bit variant (opc = 10)

LDTRSH <Xt>, [<Xn|SP>{, #<sim>}]

```
boolean wback = FALSE;
boolean postindex = FALSE;
integer scale = UInt(size);
bits(64) offset = SignExtend(imm9, 64);
```

Assembler Symbols

- <Wt> Is the 32-bit name of the general-purpose register to be transferred, encoded in the "Rt" field.
- <Xt> Is the 64-bit name of the general-purpose register to be transferred, encoded in the "Rt" field.
- <Xn|SP> Is the 64-bit name of the general-purpose base register or stack pointer, encoded in the "Rn" field.
- <sim> Is the optional signed immediate byte offset, in the range -256 to 255, defaulting to 0 and encoded in the "imm9" field.

Shared decode for all variants

```
integer n = UInt(Rn);
integer t = UInt(Rt);
AccType acctype = AccType_UNPRIV;
MemOp memop;
boolean signed;
integer regsize;

if opc<1> == '0' then
    // store or zero-extending load
    memop = if opc<0> == '1' then MemOp_LOAD else MemOp_STORE;
    regsize = if size == '11' then 64 else 32;
    signed = FALSE;
else
    if size == '11' then
        // no unprivileged prefetch
        UnallocatedEncoding();
    else
        // sign-extending load
        memop = MemOp_LOAD;
        if size == '10' && opc<0> == '1' then UnallocatedEncoding();
        regsize = if opc<0> == '1' then 32 else 64;
        signed = TRUE;

integer datasize = 8 << scale;
```

Operation

```

bits(64) address;
bits(datasize) data;
boolean wb_unknown = FALSE;
boolean rt_unknown = FALSE;

if memop == MemOp_LOAD && wback && n == t && n != 31 then
    c = ConstrainUnpredictable();
    assert c IN {Constraint_WBSUPPRESS, Constraint_UNKNOWN, Constraint_UNDEF, Constraint_NOP};
    case c of
        when Constraint_WBSUPPRESS wback = FALSE; // writeback is suppressed
        when Constraint_UNKNOWN wb_unknown = TRUE; // writeback is UNKNOWN
        when Constraint_UNDEF UnallocatedEncoding();
        when Constraint_NOP EndOfInstruction();

if memop == MemOp_STORE && wback && n == t && n != 31 then
    c = ConstrainUnpredictable();
    assert c IN {Constraint_NONE, Constraint_UNKNOWN, Constraint_UNDEF, Constraint_NOP};
    case c of
        when Constraint_NONE rt_unknown = FALSE; // value stored is original value
        when Constraint_UNKNOWN rt_unknown = TRUE; // value stored is UNKNOWN
        when Constraint_UNDEF UnallocatedEncoding();
        when Constraint_NOP EndOfInstruction();

if n == 31 then
    if memop != MemOp_PREFETCH then CheckSPAlignment();
    address = SP[];
else
    address = X[n];

if ! postindex then
    address = address + offset;

case memop of
    when MemOp_STORE
        if rt_unknown then
            data = bits(datasize) UNKNOWN;
        else
            data = X[t];
            Mem[address, datasize DIV 8, acctype] = data;

    when MemOp_LOAD
        data = Mem[address, datasize DIV 8, acctype];
        if signed then
            X[t] = SignExtend(data, regsize);
        else
            X[t] = ZeroExtend(data, regsize);

    when MemOp_PREFETCH
        Prefetch(address, t<4:0>);

if wback then
    if wb_unknown then
        address = bits(64) UNKNOWN;
    elsif postindex then
        address = address + offset;
    if n == 31 then
        SP[] = address;
    else
        X[n] = address;

```

C5.6.102 LDTRSW

Load register signed word (unprivileged)



Unsigned offset variant

LDTRSW <Xt>, [<Xn|SP>{, #<sim>}]

```
boolean wback = FALSE;
boolean postindex = FALSE;
integer scale = UInt(size);
bits(64) offset = SignExtend(imm9, 64);
```

Assembler Symbols

- <Xt> Is the 64-bit name of the general-purpose register to be transferred, encoded in the "Rt" field.
- <Xn|SP> Is the 64-bit name of the general-purpose base register or stack pointer, encoded in the "Rn" field.
- <sim> Is the optional signed immediate byte offset, in the range -256 to 255, defaulting to 0 and encoded in the "imm9" field.

Shared decode for all variants

```
integer n = UInt(Rn);
integer t = UInt(Rt);
AccType acctype = AccType_UNPRIV;
MemOp memop;
boolean signed;
integer regsize;

if opc<1> == '0' then
  // store or zero-extending load
  memop = if opc<0> == '1' then MemOp_LOAD else MemOp_STORE;
  regsize = if size == '11' then 64 else 32;
  signed = FALSE;
else
  if size == '11' then
    // no unprivileged prefetch
    UnallocatedEncoding();
  else
    // sign-extending load
    memop = MemOp_LOAD;
    if size == '10' && opc<0> == '1' then UnallocatedEncoding();
    regsize = if opc<0> == '1' then 32 else 64;
    signed = TRUE;

integer datasize = 8 << scale;
```

Operation

```
bits(64) address;
bits(datasize) data;
boolean wb_unknown = FALSE;
boolean rt_unknown = FALSE;

if memop == MemOp_LOAD && wback && n == t && n != 31 then
```

```

c = ConstrainUnpredictable();
assert c IN {Constraint_WBSUPPRESS, Constraint_UNKNOWN, Constraint_UNDEF, Constraint_NOP};
case c of
  when Constraint_WBSUPPRESS wback = FALSE; // writeback is suppressed
  when Constraint_UNKNOWN wb_unknown = TRUE; // writeback is UNKNOWN
  when Constraint_UNDEF UnallocatedEncoding();
  when Constraint_NOP EndOfInstruction();

if memop == MemOp_STORE && wback && n == t && n != 31 then
  c = ConstrainUnpredictable();
  assert c IN {Constraint_NONE, Constraint_UNKNOWN, Constraint_UNDEF, Constraint_NOP};
  case c of
    when Constraint_NONE rt_unknown = FALSE; // value stored is original value
    when Constraint_UNKNOWN rt_unknown = TRUE; // value stored is UNKNOWN
    when Constraint_UNDEF UnallocatedEncoding();
    when Constraint_NOP EndOfInstruction();

if n == 31 then
  if memop != MemOp_PREFETCH then CheckSPAlignment();
  address = SP[];
else
  address = X[n];

if ! postindex then
  address = address + offset;

case memop of
  when MemOp_STORE
    if rt_unknown then
      data = bits(datasize) UNKNOWN;
    else
      data = X[t];
      Mem[address, datasize DIV 8, acctype] = data;

  when MemOp_LOAD
    data = Mem[address, datasize DIV 8, acctype];
    if signed then
      X[t] = SignExtend(data, regsize);
    else
      X[t] = ZeroExtend(data, regsize);

  when MemOp_PREFETCH
    Prefetch(address, t<4:0>);

if wback then
  if wb_unknown then
    address = bits(64) UNKNOWN;
  elsif postindex then
    address = address + offset;
  if n == 31 then
    SP[] = address;
  else
    X[n] = address;

```

C5.6.103 LDUR

Load register (unscaled offset)

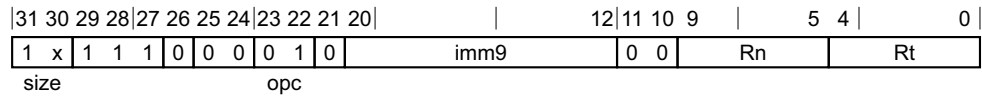

32-bit variant (size = 10)

LDUR <Wt>, [<Xn|SP>{, #<sim>}]

64-bit variant (size = 11)

LDUR <Xt>, [<Xn|SP>{, #<sim>}]

```
boolean wback = FALSE;
boolean postindex = FALSE;
integer scale = UInt(size);
bits(64) offset = SignExtend(imm9, 64);
```

Assembler Symbols

- <Wt> Is the 32-bit name of the general-purpose register to be transferred, encoded in the "Rt" field.
- <Xt> Is the 64-bit name of the general-purpose register to be transferred, encoded in the "Rt" field.
- <Xn|SP> Is the 64-bit name of the general-purpose base register or stack pointer, encoded in the "Rn" field.
- <sim> Is the optional signed immediate byte offset, in the range -256 to 255, defaulting to 0 and encoded in the "imm9" field.

Shared decode for all variants

```
integer n = UInt(Rn);
integer t = UInt(Rt);
AccType acctype = AccType_NORMAL;
MemOp memop;
boolean signed;
integer regsize;

if opc<1> == '0' then
    // store or zero-extending load
    memop = if opc<0> == '1' then MemOp_LOAD else MemOp_STORE;
    regsize = if size == '11' then 64 else 32;
    signed = FALSE;
else
    if size == '11' then
        memop = MemOp_PREFETCH;
        if opc<0> == '1' then UnallocatedEncoding();
    else
        // sign-extending load
        memop = MemOp_LOAD;
        if size == '10' && opc<0> == '1' then UnallocatedEncoding();
        regsize = if opc<0> == '1' then 32 else 64;
        signed = TRUE;

integer datasize = 8 << scale;
```

Operation

```

bits(64) address;
bits(datasize) data;
boolean wb_unknown = FALSE;
boolean rt_unknown = FALSE;

if memop == MemOp_LOAD && wback && n == t && n != 31 then
    c = ConstrainUnpredictable();
    assert c IN {Constraint_WBSUPPRESS, Constraint_UNKNOWN, Constraint_UNDEF, Constraint_NOP};
    case c of
        when Constraint_WBSUPPRESS wback = FALSE; // writeback is suppressed
        when Constraint_UNKNOWN wb_unknown = TRUE; // writeback is UNKNOWN
        when Constraint_UNDEF UnallocatedEncoding();
        when Constraint_NOP EndOfInstruction();

if memop == MemOp_STORE && wback && n == t && n != 31 then
    c = ConstrainUnpredictable();
    assert c IN {Constraint_NONE, Constraint_UNKNOWN, Constraint_UNDEF, Constraint_NOP};
    case c of
        when Constraint_NONE rt_unknown = FALSE; // value stored is original value
        when Constraint_UNKNOWN rt_unknown = TRUE; // value stored is UNKNOWN
        when Constraint_UNDEF UnallocatedEncoding();
        when Constraint_NOP EndOfInstruction();

if n == 31 then
    if memop != MemOp_PREFETCH then CheckSPAlignment();
    address = SP[];
else
    address = X[n];

if ! postindex then
    address = address + offset;

case memop of
    when MemOp_STORE
        if rt_unknown then
            data = bits(datasize) UNKNOWN;
        else
            data = X[t];
            Mem[address, datasize DIV 8, acctype] = data;

    when MemOp_LOAD
        data = Mem[address, datasize DIV 8, acctype];
        if signed then
            X[t] = SignExtend(data, regsize);
        else
            X[t] = ZeroExtend(data, regsize);

    when MemOp_PREFETCH
        Prefetch(address, t<4:0>);

if wback then
    if wb_unknown then
        address = bits(64) UNKNOWN;
    elsif postindex then
        address = address + offset;
    if n == 31 then
        SP[] = address;
    else
        X[n] = address;

```

C5.6.104 LDURB

Load register byte (unscaled offset)

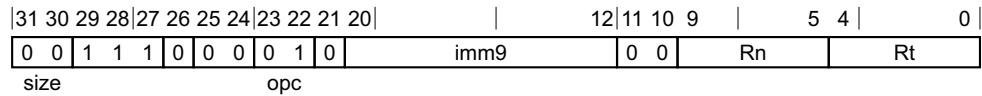

Unsigned offset variant

LDURB <Wt>, [<Xn|SP>{, #<sim>}]

```
boolean wback = FALSE;
boolean postindex = FALSE;
integer scale = UInt(size);
bits(64) offset = SignExtend(imm9, 64);
```

Assembler Symbols

- <Wt> Is the 32-bit name of the general-purpose register to be transferred, encoded in the "Rt" field.
- <Xn|SP> Is the 64-bit name of the general-purpose base register or stack pointer, encoded in the "Rn" field.
- <sim> Is the optional signed immediate byte offset, in the range -256 to 255, defaulting to 0 and encoded in the "imm9" field.

Shared decode for all variants

```
integer n = UInt(Rn);
integer t = UInt(Rt);
AccType acctype = AccType_NORMAL;
MemOp memop;
boolean signed;
integer regsize;

if opc<1> == '0' then
    // store or zero-extending load
    memop = if opc<0> == '1' then MemOp_LOAD else MemOp_STORE;
    regsize = if size == '11' then 64 else 32;
    signed = FALSE;
else
    if size == '11' then
        memop = MemOp_PREFETCH;
        if opc<0> == '1' then UnallocatedEncoding();
    else
        // sign-extending load
        memop = MemOp_LOAD;
        if size == '10' && opc<0> == '1' then UnallocatedEncoding();
        regsize = if opc<0> == '1' then 32 else 64;
        signed = TRUE;

integer datasize = 8 << scale;
```

Operation

```
bits(64) address;
bits(datasize) data;
boolean wb_unknown = FALSE;
boolean rt_unknown = FALSE;

if memop == MemOp_LOAD && wback && n == t && n != 31 then
```

```
c = ConstrainUnpredictable();
assert c IN {Constraint_WBSUPPRESS, Constraint_UNKNOWN, Constraint_UNDEF, Constraint_NOP};
case c of
  when Constraint_WBSUPPRESS wback = FALSE; // writeback is suppressed
  when Constraint_UNKNOWN wb_unknown = TRUE; // writeback is UNKNOWN
  when Constraint_UNDEF UnallocatedEncoding();
  when Constraint_NOP EndOfInstruction();

if memop == MemOp_STORE && wback && n == t && n != 31 then
  c = ConstrainUnpredictable();
  assert c IN {Constraint_NONE, Constraint_UNKNOWN, Constraint_UNDEF, Constraint_NOP};
  case c of
    when Constraint_NONE rt_unknown = FALSE; // value stored is original value
    when Constraint_UNKNOWN rt_unknown = TRUE; // value stored is UNKNOWN
    when Constraint_UNDEF UnallocatedEncoding();
    when Constraint_NOP EndOfInstruction();

if n == 31 then
  if memop != MemOp_PREFETCH then CheckSPAlignment();
  address = SP[];
else
  address = X[n];

if ! postindex then
  address = address + offset;

case memop of
  when MemOp_STORE
    if rt_unknown then
      data = bits(datasize) UNKNOWN;
    else
      data = X[t];
    Mem[address, datasize DIV 8, acctype] = data;

  when MemOp_LOAD
    data = Mem[address, datasize DIV 8, acctype];
    if signed then
      X[t] = SignExtend(data, regsize);
    else
      X[t] = ZeroExtend(data, regsize);

  when MemOp_PREFETCH
    Prefetch(address, t<4:0>);

if wback then
  if wb_unknown then
    address = bits(64) UNKNOWN;
  elsif postindex then
    address = address + offset;
  if n == 31 then
    SP[] = address;
  else
    X[n] = address;
```

C5.6.105 LDURH

Load register halfword (unscaled offset)

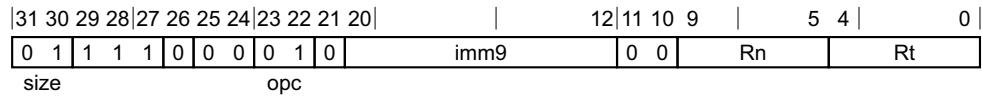

Unsigned offset variant

LDURH <Wt>, [<Xn|SP>{, #<sim>}]

```
boolean wback = FALSE;
boolean postindex = FALSE;
integer scale = UInt(size);
bits(64) offset = SignExtend(imm9, 64);
```

Assembler Symbols

- <Wt> Is the 32-bit name of the general-purpose register to be transferred, encoded in the "Rt" field.
- <Xn|SP> Is the 64-bit name of the general-purpose base register or stack pointer, encoded in the "Rn" field.
- <sim> Is the optional signed immediate byte offset, in the range -256 to 255, defaulting to 0 and encoded in the "imm9" field.

Shared decode for all variants

```
integer n = UInt(Rn);
integer t = UInt(Rt);
AccType acctype = AccType_NORMAL;
MemOp memop;
boolean signed;
integer regsize;

if opc<1> == '0' then
    // store or zero-extending load
    memop = if opc<0> == '1' then MemOp_LOAD else MemOp_STORE;
    regsize = if size == '11' then 64 else 32;
    signed = FALSE;
else
    if size == '11' then
        memop = MemOp_PREFETCH;
        if opc<0> == '1' then UnallocatedEncoding();
    else
        // sign-extending load
        memop = MemOp_LOAD;
        if size == '10' && opc<0> == '1' then UnallocatedEncoding();
        regsize = if opc<0> == '1' then 32 else 64;
        signed = TRUE;

integer datasize = 8 << scale;
```

Operation

```
bits(64) address;
bits(datasize) data;
boolean wb_unknown = FALSE;
boolean rt_unknown = FALSE;

if memop == MemOp_LOAD && wback && n == t && n != 31 then
```

```
c = ConstrainUnpredictable();
assert c IN {Constraint_WBSUPPRESS, Constraint_UNKNOWN, Constraint_UNDEF, Constraint_NOP};
case c of
  when Constraint_WBSUPPRESS wback = FALSE; // writeback is suppressed
  when Constraint_UNKNOWN wb_unknown = TRUE; // writeback is UNKNOWN
  when Constraint_UNDEF UnallocatedEncoding();
  when Constraint_NOP EndOfInstruction();

if memop == MemOp_STORE && wback && n == t && n != 31 then
  c = ConstrainUnpredictable();
  assert c IN {Constraint_NONE, Constraint_UNKNOWN, Constraint_UNDEF, Constraint_NOP};
  case c of
    when Constraint_NONE rt_unknown = FALSE; // value stored is original value
    when Constraint_UNKNOWN rt_unknown = TRUE; // value stored is UNKNOWN
    when Constraint_UNDEF UnallocatedEncoding();
    when Constraint_NOP EndOfInstruction();

if n == 31 then
  if memop != MemOp_PREFETCH then CheckSPAlignment();
  address = SP[];
else
  address = X[n];

if ! postindex then
  address = address + offset;

case memop of
  when MemOp_STORE
    if rt_unknown then
      data = bits(datasize) UNKNOWN;
    else
      data = X[t];
      Mem[address, datasize DIV 8, acctype] = data;

  when MemOp_LOAD
    data = Mem[address, datasize DIV 8, acctype];
    if signed then
      X[t] = SignExtend(data, regsize);
    else
      X[t] = ZeroExtend(data, regsize);

  when MemOp_PREFETCH
    Prefetch(address, t<4:0>);

if wback then
  if wb_unknown then
    address = bits(64) UNKNOWN;
  elsif postindex then
    address = address + offset;
  if n == 31 then
    SP[] = address;
  else
    X[n] = address;
```

C5.6.106 LDURSB

Load register signed byte (unscaled offset)

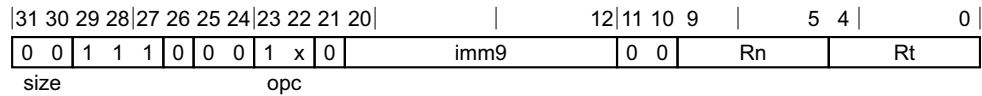

32-bit variant (opc = 11)

LDURSB <Wt>, [<Xn|SP>{, #<sim>}]

64-bit variant (opc = 10)

LDURSB <Xt>, [<Xn|SP>{, #<sim>}]

```
boolean wback = FALSE;
boolean postindex = FALSE;
integer scale = UInt(size);
bits(64) offset = SignExtend(imm9, 64);
```

Assembler Symbols

- <Wt> Is the 32-bit name of the general-purpose register to be transferred, encoded in the "Rt" field.
- <Xt> Is the 64-bit name of the general-purpose register to be transferred, encoded in the "Rt" field.
- <Xn|SP> Is the 64-bit name of the general-purpose base register or stack pointer, encoded in the "Rn" field.
- <sim> Is the optional signed immediate byte offset, in the range -256 to 255, defaulting to 0 and encoded in the "imm9" field.

Shared decode for all variants

```
integer n = UInt(Rn);
integer t = UInt(Rt);
AccType acctype = AccType_NORMAL;
MemOp memop;
boolean signed;
integer regsize;

if opc<1> == '0' then
    // store or zero-extending load
    memop = if opc<0> == '1' then MemOp_LOAD else MemOp_STORE;
    regsize = if size == '11' then 64 else 32;
    signed = FALSE;
else
    if size == '11' then
        memop = MemOp_PREFETCH;
        if opc<0> == '1' then UnallocatedEncoding();
    else
        // sign-extending load
        memop = MemOp_LOAD;
        if size == '10' && opc<0> == '1' then UnallocatedEncoding();
        regsize = if opc<0> == '1' then 32 else 64;
        signed = TRUE;

integer datasize = 8 << scale;
```

Operation

```
bits(64) address;
bits(datasize) data;
boolean wb_unknown = FALSE;
boolean rt_unknown = FALSE;

if memop == MemOp_LOAD && wback && n == t && n != 31 then
    c = ConstrainUnpredictable();
    assert c IN {Constraint_WBSUPPRESS, Constraint_UNKNOWN, Constraint_UNDEF, Constraint_NOP};
    case c of
        when Constraint_WBSUPPRESS wback = FALSE; // writeback is suppressed
        when Constraint_UNKNOWN wb_unknown = TRUE; // writeback is UNKNOWN
        when Constraint_UNDEF UnallocatedEncoding();
        when Constraint_NOP EndOfInstruction();

if memop == MemOp_STORE && wback && n == t && n != 31 then
    c = ConstrainUnpredictable();
    assert c IN {Constraint_NONE, Constraint_UNKNOWN, Constraint_UNDEF, Constraint_NOP};
    case c of
        when Constraint_NONE rt_unknown = FALSE; // value stored is original value
        when Constraint_UNKNOWN rt_unknown = TRUE; // value stored is UNKNOWN
        when Constraint_UNDEF UnallocatedEncoding();
        when Constraint_NOP EndOfInstruction();

if n == 31 then
    if memop != MemOp_PREFETCH then CheckSPAlignment();
    address = SP[];
else
    address = X[n];

if ! postindex then
    address = address + offset;

case memop of
    when MemOp_STORE
        if rt_unknown then
            data = bits(datasize) UNKNOWN;
        else
            data = X[t];
            Mem[address, datasize DIV 8, acctype] = data;

    when MemOp_LOAD
        data = Mem[address, datasize DIV 8, acctype];
        if signed then
            X[t] = SignExtend(data, regsize);
        else
            X[t] = ZeroExtend(data, regsize);

    when MemOp_PREFETCH
        Prefetch(address, t<4:0>);

if wback then
    if wb_unknown then
        address = bits(64) UNKNOWN;
    elsif postindex then
        address = address + offset;
    if n == 31 then
        SP[] = address;
    else
        X[n] = address;
```

C5.6.107 LDURSH

Load register signed halfword (unscaled offset)

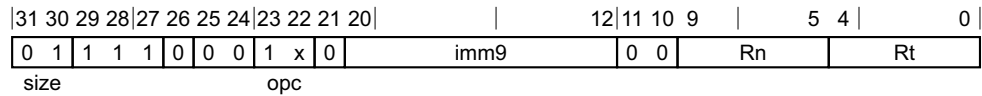

32-bit variant (opc = 11)

LDURSH <Wt>, [<Xn|SP>{, #<sim>}]

64-bit variant (opc = 10)

LDURSH <Xt>, [<Xn|SP>{, #<sim>}]

```
boolean wback = FALSE;
boolean postindex = FALSE;
integer scale = UInt(size);
bits(64) offset = SignExtend(imm9, 64);
```

Assembler Symbols

<Wt>	Is the 32-bit name of the general-purpose register to be transferred, encoded in the "Rt" field.
<Xt>	Is the 64-bit name of the general-purpose register to be transferred, encoded in the "Rt" field.
<Xn SP>	Is the 64-bit name of the general-purpose base register or stack pointer, encoded in the "Rn" field.
<sim>	Is the optional signed immediate byte offset, in the range -256 to 255, defaulting to 0 and encoded in the "imm9" field.

Shared decode for all variants

```
integer n = UInt(Rn);
integer t = UInt(Rt);
AccType acctype = AccType_NORMAL;
MemOp memop;
boolean signed;
integer regsize;

if opc<1> == '0' then
    // store or zero-extending load
    memop = if opc<0> == '1' then MemOp_LOAD else MemOp_STORE;
    regsize = if size == '11' then 64 else 32;
    signed = FALSE;
else
    if size == '11' then
        memop = MemOp_PREFETCH;
        if opc<0> == '1' then UnallocatedEncoding();
    else
        // sign-extending load
        memop = MemOp_LOAD;
        if size == '10' && opc<0> == '1' then UnallocatedEncoding();
        regsize = if opc<0> == '1' then 32 else 64;
        signed = TRUE;

integer datasize = 8 << scale;
```

Operation

```

bits(64) address;
bits(datasize) data;
boolean wb_unknown = FALSE;
boolean rt_unknown = FALSE;

if memop == MemOp_LOAD && wback && n == t && n != 31 then
    c = ConstrainUnpredictable();
    assert c IN {Constraint_WBSUPPRESS, Constraint_UNKOWN, Constraint_UNDEF, Constraint_NOP};
    case c of
        when Constraint_WBSUPPRESS wback = FALSE; // writeback is suppressed
        when Constraint_UNKOWN      wb_unknown = TRUE; // writeback is UNKNOWN
        when Constraint_UNDEF       UnallocatedEncoding();
        when Constraint_NOP         EndOfInstruction();

if memop == MemOp_STORE && wback && n == t && n != 31 then
    c = ConstrainUnpredictable();
    assert c IN {Constraint_NONE, Constraint_UNKOWN, Constraint_UNDEF, Constraint_NOP};
    case c of
        when Constraint_NONE      rt_unknown = FALSE; // value stored is original value
        when Constraint_UNKOWN     rt_unknown = TRUE; // value stored is UNKNOWN
        when Constraint_UNDEF      UnallocatedEncoding();
        when Constraint_NOP        EndOfInstruction();

if n == 31 then
    if memop != MemOp_PREFETCH then CheckSPAlignment();
    address = SP[];
else
    address = X[n];

if ! postindex then
    address = address + offset;

case memop of
    when MemOp_STORE
        if rt_unknown then
            data = bits(datasize) UNKNOWN;
        else
            data = X[t];
            Mem[address, datasize DIV 8, acctype] = data;

    when MemOp_LOAD
        data = Mem[address, datasize DIV 8, acctype];
        if signed then
            X[t] = SignExtend(data, regsize);
        else
            X[t] = ZeroExtend(data, regsize);

    when MemOp_PREFETCH
        Prefetch(address, t<4:0>);

if wback then
    if wb_unknown then
        address = bits(64) UNKNOWN;
    elsif postindex then
        address = address + offset;
    if n == 31 then
        SP[] = address;
    else
        X[n] = address;

```

C5.6.108 LDURSW

Load register signed word (unscaled offset)

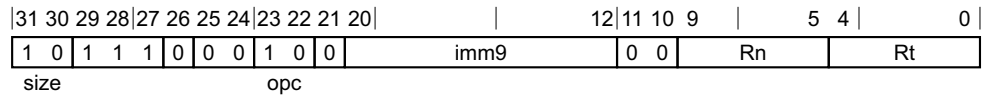

Unsigned offset variant

LDURSW <Xt>, [<Xn|SP>{, #<sim>}]

```
boolean wback = FALSE;
boolean postindex = FALSE;
integer scale = UInt(size);
bits(64) offset = SignExtend(imm9, 64);
```

Assembler Symbols

- <Xt> Is the 64-bit name of the general-purpose register to be transferred, encoded in the "Rt" field.
- <Xn|SP> Is the 64-bit name of the general-purpose base register or stack pointer, encoded in the "Rn" field.
- <sim> Is the optional signed immediate byte offset, in the range -256 to 255, defaulting to 0 and encoded in the "imm9" field.

Shared decode for all variants

```
integer n = UInt(Rn);
integer t = UInt(Rt);
AccType acctype = AccType_NORMAL;
MemOp memop;
boolean signed;
integer regsize;

if opc<1> == '0' then
  // store or zero-extending load
  memop = if opc<0> == '1' then MemOp_LOAD else MemOp_STORE;
  regsize = if size == '11' then 64 else 32;
  signed = FALSE;
else
  if size == '11' then
    memop = MemOp_PREFETCH;
    if opc<0> == '1' then UnallocatedEncoding();
  else
    // sign-extending load
    memop = MemOp_LOAD;
    if size == '10' && opc<0> == '1' then UnallocatedEncoding();
    regsize = if opc<0> == '1' then 32 else 64;
    signed = TRUE;

integer datasize = 8 << scale;
```

Operation

```
bits(64) address;
bits(datasize) data;
boolean wb_unknown = FALSE;
boolean rt_unknown = FALSE;

if memop == MemOp_LOAD && wback && n == t && n != 31 then
```

```
c = ConstrainUnpredictable();
assert c IN {Constraint_WBSUPPRESS, Constraint_UNKNOWN, Constraint_UNDEF, Constraint_NOP};
case c of
  when Constraint_WBSUPPRESS wback = FALSE; // writeback is suppressed
  when Constraint_UNKNOWN wb_unknown = TRUE; // writeback is UNKNOWN
  when Constraint_UNDEF UnallocatedEncoding();
  when Constraint_NOP EndOfInstruction();

if memop == MemOp_STORE && wback && n == t && n != 31 then
  c = ConstrainUnpredictable();
  assert c IN {Constraint_NONE, Constraint_UNKNOWN, Constraint_UNDEF, Constraint_NOP};
  case c of
    when Constraint_NONE rt_unknown = FALSE; // value stored is original value
    when Constraint_UNKNOWN rt_unknown = TRUE; // value stored is UNKNOWN
    when Constraint_UNDEF UnallocatedEncoding();
    when Constraint_NOP EndOfInstruction();

if n == 31 then
  if memop != MemOp_PREFETCH then CheckSPAlignment();
  address = SP[];
else
  address = X[n];

if ! postindex then
  address = address + offset;

case memop of
  when MemOp_STORE
    if rt_unknown then
      data = bits(datasize) UNKNOWN;
    else
      data = X[t];
    Mem[address, datasize DIV 8, acctype] = data;

  when MemOp_LOAD
    data = Mem[address, datasize DIV 8, acctype];
    if signed then
      X[t] = SignExtend(data, regsize);
    else
      X[t] = ZeroExtend(data, regsize);

  when MemOp_PREFETCH
    Prefetch(address, t<4:0>);

if wback then
  if wb_unknown then
    address = bits(64) UNKNOWN;
  elsif postindex then
    address = address + offset;
  if n == 31 then
    SP[] = address;
  else
    X[n] = address;
```

C5.6.109 LDXP

Load exclusive pair of registers

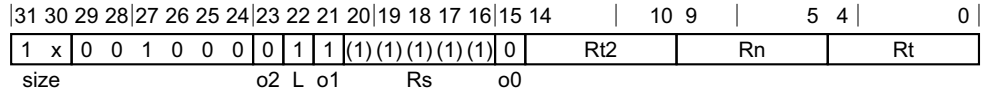

32-bit variant (size = 10)

LDXP <Wt1>, <Wt2>, [<Xn|SP>{,#0}]

64-bit variant (size = 11)

LDXP <Xt1>, <Xt2>, [<Xn|SP>{,#0}]

```
integer n = UInt(Rn);
integer t = UInt(Rt);
integer t2 = UInt(Rt2); // ignored by load/store single register
integer s = UInt(Rs); // ignored by all loads and store-release
```

```
if o2:o1:o0 == '100' || o2:o1:o0 == '11x' then UnallocatedEncoding();
if o1 == '1' && size<L> == '0' then UnallocatedEncoding();
```

```
AccType acctype = if o0 == '1' then AccType_ORDERED else AccType_ATOMIC;
boolean excl = (o2 == '0');
boolean pair = (o1 == '1');
MemOp memop = if L == '1' then MemOp_LOAD else MemOp_STORE;
integer elsize = 8 << UInt(size);
integer regsize = if elsize == 64 then 64 else 32;
integer datasize = if pair then elsize * 2 else elsize;
```

Assembler Symbols

- <Wt1> Is the 32-bit name of the first general-purpose register to be transferred, encoded in the "Rt" field.
- <Wt2> Is the 32-bit name of the second general-purpose register to be transferred, encoded in the "Rt2" field.
- <Xt1> Is the 64-bit name of the first general-purpose register to be transferred, encoded in the "Rt" field.
- <Xt2> Is the 64-bit name of the second general-purpose register to be transferred, encoded in the "Rt2" field.
- <Xn|SP> Is the 64-bit name of the general-purpose base register or stack pointer, encoded in the "Rn" field.

Operation

```
bits(64) address;
bits(datasize) data;
constant integer dbytes = datasize DIV 8;
boolean rt_unknown = FALSE;
boolean rn_unknown = FALSE;

if memop == MemOp_LOAD && pair && t == t2 then
    Constraint c = ConstrainUnpredictable();
    assert c IN {Constraint_UNKNOWN, Constraint_UNDEF, Constraint_NOP};
    case c of
        when Constraint_UNKNOWN    rt_unknown = TRUE; // result is UNKNOWN
        when Constraint_UNDEF      UnallocatedEncoding();
        when Constraint_NOP        EndOfInstruction();

if memop == MemOp_STORE && excl then
```

```

if s == t || (pair && s == t2) then
    Constraint c = ConstrainUnpredictable();
    assert c IN {Constraint_UNKNOWN, Constraint_NONE, Constraint_UNDEF, Constraint_NOP};
    case c of
        when Constraint_UNKNOWN    rt_unknown = TRUE;    // store UNKNOWN value
        when Constraint_NONE        rt_unknown = FALSE;    // store original value
        when Constraint_UNDEF        UnallocatedEncoding();
        when Constraint_NOP          EndOfInstruction();
if s == n && n != 31 then
    Constraint c = ConstrainUnpredictable();
    assert c IN {Constraint_UNKNOWN, Constraint_NONE, Constraint_UNDEF, Constraint_NOP};
    case c of
        when Constraint_UNKNOWN    rn_unknown = TRUE;    // address is UNKNOWN
        when Constraint_NONE        rn_unknown = FALSE;    // address is original base
        when Constraint_UNDEF        UnallocatedEncoding();
        when Constraint_NOP          EndOfInstruction();

if n == 31 then
    CheckSPAlignment();
    address = SP[];
elseif rn_unknown then
    address = bits(64) UNKNOWN;
else
    address = X[n];

case memop of
    when MemOp_STORE
        if rt_unknown then
            data = bits(datasize) UNKNOWN;
        elseif pair then
            assert excl;
            bits(datasize DIV 2) e11 = X[t];
            bits(datasize DIV 2) e12 = X[t2];
            data = if BigEndian() then e11 : e12 else e12 : e11;
        else
            data = X[t];

        if excl then
            // store {release} exclusive register|pair (atomic)
            bit status = '1';
            // Check whether the Exclusive Monitors are set to include the
            // physical memory locations corresponding to virtual address
            // range [address, address+dbytes-1].
            if AArch64.ExclusiveMonitorsPass(address, dbytes) then
                // This atomic write will be rejected if it does not refer
                // to the same physical locations after address translation.
                Mem[address, dbytes, acctype] = data;
                status = ExclusiveMonitorsStatus();
                X[s] = ZeroExtend(status, 32);
            else
                // store release register (atomic)
                Mem[address, dbytes, acctype] = data;

    when MemOp_LOAD
        if excl then
            // Tell the Exclusive Monitors to record a sequence of one or more atomic
            // memory reads from virtual address range [address, address+dbytes-1].
            // The Exclusive Monitor will only be set if all the reads are from the
            // same dbytes-aligned physical address, to allow for the possibility of
            // an atomicity break if the translation is changed between reads.
            AArch64.SetExclusiveMonitors(address, dbytes);

        if pair then
            // load exclusive pair
            assert excl;
            if rt_unknown then
                // ConstrainedUNPREDICTABLE case
                X[t] = bits(datasize) UNKNOWN;

```

```
elseif elsize == 32 then
    // 32-bit load exclusive pair (atomic)
    data = Mem[address, dbytes, acctype];
    if BigEndian() then
        X[t] = data<datasize-1:elsize>;
        X[t2] = data<elsize-1:0>;
    else
        X[t] = data<elsize-1:0>;
        X[t2] = data<datasize-1:elsize>;
else // elsize == 64
    // 64-bit load exclusive pair (not atomic),
    // but must be 128-bit aligned
    if address != Align(address, dbytes) then
        iswrite = FALSE;
        secondstage = FALSE;
        AArch64.Abort(address, AArch64.AlignmentFault(acctype, iswrite, secondstage));
    X[t] = Mem[address + 0, 8, acctype];
    X[t2] = Mem[address + 8, 8, acctype];
else
    // load {acquire} {exclusive} single register
    data = Mem[address, dbytes, acctype];
    X[t] = ZeroExtend(data, regsize);
```

C5.6.110 LDXR

Load exclusive register

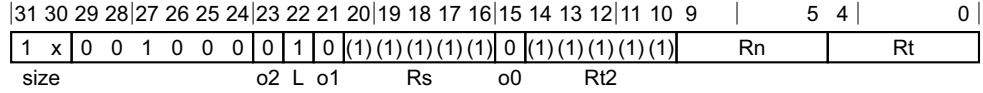

32-bit variant (size = 10)

LDXR <Wt>, [<Xn|SP>{,#0}]

64-bit variant (size = 11)

LDXR <Xt>, [<Xn|SP>{,#0}]

```
integer n = UInt(Rn);
integer t = UInt(Rt);
integer t2 = UInt(Rt2); // ignored by load/store single register
integer s = UInt(Rs); // ignored by all loads and store-release
```

```
if o2:o1:o0 == '100' || o2:o1:o0 == '11x' then UnallocatedEncoding();
if o1 == '1' && size<L> == '0' then UnallocatedEncoding();
```

```
AccType acctype = if o0 == '1' then AccType_ORDERED else AccType_ATOMIC;
boolean excl = (o2 == '0');
boolean pair = (o1 == '1');
MemOp memop = if L == '1' then MemOp_LOAD else MemOp_STORE;
integer elsize = 8 << UInt(size);
integer regsize = if elsize == 64 then 64 else 32;
integer datasize = if pair then elsize * 2 else elsize;
```

Assembler Symbols

- <Wt> Is the 32-bit name of the general-purpose register to be transferred, encoded in the "Rt" field.
- <Xt> Is the 64-bit name of the general-purpose register to be transferred, encoded in the "Rt" field.
- <Xn|SP> Is the 64-bit name of the general-purpose base register or stack pointer, encoded in the "Rn" field.

Operation

```
bits(64) address;
bits(datasize) data;
constant integer dbytes = datasize DIV 8;
boolean rt_unknown = FALSE;
boolean rn_unknown = FALSE;

if memop == MemOp_LOAD && pair && t == t2 then
    Constraint c = ConstrainUnpredictable();
    assert c IN {Constraint_UNKNOWN, Constraint_UNDEF, Constraint_NOP};
    case c of
        when Constraint_UNKNOWN    rt_unknown = TRUE; // result is UNKNOWN
        when Constraint_UNDEF      UnallocatedEncoding();
        when Constraint_NOP        EndOfInstruction();

if memop == MemOp_STORE && excl then
    if s == t || (pair && s == t2) then
        Constraint c = ConstrainUnpredictable();
        assert c IN {Constraint_UNKNOWN, Constraint_NONE, Constraint_UNDEF, Constraint_NOP};
        case c of
            when Constraint_UNKNOWN    rt_unknown = TRUE; // store UNKNOWN value
            when Constraint_NONE      rt_unknown = FALSE; // store original value
```

```

        when Constraint_UNDEF      UnallocatedEncoding();
        when Constraint_NOP        EndOfInstruction();
    if s == n && n != 31 then
        Constraint c = ConstrainUnpredictable();
        assert c IN {Constraint_UNKNOWN, Constraint_NONE, Constraint_UNDEF, Constraint_NOP};
        case c of
            when Constraint_UNKNOWN    rn_unknown = TRUE;    // address is UNKNOWN
            when Constraint_NONE        rn_unknown = FALSE;   // address is original base
            when Constraint_UNDEF      UnallocatedEncoding();
            when Constraint_NOP        EndOfInstruction();

    if n == 31 then
        CheckSPAlignment();
        address = SP[];
    elsif rn_unknown then
        address = bits(64) UNKNOWN;
    else
        address = X[n];

    case memop of
        when MemOp_STORE
            if rt_unknown then
                data = bits(datasize) UNKNOWN;
            elsif pair then
                assert excl;
                bits(datasize DIV 2) e11 = X[t];
                bits(datasize DIV 2) e12 = X[t2];
                data = if BigEndian() then e11 : e12 else e12 : e11;
            else
                data = X[t];

            if excl then
                // store {release} exclusive register|pair (atomic)
                bit status = '1';
                // Check whether the Exclusive Monitors are set to include the
                // physical memory locations corresponding to virtual address
                // range [address, address+dbytes-1].
                if AArch64.ExclusiveMonitorsPass(address, dbytes) then
                    // This atomic write will be rejected if it does not refer
                    // to the same physical locations after address translation.
                    Mem[address, dbytes, acctype] = data;
                    status = ExclusiveMonitorsStatus();
                    X[s] = ZeroExtend(status, 32);
                else
                    // store release register (atomic)
                    Mem[address, dbytes, acctype] = data;

        when MemOp_LOAD
            if excl then
                // Tell the Exclusive Monitors to record a sequence of one or more atomic
                // memory reads from virtual address range [address, address+dbytes-1].
                // The Exclusive Monitor will only be set if all the reads are from the
                // same dbytes-aligned physical address, to allow for the possibility of
                // an atomicity break if the translation is changed between reads.
                AArch64.SetExclusiveMonitors(address, dbytes);

            if pair then
                // load exclusive pair
                assert excl;
                if rt_unknown then
                    // ConstrainedUNPREDICTABLE case
                    X[t] = bits(datasize) UNKNOWN;
                elsif elsize == 32 then
                    // 32-bit load exclusive pair (atomic)
                    data = Mem[address, dbytes, acctype];
                    if BigEndian() then
                        X[t] = data<datasize-1:elsize>;
                        X[t2] = data<elsize-1:0>;

```

```
        else
            X[t] = data<elsize-1:0>;
            X[t2] = data<datasize-1:elsize>;
    else // elsize == 64
        // 64-bit load exclusive pair (not atomic),
        // but must be 128-bit aligned
        if address != Align(address, dbytes) then
            iswrite = FALSE;
            secondstage = FALSE;
            AArch64.Abort(address, AArch64.AlignmentFault(acctype, iswrite, secondstage));
        X[t] = Mem[address + 0, 8, acctype];
        X[t2] = Mem[address + 8, 8, acctype];
    else
        // load {acquire} {exclusive} single register
        data = Mem[address, dbytes, acctype];
        X[t] = ZeroExtend(data, regsize);
```

C5.6.111 LDXRB

Load exclusive register byte

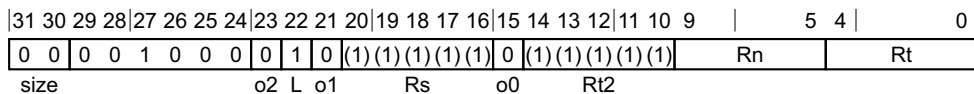

No offset variant

LDXRB <Wt>, [<Xn|SP>{, #0}]

```
integer n = UInt(Rn);
integer t = UInt(Rt);
integer t2 = UInt(Rt2); // ignored by load/store single register
integer s = UInt(Rs); // ignored by all loads and store-release
```

```
if o2:o1:o0 == '100' || o2:o1:o0 == '11x' then UnallocatedEncoding();
if o1 == '1' && size<1> == '0' then UnallocatedEncoding();
```

```
AccType acctype = if o0 == '1' then AccType_ORDERED else AccType_ATOMIC;
boolean excl = (o2 == '0');
boolean pair = (o1 == '1');
MemOp memop = if L == '1' then MemOp_LOAD else MemOp_STORE;
integer elsize = 8 << UInt(size);
integer regsize = if elsize == 64 then 64 else 32;
integer datasize = if pair then elsize * 2 else elsize;
```

Assembler Symbols

<Wt> Is the 32-bit name of the general-purpose register to be transferred, encoded in the "Rt" field.

<Xn|SP> Is the 64-bit name of the general-purpose base register or stack pointer, encoded in the "Rn" field.

Operation

```
bits(64) address;
bits(datasize) data;
constant integer dbytes = datasize DIV 8;
boolean rt_unknown = FALSE;
boolean rn_unknown = FALSE;

if memop == MemOp_LOAD && pair && t == t2 then
    Constraint c = ConstrainUnpredictable();
    assert c IN {Constraint_UNKNOWN, Constraint_UNDEF, Constraint_NOP};
    case c of
        when Constraint_UNKNOWN    rt_unknown = TRUE; // result is UNKNOWN
        when Constraint_UNDEF       UnallocatedEncoding();
        when Constraint_NOP         EndOfInstruction();

if memop == MemOp_STORE && excl then
    if s == t || (pair && s == t2) then
        Constraint c = ConstrainUnpredictable();
        assert c IN {Constraint_UNKNOWN, Constraint_NONE, Constraint_UNDEF, Constraint_NOP};
        case c of
            when Constraint_UNKNOWN    rt_unknown = TRUE; // store UNKNOWN value
            when Constraint_NONE        rt_unknown = FALSE; // store original value
            when Constraint_UNDEF       UnallocatedEncoding();
            when Constraint_NOP         EndOfInstruction();
    if s == n && n != 31 then
        Constraint c = ConstrainUnpredictable();
        assert c IN {Constraint_UNKNOWN, Constraint_NONE, Constraint_UNDEF, Constraint_NOP};
```

```

        case c of
            when Constraint_UNKNOWN    rn_unknown = TRUE;    // address is UNKNOWN
            when Constraint_NONE       rn_unknown = FALSE;   // address is original base
            when Constraint_UNDEF     UnallocatedEncoding();
            when Constraint_NOP       EndOfInstruction();

if n == 31 then
    CheckSPAlignment();
    address = SP[];
elseif rn_unknown then
    address = bits(64) UNKNOWN;
else
    address = X[n];

case memop of
    when MemOp_STORE
        if rt_unknown then
            data = bits(datasize) UNKNOWN;
        elseif pair then
            assert excl;
            bits(datasize DIV 2) e11 = X[t];
            bits(datasize DIV 2) e12 = X[t2];
            data = if BigEndian() then e11 : e12 else e12 : e11;
        else
            data = X[t];

        if excl then
            // store {release} exclusive register|pair (atomic)
            bit status = '1';
            // Check whether the Exclusive Monitors are set to include the
            // physical memory locations corresponding to virtual address
            // range [address, address+dbytes-1].
            if AArch64.ExclusiveMonitorsPass(address, dbytes) then
                // This atomic write will be rejected if it does not refer
                // to the same physical locations after address translation.
                Mem[address, dbytes, acctype] = data;
                status = ExclusiveMonitorsStatus();
                X[s] = ZeroExtend(status, 32);
            else
                // store release register (atomic)
                Mem[address, dbytes, acctype] = data;

    when MemOp_LOAD
        if excl then
            // Tell the Exclusive Monitors to record a sequence of one or more atomic
            // memory reads from virtual address range [address, address+dbytes-1].
            // The Exclusive Monitor will only be set if all the reads are from the
            // same dbytes-aligned physical address, to allow for the possibility of
            // an atomicity break if the translation is changed between reads.
            AArch64.SetExclusiveMonitors(address, dbytes);

        if pair then
            // load exclusive pair
            assert excl;
            if rt_unknown then
                // ConstrainedUNPREDICTABLE case
                X[t] = bits(datasize) UNKNOWN;
            elseif elsize == 32 then
                // 32-bit load exclusive pair (atomic)
                data = Mem[address, dbytes, acctype];
                if BigEndian() then
                    X[t] = data<datasize-1:elsize>;
                    X[t2] = data<elsize-1:0>;
                else
                    X[t] = data<elsize-1:0>;
                    X[t2] = data<datasize-1:elsize>;
            else // elsize == 64
                // 64-bit load exclusive pair (not atomic),

```



```
// but must be 128-bit aligned
if address != Align(address, dbytes) then
    iswrite = FALSE;
    secondstage = FALSE;
    AArch64.Abort(address, AArch64.AlignmentFault(acctype, iswrite, secondstage));
X[t] = Mem[address + 0, 8, acctype];
X[t2] = Mem[address + 8, 8, acctype];
else
    // load {acquire} {exclusive} single register
    data = Mem[address, dbytes, acctype];
    X[t] = ZeroExtend(data, regsize);
```

C5.6.112 LDXRH

Load exclusive register halfword

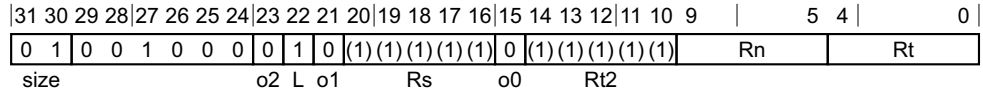

No offset variant

LDXRH <Wt>, [<Xn|SP>{, #0}]

```
integer n = UInt(Rn);
integer t = UInt(Rt);
integer t2 = UInt(Rt2); // ignored by load/store single register
integer s = UInt(Rs); // ignored by all loads and store-release
```

```
if o2:o1:o0 == '100' || o2:o1:o0 == '11x' then UnallocatedEncoding();
if o1 == '1' && size<1> == '0' then UnallocatedEncoding();
```

```
AccType acctype = if o0 == '1' then AccType_ORDERED else AccType_ATOMIC;
boolean excl = (o2 == '0');
boolean pair = (o1 == '1');
MemOp memop = if L == '1' then MemOp_LOAD else MemOp_STORE;
integer elsize = 8 << UInt(size);
integer regsize = if elsize == 64 then 64 else 32;
integer datasize = if pair then elsize * 2 else elsize;
```

Assembler Symbols

- <Wt> Is the 32-bit name of the general-purpose register to be transferred, encoded in the "Rt" field.
- <Xn|SP> Is the 64-bit name of the general-purpose base register or stack pointer, encoded in the "Rn" field.

Operation

```
bits(64) address;
bits(datasize) data;
constant integer dbytes = datasize DIV 8;
boolean rt_unknown = FALSE;
boolean rn_unknown = FALSE;

if memop == MemOp_LOAD && pair && t == t2 then
  Constraint c = ConstrainUnpredictable();
  assert c IN {Constraint_UNKNOWN, Constraint_UNDEF, Constraint_NOP};
  case c of
    when Constraint_UNKNOWN rt_unknown = TRUE; // result is UNKNOWN
    when Constraint_UNDEF UnallocatedEncoding();
    when Constraint_NOP EndOfInstruction();

if memop == MemOp_STORE && excl then
  if s == t || (pair && s == t2) then
    Constraint c = ConstrainUnpredictable();
    assert c IN {Constraint_UNKNOWN, Constraint_NONE, Constraint_UNDEF, Constraint_NOP};
    case c of
      when Constraint_UNKNOWN rt_unknown = TRUE; // store UNKNOWN value
      when Constraint_NONE rt_unknown = FALSE; // store original value
      when Constraint_UNDEF UnallocatedEncoding();
      when Constraint_NOP EndOfInstruction();
  if s == n && n != 31 then
    Constraint c = ConstrainUnpredictable();
    assert c IN {Constraint_UNKNOWN, Constraint_NONE, Constraint_UNDEF, Constraint_NOP};
```

```

        case c of
            when Constraint_UNKNOWN    rn_unknown = TRUE;    // address is UNKNOWN
            when Constraint_NONE       rn_unknown = FALSE;   // address is original base
            when Constraint_UNDEF      UnallocatedEncoding();
            when Constraint_NOP        EndOfInstruction();

if n == 31 then
    CheckSPAlignment();
    address = SP[];
elseif rn_unknown then
    address = bits(64) UNKNOWN;
else
    address = X[n];

case memop of
    when MemOp_STORE
        if rt_unknown then
            data = bits(datasize) UNKNOWN;
        elseif pair then
            assert excl;
            bits(datasize DIV 2) e11 = X[t];
            bits(datasize DIV 2) e12 = X[t2];
            data = if BigEndian() then e11 : e12 else e12 : e11;
        else
            data = X[t];

        if excl then
            // store {release} exclusive register|pair (atomic)
            bit status = '1';
            // Check whether the Exclusive Monitors are set to include the
            // physical memory locations corresponding to virtual address
            // range [address, address+dbytes-1].
            if AArch64.ExclusiveMonitorsPass(address, dbytes) then
                // This atomic write will be rejected if it does not refer
                // to the same physical locations after address translation.
                Mem[address, dbytes, acctype] = data;
                status = ExclusiveMonitorsStatus();
                X[s] = ZeroExtend(status, 32);
            else
                // store release register (atomic)
                Mem[address, dbytes, acctype] = data;

    when MemOp_LOAD
        if excl then
            // Tell the Exclusive Monitors to record a sequence of one or more atomic
            // memory reads from virtual address range [address, address+dbytes-1].
            // The Exclusive Monitor will only be set if all the reads are from the
            // same dbytes-aligned physical address, to allow for the possibility of
            // an atomicity break if the translation is changed between reads.
            AArch64.SetExclusiveMonitors(address, dbytes);

        if pair then
            // load exclusive pair
            assert excl;
            if rt_unknown then
                // ConstrainedUNPREDICTABLE case
                X[t] = bits(datasize) UNKNOWN;
            elseif elsize == 32 then
                // 32-bit load exclusive pair (atomic)
                data = Mem[address, dbytes, acctype];
                if BigEndian() then
                    X[t] = data<datasize-1:elsize>;
                    X[t2] = data<elsize-1:0>;
                else
                    X[t] = data<elsize-1:0>;
                    X[t2] = data<datasize-1:elsize>;
            else // elsize == 64
                // 64-bit load exclusive pair (not atomic),

```

```
// but must be 128-bit aligned
if address != Align(address, dbytes) then
    iswrite = FALSE;
    secondstage = FALSE;
    AArch64.Abort(address, AArch64.AlignmentFault(acctype, iswrite, secondstage));
X[t] = Mem[address + 0, 8, acctype];
X[t2] = Mem[address + 8, 8, acctype];
else
    // load {acquire} {exclusive} single register
    data = Mem[address, dbytes, acctype];
    X[t] = ZeroExtend(data, regsize);
```

C5.6.113 LSL (register)

Logical shift left (register): $Rd = LSL(Rn, Rm)$

This instruction is an alias of the [LSLV](#) instruction.

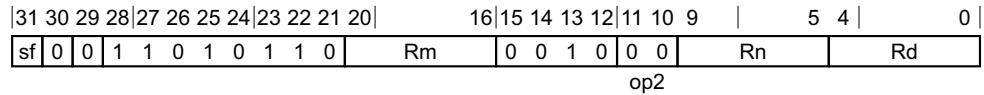

32-bit variant (sf = 0)

LSL <Wd>, <Wn>, <Wm>

is equivalent to

LSLV <Wd>, <Wn>, <Wm>

and is always the preferred disassembly.

64-bit variant (sf = 1)

LSL <Xd>, <Xn>, <Xm>

is equivalent to

LSLV <Xd>, <Xn>, <Xm>

and is always the preferred disassembly.

Assembler Symbols

- <Wd> Is the 32-bit name of the general-purpose destination register, encoded in the "Rd" field.
- <Wn> Is the 32-bit name of the first general-purpose source register, encoded in the "Rn" field.
- <Wm> Is the 32-bit name of the second general-purpose source register holding a shift amount from 0 to 31 in its bottom 5 bits, encoded in the "Rm" field.
- <Xd> Is the 64-bit name of the general-purpose destination register, encoded in the "Rd" field.
- <Xn> Is the 64-bit name of the first general-purpose source register, encoded in the "Rn" field.
- <Xm> Is the 64-bit name of the second general-purpose source register holding a shift amount from 0 to 63 in its bottom 6 bits, encoded in the "Rm" field.

C5.6.114 LSL (immediate)

Logical shift left (immediate): Rd = LSL(Rn, shift)

This instruction is an alias of the [UBFM](#) instruction.

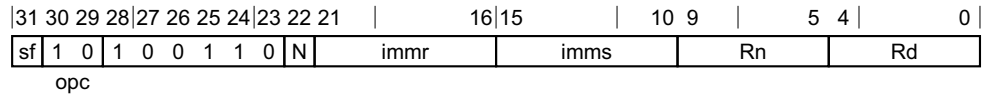

32-bit variant (sf = 0, N = 0)

LSL <Wd>, <Wn>, #<shift>

is equivalent to

UBFM <Wd>, <Wn>, #(-<shift> MOD 32), #(31-<shift>)

and is the preferred disassembly when `imms != '011111' && imms + 1 == immr`.

64-bit variant (sf = 1, N = 1)

LSL <Xd>, <Xn>, #<shift>

is equivalent to

UBFM <Xd>, <Xn>, #(-<shift> MOD 64), #(63-<shift>)

and is the preferred disassembly when `imms != '111111' && imms + 1 == immr`.

Assembler Symbols

- <Wd> Is the 32-bit name of the general-purpose destination register, encoded in the "Rd" field.
- <Wn> Is the 32-bit name of the general-purpose source register, encoded in the "Rn" field.
- <Xd> Is the 64-bit name of the general-purpose destination register, encoded in the "Rd" field.
- <Xn> Is the 64-bit name of the general-purpose source register, encoded in the "Rn" field.
- <shift> For the 32-bit variant: is the shift amount, in the range 0 to 31.
- <shift> For the 64-bit variant: is the shift amount, in the range 0 to 63.

C5.6.115 LSLV

Logical shift left variable: $Rd = LSL(Rn, Rm)$

This instruction is used by the alias [LSL \(register\)](#). The alias is always the preferred disassembly.

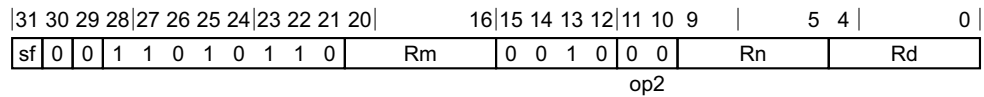

32-bit variant (sf = 0)

LSLV <Wd>, <Wn>, <Wm>

64-bit variant (sf = 1)

LSLV <Xd>, <Xn>, <Xm>

```
integer d = UInt(Rd);
integer n = UInt(Rn);
integer m = UInt(Rm);
integer datasize = if sf == '1' then 64 else 32;
ShiftType shift_type = DecodeShift(op2);
```

Assembler Symbols

- <Wd> Is the 32-bit name of the general-purpose destination register, encoded in the "Rd" field.
- <Wn> Is the 32-bit name of the first general-purpose source register, encoded in the "Rn" field.
- <Wm> Is the 32-bit name of the second general-purpose source register holding a shift amount from 0 to 31 in its bottom 5 bits, encoded in the "Rm" field.
- <Xd> Is the 64-bit name of the general-purpose destination register, encoded in the "Rd" field.
- <Xn> Is the 64-bit name of the first general-purpose source register, encoded in the "Rn" field.
- <Xm> Is the 64-bit name of the second general-purpose source register holding a shift amount from 0 to 63 in its bottom 6 bits, encoded in the "Rm" field.

Operation

```
bits(datasize) result;
bits(datasize) operand2 = X[m];

result = ShiftReg(n, shift_type, UInt(operand2) MOD datasize);
X[d] = result;
```

C5.6.116 LSR (register)

Logical shift right (register) : $Rd = LSR(Rn, Rm)$

This instruction is an alias of the [LSRV](#) instruction.

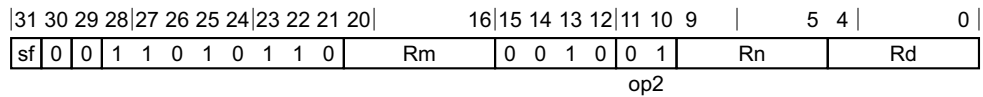

32-bit variant (sf = 0)

LSR <Wd>, <Wn>, <Wm>

is equivalent to

LSRV <Wd>, <Wn>, <Wm>

and is always the preferred disassembly.

64-bit variant (sf = 1)

LSR <Xd>, <Xn>, <Xm>

is equivalent to

LSRV <Xd>, <Xn>, <Xm>

and is always the preferred disassembly.

Assembler Symbols

- <Wd> Is the 32-bit name of the general-purpose destination register, encoded in the "Rd" field.
- <Wn> Is the 32-bit name of the first general-purpose source register, encoded in the "Rn" field.
- <Wm> Is the 32-bit name of the second general-purpose source register holding a shift amount from 0 to 31 in its bottom 5 bits, encoded in the "Rm" field.
- <Xd> Is the 64-bit name of the general-purpose destination register, encoded in the "Rd" field.
- <Xn> Is the 64-bit name of the first general-purpose source register, encoded in the "Rn" field.
- <Xm> Is the 64-bit name of the second general-purpose source register holding a shift amount from 0 to 63 in its bottom 6 bits, encoded in the "Rm" field.

C5.6.117 LSR (immediate)

Logical shift right (immediate): $Rd = LSR(Rn, \text{shift})$

This instruction is an alias of the [UBFM](#) instruction.

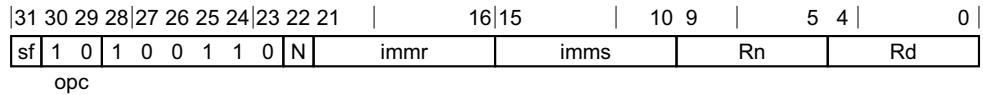

32-bit variant (sf = 0, N = 0)

LSR <Wd>, <Wn>, #<shift>

is equivalent to

UBFM <Wd>, <Wn>, #<shift>, #31

and is the preferred disassembly when `imms == '011111'`.

64-bit variant (sf = 1, N = 1)

LSR <Xd>, <Xn>, #<shift>

is equivalent to

UBFM <Xd>, <Xn>, #<shift>, #63

and is the preferred disassembly when `imms == '111111'`.

Assembler Symbols

- <Wd> Is the 32-bit name of the general-purpose destination register, encoded in the "Rd" field.
- <Wn> Is the 32-bit name of the general-purpose source register, encoded in the "Rn" field.
- <Xd> Is the 64-bit name of the general-purpose destination register, encoded in the "Rd" field.
- <Xn> Is the 64-bit name of the general-purpose source register, encoded in the "Rn" field.
- <shift> For the 32-bit variant: is the shift amount, in the range 0 to 31.
- <shift> For the 64-bit variant: is the shift amount, in the range 0 to 63.

C5.6.118 LSRV

Logical shift right variable: $Rd = \text{LSR}(Rn, Rm)$

This instruction is used by the alias [LSR \(register\)](#). The alias is always the preferred disassembly.

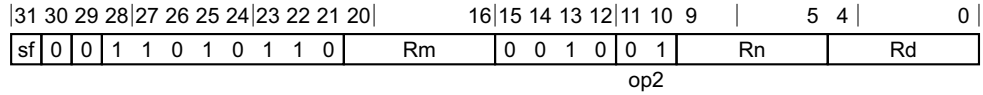

32-bit variant (sf = 0)

LSRV <Wd>, <Wn>, <Wm>

64-bit variant (sf = 1)

LSRV <Xd>, <Xn>, <Xm>

```
integer d = UInt(Rd);
integer n = UInt(Rn);
integer m = UInt(Rm);
integer datasize = if sf == '1' then 64 else 32;
ShiftType shift_type = DecodeShift(op2);
```

Assembler Symbols

- <Wd> Is the 32-bit name of the general-purpose destination register, encoded in the "Rd" field.
- <Wn> Is the 32-bit name of the first general-purpose source register, encoded in the "Rn" field.
- <Wm> Is the 32-bit name of the second general-purpose source register holding a shift amount from 0 to 31 in its bottom 5 bits, encoded in the "Rm" field.
- <Xd> Is the 64-bit name of the general-purpose destination register, encoded in the "Rd" field.
- <Xn> Is the 64-bit name of the first general-purpose source register, encoded in the "Rn" field.
- <Xm> Is the 64-bit name of the second general-purpose source register holding a shift amount from 0 to 63 in its bottom 6 bits, encoded in the "Rm" field.

Operation

```
bits(datasize) result;
bits(datasize) operand2 = X[m];

result = ShiftReg(n, shift_type, UInt(operand2) MOD datasize);
X[d] = result;
```

C5.6.119 MADD

Multiply-add: $Rd = Ra + Rn * Rm$

This instruction is used by the alias [MUL](#). See the *Alias conditions* table for details of when each alias is preferred.

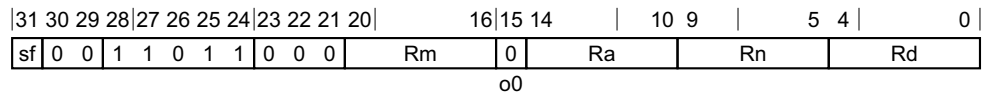

32-bit variant (sf = 0)

MADD <Wd>, <Wn>, <Wm>, <Wa>

64-bit variant (sf = 1)

MADD <Xd>, <Xn>, <Xm>, <Xa>

```
integer d = UInt(Rd);
integer n = UInt(Rn);
integer m = UInt(Rm);
integer a = UInt(Ra);
integer destsize = if sf == '1' then 64 else 32;
integer datasize = destsize;
boolean sub_op = (o0 == '1');
```

Alias conditions

Alias	is preferred when
MUL	Ra == '11111'

Assembler Symbols

<Wd>	Is the 32-bit name of the general-purpose destination register, encoded in the "Rd" field.
<Wn>	Is the 32-bit name of the first general-purpose source register holding the multiplicand, encoded in the "Rn" field.
<Wm>	Is the 32-bit name of the second general-purpose source register holding the multiplier, encoded in the "Rm" field.
<Wa>	Is the 32-bit name of the third general-purpose source register holding the addend, encoded in the "Ra" field.
<Xd>	Is the 64-bit name of the general-purpose destination register, encoded in the "Rd" field.
<Xn>	Is the 64-bit name of the first general-purpose source register holding the multiplicand, encoded in the "Rn" field.
<Xm>	Is the 64-bit name of the second general-purpose source register holding the multiplier, encoded in the "Rm" field.
<Xa>	Is the 64-bit name of the third general-purpose source register holding the addend, encoded in the "Ra" field.

Operation

```
bits(datasize) operand1 = X[n];  
bits(datasize) operand2 = X[m];  
bits(destsize) operand3 = X[a];  
  
integer result;  
  
if sub_op then  
    result = UInt(operand3) - (UInt(operand1) * UInt(operand2));  
else  
    result = UInt(operand3) + (UInt(operand1) * UInt(operand2));  
  
X[d] = result<destsize-1:0>;
```

C5.6.120 MNEG

Multiply-negate: $Rd = -(Rn * Rm)$

This instruction is an alias of the [MSUB](#) instruction.

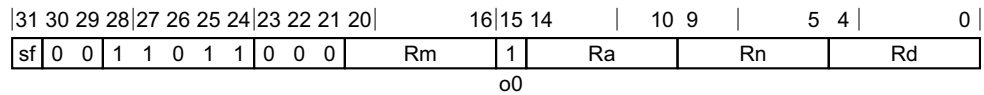

32-bit variant (sf = 0)

MNEG <Wd>, <Wn>, <Wm>

is equivalent to

MSUB <Wd>, <Wn>, <Wm>, WZR

and is the preferred disassembly when Ra == '11111'.

64-bit variant (sf = 1)

MNEG <Xd>, <Xn>, <Xm>

is equivalent to

MSUB <Xd>, <Xn>, <Xm>, XZR

and is the preferred disassembly when Ra == '11111'.

Assembler Symbols

- <Wd> Is the 32-bit name of the general-purpose destination register, encoded in the "Rd" field.
- <Wn> Is the 32-bit name of the first general-purpose source register holding the multiplicand, encoded in the "Rn" field.
- <Wm> Is the 32-bit name of the second general-purpose source register holding the multiplier, encoded in the "Rm" field.
- <Xd> Is the 64-bit name of the general-purpose destination register, encoded in the "Rd" field.
- <Xn> Is the 64-bit name of the first general-purpose source register holding the multiplicand, encoded in the "Rn" field.
- <Xm> Is the 64-bit name of the second general-purpose source register holding the multiplier, encoded in the "Rm" field.

C5.6.121 MOV (to/from SP)

Move between register and stack pointer: Rd = Rn

This instruction is an alias of the [ADD \(immediate\)](#) instruction.

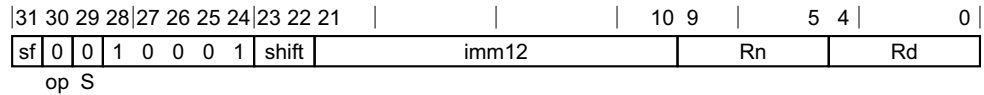

32-bit variant (sf = 0)

MOV <Wd|WSP>, <Wn|WSP>

is equivalent to

ADD <Wd|WSP>, <Wn|WSP>, #0

and is the preferred disassembly when (Rd == '11111' || Rn == '11111') && IsZero(shift:imm12).

64-bit variant (sf = 1)

MOV <Xd|SP>, <Xn|SP>

is equivalent to

ADD <Xd|SP>, <Xn|SP>, #0

and is the preferred disassembly when (Rd == '11111' || Rn == '11111') && IsZero(shift:imm12).

Assembler Symbols

- <Wd|WSP> Is the 32-bit name of the destination general-purpose register or stack pointer, encoded in the "Rd" field.
- <Wn|WSP> Is the 32-bit name of the source general-purpose register or stack pointer, encoded in the "Rn" field.
- <Xd|SP> Is the 64-bit name of the destination general-purpose register or stack pointer, encoded in the "Rd" field.
- <Xn|SP> Is the 64-bit name of the source general-purpose register or stack pointer, encoded in the "Rn" field.

C5.6.122 MOV (inverted wide immediate)

Move inverted 16-bit immediate to register: Rd = imm

This instruction is an alias of the [MOVN](#) instruction.

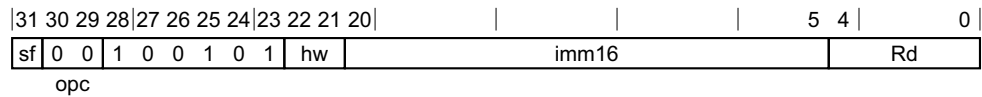

32-bit variant (sf = 0)

MOV <Wd>, #<imm>

is equivalent to

MOVN <Wd>, #<imm16>, LSL #<shift>

and is the preferred disassembly when ! (IsZeros(imm16) && hw != '00') && ! IsOnes(imm16).

64-bit variant (sf = 1)

MOV <Xd>, #<imm>

is equivalent to

MOVN <Xd>, #<imm16>, LSL #<shift>

and is the preferred disassembly when ! (IsZeros(imm16) && hw != '00').

Assembler Symbols

- <Wd> Is the 32-bit name of the general-purpose destination register, encoded in the "Rd" field.
- <Xd> Is the 64-bit name of the general-purpose destination register, encoded in the "Rd" field.
- <imm> For the 32-bit variant: is a 32-bit immediate, the bitwise inverse of which can be encoded in "imm16:hw", but excluding 0xffff0000 and 0x0000ffff
- <imm> For the 64-bit variant: is a 64-bit immediate, the bitwise inverse of which can be encoded in "imm16:hw".
- <imm16> Is the computed 16-bit immediate which, together with <shift>, encodes NOT(<imm>).
- <shift> For the 32-bit variant: is the computed minimum left shift of 0 or 16 which applied to <imm16> will encode the value of NOT(<imm>).
- <shift> For the 64-bit variant: is the computed minimum left shift of 0, 16, 32 or 48 which applied to <imm16> will encode the value of NOT(<imm>).

C5.6.123 MOV (wide immediate)

Move 16-bit immediate to register: Rd = imm

This instruction is an alias of the [MOVZ](#) instruction.

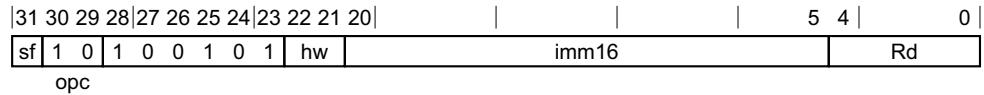

32-bit variant (sf = 0)

MOV <Wd>, #<imm>

is equivalent to

MOVZ <Wd>, #<imm16>, LSL #<shift>

and is the preferred disassembly when ! (IsZeros(imm16) && hw != '00').

64-bit variant (sf = 1)

MOV <Xd>, #<imm>

is equivalent to

MOVZ <Xd>, #<imm16>, LSL #<shift>

and is the preferred disassembly when ! (IsZeros(imm16) && hw != '00').

Assembler Symbols

- <Wd> Is the 32-bit name of the general-purpose destination register, encoded in the "Rd" field.
- <Xd> Is the 64-bit name of the general-purpose destination register, encoded in the "Rd" field.
- <imm> For the 32-bit variant: is a 32-bit immediate which can be encoded in "imm16:hw".
- <imm> For the 64-bit variant: is a 64-bit immediate which can be encoded in "imm16:hw".
- <imm16> Is the computed 16-bit immediate which, together with <shift>, encodes <imm>.
- <shift> For the 32-bit variant: is the computed minimum left shift of 0 or 16 which applied to <imm16> will encode the value of <imm>.
- <shift> For the 64-bit variant: is the computed minimum left shift of 0, 16, 32 or 48 which applied to <imm16> will encode the value of <imm>.

C5.6.124 MOV (bitmask immediate)

Move bitmask immediate to register: Rd = imm

This instruction is an alias of the [ORR \(immediate\)](#) instruction.

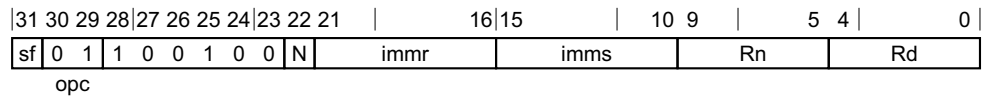

32-bit variant (sf = 0, N = 0)

MOV <Wd|WSP>, #<imm>

is equivalent to

ORR <Wd|WSP>, WZR, #<imm>

and is the preferred disassembly when ! MoveWidePreferred(sf, N, imms, immr).

64-bit variant (sf = 1)

MOV <Xd|SP>, #<imm>

is equivalent to

ORR <Xd|SP>, XZR, #<imm>

and is the preferred disassembly when ! MoveWidePreferred(sf, N, imms, immr).

Assembler Symbols

- <Wd|WSP> Is the 32-bit name of the destination general-purpose register or stack pointer, encoded in the "Rd" field.
- <Xd|SP> Is the 64-bit name of the destination general-purpose register or stack pointer, encoded in the "Rd" field.
- <imm> Is the bitmask immediate, encoded in "N:imms:immr", but excluding values which could be encoded by MOVZ or MOVN.

C5.6.125 MOV (register)

Move register to register: Rd = Rm

This instruction is an alias of the [ORR \(shifted register\)](#) instruction.

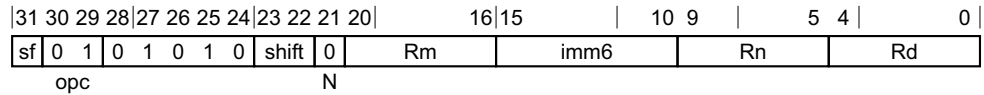

32-bit variant (sf = 0)

MOV <Wd>, <Wm>

is equivalent to

ORR <Wd>, WZR, <Wm>

and is the preferred disassembly when Rn == '11111' && IsZero(shift:imm6).

64-bit variant (sf = 1)

MOV <Xd>, <Xm>

is equivalent to

ORR <Xd>, XZR, <Xm>

and is the preferred disassembly when Rn == '11111' && IsZero(shift:imm6).

Assembler Symbols

- <Wd> Is the 32-bit name of the general-purpose destination register, encoded in the "Rd" field.
- <Wm> Is the 32-bit name of the general-purpose source register, encoded in the "Rm" field.
- <Xd> Is the 64-bit name of the general-purpose destination register, encoded in the "Rd" field.
- <Xm> Is the 64-bit name of the general-purpose source register, encoded in the "Rm" field.

C5.6.126 MOVK

Move 16-bit immediate into register, keeping other bits unchanged: $Rd\langle shift+15:shift \rangle = imm16$

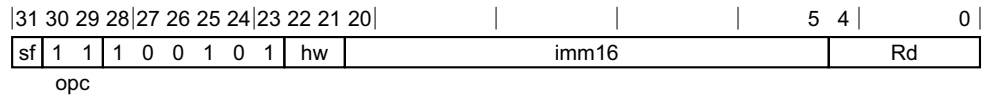

32-bit variant (sf = 0)

MOVK <Wd>, #<imm>{, LSL #<shift>}

64-bit variant (sf = 1)

MOVK <Xd>, #<imm>{, LSL #<shift>}

```
integer d = UInt(Rd);
integer datasize = if sf == '1' then 64 else 32;
bits(16) imm = imm16;
integer pos;
MoveWideOp opcode;

case opc of
  when '00' opcode = MoveWideOp_N;
  when '10' opcode = MoveWideOp_Z;
  when '11' opcode = MoveWideOp_K;
  otherwise UnallocatedEncoding();

if sf == '0' && hw<1> == '1' then UnallocatedEncoding();
pos = UInt(hw:'0000');
```

Assembler Symbols

- <Wd> Is the 32-bit name of the general-purpose destination register, encoded in the "Rd" field.
- <Xd> Is the 64-bit name of the general-purpose destination register, encoded in the "Rd" field.
- <imm> Is the 16-bit unsigned immediate, in the range 0 to 65535, encoded in the "imm16" field.
- <shift> For the 32-bit variant: is the amount by which to shift the immediate left, either 0 (the default) or 16, encoded in the "hw" field as <shift>/16.
- <shift> For the 64-bit variant: is the amount by which to shift the immediate left, either 0 (the default), 16, 32 or 48, encoded in the "hw" field as <shift>/16.

Operation

```
bits(datasize) result;

if opcode == MoveWideOp_K then
  result = X[d];
else
  result = Zeros();

result<pos+15:pos> = imm;
if opcode == MoveWideOp_N then
  result = NOT(result);
X[d] = result;
```

C5.6.127 MOVN

Move inverse of shifted 16-bit immediate to register: $Rd = NOT (LSL (imm16, shift))$

This instruction is used by the alias [MOV \(inverted wide immediate\)](#). See the [Alias conditions](#) table for details of when each alias is preferred.

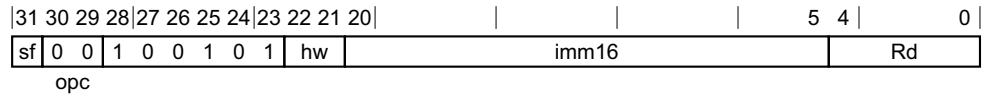

32-bit variant (sf = 0)

MOVN <Wd>, #<imm>{, LSL #<shift>}

64-bit variant (sf = 1)

MOVN <Xd>, #<imm>{, LSL #<shift>}

```
integer d = UInt(Rd);
integer datasize = if sf == '1' then 64 else 32;
bits(16) imm = imm16;
integer pos;
MoveWideOp opcode;

case opc of
  when '00' opcode = MoveWideOp_N;
  when '10' opcode = MoveWideOp_Z;
  when '11' opcode = MoveWideOp_K;
  otherwise UnallocatedEncoding();

if sf == '0' && hw<1> == '1' then UnallocatedEncoding();
pos = UInt(hw:'0000');
```

Alias conditions

Alias	of variant	is preferred when
MOV (inverted wide immediate)	64-bit	! (IsZeros(imm16) && hw != '00')
MOV (inverted wide immediate)	32-bit	! (IsZeros(imm16) && hw != '00') && ! IsOnes(imm16)

Assembler Symbols

<Wd>	Is the 32-bit name of the general-purpose destination register, encoded in the "Rd" field.
<Xd>	Is the 64-bit name of the general-purpose destination register, encoded in the "Rd" field.
<imm>	Is the 16-bit unsigned immediate, in the range 0 to 65535, encoded in the "imm16" field.
<shift>	For the 32-bit variant: is the amount by which to shift the immediate left, either 0 (the default) or 16, encoded in the "hw" field as <shift>/16.
<shift>	For the 64-bit variant: is the amount by which to shift the immediate left, either 0 (the default), 16, 32 or 48, encoded in the "hw" field as <shift>/16.

Operation

```
bits(datasize) result;  
  
if opcode == MoveWideOp_K then  
    result = X[d];  
else  
    result = Zeros();  
  
result<pos+15:pos> = imm;  
if opcode == MoveWideOp_N then  
    result = NOT(result);  
X[d] = result;
```

C5.6.128 MOVZ

Move shifted 16-bit immediate to register: $Rd = LSL(imm16, shift)$

This instruction is used by the alias [MOV \(wide immediate\)](#). See the [Alias conditions](#) table for details of when each alias is preferred.

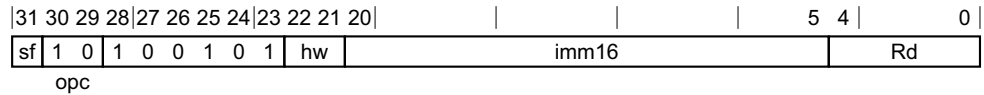

32-bit variant (sf = 0)

MOVZ <Wd>, #<imm>{, LSL #<shift>}

64-bit variant (sf = 1)

MOVZ <Xd>, #<imm>{, LSL #<shift>}

```
integer d = UInt(Rd);
integer datasize = if sf == '1' then 64 else 32;
bits(16) imm = imm16;
integer pos;
MoveWideOp opcode;

case opc of
  when '00' opcode = MoveWideOp_N;
  when '10' opcode = MoveWideOp_Z;
  when '11' opcode = MoveWideOp_K;
  otherwise UnallocatedEncoding();

if sf == '0' && hw<1> == '1' then UnallocatedEncoding();
pos = UInt(hw:'0000');
```

Alias conditions

Alias	is preferred when
MOV (wide immediate)	! (IsZeros(imm16) && hw != '00')

Assembler Symbols

<Wd>	Is the 32-bit name of the general-purpose destination register, encoded in the "Rd" field.
<Xd>	Is the 64-bit name of the general-purpose destination register, encoded in the "Rd" field.
<imm>	Is the 16-bit unsigned immediate, in the range 0 to 65535, encoded in the "imm16" field.
<shift>	For the 32-bit variant: is the amount by which to shift the immediate left, either 0 (the default) or 16, encoded in the "hw" field as <shift>/16.
<shift>	For the 64-bit variant: is the amount by which to shift the immediate left, either 0 (the default), 16, 32 or 48, encoded in the "hw" field as <shift>/16.

Operation

```
bits(datasize) result;

if opcode == MoveWideOp_K then
  result = X[d];
```

```
else
    result = Zeros();

result<pos+15:pos> = imm;
if opcode == MoveWideOp_N then
    result = NOT(result);
X[d] = result;
```

C5.6.129 MRS

Move from system register

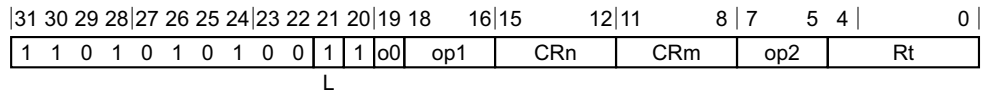

System variant

MRS <Xt>, <systemreg>

```
CheckSystemAccess(op1);
```

```
integer t = UInt(Rt);
```

```
integer sys_op0 = 2 + UInt(o0);
integer sys_op1 = UInt(op1);
integer sys_op2 = UInt(op2);
integer sys_crn = UInt(CRn);
integer sys_crm = UInt(CRm);
boolean read = (L == '1');
```

Assembler Symbols

<Xt> Is the 64-bit name of the general-purpose destination register, encoded in the "Rt" field.

<systemreg> Is a system register name, encoded in the "o0:op1:CRn:CRm:op2".

Operation

```
if read then
    X[t] = System_Get(sys_op0, sys_op1, sys_crn, sys_crm, sys_op2);
else
    System_Put(sys_op0, sys_op1, sys_crn, sys_crm, sys_op2, X[t]);
```

C5.6.130 MSR (immediate)

Move immediate to processor state field

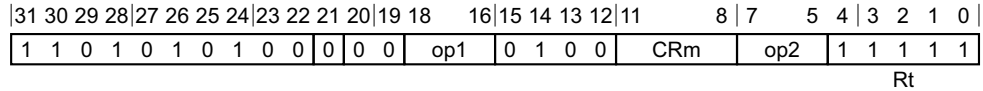

System variant

MSR <pstatefield>, #<imm>

```
CheckSystemAccess(op1);
```

```
// Check that an AArch64 MSR/MRS access to the DAIF flags is permitted
if op1 == '011' && PSTATE.EL == EL0 && SCTLRL_EL1.UMA == '0' then
    AArch64.SystemRegisterTrap(EL1, '00', op2, op1, '0100', Rt, CRm, '0');
```

```
bits(4) operand = CRm;
PSTATEField field;
case op1:op2 of
    when '000 101' field = PSTATEField_SP;
    when '011 110' field = PSTATEField_DAIFSet;
    when '011 111' field = PSTATEField_DAIFClr;
    otherwise      UnallocatedEncoding();
```

Assembler Symbols

<pstatefield> Is a PSTATE field name,

RESERVED when op1 = 000, op2 = 0xx
RESERVED when op1 = 000, op2 = 100
SPSel when op1 = 000, op2 = 101
RESERVED when op1 = 000, op2 = 11x
RESERVED when op1 = 001, op2 = xxx
RESERVED when op1 = 010, op2 = xxx
RESERVED when op1 = 011, op2 = 0xx
RESERVED when op1 = 011, op2 = 10x
DAIFSet when op1 = 011, op2 = 110
DAIFClr when op1 = 011, op2 = 111
RESERVED when op1 = 1xx, op2 = xxx

<imm> Is a 4-bit unsigned immediate, in the range 0 to 15, encoded in the "CRm" field.

Operation

```
case field of
    when PSTATEField_SP
        PSTATE.SP = operand<0>;
    when PSTATEField_DAIFSet
        PSTATE.D = PSTATE.D OR operand<3>;
        PSTATE.A = PSTATE.A OR operand<2>;
        PSTATE.I = PSTATE.I OR operand<1>;
        PSTATE.F = PSTATE.F OR operand<0>;
    when PSTATEField_DAIFClr
        PSTATE.D = PSTATE.D AND NOT(operand<3>);
```

PSTATE.A = PSTATE.A AND NOT(operand<2>);
PSTATE.I = PSTATE.I AND NOT(operand<1>);
PSTATE.F = PSTATE.F AND NOT(operand<0>);

C5.6.131 MSR (register)

Move to system register

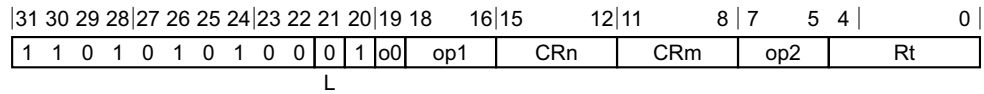

System variant

MSR <systemreg>, <Xt>

```
CheckSystemAccess(op1);
```

```
integer t = UInt(Rt);
```

```
integer sys_op0 = 2 + UInt(o0);
```

```
integer sys_op1 = UInt(op1);
```

```
integer sys_op2 = UInt(op2);
```

```
integer sys_crn = UInt(CRn);
```

```
integer sys_crm = UInt(CRm);
```

```
boolean read = (L == '1');
```

Assembler Symbols

<systemreg> Is a system register name, encoded in the "o0:op1:CRn:CRm:op2".

<Xt> Is the 64-bit name of the general-purpose source register, encoded in the "Rt" field.

Operation

```
if read then
```

```
    X[t] = System_Get(sys_op0, sys_op1, sys_crn, sys_crm, sys_op2);
```

```
else
```

```
    System_Put(sys_op0, sys_op1, sys_crn, sys_crm, sys_op2, X[t]);
```

C5.6.132 MSUB

Multiply-subtract: $Rd = Ra - Rn * Rm$

This instruction is used by the alias [MNEG](#). See the [Alias conditions](#) table for details of when each alias is preferred.

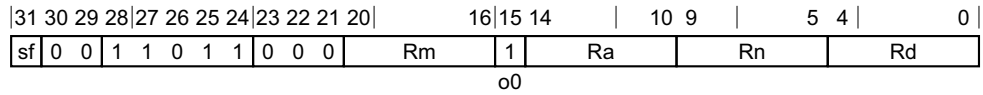

32-bit variant (sf = 0)

MSUB <Wd>, <Wn>, <Wm>, <Wa>

64-bit variant (sf = 1)

MSUB <Xd>, <Xn>, <Xm>, <Xa>

```
integer d = UInt(Rd);
integer n = UInt(Rn);
integer m = UInt(Rm);
integer a = UInt(Ra);
integer destsize = if sf == '1' then 64 else 32;
integer datasize = destsize;
boolean sub_op = (o0 == '1');
```

Alias conditions

Alias	is preferred when
MNEG	Ra == '11111'

Assembler Symbols

- <Wd> Is the 32-bit name of the general-purpose destination register, encoded in the "Rd" field.
- <Wn> Is the 32-bit name of the first general-purpose source register holding the multiplicand, encoded in the "Rn" field.
- <Wm> Is the 32-bit name of the second general-purpose source register holding the multiplier, encoded in the "Rm" field.
- <Wa> Is the 32-bit name of the third general-purpose source register holding the minuend, encoded in the "Ra" field.
- <Xd> Is the 64-bit name of the general-purpose destination register, encoded in the "Rd" field.
- <Xn> Is the 64-bit name of the first general-purpose source register holding the multiplicand, encoded in the "Rn" field.
- <Xm> Is the 64-bit name of the second general-purpose source register holding the multiplier, encoded in the "Rm" field.
- <Xa> Is the 64-bit name of the third general-purpose source register holding the minuend, encoded in the "Ra" field.

Operation

```
bits(datasize) operand1 = X[n];
bits(datasize) operand2 = X[m];
bits(destsize) operand3 = X[a];

integer result;

if sub_op then
    result = UInt(operand3) - (UInt(operand1) * UInt(operand2));
else
    result = UInt(operand3) + (UInt(operand1) * UInt(operand2));

X[d] = result<destsize-1:0>;
```

C5.6.133 MUL

Multiply: $Rd = Rn * Rm$

This instruction is an alias of the [MADD](#) instruction.

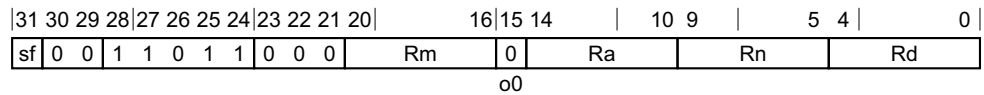

32-bit variant (sf = 0)

MUL <Wd>, <Wn>, <Wm>

is equivalent to

MADD <Wd>, <Wn>, <Wm>, WZR

and is the preferred disassembly when Ra == '11111'.

64-bit variant (sf = 1)

MUL <Xd>, <Xn>, <Xm>

is equivalent to

MADD <Xd>, <Xn>, <Xm>, XZR

and is the preferred disassembly when Ra == '11111'.

Assembler Symbols

- <Wd> Is the 32-bit name of the general-purpose destination register, encoded in the "Rd" field.
- <Wn> Is the 32-bit name of the first general-purpose source register holding the multiplicand, encoded in the "Rn" field.
- <Wm> Is the 32-bit name of the second general-purpose source register holding the multiplier, encoded in the "Rm" field.
- <Xd> Is the 64-bit name of the general-purpose destination register, encoded in the "Rd" field.
- <Xn> Is the 64-bit name of the first general-purpose source register holding the multiplicand, encoded in the "Rn" field.
- <Xm> Is the 64-bit name of the second general-purpose source register holding the multiplier, encoded in the "Rm" field.

C5.6.134 MVN

Bitwise NOT (shifted register): $Rd = \text{NOT shift}(Rm, \text{amount})$

This instruction is an alias of the [ORN \(shifted register\)](#) instruction.

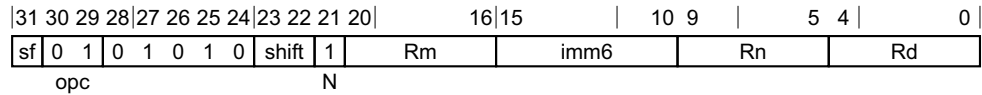

32-bit variant (sf = 0)

MVN <Wd>, <Wm>{, <shift> #<amount>}

is equivalent to

ORN <Wd>, WZR, <Wm>{, <shift> #<amount>}

and is the preferred disassembly when $Rn == '11111'$.

64-bit variant (sf = 1)

MVN <Xd>, <Xm>{, <shift> #<amount>}

is equivalent to

ORN <Xd>, XZR, <Xm>{, <shift> #<amount>}

and is the preferred disassembly when $Rn == '11111'$.

Assembler Symbols

- <Wd> Is the 32-bit name of the general-purpose destination register, encoded in the "Rd" field.
- <Wm> Is the 32-bit name of the general-purpose source register, encoded in the "Rm" field.
- <Xd> Is the 64-bit name of the general-purpose destination register, encoded in the "Rd" field.
- <Xm> Is the 64-bit name of the general-purpose source register, encoded in the "Rm" field.
- <shift> Is the optional shift to be applied to the final source, defaulting to LSL and
 - LSL** when shift = 00
 - LSR** when shift = 01
 - ASR** when shift = 10
 - ROR** when shift = 11
- <amount> For the 32-bit variant: is the shift amount, in the range 0 to 31, defaulting to 0 and encoded in the "imm6" field.
- <amount> For the 64-bit variant: is the shift amount, in the range 0 to 63, defaulting to 0 and encoded in the "imm6" field,

C5.6.135 NEG

Negate: $Rd = 0 - \text{shift}(Rm, \text{amount})$

This instruction is an alias of the [SUB \(shifted register\)](#) instruction.

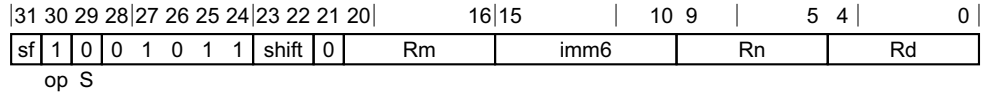

32-bit variant (sf = 0)

NEG <Wd>, <Wm>{, <shift> #<amount>}

is equivalent to

SUB <Wd>, WZR, <Wm> {, <shift> #<amount>}

and is the preferred disassembly when Rn == '11111'.

64-bit variant (sf = 1)

NEG <Xd>, <Xm>{, <shift> #<amount>}

is equivalent to

SUB <Xd>, XZR, <Xm> {, <shift> #<amount>}

and is the preferred disassembly when Rn == '11111'.

Assembler Symbols

- <Wd> Is the 32-bit name of the general-purpose destination register, encoded in the "Rd" field.
- <Wm> Is the 32-bit name of the general-purpose source register, encoded in the "Rm" field.
- <Xd> Is the 64-bit name of the general-purpose destination register, encoded in the "Rd" field.
- <Xm> Is the 64-bit name of the general-purpose source register, encoded in the "Rm" field.
- <shift> Is the optional shift type to be applied to the second source operand, defaulting to LSL and
 - LSL** when shift = 00
 - LSR** when shift = 01
 - ASR** when shift = 10
 - RESERVED** when shift = 11
- <amount> For the 32-bit variant: is the shift amount, in the range 0 to 31, defaulting to 0 and encoded in the "imm6" field.
- <amount> For the 64-bit variant: is the shift amount, in the range 0 to 63, defaulting to 0 and encoded in the "imm6" field.

C5.6.136 NEGS

Negate, setting the condition flags: $Rd = 0 - \text{shift}(Rm, \text{amount})$

This instruction is an alias of the [SUBS \(shifted register\)](#) instruction.

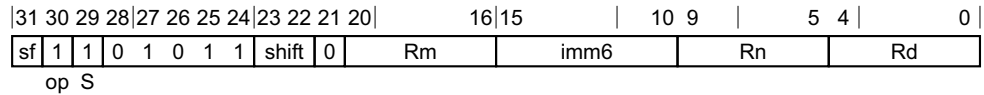

32-bit variant (sf = 0)

NEGS <Wd>, <Wm>{, <shift> #<amount>}

is equivalent to

SUBS <Wd>, WZR, <Wm> {, <shift> #<amount>}

and is the preferred disassembly when $Rn == '11111'$.

64-bit variant (sf = 1)

NEGS <Xd>, <Xm>{, <shift> #<amount>}

is equivalent to

SUBS <Xd>, XZR, <Xm> {, <shift> #<amount>}

and is the preferred disassembly when $Rn == '11111'$.

Assembler Symbols

- <Wd> Is the 32-bit name of the general-purpose destination register, encoded in the "Rd" field.
- <Wm> Is the 32-bit name of the general-purpose source register, encoded in the "Rm" field.
- <Xd> Is the 64-bit name of the general-purpose destination register, encoded in the "Rd" field.
- <Xm> Is the 64-bit name of the general-purpose source register, encoded in the "Rm" field.
- <shift> Is the optional shift type to be applied to the second source operand, defaulting to LSL and
 - LSL** when shift = 00
 - LSR** when shift = 01
 - ASR** when shift = 10
 - RESERVED** when shift = 11
- <amount> For the 32-bit variant: is the shift amount, in the range 0 to 31, defaulting to 0 and encoded in the "imm6" field.
- <amount> For the 64-bit variant: is the shift amount, in the range 0 to 63, defaulting to 0 and encoded in the "imm6" field.

C5.6.137 NGC

Negate with carry: $Rd = 0 - Rm - 1 + C$

This instruction is an alias of the [SBC](#) instruction.

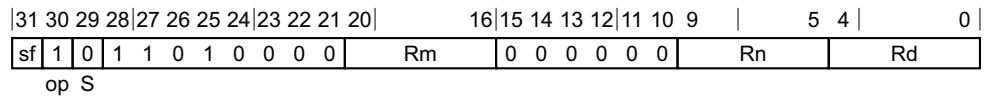

32-bit variant (sf = 0)

NGC <Wd>, <Wm>

is equivalent to

SBC <Wd>, WZR, <Wm>

and is the preferred disassembly when $Rn == '11111'$.

64-bit variant (sf = 1)

NGC <Xd>, <Xm>

is equivalent to

SBC <Xd>, XZR, <Xm>

and is the preferred disassembly when $Rn == '11111'$.

Assembler Symbols

- <Wd> Is the 32-bit name of the general-purpose destination register, encoded in the "Rd" field.
- <Wm> Is the 32-bit name of the general-purpose source register, encoded in the "Rm" field.
- <Xd> Is the 64-bit name of the general-purpose destination register, encoded in the "Rd" field.
- <Xm> Is the 64-bit name of the general-purpose source register, encoded in the "Rm" field.

C5.6.138 NGCS

Negate with carry, setting the condition flags: $Rd = 0 - Rm - 1 + C$

This instruction is an alias of the [SBCS](#) instruction.

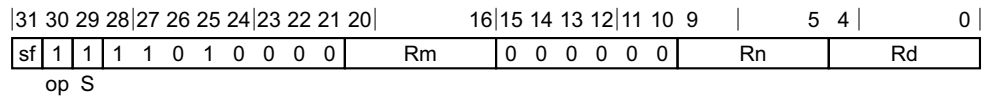

32-bit variant (sf = 0)

NGCS <Wd>, <Wm>

is equivalent to

SBCS <Wd>, WZR, <Wm>

and is the preferred disassembly when $Rn == '11111'$.

64-bit variant (sf = 1)

NGCS <Xd>, <Xm>

is equivalent to

SBCS <Xd>, XZR, <Xm>

and is the preferred disassembly when $Rn == '11111'$.

Assembler Symbols

- <Wd> Is the 32-bit name of the general-purpose destination register, encoded in the "Rd" field.
- <Wm> Is the 32-bit name of the general-purpose source register, encoded in the "Rm" field.
- <Xd> Is the 64-bit name of the general-purpose destination register, encoded in the "Rd" field.
- <Xm> Is the 64-bit name of the general-purpose source register, encoded in the "Rm" field.

C5.6.139 NOP

No operation

This instruction is an alias of the [HINT](#) instruction.

31	30	29	28	27	26	25	24	23	22	21	20	19	18	17	16	15	14	13	12	11	8	7	5	4	3	2	1	0
1	1	0	1	0	1	0	1	0	0	0	0	0	0	1	1	0	0	1	0	CRm	op2	1	1	1	1	1	1	1

System variant

NOP

is equivalent to

HINT #0

and is the preferred disassembly when $UInt(CRm:op2) == 0$.

C5.6.140 ORN (shifted register)

Bitwise inclusive OR NOT (shifted register): Rd = Rn OR NOT shift(Rm, amount)

This instruction is used by the alias *MVN*. See the *Alias conditions* table for details of when each alias is preferred.

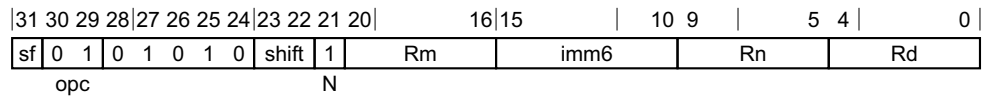

32-bit variant (sf = 0)

ORN <Wd>, <Wn>, <Wm>{, <shift> #<amount>}

64-bit variant (sf = 1)

ORN <Xd>, <Xn>, <Xm>{, <shift> #<amount>}

```
integer d = UInt(Rd);
integer n = UInt(Rn);
integer m = UInt(Rm);
integer datasize = if sf == '1' then 64 else 32;
boolean setflags;
LogicalOp op;
case opc of
  when '00' op = LogicalOp_AND; setflags = FALSE;
  when '01' op = LogicalOp_ORR; setflags = FALSE;
  when '10' op = LogicalOp_EOR; setflags = FALSE;
  when '11' op = LogicalOp_AND; setflags = TRUE;

if sf == '0' && imm6<5> == '1' then ReservedValue();

ShiftType shift_type = DecodeShift(shift);
integer shift_amount = UInt(imm6);
boolean invert = (N == '1');
```

Alias conditions

Alias	is preferred when
<i>MVN</i>	Rn == '11111'

Assembler Symbols

<Wd>	Is the 32-bit name of the general-purpose destination register, encoded in the "Rd" field.						
<Wn>	Is the 32-bit name of the first general-purpose source register, encoded in the "Rn" field.						
<Wm>	Is the 32-bit name of the second general-purpose source register, encoded in the "Rm" field.						
<Xd>	Is the 64-bit name of the general-purpose destination register, encoded in the "Rd" field.						
<Xn>	Is the 64-bit name of the first general-purpose source register, encoded in the "Rn" field.						
<Xm>	Is the 64-bit name of the second general-purpose source register, encoded in the "Rm" field.						
<shift>	Is the optional shift to be applied to the final source, defaulting to LSL and <table style="width: 100%; border-collapse: collapse; margin-top: 5px;"> <tr> <td style="width: 10%;">LSL</td> <td>when shift = 00</td> </tr> <tr> <td>LSR</td> <td>when shift = 01</td> </tr> <tr> <td>ASR</td> <td>when shift = 10</td> </tr> </table>	LSL	when shift = 00	LSR	when shift = 01	ASR	when shift = 10
LSL	when shift = 00						
LSR	when shift = 01						
ASR	when shift = 10						

ROR when shift = 11

<amount> For the 32-bit variant: is the shift amount, in the range 0 to 31, defaulting to 0 and encoded in the "imm6" field.

<amount> For the 64-bit variant: is the shift amount, in the range 0 to 63, defaulting to 0 and encoded in the "imm6" field,.

Operation

```
bits(datasize) operand1 = X[n];
bits(datasize) operand2 = ShiftReg(m, shift_type, shift_amount);

if invert then operand2 = NOT(operand2);

case op of
  when LogicalOp_AND result = operand1 AND operand2;
  when LogicalOp_ORR result = operand1 OR operand2;
  when LogicalOp_EOR result = operand1 EOR operand2;

if setflags then
  PSTATE.<N,Z,C,V> = result<datasize-1>:IsZeroBit(result):'00';

X[d] = result;
```

C5.6.141 ORR (immediate)

Bitwise inclusive OR (immediate): $Rd = Rn \text{ OR } imm$

This instruction is used by the alias [MOV \(bitmask immediate\)](#). See the [Alias conditions](#) table for details of when each alias is preferred.

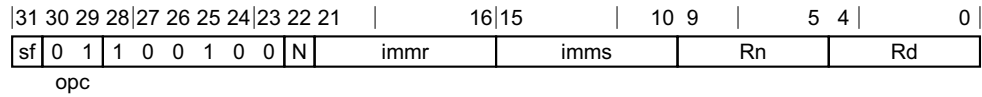

32-bit variant (sf = 0, N = 0)

ORR <Wd|WSP>, <Wn>, #<imm>

64-bit variant (sf = 1)

ORR <Xd|SP>, <Xn>, #<imm>

```
integer d = UInt(Rd);
integer n = UInt(Rn);
integer datasize = if sf == '1' then 64 else 32;
boolean setflags;
LogicalOp op;
case opc of
  when '00' op = LogicalOp_AND; setflags = FALSE;
  when '01' op = LogicalOp_ORR; setflags = FALSE;
  when '10' op = LogicalOp_EOR; setflags = FALSE;
  when '11' op = LogicalOp_AND; setflags = TRUE;

bits(datasize) imm;
if sf == '0' && N != '0' then ReservedValue();
(imm, -) = DecodeBitMasks(N, imms, immr, TRUE);
```

Alias conditions

Alias	is preferred when
MOV (bitmask immediate)	<code>! MoveWidePreferred(sf, N, imms, immr)</code>

Assembler Symbols

<Wd WSP>	Is the 32-bit name of the destination general-purpose register or stack pointer, encoded in the "Rd" field.
<Wn>	Is the 32-bit name of the general-purpose source register, encoded in the "Rn" field.
<Xd SP>	Is the 64-bit name of the destination general-purpose register or stack pointer, encoded in the "Rd" field.
<Xn>	Is the 64-bit name of the general-purpose source register, encoded in the "Rn" field.
<imm>	Is the bitmask immediate, encoded in "N:imms:immr".

Operation

```
bits(datasize) result;
bits(datasize) operand1 = X[n];
bits(datasize) operand2 = imm;
```

```
case op of
  when Logicalp_AND result = operand1 AND operand2;
  when Logicalp_ORR result = operand1 OR operand2;
  when Logicalp_EOR result = operand1 EOR operand2;

if setflags then
  PSTATE.<N,Z,C,V> = result<datasize-1>:IsZeroBit(result):'00';

if d == 31 && !setflags then
  SP[] = result;
else
  X[d] = result;
```

C5.6.142 ORR (shifted register)

Bitwise inclusive OR (shifted register): $Rd = Rn \text{ OR } \text{shift}(Rm, \text{amount})$

This instruction is used by the alias [MOV \(register\)](#). See the *Alias conditions* table for details of when each alias is preferred.

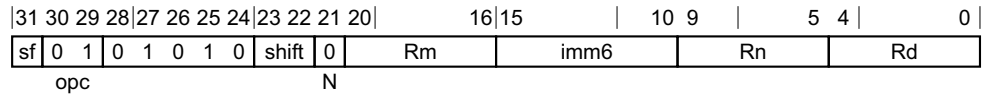

32-bit variant (sf = 0)

ORR <Wd>, <Wn>, <Wm>{, <shift> #<amount>}

64-bit variant (sf = 1)

ORR <Xd>, <Xn>, <Xm>{, <shift> #<amount>}

```

integer d = UInt(Rd);
integer n = UInt(Rn);
integer m = UInt(Rm);
integer datasize = if sf == '1' then 64 else 32;
boolean setflags;
LogicalOp op;
case opc of
    when '00' op = LogicalOp_AND; setflags = FALSE;
    when '01' op = LogicalOp_ORR; setflags = FALSE;
    when '10' op = LogicalOp_EOR; setflags = FALSE;
    when '11' op = LogicalOp_AND; setflags = TRUE;

if sf == '0' && imm6<5> == '1' then ReservedValue();

ShiftType shift_type = DecodeShift(shift);
integer shift_amount = UInt(imm6);
boolean invert = (N == '1');
```

Alias conditions

Alias	is preferred when
MOV (register)	$Rn == '11111' \ \&\& \ \text{IsZero}(\text{shift:imm6})$

Assembler Symbols

<Wd>	Is the 32-bit name of the general-purpose destination register, encoded in the "Rd" field.				
<Wn>	Is the 32-bit name of the first general-purpose source register, encoded in the "Rn" field.				
<Wm>	Is the 32-bit name of the second general-purpose source register, encoded in the "Rm" field.				
<Xd>	Is the 64-bit name of the general-purpose destination register, encoded in the "Rd" field.				
<Xn>	Is the 64-bit name of the first general-purpose source register, encoded in the "Rn" field.				
<Xm>	Is the 64-bit name of the second general-purpose source register, encoded in the "Rm" field.				
<shift>	Is the optional shift to be applied to the final source, defaulting to LSL and <table style="margin-left: 20px; border-collapse: collapse;"> <tr> <td style="padding-right: 10px;">LSL</td> <td>when shift = 00</td> </tr> <tr> <td>LSR</td> <td>when shift = 01</td> </tr> </table>	LSL	when shift = 00	LSR	when shift = 01
LSL	when shift = 00				
LSR	when shift = 01				

ASR when shift = 10

ROR when shift = 11

<amount> For the 32-bit variant: is the shift amount, in the range 0 to 31, defaulting to 0 and encoded in the "imm6" field.

<amount> For the 64-bit variant: is the shift amount, in the range 0 to 63, defaulting to 0 and encoded in the "imm6" field,.

Operation

```
bits(datasize) operand1 = X[n];
bits(datasize) operand2 = ShiftReg(m, shift_type, shift_amount);

if invert then operand2 = NOT(operand2);

case op of
  when Logicalp_AND result = operand1 AND operand2;
  when Logicalp_ORR result = operand1 OR operand2;
  when Logicalp_EOR result = operand1 EOR operand2;

if setflags then
  PSTATE.<N,Z,C,V> = result<datasize-1>:IsZeroBit(result):'00';

X[d] = result;
```

C5.6.143 PRFM (immediate)

Prefetch memory (immediate offset)

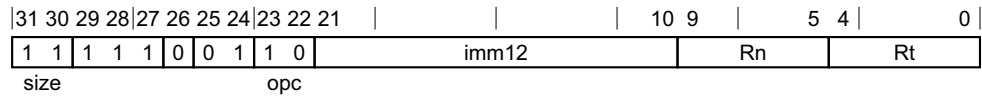

Unsigned offset variant

PRFM <prfop>, [<Xn|SP>{, #<pimm>}]

```
boolean wback = FALSE;
boolean postindex = FALSE;
integer scale = UInt(size);
bits(64) offset = LSL(ZeroExtend(imm12, 64), scale);
```

Assembler Symbols

- <prfop> Is the prefetch operation,
- PLDL1KEEP** when Rt = 00000
 - PLDL1STRM** when Rt = 00001
 - PLDL2KEEP** when Rt = 00010
 - PLDL2STRM** when Rt = 00011
 - PLDL3KEEP** when Rt = 00100
 - PLDL3STRM** when Rt = 00101
 - #uimm5** when Rt = 0011x
 - PLIL1KEEP** when Rt = 01000
 - PLIL1STRM** when Rt = 01001
 - PLIL2KEEP** when Rt = 01010
 - PLIL2STRM** when Rt = 01011
 - PLIL3KEEP** when Rt = 01100
 - PLIL3STRM** when Rt = 01101
 - #uimm5** when Rt = 0111x
 - PSTL1KEEP** when Rt = 10000
 - PSTL1STRM** when Rt = 10001
 - PSTL2KEEP** when Rt = 10010
 - PSTL2STRM** when Rt = 10011
 - PSTL3KEEP** when Rt = 10100
 - PSTL3STRM** when Rt = 10101
 - #uimm5** when Rt = 1011x
 - #uimm5** when Rt = 11xxx
- <Xn|SP> Is the 64-bit name of the general-purpose base register or stack pointer, encoded in the "Rn" field.
- <pimm> Is the optional positive immediate byte offset, a multiple of 8 in the range 0 to 32760, defaulting to 0 and encoded in the "imm12" field as <pimm>/8.

Shared decode for all variants

```

integer n = UInt(Rn);
integer t = UInt(Rt);
AccType acctype = AccType_NORMAL;
MemOp memop;
boolean signed;
integer regsize;

if opc<1> == '0' then
  // store or zero-extending load
  memop = if opc<0> == '1' then MemOp_LOAD else MemOp_STORE;
  regsize = if size == '11' then 64 else 32;
  signed = FALSE;
else
  if size == '11' then
    memop = MemOp_PREFETCH;
    if opc<0> == '1' then UnallocatedEncoding();
  else
    // sign-extending load
    memop = MemOp_LOAD;
    if size == '10' && opc<0> == '1' then UnallocatedEncoding();
    regsize = if opc<0> == '1' then 32 else 64;
    signed = TRUE;

integer datasize = 8 << scale;
  
```

Operation

```

bits(64) address;
bits(datasize) data;
boolean wb_unknown = FALSE;
boolean rt_unknown = FALSE;

if memop == MemOp_LOAD && wback && n == t && n != 31 then
  c = ConstrainUnpredictable();
  assert c IN {Constraint_WBSUPPRESS, Constraint_UNKNOWN, Constraint_UNDEF, Constraint_NOP};
  case c of
    when Constraint_WBSUPPRESS wback = FALSE; // writeback is suppressed
    when Constraint_UNKNOWN wb_unknown = TRUE; // writeback is UNKNOWN
    when Constraint_UNDEF UnallocatedEncoding();
    when Constraint_NOP EndOfInstruction();

if memop == MemOp_STORE && wback && n == t && n != 31 then
  c = ConstrainUnpredictable();
  assert c IN {Constraint_NONE, Constraint_UNKNOWN, Constraint_UNDEF, Constraint_NOP};
  case c of
    when Constraint_NONE rt_unknown = FALSE; // value stored is original value
    when Constraint_UNKNOWN rt_unknown = TRUE; // value stored is UNKNOWN
    when Constraint_UNDEF UnallocatedEncoding();
    when Constraint_NOP EndOfInstruction();

if n == 31 then
  if memop != MemOp_PREFETCH then CheckSPAlignment();
  address = SP[];
else
  address = X[n];

if ! postindex then
  address = address + offset;

case memop of
  when MemOp_STORE
    if rt_unknown then
      data = bits(datasize) UNKNOWN;
    else
      data = X[t];
  
```

```
Mem[address, datasize DIV 8, acctype] = data;

when MemOp_LOAD
  data = Mem[address, datasize DIV 8, acctype];
  if signed then
    X[t] = SignExtend(data, regsize);
  else
    X[t] = ZeroExtend(data, regsize);

when MemOp_PREFETCH
  Prefetch(address, t<4:0>);

if wback then
  if wb_unknown then
    address = bits(64) UNKNOWN;
  elsif postindex then
    address = address + offset;
  if n == 31 then
    SP[] = address;
  else
    X[n] = address;
```

C5.6.144 PRFM (literal)

Prefetch memory (PC-relative offset)

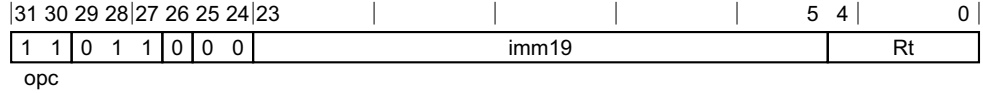

Literal variant

PRFM <prfop>, <label>

```
integer t = UInt(Rt);
MemOp memop = MemOp_LOAD;
boolean signed = FALSE;
integer size;
bits(64) offset;

case opc of
    when '00'
        size = 4;
    when '01'
        size = 8;
    when '10'
        size = 4;
        signed = TRUE;
    when '11'
        memop = MemOp_PREFETCH;

offset = SignExtend(imm19:'00', 64);
```

Assembler Symbols

- <prfop> Is the prefetch operation,
- PLDL1KEEP** when Rt = 00000
 - PLDL1STRM** when Rt = 00001
 - PLDL2KEEP** when Rt = 00010
 - PLDL2STRM** when Rt = 00011
 - PLDL3KEEP** when Rt = 00100
 - PLDL3STRM** when Rt = 00101
 - #uimm5** when Rt = 0011x
 - PLIL1KEEP** when Rt = 01000
 - PLIL1STRM** when Rt = 01001
 - PLIL2KEEP** when Rt = 01010
 - PLIL2STRM** when Rt = 01011
 - PLIL3KEEP** when Rt = 01100
 - PLIL3STRM** when Rt = 01101
 - #uimm5** when Rt = 0111x
 - PSTL1KEEP** when Rt = 10000
 - PSTL1STRM** when Rt = 10001
 - PSTL2KEEP** when Rt = 10010
 - PSTL2STRM** when Rt = 10011

PSTL3KEEP when Rt = 10100

PSTL3STRM when Rt = 10101

#uimm5 when Rt = 1011x

#uimm5 when Rt = 11xxx

<label> Is the program label from which the data is to be loaded. Its offset from the address of this instruction, in the range +/-1MB, is encoded as "imm19" times 4.

Operation

```
bits(64) address = PC[] + offset;  
bits(size*8) data;
```

```
case memop of  
  when MemOp_LOAD  
    data = Mem[address, size, AccType_NORMAL];  
    if signed then  
      X[t] = SignExtend(data, 64);  
    else  
      X[t] = data;  
  
  when MemOp_PREFETCH  
    Prefetch(address, t<4:0>);
```

C5.6.145 PRFM (register)

Prefetch memory (register offset)

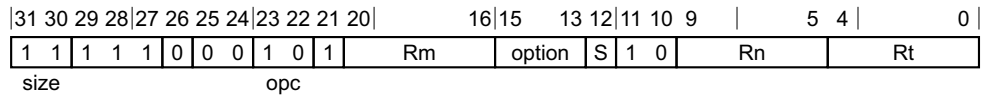

Integer variant

PRFM <prfop>, [<Xn|SP>, <R><m>{, <extend> {<amount>}}]

```

boolean wback = FALSE;
boolean postindex = FALSE;
integer scale = UInt(size);
if option<1> == '0' then UnallocatedEncoding(); // sub-word index
ExtendType extend_type = DecodeRegExtend(option);
integer shift = if S == '1' then scale else 0;
  
```

Assembler Symbols

- <prfop> Is the prefetch operation,
- PLDL1KEEP** when Rt = 00000
 - PLDL1STRM** when Rt = 00001
 - PLDL2KEEP** when Rt = 00010
 - PLDL2STRM** when Rt = 00011
 - PLDL3KEEP** when Rt = 00100
 - PLDL3STRM** when Rt = 00101
 - #uimm5** when Rt = 0011x
 - PLIL1KEEP** when Rt = 01000
 - PLIL1STRM** when Rt = 01001
 - PLIL2KEEP** when Rt = 01010
 - PLIL2STRM** when Rt = 01011
 - PLIL3KEEP** when Rt = 01100
 - PLIL3STRM** when Rt = 01101
 - #uimm5** when Rt = 0111x
 - PSTL1KEEP** when Rt = 10000
 - PSTL1STRM** when Rt = 10001
 - PSTL2KEEP** when Rt = 10010
 - PSTL2STRM** when Rt = 10011
 - PSTL3KEEP** when Rt = 10100
 - PSTL3STRM** when Rt = 10101
 - #uimm5** when Rt = 1011x
 - #uimm5** when Rt = 11xxx
- <Xn|SP> Is the 64-bit name of the general-purpose base register or stack pointer, encoded in the "Rn" field.
- <R> Is the index width specifier,
- RESERVED** when option = 00x
 - W** when option = x10

	X	when option = x11
	RESERVED	when option = 10x
<m>		Is the number [0-30] of the general-purpose index register or the name ZR (31), encoded in the "Rm" field.
<extend>		Is the index extend/shift specifier, defaulting to LSL and
	RESERVED	when option = 00x
	UXTW	when option = 010
	LSL	when option = 011
	RESERVED	when option = 10x
	SXTW	when option = 110
	SXTX	when option = 111
<amount>		Is the index shift amount, optional and defaulting to #0 when <extend> is not LSL,
	#0	when S = 0
	#3	when S = 1

Shared decode for all variants

```

integer n = UInt(Rn);
integer t = UInt(Rt);
integer m = UInt(Rm);
AccType acctype = AccType_NORMAL;
MemOp memop;
boolean signed;
integer regsize;

if opc<1> == '0' then
  // store or zero-extending load
  memop = if opc<0> == '1' then MemOp_LOAD else MemOp_STORE;
  regsize = if size == '11' then 64 else 32;
  signed = FALSE;
else
  if size == '11' then
    memop = MemOp_PREFETCH;
    if opc<0> == '1' then UnallocatedEncoding();
  else
    // sign-extending load
    memop = MemOp_LOAD;
    if size == '10' && opc<0> == '1' then UnallocatedEncoding();
    regsize = if opc<0> == '1' then 32 else 64;
    signed = TRUE;

integer datasize = 8 << scale;
  
```

Operation

```

bits(64) offset = ExtendReg(m, extend_type, shift);
bits(64) address;
bits(datasize) data;
boolean wb_unknown = FALSE;
boolean rt_unknown = FALSE;

if memop == MemOp_LOAD && wback && n == t && n != 31 then
  c = ConstrainUnpredictable();
  assert c IN {Constraint_WBSUPPRESS, Constraint_UNKNOWN, Constraint_UNDEF, Constraint_NOP};
  case c of
    when Constraint_WBSUPPRESS wback = FALSE; // writeback is suppressed
    when Constraint_UNKNOWN wb_unknown = TRUE; // writeback is UNKNOWN
    when Constraint_UNDEF UnallocatedEncoding();
  
```

```
        when Constraint_NOP      EndOfInstruction();

if memop == MemOp_STORE && wback && n == t && n != 31 then
    c = ConstraiUnpredictable();
    assert c IN {Constraint_NONE, Constraint_UNKNOWN, Constraint_UNDEF, Constraint_NOP};
    case c of
        when Constraint_NONE      rt_unknown = FALSE; // value stored is original value
        when Constraint_UNKNOWN    rt_unknown = TRUE;  // value stored is UNKNOWN
        when Constraint_UNDEF      UnallocatedEncoding();
        when Constraint_NOP        EndOfInstruction();

    if n == 31 then
        if memop != MemOp_PREFETCH then CheckSPAlignment();
        address = SP[];
    else
        address = X[n];

    if ! postindex then
        address = address + offset;

    case memop of
        when MemOp_STORE
            if rt_unknown then
                data = bits(datasize) UNKNOWN;
            else
                data = X[t];
            Mem[address, datasize DIV 8, acctype] = data;

        when MemOp_LOAD
            data = Mem[address, datasize DIV 8, acctype];
            if signed then
                X[t] = SignExtend(data, regsize);
            else
                X[t] = ZeroExtend(data, regsize);

        when MemOp_PREFETCH
            Prefetch(address, t<4:0>);

    if wback then
        if wb_unknown then
            address = bits(64) UNKNOWN;
        elsif postindex then
            address = address + offset;
        if n == 31 then
            SP[] = address;
        else
            X[n] = address;
```

C5.6.146 PRFUM

Prefetch memory (unscaled offset)

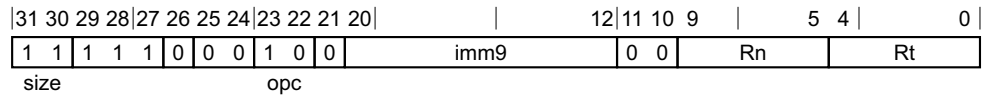

Unsigned offset variant

PRFUM <prfop>, [<Xn|SP>{, #<simm>}]

boolean wback = FALSE;
boolean postindex = FALSE;
integer scale = UInt(size);
bits(64) offset = SignExtend(imm9, 64);

Assembler Symbols

<prfop>	<p>Is the prefetch operation,</p> <p>PLDL1KEEP when Rt = 00000</p> <p>PLDL1STRM when Rt = 00001</p> <p>PLDL2KEEP when Rt = 00010</p> <p>PLDL2STRM when Rt = 00011</p> <p>PLDL3KEEP when Rt = 00100</p> <p>PLDL3STRM when Rt = 00101</p> <p>#uimm5 when Rt = 0011x</p> <p>PLIL1KEEP when Rt = 01000</p> <p>PLIL1STRM when Rt = 01001</p> <p>PLIL2KEEP when Rt = 01010</p> <p>PLIL2STRM when Rt = 01011</p> <p>PLIL3KEEP when Rt = 01100</p> <p>PLIL3STRM when Rt = 01101</p> <p>#uimm5 when Rt = 0111x</p> <p>PSTL1KEEP when Rt = 10000</p> <p>PSTL1STRM when Rt = 10001</p> <p>PSTL2KEEP when Rt = 10010</p> <p>PSTL2STRM when Rt = 10011</p> <p>PSTL3KEEP when Rt = 10100</p> <p>PSTL3STRM when Rt = 10101</p> <p>#uimm5 when Rt = 1011x</p> <p>#uimm5 when Rt = 11xxx</p>
<Xn SP>	Is the 64-bit name of the general-purpose base register or stack pointer, encoded in the "Rn" field.
<simm>	Is the optional signed immediate byte offset, in the range -256 to 255, defaulting to 0 and encoded in the "imm9" field.

Shared decode for all variants

```

integer n = UInt(Rn);
integer t = UInt(Rt);
AccType acctype = AccType_NORMAL;
MemOp memop;
boolean signed;
integer regsize;

if opc<1> == '0' then
    // store or zero-extending load
    memop = if opc<0> == '1' then MemOp_LOAD else MemOp_STORE;
    regsize = if size == '11' then 64 else 32;
    signed = FALSE;
else
    if size == '11' then
        memop = MemOp_PREFETCH;
        if opc<0> == '1' then UnallocatedEncoding();
    else
        // sign-extending load
        memop = MemOp_LOAD;
        if size == '10' && opc<0> == '1' then UnallocatedEncoding();
        regsize = if opc<0> == '1' then 32 else 64;
        signed = TRUE;

integer datasize = 8 << scale;

```

Operation

```

bits(64) address;
bits(datasize) data;
boolean wb_unknown = FALSE;
boolean rt_unknown = FALSE;

if memop == MemOp_LOAD && wback && n == t && n != 31 then
    c = ConstrainUnpredictable();
    assert c IN {Constraint_WBSUPPRESS, Constraint_UNKNOWN, Constraint_UNDEF, Constraint_NOP};
    case c of
        when Constraint_WBSUPPRESS wback = FALSE; // writeback is suppressed
        when Constraint_UNKNOWN wb_unknown = TRUE; // writeback is UNKNOWN
        when Constraint_UNDEF UnallocatedEncoding();
        when Constraint_NOP EndOfInstruction();

if memop == MemOp_STORE && wback && n == t && n != 31 then
    c = ConstrainUnpredictable();
    assert c IN {Constraint_NONE, Constraint_UNKNOWN, Constraint_UNDEF, Constraint_NOP};
    case c of
        when Constraint_NONE rt_unknown = FALSE; // value stored is original value
        when Constraint_UNKNOWN rt_unknown = TRUE; // value stored is UNKNOWN
        when Constraint_UNDEF UnallocatedEncoding();
        when Constraint_NOP EndOfInstruction();

if n == 31 then
    if memop != MemOp_PREFETCH then CheckSPAlignment();
    address = SP[];
else
    address = X[n];

if ! postindex then
    address = address + offset;

case memop of
    when MemOp_STORE
        if rt_unknown then
            data = bits(datasize) UNKNOWN;
        else
            data = X[t];

```

```
Mem[address, datasize DIV 8, acctype] = data;

when MemOp_LOAD
  data = Mem[address, datasize DIV 8, acctype];
  if signed then
    X[t] = SignExtend(data, regsize);
  else
    X[t] = ZeroExtend(data, regsize);

when MemOp_PREFETCH
  Prefetch(address, t<4:0>);

if wback then
  if wb_unknown then
    address = bits(64) UNKNOWN;
  elsif postindex then
    address = address + offset;
  if n == 31 then
    SP[] = address;
  else
    X[n] = address;
```

C5.6.147 RBIT

Reverse bit order

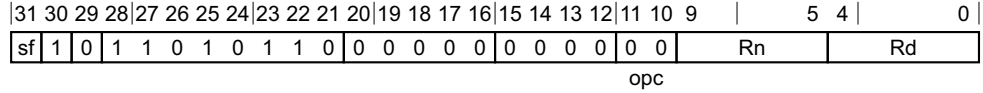

32-bit variant (sf = 0)

RBIT <Wd>, <Wn>

64-bit variant (sf = 1)

RBIT <Xd>, <Xn>

```
integer d = UInt(Rd);
integer n = UInt(Rn);

integer datasize = if sf == '1' then 64 else 32;

RevOp op;
case opc of
    when '00'
        op = RevOp_RBIt;
    when '01'
        op = RevOp_REV16;
    when '10'
        op = RevOp_REV32;
    when '11'
        if sf == '0' then UnallocatedEncoding();
        op = RevOp_REV64;
```

Assembler Symbols

- <Wd> Is the 32-bit name of the general-purpose destination register, encoded in the "Rd" field.
- <Wn> Is the 32-bit name of the general-purpose source register, encoded in the "Rn" field.
- <Xd> Is the 64-bit name of the general-purpose destination register, encoded in the "Rd" field.
- <Xn> Is the 64-bit name of the general-purpose source register, encoded in the "Rn" field.

Operation

```
bits(datasize) result;
bits(6) V;
integer vbit;

case op of
    when RevOp_REV16 V = '001000';
    when RevOp_REV32 V = '011000';
    when RevOp_REV64 V = '111000';
    when RevOp_RBIt V = if datasize == 64 then '111111' else '011111';

result = X[n];
for vbit = 0 to 5
    // Swap pairs of 2^vbit bits in result
    if V<vbit> == '1' then
        bits(datasize) tmp = result;
        integer vsize = 1 << vbit;
        integer base = 0;
        while base < datasize do
```

```
result<base+vsize-1:base> = tmp<base+(2*vsize)-1:base+vsize>;  
result<base+(2*vsize)-1:base+vsize> = tmp<base+vsize-1:base>;  
base = base + (2 * vsize);  
X[d] = result;
```

C5.6.148 RET

Return from subroutine, branches unconditionally to an address in a register, with a hint that this is a subroutine return

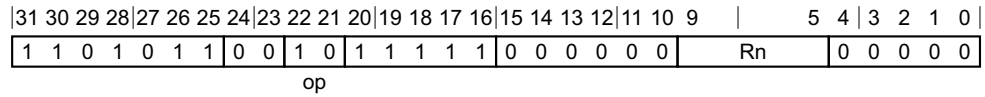

Integer variant

RET {<Xn>}

```
integer n = UInt(Rn);
BranchType branch_type;
```

```
case op of
  when '00' branch_type = BranchType_JMP;
  when '01' branch_type = BranchType_CALL;
  when '10' branch_type = BranchType_RET;
  otherwise UnallocatedEncoding();
```

Assembler Symbols

<Xn> Is the 64-bit name of the general-purpose register holding the address to be branched to, encoded in the "Rn" field. Defaults to X30 if absent.

Operation

```
bits(64) target = X[n];
```

```
if branch_type == BranchType_CALL then X[30] = PC[] + 4;
BranchTo(target, branch_type);
```

C5.6.149 REV

Reverse bytes

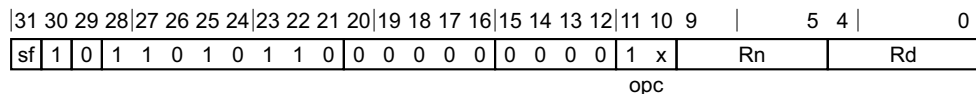

32-bit variant (sf = 0, opc = 10)

REV <Wd>, <Wn>

64-bit variant (sf = 1, opc = 11)

REV <Xd>, <Xn>

```
integer d = UInt(Rd);
integer n = UInt(Rn);

integer datasize = if sf == '1' then 64 else 32;
```

```
RevOp op;
case opc of
  when '00'
    op = RevOp_RBIT;
  when '01'
    op = RevOp_REV16;
  when '10'
    op = RevOp_REV32;
  when '11'
    if sf == '0' then UnallocatedEncoding();
    op = RevOp_REV64;
```

Assembler Symbols

<Wd> Is the 32-bit name of the general-purpose destination register, encoded in the "Rd" field.

<Wn> Is the 32-bit name of the general-purpose source register, encoded in the "Rn" field.

<Xd> Is the 64-bit name of the general-purpose destination register, encoded in the "Rd" field.

<Xn> Is the 64-bit name of the general-purpose source register, encoded in the "Rn" field.

Operation

```
bits(datasize) result;
bits(6) V;
integer vbit;

case op of
  when RevOp_REV16 V = '001000';
  when RevOp_REV32 V = '011000';
  when RevOp_REV64 V = '111000';
  when RevOp_RBIT V = if datasize == 64 then '111111' else '011111';

result = X[n];
for vbit = 0 to 5
  // Swap pairs of 2^vbit bits in result
  if V<vbit> == '1' then
    bits(datasize) tmp = result;
    integer vsize = 1 << vbit;
    integer base = 0;
    while base < datasize do
```

```
result<base+vsizel-1:base> = tmp<base+(2*vsizel)-1:base+vsizel>;  
result<base+(2*vsizel)-1:base+vsizel> = tmp<base+vsizel-1:base>;  
base = base + (2 * vsizel);  
X[d] = result;
```

C5.6.150 REV16

Reverse bytes in 16-bit halfwords

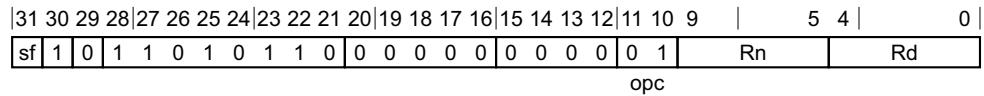

32-bit variant (sf = 0)

REV16 <Wd>, <Wn>

64-bit variant (sf = 1)

REV16 <Xd>, <Xn>

```
integer d = UInt(Rd);
integer n = UInt(Rn);

integer datasize = if sf == '1' then 64 else 32;

RevOp op;
case opc of
  when '00'
    op = RevOp_RBIT;
  when '01'
    op = RevOp_REV16;
  when '10'
    op = RevOp_REV32;
  when '11'
    if sf == '0' then UnallocatedEncoding();
    op = RevOp_REV64;
```

Assembler Symbols

<Wd> Is the 32-bit name of the general-purpose destination register, encoded in the "Rd" field.

<Wn> Is the 32-bit name of the general-purpose source register, encoded in the "Rn" field.

<Xd> Is the 64-bit name of the general-purpose destination register, encoded in the "Rd" field.

<Xn> Is the 64-bit name of the general-purpose source register, encoded in the "Rn" field.

Operation

```
bits(datasize) result;
bits(6) V;
integer vbit;

case op of
  when RevOp_REV16 V = '001000';
  when RevOp_REV32 V = '011000';
  when RevOp_REV64 V = '111000';
  when RevOp_RBIT V = if datasize == 64 then '111111' else '011111';

result = X[n];
for vbit = 0 to 5
  // Swap pairs of 2^vbit bits in result
  if V<vbit> == '1' then
    bits(datasize) tmp = result;
    integer vsize = 1 << vbit;
    integer base = 0;
    while base < datasize do
```

```
result<base+vsize-1:base> = tmp<base+(2*vsize)-1:base+vsize>;  
result<base+(2*vsize)-1:base+vsize> = tmp<base+vsize-1:base>;  
base = base + (2 * vsize);  
X[d] = result;
```

C5.6.151 REV32

Reverse bytes in 32-bit words

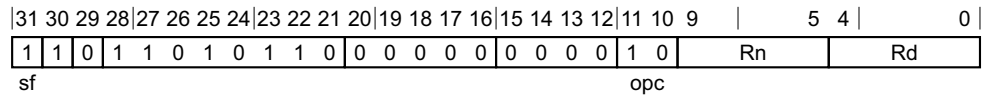

64-bit variant

REV32 <Xd>, <Xn>

```
integer d = UInt(Rd);
integer n = UInt(Rn);
```

```
integer datasize = if sf == '1' then 64 else 32;
```

```
RevOp op;
case opc of
  when '00'
    op = RevOp_RBIT;
  when '01'
    op = RevOp_REV16;
  when '10'
    op = RevOp_REV32;
  when '11'
    if sf == '0' then UnallocatedEncoding();
    op = RevOp_REV64;
```

Assembler Symbols

<Xd> Is the 64-bit name of the general-purpose destination register, encoded in the "Rd" field.

<Xn> Is the 64-bit name of the general-purpose source register, encoded in the "Rn" field.

Operation

```
bits(datasize) result;
bits(6) V;
integer vbit;
```

```
case op of
  when RevOp_REV16 V = '001000';
  when RevOp_REV32 V = '011000';
  when RevOp_REV64 V = '111000';
  when RevOp_RBIT V = if datasize == 64 then '111111' else '011111';
```

```
result = X[n];
for vbit = 0 to 5
  // Swap pairs of 2^vbit bits in result
  if V<vbit> == '1' then
    bits(datasize) tmp = result;
    integer vsize = 1 << vbit;
    integer base = 0;
    while base < datasize do
      result<base+vsize-1:base> = tmp<base+(2*vsize)-1:base+vsize>;
      result<base+(2*vsize)-1:base+vsize> = tmp<base+vsize-1:base>;
      base = base + (2 * vsize);
X[d] = result;
```

C5.6.152 ROR (immediate)

Rotate right (immediate): $Rd = ROR(Rs, shift)$

This instruction is an alias of the [EXTR](#) instruction.

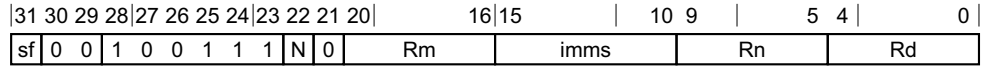

32-bit variant (sf = 0, N = 0, imms = 0xxxxx)

ROR <Wd>, <Ws>, #<shift>

is equivalent to

EXTR <Wd>, <Ws>, <Ws>, #<shift>

and is the preferred disassembly when $Rn == Rm$.

64-bit variant (sf = 1, N = 1)

ROR <Xd>, <Xs>, #<shift>

is equivalent to

EXTR <Xd>, <Xs>, <Xs>, #<shift>

and is the preferred disassembly when $Rn == Rm$.

Assembler Symbols

- <Wd> Is the 32-bit name of the general-purpose destination register, encoded in the "Rd" field.
- <Ws> Is the 32-bit name of the general-purpose source register, encoded in the "Rn" and "Rm" fields.
- <Xd> Is the 64-bit name of the general-purpose destination register, encoded in the "Rd" field.
- <Xs> Is the 64-bit name of the general-purpose source register, encoded in the "Rn" and "Rm" fields.
- <shift> For the 32-bit variant: is the amount by which to rotate, in the range 0 to 31, encoded in the "imms" field.
- <shift> For the 64-bit variant: is the amount by which to rotate, in the range 0 to 63, encoded in the "imms" field.

C5.6.153 ROR (register)

Rotate right (register): Rd = ROR(Rn, Rm)

This instruction is an alias of the [RORV](#) instruction.

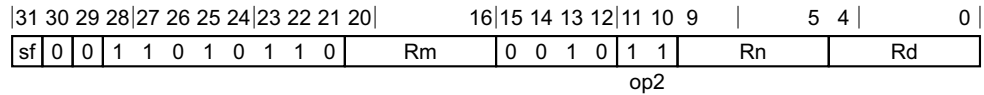

32-bit variant (sf = 0)

ROR <Wd>, <Wn>, <Wm>

is equivalent to

RORV <Wd>, <Wn>, <Wm>

and is always the preferred disassembly.

64-bit variant (sf = 1)

ROR <Xd>, <Xn>, <Xm>

is equivalent to

RORV <Xd>, <Xn>, <Xm>

and is always the preferred disassembly.

Assembler Symbols

- <Wd> Is the 32-bit name of the general-purpose destination register, encoded in the "Rd" field.
- <Wn> Is the 32-bit name of the first general-purpose source register, encoded in the "Rn" field.
- <Wm> Is the 32-bit name of the second general-purpose source register holding a shift amount from 0 to 31 in its bottom 5 bits, encoded in the "Rm" field.
- <Xd> Is the 64-bit name of the general-purpose destination register, encoded in the "Rd" field.
- <Xn> Is the 64-bit name of the first general-purpose source register, encoded in the "Rn" field.
- <Xm> Is the 64-bit name of the second general-purpose source register holding a shift amount from 0 to 63 in its bottom 6 bits, encoded in the "Rm" field.

C5.6.154 RORV

Rotate right variable: $Rd = ROR(Rn, Rm)$

This instruction is used by the alias **ROR (register)**. The alias is always the preferred disassembly.

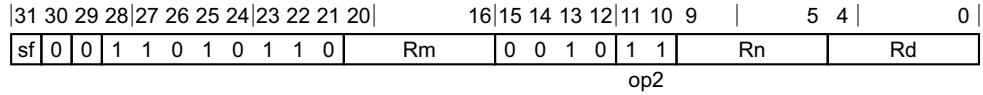

32-bit variant (sf = 0)

RORV <Wd>, <Wn>, <Wm>

64-bit variant (sf = 1)

RORV <Xd>, <Xn>, <Xm>

```
integer d = UInt(Rd);
integer n = UInt(Rn);
integer m = UInt(Rm);
integer datasize = if sf == '1' then 64 else 32;
ShiftType shift_type = DecodeShift(op2);
```

Assembler Symbols

- <Wd> Is the 32-bit name of the general-purpose destination register, encoded in the "Rd" field.
- <Wn> Is the 32-bit name of the first general-purpose source register, encoded in the "Rn" field.
- <Wm> Is the 32-bit name of the second general-purpose source register holding a shift amount from 0 to 31 in its bottom 5 bits, encoded in the "Rm" field.
- <Xd> Is the 64-bit name of the general-purpose destination register, encoded in the "Rd" field.
- <Xn> Is the 64-bit name of the first general-purpose source register, encoded in the "Rn" field.
- <Xm> Is the 64-bit name of the second general-purpose source register holding a shift amount from 0 to 63 in its bottom 6 bits, encoded in the "Rm" field.

Operation

```
bits(datasize) result;
bits(datasize) operand2 = X[m];

result = ShiftReg(n, shift_type, UInt(operand2) MOD datasize);
X[d] = result;
```

C5.6.155 SBC

Subtract with carry: $Rd = Rn - Rm - 1 + C$

This instruction is used by the alias [NGC](#). See the [Alias conditions](#) table for details of when each alias is preferred.

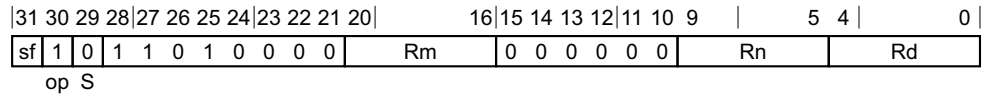

32-bit variant (sf = 0)

SBC <Wd>, <Wn>, <Wm>

64-bit variant (sf = 1)

SBC <Xd>, <Xn>, <Xm>

```
integer d = UInt(Rd);
integer n = UInt(Rn);
integer m = UInt(Rm);
integer datasize = if sf == '1' then 64 else 32;
boolean sub_op = (op == '1');
boolean setflags = (S == '1');
```

Alias conditions

Alias	is preferred when
NGC	Rn == '11111'

Assembler Symbols

<Wd>	Is the 32-bit name of the general-purpose destination register, encoded in the "Rd" field.
<Wn>	Is the 32-bit name of the first general-purpose source register, encoded in the "Rn" field.
<Wm>	Is the 32-bit name of the second general-purpose source register, encoded in the "Rm" field.
<Xd>	Is the 64-bit name of the general-purpose destination register, encoded in the "Rd" field.
<Xn>	Is the 64-bit name of the first general-purpose source register, encoded in the "Rn" field.
<Xm>	Is the 64-bit name of the second general-purpose source register, encoded in the "Rm" field.

Operation

```
bits(datasize) result;
bits(datasize) operand1 = X[n];
bits(datasize) operand2 = X[m];
bits(4) nzcvc;

if sub_op then
    operand2 = NOT(operand2);

(result, nzcvc) = AddWithCarry(operand1, operand2, PSTATE.C);

if setflags then
```

PSTATE.<N,Z,C,V> = nzcvc;

X[d] = result;

C5.6.156 SBCS

Subtract with carry, setting the condition flags: $Rd = Rn - Rm - 1 + C$

This instruction is used by the alias *NGCS*. See the *Alias conditions* table for details of when each alias is preferred.

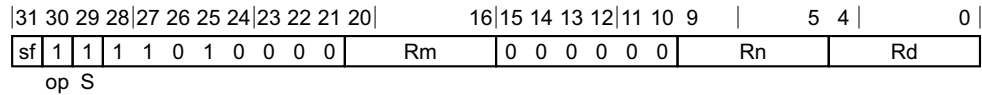

32-bit variant (sf = 0)

SBCS <Wd>, <Wn>, <Wm>

64-bit variant (sf = 1)

SBCS <Xd>, <Xn>, <Xm>

```
integer d = UInt(Rd);
integer n = UInt(Rn);
integer m = UInt(Rm);
integer datasize = if sf == '1' then 64 else 32;
boolean sub_op = (op == '1');
boolean setflags = (S == '1');
```

Alias conditions

Alias	is preferred when
<i>NGCS</i>	Rn == '11111'

Assembler Symbols

<Wd>	Is the 32-bit name of the general-purpose destination register, encoded in the "Rd" field.
<Wn>	Is the 32-bit name of the first general-purpose source register, encoded in the "Rn" field.
<Wm>	Is the 32-bit name of the second general-purpose source register, encoded in the "Rm" field.
<Xd>	Is the 64-bit name of the general-purpose destination register, encoded in the "Rd" field.
<Xn>	Is the 64-bit name of the first general-purpose source register, encoded in the "Rn" field.
<Xm>	Is the 64-bit name of the second general-purpose source register, encoded in the "Rm" field.

Operation

```
bits(datasize) result;
bits(datasize) operand1 = X[n];
bits(datasize) operand2 = X[m];
bits(4) nzcvc;

if sub_op then
    operand2 = NOT(operand2);

(result, nzcvc) = AddWithCarry(operand1, operand2, PSTATE.C);

if setflags then
```

```
PSTATE.<N,Z,C,V> = nzcvc;  
X[d] = result;
```

C5.6.157 SBFIZ

Signed bitfield insert in zero, with sign replication to left and zeros to right.

This instruction is an alias of the [SBFM](#) instruction.

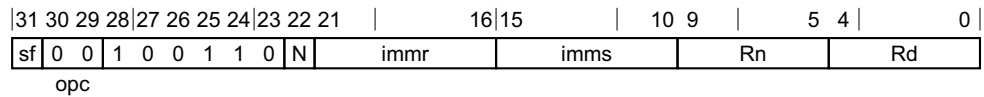

32-bit variant (sf = 0, N = 0)

SBFIZ <Wd>, <Wn>, #<lsb>, #<width>

is equivalent to

SBFM <Wd>, <Wn>, #(-<lsb> MOD 32), #(<width>-1)

and is the preferred disassembly when $\text{UInt}(\text{imms}) < \text{UInt}(\text{immr})$.

64-bit variant (sf = 1, N = 1)

SBFIZ <Xd>, <Xn>, #<lsb>, #<width>

is equivalent to

SBFM <Xd>, <Xn>, #(-<lsb> MOD 64), #(<width>-1)

and is the preferred disassembly when $\text{UInt}(\text{imms}) < \text{UInt}(\text{immr})$.

Assembler Symbols

<Wd>	Is the 32-bit name of the general-purpose destination register, encoded in the "Rd" field.
<Wn>	Is the 32-bit name of the general-purpose source register, encoded in the "Rn" field.
<Xd>	Is the 64-bit name of the general-purpose destination register, encoded in the "Rd" field.
<Xn>	Is the 64-bit name of the general-purpose source register, encoded in the "Rn" field.
<lsb>	For the 32-bit variant: is the bit number of the lsb of the source bitfield, in the range 0 to 31.
<lsb>	For the 64-bit variant: is the bit number of the lsb of the source bitfield, in the range 0 to 63.
<width>	For the 32-bit variant: is the width of the bitfield, in the range 1 to 32-<lsb>.
<width>	For the 64-bit variant: is the width of the bitfield, in the range 1 to 64-<lsb>.

C5.6.158 SBFM

Signed bitfield move, with sign replication to left and zeros to right.

This instruction is used by the aliases [ASR \(immediate\)](#), [SBFIZ](#), [SBFX](#), [SXTB](#), [SXTH](#), and [SXTW](#). See the [Alias conditions on page C5-657](#) table for details of when each alias is preferred.

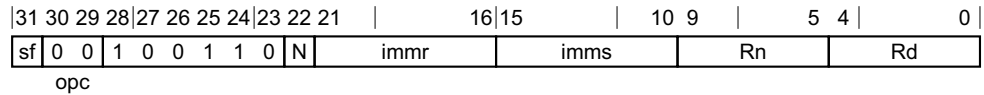

32-bit variant (sf = 0, N = 0)

SBFM <Wd>, <Wn>, #<immr>, #<imms>

64-bit variant (sf = 1, N = 1)

SBFM <Xd>, <Xn>, #<immr>, #<imms>

```

integer d = UInt(Rd);
integer n = UInt(Rn);
integer datasize = if sf == '1' then 64 else 32;

boolean inzero;
boolean extend;
integer R;
integer S;
bits(datasize) wmask;
bits(datasize) tmask;

case opc of
  when '00' inzero = TRUE; extend = TRUE; // SBFM
  when '01' inzero = FALSE; extend = FALSE; // BFM
  when '10' inzero = TRUE; extend = FALSE; // UBFM
  when '11' UnallocatedEncoding();

if sf == '1' && N != '1' then ReservedValue();
if sf == '0' && (N != '0' || immr<5> != '0' || imms<5> != '0') then ReservedValue();

R = UInt(immr);
S = UInt(imms);
(wmask, tmask) = DecodeBitMasks(N, imms, immr, FALSE);

```

Alias conditions

Alias	of variant	is preferred when
ASR (immediate)	32-bit	<code>imms == '011111'</code>
ASR (immediate)	64-bit	<code>imms == '111111'</code>
SBFIZ	-	<code>UInt(imms) < UInt(immr)</code>
SBFX	-	<code>BFXPreferred(sf, opc<1>, imms, immr)</code>
SXTB	-	<code>immr == '000000' && imms == '000111'</code>
SXTH	-	<code>immr == '000000' && imms == '001111'</code>
SXTW	-	<code>immr == '000000' && imms == '011111'</code>

Assembler Symbols

<wd>	Is the 32-bit name of the general-purpose destination register, encoded in the "Rd" field.
<wn>	Is the 32-bit name of the general-purpose source register, encoded in the "Rn" field.
<Xd>	Is the 64-bit name of the general-purpose destination register, encoded in the "Rd" field.
<Xn>	Is the 64-bit name of the general-purpose source register, encoded in the "Rn" field.
<immr>	For the 32-bit variant: is the right rotate amount, in the range 0 to 31, encoded in the "immr" field.
<immr>	For the 64-bit variant: is the right rotate amount, in the range 0 to 63, encoded in the "immr" field.
<imms>	For the 32-bit variant: is the leftmost bit number to be moved from the source, in the range 0 to 31, encoded in the "imms" field.
<imms>	For the 64-bit variant: is the leftmost bit number to be moved from the source, in the range 0 to 63, encoded in the "imms" field.

Operation

```

bits(datasize) dst = if inzero then Zeros() else X[d];
bits(datasize) src = X[n];

// perform bitfield move on low bits
bits(datasize) bot = (dst AND NOT(wmask)) OR (ROR(src, R) AND wmask);

// determine extension bits (sign, zero or dest register)
bits(datasize) top = if extend then Replicate(src<S>) else dst;

// combine extension bits and result bits
X[d] = (top AND NOT(tmask)) OR (bot AND tmask);

```

C5.6.159 SBFX

Signed bitfield extract

This instruction is an alias of the [SBFM](#) instruction.

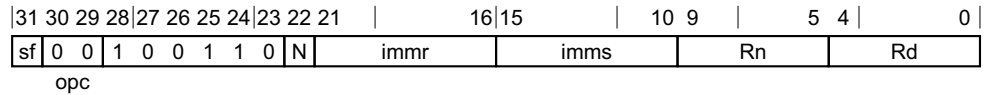

32-bit variant (sf = 0, N = 0)

SBFX <Wd>, <Wn>, #<lsb>, #<width>

is equivalent to

SBFM <Wd>, <Wn>, #<lsb>, #(<lsb>+<width>-1)

and is the preferred disassembly when `BFXPreferred(sf, opc<1>, imms, immr)`.

64-bit variant (sf = 1, N = 1)

SBFX <Xd>, <Xn>, #<lsb>, #<width>

is equivalent to

SBFM <Xd>, <Xn>, #<lsb>, #(<lsb>+<width>-1)

and is the preferred disassembly when `BFXPreferred(sf, opc<1>, imms, immr)`.

Assembler Symbols

- <Wd> Is the 32-bit name of the general-purpose destination register, encoded in the "Rd" field.
- <Wn> Is the 32-bit name of the general-purpose source register, encoded in the "Rn" field.
- <Xd> Is the 64-bit name of the general-purpose destination register, encoded in the "Rd" field.
- <Xn> Is the 64-bit name of the general-purpose source register, encoded in the "Rn" field.
- <lsb> For the 32-bit variant: is the bit number of the lsb of the source bitfield, in the range 0 to 31.
- <lsb> For the 64-bit variant: is the bit number of the lsb of the source bitfield, in the range 0 to 63.
- <width> For the 32-bit variant: is the width of the bitfield, in the range 1 to 32-<lsb>.
- <width> For the 64-bit variant: is the width of the bitfield, in the range 1 to 64-<lsb>.

C5.6.160 SDIV

Signed divide: $Rd = Rn / Rm$

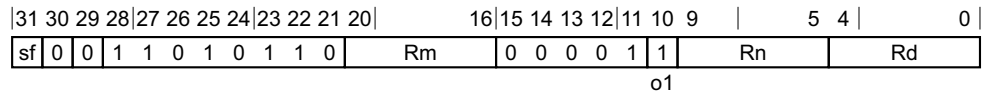

32-bit variant (sf = 0)

SDIV <Wd>, <Wn>, <Wm>

64-bit variant (sf = 1)

SDIV <Xd>, <Xn>, <Xm>

```
integer d = UInt(Rd);
integer n = UInt(Rn);
integer m = UInt(Rm);
integer datasize = if sf == '1' then 64 else 32;
boolean unsigned = (o1 == '0');
```

Assembler Symbols

- <Wd> Is the 32-bit name of the general-purpose destination register, encoded in the "Rd" field.
- <Wn> Is the 32-bit name of the first general-purpose source register, encoded in the "Rn" field.
- <Wm> Is the 32-bit name of the second general-purpose source register, encoded in the "Rm" field.
- <Xd> Is the 64-bit name of the general-purpose destination register, encoded in the "Rd" field.
- <Xn> Is the 64-bit name of the first general-purpose source register, encoded in the "Rn" field.
- <Xm> Is the 64-bit name of the second general-purpose source register, encoded in the "Rm" field.

Operation

```
bits(datasize) operand1 = X[n];
bits(datasize) operand2 = X[m];
integer result;

if IsZero(operand2) then
  result = 0;
else
  result = RoundTowardsZero (Int(operand1, unsigned) / Int(operand2, unsigned));

X[d] = result<datasize-1:0>;
```

C5.6.161 SEV

Send event

This instruction is an alias of the [HINT](#) instruction.

31	30	29	28	27	26	25	24	23	22	21	20	19	18	17	16	15	14	13	12	11	8	7	5	4	3	2	1	0
1	1	0	1	0	1	0	1	0	0	0	0	0	0	1	1	0	0	1	0		CRm		op2	1	1	1	1	1

System variant

SEV

is equivalent to

HINT #4

and is the preferred disassembly when $UInt(CRm:op2) == 4$.

C5.6.162 SEVL

Send event locally

This instruction is an alias of the [HINT](#) instruction.

31	30	29	28	27	26	25	24	23	22	21	20	19	18	17	16	15	14	13	12	11	8	7	5	4	3	2	1	0
1	1	0	1	0	1	0	1	0	0	0	0	0	0	1	1	0	0	1	0	CRm	op2	1	1	1	1	1	1	1

System variant

SEVL

is equivalent to

HINT #5

and is the preferred disassembly when $UInt(CRm:op2) == 5$.

C5.6.163 SMADDL

Signed multiply-add long: $X_d = X_a + W_n * W_m$

This instruction is used by the alias [SMULL](#). See the *Alias conditions* table for details of when each alias is preferred.

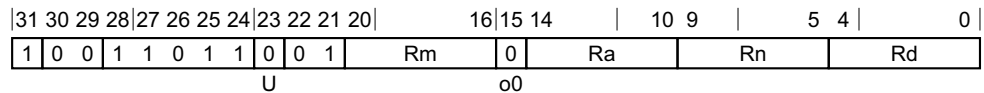

64-bit variant

SMADDL <Xd>, <Wn>, <Wm>, <Xa>

```
integer d = UInt(Rd);
integer n = UInt(Rn);
integer m = UInt(Rm);
integer a = UInt(Ra);
integer destsize = 64;
integer datasize = 32;
boolean sub_op = (o0 == '1');
boolean unsigned = (U == '1');
```

Alias conditions

Alias	is preferred when
SMULL	Ra == '11111'

Assembler Symbols

- <Xd> Is the 64-bit name of the general-purpose destination register, encoded in the "Rd" field.
- <Wn> Is the 32-bit name of the first general-purpose source register holding the multiplicand, encoded in the "Rn" field.
- <Wm> Is the 32-bit name of the second general-purpose source register holding the multiplier, encoded in the "Rm" field.
- <Xa> Is the 64-bit name of the third general-purpose source register holding the addend, encoded in the "Ra" field.

Operation

```
bits(datasize) operand1 = X[n];
bits(datasize) operand2 = X[m];
bits(destsize) operand3 = X[a];

integer result;

if sub_op then
  result = Int(operand3, unsigned) - (Int(operand1, unsigned) * Int(operand2, unsigned));
else
  result = Int(operand3, unsigned) + (Int(operand1, unsigned) * Int(operand2, unsigned));

X[d] = result<63:0>;
```

C5.6.164 SMC

Generate exception targeting exception level 3

31	30	29	28	27	26	25	24	23	22	21	20							5	4	3	2	1	0
1	1	0	1	0	1	0	0	0	0	0		imm16					0	0	0	1	1		

System variant

SMC #<imm>

bits(16) imm = imm16;

Assembler Symbols

<imm> Is a 16-bit unsigned immediate, in the range 0 to 65535, encoded in the "imm16" field.

Operation

```

if !HaveEL(EL3) || PSTATE.EL == EL0 then
    UnallocatedEncoding();

route_to_e12 = HaveEL(EL2) && !IsSecure() && HCR_EL2.TSC == '1';

if route_to_e12 then
    AArch64.SMCTrap();
elseif SCR_EL3.SMD == '1' then
    // SMC disabled
    if IsSecure() then
        // Executes either as a NOP or UNALLOCATED.
        c = ConstrainUnpredictable();
        assert c IN {Constraint_NOP, Constraint_UNDEF};
        if c == Constraint_NOP then EndOfInstruction();
        UnallocatedEncoding();
    else
        AArch64.CallSecureMonitor(imm);

```

C5.6.165 SMNEGL

Signed multiply-negate long: $Xd = -(Wn * Wm)$

This instruction is an alias of the [SMSUBL](#) instruction.

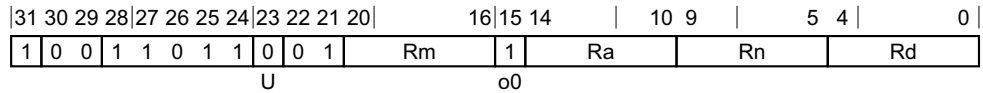

64-bit variant

SMNEGL <Xd>, <Wn>, <Wm>

is equivalent to

SMSUBL <Xd>, <Wn>, <Wm>, XZR

and is the preferred disassembly when Ra == '11111'.

Assembler Symbols

- <Xd> Is the 64-bit name of the general-purpose destination register, encoded in the "Rd" field.
- <Wn> Is the 32-bit name of the first general-purpose source register holding the multiplicand, encoded in the "Rn" field.
- <Wm> Is the 32-bit name of the second general-purpose source register holding the multiplier, encoded in the "Rm" field.

C5.6.166 SMSUBL

Signed multiply-subtract long: $Xd = Xa - Wn * Wm$

This instruction is used by the alias [SMNEGL](#). See the [Alias conditions](#) table for details of when each alias is preferred.

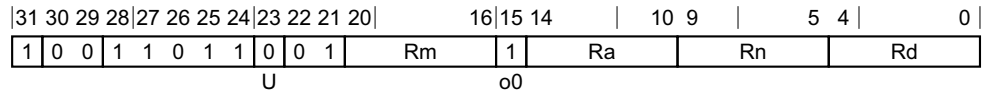

64-bit variant

SMSUBL <Xd>, <Wn>, <Wm>, <Xa>

```
integer d = UInt(Rd);
integer n = UInt(Rn);
integer m = UInt(Rm);
integer a = UInt(Ra);
integer destsize = 64;
integer datasize = 32;
boolean sub_op = (o0 == '1');
boolean unsigned = (U == '1');
```

Alias conditions

Alias	is preferred when
SMNEGL	Ra == '11111'

Assembler Symbols

- <Xd> Is the 64-bit name of the general-purpose destination register, encoded in the "Rd" field.
- <Wn> Is the 32-bit name of the first general-purpose source register holding the multiplicand, encoded in the "Rn" field.
- <Wm> Is the 32-bit name of the second general-purpose source register holding the multiplier, encoded in the "Rm" field.
- <Xa> Is the 64-bit name of the third general-purpose source register holding the minuend, encoded in the "Ra" field.

Operation

```
bits(datasize) operand1 = X[n];
bits(datasize) operand2 = X[m];
bits(destsize) operand3 = X[a];

integer result;

if sub_op then
    result = Int(operand3, unsigned) - (Int(operand1, unsigned) * Int(operand2, unsigned));
else
    result = Int(operand3, unsigned) + (Int(operand1, unsigned) * Int(operand2, unsigned));

X[d] = result<63:0>;
```

C5.6.167 SMULH

Signed multiply high: $Xd = \text{bits}\langle 127:64 \rangle$ of $Xn * Xm$

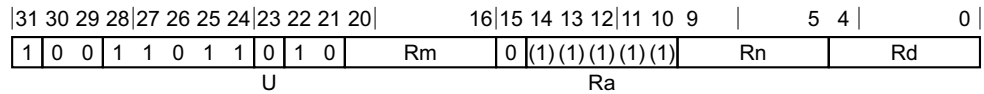

64-bit variant

SMULH <Xd>, <Xn>, <Xm>

```
integer d = UInt(Rd);
integer n = UInt(Rn);
integer m = UInt(Rm);
integer a = UInt(Ra);           // ignored by UMULH/SMULH
integer destsize = 64;
integer datasize = destsize;
boolean unsigned = (U == '1');
```

Assembler Symbols

- <Xd> Is the 64-bit name of the general-purpose destination register, encoded in the "Rd" field.
- <Xn> Is the 64-bit name of the first general-purpose source register holding the multiplicand, encoded in the "Rn" field.
- <Xm> Is the 64-bit name of the second general-purpose source register holding the multiplier, encoded in the "Rm" field.

Operation

```
bits(datasize) operand1 = X[n];
bits(datasize) operand2 = X[m];

integer result;

result = Int(operand1, unsigned) * Int(operand2, unsigned);

X[d] = result<127:64>;
```

C5.6.168 SMULL

Signed multiply long: $Xd = Wn * Wm$

This instruction is an alias of the [SMADDL](#) instruction.

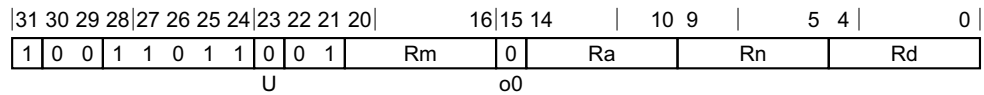

64-bit variant

SMULL <Xd>, <Wn>, <Wm>

is equivalent to

SMADDL <Xd>, <Wn>, <Wm>, XZR

and is the preferred disassembly when Ra == '11111'.

Assembler Symbols

- <Xd> Is the 64-bit name of the general-purpose destination register, encoded in the "Rd" field.
- <Wn> Is the 32-bit name of the first general-purpose source register holding the multiplicand, encoded in the "Rn" field.
- <Wm> Is the 32-bit name of the second general-purpose source register holding the multiplier, encoded in the "Rm" field.

C5.6.169 STLR

Store-release register

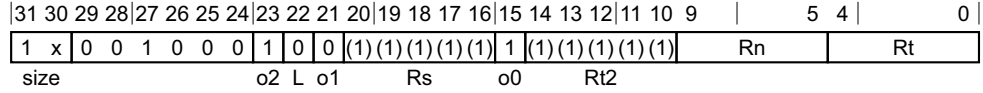

32-bit variant (size = 10)

STLR <Wt>, [<Xn|SP>{,#0}]

64-bit variant (size = 11)

STLR <Xt>, [<Xn|SP>{,#0}]

```
integer n = UInt(Rn);
integer t = UInt(Rt);
integer t2 = UInt(Rt2); // ignored by load/store single register
integer s = UInt(Rs); // ignored by all loads and store-release

if o2:o1:o0 == '100' || o2:o1:o0 == '11x' then UnallocatedEncoding();
if o1 == '1' && size<L> == '0' then UnallocatedEncoding();

AccType acctype = if o0 == '1' then AccType_ORDERED else AccType_ATOMIC;
boolean excl = (o2 == '0');
boolean pair = (o1 == '1');
MemOp memop = if L == '1' then MemOp_LOAD else MemOp_STORE;
integer elsize = 8 << UInt(size);
integer regsize = if elsize == 64 then 64 else 32;
integer datasize = if pair then elsize * 2 else elsize;
```

Assembler Symbols

- <Wt> Is the 32-bit name of the general-purpose register to be transferred, encoded in the "Rt" field.
- <Xt> Is the 64-bit name of the general-purpose register to be transferred, encoded in the "Rt" field.
- <Xn|SP> Is the 64-bit name of the general-purpose base register or stack pointer, encoded in the "Rn" field.

Operation

```
bits(64) address;
bits(datasize) data;
constant integer dbytes = datasize DIV 8;
boolean rt_unknown = FALSE;
boolean rn_unknown = FALSE;

if memop == MemOp_LOAD && pair && t == t2 then
    Constraint c = ConstrainUnpredictable();
    assert c IN {Constraint_UNKNOWN, Constraint_UNDEF, Constraint_NOP};
    case c of
        when Constraint_UNKNOWN    rt_unknown = TRUE; // result is UNKNOWN
        when Constraint_UNDEF      UnallocatedEncoding();
        when Constraint_NOP        EndOfInstruction();

if memop == MemOp_STORE && excl then
    if s == t || (pair && s == t2) then
        Constraint c = ConstrainUnpredictable();
        assert c IN {Constraint_UNKNOWN, Constraint_NONE, Constraint_UNDEF, Constraint_NOP};
        case c of
            when Constraint_UNKNOWN    rt_unknown = TRUE; // store UNKNOWN value
            when Constraint_NONE      rt_unknown = FALSE; // store original value
```

```

        when Constraint_UNDEF      UnallocatedEncoding();
        when Constraint_NOP        EndOfInstruction();
    if s == n && n != 31 then
        Constraint c = ConstrainUnpredictable();
        assert c IN {Constraint_UNKNOWN, Constraint_NONE, Constraint_UNDEF, Constraint_NOP};
        case c of
            when Constraint_UNKNOWN  rn_unknown = TRUE;    // address is UNKNOWN
            when Constraint_NONE      rn_unknown = FALSE;   // address is original base
            when Constraint_UNDEF     UnallocatedEncoding();
            when Constraint_NOP       EndOfInstruction();

    if n == 31 then
        CheckSPAlignment();
        address = SP[];
    elsif rn_unknown then
        address = bits(64) UNKNOWN;
    else
        address = X[n];

    case memop of
        when MemOp_STORE
            if rt_unknown then
                data = bits(datasize) UNKNOWN;
            elsif pair then
                assert excl;
                bits(datasize DIV 2) e11 = X[t];
                bits(datasize DIV 2) e12 = X[t2];
                data = if BigEndian() then e11 : e12 else e12 : e11;
            else
                data = X[t];

            if excl then
                // store {release} exclusive register|pair (atomic)
                bit status = '1';
                // Check whether the Exclusive Monitors are set to include the
                // physical memory locations corresponding to virtual address
                // range [address, address+dbytes-1].
                if AArch64.ExclusiveMonitorsPass(address, dbytes) then
                    // This atomic write will be rejected if it does not refer
                    // to the same physical locations after address translation.
                    Mem[address, dbytes, acctype] = data;
                    status = ExclusiveMonitorsStatus();
                    X[s] = ZeroExtend(status, 32);
                else
                    // store release register (atomic)
                    Mem[address, dbytes, acctype] = data;

        when MemOp_LOAD
            if excl then
                // Tell the Exclusive Monitors to record a sequence of one or more atomic
                // memory reads from virtual address range [address, address+dbytes-1].
                // The Exclusive Monitor will only be set if all the reads are from the
                // same dbytes-aligned physical address, to allow for the possibility of
                // an atomicity break if the translation is changed between reads.
                AArch64.SetExclusiveMonitors(address, dbytes);

            if pair then
                // load exclusive pair
                assert excl;
                if rt_unknown then
                    // ConstrainedUNPREDICTABLE case
                    X[t] = bits(datasize) UNKNOWN;
                elsif elsize == 32 then
                    // 32-bit load exclusive pair (atomic)
                    data = Mem[address, dbytes, acctype];
                    if BigEndian() then
                        X[t] = data<datasize-1:elsize>;
                        X[t2] = data<elsize-1:0>;

```

```
        else
            X[t] = data<elsize-1:0>;
            X[t2] = data<datasize-1:elsize>;
    else // elsize == 64
        // 64-bit load exclusive pair (not atomic),
        // but must be 128-bit aligned
        if address != Align(address, dbytes) then
            iswrite = FALSE;
            secondstage = FALSE;
            AArch64.Abort(address, AArch64.AlignmentFault(acctype, iswrite, secondstage));
        X[t] = Mem[address + 0, 8, acctype];
        X[t2] = Mem[address + 8, 8, acctype];
    else
        // load {acquire} {exclusive} single register
        data = Mem[address, dbytes, acctype];
        X[t] = ZeroExtend(data, regsize);
```

C5.6.170 STLRB

Store-release register byte

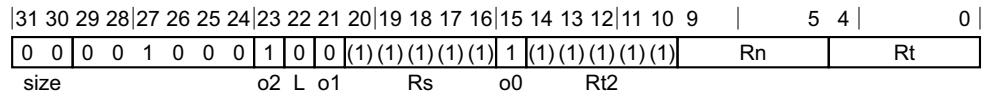

No offset variant

STLRB <Wt>, [<Xn|SP>{, #0}]

```
integer n = UInt(Rn);
integer t = UInt(Rt);
integer t2 = UInt(Rt2); // ignored by load/store single register
integer s = UInt(Rs); // ignored by all loads and store-release
```

```
if o2:o1:o0 == '100' || o2:o1:o0 == '11x' then UnallocatedEncoding();
if o1 == '1' && size<1> == '0' then UnallocatedEncoding();
```

```
AccType acctype = if o0 == '1' then AccType_ORDERED else AccType_ATOMIC;
boolean excl = (o2 == '0');
boolean pair = (o1 == '1');
MemOp memop = if L == '1' then MemOp_LOAD else MemOp_STORE;
integer elsize = 8 << UInt(size);
integer regsize = if elsize == 64 then 64 else 32;
integer datasize = if pair then elsize * 2 else elsize;
```

Assembler Symbols

<Wt> Is the 32-bit name of the general-purpose register to be transferred, encoded in the "Rt" field.

<Xn|SP> Is the 64-bit name of the general-purpose base register or stack pointer, encoded in the "Rn" field.

Operation

```
bits(64) address;
bits(datasize) data;
constant integer dbytes = datasize DIV 8;
boolean rt_unknown = FALSE;
boolean rn_unknown = FALSE;

if memop == MemOp_LOAD && pair && t == t2 then
    Constraint c = ConstrainUnpredictable();
    assert c IN {Constraint_UNKNOWN, Constraint_UNDEF, Constraint_NOP};
    case c of
        when Constraint_UNKNOWN    rt_unknown = TRUE; // result is UNKNOWN
        when Constraint_UNDEF      UnallocatedEncoding();
        when Constraint_NOP        EndOfInstruction();

if memop == MemOp_STORE && excl then
    if s == t || (pair && s == t2) then
        Constraint c = ConstrainUnpredictable();
        assert c IN {Constraint_UNKNOWN, Constraint_NONE, Constraint_UNDEF, Constraint_NOP};
        case c of
            when Constraint_UNKNOWN    rt_unknown = TRUE; // store UNKNOWN value
            when Constraint_NONE       rt_unknown = FALSE; // store original value
            when Constraint_UNDEF      UnallocatedEncoding();
            when Constraint_NOP        EndOfInstruction();
    if s == n && n != 31 then
        Constraint c = ConstrainUnpredictable();
        assert c IN {Constraint_UNKNOWN, Constraint_NONE, Constraint_UNDEF, Constraint_NOP};
```

```

        case c of
            when Constraint_UNKNOWN    rn_unknown = TRUE;    // address is UNKNOWN
            when Constraint_NONE        rn_unknown = FALSE;    // address is original base
            when Constraint_UNDEF      UnallocatedEncoding();
            when Constraint_NOP        EndOfInstruction();

if n == 31 then
    CheckSPAlignment();
    address = SP[];
elseif rn_unknown then
    address = bits(64) UNKNOWN;
else
    address = X[n];

case memop of
    when MemOp_STORE
        if rt_unknown then
            data = bits(datasize) UNKNOWN;
        elseif pair then
            assert excl;
            bits(datasize DIV 2) e11 = X[t];
            bits(datasize DIV 2) e12 = X[t2];
            data = if BigEndian() then e11 : e12 else e12 : e11;
        else
            data = X[t];

        if excl then
            // store {release} exclusive register|pair (atomic)
            bit status = '1';
            // Check whether the Exclusive Monitors are set to include the
            // physical memory locations corresponding to virtual address
            // range [address, address+dbytes-1].
            if AArch64.ExclusiveMonitorsPass(address, dbytes) then
                // This atomic write will be rejected if it does not refer
                // to the same physical locations after address translation.
                Mem[address, dbytes, acctype] = data;
                status = ExclusiveMonitorsStatus();
                X[s] = ZeroExtend(status, 32);
            else
                // store release register (atomic)
                Mem[address, dbytes, acctype] = data;

    when MemOp_LOAD
        if excl then
            // Tell the Exclusive Monitors to record a sequence of one or more atomic
            // memory reads from virtual address range [address, address+dbytes-1].
            // The Exclusive Monitor will only be set if all the reads are from the
            // same dbytes-aligned physical address, to allow for the possibility of
            // an atomicity break if the translation is changed between reads.
            AArch64.SetExclusiveMonitors(address, dbytes);

        if pair then
            // load exclusive pair
            assert excl;
            if rt_unknown then
                // ConstrainedUNPREDICTABLE case
                X[t] = bits(datasize) UNKNOWN;
            elseif elsize == 32 then
                // 32-bit load exclusive pair (atomic)
                data = Mem[address, dbytes, acctype];
                if BigEndian() then
                    X[t] = data<datasize-1:elsize>;
                    X[t2] = data<elsize-1:0>;
                else
                    X[t] = data<elsize-1:0>;
                    X[t2] = data<datasize-1:elsize>;
            else // elsize == 64
                // 64-bit load exclusive pair (not atomic),

```

```
// but must be 128-bit aligned
if address != Align(address, dbytes) then
    iswrite = FALSE;
    secondstage = FALSE;
    AArch64.Abort(address, AArch64.AlignmentFault(acctype, iswrite, secondstage));
X[t] = Mem[address + 0, 8, acctype];
X[t2] = Mem[address + 8, 8, acctype];
else
    // load {acquire} {exclusive} single register
    data = Mem[address, dbytes, acctype];
    X[t] = ZeroExtend(data, regsize);
```

C5.6.171 STLRH

Store-release register halfword

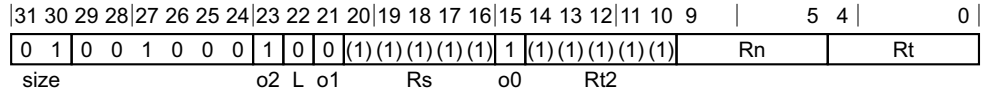

No offset variant

STLRH <Wt>, [<Xn|SP>{, #0}]

```
integer n = UInt(Rn);
integer t = UInt(Rt);
integer t2 = UInt(Rt2); // ignored by load/store single register
integer s = UInt(Rs); // ignored by all loads and store-release
```

```
if o2:o1:o0 == '100' || o2:o1:o0 == '11x' then UnallocatedEncoding();
if o1 == '1' && size<1> == '0' then UnallocatedEncoding();
```

```
AccType acctype = if o0 == '1' then AccType_ORDERED else AccType_ATOMIC;
boolean excl = (o2 == '0');
boolean pair = (o1 == '1');
MemOp memop = if L == '1' then MemOp_LOAD else MemOp_STORE;
integer elsize = 8 << UInt(size);
integer regsize = if elsize == 64 then 64 else 32;
integer datasize = if pair then elsize * 2 else elsize;
```

Assembler Symbols

- <Wt> Is the 32-bit name of the general-purpose register to be transferred, encoded in the "Rt" field.
- <Xn|SP> Is the 64-bit name of the general-purpose base register or stack pointer, encoded in the "Rn" field.

Operation

```
bits(64) address;
bits(datasize) data;
constant integer dbytes = datasize DIV 8;
boolean rt_unknown = FALSE;
boolean rn_unknown = FALSE;

if memop == MemOp_LOAD && pair && t == t2 then
    Constraint c = ConstrainUnpredictable();
    assert c IN {Constraint_UNKNOWN, Constraint_UNDEF, Constraint_NOP};
    case c of
        when Constraint_UNKNOWN    rt_unknown = TRUE; // result is UNKNOWN
        when Constraint_UNDEF      UnallocatedEncoding();
        when Constraint_NOP        EndOfInstruction();

if memop == MemOp_STORE && excl then
    if s == t || (pair && s == t2) then
        Constraint c = ConstrainUnpredictable();
        assert c IN {Constraint_UNKNOWN, Constraint_NONE, Constraint_UNDEF, Constraint_NOP};
        case c of
            when Constraint_UNKNOWN    rt_unknown = TRUE; // store UNKNOWN value
            when Constraint_NONE        rt_unknown = FALSE; // store original value
            when Constraint_UNDEF      UnallocatedEncoding();
            when Constraint_NOP        EndOfInstruction();
    if s == n && n != 31 then
        Constraint c = ConstrainUnpredictable();
        assert c IN {Constraint_UNKNOWN, Constraint_NONE, Constraint_UNDEF, Constraint_NOP};
```



```

    case c of
        when Constraint_UNKNOWN    rn_unknown = TRUE;    // address is UNKNOWN
        when Constraint_NONE       rn_unknown = FALSE;   // address is original base
        when Constraint_UNDEF     UnallocatedEncoding();
        when Constraint_NOP       EndOfInstruction();

    if n == 31 then
        CheckSPAlignment();
        address = SP[];
    elsif rn_unknown then
        address = bits(64) UNKNOWN;
    else
        address = X[n];

    case memop of
        when MemOp_STORE
            if rt_unknown then
                data = bits(datasize) UNKNOWN;
            elsif pair then
                assert excl;
                bits(datasize DIV 2) e11 = X[t];
                bits(datasize DIV 2) e12 = X[t2];
                data = if BigEndian() then e11 : e12 else e12 : e11;
            else
                data = X[t];

            if excl then
                // store {release} exclusive register|pair (atomic)
                bit status = '1';
                // Check whether the Exclusive Monitors are set to include the
                // physical memory locations corresponding to virtual address
                // range [address, address+dbytes-1].
                if AArch64.ExclusiveMonitorsPass(address, dbytes) then
                    // This atomic write will be rejected if it does not refer
                    // to the same physical locations after address translation.
                    Mem[address, dbytes, acctype] = data;
                    status = ExclusiveMonitorsStatus();
                    X[s] = ZeroExtend(status, 32);
                else
                    // store release register (atomic)
                    Mem[address, dbytes, acctype] = data;

        when MemOp_LOAD
            if excl then
                // Tell the Exclusive Monitors to record a sequence of one or more atomic
                // memory reads from virtual address range [address, address+dbytes-1].
                // The Exclusive Monitor will only be set if all the reads are from the
                // same dbytes-aligned physical address, to allow for the possibility of
                // an atomicity break if the translation is changed between reads.
                AArch64.SetExclusiveMonitors(address, dbytes);

            if pair then
                // load exclusive pair
                assert excl;
                if rt_unknown then
                    // ConstrainedUNPREDICTABLE case
                    X[t] = bits(datasize) UNKNOWN;
                elsif elsize == 32 then
                    // 32-bit load exclusive pair (atomic)
                    data = Mem[address, dbytes, acctype];
                    if BigEndian() then
                        X[t] = data<datasize-1:elsize>;
                        X[t2] = data<elsize-1:0>;
                    else
                        X[t] = data<elsize-1:0>;
                        X[t2] = data<datasize-1:elsize>;
                else // elsize == 64
                    // 64-bit load exclusive pair (not atomic),

```

```
// but must be 128-bit aligned
if address != Align(address, dbytes) then
    iswrite = FALSE;
    secondstage = FALSE;
    AArch64.Abort(address, AArch64.AlignmentFault(acctype, iswrite, secondstage));
X[t] = Mem[address + 0, 8, acctype];
X[t2] = Mem[address + 8, 8, acctype];
else
    // load {acquire} {exclusive} single register
    data = Mem[address, dbytes, acctype];
    X[t] = ZeroExtend(data, regsize);
```

C5.6.172 STLXP

Store-release exclusive pair of registers, returning status

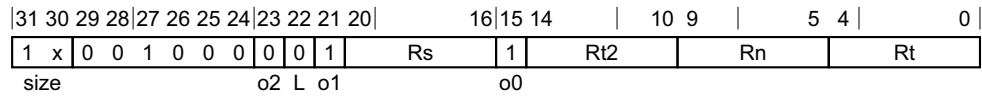

32-bit variant (size = 10)

STLXP <Ws>, <Xt1>, <Xt2>, [<Xn|SP>{,#0}]

64-bit variant (size = 11)

STLXP <Ws>, <Xt1>, <Xt2>, [<Xn|SP>{,#0}]

```

integer n = UInt(Rn);
integer t = UInt(Rt);
integer t2 = UInt(Rt2); // ignored by load/store single register
integer s = UInt(Rs); // ignored by all loads and store-release

if o2:o1:o0 == '100' || o2:o1:o0 == '11x' then UnallocatedEncoding();
if o1 == '1' && size<L> == '0' then UnallocatedEncoding();

AccType acctype = if o0 == '1' then AccType_ORDERED else AccType_ATOMIC;
boolean excl = (o2 == '0');
boolean pair = (o1 == '1');
MemOp memop = if L == '1' then MemOp_LOAD else MemOp_STORE;
integer elsize = 8 << UInt(size);
integer regsize = if elsize == 64 then 64 else 32;
integer datasize = if pair then elsize * 2 else elsize;

```

Assembler Symbols

<Ws>	Is the 32-bit name of the general-purpose register into which the status result of the store exclusive is written, encoded in the "Rs" field.
<Xt1>	Is the 64-bit name of the first general-purpose register to be transferred, encoded in the "Rt" field.
<Xt2>	Is the 64-bit name of the second general-purpose register to be transferred, encoded in the "Rt2" field.
<Wt1>	Is the 32-bit name of the first general-purpose register to be transferred, encoded in the "Rt" field.
<Wt2>	Is the 32-bit name of the second general-purpose register to be transferred, encoded in the "Rt2" field.
<Xn SP>	Is the 64-bit name of the general-purpose base register or stack pointer, encoded in the "Rn" field.

Operation

```

bits(64) address;
bits(datasize) data;
constant integer dbytes = datasize DIV 8;
boolean rt_unknown = FALSE;
boolean rn_unknown = FALSE;

if memop == MemOp_LOAD && pair && t == t2 then
    Constraint c = ConstrainUnpredictable();
    assert c IN {Constraint_UNKNOWN, Constraint_UNDEF, Constraint_NOP};
    case c of
        when Constraint_UNKNOWN    rt_unknown = TRUE; // result is UNKNOWN

```

```

        when Constraint_UNDEF    UnallocatedEncoding();
        when Constraint_NOP      EndOfInstruction();

if memop == MemOp_STORE && excl then
    if s == t || (pair && s == t2) then
        Constraint c = ConstrainUnpredictable();
        assert c IN {Constraint_UNKNOWN, Constraint_NONE, Constraint_UNDEF, Constraint_NOP};
        case c of
            when Constraint_UNKNOWN    rt_unknown = TRUE;    // store UNKNOWN value
            when Constraint_NONE        rt_unknown = FALSE;   // store original value
            when Constraint_UNDEF       UnallocatedEncoding();
            when Constraint_NOP         EndOfInstruction();
        if s == n && n != 31 then
            Constraint c = ConstrainUnpredictable();
            assert c IN {Constraint_UNKNOWN, Constraint_NONE, Constraint_UNDEF, Constraint_NOP};
            case c of
                when Constraint_UNKNOWN    rn_unknown = TRUE;    // address is UNKNOWN
                when Constraint_NONE        rn_unknown = FALSE;   // address is original base
                when Constraint_UNDEF       UnallocatedEncoding();
                when Constraint_NOP         EndOfInstruction();

if n == 31 then
    CheckSPAlignment();
    address = SP[];
elseif rn_unknown then
    address = bits(64) UNKNOWN;
else
    address = X[n];

case memop of
    when MemOp_STORE
        if rt_unknown then
            data = bits(datasize) UNKNOWN;
        elseif pair then
            assert excl;
            bits(datasize DIV 2) e11 = X[t];
            bits(datasize DIV 2) e12 = X[t2];
            data = if BigEndian() then e11 : e12 else e12 : e11;
        else
            data = X[t];

        if excl then
            // store {release} exclusive register|pair (atomic)
            bit status = '1';
            // Check whether the Exclusive Monitors are set to include the
            // physical memory locations corresponding to virtual address
            // range [address, address+dbytes-1].
            if AArch64.ExclusiveMonitorsPass(address, dbytes) then
                // This atomic write will be rejected if it does not refer
                // to the same physical locations after address translation.
                Mem[address, dbytes, acctype] = data;
                status = ExclusiveMonitorsStatus();
                X[s] = ZeroExtend(status, 32);
            else
                // store release register (atomic)
                Mem[address, dbytes, acctype] = data;

    when MemOp_LOAD
        if excl then
            // Tell the Exclusive Monitors to record a sequence of one or more atomic
            // memory reads from virtual address range [address, address+dbytes-1].
            // The Exclusive Monitor will only be set if all the reads are from the
            // same dbytes-aligned physical address, to allow for the possibility of
            // an atomicity break if the translation is changed between reads.
            AArch64.SetExclusiveMonitors(address, dbytes);

        if pair then
            // load exclusive pair

```

```

assert excl;
if rt_unknown then
    // ConstrainedUNPREDICTABLE case
    X[t] = bits(datasize) UNKNOWN;
elseif elsize == 32 then
    // 32-bit load exclusive pair (atomic)
    data = Mem[address, dbytes, acctype];
    if BigEndian() then
        X[t] = data<datasize-1:elsize>;
        X[t2] = data<elsize-1:0>;
    else
        X[t] = data<elsize-1:0>;
        X[t2] = data<datasize-1:elsize>;
else // elsize == 64
    // 64-bit load exclusive pair (not atomic),
    // but must be 128-bit aligned
    if address != Align(address, dbytes) then
        iswrite = FALSE;
        secondstage = FALSE;
        AArch64.Abort(address, AArch64.AlignmentFault(acctype, iswrite, secondstage));
    X[t] = Mem[address + 0, 8, acctype];
    X[t2] = Mem[address + 8, 8, acctype];
else
    // load {acquire} {exclusive} single register
    data = Mem[address, dbytes, acctype];
    X[t] = ZeroExtend(data, regsize);

```

C5.6.173 STLXR

Store-release exclusive register, returning status

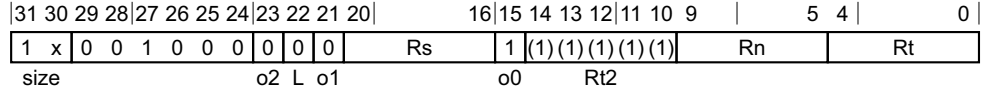

32-bit variant (size = 10)

STLXR <Ws>, <Wt>, [<Xn|SP>{,#0}]

64-bit variant (size = 11)

STLXR <Ws>, <Xt>, [<Xn|SP>{,#0}]

```
integer n = UInt(Rn);
integer t = UInt(Rt);
integer t2 = UInt(Rt2); // ignored by load/store single register
integer s = UInt(Rs); // ignored by all loads and store-release
```

```
if o2:o1:o0 == '100' || o2:o1:o0 == '11x' then UnallocatedEncoding();
if o1 == '1' && size<L> == '0' then UnallocatedEncoding();
```

```
AccType acctype = if o0 == '1' then AccType_ORDERED else AccType_ATOMIC;
boolean excl = (o2 == '0');
boolean pair = (o1 == '1');
MemOp memop = if L == '1' then MemOp_LOAD else MemOp_STORE;
integer elsize = 8 << UInt(size);
integer regsize = if elsize == 64 then 64 else 32;
integer datasize = if pair then elsize * 2 else elsize;
```

Assembler Symbols

- <Ws> Is the 32-bit name of the general-purpose register into which the status result of the store exclusive is written, encoded in the "Rs" field.
- <Xt> Is the 64-bit name of the general-purpose register to be transferred, encoded in the "Rt" field.
- <Wt> Is the 32-bit name of the general-purpose register to be transferred, encoded in the "Rt" field.
- <Xn|SP> Is the 64-bit name of the general-purpose base register or stack pointer, encoded in the "Rn" field.

Operation

```
bits(64) address;
bits(datasize) data;
constant integer dbytes = datasize DIV 8;
boolean rt_unknown = FALSE;
boolean rn_unknown = FALSE;

if memop == MemOp_LOAD && pair && t == t2 then
    Constraint c = ConstrainUnpredictable();
    assert c IN {Constraint_UNKNOWN, Constraint_UNDEF, Constraint_NOP};
    case c of
        when Constraint_UNKNOWN    rt_unknown = TRUE; // result is UNKNOWN
        when Constraint_UNDEF      UnallocatedEncoding();
        when Constraint_NOP        EndOfInstruction();

if memop == MemOp_STORE && excl then
    if s == t || (pair && s == t2) then
        Constraint c = ConstrainUnpredictable();
        assert c IN {Constraint_UNKNOWN, Constraint_NONE, Constraint_UNDEF, Constraint_NOP};
```

```

case c of
  when Constraint_UNKNOWN    rt_unknown = TRUE;    // store UNKNOWN value
  when Constraint_NONE       rt_unknown = FALSE;   // store original value
  when Constraint_UNDEF      UnallocatedEncoding();
  when Constraint_NOP        EndOfInstruction();
if s == n && n != 31 then
  Constraint c = ConstrainUnpredictable();
assert c IN {Constraint_UNKNOWN, Constraint_NONE, Constraint_UNDEF, Constraint_NOP};
case c of
  when Constraint_UNKNOWN    rn_unknown = TRUE;    // address is UNKNOWN
  when Constraint_NONE       rn_unknown = FALSE;   // address is original base
  when Constraint_UNDEF      UnallocatedEncoding();
  when Constraint_NOP        EndOfInstruction();

if n == 31 then
  CheckSPAAlignment();
  address = SP[];
elseif rn_unknown then
  address = bits(64) UNKNOWN;
else
  address = X[n];

case memop of
  when MemOp_STORE
    if rt_unknown then
      data = bits(datasize) UNKNOWN;
    elseif pair then
      assert excl;
      bits(datasize DIV 2) e11 = X[t];
      bits(datasize DIV 2) e12 = X[t2];
      data = if BigEndian() then e11 : e12 else e12 : e11;
    else
      data = X[t];

    if excl then
      // store {release} exclusive register|pair (atomic)
      bit status = '1';
      // Check whether the Exclusive Monitors are set to include the
      // physical memory locations corresponding to virtual address
      // range [address, address+dbytes-1].
      if AArch64.ExclusiveMonitorsPass(address, dbytes) then
        // This atomic write will be rejected if it does not refer
        // to the same physical locations after address translation.
        Mem[address, dbytes, acctype] = data;
        status = ExclusiveMonitorsStatus();
        X[s] = ZeroExtend(status, 32);
      else
        // store release register (atomic)
        Mem[address, dbytes, acctype] = data;

  when MemOp_LOAD
    if excl then
      // Tell the Exclusive Monitors to record a sequence of one or more atomic
      // memory reads from virtual address range [address, address+dbytes-1].
      // The Exclusive Monitor will only be set if all the reads are from the
      // same dbytes-aligned physical address, to allow for the possibility of
      // an atomicity break if the translation is changed between reads.
      AArch64.SetExclusiveMonitors(address, dbytes);

    if pair then
      // load exclusive pair
      assert excl;
      if rt_unknown then
        // ConstrainedUNPREDICTABLE case
        X[t] = bits(datasize) UNKNOWN;
      elseif elsize == 32 then
        // 32-bit load exclusive pair (atomic)
        data = Mem[address, dbytes, acctype];

```

```
    if BigEndian() then
        X[t] = data<datasize-1:elsize>;
        X[t2] = data<elsize-1:0>;
    else
        X[t] = data<elsize-1:0>;
        X[t2] = data<datasize-1:elsize>;
else // elsize == 64
    // 64-bit load exclusive pair (not atomic),
    // but must be 128-bit aligned
    if address != Align(address, dbytes) then
        iswrite = FALSE;
        secondstage = FALSE;
        AArch64.Abort(address, AArch64.AlignmentFault(acctype, iswrite, secondstage));
    X[t] = Mem[address + 0, 8, acctype];
    X[t2] = Mem[address + 8, 8, acctype];
else
    // load {acquire} {exclusive} single register
    data = Mem[address, dbytes, acctype];
    X[t] = ZeroExtend(data, regsize);
```

C5.6.174 STLXRB

Store-release exclusive register byte, returning status

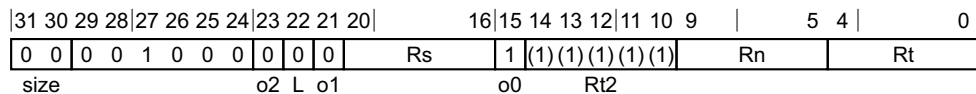

No offset variant

STLXRB <Ws>, <Wt>, [<Xn|SP>{, #0}]

```
integer n = UInt(Rn);
integer t = UInt(Rt);
integer t2 = UInt(Rt2); // ignored by load/store single register
integer s = UInt(Rs); // ignored by all loads and store-release
```

```
if o2:o1:o0 == '100' || o2:o1:o0 == '11x' then UnallocatedEncoding();
if o1 == '1' && size<L> == '0' then UnallocatedEncoding();
```

```
AccType acctype = if o0 == '1' then AccType_ORDERED else AccType_ATOMIC;
boolean excl = (o2 == '0');
boolean pair = (o1 == '1');
MemOp memop = if L == '1' then MemOp_LOAD else MemOp_STORE;
integer elsize = 8 << UInt(size);
integer regsize = if elsize == 64 then 64 else 32;
integer datasize = if pair then elsize * 2 else elsize;
```

Assembler Symbols

- <Ws> Is the 32-bit name of the general-purpose register into which the status result of the store exclusive is written, encoded in the "Rs" field.
- <Wt> Is the 32-bit name of the general-purpose register to be transferred, encoded in the "Rt" field.
- <Xn|SP> Is the 64-bit name of the general-purpose base register or stack pointer, encoded in the "Rn" field.

Operation

```
bits(64) address;
bits(datasize) data;
constant integer dbytes = datasize DIV 8;
boolean rt_unknown = FALSE;
boolean rn_unknown = FALSE;

if memop == MemOp_LOAD && pair && t == t2 then
    Constraint c = ConstrainUnpredictable();
    assert c IN {Constraint_UNKNOWN, Constraint_UNDEF, Constraint_NOP};
    case c of
        when Constraint_UNKNOWN    rt_unknown = TRUE; // result is UNKNOWN
        when Constraint_UNDEF       UnallocatedEncoding();
        when Constraint_NOP         EndOfInstruction();

if memop == MemOp_STORE && excl then
    if s == t || (pair && s == t2) then
        Constraint c = ConstrainUnpredictable();
        assert c IN {Constraint_UNKNOWN, Constraint_NONE, Constraint_UNDEF, Constraint_NOP};
        case c of
            when Constraint_UNKNOWN    rt_unknown = TRUE; // store UNKNOWN value
            when Constraint_NONE        rt_unknown = FALSE; // store original value
            when Constraint_UNDEF       UnallocatedEncoding();
            when Constraint_NOP         EndOfInstruction();
```

```

if s == n && n != 31 then
    Constraint c = ConstrainUnpredictable();
    assert c IN {Constraint_UNKNOWN, Constraint_NONE, Constraint_UNDEF, Constraint_NOP};
    case c of
        when Constraint_UNKNOWN    rn_unknown = TRUE;    // address is UNKNOWN
        when Constraint_NONE        rn_unknown = FALSE;   // address is original base
        when Constraint_UNDEF        UnallocatedEncoding();
        when Constraint_NOP          EndOfInstruction();

if n == 31 then
    CheckSPAAlignment();
    address = SP[];
elseif rn_unknown then
    address = bits(64) UNKNOWN;
else
    address = X[n];

case memop of
    when MemOp_STORE
        if rt_unknown then
            data = bits(datasize) UNKNOWN;
        elseif pair then
            assert excl;
            bits(datasize DIV 2) e11 = X[t];
            bits(datasize DIV 2) e12 = X[t2];
            data = if BigEndian() then e11 : e12 else e12 : e11;
        else
            data = X[t];

        if excl then
            // store {release} exclusive register|pair (atomic)
            bit status = '1';
            // Check whether the Exclusive Monitors are set to include the
            // physical memory locations corresponding to virtual address
            // range [address, address+dbytes-1].
            if AArch64.ExclusiveMonitorsPass(address, dbytes) then
                // This atomic write will be rejected if it does not refer
                // to the same physical locations after address translation.
                Mem[address, dbytes, acctype] = data;
                status = ExclusiveMonitorsStatus();
                X[s] = ZeroExtend(status, 32);
            else
                // store release register (atomic)
                Mem[address, dbytes, acctype] = data;

    when MemOp_LOAD
        if excl then
            // Tell the Exclusive Monitors to record a sequence of one or more atomic
            // memory reads from virtual address range [address, address+dbytes-1].
            // The Exclusive Monitor will only be set if all the reads are from the
            // same dbytes-aligned physical address, to allow for the possibility of
            // an atomicity break if the translation is changed between reads.
            AArch64.SetExclusiveMonitors(address, dbytes);

        if pair then
            // load exclusive pair
            assert excl;
            if rt_unknown then
                // ConstrainedUNPREDICTABLE case
                X[t] = bits(datasize) UNKNOWN;
            elseif elsize == 32 then
                // 32-bit load exclusive pair (atomic)
                data = Mem[address, dbytes, acctype];
                if BigEndian() then
                    X[t] = data<datasize-1:elsize>;
                    X[t2] = data<elsize-1:0>;
                else
                    X[t] = data<elsize-1:0>;

```

```
        X[t2] = data<datasize-1:elsize>;
else // elsize == 64
    // 64-bit load exclusive pair (not atomic),
    // but must be 128-bit aligned
    if address != Align(address, dbytes) then
        iswrite = FALSE;
        secondstage = FALSE;
        AArch64.Abort(address, AArch64.AlignmentFault(acctype, iswrite, secondstage));
    X[t] = Mem[address + 0, 8, acctype];
    X[t2] = Mem[address + 8, 8, acctype];
else
    // load {acquire} {exclusive} single register
    data = Mem[address, dbytes, acctype];
    X[t] = ZeroExtend(data, regsize);
```

C5.6.175 STLXRH

Store-release exclusive register halfword, returning status

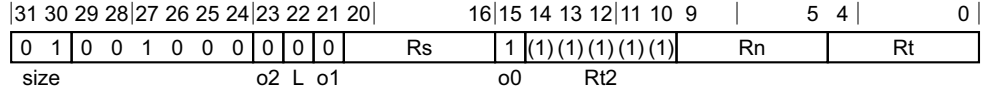

No offset variant

STLXRH <Ws>, <Wt>, [<Xn|SP>{, #0}]

```
integer n = UInt(Rn);
integer t = UInt(Rt);
integer t2 = UInt(Rt2); // ignored by load/store single register
integer s = UInt(Rs); // ignored by all loads and store-release
```

```
if o2:o1:o0 == '100' || o2:o1:o0 == '11x' then UnallocatedEncoding();
if o1 == '1' && size<L> == '0' then UnallocatedEncoding();
```

```
AccType acctype = if o0 == '1' then AccType_ORDERED else AccType_ATOMIC;
boolean excl = (o2 == '0');
boolean pair = (o1 == '1');
MemOp memop = if L == '1' then MemOp_LOAD else MemOp_STORE;
integer elsize = 8 << UInt(size);
integer regsize = if elsize == 64 then 64 else 32;
integer datasize = if pair then elsize * 2 else elsize;
```

Assembler Symbols

- <Ws> Is the 32-bit name of the general-purpose register into which the status result of the store exclusive is written, encoded in the "Rs" field.
- <Wt> Is the 32-bit name of the general-purpose register to be transferred, encoded in the "Rt" field.
- <Xn|SP> Is the 64-bit name of the general-purpose base register or stack pointer, encoded in the "Rn" field.

Operation

```
bits(64) address;
bits(datasize) data;
constant integer dbytes = datasize DIV 8;
boolean rt_unknown = FALSE;
boolean rn_unknown = FALSE;

if memop == MemOp_LOAD && pair && t == t2 then
  Constraint c = ConstrainUnpredictable();
  assert c IN {Constraint_UNKNOWN, Constraint_UNDEF, Constraint_NOP};
  case c of
    when Constraint_UNKNOWN rt_unknown = TRUE; // result is UNKNOWN
    when Constraint_UNDEF UnallocatedEncoding();
    when Constraint_NOP EndOfInstruction();

if memop == MemOp_STORE && excl then
  if s == t || (pair && s == t2) then
    Constraint c = ConstrainUnpredictable();
    assert c IN {Constraint_UNKNOWN, Constraint_NONE, Constraint_UNDEF, Constraint_NOP};
    case c of
      when Constraint_UNKNOWN rt_unknown = TRUE; // store UNKNOWN value
      when Constraint_NONE rt_unknown = FALSE; // store original value
      when Constraint_UNDEF UnallocatedEncoding();
      when Constraint_NOP EndOfInstruction();
```

```

if s == n && n != 31 then
    Constraint c = ConstrainUnpredictable();
    assert c IN {Constraint_UNKNOWN, Constraint_NONE, Constraint_UNDEF, Constraint_NOP};
    case c of
        when Constraint_UNKNOWN    rn_unknown = TRUE;    // address is UNKNOWN
        when Constraint_NONE        rn_unknown = FALSE;   // address is original base
        when Constraint_UNDEF       UnallocatedEncoding();
        when Constraint_NOP         EndOfInstruction();

if n == 31 then
    CheckSPAlignment();
    address = SP[];
elseif rn_unknown then
    address = bits(64) UNKNOWN;
else
    address = X[n];

case memop of
    when MemOp_STORE
        if rt_unknown then
            data = bits(datasize) UNKNOWN;
        elseif pair then
            assert excl;
            bits(datasize DIV 2) e11 = X[t];
            bits(datasize DIV 2) e12 = X[t2];
            data = if BigEndian() then e11 : e12 else e12 : e11;
        else
            data = X[t];

        if excl then
            // store {release} exclusive register|pair (atomic)
            bit status = '1';
            // Check whether the Exclusive Monitors are set to include the
            // physical memory locations corresponding to virtual address
            // range [address, address+dbytes-1].
            if AArch64.ExclusiveMonitorsPass(address, dbytes) then
                // This atomic write will be rejected if it does not refer
                // to the same physical locations after address translation.
                Mem[address, dbytes, acctype] = data;
                status = ExclusiveMonitorsStatus();
                X[s] = ZeroExtend(status, 32);
            else
                // store release register (atomic)
                Mem[address, dbytes, acctype] = data;

    when MemOp_LOAD
        if excl then
            // Tell the Exclusive Monitors to record a sequence of one or more atomic
            // memory reads from virtual address range [address, address+dbytes-1].
            // The Exclusive Monitor will only be set if all the reads are from the
            // same dbytes-aligned physical address, to allow for the possibility of
            // an atomicity break if the translation is changed between reads.
            AArch64.SetExclusiveMonitors(address, dbytes);

        if pair then
            // load exclusive pair
            assert excl;
            if rt_unknown then
                // ConstrainedUNPREDICTABLE case
                X[t] = bits(datasize) UNKNOWN;
            elseif elsize == 32 then
                // 32-bit load exclusive pair (atomic)
                data = Mem[address, dbytes, acctype];
                if BigEndian() then
                    X[t] = data<datasize-1:elsize>;
                    X[t2] = data<elsize-1:0>;
                else
                    X[t] = data<elsize-1:0>;

```

```
        X[t2] = data<datasize-1:elsize>;
else // elsize == 64
    // 64-bit load exclusive pair (not atomic),
    // but must be 128-bit aligned
    if address != Align(address, dbytes) then
        iswrite = FALSE;
        secondstage = FALSE;
        AArch64.Abort(address, AArch64.AlignmentFault(acctype, iswrite, secondstage));
    X[t] = Mem[address + 0, 8, acctype];
    X[t2] = Mem[address + 8, 8, acctype];
else
    // load {acquire} {exclusive} single register
    data = Mem[address, dbytes, acctype];
    X[t] = ZeroExtend(data, regsize);
```

C5.6.176 STNP

Store pair of registers, with non-temporal hint

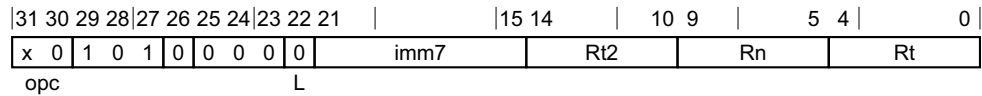

32-bit variant (opc = 00)

STNP <Wt1>, <Wt2>, [<Xn|SP>{, #<imm>}]

64-bit variant (opc = 10)

STNP <Xt1>, <Xt2>, [<Xn|SP>{, #<imm>}]

boolean wback = FALSE;
boolean postindex = FALSE;

Assembler Symbols

- <Wt1> Is the 32-bit name of the first general-purpose register to be transferred, encoded in the "Rt" field.
- <Wt2> Is the 32-bit name of the second general-purpose register to be transferred, encoded in the "Rt2" field.
- <Xt1> Is the 64-bit name of the first general-purpose register to be transferred, encoded in the "Rt" field.
- <Xt2> Is the 64-bit name of the second general-purpose register to be transferred, encoded in the "Rt2" field.
- <Xn|SP> Is the 64-bit name of the general-purpose base register or stack pointer, encoded in the "Rn" field.
- <imm> For the 32-bit variant: is the optional signed immediate byte offset, a multiple of 4 in the range -256 to 252, defaulting to 0 and encoded in the "imm7" field as <imm>/4.
- <imm> For the 64-bit variant: is the optional signed immediate byte offset, a multiple of 8 in the range -512 to 504, defaulting to 0 and encoded in the "imm7" field as <imm>/8.

Shared decode for all variants

```
integer n = UInt(Rn);
integer t = UInt(Rt);
integer t2 = UInt(Rt2);
AccType acctype = AccType_STREAM;
MemOp memop = if L == '1' then MemOp_LOAD else MemOp_STORE;
if opc<0> == '1' then UnallocatedEncoding();
integer scale = 2 + UInt(opc<1>);
integer datasize = 8 << scale;
bits(64) offset = LSL(SignExtend(imm7, 64), scale);
```

Operation

```
bits(64) address;
bits(datasize) data1;
bits(datasize) data2;
constant integer dbytes = datasize DIV 8;
boolean rt_unknown = FALSE;

if memop == MemOp_LOAD && t == t2 then
    Constraint c = ConstrainUnpredictable();
    assert c IN {Constraint_UNKNOWN, Constraint_UNDEF, Constraint_NOP};
```

```
    case c of
        when Constraint_UNKNOWN    rt_unknown = TRUE;    // result is UNKNOWN
        when Constraint_UNDEF      UnallocatedEncoding();
        when Constraint_NOP        EndOfInstruction();

    if n == 31 then
        CheckSPAlignment();
        address = SP[];
    else
        address = X[n];

    if ! postindex then
        address = address + offset;

    case memop of
        when MemOp_STORE
            if rt_unknown && t == n then
                data1 = bits(datasize) UNKNOWN;
            else
                data1 = X[t];
            if rt_unknown && t2 == n then
                data2 = bits(datasize) UNKNOWN;
            else
                data2 = X[t2];
            Mem[address + 0      , dbytes, acctype] = data1;
            Mem[address + dbytes, dbytes, acctype] = data2;

        when MemOp_LOAD
            data1 = Mem[address + 0      , dbytes, acctype];
            data2 = Mem[address + dbytes, dbytes, acctype];
            if rt_unknown then
                data1 = bits(datasize) UNKNOWN;
                data2 = bits(datasize) UNKNOWN;
            X[t] = data1;
            X[t2] = data2;

    if wback then
        if postindex then
            address = address + offset;
        if n == 31 then
            SP[] = address;
        else
            X[n] = address;
```

C5.6.177 STP

Store pair of registers

It has encodings from 3 classes: *Post-index*, *Pre-index* and *Signed offset*

Post-index

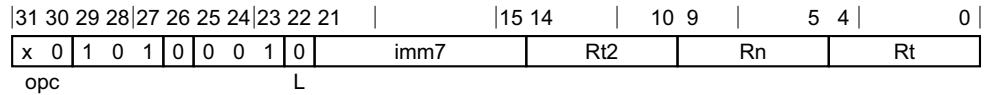

32-bit variant (opc = 00)

STP <Wt1>, <Wt2>, [<Xn|SP>], #<imm>

64-bit variant (opc = 10)

STP <Xt1>, <Xt2>, [<Xn|SP>], #<imm>

boolean wback = TRUE;
 boolean postindex = TRUE;

Pre-index

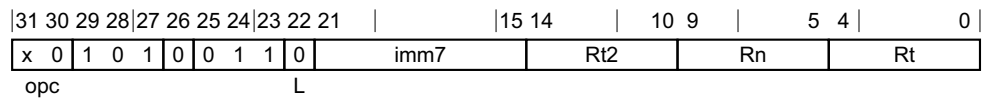

32-bit variant (opc = 00)

STP <Wt1>, <Wt2>, [<Xn|SP>, #<imm>]!

64-bit variant (opc = 10)

STP <Xt1>, <Xt2>, [<Xn|SP>, #<imm>]!

boolean wback = TRUE;
 boolean postindex = FALSE;

Signed offset

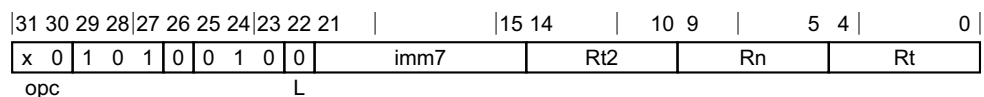

32-bit variant (opc = 00)

STP <Wt1>, <Wt2>, [<Xn|SP>{, #<imm>}]

64-bit variant (opc = 10)

STP <Xt1>, <Xt2>, [<Xn|SP>{, #<imm>}]

boolean wback = FALSE;
 boolean postindex = FALSE;

Assembler Symbols

- <Wt1> Is the 32-bit name of the first general-purpose register to be transferred, encoded in the "Rt" field.
- <Wt2> Is the 32-bit name of the second general-purpose register to be transferred, encoded in the "Rt2" field.

- <Xt1> Is the 64-bit name of the first general-purpose register to be transferred, encoded in the "Rt" field.
- <Xt2> Is the 64-bit name of the second general-purpose register to be transferred, encoded in the "Rt2" field.
- <Xn|SP> Is the 64-bit name of the general-purpose base register or stack pointer, encoded in the "Rn" field.
- <imm> For the 32-bit post-index and 32-bit pre-index variant: is the signed immediate byte offset, a multiple of 4 in the range -256 to 252, encoded in the "imm7" field as <imm>/4.
- <imm> For the 32-bit signed offset variant: is the optional signed immediate byte offset, a multiple of 4 in the range -256 to 252, defaulting to 0 and encoded in the "imm7" field as <imm>/4.
- <imm> For the 64-bit post-index and 64-bit pre-index variant: is the signed immediate byte offset, a multiple of 8 in the range -512 to 504, encoded in the "imm7" field as <imm>/8.
- <imm> For the 64-bit signed offset variant: is the optional signed immediate byte offset, a multiple of 8 in the range -512 to 504, defaulting to 0 and encoded in the "imm7" field as <imm>/8.

Shared decode for all variants

```
integer n = UInt(Rn);
integer t = UInt(Rt);
integer t2 = UInt(Rt2);
AccType acctype = AccType_NORMAL;
MemOp memop = if L == '1' then MemOp_LOAD else MemOp_STORE;
if L:opc<0> == '01' || opc == '11' then UnallocatedEncoding();
boolean signed = (opc<0> != '0');
integer scale = 2 + UInt(opc<1>);
integer datasize = 8 << scale;
bits(64) offset = LSL(SignExtend(imm7, 64), scale);
```

Operation for all classes

```
bits(64) address;
bits(datasize) data1;
bits(datasize) data2;
constant integer dbytes = datasize DIV 8;
boolean rt_unknown = FALSE;
boolean wb_unknown = FALSE;

if memop == MemOp_LOAD && wback && (t == n || t2 == n) && n != 31 then
  c = ConstrainUnpredictable();
  assert c IN {Constraint_WBSUPPRESS, Constraint_UNKNOWN, Constraint_UNDEF, Constraint_NOP};
  case c of
    when Constraint_WBSUPPRESS wback = FALSE; // writeback is suppressed
    when Constraint_UNKNOWN wb_unknown = TRUE; // writeback is UNKNOWN
    when Constraint_UNDEF UnallocatedEncoding();
    when Constraint_NOP EndOfInstruction();

if memop == MemOp_STORE && wback && (t == n || t2 == n) && n != 31 then
  c = ConstrainUnpredictable();
  assert c IN {Constraint_NONE, Constraint_UNKNOWN, Constraint_UNDEF, Constraint_NOP};
  case c of
    when Constraint_NONE rt_unknown = FALSE; // value stored is pre-writeback
    when Constraint_UNKNOWN rt_unknown = TRUE; // value stored is UNKNOWN
    when Constraint_UNDEF UnallocatedEncoding();
    when Constraint_NOP EndOfInstruction();

if memop == MemOp_LOAD && t == t2 then
  Constraint c = ConstrainUnpredictable();
  assert c IN {Constraint_UNKNOWN, Constraint_UNDEF, Constraint_NOP};
  case c of
    when Constraint_UNKNOWN rt_unknown = TRUE; // result is UNKNOWN
    when Constraint_UNDEF UnallocatedEncoding();
    when Constraint_NOP EndOfInstruction();
```

```

if n == 31 then
    CheckSPAAlignment();
    address = SP[];
else
    address = X[n];

if ! postindex then
    address = address + offset;

case memop of
when MemOp_STORE
    if rt_unknown && t == n then
        data1 = bits(datasize) UNKNOWN;
    else
        data1 = X[t];
    if rt_unknown && t2 == n then
        data2 = bits(datasize) UNKNOWN;
    else
        data2 = X[t2];
    Mem[address + 0, dbytes, acctype] = data1;
    Mem[address + dbytes, dbytes, acctype] = data2;

when MemOp_LOAD
    data1 = Mem[address + 0, dbytes, acctype];
    data2 = Mem[address + dbytes, dbytes, acctype];
    if rt_unknown then
        data1 = bits(datasize) UNKNOWN;
        data2 = bits(datasize) UNKNOWN;
    if signed then
        X[t] = SignExtend(data1, 64);
        X[t2] = SignExtend(data2, 64);
    else
        X[t] = data1;
        X[t2] = data2;

if wback then
    if wb_unknown then
        address = bits(64) UNKNOWN;
    elsif postindex then
        address = address + offset;
    if n == 31 then
        SP[] = address;
    else
        X[n] = address;

```

C5.6.178 STR (immediate)

Store register (immediate offset)

It has encodings from 3 classes: *Post-index*, *Pre-index* and *Unsigned offset*

Post-index

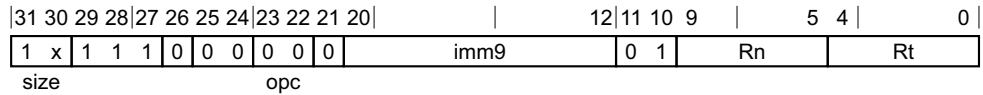

32-bit variant (size = 10)

STR <Wt>, [<Xn|SP>], #<sim>

64-bit variant (size = 11)

STR <Xt>, [<Xn|SP>], #<sim>

```
boolean wback = TRUE;
boolean postindex = TRUE;
integer scale = UInt(size);
bits(64) offset = SignExtend(imm9, 64);
```

Pre-index

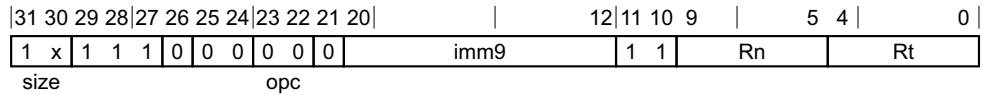

32-bit variant (size = 10)

STR <Wt>, [<Xn|SP>, #<sim>]!

64-bit variant (size = 11)

STR <Xt>, [<Xn|SP>, #<sim>]!

```
boolean wback = TRUE;
boolean postindex = FALSE;
integer scale = UInt(size);
bits(64) offset = SignExtend(imm9, 64);
```

Unsigned offset

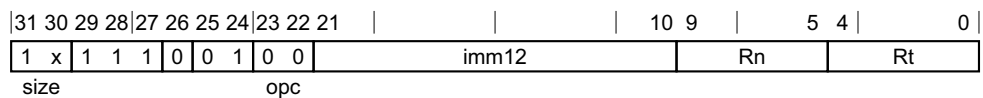

32-bit variant (size = 10)

STR <Wt>, [<Xn|SP>{, #<pimm>}]

64-bit variant (size = 11)

STR <Xt>, [<Xn|SP>{, #<pimm>}]

```
boolean wback = FALSE;
boolean postindex = FALSE;
integer scale = UInt(size);
bits(64) offset = LSL(ZeroExtend(imm12, 64), scale);
```

Assembler Symbols

<Wt>	Is the 32-bit name of the general-purpose register to be transferred, encoded in the "Rt" field.
<Xt>	Is the 64-bit name of the general-purpose register to be transferred, encoded in the "Rt" field.
<Xn SP>	Is the 64-bit name of the general-purpose base register or stack pointer, encoded in the "Rn" field.
<simm>	Is the signed immediate byte offset, in the range -256 to 255, encoded in the "imm9" field.
<pimm>	For the 32-bit variant: is the optional positive immediate byte offset, a multiple of 4 in the range 0 to 16380, defaulting to 0 and encoded in the "imm12" field as <pimm>/4.
<pimm>	For the 64-bit variant: is the optional positive immediate byte offset, a multiple of 8 in the range 0 to 32760, defaulting to 0 and encoded in the "imm12" field as <pimm>/8.

Shared decode for all variants

```

integer n = UInt(Rn);
integer t = UInt(Rt);
AccType acctype = AccType_NORMAL;
MemOp memop;
boolean signed;
integer regsize;

if opc<1> == '0' then
    // store or zero-extending load
    memop = if opc<0> == '1' then MemOp_LOAD else MemOp_STORE;
    regsize = if size == '11' then 64 else 32;
    signed = FALSE;
else
    if size == '11' then
        memop = MemOp_PREFETCH;
        if opc<0> == '1' then UnallocatedEncoding();
    else
        // sign-extending load
        memop = MemOp_LOAD;
        if size == '10' && opc<0> == '1' then UnallocatedEncoding();
        regsize = if opc<0> == '1' then 32 else 64;
        signed = TRUE;

integer datasize = 8 << scale;
  
```

Operation for all classes

```

bits(64) address;
bits(datasize) data;
boolean wb_unknown = FALSE;
boolean rt_unknown = FALSE;

if memop == MemOp_LOAD && wback && n == t && n != 31 then
    c = ConstrainUnpredictable();
    assert c IN {Constraint_WBSUPPRESS, Constraint_UNKNOWN, Constraint_UNDEF, Constraint_NOP};
    case c of
        when Constraint_WBSUPPRESS wback = FALSE; // writeback is suppressed
        when Constraint_UNKNOWN wb_unknown = TRUE; // writeback is UNKNOWN
        when Constraint_UNDEF UnallocatedEncoding();
        when Constraint_NOP EndOfInstruction();

if memop == MemOp_STORE && wback && n == t && n != 31 then
    c = ConstrainUnpredictable();
    assert c IN {Constraint_NONE, Constraint_UNKNOWN, Constraint_UNDEF, Constraint_NOP};
    case c of
        when Constraint_NONE rt_unknown = FALSE; // value stored is original value
        when Constraint_UNKNOWN rt_unknown = TRUE; // value stored is UNKNOWN
        when Constraint_UNDEF UnallocatedEncoding();
  
```

```
        when Constraint_NOP      EndOfInstruction();

if n == 31 then
    if memop != MemOp_PREFETCH then CheckSPAlignment();
    address = SP[];
else
    address = X[n];

if ! postindex then
    address = address + offset;

case memop of
    when MemOp_STORE
        if rt_unknown then
            data = bits(datasize) UNKNOWN;
        else
            data = X[t];
            Mem[address, datasize DIV 8, acctype] = data;

    when MemOp_LOAD
        data = Mem[address, datasize DIV 8, acctype];
        if signed then
            X[t] = SignExtend(data, regsize);
        else
            X[t] = ZeroExtend(data, regsize);

    when MemOp_PREFETCH
        Prefetch(address, t<4:0>);

if wback then
    if wb_unknown then
        address = bits(64) UNKNOWN;
    elsif postindex then
        address = address + offset;
    if n == 31 then
        SP[] = address;
    else
        X[n] = address;
```

C5.6.179 STR (register)

Store register (register offset)

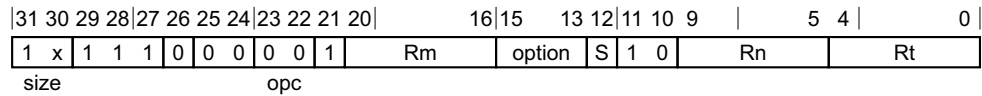

32-bit variant (size = 10)

STR <Wt>, [<Xn|SP>, <R><m>{, <extend> {<amount>}}]

64-bit variant (size = 11)

STR <Xt>, [<Xn|SP>, <R><m>{, <extend> {<amount>}}]

```
boolean wback = FALSE;
boolean postindex = FALSE;
integer scale = UInt(size);
if option<1> == '0' then UnallocatedEncoding(); // sub-word index
ExtendType extend_type = DecodeRegExtend(option);
integer shift = if S == '1' then scale else 0;
```

Assembler Symbols

<Wt>	Is the 32-bit name of the general-purpose register to be transferred, encoded in the "Rt" field.
<Xt>	Is the 64-bit name of the general-purpose register to be transferred, encoded in the "Rt" field.
<Xn SP>	Is the 64-bit name of the general-purpose base register or stack pointer, encoded in the "Rn" field.
<R>	Is the index width specifier, RESERVED when option = 00x W when option = x10 X when option = x11 RESERVED when option = 10x
<m>	Is the number [0-30] of the general-purpose index register or the name ZR (31), encoded in the "Rm" field.
<extend>	Is the index extend/shift specifier, defaulting to LSL and RESERVED when option = 00x UXTW when option = 010 LSL when option = 011 RESERVED when option = 10x SXTW when option = 110 SXTX when option = 111
<amount>	For the 32-bit variant: is the index shift amount, optional and defaulting to #0 when <extend> is not LSL, #0 when S = 0 #2 when S = 1
<amount>	For the 64-bit variant: is the index shift amount, optional and defaulting to #0 when <extend> is not LSL, #0 when S = 0

#3 when S = 1

Shared decode for all variants

```

integer n = UInt(Rn);
integer t = UInt(Rt);
integer m = UInt(Rm);
AccType acctype = AccType_NORMAL;
MemOp memop;
boolean signed;
integer regsize;

if opc<1> == '0' then
    // store or zero-extending load
    memop = if opc<0> == '1' then MemOp_LOAD else MemOp_STORE;
    regsize = if size == '11' then 64 else 32;
    signed = FALSE;
else
    if size == '11' then
        memop = MemOp_PREFETCH;
        if opc<0> == '1' then UnallocatedEncoding();
    else
        // sign-extending load
        memop = MemOp_LOAD;
        if size == '10' && opc<0> == '1' then UnallocatedEncoding();
        regsize = if opc<0> == '1' then 32 else 64;
        signed = TRUE;

integer datasize = 8 << scale;

```

Operation

```

bits(64) offset = ExtendReg(m, extend_type, shift);
bits(64) address;
bits(datasize) data;
boolean wb_unknown = FALSE;
boolean rt_unknown = FALSE;

if memop == MemOp_LOAD && wback && n == t && n != 31 then
    c = ConstrainUnpredictable();
    assert c IN {Constraint_WBSUPPRESS, Constraint_UNKNOWN, Constraint_UNDEF, Constraint_NOP};
    case c of
        when Constraint_WBSUPPRESS wback = FALSE; // writeback is suppressed
        when Constraint_UNKNOWN wb_unknown = TRUE; // writeback is UNKNOWN
        when Constraint_UNDEF UnallocatedEncoding();
        when Constraint_NOP EndOfInstruction();

if memop == MemOp_STORE && wback && n == t && n != 31 then
    c = ConstrainUnpredictable();
    assert c IN {Constraint_NONE, Constraint_UNKNOWN, Constraint_UNDEF, Constraint_NOP};
    case c of
        when Constraint_NONE rt_unknown = FALSE; // value stored is original value
        when Constraint_UNKNOWN rt_unknown = TRUE; // value stored is UNKNOWN
        when Constraint_UNDEF UnallocatedEncoding();
        when Constraint_NOP EndOfInstruction();

if n == 31 then
    if memop != MemOp_PREFETCH then CheckSPAlignment();
    address = SP[];
else
    address = X[n];

if ! postindex then
    address = address + offset;

```



```
case memop of
  when MemOp_STORE
    if rt_unknown then
      data = bits(datasize) UNKNOWN;
    else
      data = X[t];
      Mem[address, datasize DIV 8, acctype] = data;

  when MemOp_LOAD
    data = Mem[address, datasize DIV 8, acctype];
    if signed then
      X[t] = SignExtend(data, regsize);
    else
      X[t] = ZeroExtend(data, regsize);

  when MemOp_PREFETCH
    Prefetch(address, t<4:0>);

if wback then
  if wb_unknown then
    address = bits(64) UNKNOWN;
  elsif postindex then
    address = address + offset;
  if n == 31 then
    SP[] = address;
  else
    X[n] = address;
```

C5.6.180 STRB (immediate)

Store register byte (immediate offset)

It has encodings from 3 classes: *Post-index*, *Pre-index* and *Unsigned offset*

Post-index

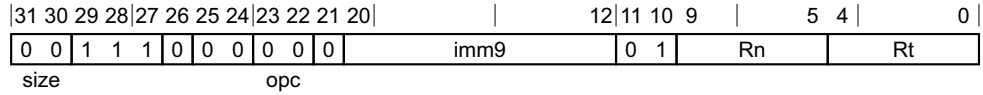

Post-index variant

STRB <Wt>, [<Xn|SP>], #<simm>

```
boolean wback = TRUE;
boolean postindex = TRUE;
integer scale = UInt(size);
bits(64) offset = SignExtend(imm9, 64);
```

Pre-index

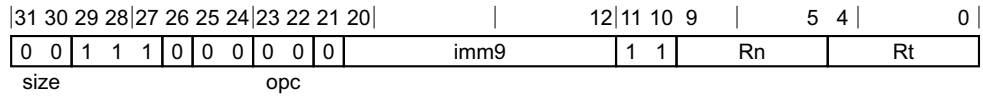

Pre-index variant

STRB <Wt>, [<Xn|SP>, #<simm>]!

```
boolean wback = TRUE;
boolean postindex = FALSE;
integer scale = UInt(size);
bits(64) offset = SignExtend(imm9, 64);
```

Unsigned offset

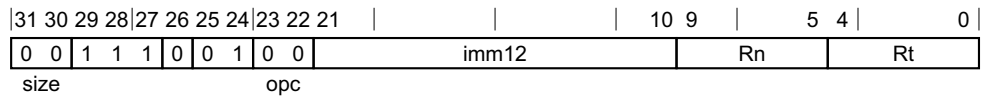

Unsigned offset variant

STRB <Wt>, [<Xn|SP>{, #<pimm>}]

```
boolean wback = FALSE;
boolean postindex = FALSE;
integer scale = UInt(size);
bits(64) offset = LSL(ZeroExtend(imm12, 64), scale);
```

Assembler Symbols

- <Wt> Is the 32-bit name of the general-purpose register to be transferred, encoded in the "Rt" field.
- <Xn|SP> Is the 64-bit name of the general-purpose base register or stack pointer, encoded in the "Rn" field.
- <simm> Is the signed immediate byte offset, in the range -256 to 255, encoded in the "imm9" field.
- <pimm> Is the optional positive immediate byte offset, in the range 0 to 4095, defaulting to 0 and encoded in the "imm12" field.

Shared decode for all variants

```

integer n = UInt(Rn);
integer t = UInt(Rt);
AccType acctype = AccType_NORMAL;
MemOp memop;
boolean signed;
integer regsize;

if opc<1> == '0' then
    // store or zero-extending load
    memop = if opc<0> == '1' then MemOp_LOAD else MemOp_STORE;
    regsize = if size == '11' then 64 else 32;
    signed = FALSE;
else
    if size == '11' then
        memop = MemOp_PREFETCH;
        if opc<0> == '1' then UnallocatedEncoding();
    else
        // sign-extending load
        memop = MemOp_LOAD;
        if size == '10' && opc<0> == '1' then UnallocatedEncoding();
        regsize = if opc<0> == '1' then 32 else 64;
        signed = TRUE;

integer datasize = 8 << scale;

```

Operation for all classes

```

bits(64) address;
bits(datasize) data;
boolean wb_unknown = FALSE;
boolean rt_unknown = FALSE;

if memop == MemOp_LOAD && wback && n == t && n != 31 then
    c = ConstrainUnpredictable();
    assert c IN {Constraint_WBSUPPRESS, Constraint_UNKNOWN, Constraint_UNDEF, Constraint_NOP};
    case c of
        when Constraint_WBSUPPRESS wback = FALSE; // writeback is suppressed
        when Constraint_UNKNOWN wb_unknown = TRUE; // writeback is UNKNOWN
        when Constraint_UNDEF UnallocatedEncoding();
        when Constraint_NOP EndOfInstruction();

if memop == MemOp_STORE && wback && n == t && n != 31 then
    c = ConstrainUnpredictable();
    assert c IN {Constraint_NONE, Constraint_UNKNOWN, Constraint_UNDEF, Constraint_NOP};
    case c of
        when Constraint_NONE rt_unknown = FALSE; // value stored is original value
        when Constraint_UNKNOWN rt_unknown = TRUE; // value stored is UNKNOWN
        when Constraint_UNDEF UnallocatedEncoding();
        when Constraint_NOP EndOfInstruction();

if n == 31 then
    if memop != MemOp_PREFETCH then CheckSPAlignment();
    address = SP[];
else
    address = X[n];

if ! postindex then
    address = address + offset;

case memop of
    when MemOp_STORE
        if rt_unknown then
            data = bits(datasize) UNKNOWN;
        else
            data = X[t];

```

```
Mem[address, datasize DIV 8, acctype] = data;

when MemOp_LOAD
  data = Mem[address, datasize DIV 8, acctype];
  if signed then
    X[t] = SignExtend(data, regsize);
  else
    X[t] = ZeroExtend(data, regsize);

when MemOp_PREFETCH
  Prefetch(address, t<4:0>);

if wback then
  if wb_unknown then
    address = bits(64) UNKNOWN;
  elsif postindex then
    address = address + offset;
  if n == 31 then
    SP[] = address;
  else
    X[n] = address;
```

C5.6.181 STRB (register)

Store register byte (register offset)

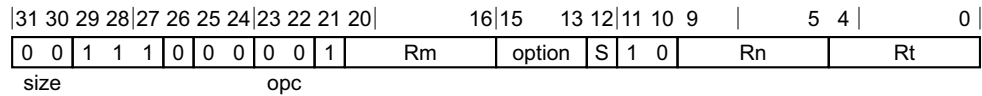

32-bit variant

STRB <Wt>, [<Xn|SP>, <R><m>{, <extend> {<amount>}}]

```
boolean wback = FALSE;
boolean postindex = FALSE;
integer scale = UInt(size);
if option<1> == '0' then UnallocatedEncoding(); // sub-word index
ExtendType extend_type = DecodeRegExtend(option);
integer shift = if S == '1' then scale else 0;
```

Assembler Symbols

<Wt>	Is the 32-bit name of the general-purpose register to be transferred, encoded in the "Rt" field.
<Xn SP>	Is the 64-bit name of the general-purpose base register or stack pointer, encoded in the "Rn" field.
<R>	Is the index width specifier, RESERVED when option = 00x W when option = x10 X when option = x11 RESERVED when option = 10x
<m>	Is the number [0-30] of the general-purpose index register or the name ZR (31), encoded in the "Rm" field.
<extend>	Is the index extend/shift specifier, defaulting to LSL and RESERVED when option = 00x UXTW when option = 010 LSL when option = 011 RESERVED when option = 10x SXTW when option = 110 SXTX when option = 111
<amount>	Is the index shift amount, optional and defaulting to #0 when <extend> is not LSL, [absent] when S = 0 #0 when S = 1

Shared decode for all variants

```
integer n = UInt(Rn);
integer t = UInt(Rt);
integer m = UInt(Rm);
AccType acctype = AccType_NORMAL;
MemOp memop;
boolean signed;
integer regsize;
```

```

if opc<1> == '0' then
    // store or zero-extending load
    memop = if opc<0> == '1' then MemOp_LOAD else MemOp_STORE;
    regsize = if size == '11' then 64 else 32;
    signed = FALSE;
else
    if size == '11' then
        memop = MemOp_PREFETCH;
        if opc<0> == '1' then UnallocatedEncoding();
    else
        // sign-extending load
        memop = MemOp_LOAD;
        if size == '10' && opc<0> == '1' then UnallocatedEncoding();
        regsize = if opc<0> == '1' then 32 else 64;
        signed = TRUE;

integer datasize = 8 << scale;

```

Operation

```

bits(64) offset = ExtendReg(m, extend_type, shift);
bits(64) address;
bits(datasize) data;
boolean wb_unknown = FALSE;
boolean rt_unknown = FALSE;

if memop == MemOp_LOAD && wback && n == t && n != 31 then
    c = ConstrainUnpredictable();
    assert c IN {Constraint_WBSUPPRESS, Constraint_UNKNOWN, Constraint_UNDEF, Constraint_NOP};
    case c of
        when Constraint_WBSUPPRESS wback = FALSE; // writeback is suppressed
        when Constraint_UNKNOWN wb_unknown = TRUE; // writeback is UNKNOWN
        when Constraint_UNDEF UnallocatedEncoding();
        when Constraint_NOP EndOfInstruction();

if memop == MemOp_STORE && wback && n == t && n != 31 then
    c = ConstrainUnpredictable();
    assert c IN {Constraint_NONE, Constraint_UNKNOWN, Constraint_UNDEF, Constraint_NOP};
    case c of
        when Constraint_NONE rt_unknown = FALSE; // value stored is original value
        when Constraint_UNKNOWN rt_unknown = TRUE; // value stored is UNKNOWN
        when Constraint_UNDEF UnallocatedEncoding();
        when Constraint_NOP EndOfInstruction();

if n == 31 then
    if memop != MemOp_PREFETCH then CheckSPAlignment();
    address = SP[];
else
    address = X[n];

if ! postindex then
    address = address + offset;

case memop of
    when MemOp_STORE
        if rt_unknown then
            data = bits(datasize) UNKNOWN;
        else
            data = X[t];
            Mem[address, datasize DIV 8, acctype] = data;

    when MemOp_LOAD
        data = Mem[address, datasize DIV 8, acctype];
        if signed then
            X[t] = SignExtend(data, regsize);
        else

```

```
        X[t] = ZeroExtend(data, regsize);  
when MemOp_PREFETCH  
    Prefetch(address, t<4:0>);  
if wback then  
    if wb_unknown then  
        address = bits(64) UNKNOWN;  
    elsif postindex then  
        address = address + offset;  
    if n == 31 then  
        SP[] = address;  
    else  
        X[n] = address;
```

C5.6.182 STRH (immediate)

Store register halfword (immediate offset)

It has encodings from 3 classes: *Post-index*, *Pre-index* and *Unsigned offset*

Post-index

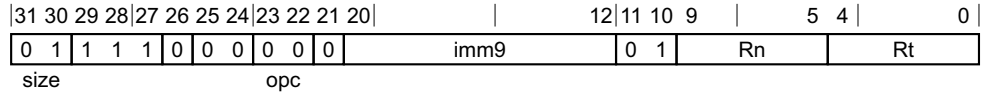

Post-index variant

STRH <Wt>, [<Xn|SP>], #<simm>

```
boolean wback = TRUE;
boolean postindex = TRUE;
integer scale = UInt(size);
bits(64) offset = SignExtend(imm9, 64);
```

Pre-index

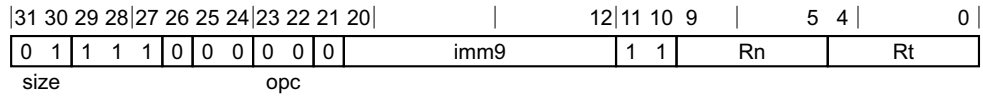

Pre-index variant

STRH <Wt>, [<Xn|SP>, #<simm>]!

```
boolean wback = TRUE;
boolean postindex = FALSE;
integer scale = UInt(size);
bits(64) offset = SignExtend(imm9, 64);
```

Unsigned offset

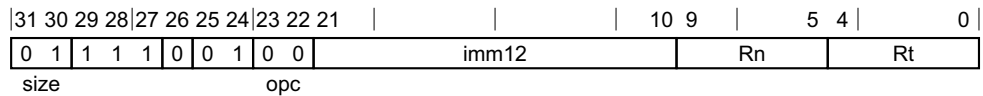

Unsigned offset variant

STRH <Wt>, [<Xn|SP>{, #<pimm>}]

```
boolean wback = FALSE;
boolean postindex = FALSE;
integer scale = UInt(size);
bits(64) offset = LSL(ZeroExtend(imm12, 64), scale);
```

Assembler Symbols

- <Wt> Is the 32-bit name of the general-purpose register to be transferred, encoded in the "Rt" field.
- <Xn|SP> Is the 64-bit name of the general-purpose base register or stack pointer, encoded in the "Rn" field.
- <simm> Is the signed immediate byte offset, in the range -256 to 255, encoded in the "imm9" field.
- <pimm> Is the optional positive immediate byte offset, a multiple of 2 in the range 0 to 8190, defaulting to 0 and encoded in the "imm12" field as <pimm>/2.

Shared decode for all variants

```

integer n = UInt(Rn);
integer t = UInt(Rt);
AccType acctype = AccType_NORMAL;
MemOp memop;
boolean signed;
integer regsize;

if opc<1> == '0' then
    // store or zero-extending load
    memop = if opc<0> == '1' then MemOp_LOAD else MemOp_STORE;
    regsize = if size == '11' then 64 else 32;
    signed = FALSE;
else
    if size == '11' then
        memop = MemOp_PREFETCH;
        if opc<0> == '1' then UnallocatedEncoding();
    else
        // sign-extending load
        memop = MemOp_LOAD;
        if size == '10' && opc<0> == '1' then UnallocatedEncoding();
        regsize = if opc<0> == '1' then 32 else 64;
        signed = TRUE;

integer datasize = 8 << scale;

```

Operation for all classes

```

bits(64) address;
bits(datasize) data;
boolean wb_unknown = FALSE;
boolean rt_unknown = FALSE;

if memop == MemOp_LOAD && wback && n == t && n != 31 then
    c = ConstrainUnpredictable();
    assert c IN {Constraint_WBSUPPRESS, Constraint_UNKNOWN, Constraint_UNDEF, Constraint_NOP};
    case c of
        when Constraint_WBSUPPRESS wback = FALSE; // writeback is suppressed
        when Constraint_UNKNOWN wb_unknown = TRUE; // writeback is UNKNOWN
        when Constraint_UNDEF UnallocatedEncoding();
        when Constraint_NOP EndOfInstruction();

if memop == MemOp_STORE && wback && n == t && n != 31 then
    c = ConstrainUnpredictable();
    assert c IN {Constraint_NONE, Constraint_UNKNOWN, Constraint_UNDEF, Constraint_NOP};
    case c of
        when Constraint_NONE rt_unknown = FALSE; // value stored is original value
        when Constraint_UNKNOWN rt_unknown = TRUE; // value stored is UNKNOWN
        when Constraint_UNDEF UnallocatedEncoding();
        when Constraint_NOP EndOfInstruction();

if n == 31 then
    if memop != MemOp_PREFETCH then CheckSPAlignment();
    address = SP[];
else
    address = X[n];

if ! postindex then
    address = address + offset;

case memop of
    when MemOp_STORE
        if rt_unknown then
            data = bits(datasize) UNKNOWN;
        else
            data = X[t];

```

```
    Mem[address, datasize DIV 8, acctype] = data;

when MemOp_LOAD
    data = Mem[address, datasize DIV 8, acctype];
    if signed then
        X[t] = SignExtend(data, regsize);
    else
        X[t] = ZeroExtend(data, regsize);

when MemOp_PREFETCH
    Prefetch(address, t<4:0>);

if wback then
    if wb_unknown then
        address = bits(64) UNKNOWN;
    elsif postindex then
        address = address + offset;
    if n == 31 then
        SP[] = address;
    else
        X[n] = address;
```

C5.6.183 STRH (register)

Store register halfword (register offset)

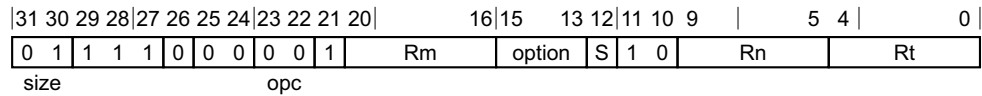

32-bit variant

STRH <Wt>, [<Xn|SP>, <R><m>{, <extend> {<amount>}}]

```

boolean wback = FALSE;
boolean postindex = FALSE;
integer scale = UInt(size);
if option<1> == '0' then UnallocatedEncoding(); // sub-word index
ExtendType extend_type = DecodeRegExtend(option);
integer shift = if S == '1' then scale else 0;

```

Assembler Symbols

<Wt>	Is the 32-bit name of the general-purpose register to be transferred, encoded in the "Rt" field.
<Xn SP>	Is the 64-bit name of the general-purpose base register or stack pointer, encoded in the "Rn" field.
<R>	Is the index width specifier, RESERVED when option = 00x W when option = x10 X when option = x11 RESERVED when option = 10x
<m>	Is the number [0-30] of the general-purpose index register or the name ZR (31), encoded in the "Rm" field.
<extend>	Is the index extend/shift specifier, defaulting to LSL and RESERVED when option = 00x UXTW when option = 010 LSL when option = 011 RESERVED when option = 10x SXTW when option = 110 SXTX when option = 111
<amount>	Is the index shift amount, optional and defaulting to #0 when <extend> is not LSL, #0 when S = 0 #1 when S = 1

Shared decode for all variants

```

integer n = UInt(Rn);
integer t = UInt(Rt);
integer m = UInt(Rm);
AccType acctype = AccType_NORMAL;
MemOp memop;
boolean signed;
integer regsize;

```

```

if opc<1> == '0' then
    // store or zero-extending load
    memop = if opc<0> == '1' then MemOp_LOAD else MemOp_STORE;
    regsize = if size == '11' then 64 else 32;
    signed = FALSE;
else
    if size == '11' then
        memop = MemOp_PREFETCH;
        if opc<0> == '1' then UnallocatedEncoding();
    else
        // sign-extending load
        memop = MemOp_LOAD;
        if size == '10' && opc<0> == '1' then UnallocatedEncoding();
        regsize = if opc<0> == '1' then 32 else 64;
        signed = TRUE;

integer datasize = 8 << scale;

```

Operation

```

bits(64) offset = ExtendReg(m, extend_type, shift);
bits(64) address;
bits(datasize) data;
boolean wb_unknown = FALSE;
boolean rt_unknown = FALSE;

if memop == MemOp_LOAD && wback && n == t && n != 31 then
    c = ConstrainUnpredictable();
    assert c IN {Constraint_WBSUPPRESS, Constraint_UNKNOWN, Constraint_UNDEF, Constraint_NOP};
    case c of
        when Constraint_WBSUPPRESS wback = FALSE; // writeback is suppressed
        when Constraint_UNKNOWN wb_unknown = TRUE; // writeback is UNKNOWN
        when Constraint_UNDEF UnallocatedEncoding();
        when Constraint_NOP EndOfInstruction();

if memop == MemOp_STORE && wback && n == t && n != 31 then
    c = ConstrainUnpredictable();
    assert c IN {Constraint_NONE, Constraint_UNKNOWN, Constraint_UNDEF, Constraint_NOP};
    case c of
        when Constraint_NONE rt_unknown = FALSE; // value stored is original value
        when Constraint_UNKNOWN rt_unknown = TRUE; // value stored is UNKNOWN
        when Constraint_UNDEF UnallocatedEncoding();
        when Constraint_NOP EndOfInstruction();

if n == 31 then
    if memop != MemOp_PREFETCH then CheckSPAlignment();
    address = SP[];
else
    address = X[n];

if ! postindex then
    address = address + offset;

case memop of
    when MemOp_STORE
        if rt_unknown then
            data = bits(datasize) UNKNOWN;
        else
            data = X[t];
            Mem[address, datasize DIV 8, acctype] = data;

    when MemOp_LOAD
        data = Mem[address, datasize DIV 8, acctype];
        if signed then
            X[t] = SignExtend(data, regsize);
        else

```

```
        X[t] = ZeroExtend(data, regsize);  
when MemOp_PREFETCH  
    Prefetch(address, t<4:0>);  
if wback then  
    if wb_unknown then  
        address = bits(64) UNKNOWN;  
    elsif postindex then  
        address = address + offset;  
    if n == 31 then  
        SP[] = address;  
    else  
        X[n] = address;
```

C5.6.184 STTR

Store register (unprivileged)

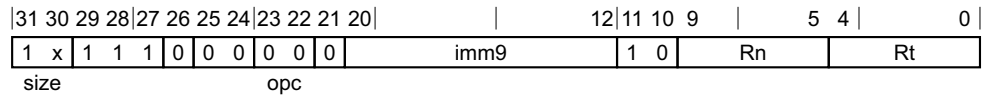

32-bit variant (size = 10)

STTR <Wt>, [<Xn|SP>{, #<sim>}]

64-bit variant (size = 11)

STTR <Xt>, [<Xn|SP>{, #<sim>}]

```
boolean wback = FALSE;
boolean postindex = FALSE;
integer scale = UInt(size);
bits(64) offset = SignExtend(imm9, 64);
```

Assembler Symbols

- <Wt> Is the 32-bit name of the general-purpose register to be transferred, encoded in the "Rt" field.
- <Xt> Is the 64-bit name of the general-purpose register to be transferred, encoded in the "Rt" field.
- <Xn|SP> Is the 64-bit name of the general-purpose base register or stack pointer, encoded in the "Rn" field.
- <sim> Is the optional signed immediate byte offset, in the range -256 to 255, defaulting to 0 and encoded in the "imm9" field.

Shared decode for all variants

```
integer n = UInt(Rn);
integer t = UInt(Rt);
AccType acctype = AccType_UNPRIV;
MemOp memop;
boolean signed;
integer regsize;

if opc<1> == '0' then
    // store or zero-extending load
    memop = if opc<0> == '1' then MemOp_LOAD else MemOp_STORE;
    regsize = if size == '11' then 64 else 32;
    signed = FALSE;
else
    if size == '11' then
        // no unprivileged prefetch
        UnallocatedEncoding();
    else
        // sign-extending load
        memop = MemOp_LOAD;
        if size == '10' && opc<0> == '1' then UnallocatedEncoding();
        regsize = if opc<0> == '1' then 32 else 64;
        signed = TRUE;

integer datasize = 8 << scale;
```

Operation

```

bits(64) address;
bits(datasize) data;
boolean wb_unknown = FALSE;
boolean rt_unknown = FALSE;

if memop == MemOp_LOAD && wback && n == t && n != 31 then
    c = ConstrainUnpredictable();
    assert c IN {Constraint_WBSUPPRESS, Constraint_UNKNOWN, Constraint_UNDEF, Constraint_NOP};
    case c of
        when Constraint_WBSUPPRESS wback = FALSE; // writeback is suppressed
        when Constraint_UNKNOWN wb_unknown = TRUE; // writeback is UNKNOWN
        when Constraint_UNDEF UnallocatedEncoding();
        when Constraint_NOP EndOfInstruction();

if memop == MemOp_STORE && wback && n == t && n != 31 then
    c = ConstrainUnpredictable();
    assert c IN {Constraint_NONE, Constraint_UNKNOWN, Constraint_UNDEF, Constraint_NOP};
    case c of
        when Constraint_NONE rt_unknown = FALSE; // value stored is original value
        when Constraint_UNKNOWN rt_unknown = TRUE; // value stored is UNKNOWN
        when Constraint_UNDEF UnallocatedEncoding();
        when Constraint_NOP EndOfInstruction();

if n == 31 then
    if memop != MemOp_PREFETCH then CheckSPAlignment();
    address = SP[];
else
    address = X[n];

if ! postindex then
    address = address + offset;

case memop of
    when MemOp_STORE
        if rt_unknown then
            data = bits(datasize) UNKNOWN;
        else
            data = X[t];
            Mem[address, datasize DIV 8, acctype] = data;

    when MemOp_LOAD
        data = Mem[address, datasize DIV 8, acctype];
        if signed then
            X[t] = SignExtend(data, regsize);
        else
            X[t] = ZeroExtend(data, regsize);

    when MemOp_PREFETCH
        Prefetch(address, t<4:0>);

if wback then
    if wb_unknown then
        address = bits(64) UNKNOWN;
    elsif postindex then
        address = address + offset;
    if n == 31 then
        SP[] = address;
    else
        X[n] = address;

```

C5.6.185 STTRB

Store register byte (unprivileged)



Unsigned offset variant

STTRB <Wt>, [<Xn|SP>{, #<sim>}]

```
boolean wback = FALSE;
boolean postindex = FALSE;
integer scale = UInt(size);
bits(64) offset = SignExtend(imm9, 64);
```

Assembler Symbols

- <Wt> Is the 32-bit name of the general-purpose register to be transferred, encoded in the "Rt" field.
- <Xn|SP> Is the 64-bit name of the general-purpose base register or stack pointer, encoded in the "Rn" field.
- <sim> Is the optional signed immediate byte offset, in the range -256 to 255, defaulting to 0 and encoded in the "imm9" field.

Shared decode for all variants

```
integer n = UInt(Rn);
integer t = UInt(Rt);
AccType acctype = AccType_UNPRIV;
MemOp memop;
boolean signed;
integer regsize;

if opc<1> == '0' then
  // store or zero-extending load
  memop = if opc<0> == '1' then MemOp_LOAD else MemOp_STORE;
  regsize = if size == '11' then 64 else 32;
  signed = FALSE;
else
  if size == '11' then
    // no unprivileged prefetch
    UnallocatedEncoding();
  else
    // sign-extending load
    memop = MemOp_LOAD;
    if size == '10' && opc<0> == '1' then UnallocatedEncoding();
    regsize = if opc<0> == '1' then 32 else 64;
    signed = TRUE;

integer datasize = 8 << scale;
```

Operation

```
bits(64) address;
bits(datasize) data;
boolean wb_unknown = FALSE;
boolean rt_unknown = FALSE;

if memop == MemOp_LOAD && wback && n == t && n != 31 then
```



```

c = ConstrainUnpredictable();
assert c IN {Constraint_WBSUPPRESS, Constraint_UNKNOWN, Constraint_UNDEF, Constraint_NOP};
case c of
  when Constraint_WBSUPPRESS wback = FALSE; // writeback is suppressed
  when Constraint_UNKNOWN wb_unknown = TRUE; // writeback is UNKNOWN
  when Constraint_UNDEF UnallocatedEncoding();
  when Constraint_NOP EndOfInstruction();

if memop == MemOp_STORE && wback && n == t && n != 31 then
  c = ConstrainUnpredictable();
  assert c IN {Constraint_NONE, Constraint_UNKNOWN, Constraint_UNDEF, Constraint_NOP};
  case c of
    when Constraint_NONE rt_unknown = FALSE; // value stored is original value
    when Constraint_UNKNOWN rt_unknown = TRUE; // value stored is UNKNOWN
    when Constraint_UNDEF UnallocatedEncoding();
    when Constraint_NOP EndOfInstruction();

if n == 31 then
  if memop != MemOp_PREFETCH then CheckSPAlignment();
  address = SP[];
else
  address = X[n];

if ! postindex then
  address = address + offset;

case memop of
  when MemOp_STORE
    if rt_unknown then
      data = bits(datasize) UNKNOWN;
    else
      data = X[t];
      Mem[address, datasize DIV 8, acctype] = data;

  when MemOp_LOAD
    data = Mem[address, datasize DIV 8, acctype];
    if signed then
      X[t] = SignExtend(data, regsize);
    else
      X[t] = ZeroExtend(data, regsize);

  when MemOp_PREFETCH
    Prefetch(address, t<4:0>);

if wback then
  if wb_unknown then
    address = bits(64) UNKNOWN;
  elsif postindex then
    address = address + offset;
  if n == 31 then
    SP[] = address;
  else
    X[n] = address;

```

C5.6.186 STTRH

Store register halfword (unprivileged)

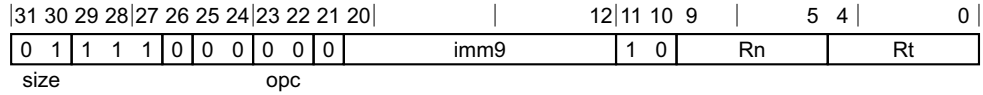

Unsigned offset variant

STTRH <Wt>, [<Xn|SP>{, #<sim>}]

```
boolean wback = FALSE;
boolean postindex = FALSE;
integer scale = UInt(size);
bits(64) offset = SignExtend(imm9, 64);
```

Assembler Symbols

- <Wt> Is the 32-bit name of the general-purpose register to be transferred, encoded in the "Rt" field.
- <Xn|SP> Is the 64-bit name of the general-purpose base register or stack pointer, encoded in the "Rn" field.
- <sim> Is the optional signed immediate byte offset, in the range -256 to 255, defaulting to 0 and encoded in the "imm9" field.

Shared decode for all variants

```
integer n = UInt(Rn);
integer t = UInt(Rt);
AccType acctype = AccType_UNPRIV;
MemOp memop;
boolean signed;
integer regsize;

if opc<1> == '0' then
  // store or zero-extending load
  memop = if opc<0> == '1' then MemOp_LOAD else MemOp_STORE;
  regsize = if size == '11' then 64 else 32;
  signed = FALSE;
else
  if size == '11' then
    // no unprivileged prefetch
    UnallocatedEncoding();
  else
    // sign-extending load
    memop = MemOp_LOAD;
    if size == '10' && opc<0> == '1' then UnallocatedEncoding();
    regsize = if opc<0> == '1' then 32 else 64;
    signed = TRUE;

integer datasize = 8 << scale;
```

Operation

```
bits(64) address;
bits(datasize) data;
boolean wb_unknown = FALSE;
boolean rt_unknown = FALSE;

if memop == MemOp_LOAD && wback && n == t && n != 31 then
```

```

c = ConstrainUnpredictable();
assert c IN {Constraint_WBSUPPRESS, Constraint_UNKNOWN, Constraint_UNDEF, Constraint_NOP};
case c of
  when Constraint_WBSUPPRESS wback = FALSE; // writeback is suppressed
  when Constraint_UNKNOWN wb_unknown = TRUE; // writeback is UNKNOWN
  when Constraint_UNDEF UnallocatedEncoding();
  when Constraint_NOP EndOfInstruction();

if memop == MemOp_STORE && wback && n == t && n != 31 then
  c = ConstrainUnpredictable();
  assert c IN {Constraint_NONE, Constraint_UNKNOWN, Constraint_UNDEF, Constraint_NOP};
  case c of
    when Constraint_NONE rt_unknown = FALSE; // value stored is original value
    when Constraint_UNKNOWN rt_unknown = TRUE; // value stored is UNKNOWN
    when Constraint_UNDEF UnallocatedEncoding();
    when Constraint_NOP EndOfInstruction();

if n == 31 then
  if memop != MemOp_PREFETCH then CheckSPAlignment();
  address = SP[];
else
  address = X[n];

if ! postindex then
  address = address + offset;

case memop of
  when MemOp_STORE
    if rt_unknown then
      data = bits(datasize) UNKNOWN;
    else
      data = X[t];
      Mem[address, datasize DIV 8, acctype] = data;

  when MemOp_LOAD
    data = Mem[address, datasize DIV 8, acctype];
    if signed then
      X[t] = SignExtend(data, regsize);
    else
      X[t] = ZeroExtend(data, regsize);

  when MemOp_PREFETCH
    Prefetch(address, t<4:0>);

if wback then
  if wb_unknown then
    address = bits(64) UNKNOWN;
  elsif postindex then
    address = address + offset;
  if n == 31 then
    SP[] = address;
  else
    X[n] = address;

```

C5.6.187 STUR

Store register (unscaled offset)

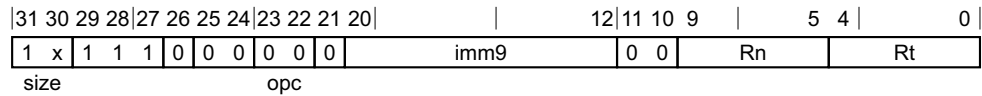

32-bit variant (size = 10)

STUR <Wt>, [<Xn|SP>{, #<sim>}]

64-bit variant (size = 11)

STUR <Xt>, [<Xn|SP>{, #<sim>}]

```
boolean wback = FALSE;
boolean postindex = FALSE;
integer scale = UInt(size);
bits(64) offset = SignExtend(imm9, 64);
```

Assembler Symbols

- <Wt> Is the 32-bit name of the general-purpose register to be transferred, encoded in the "Rt" field.
- <Xt> Is the 64-bit name of the general-purpose register to be transferred, encoded in the "Rt" field.
- <Xn|SP> Is the 64-bit name of the general-purpose base register or stack pointer, encoded in the "Rn" field.
- <sim> Is the optional signed immediate byte offset, in the range -256 to 255, defaulting to 0 and encoded in the "imm9" field.

Shared decode for all variants

```
integer n = UInt(Rn);
integer t = UInt(Rt);
AccType acctype = AccType_NORMAL;
MemOp memop;
boolean signed;
integer regsize;

if opc<1> == '0' then
    // store or zero-extending load
    memop = if opc<0> == '1' then MemOp_LOAD else MemOp_STORE;
    regsize = if size == '11' then 64 else 32;
    signed = FALSE;
else
    if size == '11' then
        memop = MemOp_PREFETCH;
        if opc<0> == '1' then UnallocatedEncoding();
    else
        // sign-extending load
        memop = MemOp_LOAD;
        if size == '10' && opc<0> == '1' then UnallocatedEncoding();
        regsize = if opc<0> == '1' then 32 else 64;
        signed = TRUE;

integer datasize = 8 << scale;
```

Operation

```

bits(64) address;
bits(datasize) data;
boolean wb_unknown = FALSE;
boolean rt_unknown = FALSE;

if memop == MemOp_LOAD && wback && n == t && n != 31 then
    c = ConstrainUnpredictable();
    assert c IN {Constraint_WBSUPPRESS, Constraint_UNKNOWN, Constraint_UNDEF, Constraint_NOP};
    case c of
        when Constraint_WBSUPPRESS wback = FALSE; // writeback is suppressed
        when Constraint_UNKNOWN wb_unknown = TRUE; // writeback is UNKNOWN
        when Constraint_UNDEF UnallocatedEncoding();
        when Constraint_NOP EndOfInstruction();

if memop == MemOp_STORE && wback && n == t && n != 31 then
    c = ConstrainUnpredictable();
    assert c IN {Constraint_NONE, Constraint_UNKNOWN, Constraint_UNDEF, Constraint_NOP};
    case c of
        when Constraint_NONE rt_unknown = FALSE; // value stored is original value
        when Constraint_UNKNOWN rt_unknown = TRUE; // value stored is UNKNOWN
        when Constraint_UNDEF UnallocatedEncoding();
        when Constraint_NOP EndOfInstruction();

if n == 31 then
    if memop != MemOp_PREFETCH then CheckSPAlignment();
    address = SP[];
else
    address = X[n];

if ! postindex then
    address = address + offset;

case memop of
    when MemOp_STORE
        if rt_unknown then
            data = bits(datasize) UNKNOWN;
        else
            data = X[t];
            Mem[address, datasize DIV 8, acctype] = data;

    when MemOp_LOAD
        data = Mem[address, datasize DIV 8, acctype];
        if signed then
            X[t] = SignExtend(data, regsize);
        else
            X[t] = ZeroExtend(data, regsize);

    when MemOp_PREFETCH
        Prefetch(address, t<4:0>);

if wback then
    if wb_unknown then
        address = bits(64) UNKNOWN;
    elsif postindex then
        address = address + offset;
    if n == 31 then
        SP[] = address;
    else
        X[n] = address;

```

C5.6.188 STURB

Store register byte (unscaled offset)

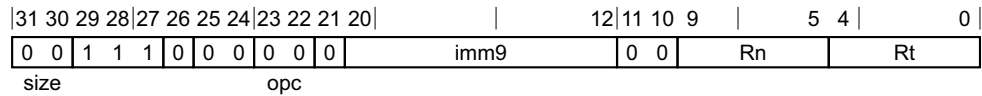

Unsigned offset variant

STURB <Wt>, [<Xn|SP>{, #<sim>}]

```
boolean wback = FALSE;
boolean postindex = FALSE;
integer scale = UInt(size);
bits(64) offset = SignExtend(imm9, 64);
```

Assembler Symbols

- <Wt> Is the 32-bit name of the general-purpose register to be transferred, encoded in the "Rt" field.
- <Xn|SP> Is the 64-bit name of the general-purpose base register or stack pointer, encoded in the "Rn" field.
- <sim> Is the optional signed immediate byte offset, in the range -256 to 255, defaulting to 0 and encoded in the "imm9" field.

Shared decode for all variants

```
integer n = UInt(Rn);
integer t = UInt(Rt);
AccType acctype = AccType_NORMAL;
MemOp memop;
boolean signed;
integer regsize;

if opc<1> == '0' then
    // store or zero-extending load
    memop = if opc<0> == '1' then MemOp_LOAD else MemOp_STORE;
    regsize = if size == '11' then 64 else 32;
    signed = FALSE;
else
    if size == '11' then
        memop = MemOp_PREFETCH;
        if opc<0> == '1' then UnallocatedEncoding();
    else
        // sign-extending load
        memop = MemOp_LOAD;
        if size == '10' && opc<0> == '1' then UnallocatedEncoding();
        regsize = if opc<0> == '1' then 32 else 64;
        signed = TRUE;

integer datasize = 8 << scale;
```

Operation

```
bits(64) address;
bits(datasize) data;
boolean wb_unknown = FALSE;
boolean rt_unknown = FALSE;

if memop == MemOp_LOAD && wback && n == t && n != 31 then
```

```

c = ConstrainUnpredictable();
assert c IN {Constraint_WBSUPPRESS, Constraint_UNKNOWN, Constraint_UNDEF, Constraint_NOP};
case c of
  when Constraint_WBSUPPRESS wback = FALSE; // writeback is suppressed
  when Constraint_UNKNOWN wb_unknown = TRUE; // writeback is UNKNOWN
  when Constraint_UNDEF UnallocatedEncoding();
  when Constraint_NOP EndOfInstruction();

if memop == MemOp_STORE && wback && n == t && n != 31 then
  c = ConstrainUnpredictable();
  assert c IN {Constraint_NONE, Constraint_UNKNOWN, Constraint_UNDEF, Constraint_NOP};
  case c of
    when Constraint_NONE rt_unknown = FALSE; // value stored is original value
    when Constraint_UNKNOWN rt_unknown = TRUE; // value stored is UNKNOWN
    when Constraint_UNDEF UnallocatedEncoding();
    when Constraint_NOP EndOfInstruction();

if n == 31 then
  if memop != MemOp_PREFETCH then CheckSPAlignment();
  address = SP[];
else
  address = X[n];

if ! postindex then
  address = address + offset;

case memop of
  when MemOp_STORE
    if rt_unknown then
      data = bits(datasize) UNKNOWN;
    else
      data = X[t];
      Mem[address, datasize DIV 8, acctype] = data;

  when MemOp_LOAD
    data = Mem[address, datasize DIV 8, acctype];
    if signed then
      X[t] = SignExtend(data, regsize);
    else
      X[t] = ZeroExtend(data, regsize);

  when MemOp_PREFETCH
    Prefetch(address, t<4:0>);

if wback then
  if wb_unknown then
    address = bits(64) UNKNOWN;
  elsif postindex then
    address = address + offset;
  if n == 31 then
    SP[] = address;
  else
    X[n] = address;

```

C5.6.189 STURH

Store register halfword (unscaled offset)

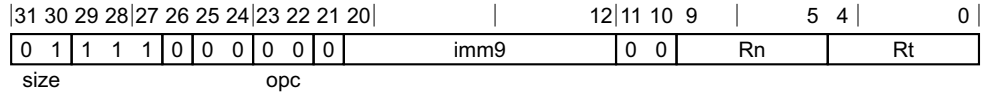

Unsigned offset variant

STURH <Wt>, [<Xn|SP>{, #<sim>}]

```
boolean wback = FALSE;
boolean postindex = FALSE;
integer scale = UInt(size);
bits(64) offset = SignExtend(imm9, 64);
```

Assembler Symbols

- <Wt> Is the 32-bit name of the general-purpose register to be transferred, encoded in the "Rt" field.
- <Xn|SP> Is the 64-bit name of the general-purpose base register or stack pointer, encoded in the "Rn" field.
- <sim> Is the optional signed immediate byte offset, in the range -256 to 255, defaulting to 0 and encoded in the "imm9" field.

Shared decode for all variants

```
integer n = UInt(Rn);
integer t = UInt(Rt);
AccType acctype = AccType_NORMAL;
MemOp memop;
boolean signed;
integer regsize;

if opc<1> == '0' then
    // store or zero-extending load
    memop = if opc<0> == '1' then MemOp_LOAD else MemOp_STORE;
    regsize = if size == '11' then 64 else 32;
    signed = FALSE;
else
    if size == '11' then
        memop = MemOp_PREFETCH;
        if opc<0> == '1' then UnallocatedEncoding();
    else
        // sign-extending load
        memop = MemOp_LOAD;
        if size == '10' && opc<0> == '1' then UnallocatedEncoding();
        regsize = if opc<0> == '1' then 32 else 64;
        signed = TRUE;

integer datasize = 8 << scale;
```

Operation

```
bits(64) address;
bits(datasize) data;
boolean wb_unknown = FALSE;
boolean rt_unknown = FALSE;

if memop == MemOp_LOAD && wback && n == t && n != 31 then
```



```

c = ConstrainUnpredictable();
assert c IN {Constraint_WBSUPPRESS, Constraint_UNKNOWN, Constraint_UNDEF, Constraint_NOP};
case c of
  when Constraint_WBSUPPRESS wback = FALSE; // writeback is suppressed
  when Constraint_UNKNOWN wb_unknown = TRUE; // writeback is UNKNOWN
  when Constraint_UNDEF UnallocatedEncoding();
  when Constraint_NOP EndOfInstruction();

if memop == MemOp_STORE && wback && n == t && n != 31 then
  c = ConstrainUnpredictable();
  assert c IN {Constraint_NONE, Constraint_UNKNOWN, Constraint_UNDEF, Constraint_NOP};
  case c of
    when Constraint_NONE rt_unknown = FALSE; // value stored is original value
    when Constraint_UNKNOWN rt_unknown = TRUE; // value stored is UNKNOWN
    when Constraint_UNDEF UnallocatedEncoding();
    when Constraint_NOP EndOfInstruction();

if n == 31 then
  if memop != MemOp_PREFETCH then CheckSPAlignment();
  address = SP[];
else
  address = X[n];

if ! postindex then
  address = address + offset;

case memop of
  when MemOp_STORE
    if rt_unknown then
      data = bits(datasize) UNKNOWN;
    else
      data = X[t];
      Mem[address, datasize DIV 8, acctype] = data;

  when MemOp_LOAD
    data = Mem[address, datasize DIV 8, acctype];
    if signed then
      X[t] = SignExtend(data, regsize);
    else
      X[t] = ZeroExtend(data, regsize);

  when MemOp_PREFETCH
    Prefetch(address, t<4:0>);

if wback then
  if wb_unknown then
    address = bits(64) UNKNOWN;
  elsif postindex then
    address = address + offset;
  if n == 31 then
    SP[] = address;
  else
    X[n] = address;

```

C5.6.190 STXP

Store exclusive pair of registers, returning status

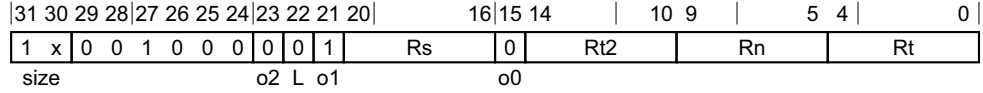

32-bit variant (size = 10)

STXP <Ws>, <Wt1>, <Wt2>, [<Xn|SP>{,#0}]

64-bit variant (size = 11)

STXP <Ws>, <Xt1>, <Xt2>, [<Xn|SP>{,#0}]

```
integer n = UInt(Rn);
integer t = UInt(Rt);
integer t2 = UInt(Rt2); // ignored by load/store single register
integer s = UInt(Rs); // ignored by all loads and store-release
```

```
if o2:o1:o0 == '100' || o2:o1:o0 == '11x' then UnallocatedEncoding();
if o1 == '1' && size<L> == '0' then UnallocatedEncoding();
```

```
AccType acctype = if o0 == '1' then AccType_ORDERED else AccType_ATOMIC;
boolean excl = (o2 == '0');
boolean pair = (o1 == '1');
MemOp memop = if L == '1' then MemOp_LOAD else MemOp_STORE;
integer elsize = 8 << UInt(size);
integer regsize = if elsize == 64 then 64 else 32;
integer datasize = if pair then elsize * 2 else elsize;
```

Assembler Symbols

- <Ws> Is the 32-bit name of the general-purpose register into which the status result of the store exclusive is written, encoded in the "Rs" field.
- <Xt1> Is the 64-bit name of the first general-purpose register to be transferred, encoded in the "Rt" field.
- <Xt2> Is the 64-bit name of the second general-purpose register to be transferred, encoded in the "Rt2" field.
- <Wt1> Is the 32-bit name of the first general-purpose register to be transferred, encoded in the "Rt" field.
- <Wt2> Is the 32-bit name of the second general-purpose register to be transferred, encoded in the "Rt2" field.
- <Xn|SP> Is the 64-bit name of the general-purpose base register or stack pointer, encoded in the "Rn" field.

Operation

```
bits(64) address;
bits(datasize) data;
constant integer dbytes = datasize DIV 8;
boolean rt_unknown = FALSE;
boolean rn_unknown = FALSE;

if memop == MemOp_LOAD && pair && t == t2 then
  Constraint c = ConstrainUnpredictable();
  assert c IN {Constraint_UNKNOWN, Constraint_UNDEF, Constraint_NOP};
  case c of
    when Constraint_UNKNOWN rt_unknown = TRUE; // result is UNKNOWN
```

```

        when Constraint_UNDEF    UnallocatedEncoding();
        when Constraint_NOP      EndOfInstruction();

if memop == MemOp_STORE && excl then
    if s == t || (pair && s == t2) then
        Constraint c = ConstrainUnpredictable();
        assert c IN {Constraint_UNKNOWN, Constraint_NONE, Constraint_UNDEF, Constraint_NOP};
        case c of
            when Constraint_UNKNOWN    rt_unknown = TRUE;    // store UNKNOWN value
            when Constraint_NONE        rt_unknown = FALSE;   // store original value
            when Constraint_UNDEF        UnallocatedEncoding();
            when Constraint_NOP          EndOfInstruction();
        if s == n && n != 31 then
            Constraint c = ConstrainUnpredictable();
            assert c IN {Constraint_UNKNOWN, Constraint_NONE, Constraint_UNDEF, Constraint_NOP};
            case c of
                when Constraint_UNKNOWN    rn_unknown = TRUE;    // address is UNKNOWN
                when Constraint_NONE        rn_unknown = FALSE;   // address is original base
                when Constraint_UNDEF        UnallocatedEncoding();
                when Constraint_NOP          EndOfInstruction();

if n == 31 then
    CheckSPAlignment();
    address = SP[];
elseif rn_unknown then
    address = bits(64) UNKNOWN;
else
    address = X[n];

case memop of
    when MemOp_STORE
        if rt_unknown then
            data = bits(datasize) UNKNOWN;
        elseif pair then
            assert excl;
            bits(datasize DIV 2) e11 = X[t];
            bits(datasize DIV 2) e12 = X[t2];
            data = if BigEndian() then e11 : e12 else e12 : e11;
        else
            data = X[t];

        if excl then
            // store {release} exclusive register|pair (atomic)
            bit status = '1';
            // Check whether the Exclusive Monitors are set to include the
            // physical memory locations corresponding to virtual address
            // range [address, address+dbytes-1].
            if AArch64.ExclusiveMonitorsPass(address, dbytes) then
                // This atomic write will be rejected if it does not refer
                // to the same physical locations after address translation.
                Mem[address, dbytes, acctype] = data;
                status = ExclusiveMonitorsStatus();
                X[s] = ZeroExtend(status, 32);
            else
                // store release register (atomic)
                Mem[address, dbytes, acctype] = data;

    when MemOp_LOAD
        if excl then
            // Tell the Exclusive Monitors to record a sequence of one or more atomic
            // memory reads from virtual address range [address, address+dbytes-1].
            // The Exclusive Monitor will only be set if all the reads are from the
            // same dbytes-aligned physical address, to allow for the possibility of
            // an atomicity break if the translation is changed between reads.
            AArch64.SetExclusiveMonitors(address, dbytes);

        if pair then
            // load exclusive pair

```

```
assert excl;
if rt_unknown then
  // ConstrainedUNPREDICTABLE case
  X[t] = bits(datasize) UNKNOWN;
elseif elsize == 32 then
  // 32-bit load exclusive pair (atomic)
  data = Mem[address, dbytes, acctype];
  if BigEndian() then
    X[t] = data<datasize-1:elsize>;
    X[t2] = data<elsize-1:0>;
  else
    X[t] = data<elsize-1:0>;
    X[t2] = data<datasize-1:elsize>;
else // elsize == 64
  // 64-bit load exclusive pair (not atomic),
  // but must be 128-bit aligned
  if address != Align(address, dbytes) then
    iswrite = FALSE;
    secondstage = FALSE;
    AArch64.Abort(address, AArch64.AlignmentFault(acctype, iswrite, secondstage));
  X[t] = Mem[address + 0, 8, acctype];
  X[t2] = Mem[address + 8, 8, acctype];
else
  // load {acquire} {exclusive} single register
  data = Mem[address, dbytes, acctype];
  X[t] = ZeroExtend(data, regsize);
```

C5.6.191 STXR

Store exclusive register, returning status

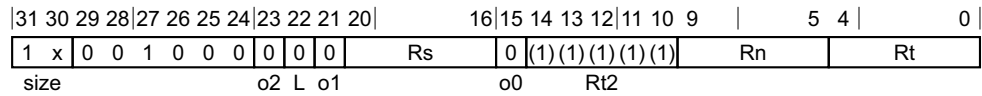

32-bit variant (size = 10)

STXR <Ws>, <Wt>, [<Xn|SP>{,#0}]

64-bit variant (size = 11)

STXR <Ws>, <Xt>, [<Xn|SP>{,#0}]

```
integer n = UInt(Rn);
integer t = UInt(Rt);
integer t2 = UInt(Rt2); // ignored by load/store single register
integer s = UInt(Rs); // ignored by all loads and store-release
```

```
if o2:o1:o0 == '100' || o2:o1:o0 == '11x' then UnallocatedEncoding();
if o1 == '1' && size<L> == '0' then UnallocatedEncoding();
```

```
AccType acctype = if o0 == '1' then AccType_ORDERED else AccType_ATOMIC;
boolean excl = (o2 == '0');
boolean pair = (o1 == '1');
MemOp memop = if L == '1' then MemOp_LOAD else MemOp_STORE;
integer elsize = 8 << UInt(size);
integer regsize = if elsize == 64 then 64 else 32;
integer datasize = if pair then elsize * 2 else elsize;
```

Assembler Symbols

- <Ws> Is the 32-bit name of the general-purpose register into which the status result of the store exclusive is written, encoded in the "Rs" field.
- <Xt> Is the 64-bit name of the general-purpose register to be transferred, encoded in the "Rt" field.
- <Wt> Is the 32-bit name of the general-purpose register to be transferred, encoded in the "Rt" field.
- <Xn|SP> Is the 64-bit name of the general-purpose base register or stack pointer, encoded in the "Rn" field.

Operation

```
bits(64) address;
bits(datasize) data;
constant integer dbytes = datasize DIV 8;
boolean rt_unknown = FALSE;
boolean rn_unknown = FALSE;

if memop == MemOp_LOAD && pair && t == t2 then
    Constraint c = ConstrainUnpredictable();
    assert c IN {Constraint_UNKNOWN, Constraint_UNDEF, Constraint_NOP};
    case c of
        when Constraint_UNKNOWN    rt_unknown = TRUE; // result is UNKNOWN
        when Constraint_UNDEF       UnallocatedEncoding();
        when Constraint_NOP         EndOfInstruction();

if memop == MemOp_STORE && excl then
    if s == t || (pair && s == t2) then
        Constraint c = ConstrainUnpredictable();
        assert c IN {Constraint_UNKNOWN, Constraint_NONE, Constraint_UNDEF, Constraint_NOP};
```

```

    case c of
        when Constraint_UNKNOWN    rt_unknown = TRUE;    // store UNKNOWN value
        when Constraint_NONE       rt_unknown = FALSE;    // store original value
        when Constraint_UNDEF     UnallocatedEncoding();
        when Constraint_NOP       EndOfInstruction();
    if s == n && n != 31 then
        Constraint c = ConstrainUnpredictable();
    assert c IN {Constraint_UNKNOWN, Constraint_NONE, Constraint_UNDEF, Constraint_NOP};
    case c of
        when Constraint_UNKNOWN    rn_unknown = TRUE;    // address is UNKNOWN
        when Constraint_NONE       rn_unknown = FALSE;    // address is original base
        when Constraint_UNDEF     UnallocatedEncoding();
        when Constraint_NOP       EndOfInstruction();

    if n == 31 then
        CheckSPAAlignment();
        address = SP[];
    elseif rn_unknown then
        address = bits(64) UNKNOWN;
    else
        address = X[n];

    case memop of
        when MemOp_STORE
            if rt_unknown then
                data = bits(datasize) UNKNOWN;
            elseif pair then
                assert excl;
                bits(datasize DIV 2) e11 = X[t];
                bits(datasize DIV 2) e12 = X[t2];
                data = if BigEndian() then e11 : e12 else e12 : e11;
            else
                data = X[t];

            if excl then
                // store {release} exclusive register|pair (atomic)
                bit status = '1';
                // Check whether the Exclusive Monitors are set to include the
                // physical memory locations corresponding to virtual address
                // range [address, address+dbytes-1].
                if AArch64.ExclusiveMonitorsPass(address, dbytes) then
                    // This atomic write will be rejected if it does not refer
                    // to the same physical locations after address translation.
                    Mem[address, dbytes, acctype] = data;
                    status = ExclusiveMonitorsStatus();
                    X[s] = ZeroExtend(status, 32);
                else
                    // store release register (atomic)
                    Mem[address, dbytes, acctype] = data;

        when MemOp_LOAD
            if excl then
                // Tell the Exclusive Monitors to record a sequence of one or more atomic
                // memory reads from virtual address range [address, address+dbytes-1].
                // The Exclusive Monitor will only be set if all the reads are from the
                // same dbytes-aligned physical address, to allow for the possibility of
                // an atomicity break if the translation is changed between reads.
                AArch64.SetExclusiveMonitors(address, dbytes);

            if pair then
                // load exclusive pair
                assert excl;
                if rt_unknown then
                    // ConstrainedUNPREDICTABLE case
                    X[t] = bits(datasize) UNKNOWN;
                elseif elsize == 32 then
                    // 32-bit load exclusive pair (atomic)
                    data = Mem[address, dbytes, acctype];

```

```
if BigEndian() then
    X[t] = data<datasize-1:elsize>;
    X[t2] = data<elsize-1:0>;
else
    X[t] = data<elsize-1:0>;
    X[t2] = data<datasize-1:elsize>;
else // elsize == 64
    // 64-bit load exclusive pair (not atomic),
    // but must be 128-bit aligned
    if address != Align(address, dbytes) then
        iswrite = FALSE;
        secondstage = FALSE;
        AArch64.Abort(address, AArch64.AlignmentFault(acctype, iswrite, secondstage));
    X[t] = Mem[address + 0, 8, acctype];
    X[t2] = Mem[address + 8, 8, acctype];
else
    // load {acquire} {exclusive} single register
    data = Mem[address, dbytes, acctype];
    X[t] = ZeroExtend(data, regsize);
```

C5.6.192 STXRB

Store exclusive register byte, returning status

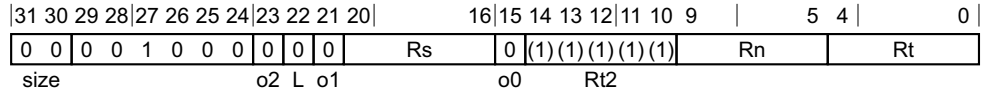

No offset variant

STXRB <Ws>, <Wt>, [<Xn|SP>{, #0}]

```
integer n = UInt(Rn);
integer t = UInt(Rt);
integer t2 = UInt(Rt2); // ignored by load/store single register
integer s = UInt(Rs); // ignored by all loads and store-release
```

```
if o2:o1:o0 == '100' || o2:o1:o0 == '11x' then UnallocatedEncoding();
if o1 == '1' && size<l> == '0' then UnallocatedEncoding();
```

```
AccType acctype = if o0 == '1' then AccType_ORDERED else AccType_ATOMIC;
boolean excl = (o2 == '0');
boolean pair = (o1 == '1');
MemOp memop = if L == '1' then MemOp_LOAD else MemOp_STORE;
integer elsize = 8 << UInt(size);
integer regsize = if elsize == 64 then 64 else 32;
integer datasize = if pair then elsize * 2 else elsize;
```

Assembler Symbols

- <Ws> Is the 32-bit name of the general-purpose register into which the status result of the store exclusive is written, encoded in the "Rs" field.
- <Wt> Is the 32-bit name of the general-purpose register to be transferred, encoded in the "Rt" field.
- <Xn|SP> Is the 64-bit name of the general-purpose base register or stack pointer, encoded in the "Rn" field.

Operation

```
bits(64) address;
bits(datasize) data;
constant integer dbytes = datasize DIV 8;
boolean rt_unknown = FALSE;
boolean rn_unknown = FALSE;

if memop == MemOp_LOAD && pair && t == t2 then
  Constraint c = ConstrainUnpredictable();
  assert c IN {Constraint_UNKNOWN, Constraint_UNDEF, Constraint_NOP};
  case c of
    when Constraint_UNKNOWN rt_unknown = TRUE; // result is UNKNOWN
    when Constraint_UNDEF UnallocatedEncoding();
    when Constraint_NOP EndOfInstruction();

if memop == MemOp_STORE && excl then
  if s == t || (pair && s == t2) then
    Constraint c = ConstrainUnpredictable();
    assert c IN {Constraint_UNKNOWN, Constraint_NONE, Constraint_UNDEF, Constraint_NOP};
    case c of
      when Constraint_UNKNOWN rt_unknown = TRUE; // store UNKNOWN value
      when Constraint_NONE rt_unknown = FALSE; // store original value
      when Constraint_UNDEF UnallocatedEncoding();
      when Constraint_NOP EndOfInstruction();
```



```

if s == n && n != 31 then
    Constraint c = ConstrainUnpredictable();
    assert c IN {Constraint_UNKNOWN, Constraint_NONE, Constraint_UNDEF, Constraint_NOP};
    case c of
        when Constraint_UNKNOWN    rn_unknown = TRUE;    // address is UNKNOWN
        when Constraint_NONE        rn_unknown = FALSE;   // address is original base
        when Constraint_UNDEF        UnallocatedEncoding();
        when Constraint_NOP          EndOfInstruction();

if n == 31 then
    CheckSPAAlignment();
    address = SP[];
elseif rn_unknown then
    address = bits(64) UNKNOWN;
else
    address = X[n];

case memop of
    when MemOp_STORE
        if rt_unknown then
            data = bits(datasize) UNKNOWN;
        elseif pair then
            assert excl;
            bits(datasize DIV 2) e11 = X[t];
            bits(datasize DIV 2) e12 = X[t2];
            data = if BigEndian() then e11 : e12 else e12 : e11;
        else
            data = X[t];

        if excl then
            // store {release} exclusive register|pair (atomic)
            bit status = '1';
            // Check whether the Exclusive Monitors are set to include the
            // physical memory locations corresponding to virtual address
            // range [address, address+dbytes-1].
            if AArch64.ExclusiveMonitorsPass(address, dbytes) then
                // This atomic write will be rejected if it does not refer
                // to the same physical locations after address translation.
                Mem[address, dbytes, acctype] = data;
                status = ExclusiveMonitorsStatus();
                X[s] = ZeroExtend(status, 32);
            else
                // store release register (atomic)
                Mem[address, dbytes, acctype] = data;

    when MemOp_LOAD
        if excl then
            // Tell the Exclusive Monitors to record a sequence of one or more atomic
            // memory reads from virtual address range [address, address+dbytes-1].
            // The Exclusive Monitor will only be set if all the reads are from the
            // same dbytes-aligned physical address, to allow for the possibility of
            // an atomicity break if the translation is changed between reads.
            AArch64.SetExclusiveMonitors(address, dbytes);

        if pair then
            // load exclusive pair
            assert excl;
            if rt_unknown then
                // ConstrainedUNPREDICTABLE case
                X[t] = bits(datasize) UNKNOWN;
            elseif elsize == 32 then
                // 32-bit load exclusive pair (atomic)
                data = Mem[address, dbytes, acctype];
                if BigEndian() then
                    X[t] = data<datasize-1:elsize>;
                    X[t2] = data<elsize-1:0>;
                else
                    X[t] = data<elsize-1:0>;

```

```
        X[t2] = data<datasize-1:elsize>;
else // elsize == 64
    // 64-bit load exclusive pair (not atomic),
    // but must be 128-bit aligned
    if address != Align(address, dbytes) then
        iswrite = FALSE;
        secondstage = FALSE;
        AArch64.Abort(address, AArch64.AlignmentFault(acctype, iswrite, secondstage));
    X[t] = Mem[address + 0, 8, acctype];
    X[t2] = Mem[address + 8, 8, acctype];
else
    // load {acquire} {exclusive} single register
    data = Mem[address, dbytes, acctype];
    X[t] = ZeroExtend(data, regsize);
```



```

if s == n && n != 31 then
    Constraint c = ConstrainUnpredictable();
    assert c IN {Constraint_UNKNOWN, Constraint_NONE, Constraint_UNDEF, Constraint_NOP};
    case c of
        when Constraint_UNKNOWN    rn_unknown = TRUE;    // address is UNKNOWN
        when Constraint_NONE        rn_unknown = FALSE;   // address is original base
        when Constraint_UNDEF        UnallocatedEncoding();
        when Constraint_NOP          EndOfInstruction();

if n == 31 then
    CheckSPAAlignment();
    address = SP[];
elseif rn_unknown then
    address = bits(64) UNKNOWN;
else
    address = X[n];

case memop of
    when MemOp_STORE
        if rt_unknown then
            data = bits(datasize) UNKNOWN;
        elseif pair then
            assert excl;
            bits(datasize DIV 2) e11 = X[t];
            bits(datasize DIV 2) e12 = X[t2];
            data = if BigEndian() then e11 : e12 else e12 : e11;
        else
            data = X[t];

        if excl then
            // store {release} exclusive register|pair (atomic)
            bit status = '1';
            // Check whether the Exclusive Monitors are set to include the
            // physical memory locations corresponding to virtual address
            // range [address, address+dbytes-1].
            if AArch64.ExclusiveMonitorsPass(address, dbytes) then
                // This atomic write will be rejected if it does not refer
                // to the same physical locations after address translation.
                Mem[address, dbytes, acctype] = data;
                status = ExclusiveMonitorsStatus();
                X[s] = ZeroExtend(status, 32);
            else
                // store release register (atomic)
                Mem[address, dbytes, acctype] = data;

    when MemOp_LOAD
        if excl then
            // Tell the Exclusive Monitors to record a sequence of one or more atomic
            // memory reads from virtual address range [address, address+dbytes-1].
            // The Exclusive Monitor will only be set if all the reads are from the
            // same dbytes-aligned physical address, to allow for the possibility of
            // an atomicity break if the translation is changed between reads.
            AArch64.SetExclusiveMonitors(address, dbytes);

        if pair then
            // load exclusive pair
            assert excl;
            if rt_unknown then
                // ConstrainedUNPREDICTABLE case
                X[t] = bits(datasize) UNKNOWN;
            elseif elsize == 32 then
                // 32-bit load exclusive pair (atomic)
                data = Mem[address, dbytes, acctype];
                if BigEndian() then
                    X[t] = data<datasize-1:elsize>;
                    X[t2] = data<elsize-1:0>;
                else
                    X[t] = data<elsize-1:0>;

```

```
        X[t2] = data<datasize-1:elsize>;
else // elsize == 64
    // 64-bit load exclusive pair (not atomic),
    // but must be 128-bit aligned
    if address != Align(address, dbytes) then
        iswrite = FALSE;
        secondstage = FALSE;
        AArch64.Abort(address, AArch64.AlignmentFault(acctype, iswrite, secondstage));
    X[t] = Mem[address + 0, 8, acctype];
    X[t2] = Mem[address + 8, 8, acctype];
else
    // load {acquire} {exclusive} single register
    data = Mem[address, dbytes, acctype];
    X[t] = ZeroExtend(data, regsize);
```

C5.6.194 SUB (extended register)

Subtract (extended register): $Rd = Rn - LSL(\text{extend}(Rm), \text{amount})$

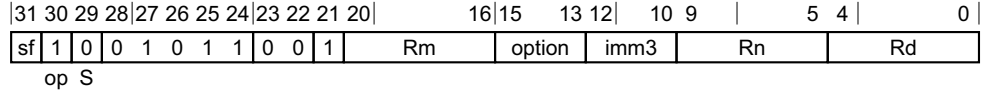

32-bit variant (sf = 0)

SUB <Wd|WSP>, <Wn|WSP>, <Wm>{, <extend> {#<amount>}}

64-bit variant (sf = 1)

SUB <Xd|SP>, <Xn|SP>, <R><m>{, <extend> {#<amount>}}

```
integer d = UInt(Rd);
integer n = UInt(Rn);
integer m = UInt(Rm);
integer datasize = if sf == '1' then 64 else 32;
boolean sub_op = (op == '1');
boolean setflags = (S == '1');
ExtendType extend_type = DecodeRegExtend(option);
integer shift = UInt(imm3);
if shift > 4 then ReservedValue();
```

Assembler Symbols

- <Wd|WSP> Is the 32-bit name of the destination general-purpose register or stack pointer, encoded in the "Rd" field.
- <Wn|WSP> Is the 32-bit name of the first source general-purpose register or stack pointer, encoded in the "Rn" field.
- <Wm> Is the 32-bit name of the second general-purpose source register, encoded in the "Rm" field.
- <Xd|SP> Is the 64-bit name of the destination general-purpose register or stack pointer, encoded in the "Rd" field.
- <Xn|SP> Is the 64-bit name of the first source general-purpose register or stack pointer, encoded in the "Rn" field.
- <R> Is a width specifier,
 - W** when option = 00x
 - W** when option = 010
 - X** when option = x11
 - W** when option = 10x
 - W** when option = 110
- <m> Is the number [0-30] of the second general-purpose source register or the name ZR (31), encoded in the "Rm" field.
- <extend> For the 32-bit variant: is the extension to be applied to the second source operand,
 - UXTB** when option = 000
 - UXTH** when option = 001
 - LSL|UXTW** when option = 010
 - UXTX** when option = 011

SXTB when option = 100
SXTH when option = 101
SXTW when option = 110
SXTX when option = 111

The LSL form can only be used when at least one of "Rd" or "Rn" is '11111' (i.e. WSP) and in that case is also the default. In all other cases <extend> must be present.

<extend> For the 64-bit variant: is the extension to be applied to the second source operand,

UXTB when option = 000
UXTH when option = 001
UXTW when option = 010
LSL|UXTX when option = 011
SXTB when option = 100
SXTH when option = 101
SXTW when option = 110
SXTX when option = 111

The LSL form can only be used when at least one of "Rd" or "Rn" is '11111' (i.e. SP) and in that case is also the default. In all other cases <extend> must be present.

<amount> Is the left shift amount in the range 0 to 4, which is optional with a default of 0 when <extend> is not LSL, encoded in the "imm3" field.

Operation

```

bits(datasize) result;
bits(datasize) operand1 = if n == 31 then SP[] else X[n];
bits(datasize) operand2 = ExtendReg(m, extend_type, shift);
bits(4) nzcvc;
bit carry_in;

if sub_op then
    operand2 = NOT(operand2);
    carry_in = '1';
else
    carry_in = '0';

(result, nzcvc) = AddWithCarry(operand1, operand2, carry_in);

if setflags then
    PSTATE.<N,Z,C,V> = nzcvc;

if d == 31 && !setflags then
    SP[] = result;
else
    X[d] = result;
  
```

C5.6.195 SUB (immediate)

Subtract (immediate): $Rd = Rn - \text{shift}(\text{imm})$

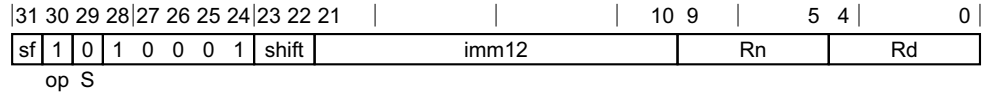

32-bit variant (sf = 0)

SUB <Wd|WSP>, <Wn|WSP>, #<imm>{, <shift>}

64-bit variant (sf = 1)

SUB <Xd|SP>, <Xn|SP>, #<imm>{, <shift>}

```
integer d = UInt(Rd);
integer n = UInt(Rn);
integer datasize = if sf == '1' then 64 else 32;
boolean sub_op = (op == '1');
boolean setflags = (S == '1');
bits(datasize) imm;

case shift of
  when '00' imm = ZeroExtend(imm12, datasize);
  when '01' imm = ZeroExtend(imm12 : Zeros(12), datasize);
  when '1x' ReservedValue();
```

Assembler Symbols

- <Wd|WSP> Is the 32-bit name of the destination general-purpose register or stack pointer, encoded in the "Rd" field.
- <Wn|WSP> Is the 32-bit name of the source general-purpose register or stack pointer, encoded in the "Rn" field.
- <Xd|SP> Is the 64-bit name of the destination general-purpose register or stack pointer, encoded in the "Rd" field.
- <Xn|SP> Is the 64-bit name of the source general-purpose register or stack pointer, encoded in the "Rn" field.
- <imm> Is an unsigned immediate, in the range 0 to 4095, encoded in the "imm12" field.
- <shift> Is the optional left shift to apply to the immediate, defaulting to LSL #0 and
 - LSL #0** when shift = 00
 - LSL #12** when shift = 01
 - RESERVED** when shift = 1x

Operation

```
bits(datasize) result;
bits(datasize) operand1 = if n == 31 then SP[] else X[n];
bits(datasize) operand2 = imm;
bits(4) nzcvc;
bit carry_in;

if sub_op then
  operand2 = NOT(operand2);
  carry_in = '1';
else
  carry_in = '0';
```



```
(result, nzcvc) = AddWithCarry(operand1, operand2, carry_in);  
  
if setflags then  
    PSTATE.<N,Z,C,V> = nzcvc;  
  
if d == 31 && !setflags then  
    SP[] = result;  
else  
    X[d] = result;
```

C5.6.196 SUB (shifted register)

Subtract (shifted register): $Rd = Rn - \text{shift}(Rm, \text{amount})$

This instruction is used by the alias [NEG](#). See the *Alias conditions* table for details of when each alias is preferred.

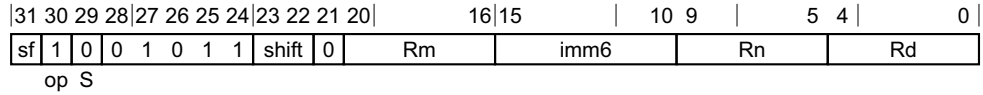

32-bit variant (sf = 0)

SUB <Wd>, <Wn>, <Wm>{, <shift> #<amount>}

64-bit variant (sf = 1)

SUB <Xd>, <Xn>, <Xm>{, <shift> #<amount>}

```
integer d = UInt(Rd);
integer n = UInt(Rn);
integer m = UInt(Rm);
integer datasize = if sf == '1' then 64 else 32;
boolean sub_op = (op == '1');
boolean setflags = (S == '1');

if shift == '11' then ReservedValue();
if sf == '0' && imm6<5> == '1' then ReservedValue();

ShiftType shift_type = DecodeShift(shift);
integer shift_amount = UInt(imm6);
```

Alias conditions

Alias	is preferred when
NEG	Rn == '11111'

Assembler Symbols

- <Wd> Is the 32-bit name of the general-purpose destination register, encoded in the "Rd" field.
- <Wn> Is the 32-bit name of the first general-purpose source register, encoded in the "Rn" field.
- <Wm> Is the 32-bit name of the second general-purpose source register, encoded in the "Rm" field.
- <Xd> Is the 64-bit name of the general-purpose destination register, encoded in the "Rd" field.
- <Xn> Is the 64-bit name of the first general-purpose source register, encoded in the "Rn" field.
- <Xm> Is the 64-bit name of the second general-purpose source register, encoded in the "Rm" field.
- <shift> Is the optional shift type to be applied to the second source operand, defaulting to LSL and
 - LSL** when shift = 00
 - LSR** when shift = 01
 - ASR** when shift = 10
 - RESERVED** when shift = 11
- <amount> For the 32-bit variant: is the shift amount, in the range 0 to 31, defaulting to 0 and encoded in the "imm6" field.

<amount> For the 64-bit variant: is the shift amount, in the range 0 to 63, defaulting to 0 and encoded in the "imm6" field.

Operation

```
bits(datasize) result;
bits(datasize) operand1 = X[n];
bits(datasize) operand2 = ShiftReg(m, shift_type, shift_amount);
bits(4) nzcvc;
bit carry_in;

if sub_op then
    operand2 = NOT(operand2);
    carry_in = '1';
else
    carry_in = '0';

(result, nzcvc) = AddWithCarry(operand1, operand2, carry_in);

if setflags then
    PSTATE.<N,Z,C,V> = nzcvc;

X[d] = result;
```

C5.6.197 SUBS (extended register)

Subtract (extended register), setting the condition flags: $Rd = Rn - LSL(\text{extend}(Rm), \text{amount})$

This instruction is used by the alias [CMP \(extended register\)](#). See the *Alias conditions* table for details of when each alias is preferred.

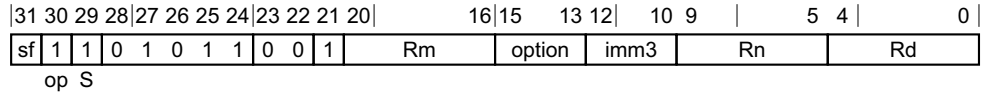

32-bit variant (sf = 0)

SUBS <Wd>, <Wn|WSP>, <Wm>{, <extend> {#<amount>}}

64-bit variant (sf = 1)

SUBS <Xd>, <Xn|SP>, <R><m>{, <extend> {#<amount>}}

```
integer d = UInt(Rd);
integer n = UInt(Rn);
integer m = UInt(Rm);
integer datasize = if sf == '1' then 64 else 32;
boolean sub_op = (op == '1');
boolean setflags = (S == '1');
ExtendType extend_type = DecodeRegExtend(option);
integer shift = UInt(imm3);
if shift > 4 then ReservedValue();
```

Alias conditions

Alias	is preferred when
CMP (extended register)	Rd == '11111'

Assembler Symbols

<Wd>	Is the 32-bit name of the general-purpose destination register, encoded in the "Rd" field.										
<Wn WSP>	Is the 32-bit name of the first source general-purpose register or stack pointer, encoded in the "Rn" field.										
<Wm>	Is the 32-bit name of the second general-purpose source register, encoded in the "Rm" field.										
<Xd>	Is the 64-bit name of the general-purpose destination register, encoded in the "Rd" field.										
<Xn SP>	Is the 64-bit name of the first source general-purpose register or stack pointer, encoded in the "Rn" field.										
<R>	Is a width specifier, <table style="margin-left: 20px; border-collapse: collapse;"> <tr><td>W</td><td>when option = 00x</td></tr> <tr><td>W</td><td>when option = 010</td></tr> <tr><td>X</td><td>when option = x11</td></tr> <tr><td>W</td><td>when option = 10x</td></tr> <tr><td>W</td><td>when option = 110</td></tr> </table>	W	when option = 00x	W	when option = 010	X	when option = x11	W	when option = 10x	W	when option = 110
W	when option = 00x										
W	when option = 010										
X	when option = x11										
W	when option = 10x										
W	when option = 110										
<m>	Is the number [0-30] of the second general-purpose source register or the name ZR (31), encoded in the "Rm" field.										

- <extend> For the 32-bit variant: is the extension to be applied to the second source operand,
- UXTB** when option = 000
 - UXTH** when option = 001
 - LSL|UXTW** when option = 010
 - UXTX** when option = 011
 - SXTB** when option = 100
 - SXTH** when option = 101
 - SXTW** when option = 110
 - SXTX** when option = 111
- The LSL form can only be used when "Rn" is '11111' (i.e. WSP) and in that case is also the default. In all other cases <extend> must be present.
- <extend> For the 64-bit variant: is the extension to be applied to the second source operand,
- UXTB** when option = 000
 - UXTH** when option = 001
 - UXTW** when option = 010
 - LSL|UXTX** when option = 011
 - SXTB** when option = 100
 - SXTH** when option = 101
 - SXTW** when option = 110
 - SXTX** when option = 111
- The LSL form can only be used when "Rn" is '11111' (i.e. SP) and in that case is also the default. In all other cases <extend> must be present.
- <amount> Is the left shift amount in the range 0 to 4, which is optional with a default of 0 when <extend> is not LSL, encoded in the "imm3" field.

Operation

```

bits(datasize) result;
bits(datasize) operand1 = if n == 31 then SP[] else X[n];
bits(datasize) operand2 = ExtendReg(m, extend_type, shift);
bits(4) nzcvc;
bit carry_in;

if sub_op then
    operand2 = NOT(operand2);
    carry_in = '1';
else
    carry_in = '0';

(result, nzcvc) = AddWithCarry(operand1, operand2, carry_in);

if setflags then
    PSTATE.<N,Z,C,V> = nzcvc;

if d == 31 && !setflags then
    SP[] = result;
else
    X[d] = result;
  
```

C5.6.198 SUBS (immediate)

Subtract (immediate), setting the condition flags: $Rd = Rn - \text{shift}(\text{imm})$

This instruction is used by the alias [CMP \(immediate\)](#). See the *Alias conditions* table for details of when each alias is preferred.

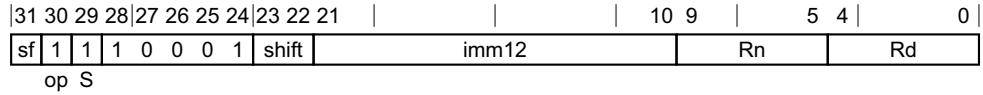

32-bit variant (sf = 0)

SUBS <Wd>, <Wn|WSP>, #<imm>{, <shift>}

64-bit variant (sf = 1)

SUBS <Xd>, <Xn|SP>, #<imm>{, <shift>}

```
integer d = UInt(Rd);
integer n = UInt(Rn);
integer datasize = if sf == '1' then 64 else 32;
boolean sub_op = (op == '1');
boolean setflags = (S == '1');
bits(datasize) imm;

case shift of
  when '00' imm = ZeroExtend(imm12, datasize);
  when '01' imm = ZeroExtend(imm12 : Zeros(12), datasize);
  when '1x' ReservedValue();
```

Alias conditions

Alias	is preferred when
CMP (immediate)	$Rd == '11111'$

Assembler Symbols

- <Wd> Is the 32-bit name of the general-purpose destination register, encoded in the "Rd" field.
- <Wn|WSP> Is the 32-bit name of the source general-purpose register or stack pointer, encoded in the "Rn" field.
- <Xd> Is the 64-bit name of the general-purpose destination register, encoded in the "Rd" field.
- <Xn|SP> Is the 64-bit name of the source general-purpose register or stack pointer, encoded in the "Rn" field.
- <imm> Is an unsigned immediate, in the range 0 to 4095, encoded in the "imm12" field.
- <shift> Is the optional left shift to apply to the immediate, defaulting to LSL #0 and
 - LSL #0** when shift = 00
 - LSL #12** when shift = 01
 - RESERVED** when shift = 1x

Operation

```
bits(datasize) result;
bits(datasize) operand1 = if n == 31 then SP[] else X[n];
bits(datasize) operand2 = imm;
```

```
bits(4) nzcvc;  
bit carry_in;  
  
if sub_op then  
    operand2 = NOT(operand2);  
    carry_in = '1';  
else  
    carry_in = '0';  
  
(result, nzcvc) = AddWithCarry(operand1, operand2, carry_in);  
  
if setflags then  
    PSTATE.<N,Z,C,V> = nzcvc;  
  
if d == 31 && !setflags then  
    SP[] = result;  
else  
    X[d] = result;
```

C5.6.199 SUBS (shifted register)

Subtract (shifted register), setting the condition flags: $Rd = Rn - \text{shift}(Rm, \text{amount})$

This instruction is used by the aliases [CMP \(shifted register\)](#) and [NEGS](#). See the *Alias conditions* table for details of when each alias is preferred.

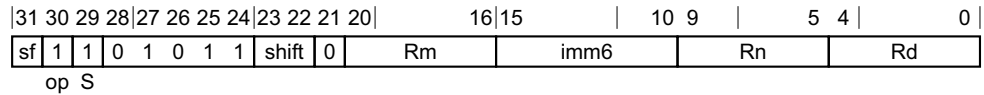

32-bit variant (sf = 0)

SUBS <Wd>, <Wn>, <Wm>{, <shift> #<amount>}

64-bit variant (sf = 1)

SUBS <Xd>, <Xn>, <Xm>{, <shift> #<amount>}

```
integer d = UInt(Rd);
integer n = UInt(Rn);
integer m = UInt(Rm);
integer datasize = if sf == '1' then 64 else 32;
boolean sub_op = (op == '1');
boolean setflags = (S == '1');

if shift == '11' then ReservedValue();
if sf == '0' && imm6<5> == '1' then ReservedValue();

ShiftType shift_type = DecodeShift(shift);
integer shift_amount = UInt(imm6);
```

Alias conditions

Alias	is preferred when
CMP (shifted register)	Rd == '11111'
NEGS	Rn == '11111'

Assembler Symbols

<Wd>	Is the 32-bit name of the general-purpose destination register, encoded in the "Rd" field.								
<Wn>	Is the 32-bit name of the first general-purpose source register, encoded in the "Rn" field.								
<Wm>	Is the 32-bit name of the second general-purpose source register, encoded in the "Rm" field.								
<Xd>	Is the 64-bit name of the general-purpose destination register, encoded in the "Rd" field.								
<Xn>	Is the 64-bit name of the first general-purpose source register, encoded in the "Rn" field.								
<Xm>	Is the 64-bit name of the second general-purpose source register, encoded in the "Rm" field.								
<shift>	Is the optional shift type to be applied to the second source operand, defaulting to LSL and <table style="margin-left: 20px; border-collapse: collapse;"> <tr><td>LSL</td><td>when shift = 00</td></tr> <tr><td>LSR</td><td>when shift = 01</td></tr> <tr><td>ASR</td><td>when shift = 10</td></tr> <tr><td>RESERVED</td><td>when shift = 11</td></tr> </table>	LSL	when shift = 00	LSR	when shift = 01	ASR	when shift = 10	RESERVED	when shift = 11
LSL	when shift = 00								
LSR	when shift = 01								
ASR	when shift = 10								
RESERVED	when shift = 11								

- <amount> For the 32-bit variant: is the shift amount, in the range 0 to 31, defaulting to 0 and encoded in the "imm6" field.
- <amount> For the 64-bit variant: is the shift amount, in the range 0 to 63, defaulting to 0 and encoded in the "imm6" field.

Operation

```
bits(datasize) result;
bits(datasize) operand1 = X[n];
bits(datasize) operand2 = ShiftReg(m, shift_type, shift_amount);
bits(4) nzcvc;
bit carry_in;

if sub_op then
    operand2 = NOT(operand2);
    carry_in = '1';
else
    carry_in = '0';

(result, nzcvc) = AddWithCarry(operand1, operand2, carry_in);

if setflags then
    PSTATE.<N,Z,C,V> = nzcvc;

X[d] = result;
```

C5.6.200 SVC

Generate exception targeting exception level 1

31	30	29	28	27	26	25	24	23	22	21	20					5	4	3	2	1	0
1	1	0	1	0	1	0	0	0	0	0		imm16				0	0	0	0	0	1

System variant

SVC #<imm>

bits(16) imm = imm16;

Assembler Symbols

<imm> Is a 16-bit unsigned immediate, in the range 0 to 65535, encoded in the "imm16" field.

Operation

[AArch64.CallSupervisor](#)(imm);

C5.6.201 SXTB

Signed extend byte: $Rd = \text{SignExtend}(Wn<7:0>)$

This instruction is an alias of the [SBFM](#) instruction.

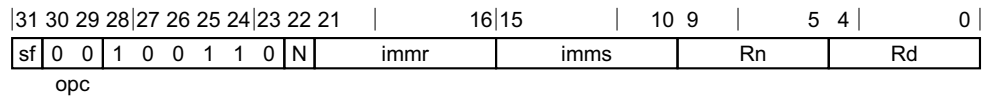

32-bit variant (sf = 0, N = 0)

SXTB <Wd>, <Wn>

is equivalent to

SBFM <Wd>, <Wn>, #0, #7

and is the preferred disassembly when `immr == '000000'` && `imms == '000111'`.

64-bit variant (sf = 1, N = 1)

SXTB <Xd>, <Wn>

is equivalent to

SBFM <Xd>, <Xn>, #0, #7

and is the preferred disassembly when `immr == '000000'` && `imms == '000111'`.

Assembler Symbols

- <Wd> Is the 32-bit name of the general-purpose destination register, encoded in the "Rd" field.
- <Xd> Is the 64-bit name of the general-purpose destination register, encoded in the "Rd" field.
- <Xn> Is the 64-bit name of the general-purpose source register, encoded in the "Rn" field.
- <Wn> Is the 32-bit name of the general-purpose source register, encoded in the "Rn" field.

C5.6.202 SXTB

Signed extend halfword: $Rd = \text{SignExtend}(Wn<15:0>)$

This instruction is an alias of the [SBFM](#) instruction.

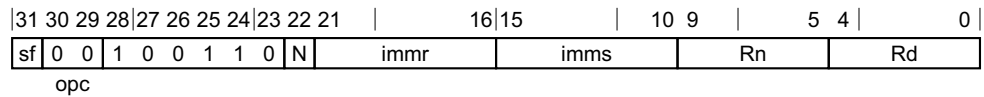

32-bit variant (sf = 0, N = 0)

SXTB <Wd>, <Wn>

is equivalent to

SBFM <Wd>, <Wn>, #0, #15

and is the preferred disassembly when `immr == '000000' && imms == '001111'`.

64-bit variant (sf = 1, N = 1)

SXTB <Xd>, <Wn>

is equivalent to

SBFM <Xd>, <Xn>, #0, #15

and is the preferred disassembly when `immr == '000000' && imms == '001111'`.

Assembler Symbols

- <Wd> Is the 32-bit name of the general-purpose destination register, encoded in the "Rd" field.
- <Xd> Is the 64-bit name of the general-purpose destination register, encoded in the "Rd" field.
- <Xn> Is the 64-bit name of the general-purpose source register, encoded in the "Rn" field.
- <Wn> Is the 32-bit name of the general-purpose source register, encoded in the "Rn" field.

C5.6.203 SXTW

Signed extend word: $Xd = \text{SignExtend}(Wn<31:0>)$

This instruction is an alias of the [SBFM](#) instruction.

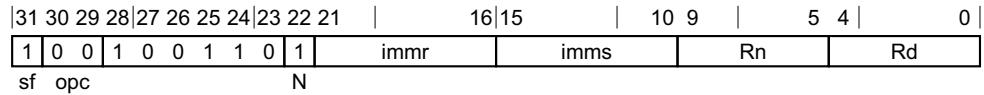

64-bit variant

SXTW <Xd>, <Wn>

is equivalent to

SBFM <Xd>, <Xn>, #0, #31

and is the preferred disassembly when `immr == '000000' && imms == '011111'`.

Assembler Symbols

<Xd> Is the 64-bit name of the general-purpose destination register, encoded in the "Rd" field.

<Xn> Is the 64-bit name of the general-purpose source register, encoded in the "Rn" field.

<Wn> Is the 32-bit name of the general-purpose source register, encoded in the "Rn" field.

C5.6.204 SYS

System instruction

This instruction is used by the aliases [AT](#), [DC](#), [IC](#), and [TLBI](#). See the [Alias conditions](#) table for details of when each alias is preferred.

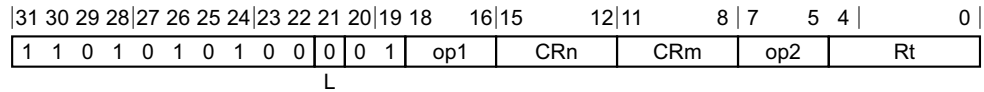

System variant

SYS #<op1>, <Cn>, <Cm>, #<op2>{, <Xt>}

```
CheckSystemAccess(op1);
```

```
integer t = UInt(Rt);
```

```
integer sys_op0 = 1;
integer sys_op1 = UInt(op1);
integer sys_op2 = UInt(op2);
integer sys_crn = UInt(CRn);
integer sys_crm = UInt(CRm);
boolean has_result = (L == '1');
```

Alias conditions

Alias	is preferred when
AT	<code>SysOp(op1, CRn, CRm, op2) == Sys_AT</code>
DC	<code>SysOp(op1, CRn, CRm, op2) == Sys_DC</code>
IC	<code>SysOp(op1, CRn, CRm, op2) == Sys_IC</code>
TLBI	<code>SysOp(op1, CRn, CRm, op2) == Sys_TLBI</code>

Assembler Symbols

<code><op1></code>	Is a 3-bit unsigned immediate, in the range 0 to 7, encoded in the "op1" field.
<code><Cn></code>	Is a name 'Cn', with 'n' in the range 0 to 15, encoded in the "CRn" field.
<code><Cm></code>	Is a name 'Cm', with 'm' in the range 0 to 15, encoded in the "CRm" field.
<code><op2></code>	Is a 3-bit unsigned immediate, in the range 0 to 7, encoded in the "op2" field.
<code><Xt></code>	Is the 64-bit name of the optional general-purpose source register, defaulting to '11111', encoded in the "Rt" field.

Operation

```
if has_result then
    X[t] = SysOp_R(sys_op0, sys_op1, sys_crn, sys_crm, sys_op2);
else
    SysOp_W(sys_op0, sys_op1, sys_crn, sys_crm, sys_op2, X[t]);
```

C5.6.205 SYSL

System instruction with result

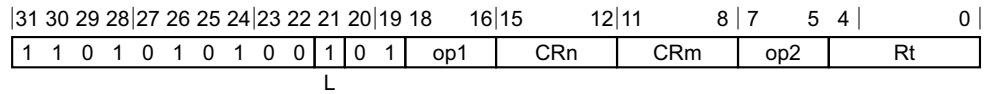

System variant

SYSL <Xt>, #<op1>, <Cn>, <Cm>, #<op2>

```
CheckSystemAccess(op1);
```

```
integer t = UInt(Rt);
```

```
integer sys_op0 = 1;
integer sys_op1 = UInt(op1);
integer sys_op2 = UInt(op2);
integer sys_crn = UInt(CRn);
integer sys_crm = UInt(CRm);
boolean has_result = (L == '1');
```

Assembler Symbols

- <Xt> Is the 64-bit name of the general-purpose destination register, encoded in the "Rt" field.
- <op1> Is a 3-bit unsigned immediate, in the range 0 to 7, encoded in the "op1" field.
- <Cn> Is a name 'Cn', with 'n' in the range 0 to 15, encoded in the "CRn" field.
- <Cm> Is a name 'Cm', with 'm' in the range 0 to 15, encoded in the "CRm" field.
- <op2> Is a 3-bit unsigned immediate, in the range 0 to 7, encoded in the "op2" field.

Operation

```
if has_result then
    X[t] = SysOp_R(sys_op0, sys_op1, sys_crn, sys_crm, sys_op2);
else
    SysOp_W(sys_op0, sys_op1, sys_crn, sys_crm, sys_op2, X[t]);
```

C5.6.206 TBNZ

Test bit and branch if nonzero to a label at a PC-relative offset, without affecting the condition flags, and with a hint that this is not a subroutine call or return

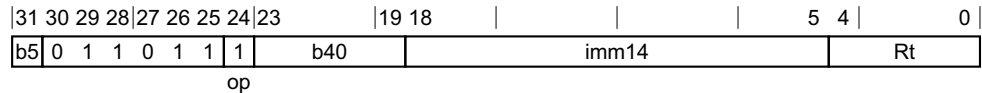

14-bit signed PC-relative branch offset variant

TBNZ <R><t>, #<imm>, <label>

```
integer t = UInt(Rt);
```

```
integer datasize = if b5 == '1' then 64 else 32;
```

```
integer bit_pos = UInt(b5:b40);
```

```
bit bit_val = op;
```

```
bits(64) offset = SignExtend(imm14:'00', 64);
```

Assembler Symbols

<R> Is a width specifier,

W when b5 = 0

X when b5 = 1

In assembler source code an 'X' specifier is always permitted, but a 'W' specifier is only permitted when the bit number is less than 32.

<t> Is the number [0-30] of the general-purpose register to be tested or the name ZR (31), encoded in the "Rt" field.

<imm> Is the bit number to be tested, in the range 0 to 63, encoded in "b5:b40".

<label> Is the program label to be conditionally branched to. Its offset from the address of this instruction, in the range +/-32KB, is encoded as "imm14" times 4.

Operation

```
bits(datasize) operand = X[t];
```

```
if operand<bit_pos> == bit_val then
  BranchTo(PC[] + offset, BranchType_JMP);
```

C5.6.207 TBZ

Test bit and branch if zero to a label at a PC-relative offset, without affecting the condition flags, and with a hint that this is not a subroutine call or return

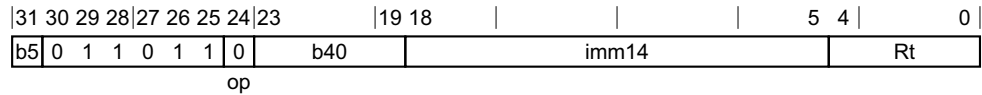

14-bit signed PC-relative branch offset variant

TBZ <R><t>, #<imm>, <label>

```
integer t = UInt(Rt);
```

```
integer datasize = if b5 == '1' then 64 else 32;
```

```
integer bit_pos = UInt(b5:b40);
```

```
bit bit_val = op;
```

```
bits(64) offset = SignExtend(imm14:'00', 64);
```

Assembler Symbols

<R> Is a width specifier,

W when b5 = 0

X when b5 = 1

In assembler source code an 'X' specifier is always permitted, but a 'W' specifier is only permitted when the bit number is less than 32.

<t> Is the number [0-30] of the general-purpose register to be tested or the name ZR (31), encoded in the "Rt" field.

<imm> Is the bit number to be tested, in the range 0 to 63, encoded in "b5:b40".

<label> Is the program label to be conditionally branched to. Its offset from the address of this instruction, in the range +/-32KB, is encoded as "imm14" times 4.

Operation

```
bits(datasize) operand = X[t];
```

```
if operand<bit_pos> == bit_val then
```

```
    BranchTo(PC[] + offset, BranchType_JMP);
```

C5.6.208 TLBI

TLB invalidate operation

This instruction is an alias of the [SYS](#) instruction.

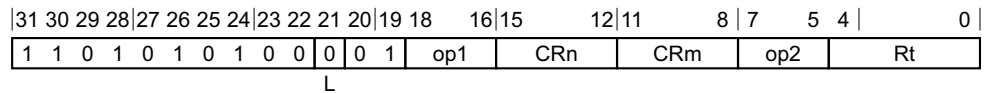

System variant

TLBI <t1bi_op>{, <Xt>}

is equivalent to

SYS #<op1>, <Cn>, <Cm>, #<op2>{, <Xt>}

and is the preferred disassembly when SysOp(op1,CRn,CRm,op2) == Sys_TLBI.

Assembler Symbols

- <op1> Is a 3-bit unsigned immediate, in the range 0 to 7, encoded in the "op1" field.
- <Cn> Is a name 'Cn', with 'n' in the range 0 to 15, encoded in the "CRn" field.
- <Cm> Is a name 'Cm', with 'm' in the range 0 to 15, encoded in the "CRm" field.
- <op2> Is a 3-bit unsigned immediate, in the range 0 to 7, encoded in the "op2" field.
- <t1bi_op> Is a TLBI operation name, as listed for the TLBI system operation group, encoded in the "op1:CRn:CRm:op2".
- <Xt> Is the 64-bit name of the optional general-purpose source register, defaulting to '11111', encoded in the "Rt" field.

C5.6.209 TST (immediate)

Test bits (immediate), setting the condition flags and discarding the result: Rn AND imm

This instruction is an alias of the [ANDS \(immediate\)](#) instruction.

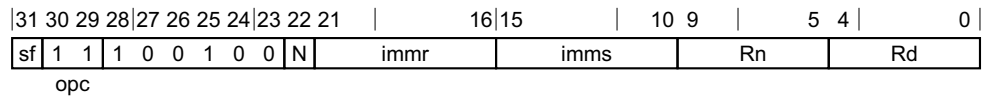

32-bit variant (sf = 0, N = 0)

TST <Wn>, #<imm>

is equivalent to

ANDS WZR, <Wn>, #<imm>

and is the preferred disassembly when Rd == '11111'.

64-bit variant (sf = 1)

TST <Xn>, #<imm>

is equivalent to

ANDS XZR, <Xn>, #<imm>

and is the preferred disassembly when Rd == '11111'.

Assembler Symbols

- <Wn> Is the 32-bit name of the general-purpose source register, encoded in the "Rn" field.
- <Xn> Is the 64-bit name of the general-purpose source register, encoded in the "Rn" field.
- <imm> Is the bitmask immediate, encoded in "N:imms:immr".

C5.6.210 TST (shifted register)

Test bits (shifted register), setting the condition flags and discarding the result: $R_n \text{ AND } \text{shift}(R_m, \text{amount})$

This instruction is an alias of the [ANDS \(shifted register\)](#) instruction.

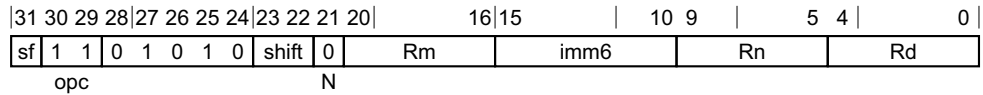

32-bit variant (sf = 0)

TST <Wn>, <Wm>{, <shift> #<amount>}

is equivalent to

ANDS WZR, <Wn>, <Wm>{, <shift> #<amount>}

and is the preferred disassembly when Rd == '11111'.

64-bit variant (sf = 1)

TST <Xn>, <Xm>{, <shift> #<amount>}

is equivalent to

ANDS XZR, <Xn>, <Xm>{, <shift> #<amount>}

and is the preferred disassembly when Rd == '11111'.

Assembler Symbols

- <Wn> Is the 32-bit name of the first general-purpose source register, encoded in the "Rn" field.
- <Wm> Is the 32-bit name of the second general-purpose source register, encoded in the "Rm" field.
- <Xn> Is the 64-bit name of the first general-purpose source register, encoded in the "Rn" field.
- <Xm> Is the 64-bit name of the second general-purpose source register, encoded in the "Rm" field.
- <shift> Is the optional shift to be applied to the final source, defaulting to LSL and
 - LSL** when shift = 00
 - LSR** when shift = 01
 - ASR** when shift = 10
 - ROR** when shift = 11
- <amount> For the 32-bit variant: is the shift amount, in the range 0 to 31, defaulting to 0 and encoded in the "imm6" field.
- <amount> For the 64-bit variant: is the shift amount, in the range 0 to 63, defaulting to 0 and encoded in the "imm6" field,

C5.6.211 UBFIZ

Unsigned bitfield insert in zero, with zeros to left and right

This instruction is an alias of the [UBFM](#) instruction.

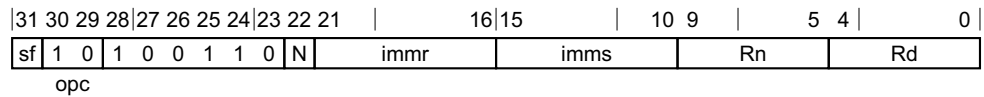

32-bit variant (sf = 0, N = 0)

UBFIZ <Wd>, <Wn>, #<lsb>, #<width>

is equivalent to

UBFM <Wd>, <Wn>, #(-<lsb> MOD 32), #(<width>-1)

and is the preferred disassembly when $UInt(imms) < UInt(immr)$.

64-bit variant (sf = 1, N = 1)

UBFIZ <Xd>, <Xn>, #<lsb>, #<width>

is equivalent to

UBFM <Xd>, <Xn>, #(-<lsb> MOD 64), #(<width>-1)

and is the preferred disassembly when $UInt(imms) < UInt(immr)$.

Assembler Symbols

- <Wd> Is the 32-bit name of the general-purpose destination register, encoded in the "Rd" field.
- <Wn> Is the 32-bit name of the general-purpose source register, encoded in the "Rn" field.
- <Xd> Is the 64-bit name of the general-purpose destination register, encoded in the "Rd" field.
- <Xn> Is the 64-bit name of the general-purpose source register, encoded in the "Rn" field.
- <lsb> For the 32-bit variant: is the bit number of the lsb of the source bitfield, in the range 0 to 31.
- <lsb> For the 64-bit variant: is the bit number of the lsb of the source bitfield, in the range 0 to 63.
- <width> For the 32-bit variant: is the width of the bitfield, in the range 1 to 32-<lsb>.
- <width> For the 64-bit variant: is the width of the bitfield, in the range 1 to 64-<lsb>.

C5.6.212 UBFM

Unsigned bitfield move, with zeros to left and right

This instruction is used by the aliases [LSL \(immediate\)](#), [LSR \(immediate\)](#), [UBFIZ](#), [UBFX](#), [UXTB](#), and [UXTH](#). See the [Alias conditions on page C5-761](#) table for details of when each alias is preferred.

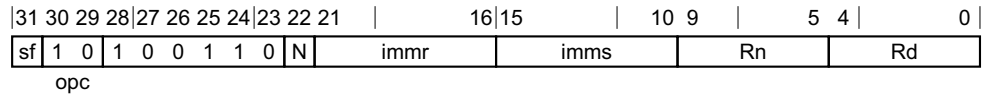

32-bit variant (sf = 0, N = 0)

UBFM <Wd>, <Wn>, #<immr>, #<imms>

64-bit variant (sf = 1, N = 1)

UBFM <Xd>, <Xn>, #<immr>, #<imms>

```
integer d = UInt(Rd);
integer n = UInt(Rn);
integer datasize = if sf == '1' then 64 else 32;

boolean inzero;
boolean extend;
integer R;
integer S;
bits(datasize) wmask;
bits(datasize) tmask;

case opc of
  when '00' inzero = TRUE; extend = TRUE; // SBFM
  when '01' inzero = FALSE; extend = FALSE; // BFM
  when '10' inzero = TRUE; extend = FALSE; // UBFM
  when '11' UnallocatedEncoding();

if sf == '1' && N != '1' then ReservedValue();
if sf == '0' && (N != '0' || immr<5> != '0' || imms<5> != '0') then ReservedValue();

R = UInt(immr);
S = UInt(imms);
(wmask, tmask) = DecodeBitMasks(N, imms, immr, FALSE);
```

Alias conditions

Alias	of variant	is preferred when
LSL (immediate)	32-bit	<code>imms != '011111' && imms + 1 == immr</code>
LSL (immediate)	64-bit	<code>imms != '111111' && imms + 1 == immr</code>
LSR (immediate)	32-bit	<code>imms == '011111'</code>
LSR (immediate)	64-bit	<code>imms == '111111'</code>
UBFIZ	-	<code>UInt(imms) < UInt(immr)</code>
UBFX	-	<code>BFXPreferred(sf, opc<1>, imms, immr)</code>
UXTB	-	<code>immr == '000000' && imms == '000111'</code>
UXTH	-	<code>immr == '000000' && imms == '001111'</code>

Assembler Symbols

<Wd>	Is the 32-bit name of the general-purpose destination register, encoded in the "Rd" field.
<Wn>	Is the 32-bit name of the general-purpose source register, encoded in the "Rn" field.
<Xd>	Is the 64-bit name of the general-purpose destination register, encoded in the "Rd" field.
<Xn>	Is the 64-bit name of the general-purpose source register, encoded in the "Rn" field.
<immr>	For the 32-bit variant: is the right rotate amount, in the range 0 to 31, encoded in the "immr" field.
<immr>	For the 64-bit variant: is the right rotate amount, in the range 0 to 63, encoded in the "immr" field.
<imms>	For the 32-bit variant: is the leftmost bit number to be moved from the source, in the range 0 to 31, encoded in the "imms" field.
<imms>	For the 64-bit variant: is the leftmost bit number to be moved from the source, in the range 0 to 63, encoded in the "imms" field.

Operation

```

bits(datasize) dst = if inzero then Zeros() else X[d];
bits(datasize) src = X[n];

// perform bitfield move on low bits
bits(datasize) bot = (dst AND NOT(wmask)) OR (ROR(src, R) AND wmask);

// determine extension bits (sign, zero or dest register)
bits(datasize) top = if extend then Replicate(src<S>) else dst;

// combine extension bits and result bits
X[d] = (top AND NOT(tmask)) OR (bot AND tmask);

```

C5.6.213 UBFX

Unsigned bitfield extract

This instruction is an alias of the [UBFM](#) instruction.

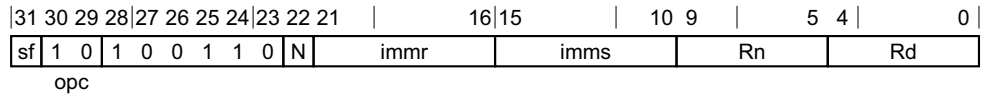

32-bit variant (sf = 0, N = 0)

UBFX <Wd>, <Wn>, #<lsb>, #<width>

is equivalent to

UBFM <Wd>, <Wn>, #<lsb>, #(<lsb>+<width>-1)

and is the preferred disassembly when `BFXPreferred(sf, opc<1>, imms, immr)`.

64-bit variant (sf = 1, N = 1)

UBFX <Xd>, <Xn>, #<lsb>, #<width>

is equivalent to

UBFM <Xd>, <Xn>, #<lsb>, #(<lsb>+<width>-1)

and is the preferred disassembly when `BFXPreferred(sf, opc<1>, imms, immr)`.

Assembler Symbols

- <Wd> Is the 32-bit name of the general-purpose destination register, encoded in the "Rd" field.
- <Wn> Is the 32-bit name of the general-purpose source register, encoded in the "Rn" field.
- <Xd> Is the 64-bit name of the general-purpose destination register, encoded in the "Rd" field.
- <Xn> Is the 64-bit name of the general-purpose source register, encoded in the "Rn" field.
- <lsb> For the 32-bit variant: is the bit number of the lsb of the source bitfield, in the range 0 to 31.
- <lsb> For the 64-bit variant: is the bit number of the lsb of the source bitfield, in the range 0 to 63.
- <width> For the 32-bit variant: is the width of the bitfield, in the range 1 to 32-<lsb>.
- <width> For the 64-bit variant: is the width of the bitfield, in the range 1 to 64-<lsb>.

C5.6.214 UDIV

Unsigned divide: $Rd = Rn / Rm$

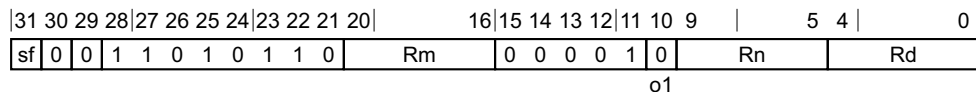

32-bit variant (sf = 0)

UDIV <Wd>, <Wn>, <Wm>

64-bit variant (sf = 1)

UDIV <Xd>, <Xn>, <Xm>

```
integer d = UInt(Rd);
integer n = UInt(Rn);
integer m = UInt(Rm);
integer datasize = if sf == '1' then 64 else 32;
boolean unsigned = (o1 == '0');
```

Assembler Symbols

- <Wd> Is the 32-bit name of the general-purpose destination register, encoded in the "Rd" field.
- <Wn> Is the 32-bit name of the first general-purpose source register, encoded in the "Rn" field.
- <Wm> Is the 32-bit name of the second general-purpose source register, encoded in the "Rm" field.
- <Xd> Is the 64-bit name of the general-purpose destination register, encoded in the "Rd" field.
- <Xn> Is the 64-bit name of the first general-purpose source register, encoded in the "Rn" field.
- <Xm> Is the 64-bit name of the second general-purpose source register, encoded in the "Rm" field.

Operation

```
bits(datasize) operand1 = X[n];
bits(datasize) operand2 = X[m];
integer result;

if IsZero(operand2) then
  result = 0;
else
  result = RoundTowardsZero (Int(operand1, unsigned) / Int(operand2, unsigned));

X[d] = result<datasize-1:0>;
```

C5.6.215 UMADDL

Unsigned multiply-add long: $X_d = X_a + W_n * W_m$

This instruction is used by the alias [UMULL](#). See the *Alias conditions* table for details of when each alias is preferred.

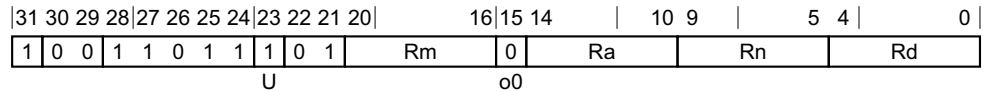

64-bit variant

UMADDL <Xd>, <Wn>, <Wm>, <Xa>

```
integer d = UInt(Rd);
integer n = UInt(Rn);
integer m = UInt(Rm);
integer a = UInt(Ra);
integer destsize = 64;
integer datasize = 32;
boolean sub_op = (o0 == '1');
boolean unsigned = (U == '1');
```

Alias conditions

Alias	is preferred when
UMULL	Ra == '11111'

Assembler Symbols

- <Xd> Is the 64-bit name of the general-purpose destination register, encoded in the "Rd" field.
- <Wn> Is the 32-bit name of the first general-purpose source register holding the multiplicand, encoded in the "Rn" field.
- <Wm> Is the 32-bit name of the second general-purpose source register holding the multiplier, encoded in the "Rm" field.
- <Xa> Is the 64-bit name of the third general-purpose source register holding the addend, encoded in the "Ra" field.

Operation

```
bits(datasize) operand1 = X[n];
bits(datasize) operand2 = X[m];
bits(destsize) operand3 = X[a];

integer result;

if sub_op then
    result = Int(operand3, unsigned) - (Int(operand1, unsigned) * Int(operand2, unsigned));
else
    result = Int(operand3, unsigned) + (Int(operand1, unsigned) * Int(operand2, unsigned));

X[d] = result<63:0>;
```

C5.6.216 UMNEGL

Unsigned multiply-negate long: $Xd = -(Wn * Wm)$

This instruction is an alias of the [UMSUBL](#) instruction.

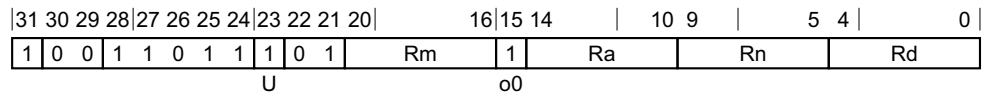

64-bit variant

UMNEGL <Xd>, <Wn>, <Wm>

is equivalent to

UMSUBL <Xd>, <Wn>, <Wm>, XZR

and is the preferred disassembly when Ra == '11111'.

Assembler Symbols

- <Xd> Is the 64-bit name of the general-purpose destination register, encoded in the "Rd" field.
- <Wn> Is the 32-bit name of the first general-purpose source register holding the multiplicand, encoded in the "Rn" field.
- <Wm> Is the 32-bit name of the second general-purpose source register holding the multiplier, encoded in the "Rm" field.

C5.6.217 UMSUBL

Unsigned multiply-subtract long: $Xd = Xa - Wn * Wm$

This instruction is used by the alias [UMNEGL](#). See the *Alias conditions* table for details of when each alias is preferred.

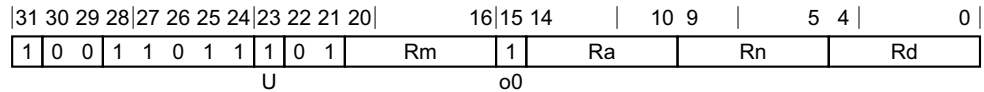

64-bit variant

UMSUBL <Xd>, <Wn>, <Wm>, <Xa>

```
integer d = UInt(Rd);
integer n = UInt(Rn);
integer m = UInt(Rm);
integer a = UInt(Ra);
integer destsize = 64;
integer datasize = 32;
boolean sub_op = (o0 == '1');
boolean unsigned = (U == '1');
```

Alias conditions

Alias	is preferred when
UMNEGL	Ra == '11111'

Assembler Symbols

- <Xd> Is the 64-bit name of the general-purpose destination register, encoded in the "Rd" field.
- <Wn> Is the 32-bit name of the first general-purpose source register holding the multiplicand, encoded in the "Rn" field.
- <Wm> Is the 32-bit name of the second general-purpose source register holding the multiplier, encoded in the "Rm" field.
- <Xa> Is the 64-bit name of the third general-purpose source register holding the minuend, encoded in the "Ra" field.

Operation

```
bits(datasize) operand1 = X[n];
bits(datasize) operand2 = X[m];
bits(destsize) operand3 = X[a];

integer result;

if sub_op then
    result = Int(operand3, unsigned) - (Int(operand1, unsigned) * Int(operand2, unsigned));
else
    result = Int(operand3, unsigned) + (Int(operand1, unsigned) * Int(operand2, unsigned));

X[d] = result<63:0>;
```

C5.6.218 UMULH

Unsigned multiply high: $X_d = \text{bits}\langle 127:64 \rangle$ of $X_n * X_m$

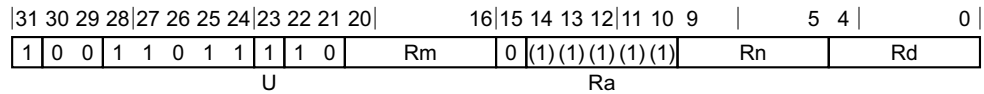

64-bit variant

UMULH <Xd>, <Xn>, <Xm>

```
integer d = UInt(Rd);
integer n = UInt(Rn);
integer m = UInt(Rm);
integer a = UInt(Ra);           // ignored by UMULH/SMULH
integer destsize = 64;
integer datasize = destsize;
boolean unsigned = (U == '1');
```

Assembler Symbols

- <Xd> Is the 64-bit name of the general-purpose destination register, encoded in the "Rd" field.
- <Xn> Is the 64-bit name of the first general-purpose source register holding the multiplicand, encoded in the "Rn" field.
- <Xm> Is the 64-bit name of the second general-purpose source register holding the multiplier, encoded in the "Rm" field.

Operation

```
bits(datasize) operand1 = X[n];
bits(datasize) operand2 = X[m];

integer result;

result = Int(operand1, unsigned) * Int(operand2, unsigned);
X[d] = result<127:64>;
```

C5.6.219 UMULL

Unsigned multiply long: $Xd = Wn * Wm$

This instruction is an alias of the [UMADDL](#) instruction.

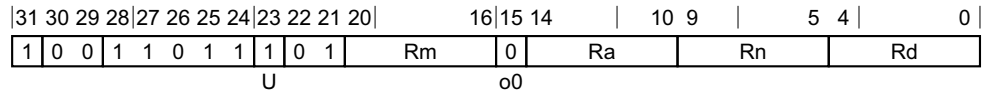

64-bit variant

UMULL <Xd>, <Wn>, <Wm>

is equivalent to

UMADDL <Xd>, <Wn>, <Wm>, XZR

and is the preferred disassembly when Ra == '11111'.

Assembler Symbols

- <Xd> Is the 64-bit name of the general-purpose destination register, encoded in the "Rd" field.
- <Wn> Is the 32-bit name of the first general-purpose source register holding the multiplicand, encoded in the "Rn" field.
- <Wm> Is the 32-bit name of the second general-purpose source register holding the multiplier, encoded in the "Rm" field.

C5.6.220 UXTB

Unsigned extend byte: $Wd = \text{ZeroExtend}(Wn<7:0>)$

This instruction is an alias of the [UBFM](#) instruction.

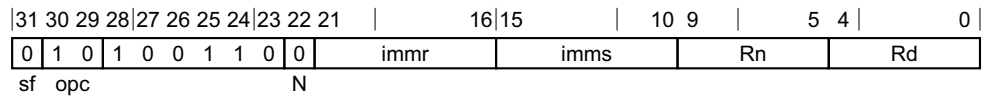

32-bit variant

UXTB <wd>, <wn>

is equivalent to

UBFM <wd>, <wn>, #0, #7

and is the preferred disassembly when `immr == '000000' && imms == '000111'`.

Assembler Symbols

<wd> Is the 32-bit name of the general-purpose destination register, encoded in the "Rd" field.

<wn> Is the 32-bit name of the general-purpose source register, encoded in the "Rn" field.

C5.6.221 UXTH

Unsigned extend halfword: $Wd = \text{ZeroExtend}(Wn<15:0>)$

This instruction is an alias of the [UBFM](#) instruction.

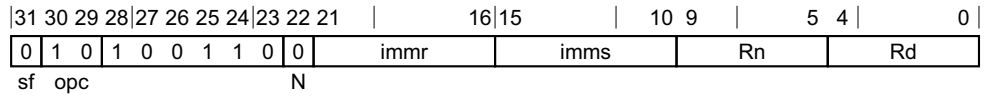

32-bit variant

UXTH <wd>, <wn>

is equivalent to

UBFM <wd>, <wn>, #0, #15

and is the preferred disassembly when `immr == '000000'` && `imms == '001111'`.

Assembler Symbols

<wd> Is the 32-bit name of the general-purpose destination register, encoded in the "Rd" field.

<wn> Is the 32-bit name of the general-purpose source register, encoded in the "Rn" field.

C5.6.222 WFE

Wait for event

This instruction is an alias of the [HINT](#) instruction.

31	30	29	28	27	26	25	24	23	22	21	20	19	18	17	16	15	14	13	12	11	8	7	5	4	3	2	1	0
1	1	0	1	0	1	0	1	0	0	0	0	0	0	1	1	0	0	1	0	CRm	op2	1	1	1	1	1	1	1

System variant

WFE

is equivalent to

HINT #2

and is the preferred disassembly when $UInt(CRm:op2) == 2$.

C5.6.223 WFI

Wait for interrupt

This instruction is an alias of the [HINT](#) instruction.

31	30	29	28	27	26	25	24	23	22	21	20	19	18	17	16	15	14	13	12	11	8	7	5	4	3	2	1	0
1	1	0	1	0	1	0	1	0	0	0	0	0	0	1	1	0	0	1	0		CRm		op2	1	1	1	1	1

System variant

WFI

is equivalent to

HINT #3

and is the preferred disassembly when $UInt(CRm:op2) == 3$.

C5.6.224 YIELD

Yield hint

This instruction is an alias of the [HINT](#) instruction.

31	30	29	28	27	26	25	24	23	22	21	20	19	18	17	16	15	14	13	12	11	8	7	5	4	3	2	1	0
1	1	0	1	0	1	0	1	0	0	0	0	0	0	1	1	0	0	1	0	CRm	op2	1	1	1	1	1	1	1

System variant

YIELD

is equivalent to

HINT #1

and is the preferred disassembly when $UInt(CRm:op2) == 1$.

Chapter C6

A64 SIMD and Floating-point Instruction Descriptions

This chapter describes the A64 SIMD and floating-point instructions.

It contains the following sections:

- *Introduction on page C6-776.*
- *About the SIMD and floating-point instructions on page C6-777.*
- *Alphabetical list of floating-point and Advanced SIMD instructions on page C6-779.*

C6.1 Introduction

Alphabetical list of floating-point and Advanced SIMD instructions on page C6-779 is an alphabetical list of instructions that are part of the following two functional groups:

- Loads and store instructions associated with the SIMD and floating-point registers.
- Data processing instructions with SIMD and floating-point registers.

A64 instruction index by encoding on page C3-172 in the A64 Instruction Encodings chapter provides an overview of the instruction encodings as part of an instruction class within a functional group.

C6.2 About the SIMD and floating-point instructions

This section provides a general description of the SIMD and floating-point instructions. It contains the following subsections:

- [Register size](#).
- [Data types](#).
- [Condition flags and related instructions on page C6-778](#).
- [General capabilities on page C6-778](#).

C6.2.1 Register size

A64 provides a comprehensive set of packed Single Instruction Multiple Data (SIMD) and scalar operations using data held in the 32 entry 128-bit wide SIMD and floating-point register file.

Each SIMD and floating-point register can be used to hold:

- A single scalar value of the floating-point or integer type.
- A 64-bit wide vector containing one or more elements.
- A 128-bit wide vector containing two or more elements.

Where the entire 128-bit wide register is not fully utilized, the vector or scalar quantity is held in the least significant bits of the register, with the most significant bits being cleared to zero on a write, see [Vector formats on page A1-37](#).

The following instructions can insert data into individual elements within a SIMD and floating-point register without clearing the remaining bits to zero:

- Insert vector element from another vector element or general-purpose register, `INS`.
- Load structure into a single lane, for example `LD3`.
- All second-part narrowing operations, for example `SHRN2`.

C6.2.2 Data types

The A64 instruction set provides support for arithmetic, conversion, and bitwise operations on:

- Half-precision, single-precision, and double-precision floating points.
- Signed and unsigned integers.
- Polynomials over $\{0, 1\}$.

For all AArch64 floating-point operations, including SIMD operations, the rounding mode and exception trap handling are controlled by the `FPCR`.

———— **Note** —————

AArch32 Advanced SIMD operations always use ARM standard floating-point arithmetic independent of the `FPCR` and `FPSCR` rounding mode. In addition, floating-point multiply-addition operations in AArch64 are always performed as fused operations, whereas AArch32 provides both fused and chained variants.

In addition to operations that consume and produce values of the same width and type, the A64 instruction set supports SIMD and scalar operations that produce a wider or narrower vector result:

- Where a SIMD operation narrows a 128-bit vector to a 64-bit vector, the A64 instruction set provides a second-part operation, for example `SHRN2`, that can pack the result of a second operation into the upper part of the same destination register.
- Where a SIMD operation widens a 64-bit vector to a 128-bit vector, the A64 instruction set provides a second-part operation, for example `SMLAL2`, that can extract the source from the upper 64 bits of the source registers.

All SIMD operations that could produce side-effects that are not limited to the destination SIMD and floating-point register, for example a potential update of `FPSR.Q` or `FPSR.IDC`, have a dedicated scalar variant to support the use of SIMD with loops requiring specialised head or tail handling, or both.

C6.2.3 Condition flags and related instructions

The A64 instruction set provides support for flag setting and conditional operations on the SIMD and floating-point register file:

- Floating-point FCSEL and FCCMP instructions are equivalent to the integer CSEL and CCMP instructions.
- Floating-point FCMP, FCMP, FCCMP, and FCCMP set the PSTATE.{N, Z, C, V} flags based on the result of the floating-point comparison.
- Floating-point and integer instructions provide a means of producing either a scalar or a vector mask based on a comparison in a SIMD and floating-point register, for example FCMEQ.

———— **Note** —————

FCMP and FCMP differ from the A32/T32 VCMPE and VCMPE instructions, which use the dedicated FPSCR.NZCV field for the result. A64 instructions store the result of an FCMP or FCMP operation in the PSTATE.{N, Z, C, V} field.

—————

C6.2.4 General capabilities

A64 SIMD and floating-point instructions provide the following capabilities:

- General arithmetic on vector and scalar floating-point and integer values.
- Dedicated polynomial multiply over {0, 1}.
- Vector and scalar fused multiply-addition of single-precision and double-precision floating-points.
- Load and store of single and pairs of SIMD and floating-point registers.
- Load and store of structures and individual lanes of between one and four SIMD and floating-point registers.
- Direct conversion between 64-bit integers and floating-point values, with explicit rounding.
- Double-rounding free conversion between double-precision and half-precision floating-point values.
- Comprehensive SIMD with widening and narrowing support.
- Vector to scalar reduction returning the minimum or maximum value, or the sum.
- Floating-point to nearest integer in floating-point format.

C6.3 Alphabetical list of floating-point and Advanced SIMD instructions

This section lists every section in the floating-point and Advanced SIMD categories of the A64 instruction set. For details of the format used, see [Structure of the A64 assembler language on page C1-113](#).

C6.3.1 ABS

Absolute value (vector)

It has encodings from 2 classes: *Scalar* and *Vector*

Scalar

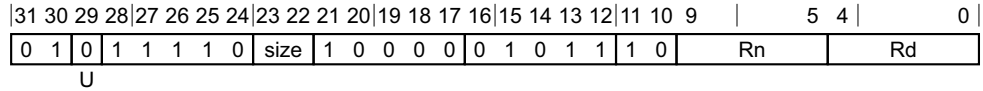

Scalar variant

ABS <V><d>, <V><n>

```
integer d = UInt(Rd);
integer n = UInt(Rn);
```

```
if size != '11' then ReservedValue();
integer esize = 8 << UInt(size);
integer datasize = esize;
integer elements = 1;
```

```
boolean neg = (U == '1');
```

Vector

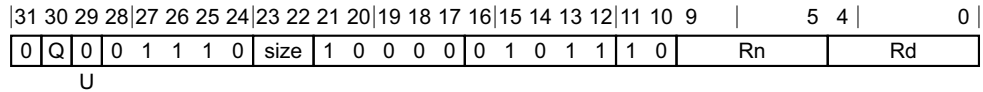

Vector variant

ABS <Vd>.<T>, <Vn>.<T>

```
integer d = UInt(Rd);
integer n = UInt(Rn);
```

```
if size:Q == '110' then ReservedValue();
integer esize = 8 << UInt(size);
integer datasize = if Q == '1' then 128 else 64;
integer elements = datasize DIV esize;
```

```
boolean neg = (U == '1');
```

Assembler Symbols

- <V> Is a width specifier,
RESERVED when size = 0x
RESERVED when size = 10
D when size = 11
- <d> Is the number of the SIMD&FP destination register, encoded in the "Rd" field.
- <n> Is the number of the SIMD&FP source register, encoded in the "Rn" field.
- <Vd> Is the name of the SIMD&FP destination register, encoded in the "Rd" field.
- <T> Is an arrangement specifier,
8B when size = 00, Q = 0

16B when size = 00, Q = 1
4H when size = 01, Q = 0
8H when size = 01, Q = 1
2S when size = 10, Q = 0
4S when size = 10, Q = 1
RESERVED when size = 11, Q = 0
2D when size = 11, Q = 1

<Vn> Is the name of the SIMD&FP source register, encoded in the "Rn" field.

Operation for all classes

```
CheckFPAdvSIMDEnabled64();
bits(datasize) operand = V[n];
bits(datasize) result;
integer element;

for e = 0 to elements-1
    element = SInt(Elem[operand, e, esize]);
    if neg then
        element = -element;
    else
        element = Abs(element);
    Elem[result, e, esize] = element<esize-1:0>;

V[d] = result;
```

C6.3.2 ADD (vector)

Add (vector)

It has encodings from 2 classes: *Scalar* and *Vector*

Scalar

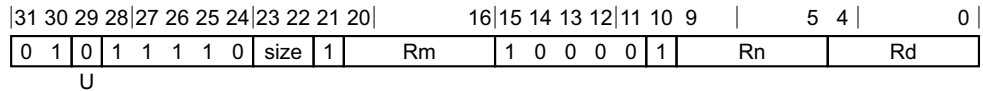

Scalar variant

ADD <V><d>, <V><n>, <V><m>

```
integer d = UInt(Rd);
integer n = UInt(Rn);
integer m = UInt(Rm);
if size != '11' then ReservedValue();
integer esize = 8 << UInt(size);
integer datasize = esize;
integer elements = 1;
boolean sub_op = (U == '1');
```

Vector

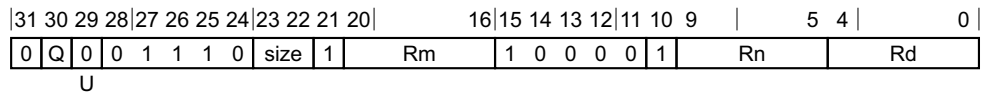

Vector variant

ADD <Vd>.<T>, <Vn>.<T>, <Vm>.<T>

```
integer d = UInt(Rd);
integer n = UInt(Rn);
integer m = UInt(Rm);
if size:Q == '110' then ReservedValue();
integer esize = 8 << UInt(size);
integer datasize = if Q == '1' then 128 else 64;
integer elements = datasize DIV esize;
boolean sub_op = (U == '1');
```

Assembler Symbols

- <V> Is a width specifier,
RESERVED when size = 0x
RESERVED when size = 10
D when size = 11
- <d> Is the number of the SIMD&FP destination register, in the "Rd" field.
- <n> Is the number of the first SIMD&FP source register, encoded in the "Rn" field.
- <m> Is the number of the second SIMD&FP source register, encoded in the "Rm" field.
- <Vd> Is the name of the SIMD&FP destination register, encoded in the "Rd" field.
- <T> Is an arrangement specifier,
8B when size = 00, Q = 0

16B when size = 00, Q = 1
4H when size = 01, Q = 0
8H when size = 01, Q = 1
2S when size = 10, Q = 0
4S when size = 10, Q = 1
RESERVED when size = 11, Q = 0
2D when size = 11, Q = 1

<Vn> Is the name of the first SIMD&FP source register, encoded in the "Rn" field.

<Vm> Is the name of the second SIMD&FP source register, encoded in the "Rm" field.

Operation for all classes

```
CheckFPAdvSIMDEnabled64();
bits(datasize) operand1 = V[n];
bits(datasize) operand2 = V[m];
bits(datasize) result;
bits(esize) element1;
bits(esize) element2;

for e = 0 to elements-1
    element1 = Elem[operand1, e, esize];
    element2 = Elem[operand2, e, esize];
    if sub_op then
        Elem[result, e, esize] = element1 - element2;
    else
        Elem[result, e, esize] = element1 + element2;

V[d] = result;
```

C6.3.3 ADDHN, ADDHN2

Add returning high narrow

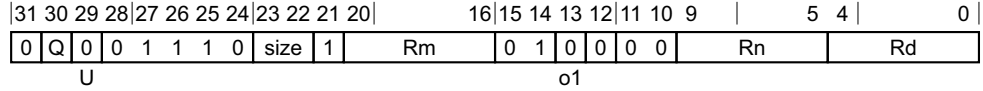

Three registers, not all the same type variant

ADDHN{2} <Vd>.<Tb>, <Vn>.<Ta>, <Vm>.<Ta>

```
integer d = UInt(Rd);
integer n = UInt(Rn);
integer m = UInt(Rm);

if size == '11' then ReservedValue();
integer esize = 8 << UInt(size);
integer datasize = 64;
integer part = UInt(Q);
integer elements = datasize DIV esize;

boolean sub_op = (o1 == '1');
boolean round = (U == '1');
```

Assembler Symbols

- 2 Is the second and upper half specifier. If present it causes the operation to be performed on the upper 64 bits of the registers holding the narrower elements, and is
 - [absent]** when Q = 0
 - [present]** when Q = 1
- <Vd> Is the name of the SIMD&FP destination register, encoded in the "Rd" field.
- <Tb> Is an arrangement specifier,
 - 8B** when size = 00, Q = 0
 - 16B** when size = 00, Q = 1
 - 4H** when size = 01, Q = 0
 - 8H** when size = 01, Q = 1
 - 2S** when size = 10, Q = 0
 - 4S** when size = 10, Q = 1
 - RESERVED** when size = 11, Q = x
- <Vn> Is the name of the first SIMD&FP source register, encoded in the "Rn" field.
- <Ta> Is an arrangement specifier,
 - 8H** when size = 00
 - 4S** when size = 01
 - 2D** when size = 10
 - RESERVED** when size = 11
- <Vm> Is the name of the second SIMD&FP source register, encoded in the "Rm" field.

Operation

```
CheckFPAdvSIMDEnabled64();
bits(2*datasize) operand1 = V[n];
bits(2*datasize) operand2 = V[m];
bits(datasize) result;
integer round_const = if round then 1 << (esize - 1) else 0;
bits(2*esize) element1;
bits(2*esize) element2;
bits(2*esize) sum;

for e = 0 to elements-1
    element1 = Elem[operand1, e, 2*esize];
    element2 = Elem[operand2, e, 2*esize];
    if sub_op then
        sum = element1 - element2;
    else
        sum = element1 + element2;
    sum = sum + round_const;
    Elem[result, e, esize] = sum<2*esize-1:esize>;

Vpart[d, part] = result;
```

C6.3.4 ADDP (scalar)

Add pair of elements (scalar)

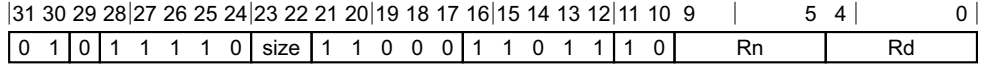

Advanced SIMD variant

ADDP <V><d>, <Vn>.<T>

```
integer d = UInt(Rd);
integer n = UInt(Rn);
```

```
if size != '11' then ReservedValue();
```

```
integer esize = 8 << UInt(size);
integer datasize = esize * 2;
integer elements = 2;
```

```
ReduceOp op = ReduceOp_ADD;
```

Assembler Symbols

- <V> Is the destination width specifier,
RESERVED when size = 0x
RESERVED when size = 10
D when size = 11
- <d> Is the number of the SIMD&FP destination register, encoded in the "Rd" field.
- <Vn> Is the name of the SIMD&FP source register, encoded in the "Rn" field.
- <T> Is the source arrangement specifier,
RESERVED when size = 0x
RESERVED when size = 10
2D when size = 11

Operation

```
CheckFPAdvSIMDEnabled64();
bits(datasize) operand = V[n];
V[d] = Reduce(op, operand, esize);
```

C6.3.5 ADDP (vector)

Add pairwise (vector)

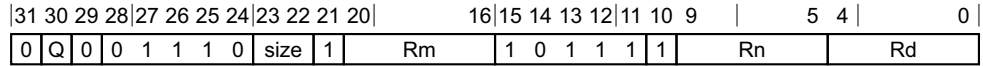

Three registers of the same type variant

ADDP <Vd>.<T>, <Vn>.<T>, <Vm>.<T>

```
integer d = UInt(Rd);
integer n = UInt(Rn);
integer m = UInt(Rm);
if size:Q == '110' then ReservedValue();
integer esize = 8 << UInt(size);
integer datasize = if Q == '1' then 128 else 64;
integer elements = datasize DIV esize;
```

Assembler Symbols

- <Vd> Is the name of the SIMD&FP destination register, encoded in the "Rd" field.
- <T> Is an arrangement specifier,
- 8B** when size = 00, Q = 0
 - 16B** when size = 00, Q = 1
 - 4H** when size = 01, Q = 0
 - 8H** when size = 01, Q = 1
 - 2S** when size = 10, Q = 0
 - 4S** when size = 10, Q = 1
 - RESERVED** when size = 11, Q = 0
 - 2D** when size = 11, Q = 1
- <Vn> Is the name of the first SIMD&FP source register, encoded in the "Rn" field.
- <Vm> Is the name of the second SIMD&FP source register, encoded in the "Rm" field.

Operation

```
CheckFPAdvSIMDEnabled64();
bits(datasize) operand1 = V[n];
bits(datasize) operand2 = V[m];
bits(datasize) result;
bits(2*datasize) concat = operand2:operand1;
bits(esize) element1;
bits(esize) element2;

for e = 0 to elements-1
    element1 = Elem[concat, 2*e, esize];
    element2 = Elem[concat, (2*e)+1, esize];
    Elem[result, e, esize] = element1 + element2;

V[d] = result;
```

C6.3.6 ADDV

Add across vector

31	30	29	28	27	26	25	24	23	22	21	20	19	18	17	16	15	14	13	12	11	10	9				5	4				0
0	Q	0	0	1	1	1	0	size	1	1	0	0	0	1	1	0	1	1	1	0	Rn			Rd							

Advanced SIMD variant

ADDV <V><d>, <Vn>.<T>

```
integer d = UInt(Rd);
integer n = UInt(Rn);
```

```
if size:Q == '100' then ReservedValue();
if size == '11' then ReservedValue();
```

```
integer esize = 8 << UInt(size);
integer datasize = if Q == '1' then 128 else 64;
integer elements = datasize DIV esize;
```

```
ReduceOp op = ReduceOp_ADD;
```

Assembler Symbols

<V>	Is the destination width specifier, B when size = 00 H when size = 01 S when size = 10 RESERVED when size = 11
<d>	Is the number of the SIMD&FP destination register, encoded in the "Rd" field.
<Vn>	Is the name of the SIMD&FP source register, encoded in the "Rn" field.
<T>	Is an arrangement specifier, 8B when size = 00, Q = 0 16B when size = 00, Q = 1 4H when size = 01, Q = 0 8H when size = 01, Q = 1 RESERVED when size = 10, Q = 0 4S when size = 10, Q = 1 RESERVED when size = 11, Q = x

Operation

```
CheckFPAdvSIMDEnabled64();
bits(datasize) operand = V[n];
V[d] = Reduce(op, operand, esize);
```

C6.3.7 AESD

AES single round decryption

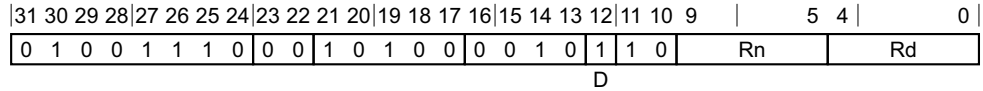

Advanced SIMD variant

AESD <Vd>.16B, <Vn>.16B

```
integer d = UInt(Rd);
integer n = UInt(Rn);
if ! HaveCryptoExt() then UnallocatedEncoding();
boolean decrypt = (D == '1');
```

Assembler Symbols

<Vd> Is the name of the SIMD&FP source and destination register, encoded in the "Rd" field.

<Vn> Is the name of the second SIMD&FP source register, encoded in the "Rn" field.

Operation

```
CheckCryptoEnabled64();

bits(128) operand1 = V[d];
bits(128) operand2 = V[n];
bits(128) result;
result = operand1 EOR operand2;
if decrypt then
    result = AESInvSubBytes(AESInvShiftRows(result));
else
    result = AESSubBytes(AESShiftRows(result));

V[d] = result;
```

C6.3.8 AESE

AES single round encryption

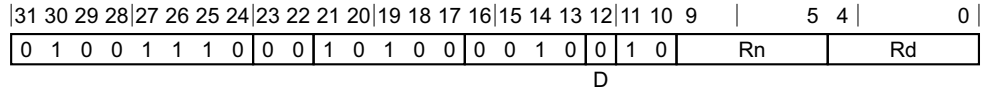

Advanced SIMD variant

AESE <Vd>.16B, <Vn>.16B

```
integer d = UInt(Rd);
integer n = UInt(Rn);
if ! HaveCryptoExt() then UnallocatedEncoding();
boolean decrypt = (D == '1');
```

Assembler Symbols

<Vd> Is the name of the SIMD&FP source and destination register, encoded in the "Rd" field.

<Vn> Is the name of the second SIMD&FP source register, encoded in the "Rn" field.

Operation

```
CheckCryptoEnabled64();

bits(128) operand1 = V[d];
bits(128) operand2 = V[n];
bits(128) result;
result = operand1 EOR operand2;
if decrypt then
    result = AESInvSubBytes(AESInvShiftRows(result));
else
    result = AESSubBytes(AESShiftRows(result));

V[d] = result;
```

C6.3.9 AESIMC

AES inverse mix columns

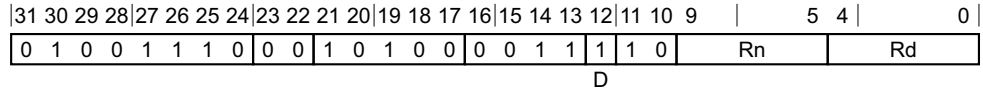

Advanced SIMD variant

AESIMC <Vd>.16B, <Vn>.16B

```
integer d = UInt(Rd);
integer n = UInt(Rn);
if ! HaveCryptoExt() then UnallocatedEncoding();
boolean decrypt = (D == '1');
```

Assembler Symbols

<Vd> Is the name of the SIMD&FP destination register, encoded in the "Rd" field.

<Vn> Is the name of the SIMD&FP source register, encoded in the "Rn" field.

Operation

```
CheckCryptoEnabled64();

bits(128) operand = V[n];
bits(128) result;
if decrypt then
    result = AESInvMixColumns(operand);
else
    result = AESMixColumns(operand);
V[d] = result;
```

C6.3.10 AESMC

AES mix columns

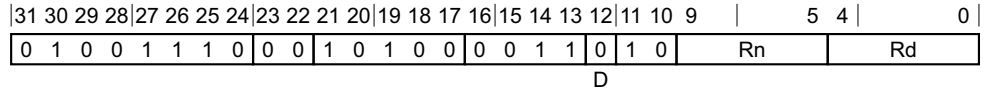

Advanced SIMD variant

AESMC <Vd>.16B, <Vn>.16B

```
integer d = UInt(Rd);
integer n = UInt(Rn);
if ! HaveCryptoExt() then UnallocatedEncoding();
boolean decrypt = (D == '1');
```

Assembler Symbols

<Vd> Is the name of the SIMD&FP destination register, encoded in the "Rd" field.

<Vn> Is the name of the SIMD&FP source register, encoded in the "Rn" field.

Operation

```
CheckCryptoEnabled64();

bits(128) operand = V[n];
bits(128) result;
if decrypt then
    result = AESInvMixColumns(operand);
else
    result = AESMixColumns(operand);
V[d] = result;
```

C6.3.11 AND (vector)

Bitwise AND (vector)

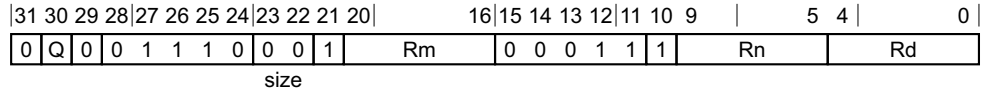

Three registers of the same type variant

AND <Vd>.<T>, <Vn>.<T>, <Vm>.<T>

```
integer d = UInt(Rd);
integer n = UInt(Rn);
integer m = UInt(Rm);
integer esize = 8;
integer datasize = if Q == '1' then 128 else 64;
integer elements = datasize DIV esize;
```

```
boolean invert = (size<0> == '1');
LogicalOp op = if size<1> == '1' then LogicalOp_ORR else LogicalOp_AND;
```

Assembler Symbols

- <Vd> Is the name of the SIMD&FP destination register, encoded in the "Rd" field.
- <T> Is an arrangement specifier,
 - 8B** when Q = 0
 - 16B** when Q = 1
- <Vn> Is the name of the first SIMD&FP source register, encoded in the "Rn" field.
- <Vm> Is the name of the second SIMD&FP source register, encoded in the "Rm" field.

Operation

```
CheckFPAdvSIMDEnabled64();
bits(datasize) operand1 = V[n];
bits(datasize) operand2 = V[m];
bits(datasize) result;

if invert then operand2 = NOT(operand2);

case op of
    when LogicalOp_AND            result = operand1 AND operand2;
    when LogicalOp_ORR            result = operand1 OR operand2;

V[d] = result;
```

C6.3.12 BIC (vector, immediate)

Bitwise bit clear (vector, immediate)

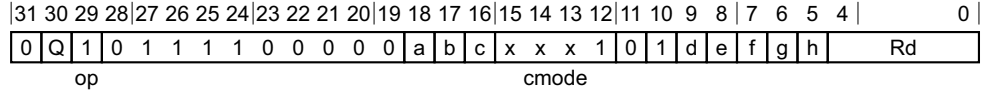

16-bit variant (cmode = 10x1)

BIC <Vd>.<T>, #<imm8>{, LSL #<amount>}

32-bit variant (cmode = 0xx1)

BIC <Vd>.<T>, #<imm8>{, LSL #<amount>}

```
integer rd = UInt(Rd);

integer datasize = if Q == '1' then 128 else 64;
bits(datasize) imm;
bits(64) imm64;

ImmediateOp operation;
case cmode:op of
    when '0xx00' operation = ImmediateOp_MOVI;
    when '0xx01' operation = ImmediateOp_MVNI;
    when '0xx10' operation = ImmediateOp_ORR;
    when '0xx11' operation = ImmediateOp_BIC;
    when '10x00' operation = ImmediateOp_MOVI;
    when '10x01' operation = ImmediateOp_MVNI;
    when '10x10' operation = ImmediateOp_ORR;
    when '10x11' operation = ImmediateOp_BIC;
    when '110x0' operation = ImmediateOp_MOVI;
    when '110x1' operation = ImmediateOp_MVNI;
    when '1110x' operation = ImmediateOp_MOVI;
    when '11110' operation = ImmediateOp_MOVI;
    when '11111'
        // FMOV Dn,#imm is in main FP instruction set
        if Q == '0' then UnallocatedEncoding();
        operation = ImmediateOp_MOVI;

imm64 = AdvSIMDExpandImm(op, cmode, a:b:c:d:e:f:g:h);
imm = Replicate(imm64, datasize DIV 64);
```

Assembler Symbols

- <Vd> Is the name of the SIMD&FP register, encoded in the "Rd" field.
- <T> For the 16-bit variant: is an arrangement specifier,
 - 4H** when Q = 0
 - 8H** when Q = 1
- <T> For the 32-bit variant: is an arrangement specifier,
 - 2S** when Q = 0
 - 4S** when Q = 1
- <imm8> Is an 8-bit immediate encoded in "a:b:c:d:e:f:g:h".
- <amount> For the 16-bit variant: is the shift amount
 - 0** when cmode<1> = 0

8 when `cmode<1> = 1`
defaulting to 0 if LSL is omitted.

<amount> For the 32-bit variant: is the shift amount

0 when `cmode<2:1> = 00`

8 when `cmode<2:1> = 01`

16 when `cmode<2:1> = 10`

24 when `cmode<2:1> = 11`
defaulting to 0 if LSL is omitted.

Operation

```
CheckFPAdvSIMDEnabled64();
bits(datasize) operand;
bits(datasize) result;

case operation of
  when ImmediateOp_MOVI
    result = imm;
  when ImmediateOp_MVNI
    result = NOT(imm);
  when ImmediateOp_ORR
    operand = V[rd];
    result = operand OR imm;
  when ImmediateOp_BIC
    operand = V[rd];
    result = operand AND NOT(imm);

V[rd] = result;
```

C6.3.13 BIC (vector, register)

Bitwise bit clear (vector, register)

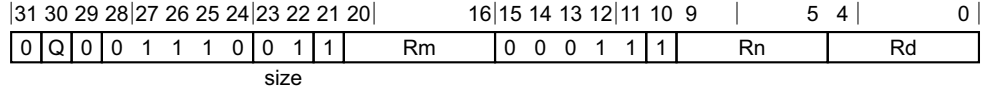

Three registers of the same type variant

BIC <Vd>.<T>, <Vn>.<T>, <Vm>.<T>

```
integer d = UInt(Rd);
integer n = UInt(Rn);
integer m = UInt(Rm);
integer esize = 8;
integer datasize = if Q == '1' then 128 else 64;
integer elements = datasize DIV esize;
```

```
boolean invert = (size<0> == '1');
LogicalOp op = if size<1> == '1' then LogicalOp_ORR else LogicalOp_AND;
```

Assembler Symbols

- <Vd> Is the name of the SIMD&FP destination register, encoded in the "Rd" field.
- <T> Is an arrangement specifier,
 - 8B** when Q = 0
 - 16B** when Q = 1
- <Vn> Is the name of the first SIMD&FP source register, encoded in the "Rn" field.
- <Vm> Is the name of the second SIMD&FP source register, encoded in the "Rm" field.

Operation

```
CheckFPAdvSIMDEnabled64();
bits(datasize) operand1 = V[n];
bits(datasize) operand2 = V[m];
bits(datasize) result;

if invert then operand2 = NOT(operand2);

case op of
    when LogicalOp_AND
        result = operand1 AND operand2;
    when LogicalOp_ORR
        result = operand1 OR operand2;

V[d] = result;
```

C6.3.14 BIF

Bitwise insert if false

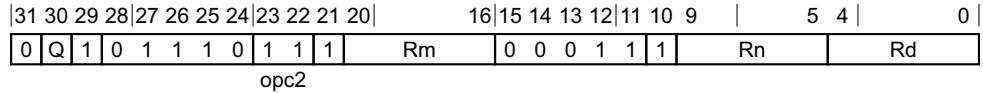

Three registers of the same type variant

BIF <Vd>.<T>, <Vn>.<T>, <Vm>.<T>

```
integer d = UInt(Rd);
integer n = UInt(Rn);
integer m = UInt(Rm);
integer esize = 8;
integer datasize = if Q == '1' then 128 else 64;
integer elements = datasize DIV esize;
```

VBitOp op;

```
case opc2 of
    when '00' op = VBitOp_VEOR;
    when '01' op = VBitOp_VBSL;
    when '10' op = VBitOp_VBIT;
    when '11' op = VBitOp_VBIF;
```

Assembler Symbols

- <Vd> Is the name of the SIMD&FP destination register, encoded in the "Rd" field.
- <T> Is an arrangement specifier,
 - 8B** when Q = 0
 - 16B** when Q = 1
- <Vn> Is the name of the first SIMD&FP source register, encoded in the "Rn" field.
- <Vm> Is the name of the second SIMD&FP source register, encoded in the "Rm" field.

Operation

```
CheckFPAdvSIMDEnabled64();
bits(datasize) operand1;
bits(datasize) operand2;
bits(datasize) operand3;
bits(datasize) operand4 = V[n];
```

```
case op of
    when VBitOp_VEOR
        operand1 = V[m];
        operand2 = Zeros();
        operand3 = Ones();
    when VBitOp_VBSL
        operand1 = V[m];
        operand2 = operand1;
        operand3 = V[d];
    when VBitOp_VBIT
        operand1 = V[d];
        operand2 = operand1;
        operand3 = V[m];
    when VBitOp_VBIF
```

```
operand1 = V[d];  
operand2 = operand1;  
operand3 = NOT(V[m]);
```

```
V[d] = operand1 EOR ((operand2 EOR operand4) AND operand3);
```

C6.3.15 BIT

Bitwise insert if true

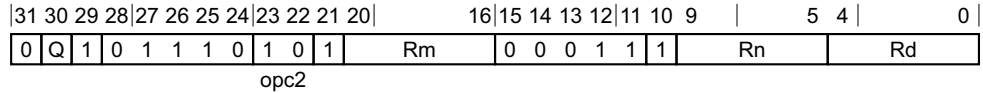

Three registers of the same type variant

BIT <Vd>.<T>, <Vn>.<T>, <Vm>.<T>

```
integer d = UInt(Rd);
integer n = UInt(Rn);
integer m = UInt(Rm);
integer esize = 8;
integer datasize = if Q == '1' then 128 else 64;
integer elements = datasize DIV esize;
```

VBitOp op;

```
case opc2 of
    when '00' op = VBitOp_VEOR;
    when '01' op = VBitOp_VBSL;
    when '10' op = VBitOp_VBIT;
    when '11' op = VBitOp_VBIF;
```

Assembler Symbols

- <Vd> Is the name of the SIMD&FP destination register, encoded in the "Rd" field.
- <T> Is an arrangement specifier,
 - 8B** when Q = 0
 - 16B** when Q = 1
- <Vn> Is the name of the first SIMD&FP source register, encoded in the "Rn" field.
- <Vm> Is the name of the second SIMD&FP source register, encoded in the "Rm" field.

Operation

```
CheckFPAdvSIMDEnabled64();
bits(datasize) operand1;
bits(datasize) operand2;
bits(datasize) operand3;
bits(datasize) operand4 = V[n];
```

```
case op of
    when VBitOp_VEOR
        operand1 = V[m];
        operand2 = Zeros();
        operand3 = Ones();
    when VBitOp_VBSL
        operand1 = V[m];
        operand2 = operand1;
        operand3 = V[d];
    when VBitOp_VBIT
        operand1 = V[d];
        operand2 = operand1;
        operand3 = V[m];
    when VBitOp_VBIF
```

```
operand1 = V[d];  
operand2 = operand1;  
operand3 = NOT(V[m]);
```

```
V[d] = operand1 EOR ((operand2 EOR operand4) AND operand3);
```

C6.3.16 BSL

Bitwise select

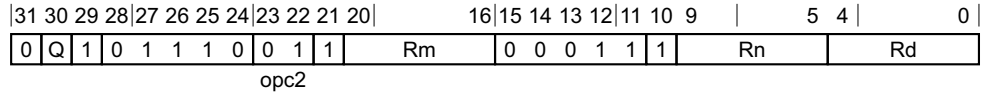

Three registers of the same type variant

BSL <Vd>.<T>, <Vn>.<T>, <Vm>.<T>

```
integer d = UInt(Rd);
integer n = UInt(Rn);
integer m = UInt(Rm);
integer esize = 8;
integer datasize = if Q == '1' then 128 else 64;
integer elements = datasize DIV esize;
```

VBitOp op;

```
case opc2 of
    when '00' op = VBitOp_VEOR;
    when '01' op = VBitOp_VBSL;
    when '10' op = VBitOp_VBIT;
    when '11' op = VBitOp_VBIF;
```

Assembler Symbols

- <Vd> Is the name of the SIMD&FP destination register, encoded in the "Rd" field.
- <T> Is an arrangement specifier,
8B when Q = 0
16B when Q = 1
- <Vn> Is the name of the first SIMD&FP source register, encoded in the "Rn" field.
- <Vm> Is the name of the second SIMD&FP source register, encoded in the "Rm" field.

Operation

```
CheckFPAdvSIMDEnabled64();
bits(datasize) operand1;
bits(datasize) operand2;
bits(datasize) operand3;
bits(datasize) operand4 = V[n];
```

```
case op of
    when VBitOp_VEOR
        operand1 = V[m];
        operand2 = Zeros();
        operand3 = Ones();
    when VBitOp_VBSL
        operand1 = V[m];
        operand2 = operand1;
        operand3 = V[d];
    when VBitOp_VBIT
        operand1 = V[d];
        operand2 = operand1;
        operand3 = V[m];
    when VBitOp_VBIF
```

```
operand1 = V[d];  
operand2 = operand1;  
operand3 = NOT(V[m]);
```

```
V[d] = operand1 EOR ((operand2 EOR operand4) AND operand3);
```

C6.3.17 CLS (vector)

Count leading sign bits (vector)

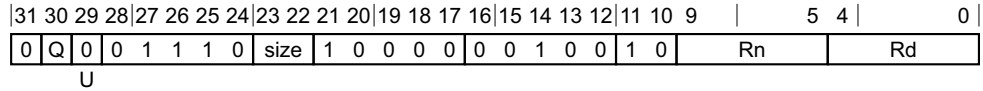

Vector variant

CLS <Vd>.<T>, <Vn>.<T>

```
integer d = UInt(Rd);
integer n = UInt(Rn);
```

```
if size == '11' then ReservedValue();
integer esize = 8 << UInt(size);
integer datasize = if Q == '1' then 128 else 64;
integer elements = datasize DIV esize;
```

```
CountOp countop = if U == '1' then CountOp_CLZ else CountOp_CLS;
```

Assembler Symbols

<Vd> Is the name of the SIMD&FP destination register, encoded in the "Rd" field.

<T> Is an arrangement specifier,

8B	when size = 00, Q = 0
16B	when size = 00, Q = 1
4H	when size = 01, Q = 0
8H	when size = 01, Q = 1
2S	when size = 10, Q = 0
4S	when size = 10, Q = 1
RESERVED	when size = 11, Q = x

<Vn> Is the name of the SIMD&FP source register, encoded in the "Rn" field.

Operation

```
CheckFPAdvSIMDEnabled64();
bits(datasize) operand = V[n];
bits(datasize) result;

integer count;
for e = 0 to elements-1
    if countop == CountOp_CLS then
        count = CountLeadingSignBits(Elem[operand, e, esize]);
    else
        count = CountLeadingZeroBits(Elem[operand, e, esize]);
    Elem[result, e, esize] = count<esize-1:0>;
V[d] = result;
```

C6.3.18 CLZ (vector)

Count leading zero bits (vector)

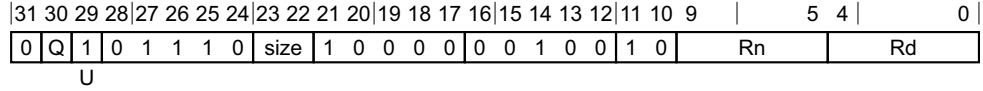

Vector variant

CLZ <Vd>.<T>, <Vn>.<T>

```
integer d = UInt(Rd);
integer n = UInt(Rn);
```

```
if size == '11' then ReservedValue();
integer esize = 8 << UInt(size);
integer datasize = if Q == '1' then 128 else 64;
integer elements = datasize DIV esize;
```

```
CountOp countop = if U == '1' then CountOp_CLZ else CountOp_CLS;
```

Assembler Symbols

<Vd> Is the name of the SIMD&FP destination register, encoded in the "Rd" field.

<T> Is an arrangement specifier,

8B	when size = 00, Q = 0
16B	when size = 00, Q = 1
4H	when size = 01, Q = 0
8H	when size = 01, Q = 1
2S	when size = 10, Q = 0
4S	when size = 10, Q = 1
RESERVED	when size = 11, Q = x

<Vn> Is the name of the SIMD&FP source register, encoded in the "Rn" field.

Operation

```
CheckFPAdvSIMDEnabled64();
bits(datasize) operand = V[n];
bits(datasize) result;

integer count;
for e = 0 to elements-1
    if countop == CountOp_CLS then
        count = CountLeadingSignBits(Elem[operand, e, esize]);
    else
        count = CountLeadingZeroBits(Elem[operand, e, esize]);
    Elem[result, e, esize] = count<esize-1:0>;
V[d] = result;
```

C6.3.19 CMEQ (register)

Compare bitwise equal (vector), setting destination vector element to all ones if the condition holds, else zero

It has encodings from 2 classes: *Scalar* and *Vector*

Scalar

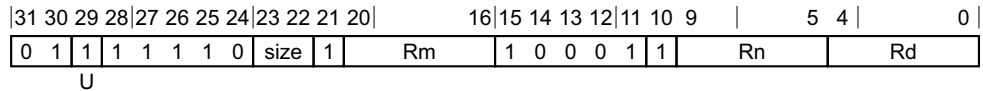

Scalar variant

CMEQ <V><d>, <V><n>, <V><m>

```
integer d = UInt(Rd);
integer n = UInt(Rn);
integer m = UInt(Rm);
if size != '11' then ReservedValue();
integer esize = 8 << UInt(size);
integer datasize = esize;
integer elements = 1;
boolean and_test = (U == '0');
```

Vector

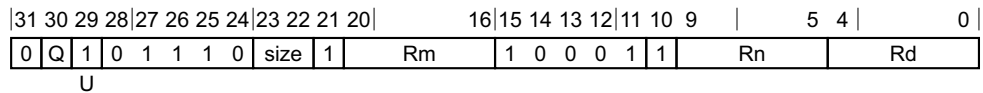

Vector variant

CMEQ <Vd>.<T>, <Vn>.<T>, <Vm>.<T>

```
integer d = UInt(Rd);
integer n = UInt(Rn);
integer m = UInt(Rm);
if size:Q == '110' then ReservedValue();
integer esize = 8 << UInt(size);
integer datasize = if Q == '1' then 128 else 64;
integer elements = datasize DIV esize;
boolean and_test = (U == '0');
```

Assembler Symbols

- <V> Is a width specifier,
RESERVED when size = 0x
RESERVED when size = 10
D when size = 11
- <d> Is the number of the SIMD&FP destination register, in the "Rd" field.
- <n> Is the number of the first SIMD&FP source register, encoded in the "Rn" field.
- <m> Is the number of the second SIMD&FP source register, encoded in the "Rm" field.
- <Vd> Is the name of the SIMD&FP destination register, encoded in the "Rd" field.
- <T> Is an arrangement specifier,
8B when size = 00, Q = 0

16B when size = 00, Q = 1
4H when size = 01, Q = 0
8H when size = 01, Q = 1
2S when size = 10, Q = 0
4S when size = 10, Q = 1
RESERVED when size = 11, Q = 0
2D when size = 11, Q = 1

<Vn> Is the name of the first SIMD&FP source register, encoded in the "Rn" field.

<Vm> Is the name of the second SIMD&FP source register, encoded in the "Rm" field.

Operation for all classes

```
CheckFPAdvSIMDEnabled64();
bits(datasize) operand1 = V[n];
bits(datasize) operand2 = V[m];
bits(datasize) result;
bits(esize) element1;
bits(esize) element2;
boolean test_passed;

for e = 0 to elements-1
    element1 = Elem[operand1, e, esize];
    element2 = Elem[operand2, e, esize];
    if and_test then
        test_passed = !IsZero(element1 AND element2);
    else
        test_passed = (element1 == element2);
    Elem[result, e, esize] = if test_passed then Ones() else Zeros();

V[d] = result;
```

C6.3.20 CMEQ (zero)

Compare bitwise equal to zero (vector), setting destination vector element to all ones if the condition holds, else zero

It has encodings from 2 classes: *Scalar* and *Vector*

Scalar

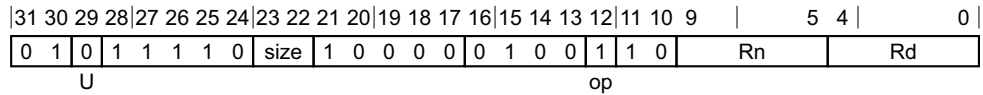

Scalar variant

CMEQ <V><d>, <V><n>, #0

```
integer d = UInt(Rd);
integer n = UInt(Rn);
```

```
if size != '11' then ReservedValue();
integer esize = 8 << UInt(size);
integer datasize = esize;
integer elements = 1;
```

```
CompareOp comparison;
case op:U of
    when '00' comparison = CompareOp_GT;
    when '01' comparison = CompareOp_GE;
    when '10' comparison = CompareOp_EQ;
    when '11' comparison = CompareOp_LE;
```

Vector

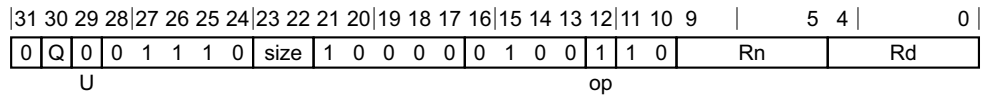

Vector variant

CMEQ <Vd>.<T>, <Vn>.<T>, #0

```
integer d = UInt(Rd);
integer n = UInt(Rn);
```

```
if size:Q == '110' then ReservedValue();
integer esize = 8 << UInt(size);
integer datasize = if Q == '1' then 128 else 64;
integer elements = datasize DIV esize;
```

```
CompareOp comparison;
case op:U of
    when '00' comparison = CompareOp_GT;
    when '01' comparison = CompareOp_GE;
    when '10' comparison = CompareOp_EQ;
    when '11' comparison = CompareOp_LE;
```

Assembler Symbols

<V> Is a width specifier,
RESERVED when size = 0x
RESERVED when size = 10

	D	when size = 11
<d>	Is the number of the SIMD&FP destination register, encoded in the "Rd" field.	
<n>	Is the number of the SIMD&FP source register, encoded in the "Rn" field.	
<Vd>	Is the name of the SIMD&FP destination register, encoded in the "Rd" field.	
<T>	Is an arrangement specifier,	
	8B	when size = 00, Q = 0
	16B	when size = 00, Q = 1
	4H	when size = 01, Q = 0
	8H	when size = 01, Q = 1
	2S	when size = 10, Q = 0
	4S	when size = 10, Q = 1
	RESERVED	when size = 11, Q = 0
	2D	when size = 11, Q = 1
<Vn>	Is the name of the SIMD&FP source register, encoded in the "Rn" field.	

Operation for all classes

```
CheckFPAdvSIMDEnabled64();
bits(datasize) operand = V[n];
bits(datasize) result;
integer element;
boolean test_passed;

for e = 0 to elements-1
    element = SInt(Elem[operand, e, esize]);
    case comparison of
        when CompareOp_GT test_passed = element > 0;
        when CompareOp_GE test_passed = element >= 0;
        when CompareOp_EQ test_passed = element == 0;
        when CompareOp_LE test_passed = element <= 0;
        when CompareOp_LT test_passed = element < 0;
    Elem[result, e, esize] = if test_passed then Ones() else Zeros();

V[d] = result;
```

C6.3.21 CMGE (register)

Compare signed greater than or equal (vector)

It has encodings from 2 classes: *Scalar* and *Vector*

Scalar

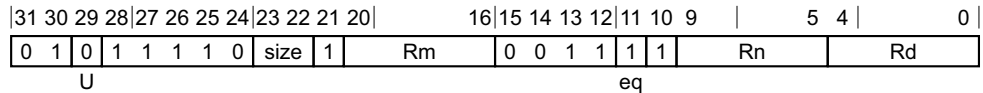

Scalar variant

CMGE <V><d>, <V><n>, <V><m>

```
integer d = UInt(Rd);
integer n = UInt(Rn);
integer m = UInt(Rm);
if size != '11' then ReservedValue();
integer esize = 8 << UInt(size);
integer datasize = esize;
integer elements = 1;
boolean unsigned = (U == '1');
boolean cmp_eq = (eq == '1');
```

Vector

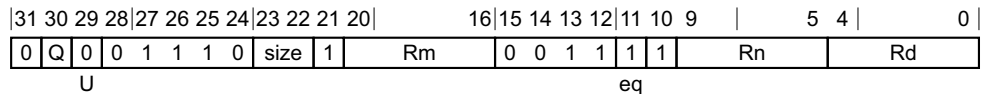

Vector variant

CMGE <Vd>.<T>, <Vn>.<T>, <Vm>.<T>

```
integer d = UInt(Rd);
integer n = UInt(Rn);
integer m = UInt(Rm);
if size:Q == '110' then ReservedValue();
integer esize = 8 << UInt(size);
integer datasize = if Q == '1' then 128 else 64;
integer elements = datasize DIV esize;
boolean unsigned = (U == '1');
boolean cmp_eq = (eq == '1');
```

Assembler Symbols

- <V> Is a width specifier,
RESERVED when size = 0x
RESERVED when size = 10
D when size = 11
- <d> Is the number of the SIMD&FP destination register, in the "Rd" field.
- <n> Is the number of the first SIMD&FP source register, encoded in the "Rn" field.
- <m> Is the number of the second SIMD&FP source register, encoded in the "Rm" field.
- <Vd> Is the name of the SIMD&FP destination register, encoded in the "Rd" field.

<T>	Is an arrangement specifier, 8B when size = 00, Q = 0 16B when size = 00, Q = 1 4H when size = 01, Q = 0 8H when size = 01, Q = 1 2S when size = 10, Q = 0 4S when size = 10, Q = 1 RESERVED when size = 11, Q = 0 2D when size = 11, Q = 1
<Vn>	Is the name of the first SIMD&FP source register, encoded in the "Rn" field.
<Vm>	Is the name of the second SIMD&FP source register, encoded in the "Rm" field.

Operation for all classes

```
CheckFPAdvSIMDEnabled64();
bits(datasize) operand1 = V[n];
bits(datasize) operand2 = V[m];
bits(datasize) result;
integer element1;
integer element2;
boolean test_passed;

for e = 0 to elements-1
    element1 = Int(Elem[operand1, e, esize], unsigned);
    element2 = Int(Elem[operand2, e, esize], unsigned);
    test_passed = if cmp_eq then element1 >= element2 else element1 > element2;
    Elem[result, e, esize] = if test_passed then Ones() else Zeros();

V[d] = result;
```

C6.3.22 CMGE (zero)

Compare signed greater than or equal to zero (vector), setting destination vector element to all ones if the condition holds, else zero

It has encodings from 2 classes: *Scalar* and *Vector*

Scalar

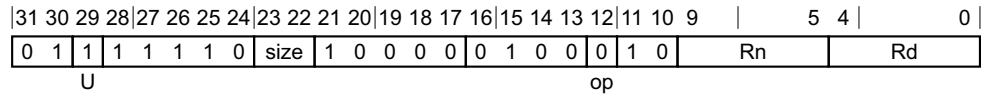

Scalar variant

CMGE <V><d>, <V><n>, #0

```
integer d = UInt(Rd);
integer n = UInt(Rn);

if size != '11' then ReservedValue();
integer esize = 8 << UInt(size);
integer datasize = esize;
integer elements = 1;

CompareOp comparison;
case op:U of
    when '00' comparison = CompareOp_GT;
    when '01' comparison = CompareOp_GE;
    when '10' comparison = CompareOp_EQ;
    when '11' comparison = CompareOp_LE;
```

Vector

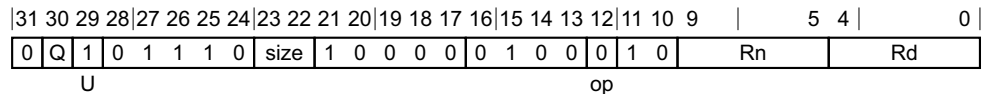

Vector variant

CMGE <Vd>.<T>, <Vn>.<T>, #0

```
integer d = UInt(Rd);
integer n = UInt(Rn);

if size:Q == '110' then ReservedValue();
integer esize = 8 << UInt(size);
integer datasize = if Q == '1' then 128 else 64;
integer elements = datasize DIV esize;

CompareOp comparison;
case op:U of
    when '00' comparison = CompareOp_GT;
    when '01' comparison = CompareOp_GE;
    when '10' comparison = CompareOp_EQ;
    when '11' comparison = CompareOp_LE;
```

Assembler Symbols

<V> Is a width specifier,
RESERVED when size = 0x
RESERVED when size = 10

	D	when size = 11
<d>	Is the number of the SIMD&FP destination register, encoded in the "Rd" field.	
<n>	Is the number of the SIMD&FP source register, encoded in the "Rn" field.	
<Vd>	Is the name of the SIMD&FP destination register, encoded in the "Rd" field.	
<T>	Is an arrangement specifier,	
	8B	when size = 00, Q = 0
	16B	when size = 00, Q = 1
	4H	when size = 01, Q = 0
	8H	when size = 01, Q = 1
	2S	when size = 10, Q = 0
	4S	when size = 10, Q = 1
	RESERVED	when size = 11, Q = 0
	2D	when size = 11, Q = 1
<Vn>	Is the name of the SIMD&FP source register, encoded in the "Rn" field.	

Operation for all classes

```
CheckFPAdvSIMDEnabled64();
bits(datasize) operand = V[n];
bits(datasize) result;
integer element;
boolean test_passed;

for e = 0 to elements-1
    element = SInt(Elem[operand, e, esize]);
    case comparison of
        when CompareOp_GT test_passed = element > 0;
        when CompareOp_GE test_passed = element >= 0;
        when CompareOp_EQ test_passed = element == 0;
        when CompareOp_LE test_passed = element <= 0;
        when CompareOp_LT test_passed = element < 0;
    Elem[result, e, esize] = if test_passed then Ones() else Zeros();

V[d] = result;
```

C6.3.23 CMGT (register)

Compare signed greater than (vector), setting destination vector element to all ones if the condition holds, else zero

It has encodings from 2 classes: *Scalar* and *Vector*

Scalar

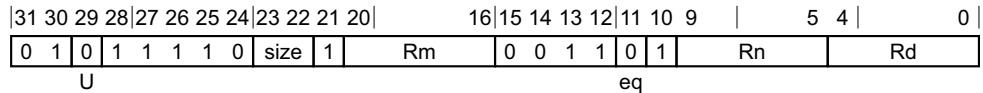

Scalar variant

CMGT <V><d>, <V><n>, <V><m>

```
integer d = UInt(Rd);
integer n = UInt(Rn);
integer m = UInt(Rm);
if size != '11' then ReservedValue();
integer esize = 8 << UInt(size);
integer datasize = esize;
integer elements = 1;
boolean unsigned = (U == '1');
boolean cmp_eq = (eq == '1');
```

Vector

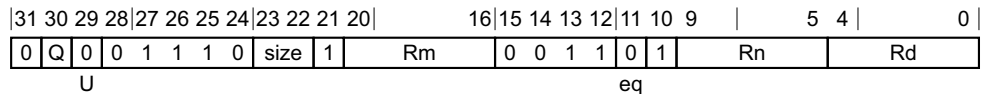

Vector variant

CMGT <Vd>.<T>, <Vn>.<T>, <Vm>.<T>

```
integer d = UInt(Rd);
integer n = UInt(Rn);
integer m = UInt(Rm);
if size:Q == '110' then ReservedValue();
integer esize = 8 << UInt(size);
integer datasize = if Q == '1' then 128 else 64;
integer elements = datasize DIV esize;
boolean unsigned = (U == '1');
boolean cmp_eq = (eq == '1');
```

Assembler Symbols

- <V> Is a width specifier,
RESERVED when size = 0x
RESERVED when size = 10
D when size = 11
- <d> Is the number of the SIMD&FP destination register, in the "Rd" field.
- <n> Is the number of the first SIMD&FP source register, encoded in the "Rn" field.
- <m> Is the number of the second SIMD&FP source register, encoded in the "Rm" field.
- <Vd> Is the name of the SIMD&FP destination register, encoded in the "Rd" field.

<T>	Is an arrangement specifier, 8B when size = 00, Q = 0 16B when size = 00, Q = 1 4H when size = 01, Q = 0 8H when size = 01, Q = 1 2S when size = 10, Q = 0 4S when size = 10, Q = 1 RESERVED when size = 11, Q = 0 2D when size = 11, Q = 1
<Vn>	Is the name of the first SIMD&FP source register, encoded in the "Rn" field.
<Vm>	Is the name of the second SIMD&FP source register, encoded in the "Rm" field.

Operation for all classes

```
CheckFPAdvSIMDEnabled64();
bits(datasize) operand1 = V[n];
bits(datasize) operand2 = V[m];
bits(datasize) result;
integer element1;
integer element2;
boolean test_passed;

for e = 0 to elements-1
    element1 = Int(Elem[operand1, e, esize], unsigned);
    element2 = Int(Elem[operand2, e, esize], unsigned);
    test_passed = if cmp_eq then element1 >= element2 else element1 > element2;
    Elem[result, e, esize] = if test_passed then Ones() else Zeros();

V[d] = result;
```

C6.3.24 CMGT (zero)

Compare signed greater than zero (vector), setting destination vector element to all ones if the condition holds, else zero

It has encodings from 2 classes: *Scalar* and *Vector*

Scalar

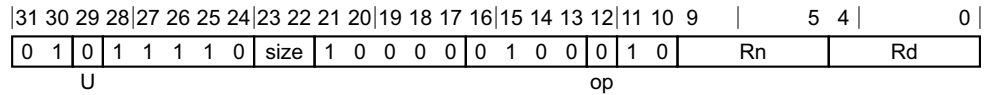

Scalar variant

CMGT <V><d>, <V><n>, #0

```
integer d = UInt(Rd);
integer n = UInt(Rn);
```

```
if size != '11' then ReservedValue();
integer esize = 8 << UInt(size);
integer datasize = esize;
integer elements = 1;
```

```
CompareOp comparison;
case op:U of
    when '00' comparison = CompareOp_GT;
    when '01' comparison = CompareOp_GE;
    when '10' comparison = CompareOp_EQ;
    when '11' comparison = CompareOp_LE;
```

Vector

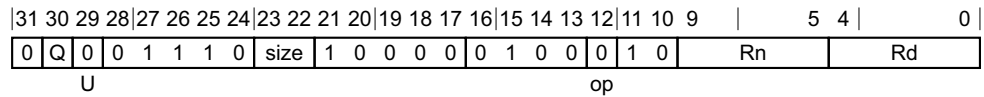

Vector variant

CMGT <Vd>.<T>, <Vn>.<T>, #0

```
integer d = UInt(Rd);
integer n = UInt(Rn);
```

```
if size:Q == '110' then ReservedValue();
integer esize = 8 << UInt(size);
integer datasize = if Q == '1' then 128 else 64;
integer elements = datasize DIV esize;
```

```
CompareOp comparison;
case op:U of
    when '00' comparison = CompareOp_GT;
    when '01' comparison = CompareOp_GE;
    when '10' comparison = CompareOp_EQ;
    when '11' comparison = CompareOp_LE;
```

Assembler Symbols

<V> Is a width specifier,
RESERVED when size = 0x
RESERVED when size = 10

	D	when size = 11
<d>	Is the number of the SIMD&FP destination register, encoded in the "Rd" field.	
<n>	Is the number of the SIMD&FP source register, encoded in the "Rn" field.	
<Vd>	Is the name of the SIMD&FP destination register, encoded in the "Rd" field.	
<T>	Is an arrangement specifier,	
	8B	when size = 00, Q = 0
	16B	when size = 00, Q = 1
	4H	when size = 01, Q = 0
	8H	when size = 01, Q = 1
	2S	when size = 10, Q = 0
	4S	when size = 10, Q = 1
	RESERVED	when size = 11, Q = 0
	2D	when size = 11, Q = 1
<Vn>	Is the name of the SIMD&FP source register, encoded in the "Rn" field.	

Operation for all classes

```
CheckFPAdvSIMDEnabled64();
bits(datasize) operand = V[n];
bits(datasize) result;
integer element;
boolean test_passed;

for e = 0 to elements-1
    element = SInt(Elem[operand, e, esize]);
    case comparison of
        when CompareOp_GT test_passed = element > 0;
        when CompareOp_GE test_passed = element >= 0;
        when CompareOp_EQ test_passed = element == 0;
        when CompareOp_LE test_passed = element <= 0;
        when CompareOp_LT test_passed = element < 0;
    Elem[result, e, esize] = if test_passed then Ones() else Zeros();

V[d] = result;
```

C6.3.25 CMHI (register)

Compare unsigned higher (vector), setting destination vector element to all ones if the condition holds, else zero

It has encodings from 2 classes: *Scalar* and *Vector*

Scalar

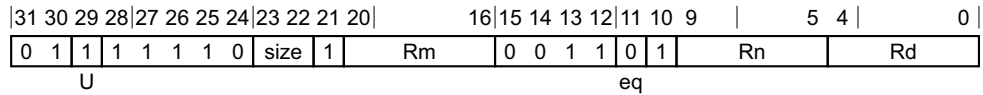

Scalar variant

CMHI <V><d>, <V><n>, <V><m>

```
integer d = UInt(Rd);
integer n = UInt(Rn);
integer m = UInt(Rm);
if size != '11' then ReservedValue();
integer esize = 8 << UInt(size);
integer datasize = esize;
integer elements = 1;
boolean unsigned = (U == '1');
boolean cmp_eq = (eq == '1');
```

Vector

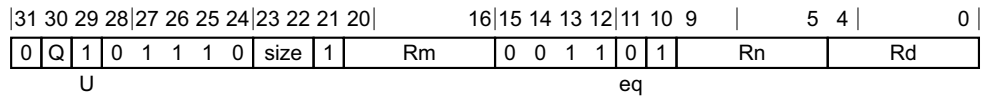

Vector variant

CMHI <Vd>.<T>, <Vn>.<T>, <Vm>.<T>

```
integer d = UInt(Rd);
integer n = UInt(Rn);
integer m = UInt(Rm);
if size:Q == '110' then ReservedValue();
integer esize = 8 << UInt(size);
integer datasize = if Q == '1' then 128 else 64;
integer elements = datasize DIV esize;
boolean unsigned = (U == '1');
boolean cmp_eq = (eq == '1');
```

Assembler Symbols

- <V> Is a width specifier,
RESERVED when size = 0x
RESERVED when size = 10
D when size = 11
- <d> Is the number of the SIMD&FP destination register, in the "Rd" field.
- <n> Is the number of the first SIMD&FP source register, encoded in the "Rn" field.
- <m> Is the number of the second SIMD&FP source register, encoded in the "Rm" field.
- <Vd> Is the name of the SIMD&FP destination register, encoded in the "Rd" field.

<T>	Is an arrangement specifier, 8B when size = 00, Q = 0 16B when size = 00, Q = 1 4H when size = 01, Q = 0 8H when size = 01, Q = 1 2S when size = 10, Q = 0 4S when size = 10, Q = 1 RESERVED when size = 11, Q = 0 2D when size = 11, Q = 1
<Vn>	Is the name of the first SIMD&FP source register, encoded in the "Rn" field.
<Vm>	Is the name of the second SIMD&FP source register, encoded in the "Rm" field.

Operation for all classes

```
CheckFPAdvSIMDEnabled64();
bits(datasize) operand1 = V[n];
bits(datasize) operand2 = V[m];
bits(datasize) result;
integer element1;
integer element2;
boolean test_passed;

for e = 0 to elements-1
    element1 = Int(Elem[operand1, e, esize], unsigned);
    element2 = Int(Elem[operand2, e, esize], unsigned);
    test_passed = if cmp_eq then element1 >= element2 else element1 > element2;
    Elem[result, e, esize] = if test_passed then Ones() else Zeros();

V[d] = result;
```

C6.3.26 CMHS (register)

Compare unsigned higher or same (vector), setting destination vector element to all ones if the condition holds, else zero

It has encodings from 2 classes: *Scalar* and *Vector*

Scalar

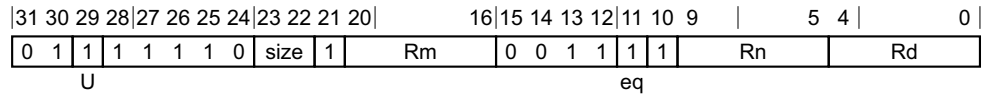

Scalar variant

CMHS <V><d>, <V><n>, <V><m>

```
integer d = UInt(Rd);
integer n = UInt(Rn);
integer m = UInt(Rm);
if size != '11' then ReservedValue();
integer esize = 8 << UInt(size);
integer datasize = esize;
integer elements = 1;
boolean unsigned = (U == '1');
boolean cmp_eq = (eq == '1');
```

Vector

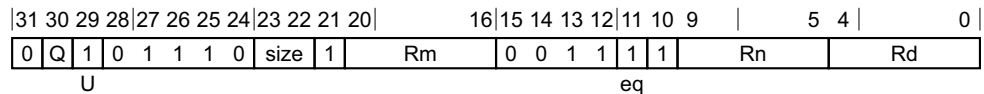

Vector variant

CMHS <Vd>.<T>, <Vn>.<T>, <Vm>.<T>

```
integer d = UInt(Rd);
integer n = UInt(Rn);
integer m = UInt(Rm);
if size:Q == '110' then ReservedValue();
integer esize = 8 << UInt(size);
integer datasize = if Q == '1' then 128 else 64;
integer elements = datasize DIV esize;
boolean unsigned = (U == '1');
boolean cmp_eq = (eq == '1');
```

Assembler Symbols

- <V> Is a width specifier,
RESERVED when size = 0x
RESERVED when size = 10
D when size = 11
- <d> Is the number of the SIMD&FP destination register, in the "Rd" field.
- <n> Is the number of the first SIMD&FP source register, encoded in the "Rn" field.
- <m> Is the number of the second SIMD&FP source register, encoded in the "Rm" field.
- <Vd> Is the name of the SIMD&FP destination register, encoded in the "Rd" field.

<T>	Is an arrangement specifier, 8B when size = 00, Q = 0 16B when size = 00, Q = 1 4H when size = 01, Q = 0 8H when size = 01, Q = 1 2S when size = 10, Q = 0 4S when size = 10, Q = 1 RESERVED when size = 11, Q = 0 2D when size = 11, Q = 1
<Vn>	Is the name of the first SIMD&FP source register, encoded in the "Rn" field.
<Vm>	Is the name of the second SIMD&FP source register, encoded in the "Rm" field.

Operation for all classes

```
CheckFPAdvSIMDEnabled64();
bits(datasize) operand1 = V[n];
bits(datasize) operand2 = V[m];
bits(datasize) result;
integer element1;
integer element2;
boolean test_passed;

for e = 0 to elements-1
    element1 = Int(Elem[operand1, e, esize], unsigned);
    element2 = Int(Elem[operand2, e, esize], unsigned);
    test_passed = if cmp_eq then element1 >= element2 else element1 > element2;
    Elem[result, e, esize] = if test_passed then Ones() else Zeros();

V[d] = result;
```

C6.3.27 CMLE (zero)

Compare signed less than or equal to zero (vector), setting destination vector element to all ones if the condition holds, else zero

It has encodings from 2 classes: *Scalar* and *Vector*

Scalar

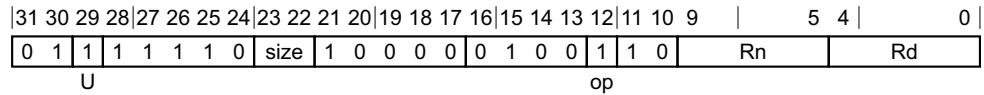

Scalar variant

CMLE <V><d>, <V><n>, #0

```
integer d = UInt(Rd);
integer n = UInt(Rn);
```

```
if size != '11' then ReservedValue();
integer esize = 8 << UInt(size);
integer datasize = esize;
integer elements = 1;
```

```
CompareOp comparison;
case op:U of
    when '00' comparison = CompareOp_GT;
    when '01' comparison = CompareOp_GE;
    when '10' comparison = CompareOp_EQ;
    when '11' comparison = CompareOp_LE;
```

Vector

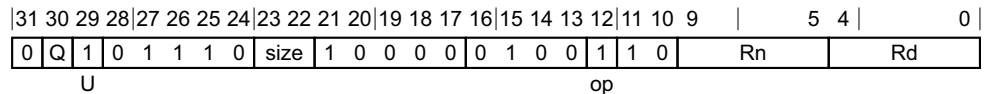

Vector variant

CMLE <Vd>.<T>, <Vn>.<T>, #0

```
integer d = UInt(Rd);
integer n = UInt(Rn);
```

```
if size:Q == '110' then ReservedValue();
integer esize = 8 << UInt(size);
integer datasize = if Q == '1' then 128 else 64;
integer elements = datasize DIV esize;
```

```
CompareOp comparison;
case op:U of
    when '00' comparison = CompareOp_GT;
    when '01' comparison = CompareOp_GE;
    when '10' comparison = CompareOp_EQ;
    when '11' comparison = CompareOp_LE;
```

Assembler Symbols

<V> Is a width specifier,
RESERVED when size = 0x
RESERVED when size = 10

	D	when size = 11
<d>	Is the number of the SIMD&FP destination register, encoded in the "Rd" field.	
<n>	Is the number of the SIMD&FP source register, encoded in the "Rn" field.	
<Vd>	Is the name of the SIMD&FP destination register, encoded in the "Rd" field.	
<T>	Is an arrangement specifier,	
	8B	when size = 00, Q = 0
	16B	when size = 00, Q = 1
	4H	when size = 01, Q = 0
	8H	when size = 01, Q = 1
	2S	when size = 10, Q = 0
	4S	when size = 10, Q = 1
	RESERVED	when size = 11, Q = 0
	2D	when size = 11, Q = 1
<Vn>	Is the name of the SIMD&FP source register, encoded in the "Rn" field.	

Operation for all classes

```
CheckFPAdvSIMDEnabled64();
bits(datasize) operand = V[n];
bits(datasize) result;
integer element;
boolean test_passed;

for e = 0 to elements-1
    element = SInt(Elem[operand, e, esize]);
    case comparison of
        when CompareOp_GT test_passed = element > 0;
        when CompareOp_GE test_passed = element >= 0;
        when CompareOp_EQ test_passed = element == 0;
        when CompareOp_LE test_passed = element <= 0;
        when CompareOp_LT test_passed = element < 0;
    Elem[result, e, esize] = if test_passed then Ones() else Zeros();

V[d] = result;
```

C6.3.28 CMLT (zero)

Compare signed less than zero (vector), setting destination vector element to all ones if the condition holds, else zero

It has encodings from 2 classes: *Scalar* and *Vector*

Scalar

31	30	29	28	27	26	25	24	23	22	21	20	19	18	17	16	15	14	13	12	11	10	9				5	4			0
0	1	0	1	1	1	1	0	size	1	0	0	0	0	0	0	1	0	1	0	1	0				Rn				Rd	

Scalar variant

CMLT <V><d>, <V><n>, #0

```
integer d = UInt(Rd);
integer n = UInt(Rn);
```

```
if size != '11' then ReservedValue();
integer esize = 8 << UInt(size);
integer datasize = esize;
integer elements = 1;
```

CompareOp comparison = CompareOp_LT;

Vector

31	30	29	28	27	26	25	24	23	22	21	20	19	18	17	16	15	14	13	12	11	10	9				5	4			0
0	Q	0	0	1	1	1	0	size	1	0	0	0	0	0	0	1	0	1	0	1	0				Rn				Rd	

Vector variant

CMLT <Vd>.<T>, <Vn>.<T>, #0

```
integer d = UInt(Rd);
integer n = UInt(Rn);
```

```
if size:Q == '110' then ReservedValue();
integer esize = 8 << UInt(size);
integer datasize = if Q == '1' then 128 else 64;
integer elements = datasize DIV esize;
```

CompareOp comparison = CompareOp_LT;

Assembler Symbols

<V>	Is a width specifier, RESERVED when size = 0x RESERVED when size = 10 D when size = 11
<d>	Is the number of the SIMD&FP destination register, encoded in the "Rd" field.
<n>	Is the number of the SIMD&FP source register, encoded in the "Rn" field.
<Vd>	Is the name of the SIMD&FP destination register, encoded in the "Rd" field.
<T>	Is an arrangement specifier, 8B when size = 00, Q = 0

16B when size = 00, Q = 1
4H when size = 01, Q = 0
8H when size = 01, Q = 1
2S when size = 10, Q = 0
4S when size = 10, Q = 1
RESERVED when size = 11, Q = 0
2D when size = 11, Q = 1

<Vn> Is the name of the SIMD&FP source register, encoded in the "Rn" field.

Operation for all classes

```
CheckFPAdvSIMDEnabled64();
bits(datasize) operand = V[n];
bits(datasize) result;
integer element;
boolean test_passed;

for e = 0 to elements-1
    element = SInt(Elem[operand, e, esize]);
    case comparison of
        when CompareOp_GT test_passed = element > 0;
        when CompareOp_GE test_passed = element >= 0;
        when CompareOp_EQ test_passed = element == 0;
        when CompareOp_LE test_passed = element <= 0;
        when CompareOp_LT test_passed = element < 0;
    Elem[result, e, esize] = if test_passed then Ones() else Zeros();

V[d] = result;
```

C6.3.29 CMTST

Compare bitwise test bits nonzero (vector), setting destination vector element to all ones if the condition holds, else zero

It has encodings from 2 classes: *Scalar* and *Vector*

Scalar

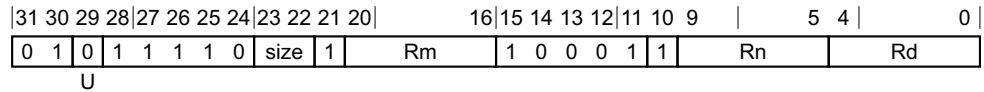

Scalar variant

CMTST <V><d>, <V><n>, <V><m>

```
integer d = UInt(Rd);
integer n = UInt(Rn);
integer m = UInt(Rm);
if size != '11' then ReservedValue();
integer esize = 8 << UInt(size);
integer datasize = esize;
integer elements = 1;
boolean and_test = (U == '0');
```

Vector

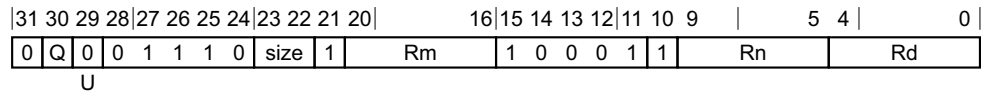

Vector variant

CMTST <Vd>.<T>, <Vn>.<T>, <Vm>.<T>

```
integer d = UInt(Rd);
integer n = UInt(Rn);
integer m = UInt(Rm);
if size:Q == '110' then ReservedValue();
integer esize = 8 << UInt(size);
integer datasize = if Q == '1' then 128 else 64;
integer elements = datasize DIV esize;
boolean and_test = (U == '0');
```

Assembler Symbols

- <V> Is a width specifier,
RESERVED when size = 0x
RESERVED when size = 10
D when size = 11
- <d> Is the number of the SIMD&FP destination register, in the "Rd" field.
- <n> Is the number of the first SIMD&FP source register, encoded in the "Rn" field.
- <m> Is the number of the second SIMD&FP source register, encoded in the "Rm" field.
- <Vd> Is the name of the SIMD&FP destination register, encoded in the "Rd" field.

<T>	Is an arrangement specifier, 8B when size = 00, Q = 0 16B when size = 00, Q = 1 4H when size = 01, Q = 0 8H when size = 01, Q = 1 2S when size = 10, Q = 0 4S when size = 10, Q = 1 RESERVED when size = 11, Q = 0 2D when size = 11, Q = 1
<Vn>	Is the name of the first SIMD&FP source register, encoded in the "Rn" field.
<Vm>	Is the name of the second SIMD&FP source register, encoded in the "Rm" field.

Operation for all classes

```
CheckFPAdvSIMDEnabled64();
bits(datasize) operand1 = V[n];
bits(datasize) operand2 = V[m];
bits(datasize) result;
bits(esize) element1;
bits(esize) element2;
boolean test_passed;

for e = 0 to elements-1
    element1 = Elem[operand1, e, esize];
    element2 = Elem[operand2, e, esize];
    if and_test then
        test_passed = !IsZero(element1 AND element2);
    else
        test_passed = (element1 == element2);
    Elem[result, e, esize] = if test_passed then Ones() else Zeros();

V[d] = result;
```

C6.3.30 CNT

Population count per byte

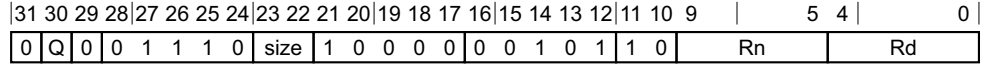

Vector variant

CNT <Vd>.<T>, <Vn>.<T>

```
integer d = UInt(Rd);
integer n = UInt(Rn);
```

```
if size != '00' then ReservedValue();
integer esize = 8;
integer datasize = if Q == '1' then 128 else 64;
integer elements = datasize DIV 8;
```

Assembler Symbols

<Vd> Is the name of the SIMD&FP destination register, encoded in the "Rd" field.

<T> Is an arrangement specifier,
8B when size = 00, Q = 0
16B when size = 00, Q = 1
RESERVED when size = 01, Q = x
RESERVED when size = 1x, Q = x

<Vn> Is the name of the SIMD&FP source register, encoded in the "Rn" field.

Operation

```
CheckFPAdvSIMDEnabled64();
bits(datasize) operand = V[n];
bits(datasize) result;

integer count;
for e = 0 to elements-1
    count = BitCount(Elem[operand, e, esize]);
    Elem[result, e, esize] = count<esize-1:0>;
V[d] = result;
```

C6.3.31 DUP (element)

Duplicate vector element to vector or scalar

This instruction is used by the alias **MOV (scalar)**. The alias is always the preferred disassembly.

It has encodings from 2 classes: *Scalar* and *Vector*

Scalar

31	30	29	28	27	26	25	24	23	22	21	20	16	15	14	13	12	11	10	9	5	4	0
0	1	0	1	1	1	1	0	0	0	0	imm5	0	0	0	0	0	1	Rn	Rd			

Scalar variant

DUP <V><d>, <Vn>.<T>[<index>]

```
integer d = UInt(Rd);
integer n = UInt(Rn);

integer size = LowestSetBit(imm5);
if size > 3 then UnallocatedEncoding();

integer index = UInt(imm5<4:size+1>);
integer idxsize = if imm5<4> == '1' then 128 else 64;

integer esize = 8 << size;
integer datasize = esize;
integer elements = 1;
```

Vector

31	30	29	28	27	26	25	24	23	22	21	20	16	15	14	13	12	11	10	9	5	4	0
0	Q	0	0	1	1	1	0	0	0	0	imm5	0	0	0	0	0	1	Rn	Rd			

Vector variant

DUP <Vd>.<T>, <Vn>.<Ts>[<index>]

```
integer d = UInt(Rd);
integer n = UInt(Rn);

integer size = LowestSetBit(imm5);
if size > 3 then UnallocatedEncoding();

integer index = UInt(imm5<4:size+1>);
integer idxsize = if imm5<4> == '1' then 128 else 64;

if size == 3 && Q == '0' then ReservedValue();
integer esize = 8 << size;
integer datasize = if Q == '1' then 128 else 64;
integer elements = datasize DIV esize;
```

Assembler Symbols

- <T> For the scalar variant: is the element width specifier,
 - RESERVED** when imm5 = x0000
 - B** when imm5 = xxxx1
 - H** when imm5 = xxx10

- S** when imm5 = xx100
D when imm5 = x1000
- <T> For the vector variant: is an arrangement specifier,
RESERVED when imm5 = x0000, Q = x
8B when imm5 = xxxx1, Q = 0
16B when imm5 = xxxx1, Q = 1
4H when imm5 = xxx10, Q = 0
8H when imm5 = xxx10, Q = 1
2S when imm5 = xx100, Q = 0
4S when imm5 = xx100, Q = 1
RESERVED when imm5 = x1000, Q = 0
2D when imm5 = x1000, Q = 1
- <Ts> Is an element size specifier,
RESERVED when imm5 = x0000
B when imm5 = xxxx1
H when imm5 = xxx10
S when imm5 = xx100
D when imm5 = x1000
- <V> Is the destination width specifier,
RESERVED when imm5 = x0000
B when imm5 = xxxx1
H when imm5 = xxx10
S when imm5 = xx100
D when imm5 = x1000
- <Vn> Is the name of the SIMD&FP source register, encoded in the "Rn" field.
- <index> Is the element index
RESERVED when imm5 = x0000
imm5<4:1> when imm5 = xxxx1
imm5<4:2> when imm5 = xxx10
imm5<4:3> when imm5 = xx100
imm5<4> when imm5 = x1000
- <d> Is the number of the SIMD&FP destination register, encoded in the "Rd" field.
- <Vd> Is the name of the SIMD&FP destination register, encoded in the "Rd" field.

Operation for all classes

```

CheckFPAdvSIMDEnabled64();
bits(idxsized) operand = V[n];
bits(datasized) result;
bits(esized) element;

element = Elem[operand, index, esized];
for e = 0 to elements-1
    Elem[result, e, esized] = element;
V[d] = result;
    
```

C6.3.32 DUP (general)

Duplicate general-purpose register to vector

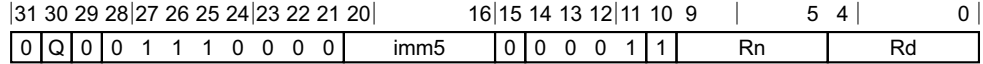

Advanced SIMD variant

DUP <Vd>.<T>, <R><n>

```
integer d = UInt(Rd);
integer n = UInt(Rn);
```

```
integer size = LowestSetBit(imm5);
if size > 3 then UnallocatedEncoding();
```

// imm5<4:size+1> is IGNORED

```
if size == 3 && Q == '0' then ReservedValue();
integer esize = 8 << size;
integer datasize = if Q == '1' then 128 else 64;
integer elements = datasize DIV esize;
```

Assembler Symbols

<Vd> Is the name of the SIMD&FP destination register, encoded in the "Rd" field.

<T> Is an arrangement specifier,
RESERVED when imm5 = x0000, Q = x
8B when imm5 = xxxx1, Q = 0
16B when imm5 = xxxx1, Q = 1
4H when imm5 = xxx10, Q = 0
8H when imm5 = xxx10, Q = 1
2S when imm5 = xx100, Q = 0
4S when imm5 = xx100, Q = 1
RESERVED when imm5 = x1000, Q = 0
2D when imm5 = x1000, Q = 1

<R> Is the width specifier for the general-purpose source register,
RESERVED when imm5 = x0000
W when imm5 = xxxx1
W when imm5 = xxx10
W when imm5 = xx100
X when imm5 = x1000

Unspecified bits in "imm5" are ignored but should be set to zero by an assembler.

<n> Is the number [0-30] of the general-purpose source register or ZR (31), encoded in the "Rn" field.

Operation

```
CheckFPAdvSIMDEnabled64();  
bits(esize) element = X[n];  
bits(datasize) result;  
  
for e = 0 to elements-1  
    Elem[result, e, esize] = element;  
V[d] = result;
```

C6.3.33 EOR (vector)

Bitwise exclusive OR (vector)

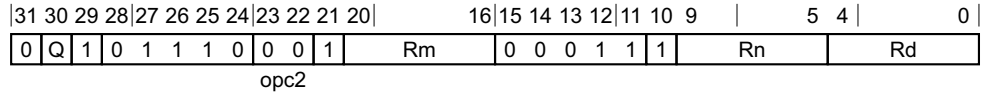

Three registers of the same type variant

EOR <Vd>.<T>, <Vn>.<T>, <Vm>.<T>

```
integer d = UInt(Rd);
integer n = UInt(Rn);
integer m = UInt(Rm);
integer esize = 8;
integer datasize = if Q == '1' then 128 else 64;
integer elements = datasize DIV esize;
```

VBitOp op;

```
case opc2 of
    when '00' op = VBitOp_VEOR;
    when '01' op = VBitOp_VBSL;
    when '10' op = VBitOp_VBIT;
    when '11' op = VBitOp_VBIF;
```

Assembler Symbols

- <Vd> Is the name of the SIMD&FP destination register, encoded in the "Rd" field.
- <T> Is an arrangement specifier,
 - 8B** when Q = 0
 - 16B** when Q = 1
- <Vn> Is the name of the first SIMD&FP source register, encoded in the "Rn" field.
- <Vm> Is the name of the second SIMD&FP source register, encoded in the "Rm" field.

Operation

```
CheckFPAdvSIMDEnabled64();
bits(datasize) operand1;
bits(datasize) operand2;
bits(datasize) operand3;
bits(datasize) operand4 = V[n];
```

```
case op of
    when VBitOp_VEOR
        operand1 = V[m];
        operand2 = Zeros();
        operand3 = Ones();
    when VBitOp_VBSL
        operand1 = V[m];
        operand2 = operand1;
        operand3 = V[d];
    when VBitOp_VBIT
        operand1 = V[d];
        operand2 = operand1;
        operand3 = V[m];
    when VBitOp_VBIF
```

```
operand1 = V[d];  
operand2 = operand1;  
operand3 = NOT(V[m]);
```

```
V[d] = operand1 EOR ((operand2 EOR operand4) AND operand3);
```

C6.3.34 EXT

Extract vector from pair of vectors

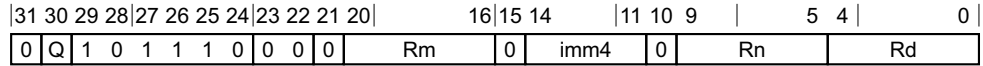

Advanced SIMD variant

EXT <Vd>.<T>, <Vn>.<T>, <Vm>.<T>, #<index>

```
integer d = UInt(Rd);
integer n = UInt(Rn);
integer m = UInt(Rm);
```

```
if Q == '0' && imm4<3> == '1' then UnallocatedEncoding();
```

```
integer datasize = if Q == '1' then 128 else 64;
integer position = UInt(imm4) << 3;
```

Assembler Symbols

- <Vd> Is the name of the SIMD&FP destination register, encoded in the "Rd" field.
- <T> Is an arrangement specifier,
 - 8B** when Q = 0
 - 16B** when Q = 1
- <Vn> Is the name of the first SIMD&FP source register, encoded in the "Rn" field.
- <Vm> Is the name of the second SIMD&FP source register, encoded in the "Rm" field.
- <index> Is the lowest numbered byte element to be extracted,
 - imm4<2:0>** when Q = 0, imm4<3> = 0
 - RESERVED** when Q = 0, imm4<3> = 1
 - imm4** when Q = 1, imm4<3> = x

Operation

```
CheckFPAdvSIMDEnabled64();
bits(datasize) hi = V[m];
bits(datasize) lo = V[n];
bits(datasize*2) concat = hi : lo;

V[d] = concat<position+datasize-1:position>;
```

C6.3.35 FABD

Floating-point absolute difference (vector)

It has encodings from 2 classes: *Scalar* and *Vector*

Scalar

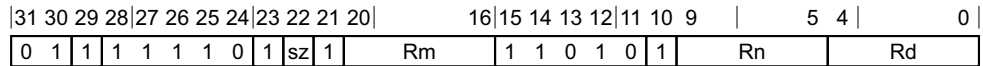

Scalar variant

FABD <V><d>, <V><n>, <V><m>

```
integer d = UInt(Rd);
integer n = UInt(Rn);
integer m = UInt(Rm);
integer esize = 32 << UInt(sz);
integer datasize = esize;
integer elements = 1;
boolean abs = TRUE;
```

Vector

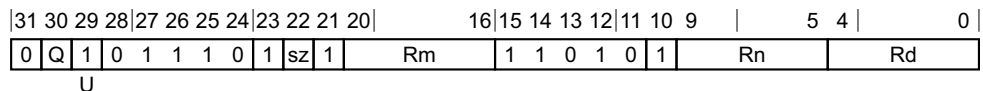

Vector variant

FABD <Vd>.<T>, <Vn>.<T>, <Vm>.<T>

```
integer d = UInt(Rd);
integer n = UInt(Rn);
integer m = UInt(Rm);
if sz:Q == '10' then ReservedValue();
integer esize = 32 << UInt(sz);
integer datasize = if Q == '1' then 128 else 64;
integer elements = datasize DIV esize;
boolean abs = (U == '1');
```

Assembler Symbols

- <V> Is a width specifier,
 - S** when sz = 0
 - D** when sz = 1
- <d> Is the number of the SIMD&FP destination register, in the "Rd" field.
- <n> Is the number of the first SIMD&FP source register, encoded in the "Rn" field.
- <m> Is the number of the second SIMD&FP source register, encoded in the "Rm" field.
- <Vd> Is the name of the SIMD&FP destination register, encoded in the "Rd" field.
- <T> Is an arrangement specifier,
 - 2S** when sz = 0, Q = 0
 - 4S** when sz = 0, Q = 1

RESERVED when $sz = 1, Q = 0$

2D when $sz = 1, Q = 1$

<Vn> Is the name of the first SIMD&FP source register, encoded in the "Rn" field.

<Vm> Is the name of the second SIMD&FP source register, encoded in the "Rm" field.

Operation for all classes

```
CheckFPAdvSIMDEnabled64();
bits(datasize) operand1 = V[n];
bits(datasize) operand2 = V[m];
bits(datasize) result;
bits(esize) element1;
bits(esize) element2;
bits(esize) diff;

for e = 0 to elements-1
    element1 = Elem[operand1, e, esize];
    element2 = Elem[operand2, e, esize];
    diff = FPSub(element1, element2, FPCR);
    Elem[result, e, esize] = if abs then FPAbs(diff) else diff;

V[d] = result;
```

C6.3.36 FABS (vector)

Floating-point absolute value (vector)

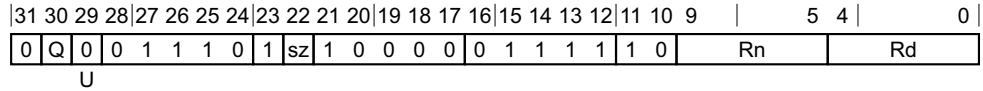

Vector variant

FABS <Vd>.<T>, <Vn>.<T>

```
integer d = UInt(Rd);
integer n = UInt(Rn);
```

```
if sz:Q == '10' then ReservedValue();
integer esize = 32 << UInt(sz);
integer datasize = if Q == '1' then 128 else 64;
integer elements = datasize DIV esize;
```

```
boolean neg = (U == '1');
```

Assembler Symbols

<Vd> Is the name of the SIMD&FP destination register, encoded in the "Rd" field.

<T> Is an arrangement specifier,

2S	when sz = 0, Q = 0
4S	when sz = 0, Q = 1
RESERVED	when sz = 1, Q = 0
2D	when sz = 1, Q = 1

<Vn> Is the name of the SIMD&FP source register, encoded in the "Rn" field.

Operation

```
CheckFPAdvSIMDEnabled64();
bits(datasize) operand = V[n];
bits(datasize) result;
bits(esize) element;

for e = 0 to elements-1
    element = Elem[operand, e, esize];
    if neg then
        element = FPNeg(element);
    else
        element = FPAbs(element);
    Elem[result, e, esize] = element;

V[d] = result;
```

C6.3.37 FABS (scalar)

Floating-point absolute value (scalar): $Vd = \text{abs}(Vn)$

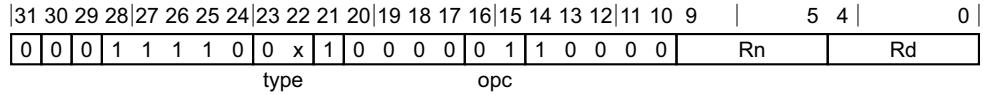

Single-precision variant (type = 00)

FABS <Sd>, <Sn>

Double-precision variant (type = 01)

FABS <Dd>, <Dn>

```
integer d = UInt(Rd);
integer n = UInt(Rn);

integer datasize;
case type of
    when '00' datasize = 32;
    when '01' datasize = 64;
    when '1x' UnallocatedEncoding();

FUnaryOp fpop;
case opc of
    when '00' fpop = FUnaryOp_MOV;
    when '01' fpop = FUnaryOp_ABS;
    when '10' fpop = FUnaryOp_NEG;
    when '11' fpop = FUnaryOp_SQRT;
```

Assembler Symbols

- <Dd> Is the 64-bit name of the SIMD&FP destination register, encoded in the "Rd" field.
- <Dn> Is the 64-bit name of the SIMD&FP source register, encoded in the "Rn" field.
- <Sd> Is the 32-bit name of the SIMD&FP destination register, encoded in the "Rd" field.
- <Sn> Is the 32-bit name of the SIMD&FP source register, encoded in the "Rn" field.

Operation

```
CheckFPAdvSIMDEnabled64();

bits(datasize) result;
bits(datasize) operand = V[n];

case fpop of
    when FUnaryOp_MOV result = operand;
    when FUnaryOp_ABS result = FPabs(operand);
    when FUnaryOp_NEG result = FPNeg(operand);
    when FUnaryOp_SQRT result = FPSqrt(operand, FPCR);

V[d] = result;
```

C6.3.38 FACGE

Floating-point absolute compare greater than or equal (vector)

It has encodings from 2 classes: *Scalar* and *Vector*

Scalar

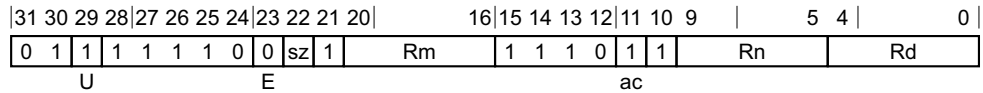

Scalar variant

FACGE <V><d>, <V><n>, <V><m>

```
integer d = UInt(Rd);
integer n = UInt(Rn);
integer m = UInt(Rm);
integer esize = 32 << UInt(sz);
integer datasize = esize;
integer elements = 1;
CompareOp cmp;
boolean abs;

case E:U:ac of
    when '000' cmp = CompareOp_EQ; abs = FALSE;
    when '010' cmp = CompareOp_GE; abs = FALSE;
    when '011' cmp = CompareOp_GE; abs = TRUE;
    when '110' cmp = CompareOp_GT; abs = FALSE;
    when '111' cmp = CompareOp_GT; abs = TRUE;
    otherwise UnallocatedEncoding();
```

Vector

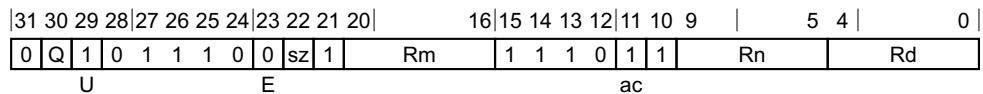

Vector variant

FACGE <Vd>.<T>, <Vn>.<T>, <Vm>.<T>

```
integer d = UInt(Rd);
integer n = UInt(Rn);
integer m = UInt(Rm);
if sz:Q == '10' then ReservedValue();
integer esize = 32 << UInt(sz);
integer datasize = if Q == '1' then 128 else 64;
integer elements = datasize DIV esize;
CompareOp cmp;
boolean abs;

case E:U:ac of
    when '000' cmp = CompareOp_EQ; abs = FALSE;
    when '010' cmp = CompareOp_GE; abs = FALSE;
    when '011' cmp = CompareOp_GE; abs = TRUE;
    when '110' cmp = CompareOp_GT; abs = FALSE;
    when '111' cmp = CompareOp_GT; abs = TRUE;
    otherwise UnallocatedEncoding();
```

Assembler Symbols

<V>	Is a width specifier, S when $sz = 0$ D when $sz = 1$
<d>	Is the number of the SIMD&FP destination register, in the "Rd" field.
<n>	Is the number of the first SIMD&FP source register, encoded in the "Rn" field.
<m>	Is the number of the second SIMD&FP source register, encoded in the "Rm" field.
<Vd>	Is the name of the SIMD&FP destination register, encoded in the "Rd" field.
<T>	Is an arrangement specifier, 2S when $sz = 0, Q = 0$ 4S when $sz = 0, Q = 1$ RESERVED when $sz = 1, Q = 0$ 2D when $sz = 1, Q = 1$
<Vn>	Is the name of the first SIMD&FP source register, encoded in the "Rn" field.
<Vm>	Is the name of the second SIMD&FP source register, encoded in the "Rm" field.

Operation for all classes

```
CheckFPAdvSIMDEnabled64();
bits(datasize) operand1 = V[n];
bits(datasize) operand2 = V[m];
bits(datasize) result;
bits(esize) element1;
bits(esize) element2;
boolean test_passed;

for e = 0 to elements-1
    element1 = Elem[operand1, e, esize];
    element2 = Elem[operand2, e, esize];
    if abs then
        element1 = FPAbs(element1);
        element2 = FPAbs(element2);
    case cmp of
        when CompareOp_EQ test_passed = FPCompareEQ(element1, element2, FPCR);
        when CompareOp_GE test_passed = FPCompareGE(element1, element2, FPCR);
        when CompareOp_GT test_passed = FPCompareGT(element1, element2, FPCR);
    Elem[result, e, esize] = if test_passed then Ones() else Zeros();

V[d] = result;
```

C6.3.39 FACGT

Floating-point absolute compare greater than (vector)

It has encodings from 2 classes: *Scalar* and *Vector*

Scalar

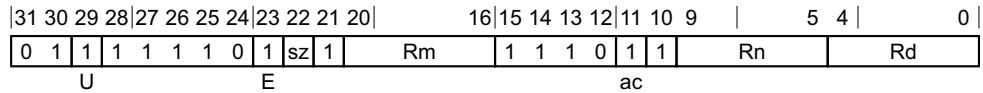

Scalar variant

FACGT <V><d>, <V><n>, <V><m>

```
integer d = UInt(Rd);
integer n = UInt(Rn);
integer m = UInt(Rm);
integer esize = 32 << UInt(sz);
integer datasize = esize;
integer elements = 1;
CompareOp cmp;
boolean abs;

case E:U:ac of
    when '000' cmp = CompareOp_EQ; abs = FALSE;
    when '010' cmp = CompareOp_GE; abs = FALSE;
    when '011' cmp = CompareOp_GE; abs = TRUE;
    when '110' cmp = CompareOp_GT; abs = FALSE;
    when '111' cmp = CompareOp_GT; abs = TRUE;
    otherwise UnallocatedEncoding();
```

Vector

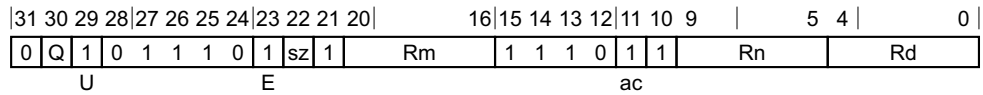

Vector variant

FACGT <Vd>.<T>, <Vn>.<T>, <Vm>.<T>

```
integer d = UInt(Rd);
integer n = UInt(Rn);
integer m = UInt(Rm);
if sz:Q == '10' then ReservedValue();
integer esize = 32 << UInt(sz);
integer datasize = if Q == '1' then 128 else 64;
integer elements = datasize DIV esize;
CompareOp cmp;
boolean abs;

case E:U:ac of
    when '000' cmp = CompareOp_EQ; abs = FALSE;
    when '010' cmp = CompareOp_GE; abs = FALSE;
    when '011' cmp = CompareOp_GE; abs = TRUE;
    when '110' cmp = CompareOp_GT; abs = FALSE;
    when '111' cmp = CompareOp_GT; abs = TRUE;
    otherwise UnallocatedEncoding();
```

Assembler Symbols

<V>	Is a width specifier, S when $sz = 0$ D when $sz = 1$
<d>	Is the number of the SIMD&FP destination register, in the "Rd" field.
<n>	Is the number of the first SIMD&FP source register, encoded in the "Rn" field.
<m>	Is the number of the second SIMD&FP source register, encoded in the "Rm" field.
<Vd>	Is the name of the SIMD&FP destination register, encoded in the "Rd" field.
<T>	Is an arrangement specifier, 2S when $sz = 0, Q = 0$ 4S when $sz = 0, Q = 1$ RESERVED when $sz = 1, Q = 0$ 2D when $sz = 1, Q = 1$
<Vn>	Is the name of the first SIMD&FP source register, encoded in the "Rn" field.
<Vm>	Is the name of the second SIMD&FP source register, encoded in the "Rm" field.

Operation for all classes

```

CheckFPAdvSIMDEnabled64();
bits(datasize) operand1 = V[n];
bits(datasize) operand2 = V[m];
bits(datasize) result;
bits(esize) element1;
bits(esize) element2;
boolean test_passed;

for e = 0 to elements-1
  element1 = Elem[operand1, e, esize];
  element2 = Elem[operand2, e, esize];
  if abs then
    element1 = FPAbs(element1);
    element2 = FPAbs(element2);
  case cmp of
    when CompareOp_EQ test_passed = FPCompareEQ(element1, element2, FPCR);
    when CompareOp_GE test_passed = FPCompareGE(element1, element2, FPCR);
    when CompareOp_GT test_passed = FPCompareGT(element1, element2, FPCR);
  Elem[result, e, esize] = if test_passed then Ones() else Zeros();

V[d] = result;

```

C6.3.40 FADD (vector)

Floating-point add (vector)

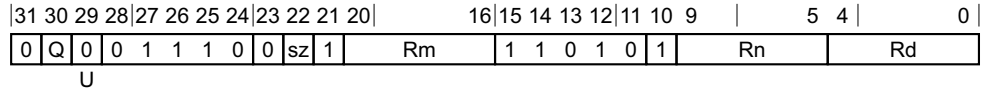

Three registers of the same type variant

FADD <Vd>.<T>, <Vn>.<T>, <Vm>.<T>

```
integer d = UInt(Rd);
integer n = UInt(Rn);
integer m = UInt(Rm);
if sz:Q == '10' then ReservedValue();
integer esize = 32 << UInt(sz);
integer datasize = if Q == '1' then 128 else 64;
integer elements = datasize DIV esize;

boolean pair = (U == '1');
```

Assembler Symbols

- <Vd> Is the name of the SIMD&FP destination register, encoded in the "Rd" field.
- <T> Is an arrangement specifier,
 - 2S** when sz = 0, Q = 0
 - 4S** when sz = 0, Q = 1
 - RESERVED** when sz = 1, Q = 0
 - 2D** when sz = 1, Q = 1
- <Vn> Is the name of the first SIMD&FP source register, encoded in the "Rn" field.
- <Vm> Is the name of the second SIMD&FP source register, encoded in the "Rm" field.

Operation

```
CheckFPAdvSIMDEnabled64();
bits(datasize) operand1 = V[n];
bits(datasize) operand2 = V[m];
bits(datasize) result;
bits(2*datasize) concat = operand2:operand1;
bits(esize) element1;
bits(esize) element2;

for e = 0 to elements-1
    if pair then
        element1 = Elem[concat, 2*e, esize];
        element2 = Elem[concat, (2*e)+1, esize];
    else
        element1 = Elem[operand1, e, esize];
        element2 = Elem[operand2, e, esize];
    Elem[result, e, esize] = FPAdd(element1, element2, FPCR);

V[d] = result;
```

C6.3.41 FADD (scalar)

Floating-point add (scalar): $Vd = Vn + Vm$

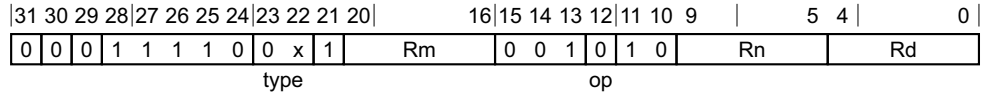

Single-precision variant (type = 00)

FADD <Sd>, <Sn>, <Sm>

Double-precision variant (type = 01)

FADD <Dd>, <Dn>, <Dm>

```
integer d = UInt(Rd);
integer n = UInt(Rn);
integer m = UInt(Rm);

integer datasize;
case type of
    when '00' datasize = 32;
    when '01' datasize = 64;
    when '1x' UnallocatedEncoding();

boolean sub_op = (op == '1');
```

Assembler Symbols

- <Dd> Is the 64-bit name of the SIMD&FP destination register, encoded in the "Rd" field.
- <Dn> Is the 64-bit name of the first SIMD&FP source register, encoded in the "Rn" field.
- <Dm> Is the 64-bit name of the second SIMD&FP source register, encoded in the "Rm" field.
- <Sd> Is the 32-bit name of the SIMD&FP destination register, encoded in the "Rd" field.
- <Sn> Is the 32-bit name of the first SIMD&FP source register, encoded in the "Rn" field.
- <Sm> Is the 32-bit name of the second SIMD&FP source register, encoded in the "Rm" field.

Operation

```
CheckFPAdvSIMDEnabled64();
bits(datasize) result;
bits(datasize) operand1 = V[n];
bits(datasize) operand2 = V[m];

if sub_op then
    result = FPSub(operand1, operand2, FPCR);
else
    result = FPAdd(operand1, operand2, FPCR);

V[d] = result;
```

C6.3.42 FADDP (scalar)

Floating-point add pair of elements (scalar)

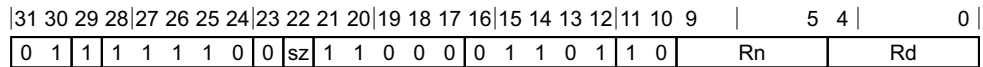

Advanced SIMD variant

FADDP <V><d>, <Vn>.<T>

integer d = UInt(Rd);
 integer n = UInt(Rn);

integer esize = 32 << UInt(sz);
 integer datasize = esize * 2;
 integer elements = 2;

ReduceOp op = ReduceOp_FADD;

Assembler Symbols

- <V> Is the destination width specifier,
 S when sz = 0
 D when sz = 1
- <d> Is the number of the SIMD&FP destination register, encoded in the "Rd" field.
- <Vn> Is the name of the SIMD&FP source register, encoded in the "Rn" field.
- <T> Is the source arrangement specifier,
 2S when sz = 0
 2D when sz = 1

Operation

CheckFPAdvSIMDEnabled64();
 bits(datasize) operand = V[n];
 V[d] = Reduce(op, operand, esize);

C6.3.43 FADDP (vector)

Floating-point add pairwise (vector)

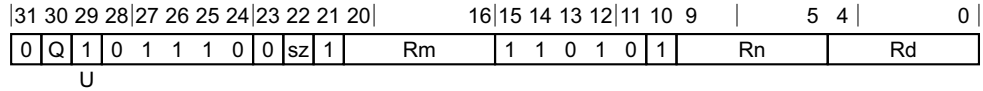

Three registers of the same type variant

FADDP <Vd>.<T>, <Vn>.<T>, <Vm>.<T>

```
integer d = UInt(Rd);
integer n = UInt(Rn);
integer m = UInt(Rm);
if sz:Q == '10' then ReservedValue();
integer esize = 32 << UInt(sz);
integer datasize = if Q == '1' then 128 else 64;
integer elements = datasize DIV esize;

boolean pair = (U == '1');
```

Assembler Symbols

- <Vd> Is the name of the SIMD&FP destination register, encoded in the "Rd" field.
- <T> Is an arrangement specifier,
 - 2S** when sz = 0, Q = 0
 - 4S** when sz = 0, Q = 1
 - RESERVED** when sz = 1, Q = 0
 - 2D** when sz = 1, Q = 1
- <Vn> Is the name of the first SIMD&FP source register, encoded in the "Rn" field.
- <Vm> Is the name of the second SIMD&FP source register, encoded in the "Rm" field.

Operation

```
CheckFPAdvSIMDEnabled64();
bits(datasize) operand1 = V[n];
bits(datasize) operand2 = V[m];
bits(datasize) result;
bits(2*datasize) concat = operand2:operand1;
bits(esize) element1;
bits(esize) element2;

for e = 0 to elements-1
    if pair then
        element1 = Elem[concat, 2*e, esize];
        element2 = Elem[concat, (2*e)+1, esize];
    else
        element1 = Elem[operand1, e, esize];
        element2 = Elem[operand2, e, esize];
    Elem[result, e, esize] = FAdd(element1, element2, FPCR);

V[d] = result;
```

C6.3.44 FCCMP

Floating-point conditional quiet compare (scalar), setting condition flags to result of comparison or an immediate value: flags = if cond then compareQuiet(Vn,Vm) else #nzcvc

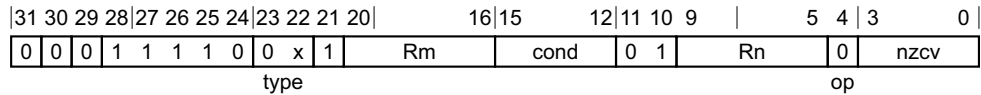

Single-precision variant (type = 00)

FCCMP <Sn>, <Sm>, #<nzcvc>, <cond>

Double-precision variant (type = 01)

FCCMP <Dn>, <Dm>, #<nzcvc>, <cond>

```
integer n = UInt(Rn);
integer m = UInt(Rm);

integer datasize;
case type of
    when '00' datasize = 32;
    when '01' datasize = 64;
    when '1x' UnallocatedEncoding();

boolean signal_all_nans = (op == '1');
bits(4) condition = cond;
bits(4) flags = nzcvc;
```

Assembler Symbols

- <Dn> Is the 64-bit name of the first SIMD&FP source register, encoded in the "Rn" field.
- <Dm> Is the 64-bit name of the second SIMD&FP source register, encoded in the "Rm" field.
- <Sn> Is the 32-bit name of the first SIMD&FP source register, encoded in the "Rn" field.
- <Sm> Is the 32-bit name of the second SIMD&FP source register, encoded in the "Rm" field.
- <nzcvc> Is the flag bit specifier, an immediate in the range 0 to 15, giving the alternative state for the 4-bit NZCV condition flags, encoded in the "nzcvc" field.
- <cond> Is one of the standard conditions, encoded in the "cond" field in the standard way.

Operation

```
CheckFPAdvSIMDEnabled64();

bits(datasize) operand1 = V[n];
bits(datasize) operand2;

operand2 = V[m];

if ConditionHolds(condition) then
    flags = FPCompare(operand1, operand2, signal_all_nans, FPCR);
PSTATE.<N,Z,C,V> = flags;
```

C6.3.45 FCCMPE

Floating-point conditional signaling compare (scalar), setting condition flags to result of comparison or an immediate value: flags = if cond then compareSignaling(Vn,Vm) else #nzcw

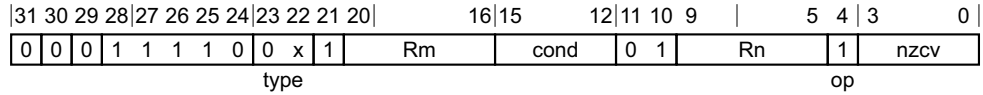

Single-precision variant (type = 00)

FCCMPE <Sn>, <Sm>, #<nzcw>, <cond>

Double-precision variant (type = 01)

FCCMPE <Dn>, <Dm>, #<nzcw>, <cond>

```
integer n = UInt(Rn);
integer m = UInt(Rm);

integer datasize;
case type of
    when '00' datasize = 32;
    when '01' datasize = 64;
    when '1x' UnallocatedEncoding();

boolean signal_all_nans = (op == '1');
bits(4) condition = cond;
bits(4) flags = nzcw;
```

Assembler Symbols

- <Dn> Is the 64-bit name of the first SIMD&FP source register, encoded in the "Rn" field.
- <Dm> Is the 64-bit name of the second SIMD&FP source register, encoded in the "Rm" field.
- <Sn> Is the 32-bit name of the first SIMD&FP source register, encoded in the "Rn" field.
- <Sm> Is the 32-bit name of the second SIMD&FP source register, encoded in the "Rm" field.
- <nzcw> Is the flag bit specifier, an immediate in the range 0 to 15, giving the alternative state for the 4-bit NZCV condition flags, encoded in the "nzcw" field.
- <cond> Is one of the standard conditions, encoded in the "cond" field in the standard way.

Operation

```
CheckFPAdvSIMDEnabled64();

bits(datasize) operand1 = V[n];
bits(datasize) operand2;

operand2 = V[m];

if ConditionHolds(condition) then
    flags = FPCompare(operand1, operand2, signal_all_nans, FPCR);
PSTATE.<N,Z,C,V> = flags;
```

C6.3.46 FCMEQ (register)

Floating-point compare equal (vector), setting destination vector element to all ones if the condition holds, else zero

It has encodings from 2 classes: *Scalar* and *Vector*

Scalar

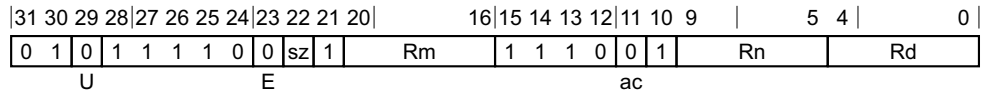

Scalar variant

FCMEQ <V><d>, <V><n>, <V><m>

```

integer d = UInt(Rd);
integer n = UInt(Rn);
integer m = UInt(Rm);
integer esize = 32 << UInt(sz);
integer datasize = esize;
integer elements = 1;
CompareOp cmp;
boolean abs;

case E:U:ac of
    when '000' cmp = CompareOp_EQ; abs = FALSE;
    when '010' cmp = CompareOp_GE; abs = FALSE;
    when '011' cmp = CompareOp_GE; abs = TRUE;
    when '110' cmp = CompareOp_GT; abs = FALSE;
    when '111' cmp = CompareOp_GT; abs = TRUE;
    otherwise UnallocatedEncoding();
    
```

Vector

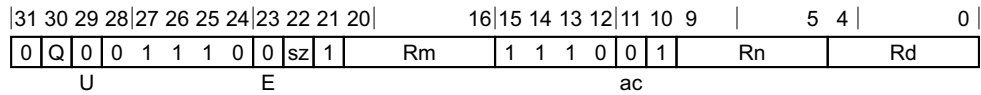

Vector variant

FCMEQ <Vd>.<T>, <Vn>.<T>, <Vm>.<T>

```

integer d = UInt(Rd);
integer n = UInt(Rn);
integer m = UInt(Rm);
if sz:Q == '10' then ReservedValue();
integer esize = 32 << UInt(sz);
integer datasize = if Q == '1' then 128 else 64;
integer elements = datasize DIV esize;
CompareOp cmp;
boolean abs;

case E:U:ac of
    when '000' cmp = CompareOp_EQ; abs = FALSE;
    when '010' cmp = CompareOp_GE; abs = FALSE;
    when '011' cmp = CompareOp_GE; abs = TRUE;
    when '110' cmp = CompareOp_GT; abs = FALSE;
    when '111' cmp = CompareOp_GT; abs = TRUE;
    otherwise UnallocatedEncoding();
    
```

Assembler Symbols

<V>	Is a width specifier, S when $sz = 0$ D when $sz = 1$
<d>	Is the number of the SIMD&FP destination register, in the "Rd" field.
<n>	Is the number of the first SIMD&FP source register, encoded in the "Rn" field.
<m>	Is the number of the second SIMD&FP source register, encoded in the "Rm" field.
<Vd>	Is the name of the SIMD&FP destination register, encoded in the "Rd" field.
<T>	Is an arrangement specifier, 2S when $sz = 0, Q = 0$ 4S when $sz = 0, Q = 1$ RESERVED when $sz = 1, Q = 0$ 2D when $sz = 1, Q = 1$
<Vn>	Is the name of the first SIMD&FP source register, encoded in the "Rn" field.
<Vm>	Is the name of the second SIMD&FP source register, encoded in the "Rm" field.

Operation for all classes

```

CheckFPAdvSIMDEnabled64();
bits(datasize) operand1 = V[n];
bits(datasize) operand2 = V[m];
bits(datasize) result;
bits(esize) element1;
bits(esize) element2;
boolean test_passed;

for e = 0 to elements-1
  element1 = Elem[operand1, e, esize];
  element2 = Elem[operand2, e, esize];
  if abs then
    element1 = FPAbs(element1);
    element2 = FPAbs(element2);
  case cmp of
    when CompareOp_EQ test_passed = FPCompareEQ(element1, element2, FPCR);
    when CompareOp_GE test_passed = FPCompareGE(element1, element2, FPCR);
    when CompareOp_GT test_passed = FPCompareGT(element1, element2, FPCR);
  Elem[result, e, esize] = if test_passed then Ones() else Zeros();

V[d] = result;

```

C6.3.47 FCMEQ (zero)

Floating-point compare equal to zero (vector), setting destination vector element to all ones if the condition holds, else zero

It has encodings from 2 classes: *Scalar* and *Vector*

Scalar

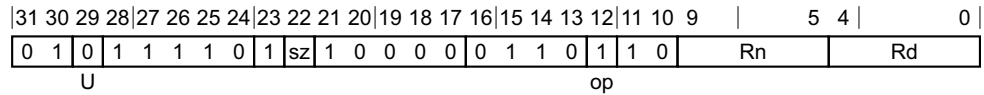

Scalar variant

FCMEQ <V><d>, <V><n>, #0

```
integer d = UInt(Rd);
integer n = UInt(Rn);
```

```
integer esize = 32 << UInt(sz);
integer datasize = esize;
integer elements = 1;
```

```
CompareOp comparison;
case op:U of
    when '00' comparison = CompareOp_GT;
    when '01' comparison = CompareOp_GE;
    when '10' comparison = CompareOp_EQ;
    when '11' comparison = CompareOp_LE;
```

Vector

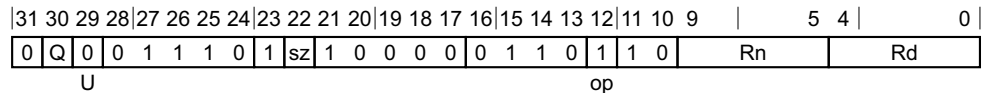

Vector variant

FCMEQ <Vd>.<T>, <Vn>.<T>, #0

```
integer d = UInt(Rd);
integer n = UInt(Rn);
```

```
if sz:Q == '10' then ReservedValue();
integer esize = 32 << UInt(sz);
integer datasize = if Q == '1' then 128 else 64;
integer elements = datasize DIV esize;
```

```
CompareOp comparison;
case op:U of
    when '00' comparison = CompareOp_GT;
    when '01' comparison = CompareOp_GE;
    when '10' comparison = CompareOp_EQ;
    when '11' comparison = CompareOp_LE;
```

Assembler Symbols

<V> Is a width specifier,
 S when sz = 0
 D when sz = 1

- <d> Is the number of the SIMD&FP destination register, encoded in the "Rd" field.
- <n> Is the number of the SIMD&FP source register, encoded in the "Rn" field.
- <Vd> Is the name of the SIMD&FP destination register, encoded in the "Rd" field.
- <T> Is an arrangement specifier,
2S when $sz = 0, Q = 0$
4S when $sz = 0, Q = 1$
RESERVED when $sz = 1, Q = 0$
2D when $sz = 1, Q = 1$
- <Vn> Is the name of the SIMD&FP source register, encoded in the "Rn" field.

Operation for all classes

```
CheckFPAdvSIMDEnabled64();
bits(datasize) operand = V[n];
bits(datasize) result;
bits(esize) zero = FPZero('0');
bits(esize) element;
boolean test_passed;

for e = 0 to elements-1
  element = Elem[operand, e, esize];
  case comparison of
    when CompareOp_GT test_passed = FPCompareGT(element, zero, FPCR);
    when CompareOp_GE test_passed = FPCompareGE(element, zero, FPCR);
    when CompareOp_EQ test_passed = FPCompareEQ(element, zero, FPCR);
    when CompareOp_LE test_passed = FPCompareGE(zero, element, FPCR);
    when CompareOp_LT test_passed = FPCompareGT(zero, element, FPCR);
  Elem[result, e, esize] = if test_passed then Ones() else Zeros();

V[d] = result;
```

C6.3.48 FCMGE (register)

Floating-point compare greater than or equal (vector), setting destination vector element to all ones if the condition holds, else zero

It has encodings from 2 classes: *Scalar* and *Vector*

Scalar

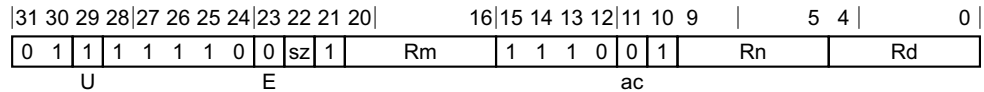

Scalar variant

FCMGE <V><d>, <V><n>, <V><m>

```
integer d = UInt(Rd);
integer n = UInt(Rn);
integer m = UInt(Rm);
integer esize = 32 << UInt(sz);
integer datasize = esize;
integer elements = 1;
CompareOp cmp;
boolean abs;

case E:U:ac of
    when '000' cmp = CompareOp_EQ; abs = FALSE;
    when '010' cmp = CompareOp_GE; abs = FALSE;
    when '011' cmp = CompareOp_GE; abs = TRUE;
    when '110' cmp = CompareOp_GT; abs = FALSE;
    when '111' cmp = CompareOp_GT; abs = TRUE;
    otherwise UnallocatedEncoding();
```

Vector

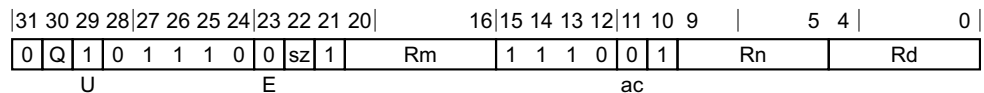

Vector variant

FCMGE <Vd>.<T>, <Vn>.<T>, <Vm>.<T>

```
integer d = UInt(Rd);
integer n = UInt(Rn);
integer m = UInt(Rm);
if sz:Q == '10' then ReservedValue();
integer esize = 32 << UInt(sz);
integer datasize = if Q == '1' then 128 else 64;
integer elements = datasize DIV esize;
CompareOp cmp;
boolean abs;

case E:U:ac of
    when '000' cmp = CompareOp_EQ; abs = FALSE;
    when '010' cmp = CompareOp_GE; abs = FALSE;
    when '011' cmp = CompareOp_GE; abs = TRUE;
    when '110' cmp = CompareOp_GT; abs = FALSE;
    when '111' cmp = CompareOp_GT; abs = TRUE;
    otherwise UnallocatedEncoding();
```

Assembler Symbols

<V>	Is a width specifier, S when $sz = 0$ D when $sz = 1$
<d>	Is the number of the SIMD&FP destination register, in the "Rd" field.
<n>	Is the number of the first SIMD&FP source register, encoded in the "Rn" field.
<m>	Is the number of the second SIMD&FP source register, encoded in the "Rm" field.
<Vd>	Is the name of the SIMD&FP destination register, encoded in the "Rd" field.
<T>	Is an arrangement specifier, 2S when $sz = 0, Q = 0$ 4S when $sz = 0, Q = 1$ RESERVED when $sz = 1, Q = 0$ 2D when $sz = 1, Q = 1$
<Vn>	Is the name of the first SIMD&FP source register, encoded in the "Rn" field.
<Vm>	Is the name of the second SIMD&FP source register, encoded in the "Rm" field.

Operation for all classes

```
CheckFPAdvSIMDEnabled64();
bits(datasize) operand1 = V[n];
bits(datasize) operand2 = V[m];
bits(datasize) result;
bits(esize) element1;
bits(esize) element2;
boolean test_passed;

for e = 0 to elements-1
    element1 = Elem[operand1, e, esize];
    element2 = Elem[operand2, e, esize];
    if abs then
        element1 = FPAbs(element1);
        element2 = FPAbs(element2);
    case cmp of
        when CompareOp_EQ test_passed = FPCompareEQ(element1, element2, FPCR);
        when CompareOp_GE test_passed = FPCompareGE(element1, element2, FPCR);
        when CompareOp_GT test_passed = FPCompareGT(element1, element2, FPCR);
    Elem[result, e, esize] = if test_passed then Ones() else Zeros();

V[d] = result;
```

C6.3.49 FCMGE (zero)

Floating-point compare greater than or equal to zero (vector), setting destination vector element to all ones if the condition holds, else zero

It has encodings from 2 classes: *Scalar* and *Vector*

Scalar

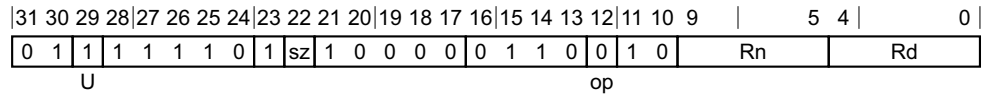

Scalar variant

FCMGE <V><d>, <V><n>, #0

```
integer d = UInt(Rd);
integer n = UInt(Rn);
```

```
integer esize = 32 << UInt(sz);
integer datasize = esize;
integer elements = 1;
```

```
CompareOp comparison;
case op:U of
    when '00' comparison = CompareOp_GT;
    when '01' comparison = CompareOp_GE;
    when '10' comparison = CompareOp_EQ;
    when '11' comparison = CompareOp_LE;
```

Vector

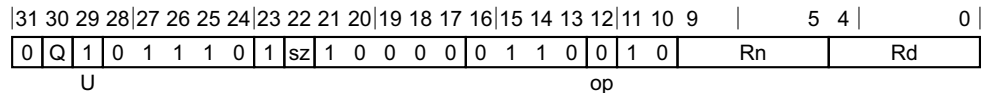

Vector variant

FCMGE <Vd>.<T>, <Vn>.<T>, #0

```
integer d = UInt(Rd);
integer n = UInt(Rn);
```

```
if sz:Q == '10' then ReservedValue();
integer esize = 32 << UInt(sz);
integer datasize = if Q == '1' then 128 else 64;
integer elements = datasize DIV esize;
```

```
CompareOp comparison;
case op:U of
    when '00' comparison = CompareOp_GT;
    when '01' comparison = CompareOp_GE;
    when '10' comparison = CompareOp_EQ;
    when '11' comparison = CompareOp_LE;
```

Assembler Symbols

<V> Is a width specifier,
 S when sz = 0
 D when sz = 1

- <d> Is the number of the SIMD&FP destination register, encoded in the "Rd" field.
- <n> Is the number of the SIMD&FP source register, encoded in the "Rn" field.
- <Vd> Is the name of the SIMD&FP destination register, encoded in the "Rd" field.
- <T> Is an arrangement specifier,
2S when $sz = 0, Q = 0$
4S when $sz = 0, Q = 1$
RESERVED when $sz = 1, Q = 0$
2D when $sz = 1, Q = 1$
- <Vn> Is the name of the SIMD&FP source register, encoded in the "Rn" field.

Operation for all classes

```
CheckFPAdvSIMDEnabled64();
bits(datasize) operand = V[n];
bits(datasize) result;
bits(esize) zero = FPZero('0');
bits(esize) element;
boolean test_passed;

for e = 0 to elements-1
  element = Elem[operand, e, esize];
  case comparison of
    when CompareOp_GT test_passed = FPCompareGT(element, zero, FPCR);
    when CompareOp_GE test_passed = FPCompareGE(element, zero, FPCR);
    when CompareOp_EQ test_passed = FPCompareEQ(element, zero, FPCR);
    when CompareOp_LE test_passed = FPCompareGE(zero, element, FPCR);
    when CompareOp_LT test_passed = FPCompareGT(zero, element, FPCR);
  Elem[result, e, esize] = if test_passed then Ones() else Zeros();

V[d] = result;
```

C6.3.50 FCMGT (register)

Floating-point compare greater than (vector), setting destination vector element to all ones if the condition holds, else zero

It has encodings from 2 classes: *Scalar* and *Vector*

Scalar

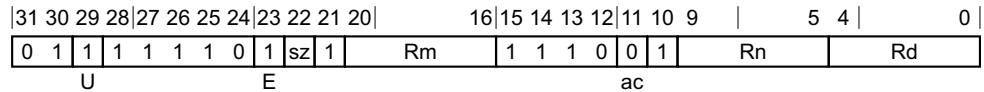

Scalar variant

FCMGT <V><d>, <V><n>, <V><m>

```
integer d = UInt(Rd);
integer n = UInt(Rn);
integer m = UInt(Rm);
integer esize = 32 << UInt(sz);
integer datasize = esize;
integer elements = 1;
CompareOp cmp;
boolean abs;

case E:U:ac of
    when '000' cmp = CompareOp_EQ; abs = FALSE;
    when '010' cmp = CompareOp_GE; abs = FALSE;
    when '011' cmp = CompareOp_GE; abs = TRUE;
    when '110' cmp = CompareOp_GT; abs = FALSE;
    when '111' cmp = CompareOp_GT; abs = TRUE;
    otherwise UnallocatedEncoding();
```

Vector

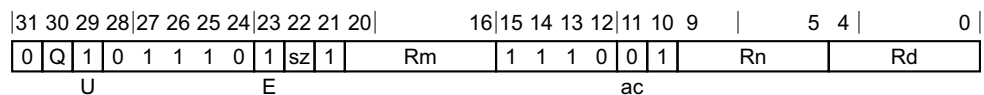

Vector variant

FCMGT <Vd>.<T>, <Vn>.<T>, <Vm>.<T>

```
integer d = UInt(Rd);
integer n = UInt(Rn);
integer m = UInt(Rm);
if sz:Q == '10' then ReservedValue();
integer esize = 32 << UInt(sz);
integer datasize = if Q == '1' then 128 else 64;
integer elements = datasize DIV esize;
CompareOp cmp;
boolean abs;

case E:U:ac of
    when '000' cmp = CompareOp_EQ; abs = FALSE;
    when '010' cmp = CompareOp_GE; abs = FALSE;
    when '011' cmp = CompareOp_GE; abs = TRUE;
    when '110' cmp = CompareOp_GT; abs = FALSE;
    when '111' cmp = CompareOp_GT; abs = TRUE;
    otherwise UnallocatedEncoding();
```

Assembler Symbols

<V>	Is a width specifier, S when $sz = 0$ D when $sz = 1$
<d>	Is the number of the SIMD&FP destination register, in the "Rd" field.
<n>	Is the number of the first SIMD&FP source register, encoded in the "Rn" field.
<m>	Is the number of the second SIMD&FP source register, encoded in the "Rm" field.
<Vd>	Is the name of the SIMD&FP destination register, encoded in the "Rd" field.
<T>	Is an arrangement specifier, 2S when $sz = 0, Q = 0$ 4S when $sz = 0, Q = 1$ RESERVED when $sz = 1, Q = 0$ 2D when $sz = 1, Q = 1$
<Vn>	Is the name of the first SIMD&FP source register, encoded in the "Rn" field.
<Vm>	Is the name of the second SIMD&FP source register, encoded in the "Rm" field.

Operation for all classes

```
CheckFPAdvSIMDEnabled64();
bits(datasize) operand1 = V[n];
bits(datasize) operand2 = V[m];
bits(datasize) result;
bits(esize) element1;
bits(esize) element2;
boolean test_passed;

for e = 0 to elements-1
    element1 = Elem[operand1, e, esize];
    element2 = Elem[operand2, e, esize];
    if abs then
        element1 = FPAbs(element1);
        element2 = FPAbs(element2);
    case cmp of
        when CompareOp_EQ test_passed = FPCompareEQ(element1, element2, FPCR);
        when CompareOp_GE test_passed = FPCompareGE(element1, element2, FPCR);
        when CompareOp_GT test_passed = FPCompareGT(element1, element2, FPCR);
    Elem[result, e, esize] = if test_passed then Ones() else Zeros();

V[d] = result;
```

C6.3.51 FCMGT (zero)

Floating-point compare greater than zero (vector), setting destination vector element to all ones if the condition holds, else zero

It has encodings from 2 classes: *Scalar* and *Vector*

Scalar

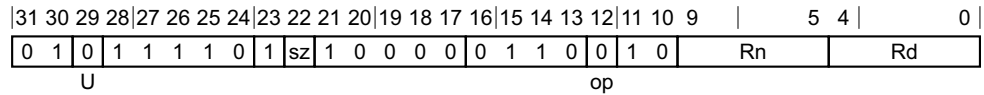

Scalar variant

FCMGT <V><d>, <V><n>, #0

```
integer d = UInt(Rd);
integer n = UInt(Rn);
```

```
integer esize = 32 << UInt(sz);
integer datasize = esize;
integer elements = 1;
```

```
CompareOp comparison;
case op:U of
    when '00' comparison = CompareOp_GT;
    when '01' comparison = CompareOp_GE;
    when '10' comparison = CompareOp_EQ;
    when '11' comparison = CompareOp_LE;
```

Vector

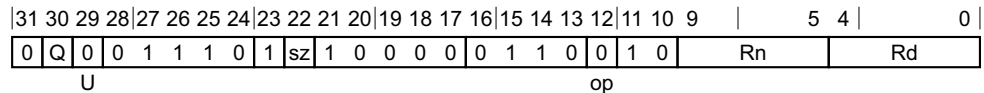

Vector variant

FCMGT <Vd>.<T>, <Vn>.<T>, #0

```
integer d = UInt(Rd);
integer n = UInt(Rn);
```

```
if sz:Q == '10' then ReservedValue();
integer esize = 32 << UInt(sz);
integer datasize = if Q == '1' then 128 else 64;
integer elements = datasize DIV esize;
```

```
CompareOp comparison;
case op:U of
    when '00' comparison = CompareOp_GT;
    when '01' comparison = CompareOp_GE;
    when '10' comparison = CompareOp_EQ;
    when '11' comparison = CompareOp_LE;
```

Assembler Symbols

<V> Is a width specifier,
 S when sz = 0
 D when sz = 1

- <d> Is the number of the SIMD&FP destination register, encoded in the "Rd" field.
- <n> Is the number of the SIMD&FP source register, encoded in the "Rn" field.
- <Vd> Is the name of the SIMD&FP destination register, encoded in the "Rd" field.
- <T> Is an arrangement specifier,
2S when $sz = 0, Q = 0$
4S when $sz = 0, Q = 1$
RESERVED when $sz = 1, Q = 0$
2D when $sz = 1, Q = 1$
- <Vn> Is the name of the SIMD&FP source register, encoded in the "Rn" field.

Operation for all classes

```
CheckFPAdvSIMDEnabled64();
bits(datasize) operand = V[n];
bits(datasize) result;
bits(esize) zero = FPZero('0');
bits(esize) element;
boolean test_passed;

for e = 0 to elements-1
    element = Elem[operand, e, esize];
    case comparison of
        when CompareOp_GT test_passed = FPCompareGT(element, zero, FPCR);
        when CompareOp_GE test_passed = FPCompareGE(element, zero, FPCR);
        when CompareOp_EQ test_passed = FPCompareEQ(element, zero, FPCR);
        when CompareOp_LE test_passed = FPCompareGE(zero, element, FPCR);
        when CompareOp_LT test_passed = FPCompareGT(zero, element, FPCR);
    Elem[result, e, esize] = if test_passed then Ones() else Zeros();

V[d] = result;
```

C6.3.52 FCMLE (zero)

Floating-point compare less than or equal to zero (vector), setting destination vector element to all ones if the condition holds, else zero

It has encodings from 2 classes: *Scalar* and *Vector*

Scalar

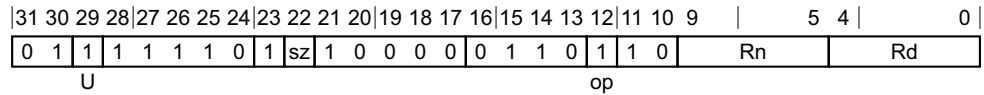

Scalar variant

FCMLE <V><d>, <V><n>, #0

```
integer d = UInt(Rd);
integer n = UInt(Rn);
```

```
integer esize = 32 << UInt(sz);
integer datasize = esize;
integer elements = 1;
```

```
CompareOp comparison;
case op:U of
    when '00' comparison = CompareOp_GT;
    when '01' comparison = CompareOp_GE;
    when '10' comparison = CompareOp_EQ;
    when '11' comparison = CompareOp_LE;
```

Vector

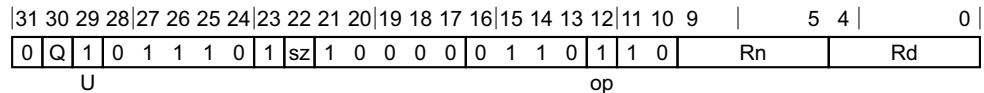

Vector variant

FCMLE <Vd>.<T>, <Vn>.<T>, #0

```
integer d = UInt(Rd);
integer n = UInt(Rn);
```

```
if sz:Q == '10' then ReservedValue();
integer esize = 32 << UInt(sz);
integer datasize = if Q == '1' then 128 else 64;
integer elements = datasize DIV esize;
```

```
CompareOp comparison;
case op:U of
    when '00' comparison = CompareOp_GT;
    when '01' comparison = CompareOp_GE;
    when '10' comparison = CompareOp_EQ;
    when '11' comparison = CompareOp_LE;
```

Assembler Symbols

<V> Is a width specifier,
 S when sz = 0
 D when sz = 1

- <d> Is the number of the SIMD&FP destination register, encoded in the "Rd" field.
- <n> Is the number of the SIMD&FP source register, encoded in the "Rn" field.
- <Vd> Is the name of the SIMD&FP destination register, encoded in the "Rd" field.
- <T> Is an arrangement specifier,
2S when $sz = 0, Q = 0$
4S when $sz = 0, Q = 1$
RESERVED when $sz = 1, Q = 0$
2D when $sz = 1, Q = 1$
- <Vn> Is the name of the SIMD&FP source register, encoded in the "Rn" field.

Operation for all classes

```
CheckFPAdvSIMDEnabled64();
bits(datasize) operand = V[n];
bits(datasize) result;
bits(esize) zero = FPZero('0');
bits(esize) element;
boolean test_passed;

for e = 0 to elements-1
    element = Elem[operand, e, esize];
    case comparison of
        when CompareOp_GT test_passed = FPCompareGT(element, zero, FPCR);
        when CompareOp_GE test_passed = FPCompareGE(element, zero, FPCR);
        when CompareOp_EQ test_passed = FPCompareEQ(element, zero, FPCR);
        when CompareOp_LE test_passed = FPCompareGE(zero, element, FPCR);
        when CompareOp_LT test_passed = FPCompareGT(zero, element, FPCR);
    Elem[result, e, esize] = if test_passed then Ones() else Zeros();

V[d] = result;
```

C6.3.53 FCMLT (zero)

Floating-point compare less than zero (vector), setting destination vector element to all ones if the condition holds, else zero

It has encodings from 2 classes: *Scalar* and *Vector*

Scalar

31	30	29	28	27	26	25	24	23	22	21	20	19	18	17	16	15	14	13	12	11	10	9				5	4			0
0	1	0	1	1	1	1	0	1	sz	1	0	0	0	0	0	0	1	1	1	0	1	0				Rn				Rd

Scalar variant

FCMLT <V><d>, <V><n>, #0

```
integer d = UInt(Rd);
integer n = UInt(Rn);
```

```
integer esize = 32 << UInt(sz);
integer datasize = esize;
integer elements = 1;
```

CompareOp comparison = CompareOp_LT;

Vector

31	30	29	28	27	26	25	24	23	22	21	20	19	18	17	16	15	14	13	12	11	10	9				5	4			0
0	Q	0	0	1	1	1	0	1	sz	1	0	0	0	0	0	0	1	1	1	0	1	0				Rn				Rd

Vector variant

FCMLT <Vd>.<T>, <Vn>.<T>, #0

```
integer d = UInt(Rd);
integer n = UInt(Rn);
```

```
if sz:Q == '10' then ReservedValue();
integer esize = 32 << UInt(sz);
integer datasize = if Q == '1' then 128 else 64;
integer elements = datasize DIV esize;
```

CompareOp comparison = CompareOp_LT;

Assembler Symbols

<V>	Is a width specifier, S when sz = 0 D when sz = 1
<d>	Is the number of the SIMD&FP destination register, encoded in the "Rd" field.
<n>	Is the number of the SIMD&FP source register, encoded in the "Rn" field.
<Vd>	Is the name of the SIMD&FP destination register, encoded in the "Rd" field.
<T>	Is an arrangement specifier, 2S when sz = 0, Q = 0 4S when sz = 0, Q = 1

RESERVED when $sz = 1, Q = 0$

2D when $sz = 1, Q = 1$

<Vn> Is the name of the SIMD&FP source register, encoded in the "Rn" field.

Operation for all classes

```
CheckFPAdvSIMDEnabled64();
bits(datasize) operand = V[n];
bits(datasize) result;
bits(esize) zero = FPZero('0');
bits(esize) element;
boolean test_passed;

for e = 0 to elements-1
    element = Elem[operand, e, esize];
    case comparison of
        when CompareOp_GT test_passed = FPCompareGT(element, zero, FPCR);
        when CompareOp_GE test_passed = FPCompareGE(element, zero, FPCR);
        when CompareOp_EQ test_passed = FPCompareEQ(element, zero, FPCR);
        when CompareOp_LE test_passed = FPCompareLE(zero, element, FPCR);
        when CompareOp_LT test_passed = FPCompareLT(zero, element, FPCR);
    Elem[result, e, esize] = if test_passed then Ones() else Zeros();

V[d] = result;
```

C6.3.54 FCMP

Floating-point quiet compare (scalar): flags = compareQuiet(Vn, Vm) // with register

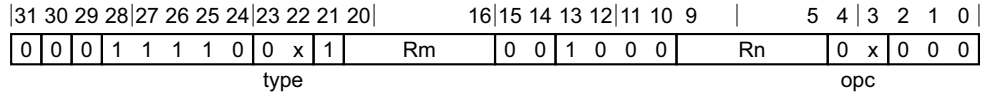

Single-precision variant (type = 00, opc = 00)

FCMP <Sn>, <Sm>

Single-precision, zero variant (type = 00, Rm = (00000), opc = 01)

FCMP <Sn>, #0.0

Double-precision variant (type = 01, opc = 00)

FCMP <Dn>, <Dm>

Double-precision, zero variant (type = 01, Rm = (00000), opc = 01)

FCMP <Dn>, #0.0

```
integer n = UInt(Rn);
integer m = UInt(Rm); // ignored when opc<0> == '1'
```

```
integer datasize;
case type of
    when '00' datasize = 32;
    when '01' datasize = 64;
    when '1x' UnallocatedEncoding();
```

```
boolean signal_all_nans = (opc<1> == '1');
boolean cmp_with_zero = (opc<0> == '1');
```

Assembler Symbols

- <Dn> For the double-precision variant: is the 64-bit name of the first SIMD&FP source register, encoded in the "Rn" field.
- <Dn> For the double-precision, zero variant: is the 64-bit name of the SIMD&FP source register, encoded in the "Rn" field.
- <Dm> Is the 64-bit name of the second SIMD&FP source register, encoded in the "Rm" field.
- <Sn> For the single-precision variant: is the 32-bit name of the first SIMD&FP source register, encoded in the "Rn" field.
- <Sn> For the single-precision, zero variant: is the 32-bit name of the SIMD&FP source register, encoded in the "Rn" field.
- <Sm> Is the 32-bit name of the second SIMD&FP source register, encoded in the "Rm" field.

Operation

```
CheckFPAdvSIMDEnabled64();
```

```
bits(datasize) operand1 = V[n];
bits(datasize) operand2;
```

```
operand2 = if cmp_with_zero then FPZero('0') else V[m];
```

```
PSTATE.<N,Z,C,V> = FPCompare(operand1, operand2, signal_all_nans, FPCR);
```

C6.3.55 FCMPE

Floating-point signaling compare (scalar): flags = compareSignaling(Vn, Vm) // with register

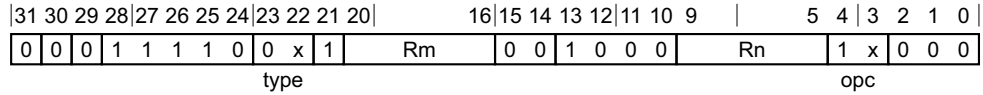

Single-precision variant (type = 00, opc = 10)

FCMPE <Sn>, <Sm>

Single-precision, zero variant (type = 00, Rm = (00000), opc = 11)

FCMPE <Sn>, #0.0

Double-precision variant (type = 01, opc = 10)

FCMPE <Dn>, <Dm>

Double-precision, zero variant (type = 01, Rm = (00000), opc = 11)

FCMPE <Dn>, #0.0

```
integer n = UInt(Rn);
integer m = UInt(Rm); // ignored when opc<0> == '1'
```

```
integer datasize;
case type of
    when '00' datasize = 32;
    when '01' datasize = 64;
    when '1x' UnallocatedEncoding();
```

```
boolean signal_all_nans = (opc<1> == '1');
boolean cmp_with_zero = (opc<0> == '1');
```

Assembler Symbols

- <Dn> For the double-precision variant: is the 64-bit name of the first SIMD&FP source register, encoded in the "Rn" field.
- <Dm> For the double-precision, zero variant: is the 64-bit name of the SIMD&FP source register, encoded in the "Rn" field.
- <Dm> Is the 64-bit name of the second SIMD&FP source register, encoded in the "Rm" field.
- <Sn> For the single-precision variant: is the 32-bit name of the first SIMD&FP source register, encoded in the "Rn" field.
- <Sm> For the single-precision, zero variant: is the 32-bit name of the SIMD&FP source register, encoded in the "Rn" field.
- <Sm> Is the 32-bit name of the second SIMD&FP source register, encoded in the "Rm" field.

Operation

```
CheckFPAdvSIMDEnabled64();

bits(datasize) operand1 = V[n];
bits(datasize) operand2;

operand2 = if cmp_with_zero then FPZero('0') else V[m];

PSTATE.<N,Z,C,V> = FPCompare(operand1, operand2, signal_all_nans, FPCR);
```

C6.3.56 FCSEL

Floating-point conditional select (scalar): $Vd = \text{if cond then } Vn \text{ else } Vm$

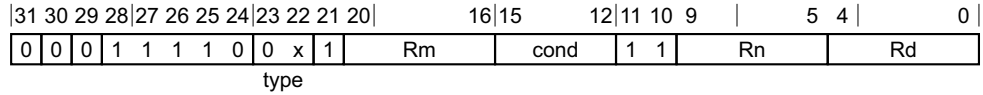

Single-precision variant (type = 00)

FCSEL <Sd>, <Sn>, <Sm>, <cond>

Double-precision variant (type = 01)

FCSEL <Dd>, <Dn>, <Dm>, <cond>

```
integer d = UInt(Rd);
integer n = UInt(Rn);
integer m = UInt(Rm);

integer datasize;
case type of
    when '00' datasize = 32;
    when '01' datasize = 64;
    when '1x' UnallocatedEncoding();

bits(4) condition = cond;
```

Assembler Symbols

- <Dd> Is the 64-bit name of the SIMD&FP destination register, encoded in the "Rd" field.
- <Dn> Is the 64-bit name of the first SIMD&FP source register, encoded in the "Rn" field.
- <Dm> Is the 64-bit name of the second SIMD&FP source register, encoded in the "Rm" field.
- <Sd> Is the 32-bit name of the SIMD&FP destination register, encoded in the "Rd" field.
- <Sn> Is the 32-bit name of the first SIMD&FP source register, encoded in the "Rn" field.
- <Sm> Is the 32-bit name of the second SIMD&FP source register, encoded in the "Rm" field.
- <cond> Is one of the standard conditions, encoded in the "cond" field in the standard way.

Operation

```
CheckFPAdvSIMDEnabled64();
bits(datasize) result;

result = if ConditionHolds(condition) then V[n] else V[m];

V[d] = result;
```

C6.3.57 FCVT

Floating-point convert precision (scalar): $Vd = \text{convertFormat}(Vn)$

31	30	29	28	27	26	25	24	23	22	21	20	19	18	17	16	15	14	13	12	11	10	9				5	4			0
0	0	0	1	1	1	1	0	type				1	0	0	0	1	opc				Rn				Rd					

Half-precision to single-precision variant (type = 11, opc = 00)

FCVT <Sd>, <Hn>

Half-precision to double-precision variant (type = 11, opc = 01)

FCVT <Dd>, <Hn>

Single-precision to half-precision variant (type = 00, opc = 11)

FCVT <Hd>, <Sn>

Single-precision to double-precision variant (type = 00, opc = 01)

FCVT <Dd>, <Sn>

Double-precision to half-precision variant (type = 01, opc = 11)

FCVT <Hd>, <Dn>

Double-precision to single-precision variant (type = 01, opc = 00)

FCVT <Sd>, <Dn>

```
integer d = UInt(Rd);
integer n = UInt(Rn);

integer srcsize;
case type of
    when '00' srcsize = 32;
    when '01' srcsize = 64;
    when '10' UnallocatedEncoding();
    when '11' srcsize = 16;

integer dstsize;
case opc of
    when '00' dstsize = 32;
    when '01' dstsize = 64;
    when '10' UnallocatedEncoding();
    when '11' dstsize = 16;
```

Assembler Symbols

<Dd>	Is the 64-bit name of the SIMD&FP destination register, encoded in the "Rd" field.
<Hd>	Is the 16-bit name of the SIMD&FP destination register, encoded in the "Rd" field.
<Sn>	Is the 32-bit name of the SIMD&FP source register, encoded in the "Rn" field.
<Sd>	Is the 32-bit name of the SIMD&FP destination register, encoded in the "Rd" field.
<Hn>	Is the 16-bit name of the SIMD&FP source register, encoded in the "Rn" field.
<Dn>	Is the 64-bit name of the SIMD&FP source register, encoded in the "Rn" field.

Operation

```
CheckFPAdvSIMDEnabled64();  
  
bits(dstsize) result;  
bits(srcsize) operand = V[n];  
  
result = FPConvert(operand, FPCR);  
V[d] = result;
```

C6.3.58 FCVTAS (vector)

Floating-point convert to signed integer, rounding to nearest with ties to away (vector)

It has encodings from 2 classes: *Scalar* and *Vector*

Scalar

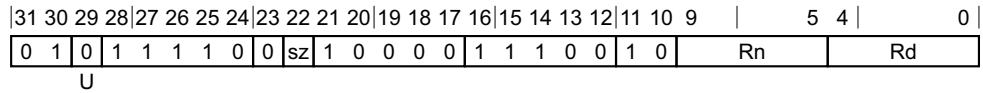

Scalar variant

FCVTAS <V><d>, <V><n>

```
integer d = UInt(Rd);
integer n = UInt(Rn);
```

```
integer esize = 32 << UInt(sz);
integer datasize = esize;
integer elements = 1;
```

```
FPRounding rounding = FPRounding_TIEAWAY;
boolean unsigned = (U == '1');
```

Vector

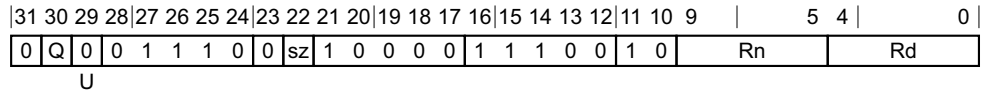

Vector variant

FCVTAS <Vd>.<T>, <Vn>.<T>

```
integer d = UInt(Rd);
integer n = UInt(Rn);
```

```
if sz:Q == '10' then ReservedValue();
integer esize = 32 << UInt(sz);
integer datasize = if Q == '1' then 128 else 64;
integer elements = datasize DIV esize;
```

```
FPRounding rounding = FPRounding_TIEAWAY;
boolean unsigned = (U == '1');
```

Assembler Symbols

- <V> Is a width specifier,
 - S** when sz = 0
 - D** when sz = 1
- <d> Is the number of the SIMD&FP destination register, encoded in the "Rd" field.
- <n> Is the number of the SIMD&FP source register, encoded in the "Rn" field.
- <Vd> Is the name of the SIMD&FP destination register, encoded in the "Rd" field.
- <T> Is an arrangement specifier,
 - 2S** when sz = 0, Q = 0

4S when $sz = 0, Q = 1$
RESERVED when $sz = 1, Q = 0$
2D when $sz = 1, Q = 1$

<Vn> Is the name of the SIMD&FP source register, encoded in the "Rn" field.

Operation for all classes

```
CheckFPAdvSIMDEnabled64();
bits(datasize) operand = V[n];
bits(datasize) result;
bits(esize) element;

for e = 0 to elements-1
    element = Elem[operand, e, esize];
    Elem[result, e, esize] = FPToFixed(element, 0, unsigned, FPCR, rounding);

V[d] = result;
```

C6.3.59 FCVTAS (scalar)

Floating-point convert to signed integer, rounding to nearest with ties to away (scalar): Rd = signed_convertToIntegerExactTiesToAway(Vn)

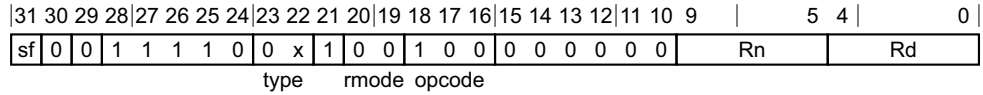

Single-precision to 32-bit variant (sf = 0, type = 00)

FCVTAS <Wd>, <Sn>

Single-precision to 64-bit variant (sf = 1, type = 00)

FCVTAS <Xd>, <Sn>

Double-precision to 32-bit variant (sf = 0, type = 01)

FCVTAS <Wd>, <Dn>

Double-precision to 64-bit variant (sf = 1, type = 01)

FCVTAS <Xd>, <Dn>

```
integer d = UInt(Rd);
integer n = UInt(Rn);

integer intsize = if sf == '1' then 64 else 32;
integer fltsize;
FPCConvOp op;
FPRounding rounding;
boolean unsigned;
integer part;

case type of
when '00'
    fltsize = 32;
when '01'
    fltsize = 64;
when '10'
    if opcode<2:1>:rmode != '11 01' then UnallocatedEncoding();
    fltsize = 128;
when '11'
    UnallocatedEncoding();

case opcode<2:1>:rmode of
when '00 xx' // FCVT[NPMZ][US]
    rounding = FPDecodeRounding(rmode);
    unsigned = (opcode<0> == '1');
    op = FPCConvOp_CVT_FtoI;
when '01 00' // [US]CVTF
    rounding = FPRoundingMode(FPCR);
    unsigned = (opcode<0> == '1');
    op = FPCConvOp_CVT_ItoF;
when '10 00' // FCVTA[US]
    rounding = FPRounding_TIEAWAY;
    unsigned = (opcode<0> == '1');
    op = FPCConvOp_CVT_FtoI;
when '11 00' // FMOV
    if fltsize != intsize then UnallocatedEncoding();
    op = if opcode<0> == '1' then FPCConvOp_MOV_ItoF else FPCConvOp_MOV_FtoI;
    part = 0;
when '11 01' // FMOV D[1]
    if intsize != 64 || fltsize != 128 then UnallocatedEncoding();
```

```

    op = if opcode<0> == '1' then FPConvOp_MOV_ItoF else FPConvOp_MOV_FtoI;
    part = 1;
    otherwise
        UnallocatedEncoding();
    
```

Assembler Symbols

- <Wd> Is the 32-bit name of the general-purpose destination register, encoded in the "Rd" field.
- <Xd> Is the 64-bit name of the general-purpose destination register, encoded in the "Rd" field.
- <Sn> Is the 32-bit name of the SIMD&FP source register, encoded in the "Rn" field.
- <Dn> Is the 64-bit name of the SIMD&FP source register, encoded in the "Rn" field.

Operation

```

CheckFPAdvSIMDEnabled64();

bits(fltsize) fltval;
bits(intsize) intval;

case op of
    when FPConvOp_CVT_FtoI
        fltval = V[n];
        intval = FPToFixed(fltval, 0, unsigned, FPCR, rounding);
        X[d] = intval;
    when FPConvOp_CVT_ItoF
        intval = X[n];
        fltval = FixedToFP(intval, 0, unsigned, FPCR, rounding);
        V[d] = fltval;
    when FPConvOp_MOV_FtoI
        intval = Vpart[n,part];
        X[d] = intval;
    when FPConvOp_MOV_ItoF
        intval = X[n];
        Vpart[d,part] = intval;
    
```

C6.3.60 FCVTAU (vector)

Floating-point convert to unsigned integer, rounding to nearest with ties to away (vector)

It has encodings from 2 classes: *Scalar* and *Vector*

Scalar

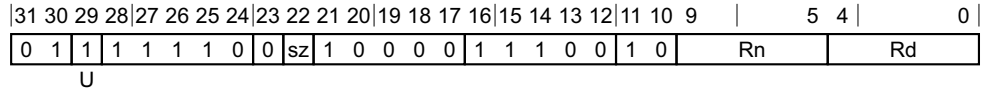

Scalar variant

FCVTAU <V><d>, <V><n>

```
integer d = UInt(Rd);
integer n = UInt(Rn);
```

```
integer esize = 32 << UInt(sz);
integer datasize = esize;
integer elements = 1;
```

```
FPRounding rounding = FPRounding_TIEAWAY;
boolean unsigned = (U == '1');
```

Vector

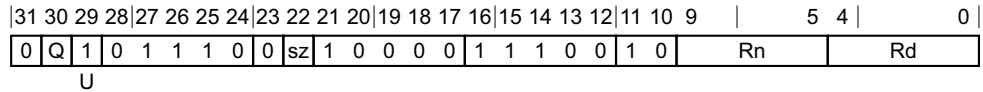

Vector variant

FCVTAU <Vd>.<T>, <Vn>.<T>

```
integer d = UInt(Rd);
integer n = UInt(Rn);
```

```
if sz:Q == '10' then ReservedValue();
integer esize = 32 << UInt(sz);
integer datasize = if Q == '1' then 128 else 64;
integer elements = datasize DIV esize;
```

```
FPRounding rounding = FPRounding_TIEAWAY;
boolean unsigned = (U == '1');
```

Assembler Symbols

- <V> Is a width specifier,
 - S** when sz = 0
 - D** when sz = 1
- <d> Is the number of the SIMD&FP destination register, encoded in the "Rd" field.
- <n> Is the number of the SIMD&FP source register, encoded in the "Rn" field.
- <Vd> Is the name of the SIMD&FP destination register, encoded in the "Rd" field.
- <T> Is an arrangement specifier,
 - 2S** when sz = 0, Q = 0

4S when $sz = 0, Q = 1$
RESERVED when $sz = 1, Q = 0$
2D when $sz = 1, Q = 1$

<Vn> Is the name of the SIMD&FP source register, encoded in the "Rn" field.

Operation for all classes

```
CheckFPAdvSIMDEnabled64();
bits(datasize) operand = V[n];
bits(datasize) result;
bits(esize) element;

for e = 0 to elements-1
    element = Elem[operand, e, esize];
    Elem[result, e, esize] = FPToFixed(element, 0, unsigned, FPCR, rounding);

V[d] = result;
```

C6.3.61 FCVTAU (scalar)

Floating-point convert to unsigned integer, rounding to nearest with ties to away (scalar): Rd = unsigned_convertToIntegerExactTiesToAway(Vn)

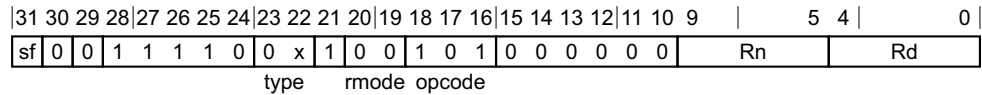

Single-precision to 32-bit variant (sf = 0, type = 00)

FCVTAU <Wd>, <Sn>

Single-precision to 64-bit variant (sf = 1, type = 00)

FCVTAU <Xd>, <Sn>

Double-precision to 32-bit variant (sf = 0, type = 01)

FCVTAU <Wd>, <Dn>

Double-precision to 64-bit variant (sf = 1, type = 01)

FCVTAU <Xd>, <Dn>

```
integer d = UInt(Rd);
integer n = UInt(Rn);

integer intsize = if sf == '1' then 64 else 32;
integer fltsize;
FPConvOp op;
FPRounding rounding;
boolean unsigned;
integer part;

case type of
    when '00'
        fltsize = 32;
    when '01'
        fltsize = 64;
    when '10'
        if opcode<2:1>:rmode != '11 01' then UnallocatedEncoding();
        fltsize = 128;
    when '11'
        UnallocatedEncoding();

case opcode<2:1>:rmode of
    when '00 xx' // FCVT[NPMZ][US]
        rounding = FPDecodeRounding(rmode);
        unsigned = (opcode<0> == '1');
        op = FPConvOp_CVT_FtoI;
    when '01 00' // [US]CVTF
        rounding = FPRoundingMode(FPCR);
        unsigned = (opcode<0> == '1');
        op = FPConvOp_CVT_ItoF;
    when '10 00' // FCVTA[US]
        rounding = FPRounding_TIEAWAY;
        unsigned = (opcode<0> == '1');
        op = FPConvOp_CVT_FtoI;
    when '11 00' // FMOV
        if fltsize != intsize then UnallocatedEncoding();
        op = if opcode<0> == '1' then FPConvOp_MOV_ItoF else FPConvOp_MOV_FtoI;
        part = 0;
    when '11 01' // FMOV D[1]
        if intsize != 64 || fltsize != 128 then UnallocatedEncoding();
```

```
op = if opcode<0> == '1' then FPConvOp_MOV_ItoF else FPConvOp_MOV_FtoI;
part = 1;
otherwise
    UnallocatedEncoding();
```

Assembler Symbols

- <Wd> Is the 32-bit name of the general-purpose destination register, encoded in the "Rd" field.
- <Xd> Is the 64-bit name of the general-purpose destination register, encoded in the "Rd" field.
- <Sn> Is the 32-bit name of the SIMD&FP source register, encoded in the "Rn" field.
- <Dn> Is the 64-bit name of the SIMD&FP source register, encoded in the "Rn" field.

Operation

```
CheckFPAdvSIMDEnabled64();

bits(fltsize) fltval;
bits(intsize) intval;

case op of
    when FPConvOp_CVT_FtoI
        fltval = V[n];
        intval = FPToFixed(fltval, 0, unsigned, FPCR, rounding);
        X[d] = intval;
    when FPConvOp_CVT_ItoF
        intval = X[n];
        fltval = FixedToFP(intval, 0, unsigned, FPCR, rounding);
        V[d] = fltval;
    when FPConvOp_MOV_FtoI
        intval = Vpart[n,part];
        X[d] = intval;
    when FPConvOp_MOV_ItoF
        intval = X[n];
        Vpart[d,part] = intval;
```

C6.3.62 FCVTL, FCVTL2

Floating-point convert to higher precision long (vector)

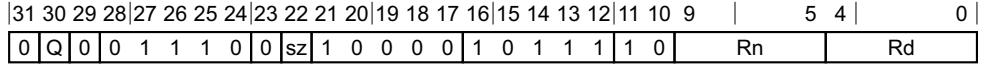

Vector variant

FCVTL{2} <Vd>.<Ta>, <Vn>.<Tb>

integer d = UInt(Rd);
 integer n = UInt(Rn);

integer esize = 16 << UInt(sz);
 integer datasize = 64;
 integer part = UInt(Q);
 integer elements = datasize DIV esize;

Assembler Symbols

2 Is the second and upper half specifier. If present it causes the operation to be performed on the upper 64 bits of the registers holding the narrower elements, and is

[absent] when Q = 0

[present] when Q = 1

<Vd> Is the name of the SIMD&FP destination register, encoded in the "Rd" field.

<Ta> Is an arrangement specifier,

4S when sz = 0

2D when sz = 1

<Vn> Is the name of the SIMD&FP source register, encoded in the "Rn" field.

<Tb> Is an arrangement specifier,

4H when sz = 0, Q = 0

8H when sz = 0, Q = 1

2S when sz = 1, Q = 0

4S when sz = 1, Q = 1

Operation

```
CheckFPAdvSIMDEnabled64();
bits(datasize) operand = Vpart[n, part];
bits(2*datasize) result;
```

for e = 0 to elements-1

```
    Elem[result, e, 2*esize] = FPConvert(Elem[operand, e, esize], FPCR);
```

V[d] = result;

C6.3.63 FCVTMS (vector)

Floating-point convert to signed integer, rounding toward minus infinity (vector)

It has encodings from 2 classes: *Scalar* and *Vector*

Scalar

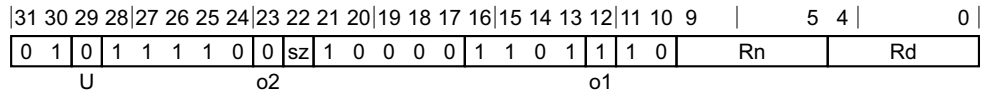

Scalar variant

FCVTMS <V><d>, <V><n>

```
integer d = UInt(Rd);
integer n = UInt(Rn);
```

```
integer esize = 32 << UInt(sz);
integer datasize = esize;
integer elements = 1;
```

```
FPRounding rounding = FPDecodeRounding(o1:o2);
boolean unsigned = (U == '1');
```

Vector

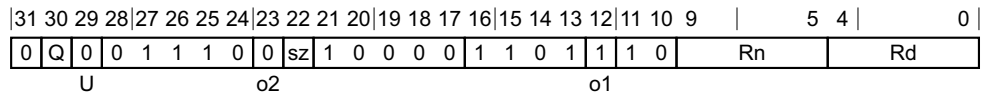

Vector variant

FCVTMS <Vd>.<T>, <Vn>.<T>

```
integer d = UInt(Rd);
integer n = UInt(Rn);
```

```
if sz:Q == '10' then ReservedValue();
integer esize = 32 << UInt(sz);
integer datasize = if Q == '1' then 128 else 64;
integer elements = datasize DIV esize;
```

```
FPRounding rounding = FPDecodeRounding(o1:o2);
boolean unsigned = (U == '1');
```

Assembler Symbols

- <V> Is a width specifier,
 - S** when sz = 0
 - D** when sz = 1
- <d> Is the number of the SIMD&FP destination register, encoded in the "Rd" field.
- <n> Is the number of the SIMD&FP source register, encoded in the "Rn" field.
- <Vd> Is the name of the SIMD&FP destination register, encoded in the "Rd" field.
- <T> Is an arrangement specifier,
 - 2S** when sz = 0, Q = 0

4S when $sz = 0, Q = 1$
RESERVED when $sz = 1, Q = 0$
2D when $sz = 1, Q = 1$

<Vn> Is the name of the SIMD&FP source register, encoded in the "Rn" field.

Operation for all classes

```
CheckFPAdvSIMDEnabled64();
bits(datasize) operand = V[n];
bits(datasize) result;
bits(esize) element;

for e = 0 to elements-1
    element = Elem[operand, e, esize];
    Elem[result, e, esize] = FPToFixed(element, 0, unsigned, FPCR, rounding);

V[d] = result;
```

C6.3.64 FCVTMS (scalar)

Floating-point convert to signed integer, rounding toward minus infinity (scalar): Rd = signed_convertToIntegerExactTowardNegative(Vn)

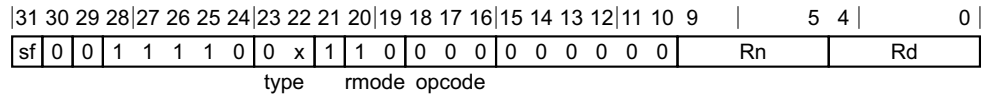

Single-precision to 32-bit variant (sf = 0, type = 00)

FCVTMS <Wd>, <Sn>

Single-precision to 64-bit variant (sf = 1, type = 00)

FCVTMS <Xd>, <Sn>

Double-precision to 32-bit variant (sf = 0, type = 01)

FCVTMS <Wd>, <Dn>

Double-precision to 64-bit variant (sf = 1, type = 01)

FCVTMS <Xd>, <Dn>

```
integer d = UInt(Rd);
integer n = UInt(Rn);

integer intsize = if sf == '1' then 64 else 32;
integer fltsize;
FPCConvOp op;
FPRounding rounding;
boolean unsigned;
integer part;

case type of
    when '00'
        fltsize = 32;
    when '01'
        fltsize = 64;
    when '10'
        if opcode<2:1>:rmode != '11 01' then UnallocatedEncoding();
        fltsize = 128;
    when '11'
        UnallocatedEncoding();

case opcode<2:1>:rmode of
    when '00 xx' // FCVT[NPMZ][US]
        rounding = FPDecodeRounding(rmode);
        unsigned = (opcode<0> == '1');
        op = FPCConvOp_CVT_FtoI;
    when '01 00' // [US]CVTF
        rounding = FPRoundingMode(FPCR);
        unsigned = (opcode<0> == '1');
        op = FPCConvOp_CVT_ItoF;
    when '10 00' // FCVTA[US]
        rounding = FPRounding_TIEAWAY;
        unsigned = (opcode<0> == '1');
        op = FPCConvOp_CVT_FtoI;
    when '11 00' // FMOV
        if fltsize != intsize then UnallocatedEncoding();
        op = if opcode<0> == '1' then FPCConvOp_MOV_ItoF else FPCConvOp_MOV_FtoI;
        part = 0;
    when '11 01' // FMOV D[1]
        if intsize != 64 || fltsize != 128 then UnallocatedEncoding();
```

```
op = if opcode<0> == '1' then FPConvOp_MOV_ItoF else FPConvOp_MOV_FtoI;
part = 1;
otherwise
    UnallocatedEncoding();
```

Assembler Symbols

- <Wd> Is the 32-bit name of the general-purpose destination register, encoded in the "Rd" field.
- <Xd> Is the 64-bit name of the general-purpose destination register, encoded in the "Rd" field.
- <Sn> Is the 32-bit name of the SIMD&FP source register, encoded in the "Rn" field.
- <Dn> Is the 64-bit name of the SIMD&FP source register, encoded in the "Rn" field.

Operation

```
CheckFPAdvSIMDEnabled64();

bits(fltsize) fltval;
bits(intsize) intval;

case op of
    when FPConvOp_CVT_FtoI
        fltval = V[n];
        intval = FPToFixed(fltval, 0, unsigned, FPCR, rounding);
        X[d] = intval;
    when FPConvOp_CVT_ItoF
        intval = X[n];
        fltval = FixedToFP(intval, 0, unsigned, FPCR, rounding);
        V[d] = fltval;
    when FPConvOp_MOV_FtoI
        intval = Vpart[n,part];
        X[d] = intval;
    when FPConvOp_MOV_ItoF
        intval = X[n];
        Vpart[d,part] = intval;
```

C6.3.65 FCVTMU (vector)

Floating-point convert to unsigned integer, rounding toward minus infinity (vector)

It has encodings from 2 classes: *Scalar* and *Vector*

Scalar

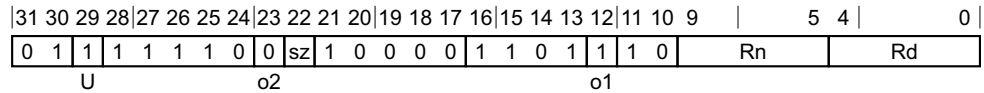

Scalar variant

FCVTMU <V><d>, <V><n>

```
integer d = UInt(Rd);
integer n = UInt(Rn);
```

```
integer esize = 32 << UInt(sz);
integer datasize = esize;
integer elements = 1;
```

```
FPRounding rounding = FPDecodeRounding(o1:o2);
boolean unsigned = (U == '1');
```

Vector

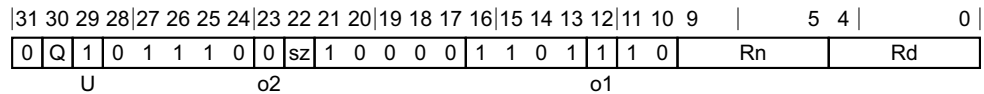

Vector variant

FCVTMU <Vd>.<T>, <Vn>.<T>

```
integer d = UInt(Rd);
integer n = UInt(Rn);
```

```
if sz:Q == '10' then ReservedValue();
integer esize = 32 << UInt(sz);
integer datasize = if Q == '1' then 128 else 64;
integer elements = datasize DIV esize;
```

```
FPRounding rounding = FPDecodeRounding(o1:o2);
boolean unsigned = (U == '1');
```

Assembler Symbols

- <V> Is a width specifier,
 - S** when sz = 0
 - D** when sz = 1
- <d> Is the number of the SIMD&FP destination register, encoded in the "Rd" field.
- <n> Is the number of the SIMD&FP source register, encoded in the "Rn" field.
- <Vd> Is the name of the SIMD&FP destination register, encoded in the "Rd" field.
- <T> Is an arrangement specifier,
 - 2S** when sz = 0, Q = 0

4S when $sz = 0, Q = 1$
RESERVED when $sz = 1, Q = 0$
2D when $sz = 1, Q = 1$

<Vn> Is the name of the SIMD&FP source register, encoded in the "Rn" field.

Operation for all classes

```
CheckFPAdvSIMDEnabled64();
bits(datasize) operand = V[n];
bits(datasize) result;
bits(esize) element;

for e = 0 to elements-1
    element = Elem[operand, e, esize];
    Elem[result, e, esize] = FPToFixed(element, 0, unsigned, FPCR, rounding);

V[d] = result;
```

C6.3.66 FCVTMU (scalar)

Floating-point convert to unsigned integer, rounding toward minus infinity (scalar): Rd = unsigned_convertToIntegerExactTowardNegative(Vn)

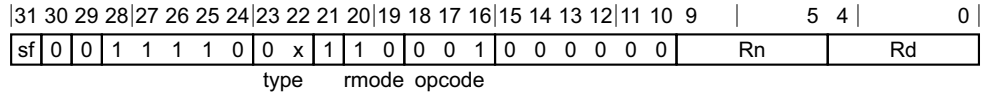

Single-precision to 32-bit variant (sf = 0, type = 00)

FCVTMU <Wd>, <Sn>

Single-precision to 64-bit variant (sf = 1, type = 00)

FCVTMU <Xd>, <Sn>

Double-precision to 32-bit variant (sf = 0, type = 01)

FCVTMU <Wd>, <Dn>

Double-precision to 64-bit variant (sf = 1, type = 01)

FCVTMU <Xd>, <Dn>

```
integer d = UInt(Rd);
integer n = UInt(Rn);

integer intsize = if sf == '1' then 64 else 32;
integer fltsize;
FPCConvOp op;
FPRounding rounding;
boolean unsigned;
integer part;

case type of
    when '00'
        fltsize = 32;
    when '01'
        fltsize = 64;
    when '10'
        if opcode<2:1>:rmode != '11 01' then UnallocatedEncoding();
        fltsize = 128;
    when '11'
        UnallocatedEncoding();

case opcode<2:1>:rmode of
    when '00 xx' // FCVT[NPMZ][US]
        rounding = FPDecodeRounding(rmode);
        unsigned = (opcode<0> == '1');
        op = FPCConvOp_CVT_FtoI;
    when '01 00' // [US]CVTF
        rounding = FPRoundingMode(FPCR);
        unsigned = (opcode<0> == '1');
        op = FPCConvOp_CVT_ItoF;
    when '10 00' // FCVTA[US]
        rounding = FPRounding_TIEAWAY;
        unsigned = (opcode<0> == '1');
        op = FPCConvOp_CVT_FtoI;
    when '11 00' // FMOV
        if fltsize != intsize then UnallocatedEncoding();
        op = if opcode<0> == '1' then FPCConvOp_MOV_ItoF else FPCConvOp_MOV_FtoI;
        part = 0;
    when '11 01' // FMOV D[1]
        if intsize != 64 || fltsize != 128 then UnallocatedEncoding();
```

```
op = if opcode<0> == '1' then FPConvOp_MOV_ItoF else FPConvOp_MOV_FtoI;
part = 1;
otherwise
    UnallocatedEncoding();
```

Assembler Symbols

- <Wd> Is the 32-bit name of the general-purpose destination register, encoded in the "Rd" field.
- <Xd> Is the 64-bit name of the general-purpose destination register, encoded in the "Rd" field.
- <Sn> Is the 32-bit name of the SIMD&FP source register, encoded in the "Rn" field.
- <Dn> Is the 64-bit name of the SIMD&FP source register, encoded in the "Rn" field.

Operation

```
CheckFPAdvSIMDEnabled64();

bits(fltsize) fltval;
bits(intsize) intval;

case op of
    when FPConvOp_CVT_FtoI
        fltval = V[n];
        intval = FPToFixed(fltval, 0, unsigned, FPCR, rounding);
        X[d] = intval;
    when FPConvOp_CVT_ItoF
        intval = X[n];
        fltval = FixedToFP(intval, 0, unsigned, FPCR, rounding);
        V[d] = fltval;
    when FPConvOp_MOV_FtoI
        intval = Vpart[n,part];
        X[d] = intval;
    when FPConvOp_MOV_ItoF
        intval = X[n];
        Vpart[d,part] = intval;
```

C6.3.67 FCVTN, FCVTN2

Floating-point convert to lower precision narrow (vector)

31	30	29	28	27	26	25	24	23	22	21	20	19	18	17	16	15	14	13	12	11	10	9				5	4				0
0	Q	0	0	1	1	1	0	0	sz	1	0	0	0	0	1	0	1	1	0	1	0	Rn			Rd						

Vector variant

FCVTN{2} <Vd>.<Tb>, <Vn>.<Ta>

integer d = UInt(Rd);
 integer n = UInt(Rn);

integer esize = 16 << UInt(sz);
 integer datasize = 64;
 integer part = UInt(Q);
 integer elements = datasize DIV esize;

Assembler Symbols

2 Is the second and upper half specifier. If present it causes the operation to be performed on the upper 64 bits of the registers holding the narrower elements, and is

[absent] when Q = 0

[present] when Q = 1

<Vd> Is the name of the SIMD&FP destination register, encoded in the "Rd" field.

<Tb> Is an arrangement specifier,

4H when sz = 0, Q = 0

8H when sz = 0, Q = 1

2S when sz = 1, Q = 0

4S when sz = 1, Q = 1

<Vn> Is the name of the SIMD&FP source register, encoded in the "Rn" field.

<Ta> Is an arrangement specifier,

4S when sz = 0

2D when sz = 1

Operation

CheckFPAdvSIMDEnabled64();
 bits(2*datasize) operand = V[n];
 bits(datasize) result;

for e = 0 to elements-1

Elem[result, e, esize] = FPConvert(Elem[operand, e, 2*esize], FPCR);

Vpart[d, part] = result;

C6.3.68 FCVTNS (vector)

Floating-point convert to signed integer, rounding to nearest with ties to even (vector)

It has encodings from 2 classes: *Scalar* and *Vector*

Scalar

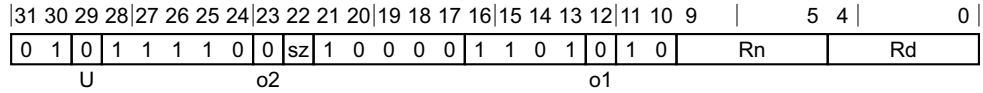

Scalar variant

FCVTNS <V><d>, <V><n>

```
integer d = UInt(Rd);
integer n = UInt(Rn);
```

```
integer esize = 32 << UInt(sz);
integer datasize = esize;
integer elements = 1;
```

```
FP Rounding rounding = FPDecodeRounding(o1:o2);
boolean unsigned = (U == '1');
```

Vector

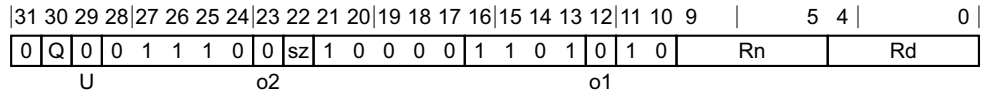

Vector variant

FCVTNS <Vd>.<T>, <Vn>.<T>

```
integer d = UInt(Rd);
integer n = UInt(Rn);
```

```
if sz:Q == '10' then ReservedValue();
integer esize = 32 << UInt(sz);
integer datasize = if Q == '1' then 128 else 64;
integer elements = datasize DIV esize;
```

```
FP Rounding rounding = FPDecodeRounding(o1:o2);
boolean unsigned = (U == '1');
```

Assembler Symbols

- <V> Is a width specifier,
 - S** when sz = 0
 - D** when sz = 1
- <d> Is the number of the SIMD&FP destination register, encoded in the "Rd" field.
- <n> Is the number of the SIMD&FP source register, encoded in the "Rn" field.
- <Vd> Is the name of the SIMD&FP destination register, encoded in the "Rd" field.
- <T> Is an arrangement specifier,
 - 2S** when sz = 0, Q = 0

4S when $sz = 0, Q = 1$
RESERVED when $sz = 1, Q = 0$
2D when $sz = 1, Q = 1$

<Vn> Is the name of the SIMD&FP source register, encoded in the "Rn" field.

Operation for all classes

```
CheckFPAdvSIMDEnabled64();
bits(datasize) operand = V[n];
bits(datasize) result;
bits(esize) element;

for e = 0 to elements-1
    element = Elem[operand, e, esize];
    Elem[result, e, esize] = FPToFixed(element, 0, unsigned, FPCR, rounding);

V[d] = result;
```

C6.3.69 FCVTNS (scalar)

Floating-point convert to signed integer, rounding to nearest with ties to even (scalar): Rd = signed_convertToIntegerExactTiesToEven(Vn)

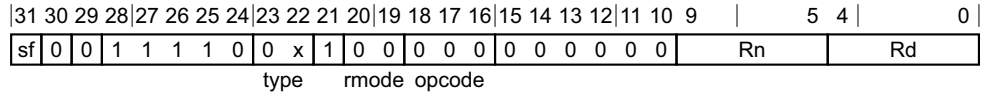

Single-precision to 32-bit variant (sf = 0, type = 00)

FCVTNS <Wd>, <Sn>

Single-precision to 64-bit variant (sf = 1, type = 00)

FCVTNS <Xd>, <Sn>

Double-precision to 32-bit variant (sf = 0, type = 01)

FCVTNS <Wd>, <Dn>

Double-precision to 64-bit variant (sf = 1, type = 01)

FCVTNS <Xd>, <Dn>

```
integer d = UInt(Rd);
integer n = UInt(Rn);

integer intsize = if sf == '1' then 64 else 32;
integer fltsize;
FPConvOp op;
FPRounding rounding;
boolean unsigned;
integer part;

case type of
when '00'
    fltsize = 32;
when '01'
    fltsize = 64;
when '10'
    if opcode<2:1>:rmode != '11 01' then UnallocatedEncoding();
    fltsize = 128;
when '11'
    UnallocatedEncoding();

case opcode<2:1>:rmode of
when '00 xx' // FCVT[NPMZ][US]
    rounding = FPDecodeRounding(rmode);
    unsigned = (opcode<0> == '1');
    op = FPConvOp_CVT_FtoI;
when '01 00' // [US]CVTF
    rounding = FPRoundingMode(FPCR);
    unsigned = (opcode<0> == '1');
    op = FPConvOp_CVT_ItoF;
when '10 00' // FCVTA[US]
    rounding = FPRounding_TIEAWAY;
    unsigned = (opcode<0> == '1');
    op = FPConvOp_CVT_FtoI;
when '11 00' // FMOV
    if fltsize != intsize then UnallocatedEncoding();
    op = if opcode<0> == '1' then FPConvOp_MOV_ItoF else FPConvOp_MOV_FtoI;
    part = 0;
when '11 01' // FMOV D[1]
    if intsize != 64 || fltsize != 128 then UnallocatedEncoding();
```



```
op = if opcode<0> == '1' then FPConvOp_MOV_ItoF else FPConvOp_MOV_FtoI;
part = 1;
otherwise
    UnallocatedEncoding();
```

Assembler Symbols

- <Wd> Is the 32-bit name of the general-purpose destination register, encoded in the "Rd" field.
- <Xd> Is the 64-bit name of the general-purpose destination register, encoded in the "Rd" field.
- <Sn> Is the 32-bit name of the SIMD&FP source register, encoded in the "Rn" field.
- <Dn> Is the 64-bit name of the SIMD&FP source register, encoded in the "Rn" field.

Operation

```
CheckFPAdvSIMDEnabled64();

bits(fltsize) fltval;
bits(intsize) intval;

case op of
    when FPConvOp_CVT_FtoI
        fltval = V[n];
        intval = FPToFixed(fltval, 0, unsigned, FPCR, rounding);
        X[d] = intval;
    when FPConvOp_CVT_ItoF
        intval = X[n];
        fltval = FixedToFP(intval, 0, unsigned, FPCR, rounding);
        V[d] = fltval;
    when FPConvOp_MOV_FtoI
        intval = Vpart[n,part];
        X[d] = intval;
    when FPConvOp_MOV_ItoF
        intval = X[n];
        Vpart[d,part] = intval;
```

C6.3.70 FCVTNU (vector)

Floating-point convert to unsigned integer, rounding to nearest with ties to even (vector)

It has encodings from 2 classes: *Scalar* and *Vector*

Scalar

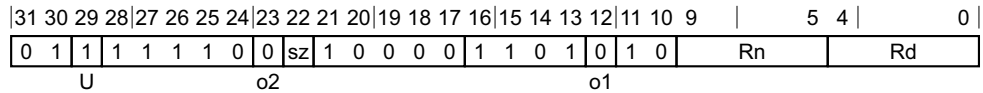

Scalar variant

FCVTNU <V><d>, <V><n>

```
integer d = UInt(Rd);
integer n = UInt(Rn);
```

```
integer esize = 32 << UInt(sz);
integer datasize = esize;
integer elements = 1;
```

```
FPRounding rounding = FPDecodeRounding(o1:o2);
boolean unsigned = (U == '1');
```

Vector

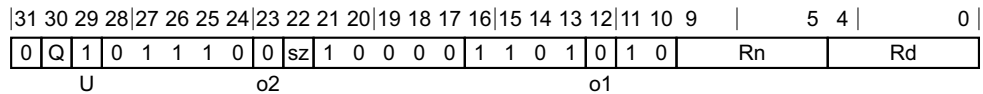

Vector variant

FCVTNU <Vd>.<T>, <Vn>.<T>

```
integer d = UInt(Rd);
integer n = UInt(Rn);
```

```
if sz:Q == '10' then ReservedValue();
integer esize = 32 << UInt(sz);
integer datasize = if Q == '1' then 128 else 64;
integer elements = datasize DIV esize;
```

```
FPRounding rounding = FPDecodeRounding(o1:o2);
boolean unsigned = (U == '1');
```

Assembler Symbols

- <V> Is a width specifier,
 - S** when sz = 0
 - D** when sz = 1
- <d> Is the number of the SIMD&FP destination register, encoded in the "Rd" field.
- <n> Is the number of the SIMD&FP source register, encoded in the "Rn" field.
- <Vd> Is the name of the SIMD&FP destination register, encoded in the "Rd" field.
- <T> Is an arrangement specifier,
 - 2S** when sz = 0, Q = 0

4S when $sz = 0, Q = 1$
RESERVED when $sz = 1, Q = 0$
2D when $sz = 1, Q = 1$

<Vn> Is the name of the SIMD&FP source register, encoded in the "Rn" field.

Operation for all classes

```
CheckFPAdvSIMDEnabled64();
bits(datasize) operand = V[n];
bits(datasize) result;
bits(esize) element;

for e = 0 to elements-1
    element = Elem[operand, e, esize];
    Elem[result, e, esize] = FPToFixed(element, 0, unsigned, FPCR, rounding);

V[d] = result;
```

C6.3.71 FCVTNU (scalar)

Floating-point convert to unsigned integer, rounding to nearest with ties to even (scalar): Rd = unsigned_convertToIntegerExactTiesToEven(Vn)

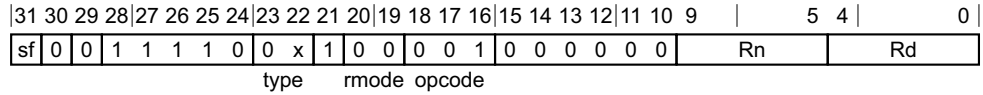

Single-precision to 32-bit variant (sf = 0, type = 00)

FCVTNU <Wd>, <Sn>

Single-precision to 64-bit variant (sf = 1, type = 00)

FCVTNU <Xd>, <Sn>

Double-precision to 32-bit variant (sf = 0, type = 01)

FCVTNU <Wd>, <Dn>

Double-precision to 64-bit variant (sf = 1, type = 01)

FCVTNU <Xd>, <Dn>

```
integer d = UInt(Rd);
integer n = UInt(Rn);

integer intsize = if sf == '1' then 64 else 32;
integer fltsize;
FPConvOp op;
FPRounding rounding;
boolean unsigned;
integer part;

case type of
    when '00'
        fltsize = 32;
    when '01'
        fltsize = 64;
    when '10'
        if opcode<2:1>:rmode != '11 01' then UnallocatedEncoding();
        fltsize = 128;
    when '11'
        UnallocatedEncoding();

case opcode<2:1>:rmode of
    when '00 xx' // FCVT[NPMZ][US]
        rounding = FPDecodeRounding(rmode);
        unsigned = (opcode<0> == '1');
        op = FPConvOp_CVT_FtoI;
    when '01 00' // [US]CVTF
        rounding = FPRoundingMode(FPCR);
        unsigned = (opcode<0> == '1');
        op = FPConvOp_CVT_ItoF;
    when '10 00' // FCVTA[US]
        rounding = FPRounding_TIEAWAY;
        unsigned = (opcode<0> == '1');
        op = FPConvOp_CVT_FtoI;
    when '11 00' // FMOV
        if fltsize != intsize then UnallocatedEncoding();
        op = if opcode<0> == '1' then FPConvOp_MOV_ItoF else FPConvOp_MOV_FtoI;
        part = 0;
    when '11 01' // FMOV D[1]
        if intsize != 64 || fltsize != 128 then UnallocatedEncoding();
```

```
op = if opcode<0> == '1' then FPConvOp_MOV_ItoF else FPConvOp_MOV_FtoI;
part = 1;
otherwise
    UnallocatedEncoding();
```

Assembler Symbols

- <Wd> Is the 32-bit name of the general-purpose destination register, encoded in the "Rd" field.
- <Xd> Is the 64-bit name of the general-purpose destination register, encoded in the "Rd" field.
- <Sn> Is the 32-bit name of the SIMD&FP source register, encoded in the "Rn" field.
- <Dn> Is the 64-bit name of the SIMD&FP source register, encoded in the "Rn" field.

Operation

```
CheckFPAdvSIMDEnabled64();

bits(fltsize) fltval;
bits(intsize) intval;

case op of
    when FPConvOp_CVT_FtoI
        fltval = V[n];
        intval = FPToFixed(fltval, 0, unsigned, FPCR, rounding);
        X[d] = intval;
    when FPConvOp_CVT_ItoF
        intval = X[n];
        fltval = FixedToFP(intval, 0, unsigned, FPCR, rounding);
        V[d] = fltval;
    when FPConvOp_MOV_FtoI
        intval = Vpart[n,part];
        X[d] = intval;
    when FPConvOp_MOV_ItoF
        intval = X[n];
        Vpart[d,part] = intval;
```

C6.3.72 FCVTPS (vector)

Floating-point convert to signed integer, rounding toward positive infinity (vector)

It has encodings from 2 classes: *Scalar* and *Vector*

Scalar

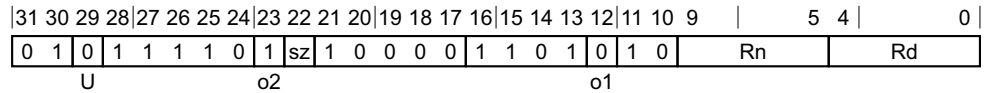

Scalar variant

FCVTPS <V><d>, <V><n>

```
integer d = UInt(Rd);
integer n = UInt(Rn);
```

```
integer esize = 32 << UInt(sz);
integer datasize = esize;
integer elements = 1;
```

```
FPRounding rounding = FPDecodeRounding(o1:o2);
boolean unsigned = (U == '1');
```

Vector

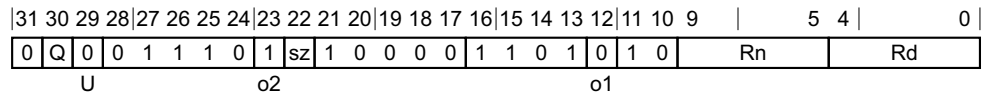

Vector variant

FCVTPS <Vd>.<T>, <Vn>.<T>

```
integer d = UInt(Rd);
integer n = UInt(Rn);
```

```
if sz:Q == '10' then ReservedValue();
integer esize = 32 << UInt(sz);
integer datasize = if Q == '1' then 128 else 64;
integer elements = datasize DIV esize;
```

```
FPRounding rounding = FPDecodeRounding(o1:o2);
boolean unsigned = (U == '1');
```

Assembler Symbols

- <V> Is a width specifier,
 - S** when sz = 0
 - D** when sz = 1
- <d> Is the number of the SIMD&FP destination register, encoded in the "Rd" field.
- <n> Is the number of the SIMD&FP source register, encoded in the "Rn" field.
- <Vd> Is the name of the SIMD&FP destination register, encoded in the "Rd" field.
- <T> Is an arrangement specifier,
 - 2S** when sz = 0, Q = 0

4S when $sz = 0, Q = 1$
RESERVED when $sz = 1, Q = 0$
2D when $sz = 1, Q = 1$

<Vn> Is the name of the SIMD&FP source register, encoded in the "Rn" field.

Operation for all classes

```
CheckFPAdvSIMDEnabled64();
bits(datasize) operand = V[n];
bits(datasize) result;
bits(esize) element;

for e = 0 to elements-1
    element = Elem[operand, e, esize];
    Elem[result, e, esize] = FPToFixed(element, 0, unsigned, FPCR, rounding);

V[d] = result;
```

C6.3.73 FCVTPS (scalar)

Floating-point convert to signed integer, rounding toward positive infinity (scalar): Rd = signed_convertToIntegerExactTowardPositive(Vn)

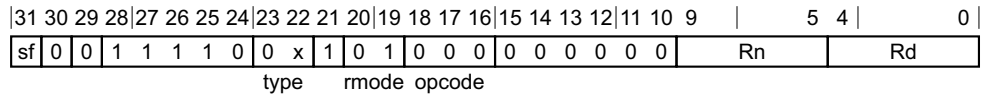

Single-precision to 32-bit variant (sf = 0, type = 00)

FCVTPS <Wd>, <Sn>

Single-precision to 64-bit variant (sf = 1, type = 00)

FCVTPS <Xd>, <Sn>

Double-precision to 32-bit variant (sf = 0, type = 01)

FCVTPS <Wd>, <Dn>

Double-precision to 64-bit variant (sf = 1, type = 01)

FCVTPS <Xd>, <Dn>

```
integer d = UInt(Rd);
integer n = UInt(Rn);

integer intsize = if sf == '1' then 64 else 32;
integer fltsize;
FPConvOp op;
FPRounding rounding;
boolean unsigned;
integer part;

case type of
    when '00'
        fltsize = 32;
    when '01'
        fltsize = 64;
    when '10'
        if opcode<2:1>:rmode != '11 01' then UnallocatedEncoding();
        fltsize = 128;
    when '11'
        UnallocatedEncoding();

case opcode<2:1>:rmode of
    when '00 xx' // FCVT[NPMZ][US]
        rounding = FPDecodeRounding(rmode);
        unsigned = (opcode<0> == '1');
        op = FPConvOp_CVT_FtoI;
    when '01 00' // [US]CVTF
        rounding = FPRoundingMode(FPCR);
        unsigned = (opcode<0> == '1');
        op = FPConvOp_CVT_ItoF;
    when '10 00' // FCVTA[US]
        rounding = FPRounding_TIEAWAY;
        unsigned = (opcode<0> == '1');
        op = FPConvOp_CVT_FtoI;
    when '11 00' // FMOV
        if fltsize != intsize then UnallocatedEncoding();
        op = if opcode<0> == '1' then FPConvOp_MOV_ItoF else FPConvOp_MOV_FtoI;
        part = 0;
    when '11 01' // FMOV D[1]
        if intsize != 64 || fltsize != 128 then UnallocatedEncoding();
```



```
op = if opcode<0> == '1' then FPConvOp_MOV_ItoF else FPConvOp_MOV_FtoI;
part = 1;
otherwise
    UnallocatedEncoding();
```

Assembler Symbols

- <Wd> Is the 32-bit name of the general-purpose destination register, encoded in the "Rd" field.
- <Xd> Is the 64-bit name of the general-purpose destination register, encoded in the "Rd" field.
- <Sn> Is the 32-bit name of the SIMD&FP source register, encoded in the "Rn" field.
- <Dn> Is the 64-bit name of the SIMD&FP source register, encoded in the "Rn" field.

Operation

```
CheckFPAdvSIMDEnabled64();

bits(fltsize) fltval;
bits(intsize) intval;

case op of
    when FPConvOp_CVT_FtoI
        fltval = V[n];
        intval = FPToFixed(fltval, 0, unsigned, FPCR, rounding);
        X[d] = intval;
    when FPConvOp_CVT_ItoF
        intval = X[n];
        fltval = FixedToFP(intval, 0, unsigned, FPCR, rounding);
        V[d] = fltval;
    when FPConvOp_MOV_FtoI
        intval = Vpart[n,part];
        X[d] = intval;
    when FPConvOp_MOV_ItoF
        intval = X[n];
        Vpart[d,part] = intval;
```

C6.3.74 FCVTPU (vector)

Floating-point convert to unsigned integer, rounding toward positive infinity (vector)

It has encodings from 2 classes: *Scalar* and *Vector*

Scalar

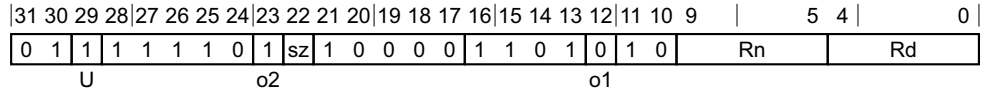

Scalar variant

FCVTPU <V><d>, <V><n>

```
integer d = UInt(Rd);
integer n = UInt(Rn);
```

```
integer esize = 32 << UInt(sz);
integer datasize = esize;
integer elements = 1;
```

```
FPRounding rounding = FPDecodeRounding(o1:o2);
boolean unsigned = (U == '1');
```

Vector

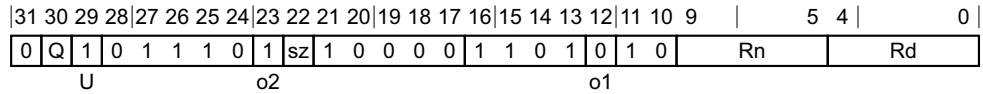

Vector variant

FCVTPU <Vd>.<T>, <Vn>.<T>

```
integer d = UInt(Rd);
integer n = UInt(Rn);
```

```
if sz:Q == '10' then ReservedValue();
integer esize = 32 << UInt(sz);
integer datasize = if Q == '1' then 128 else 64;
integer elements = datasize DIV esize;
```

```
FPRounding rounding = FPDecodeRounding(o1:o2);
boolean unsigned = (U == '1');
```

Assembler Symbols

- <V> Is a width specifier,
 - S** when sz = 0
 - D** when sz = 1
- <d> Is the number of the SIMD&FP destination register, encoded in the "Rd" field.
- <n> Is the number of the SIMD&FP source register, encoded in the "Rn" field.
- <Vd> Is the name of the SIMD&FP destination register, encoded in the "Rd" field.
- <T> Is an arrangement specifier,
 - 2S** when sz = 0, Q = 0

4S when $sz = 0, Q = 1$
RESERVED when $sz = 1, Q = 0$
2D when $sz = 1, Q = 1$

<Vn> Is the name of the SIMD&FP source register, encoded in the "Rn" field.

Operation for all classes

```
CheckFPAdvSIMDEnabled64();
bits(datasize) operand = V[n];
bits(datasize) result;
bits(esize) element;

for e = 0 to elements-1
    element = Elem[operand, e, esize];
    Elem[result, e, esize] = FPToFixed(element, 0, unsigned, FPCR, rounding);

V[d] = result;
```

C6.3.75 FCVTPU (scalar)

Floating-point convert to unsigned integer, rounding toward positive infinity (scalar): Rd = unsigned_convertToIntegerExactTowardPositive(Vn)

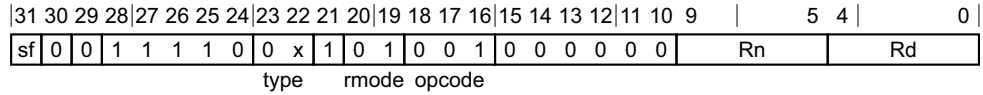

Single-precision to 32-bit variant (sf = 0, type = 00)

FCVTPU <Wd>, <Sn>

Single-precision to 64-bit variant (sf = 1, type = 00)

FCVTPU <Xd>, <Sn>

Double-precision to 32-bit variant (sf = 0, type = 01)

FCVTPU <Wd>, <Dn>

Double-precision to 64-bit variant (sf = 1, type = 01)

FCVTPU <Xd>, <Dn>

```
integer d = UInt(Rd);
integer n = UInt(Rn);

integer intsize = if sf == '1' then 64 else 32;
integer fltsize;
FPConvOp op;
FPRounding rounding;
boolean unsigned;
integer part;

case type of
    when '00'
        fltsize = 32;
    when '01'
        fltsize = 64;
    when '10'
        if opcode<2:1>:rmode != '11 01' then UnallocatedEncoding();
        fltsize = 128;
    when '11'
        UnallocatedEncoding();

case opcode<2:1>:rmode of
    when '00 xx' // FCVT[NPMZ][US]
        rounding = FPDecodeRounding(rmode);
        unsigned = (opcode<0> == '1');
        op = FPConvOp_CVT_FtoI;
    when '01 00' // [US]CVTF
        rounding = FPRoundingMode(FPCR);
        unsigned = (opcode<0> == '1');
        op = FPConvOp_CVT_ItoF;
    when '10 00' // FCVTA[US]
        rounding = FPRounding_TIEAWAY;
        unsigned = (opcode<0> == '1');
        op = FPConvOp_CVT_FtoI;
    when '11 00' // FMOV
        if fltsize != intsize then UnallocatedEncoding();
        op = if opcode<0> == '1' then FPConvOp_MOV_ItoF else FPConvOp_MOV_FtoI;
        part = 0;
    when '11 01' // FMOV D[1]
        if intsize != 64 || fltsize != 128 then UnallocatedEncoding();
```

```
op = if opcode<0> == '1' then FPConvOp_MOV_ItoF else FPConvOp_MOV_FtoI;
part = 1;
otherwise
    UnallocatedEncoding();
```

Assembler Symbols

- <Wd> Is the 32-bit name of the general-purpose destination register, encoded in the "Rd" field.
- <Xd> Is the 64-bit name of the general-purpose destination register, encoded in the "Rd" field.
- <Sn> Is the 32-bit name of the SIMD&FP source register, encoded in the "Rn" field.
- <Dn> Is the 64-bit name of the SIMD&FP source register, encoded in the "Rn" field.

Operation

```
CheckFPAdvSIMDEnabled64();

bits(fltsize) fltval;
bits(intsize) intval;

case op of
    when FPConvOp_CVT_FtoI
        fltval = V[n];
        intval = FPToFixed(fltval, 0, unsigned, FPCR, rounding);
        X[d] = intval;
    when FPConvOp_CVT_ItoF
        intval = X[n];
        fltval = FixedToFP(intval, 0, unsigned, FPCR, rounding);
        V[d] = fltval;
    when FPConvOp_MOV_FtoI
        intval = Vpart[n,part];
        X[d] = intval;
    when FPConvOp_MOV_ItoF
        intval = X[n];
        Vpart[d,part] = intval;
```

C6.3.76 FCVTXN, FCVTXN2

Floating-point convert to lower precision narrow, rounding to odd (vector)

It has encodings from 2 classes: *Scalar* and *Vector*

Scalar

31	30	29	28	27	26	25	24	23	22	21	20	19	18	17	16	15	14	13	12	11	10	9				5	4				0
0	1	1	1	1	1	1	0	0	sz	1	0	0	0	0	1	0	1	1	0	1	0				Rn						Rd

Scalar variant

FCVTXN <Vb><d>, <Va><n>

integer d = UInt(Rd);
 integer n = UInt(Rn);

if sz == '0' then ReservedValue();
 integer esize = 32;
 integer datasize = esize;
 integer elements = 1;
 integer part = 0;

Vector

31	30	29	28	27	26	25	24	23	22	21	20	19	18	17	16	15	14	13	12	11	10	9				5	4				0
0	Q	1	0	1	1	1	0	0	sz	1	0	0	0	0	1	0	1	1	0	1	0				Rn						Rd

Vector variant

FCVTXN{2} <Vd>.<Tb>, <Vn>.<Ta>

integer d = UInt(Rd);
 integer n = UInt(Rn);

if sz == '0' then ReservedValue();
 integer esize = 32;
 integer datasize = 64;
 integer elements = 2;
 integer part = UInt(Q);

Assembler Symbols

- 2 Is the second and upper half specifier. If present it causes the operation to be performed on the upper 64 bits of the registers holding the narrower elements, and is
 - [absent]** when Q = 0
 - [present]** when Q = 1
- <Vd> Is the name of the SIMD&FP destination register, encoded in the "Rd" field.
- <Tb> Is an arrangement specifier,
 - RESERVED** when sz = 0, Q = x
 - 2S** when sz = 1, Q = 0
 - 4S** when sz = 1, Q = 1
- <Vn> Is the name of the SIMD&FP source register, encoded in the "Rn" field.

<Ta>	Is an arrangement specifier, RESERVED when $sz = 0$ 2D when $sz = 1$
<Vb>	Is the destination width specifier, RESERVED when $sz = 0$ S when $sz = 1$
<d>	Is the number of the SIMD&FP destination register, encoded in the "Rd" field.
<Va>	Is the source width specifier, RESERVED when $sz = 0$ D when $sz = 1$
<n>	Is the number of the SIMD&FP source register, encoded in the "Rn" field.

Operation for all classes

```
CheckFPAdvSIMDEnabled64();
bits(2*datasize) operand = V[n];
bits(datasize) result;

for e = 0 to elements-1
    Elem[result, e, esize] = FPConvert(Elem[operand, e, 2*esize], FPCR, FPRounding_ODD);

Vpart[d, part] = result;
```

C6.3.77 FCVTZS (vector, fixed-point)

Floating-point convert to signed fixed-point, rounding toward zero (vector)

It has encodings from 2 classes: *Scalar* and *Vector*

Scalar

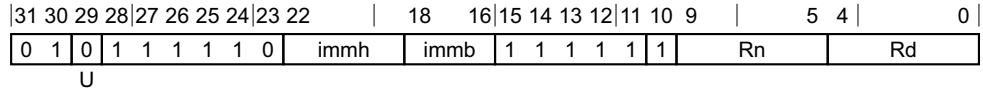

Scalar variant

FCVTZS <V><d>, <V><n>, #<fbits>

```
integer d = UInt(Rd);
integer n = UInt(Rn);

if immh == '00xx' then ReservedValue();
integer esize = 32 << UInt(immh<3>);
integer datasize = esize;
integer elements = 1;

integer fracbits = (esize * 2) - UInt(immh:immb);
boolean unsigned = (U == '1');
FPRounding rounding = FPRounding_ZERO;
```

Vector

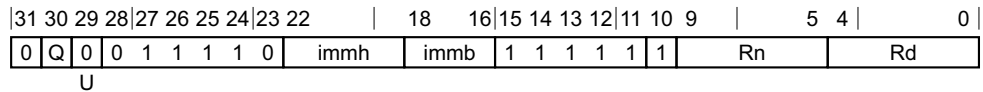

Vector variant

FCVTZS <Vd>.<T>, <Vn>.<T>, #<fbits>

```
integer d = UInt(Rd);
integer n = UInt(Rn);

if immh == '0000' then AdvSIMD modified immediate;
if immh == '00xx' then ReservedValue();
if immh<3>:Q == '10' then ReservedValue();
integer esize = 32 << UInt(immh<3>);
integer datasize = if Q == '1' then 128 else 64;
integer elements = datasize DIV esize;

integer fracbits = (esize * 2) - UInt(immh:immb);
boolean unsigned = (U == '1');
FPRounding rounding = FPRounding_ZERO;
```

Assembler Symbols

- <V> Is a width specifier,
 - RESERVED** when immh = 00xx
 - S** when immh = 01xx
 - D** when immh = 1xxx

- <d> Is the number of the SIMD&FP destination register, in the "Rd" field.

- <n> Is the number of the first SIMD&FP source register, encoded in the "Rn" field.
- <Vd> Is the name of the SIMD&FP destination register, encoded in the "Rd" field.
- <T> Is an arrangement specifier,
See AdvSIMD modified immediate. when immh = 0000, Q = x
RESERVED when immh = 0001, Q = x
RESERVED when immh = 001x, Q = x
2S when immh = 01xx, Q = 0
4S when immh = 01xx, Q = 1
RESERVED when immh = 1xxx, Q = 0
2D when immh = 1xxx, Q = 1
- <Vn> Is the name of the SIMD&FP source register, encoded in the "Rn" field.
- <fbits> For the scalar variant: is the number of fractional bits, in the range 1 to element bits,
RESERVED when immh = 00xx
(64-UInt(immh:immb)) when immh = 01xx
(128-UInt(immh:immb)) when immh = 1xxx
- <fbits> For the vector variant: is the number of fractional bits, in the range 1 to element bits,
See AdvSIMD modified immediate. when immh = 0000
RESERVED when immh = 0001
RESERVED when immh = 001x
(64-UInt(immh:immb)) when immh = 01xx
(128-UInt(immh:immb)) when immh = 1xxx

Operation for all classes

```

CheckFPAdvSIMDEnabled64();
bits(datasize) operand = V[n];
bits(datasize) result;
bits(esize) element;

for e = 0 to elements-1
    element = Elem[operand, e, esize];
    Elem[result, e, esize] = FPToFixed(element, fracbits, unsigned, FPCR, rounding);

V[d] = result;
    
```

C6.3.78 FCVTZS (vector, integer)

Floating-point convert to signed integer, rounding toward zero (vector)

It has encodings from 2 classes: *Scalar* and *Vector*

Scalar

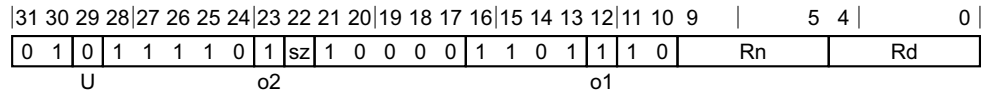

Scalar variant

FCVTZS <V><d>, <V><n>

```
integer d = UInt(Rd);
integer n = UInt(Rn);
```

```
integer esize = 32 << UInt(sz);
integer datasize = esize;
integer elements = 1;
```

```
FPRounding rounding = FPDecodeRounding(o1:o2);
boolean unsigned = (U == '1');
```

Vector

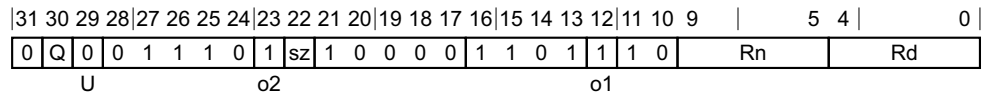

Vector variant

FCVTZS <Vd>.<T>, <Vn>.<T>

```
integer d = UInt(Rd);
integer n = UInt(Rn);
```

```
if sz:Q == '10' then ReservedValue();
integer esize = 32 << UInt(sz);
integer datasize = if Q == '1' then 128 else 64;
integer elements = datasize DIV esize;
```

```
FPRounding rounding = FPDecodeRounding(o1:o2);
boolean unsigned = (U == '1');
```

Assembler Symbols

- <V> Is a width specifier,
 - S** when sz = 0
 - D** when sz = 1
- <d> Is the number of the SIMD&FP destination register, encoded in the "Rd" field.
- <n> Is the number of the SIMD&FP source register, encoded in the "Rn" field.
- <Vd> Is the name of the SIMD&FP destination register, encoded in the "Rd" field.
- <T> Is an arrangement specifier,
 - 2S** when sz = 0, Q = 0

4S when $sz = 0, Q = 1$
RESERVED when $sz = 1, Q = 0$
2D when $sz = 1, Q = 1$

<Vn> Is the name of the SIMD&FP source register, encoded in the "Rn" field.

Operation for all classes

```
CheckFPAdvSIMDEnabled64();
bits(datasize) operand = V[n];
bits(datasize) result;
bits(esize) element;

for e = 0 to elements-1
    element = Elem[operand, e, esize];
    Elem[result, e, esize] = FPToFixed(element, 0, unsigned, FPCR, rounding);

V[d] = result;
```

C6.3.79 FCVTZS (scalar, fixed-point)

Floating-point convert to signed fixed-point, rounding toward zero (scalar): Rd = signed_convertToIntegerExactTowardZero(Vn*(2^{fbits}))

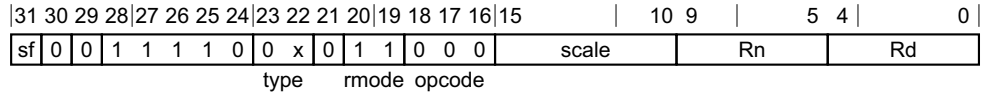

Single-precision to 32-bit variant (sf = 0, type = 00)

FCVTZS <Wd>, <Sn>, #<fbits>

Single-precision to 64-bit variant (sf = 1, type = 00)

FCVTZS <Xd>, <Sn>, #<fbits>

Double-precision to 32-bit variant (sf = 0, type = 01)

FCVTZS <Wd>, <Dn>, #<fbits>

Double-precision to 64-bit variant (sf = 1, type = 01)

FCVTZS <Xd>, <Dn>, #<fbits>

```
integer d = UInt(Rd);
integer n = UInt(Rn);

integer intsize = if sf == '1' then 64 else 32;
integer fltsize;
FPConvOp op;
FPRounding rounding;
boolean unsigned;

case type of
    when '00' fltsize = 32;
    when '01' fltsize = 64;
    when '1x' UnallocatedEncoding();

if sf == '0' && scale<5> == '0' then UnallocatedEncoding();
integer fracbits = 64 - UInt(scale);

case opcode<2:1>:rmode of
    when '00 11' // FCVTZ
        rounding = FPRounding_ZERO;
        unsigned = (opcode<0> == '1');
        op = FPConvOp_CVT_FtoI;
    when '01 00' // [US]CVTF
        rounding = FPRoundingMode(FPCR);
        unsigned = (opcode<0> == '1');
        op = FPConvOp_CVT_ItoF;
    otherwise
        UnallocatedEncoding();
```

Assembler Symbols

- <Wd> Is the 32-bit name of the general-purpose destination register, encoded in the "Rd" field.
- <Xd> Is the 64-bit name of the general-purpose destination register, encoded in the "Rd" field.
- <Sn> Is the 32-bit name of the SIMD&FP source register, encoded in the "Rn" field.
- <Dn> Is the 64-bit name of the SIMD&FP source register, encoded in the "Rn" field.

- <fbits> For the double-precision to 32-bit and single-precision to 32-bit variant: is the number of bits after the binary point in the fixed-point destination, in the range 1 to 32, encoded as 64 minus "scale".
- <fbits> For the double-precision to 64-bit and single-precision to 64-bit variant: is the number of bits after the binary point in the fixed-point destination, in the range 1 to 64, encoded as 64 minus "scale".

Operation

```
CheckFPAdvSIMDEnabled64();

bits(fltsize) fltval;
bits(intsize) intval;

case op of
  when FPConvOp_CVT_FtoI
    fltval = V[n];
    intval = FPToFixed(fltval, fracbits, unsigned, FPCR, rounding);
    X[d] = intval;
  when FPConvOp_CVT_ItoF
    intval = X[n];
    fltval = FixedToFP(intval, fracbits, unsigned, FPCR, rounding);
    V[d] = fltval;
```

C6.3.80 FCVTZS (scalar, integer)

Floating-point convert to signed integer, rounding toward zero (scalar): Rd = signed_convertToIntegerExactTowardZero(Vn)

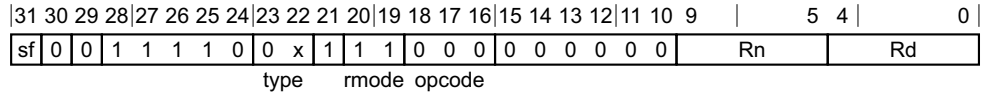

Single-precision to 32-bit variant (sf = 0, type = 00)

FCVTZS <Wd>, <Sn>

Single-precision to 64-bit variant (sf = 1, type = 00)

FCVTZS <Xd>, <Sn>

Double-precision to 32-bit variant (sf = 0, type = 01)

FCVTZS <Wd>, <Dn>

Double-precision to 64-bit variant (sf = 1, type = 01)

FCVTZS <Xd>, <Dn>

```
integer d = UInt(Rd);
integer n = UInt(Rn);

integer intsize = if sf == '1' then 64 else 32;
integer fltsize;
FPConvOp op;
FPRounding rounding;
boolean unsigned;
integer part;

case type of
    when '00'
        fltsize = 32;
    when '01'
        fltsize = 64;
    when '10'
        if opcode<2:1>:rmode != '11 01' then UnallocatedEncoding();
        fltsize = 128;
    when '11'
        UnallocatedEncoding();

case opcode<2:1>:rmode of
    when '00 xx' // FCVT[NPMZ][US]
        rounding = FPDecodeRounding(rmode);
        unsigned = (opcode<0> == '1');
        op = FPConvOp_CVT_FtoI;
    when '01 00' // [US]CVTF
        rounding = FPRoundingMode(FPCR);
        unsigned = (opcode<0> == '1');
        op = FPConvOp_CVT_ItoF;
    when '10 00' // FCVTA[US]
        rounding = FPRounding_TIEAWAY;
        unsigned = (opcode<0> == '1');
        op = FPConvOp_CVT_FtoI;
    when '11 00' // FMOV
        if fltsize != intsize then UnallocatedEncoding();
        op = if opcode<0> == '1' then FPConvOp_MOV_ItoF else FPConvOp_MOV_FtoI;
        part = 0;
    when '11 01' // FMOV D[1]
        if intsize != 64 || fltsize != 128 then UnallocatedEncoding();
```

```

    op = if opcode<0> == '1' then FPConvOp_MOV_ItoF else FPConvOp_MOV_FtoI;
    part = 1;
  otherwise
    UnallocatedEncoding();
  
```

Assembler Symbols

- <Wd> Is the 32-bit name of the general-purpose destination register, encoded in the "Rd" field.
- <Xd> Is the 64-bit name of the general-purpose destination register, encoded in the "Rd" field.
- <Sn> Is the 32-bit name of the SIMD&FP source register, encoded in the "Rn" field.
- <Dn> Is the 64-bit name of the SIMD&FP source register, encoded in the "Rn" field.

Operation

```

CheckFPAdvSIMDEnabled64();

bits(fltsize) fltval;
bits(intsize) intval;

case op of
  when FPConvOp_CVT_FtoI
    fltval = V[n];
    intval = FPToFixed(fltval, 0, unsigned, FPCR, rounding);
    X[d] = intval;
  when FPConvOp_CVT_ItoF
    intval = X[n];
    fltval = FixedToFP(intval, 0, unsigned, FPCR, rounding);
    V[d] = fltval;
  when FPConvOp_MOV_FtoI
    intval = Vpart[n,part];
    X[d] = intval;
  when FPConvOp_MOV_ItoF
    intval = X[n];
    Vpart[d,part] = intval;
  
```

C6.3.81 FCVTZU (vector, fixed-point)

Floating-point convert to unsigned fixed-point, rounding toward zero (vector)

It has encodings from 2 classes: *Scalar* and *Vector*

Scalar

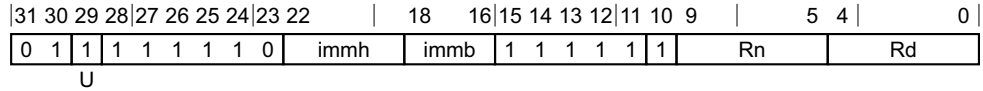

Scalar variant

FCVTZU <V><d>, <V><n>, #<fbits>

```
integer d = UInt(Rd);
integer n = UInt(Rn);

if immh == '00xx' then ReservedValue();
integer esize = 32 << UInt(immh<3>);
integer datasize = esize;
integer elements = 1;

integer fracbits = (esize * 2) - UInt(immh:immb);
boolean unsigned = (U == '1');
FPRounding rounding = FPRounding_ZERO;
```

Vector

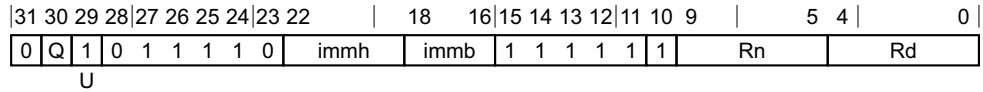

Vector variant

FCVTZU <Vd>.<T>, <Vn>.<T>, #<fbits>

```
integer d = UInt(Rd);
integer n = UInt(Rn);

if immh == '0000' then AdvSIMD modified immediate;
if immh == '00xx' then ReservedValue();
if immh<3>:Q == '10' then ReservedValue();
integer esize = 32 << UInt(immh<3>);
integer datasize = if Q == '1' then 128 else 64;
integer elements = datasize DIV esize;

integer fracbits = (esize * 2) - UInt(immh:immb);
boolean unsigned = (U == '1');
FPRounding rounding = FPRounding_ZERO;
```

Assembler Symbols

- <V> Is a width specifier,
 - RESERVED** when immh = 00xx
 - S** when immh = 01xx
 - D** when immh = 1xxx

- <d> Is the number of the SIMD&FP destination register, in the "Rd" field.

- <n> Is the number of the first SIMD&FP source register, encoded in the "Rn" field.
- <Vd> Is the name of the SIMD&FP destination register, encoded in the "Rd" field.
- <T> Is an arrangement specifier,
See AdvSIMD modified immediate. when immh = 0000, Q = x
RESERVED when immh = 0001, Q = x
RESERVED when immh = 001x, Q = x
2S when immh = 01xx, Q = 0
4S when immh = 01xx, Q = 1
RESERVED when immh = 1xxx, Q = 0
2D when immh = 1xxx, Q = 1
- <Vn> Is the name of the SIMD&FP source register, encoded in the "Rn" field.
- <fbits> For the scalar variant: is the number of fractional bits, in the range 1 to element bits,
RESERVED when immh = 00xx
(64-UInt(immh:immb)) when immh = 01xx
(128-UInt(immh:immb)) when immh = 1xxx
- <fbits> For the vector variant: is the number of fractional bits, in the range 1 to element bits,
See AdvSIMD modified immediate. when immh = 0000
RESERVED when immh = 0001
RESERVED when immh = 001x
(64-UInt(immh:immb)) when immh = 01xx
(128-UInt(immh:immb)) when immh = 1xxx

Operation for all classes

```

CheckFPAdvSIMDEnabled64();
bits(datasize) operand = V[n];
bits(datasize) result;
bits(esize) element;

for e = 0 to elements-1
    element = Elem[operand, e, esize];
    Elem[result, e, esize] = FPToFixed(element, fracbits, unsigned, FPCR, rounding);

V[d] = result;
    
```

C6.3.82 FCVTZU (vector, integer)

Floating-point convert to unsigned integer, rounding toward zero (vector)

It has encodings from 2 classes: *Scalar* and *Vector*

Scalar

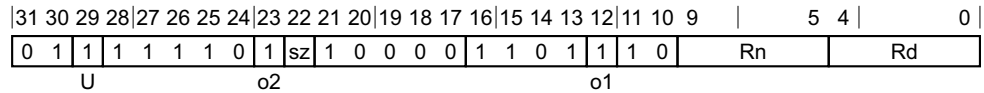

Scalar variant

FCVTZU <V><d>, <V><n>

```
integer d = UInt(Rd);
integer n = UInt(Rn);
```

```
integer esize = 32 << UInt(sz);
integer datasize = esize;
integer elements = 1;
```

```
FPRounding rounding = FPDecodeRounding(o1:o2);
boolean unsigned = (U == '1');
```

Vector

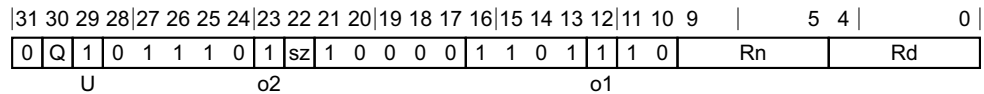

Vector variant

FCVTZU <Vd>.<T>, <Vn>.<T>

```
integer d = UInt(Rd);
integer n = UInt(Rn);
```

```
if sz:Q == '10' then ReservedValue();
integer esize = 32 << UInt(sz);
integer datasize = if Q == '1' then 128 else 64;
integer elements = datasize DIV esize;
```

```
FPRounding rounding = FPDecodeRounding(o1:o2);
boolean unsigned = (U == '1');
```

Assembler Symbols

- <V> Is a width specifier,
 - S** when sz = 0
 - D** when sz = 1
- <d> Is the number of the SIMD&FP destination register, encoded in the "Rd" field.
- <n> Is the number of the SIMD&FP source register, encoded in the "Rn" field.
- <Vd> Is the name of the SIMD&FP destination register, encoded in the "Rd" field.
- <T> Is an arrangement specifier,
 - 2S** when sz = 0, Q = 0

4S when $sz = 0, Q = 1$
RESERVED when $sz = 1, Q = 0$
2D when $sz = 1, Q = 1$

<Vn> Is the name of the SIMD&FP source register, encoded in the "Rn" field.

Operation for all classes

```
CheckFPAdvSIMDEnabled64();
bits(datasize) operand = V[n];
bits(datasize) result;
bits(esize) element;

for e = 0 to elements-1
    element = Elem[operand, e, esize];
    Elem[result, e, esize] = FPToFixed(element, 0, unsigned, FPCR, rounding);

V[d] = result;
```

C6.3.83 FCVTZU (scalar, fixed-point)

Floating-point convert to unsigned fixed-point, rounding toward zero (scalar): Rd = unsigned_convertToIntegerExactTowardZero(Vn*(2^{fbits}))

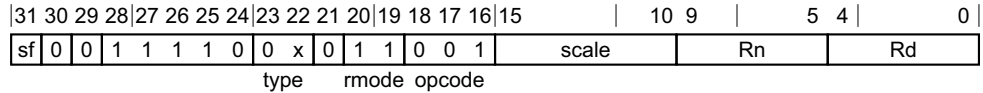

Single-precision to 32-bit variant (sf = 0, type = 00)

FCVTZU <Wd>, <Sn>, #<fbits>

Single-precision to 64-bit variant (sf = 1, type = 00)

FCVTZU <Xd>, <Sn>, #<fbits>

Double-precision to 32-bit variant (sf = 0, type = 01)

FCVTZU <Wd>, <Dn>, #<fbits>

Double-precision to 64-bit variant (sf = 1, type = 01)

FCVTZU <Xd>, <Dn>, #<fbits>

```
integer d = UInt(Rd);
integer n = UInt(Rn);

integer intsize = if sf == '1' then 64 else 32;
integer fltsize;
FPConvOp op;
FPRounding rounding;
boolean unsigned;

case type of
    when '00' fltsize = 32;
    when '01' fltsize = 64;
    when '1x' UnallocatedEncoding();

if sf == '0' && scale<5> == '0' then UnallocatedEncoding();
integer fracbits = 64 - UInt(scale);

case opcode<2:1>:rmode of
    when '00 11' // FCVTZ
        rounding = FPRounding_ZERO;
        unsigned = (opcode<0> == '1');
        op = FPConvOp_CVT_FtoI;
    when '01 00' // [US]CVTF
        rounding = FPRoundingMode(FPCR);
        unsigned = (opcode<0> == '1');
        op = FPConvOp_CVT_ItoF;
    otherwise
        UnallocatedEncoding();
```

Assembler Symbols

- <Wd> Is the 32-bit name of the general-purpose destination register, encoded in the "Rd" field.
- <Xd> Is the 64-bit name of the general-purpose destination register, encoded in the "Rd" field.
- <Sn> Is the 32-bit name of the SIMD&FP source register, encoded in the "Rn" field.
- <Dn> Is the 64-bit name of the SIMD&FP source register, encoded in the "Rn" field.

- <fbits> For the double-precision to 32-bit and single-precision to 32-bit variant: is the number of bits after the binary point in the fixed-point destination, in the range 1 to 32, encoded as 64 minus "scale".
- <fbits> For the double-precision to 64-bit and single-precision to 64-bit variant: is the number of bits after the binary point in the fixed-point destination, in the range 1 to 64, encoded as 64 minus "scale".

Operation

```
CheckFPAdvSIMDEnabled64();

bits(fltsize) fltval;
bits(intsize) intval;

case op of
  when FPConvOp_CVT_FtoI
    fltval = V[n];
    intval = FPToFixed(fltval, fracbits, unsigned, FPCR, rounding);
    X[d] = intval;
  when FPConvOp_CVT_ItoF
    intval = X[n];
    fltval = FixedToFP(intval, fracbits, unsigned, FPCR, rounding);
    V[d] = fltval;
```

C6.3.84 FCVTZU (scalar, integer)

Floating-point convert to unsigned integer, rounding toward zero (scalar): Rd = unsigned_convertToIntegerExactTowardZero(Vn)

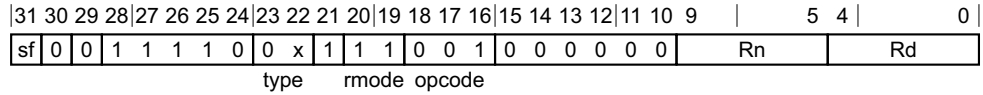

Single-precision to 32-bit variant (sf = 0, type = 00)

FCVTZU <Wd>, <Sn>

Single-precision to 64-bit variant (sf = 1, type = 00)

FCVTZU <Xd>, <Sn>

Double-precision to 32-bit variant (sf = 0, type = 01)

FCVTZU <Wd>, <Dn>

Double-precision to 64-bit variant (sf = 1, type = 01)

FCVTZU <Xd>, <Dn>

```
integer d = UInt(Rd);
integer n = UInt(Rn);

integer intsize = if sf == '1' then 64 else 32;
integer fltsize;
FPCConvOp op;
FPRounding rounding;
boolean unsigned;
integer part;

case type of
    when '00'
        fltsize = 32;
    when '01'
        fltsize = 64;
    when '10'
        if opcode<2:1>:rmode != '11 01' then UnallocatedEncoding();
        fltsize = 128;
    when '11'
        UnallocatedEncoding();

case opcode<2:1>:rmode of
    when '00 xx' // FCVT[NPMZ][US]
        rounding = FPDecodeRounding(rmode);
        unsigned = (opcode<0> == '1');
        op = FPCConvOp_CVT_FtoI;
    when '01 00' // [US]CVTF
        rounding = FPRoundingMode(FPCR);
        unsigned = (opcode<0> == '1');
        op = FPCConvOp_CVT_ItoF;
    when '10 00' // FCVTA[US]
        rounding = FPRounding_TIEAWAY;
        unsigned = (opcode<0> == '1');
        op = FPCConvOp_CVT_FtoI;
    when '11 00' // FMOV
        if fltsize != intsize then UnallocatedEncoding();
        op = if opcode<0> == '1' then FPCConvOp_MOV_ItoF else FPCConvOp_MOV_FtoI;
        part = 0;
    when '11 01' // FMOV D[1]
        if intsize != 64 || fltsize != 128 then UnallocatedEncoding();
```

```

    op = if opcode<0> == '1' then FPConvOp_MOV_ItoF else FPConvOp_MOV_FtoI;
    part = 1;
  otherwise
    UnallocatedEncoding();
  
```

Assembler Symbols

- <Wd> Is the 32-bit name of the general-purpose destination register, encoded in the "Rd" field.
- <Xd> Is the 64-bit name of the general-purpose destination register, encoded in the "Rd" field.
- <Sn> Is the 32-bit name of the SIMD&FP source register, encoded in the "Rn" field.
- <Dn> Is the 64-bit name of the SIMD&FP source register, encoded in the "Rn" field.

Operation

```

CheckFPAdvSIMDEnabled64();

bits(fltsize) fltval;
bits(intsize) intval;

case op of
  when FPConvOp_CVT_FtoI
    fltval = V[n];
    intval = FPToFixed(fltval, 0, unsigned, FPCR, rounding);
    X[d] = intval;
  when FPConvOp_CVT_ItoF
    intval = X[n];
    fltval = FixedToFP(intval, 0, unsigned, FPCR, rounding);
    V[d] = fltval;
  when FPConvOp_MOV_FtoI
    intval = Vpart[n,part];
    X[d] = intval;
  when FPConvOp_MOV_ItoF
    intval = X[n];
    Vpart[d,part] = intval;
  
```

C6.3.85 FDIV (vector)

Floating-point divide (vector)

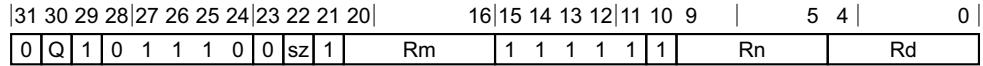

Three registers of the same type variant

FDIV <Vd>.<T>, <Vn>.<T>, <Vm>.<T>

```
integer d = UInt(Rd);
integer n = UInt(Rn);
integer m = UInt(Rm);
if sz:Q == '10' then ReservedValue();
integer esize = 32 << UInt(sz);
integer datasize = if Q == '1' then 128 else 64;
integer elements = datasize DIV esize;
```

Assembler Symbols

- <Vd> Is the name of the SIMD&FP destination register, encoded in the "Rd" field.
- <T> Is an arrangement specifier,
 - 2S** when sz = 0, Q = 0
 - 4S** when sz = 0, Q = 1
 - RESERVED** when sz = 1, Q = 0
 - 2D** when sz = 1, Q = 1
- <Vn> Is the name of the first SIMD&FP source register, encoded in the "Rn" field.
- <Vm> Is the name of the second SIMD&FP source register, encoded in the "Rm" field.

Operation

```
CheckFPAdvSIMDEnabled64();
bits(datasize) operand1 = V[n];
bits(datasize) operand2 = V[m];
bits(datasize) result;
bits(esize) element1;
bits(esize) element2;

for e = 0 to elements-1
    element1 = Elem[operand1, e, esize];
    element2 = Elem[operand2, e, esize];
    Elem[result, e, esize] = FPDiv(element1, element2, FPCR);

V[d] = result;
```

C6.3.86 FDIV (scalar)

Floating-point divide (scalar): $Vd = Vn / Vm$

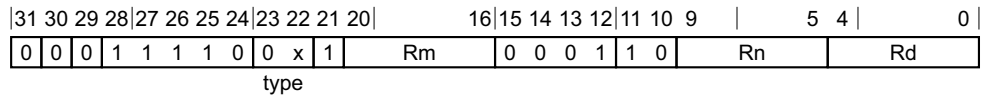

Single-precision variant (type = 00)

FDIV <Sd>, <Sn>, <Sm>

Double-precision variant (type = 01)

FDIV <Dd>, <Dn>, <Dm>

```
integer d = UInt(Rd);
integer n = UInt(Rn);
integer m = UInt(Rm);

integer datasize;
case type of
    when '00' datasize = 32;
    when '01' datasize = 64;
    when '1x' UnallocatedEncoding();
```

Assembler Symbols

- <Dd> Is the 64-bit name of the SIMD&FP destination register, encoded in the "Rd" field.
- <Dn> Is the 64-bit name of the first SIMD&FP source register, encoded in the "Rn" field.
- <Dm> Is the 64-bit name of the second SIMD&FP source register, encoded in the "Rm" field.
- <Sd> Is the 32-bit name of the SIMD&FP destination register, encoded in the "Rd" field.
- <Sn> Is the 32-bit name of the first SIMD&FP source register, encoded in the "Rn" field.
- <Sm> Is the 32-bit name of the second SIMD&FP source register, encoded in the "Rm" field.

Operation

```
CheckFPAdvSIMDEnabled64();
bits(datasize) result;
bits(datasize) operand1 = V[n];
bits(datasize) operand2 = V[m];

result = FPDiv(operand1, operand2, FPCR);

V[d] = result;
```

C6.3.87 FMADD

Floating-point fused multiply-add (scalar): $Vd = Va + Vn \times Vm$

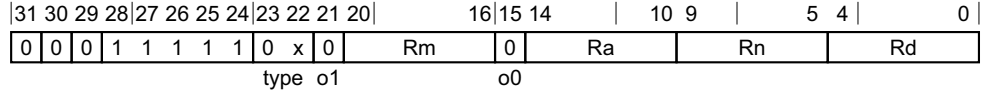

Single-precision variant (type = 00)

FMADD <Sd>, <Sn>, <Sm>, <Sa>

Double-precision variant (type = 01)

FMADD <Dd>, <Dn>, <Dm>, <Da>

```
integer d = UInt(Rd);
integer a = UInt(Ra);
integer n = UInt(Rn);
integer m = UInt(Rm);

integer datasize;
case type of
    when '00' datasize = 32;
    when '01' datasize = 64;
    when '1x' UnallocatedEncoding();

boolean opa_neg = (o1 == '1');
boolean op1_neg = (o0 != o1);
```

Assembler Symbols

- <Dd> Is the 64-bit name of the SIMD&FP destination register, encoded in the "Rd" field.
- <Dn> Is the 64-bit name of the first SIMD&FP source register holding the multiplicand, encoded in the "Rn" field.
- <Dm> Is the 64-bit name of the second SIMD&FP source register holding the multiplier, encoded in the "Rm" field.
- <Da> Is the 64-bit name of the third SIMD&FP source register holding the addend, encoded in the "Ra" field.
- <Sd> Is the 32-bit name of the SIMD&FP destination register, encoded in the "Rd" field.
- <Sn> Is the 32-bit name of the first SIMD&FP source register holding the multiplicand, encoded in the "Rn" field.
- <Sm> Is the 32-bit name of the second SIMD&FP source register holding the multiplier, encoded in the "Rm" field.
- <Sa> Is the 32-bit name of the third SIMD&FP source register holding the addend, encoded in the "Ra" field.

Operation

```
CheckFPAdvSIMDEnabled64();
bits(datasize) result;
bits(datasize) operands = V[a];
bits(datasize) operand1 = V[n];
bits(datasize) operand2 = V[m];
```

```
if opa_neg then operanda = FPNeg(operanda);  
if op1_neg then operand1 = FPNeg(operand1);  
result = FPMu1Add(operanda, operand1, operand2, FPCR);  
  
V[d] = result;
```

C6.3.88 FMAX (vector)

Floating-point maximum (vector)

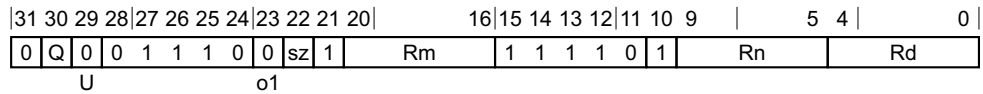

Three registers of the same type variant

FMAX <Vd>.<T>, <Vn>.<T>, <Vm>.<T>

```
integer d = UInt(Rd);
integer n = UInt(Rn);
integer m = UInt(Rm);
if sz:Q == '10' then ReservedValue();
integer esize = 32 << UInt(sz);
integer datasize = if Q == '1' then 128 else 64;
integer elements = datasize DIV esize;
```

```
boolean pair = (U == '1');
boolean minimum = (o1 == '1');
```

Assembler Symbols

- <Vd> Is the name of the SIMD&FP destination register, encoded in the "Rd" field.
- <T> Is an arrangement specifier,
 - 2S** when sz = 0, Q = 0
 - 4S** when sz = 0, Q = 1
 - RESERVED** when sz = 1, Q = 0
 - 2D** when sz = 1, Q = 1
- <Vn> Is the name of the first SIMD&FP source register, encoded in the "Rn" field.
- <Vm> Is the name of the second SIMD&FP source register, encoded in the "Rm" field.

Operation

```
CheckFPAdvSIMDEnabled64();
bits(datasize) operand1 = V[n];
bits(datasize) operand2 = V[m];
bits(datasize) result;
bits(2*datasize) concat = operand2:operand1;
bits(esize) element1;
bits(esize) element2;

for e = 0 to elements-1
    if pair then
        element1 = Elem[concat, 2*e, esize];
        element2 = Elem[concat, (2*e)+1, esize];
    else
        element1 = Elem[operand1, e, esize];
        element2 = Elem[operand2, e, esize];

    if minimum then
        Elem[result, e, esize] = FPMIn(element1, element2, FPCR);
    else
```

```
Elem[result, e, esize] = FMax(element1, element2, FPCR);  
V[d] = result;
```

C6.3.89 FMAX (scalar)

Floating-point maximum (scalar): $Vd = \max(Vn, Vm)$

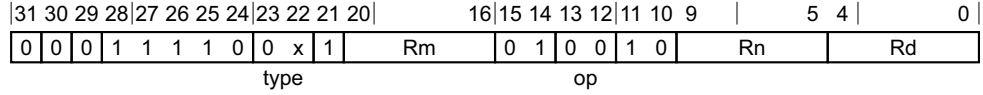

Single-precision variant (type = 00)

FMAX <Sd>, <Sn>, <Sm>

Double-precision variant (type = 01)

FMAX <Dd>, <Dn>, <Dm>

```
integer d = UInt(Rd);
integer n = UInt(Rn);
integer m = UInt(Rm);
```

```
integer datasize;
case type of
    when '00' datasize = 32;
    when '01' datasize = 64;
    when '1x' UnallocatedEncoding();
```

```
FPMaXMinOp operation;
case op of
    when '00' operation = FPMaXMinOp_MAX;
    when '01' operation = FPMaXMinOp_MIN;
    when '10' operation = FPMaXMinOp_MAXNUM;
    when '11' operation = FPMaXMinOp_MINNUM;
```

Assembler Symbols

- <Dd> Is the 64-bit name of the SIMD&FP destination register, encoded in the "Rd" field.
- <Dn> Is the 64-bit name of the first SIMD&FP source register, encoded in the "Rn" field.
- <Dm> Is the 64-bit name of the second SIMD&FP source register, encoded in the "Rm" field.
- <Sd> Is the 32-bit name of the SIMD&FP destination register, encoded in the "Rd" field.
- <Sn> Is the 32-bit name of the first SIMD&FP source register, encoded in the "Rn" field.
- <Sm> Is the 32-bit name of the second SIMD&FP source register, encoded in the "Rm" field.

Operation

```
CheckFPAdvSIMDEnabled64();
bits(datasize) result;
bits(datasize) operand1 = V[n];
bits(datasize) operand2 = V[m];

case operation of
    when FPMaXMinOp_MAX result = FPMaX(operand1, operand2, FPCR);
    when FPMaXMinOp_MIN result = FPMiN(operand1, operand2, FPCR);
    when FPMaXMinOp_MAXNUM result = FPMaXNum(operand1, operand2, FPCR);
    when FPMaXMinOp_MINNUM result = FPMiNNum(operand1, operand2, FPCR);

V[d] = result;
```

C6.3.90 FMAXNM (vector)

Floating-point maximum number (vector)

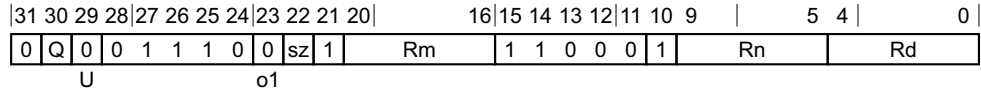

Three registers of the same type variant

FMAXNM <Vd>.<T>, <Vn>.<T>, <Vm>.<T>

```
integer d = UInt(Rd);
integer n = UInt(Rn);
integer m = UInt(Rm);
if sz:Q == '10' then ReservedValue();
integer esize = 32 << UInt(sz);
integer datasize = if Q == '1' then 128 else 64;
integer elements = datasize DIV esize;
```

```
boolean pair = (U == '1');
boolean minimum = (o1 == '1');
```

Assembler Symbols

- <Vd> Is the name of the SIMD&FP destination register, encoded in the "Rd" field.
- <T> Is an arrangement specifier,
2S when sz = 0, Q = 0
4S when sz = 0, Q = 1
RESERVED when sz = 1, Q = 0
2D when sz = 1, Q = 1
- <Vn> Is the name of the first SIMD&FP source register, encoded in the "Rn" field.
- <Vm> Is the name of the second SIMD&FP source register, encoded in the "Rm" field.

Operation

```
CheckFPAdvSIMDEnabled64();
bits(datasize) operand1 = V[n];
bits(datasize) operand2 = V[m];
bits(datasize) result;
bits(2*datasize) concat = operand2:operand1;
bits(esize) element1;
bits(esize) element2;

for e = 0 to elements-1
    if pair then
        element1 = Elem[concat, 2*e, esize];
        element2 = Elem[concat, (2*e)+1, esize];
    else
        element1 = Elem[operand1, e, esize];
        element2 = Elem[operand2, e, esize];

    if minimum then
        Elem[result, e, esize] = FMinNum(element1, element2, FPCR);
    else
```

```
Elem[result, e, esize] = FMaxNum(element1, element2, FPCR);  
V[d] = result;
```

C6.3.91 FMAXNM (scalar)

Floating-point maximum number (scalar): $Vd = \maxNum(Vn, Vm)$

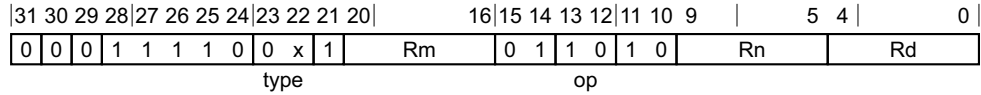

Single-precision variant (type = 00)

FMAXNM <Sd>, <Sn>, <Sm>

Double-precision variant (type = 01)

FMAXNM <Dd>, <Dn>, <Dm>

```
integer d = UInt(Rd);
integer n = UInt(Rn);
integer m = UInt(Rm);
```

```
integer datasize;
case type of
    when '00' datasize = 32;
    when '01' datasize = 64;
    when '1x' UnallocatedEncoding();
```

```
FPMaXmInOp operation;
case op of
    when '00' operation = FPMaXmInOp_MAX;
    when '01' operation = FPMaXmInOp_MIN;
    when '10' operation = FPMaXmInOp_MAXNUM;
    when '11' operation = FPMaXmInOp_MINNUM;
```

Assembler Symbols

- <Dd> Is the 64-bit name of the SIMD&FP destination register, encoded in the "Rd" field.
- <Dn> Is the 64-bit name of the first SIMD&FP source register, encoded in the "Rn" field.
- <Dm> Is the 64-bit name of the second SIMD&FP source register, encoded in the "Rm" field.
- <Sd> Is the 32-bit name of the SIMD&FP destination register, encoded in the "Rd" field.
- <Sn> Is the 32-bit name of the first SIMD&FP source register, encoded in the "Rn" field.
- <Sm> Is the 32-bit name of the second SIMD&FP source register, encoded in the "Rm" field.

Operation

```
CheckFPAdvSIMDEnabled64();
bits(datasize) result;
bits(datasize) operand1 = V[n];
bits(datasize) operand2 = V[m];

case operation of
    when FPMaXmInOp_MAX result = FPMaX(operand1, operand2, FPCR);
    when FPMaXmInOp_MIN result = FPMIn(operand1, operand2, FPCR);
    when FPMaXmInOp_MAXNUM result = FPMaXNum(operand1, operand2, FPCR);
    when FPMaXmInOp_MINNUM result = FPMInNum(operand1, operand2, FPCR);

V[d] = result;
```

C6.3.92 FMAXNMP (scalar)

Floating-point maximum number of pair of elements (scalar)

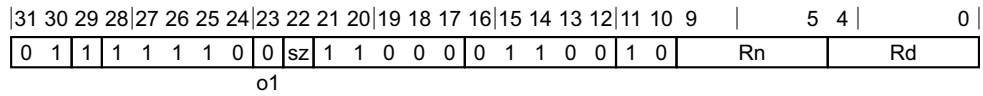

Advanced SIMD variant

FMAXNMP <V><d>, <Vn>.<T>

integer d = UInt(Rd);
 integer n = UInt(Rn);

integer esize = 32 << UInt(sz);
 integer datasize = esize * 2;
 integer elements = 2;

ReduceOp op = if o1 == '1' then ReduceOp_FMIMUM else ReduceOp_FMAXNUM;

Assembler Symbols

- <V> Is the destination width specifier,
 - S** when sz = 0
 - D** when sz = 1
- <d> Is the number of the SIMD&FP destination register, encoded in the "Rd" field.
- <Vn> Is the name of the SIMD&FP source register, encoded in the "Rn" field.
- <T> Is the source arrangement specifier,
 - 2S** when sz = 0
 - 2D** when sz = 1

Operation

```
CheckFPAdvSIMDEnabled64();
bits(datasize) operand = V[n];
V[d] = Reduce(op, operand, esize);
```

C6.3.93 FMAXNMP (vector)

Floating-point maximum number pairwise (vector)

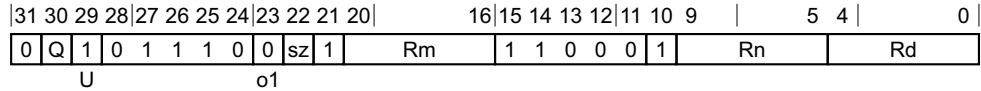

Three registers of the same type variant

FMAXNMP <Vd>.<T>, <Vn>.<T>, <Vm>.<T>

```
integer d = UInt(Rd);
integer n = UInt(Rn);
integer m = UInt(Rm);
if sz:Q == '10' then ReservedValue();
integer esize = 32 << UInt(sz);
integer datasize = if Q == '1' then 128 else 64;
integer elements = datasize DIV esize;
```

```
boolean pair = (U == '1');
boolean minimum = (o1 == '1');
```

Assembler Symbols

- <Vd> Is the name of the SIMD&FP destination register, encoded in the "Rd" field.
- <T> Is an arrangement specifier,
 - 2S** when sz = 0, Q = 0
 - 4S** when sz = 0, Q = 1
 - RESERVED** when sz = 1, Q = 0
 - 2D** when sz = 1, Q = 1
- <Vn> Is the name of the first SIMD&FP source register, encoded in the "Rn" field.
- <Vm> Is the name of the second SIMD&FP source register, encoded in the "Rm" field.

Operation

```
CheckFPAdvSIMDEnabled64();
bits(datasize) operand1 = V[n];
bits(datasize) operand2 = V[m];
bits(datasize) result;
bits(2*datasize) concat = operand2:operand1;
bits(esize) element1;
bits(esize) element2;

for e = 0 to elements-1
    if pair then
        element1 = Elem[concat, 2*e, esize];
        element2 = Elem[concat, (2*e)+1, esize];
    else
        element1 = Elem[operand1, e, esize];
        element2 = Elem[operand2, e, esize];

    if minimum then
        Elem[result, e, esize] = FPMinNum(element1, element2, FPCR);
    else
```

```
Elem[result, e, esize] = FMaxNum(element1, element2, FPCR);  
V[d] = result;
```

C6.3.94 FMAXNMV

Floating-point maximum number across vector

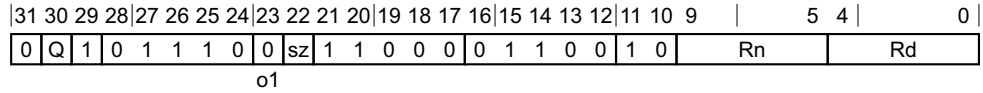

Advanced SIMD variant

FMAXNMV <V><d>, <Vn>.<T>

```
integer d = UInt(Rd);
integer n = UInt(Rn);
```

```
if sz:Q != '01' then ReservedValue(); // .4S only
```

```
integer esize = 32 << UInt(sz);
integer datasize = if Q == '1' then 128 else 64;
integer elements = datasize DIV esize;
```

```
ReduceOp op = if o1 == '1' then ReduceOp_FMIMUM else ReduceOp_FMAXNUM;
```

Assembler Symbols

- <V> Is the destination width specifier,
S when sz = 0
RESERVED when sz = 1
- <d> Is the number of the SIMD&FP destination register, encoded in the "Rd" field.
- <Vn> Is the name of the SIMD&FP source register, encoded in the "Rn" field.
- <T> Is an arrangement specifier,
RESERVED when Q = 0, sz = x
4S when Q = 1, sz = 0
RESERVED when Q = 1, sz = 1

Operation

```
CheckFPAdvSIMDEnabled64();
bits(datasize) operand = V[n];
V[d] = Reduce(op, operand, esize);
```

C6.3.95 FMAXP (scalar)

Floating-point maximum of pair of elements (scalar)

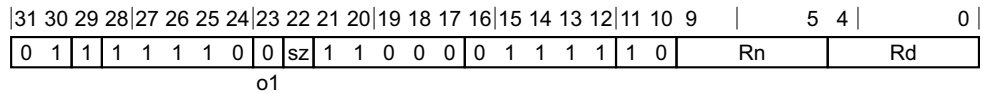

Advanced SIMD variant

FMAXP <V><d>, <Vn>.<T>

integer d = UInt(Rd);
 integer n = UInt(Rn);

integer esize = 32 << UInt(sz);
 integer datasize = esize * 2;
 integer elements = 2;

ReduceOp op = if o1 == '1' then ReduceOp_FMIN else ReduceOp_FMAX;

Assembler Symbols

- <V> Is the destination width specifier,
 S when sz = 0
 D when sz = 1
- <d> Is the number of the SIMD&FP destination register, encoded in the "Rd" field.
- <Vn> Is the name of the SIMD&FP source register, encoded in the "Rn" field.
- <T> Is the source arrangement specifier,
 2S when sz = 0
 2D when sz = 1

Operation

```
CheckFPAdvSIMDEnabled64();
bits(datasize) operand = V[n];
V[d] = Reduce(op, operand, esize);
```

C6.3.96 FMAXP (vector)

Floating-point maximum pairwise (vector)

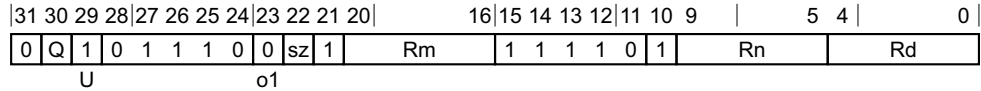

Three registers of the same type variant

FMAXP <Vd>.<T>, <Vn>.<T>, <Vm>.<T>

```
integer d = UInt(Rd);
integer n = UInt(Rn);
integer m = UInt(Rm);
if sz:Q == '10' then ReservedValue();
integer esize = 32 << UInt(sz);
integer datasize = if Q == '1' then 128 else 64;
integer elements = datasize DIV esize;
```

```
boolean pair = (U == '1');
boolean minimum = (o1 == '1');
```

Assembler Symbols

- <Vd> Is the name of the SIMD&FP destination register, encoded in the "Rd" field.
- <T> Is an arrangement specifier,
 - 2S** when sz = 0, Q = 0
 - 4S** when sz = 0, Q = 1
 - RESERVED** when sz = 1, Q = 0
 - 2D** when sz = 1, Q = 1
- <Vn> Is the name of the first SIMD&FP source register, encoded in the "Rn" field.
- <Vm> Is the name of the second SIMD&FP source register, encoded in the "Rm" field.

Operation

```
CheckFPAdvSIMDEnabled64();
bits(datasize) operand1 = V[n];
bits(datasize) operand2 = V[m];
bits(datasize) result;
bits(2*datasize) concat = operand2:operand1;
bits(esize) element1;
bits(esize) element2;

for e = 0 to elements-1
    if pair then
        element1 = Elem[concat, 2*e, esize];
        element2 = Elem[concat, (2*e)+1, esize];
    else
        element1 = Elem[operand1, e, esize];
        element2 = Elem[operand2, e, esize];

    if minimum then
        Elem[result, e, esize] = FPMIn(element1, element2, FPCR);
    else
```

```
Elem[result, e, esize] = FMax(element1, element2, FPCR);  
V[d] = result;
```

C6.3.97 FMAXV

Floating-point maximum across vector

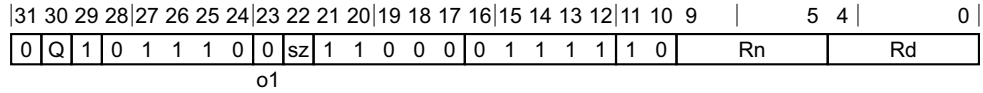

Advanced SIMD variant

FMAXV <V><d>, <Vn>.<T>

```
integer d = UInt(Rd);
integer n = UInt(Rn);
```

```
if sz:Q != '01' then ReservedValue();
```

```
integer esize = 32 << UInt(sz);
integer datasize = if Q == '1' then 128 else 64;
integer elements = datasize DIV esize;
```

```
ReduceOp op = if o1 == '1' then ReduceOp_FMIN else ReduceOp_FMAX;
```

Assembler Symbols

- <V> Is the destination width specifier,
S when sz = 0
RESERVED when sz = 1
- <d> Is the number of the SIMD&FP destination register, encoded in the "Rd" field.
- <Vn> Is the name of the SIMD&FP source register, encoded in the "Rn" field.
- <T> Is an arrangement specifier,
RESERVED when Q = 0, sz = x
4S when Q = 1, sz = 0
RESERVED when Q = 1, sz = 1

Operation

```
CheckFPAdvSIMDEnabled64();
bits(datasize) operand = V[n];
V[d] = Reduce(op, operand, esize);
```

C6.3.98 FMIN (vector)

Floating-point minimum (vector)

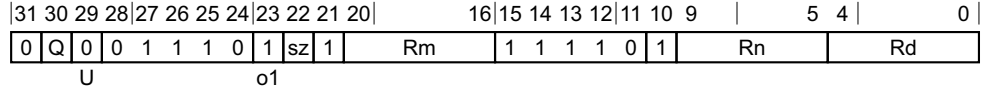

Three registers of the same type variant

FMIN <Vd>.<T>, <Vn>.<T>, <Vm>.<T>

```
integer d = UInt(Rd);
integer n = UInt(Rn);
integer m = UInt(Rm);
if sz:Q == '10' then ReservedValue();
integer esize = 32 << UInt(sz);
integer datasize = if Q == '1' then 128 else 64;
integer elements = datasize DIV esize;
```

```
boolean pair = (U == '1');
boolean minimum = (o1 == '1');
```

Assembler Symbols

- <Vd> Is the name of the SIMD&FP destination register, encoded in the "Rd" field.
- <T> Is an arrangement specifier,
 - 2S** when sz = 0, Q = 0
 - 4S** when sz = 0, Q = 1
 - RESERVED** when sz = 1, Q = 0
 - 2D** when sz = 1, Q = 1
- <Vn> Is the name of the first SIMD&FP source register, encoded in the "Rn" field.
- <Vm> Is the name of the second SIMD&FP source register, encoded in the "Rm" field.

Operation

```
CheckFPAdvSIMDEnabled64();
bits(datasize) operand1 = V[n];
bits(datasize) operand2 = V[m];
bits(datasize) result;
bits(2*datasize) concat = operand2:operand1;
bits(esize) element1;
bits(esize) element2;

for e = 0 to elements-1
    if pair then
        element1 = Elem[concat, 2*e, esize];
        element2 = Elem[concat, (2*e)+1, esize];
    else
        element1 = Elem[operand1, e, esize];
        element2 = Elem[operand2, e, esize];

    if minimum then
        Elem[result, e, esize] = FPMIn(element1, element2, FPCR);
    else
```

```
Elem[result, e, esize] = FMax(element1, element2, FPCR);  
V[d] = result;
```

C6.3.99 FMIN (scalar)

Floating-point minimum (scalar): $Vd = \min(Vn, Vm)$

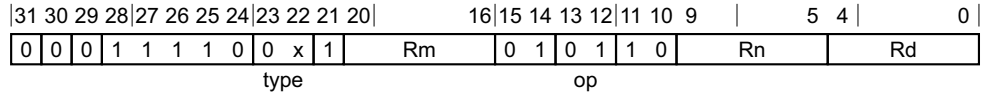

Single-precision variant (type = 00)

FMIN <Sd>, <Sn>, <Sm>

Double-precision variant (type = 01)

FMIN <Dd>, <Dn>, <Dm>

```
integer d = UInt(Rd);
integer n = UInt(Rn);
integer m = UInt(Rm);
```

```
integer datasize;
case type of
    when '00' datasize = 32;
    when '01' datasize = 64;
    when '1x' UnallocatedEncoding();
```

```
FPMaXMinOp operation;
case op of
    when '00' operation = FPMaXMinOp_MAX;
    when '01' operation = FPMaXMinOp_MIN;
    when '10' operation = FPMaXMinOp_MAXNUM;
    when '11' operation = FPMaXMinOp_MINNUM;
```

Assembler Symbols

- <Dd> Is the 64-bit name of the SIMD&FP destination register, encoded in the "Rd" field.
- <Dn> Is the 64-bit name of the first SIMD&FP source register, encoded in the "Rn" field.
- <Dm> Is the 64-bit name of the second SIMD&FP source register, encoded in the "Rm" field.
- <Sd> Is the 32-bit name of the SIMD&FP destination register, encoded in the "Rd" field.
- <Sn> Is the 32-bit name of the first SIMD&FP source register, encoded in the "Rn" field.
- <Sm> Is the 32-bit name of the second SIMD&FP source register, encoded in the "Rm" field.

Operation

```
CheckFPAdvSIMDEnabled64();
bits(datasize) result;
bits(datasize) operand1 = V[n];
bits(datasize) operand2 = V[m];

case operation of
    when FPMaXMinOp_MAX result = FPMaX(operand1, operand2, FPCR);
    when FPMaXMinOp_MIN result = FPMiN(operand1, operand2, FPCR);
    when FPMaXMinOp_MAXNUM result = FPMaXNum(operand1, operand2, FPCR);
    when FPMaXMinOp_MINNUM result = FPMiNNum(operand1, operand2, FPCR);

V[d] = result;
```

C6.3.100 FMINNM (vector)

Floating-point minimum number (vector)

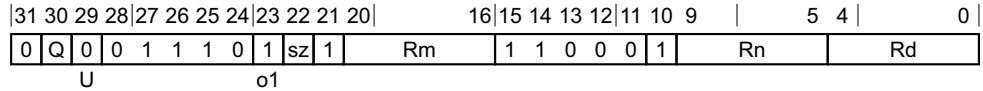

Three registers of the same type variant

FMINNM <Vd>.<T>, <Vn>.<T>, <Vm>.<T>

```
integer d = UInt(Rd);
integer n = UInt(Rn);
integer m = UInt(Rm);
if sz:Q == '10' then ReservedValue();
integer esize = 32 << UInt(sz);
integer datasize = if Q == '1' then 128 else 64;
integer elements = datasize DIV esize;
```

```
boolean pair = (U == '1');
boolean minimum = (o1 == '1');
```

Assembler Symbols

- <Vd> Is the name of the SIMD&FP destination register, encoded in the "Rd" field.
- <T> Is an arrangement specifier,
 - 2S** when sz = 0, Q = 0
 - 4S** when sz = 0, Q = 1
 - RESERVED** when sz = 1, Q = 0
 - 2D** when sz = 1, Q = 1
- <Vn> Is the name of the first SIMD&FP source register, encoded in the "Rn" field.
- <Vm> Is the name of the second SIMD&FP source register, encoded in the "Rm" field.

Operation

```
CheckFPAdvSIMDEnabled64();
bits(datasize) operand1 = V[n];
bits(datasize) operand2 = V[m];
bits(datasize) result;
bits(2*datasize) concat = operand2:operand1;
bits(esize) element1;
bits(esize) element2;

for e = 0 to elements-1
    if pair then
        element1 = Elem[concat, 2*e, esize];
        element2 = Elem[concat, (2*e)+1, esize];
    else
        element1 = Elem[operand1, e, esize];
        element2 = Elem[operand2, e, esize];

    if minimum then
        Elem[result, e, esize] = FMinNum(element1, element2, FPCR);
    else
```

```
Elem[result, e, esize] = FMaxNum(element1, element2, FPCR);  
V[d] = result;
```

C6.3.101 FMINNM (scalar)

Floating-point minimum number (scalar): $Vd = \text{minNum}(Vn, Vm)$

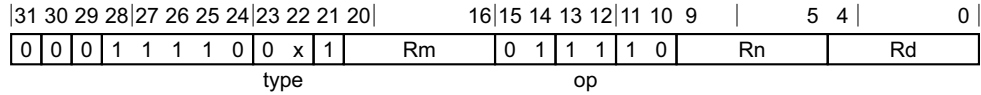

Single-precision variant (type = 00)

FMINNM <Sd>, <Sn>, <Sm>

Double-precision variant (type = 01)

FMINNM <Dd>, <Dn>, <Dm>

```
integer d = UInt(Rd);
integer n = UInt(Rn);
integer m = UInt(Rm);
```

```
integer datasize;
case type of
    when '00' datasize = 32;
    when '01' datasize = 64;
    when '1x' UnallocatedEncoding();
```

```
FPMaXMinOp operation;
case op of
    when '00' operation = FPMaXMinOp_MAX;
    when '01' operation = FPMaXMinOp_MIN;
    when '10' operation = FPMaXMinOp_MAXNUM;
    when '11' operation = FPMaXMinOp_MINNUM;
```

Assembler Symbols

- <Dd> Is the 64-bit name of the SIMD&FP destination register, encoded in the "Rd" field.
- <Dn> Is the 64-bit name of the first SIMD&FP source register, encoded in the "Rn" field.
- <Dm> Is the 64-bit name of the second SIMD&FP source register, encoded in the "Rm" field.
- <Sd> Is the 32-bit name of the SIMD&FP destination register, encoded in the "Rd" field.
- <Sn> Is the 32-bit name of the first SIMD&FP source register, encoded in the "Rn" field.
- <Sm> Is the 32-bit name of the second SIMD&FP source register, encoded in the "Rm" field.

Operation

```
CheckFPAdvSIMDEnabled64();
bits(datasize) result;
bits(datasize) operand1 = V[n];
bits(datasize) operand2 = V[m];

case operation of
    when FPMaXMinOp_MAX result = FPMaX(operand1, operand2, FPCR);
    when FPMaXMinOp_MIN result = FPMiN(operand1, operand2, FPCR);
    when FPMaXMinOp_MAXNUM result = FPMaXNum(operand1, operand2, FPCR);
    when FPMaXMinOp_MINNUM result = FPMiNNum(operand1, operand2, FPCR);

V[d] = result;
```

C6.3.102 FMINNMP (scalar)

Floating-point minimum number of pair of elements (scalar)

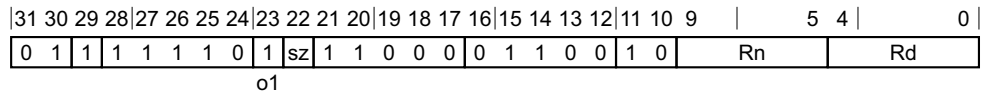

Advanced SIMD variant

FMINNMP <V><d>, <Vn>.<T>

```
integer d = UInt(Rd);
integer n = UInt(Rn);
```

```
integer esize = 32 << UInt(sz);
integer datasize = esize * 2;
integer elements = 2;
```

ReduceOp op = if o1 == '1' then ReduceOp_FMIMUM else ReduceOp_FMAXNUM;

Assembler Symbols

- <V> Is the destination width specifier,
 - S** when sz = 0
 - D** when sz = 1
- <d> Is the number of the SIMD&FP destination register, encoded in the "Rd" field.
- <Vn> Is the name of the SIMD&FP source register, encoded in the "Rn" field.
- <T> Is the source arrangement specifier,
 - 2S** when sz = 0
 - 2D** when sz = 1

Operation

```
CheckFPAdvSIMDEnabled64();
bits(datasize) operand = V[n];
V[d] = Reduce(op, operand, esize);
```

C6.3.103 FMINNMP (vector)

Floating-point minimum number pairwise (vector)

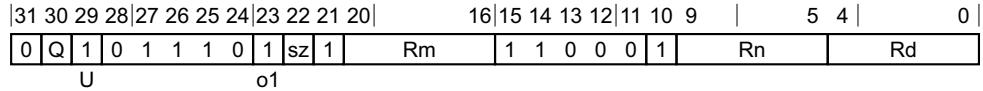

Three registers of the same type variant

FMINNMP <Vd>.<T>, <Vn>.<T>, <Vm>.<T>

```
integer d = UInt(Rd);
integer n = UInt(Rn);
integer m = UInt(Rm);
if sz:Q == '10' then ReservedValue();
integer esize = 32 << UInt(sz);
integer datasize = if Q == '1' then 128 else 64;
integer elements = datasize DIV esize;
```

```
boolean pair = (U == '1');
boolean minimum = (o1 == '1');
```

Assembler Symbols

- <Vd> Is the name of the SIMD&FP destination register, encoded in the "Rd" field.
- <T> Is an arrangement specifier,
 - 2S** when sz = 0, Q = 0
 - 4S** when sz = 0, Q = 1
 - RESERVED** when sz = 1, Q = 0
 - 2D** when sz = 1, Q = 1
- <Vn> Is the name of the first SIMD&FP source register, encoded in the "Rn" field.
- <Vm> Is the name of the second SIMD&FP source register, encoded in the "Rm" field.

Operation

```
CheckFPAdvSIMDEnabled64();
bits(datasize) operand1 = V[n];
bits(datasize) operand2 = V[m];
bits(datasize) result;
bits(2*datasize) concat = operand2:operand1;
bits(esize) element1;
bits(esize) element2;

for e = 0 to elements-1
    if pair then
        element1 = Elem[concat, 2*e, esize];
        element2 = Elem[concat, (2*e)+1, esize];
    else
        element1 = Elem[operand1, e, esize];
        element2 = Elem[operand2, e, esize];

    if minimum then
        Elem[result, e, esize] = FMinNum(element1, element2, FPCR);
    else
```

```
Elem[result, e, esize] = FMaxNum(element1, element2, FPCR);  
V[d] = result;
```

C6.3.104 FMINNMV

Floating-point minimum number across vector

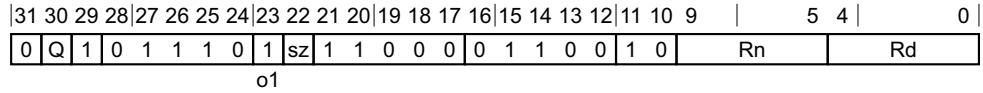

Advanced SIMD variant

FMINNMV <V><d>, <Vn>.<T>

```
integer d = UInt(Rd);
integer n = UInt(Rn);
```

```
if sz:Q != '01' then ReservedValue(); // .4S only
```

```
integer esize = 32 << UInt(sz);
integer datasize = if Q == '1' then 128 else 64;
integer elements = datasize DIV esize;
```

```
ReduceOp op = if o1 == '1' then ReduceOp_FMINNUM else ReduceOp_FMAXNUM;
```

Assembler Symbols

- <V> Is the destination width specifier,
S when sz = 0
RESERVED when sz = 1
- <d> Is the number of the SIMD&FP destination register, encoded in the "Rd" field.
- <Vn> Is the name of the SIMD&FP source register, encoded in the "Rn" field.
- <T> Is an arrangement specifier,
RESERVED when Q = 0, sz = x
4S when Q = 1, sz = 0
RESERVED when Q = 1, sz = 1

Operation

```
CheckFPAdvSIMDEnabled64();
bits(datasize) operand = V[n];
V[d] = Reduce(op, operand, esize);
```

C6.3.105 FMINP (scalar)

Floating-point minimum of pair of elements (scalar)

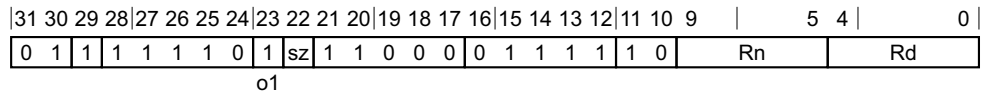

Advanced SIMD variant

FMINP <V><d>, <Vn>.<T>

```
integer d = UInt(Rd);
integer n = UInt(Rn);
```

```
integer esize = 32 << UInt(sz);
integer datasize = esize * 2;
integer elements = 2;
```

ReduceOp op = if o1 == '1' then ReduceOp_FMIN else ReduceOp_FMAX;

Assembler Symbols

- <V> Is the destination width specifier,
 - S** when sz = 0
 - D** when sz = 1
- <d> Is the number of the SIMD&FP destination register, encoded in the "Rd" field.
- <Vn> Is the name of the SIMD&FP source register, encoded in the "Rn" field.
- <T> Is the source arrangement specifier,
 - 2S** when sz = 0
 - 2D** when sz = 1

Operation

```
CheckFPAdvSIMDEnabled64();
bits(datasize) operand = V[n];
V[d] = Reduce(op, operand, esize);
```

C6.3.106 FMINP (vector)

Floating-point minimum pairwise (vector)

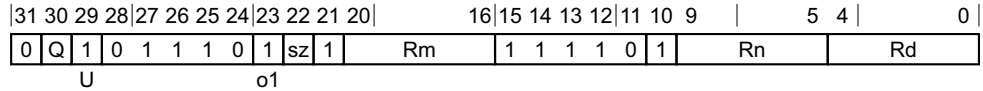

Three registers of the same type variant

FMINP <Vd>.<T>, <Vn>.<T>, <Vm>.<T>

```
integer d = UInt(Rd);
integer n = UInt(Rn);
integer m = UInt(Rm);
if sz:Q == '10' then ReservedValue();
integer esize = 32 << UInt(sz);
integer datasize = if Q == '1' then 128 else 64;
integer elements = datasize DIV esize;
```

```
boolean pair = (U == '1');
boolean minimum = (o1 == '1');
```

Assembler Symbols

- <Vd> Is the name of the SIMD&FP destination register, encoded in the "Rd" field.
- <T> Is an arrangement specifier,
2S when sz = 0, Q = 0
4S when sz = 0, Q = 1
RESERVED when sz = 1, Q = 0
2D when sz = 1, Q = 1
- <Vn> Is the name of the first SIMD&FP source register, encoded in the "Rn" field.
- <Vm> Is the name of the second SIMD&FP source register, encoded in the "Rm" field.

Operation

```
CheckFPAdvSIMDEnabled64();
bits(datasize) operand1 = V[n];
bits(datasize) operand2 = V[m];
bits(datasize) result;
bits(2*datasize) concat = operand2:operand1;
bits(esize) element1;
bits(esize) element2;

for e = 0 to elements-1
    if pair then
        element1 = Elem[concat, 2*e, esize];
        element2 = Elem[concat, (2*e)+1, esize];
    else
        element1 = Elem[operand1, e, esize];
        element2 = Elem[operand2, e, esize];

    if minimum then
        Elem[result, e, esize] = FPMIn(element1, element2, FPCR);
    else
```

```
Elem[result, e, esize] = FMax(element1, element2, FPCR);  
V[d] = result;
```

C6.3.107 FMINV

Floating-point minimum across vector

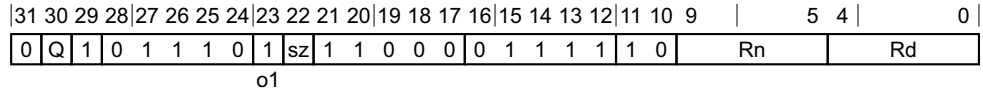

Advanced SIMD variant

FMINV <V><d>, <Vn>.<T>

```
integer d = UInt(Rd);
integer n = UInt(Rn);
```

```
if sz:Q != '01' then ReservedValue();
```

```
integer esize = 32 << UInt(sz);
integer datasize = if Q == '1' then 128 else 64;
integer elements = datasize DIV esize;
```

```
ReduceOp op = if o1 == '1' then ReduceOp_FMIN else ReduceOp_FMAX;
```

Assembler Symbols

- <V> Is the destination width specifier,
S when sz = 0
RESERVED when sz = 1
- <d> Is the number of the SIMD&FP destination register, encoded in the "Rd" field.
- <Vn> Is the name of the SIMD&FP source register, encoded in the "Rn" field.
- <T> Is an arrangement specifier,
RESERVED when Q = 0, sz = x
4S when Q = 1, sz = 0
RESERVED when Q = 1, sz = 1

Operation

```
CheckFPAdvSIMDEnabled64();
bits(datasize) operand = V[n];
V[d] = Reduce(op, operand, esize);
```

C6.3.108 FMLA (by element)

Floating-point fused multiply-add to accumulator (by element)

It has encodings from 2 classes: *Scalar* and *Vector*

Scalar

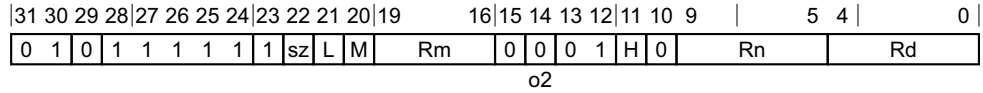

Scalar variant

FMLA <V><d>, <V><n>, <Vm>.<Ts>[<index>]

```

integer idxsize = if H == '1' then 128 else 64;
integer index;
bit Rmhi = M;
case sz:L of
    when '0x' index = UInt(H:L);
    when '10' index = UInt(H);
    when '11' UnallocatedEncoding();

integer d = UInt(Rd);
integer n = UInt(Rn);
integer m = UInt(Rmhi:Rm);

integer esize = 32 << UInt(sz);
integer datasize = esize;
integer elements = 1;
boolean sub_op = (o2 == '1');
```

Vector

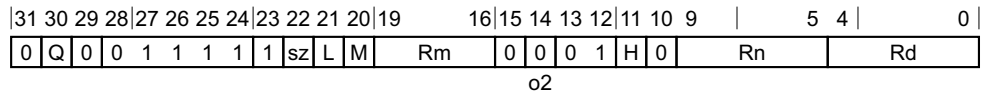

Vector variant

FMLA <Vd>.<T>, <Vn>.<T>, <Vm>.<Ts>[<index>]

```

integer idxsize = if H == '1' then 128 else 64;
integer index;
bit Rmhi = M;
case sz:L of
    when '0x' index = UInt(H:L);
    when '10' index = UInt(H);
    when '11' UnallocatedEncoding();

integer d = UInt(Rd);
integer n = UInt(Rn);
integer m = UInt(Rmhi:Rm);

if sz:Q == '10' then ReservedValue();
integer esize = 32 << UInt(sz);
integer datasize = if Q == '1' then 128 else 64;
integer elements = datasize DIV esize;
boolean sub_op = (o2 == '1');
```

Assembler Symbols

<V>	Is a width specifier, S when $sz = 0$ D when $sz = 1$
<d>	Is the number of the SIMD&FP destination register, encoded in the "Rd" field.
<n>	Is the number of the first SIMD&FP source register, encoded in the "Rn" field.
<Vd>	Is the name of the SIMD&FP destination register, encoded in the "Rd" field.
<T>	Is an arrangement specifier, 2S when $Q = 0, sz = 0$ RESERVED when $Q = 0, sz = 1$ 4S when $Q = 1, sz = 0$ 2D when $Q = 1, sz = 1$
<Vn>	Is the name of the first SIMD&FP source register, encoded in the "Rn" field.
<Vm>	For the scalar variant: is the name of the SIMD&FP source register, encoded in the M:Rm fields.
<Vm>	For the vector variant: is the name of the second SIMD&FP source register, encoded in the M:Rm fields.
<Ts>	For the scalar variant: is the element width specifier, S when $sz = 0$ D when $sz = 1$
<Ts>	For the vector variant: is an element size specifier, S when $sz = 0$ D when $sz = 1$
<index>	For the scalar variant: is the element index, H:L when $sz = 0, L = x$ H when $sz = 1, L = 0$ RESERVED when $sz = 1, L = 1$
<index>	For the vector variant: is the element index H:L when $sz = 0, L = x$ H when $sz = 1, L = 0$ RESERVED when $sz = 1, L = 1$

Operation for all classes

```

CheckFPAdvSIMDEnabled64();
bits(datasize) operand1 = V[n];
bits(idxsize) operand2 = V[m];
bits(datasize) operand3 = V[d];
bits(datasize) result;
bits(esize) element1;
bits(esize) element2 = Elem[operand2, index, esize];

for e = 0 to elements-1
    element1 = Elem[operand1, e, esize];
    if sub_op then element1 = FPNeg(element1);
    Elem[result, e, esize] = FPMu1Add(Elem[operand3, e, esize], element1, element2, FPCR);
V[d] = result;

```

C6.3.109 FMLA (vector)

Floating-point fused multiply-add to accumulator (vector)

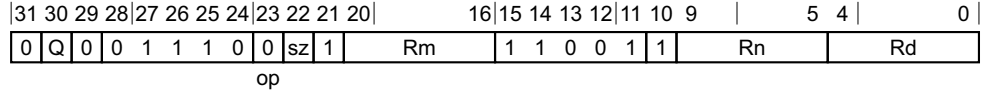

Three registers of the same type variant

FMLA <Vd>.<T>, <Vn>.<T>, <Vm>.<T>

```
integer d = UInt(Rd);
integer n = UInt(Rn);
integer m = UInt(Rm);
if sz:Q == '10' then ReservedValue();
integer esize = 32 << UInt(sz);
integer datasize = if Q == '1' then 128 else 64;
integer elements = datasize DIV esize;

boolean sub_op = (op == '1');
```

Assembler Symbols

- <Vd> Is the name of the SIMD&FP destination register, encoded in the "Rd" field.
- <T> Is an arrangement specifier,
 - 2S** when sz = 0, Q = 0
 - 4S** when sz = 0, Q = 1
 - RESERVED** when sz = 1, Q = 0
 - 2D** when sz = 1, Q = 1
- <Vn> Is the name of the first SIMD&FP source register, encoded in the "Rn" field.
- <Vm> Is the name of the second SIMD&FP source register, encoded in the "Rm" field.

Operation

```
CheckFPAdvSIMDEnabled64();
bits(datasize) operand1 = V[n];
bits(datasize) operand2 = V[m];
bits(datasize) operand3 = V[d];
bits(datasize) result;
bits(esize) element1;
bits(esize) element2;

for e = 0 to elements-1
    element1 = Elem[operand1, e, esize];
    element2 = Elem[operand2, e, esize];
    if sub_op then element1 = FPNeg(element1);
    Elem[result, e, esize] = FPMu1Add(Elem[operand3, e, esize], element1, element2, FPCR);

V[d] = result;
```

C6.3.110 FMLS (by element)

Floating-point fused multiply-subtract from accumulator (by element)

It has encodings from 2 classes: *Scalar* and *Vector*

Scalar

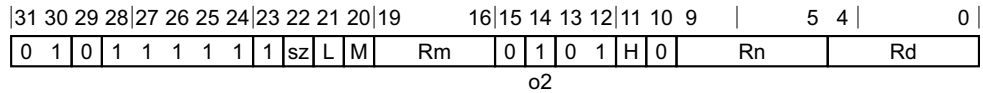

Scalar variant

FMLS <V><d>, <V><n>, <Vm>.<Ts>[<index>]

```

integer idxsize = if H == '1' then 128 else 64;
integer index;
bit Rmhi = M;
case sz:L of
    when '0x' index = UInt(H:L);
    when '10' index = UInt(H);
    when '11' UnallocatedEncoding();

integer d = UInt(Rd);
integer n = UInt(Rn);
integer m = UInt(Rmhi:Rm);

integer esize = 32 << UInt(sz);
integer datasize = esize;
integer elements = 1;
boolean sub_op = (o2 == '1');
```

Vector

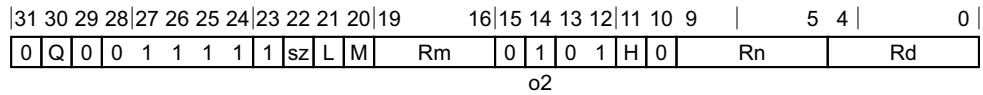

Vector variant

FMLS <Vd>.<T>, <Vn>.<T>, <Vm>.<Ts>[<index>]

```

integer idxsize = if H == '1' then 128 else 64;
integer index;
bit Rmhi = M;
case sz:L of
    when '0x' index = UInt(H:L);
    when '10' index = UInt(H);
    when '11' UnallocatedEncoding();

integer d = UInt(Rd);
integer n = UInt(Rn);
integer m = UInt(Rmhi:Rm);

if sz:Q == '10' then ReservedValue();
integer esize = 32 << UInt(sz);
integer datasize = if Q == '1' then 128 else 64;
integer elements = datasize DIV esize;
boolean sub_op = (o2 == '1');
```

Assembler Symbols

<V>	Is a width specifier, S when $sz = 0$ D when $sz = 1$
<d>	Is the number of the SIMD&FP destination register, encoded in the "Rd" field.
<n>	Is the number of the first SIMD&FP source register, encoded in the "Rn" field.
<Vd>	Is the name of the SIMD&FP destination register, encoded in the "Rd" field.
<T>	Is an arrangement specifier, 2S when $Q = 0, sz = 0$ RESERVED when $Q = 0, sz = 1$ 4S when $Q = 1, sz = 0$ 2D when $Q = 1, sz = 1$
<Vn>	Is the name of the first SIMD&FP source register, encoded in the "Rn" field.
<Vm>	For the scalar variant: is the name of the SIMD&FP source register, encoded in the "M:Rm" fields.
<Vm>	For the vector variant: is the name of the second SIMD&FP source register, encoded in the "M:Rm" fields.
<Ts>	For the scalar variant: is the element width specifier, S when $sz = 0$ D when $sz = 1$
<Ts>	For the vector variant: is an element size specifier, S when $sz = 0$ D when $sz = 1$
<index>	For the scalar variant: is the element index, H:L when $sz = 0, L = x$ H when $sz = 1, L = 0$ RESERVED when $sz = 1, L = 1$
<index>	For the vector variant: is the element index H:L when $sz = 0, L = x$ H when $sz = 1, L = 0$ RESERVED when $sz = 1, L = 1$

Operation for all classes

```

CheckFPAdvSIMDEnabled64();
bits(datasize) operand1 = V[n];
bits(idxsize) operand2 = V[m];
bits(datasize) operand3 = V[d];
bits(datasize) result;
bits(esize) element1;
bits(esize) element2 = Elem[operand2, index, esize];

for e = 0 to elements-1
  element1 = Elem[operand1, e, esize];
  if sub_op then element1 = FPNeg(element1);
  Elem[result, e, esize] = FPMu1Add(Elem[operand3, e, esize], element1, element2, FPCR);
V[d] = result;

```

C6.3.111 FMLS (vector)

Floating-point fused multiply-subtract from accumulator (vector)

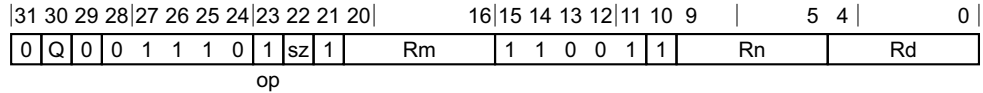

Three registers of the same type variant

FMLS <Vd>.<T>, <Vn>.<T>, <Vm>.<T>

```
integer d = UInt(Rd);
integer n = UInt(Rn);
integer m = UInt(Rm);
if sz:Q == '10' then ReservedValue();
integer esize = 32 << UInt(sz);
integer datasize = if Q == '1' then 128 else 64;
integer elements = datasize DIV esize;

boolean sub_op = (op == '1');
```

Assembler Symbols

- <Vd> Is the name of the SIMD&FP destination register, encoded in the "Rd" field.
- <T> Is an arrangement specifier,
 - 2S** when sz = 0, Q = 0
 - 4S** when sz = 0, Q = 1
 - RESERVED** when sz = 1, Q = 0
 - 2D** when sz = 1, Q = 1
- <Vn> Is the name of the first SIMD&FP source register, encoded in the "Rn" field.
- <Vm> Is the name of the second SIMD&FP source register, encoded in the "Rm" field.

Operation

```
CheckFPAdvSIMDEnabled64();
bits(datasize) operand1 = V[n];
bits(datasize) operand2 = V[m];
bits(datasize) operand3 = V[d];
bits(datasize) result;
bits(esize) element1;
bits(esize) element2;

for e = 0 to elements-1
    element1 = Elem[operand1, e, esize];
    element2 = Elem[operand2, e, esize];
    if sub_op then element1 = FPNeg(element1);
    Elem[result, e, esize] = FPMu1Add(Elem[operand3, e, esize], element1, element2, FPCR);

V[d] = result;
```

C6.3.112 FMOV (vector, immediate)

Floating-point move immediate (vector)

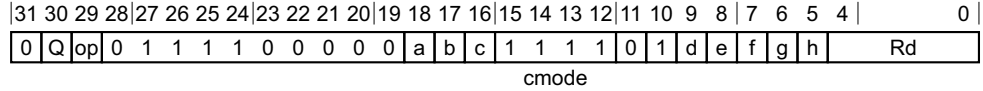

Single-precision variant (op = 0)

FMOV <Vd>.<T>, #<imm>

Double-precision variant (Q = 1, op = 1)

FMOV <Vd>.<2D>, #<imm>

integer rd = UInt(Rd);

integer datasize = if Q == '1' then 128 else 64;
 bits(datasize) imm;
 bits(64) imm64;

ImmediateOp operation;

case cmode:op of

```

when '0xx00' operation = ImmediateOp_MOVI;
when '0xx01' operation = ImmediateOp_MVNI;
when '0xx10' operation = ImmediateOp_ORR;
when '0xx11' operation = ImmediateOp_BIC;
when '10x00' operation = ImmediateOp_MOVI;
when '10x01' operation = ImmediateOp_MVNI;
when '10x10' operation = ImmediateOp_ORR;
when '10x11' operation = ImmediateOp_BIC;
when '110x0' operation = ImmediateOp_MOVI;
when '110x1' operation = ImmediateOp_MVNI;
when '1110x' operation = ImmediateOp_MOVI;
when '11110' operation = ImmediateOp_MOVI;
when '11111'
    // FMOV Dn,#imm is in main FP instruction set
    if Q == '0' then UnallocatedEncoding();
    operation = ImmediateOp_MOVI;
    
```

imm64 = AdvSIMDExpandImm(op, cmode, a:b:c:d:e:f:g:h);
 imm = Replicate(imm64, datasize DIV 64);

Assembler Symbols

<Vd> Is the name of the SIMD&FP destination register, encoded in the "Rd" field.

<T> Is an arrangement specifier,

2S when Q = 0

4S when Q = 1

<imm> Is a floating-point constant with sign, 3-bit exponent and normalized 4 bits of precision, encoded in "a:b:c:d:e:f:g:h".

Operation

```

CheckFPAdvSIMDEnabled64();
bits(datasize) operand;
bits(datasize) result;
    
```

```
case operation of
  when ImmediateOp_MOVI
    result = imm;
  when ImmediateOp_MVNI
    result = NOT(imm);
  when ImmediateOp_ORR
    operand = V[rd];
    result = operand OR imm;
  when ImmediateOp_BIC
    operand = V[rd];
    result = operand AND NOT(imm);

V[rd] = result;
```

C6.3.113 FMOV (register)

Floating-point move register without conversion: $Vd = Vn$

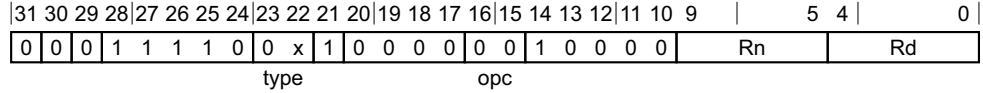

Single-precision variant (type = 00)

FMOV <Sd>, <Sn>

Double-precision variant (type = 01)

FMOV <Dd>, <Dn>

```
integer d = UInt(Rd);
integer n = UInt(Rn);

integer datasize;
case type of
    when '00' datasize = 32;
    when '01' datasize = 64;
    when '1x' UnallocatedEncoding();

FUnaryOp fpop;
case opc of
    when '00' fpop = FUnaryOp_MOV;
    when '01' fpop = FUnaryOp_ABS;
    when '10' fpop = FUnaryOp_NEG;
    when '11' fpop = FUnaryOp_SQRT;
```

Assembler Symbols

- <Dd> Is the 64-bit name of the SIMD&FP destination register, encoded in the "Rd" field.
- <Dn> Is the 64-bit name of the SIMD&FP source register, encoded in the "Rn" field.
- <Sd> Is the 32-bit name of the SIMD&FP destination register, encoded in the "Rd" field.
- <Sn> Is the 32-bit name of the SIMD&FP source register, encoded in the "Rn" field.

Operation

```
CheckFPAdvSIMDEnabled64();

bits(datasize) result;
bits(datasize) operand = V[n];

case fpop of
    when FUnaryOp_MOV result = operand;
    when FUnaryOp_ABS result = FPAbs(operand);
    when FUnaryOp_NEG result = FPNeg(operand);
    when FUnaryOp_SQRT result = FPSqrt(operand, FPCR);

V[d] = result;
```

C6.3.114 FMOV (general)

Floating-point move to or from general-purpose register without conversion

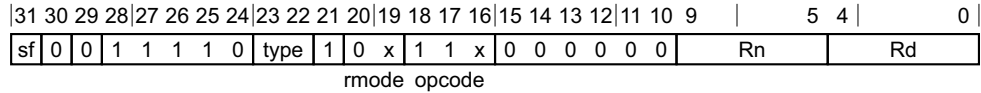

32-bit to single-precision variant (sf = 0, type = 00, rmode = 00, opcode = 111)

FMOV <Sd>, <Wn>

Single-precision to 32-bit variant (sf = 0, type = 00, rmode = 00, opcode = 110)

FMOV <Wd>, <Sn>

64-bit to double-precision variant (sf = 1, type = 01, rmode = 00, opcode = 111)

FMOV <Dd>, <Xn>

64-bit to top half of 128-bit variant (sf = 1, type = 10, rmode = 01, opcode = 111)

FMOV <Vd>.D[1], <Xn>

Double-precision to 64-bit variant (sf = 1, type = 01, rmode = 00, opcode = 110)

FMOV <Xd>, <Dn>

Top half of 128-bit to 64-bit variant (sf = 1, type = 10, rmode = 01, opcode = 110)

FMOV <Xd>, <Vn>.D[1]

```
integer d = UInt(Rd);
integer n = UInt(Rn);

integer intsize = if sf == '1' then 64 else 32;
integer fltsize;
FPConvOp op;
FPRounding rounding;
boolean unsigned;
integer part;

case type of
    when '00'
        fltsize = 32;
    when '01'
        fltsize = 64;
    when '10'
        if opcode<2:1>:rmode != '11 01' then UnallocatedEncoding();
        fltsize = 128;
    when '11'
        UnallocatedEncoding();

case opcode<2:1>:rmode of
    when '00 xx' // FCVT[NPMZ][US]
        rounding = FPDecodeRounding(rmode);
        unsigned = (opcode<0> == '1');
        op = FPConvOp_CVT_FtoI;
    when '01 00' // [US]CVTF
        rounding = FPRoundingMode(FPCR);
```

```

    unsigned = (opcode<0> == '1');
    op = FPConvOp_CVT_ItoF;
  when '10 00' // FCVTA[US]
    rounding = FPRounding_TIEAWAY;
    unsigned = (opcode<0> == '1');
    op = FPConvOp_CVT_FtoI;
  when '11 00' // FMOV
    if fltsize != intsize then UnallocatedEncoding();
    op = if opcode<0> == '1' then FPConvOp_MOV_ItoF else FPConvOp_MOV_FtoI;
    part = 0;
  when '11 01' // FMOV D[1]
    if intsize != 64 || fltsize != 128 then UnallocatedEncoding();
    op = if opcode<0> == '1' then FPConvOp_MOV_ItoF else FPConvOp_MOV_FtoI;
    part = 1;
  otherwise
    UnallocatedEncoding();

```

Assembler Symbols

- <Dd> Is the 64-bit name of the SIMD&FP destination register, encoded in the "Rd" field.
- <Sd> Is the 32-bit name of the SIMD&FP destination register, encoded in the "Rd" field.
- <Wn> Is the 32-bit name of the general-purpose source register, encoded in the "Rn" field.
- <Vd> Is the name of the SIMD&FP destination register, encoded in the "Rd" field.
- <Xn> Is the 64-bit name of the general-purpose source register, encoded in the "Rn" field.
- <Wd> Is the 32-bit name of the general-purpose destination register, encoded in the "Rd" field.
- <Sn> Is the 32-bit name of the SIMD&FP source register, encoded in the "Rn" field.
- <Xd> Is the 64-bit name of the general-purpose destination register, encoded in the "Rd" field.
- <Vn> Is the name of the SIMD&FP source register, encoded in the "Rn" field.
- <Dn> Is the 64-bit name of the SIMD&FP source register, encoded in the "Rn" field.

Operation

```

CheckFPAdvSIMDEnabled64();

bits(fltsize) fltval;
bits(intsize) intval;

case op of
  when FPConvOp_CVT_FtoI
    fltval = V[n];
    intval = FPToFixed(fltval, 0, unsigned, FPCR, rounding);
    X[d] = intval;
  when FPConvOp_CVT_ItoF
    intval = X[n];
    fltval = FixedToFP(intval, 0, unsigned, FPCR, rounding);
    V[d] = fltval;
  when FPConvOp_MOV_FtoI
    intval = Vpart[n,part];
    X[d] = intval;
  when FPConvOp_MOV_ItoF
    intval = X[n];
    Vpart[d,part] = intval;

```

C6.3.115 FMOV (scalar, immediate)

Floating-point move immediate (scalar): Vd=#imm

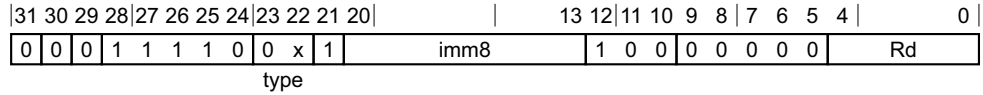

Single-precision variant (type = 00)

FMOV <Sd>, #<imm>

Double-precision variant (type = 01)

FMOV <Dd>, #<imm>

```
integer d = UInt(Rd);

integer datasize;
case type of
    when '00' datasize = 32;
    when '01' datasize = 64;
    when '1x' UnallocatedEncoding();

bits(datasize) imm = VFPEExpandImm(imm8);
```

Assembler Symbols

- <Dd> Is the 64-bit name of the SIMD&FP destination register, encoded in the "Rd" field.
- <Sd> Is the 32-bit name of the SIMD&FP destination register, encoded in the "Rd" field.
- <imm> Is a signed floating-point constant with 3-bit exponent and normalized 4 bits of precision, encoded in the "imm8" field.

Operation

```
CheckFPAdvSIMDEnabled64();
```

```
V[d] = imm;
```

C6.3.116 FMSUB

Floating-point fused multiply-subtract (scalar): $Vd = Va + (-Vn) * Vm$

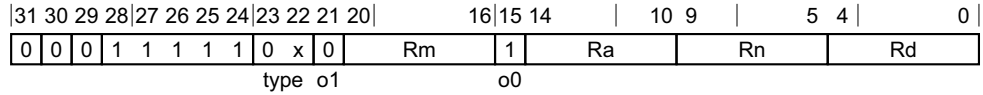

Single-precision variant (type = 00)

FMSUB <Sd>, <Sn>, <Sm>, <Sa>

Double-precision variant (type = 01)

FMSUB <Dd>, <Dn>, <Dm>, <Da>

```
integer d = UInt(Rd);
integer a = UInt(Ra);
integer n = UInt(Rn);
integer m = UInt(Rm);

integer datasize;
case type of
    when '00' datasize = 32;
    when '01' datasize = 64;
    when '1x' UnallocatedEncoding();

boolean opa_neg = (o1 == '1');
boolean op1_neg = (o0 != o1);
```

Assembler Symbols

- <Dd> Is the 64-bit name of the SIMD&FP destination register, encoded in the "Rd" field.
- <Dn> Is the 64-bit name of the first SIMD&FP source register holding the multiplicand, encoded in the "Rn" field.
- <Dm> Is the 64-bit name of the second SIMD&FP source register holding the multiplier, encoded in the "Rm" field.
- <Da> Is the 64-bit name of the third SIMD&FP source register holding the minuend, encoded in the "Ra" field.
- <Sd> Is the 32-bit name of the SIMD&FP destination register, encoded in the "Rd" field.
- <Sn> Is the 32-bit name of the first SIMD&FP source register holding the multiplicand, encoded in the "Rn" field.
- <Sm> Is the 32-bit name of the second SIMD&FP source register holding the multiplier, encoded in the "Rm" field.
- <Sa> Is the 32-bit name of the third SIMD&FP source register holding the minuend, encoded in the "Ra" field.

Operation

```
CheckFPAdvSIMDEnabled64();
bits(datasize) result;
bits(datasize) operands = V[a];
bits(datasize) operand1 = V[n];
bits(datasize) operand2 = V[m];
```

```
if opa_neg then operanda = FPNeg(operanda);  
if op1_neg then operand1 = FPNeg(operand1);  
result = FPMu1Add(operanda, operand1, operand2, FPCR);  
  
V[d] = result;
```

C6.3.117 FMUL (by element)

Floating-point multiply (by element)

It has encodings from 2 classes: *Scalar* and *Vector*

Scalar

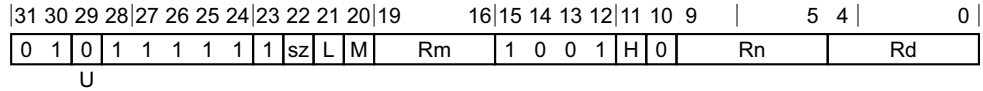

Scalar variant

FMUL <V><d>, <V><n>, <Vm>.<Ts>[<index>]

```

integer idxsize = if H == '1' then 128 else 64;
integer index;
bit Rmhi = M;
case sz:L of
    when '0x' index = UInt(H:L);
    when '10' index = UInt(H);
    when '11' UnallocatedEncoding();

integer d = UInt(Rd);
integer n = UInt(Rn);
integer m = UInt(Rmhi:Rm);

integer esize = 32 << UInt(sz);
integer datasize = esize;
integer elements = 1;
boolean mulx_op = (U == '1');
```

Vector

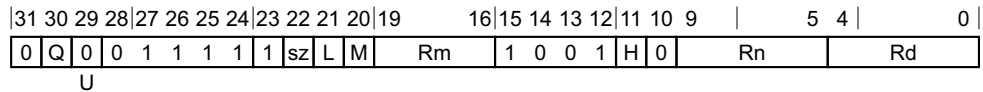

Vector variant

FMUL <Vd>.<T>, <Vn>.<T>, <Vm>.<Ts>[<index>]

```

integer idxsize = if H == '1' then 128 else 64;
integer index;
bit Rmhi = M;
case sz:L of
    when '0x' index = UInt(H:L);
    when '10' index = UInt(H);
    when '11' UnallocatedEncoding();

integer d = UInt(Rd);
integer n = UInt(Rn);
integer m = UInt(Rmhi:Rm);

if sz:Q == '10' then ReservedValue();
integer esize = 32 << UInt(sz);
integer datasize = if Q == '1' then 128 else 64;
integer elements = datasize DIV esize;
boolean mulx_op = (U == '1');
```

Assembler Symbols

<V>	Is a width specifier, S when $sz = 0$ D when $sz = 1$
<d>	Is the number of the SIMD&FP destination register, encoded in the "Rd" field.
<n>	Is the number of the first SIMD&FP source register, encoded in the "Rn" field.
<Vd>	Is the name of the SIMD&FP destination register, encoded in the "Rd" field.
<T>	Is an arrangement specifier, 2S when $Q = 0, sz = 0$ RESERVED when $Q = 0, sz = 1$ 4S when $Q = 1, sz = 0$ 2D when $Q = 1, sz = 1$
<Vn>	Is the name of the first SIMD&FP source register, encoded in the "Rn" field.
<Vm>	For the scalar variant: is the name of the SIMD&FP source register, encoded in the "M:Rm" fields.
<Vm>	For the vector variant: is the name of the second SIMD&FP source register, encoded in the "M:Rm" fields.
<Ts>	For the scalar variant: is the element width specifier, S when $sz = 0$ D when $sz = 1$
<Ts>	For the vector variant: is an element size specifier, S when $sz = 0$ D when $sz = 1$
<index>	For the scalar variant: is the element index, H:L when $sz = 0, L = x$ H when $sz = 1, L = 0$ RESERVED when $sz = 1, L = 1$
<index>	For the vector variant: is the element index H:L when $sz = 0, L = x$ H when $sz = 1, L = 0$ RESERVED when $sz = 1, L = 1$

Operation for all classes

```

CheckFPAdvSIMDEnabled64();
bits(datasize) operand1 = V[n];
bits(idxsize) operand2 = V[m];
bits(datasize) result;
bits(esize) element1;
bits(esize) element2 = Elem[operand2, index, esize];

for e = 0 to elements-1
  element1 = Elem[operand1, e, esize];
  if mulx_op then
    Elem[result, e, esize] = FPMuIX(element1, element2, FPCR);
  else

```

```
Elem[result, e, esize] = FPMu1(element1, element2, FPCR);  
V[d] = result;
```

C6.3.118 FMUL (vector)

Floating-point multiply (vector)

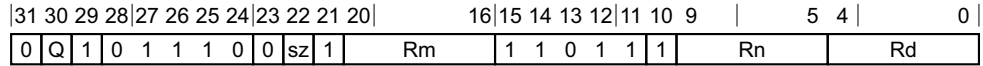

Three registers of the same type variant

FMUL <Vd>.<T>, <Vn>.<T>, <Vm>.<T>

```
integer d = UInt(Rd);
integer n = UInt(Rn);
integer m = UInt(Rm);
if sz:Q == '10' then ReservedValue();
integer esize = 32 << UInt(sz);
integer datasize = if Q == '1' then 128 else 64;
integer elements = datasize DIV esize;
```

Assembler Symbols

- <Vd> Is the name of the SIMD&FP destination register, encoded in the "Rd" field.
- <T> Is an arrangement specifier,
 - 2S** when sz = 0, Q = 0
 - 4S** when sz = 0, Q = 1
 - RESERVED** when sz = 1, Q = 0
 - 2D** when sz = 1, Q = 1
- <Vn> Is the name of the first SIMD&FP source register, encoded in the "Rn" field.
- <Vm> Is the name of the second SIMD&FP source register, encoded in the "Rm" field.

Operation

```
CheckFPAdvSIMDEnabled64();
bits(datasize) operand1 = V[n];
bits(datasize) operand2 = V[m];
bits(datasize) result;
bits(esize) element1;
bits(esize) element2;

for e = 0 to elements-1
    element1 = Elem[operand1, e, esize];
    element2 = Elem[operand2, e, esize];
    Elem[result, e, esize] = FPMu1(element1, element2, FPCR);

V[d] = result;
```

C6.3.119 FMUL (scalar)

Floating-point multiply (scalar): $Vd = Vn * Vm$

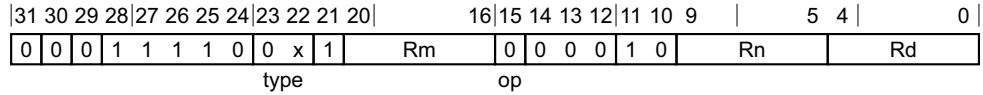

Single-precision variant (type = 00)

FMUL <Sd>, <Sn>, <Sm>

Double-precision variant (type = 01)

FMUL <Dd>, <Dn>, <Dm>

```
integer d = UInt(Rd);
integer n = UInt(Rn);
integer m = UInt(Rm);

integer datasize;
case type of
    when '00' datasize = 32;
    when '01' datasize = 64;
    when '1x' UnallocatedEncoding();

boolean negated = (op == '1');
```

Assembler Symbols

- <Dd> Is the 64-bit name of the SIMD&FP destination register, encoded in the "Rd" field.
- <Dn> Is the 64-bit name of the first SIMD&FP source register, encoded in the "Rn" field.
- <Dm> Is the 64-bit name of the second SIMD&FP source register, encoded in the "Rm" field.
- <Sd> Is the 32-bit name of the SIMD&FP destination register, encoded in the "Rd" field.
- <Sn> Is the 32-bit name of the first SIMD&FP source register, encoded in the "Rn" field.
- <Sm> Is the 32-bit name of the second SIMD&FP source register, encoded in the "Rm" field.

Operation

```
CheckFPAdvSIMDEnabled64();
bits(datasize) result;
bits(datasize) operand1 = V[n];
bits(datasize) operand2 = V[m];

result = FPMu1(operand1, operand2, FPCR);

if negated then result = FPNeg(result);

V[d] = result;
```

C6.3.120 FMULX (by element)

Floating-point multiply extended (by element)

It has encodings from 2 classes: *Scalar* and *Vector*

Scalar

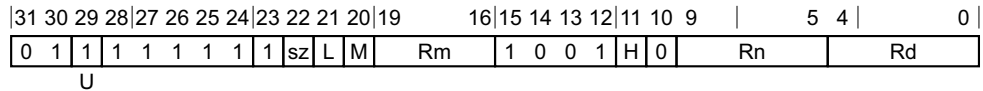

Scalar variant

FMULX <V><d>, <V><n>, <Vm>.<Ts>[<index>]

```
integer idxdsize = if H == '1' then 128 else 64;
integer index;
bit Rmhi = M;
case sz:L of
    when '0x' index = UInt(H:L);
    when '10' index = UInt(H);
    when '11' UnallocatedEncoding();

integer d = UInt(Rd);
integer n = UInt(Rn);
integer m = UInt(Rmhi:Rm);

integer esize = 32 << UInt(sz);
integer datasize = esize;
integer elements = 1;
boolean mulx_op = (U == '1');
```

Vector

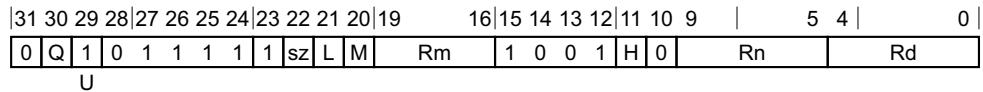

Vector variant

FMULX <Vd>.<T>, <Vn>.<T>, <Vm>.<Ts>[<index>]

```
integer idxdsize = if H == '1' then 128 else 64;
integer index;
bit Rmhi = M;
case sz:L of
    when '0x' index = UInt(H:L);
    when '10' index = UInt(H);
    when '11' UnallocatedEncoding();

integer d = UInt(Rd);
integer n = UInt(Rn);
integer m = UInt(Rmhi:Rm);

if sz:Q == '10' then ReservedValue();
integer esize = 32 << UInt(sz);
integer datasize = if Q == '1' then 128 else 64;
integer elements = datasize DIV esize;
boolean mulx_op = (U == '1');
```

Assembler Symbols

<V>	Is a width specifier, S when $sz = 0$ D when $sz = 1$
<d>	Is the number of the SIMD&FP destination register, encoded in the "Rd" field.
<n>	Is the number of the first SIMD&FP source register, encoded in the "Rn" field.
<Vd>	Is the name of the SIMD&FP destination register, encoded in the "Rd" field.
<T>	Is an arrangement specifier, 2S when $Q = 0, sz = 0$ RESERVED when $Q = 0, sz = 1$ 4S when $Q = 1, sz = 0$ 2D when $Q = 1, sz = 1$
<Vn>	Is the name of the first SIMD&FP source register, encoded in the "Rn" field.
<Vm>	For the scalar variant: is the name of the SIMD&FP source register, encoded in the "M:Rm" fields.
<Vm>	For the vector variant: is the name of the second SIMD&FP source register, encoded in the "M:Rm" fields.
<Ts>	For the scalar variant: is the element width specifier, S when $sz = 0$ D when $sz = 1$
<Ts>	For the vector variant: is an element size specifier, S when $sz = 0$ D when $sz = 1$
<index>	For the scalar variant: is the element index, H:L when $sz = 0, L = x$ H when $sz = 1, L = 0$ RESERVED when $sz = 1, L = 1$
<index>	For the vector variant: is the element index H:L when $sz = 0, L = x$ H when $sz = 1, L = 0$ RESERVED when $sz = 1, L = 1$

Operation for all classes

```

CheckFPAdvSIMDEnabled64();
bits(datasize) operand1 = V[n];
bits(idxsize) operand2 = V[m];
bits(datasize) result;
bits(esize) element1;
bits(esize) element2 = Elem[operand2, index, esize];

for e = 0 to elements-1
    element1 = Elem[operand1, e, esize];
    if mulx_op then
        Elem[result, e, esize] = FPMu1X(element1, element2, FPCR);
    else

```

```
Elem[result, e, esize] = FPMu1(element1, element2, FPCR);  
V[d] = result;
```

C6.3.121 FMULX

Floating-point multiply extended

It has encodings from 2 classes: *Scalar* and *Vector*

Scalar

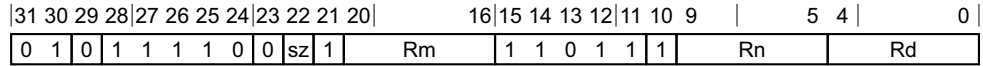

Scalar variant

FMULX <V><d>, <V><n>, <V><m>

```
integer d = UInt(Rd);
integer n = UInt(Rn);
integer m = UInt(Rm);
integer esize = 32 << UInt(sz);
integer datasize = esize;
integer elements = 1;
```

Vector

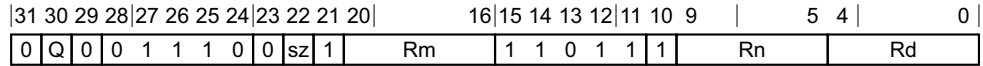

Vector variant

FMULX <Vd>.<T>, <Vn>.<T>, <Vm>.<T>

```
integer d = UInt(Rd);
integer n = UInt(Rn);
integer m = UInt(Rm);
if sz:Q == '10' then ReservedValue();
integer esize = 32 << UInt(sz);
integer datasize = if Q == '1' then 128 else 64;
integer elements = datasize DIV esize;
```

Assembler Symbols

- <V> Is a width specifier,
 - S** when sz = 0
 - D** when sz = 1
- <d> Is the number of the SIMD&FP destination register, in the "Rd" field.
- <n> Is the number of the first SIMD&FP source register, encoded in the "Rn" field.
- <m> Is the number of the second SIMD&FP source register, encoded in the "Rm" field.
- <Vd> Is the name of the SIMD&FP destination register, encoded in the "Rd" field.
- <T> Is an arrangement specifier,
 - 2S** when sz = 0, Q = 0
 - 4S** when sz = 0, Q = 1
 - RESERVED** when sz = 1, Q = 0
 - 2D** when sz = 1, Q = 1

- <Vn> Is the name of the first SIMD&FP source register, encoded in the "Rn" field.
- <Vm> Is the name of the second SIMD&FP source register, encoded in the "Rm" field.

Operation for all classes

```
CheckFPAdvSIMDEnabled64();
bits(datasize) operand1 = V[n];
bits(datasize) operand2 = V[m];
bits(datasize) result;
bits(esize) element1;
bits(esize) element2;

for e = 0 to elements-1
    element1 = Elem[operand1, e, esize];
    element2 = Elem[operand2, e, esize];
    Elem[result, e, esize] = FPMuTX(element1, element2, FPCR);
V[d] = result;
```

C6.3.122 FNEG (vector)

Floating-point negate (vector)

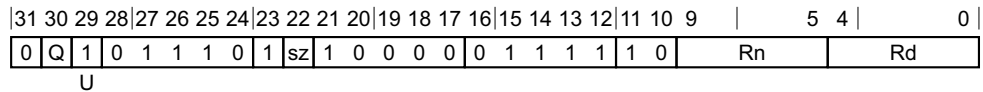

Vector variant

FNEG <Vd>.<T>, <Vn>.<T>

```
integer d = UInt(Rd);
integer n = UInt(Rn);
```

```
if sz:Q == '10' then ReservedValue();
integer esize = 32 << UInt(sz);
integer datasize = if Q == '1' then 128 else 64;
integer elements = datasize DIV esize;
```

```
boolean neg = (U == '1');
```

Assembler Symbols

<Vd> Is the name of the SIMD&FP destination register, encoded in the "Rd" field.

<T> Is an arrangement specifier,
2S when sz = 0, Q = 0
4S when sz = 0, Q = 1
RESERVED when sz = 1, Q = 0
2D when sz = 1, Q = 1

<Vn> Is the name of the SIMD&FP source register, encoded in the "Rn" field.

Operation

```
CheckFPAdvSIMDEnabled64();
bits(datasize) operand = V[n];
bits(datasize) result;
bits(esize) element;

for e = 0 to elements-1
    element = Elem[operand, e, esize];
    if neg then
        element = FPNeg(element);
    else
        element = FPAbs(element);
    Elem[result, e, esize] = element;

V[d] = result;
```

C6.3.123 FNEG (scalar)

Floating-point negate (scalar): $Vd = -Vn$

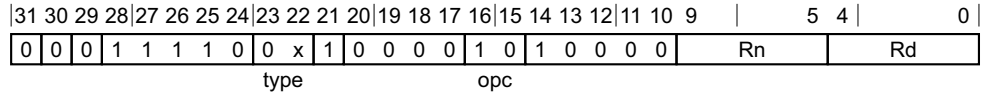

Single-precision variant (type = 00)

FNEG <Sd>, <Sn>

Double-precision variant (type = 01)

FNEG <Dd>, <Dn>

```
integer d = UInt(Rd);
integer n = UInt(Rn);

integer datasize;
case type of
    when '00' datasize = 32;
    when '01' datasize = 64;
    when '1x' UnallocatedEncoding();

FUnaryOp fpop;
case opc of
    when '00' fpop = FUnaryOp_MOV;
    when '01' fpop = FUnaryOp_ABS;
    when '10' fpop = FUnaryOp_NEG;
    when '11' fpop = FUnaryOp_SQRT;
```

Assembler Symbols

- <Dd> Is the 64-bit name of the SIMD&FP destination register, encoded in the "Rd" field.
- <Dn> Is the 64-bit name of the SIMD&FP source register, encoded in the "Rn" field.
- <Sd> Is the 32-bit name of the SIMD&FP destination register, encoded in the "Rd" field.
- <Sn> Is the 32-bit name of the SIMD&FP source register, encoded in the "Rn" field.

Operation

```
CheckFPAdvSIMDEnabled64();

bits(datasize) result;
bits(datasize) operand = V[n];

case fpop of
    when FUnaryOp_MOV result = operand;
    when FUnaryOp_ABS result = FPAbs(operand);
    when FUnaryOp_NEG result = FPNeg(operand);
    when FUnaryOp_SQRT result = FPSqrt(operand, FPCR);

V[d] = result;
```

C6.3.124 FNMADD

Floating-point negated fused multiply-add (scalar): $Vd = (-Va) + (-Vn) * Vm$

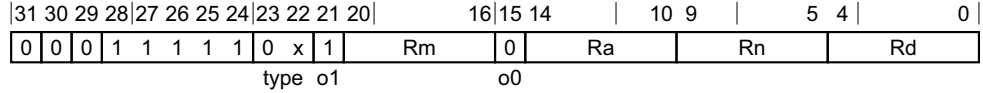

Single-precision variant (type = 00)

FNMADD <Sd>, <Sn>, <Sm>, <Sa>

Double-precision variant (type = 01)

FNMADD <Dd>, <Dn>, <Dm>, <Da>

```
integer d = UInt(Rd);
integer a = UInt(Ra);
integer n = UInt(Rn);
integer m = UInt(Rm);

integer datasize;
case type of
    when '00' datasize = 32;
    when '01' datasize = 64;
    when '1x' UnallocatedEncoding();

boolean opa_neg = (o1 == '1');
boolean op1_neg = (o0 != o1);
```

Assembler Symbols

- <Dd> Is the 64-bit name of the SIMD&FP destination register, encoded in the "Rd" field.
- <Dn> Is the 64-bit name of the first SIMD&FP source register holding the multiplicand, encoded in the "Rn" field.
- <Dm> Is the 64-bit name of the second SIMD&FP source register holding the multiplier, encoded in the "Rm" field.
- <Da> Is the 64-bit name of the third SIMD&FP source register holding the addend, encoded in the "Ra" field.
- <Sd> Is the 32-bit name of the SIMD&FP destination register, encoded in the "Rd" field.
- <Sn> Is the 32-bit name of the first SIMD&FP source register holding the multiplicand, encoded in the "Rn" field.
- <Sm> Is the 32-bit name of the second SIMD&FP source register holding the multiplier, encoded in the "Rm" field.
- <Sa> Is the 32-bit name of the third SIMD&FP source register holding the addend, encoded in the "Ra" field.

Operation

```
CheckFPAdvSIMDEnabled64();
bits(datasize) result;
bits(datasize) operands = V[a];
bits(datasize) operand1 = V[n];
bits(datasize) operand2 = V[m];
```

```
if opa_neg then operanda = FPNeg(operanda);  
if op1_neg then operand1 = FPNeg(operand1);  
result = FPMu1Add(operanda, operand1, operand2, FPCR);  
  
V[d] = result;
```

C6.3.125 FNMSUB

Floating-point negated fused multiply-subtract (scalar): $Vd = (-Va) + Vn * Vm$

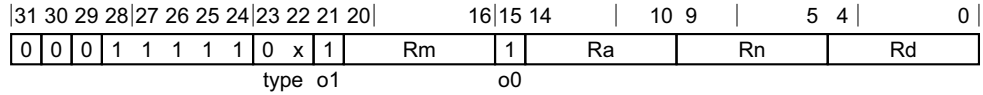

Single-precision variant (type = 00)

FNMSUB <Sd>, <Sn>, <Sm>, <Sa>

Double-precision variant (type = 01)

FNMSUB <Dd>, <Dn>, <Dm>, <Da>

```
integer d = UInt(Rd);
integer a = UInt(Ra);
integer n = UInt(Rn);
integer m = UInt(Rm);

integer datasize;
case type of
    when '00' datasize = 32;
    when '01' datasize = 64;
    when '1x' UnallocatedEncoding();

boolean opa_neg = (o1 == '1');
boolean op1_neg = (o0 != o1);
```

Assembler Symbols

- <Dd> Is the 64-bit name of the SIMD&FP destination register, encoded in the "Rd" field.
- <Dn> Is the 64-bit name of the first SIMD&FP source register holding the multiplicand, encoded in the "Rn" field.
- <Dm> Is the 64-bit name of the second SIMD&FP source register holding the multiplier, encoded in the "Rm" field.
- <Da> Is the 64-bit name of the third SIMD&FP source register holding the minuend, encoded in the "Ra" field.
- <Sd> Is the 32-bit name of the SIMD&FP destination register, encoded in the "Rd" field.
- <Sn> Is the 32-bit name of the first SIMD&FP source register holding the multiplicand, encoded in the "Rn" field.
- <Sm> Is the 32-bit name of the second SIMD&FP source register holding the multiplier, encoded in the "Rm" field.
- <Sa> Is the 32-bit name of the third SIMD&FP source register holding the minuend, encoded in the "Ra" field.

Operation

```
CheckFPAdvSIMDEnabled64();
bits(datasize) result;
bits(datasize) operands = V[a];
bits(datasize) operand1 = V[n];
bits(datasize) operand2 = V[m];
```

```
if opa_neg then operanda = FPNeg(operanda);  
if op1_neg then operand1 = FPNeg(operand1);  
result = FPMu1Add(operanda, operand1, operand2, FPCR);  
  
V[d] = result;
```

C6.3.126 FNMUL

Floating-point multiply-negate (scalar): $Vd = -(Vn * Vm)$

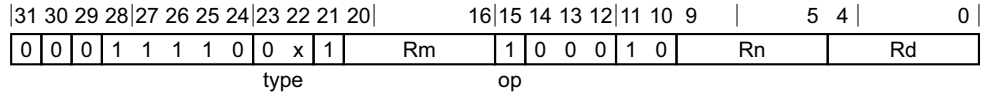

Single-precision variant (type = 00)

FNMUL <Sd>, <Sn>, <Sm>

Double-precision variant (type = 01)

FNMUL <Dd>, <Dn>, <Dm>

```
integer d = UInt(Rd);
integer n = UInt(Rn);
integer m = UInt(Rm);

integer datasize;
case type of
    when '00' datasize = 32;
    when '01' datasize = 64;
    when '1x' UnallocatedEncoding();

boolean negated = (op == '1');
```

Assembler Symbols

- <Dd> Is the 64-bit name of the SIMD&FP destination register, encoded in the "Rd" field.
- <Dn> Is the 64-bit name of the first SIMD&FP source register, encoded in the "Rn" field.
- <Dm> Is the 64-bit name of the second SIMD&FP source register, encoded in the "Rm" field.
- <Sd> Is the 32-bit name of the SIMD&FP destination register, encoded in the "Rd" field.
- <Sn> Is the 32-bit name of the first SIMD&FP source register, encoded in the "Rn" field.
- <Sm> Is the 32-bit name of the second SIMD&FP source register, encoded in the "Rm" field.

Operation

```
CheckFPAdvSIMDEnabled64();
bits(datasize) result;
bits(datasize) operand1 = V[n];
bits(datasize) operand2 = V[m];

result = FPMu1(operand1, operand2, FPCR);

if negated then result = FPNeg(result);

V[d] = result;
```

C6.3.127 FRECPE

Floating-point reciprocal estimate

It has encodings from 2 classes: *Scalar* and *Vector*

Scalar

31	30	29	28	27	26	25	24	23	22	21	20	19	18	17	16	15	14	13	12	11	10	9	5 4			0
0	1	0	1	1	1	1	0	1	sz	1	0	0	0	0	1	1	1	0	1	1	0	Rn			Rd	

Scalar variant

FRECPE <V><d>, <V><n>

integer d = UInt(Rd);
 integer n = UInt(Rn);

integer esize = 32 << UInt(sz);
 integer datasize = esize;
 integer elements = 1;

Vector

31	30	29	28	27	26	25	24	23	22	21	20	19	18	17	16	15	14	13	12	11	10	9	5 4			0
0	Q	0	0	1	1	1	0	1	sz	1	0	0	0	0	1	1	1	0	1	1	0	Rn			Rd	

Vector variant

FRECPE <Vd>.<T>, <Vn>.<T>

integer d = UInt(Rd);
 integer n = UInt(Rn);

if sz:Q == '10' then ReservedValue();
 integer esize = 32 << UInt(sz);
 integer datasize = if Q == '1' then 128 else 64;
 integer elements = datasize DIV esize;

Assembler Symbols

- <V> Is a width specifier,
 - S** when sz = 0
 - D** when sz = 1
- <d> Is the number of the SIMD&FP destination register, encoded in the "Rd" field.
- <n> Is the number of the SIMD&FP source register, encoded in the "Rn" field.
- <Vd> Is the name of the SIMD&FP destination register, encoded in the "Rd" field.
- <T> Is an arrangement specifier,
 - 2S** when sz = 0, Q = 0
 - 4S** when sz = 0, Q = 1
 - RESERVED** when sz = 1, Q = 0
 - 2D** when sz = 1, Q = 1
- <Vn> Is the name of the SIMD&FP source register, encoded in the "Rn" field.

Operation for all classes

```
CheckFPAdvSIMDEnabled64();  
bits(datasize) operand = V[n];  
bits(datasize) result;  
bits(esize) element;  
  
for e = 0 to elements-1  
    element = Elem[operand, e, esize];  
    Elem[result, e, esize] = FPRecipEstimate(element, FPCR);  
  
V[d] = result;
```

C6.3.128 FRECPs

Floating-point reciprocal step

It has encodings from 2 classes: *Scalar* and *Vector*

Scalar

31	30	29	28	27	26	25	24	23	22	21	20	16	15	14	13	12	11	10	9	5	4	0
0	1	0	1	1	1	1	0	0	sz	1	Rm	1	1	1	1	1	1	Rn	Rd			

Scalar variant

FRECPs <V><d>, <V><n>, <V><m>

```
integer d = UInt(Rd);
integer n = UInt(Rn);
integer m = UInt(Rm);
integer esize = 32 << UInt(sz);
integer datasize = esize;
integer elements = 1;
```

Vector

31	30	29	28	27	26	25	24	23	22	21	20	16	15	14	13	12	11	10	9	5	4	0
0	Q	0	0	1	1	1	0	0	sz	1	Rm	1	1	1	1	1	1	Rn	Rd			

Vector variant

FRECPs <Vd>.<T>, <Vn>.<T>, <Vm>.<T>

```
integer d = UInt(Rd);
integer n = UInt(Rn);
integer m = UInt(Rm);
if sz:Q == '10' then ReservedValue();
integer esize = 32 << UInt(sz);
integer datasize = if Q == '1' then 128 else 64;
integer elements = datasize DIV esize;
```

Assembler Symbols

<V>	Is a width specifier, S when sz = 0 D when sz = 1
<d>	Is the number of the SIMD&FP destination register, in the "Rd" field.
<n>	Is the number of the first SIMD&FP source register, encoded in the "Rn" field.
<m>	Is the number of the second SIMD&FP source register, encoded in the "Rm" field.
<Vd>	Is the name of the SIMD&FP destination register, encoded in the "Rd" field.
<T>	Is an arrangement specifier, 2S when sz = 0, Q = 0 4S when sz = 0, Q = 1 RESERVED when sz = 1, Q = 0 2D when sz = 1, Q = 1

- <Vn> Is the name of the first SIMD&FP source register, encoded in the "Rn" field.
- <Vm> Is the name of the second SIMD&FP source register, encoded in the "Rm" field.

Operation for all classes

```
CheckFPAdvSIMDEnabled64();
bits(datasize) operand1 = V[n];
bits(datasize) operand2 = V[m];
bits(datasize) result;
bits(esize) element1;
bits(esize) element2;

for e = 0 to elements-1
    element1 = Elem[operand1, e, esize];
    element2 = Elem[operand2, e, esize];
    Elem[result, e, esize] = FPrecipStepFused(element1, element2);

V[d] = result;
```

C6.3.129 FRECPX

Floating-point reciprocal exponent (scalar)

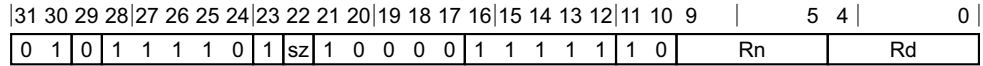

Scalar variant

FRECPX <V><d>, <V><n>

integer d = UInt(Rd);
 integer n = UInt(Rn);

integer esize = 32 << UInt(sz);
 integer datasize = esize;
 integer elements = 1;

Assembler Symbols

<V> Is a width specifier,
 S when sz = 0
 D when sz = 1

<d> Is the number of the SIMD&FP destination register, encoded in the "Rd" field.

<n> Is the number of the SIMD&FP source register, encoded in the "Rn" field.

Operation

```

CheckFPAdvSIMDEnabled64();
bits(datasize) operand = V[n];
bits(datasize) result;
bits(esome) element;

for e = 0 to elements-1
    element = Elem[operand, e, esize];
    Elem[result, e, esize] = FPrecpX(element, FPCR);

V[d] = result;
    
```

C6.3.130 FRINTA (vector)

Floating-point round to integral, to nearest with ties to away (vector)

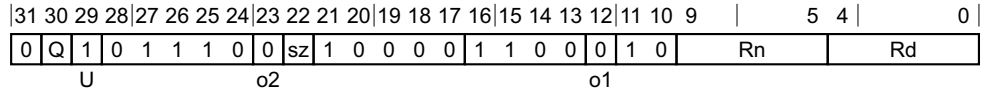

Vector variant

FRINTA <Vd>.<T>, <Vn>.<T>

```
integer d = UInt(Rd);
integer n = UInt(Rn);
```

```
if sz:Q == '10' then ReservedValue();
integer esize = 32 << UInt(sz);
integer datasize = if Q == '1' then 128 else 64;
integer elements = datasize DIV esize;
```

```
boolean exact = FALSE;
FPRounding rounding;
case U:o1:o2 of
    when '0xx' rounding = FPDecodeRounding(o1:o2);
    when '100' rounding = FPRounding_TIEAWAY;
    when '101' UnallocatedEncoding();
    when '110' rounding = FPRoundingMode(FPCR); exact = TRUE;
    when '111' rounding = FPRoundingMode(FPCR);
```

Assembler Symbols

<Vd> Is the name of the SIMD&FP destination register, encoded in the "Rd" field.

<T> Is an arrangement specifier,
2S when sz = 0, Q = 0
4S when sz = 0, Q = 1
RESERVED when sz = 1, Q = 0
2D when sz = 1, Q = 1

<Vn> Is the name of the SIMD&FP source register, encoded in the "Rn" field.

Operation

```
CheckFPAdvSIMDEnabled64();
bits(datasize) operand = V[n];
bits(datasize) result;
bits(esize) element;

for e = 0 to elements-1
    element = Elem[operand, e, esize];
    Elem[result, e, esize] = FPRoundInt(element, FPCR, rounding, exact);
```

V[d] = result;

C6.3.131 FRINTA (scalar)

Floating-point round to integral, to nearest with ties to away (scalar): $Vd = \text{roundToIntegralTiesToAway}(Vn)$

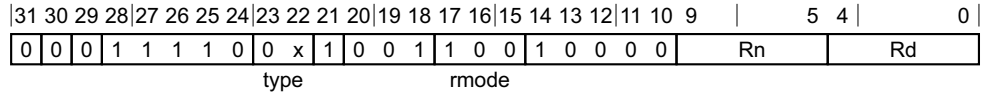

Single-precision variant (type = 00)

FRINTA <Sd>, <Sn>

Double-precision variant (type = 01)

FRINTA <Dd>, <Dn>

```
integer d = UInt(Rd);
integer n = UInt(Rn);

integer datasize;
case type of
    when '00' datasize = 32;
    when '01' datasize = 64;
    when '1x' UnallocatedEncoding();

boolean exact = FALSE;
FPRounding rounding;
case rmode of
    when '0xx' rounding = FPDecodeRounding(rmode<1:0>);
    when '100' rounding = FPRounding_TIEAWAY;
    when '101' UnallocatedEncoding();
    when '110' rounding = FPRoundingMode(FPCR); exact = TRUE;
    when '111' rounding = FPRoundingMode(FPCR);
```

Assembler Symbols

- <Dd> Is the 64-bit name of the SIMD&FP destination register, encoded in the "Rd" field.
- <Dn> Is the 64-bit name of the SIMD&FP source register, encoded in the "Rn" field.
- <Sd> Is the 32-bit name of the SIMD&FP destination register, encoded in the "Rd" field.
- <Sn> Is the 32-bit name of the SIMD&FP source register, encoded in the "Rn" field.

Operation

```
CheckFPAdvSIMDEnabled64();

bits(datasize) result;
bits(datasize) operand = V[n];

result = FPRoundInt(operand, FPCR, rounding, exact);

V[d] = result;
```

C6.3.132 FRINTI (vector)

Floating-point round to integral, using current rounding mode (vector)

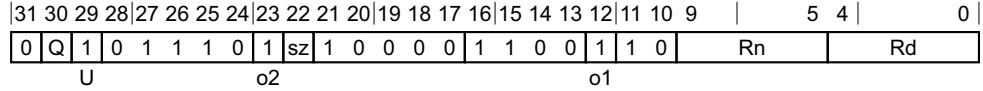

Vector variant

FRINTI <Vd>.<T>, <Vn>.<T>

```
integer d = UInt(Rd);
integer n = UInt(Rn);

if sz:Q == '10' then ReservedValue();
integer esize = 32 << UInt(sz);
integer datasize = if Q == '1' then 128 else 64;
integer elements = datasize DIV esize;

boolean exact = FALSE;
FPRounding rounding;
case U:o1:o2 of
    when '0xx' rounding = FPDecodeRounding(o1:o2);
    when '100' rounding = FPRounding_TIEAWAY;
    when '101' UnallocatedEncoding();
    when '110' rounding = FPRoundingMode(FPCR); exact = TRUE;
    when '111' rounding = FPRoundingMode(FPCR);
```

Assembler Symbols

- <Vd> Is the name of the SIMD&FP destination register, encoded in the "Rd" field.
- <T> Is an arrangement specifier,
 - 2S** when sz = 0, Q = 0
 - 4S** when sz = 0, Q = 1
 - RESERVED** when sz = 1, Q = 0
 - 2D** when sz = 1, Q = 1
- <Vn> Is the name of the SIMD&FP source register, encoded in the "Rn" field.

Operation

```
CheckFPAdvSIMDEnabled64();
bits(datasize) operand = V[n];
bits(datasize) result;
bits(esize) element;

for e = 0 to elements-1
    element = Elem[operand, e, esize];
    Elem[result, e, esize] = FPRoundInt(element, FPCR, rounding, exact);

V[d] = result;
```

C6.3.133 FRINTI (scalar)

Floating-point round to integral, using current rounding mode (scalar): $Vd = \text{roundToIntegral}(Vn)$

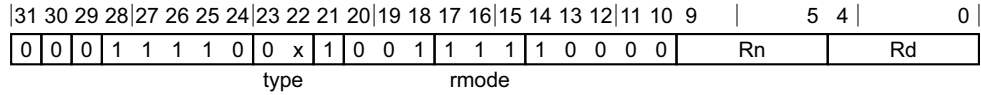

Single-precision variant (type = 00)

FRINTI <Sd>, <Sn>

Double-precision variant (type = 01)

FRINTI <Dd>, <Dn>

```
integer d = UInt(Rd);
integer n = UInt(Rn);

integer datasize;
case type of
    when '00' datasize = 32;
    when '01' datasize = 64;
    when '1x' UnallocatedEncoding();

boolean exact = FALSE;
FPRounding rounding;
case rmode of
    when '0xx' rounding = FPDecodeRounding(rmode<1:0>);
    when '100' rounding = FPRounding_TIEAWAY;
    when '101' UnallocatedEncoding();
    when '110' rounding = FPRoundingMode(FPCR); exact = TRUE;
    when '111' rounding = FPRoundingMode(FPCR);
```

Assembler Symbols

- <Dd> Is the 64-bit name of the SIMD&FP destination register, encoded in the "Rd" field.
- <Dn> Is the 64-bit name of the SIMD&FP source register, encoded in the "Rn" field.
- <Sd> Is the 32-bit name of the SIMD&FP destination register, encoded in the "Rd" field.
- <Sn> Is the 32-bit name of the SIMD&FP source register, encoded in the "Rn" field.

Operation

```
CheckFPAdvSIMDEnabled64();

bits(datasize) result;
bits(datasize) operand = V[n];

result = FPRoundInt(operand, FPCR, rounding, exact);

V[d] = result;
```

C6.3.134 FRINTM (vector)

Floating-point round to integral, toward minus infinity (vector)

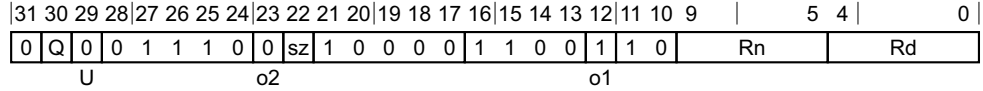

Vector variant

FRINTM <Vd>.<T>, <Vn>.<T>

```
integer d = UInt(Rd);
integer n = UInt(Rn);

if sz:Q == '10' then ReservedValue();
integer esize = 32 << UInt(sz);
integer datasize = if Q == '1' then 128 else 64;
integer elements = datasize DIV esize;

boolean exact = FALSE;
FPRounding rounding;
case U:o1:o2 of
    when '0xx' rounding = FPDecodeRounding(o1:o2);
    when '100' rounding = FPRounding_TIEAWAY;
    when '101' UnallocatedEncoding();
    when '110' rounding = FPRoundingMode(FPCR); exact = TRUE;
    when '111' rounding = FPRoundingMode(FPCR);
```

Assembler Symbols

- <Vd> Is the name of the SIMD&FP destination register, encoded in the "Rd" field.
- <T> Is an arrangement specifier,
 - 2S** when sz = 0, Q = 0
 - 4S** when sz = 0, Q = 1
 - RESERVED** when sz = 1, Q = 0
 - 2D** when sz = 1, Q = 1
- <Vn> Is the name of the SIMD&FP source register, encoded in the "Rn" field.

Operation

```
CheckFPAdvSIMDEnabled64();
bits(datasize) operand = V[n];
bits(datasize) result;
bits(esize) element;

for e = 0 to elements-1
    element = Elem[operand, e, esize];
    Elem[result, e, esize] = FPRoundInt(element, FPCR, rounding, exact);

V[d] = result;
```

C6.3.135 FRINTM (scalar)

Floating-point round to integral, toward minus infinity (scalar): $Vd = \text{roundToIntegralTowardNegative}(Vn)$

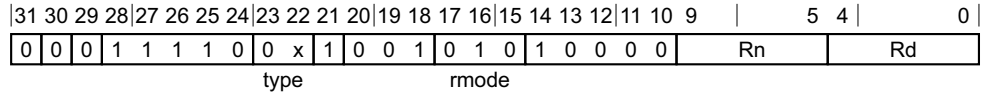

Single-precision variant (type = 00)

FRINTM <Sd>, <Sn>

Double-precision variant (type = 01)

FRINTM <Dd>, <Dn>

```
integer d = UInt(Rd);
integer n = UInt(Rn);

integer datasize;
case type of
    when '00' datasize = 32;
    when '01' datasize = 64;
    when '1x' UnallocatedEncoding();

boolean exact = FALSE;
FPRounding rounding;
case rmode of
    when '0xx' rounding = FPDecodeRounding(rmode<1:0>);
    when '100' rounding = FPRounding_TIEAWAY;
    when '101' UnallocatedEncoding();
    when '110' rounding = FPRoundingMode(FPCR); exact = TRUE;
    when '111' rounding = FPRoundingMode(FPCR);
```

Assembler Symbols

- <Dd> Is the 64-bit name of the SIMD&FP destination register, encoded in the "Rd" field.
- <Dn> Is the 64-bit name of the SIMD&FP source register, encoded in the "Rn" field.
- <Sd> Is the 32-bit name of the SIMD&FP destination register, encoded in the "Rd" field.
- <Sn> Is the 32-bit name of the SIMD&FP source register, encoded in the "Rn" field.

Operation

```
CheckFPAdvSIMDEnabled64();

bits(datasize) result;
bits(datasize) operand = V[n];

result = FPRoundInt(operand, FPCR, rounding, exact);

V[d] = result;
```

C6.3.136 FRINTN (vector)

Floating-point round to integral, to nearest with ties to even (vector)

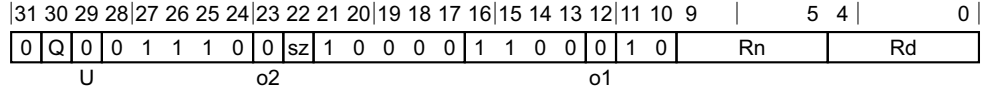

Vector variant

FRINTN <Vd>.<T>, <Vn>.<T>

```
integer d = UInt(Rd);
integer n = UInt(Rn);

if sz:Q == '10' then ReservedValue();
integer esize = 32 << UInt(sz);
integer datasize = if Q == '1' then 128 else 64;
integer elements = datasize DIV esize;

boolean exact = FALSE;
FPRounding rounding;
case U:o1:o2 of
    when '0xx' rounding = FPDecodeRounding(o1:o2);
    when '100' rounding = FPRounding_TIEAWAY;
    when '101' UnallocatedEncoding();
    when '110' rounding = FPRoundingMode(FPCR); exact = TRUE;
    when '111' rounding = FPRoundingMode(FPCR);
```

Assembler Symbols

- <Vd> Is the name of the SIMD&FP destination register, encoded in the "Rd" field.
- <T> Is an arrangement specifier,
 - 2S** when sz = 0, Q = 0
 - 4S** when sz = 0, Q = 1
 - RESERVED** when sz = 1, Q = 0
 - 2D** when sz = 1, Q = 1
- <Vn> Is the name of the SIMD&FP source register, encoded in the "Rn" field.

Operation

```
CheckFPAdvSIMDEnabled64();
bits(datasize) operand = V[n];
bits(datasize) result;
bits(esize) element;

for e = 0 to elements-1
    element = Elem[operand, e, esize];
    Elem[result, e, esize] = FPRoundInt(element, FPCR, rounding, exact);

V[d] = result;
```

C6.3.137 FRINTN (scalar)

Floating-point round to integral, to nearest with ties to even (scalar): $Vd = \text{roundToIntegralTiesToEven}(Vn)$

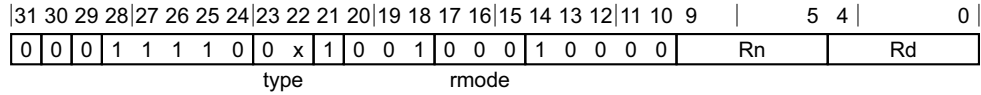

Single-precision variant (type = 00)

FRINTN <Sd>, <Sn>

Double-precision variant (type = 01)

FRINTN <Dd>, <Dn>

```
integer d = UInt(Rd);
integer n = UInt(Rn);

integer datasize;
case type of
    when '00' datasize = 32;
    when '01' datasize = 64;
    when '1x' UnallocatedEncoding();

boolean exact = FALSE;
FPRounding rounding;
case rmode of
    when '0xx' rounding = FPDecodeRounding(rmode<1:0>);
    when '100' rounding = FPRounding_TIEAWAY;
    when '101' UnallocatedEncoding();
    when '110' rounding = FPRoundingMode(FPCR); exact = TRUE;
    when '111' rounding = FPRoundingMode(FPCR);
```

Assembler Symbols

- <Dd> Is the 64-bit name of the SIMD&FP destination register, encoded in the "Rd" field.
- <Dn> Is the 64-bit name of the SIMD&FP source register, encoded in the "Rn" field.
- <Sd> Is the 32-bit name of the SIMD&FP destination register, encoded in the "Rd" field.
- <Sn> Is the 32-bit name of the SIMD&FP source register, encoded in the "Rn" field.

Operation

```
CheckFPAdvSIMDEnabled64();

bits(datasize) result;
bits(datasize) operand = V[n];

result = FPRoundInt(operand, FPCR, rounding, exact);

V[d] = result;
```

C6.3.138 FRINTP (vector)

Floating-point round to integral, toward positive infinity (vector)

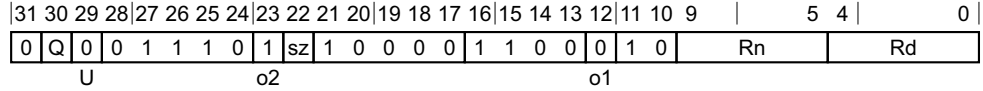

Vector variant

FRINTP <Vd>.<T>, <Vn>.<T>

```
integer d = UInt(Rd);
integer n = UInt(Rn);

if sz:Q == '10' then ReservedValue();
integer esize = 32 << UInt(sz);
integer datasize = if Q == '1' then 128 else 64;
integer elements = datasize DIV esize;

boolean exact = FALSE;
FPRounding rounding;
case U:o1:o2 of
    when '0xx' rounding = FPDecodeRounding(o1:o2);
    when '100' rounding = FPRounding_TIEAWAY;
    when '101' UnallocatedEncoding();
    when '110' rounding = FPRoundingMode(FPCR); exact = TRUE;
    when '111' rounding = FPRoundingMode(FPCR);
```

Assembler Symbols

- <Vd> Is the name of the SIMD&FP destination register, encoded in the "Rd" field.
- <T> Is an arrangement specifier,
 - 2S** when sz = 0, Q = 0
 - 4S** when sz = 0, Q = 1
 - RESERVED** when sz = 1, Q = 0
 - 2D** when sz = 1, Q = 1
- <Vn> Is the name of the SIMD&FP source register, encoded in the "Rn" field.

Operation

```
CheckFPAdvSIMDEnabled64();
bits(datasize) operand = V[n];
bits(datasize) result;
bits(esize) element;

for e = 0 to elements-1
    element = Elem[operand, e, esize];
    Elem[result, e, esize] = FPRoundInt(element, FPCR, rounding, exact);

V[d] = result;
```

C6.3.139 FRINTP (scalar)

Floating-point round to integral, toward positive infinity (scalar): $Vd = \text{roundToIntegralTowardPositive}(Vn)$

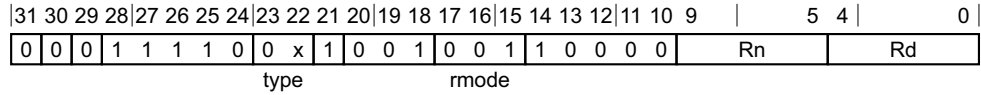

Single-precision variant (type = 00)

FRINTP <Sd>, <Sn>

Double-precision variant (type = 01)

FRINTP <Dd>, <Dn>

```
integer d = UInt(Rd);
integer n = UInt(Rn);

integer datasize;
case type of
    when '00' datasize = 32;
    when '01' datasize = 64;
    when '1x' UnallocatedEncoding();

boolean exact = FALSE;
FPRounding rounding;
case rmode of
    when '0xx' rounding = FPDecodeRounding(rmode<1:0>);
    when '100' rounding = FPRounding_TIEAWAY;
    when '101' UnallocatedEncoding();
    when '110' rounding = FPRoundingMode(FPCR); exact = TRUE;
    when '111' rounding = FPRoundingMode(FPCR);
```

Assembler Symbols

- <Dd> Is the 64-bit name of the SIMD&FP destination register, encoded in the "Rd" field.
- <Dn> Is the 64-bit name of the SIMD&FP source register, encoded in the "Rn" field.
- <Sd> Is the 32-bit name of the SIMD&FP destination register, encoded in the "Rd" field.
- <Sn> Is the 32-bit name of the SIMD&FP source register, encoded in the "Rn" field.

Operation

```
CheckFPAdvSIMDEnabled64();

bits(datasize) result;
bits(datasize) operand = V[n];

result = FPRoundInt(operand, FPCR, rounding, exact);

V[d] = result;
```

C6.3.140 FRINTX (vector)

Floating-point round to integral exact, using current rounding mode (vector)

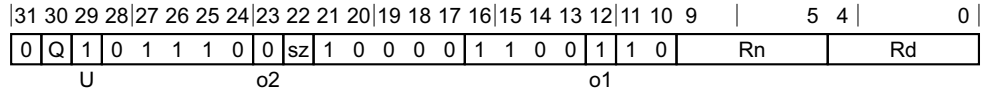

Vector variant

FRINTX <Vd>.<T>, <Vn>.<T>

```
integer d = UInt(Rd);
integer n = UInt(Rn);

if sz:Q == '10' then ReservedValue();
integer esize = 32 << UInt(sz);
integer datasize = if Q == '1' then 128 else 64;
integer elements = datasize DIV esize;

boolean exact = FALSE;
FPRounding rounding;
case U:o1:o2 of
    when '0xx' rounding = FPDecodeRounding(o1:o2);
    when '100' rounding = FPRounding_TIEAWAY;
    when '101' UnallocatedEncoding();
    when '110' rounding = FPRoundingMode(FPCR); exact = TRUE;
    when '111' rounding = FPRoundingMode(FPCR);
```

Assembler Symbols

<Vd> Is the name of the SIMD&FP destination register, encoded in the "Rd" field.

<T> Is an arrangement specifier,

2S	when sz = 0, Q = 0
4S	when sz = 0, Q = 1
RESERVED	when sz = 1, Q = 0
2D	when sz = 1, Q = 1

<Vn> Is the name of the SIMD&FP source register, encoded in the "Rn" field.

Operation

```
CheckFPAdvSIMDEnabled64();
bits(datasize) operand = V[n];
bits(datasize) result;
bits(esize) element;

for e = 0 to elements-1
    element = Elem[operand, e, esize];
    Elem[result, e, esize] = FPRoundInt(element, FPCR, rounding, exact);

V[d] = result;
```

C6.3.141 FRINTX (scalar)

Floating-point round to integral exact, using current rounding mode (scalar): $Vd = \text{roundToIntegralExact}(Vn)$

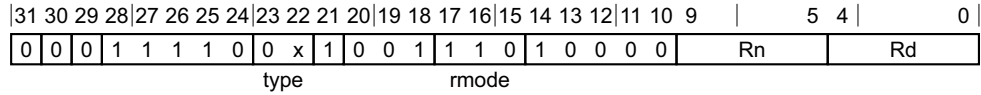

Single-precision variant (type = 00)

FRINTX <Sd>, <Sn>

Double-precision variant (type = 01)

FRINTX <Dd>, <Dn>

```
integer d = UInt(Rd);
integer n = UInt(Rn);

integer datasize;
case type of
    when '00' datasize = 32;
    when '01' datasize = 64;
    when '1x' UnallocatedEncoding();

boolean exact = FALSE;
FPRounding rounding;
case rmode of
    when '0xx' rounding = FPDecodeRounding(rmode<1:0>);
    when '100' rounding = FPRounding_TIEAWAY;
    when '101' UnallocatedEncoding();
    when '110' rounding = FPRoundingMode(FPCR); exact = TRUE;
    when '111' rounding = FPRoundingMode(FPCR);
```

Assembler Symbols

- <Dd> Is the 64-bit name of the SIMD&FP destination register, encoded in the "Rd" field.
- <Dn> Is the 64-bit name of the SIMD&FP source register, encoded in the "Rn" field.
- <Sd> Is the 32-bit name of the SIMD&FP destination register, encoded in the "Rd" field.
- <Sn> Is the 32-bit name of the SIMD&FP source register, encoded in the "Rn" field.

Operation

```
CheckFPAdvSIMDEnabled64();

bits(datasize) result;
bits(datasize) operand = V[n];

result = FPRoundInt(operand, FPCR, rounding, exact);

V[d] = result;
```

C6.3.142 FRINTZ (vector)

Floating-point round to integral, toward zero (vector)

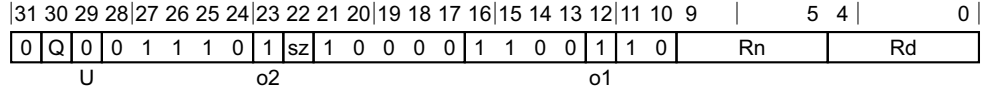

Vector variant

FRINTZ <Vd>.<T>, <Vn>.<T>

```
integer d = UInt(Rd);
integer n = UInt(Rn);

if sz:Q == '10' then ReservedValue();
integer esize = 32 << UInt(sz);
integer datasize = if Q == '1' then 128 else 64;
integer elements = datasize DIV esize;

boolean exact = FALSE;
FPRounding rounding;
case U:o1:o2 of
    when '0xx' rounding = FPDecodeRounding(o1:o2);
    when '100' rounding = FPRounding_TIEAWAY;
    when '101' UnallocatedEncoding();
    when '110' rounding = FPRoundingMode(FPCR); exact = TRUE;
    when '111' rounding = FPRoundingMode(FPCR);
```

Assembler Symbols

- <Vd> Is the name of the SIMD&FP destination register, encoded in the "Rd" field.
- <T> Is an arrangement specifier,
 - 2S** when sz = 0, Q = 0
 - 4S** when sz = 0, Q = 1
 - RESERVED** when sz = 1, Q = 0
 - 2D** when sz = 1, Q = 1
- <Vn> Is the name of the SIMD&FP source register, encoded in the "Rn" field.

Operation

```
CheckFPAdvSIMDEnabled64();
bits(datasize) operand = V[n];
bits(datasize) result;
bits(esize) element;

for e = 0 to elements-1
    element = Elem[operand, e, esize];
    Elem[result, e, esize] = FPRoundInt(element, FPCR, rounding, exact);

V[d] = result;
```

C6.3.143 FRINTZ (scalar)

Floating-point round to integral, toward zero (scalar): $Vd = \text{roundToIntegralTowardZero}(Vn)$

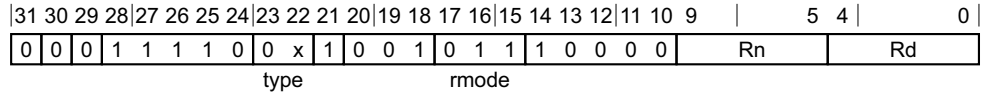

Single-precision variant (type = 00)

FRINTZ <Sd>, <Sn>

Double-precision variant (type = 01)

FRINTZ <Dd>, <Dn>

```
integer d = UInt(Rd);
integer n = UInt(Rn);

integer datasize;
case type of
    when '00' datasize = 32;
    when '01' datasize = 64;
    when '1x' UnallocatedEncoding();

boolean exact = FALSE;
FPRounding rounding;
case rmode of
    when '0xx' rounding = FPDecodeRounding(rmode<1:0>);
    when '100' rounding = FPRounding_TIEAWAY;
    when '101' UnallocatedEncoding();
    when '110' rounding = FPRoundingMode(FPCR); exact = TRUE;
    when '111' rounding = FPRoundingMode(FPCR);
```

Assembler Symbols

- <Dd> Is the 64-bit name of the SIMD&FP destination register, encoded in the "Rd" field.
- <Dn> Is the 64-bit name of the SIMD&FP source register, encoded in the "Rn" field.
- <Sd> Is the 32-bit name of the SIMD&FP destination register, encoded in the "Rd" field.
- <Sn> Is the 32-bit name of the SIMD&FP source register, encoded in the "Rn" field.

Operation

```
CheckFPAdvSIMDEnabled64();

bits(datasize) result;
bits(datasize) operand = V[n];

result = FPRoundInt(operand, FPCR, rounding, exact);

V[d] = result;
```

C6.3.144 FRSQRTE

Floating-point reciprocal square root estimate

It has encodings from 2 classes: *Scalar* and *Vector*

Scalar

31	30	29	28	27	26	25	24	23	22	21	20	19	18	17	16	15	14	13	12	11	10	9				5	4			0
0	1	1	1	1	1	1	0	1	sz	1	0	0	0	0	1	1	1	0	1	1	0	Rn			Rd					

Scalar variant

FRSQRTE <V><d>, <V><n>

integer d = UInt(Rd);
 integer n = UInt(Rn);

integer esize = 32 << UInt(sz);
 integer datasize = esize;
 integer elements = 1;

Vector

31	30	29	28	27	26	25	24	23	22	21	20	19	18	17	16	15	14	13	12	11	10	9				5	4			0
0	Q	1	0	1	1	1	0	1	sz	1	0	0	0	0	1	1	1	0	1	1	0	Rn			Rd					

Vector variant

FRSQRTE <Vd>.<T>, <Vn>.<T>

integer d = UInt(Rd);
 integer n = UInt(Rn);

if sz:Q == '10' then ReservedValue();
 integer esize = 32 << UInt(sz);
 integer datasize = if Q == '1' then 128 else 64;
 integer elements = datasize DIV esize;

Assembler Symbols

- <V> Is a width specifier,
 - S** when sz = 0
 - D** when sz = 1
- <d> Is the number of the SIMD&FP destination register, encoded in the "Rd" field.
- <n> Is the number of the SIMD&FP source register, encoded in the "Rn" field.
- <Vd> Is the name of the SIMD&FP destination register, encoded in the "Rd" field.
- <T> Is an arrangement specifier,
 - 2S** when sz = 0, Q = 0
 - 4S** when sz = 0, Q = 1
 - RESERVED** when sz = 1, Q = 0
 - 2D** when sz = 1, Q = 1
- <Vn> Is the name of the SIMD&FP source register, encoded in the "Rn" field.

Operation for all classes

```
CheckFPAdvSIMDEnabled64();  
bits(datasize) operand = V[n];  
bits(datasize) result;  
bits(esize) element;  
  
for e = 0 to elements-1  
    element = Elem[operand, e, esize];  
    Elem[result, e, esize] = FPRSqrtEstimate(element, FPCR);  
  
V[d] = result;
```

C6.3.145 FRSQRTS

Floating-point reciprocal square root step

It has encodings from 2 classes: *Scalar* and *Vector*

Scalar

31	30	29	28	27	26	25	24	23	22	21	20	16	15	14	13	12	11	10	9	5	4	0
0	1	0	1	1	1	1	0	1	sz	1	Rm	1	1	1	1	1	1	Rn	Rd			

Scalar variant

FRSQRTS <V><d>, <V><n>, <V><m>

```
integer d = UInt(Rd);
integer n = UInt(Rn);
integer m = UInt(Rm);
integer esize = 32 << UInt(sz);
integer datasize = esize;
integer elements = 1;
```

Vector

31	30	29	28	27	26	25	24	23	22	21	20	16	15	14	13	12	11	10	9	5	4	0
0	Q	0	0	1	1	1	0	1	sz	1	Rm	1	1	1	1	1	1	Rn	Rd			

Vector variant

FRSQRTS <Vd>.<T>, <Vn>.<T>, <Vm>.<T>

```
integer d = UInt(Rd);
integer n = UInt(Rn);
integer m = UInt(Rm);
if sz:Q == '10' then ReservedValue();
integer esize = 32 << UInt(sz);
integer datasize = if Q == '1' then 128 else 64;
integer elements = datasize DIV esize;
```

Assembler Symbols

<V>	Is a width specifier, S when sz = 0 D when sz = 1
<d>	Is the number of the SIMD&FP destination register, in the "Rd" field.
<n>	Is the number of the first SIMD&FP source register, encoded in the "Rn" field.
<m>	Is the number of the second SIMD&FP source register, encoded in the "Rm" field.
<Vd>	Is the name of the SIMD&FP destination register, encoded in the "Rd" field.
<T>	Is an arrangement specifier, 2S when sz = 0, Q = 0 4S when sz = 0, Q = 1 RESERVED when sz = 1, Q = 0 2D when sz = 1, Q = 1

- <Vn> Is the name of the first SIMD&FP source register, encoded in the "Rn" field.
- <Vm> Is the name of the second SIMD&FP source register, encoded in the "Rm" field.

Operation for all classes

```
CheckFPAdvSIMDEnabled64();
bits(datasize) operand1 = V[n];
bits(datasize) operand2 = V[m];
bits(datasize) result;
bits(esize) element1;
bits(esize) element2;

for e = 0 to elements-1
    element1 = Elem[operand1, e, esize];
    element2 = Elem[operand2, e, esize];
    Elem[result, e, esize] = FPRSqrtStepFused(element1, element2);

V[d] = result;
```

C6.3.146 FSQRT (vector)

Floating-point square root (vector)

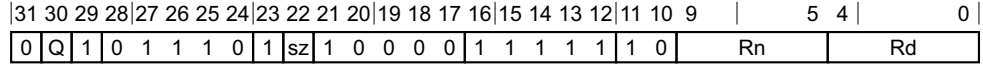

Vector variant

FSQRT <Vd>.<T>, <Vn>.<T>

```
integer d = UInt(Rd);
integer n = UInt(Rn);
```

```
if sz:Q == '10' then ReservedValue();
integer esize = 32 << UInt(sz);
integer datasize = if Q == '1' then 128 else 64;
integer elements = datasize DIV esize;
```

Assembler Symbols

<Vd> Is the name of the SIMD&FP destination register, encoded in the "Rd" field.

<T> Is an arrangement specifier,
2S when sz = 0, Q = 0
4S when sz = 0, Q = 1
RESERVED when sz = 1, Q = 0
2D when sz = 1, Q = 1

<Vn> Is the name of the SIMD&FP source register, encoded in the "Rn" field.

Operation

```
CheckFPAdvSIMDEnabled64();
bits(datasize) operand = V[n];
bits(datasize) result;
bits(esome) element;

for e = 0 to elements-1
    element = Elem[operand, e, esize];
    Elem[result, e, esize] = FPSqrt(element, FPCR);

V[d] = result;
```

C6.3.147 FSQRT (scalar)

Floating-point square root (scalar): $Vd = \text{sqrt}(Vn)$

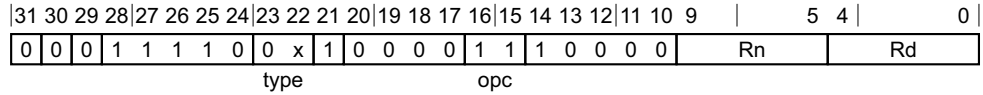

Single-precision variant (type = 00)

FSQRT <Sd>, <Sn>

Double-precision variant (type = 01)

FSQRT <Dd>, <Dn>

```
integer d = UInt(Rd);
integer n = UInt(Rn);

integer datasize;
case type of
    when '00' datasize = 32;
    when '01' datasize = 64;
    when '1x' UnallocatedEncoding();

FPUUnaryOp fpop;
case opc of
    when '00' fpop = FPUUnaryOp_MOV;
    when '01' fpop = FPUUnaryOp_ABS;
    when '10' fpop = FPUUnaryOp_NEG;
    when '11' fpop = FPUUnaryOp_SQRT;
```

Assembler Symbols

- <Dd> Is the 64-bit name of the SIMD&FP destination register, encoded in the "Rd" field.
- <Dn> Is the 64-bit name of the SIMD&FP source register, encoded in the "Rn" field.
- <Sd> Is the 32-bit name of the SIMD&FP destination register, encoded in the "Rd" field.
- <Sn> Is the 32-bit name of the SIMD&FP source register, encoded in the "Rn" field.

Operation

```
CheckFPAdvSIMDEnabled64();

bits(datasize) result;
bits(datasize) operand = V[n];

case fpop of
    when FPUUnaryOp_MOV result = operand;
    when FPUUnaryOp_ABS result = FPAbs(operand);
    when FPUUnaryOp_NEG result = FPNeg(operand);
    when FPUUnaryOp_SQRT result = FPSqrt(operand, FPCR);

V[d] = result;
```

C6.3.148 FSUB (vector)

Floating-point subtract (vector)

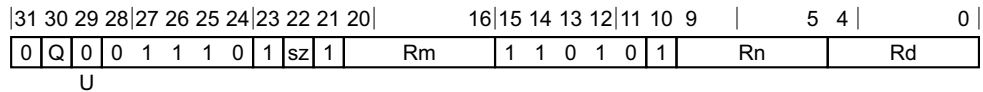

Three registers of the same type variant

FSUB <Vd>.<T>, <Vn>.<T>, <Vm>.<T>

```
integer d = UInt(Rd);
integer n = UInt(Rn);
integer m = UInt(Rm);
if sz:Q == '10' then ReservedValue();
integer esize = 32 << UInt(sz);
integer datasize = if Q == '1' then 128 else 64;
integer elements = datasize DIV esize;
boolean abs = (U == '1');
```

Assembler Symbols

- <Vd> Is the name of the SIMD&FP destination register, encoded in the "Rd" field.
- <T> Is an arrangement specifier,
 - 2S** when sz = 0, Q = 0
 - 4S** when sz = 0, Q = 1
 - RESERVED** when sz = 1, Q = 0
 - 2D** when sz = 1, Q = 1
- <Vn> Is the name of the first SIMD&FP source register, encoded in the "Rn" field.
- <Vm> Is the name of the second SIMD&FP source register, encoded in the "Rm" field.

Operation

```
CheckFPAdvSIMDEnabled64();
bits(datasize) operand1 = V[n];
bits(datasize) operand2 = V[m];
bits(datasize) result;
bits(esize) element1;
bits(esize) element2;
bits(esize) diff;

for e = 0 to elements-1
    element1 = Elem[operand1, e, esize];
    element2 = Elem[operand2, e, esize];
    diff = FPSub(element1, element2, FPCR);
    Elem[result, e, esize] = if abs then FPAbs(diff) else diff;

V[d] = result;
```

C6.3.149 FSUB (scalar)

Floating-point subtract (scalar): $Vd = Vn - Vm$

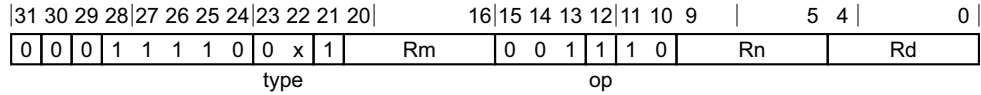

Single-precision variant (type = 00)

FSUB <Sd>, <Sn>, <Sm>

Double-precision variant (type = 01)

FSUB <Dd>, <Dn>, <Dm>

```
integer d = UInt(Rd);
integer n = UInt(Rn);
integer m = UInt(Rm);

integer datasize;
case type of
    when '00' datasize = 32;
    when '01' datasize = 64;
    when '1x' UnallocatedEncoding();

boolean sub_op = (op == '1');
```

Assembler Symbols

- <Dd> Is the 64-bit name of the SIMD&FP destination register, encoded in the "Rd" field.
- <Dn> Is the 64-bit name of the first SIMD&FP source register, encoded in the "Rn" field.
- <Dm> Is the 64-bit name of the second SIMD&FP source register, encoded in the "Rm" field.
- <Sd> Is the 32-bit name of the SIMD&FP destination register, encoded in the "Rd" field.
- <Sn> Is the 32-bit name of the first SIMD&FP source register, encoded in the "Rn" field.
- <Sm> Is the 32-bit name of the second SIMD&FP source register, encoded in the "Rm" field.

Operation

```
CheckFPAdvSIMDEnabled64();
bits(datasize) result;
bits(datasize) operand1 = V[n];
bits(datasize) operand2 = V[m];

if sub_op then
    result = FPSub(operand1, operand2, FPCR);
else
    result = FPAdd(operand1, operand2, FPCR);

V[d] = result;
```

C6.3.150 INS (element)

Insert vector element from another vector element

This instruction is used by the alias [MOV \(element\)](#). The alias is always the preferred disassembly.

31	30	29	28	27	26	25	24	23	22	21	20	16	15	14	11	10	9	5	4	0
0	1	1	0	1	1	1	0	0	0	0	imm5	0	imm4	1	Rn					Rd

Advanced SIMD variant

INS <Vd>.<Ts>[<index1>], <Vn>.<Ts>[<index2>]

```
integer d = UInt(Rd);
integer n = UInt(Rn);

integer size = LowestSetBit(imm5);
if size > 3 then UnallocatedEncoding();

integer dst_index = UInt(imm5<4:size+1>);
integer src_index = UInt(imm4<3:size>);
integer idxsize = if imm4<3> == '1' then 128 else 64;
// imm4<size-1:0> is IGNORED

integer esize = 8 << size;
```

Assembler Symbols

- <Vd> Is the name of the SIMD&FP destination register, encoded in the "Rd" field.
- <Ts> Is an element size specifier,
 - RESERVED** when imm5 = x0000
 - B** when imm5 = xxxx1
 - H** when imm5 = xxx10
 - S** when imm5 = xx100
 - D** when imm5 = x1000
- <index1> Is the destination element index
 - RESERVED** when imm5 = x0000
 - imm5<4:1>** when imm5 = xxxx1
 - imm5<4:2>** when imm5 = xxx10
 - imm5<4:3>** when imm5 = xx100
 - imm5<4>** when imm5 = x1000
- <Vn> Is the name of the SIMD&FP source register, encoded in the "Rn" field.
- <index2> Is the source element index
 - RESERVED** when imm5 = x0000
 - imm4<3:0>** when imm5 = xxxx1
 - imm4<3:1>** when imm5 = xxx10
 - imm4<3:2>** when imm5 = xx100
 - imm4<3>** when imm5 = x1000

Unspecified bits in "imm4" are ignored but should be set to zero by an assembler.

Operation

```
CheckFPAdvSIMDEnabled64();  
bits(idxsize) operand = V[n];  
bits(128) result;  
  
result = V[d];  
Elem[result, dst_index, esize] = Elem[operand, src_index, esize];  
V[d] = result;
```

C6.3.151 INS (general)

Insert vector element from general-purpose register

This instruction is used by the alias [MOV \(from general\)](#). The alias is always the preferred disassembly.

31	30	29	28	27	26	25	24	23	22	21	20	16	15	14	13	12	11	10	9	5	4	0
0	1	0	0	1	1	1	0	0	0	0	imm5	0	0	0	1	1	1	Rn	Rd			

Advanced SIMD variant

INS <Vd>.<Ts>[<index>], <R><n>

```
integer d = UInt(Rd);
integer n = UInt(Rn);
```

```
integer size = LowestSetBit(imm5);
```

```
if size > 3 then UnallocatedEncoding();
integer index = UInt(imm5<4:size+1>);
```

```
integer esize = 8 << size;
integer datasize = 128;
```

Assembler Symbols

- <Vd> Is the name of the SIMD&FP destination register, encoded in the "Rd" field.
- <Ts> Is an element size specifier,
RESERVED when imm5 = x0000
B when imm5 = xxxx1
H when imm5 = xxx10
S when imm5 = xx100
D when imm5 = x1000
- <index> Is the element index
RESERVED when imm5 = x0000
imm5<4:1> when imm5 = xxxx1
imm5<4:2> when imm5 = xxx10
imm5<4:3> when imm5 = xx100
imm5<4> when imm5 = x1000
- <R> Is the width specifier for the general-purpose source register,
RESERVED when imm5 = x0000
W when imm5 = xxxx1
W when imm5 = xxx10
W when imm5 = xx100
X when imm5 = x1000
- <n> Is the number [0-30] of the general-purpose source register or ZR (31), encoded in the "Rn" field.

Operation

```
CheckFPAdvSIMDEnabled64();  
bits(esize) element = X[n];  
bits(datasize) result;  
  
result = V[d];  
Elem[result, index, esize] = element;  
V[d] = result;
```

C6.3.152 LD1 (multiple structures)

Load multiple 1-element structures to one, two, three or four registers

It has encodings from 2 classes: *No offset* and *Post-index*

No offset

31	30	29	28	27	26	25	24	23	22	21	20	19	18	17	16	15	14	13	12	11	10	9	5	4	0
0	Q	0	0	1	1	0	0	0	1	0	0	0	0	0	0	x	x	1	x	size	Rn				Rt
L											opcode														

One register variant (opcode = 0111)

LD1 { <Vt>.<T> }, [<Xn|SP>]

Two registers variant (opcode = 1010)

LD1 { <Vt>.<T>, <Vt2>.<T> }, [<Xn|SP>]

Three registers variant (opcode = 0110)

LD1 { <Vt>.<T>, <Vt2>.<T>, <Vt3>.<T> }, [<Xn|SP>]

Four registers variant (opcode = 0010)

LD1 { <Vt>.<T>, <Vt2>.<T>, <Vt3>.<T>, <Vt4>.<T> }, [<Xn|SP>]

```
integer t = UInt(Rt);
integer n = UInt(Rn);
integer m = integer UNKNOWN;
boolean wback = FALSE;
```

Post-index

31	30	29	28	27	26	25	24	23	22	21	20	16	15	14	13	12	11	10	9	5	4	0		
0	Q	0	0	1	1	0	0	1	1	0		Rm	x	x	1	x	size	Rn					Rt	
L											opcode													

One register, immediate offset variant (Rm = 11111, opcode = 0111)

LD1 { <Vt>.<T> }, [<Xn|SP>], <imm>

One register, register offset variant (Rm != 11111, opcode = 0111)

LD1 { <Vt>.<T> }, [<Xn|SP>], <Xm>

Two registers, immediate offset variant (Rm = 11111, opcode = 1010)

LD1 { <Vt>.<T>, <Vt2>.<T> }, [<Xn|SP>], <imm>

Two registers, register offset variant (Rm != 11111, opcode = 1010)

LD1 { <Vt>.<T>, <Vt2>.<T> }, [<Xn|SP>], <Xm>

Three registers, immediate offset variant (Rm = 11111, opcode = 0110)

LD1 { <Vt>.<T>, <Vt2>.<T>, <Vt3>.<T> }, [<Xn|SP>], <imm>

Three registers, register offset variant (Rm != 11111, opcode = 0110)

LD1 { <Vt>.<T>, <Vt2>.<T>, <Vt3>.<T> }, [<Xn|SP>], <Xm>

Four registers, immediate offset variant (Rm = 11111, opcode = 0010)

LD1 { <Vt>.<T>, <Vt2>.<T>, <Vt3>.<T>, <Vt4>.<T> }, [<Xn|SP>], <imm>

Four registers, register offset variant (Rm != 11111, opcode = 0010)

LD1 { <Vt>.<T>, <Vt2>.<T>, <Vt3>.<T>, <Vt4>.<T> }, [<Xn|SP>], <Xm>

```
integer t = UInt(Rt);
integer n = UInt(Rn);
integer m = UInt(Rm);
boolean wback = TRUE;
```

Assembler Symbols

<Vt>	Is the name of the first or only SIMD&FP register to be transferred, encoded in the "Rt" field.
<T>	Is an arrangement specifier, <ul style="list-style-type: none"> 8B when size = 00, Q = 0 16B when size = 00, Q = 1 4H when size = 01, Q = 0 8H when size = 01, Q = 1 2S when size = 10, Q = 0 4S when size = 10, Q = 1 1D when size = 11, Q = 0 2D when size = 11, Q = 1
<Vt2>	Is the name of the second SIMD&FP register to be transferred, encoded as "Rt" plus 1 modulo 32.
<Vt3>	Is the name of the third SIMD&FP register to be transferred, encoded as "Rt" plus 2 modulo 32.
<Vt4>	Is the name of the fourth SIMD&FP register to be transferred, encoded as "Rt" plus 3 modulo 32.
<Xn SP>	Is the 64-bit name of the general-purpose base register or stack pointer, encoded in the "Rn" field.
<imm>	For the one register, immediate offset variant: is the post-index immediate offset, <ul style="list-style-type: none"> #8 when Q = 0 #16 when Q = 1
<imm>	For the two registers, immediate offset variant: is the post-index immediate offset, <ul style="list-style-type: none"> #16 when Q = 0 #32 when Q = 1
<imm>	For the three registers, immediate offset variant: is the post-index immediate offset, <ul style="list-style-type: none"> #24 when Q = 0 #48 when Q = 1
<imm>	For the four registers, immediate offset variant: is the post-index immediate offset, <ul style="list-style-type: none"> #32 when Q = 0 #64 when Q = 1
<Xm>	Is the 64-bit name of the general-purpose post-index register, excluding XZR, encoded in the "Rm" field.

Shared decode for all variants

```
MemOp memop = if L == '1' then MemOp_LOAD else MemOp_STORE;
integer datasize = if Q == '1' then 128 else 64;
integer esize = 8 << UInt(size);
integer elements = datasize DIV esize;

integer rpt; // number of iterations
integer selem; // structure elements

case opcode of
    when '0000' rpt = 1; selem = 4; // LD/ST4 (4 registers)
```

```

when '0010' rpt = 4; selem = 1; // LD/ST1 (4 registers)
when '0100' rpt = 1; selem = 3; // LD/ST3 (3 registers)
when '0110' rpt = 3; selem = 1; // LD/ST1 (3 registers)
when '0111' rpt = 1; selem = 1; // LD/ST1 (1 register)
when '1000' rpt = 1; selem = 2; // LD/ST2 (2 registers)
when '1010' rpt = 2; selem = 1; // LD/ST1 (2 registers)
otherwise UnallocatedEncoding();

// .1D format only permitted with LD1 & ST1
if size:Q == '110' && selem != 1 then ReservedValue();

```

Operation for all classes

```

CheckFPAdvSIMDEnabled64();

bits(64) address;
bits(64) offs;
bits(datasize) rval;
integer e, r, s, tt;
constant integer ebytes = esize DIV 8;

if n == 31 then
  CheckSPAlignment();
  address = SP[];
else
  address = X[n];

offs = Zeros();
for r = 0 to rpt-1
  for e = 0 to elements-1
    tt = (t + r) MOD 32;
    for s = 0 to selem-1
      rval = V[tt];
      if memop == MemOp_LOAD then
        Elem[rval, e, esize] = Mem[address + offs, ebytes, AccType_VEC];
        V[tt] = rval;
      else // memop == MemOp_STORE
        Mem[address + offs, ebytes, AccType_VEC] = Elem[rval, e, esize];
        offs = offs + ebytes;
        tt = (tt + 1) MOD 32;

if wback then
  if m != 31 then
    offs = X[m];
  if n == 31 then
    SP[] = address + offs;
  else
    X[n] = address + offs;

```

C6.3.153 LD1 (single structure)

Load single 1-element structure to one lane of one register

It has encodings from 2 classes: *No offset* and *Post-index*

No offset

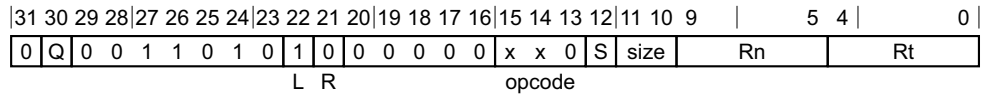

8-bit variant (opcode = 000)

LD1 { <Vt>.B }[<index>], [<Xn|SP>]

16-bit variant (opcode = 010, size = x0)

LD1 { <Vt>.H }[<index>], [<Xn|SP>]

32-bit variant (opcode = 100, size = 00)

LD1 { <Vt>.S }[<index>], [<Xn|SP>]

64-bit variant (opcode = 100, S = 0, size = 01)

LD1 { <Vt>.D }[<index>], [<Xn|SP>]

```
integer t = UInt(Rt);
integer n = UInt(Rn);
integer m = integer UNKNOWN;
boolean wback = FALSE;
```

Post-index

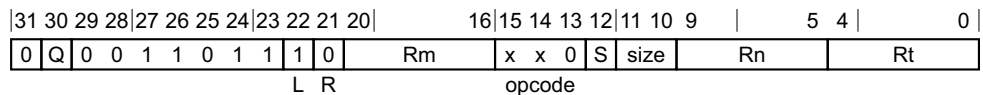

8-bit, immediate offset variant (Rm = 11111, opcode = 000)

LD1 { <Vt>.B }[<index>], [<Xn|SP>], #1

8-bit, register offset variant (Rm != 11111, opcode = 000)

LD1 { <Vt>.B }[<index>], [<Xn|SP>], <Xm>

16-bit, immediate offset variant (Rm = 11111, opcode = 010, size = x0)

LD1 { <Vt>.H }[<index>], [<Xn|SP>], #2

16-bit, register offset variant (Rm != 11111, opcode = 010, size = x0)

LD1 { <Vt>.H }[<index>], [<Xn|SP>], <Xm>

32-bit, immediate offset variant (Rm = 11111, opcode = 100, size = 00)

LD1 { <Vt>.S }[<index>], [<Xn|SP>], #4

32-bit, register offset variant (Rm != 11111, opcode = 100, size = 00)

LD1 { <Vt>.S }[<index>], [<Xn|SP>], <Xm>

64-bit, immediate offset variant (Rm = 11111, opcode = 100, S = 0, size = 01)

LD1 { <Vt>.D }[<index>], [<Xn|SP>], #8

64-bit, register offset variant (Rm != 11111, opcode = 100, S = 0, size = 01)

```
LDI { <Vt>.D }[<i>index</i>], [<Xn|SP>], <Xm>
```

```
integer t = UInt(Rt);
integer n = UInt(Rn);
integer m = UInt(Rm);
boolean wback = TRUE;
```

Assembler Symbols

<Vt>	Is the name of the first or only SIMD&FP register to be transferred, encoded in the Rt field.
<i>index</i>	For the 8-bit variant: is the element index, encoded in Q:S:size.
<i>index</i>	For the 16-bit variant: is the element index, encoded in Q:S:size<1>.
<i>index</i>	For the 32-bit variant: is the element index, encoded in Q:S.
<i>index</i>	For the 64-bit variant: is the element index, encoded in Q.
<Xn SP>	Is the 64-bit name of the general-purpose base register or stack pointer, encoded in the Rn field.
<Xm>	Is the 64-bit name of the general-purpose post-index register, excluding XZR, encoded in the Rm field.

Shared decode for all variants

```
integer scale = UInt(opcode<2:1>);
integer selem = UInt(opcode<0>:R) + 1;
boolean replicate = FALSE;
integer index;

case scale of
  when 3
    // load and replicate
    if L == '0' || S == '1' then UnallocatedEncoding();
    scale = UInt(size);
    replicate = TRUE;
  when 0
    index = UInt(Q:S:size); // B[0-15]
  when 1
    if size<0> == '1' then UnallocatedEncoding();
    index = UInt(Q:S:size<1>); // H[0-7]
  when 2
    if size<1> == '1' then UnallocatedEncoding();
    if size<0> == '0' then
      index = UInt(Q:S); // S[0-3]
    else
      if S == '1' then UnallocatedEncoding();
      index = UInt(Q); // D[0-1]
      scale = 3;

MemOp memop = if L == '1' then MemOp_LOAD else MemOp_STORE;
integer datasize = if Q == '1' then 128 else 64;
integer esize = 8 << scale;
```

Operation for all classes

```
CheckFPAdvSIMDEnabled64();

bits(64) address;
bits(64) offs;
bits(128) rval;
bits(esize) element;
integer s;
```

```

constant integer ebytes = esize DIV 8;

if n == 31 then
    CheckSPAlignment();
    address = SP[];
else
    address = X[n];

offs = Zeros();
if replicate then
    // load and replicate to all elements
    for s = 0 to selem-1
        element = Mem[address + offs, ebytes, AccType_VEC];
        // replicate to fill 128- or 64-bit register
        V[t] = Replicate(element, datasize DIV esize);
        offs = offs + ebytes;
        t = (t + 1) MOD 32;
else
    // load/store one element per register
    for s = 0 to selem-1
        rval = V[t];
        if memop == MemOp_LOAD then
            // insert into one lane of 128-bit register
            Elem[rval, index, esize] = Mem[address + offs, ebytes, AccType_VEC];
            V[t] = rval;
        else // memop == MemOp_STORE
            // extract from one lane of 128-bit register
            Mem[address + offs, ebytes, AccType_VEC] = Elem[rval, index, esize];
        offs = offs + ebytes;
        t = (t + 1) MOD 32;

if wback then
    if m != 31 then
        offs = X[m];
    if n == 31 then
        SP[] = address + offs;
    else
        X[n] = address + offs;

```

C6.3.154 LD1R

Load single 1-element structure and replicate to all lanes (of one register)

It has encodings from 2 classes: *No offset* and *Post-index*

No offset

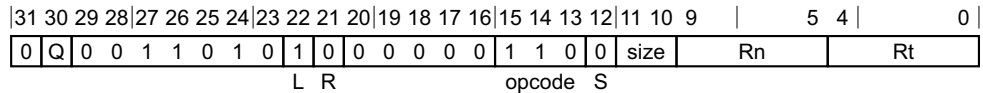

No offset variant

LD1R { <Vt>.<T> }, [<Xn|SP>]

```
integer t = UInt(Rt);
integer n = UInt(Rn);
integer m = integer UNKNOWN;
boolean wback = FALSE;
```

Post-index

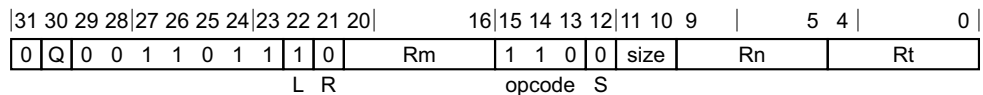

Immediate offset variant (Rm = 11111)

LD1R { <Vt>.<T> }, [<Xn|SP>], <imm>

Register offset variant (Rm != 11111)

LD1R { <Vt>.<T> }, [<Xn|SP>], <Xm>

```
integer t = UInt(Rt);
integer n = UInt(Rn);
integer m = UInt(Rm);
boolean wback = TRUE;
```

Assembler Symbols

<Vt> Is the name of the first or only SIMD&FP register to be transferred, encoded in the "Rt" field.

<T> Is an arrangement specifier,

8B	when size = 00, Q = 0
16B	when size = 00, Q = 1
4H	when size = 01, Q = 0
8H	when size = 01, Q = 1
2S	when size = 10, Q = 0
4S	when size = 10, Q = 1
1D	when size = 11, Q = 0
2D	when size = 11, Q = 1

<Xn|SP> Is the 64-bit name of the general-purpose base register or stack pointer, encoded in the "Rn" field.

<imm> Is the post-index immediate offset,

#1	when size = 00
-----------	----------------

#2 when size = 01
 #4 when size = 10
 #8 when size = 11

<Xm> Is the 64-bit name of the general-purpose post-index register, excluding XZR, encoded in the "Rm" field.

Shared decode for all variants

```
integer scale = UInt(opcode<2:1>);
integer selem = UInt(opcode<0>:R) + 1;
boolean replicate = FALSE;
integer index;

case scale of
    when 3
        // load and replicate
        if L == '0' || S == '1' then UnallocatedEncoding();
        scale = UInt(size);
        replicate = TRUE;
    when 0
        index = UInt(Q:S:size);           // B[0-15]
    when 1
        if size<0> == '1' then UnallocatedEncoding();
        index = UInt(Q:S:size<1>);       // H[0-7]
    when 2
        if size<1> == '1' then UnallocatedEncoding();
        if size<0> == '0' then
            index = UInt(Q:S);           // S[0-3]
        else
            if S == '1' then UnallocatedEncoding();
            index = UInt(Q);           // D[0-1]
            scale = 3;

MemOp memop = if L == '1' then MemOp_LOAD else MemOp_STORE;
integer datasize = if Q == '1' then 128 else 64;
integer esize = 8 << scale;
```

Operation for all classes

```
CheckFPAdvSIMDEnabled64();

bits(64) address;
bits(64) offs;
bits(128) rval;
bits(esize) element;
integer s;
constant integer ebytes = esize DIV 8;

if n == 31 then
    CheckSPAlignment();
    address = SP[];
else
    address = X[n];

offs = Zeros();
if replicate then
    // load and replicate to all elements
    for s = 0 to selem-1
        element = Mem[address + offs, ebytes, AccType_VEC];
        // replicate to fill 128- or 64-bit register
        V[t] = Replicate(element, datasize DIV esize);
        offs = offs + ebytes;
        t = (t + 1) MOD 32;
else
```

```
// load/store one element per register
for s = 0 to selem-1
    rval = V[t];
    if memop == MemOp_LOAD then
        // insert into one lane of 128-bit register
        Elem[rval, index, esize] = Mem[address + offs, ebytes, AccType_VEC];
        V[t] = rval;
    else // memop == MemOp_STORE
        // extract from one lane of 128-bit register
        Mem[address + offs, ebytes, AccType_VEC] = Elem[rval, index, esize];
        offs = offs + ebytes;
        t = (t + 1) MOD 32;

if wback then
    if m != 31 then
        offs = X[m];
    if n == 31 then
        SP[] = address + offs;
    else
        X[n] = address + offs;
```

C6.3.155 LD2 (multiple structures)

Load multiple 2-element structures to two registers

It has encodings from 2 classes: *No offset* and *Post-index*

No offset

31	30	29	28	27	26	25	24	23	22	21	20	19	18	17	16	15	14	13	12	11	10	9				5	4			0
0	Q	0	0	1	1	0	0	0	1	0	0	0	0	0	0	1	0	0	0	size	Rn			Rt						
L											opcode																			

No offset variant

LD2 { <Vt>.<T>, <Vt2>.<T> }, [<Xn|SP>]

```
integer t = UInt(Rt);
integer n = UInt(Rn);
integer m = integer UNKNOWN;
boolean wback = FALSE;
```

Post-index

31	30	29	28	27	26	25	24	23	22	21	20					16	15	14	13	12	11	10	9				5	4			0
0	Q	0	0	1	1	0	0	1	1	0	Rm						1	0	0	0	size	Rn			Rt						
L											opcode																				

Immediate offset variant (Rm = 11111)

LD2 { <Vt>.<T>, <Vt2>.<T> }, [<Xn|SP>], <imm>

Register offset variant (Rm != 11111)

LD2 { <Vt>.<T>, <Vt2>.<T> }, [<Xn|SP>], <Xm>

```
integer t = UInt(Rt);
integer n = UInt(Rn);
integer m = UInt(Rm);
boolean wback = TRUE;
```

Assembler Symbols

- <Vt> Is the name of the first or only SIMD&FP register to be transferred, encoded in the "Rt" field.
- <T> Is an arrangement specifier,
 - 8B** when size = 00, Q = 0
 - 16B** when size = 00, Q = 1
 - 4H** when size = 01, Q = 0
 - 8H** when size = 01, Q = 1
 - 2S** when size = 10, Q = 0
 - 4S** when size = 10, Q = 1
 - RESERVED** when size = 11, Q = 0
 - 2D** when size = 11, Q = 1
- <Vt2> Is the name of the second SIMD&FP register to be transferred, encoded as "Rt" plus 1 modulo 32.
- <Xn|SP> Is the 64-bit name of the general-purpose base register or stack pointer, encoded in the "Rn" field.

<imm> Is the post-index immediate offset,
 #16 when Q = 0
 #32 when Q = 1

<Xm> Is the 64-bit name of the general-purpose post-index register, excluding XZR, encoded in the "Rm" field.

Shared decode for all variants

```
MemOp memop = if L == '1' then MemOp_LOAD else MemOp_STORE;
integer datasize = if Q == '1' then 128 else 64;
integer esize = 8 << UInt(size);
integer elements = datasize DIV esize;

integer rpt; // number of iterations
integer selem; // structure elements

case opcode of
  when '0000' rpt = 1; selem = 4; // LD/ST4 (4 registers)
  when '0010' rpt = 4; selem = 1; // LD/ST1 (4 registers)
  when '0100' rpt = 1; selem = 3; // LD/ST3 (3 registers)
  when '0110' rpt = 3; selem = 1; // LD/ST1 (3 registers)
  when '0111' rpt = 1; selem = 1; // LD/ST1 (1 register)
  when '1000' rpt = 1; selem = 2; // LD/ST2 (2 registers)
  when '1010' rpt = 2; selem = 1; // LD/ST1 (2 registers)
  otherwise UnallocatedEncoding();

// .1D format only permitted with LD1 & ST1
if size:Q == '110' && selem != 1 then ReservedValue();
```

Operation for all classes

```
CheckFPAdvSIMDEnabled64();

bits(64) address;
bits(64) offs;
bits(datasize) rval;
integer e, r, s, tt;
constant integer ebytes = esize DIV 8;

if n == 31 then
  CheckSPAlignment();
  address = SP[];
else
  address = X[n];

offs = Zeros();
for r = 0 to rpt-1
  for e = 0 to elements-1
    tt = (t + r) MOD 32;
    for s = 0 to selem-1
      rval = V[tt];
      if memop == MemOp_LOAD then
        Elem[rval, e, esize] = Mem[address + offs, ebytes, AccType_VEC];
        V[tt] = rval;
      else // memop == MemOp_STORE
        Mem[address + offs, ebytes, AccType_VEC] = Elem[rval, e, esize];
        offs = offs + ebytes;
        tt = (tt + 1) MOD 32;

if wback then
  if m != 31 then
    offs = X[m];
  if n == 31 then
```



```
    SP[] = address + offs;  
else  
    X[n] = address + offs;
```

C6.3.156 LD2 (single structure)

Load single 2-element structure to one lane of two registers

It has encodings from 2 classes: *No offset* and *Post-index*

No offset

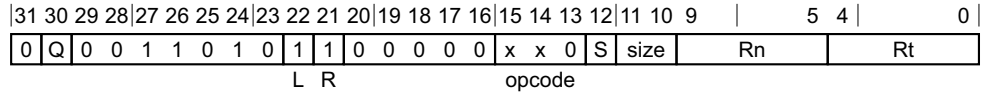

8-bit variant (opcode = 000)

LD2 { <Vt>.B, <Vt2>.B }[<index>], [<Xn|SP>]

16-bit variant (opcode = 010, size = x0)

LD2 { <Vt>.H, <Vt2>.H }[<index>], [<Xn|SP>]

32-bit variant (opcode = 100, size = 00)

LD2 { <Vt>.S, <Vt2>.S }[<index>], [<Xn|SP>]

64-bit variant (opcode = 100, S = 0, size = 01)

LD2 { <Vt>.D, <Vt2>.D }[<index>], [<Xn|SP>]

```
integer t = UInt(Rt);
integer n = UInt(Rn);
integer m = integer UNKNOWN;
boolean wback = FALSE;
```

Post-index

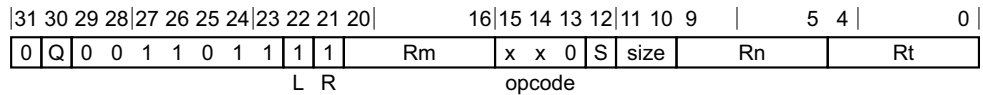

8-bit, immediate offset variant (Rm = 11111, opcode = 000)

LD2 { <Vt>.B, <Vt2>.B }[<index>], [<Xn|SP>], #2

8-bit, register offset variant (Rm != 11111, opcode = 000)

LD2 { <Vt>.B, <Vt2>.B }[<index>], [<Xn|SP>], <Xm>

16-bit, immediate offset variant (Rm = 11111, opcode = 010, size = x0)

LD2 { <Vt>.H, <Vt2>.H }[<index>], [<Xn|SP>], #4

16-bit, register offset variant (Rm != 11111, opcode = 010, size = x0)

LD2 { <Vt>.H, <Vt2>.H }[<index>], [<Xn|SP>], <Xm>

32-bit, immediate offset variant (Rm = 11111, opcode = 100, size = 00)

LD2 { <Vt>.S, <Vt2>.S }[<index>], [<Xn|SP>], #8

32-bit, register offset variant (Rm != 11111, opcode = 100, size = 00)

LD2 { <Vt>.S, <Vt2>.S }[<index>], [<Xn|SP>], <Xm>

64-bit, immediate offset variant (Rm = 11111, opcode = 100, S = 0, size = 01)

LD2 { <Vt>.D, <Vt2>.D }[<index>], [<Xn|SP>], #16

64-bit, register offset variant (Rm != 11111, opcode = 100, S = 0, size = 01)

```
LD2 { <Vt>.D, <Vt2>.D }[<index>], [<Xn|SP>], <Xm>
```

```
integer t = UInt(Rt);
integer n = UInt(Rn);
integer m = UInt(Rm);
boolean wback = TRUE;
```

Assembler Symbols

<Vt>	Is the name of the first or only SIMD&FP register to be transferred, encoded in the "Rt" field.
<Vt2>	Is the name of the second SIMD&FP register to be transferred, encoded as "Rt" plus 1 modulo 32.
<index>	For the 8-bit variant: is the element index, encoded in "Q:S:size".
<index>	For the 16-bit variant: is the element index, encoded in "Q:S:size<1>".
<index>	For the 32-bit variant: is the element index, encoded in "Q:S".
<index>	For the 64-bit variant: is the element index, encoded in "Q".
<Xn SP>	Is the 64-bit name of the general-purpose base register or stack pointer, encoded in the "Rn" field.
<Xm>	Is the 64-bit name of the general-purpose post-index register, excluding XZR, encoded in the "Rm" field.

Shared decode for all variants

```
integer scale = UInt(opcode<2:1>);
integer selem = UInt(opcode<0>:R) + 1;
boolean replicate = FALSE;
integer index;

case scale of
    when 3
        // load and replicate
        if L == '0' || S == '1' then UnallocatedEncoding();
        scale = UInt(size);
        replicate = TRUE;
    when 0
        index = UInt(Q:S:size); // B[0-15]
    when 1
        if size<0> == '1' then UnallocatedEncoding();
        index = UInt(Q:S:size<1>); // H[0-7]
    when 2
        if size<1> == '1' then UnallocatedEncoding();
        if size<0> == '0' then
            index = UInt(Q:S); // S[0-3]
        else
            if S == '1' then UnallocatedEncoding();
            index = UInt(Q); // D[0-1]
            scale = 3;

MemOp memop = if L == '1' then MemOp_LOAD else MemOp_STORE;
integer datasize = if Q == '1' then 128 else 64;
integer esize = 8 << scale;
```

Operation for all classes

```
CheckFPAdvSIMDEnabled64();

bits(64) address;
bits(64) offs;
bits(128) rval;
```

```
bits(esize) element;
integer s;
constant integer ebytes = esize DIV 8;

if n == 31 then
    CheckSPAAlignment();
    address = SP[];
else
    address = X[n];

offs = Zeros();
if replicate then
    // load and replicate to all elements
    for s = 0 to selem-1
        element = Mem[address + offs, ebytes, AccType_VEC];
        // replicate to fill 128- or 64-bit register
        V[t] = Replicate(element, datasize DIV esize);
        offs = offs + ebytes;
        t = (t + 1) MOD 32;
else
    // load/store one element per register
    for s = 0 to selem-1
        rval = V[t];
        if memop == MemOp_LOAD then
            // insert into one lane of 128-bit register
            Elem[rval, index, esize] = Mem[address + offs, ebytes, AccType_VEC];
            V[t] = rval;
        else // memop == MemOp_STORE
            // extract from one lane of 128-bit register
            Mem[address + offs, ebytes, AccType_VEC] = Elem[rval, index, esize];
            offs = offs + ebytes;
            t = (t + 1) MOD 32;

if wback then
    if m != 31 then
        offs = X[m];
    if n == 31 then
        SP[] = address + offs;
    else
        X[n] = address + offs;
```

C6.3.157 LD2R

Load single 2-element structure and replicate to all lanes of two registers

It has encodings from 2 classes: *No offset* and *Post-index*

No offset

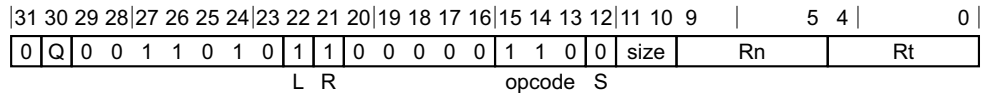

No offset variant

LD2R { <Vt>.<T>, <Vt2>.<T> }, [<Xn|SP>]

```
integer t = UInt(Rt);
integer n = UInt(Rn);
integer m = integer UNKNOWN;
boolean wback = FALSE;
```

Post-index

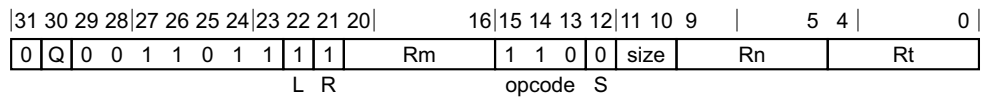

Immediate offset variant (Rm = 11111)

LD2R { <Vt>.<T>, <Vt2>.<T> }, [<Xn|SP>], <imm>

Register offset variant (Rm != 11111)

LD2R { <Vt>.<T>, <Vt2>.<T> }, [<Xn|SP>], <Xm>

```
integer t = UInt(Rt);
integer n = UInt(Rn);
integer m = UInt(Rm);
boolean wback = TRUE;
```

Assembler Symbols

- <Vt> Is the name of the first or only SIMD&FP register to be transferred, encoded in the "Rt" field.
- <T> Is an arrangement specifier,
 - 8B** when size = 00, Q = 0
 - 16B** when size = 00, Q = 1
 - 4H** when size = 01, Q = 0
 - 8H** when size = 01, Q = 1
 - 2S** when size = 10, Q = 0
 - 4S** when size = 10, Q = 1
 - 1D** when size = 11, Q = 0
 - 2D** when size = 11, Q = 1
- <Vt2> Is the name of the second SIMD&FP register to be transferred, encoded as "Rt" plus 1 modulo 32.
- <Xn|SP> Is the 64-bit name of the general-purpose base register or stack pointer, encoded in the "Rn" field.

<imm> Is the post-index immediate offset,
 #2 when size = 00
 #4 when size = 01
 #8 when size = 10
 #16 when size = 11

<Xm> Is the 64-bit name of the general-purpose post-index register, excluding XZR, encoded in the "Rm" field.

Shared decode for all variants

```
integer scale = UInt(opcode<2:1>);
integer selem = UInt(opcode<0>:R) + 1;
boolean replicate = FALSE;
integer index;

case scale of
  when 3
    // load and replicate
    if L == '0' || S == '1' then UnallocatedEncoding();
    scale = UInt(size);
    replicate = TRUE;
  when 0
    index = UInt(Q:S:size);      // B[0-15]
  when 1
    if size<0> == '1' then UnallocatedEncoding();
    index = UInt(Q:S:size<1>);  // H[0-7]
  when 2
    if size<1> == '1' then UnallocatedEncoding();
    if size<0> == '0' then
      index = UInt(Q:S);        // S[0-3]
    else
      if S == '1' then UnallocatedEncoding();
      index = UInt(Q);          // D[0-1]
      scale = 3;

MemOp memop = if L == '1' then MemOp_LOAD else MemOp_STORE;
integer datasize = if Q == '1' then 128 else 64;
integer esize = 8 << scale;
```

Operation for all classes

```
CheckFPAdvSIMDEnabled64();

bits(64) address;
bits(64) offs;
bits(128) rval;
bits(esize) element;
integer s;
constant integer ebytes = esize DIV 8;

if n == 31 then
  CheckSPAAlignment();
  address = SP[];
else
  address = X[n];

offs = Zeros();
if replicate then
  // load and replicate to all elements
  for s = 0 to selem-1
    element = Mem[address + offs, ebytes, AccType_VEC];
    // replicate to fill 128- or 64-bit register
    V[t] = Replicate(element, datasize DIV esize);
```

```
        offs = offs + ebytes;
        t = (t + 1) MOD 32;
else
    // load/store one element per register
    for s = 0 to selem-1
        rval = V[t];
        if memop == MemOp_LOAD then
            // insert into one lane of 128-bit register
            Elem[rval, index, esize] = Mem[address + offs, ebytes, AccType_VEC];
            V[t] = rval;
        else // memop == MemOp_STORE
            // extract from one lane of 128-bit register
            Mem[address + offs, ebytes, AccType_VEC] = Elem[rval, index, esize];
        offs = offs + ebytes;
        t = (t + 1) MOD 32;

if wback then
    if m != 31 then
        offs = X[m];
    if n == 31 then
        SP[] = address + offs;
    else
        X[n] = address + offs;
```

C6.3.158 LD3 (multiple structures)

Load multiple 3-element structures to three registers

It has encodings from 2 classes: *No offset* and *Post-index*

No offset

31	30	29	28	27	26	25	24	23	22	21	20	19	18	17	16	15	14	13	12	11	10	9				5	4			0
0	Q	0	0	1	1	0	0	0	1	0	0	0	0	0	0	0	1	0	0	0	size				Rn				Rt	
L											opcode																			

No offset variant

LD3 { <Vt>.<T>, <Vt2>.<T>, <Vt3>.<T> }, [<Xn|SP>]

```
integer t = UInt(Rt);
integer n = UInt(Rn);
integer m = integer UNKNOWN;
boolean wback = FALSE;
```

Post-index

31	30	29	28	27	26	25	24	23	22	21	20					16	15	14	13	12	11	10	9				5	4			0
0	Q	0	0	1	1	0	0	1	1	0			Rm		0	1	0	0	size				Rn				Rt				
L											opcode																				

Immediate offset variant (Rm = 11111)

LD3 { <Vt>.<T>, <Vt2>.<T>, <Vt3>.<T> }, [<Xn|SP>], <imm>

Register offset variant (Rm != 11111)

LD3 { <Vt>.<T>, <Vt2>.<T>, <Vt3>.<T> }, [<Xn|SP>], <Xm>

```
integer t = UInt(Rt);
integer n = UInt(Rn);
integer m = UInt(Rm);
boolean wback = TRUE;
```

Assembler Symbols

- <Vt> Is the name of the first or only SIMD&FP register to be transferred, encoded in the "Rt" field.
- <T> Is an arrangement specifier,
 - 8B** when size = 00, Q = 0
 - 16B** when size = 00, Q = 1
 - 4H** when size = 01, Q = 0
 - 8H** when size = 01, Q = 1
 - 2S** when size = 10, Q = 0
 - 4S** when size = 10, Q = 1
 - RESERVED** when size = 11, Q = 0
 - 2D** when size = 11, Q = 1
- <Vt2> Is the name of the second SIMD&FP register to be transferred, encoded as "Rt" plus 1 modulo 32.
- <Vt3> Is the name of the third SIMD&FP register to be transferred, encoded as "Rt" plus 2 modulo 32.
- <Xn|SP> Is the 64-bit name of the general-purpose base register or stack pointer, encoded in the "Rn" field.

<imm> Is the post-index immediate offset,
 #24 when Q = 0
 #48 when Q = 1

<Xm> Is the 64-bit name of the general-purpose post-index register, excluding XZR, encoded in the "Rm" field.

Shared decode for all variants

```
MemOp memop = if L == '1' then MemOp_LOAD else MemOp_STORE;
integer datasize = if Q == '1' then 128 else 64;
integer esize = 8 << UInt(size);
integer elements = datasize DIV esize;

integer rpt; // number of iterations
integer selem; // structure elements

case opcode of
    when '0000' rpt = 1; selem = 4; // LD/ST4 (4 registers)
    when '0010' rpt = 4; selem = 1; // LD/ST1 (4 registers)
    when '0100' rpt = 1; selem = 3; // LD/ST3 (3 registers)
    when '0110' rpt = 3; selem = 1; // LD/ST1 (3 registers)
    when '0111' rpt = 1; selem = 1; // LD/ST1 (1 register)
    when '1000' rpt = 1; selem = 2; // LD/ST2 (2 registers)
    when '1010' rpt = 2; selem = 1; // LD/ST1 (2 registers)
    otherwise UnallocatedEncoding();

// .1D format only permitted with LD1 & ST1
if size:Q == '110' && selem != 1 then ReservedValue();
```

Operation for all classes

```
CheckFPAdvSIMDEnabled64();

bits(64) address;
bits(64) offs;
bits(datasize) rval;
integer e, r, s, tt;
constant integer ebytes = esize DIV 8;

if n == 31 then
    CheckSPAlignment();
    address = SP[];
else
    address = X[n];

offs = Zeros();
for r = 0 to rpt-1
    for e = 0 to elements-1
        tt = (t + r) MOD 32;
        for s = 0 to selem-1
            rval = V[tt];
            if memop == MemOp_LOAD then
                Elem[rval, e, esize] = Mem[address + offs, ebytes, AccType_VEC];
                V[tt] = rval;
            else // memop == MemOp_STORE
                Mem[address + offs, ebytes, AccType_VEC] = Elem[rval, e, esize];
            offs = offs + ebytes;
            tt = (tt + 1) MOD 32;

if wback then
    if m != 31 then
        offs = X[m];
    if n == 31 then
```

```
    SP[] = address + offs;  
else  
    X[n] = address + offs;
```

C6.3.159 LD3 (single structure)

Load single 3-element structure to one lane of three registers)

It has encodings from 2 classes: *No offset* and *Post-index*

No offset

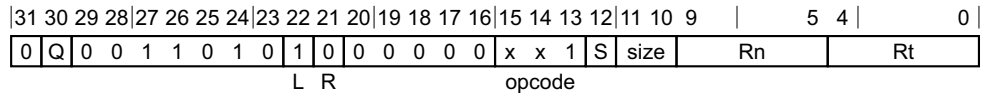

8-bit variant (opcode = 001)

LD3 { <Vt>.B, <Vt2>.B, <Vt3>.B }[<index>], [<Xn|SP>]

16-bit variant (opcode = 011, size = x0)

LD3 { <Vt>.H, <Vt2>.H, <Vt3>.H }[<index>], [<Xn|SP>]

32-bit variant (opcode = 101, size = 00)

LD3 { <Vt>.S, <Vt2>.S, <Vt3>.S }[<index>], [<Xn|SP>]

64-bit variant (opcode = 101, S = 0, size = 01)

LD3 { <Vt>.D, <Vt2>.D, <Vt3>.D }[<index>], [<Xn|SP>]

```
integer t = UInt(Rt);
integer n = UInt(Rn);
integer m = integer UNKNOWN;
boolean wback = FALSE;
```

Post-index

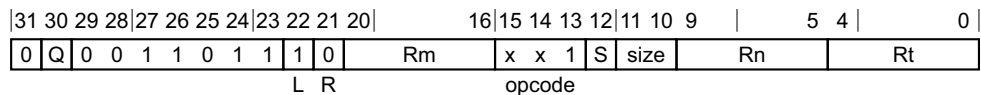

8-bit, immediate offset variant (Rm = 11111, opcode = 001)

LD3 { <Vt>.B, <Vt2>.B, <Vt3>.B }[<index>], [<Xn|SP>], #3

8-bit, register offset variant (Rm != 11111, opcode = 001)

LD3 { <Vt>.B, <Vt2>.B, <Vt3>.B }[<index>], [<Xn|SP>], <Xm>

16-bit, immediate offset variant (Rm = 11111, opcode = 011, size = x0)

LD3 { <Vt>.H, <Vt2>.H, <Vt3>.H }[<index>], [<Xn|SP>], #6

16-bit, register offset variant (Rm != 11111, opcode = 011, size = x0)

LD3 { <Vt>.H, <Vt2>.H, <Vt3>.H }[<index>], [<Xn|SP>], <Xm>

32-bit, immediate offset variant (Rm = 11111, opcode = 101, size = 00)

LD3 { <Vt>.S, <Vt2>.S, <Vt3>.S }[<index>], [<Xn|SP>], #12

32-bit, register offset variant (Rm != 11111, opcode = 101, size = 00)

LD3 { <Vt>.S, <Vt2>.S, <Vt3>.S }[<index>], [<Xn|SP>], <Xm>

64-bit, immediate offset variant (Rm = 11111, opcode = 101, S = 0, size = 01)

LD3 { <Vt>.D, <Vt2>.D, <Vt3>.D }[<index>], [<Xn|SP>], #24

64-bit, register offset variant (Rm != 11111, opcode = 101, S = 0, size = 01)

```
LD3 { <Vt>.D, <Vt2>.D, <Vt3>.D }[<index>], [<Xn|SP>], <Xm>
```

```
integer t = UInt(Rt);
integer n = UInt(Rn);
integer m = UInt(Rm);
boolean wback = TRUE;
```

Assembler Symbols

- <Vt> Is the name of the first or only SIMD&FP register to be transferred, encoded in the "Rt" field.
- <Vt2> Is the name of the second SIMD&FP register to be transferred, encoded as "Rt" plus 1 modulo 32.
- <Vt3> Is the name of the third SIMD&FP register to be transferred, encoded as "Rt" plus 2 modulo 32.
- <index> For the 8-bit variant: is the element index, encoded in "Q:S:size".
- <index> For the 16-bit variant: is the element index, encoded in "Q:S:size<1>".
- <index> For the 32-bit variant: is the element index, encoded in "Q:S".
- <index> For the 64-bit variant: is the element index, encoded in "Q".
- <Xn|SP> Is the 64-bit name of the general-purpose base register or stack pointer, encoded in the "Rn" field.
- <Xm> Is the 64-bit name of the general-purpose post-index register, excluding XZR, encoded in the "Rm" field.

Shared decode for all variants

```
integer scale = UInt(opcode<2:1>);
integer selem = UInt(opcode<0>:R) + 1;
boolean replicate = FALSE;
integer index;

case scale of
  when 3
    // load and replicate
    if L == '0' || S == '1' then UnallocatedEncoding();
    scale = UInt(size);
    replicate = TRUE;
  when 0
    index = UInt(Q:S:size); // B[0-15]
  when 1
    if size<0> == '1' then UnallocatedEncoding();
    index = UInt(Q:S:size<1>); // H[0-7]
  when 2
    if size<1> == '1' then UnallocatedEncoding();
    if size<0> == '0' then
      index = UInt(Q:S); // S[0-3]
    else
      if S == '1' then UnallocatedEncoding();
      index = UInt(Q); // D[0-1]
      scale = 3;

MemOp memop = if L == '1' then MemOp_LOAD else MemOp_STORE;
integer datasize = if Q == '1' then 128 else 64;
integer esize = 8 << scale;
```

Operation for all classes

```
CheckFPAdvSIMDEnabled64();

bits(64) address;
```

```

bits(64) offs;
bits(128) rval;
bits(esize) element;
integer s;
constant integer ebytes = esize DIV 8;

if n == 31 then
    CheckSPAlignment();
    address = SP[];
else
    address = X[n];

offs = Zeros();
if replicate then
    // load and replicate to all elements
    for s = 0 to selem-1
        element = Mem[address + offs, ebytes, AccType_VEC];
        // replicate to fill 128- or 64-bit register
        V[t] = Replicate(element, datasize DIV esize);
        offs = offs + ebytes;
        t = (t + 1) MOD 32;
else
    // load/store one element per register
    for s = 0 to selem-1
        rval = V[t];
        if memop == MemOp_LOAD then
            // insert into one lane of 128-bit register
            Elem[rval, index, esize] = Mem[address + offs, ebytes, AccType_VEC];
            V[t] = rval;
        else // memop == MemOp_STORE
            // extract from one lane of 128-bit register
            Mem[address + offs, ebytes, AccType_VEC] = Elem[rval, index, esize];
        offs = offs + ebytes;
        t = (t + 1) MOD 32;

if wback then
    if m != 31 then
        offs = X[m];
    if n == 31 then
        SP[] = address + offs;
    else
        X[n] = address + offs;
    
```

C6.3.160 LD3R

Load single 3-element structure and replicate to all lanes of three registers

It has encodings from 2 classes: *No offset* and *Post-index*

No offset

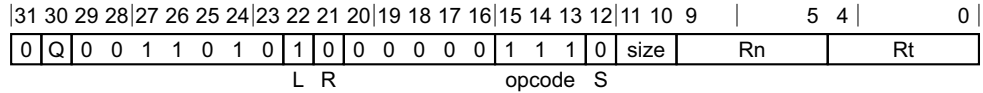

No offset variant

LD3R { <Vt>.<T>, <Vt2>.<T>, <Vt3>.<T> }, [<Xn|SP>]

```
integer t = UInt(Rt);
integer n = UInt(Rn);
integer m = integer UNKNOWN;
boolean wback = FALSE;
```

Post-index

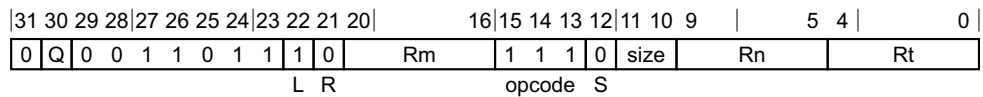

Immediate offset variant (Rm = 11111)

LD3R { <Vt>.<T>, <Vt2>.<T>, <Vt3>.<T> }, [<Xn|SP>], <imm>

Register offset variant (Rm != 11111)

LD3R { <Vt>.<T>, <Vt2>.<T>, <Vt3>.<T> }, [<Xn|SP>], <Xm>

```
integer t = UInt(Rt);
integer n = UInt(Rn);
integer m = UInt(Rm);
boolean wback = TRUE;
```

Assembler Symbols

- <Vt> Is the name of the first or only SIMD&FP register to be transferred, encoded in the "Rt" field.
- <T> Is an arrangement specifier,
 - 8B** when size = 00, Q = 0
 - 16B** when size = 00, Q = 1
 - 4H** when size = 01, Q = 0
 - 8H** when size = 01, Q = 1
 - 2S** when size = 10, Q = 0
 - 4S** when size = 10, Q = 1
 - 1D** when size = 11, Q = 0
 - 2D** when size = 11, Q = 1
- <Vt2> Is the name of the second SIMD&FP register to be transferred, encoded as "Rt" plus 1 modulo 32.
- <Vt3> Is the name of the third SIMD&FP register to be transferred, encoded as "Rt" plus 2 modulo 32.
- <Xn|SP> Is the 64-bit name of the general-purpose base register or stack pointer, encoded in the "Rn" field.

<imm> Is the post-index immediate offset,
 #3 when size = 00
 #6 when size = 01
 #12 when size = 10
 #24 when size = 11

<Xm> Is the 64-bit name of the general-purpose post-index register, excluding XZR, encoded in the "Rm" field.

Shared decode for all variants

```
integer scale = UInt(opcode<2:1>);
integer selem = UInt(opcode<0>:R) + 1;
boolean replicate = FALSE;
integer index;

case scale of
  when 3
    // load and replicate
    if L == '0' || S == '1' then UnallocatedEncoding();
    scale = UInt(size);
    replicate = TRUE;
  when 0
    index = UInt(Q:S:size);      // B[0-15]
  when 1
    if size<0> == '1' then UnallocatedEncoding();
    index = UInt(Q:S:size<1>);  // H[0-7]
  when 2
    if size<1> == '1' then UnallocatedEncoding();
    if size<0> == '0' then
      index = UInt(Q:S);        // S[0-3]
    else
      if S == '1' then UnallocatedEncoding();
      index = UInt(Q);          // D[0-1]
      scale = 3;

MemOp memop = if L == '1' then MemOp_LOAD else MemOp_STORE;
integer datasize = if Q == '1' then 128 else 64;
integer esize = 8 << scale;
```

Operation for all classes

```
CheckFPAdvSIMDEnabled64();

bits(64) address;
bits(64) offs;
bits(128) rval;
bits(esize) element;
integer s;
constant integer ebytes = esize DIV 8;

if n == 31 then
  CheckSPAlignment();
  address = SP[];
else
  address = X[n];

offs = Zeros();
if replicate then
  // load and replicate to all elements
  for s = 0 to selem-1
    element = Mem[address + offs, ebytes, AccType_VEC];
    // replicate to fill 128- or 64-bit register
    V[t] = Replicate(element, datasize DIV esize);
```

```
        offs = offs + ebytes;
        t = (t + 1) MOD 32;
else
    // load/store one element per register
    for s = 0 to selem-1
        rval = V[t];
        if memop == MemOp_LOAD then
            // insert into one lane of 128-bit register
            Elem[rval, index, esize] = Mem[address + offs, ebytes, AccType_VEC];
            V[t] = rval;
        else // memop == MemOp_STORE
            // extract from one lane of 128-bit register
            Mem[address + offs, ebytes, AccType_VEC] = Elem[rval, index, esize];
        offs = offs + ebytes;
        t = (t + 1) MOD 32;

if wback then
    if m != 31 then
        offs = X[m];
    if n == 31 then
        SP[] = address + offs;
    else
        X[n] = address + offs;
```

C6.3.161 LD4 (multiple structures)

Load multiple 4-element structures to four registers

It has encodings from 2 classes: *No offset* and *Post-index*

No offset

31	30	29	28	27	26	25	24	23	22	21	20	19	18	17	16	15	14	13	12	11	10	9				5	4			0
0	Q	0	0	1	1	0	0	0	1	0	0	0	0	0	0	0	0	0	0	size	Rn			Rt						
L										opcode																				

No offset variant

LD4 { <Vt>.<T>, <Vt2>.<T>, <Vt3>.<T>, <Vt4>.<T> }, [<Xn|SP>]

```
integer t = UInt(Rt);
integer n = UInt(Rn);
integer m = integer UNKNOWN;
boolean wback = FALSE;
```

Post-index

31	30	29	28	27	26	25	24	23	22	21	20	16				15	14	13	12	11	10	9				5	4			0
0	Q	0	0	1	1	0	0	1	1	0	Rm				0	0	0	0	size	Rn			Rt							
L										opcode																				

Immediate offset variant (Rm = 11111)

LD4 { <Vt>.<T>, <Vt2>.<T>, <Vt3>.<T>, <Vt4>.<T> }, [<Xn|SP>], <imm>

Register offset variant (Rm != 11111)

LD4 { <Vt>.<T>, <Vt2>.<T>, <Vt3>.<T>, <Vt4>.<T> }, [<Xn|SP>], <Xm>

```
integer t = UInt(Rt);
integer n = UInt(Rn);
integer m = UInt(Rm);
boolean wback = TRUE;
```

Assembler Symbols

- <Vt> Is the name of the first or only SIMD&FP register to be transferred, encoded in the "Rt" field.
- <T> Is an arrangement specifier,
 - 8B** when size = 00, Q = 0
 - 16B** when size = 00, Q = 1
 - 4H** when size = 01, Q = 0
 - 8H** when size = 01, Q = 1
 - 2S** when size = 10, Q = 0
 - 4S** when size = 10, Q = 1
 - RESERVED** when size = 11, Q = 0
 - 2D** when size = 11, Q = 1
- <Vt2> Is the name of the second SIMD&FP register to be transferred, encoded as "Rt" plus 1 modulo 32.
- <Vt3> Is the name of the third SIMD&FP register to be transferred, encoded as "Rt" plus 2 modulo 32.
- <Vt4> Is the name of the fourth SIMD&FP register to be transferred, encoded as "Rt" plus 3 modulo 32.

<Xn|SP> Is the 64-bit name of the general-purpose base register or stack pointer, encoded in the "Rn" field.

<imm> Is the post-index immediate offset,
 #32 when Q = 0
 #64 when Q = 1

<Xm> Is the 64-bit name of the general-purpose post-index register, excluding XZR, encoded in the "Rm" field.

Shared decode for all variants

```
MemOp memop = if L == '1' then MemOp_LOAD else MemOp_STORE;
integer datasize = if Q == '1' then 128 else 64;
integer esize = 8 << UInt(size);
integer elements = datasize DIV esize;

integer rpt; // number of iterations
integer selem; // structure elements

case opcode of
  when '0000' rpt = 1; selem = 4; // LD/ST4 (4 registers)
  when '0010' rpt = 4; selem = 1; // LD/ST1 (4 registers)
  when '0100' rpt = 1; selem = 3; // LD/ST3 (3 registers)
  when '0110' rpt = 3; selem = 1; // LD/ST1 (3 registers)
  when '0111' rpt = 1; selem = 1; // LD/ST1 (1 register)
  when '1000' rpt = 1; selem = 2; // LD/ST2 (2 registers)
  when '1010' rpt = 2; selem = 1; // LD/ST1 (2 registers)
  otherwise UnallocatedEncoding();

// .1D format only permitted with LD1 & ST1
if size:Q == '110' && selem != 1 then ReservedValue();
```

Operation for all classes

```
CheckFPAdvSIMDEnabled64();

bits(64) address;
bits(64) offs;
bits(datasize) rval;
integer e, r, s, tt;
constant integer ebytes = esize DIV 8;

if n == 31 then
  CheckSPAlignment();
  address = SP[];
else
  address = X[n];

offs = Zeros();
for r = 0 to rpt-1
  for e = 0 to elements-1
    tt = (t + r) MOD 32;
    for s = 0 to selem-1
      rval = V[tt];
      if memop == MemOp_LOAD then
        Elem[rval, e, esize] = Mem[address + offs, ebytes, AccType_VEC];
        V[tt] = rval;
      else // memop == MemOp_STORE
        Mem[address + offs, ebytes, AccType_VEC] = Elem[rval, e, esize];
        offs = offs + ebytes;
        tt = (tt + 1) MOD 32;

if wback then
  if m != 31 then
    offs = X[m];
```

```
if n == 31 then
    SP[] = address + offs;
else
    X[n] = address + offs;
```

C6.3.162 LD4 (single structure)

Load single 4-element structure to one lane of four registers

It has encodings from 2 classes: *No offset* and *Post-index*

No offset

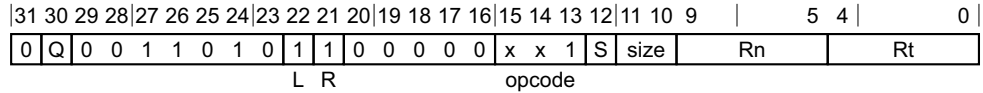

8-bit variant (opcode = 001)

LD4 { <Vt>.B, <Vt2>.B, <Vt3>.B, <Vt4>.B }[<index>], [<Xn|SP>]

16-bit variant (opcode = 011, size = x0)

LD4 { <Vt>.H, <Vt2>.H, <Vt3>.H, <Vt4>.H }[<index>], [<Xn|SP>]

32-bit variant (opcode = 101, size = 00)

LD4 { <Vt>.S, <Vt2>.S, <Vt3>.S, <Vt4>.S }[<index>], [<Xn|SP>]

64-bit variant (opcode = 101, S = 0, size = 01)

LD4 { <Vt>.D, <Vt2>.D, <Vt3>.D, <Vt4>.D }[<index>], [<Xn|SP>]

```
integer t = UInt(Rt);
integer n = UInt(Rn);
integer m = integer UNKNOWN;
boolean wback = FALSE;
```

Post-index

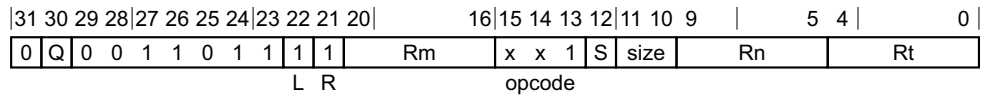

8-bit, immediate offset variant (Rm = 11111, opcode = 001)

LD4 { <Vt>.B, <Vt2>.B, <Vt3>.B, <Vt4>.B }[<index>], [<Xn|SP>], #4

8-bit, register offset variant (Rm != 11111, opcode = 001)

LD4 { <Vt>.B, <Vt2>.B, <Vt3>.B, <Vt4>.B }[<index>], [<Xn|SP>], <Xm>

16-bit, immediate offset variant (Rm = 11111, opcode = 011, size = x0)

LD4 { <Vt>.H, <Vt2>.H, <Vt3>.H, <Vt4>.H }[<index>], [<Xn|SP>], #8

16-bit, register offset variant (Rm != 11111, opcode = 011, size = x0)

LD4 { <Vt>.H, <Vt2>.H, <Vt3>.H, <Vt4>.H }[<index>], [<Xn|SP>], <Xm>

32-bit, immediate offset variant (Rm = 11111, opcode = 101, size = 00)

LD4 { <Vt>.S, <Vt2>.S, <Vt3>.S, <Vt4>.S }[<index>], [<Xn|SP>], #16

32-bit, register offset variant (Rm != 11111, opcode = 101, size = 00)

LD4 { <Vt>.S, <Vt2>.S, <Vt3>.S, <Vt4>.S }[<index>], [<Xn|SP>], <Xm>

64-bit, immediate offset variant (Rm = 11111, opcode = 101, S = 0, size = 01)

LD4 { <Vt>.D, <Vt2>.D, <Vt3>.D, <Vt4>.D }[<index>], [<Xn|SP>], #32

64-bit, register offset variant (Rm != 11111, opcode = 101, S = 0, size = 01)

LD4 { <Vt>.D, <Vt2>.D, <Vt3>.D, <Vt4>.D }[<index>], [<Xn|SP>], <Xm>

```
integer t = UInt(Rt);
integer n = UInt(Rn);
integer m = UInt(Rm);
boolean wback = TRUE;
```

Assembler Symbols

- <Vt> Is the name of the first or only SIMD&FP register to be transferred, encoded in the "Rt" field.
- <Vt2> Is the name of the second SIMD&FP register to be transferred, encoded as "Rt" plus 1 modulo 32.
- <Vt3> Is the name of the third SIMD&FP register to be transferred, encoded as "Rt" plus 2 modulo 32.
- <Vt4> Is the name of the fourth SIMD&FP register to be transferred, encoded as "Rt" plus 3 modulo 32.
- <index> For the 8-bit variant: is the element index, encoded in "Q:S:size".
- <index> For the 16-bit variant: is the element index, encoded in "Q:S:size<1>".
- <index> For the 32-bit variant: is the element index, encoded in "Q:S".
- <index> For the 64-bit variant: is the element index, encoded in "Q".
- <Xn|SP> Is the 64-bit name of the general-purpose base register or stack pointer, encoded in the "Rn" field.
- <Xm> Is the 64-bit name of the general-purpose post-index register, excluding XZR, encoded in the "Rm" field.

Shared decode for all variants

```
integer scale = UInt(opcode<2:1>);
integer selem = UInt(opcode<0>:R) + 1;
boolean replicate = FALSE;
integer index;

case scale of
    when 3
        // load and replicate
        if L == '0' || S == '1' then UnallocatedEncoding();
        scale = UInt(size);
        replicate = TRUE;
    when 0
        index = UInt(Q:S:size); // B[0-15]
    when 1
        if size<0> == '1' then UnallocatedEncoding();
        index = UInt(Q:S:size<1>); // H[0-7]
    when 2
        if size<1> == '1' then UnallocatedEncoding();
        if size<0> == '0' then
            index = UInt(Q:S); // S[0-3]
        else
            if S == '1' then UnallocatedEncoding();
            index = UInt(Q); // D[0-1]
            scale = 3;

MemOp memop = if L == '1' then MemOp_LOAD else MemOp_STORE;
integer datasize = if Q == '1' then 128 else 64;
integer esize = 8 << scale;
```

Operation for all classes

```
CheckFPAdvSIMDEnabled64();

bits(64) address;
bits(64) offs;
bits(128) rval;
bits(esize) element;
integer s;
constant integer ebytes = esize DIV 8;

if n == 31 then
    CheckSPAlignment();
    address = SP[];
else
    address = X[n];

offs = Zeros();
if replicate then
    // load and replicate to all elements
    for s = 0 to selem-1
        element = Mem[address + offs, ebytes, AccType_VEC];
        // replicate to fill 128- or 64-bit register
        V[t] = Replicate(element, datasize DIV esize);
        offs = offs + ebytes;
        t = (t + 1) MOD 32;
else
    // load/store one element per register
    for s = 0 to selem-1
        rval = V[t];
        if memop == MemOp_LOAD then
            // insert into one lane of 128-bit register
            Elem[rval, index, esize] = Mem[address + offs, ebytes, AccType_VEC];
            V[t] = rval;
        else // memop == MemOp_STORE
            // extract from one lane of 128-bit register
            Mem[address + offs, ebytes, AccType_VEC] = Elem[rval, index, esize];
        offs = offs + ebytes;
        t = (t + 1) MOD 32;

if wback then
    if m != 31 then
        offs = X[m];
    if n == 31 then
        SP[] = address + offs;
    else
        X[n] = address + offs;
```

C6.3.163 LD4R

Load single 4-element structure and replicate to all lanes of four registers

It has encodings from 2 classes: *No offset* and *Post-index*

No offset

31	30	29	28	27	26	25	24	23	22	21	20	19	18	17	16	15	14	13	12	11	10	9				5	4			0
0	Q	0	0	1	1	0	1	0	1	1	0	0	0	0	0	1	1	1	0	size	Rn			Rt						
L R										opcode S																				

No offset variant

LD4R { <Vt>.<T>, <Vt2>.<T>, <Vt3>.<T>, <Vt4>.<T> }, [<Xn|SP>]

```
integer t = UInt(Rt);
integer n = UInt(Rn);
integer m = integer UNKNOWN;
boolean wback = FALSE;
```

Post-index

31	30	29	28	27	26	25	24	23	22	21	20	16				15	14	13	12	11	10	9				5	4			0
0	Q	0	0	1	1	0	1	1	1	Rm			1	1	1	0	size	Rn			Rt									
L R										opcode S																				

Immediate offset variant (Rm = 11111)

LD4R { <Vt>.<T>, <Vt2>.<T>, <Vt3>.<T>, <Vt4>.<T> }, [<Xn|SP>], <imm>

Register offset variant (Rm != 11111)

LD4R { <Vt>.<T>, <Vt2>.<T>, <Vt3>.<T>, <Vt4>.<T> }, [<Xn|SP>], <Xm>

```
integer t = UInt(Rt);
integer n = UInt(Rn);
integer m = UInt(Rm);
boolean wback = TRUE;
```

Assembler Symbols

- <Vt> Is the name of the first or only SIMD&FP register to be transferred, encoded in the "Rt" field.
- <T> Is an arrangement specifier,
 - 8B** when size = 00, Q = 0
 - 16B** when size = 00, Q = 1
 - 4H** when size = 01, Q = 0
 - 8H** when size = 01, Q = 1
 - 2S** when size = 10, Q = 0
 - 4S** when size = 10, Q = 1
 - 1D** when size = 11, Q = 0
 - 2D** when size = 11, Q = 1
- <Vt2> Is the name of the second SIMD&FP register to be transferred, encoded as "Rt" plus 1 modulo 32.
- <Vt3> Is the name of the third SIMD&FP register to be transferred, encoded as "Rt" plus 2 modulo 32.
- <Vt4> Is the name of the fourth SIMD&FP register to be transferred, encoded as "Rt" plus 3 modulo 32.

<Xn|SP> Is the 64-bit name of the general-purpose base register or stack pointer, encoded in the "Rn" field.

<imm> Is the post-index immediate offset,
 #4 when size = 00
 #8 when size = 01
 #16 when size = 10
 #32 when size = 11

<Xm> Is the 64-bit name of the general-purpose post-index register, excluding XZR, encoded in the "Rm" field.

Shared decode for all variants

```
integer scale = UInt(opcode<2:1>);
integer selem = UInt(opcode<0>:R) + 1;
boolean replicate = FALSE;
integer index;

case scale of
  when 3
    // load and replicate
    if L == '0' || S == '1' then UnallocatedEncoding();
    scale = UInt(size);
    replicate = TRUE;
  when 0
    index = UInt(Q:S:size);           // B[0-15]
  when 1
    if size<0> == '1' then UnallocatedEncoding();
    index = UInt(Q:S:size<1>);       // H[0-7]
  when 2
    if size<1> == '1' then UnallocatedEncoding();
    if size<0> == '0' then
      index = UInt(Q:S);           // S[0-3]
    else
      if S == '1' then UnallocatedEncoding();
      index = UInt(Q);           // D[0-1]
      scale = 3;

MemOp memop = if L == '1' then MemOp_LOAD else MemOp_STORE;
integer datasize = if Q == '1' then 128 else 64;
integer esize = 8 << scale;
```

Operation for all classes

```
CheckFPAdvSIMDEnabled64();

bits(64) address;
bits(64) offs;
bits(128) rval;
bits(esize) element;
integer s;
constant integer ebytes = esize DIV 8;

if n == 31 then
  CheckSPAlignment();
  address = SP[];
else
  address = X[n];

offs = Zeros();
if replicate then
  // load and replicate to all elements
  for s = 0 to selem-1
    element = Mem[address + offs, ebytes, AccType_VEC];
```



```
// replicate to fill 128- or 64-bit register
V[t] = Replicate(element, datasize DIV esize);
offs = offs + ebytes;
t = (t + 1) MOD 32;
else
// load/store one element per register
for s = 0 to selem-1
    rval = V[t];
    if memop == MemOp_LOAD then
        // insert into one lane of 128-bit register
        Elem[rval, index, esize] = Mem[address + offs, ebytes, AccType_VEC];
        V[t] = rval;
    else // memop == MemOp_STORE
        // extract from one lane of 128-bit register
        Mem[address + offs, ebytes, AccType_VEC] = Elem[rval, index, esize];
        offs = offs + ebytes;
        t = (t + 1) MOD 32;

if wback then
    if m != 31 then
        offs = X[m];
    if n == 31 then
        SP[] = address + offs;
    else
        X[n] = address + offs;
```

C6.3.164 LDNP (SIMD&FP)

Load pair of SIMD&FP registers, with non-temporal hint

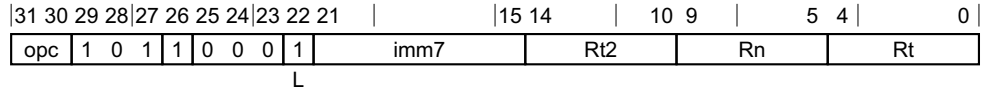

32-bit variant (opc = 00)

LDNP <St1>, <St2>, [<Xn|SP>{, #<imm>}]

64-bit variant (opc = 01)

LDNP <Dt1>, <Dt2>, [<Xn|SP>{, #<imm>}]

128-bit variant (opc = 10)

LDNP <Qt1>, <Qt2>, [<Xn|SP>{, #<imm>}]

boolean wback = FALSE;
 boolean postindex = FALSE;

Assembler Symbols

- <Dt1> Is the 64-bit name of the first SIMD&FP register to be transferred, encoded in the "Rt" field.
- <Dt2> Is the 64-bit name of the second SIMD&FP register to be transferred, encoded in the "Rt2" field.
- <Qt1> Is the 128-bit name of the first SIMD&FP register to be transferred, encoded in the "Rt" field.
- <Qt2> Is the 128-bit name of the second SIMD&FP register to be transferred, encoded in the "Rt2" field.
- <St1> Is the 32-bit name of the first SIMD&FP register to be transferred, encoded in the "Rt" field.
- <St2> Is the 32-bit name of the second SIMD&FP register to be transferred, encoded in the "Rt2" field.
- <Xn|SP> Is the 64-bit name of the general-purpose base register or stack pointer, encoded in the "Rn" field.
- <imm> For the 32-bit variant: is the optional signed immediate byte offset, a multiple of 4 in the range -256 to 252, defaulting to 0 and encoded in the "imm7" field as <imm>/4.
- <imm> For the 64-bit variant: is the optional signed immediate byte offset, a multiple of 8 in the range -512 to 504, defaulting to 0 and encoded in the "imm7" field as <imm>/8.
- <imm> For the 128-bit variant: is the optional signed immediate byte offset, a multiple of 16 in the range -1024 to 1008, defaulting to 0 and encoded in the "imm7" field as <imm>/16.

Shared decode for all variants

```
integer n = UInt(Rn);
integer t = UInt(Rt);
integer t2 = UInt(Rt2);
AccType acctype = AccType_VECSTREAM;
MemOp memop = if L == '1' then MemOp_LOAD else MemOp_STORE;
if opc == '11' then UnallocatedEncoding();
integer scale = 2 + UInt(opc);
integer datasize = 8 << scale;
bits(64) offset = LSL(SignExtend(imm7, 64), scale);
```

Operation

```

CheckFPAdvSIMDEnabled64();

bits(64) address;
bits(datasize) data1;
bits(datasize) data2;
constant integer dbytes = datasize DIV 8;
boolean rt_unknown = FALSE;

if memop == MemOp_LOAD && t == t2 then
    Constraint c = ConstrainUnpredictable();
    assert c IN {Constraint_UNKNOWN, Constraint_UNDEF, Constraint_NOP};
    case c of
        when Constraint_UNKNOWN    rt_unknown = TRUE;    // result is UNKNOWN
        when Constraint_UNDEF      UnallocatedEncoding();
        when Constraint_NOP        EndOfInstruction();

if n == 31 then
    CheckSPAlignment();
    address = SP[];
else
    address = X[n];

if ! postindex then
    address = address + offset;

case memop of
    when MemOp_STORE
        data1 = V[t];
        data2 = V[t2];
        Mem[address + 0      , dbytes, acctype] = data1;
        Mem[address + dbytes, dbytes, acctype] = data2;

    when MemOp_LOAD
        data1 = Mem[address + 0      , dbytes, acctype];
        data2 = Mem[address + dbytes, dbytes, acctype];
        if rt_unknown then
            data1 = bits(datasize) UNKNOWN;
            data2 = bits(datasize) UNKNOWN;
        V[t] = data1;
        V[t2] = data2;

if wback then
    if postindex then
        address = address + offset;
    if n == 31 then
        SP[] = address;
    else
        X[n] = address;
    
```

C6.3.165 LDP (SIMD&FP)

Load pair of SIMD&FP registers

It has encodings from 3 classes: *Post-index*, *Pre-index* and *Signed offset*

Post-index

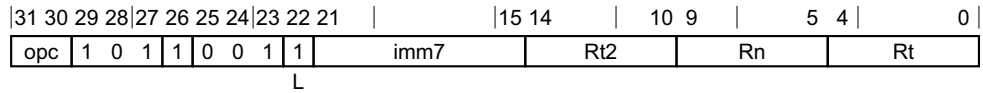

32-bit variant (opc = 00)

LDP <St1>, <St2>, [<Xn|SP>], #<imm>

64-bit variant (opc = 01)

LDP <Dt1>, <Dt2>, [<Xn|SP>], #<imm>

128-bit variant (opc = 10)

LDP <Qt1>, <Qt2>, [<Xn|SP>], #<imm>

boolean wback = TRUE;
 boolean postindex = TRUE;

Pre-index

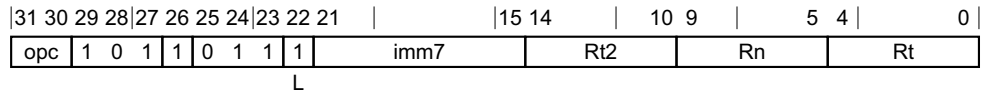

32-bit variant (opc = 00)

LDP <St1>, <St2>, [<Xn|SP>, #<imm>]!

64-bit variant (opc = 01)

LDP <Dt1>, <Dt2>, [<Xn|SP>, #<imm>]!

128-bit variant (opc = 10)

LDP <Qt1>, <Qt2>, [<Xn|SP>, #<imm>]!

boolean wback = TRUE;
 boolean postindex = FALSE;

Signed offset

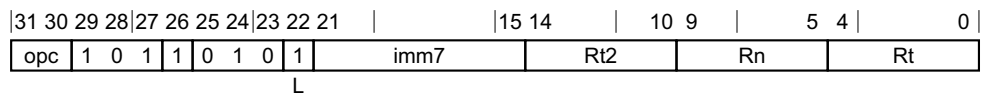

32-bit variant (opc = 00)

LDP <St1>, <St2>, [<Xn|SP>{, #<imm>}]

64-bit variant (opc = 01)

LDP <Dt1>, <Dt2>, [<Xn|SP>{, #<imm>}]

128-bit variant (opc = 10)

LDP <Qt1>, <Qt2>, [<Xn|SP>{, #<imm>}]

```
boolean wback = FALSE;
boolean postindex = FALSE;
```

Assembler Symbols

<Dt1>	Is the 64-bit name of the first SIMD&FP register to be transferred, encoded in the "Rt" field.
<Dt2>	Is the 64-bit name of the second SIMD&FP register to be transferred, encoded in the "Rt2" field.
<Qt1>	Is the 128-bit name of the first SIMD&FP register to be transferred, encoded in the "Rt" field.
<Qt2>	Is the 128-bit name of the second SIMD&FP register to be transferred, encoded in the "Rt2" field.
<St1>	Is the 32-bit name of the first SIMD&FP register to be transferred, encoded in the "Rt" field.
<St2>	Is the 32-bit name of the second SIMD&FP register to be transferred, encoded in the "Rt2" field.
<Xn SP>	Is the 64-bit name of the general-purpose base register or stack pointer, encoded in the "Rn" field.
<imm>	For the 32-bit post-index and 32-bit pre-index variant: is the signed immediate byte offset, a multiple of 4 in the range -256 to 252, encoded in the "imm7" field as <imm>/4.
<imm>	For the 32-bit signed offset variant: is the optional signed immediate byte offset, a multiple of 4 in the range -256 to 252, defaulting to 0 and encoded in the "imm7" field as <imm>/4.
<imm>	For the 64-bit post-index and 64-bit pre-index variant: is the signed immediate byte offset, a multiple of 8 in the range -512 to 504, encoded in the "imm7" field as <imm>/8.
<imm>	For the 64-bit signed offset variant: is the optional signed immediate byte offset, a multiple of 8 in the range -512 to 504, defaulting to 0 and encoded in the "imm7" field as <imm>/8.
<imm>	For the 128-bit post-index and 128-bit pre-index variant: is the signed immediate byte offset, a multiple of 16 in the range -1024 to 1008, encoded in the "imm7" field as <imm>/16.
<imm>	For the 128-bit signed offset variant: is the optional signed immediate byte offset, a multiple of 16 in the range -1024 to 1008, defaulting to 0 and encoded in the "imm7" field as <imm>/16.

Shared decode for all variants

```
integer n = UInt(Rn);
integer t = UInt(Rt);
integer t2 = UInt(Rt2);
AccType acctype = AccType_VEC;
MemOp memop = if L == '1' then MemOp_LOAD else MemOp_STORE;
if opc == '11' then UnallocatedEncoding();
integer scale = 2 + UInt(opc);
integer datasize = 8 << scale;
bits(64) offset = LSL(SignExtend(imm7, 64), scale);
```

Operation for all classes

```
CheckFPAdvSIMDEnabled64();

bits(64) address;
bits(datasize) data1;
bits(datasize) data2;
constant integer dbytes = datasize DIV 8;
boolean rt_unknown = FALSE;

if memop == MemOp_LOAD && t == t2 then
  Constraint c = ConstrainUnpredictable();
  assert c IN {Constraint_UNKNOWN, Constraint_UNDEF, Constraint_NOP};
  case c of
    when Constraint_UNKNOWN    rt_unknown = TRUE;    // result is UNKNOWN
    when Constraint_UNDEF      UnallocatedEncoding();
```

```
        when Constraint_NOP      EndOfInstruction();

if n == 31 then
    CheckSPAlignment();
    address = SP[];
else
    address = X[n];

if ! postindex then
    address = address + offset;

case memop of
    when MemOp_STORE
        data1 = V[t];
        data2 = V[t2];
        Mem[address + 0      , dbytes, acctype] = data1;
        Mem[address + dbytes, dbytes, acctype] = data2;

    when MemOp_LOAD
        data1 = Mem[address + 0      , dbytes, acctype];
        data2 = Mem[address + dbytes, dbytes, acctype];
        if rt_unknown then
            data1 = bits(datasize) UNKNOWN;
            data2 = bits(datasize) UNKNOWN;
        V[t] = data1;
        V[t2] = data2;

if wback then
    if postindex then
        address = address + offset;
    if n == 31 then
        SP[] = address;
    else
        X[n] = address;
```

C6.3.166 LDR (immediate, SIMD&FP)

Load SIMD&FP register (immediate offset)

It has encodings from 3 classes: *Post-index*, *Pre-index* and *Unsigned offset* on page C6-1058

Post-index

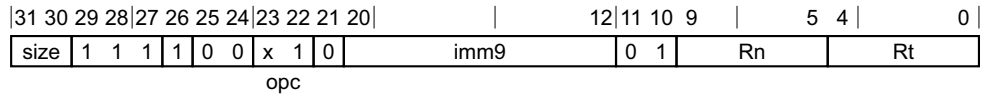

8-bit variant (size = 00, opc = 01)

LDR <Bt>, [<Xn|SP>], #<sim>

16-bit variant (size = 01, opc = 01)

LDR <Ht>, [<Xn|SP>], #<sim>

32-bit variant (size = 10, opc = 01)

LDR <St>, [<Xn|SP>], #<sim>

64-bit variant (size = 11, opc = 01)

LDR <Dt>, [<Xn|SP>], #<sim>

128-bit variant (size = 00, opc = 11)

LDR <Qt>, [<Xn|SP>], #<sim>

```
boolean wback = TRUE;
boolean postindex = TRUE;
integer scale = UInt(opc<1>:size);
if scale > 4 then UnallocatedEncoding();
bits(64) offset = SignExtend(imm9, 64);
```

Pre-index



8-bit variant (size = 00, opc = 01)

LDR <Bt>, [<Xn|SP>, #<sim>]!

16-bit variant (size = 01, opc = 01)

LDR <Ht>, [<Xn|SP>, #<sim>]!

32-bit variant (size = 10, opc = 01)

LDR <St>, [<Xn|SP>, #<sim>]!

64-bit variant (size = 11, opc = 01)

LDR <Dt>, [<Xn|SP>, #<sim>]!

128-bit variant (size = 00, opc = 11)

LDR <Qt>, [<Xn|SP>, #<sim>]!

```
boolean wback = TRUE;
boolean postindex = FALSE;
integer scale = UInt(opc<1>:size);
if scale > 4 then UnallocatedEncoding();
bits(64) offset = SignExtend(imm9, 64);
```

Unsigned offset



8-bit variant (size = 00, opc = 01)

LDR <Bt>, [<Xn|SP>{, #<pimm>}]

16-bit variant (size = 01, opc = 01)

LDR <Ht>, [<Xn|SP>{, #<pimm>}]

32-bit variant (size = 10, opc = 01)

LDR <St>, [<Xn|SP>{, #<pimm>}]

64-bit variant (size = 11, opc = 01)

LDR <Dt>, [<Xn|SP>{, #<pimm>}]

128-bit variant (size = 00, opc = 11)

LDR <Qt>, [<Xn|SP>{, #<pimm>}]

```
boolean wback = FALSE;
boolean postindex = FALSE;
integer scale = UInt(opc<1>:size);
if scale > 4 then UnallocatedEncoding();
bits(64) offset = LSL(ZeroExtend(imm12, 64), scale);
```

Assembler Symbols

- <Bt> Is the 8-bit name of the SIMD&FP register to be transferred, encoded in the "Rt" field.
- <Dt> Is the 64-bit name of the SIMD&FP register to be transferred, encoded in the "Rt" field.
- <Ht> Is the 16-bit name of the SIMD&FP register to be transferred, encoded in the "Rt" field.
- <Qt> Is the 128-bit name of the SIMD&FP register to be transferred, encoded in the "Rt" field.
- <St> Is the 32-bit name of the SIMD&FP register to be transferred, encoded in the "Rt" field.
- <Xn|SP> Is the 64-bit name of the general-purpose base register or stack pointer, encoded in the "Rn" field.
- <sim> Is the signed immediate byte offset, in the range -256 to 255, encoded in the "imm9" field.
- <pimm> For the 8-bit variant: is the optional positive immediate byte offset, in the range 0 to 4095, defaulting to 0 and encoded in the "imm12" field.
- <pimm> For the 16-bit variant: is the optional positive immediate byte offset, a multiple of 2 in the range 0 to 8190, defaulting to 0 and encoded in the "imm12" field as <pimm>/2.
- <pimm> For the 32-bit variant: is the optional positive immediate byte offset, a multiple of 4 in the range 0 to 16380, defaulting to 0 and encoded in the "imm12" field as <pimm>/4.
- <pimm> For the 64-bit variant: is the optional positive immediate byte offset, a multiple of 8 in the range 0 to 32760, defaulting to 0 and encoded in the "imm12" field as <pimm>/8.
- <pimm> For the 128-bit variant: is the optional positive immediate byte offset, a multiple of 16 in the range 0 to 65520, defaulting to 0 and encoded in the "imm12" field as <pimm>/16.

Shared decode for all variants

```
integer n = UInt(Rn);
integer t = UInt(Rt);
AccType acctype = AccType_VEC;
MemOp memop = if opc<0> == '1' then MemOp_LOAD else MemOp_STORE;
integer datasize = 8 << scale;
```

Operation for all classes

```
CheckFPAdvSIMDEnabled64();

bits(64) address;
bits(datasize) data;

if n == 31 then
    CheckSPAlignment();
    address = SP[];
else
    address = X[n];

if ! postindex then
    address = address + offset;

case memop of
    when MemOp_STORE
        data = V[t];
        Mem[address, datasize DIV 8, acctype] = data;

    when MemOp_LOAD
        data = Mem[address, datasize DIV 8, acctype];
        V[t] = data;

if wback then
    if postindex then
        address = address + offset;
    if n == 31 then
        SP[] = address;
    else
        X[n] = address;
```

C6.3.167 LDR (literal, SIMD&FP)

Load SIMD&FP register (PC-relative literal)

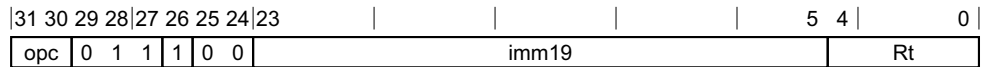

32-bit variant (opc = 00)

LDR <St>, <label>

64-bit variant (opc = 01)

LDR <Dt>, <label>

128-bit variant (opc = 10)

LDR <Qt>, <label>

```
integer t = UInt(Rt);
integer size;
bits(64) offset;
```

```
case opc of
    when '00'
        size = 4;
    when '01'
        size = 8;
    when '10'
        size = 16;
    when '11'
        UnallocatedEncoding();
```

```
offset = SignExtend(imm19:'00', 64);
```

Assembler Symbols

- <Dt> Is the 64-bit name of the SIMD&FP register to be loaded, encoded in the "Rt" field.
- <Qt> Is the 128-bit name of the SIMD&FP register to be loaded, encoded in the "Rt" field.
- <St> Is the 32-bit name of the SIMD&FP register to be loaded, encoded in the "Rt" field.
- <label> Is the program label from which the data is to be loaded. Its offset from the address of this instruction, in the range +/-1MB, is encoded as "imm19" times 4.

Operation

```
bits(64) address = PC[] + offset;
bits(size*8) data;
```

```
CheckFPAdvSIMDEnabled64();
```

```
data = Mem[address, size, AccType_VEC];
V[t] = data;
```

C6.3.168 LDR (register, SIMD&FP)

Load SIMD&FP register (register offset)

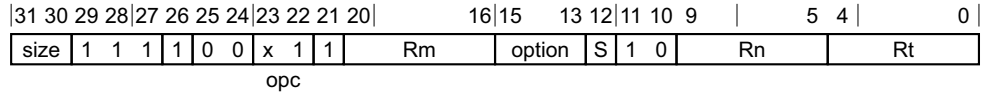

8-bit variant (size = 00, opc = 01)

LDR <Bt>, [<Xn|SP>, <R><m>{, <extend> {<amount>}}]

16-bit variant (size = 01, opc = 01)

LDR <Ht>, [<Xn|SP>, <R><m>{, <extend> {<amount>}}]

32-bit variant (size = 10, opc = 01)

LDR <St>, [<Xn|SP>, <R><m>{, <extend> {<amount>}}]

64-bit variant (size = 11, opc = 01)

LDR <Dt>, [<Xn|SP>, <R><m>{, <extend> {<amount>}}]

128-bit variant (size = 00, opc = 11)

LDR <Qt>, [<Xn|SP>, <R><m>{, <extend> {<amount>}}]

```
boolean wback = FALSE;
boolean postindex = FALSE;
integer scale = UInt(opc<1>:size);
if scale > 4 then UnallocatedEncoding();
if option<1> == '0' then UnallocatedEncoding(); // sub-word index
ExtendType extend_type = DecodeRegExtend(option);
integer shift = if S == '1' then scale else 0;
```

Assembler Symbols

- <Bt> Is the 8-bit name of the SIMD&FP register to be transferred, encoded in the "Rt" field.
- <Dt> Is the 64-bit name of the SIMD&FP register to be transferred, encoded in the "Rt" field.
- <Ht> Is the 16-bit name of the SIMD&FP register to be transferred, encoded in the "Rt" field.
- <Qt> Is the 128-bit name of the SIMD&FP register to be transferred, encoded in the "Rt" field.
- <St> Is the 32-bit name of the SIMD&FP register to be transferred, encoded in the "Rt" field.
- <Xn|SP> Is the 64-bit name of the general-purpose base register or stack pointer, encoded in the "Rn" field.
- <R> Is the index width specifier,
 - RESERVED** when option = 00x
 - W** when option = x10
 - X** when option = x11
 - RESERVED** when option = 10x
- <m> Is the number [0-30] of the general-purpose index register or the name ZR (31), encoded in the "Rm" field.
- <extend> Is the index extend/shift specifier, defaulting to LSL and
 - RESERVED** when option = 00x
 - UXTW** when option = 010

	LSL	when option = 011
	RESERVED	when option = 10x
	SXTW	when option = 110
	SXTX	when option = 111
<amount>		For the 8-bit variant: is the index shift amount, optional and defaulting to #0 when <extend> is not LSL, [absent] when S = 0 #0 when S = 1
<amount>		For the 16-bit variant: is the index shift amount, optional and defaulting to #0 when <extend> is not LSL, #0 when S = 0 #1 when S = 1
<amount>		For the 32-bit variant: is the index shift amount, optional and defaulting to #0 when <extend> is not LSL, #0 when S = 0 #2 when S = 1
<amount>		For the 64-bit variant: is the index shift amount, optional and defaulting to #0 when <extend> is not LSL, #0 when S = 0 #3 when S = 1
<amount>		For the 128-bit variant: is the index shift amount, optional and defaulting to #0 when <extend> is not LSL, #0 when S = 0 #4 when S = 1

Shared decode for all variants

```
integer n = UInt(Rn);
integer t = UInt(Rt);
integer m = UInt(Rm);
AccType acctype = AccType_VEC;
MemOp memop = if opc<0> == '1' then MemOp_LOAD else MemOp_STORE;
integer datasize = 8 << scale;
```

Operation

```
bits(64) offset = ExtendReg(m, extend_type, shift);
CheckFPAdvSIMDEnabled64();

bits(64) address;
bits(datasize) data;

if n == 31 then
  CheckSPAlignment();
  address = SP[];
else
  address = X[n];

if ! postindex then
  address = address + offset;

case memop of
  when MemOp_STORE
```

```
    data = V[t];  
    Mem[address, datasize DIV 8, acctype] = data;  
  
    when MemOp_LOAD  
        data = Mem[address, datasize DIV 8, acctype];  
        V[t] = data;  
  
    if wback then  
        if postindex then  
            address = address + offset;  
        if n == 31 then  
            SP[] = address;  
        else  
            X[n] = address;
```

C6.3.169 LDUR (SIMD&FP)

Load SIMD&FP register (unscaled offset)

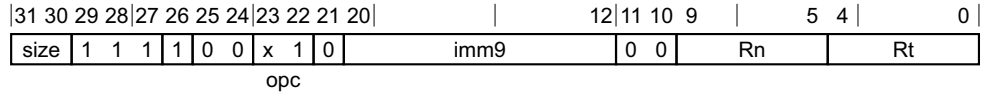

8-bit variant (size = 00, opc = 01)

LDUR <Bt>, [<Xn|SP>{, #<sim>}]

16-bit variant (size = 01, opc = 01)

LDUR <Ht>, [<Xn|SP>{, #<sim>}]

32-bit variant (size = 10, opc = 01)

LDUR <St>, [<Xn|SP>{, #<sim>}]

64-bit variant (size = 11, opc = 01)

LDUR <Dt>, [<Xn|SP>{, #<sim>}]

128-bit variant (size = 00, opc = 11)

LDUR <Qt>, [<Xn|SP>{, #<sim>}]

```
boolean wback = FALSE;
boolean postindex = FALSE;
integer scale = UInt(opc<1>:size);
if scale > 4 then UnallocatedEncoding();
bits(64) offset = SignExtend(imm9, 64);
```

Assembler Symbols

- <Bt> Is the 8-bit name of the SIMD&FP register to be transferred, encoded in the "Rt" field.
- <Dt> Is the 64-bit name of the SIMD&FP register to be transferred, encoded in the "Rt" field.
- <Ht> Is the 16-bit name of the SIMD&FP register to be transferred, encoded in the "Rt" field.
- <Qt> Is the 128-bit name of the SIMD&FP register to be transferred, encoded in the "Rt" field.
- <St> Is the 32-bit name of the SIMD&FP register to be transferred, encoded in the "Rt" field.
- <Xn|SP> Is the 64-bit name of the general-purpose base register or stack pointer, encoded in the "Rn" field.
- <sim> Is the optional signed immediate byte offset, in the range -256 to 255, defaulting to 0 and encoded in the "imm9" field.

Shared decode for all variants

```
integer n = UInt(Rn);
integer t = UInt(Rt);
AccType acctype = AccType_VEC;
MemOp memop = if opc<0> == '1' then MemOp_LOAD else MemOp_STORE;
integer datasize = 8 << scale;
```

Operation

CheckFPAdvSIMDEnabled64();

bits(64) address;

```
bits(datasize) data;

if n == 31 then
    CheckSPAlignment();
    address = SP[];
else
    address = X[n];

if ! postindex then
    address = address + offset;

case memop of
    when MemOp_STORE
        data = V[t];
        Mem[address, datasize DIV 8, acctype] = data;

    when MemOp_LOAD
        data = Mem[address, datasize DIV 8, acctype];
        V[t] = data;

if wback then
    if postindex then
        address = address + offset;
    if n == 31 then
        SP[] = address;
    else
        X[n] = address;
```

C6.3.170 MLA (by element)

Multiply-add to accumulator (vector, by element)

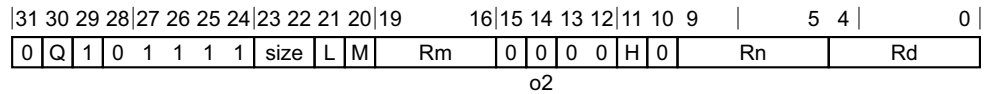

Vector variant

MLA <Vd>.<T>, <Vn>.<T>, <Vm>.<Ts>[<index>]

```
integer idxsize = if H == '1' then 128 else 64;
integer index;
bit Rmhi;
case size of
    when '01' index = UInt(H:L:M); Rmhi = '0';
    when '10' index = UInt(H:L); Rmhi = M;
    otherwise UnallocatedEncoding();

integer d = UInt(Rd);
integer n = UInt(Rn);
integer m = UInt(Rmhi:Rm);

integer esize = 8 << UInt(size);
integer datasize = if Q == '1' then 128 else 64;
integer elements = datasize DIV esize;

boolean sub_op = (o2 == '1');
```

Assembler Symbols

- <Vd> Is the name of the SIMD&FP destination register, encoded in the "Rd" field.
- <T> Is an arrangement specifier,
RESERVED when size = 00, Q = x
4H when size = 01, Q = 0
8H when size = 01, Q = 1
2S when size = 10, Q = 0
4S when size = 10, Q = 1
RESERVED when size = 11, Q = x
- <Vn> Is the name of the first SIMD&FP source register, encoded in the "Rn" field.
- <Vm> Is the name of the second SIMD&FP source register,
RESERVED when size = 00
0:Rm when size = 01
M:Rm when size = 10
RESERVED when size = 11
 Restricted to V0-V15 when element size <Ts> is H.
- <Ts> Is an element size specifier,
RESERVED when size = 00
H when size = 01
S when size = 10

RESERVED when size = 11

<index> Is the element index

RESERVED when size = 00

H:L:M when size = 01

H:L when size = 10

RESERVED when size = 11

Operation

```
CheckFPAdvSIMDEnabled64();
bits(datasize) operand1 = V[n];
bits(idxsized) operand2 = V[m];
bits(datasize) operand3 = V[d];
bits(datasize) result;
integer element1;
integer element2;
bits(esize) product;

element2 = UInt(Elem[operand2, index, esize]);
for e = 0 to elements-1
    element1 = UInt(Elem[operand1, e, esize]);
    product = (element1 * element2) <esize-1:0>;
    if sub_op then
        Elem[result, e, esize] = Elem[operand3, e, esize] - product;
    else
        Elem[result, e, esize] = Elem[operand3, e, esize] + product;
V[d] = result;
```

C6.3.171 MLA (vector)

Multiply-add to accumulator (vector)

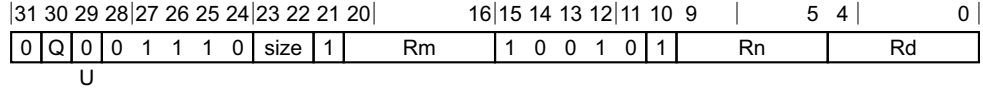

Three registers of the same type variant

MLA <Vd>.<T>, <Vn>.<T>, <Vm>.<T>

```
integer d = UInt(Rd);
integer n = UInt(Rn);
integer m = UInt(Rm);
if size == '11' then ReservedValue();
integer esize = 8 << UInt(size);
integer datasize = if Q == '1' then 128 else 64;
integer elements = datasize DIV esize;

boolean sub_op = (U == '1');
```

Assembler Symbols

- <Vd> Is the name of the SIMD&FP destination register, encoded in the "Rd" field.
- <T> Is an arrangement specifier,
 - 8B** when size = 00, Q = 0
 - 16B** when size = 00, Q = 1
 - 4H** when size = 01, Q = 0
 - 8H** when size = 01, Q = 1
 - 2S** when size = 10, Q = 0
 - 4S** when size = 10, Q = 1
 - RESERVED** when size = 11, Q = x
- <Vn> Is the name of the first SIMD&FP source register, encoded in the "Rn" field.
- <Vm> Is the name of the second SIMD&FP source register, encoded in the "Rm" field.

Operation

```
CheckFPAdvSIMDEnabled64();
bits(datasize) operand1 = V[n];
bits(datasize) operand2 = V[m];
bits(datasize) operand3 = V[d];
bits(datasize) result;
bits(esize) element1;
bits(esize) element2;
bits(esize) product;

for e = 0 to elements-1
    element1 = Elem[operand1, e, esize];
    element2 = Elem[operand2, e, esize];
    product = (UInt(element1) * UInt(element2))<esize-1:0>;
    if sub_op then
        Elem[result, e, esize] = Elem[operand3, e, esize] - product;
    else
```

```
Elem[result, e, esize] = Elem[operand3, e, esize] + product;  
V[d] = result;
```

C6.3.172 MLS (by element)

Multiply-subtract from accumulator (vector, by element)

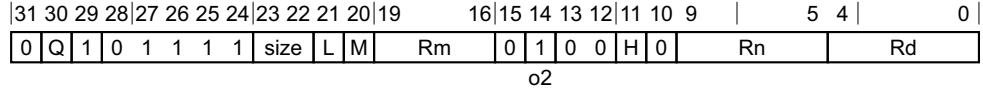

Vector variant

MLS <Vd>.<T>, <Vn>.<T>, <Vm>.<Ts>[<index>]

```

integer idxsize = if H == '1' then 128 else 64;
integer index;
bit Rmhi;
case size of
    when '01' index = UInt(H:L:M); Rmhi = '0';
    when '10' index = UInt(H:L); Rmhi = M;
    otherwise UnallocatedEncoding();

integer d = UInt(Rd);
integer n = UInt(Rn);
integer m = UInt(Rmhi:Rm);

integer esize = 8 << UInt(size);
integer datasize = if Q == '1' then 128 else 64;
integer elements = datasize DIV esize;

boolean sub_op = (o2 == '1');
```

Assembler Symbols

- <Vd> Is the name of the SIMD&FP destination register, encoded in the "Rd" field.
- <T> Is an arrangement specifier,
 - RESERVED** when size = 00, Q = x
 - 4H** when size = 01, Q = 0
 - 8H** when size = 01, Q = 1
 - 2S** when size = 10, Q = 0
 - 4S** when size = 10, Q = 1
 - RESERVED** when size = 11, Q = x
- <Vn> Is the name of the first SIMD&FP source register, encoded in the "Rn" field.
- <Vm> Is the name of the second SIMD&FP source register,
 - RESERVED** when size = 00
 - 0:Rm** when size = 01
 - M:Rm** when size = 10
 - RESERVED** when size = 11
 Restricted to V0-V15 when element size <Ts> is H.
- <Ts> Is an element size specifier,
 - RESERVED** when size = 00
 - H** when size = 01
 - S** when size = 10

RESERVED when size = 11

<index> Is the element index

RESERVED when size = 00

H:L:M when size = 01

H:L when size = 10

RESERVED when size = 11

Operation

```
CheckFPAdvSIMDEnabled64();
bits(datasize) operand1 = V[n];
bits(idxsized) operand2 = V[m];
bits(datasize) operand3 = V[d];
bits(datasize) result;
integer element1;
integer element2;
bits(esize) product;

element2 = UInt(Elem[operand2, index, esize]);
for e = 0 to elements-1
    element1 = UInt(Elem[operand1, e, esize]);
    product = (element1 * element2) <esize-1:0>;
    if sub_op then
        Elem[result, e, esize] = Elem[operand3, e, esize] - product;
    else
        Elem[result, e, esize] = Elem[operand3, e, esize] + product;
V[d] = result;
```

C6.3.173 MLS (vector)

Multiply-subtract from accumulator (vector)

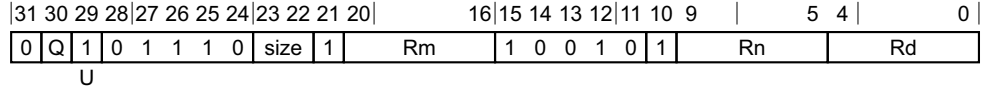

Three registers of the same type variant

MLS <Vd>.<T>, <Vn>.<T>, <Vm>.<T>

```

integer d = UInt(Rd);
integer n = UInt(Rn);
integer m = UInt(Rm);
if size == '11' then ReservedValue();
integer esize = 8 << UInt(size);
integer datasize = if Q == '1' then 128 else 64;
integer elements = datasize DIV esize;

boolean sub_op = (U == '1');
```

Assembler Symbols

- <Vd> Is the name of the SIMD&FP destination register, encoded in the "Rd" field.
- <T> Is an arrangement specifier,
 - 8B** when size = 00, Q = 0
 - 16B** when size = 00, Q = 1
 - 4H** when size = 01, Q = 0
 - 8H** when size = 01, Q = 1
 - 2S** when size = 10, Q = 0
 - 4S** when size = 10, Q = 1
 - RESERVED** when size = 11, Q = x
- <Vn> Is the name of the first SIMD&FP source register, encoded in the "Rn" field.
- <Vm> Is the name of the second SIMD&FP source register, encoded in the "Rm" field.

Operation

```

CheckFPAdvSIMDEnabled64();
bits(datasize) operand1 = V[n];
bits(datasize) operand2 = V[m];
bits(datasize) operand3 = V[d];
bits(datasize) result;
bits(esize) element1;
bits(esize) element2;
bits(esize) product;

for e = 0 to elements-1
    element1 = Elem[operand1, e, esize];
    element2 = Elem[operand2, e, esize];
    product = (UInt(element1) * UInt(element2))<esize-1:0>;
    if sub_op then
        Elem[result, e, esize] = Elem[operand3, e, esize] - product;
    else
```

```
Elem[result, e, esize] = Elem[operand3, e, esize] + product;  
V[d] = result;
```

C6.3.174 MOV (scalar)

Move vector element to scalar

This instruction is an alias of the [DUP \(element\)](#) instruction.

31	30	29	28	27	26	25	24	23	22	21	20	16	15	14	13	12	11	10	9	5	4	0
0	1	0	1	1	1	1	0	0	0	0	imm5	0	0	0	0	0	1	Rn	Rd			

Scalar variant

MOV <V><d>, <Vn>.<T>[<index>]

is equivalent to

DUP <V><d>, <Vn>.<T>[<index>]

and is always the preferred disassembly.

Assembler Symbols

<V>	Is the destination width specifier, RESERVED when imm5 = x0000 B when imm5 = xxxx1 H when imm5 = xxx10 S when imm5 = xx100 D when imm5 = x1000
<d>	Is the number of the SIMD&FP destination register, encoded in the "Rd" field.
<Vn>	Is the name of the SIMD&FP source register, encoded in the "Rn" field.
<T>	Is the element width specifier, RESERVED when imm5 = x0000 B when imm5 = xxxx1 H when imm5 = xxx10 S when imm5 = xx100 D when imm5 = x1000
<index>	Is the element index RESERVED when imm5 = x0000 imm5<4:1> when imm5 = xxxx1 imm5<4:2> when imm5 = xxx10 imm5<4:3> when imm5 = xx100 imm5<4> when imm5 = x1000

C6.3.175 MOV (element)

Move vector element to another vector element

This instruction is an alias of the [INS \(element\)](#) instruction.

31	30	29	28	27	26	25	24	23	22	21	20	16	15	14	11	10	9	5	4	0
0	1	1	0	1	1	1	0	0	0	0	imm5	0	imm4	1	Rn	Rd				

Advanced SIMD variant

MOV <Vd>.<Ts>[<index1>], <Vn>.<Ts>[<index2>]

is equivalent to

INS <Vd>.<Ts>[<index1>], <Vn>.<Ts>[<index2>]

and is always the preferred disassembly.

Assembler Symbols

- <Vd> Is the name of the SIMD&FP destination register, encoded in the "Rd" field.
- <Ts> Is an element size specifier,
 - RESERVED** when imm5 = x0000
 - B** when imm5 = xxxx1
 - H** when imm5 = xxx10
 - S** when imm5 = xx100
 - D** when imm5 = x1000
- <index1> Is the destination element index
 - RESERVED** when imm5 = x0000
 - imm5<4:1>** when imm5 = xxxx1
 - imm5<4:2>** when imm5 = xxx10
 - imm5<4:3>** when imm5 = xx100
 - imm5<4>** when imm5 = x1000
- <Vn> Is the name of the SIMD&FP source register, encoded in the "Rn" field.
- <index2> Is the source element index
 - RESERVED** when imm5 = x0000
 - imm4<3:0>** when imm5 = xxxx1
 - imm4<3:1>** when imm5 = xxx10
 - imm4<3:2>** when imm5 = xx100
 - imm4<3>** when imm5 = x1000

Unspecified bits in "imm4" are ignored but should be set to zero by an assembler.

C6.3.176 MOV (from general)

Move general-purpose register to a vector element

This instruction is an alias of the [INS \(general\)](#) instruction.

31	30	29	28	27	26	25	24	23	22	21	20	16	15	14	13	12	11	10	9	5	4	0
0	1	0	0	1	1	1	0	0	0	0	imm5	0	0	0	1	1	1	Rn	Rd			

Advanced SIMD variant

MOV <Vd>.<Ts>[<index>], <R><n>

is equivalent to

INS <Vd>.<Ts>[<index>], <R><n>

and is always the preferred disassembly.

Assembler Symbols

- <Vd> Is the name of the SIMD&FP destination register, encoded in the "Rd" field.
- <Ts> Is an element size specifier,
RESERVED when imm5 = x0000
B when imm5 = xxxx1
H when imm5 = xxx10
S when imm5 = xx100
D when imm5 = x1000
- <index> Is the element index
RESERVED when imm5 = x0000
imm5<4:1> when imm5 = xxxx1
imm5<4:2> when imm5 = xxx10
imm5<4:3> when imm5 = xx100
imm5<4> when imm5 = x1000
- <R> Is the width specifier for the general-purpose source register,
RESERVED when imm5 = x0000
W when imm5 = xxxx1
W when imm5 = xxx10
W when imm5 = xx100
X when imm5 = x1000
- <n> Is the number [0-30] of the general-purpose source register or ZR (31), encoded in the "Rn" field.

C6.3.177 MOV (vector)

Move vector

This instruction is an alias of the [ORR \(vector, register\)](#) instruction.

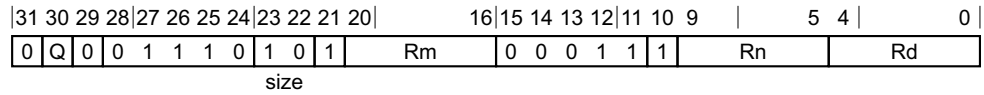

Three registers of the same type variant

MOV <Vd>.<T>, <Vn>.<T>

is equivalent to

ORR <Vd>.<T>, <Vn>.<T>, <Vn>.<T>

and is the preferred disassembly when Rm == Rn.

Assembler Symbols

<Vd> Is the name of the SIMD&FP destination register, encoded in the "Rd" field.

<T> Is an arrangement specifier,

8B when Q = 0

16B when Q = 1

<Vn> Is the name of the first SIMD&FP source register, encoded in the "Rn" field.

C6.3.178 MOV (to general)

Move vector element to general-purpose register

This instruction is an alias of the [UMOV](#) instruction.

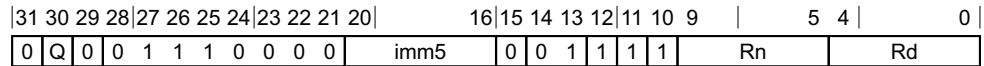

32-bit variant (Q = 0)

MOV <Wd>, <Vn>.S[<index>]

is equivalent to

UMOV <Wd>, <Vn>.S[<index>]

and is the preferred disassembly when imm5 == 'xx100'.

64-bit variant (Q = 1)

MOV <Xd>, <Vn>.D[<index>]

is equivalent to

UMOV <Xd>, <Vn>.D[<index>]

and is always the preferred disassembly.

Assembler Symbols

- <Wd> Is the 32-bit name of the general-purpose destination register, encoded in the "Rd" field.
- <Xd> Is the 64-bit name of the general-purpose destination register, encoded in the "Rd" field.
- <Vn> Is the name of the SIMD&FP source register, encoded in the "Rn" field.
- <index> For the 32-bit variant: is the element index
RESERVED when imm5 = xx000
imm5<4:1> when imm5 = xxxx1
imm5<4:2> when imm5 = xxx10
imm5<4:3> when imm5 = xx100
- <index> For the 64-bit variant: is the element index encoded in "imm5<4>".

C6.3.179 MOVI

Move immediate (vector)

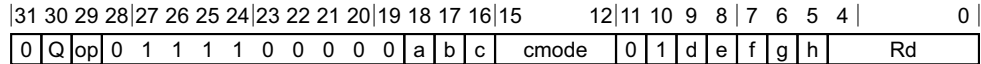

8-bit variant (op = 0, cmode = 1110)

MOVI <Vd>.<T>, #<imm8>{, LSL #0}

16-bit shifted immediate variant (op = 0, cmode = 10x0)

MOVI <Vd>.<T>, #<imm8>{, LSL #<amount>}

32-bit shifted immediate variant (op = 0, cmode = 0xx0)

MOVI <Vd>.<T>, #<imm8>{, LSL #<amount>}

32-bit shifting ones variant (op = 0, cmode = 110x)

MOVI <Vd>.<T>, #<imm8>, MSL #<amount>

64-bit scalar variant (Q = 0, op = 1, cmode = 1110)

MOVI <Dd>, #<imm>

64-bit vector variant (Q = 1, op = 1, cmode = 1110)

MOVI <Vd>.<2D>, #<imm>

integer rd = UInt(Rd);

integer datasize = if Q == '1' then 128 else 64;
 bits(datasize) imm;
 bits(64) imm64;

ImmediateOp operation;

case cmode:op of

```

when '0xx00' operation = ImmediateOp_MOVI;
when '0xx01' operation = ImmediateOp_MVNI;
when '0xx10' operation = ImmediateOp_ORR;
when '0xx11' operation = ImmediateOp_BIC;
when '10x00' operation = ImmediateOp_MOVI;
when '10x01' operation = ImmediateOp_MVNI;
when '10x10' operation = ImmediateOp_ORR;
when '10x11' operation = ImmediateOp_BIC;
when '110x0' operation = ImmediateOp_MOVI;
when '110x1' operation = ImmediateOp_MVNI;
when '1110x' operation = ImmediateOp_MOVI;
when '11110' operation = ImmediateOp_MOVI;
when '11111'
    // FMOV Dn,#imm is in main FP instruction set
    if Q == '0' then UnallocatedEncoding();
    operation = ImmediateOp_MOVI;
    
```

imm64 = AdvSIMDExpandImm(op, cmode, a:b:c:d:e:f:g:h);

imm = Replicate(imm64, datasize DIV 64);

Assembler Symbols

<Dd> Is the 64-bit name of the SIMD&FP destination register, encoded in the "Rd" field.

<Vd> Is the name of the SIMD&FP destination register, encoded in the "Rd" field.

<imm>	Is a 64-bit immediate 'aaaaaaaaabbbbbbbcccccccccdddddddeeeeeeeeeffffffffffggggggghhhhhhhh', encoded in "a:b:c:d:e:f:g:h".
<T>	For the 8-bit variant: is an arrangement specifier, 8B when Q = 0 16B when Q = 1
<T>	For the 16-bit variant: is an arrangement specifier, 4H when Q = 0 8H when Q = 1
<T>	For the 32-bit variant: is an arrangement specifier, 2S when Q = 0 4S when Q = 1
<imm8>	Is an 8-bit immediate encoded in "a:b:c:d:e:f:g:h".
<amount>	For the 16-bit shifted immediate variant: is the shift amount 0 when cmode<1> = 0 8 when cmode<1> = 1 defaulting to 0 if LSL is omitted.
<amount>	For the 32-bit shifted immediate variant: is the shift amount 0 when cmode<2:1> = 00 8 when cmode<2:1> = 01 16 when cmode<2:1> = 10 24 when cmode<2:1> = 11 defaulting to 0 if LSL is omitted.
<amount>	For the 32-bit shifting ones variant: is the shift amount 8 when cmode<0> = 0 16 when cmode<0> = 1

Operation

```

CheckFPAdvSIMDEnabled64();
bits(datasize) operand;
bits(datasize) result;

case operation of
  when ImmediateOp_MOVI
    result = imm;
  when ImmediateOp_MVNI
    result = NOT(imm);
  when ImmediateOp_ORR
    operand = V[rd];
    result = operand OR imm;
  when ImmediateOp_BIC
    operand = V[rd];
    result = operand AND NOT(imm);

V[rd] = result;

```

C6.3.180 MUL (by element)

Multiply (vector, by element)

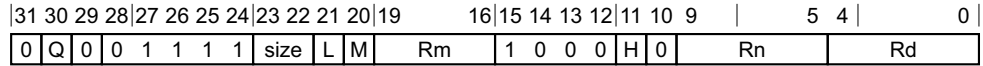

Vector variant

MUL <Vd>.<T>, <Vn>.<T>, <Vm>.<Ts>[<index>]

```
integer idxsize = if H == '1' then 128 else 64;
integer index;
bit Rmhi;
case size of
    when '01' index = UInt(H:L:M); Rmhi = '0';
    when '10' index = UInt(H:L); Rmhi = M;
    otherwise UnallocatedEncoding();

integer d = UInt(Rd);
integer n = UInt(Rn);
integer m = UInt(Rmhi:Rm);

integer esize = 8 << UInt(size);
integer datasize = if Q == '1' then 128 else 64;
integer elements = datasize DIV esize;
```

Assembler Symbols

- <Vd> Is the name of the SIMD&FP destination register, encoded in the "Rd" field.
- <T> Is an arrangement specifier,
RESERVED when size = 00, Q = x
4H when size = 01, Q = 0
8H when size = 01, Q = 1
2S when size = 10, Q = 0
4S when size = 10, Q = 1
RESERVED when size = 11, Q = x
- <Vn> Is the name of the first SIMD&FP source register, encoded in the "Rn" field.
- <Vm> Is the name of the second SIMD&FP source register,
RESERVED when size = 00
0:Rm when size = 01
M:Rm when size = 10
RESERVED when size = 11
 Restricted to V0-V15 when element size <Ts> is H.
- <Ts> Is an element size specifier,
RESERVED when size = 00
H when size = 01
S when size = 10
RESERVED when size = 11

<index> Is the element index
RESERVED when size = 00
H:L:M when size = 01
H:L when size = 10
RESERVED when size = 11

Operation

```
CheckFPAdvSIMDEnabled64();
bits(datasize) operand1 = V[n];
bits(idxsize) operand2 = V[m];
bits(datasize) result;
integer element1;
integer element2;
bits(esize) product;

element2 = UInt(Elem[operand2, index, esize]);
for e = 0 to elements-1
    element1 = UInt(Elem[operand1, e, esize]);
    product = (element1 * element2)<esize-1:0>;
    Elem[result, e, esize] = product;

V[d] = result;
```

C6.3.181 MUL (vector)

Multiply (vector)

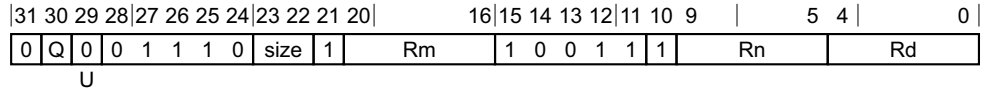

Three registers of the same type variant

MUL <Vd>.<T>, <Vn>.<T>, <Vm>.<T>

```
integer d = UInt(Rd);
integer n = UInt(Rn);
integer m = UInt(Rm);
if U == '1' && size != '00' then ReservedValue();
if size == '11' then ReservedValue();
integer esize = 8 << UInt(size);
integer datasize = if Q == '1' then 128 else 64;
integer elements = datasize DIV esize;
```

```
boolean poly = (U == '1');
```

Assembler Symbols

- <Vd> Is the name of the SIMD&FP destination register, encoded in the "Rd" field.
- <T> Is an arrangement specifier,
- 8B** when size = 00, Q = 0
 - 16B** when size = 00, Q = 1
 - 4H** when size = 01, Q = 0
 - 8H** when size = 01, Q = 1
 - 2S** when size = 10, Q = 0
 - 4S** when size = 10, Q = 1
 - RESERVED** when size = 11, Q = x
- <Vn> Is the name of the first SIMD&FP source register, encoded in the "Rn" field.
- <Vm> Is the name of the second SIMD&FP source register, encoded in the "Rm" field.

Operation

```
CheckFPAdvSIMDEnabled64();
bits(datasize) operand1 = V[n];
bits(datasize) operand2 = V[m];
bits(datasize) result;
bits(esize) element1;
bits(esize) element2;
bits(esize) product;

for e = 0 to elements-1
    element1 = Elem[operand1, e, esize];
    element2 = Elem[operand2, e, esize];
    if poly then
        product = PolynomialMult(element1, element2)<esize-1:0>;
    else
        product = (UInt(element1) * UInt(element2))<esize-1:0>;
```

```
Elem[result, e, esize] = product;  
V[d] = result;
```

C6.3.182 MVN

Bitwise NOT (vector)

This instruction is an alias of the [NOT](#) instruction.

31	30	29	28	27	26	25	24	23	22	21	20	19	18	17	16	15	14	13	12	11	10	9			5	4			0
0	Q	1	0	1	1	1	0	0	0	1	0	0	0	0	0	0	0	1	0	1	1	0			Rn				Rd

Vector variant

MVN <Vd>.<T>, <Vn>.<T>

is equivalent to

NOT <Vd>.<T>, <Vn>.<T>

and is always the preferred disassembly.

Assembler Symbols

<Vd> Is the name of the SIMD&FP destination register, encoded in the "Rd" field.

<T> Is an arrangement specifier,

8B when Q = 0

16B when Q = 1

<Vn> Is the name of the SIMD&FP source register, encoded in the "Rn" field.

C6.3.183 MVNI

Move inverted immediate (vector)

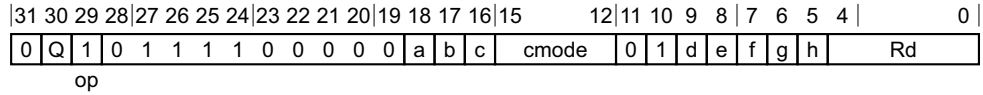

16-bit shifted immediate variant (cmode = 10x0)

MVNI <Vd>.<T>, #<imm8>{, LSL #<amount>}

32-bit shifted immediate variant (cmode = 0xx0)

MVNI <Vd>.<T>, #<imm8>{, LSL #<amount>}

32-bit shifting ones variant (cmode = 110x)

MVNI <Vd>.<T>, #<imm8>, MSL #<amount>

integer rd = UInt(Rd);

integer datasize = if Q == '1' then 128 else 64;
 bits(datasize) imm;
 bits(64) imm64;

ImmediateOp operation;

```
case cmode:op of
    when '0xx00' operation = ImmediateOp_MOVI;
    when '0xx01' operation = ImmediateOp_MVNI;
    when '0xx10' operation = ImmediateOp_ORR;
    when '0xx11' operation = ImmediateOp_BIC;
    when '10x00' operation = ImmediateOp_MOVI;
    when '10x01' operation = ImmediateOp_MVNI;
    when '10x10' operation = ImmediateOp_ORR;
    when '10x11' operation = ImmediateOp_BIC;
    when '110x0' operation = ImmediateOp_MOVI;
    when '110x1' operation = ImmediateOp_MVNI;
    when '1110x' operation = ImmediateOp_MOVI;
    when '11110' operation = ImmediateOp_MOVI;
    when '11111'
        // FMOV Dn,#imm is in main FP instruction set
        if Q == '0' then UnallocatedEncoding();
        operation = ImmediateOp_MOVI;
```

```
imm64 = AdvSIMDExpandImm(op, cmode, a:b:c:d:e:f:g:h);
imm = Replicate(imm64, datasize DIV 64);
```

Assembler Symbols

- <Vd> Is the name of the SIMD&FP destination register, encoded in the "Rd" field.
- <T> For the 16-bit variant: is an arrangement specifier,
 - 4H** when Q = 0
 - 8H** when Q = 1
- <T> For the 32-bit variant: is an arrangement specifier,
 - 2S** when Q = 0
 - 4S** when Q = 1
- <imm8> Is an 8-bit immediate encoded in "a:b:c:d:e:f:g:h".

<amount> For the 16-bit shifted immediate variant: is the shift amount
0 when cmode<1> = 0
8 when cmode<1> = 1
defaulting to 0 if LSL is omitted.

<amount> For the 32-bit shifted immediate variant: is the shift amount
0 when cmode<2:1> = 00
8 when cmode<2:1> = 01
16 when cmode<2:1> = 10
24 when cmode<2:1> = 11
defaulting to 0 if LSL is omitted.

<amount> For the 32-bit shifting ones variant: is the shift amount
8 when cmode<0> = 0
16 when cmode<0> = 1

Operation

```
CheckFPAdvSIMDEnabled64();
bits(datasize) operand;
bits(datasize) result;

case operation of
  when ImmediateOp_MOVI
    result = imm;
  when ImmediateOp_MVNI
    result = NOT(imm);
  when ImmediateOp_ORR
    operand = V[rd];
    result = operand OR imm;
  when ImmediateOp_BIC
    operand = V[rd];
    result = operand AND NOT(imm);

V[rd] = result;
```

C6.3.184 NEG (vector)

Negate (vector)

It has encodings from 2 classes: *Scalar* and *Vector*

Scalar

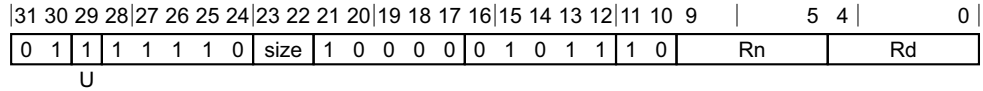

Scalar variant

NEG <V><d>, <V><n>

```
integer d = UInt(Rd);
integer n = UInt(Rn);
```

```
if size != '11' then ReservedValue();
integer esize = 8 << UInt(size);
integer datasize = esize;
integer elements = 1;
```

```
boolean neg = (U == '1');
```

Vector

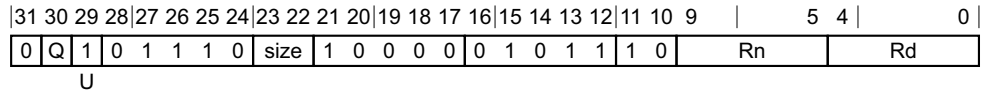

Vector variant

NEG <Vd>.<T>, <Vn>.<T>

```
integer d = UInt(Rd);
integer n = UInt(Rn);
```

```
if size:Q == '110' then ReservedValue();
integer esize = 8 << UInt(size);
integer datasize = if Q == '1' then 128 else 64;
integer elements = datasize DIV esize;
```

```
boolean neg = (U == '1');
```

Assembler Symbols

- <V> Is a width specifier,
RESERVED when size = 0x
RESERVED when size = 10
D when size = 11
- <d> Is the number of the SIMD&FP destination register, encoded in the "Rd" field.
- <n> Is the number of the SIMD&FP source register, encoded in the "Rn" field.
- <Vd> Is the name of the SIMD&FP destination register, encoded in the "Rd" field.
- <T> Is an arrangement specifier,
8B when size = 00, Q = 0

16B when size = 00, Q = 1
4H when size = 01, Q = 0
8H when size = 01, Q = 1
2S when size = 10, Q = 0
4S when size = 10, Q = 1
RESERVED when size = 11, Q = 0
2D when size = 11, Q = 1

<Vn> Is the name of the SIMD&FP source register, encoded in the "Rn" field.

Operation for all classes

```
CheckFPAdvSIMDEnabled64();
bits(datasize) operand = V[n];
bits(datasize) result;
integer element;

for e = 0 to elements-1
    element = SInt(Elem[operand, e, esize]);
    if neg then
        element = -element;
    else
        element = Abs(element);
    Elem[result, e, esize] = element<esize-1:0>;

V[d] = result;
```

C6.3.185 NOT

Bitwise NOT (vector)

This instruction is used by the alias [MVN](#). The alias is always the preferred disassembly.

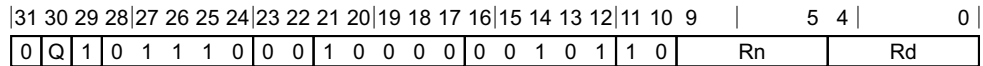

Vector variant

NOT <Vd>.<T>, <Vn>.<T>

```
integer d = UInt(Rd);
integer n = UInt(Rn);
```

```
integer esize = 8;
integer datasize = if Q == '1' then 128 else 64;
integer elements = datasize DIV 8;
```

Assembler Symbols

<Vd> Is the name of the SIMD&FP destination register, encoded in the "Rd" field.

<T> Is an arrangement specifier,

8B when Q = 0

16B when Q = 1

<Vn> Is the name of the SIMD&FP source register, encoded in the "Rn" field.

Operation

```
CheckFPAdvSIMDEnabled64();
bits(datasize) operand = V[n];
bits(datasize) result;
bits(esize) element;

for e = 0 to elements-1
  element = Elem[operand, e, esize];
  Elem[result, e, esize] = NOT(element);

V[d] = result;
```

C6.3.186 ORN (vector)

Bitwise inclusive OR NOT (vector)

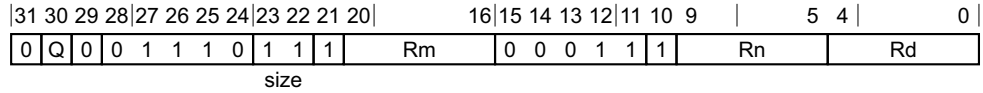

Three registers of the same type variant

ORN <Vd>.<T>, <Vn>.<T>, <Vm>.<T>

```
integer d = UInt(Rd);
integer n = UInt(Rn);
integer m = UInt(Rm);
integer esize = 8;
integer datasize = if Q == '1' then 128 else 64;
integer elements = datasize DIV esize;
```

```
boolean invert = (size<0> == '1');
LogicalOp op = if size<1> == '1' then LogicalOp_ORR else LogicalOp_AND;
```

Assembler Symbols

- <Vd> Is the name of the SIMD&FP destination register, encoded in the "Rd" field.
- <T> Is an arrangement specifier,
 - 8B** when Q = 0
 - 16B** when Q = 1
- <Vn> Is the name of the first SIMD&FP source register, encoded in the "Rn" field.
- <Vm> Is the name of the second SIMD&FP source register, encoded in the "Rm" field.

Operation

```
CheckFPAdvSIMDEnabled64();
bits(datasize) operand1 = V[n];
bits(datasize) operand2 = V[m];
bits(datasize) result;

if invert then operand2 = NOT(operand2);

case op of
    when LogicalOp_AND
        result = operand1 AND operand2;
    when LogicalOp_ORR
        result = operand1 OR operand2;

V[d] = result;
```

C6.3.187 ORR (vector, immediate)

Bitwise inclusive OR (vector, immediate)

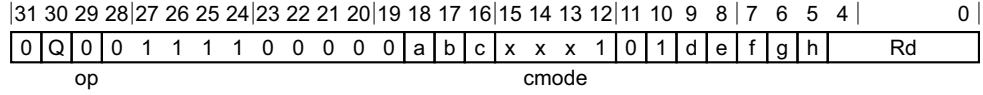

16-bit variant (cmode = 10x1)

ORR <Vd>.<T>, #<imm8>{, LSL #<amount>}

32-bit variant (cmode = 0xx1)

ORR <Vd>.<T>, #<imm8>{, LSL #<amount>}

```
integer rd = UInt(Rd);

integer datasize = if Q == '1' then 128 else 64;
bits(datasize) imm;
bits(64) imm64;

ImmediateOp operation;
case cmode:op of
    when '0xx00' operation = ImmediateOp_MOVI;
    when '0xx01' operation = ImmediateOp_MVNI;
    when '0xx10' operation = ImmediateOp_ORR;
    when '0xx11' operation = ImmediateOp_BIC;
    when '10x00' operation = ImmediateOp_MOVI;
    when '10x01' operation = ImmediateOp_MVNI;
    when '10x10' operation = ImmediateOp_ORR;
    when '10x11' operation = ImmediateOp_BIC;
    when '110x0' operation = ImmediateOp_MOVI;
    when '110x1' operation = ImmediateOp_MVNI;
    when '1110x' operation = ImmediateOp_MOVI;
    when '11110' operation = ImmediateOp_MOVI;
    when '11111'
        // FMOV Dn,#imm is in main FP instruction set
        if Q == '0' then UnallocatedEncoding();
        operation = ImmediateOp_MOVI;

imm64 = AdvSIMDExpandImm(op, cmode, a:b:c:d:e:f:g:h);
imm = Replicate(imm64, datasize DIV 64);
```

Assembler Symbols

- <Vd> Is the name of the SIMD&FP register, encoded in the "Rd" field.
- <T> For the 16-bit variant: is an arrangement specifier,
 - 4H** when Q = 0
 - 8H** when Q = 1
- <T> For the 32-bit variant: is an arrangement specifier,
 - 2S** when Q = 0
 - 4S** when Q = 1
- <imm8> Is an 8-bit immediate encoded in "a:b:c:d:e:f:g:h".
- <amount> For the 16-bit variant: is the shift amount
 - 0** when cmode<1> = 0

8 when `cmode<1> = 1`
defaulting to 0 if LSL is omitted.

<amount> For the 32-bit variant: is the shift amount

0 when `cmode<2:1> = 00`

8 when `cmode<2:1> = 01`

16 when `cmode<2:1> = 10`

24 when `cmode<2:1> = 11`
defaulting to 0 if LSL is omitted.

Operation

```
CheckFPAdvSIMDEnabled64();
bits(datasize) operand;
bits(datasize) result;

case operation of
  when ImmediateOp_MOVI
    result = imm;
  when ImmediateOp_MVNI
    result = NOT(imm);
  when ImmediateOp_ORR
    operand = V[rd];
    result = operand OR imm;
  when ImmediateOp_BIC
    operand = V[rd];
    result = operand AND NOT(imm);

V[rd] = result;
```

C6.3.188 ORR (vector, register)

Bitwise inclusive OR (vector, register)

This instruction is used by the alias [MOV \(vector\)](#). See the *Alias conditions* table for details of when each alias is preferred.

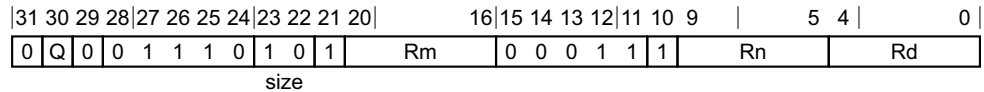

Three registers of the same type variant

ORR <Vd>.<T>, <Vn>.<T>, <Vm>.<T>

```
integer d = UInt(Rd);
integer n = UInt(Rn);
integer m = UInt(Rm);
integer esize = 8;
integer datasize = if Q == '1' then 128 else 64;
integer elements = datasize DIV esize;
```

```
boolean invert = (size<0> == '1');
LogicalOp op = if size<1> == '1' then LogicalOp_ORR else LogicalOp_AND;
```

Alias conditions

Alias	is preferred when
MOV (vector)	Rm == Rn

Assembler Symbols

- <Vd> Is the name of the SIMD&FP destination register, encoded in the "Rd" field.
- <T> Is an arrangement specifier,
 - 8B** when Q = 0
 - 16B** when Q = 1
- <Vn> Is the name of the first SIMD&FP source register, encoded in the "Rn" field.
- <Vm> Is the name of the second SIMD&FP source register, encoded in the "Rm" field.

Operation

```
CheckFPAdvSIMDEnabled64();
bits(datasize) operand1 = V[n];
bits(datasize) operand2 = V[m];
bits(datasize) result;

if invert then operand2 = NOT(operand2);

case op of
    when LogicalOp_AND
        result = operand1 AND operand2;
    when LogicalOp_ORR
        result = operand1 OR operand2;

V[d] = result;
```

C6.3.189 PMUL

Polynomial multiply

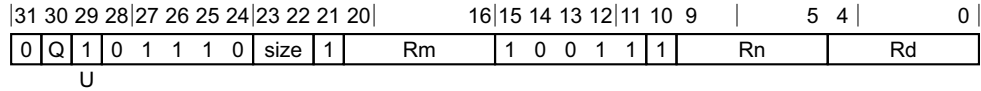

Three registers of the same type variant

PMUL <Vd>.<T>, <Vn>.<T>, <Vm>.<T>

```
integer d = UInt(Rd);
integer n = UInt(Rn);
integer m = UInt(Rm);
if U == '1' && size != '00' then ReservedValue();
if size == '11' then ReservedValue();
integer esize = 8 << UInt(size);
integer datasize = if Q == '1' then 128 else 64;
integer elements = datasize DIV esize;
```

```
boolean poly = (U == '1');
```

Assembler Symbols

- <Vd> Is the name of the SIMD&FP destination register, encoded in the "Rd" field.
- <T> Is an arrangement specifier,
8B when size = 00, Q = 0
16B when size = 00, Q = 1
RESERVED when size = 01, Q = x
RESERVED when size = 1x, Q = x
- <Vn> Is the name of the first SIMD&FP source register, encoded in the "Rn" field.
- <Vm> Is the name of the second SIMD&FP source register, encoded in the "Rm" field.

Operation

```
CheckFPAdvSIMDEnabled64();
bits(datasize) operand1 = V[n];
bits(datasize) operand2 = V[m];
bits(datasize) result;
bits(esize) element1;
bits(esize) element2;
bits(esize) product;

for e = 0 to elements-1
    element1 = Elem[operand1, e, esize];
    element2 = Elem[operand2, e, esize];
    if poly then
        product = PolynomialMult(element1, element2)<esize-1:0>;
    else
        product = (UInt(element1) * UInt(element2))<esize-1:0>;
    Elem[result, e, esize] = product;

V[d] = result;
```

C6.3.190 PMULL, PMULL2

Polynomial multiply long

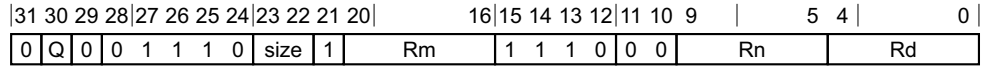

Three registers, not all the same type variant

PMULL{2} <Vd>.<Ta>, <Vn>.<Tb>, <Vm>.<Tb>

```
integer d = UInt(Rd);
integer n = UInt(Rn);
integer m = UInt(Rm);
```

```
if size == '01' || size == '10' then ReservedValue();
if size == '11' && ! HaveCryptoExt() then UnallocatedEncoding();
integer esize = 8 << UInt(size);
integer datasize = 64;
integer part = UInt(Q);
integer elements = datasize DIV esize;
```

Assembler Symbols

- 2 Is the second and upper half specifier. If present it causes the operation to be performed on the upper 64 bits of the registers holding the narrower elements, and is
 - [absent]** when Q = 0
 - [present]** when Q = 1

- <Vd> Is the name of the SIMD&FP destination register, encoded in the "Rd" field.

- <Ta> Is an arrangement specifier,
 - 8H** when size = 00
 - RESERVED** when size = 01
 - RESERVED** when size = 10
 - 1Q** when size = 11

The '1Q' arrangement is only allocated in an implementation that includes the Crypto extensions, and is otherwise RESERVED.

- <Vn> Is the name of the first SIMD&FP source register, encoded in the "Rn" field.

- <Tb> Is an arrangement specifier,
 - 8B** when size = 00, Q = 0
 - 16B** when size = 00, Q = 1
 - RESERVED** when size = 01, Q = x
 - RESERVED** when size = 10, Q = x
 - 1D** when size = 11, Q = 0
 - 2D** when size = 11, Q = 1

- <Vm> Is the name of the second SIMD&FP source register, encoded in the "Rm" field.

Operation

```
CheckFPAdvSIMDEnabled64();
bits(datasize) operand1 = Vpart[n, part];
bits(datasize) operand2 = Vpart[m, part];
bits(2*datasize) result;
bits(esize) element1;
bits(esize) element2;

for e = 0 to elements-1
    element1 = Elem[operand1, e, esize];
    element2 = Elem[operand2, e, esize];
    Elem[result, e, 2*esize] = PolynomialMult(element1, element2);

V[d] = result;
```

C6.3.191 RADDHN, RADDHN2

Rounding add returning high narrow

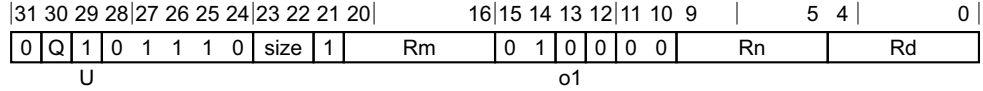

Three registers, not all the same type variant

RADDHN{2} <Vd>.<Tb>, <Vn>.<Ta>, <Vm>.<Ta>

```
integer d = UInt(Rd);
integer n = UInt(Rn);
integer m = UInt(Rm);

if size == '11' then ReservedValue();
integer esize = 8 << UInt(size);
integer datasize = 64;
integer part = UInt(Q);
integer elements = datasize DIV esize;

boolean sub_op = (o1 == '1');
boolean round = (U == '1');
```

Assembler Symbols

- 2 Is the second and upper half specifier. If present it causes the operation to be performed on the upper 64 bits of the registers holding the narrower elements, and is
 - [absent]** when Q = 0
 - [present]** when Q = 1
- <Vd> Is the name of the SIMD&FP destination register, encoded in the "Rd" field.
- <Tb> Is an arrangement specifier,
 - 8B** when size = 00, Q = 0
 - 16B** when size = 00, Q = 1
 - 4H** when size = 01, Q = 0
 - 8H** when size = 01, Q = 1
 - 2S** when size = 10, Q = 0
 - 4S** when size = 10, Q = 1
 - RESERVED** when size = 11, Q = x
- <Vn> Is the name of the first SIMD&FP source register, encoded in the "Rn" field.
- <Ta> Is an arrangement specifier,
 - 8H** when size = 00
 - 4S** when size = 01
 - 2D** when size = 10
 - RESERVED** when size = 11
- <Vm> Is the name of the second SIMD&FP source register, encoded in the "Rm" field.

Operation

```
CheckFPAdvSIMDEnabled64();
bits(2*datasize) operand1 = V[n];
bits(2*datasize) operand2 = V[m];
bits(datasize) result;
integer round_const = if round then 1 << (esize - 1) else 0;
bits(2*esize) element1;
bits(2*esize) element2;
bits(2*esize) sum;

for e = 0 to elements-1
    element1 = Elem[operand1, e, 2*esize];
    element2 = Elem[operand2, e, 2*esize];
    if sub_op then
        sum = element1 - element2;
    else
        sum = element1 + element2;
    sum = sum + round_const;
    Elem[result, e, esize] = sum<2*esize-1:esize>;

Vpart[d, part] = result;
```

C6.3.192 RBIT (vector)

Reverse bit order (vector)

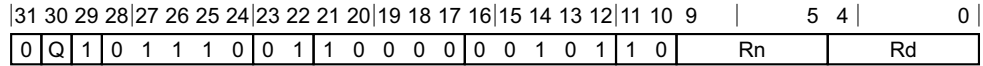

Vector variant

RBIT <Vd>.<T>, <Vn>.<T>

```
integer d = UInt(Rd);
integer n = UInt(Rn);
```

```
integer esize = 8;
integer datasize = if Q == '1' then 128 else 64;
integer elements = datasize DIV 8;
```

Assembler Symbols

<Vd> Is the name of the SIMD&FP destination register, encoded in the "Rd" field.

<T> Is an arrangement specifier,

8B when Q = 0

16B when Q = 1

<Vn> Is the name of the SIMD&FP source register, encoded in the "Rn" field.

Operation

```
CheckFPAdvSIMDEnabled64();
bits(datasize) operand = V[n];
bits(datasize) result;
bits(esize) element;
bits(esize) rev;

for e = 0 to elements-1
    element = Elem[operand, e, esize];
    for i = 0 to esize-1
        rev<esize-1-i> = element<i>;
    Elem[result, e, esize] = rev;

V[d] = result;
```

C6.3.193 REV16 (vector)

Reverse elements in 16-bit halfwords (vector)

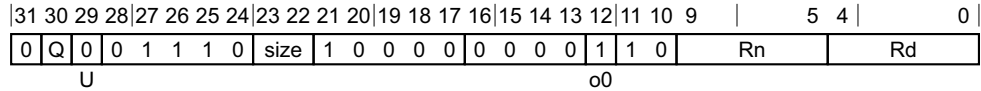

Vector variant

REV16 <Vd>.<T>, <Vn>.<T>

```
integer d = UInt(Rd);
integer n = UInt(Rn);
```

```
// size=esize: B(0), H(1), S(1), D(S)
integer esize = 8 << UInt(size);
integer datasize = if Q == '1' then 128 else 64;
integer elements = datasize DIV esize;
```

```
// op=REVx: 64(0), 32(1), 16(2)
bits(2) op = o0:U;
```

```
// => op+size:
// 64+B = 0, 64+H = 1, 64+S = 2, 64+D = X
// 32+B = 1, 32+H = 2, 32+S = X, 32+D = X
// 16+B = 2, 16+H = X, 16+S = X, 16+D = X
// 8+B = X, 8+H = X, 8+S = X, 8+D = X
// => 3-(op+size) (index bits in group)
// 64/B = 3, 64+H = 2, 64+S = 1, 64+D = X
// 32+B = 2, 32+H = 1, 32+S = X, 32+D = X
// 16+B = 1, 16+H = X, 16+S = X, 16+D = X
// 8+B = X, 8+H = X, 8+S = X, 8+D = X
```

```
// index bits within group: 1, 2, 3
if UInt(op)+UInt(size) >= 3 then UnallocatedEncoding();
integer ibits = 3-(UInt(op)+UInt(size));
```

```
// invert mask to invert index bits within group (max index = 15)
bits(4) revmask = Zeros(4-ibits):Ones(ibits);
```

Assembler Symbols

<Vd> Is the name of the SIMD&FP destination register, encoded in the "Rd" field.

<T> Is an arrangement specifier,
8B when size = 00, Q = 0
16B when size = 00, Q = 1
RESERVED when size = 01, Q = x
RESERVED when size = 1x, Q = x

<Vn> Is the name of the SIMD&FP source register, encoded in the "Rn" field.

Operation

```
CheckFPAdvSIMDEnabled64();
bits(datasize) operand = V[n];
bits(datasize) result;
integer e_rev;
for e = 0 to elements-1
```

```
e_rev = UInt(e<3:0> EOR revmask);  
Elem[result, e_rev, esize] = Elem[operand, e, esize];  
  
V[d] = result;
```

C6.3.194 REV32 (vector)

Reverse elements in 32-bit words (vector)

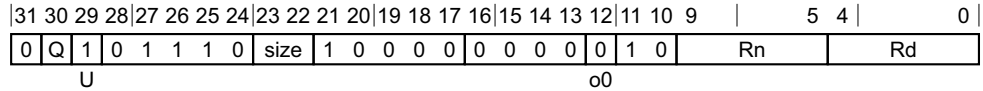

Vector variant

REV32 <Vd>.<T>, <Vn>.<T>

```
integer d = UInt(Rd);
integer n = UInt(Rn);
```

```
// size=esize: B(0), H(1), S(1), D(S)
integer esize = 8 << UInt(size);
integer datasize = if Q == '1' then 128 else 64;
integer elements = datasize DIV esize;
```

```
// op=REVx: 64(0), 32(1), 16(2)
bits(2) op = o0:U;
```

```
// => op+size:
// 64+B = 0, 64+H = 1, 64+S = 2, 64+D = X
// 32+B = 1, 32+H = 2, 32+S = X, 32+D = X
// 16+B = 2, 16+H = X, 16+S = X, 16+D = X
// 8+B = X, 8+H = X, 8+S = X, 8+D = X
// => 3-(op+size) (index bits in group)
// 64/B = 3, 64+H = 2, 64+S = 1, 64+D = X
// 32+B = 2, 32+H = 1, 32+S = X, 32+D = X
// 16+B = 1, 16+H = X, 16+S = X, 16+D = X
// 8+B = X, 8+H = X, 8+S = X, 8+D = X
```

```
// index bits within group: 1, 2, 3
if UInt(op)+UInt(size) >= 3 then UnallocatedEncoding();
integer ibits = 3-(UInt(op)+UInt(size));
```

```
// invert mask to invert index bits within group (max index = 15)
bits(4) revmask = Zeros(4-ibits):Ones(ibits);
```

Assembler Symbols

<Vd> Is the name of the SIMD&FP destination register, encoded in the "Rd" field.

<T> Is an arrangement specifier,

- 8B** when size = 00, Q = 0
- 16B** when size = 00, Q = 1
- 4H** when size = 01, Q = 0
- 8H** when size = 01, Q = 1
- RESERVED** when size = 1x, Q = x

<Vn> Is the name of the SIMD&FP source register, encoded in the "Rn" field.

Operation

```
CheckFPAdvSIMDEnabled64();
bits(datasize) operand = V[n];
bits(datasize) result;
```

```
integer e_rev;  
for e = 0 to elements-1  
    e_rev = UInt(e<3:0> EOR revmask);  
    Elem[result, e_rev, esize] = Elem[operand, e, esize];  
  
V[d] = result;
```

C6.3.195 REV64

Reverse elements in 64-bit doublewords (vector)

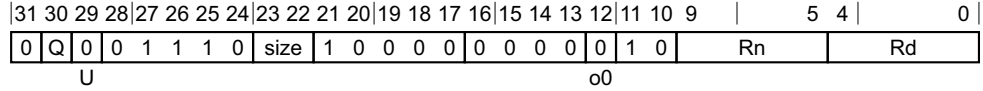

Vector variant

REV64 <Vd>.<T>, <Vn>.<T>

```
integer d = UInt(Rd);
integer n = UInt(Rn);
```

```
// size=esize: B(0), H(1), S(1), D(S)
integer esize = 8 << UInt(size);
integer datasize = if Q == '1' then 128 else 64;
integer elements = datasize DIV esize;
```

```
// op=REVx: 64(0), 32(1), 16(2)
bits(2) op = o0:U;
```

```
// => op+size:
// 64+B = 0, 64+H = 1, 64+S = 2, 64+D = X
// 32+B = 1, 32+H = 2, 32+S = X, 32+D = X
// 16+B = 2, 16+H = X, 16+S = X, 16+D = X
// 8+B = X, 8+H = X, 8+S = X, 8+D = X
// => 3-(op+size) (index bits in group)
// 64/B = 3, 64+H = 2, 64+S = 1, 64+D = X
// 32+B = 2, 32+H = 1, 32+S = X, 32+D = X
// 16+B = 1, 16+H = X, 16+S = X, 16+D = X
// 8+B = X, 8+H = X, 8+S = X, 8+D = X
```

```
// index bits within group: 1, 2, 3
if UInt(op)+UInt(size) >= 3 then UnallocatedEncoding();
integer ibits = 3-(UInt(op)+UInt(size));
```

```
// invert mask to invert index bits within group (max index = 15)
bits(4) revmask = Zeros(4-ibits):Ones(ibits);
```

Assembler Symbols

<Vd> Is the name of the SIMD&FP destination register, encoded in the "Rd" field.

<T> Is an arrangement specifier,

- 8B** when size = 00, Q = 0
- 16B** when size = 00, Q = 1
- 4H** when size = 01, Q = 0
- 8H** when size = 01, Q = 1
- 2S** when size = 10, Q = 0
- 4S** when size = 10, Q = 1
- RESERVED** when size = 11, Q = x

<Vn> Is the name of the SIMD&FP source register, encoded in the "Rn" field.

Operation

```
CheckFPAdvSIMDEnabled64();
bits(datasize) operand = V[n];
bits(datasize) result;
integer e_rev;
for e = 0 to elements-1
    e_rev = UInt(e<3:0> EOR revmask);
    Elem[result, e_rev, esize] = Elem[operand, e, esize];

V[d] = result;
```

C6.3.196 RSHRN, RSHRN2

Rounding shift right narrow (immediate)

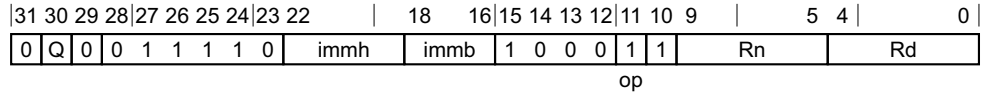

Vector variant

RSHRN{2} <Vd>.<Tb>, <Vn>.<Ta>, #<shift>

```
integer d = UInt(Rd);
integer n = UInt(Rn);

if immh == '0000' then AdvSIMD modified immediate;
if immh<3> == '1' then ReservedValue();
integer esize = 8 << HighestSetBit(immh);
integer datasize = 64;
integer part = UInt(Q);
integer elements = datasize DIV esize;

integer shift = (2 * esize) - UInt(immh:immb);
boolean round = (op == '1');
```

Assembler Symbols

- 2 Is the second and upper half specifier. If present it causes the operation to be performed on the upper 64 bits of the registers holding the narrower elements, and is
- [absent]** when Q = 0
 - [present]** when Q = 1
- <Vd> Is the name of the SIMD&FP destination register, encoded in the "Rd" field.
- <Tb> Is an arrangement specifier,
- See **AdvSIMD modified immediate**. when immh = 0000, Q = x
- 8B** when immh = 0001, Q = 0
 - 16B** when immh = 0001, Q = 1
 - 4H** when immh = 001x, Q = 0
 - 8H** when immh = 001x, Q = 1
 - 2S** when immh = 01xx, Q = 0
 - 4S** when immh = 01xx, Q = 1
 - RESERVED** when immh = 1xxx, Q = x
- <Vn> Is the name of the SIMD&FP source register, encoded in the "Rn" field.
- <Ta> Is an arrangement specifier,
- See **AdvSIMD modified immediate**. when immh = 0000
- 8H** when immh = 0001
 - 4S** when immh = 001x
 - 2D** when immh = 01xx
 - RESERVED** when immh = 1xxx

<shift> Is a shift amount, in the range 1 to element bits,
See AdvSIMD modified immediate. when immh = 0000
(16-UInt(immh:immb)) when immh = 0001
(32-UInt(immh:immb)) when immh = 001x
(64-UInt(immh:immb)) when immh = 01xx
RESERVED when immh = 1xxx

Operation

```
CheckFPAdvSIMDEnabled64();
bits(datasize*2) operand = V[n];
bits(datasize) result;
integer round_const = if round then (1 << (shift - 1)) else 0;
integer element;

for e = 0 to elements-1
    element = (UInt(Elem[operand, e, 2*esize]) + round_const) >> shift;
    Elem[result, e, esize] = element<size-1:0>;

Vpart[d, part] = result;
```

C6.3.197 RSUBHN, RSUBHN2

Rounding subtract returning high narrow

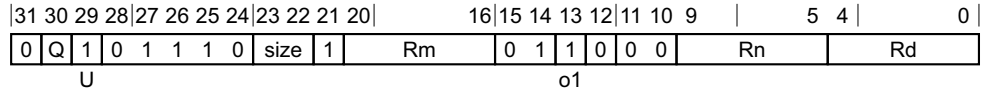

Three registers, not all the same type variant

RSUBHN{2} <Vd>.<Tb>, <Vn>.<Ta>, <Vm>.<Ta>

```
integer d = UInt(Rd);
integer n = UInt(Rn);
integer m = UInt(Rm);

if size == '11' then ReservedValue();
integer esize = 8 << UInt(size);
integer datasize = 64;
integer part = UInt(Q);
integer elements = datasize DIV esize;

boolean sub_op = (o1 == '1');
boolean round = (U == '1');
```

Assembler Symbols

- 2 Is the second and upper half specifier. If present it causes the operation to be performed on the upper 64 bits of the registers holding the narrower elements, and is
- [absent]** when Q = 0
 - [present]** when Q = 1
- <Vd> Is the name of the SIMD&FP destination register, encoded in the "Rd" field.
- <Tb> Is an arrangement specifier,
- 8B** when size = 00, Q = 0
 - 16B** when size = 00, Q = 1
 - 4H** when size = 01, Q = 0
 - 8H** when size = 01, Q = 1
 - 2S** when size = 10, Q = 0
 - 4S** when size = 10, Q = 1
 - RESERVED** when size = 11, Q = x
- <Vn> Is the name of the first SIMD&FP source register, encoded in the "Rn" field.
- <Ta> Is an arrangement specifier,
- 8H** when size = 00
 - 4S** when size = 01
 - 2D** when size = 10
 - RESERVED** when size = 11
- <Vm> Is the name of the second SIMD&FP source register, encoded in the "Rm" field.

Operation

```
CheckFPAdvSIMDEnabled64();
bits(2*datasize) operand1 = V[n];
bits(2*datasize) operand2 = V[m];
bits(datasize) result;
integer round_const = if round then 1 << (esize - 1) else 0;
bits(2*esize) element1;
bits(2*esize) element2;
bits(2*esize) sum;

for e = 0 to elements-1
    element1 = Elem[operand1, e, 2*esize];
    element2 = Elem[operand2, e, 2*esize];
    if sub_op then
        sum = element1 - element2;
    else
        sum = element1 + element2;
    sum = sum + round_const;
    Elem[result, e, esize] = sum<2*esize-1:esize>;

Vpart[d, part] = result;
```

C6.3.198 SABA

Signed absolute difference and accumulate

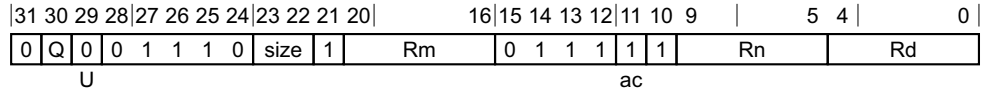

Three registers of the same type variant

SABA <Vd>.<T>, <Vn>.<T>, <Vm>.<T>

```
integer d = UInt(Rd);
integer n = UInt(Rn);
integer m = UInt(Rm);
if size == '11' then ReservedValue();
integer esize = 8 << UInt(size);
integer datasize = if Q == '1' then 128 else 64;
integer elements = datasize DIV esize;
```

```
boolean unsigned = (U == '1');
boolean accumulate = (ac == '1');
```

Assembler Symbols

- <Vd> Is the name of the SIMD&FP destination register, encoded in the "Rd" field.
- <T> Is an arrangement specifier,
- 8B** when size = 00, Q = 0
 - 16B** when size = 00, Q = 1
 - 4H** when size = 01, Q = 0
 - 8H** when size = 01, Q = 1
 - 2S** when size = 10, Q = 0
 - 4S** when size = 10, Q = 1
 - RESERVED** when size = 11, Q = x
- <Vn> Is the name of the first SIMD&FP source register, encoded in the "Rn" field.
- <Vm> Is the name of the second SIMD&FP source register, encoded in the "Rm" field.

Operation

```
CheckFPAdvSIMDEnabled64();
bits(datasize) operand1 = V[n];
bits(datasize) operand2 = V[m];
bits(datasize) result;
integer element1;
integer element2;
bits(esize) absdiff;

result = if accumulate then V[d] else Zeros();
for e = 0 to elements-1
    element1 = Int(Elem[operand1, e, esize], unsigned);
    element2 = Int(Elem[operand2, e, esize], unsigned);
    absdiff = Abs(element1 - element2)<esize-1:0>;
    Elem[result, e, esize] = Elem[result, e, esize] + absdiff;
V[d] = result;
```

C6.3.199 SABAL, SABAL2

Signed absolute difference and accumulate long

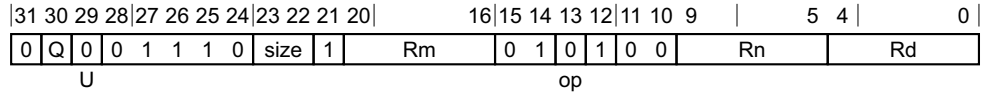

Three registers, not all the same type variant

SABAL{2} <Vd>.<Ta>, <Vn>.<Tb>, <Vm>.<Tb>

```
integer d = UInt(Rd);
integer n = UInt(Rn);
integer m = UInt(Rm);

if size == '11' then ReservedValue();
integer esize = 8 << UInt(size);
integer datasize = 64;
integer part = UInt(Q);
integer elements = datasize DIV esize;

boolean accumulate = (op == '0');
boolean unsigned = (U == '1');
```

Assembler Symbols

- 2 Is the second and upper half specifier. If present it causes the operation to be performed on the upper 64 bits of the registers holding the narrower elements, and is
 - [absent]** when Q = 0
 - [present]** when Q = 1
- <Vd> Is the name of the SIMD&FP destination register, encoded in the "Rd" field.
- <Ta> Is an arrangement specifier,
 - 8H** when size = 00
 - 4S** when size = 01
 - 2D** when size = 10
 - RESERVED** when size = 11
- <Vn> Is the name of the first SIMD&FP source register, encoded in the "Rn" field.
- <Tb> Is an arrangement specifier,
 - 8B** when size = 00, Q = 0
 - 16B** when size = 00, Q = 1
 - 4H** when size = 01, Q = 0
 - 8H** when size = 01, Q = 1
 - 2S** when size = 10, Q = 0
 - 4S** when size = 10, Q = 1
 - RESERVED** when size = 11, Q = x
- <Vm> Is the name of the second SIMD&FP source register, encoded in the "Rm" field.

Operation

```
CheckFPAdvSIMDEnabled64();
bits(datasize) operand1 = Vpart[n, part];
bits(datasize) operand2 = Vpart[m, part];
bits(2*datasize) result;
integer element1;
integer element2;
bits(2*esize) absdiff;

result = if accumulate then V[d] else Zeros();
for e = 0 to elements-1
    element1 = Int(Elem[operand1, e, esize], unsigned);
    element2 = Int(Elem[operand2, e, esize], unsigned);
    absdiff = Abs(element1 - element2)<2*esize-1:0>;
    Elem[result, e, 2*esize] = Elem[result, e, 2*esize] + absdiff;
V[d] = result;
```

C6.3.200 SABD

Signed absolute difference

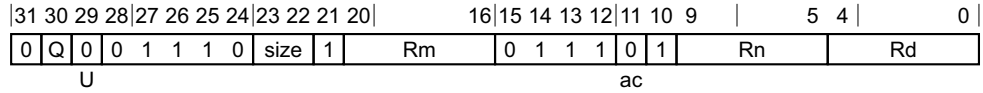

Three registers of the same type variant

SABD <Vd>.<T>, <Vn>.<T>, <Vm>.<T>

```
integer d = UInt(Rd);
integer n = UInt(Rn);
integer m = UInt(Rm);
if size == '11' then ReservedValue();
integer esize = 8 << UInt(size);
integer datasize = if Q == '1' then 128 else 64;
integer elements = datasize DIV esize;
```

```
boolean unsigned = (U == '1');
boolean accumulate = (ac == '1');
```

Assembler Symbols

- <Vd> Is the name of the SIMD&FP destination register, encoded in the "Rd" field.
- <T> Is an arrangement specifier,
 - 8B** when size = 00, Q = 0
 - 16B** when size = 00, Q = 1
 - 4H** when size = 01, Q = 0
 - 8H** when size = 01, Q = 1
 - 2S** when size = 10, Q = 0
 - 4S** when size = 10, Q = 1
 - RESERVED** when size = 11, Q = x
- <Vn> Is the name of the first SIMD&FP source register, encoded in the "Rn" field.
- <Vm> Is the name of the second SIMD&FP source register, encoded in the "Rm" field.

Operation

```
CheckFPAdvSIMDEnabled64();
bits(datasize) operand1 = V[n];
bits(datasize) operand2 = V[m];
bits(datasize) result;
integer element1;
integer element2;
bits(esize) absdiff;

result = if accumulate then V[d] else Zeros();
for e = 0 to elements-1
    element1 = Int(Elem[operand1, e, esize], unsigned);
    element2 = Int(Elem[operand2, e, esize], unsigned);
    absdiff = Abs(element1 - element2)<esize-1:0>;
    Elem[result, e, esize] = Elem[result, e, esize] + absdiff;
V[d] = result;
```

C6.3.201 SABDL, SABDL2

Signed absolute difference long

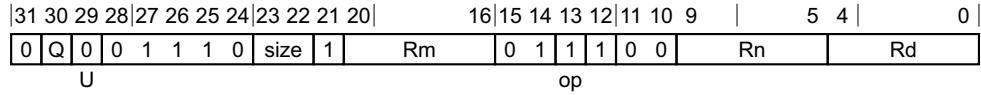

Three registers, not all the same type variant

SABDL{2} <Vd>.<Ta>, <Vn>.<Tb>, <Vm>.<Tb>

```
integer d = UInt(Rd);
integer n = UInt(Rn);
integer m = UInt(Rm);

if size == '11' then ReservedValue();
integer esize = 8 << UInt(size);
integer datasize = 64;
integer part = UInt(Q);
integer elements = datasize DIV esize;

boolean accumulate = (op == '0');
boolean unsigned = (U == '1');
```

Assembler Symbols

- 2 Is the second and upper half specifier. If present it causes the operation to be performed on the upper 64 bits of the registers holding the narrower elements, and is
- [absent]** when Q = 0
 - [present]** when Q = 1
- <Vd> Is the name of the SIMD&FP destination register, encoded in the "Rd" field.
- <Ta> Is an arrangement specifier,
- 8H** when size = 00
 - 4S** when size = 01
 - 2D** when size = 10
 - RESERVED** when size = 11
- <Vn> Is the name of the first SIMD&FP source register, encoded in the "Rn" field.
- <Tb> Is an arrangement specifier,
- 8B** when size = 00, Q = 0
 - 16B** when size = 00, Q = 1
 - 4H** when size = 01, Q = 0
 - 8H** when size = 01, Q = 1
 - 2S** when size = 10, Q = 0
 - 4S** when size = 10, Q = 1
 - RESERVED** when size = 11, Q = x
- <Vm> Is the name of the second SIMD&FP source register, encoded in the "Rm" field.

Operation

```
CheckFPAdvSIMDEnabled64();
bits(datasize) operand1 = Vpart[n, part];
bits(datasize) operand2 = Vpart[m, part];
bits(2*datasize) result;
integer element1;
integer element2;
bits(2*esize) absdiff;

result = if accumulate then V[d] else Zeros();
for e = 0 to elements-1
    element1 = Int(Elem[operand1, e, esize], unsigned);
    element2 = Int(Elem[operand2, e, esize], unsigned);
    absdiff = Abs(element1 - element2)<2*esize-1:0>;
    Elem[result, e, 2*esize] = Elem[result, e, 2*esize] + absdiff;
V[d] = result;
```

C6.3.202 SADALP

Signed add and accumulate long pairwise

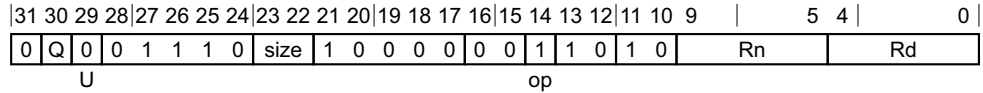

Vector variant

SADALP <Vd>.<Ta>, <Vn>.<Tb>

```
integer d = UInt(Rd);
integer n = UInt(Rn);

if size == '11' then ReservedValue();
integer esize = 8 << UInt(size);
integer datasize = if Q == '1' then 128 else 64;
integer elements = datasize DIV (2*esize);
boolean acc = (op == '1');
boolean unsigned = (U == '1');
```

Assembler Symbols

<Vd> Is the name of the SIMD&FP destination register, encoded in the "Rd" field.

<Ta> Is an arrangement specifier,

4H	when size = 00, Q = 0
8H	when size = 00, Q = 1
2S	when size = 01, Q = 0
4S	when size = 01, Q = 1
1D	when size = 10, Q = 0
2D	when size = 10, Q = 1
RESERVED	when size = 11, Q = x

<Vn> Is the name of the SIMD&FP source register, encoded in the "Rn" field.

<Tb> Is an arrangement specifier,

8B	when size = 00, Q = 0
16B	when size = 00, Q = 1
4H	when size = 01, Q = 0
8H	when size = 01, Q = 1
2S	when size = 10, Q = 0
4S	when size = 10, Q = 1
RESERVED	when size = 11, Q = x

Operation

```
CheckFPAdvSIMDEnabled64();
bits(datasize) operand = V[n];
bits(datasize) result;

bits(2*esize) sum;
integer op1;
```

```
integer op2;

result = if acc then V[d] else Zeros();
for e = 0 to elements-1
    op1 = Int(Elem[operand, 2*e+0, esize], unsigned);
    op2 = Int(Elem[operand, 2*e+1, esize], unsigned);
    sum = (op1 + op2)<2*esize-1:0>;
    Elem[result, e, 2*esize] = Elem[result, e, 2*esize] + sum;

V[d] = result;
```

C6.3.203 SADDL, SADDL2

Signed add long (vector)

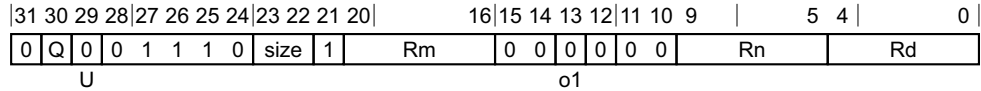

Three registers, not all the same type variant

SADDL{2} <Vd>.<Ta>, <Vn>.<Tb>, <Vm>.<Tb>

```
integer d = UInt(Rd);
integer n = UInt(Rn);
integer m = UInt(Rm);

if size == '11' then ReservedValue();
integer esize = 8 << UInt(size);
integer datasize = 64;
integer part = UInt(Q);
integer elements = datasize DIV esize;

boolean sub_op = (o1 == '1');
boolean unsigned = (U == '1');
```

Assembler Symbols

- 2 Is the second and upper half specifier. If present it causes the operation to be performed on the upper 64 bits of the registers holding the narrower elements, and is
- [absent]** when Q = 0
 - [present]** when Q = 1
- <Vd> Is the name of the SIMD&FP destination register, encoded in the "Rd" field.
- <Ta> Is an arrangement specifier,
- 8H** when size = 00
 - 4S** when size = 01
 - 2D** when size = 10
 - RESERVED** when size = 11
- <Vn> Is the name of the first SIMD&FP source register, encoded in the "Rn" field.
- <Tb> Is an arrangement specifier,
- 8B** when size = 00, Q = 0
 - 16B** when size = 00, Q = 1
 - 4H** when size = 01, Q = 0
 - 8H** when size = 01, Q = 1
 - 2S** when size = 10, Q = 0
 - 4S** when size = 10, Q = 1
 - RESERVED** when size = 11, Q = x
- <Vm> Is the name of the second SIMD&FP source register, encoded in the "Rm" field.

Operation

```
CheckFPAdvSIMDEnabled64();
bits(datasize) operand1 = Vpart[n, part];
bits(datasize) operand2 = Vpart[m, part];
bits(2*datasize) result;
integer element1;
integer element2;
integer sum;

for e = 0 to elements-1
    element1 = Int(Elem[operand1, e, esize], unsigned);
    element2 = Int(Elem[operand2, e, esize], unsigned);
    if sub_op then
        sum = element1 - element2;
    else
        sum = element1 + element2;
    Elem[result, e, 2*esize] = sum<2*esize-1:0>;

V[d] = result;
```

C6.3.204 SADDLP

Signed add long pairwise

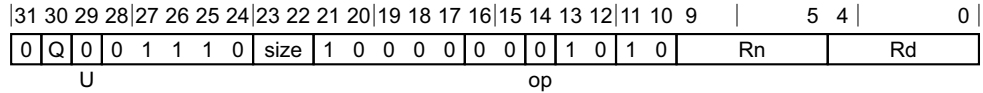

Vector variant

SADDLP <Vd>.<Ta>, <Vn>.<Tb>

```
integer d = UInt(Rd);
integer n = UInt(Rn);

if size == '11' then ReservedValue();
integer esize = 8 << UInt(size);
integer datasize = if Q == '1' then 128 else 64;
integer elements = datasize DIV (2*esize);
boolean acc = (op == '1');
boolean unsigned = (U == '1');
```

Assembler Symbols

<Vd> Is the name of the SIMD&FP destination register, encoded in the "Rd" field.

<Ta> Is an arrangement specifier,

4H	when size = 00, Q = 0
8H	when size = 00, Q = 1
2S	when size = 01, Q = 0
4S	when size = 01, Q = 1
1D	when size = 10, Q = 0
2D	when size = 10, Q = 1
RESERVED	when size = 11, Q = x

<Vn> Is the name of the SIMD&FP source register, encoded in the "Rn" field.

<Tb> Is an arrangement specifier,

8B	when size = 00, Q = 0
16B	when size = 00, Q = 1
4H	when size = 01, Q = 0
8H	when size = 01, Q = 1
2S	when size = 10, Q = 0
4S	when size = 10, Q = 1
RESERVED	when size = 11, Q = x

Operation

```
CheckFPAdvSIMDEnabled64();
bits(datasize) operand = V[n];
bits(datasize) result;

bits(2*esize) sum;
integer op1;
```

```
integer op2;

result = if acc then V[d] else Zeros();
for e = 0 to elements-1
    op1 = Int(Elem[operand, 2*e+0, esize], unsigned);
    op2 = Int(Elem[operand, 2*e+1, esize], unsigned);
    sum = (op1 + op2)<2*esize-1:0>;
    Elem[result, e, 2*esize] = Elem[result, e, 2*esize] + sum;

V[d] = result;
```

C6.3.205 SADDLV

Signed add long across vector

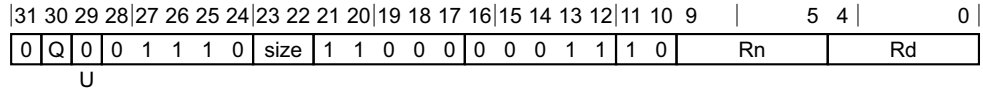

Advanced SIMD variant

SADDLV <V><d>, <Vn>.<T>

```
integer d = UInt(Rd);
integer n = UInt(Rn);

if size:Q == '100' then ReservedValue();
if size == '11' then ReservedValue();
integer esize = 8 << UInt(size);
integer datasize = if Q == '1' then 128 else 64;
integer elements = datasize DIV esize;

boolean unsigned = (U == '1');
```

Assembler Symbols

<V>	Is the destination width specifier, H when size = 00 S when size = 01 D when size = 10 RESERVED when size = 11
<d>	Is the number of the SIMD&FP destination register, encoded in the "Rd" field.
<Vn>	Is the name of the SIMD&FP source register, encoded in the "Rn" field.
<T>	Is an arrangement specifier, 8B when size = 00, Q = 0 16B when size = 00, Q = 1 4H when size = 01, Q = 0 8H when size = 01, Q = 1 RESERVED when size = 10, Q = 0 4S when size = 10, Q = 1 RESERVED when size = 11, Q = x

Operation

```
CheckFPAdvSIMDEnabled64();
bits(datasize) operand = V[n];
integer sum;

sum = Int(Elem[operand, 0, esize], unsigned);
for e = 1 to elements-1
    sum = sum + Int(Elem[operand, e, esize], unsigned);

V[d] = sum<2*esize-1:0>;
```

C6.3.206 SADDW, SADDW2

Signed add wide

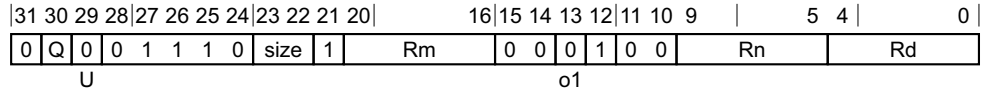

Three registers, not all the same type variant

SADDW{2} <Vd>.<Ta>, <Vn>.<Ta>, <Vm>.<Tb>

```
integer d = UInt(Rd);
integer n = UInt(Rn);
integer m = UInt(Rm);

if size == '11' then ReservedValue();
integer esize = 8 << UInt(size);
integer datasize = 64;
integer part = UInt(Q);
integer elements = datasize DIV esize;

boolean sub_op = (o1 == '1');
boolean unsigned = (U == '1');
```

Assembler Symbols

- 2 Is the second and upper half specifier. If present it causes the operation to be performed on the upper 64 bits of the registers holding the narrower elements, and is
 - [absent]** when Q = 0
 - [present]** when Q = 1
- <Vd> Is the name of the SIMD&FP destination register, encoded in the "Rd" field.
- <Ta> Is an arrangement specifier,
 - 8H** when size = 00
 - 4S** when size = 01
 - 2D** when size = 10
 - RESERVED** when size = 11
- <Vn> Is the name of the first SIMD&FP source register, encoded in the "Rn" field.
- <Vm> Is the name of the second SIMD&FP source register, encoded in the "Rm" field.
- <Tb> Is an arrangement specifier,
 - 8B** when size = 00, Q = 0
 - 16B** when size = 00, Q = 1
 - 4H** when size = 01, Q = 0
 - 8H** when size = 01, Q = 1
 - 2S** when size = 10, Q = 0
 - 4S** when size = 10, Q = 1
 - RESERVED** when size = 11, Q = x

Operation

```
CheckFPAdvSIMDEnabled64();
bits(2*datasize) operand1 = V[n];
bits(datasize) operand2 = Vpart[m, part];
bits(2*datasize) result;
integer element1;
integer element2;
integer sum;

for e = 0 to elements-1
    element1 = Int(Elem[operand1, e, 2*esize], unsigned);
    element2 = Int(Elem[operand2, e, esize], unsigned);
    if sub_op then
        sum = element1 - element2;
    else
        sum = element1 + element2;
    Elem[result, e, 2*esize] = sum<2*esize-1:0>;

V[d] = result;
```

C6.3.207 SCVTF (vector, fixed-point)

Signed fixed-point convert to floating-point (vector)

It has encodings from 2 classes: *Scalar* and *Vector*

Scalar

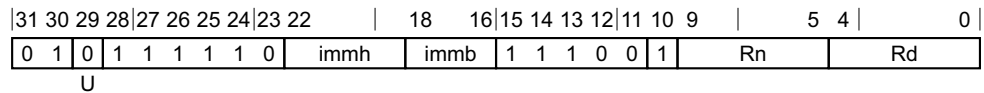

Scalar variant

SCVTF <V><d>, <V><n>, #<fbits>

```
integer d = UInt(Rd);
integer n = UInt(Rn);

if immh == '00xx' then ReservedValue();
integer esize = 32 << UInt(immh<3>);
integer datasize = esize;
integer elements = 1;

integer fracbits = (esize * 2) - UInt(immh:immb);
boolean unsigned = (U == '1');
FPRounding rounding = FPRoundingMode(FPCR);
```

Vector

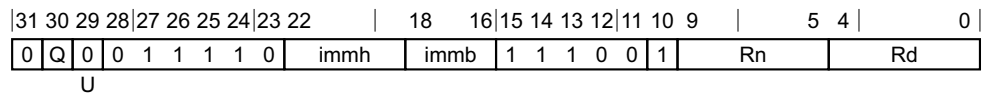

Vector variant

SCVTF <Vd>.<T>, <Vn>.<T>, #<fbits>

```
integer d = UInt(Rd);
integer n = UInt(Rn);

if immh == '0000' then AdvSIMD modified immediate;
if immh == '00xx' then ReservedValue();
if immh<3>:Q == '10' then ReservedValue();
integer esize = 32 << UInt(immh<3>);
integer datasize = if Q == '1' then 128 else 64;
integer elements = datasize DIV esize;

integer fracbits = (esize * 2) - UInt(immh:immb);
boolean unsigned = (U == '1');
FPRounding rounding = FPRoundingMode(FPCR);
```

Assembler Symbols

- <V> Is a width specifier,
 RESERVED when immh = 00xx
 S when immh = 01xx
 D when immh = 1xxx
- <d> Is the number of the SIMD&FP destination register, in the "Rd" field.

- <n> Is the number of the first SIMD&FP source register, encoded in the "Rn" field.
- <Vd> Is the name of the SIMD&FP destination register, encoded in the "Rd" field.
- <T> Is an arrangement specifier,
See AdvSIMD modified immediate. when immh = 0000, Q = x
RESERVED when immh = 0001, Q = x
RESERVED when immh = 001x, Q = x
2S when immh = 01xx, Q = 0
4S when immh = 01xx, Q = 1
RESERVED when immh = 1xxx, Q = 0
2D when immh = 1xxx, Q = 1
- <Vn> Is the name of the SIMD&FP source register, encoded in the "Rn" field.
- <fbits> For the scalar variant: is the number of fractional bits, in the range 1 to element bits,
RESERVED when immh = 00xx
(64-UInt(immh:immb)) when immh = 01xx
(128-UInt(immh:immb)) when immh = 1xxx
- <fbits> For the vector variant: is the number of fractional bits, in the range 1 to element bits,
See AdvSIMD modified immediate. when immh = 0000
RESERVED when immh = 0001
RESERVED when immh = 001x
(64-UInt(immh:immb)) when immh = 01xx
(128-UInt(immh:immb)) when immh = 1xxx

Operation for all classes

```
CheckFPAdvSIMDEnabled64();
bits(datasize) operand = V[n];
bits(datasize) result;
bits(esize) element;

for e = 0 to elements-1
    element = Elem[operand, e, esize];
    Elem[result, e, esize] = FixedToFP(element, fracbits, unsigned, FPCR, rounding);

V[d] = result;
```

C6.3.208 SCVTF (vector, integer)

Signed integer convert to floating-point (vector)

It has encodings from 2 classes: *Scalar* and *Vector*

Scalar

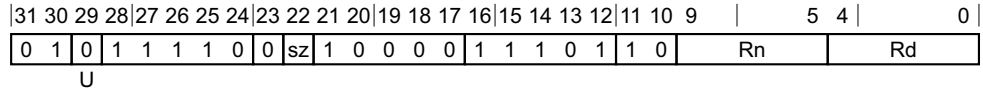

Scalar variant

SCVTF <V><d>, <V><n>

```
integer d = UInt(Rd);
integer n = UInt(Rn);
```

```
integer esize = 32 << UInt(sz);
integer datasize = esize;
integer elements = 1;
boolean unsigned = (U == '1');
```

Vector

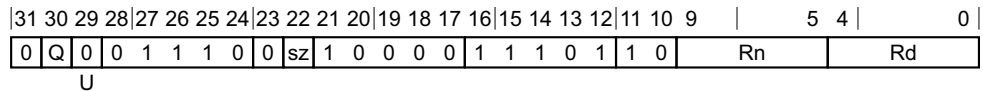

Vector variant

SCVTF <Vd>.<T>, <Vn>.<T>

```
integer d = UInt(Rd);
integer n = UInt(Rn);
```

```
if sz:Q == '10' then ReservedValue();
integer esize = 32 << UInt(sz);
integer datasize = if Q == '1' then 128 else 64;
integer elements = datasize DIV esize;
boolean unsigned = (U == '1');
```

Assembler Symbols

- <V> Is a width specifier,
 - S** when sz = 0
 - D** when sz = 1
- <d> Is the number of the SIMD&FP destination register, encoded in the "Rd" field.
- <n> Is the number of the SIMD&FP source register, encoded in the "Rn" field.
- <Vd> Is the name of the SIMD&FP destination register, encoded in the "Rd" field.
- <T> Is an arrangement specifier,
 - 2S** when sz = 0, Q = 0
 - 4S** when sz = 0, Q = 1
 - RESERVED** when sz = 1, Q = 0
 - 2D** when sz = 1, Q = 1

<Vn> Is the name of the SIMD&FP source register, encoded in the "Rn" field.

Operation for all classes

```
CheckFPAdvSIMDEnabled64();
bits(datasize) operand = V[n];
bits(datasize) result;
FPRounding rounding = FPRoundingMode(FPCR);
bits(esize) element;

for e = 0 to elements-1
    element = Elem[operand, e, esize];
    Elem[result, e, esize] = FixedToFP(element, 0, unsigned, FPCR, rounding);

V[d] = result;
```

C6.3.209 SCVTF (scalar, fixed-point)

Signed fixed-point convert to floating-point (scalar): $Vd = \text{signed_convertFromInt}(Rn/(2^{\text{fbits}}))$

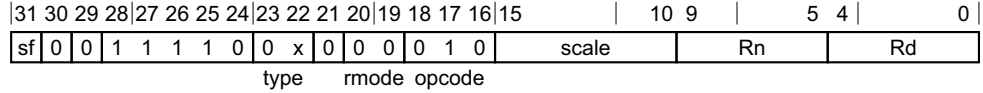

32-bit to single-precision variant (sf = 0, type = 00)

SCVTF <Sd>, <Wn>, #<fbits>

32-bit to double-precision variant (sf = 0, type = 01)

SCVTF <Dd>, <Wn>, #<fbits>

64-bit to single-precision variant (sf = 1, type = 00)

SCVTF <Sd>, <Xn>, #<fbits>

64-bit to double-precision variant (sf = 1, type = 01)

SCVTF <Dd>, <Xn>, #<fbits>

```
integer d = UInt(Rd);
integer n = UInt(Rn);

integer intsize = if sf == '1' then 64 else 32;
integer fltsize;
FPCConvOp op;
FPRounding rounding;
boolean unsigned;

case type of
    when '00' fltsize = 32;
    when '01' fltsize = 64;
    when '1x' UnallocatedEncoding();

if sf == '0' && scale<5> == '0' then UnallocatedEncoding();
integer fracbits = 64 - UInt(scale);

case opcode<2:1>:rmode of
    when '00 11' // FCVTZ
        rounding = FPRounding_ZERO;
        unsigned = (opcode<0> == '1');
        op = FPCConvOp_CVT_FtoI;
    when '01 00' // [US]CVTF
        rounding = FPRoundingMode(FPCR);
        unsigned = (opcode<0> == '1');
        op = FPCConvOp_CVT_ItoF;
    otherwise
        UnallocatedEncoding();
```

Assembler Symbols

- <Dd> Is the 64-bit name of the SIMD&FP destination register, encoded in the "Rd" field.
- <Sd> Is the 32-bit name of the SIMD&FP destination register, encoded in the "Rd" field.
- <Xn> Is the 64-bit name of the general-purpose source register, encoded in the "Rn" field.
- <Wn> Is the 32-bit name of the general-purpose source register, encoded in the "Rn" field.
- <fbits> For the 32-bit to double-precision and 32-bit to single-precision variant: is the number of bits after the binary point in the fixed-point source, in the range 1 to 32, encoded as 64 minus "scale".

<fbits> For the 64-bit to double-precision and 64-bit to single-precision variant: is the number of bits after the binary point in the fixed-point source, in the range 1 to 64, encoded as 64 minus "scale".

Operation

```
CheckFPAdvSIMDEnabled64();

bits(fltsize) fltval;
bits(intsize) intval;

case op of
  when FPConvOp_CVT_FtoI
    fltval = V[n];
    intval = FPToFixed(fltval, fracbits, unsigned, FPCR, rounding);
    X[d] = intval;
  when FPConvOp_CVT_ItoF
    intval = X[n];
    fltval = FixedToFP(intval, fracbits, unsigned, FPCR, rounding);
    V[d] = fltval;
```

C6.3.210 SCVTF (scalar, integer)

Signed integer convert to floating-point (scalar): $Vd = \text{signed_convertFromInt}(Rn)$

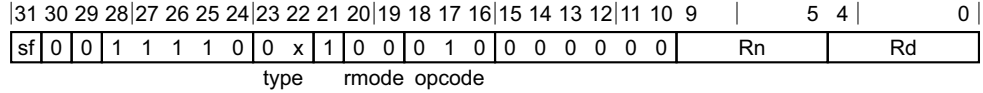

32-bit to single-precision variant (sf = 0, type = 00)

SCVTF <Sd>, <Wn>

32-bit to double-precision variant (sf = 0, type = 01)

SCVTF <Dd>, <Wn>

64-bit to single-precision variant (sf = 1, type = 00)

SCVTF <Sd>, <Xn>

64-bit to double-precision variant (sf = 1, type = 01)

SCVTF <Dd>, <Xn>

```
integer d = UInt(Rd);
integer n = UInt(Rn);

integer intsize = if sf == '1' then 64 else 32;
integer fltsize;
FPConvOp op;
FPRounding rounding;
boolean unsigned;
integer part;

case type of
    when '00'
        fltsize = 32;
    when '01'
        fltsize = 64;
    when '10'
        if opcode<2:1>:rmode != '11 01' then UnallocatedEncoding();
        fltsize = 128;
    when '11'
        UnallocatedEncoding();

case opcode<2:1>:rmode of
    when '00 xx' // FCVT[NPMZ][US]
        rounding = FPDecodeRounding(rmode);
        unsigned = (opcode<0> == '1');
        op = FPConvOp_CVT_FtoI;
    when '01 00' // [US]CVTF
        rounding = FPRoundingMode(FPCR);
        unsigned = (opcode<0> == '1');
        op = FPConvOp_CVT_ItoF;
    when '10 00' // FCVTA[US]
        rounding = FPRounding_TIEAWAY;
        unsigned = (opcode<0> == '1');
        op = FPConvOp_CVT_FtoI;
    when '11 00' // FMOV
        if fltsize != intsize then UnallocatedEncoding();
        op = if opcode<0> == '1' then FPConvOp_MOV_ItoF else FPConvOp_MOV_FtoI;
        part = 0;
    when '11 01' // FMOV D[1]
        if intsize != 64 || fltsize != 128 then UnallocatedEncoding();
        op = if opcode<0> == '1' then FPConvOp_MOV_ItoF else FPConvOp_MOV_FtoI;
```

```
part = 1;  
otherwise  
  UnallocatedEncoding();
```

Assembler Symbols

- <Dd> Is the 64-bit name of the SIMD&FP destination register, encoded in the "Rd" field.
- <Sd> Is the 32-bit name of the SIMD&FP destination register, encoded in the "Rd" field.
- <Xn> Is the 64-bit name of the general-purpose source register, encoded in the "Rn" field.
- <Wn> Is the 32-bit name of the general-purpose source register, encoded in the "Rn" field.

Operation

```
CheckFPAdvSIMDEnabled64();  
  
bits(floatsize) fltval;  
bits(intsize) intval;  
  
case op of  
  when FPConvOp_CVT_FtoI  
    fltval = V[n];  
    intval = FPToFixed(fltval, 0, unsigned, FPCR, rounding);  
    X[d] = intval;  
  when FPConvOp_CVT_ItoF  
    intval = X[n];  
    fltval = FixedToFP(intval, 0, unsigned, FPCR, rounding);  
    V[d] = fltval;  
  when FPConvOp_MOV_FtoI  
    intval = Vpart[n,part];  
    X[d] = intval;  
  when FPConvOp_MOV_ItoF  
    intval = X[n];  
    Vpart[d,part] = intval;
```

C6.3.211 SHA1C

SHA1 hash update (choose)

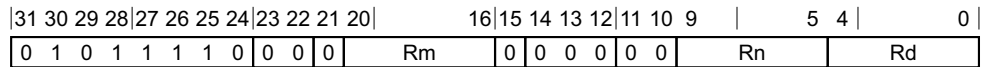

Advanced SIMD variant

SHA1C <Qd>, <Sn>, <Vm>.4S

```
integer d = UInt(Rd);
integer n = UInt(Rn);
integer m = UInt(Rm);
if ! HaveCryptoExt() then UnallocatedEncoding();
```

Assembler Symbols

- <Qd> Is the 128-bit name of the SIMD&FP source and destination, encoded in the "Rd" field.
- <Sn> Is the 32-bit name of the second SIMD&FP source register, encoded in the "Rn" field.
- <Vm> Is the name of the third SIMD&FP source register, encoded in the "Rm" field.

Operation

```
CheckCryptoEnabled64();

bits(128) X = V[d];
bits(32) Y = V[n]; // Note: 32 not 128 bits wide
bits(128) W = V[m];
bits(32) t;

for e = 0 to 3
    t = SHAchoose(X<63:32>, X<95:64>, X<127:96>);
    Y = Y + ROL(X<31:0>, 5) + t + Elem[W, e, 32];
    X<63:32> = ROL(X<63:32>, 30);
    <Y, X> = ROL(Y : X, 32);
V[d] = X;
```

C6.3.212 SHA1H

SHA1 fixed rotate

31	30	29	28	27	26	25	24	23	22	21	20	19	18	17	16	15	14	13	12	11	10	9				5	4				0
0	1	0	1	1	1	1	0	0	0	1	0	1	0	0	0	0	0	0	0	1	0				Rn						Rd

Advanced SIMD variant

SHA1H <Sd>, <Sn>

```
integer d = UInt(Rd);
integer n = UInt(Rn);
if ! HaveCryptoExt() then UnallocatedEncoding();
```

Assembler Symbols

<Sd> Is the 32-bit name of the SIMD&FP destination register, encoded in the "Rd" field.

<Sn> Is the 32-bit name of the SIMD&FP source register, encoded in the "Rn" field.

Operation

```
CheckCryptoEnabled64();
```

```
bits(32) operand = V[n]; // read element [0] only, [1-3] zeroed
V[d] = ROL(operand, 30);
```

C6.3.213 SHA1M

SHA1 hash update (majority)

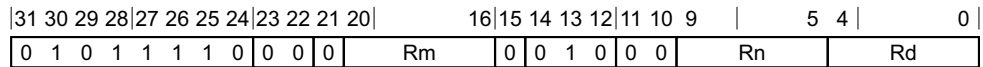

Advanced SIMD variant

SHA1M <Qd>, <Sn>, <Vm>.4S

```
integer d = UInt(Rd);
integer n = UInt(Rn);
integer m = UInt(Rm);
if ! HaveCryptoExt() then UnallocatedEncoding();
```

Assembler Symbols

- <Qd> Is the 128-bit name of the SIMD&FP source and destination, encoded in the "Rd" field.
- <Sn> Is the 32-bit name of the second SIMD&FP source register, encoded in the "Rn" field.
- <Vm> Is the name of the third SIMD&FP source register, encoded in the "Rm" field.

Operation

```
CheckCryptoEnabled64();

bits(128) X = V[d];
bits(32) Y = V[n]; // Note: 32 not 128 bits wide
bits(128) W = V[m];
bits(32) t;

for e = 0 to 3
    t = SHAmajority(X<63:32>, X<95:64>, X<127:96>);
    Y = Y + ROL(X<31:0>, 5) + t + Elem[W, e, 32];
    X<63:32> = ROL(X<63:32>, 30);
    <Y, X> = ROL(Y : X, 32);
V[d] = X;
```

C6.3.214 SHA1P

SHA1 hash update (parity)

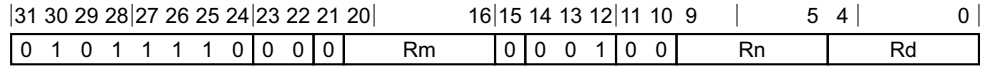

Advanced SIMD variant

SHA1P <Qd>, <Sn>, <Vm>.4S

```
integer d = UInt(Rd);
integer n = UInt(Rn);
integer m = UInt(Rm);
if ! HaveCryptoExt() then UnallocatedEncoding();
```

Assembler Symbols

- <Qd> Is the 128-bit name of the SIMD&FP source and destination, encoded in the "Rd" field.
- <Sn> Is the 32-bit name of the second SIMD&FP source register, encoded in the "Rn" field.
- <Vm> Is the name of the third SIMD&FP source register, encoded in the "Rm" field.

Operation

```
CheckCryptoEnabled64();

bits(128) X = V[d];
bits(32) Y = V[n]; // Note: 32 not 128 bits wide
bits(128) W = V[m];
bits(32) t;

for e = 0 to 3
    t = SHAparity(X<63:32>, X<95:64>, X<127:96>);
    Y = Y + ROL(X<31:0>, 5) + t + Elem[W, e, 32];
    X<63:32> = ROL(X<63:32>, 30);
    <Y, X> = ROL(Y : X, 32);
V[d] = X;
```

C6.3.215 SHA1SU0

SHA1 schedule update 0

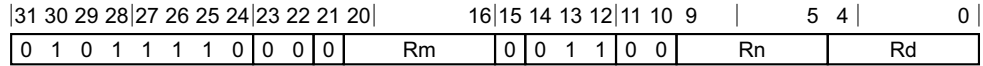

Advanced SIMD variant

SHA1SU0 <Vd>.4S, <Vn>.4S, <Vm>.4S

```
integer d = UInt(Rd);
integer n = UInt(Rn);
integer m = UInt(Rm);
if ! HaveCryptoExt() then UnallocatedEncoding();
```

Assembler Symbols

- <Vd> Is the name of the SIMD&FP source and destination register, encoded in the "Rd" field.
- <Vn> Is the name of the second SIMD&FP source register, encoded in the "Rn" field.
- <Vm> Is the name of the third SIMD&FP source register, encoded in the "Rm" field.

Operation

```
CheckCryptoEnabled64();

bits(128) operand1 = V[d];
bits(128) operand2 = V[n];
bits(128) operand3 = V[m];
bits(128) result;

result = operand2<63:0> : operand1<127:64>;
result = result EOR operand1 EOR operand3;
V[d] = result;
```

C6.3.216 SHA1SU1

SHA1 schedule update 1

31	30	29	28	27	26	25	24	23	22	21	20	19	18	17	16	15	14	13	12	11	10	9	5 4		0
0	1	0	1	1	1	1	0	0	0	1	0	1	0	0	0	0	0	1	1	0	Rn		Rd		

Advanced SIMD variant

SHA1SU1 <Vd>.4S, <Vn>.4S

```
integer d = UInt(Rd);
integer n = UInt(Rn);
if ! HaveCryptoExt() then UnallocatedEncoding();
```

Assembler Symbols

<Vd> Is the name of the SIMD&FP source and destination register, encoded in the "Rd" field.

<Vn> Is the name of the second SIMD&FP source register, encoded in the "Rn" field.

Operation

```
CheckCryptoEnabled64();

bits(128) operand1 = V[d];
bits(128) operand2 = V[n];
bits(128) result;
bits(128) T = operand1 EOR LSR(operand2, 32);
result<31:0> = ROL(T<31:0>, 1);
result<63:32> = ROL(T<63:32>, 1);
result<95:64> = ROL(T<95:64>, 1);
result<127:96> = ROL(T<127:96>, 1) EOR ROL(T<31:0>, 2);
V[d] = result;
```

C6.3.217 SHA256H2

SHA256 hash update (part 2)

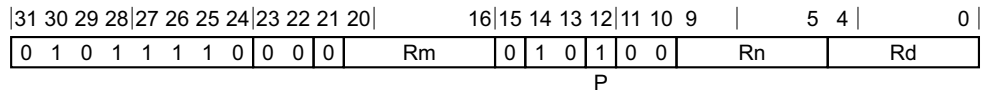

Advanced SIMD variant

SHA256H2 <Qd>, <Qn>, <Vm> .45

```
integer d = UInt(Rd);
integer n = UInt(Rn);
integer m = UInt(Rm);
if ! HaveCryptoExt() then UnallocatedEncoding();
boolean part1 = (P == '0');
```

Assembler Symbols

- <Qd> Is the 128-bit name of the SIMD&FP source and destination, encoded in the "Rd" field.
- <Qn> Is the 128-bit name of the second SIMD&FP source register, encoded in the "Rn" field.
- <Vm> Is the name of the third SIMD&FP source register, encoded in the "Rm" field.

Operation

```
CheckCryptoEnabled64();

bits(128) result;
if part1 then
    result = SHA256hash(V[d], V[n], V[m], TRUE);
else
    result = SHA256hash(V[n], V[d], V[m], FALSE);
V[d] = result;
```

C6.3.218 SHA256H

SHA256 hash update (part 1)

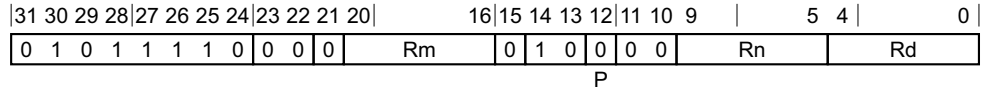

Advanced SIMD variant

SHA256H <Qd>, <Qn>, <Vm>.4S

```
integer d = UInt(Rd);
integer n = UInt(Rn);
integer m = UInt(Rm);
if ! HaveCryptoExt() then UnallocatedEncoding();
boolean part1 = (P == '0');
```

Assembler Symbols

- <Qd> Is the 128-bit name of the SIMD&FP source and destination, encoded in the "Rd" field.
- <Qn> Is the 128-bit name of the second SIMD&FP source register, encoded in the "Rn" field.
- <Vm> Is the name of the third SIMD&FP source register, encoded in the "Rm" field.

Operation

```
CheckCryptoEnabled64();

bits(128) result;
if part1 then
    result = SHA256hash(V[d], V[n], V[m], TRUE);
else
    result = SHA256hash(V[n], V[d], V[m], FALSE);
V[d] = result;
```

C6.3.219 SHA256SU0

SHA256 schedule update 0

31	30	29	28	27	26	25	24	23	22	21	20	19	18	17	16	15	14	13	12	11	10	9				5	4					0			
0	1	0	1	1	1	1	0	0	0	1	0	1	0	0	0	0	0	1	0	1	0														

Advanced SIMD variant

SHA256SU0 <Vd>.4S, <Vn>.4S

```
integer d = UInt(Rd);
integer n = UInt(Rn);
if ! HaveCryptoExt() then UnallocatedEncoding();
```

Assembler Symbols

<Vd> Is the name of the SIMD&FP source and destination register, encoded in the "Rd" field.

<Vn> Is the name of the second SIMD&FP source register, encoded in the "Rn" field.

Operation

```
CheckCryptoEnabled64();

bits(128) operand1 = V[d];
bits(128) operand2 = V[n];
bits(128) result;
bits(128) T = operand2<31:0> : operand1<127:32>;
bits(32) elt;

for e = 0 to 3
    elt = Elem[T, e, 32];
    elt = ROR(elt, 7) EOR ROR(elt, 18) EOR LSR(elt, 3);
    Elem[result, e, 32] = elt + Elem[operand1, e, 32];
V[d] = result;
```

C6.3.220 SHA256SU1

SHA256 schedule update 1

31	30	29	28	27	26	25	24	23	22	21	20	16				15	14	13	12	11	10	9	5		4	0	
0	1	0	1	1	1	1	0	0	0	0	Rm				0	1	1	0	0	0	Rn		Rd				

Advanced SIMD variant

SHA256SU1 <Vd>.4S, <Vn>.4S, <Vm>.4S

```
integer d = UInt(Rd);
integer n = UInt(Rn);
integer m = UInt(Rm);
if ! HaveCryptoExt() then UnallocatedEncoding();
```

Assembler Symbols

- <Vd> Is the name of the SIMD&FP source and destination register, encoded in the "Rd" field.
- <Vn> Is the name of the second SIMD&FP source register, encoded in the "Rn" field.
- <Vm> Is the name of the third SIMD&FP source register, encoded in the "Rm" field.

Operation

```
CheckCryptoEnabled64();
```

```
bits(128) operand1 = V[d];
bits(128) operand2 = V[n];
bits(128) operand3 = V[m];
bits(128) result;
bits(128) T0 = operand3<31:0> : operand2<127:32>;
bits(64) T1;
bits(32) elt;
```

```
T1 = operand3<127:64>;
for e = 0 to 1
    elt = Elem[T1, e, 32];
    elt = ROR(elt, 17) EOR ROR(elt, 19) EOR LSR(elt, 10);
    elt = elt + Elem[operand1, e, 32] + Elem[T0, e, 32];
    Elem[result, e, 32] = elt;
```

```
T1 = result<63:0>;
for e = 2 to 3
    elt = Elem[T1, e - 2, 32];
    elt = ROR(elt, 17) EOR ROR(elt, 19) EOR LSR(elt, 10);
    elt = elt + Elem[operand1, e, 32] + Elem[T0, e, 32];
    Elem[result, e, 32] = elt;
```

```
V[d] = result;
```

C6.3.221 SHADD

Signed halving add

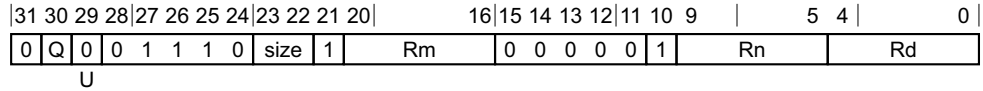

Three registers of the same type variant

SHADD <Vd>.<T>, <Vn>.<T>, <Vm>.<T>

```
integer d = UInt(Rd);
integer n = UInt(Rn);
integer m = UInt(Rm);
if size == '11' then ReservedValue();
integer esize = 8 << UInt(size);
integer datasize = if Q == '1' then 128 else 64;
integer elements = datasize DIV esize;
boolean unsigned = (U == '1');
```

Assembler Symbols

- <Vd> Is the name of the SIMD&FP destination register, encoded in the "Rd" field.
- <T> Is an arrangement specifier,
 - 8B** when size = 00, Q = 0
 - 16B** when size = 00, Q = 1
 - 4H** when size = 01, Q = 0
 - 8H** when size = 01, Q = 1
 - 2S** when size = 10, Q = 0
 - 4S** when size = 10, Q = 1
 - RESERVED** when size = 11, Q = x
- <Vn> Is the name of the first SIMD&FP source register, encoded in the "Rn" field.
- <Vm> Is the name of the second SIMD&FP source register, encoded in the "Rm" field.

Operation

```
CheckFPAdvSIMDEnabled64();
bits(datasize) operand1 = V[n];
bits(datasize) operand2 = V[m];
bits(datasize) result;
integer element1;
integer element2;
integer sum;

for e = 0 to elements-1
    element1 = Int(Elem[operand1, e, esize], unsigned);
    element2 = Int(Elem[operand2, e, esize], unsigned);
    sum = element1 + element2;
    Elem[result, e, esize] = sum<esize:1>;

V[d] = result;
```

C6.3.222 SHL

Shift left (immediate)

It has encodings from 2 classes: *Scalar* and *Vector*

Scalar

31	30	29	28	27	26	25	24	23	22	18	16	15	14	13	12	11	10	9	5	4	0
0	1	0	1	1	1	1	1	0	immh	immb	0	1	0	1	0	1	Rn		Rd		

Scalar variant

SHL <V><d>, <V><n>, #<shift>

```
integer d = UInt(Rd);
integer n = UInt(Rn);
```

```
if immh<3> != '1' then ReservedValue();
integer esize = 8 << 3;
integer datasize = esize;
integer elements = 1;
```

```
integer shift = UInt(immh:immb) - esize;
```

Vector

31	30	29	28	27	26	25	24	23	22	18	16	15	14	13	12	11	10	9	5	4	0
0	Q	0	0	1	1	1	1	0	immh	immb	0	1	0	1	0	1	Rn		Rd		

Vector variant

SHL <Vd>.<T>, <Vn>.<T>, #<shift>

```
integer d = UInt(Rd);
integer n = UInt(Rn);
```

```
if immh == '0000' then AdvSIMD modified immediate;
if immh<3>:Q == '10' then ReservedValue();
integer esize = 8 << HighestSetBit(immh);
integer datasize = if Q == '1' then 128 else 64;
integer elements = datasize DIV esize;
```

```
integer shift = UInt(immh:immb) - esize;
```

Assembler Symbols

- <V> Is a width specifier,
RESERVED when immh = 0xxx
D when immh = 1xxx
- <d> Is the number of the SIMD&FP destination register, in the "Rd" field.
- <n> Is the number of the first SIMD&FP source register, encoded in the "Rn" field.
- <Vd> Is the name of the SIMD&FP destination register, encoded in the "Rd" field.
- <T> Is an arrangement specifier,
See AdvSIMD modified immediate. when immh = 0000, Q = x

8B	when immh = 0001, Q = 0
16B	when immh = 0001, Q = 1
4H	when immh = 001x, Q = 0
8H	when immh = 001x, Q = 1
2S	when immh = 01xx, Q = 0
4S	when immh = 01xx, Q = 1
RESERVED	when immh = 1xxx, Q = 0
2D	when immh = 1xxx, Q = 1

<Vn> Is the name of the SIMD&FP source register, encoded in the "Rn" field.

<shift> For the scalar variant: is the shift amount, in the range 0 to 63,
RESERVED when immh = 0xxx
(UInt(immh:immb)-64) when immh = 1xxx

<shift> For the vector variant: is a shift amount, in the range 0 to element bits - 1,
See AdvSIMD modified immediate. when immh = 0000
(UInt(immh:immb)-8) when immh = 0001
(UInt(immh:immb)-16) when immh = 001x
(UInt(immh:immb)-32) when immh = 01xx
(UInt(immh:immb)-64) when immh = 1xxx

Operation for all classes

```
CheckFPAdvSIMDEnabled64();
bits(datasize) operand = V[n];
bits(datasize) result;

for e = 0 to elements-1
    Elem[result, e, esize] = LSL(Elem[operand, e, esize], shift);

V[d] = result;
```

C6.3.223 SHLL, SHLL2

Shift left long (by element size)

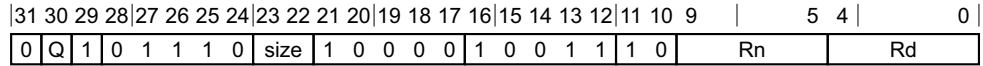

Vector variant

SHLL{2} <Vd>.<Ta>, <Vn>.<Tb>, #<shift>

```
integer d = UInt(Rd);
integer n = UInt(Rn);
```

```
if size == '11' then ReservedValue();
integer esize = 8 << UInt(size);
integer datasize = 64;
integer part = UInt(Q);
integer elements = datasize DIV esize;
```

```
integer shift = esize;
boolean unsigned = FALSE; // Or TRUE without change of functionality
```

Assembler Symbols

- 2 Is the second and upper half specifier. If present it causes the operation to be performed on the upper 64 bits of the registers holding the narrower elements, and is
- [absent]** when Q = 0
 - [present]** when Q = 1
- <Vd> Is the name of the SIMD&FP destination register, encoded in the "Rd" field.
- <Ta> Is an arrangement specifier,
- 8H** when size = 00
 - 4S** when size = 01
 - 2D** when size = 10
 - RESERVED** when size = 11
- <Vn> Is the name of the SIMD&FP source register, encoded in the "Rn" field.
- <Tb> Is an arrangement specifier,
- 8B** when size = 00, Q = 0
 - 16B** when size = 00, Q = 1
 - 4H** when size = 01, Q = 0
 - 8H** when size = 01, Q = 1
 - 2S** when size = 10, Q = 0
 - 4S** when size = 10, Q = 1
 - RESERVED** when size = 11, Q = x
- <shift> Is a shift amount
- 8** when size = 00
 - 16** when size = 01
 - 32** when size = 10

RESERVED when size = 11

Operation

```
CheckFPAdvSIMDEnabled64();
bits(datasize) operand = Vpart[n, part];
bits(2*datasize) result;
integer element;

for e = 0 to elements-1
    element = Int(Elem[operand, e, esize], unsigned) << shift;
    Elem[result, e, 2*esize] = element<2*esize-1:0>;

V[d] = result;
```

C6.3.224 SHRN, SHRN2

Shift right narrow (immediate)

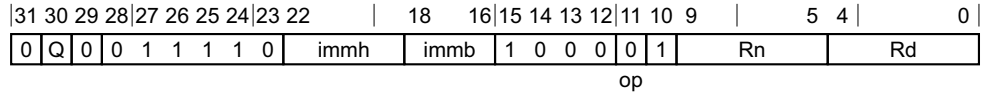

Vector variant

SHRN{2} <Vd>.<Tb>, <Vn>.<Ta>, #<shift>

```
integer d = UInt(Rd);
integer n = UInt(Rn);

if immh == '0000' then AdvSIMD modified immediate;
if immh<3> == '1' then ReservedValue();
integer esize = 8 << HighestSetBit(immh);
integer datasize = 64;
integer part = UInt(Q);
integer elements = datasize DIV esize;

integer shift = (2 * esize) - UInt(immh:immb);
boolean round = (op == '1');
```

Assembler Symbols

- 2 Is the second and upper half specifier. If present it causes the operation to be performed on the upper 64 bits of the registers holding the narrower elements, and is
- [absent]** when Q = 0
 - [present]** when Q = 1
- <Vd> Is the name of the SIMD&FP destination register, encoded in the "Rd" field.
- <Tb> Is an arrangement specifier,
- See **AdvSIMD modified immediate**. when immh = 0000, Q = x
- 8B** when immh = 0001, Q = 0
 - 16B** when immh = 0001, Q = 1
 - 4H** when immh = 001x, Q = 0
 - 8H** when immh = 001x, Q = 1
 - 2S** when immh = 01xx, Q = 0
 - 4S** when immh = 01xx, Q = 1
 - RESERVED** when immh = 1xxx, Q = x
- <Vn> Is the name of the SIMD&FP source register, encoded in the "Rn" field.
- <Ta> Is an arrangement specifier,
- See **AdvSIMD modified immediate**. when immh = 0000
- 8H** when immh = 0001
 - 4S** when immh = 001x
 - 2D** when immh = 01xx
 - RESERVED** when immh = 1xxx

<shift> Is a shift amount, in the range 1 to element bits,
See AdvSIMD modified immediate. when immh = 0000
(16-UInt(immh:immb)) when immh = 0001
(32-UInt(immh:immb)) when immh = 001x
(64-UInt(immh:immb)) when immh = 01xx
RESERVED when immh = 1xxx

Operation

```
CheckFPAdvSIMDEnabled64();
bits(datasize*2) operand = V[n];
bits(datasize) result;
integer round_const = if round then (1 << (shift - 1)) else 0;
integer element;

for e = 0 to elements-1
    element = (UInt(Elem[operand, e, 2*esize]) + round_const) >> shift;
    Elem[result, e, esize] = element<size-1:0>;

Vpart[d, part] = result;
```

C6.3.225 SHSUB

Signed halving subtract

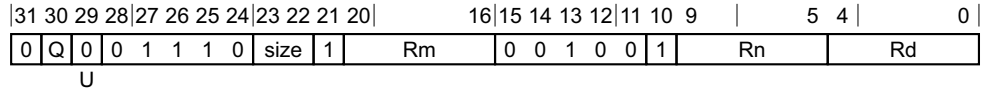

Three registers of the same type variant

SHSUB <Vd>.<T>, <Vn>.<T>, <Vm>.<T>

```
integer d = UInt(Rd);
integer n = UInt(Rn);
integer m = UInt(Rm);
if size == '11' then ReservedValue();
integer esize = 8 << UInt(size);
integer datasize = if Q == '1' then 128 else 64;
integer elements = datasize DIV esize;
boolean unsigned = (U == '1');
```

Assembler Symbols

- <Vd> Is the name of the SIMD&FP destination register, encoded in the "Rd" field.
- <T> Is an arrangement specifier,
- 8B** when size = 00, Q = 0
 - 16B** when size = 00, Q = 1
 - 4H** when size = 01, Q = 0
 - 8H** when size = 01, Q = 1
 - 2S** when size = 10, Q = 0
 - 4S** when size = 10, Q = 1
 - RESERVED** when size = 11, Q = x
- <Vn> Is the name of the first SIMD&FP source register, encoded in the "Rn" field.
- <Vm> Is the name of the second SIMD&FP source register, encoded in the "Rm" field.

Operation

```
CheckFPAdvSIMDEnabled64();
bits(datasize) operand1 = V[n];
bits(datasize) operand2 = V[m];
bits(datasize) result;
integer element1;
integer element2;
integer diff;

for e = 0 to elements-1
    element1 = Int(Elem[operand1, e, esize], unsigned);
    element2 = Int(Elem[operand2, e, esize], unsigned);
    diff = element1 - element2;
    Elem[result, e, esize] = diff<size:1>;

V[d] = result;
```

C6.3.226 SLI

Shift left and insert (immediate)

It has encodings from 2 classes: *Scalar* and *Vector*

Scalar

31	30	29	28	27	26	25	24	23	22	18	16	15	14	13	12	11	10	9	5	4	0
0	1	1	1	1	1	1	1	0	immh	immb	0	1	0	1	0	1	Rn		Rd		

Scalar variant

SLI <V><d>, <V><n>, #<shift>

```
integer d = UInt(Rd);
integer n = UInt(Rn);

if immh<3> != '1' then ReservedValue();
integer esize = 8 << 3;
integer datasize = esize;
integer elements = 1;

integer shift = UInt(immh:immb) - esize;
```

Vector

31	30	29	28	27	26	25	24	23	22	18	16	15	14	13	12	11	10	9	5	4	0
0	Q	1	0	1	1	1	1	0	immh	immb	0	1	0	1	0	1	Rn		Rd		

Vector variant

SLI <Vd>.<T>, <Vn>.<T>, #<shift>

```
integer d = UInt(Rd);
integer n = UInt(Rn);

if immh == '0000' then AdvSIMD modified immediate;
if immh<3>:Q == '10' then ReservedValue();
integer esize = 8 << HighestSetBit(immh);
integer datasize = if Q == '1' then 128 else 64;
integer elements = datasize DIV esize;

integer shift = UInt(immh:immb) - esize;
```

Assembler Symbols

- <V> Is a width specifier,
RESERVED when immh = 0xxx
D when immh = 1xxx
- <d> Is the number of the SIMD&FP destination register, in the "Rd" field.
- <n> Is the number of the first SIMD&FP source register, encoded in the "Rn" field.
- <Vd> Is the name of the SIMD&FP destination register, encoded in the "Rd" field.
- <T> Is an arrangement specifier,
See AdvSIMD modified immediate. when immh = 0000, Q = x

8B	when immh = 0001, Q = 0
16B	when immh = 0001, Q = 1
4H	when immh = 001x, Q = 0
8H	when immh = 001x, Q = 1
2S	when immh = 01xx, Q = 0
4S	when immh = 01xx, Q = 1
RESERVED	when immh = 1xxx, Q = 0
2D	when immh = 1xxx, Q = 1
<Vn>	Is the name of the SIMD&FP source register, encoded in the "Rn" field.
<shift>	For the scalar variant: is the shift amount, in the range 0 to 63, RESERVED when immh = 0xxx (UInt(immh:immb)-64) when immh = 1xxx
<shift>	For the vector variant: is a shift amount, in the range 0 to element bits - 1, See AdvSIMD modified immediate. when immh = 0000 (UInt(immh:immb)-8) when immh = 0001 (UInt(immh:immb)-16) when immh = 001x (UInt(immh:immb)-32) when immh = 01xx (UInt(immh:immb)-64) when immh = 1xxx

Operation for all classes

```

CheckFPAdvSIMDEnabled64();
bits(datasize) operand = V[n];
bits(datasize) operand2 = V[d];
bits(datasize) result;
bits(esize) mask = LSL(Ones(esize), shift);
bits(esize) shifted;

for e = 0 to elements-1
    shifted = LSL(Elem[operand, e, esize], shift);
    Elem[result, e, esize] = (Elem[operand2, e, esize] AND NOT(mask)) OR shifted;
V[d] = result;
    
```

C6.3.227 SMAX

Signed maximum (vector)

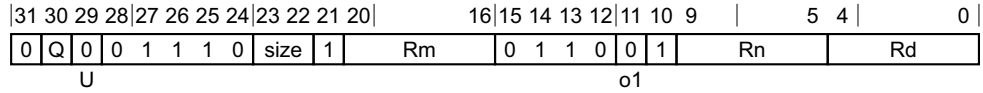

Three registers of the same type variant

SMAX <Vd>.<T>, <Vn>.<T>, <Vm>.<T>

```
integer d = UInt(Rd);
integer n = UInt(Rn);
integer m = UInt(Rm);
if size == '11' then ReservedValue();
integer esize = 8 << UInt(size);
integer datasize = if Q == '1' then 128 else 64;
integer elements = datasize DIV esize;
```

```
boolean unsigned = (U == '1');
boolean minimum = (o1 == '1');
```

Assembler Symbols

- <Vd> Is the name of the SIMD&FP destination register, encoded in the "Rd" field.
- <T> Is an arrangement specifier,
 - 8B** when size = 00, Q = 0
 - 16B** when size = 00, Q = 1
 - 4H** when size = 01, Q = 0
 - 8H** when size = 01, Q = 1
 - 2S** when size = 10, Q = 0
 - 4S** when size = 10, Q = 1
 - RESERVED** when size = 11, Q = x
- <Vn> Is the name of the first SIMD&FP source register, encoded in the "Rn" field.
- <Vm> Is the name of the second SIMD&FP source register, encoded in the "Rm" field.

Operation

```
CheckFPAdvSIMDEnabled64();
bits(datasize) operand1 = V[n];
bits(datasize) operand2 = V[m];
bits(datasize) result;
integer element1;
integer element2;
integer maxmin;

for e = 0 to elements-1
    element1 = Int(Elem[operand1, e, esize], unsigned);
    element2 = Int(Elem[operand2, e, esize], unsigned);
    maxmin = if minimum then Min(element1, element2) else Max(element1, element2);
    Elem[result, e, esize] = maxmin<esize-1:0>;

V[d] = result;
```

C6.3.228 SMAXP

Signed maximum pairwise

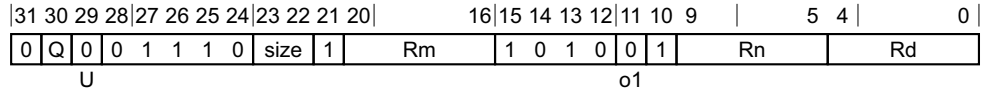

Three registers of the same type variant

SMAXP <Vd>.<T>, <Vn>.<T>, <Vm>.<T>

```
integer d = UInt(Rd);
integer n = UInt(Rn);
integer m = UInt(Rm);
if size == '11' then ReservedValue();
integer esize = 8 << UInt(size);
integer datasize = if Q == '1' then 128 else 64;
integer elements = datasize DIV esize;
```

```
boolean unsigned = (U == '1');
boolean minimum = (o1 == '1');
```

Assembler Symbols

- <Vd> Is the name of the SIMD&FP destination register, encoded in the "Rd" field.
- <T> Is an arrangement specifier,
- 8B** when size = 00, Q = 0
 - 16B** when size = 00, Q = 1
 - 4H** when size = 01, Q = 0
 - 8H** when size = 01, Q = 1
 - 2S** when size = 10, Q = 0
 - 4S** when size = 10, Q = 1
 - RESERVED** when size = 11, Q = x
- <Vn> Is the name of the first SIMD&FP source register, encoded in the "Rn" field.
- <Vm> Is the name of the second SIMD&FP source register, encoded in the "Rm" field.

Operation

```
CheckFPAdvSIMDEnabled64();
bits(datasize) operand1 = V[n];
bits(datasize) operand2 = V[m];
bits(datasize) result;
bits(2*datasize) concat = operand2:operand1;
integer element1;
integer element2;
integer maxmin;

for e = 0 to elements-1
    element1 = Int(Elem[concat, 2*e, esize], unsigned);
    element2 = Int(Elem[concat, (2*e)+1, esize], unsigned);
    maxmin = if minimum then Min(element1, element2) else Max(element1, element2);
    Elem[result, e, esize] = maxmin<esize-1:0>;

V[d] = result;
```

C6.3.229 SMAXV

Signed maximum across vector

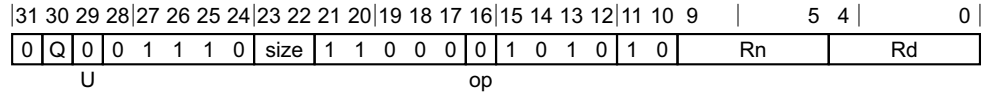

Advanced SIMD variant

SMAXV <V><d>, <Vn>.<T>

```
integer d = UInt(Rd);
integer n = UInt(Rn);

if size:Q == '100' then ReservedValue();
if size == '11' then ReservedValue();
integer esize = 8 << UInt(size);
integer datasize = if Q == '1' then 128 else 64;
integer elements = datasize DIV esize;

boolean unsigned = (U == '1');
boolean min = (op == '1');
```

Assembler Symbols

- <V> Is the destination width specifier,
B when size = 00
H when size = 01
S when size = 10
RESERVED when size = 11
- <d> Is the number of the SIMD&FP destination register, encoded in the "Rd" field.
- <Vn> Is the name of the SIMD&FP source register, encoded in the "Rn" field.
- <T> Is an arrangement specifier,
8B when size = 00, Q = 0
16B when size = 00, Q = 1
4H when size = 01, Q = 0
8H when size = 01, Q = 1
RESERVED when size = 10, Q = 0
4S when size = 10, Q = 1
RESERVED when size = 11, Q = x

Operation

```
CheckFPAdvSIMDEnabled64();
bits(datasize) operand = V[n];
integer maxmin;
integer element;

maxmin = Int(Elem[operand, 0, esize], unsigned);
for e = 1 to elements-1
    element = Int(Elem[operand, e, esize], unsigned);
```

```
maxmin = if min then Min(maxmin, element) else Max(maxmin, element);  
V[d] = maxmin<size-1:0>;
```

C6.3.230 SMIN

Signed minimum (vector)

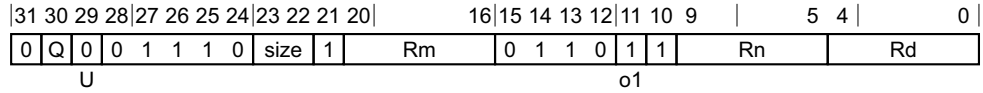

Three registers of the same type variant

SMIN <Vd>.<T>, <Vn>.<T>, <Vm>.<T>

```
integer d = UInt(Rd);
integer n = UInt(Rn);
integer m = UInt(Rm);
if size == '11' then ReservedValue();
integer esize = 8 << UInt(size);
integer datasize = if Q == '1' then 128 else 64;
integer elements = datasize DIV esize;
```

```
boolean unsigned = (U == '1');
boolean minimum = (o1 == '1');
```

Assembler Symbols

- <Vd> Is the name of the SIMD&FP destination register, encoded in the "Rd" field.
- <T> Is an arrangement specifier,
- 8B** when size = 00, Q = 0
 - 16B** when size = 00, Q = 1
 - 4H** when size = 01, Q = 0
 - 8H** when size = 01, Q = 1
 - 2S** when size = 10, Q = 0
 - 4S** when size = 10, Q = 1
 - RESERVED** when size = 11, Q = x
- <Vn> Is the name of the first SIMD&FP source register, encoded in the "Rn" field.
- <Vm> Is the name of the second SIMD&FP source register, encoded in the "Rm" field.

Operation

```
CheckFPAdvSIMDEnabled64();
bits(datasize) operand1 = V[n];
bits(datasize) operand2 = V[m];
bits(datasize) result;
integer element1;
integer element2;
integer maxmin;

for e = 0 to elements-1
    element1 = Int(Elem[operand1, e, esize], unsigned);
    element2 = Int(Elem[operand2, e, esize], unsigned);
    maxmin = if minimum then Min(element1, element2) else Max(element1, element2);
    Elem[result, e, esize] = maxmin<esize-1:0>;

V[d] = result;
```

C6.3.231 SMINP

Signed minimum pairwise

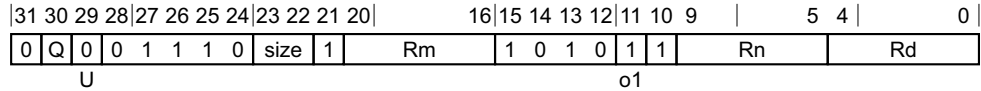

Three registers of the same type variant

SMINP <Vd>.<T>, <Vn>.<T>, <Vm>.<T>

```
integer d = UInt(Rd);
integer n = UInt(Rn);
integer m = UInt(Rm);
if size == '11' then ReservedValue();
integer esize = 8 << UInt(size);
integer datasize = if Q == '1' then 128 else 64;
integer elements = datasize DIV esize;
```

```
boolean unsigned = (U == '1');
boolean minimum = (o1 == '1');
```

Assembler Symbols

- <Vd> Is the name of the SIMD&FP destination register, encoded in the "Rd" field.
- <T> Is an arrangement specifier,
- 8B** when size = 00, Q = 0
 - 16B** when size = 00, Q = 1
 - 4H** when size = 01, Q = 0
 - 8H** when size = 01, Q = 1
 - 2S** when size = 10, Q = 0
 - 4S** when size = 10, Q = 1
 - RESERVED** when size = 11, Q = x
- <Vn> Is the name of the first SIMD&FP source register, encoded in the "Rn" field.
- <Vm> Is the name of the second SIMD&FP source register, encoded in the "Rm" field.

Operation

```
CheckFPAdvSIMDEnabled64();
bits(datasize) operand1 = V[n];
bits(datasize) operand2 = V[m];
bits(datasize) result;
bits(2*datasize) concat = operand2:operand1;
integer element1;
integer element2;
integer maxmin;

for e = 0 to elements-1
    element1 = Int(Elem[concat, 2*e, esize], unsigned);
    element2 = Int(Elem[concat, (2*e)+1, esize], unsigned);
    maxmin = if minimum then Min(element1, element2) else Max(element1, element2);
    Elem[result, e, esize] = maxmin<esize-1:0>;

V[d] = result;
```

C6.3.232 SMINV

Signed minimum across vector

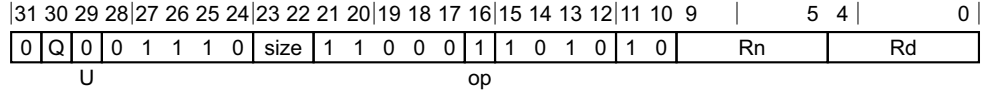

Advanced SIMD variant

SMINV <V><d>, <Vn>.<T>

```
integer d = UInt(Rd);
integer n = UInt(Rn);

if size:Q == '100' then ReservedValue();
if size == '11' then ReservedValue();
integer esize = 8 << UInt(size);
integer datasize = if Q == '1' then 128 else 64;
integer elements = datasize DIV esize;

boolean unsigned = (U == '1');
boolean min = (op == '1');
```

Assembler Symbols

- <V> Is the destination width specifier,
 - B** when size = 00
 - H** when size = 01
 - S** when size = 10
 - RESERVED** when size = 11
- <d> Is the number of the SIMD&FP destination register, encoded in the "Rd" field.
- <Vn> Is the name of the SIMD&FP source register, encoded in the "Rn" field.
- <T> Is an arrangement specifier,
 - 8B** when size = 00, Q = 0
 - 16B** when size = 00, Q = 1
 - 4H** when size = 01, Q = 0
 - 8H** when size = 01, Q = 1
 - RESERVED** when size = 10, Q = 0
 - 4S** when size = 10, Q = 1
 - RESERVED** when size = 11, Q = x

Operation

```
CheckFPAdvSIMDEnabled64();
bits(datasize) operand = V[n];
integer maxmin;
integer element;

maxmin = Int(Elem[operand, 0, esize], unsigned);
for e = 1 to elements-1
    element = Int(Elem[operand, e, esize], unsigned);
```

```
maxmin = if min then Min(maxmin, element) else Max(maxmin, element);  
V[d] = maxmin<size-1:0>;
```

C6.3.233 SMLAL, SMLAL2 (by element)

Signed multiply-add long (vector, by element)

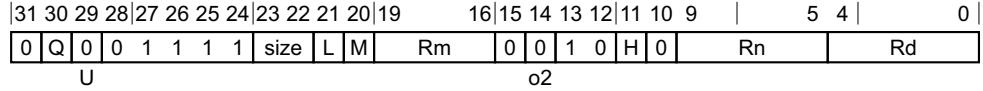

Vector variant

SMLAL{2} <Vd>.<Ta>, <Vn>.<Tb>, <Vm>.<Ts>[<index>]

```

integer idxsize = if H == '1' then 128 else 64;
integer index;
bit Rmhi;
case size of
    when '01' index = UInt(H:L:M); Rmhi = '0';
    when '10' index = UInt(H:L); Rmhi = M;
    otherwise UnallocatedEncoding();

integer d = UInt(Rd);
integer n = UInt(Rn);
integer m = UInt(Rmhi:Rm);

integer esize = 8 << UInt(size);
integer datasize = 64;
integer part = UInt(Q);
integer elements = datasize DIV esize;

boolean unsigned = (U == '1');
boolean sub_op = (o2 == '1');
```

Assembler Symbols

- 2 Is the second and upper half specifier. If present it causes the operation to be performed on the upper 64 bits of the registers holding the narrower elements, and is
 - [absent]** when Q = 0
 - [present]** when Q = 1
- <Vd> Is the name of the SIMD&FP destination register, encoded in the "Rd" field.
- <Ta> Is an arrangement specifier,
 - RESERVED** when size = 00
 - 4S** when size = 01
 - 2D** when size = 10
 - RESERVED** when size = 11
- <Vn> Is the name of the first SIMD&FP source register, encoded in the "Rn" field.
- <Tb> Is an arrangement specifier,
 - RESERVED** when size = 00, Q = x
 - 4H** when size = 01, Q = 0
 - 8H** when size = 01, Q = 1
 - 2S** when size = 10, Q = 0
 - 4S** when size = 10, Q = 1
 - RESERVED** when size = 11, Q = x

<Vm> Is the name of the second SIMD&FP source register,
RESERVED when size = 00
0:Rm when size = 01
M:Rm when size = 10
RESERVED when size = 11
 Restricted to V0-V15 when element size <Ts> is H.

<Ts> Is an element size specifier,
RESERVED when size = 00
H when size = 01
S when size = 10
RESERVED when size = 11

<index> Is the element index
RESERVED when size = 00
H:L:M when size = 01
H:L when size = 10
RESERVED when size = 11

Operation

```

CheckFPAdvSIMDEnabled64();
bits(datasize) operand1 = Vpart[n, part];
bits(idxsize) operand2 = V[m];
bits(2*datasize) operand3 = V[d];
bits(2*datasize) result;
integer element1;
integer element2;
bits(2*esize) product;

element2 = Int(Elem[operand2, index, esize], unsigned);
for e = 0 to elements-1
  element1 = Int(Elem[operand1, e, esize], unsigned);
  product = (element1 * element2)<2*esize-1:0>;
  if sub_op then
    Elem[result, e, 2*esize] = Elem[operand3, e, 2*esize] - product;
  else
    Elem[result, e, 2*esize] = Elem[operand3, e, 2*esize] + product;

V[d] = result;
  
```

C6.3.234 SMLAL, SMLAL2 (vector)

Signed multiply-add long (vector)

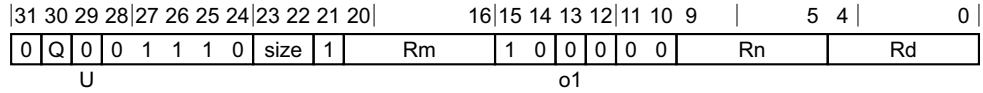

Three registers, not all the same type variant

SMLAL{2} <Vd>.<Ta>, <Vn>.<Tb>, <Vm>.<Tb>

```
integer d = UInt(Rd);
integer n = UInt(Rn);
integer m = UInt(Rm);

if size == '11' then ReservedValue();
integer esize = 8 << UInt(size);
integer datasize = 64;
integer part = UInt(Q);
integer elements = datasize DIV esize;
boolean sub_op = (o1 == '1');
boolean unsigned = (U == '1');
```

Assembler Symbols

- 2 Is the second and upper half specifier. If present it causes the operation to be performed on the upper 64 bits of the registers holding the narrower elements, and is
 - [absent] when Q = 0
 - [present] when Q = 1
- <Vd> Is the name of the SIMD&FP destination register, encoded in the "Rd" field.
- <Ta> Is an arrangement specifier,
 - 8H** when size = 00
 - 4S** when size = 01
 - 2D** when size = 10
 - RESERVED** when size = 11
- <Vn> Is the name of the first SIMD&FP source register, encoded in the "Rn" field.
- <Tb> Is an arrangement specifier,
 - 8B** when size = 00, Q = 0
 - 16B** when size = 00, Q = 1
 - 4H** when size = 01, Q = 0
 - 8H** when size = 01, Q = 1
 - 2S** when size = 10, Q = 0
 - 4S** when size = 10, Q = 1
 - RESERVED** when size = 11, Q = x
- <Vm> Is the name of the second SIMD&FP source register, encoded in the "Rm" field.

Operation

```
CheckFPAdvSIMDEnabled64();
bits(datasize) operand1 = Vpart[n, part];
bits(datasize) operand2 = Vpart[m, part];
bits(2*datasize) operand3 = V[d];
bits(2*datasize) result;
integer element1;
integer element2;
bits(2*esize) product;
bits(2*esize) accum;

for e = 0 to elements-1
    element1 = Int(Elem[operand1, e, esize], unsigned);
    element2 = Int(Elem[operand2, e, esize], unsigned);
    product = (element1 * element2) <2*esize-1:0>;
    if sub_op then
        accum = Elem[operand3, e, 2*esize] - product;
    else
        accum = Elem[operand3, e, 2*esize] + product;
    Elem[result, e, 2*esize] = accum;

V[d] = result;
```

C6.3.235 SMLSL, SMLSL2 (by element)

Signed multiply-subtract long (vector, by element)

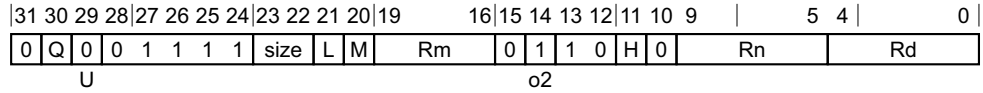

Vector variant

SMLSL{2} <Vd>.<Ta>, <Vn>.<Tb>, <Vm>.<Ts>[<i>index</i>]

```
integer idxsize = if H == '1' then 128 else 64;
integer index;
bit Rmhi;
case size of
    when '01' index = UInt(H:L:M); Rmhi = '0';
    when '10' index = UInt(H:L); Rmhi = M;
    otherwise UnallocatedEncoding();

integer d = UInt(Rd);
integer n = UInt(Rn);
integer m = UInt(Rmhi:Rm);

integer esize = 8 << UInt(size);
integer datasize = 64;
integer part = UInt(Q);
integer elements = datasize DIV esize;

boolean unsigned = (U == '1');
boolean sub_op = (o2 == '1');
```

Assembler Symbols

- 2 Is the second and upper half specifier. If present it causes the operation to be performed on the upper 64 bits of the registers holding the narrower elements, and is
 - [absent]** when Q = 0
 - [present]** when Q = 1
- <Vd> Is the name of the SIMD&FP destination register, encoded in the "Rd" field.
- <Ta> Is an arrangement specifier,
 - RESERVED** when size = 00
 - 4S** when size = 01
 - 2D** when size = 10
 - RESERVED** when size = 11
- <Vn> Is the name of the first SIMD&FP source register, encoded in the "Rn" field.
- <Tb> Is an arrangement specifier,
 - RESERVED** when size = 00, Q = x
 - 4H** when size = 01, Q = 0
 - 8H** when size = 01, Q = 1
 - 2S** when size = 10, Q = 0
 - 4S** when size = 10, Q = 1
 - RESERVED** when size = 11, Q = x

- <Vm> Is the name of the second SIMD&FP source register,
RESERVED when size = 00
0:Rm when size = 01
M:Rm when size = 10
RESERVED when size = 11
 Restricted to V0-V15 when element size <Ts> is H.
- <Ts> Is an element size specifier,
RESERVED when size = 00
H when size = 01
S when size = 10
RESERVED when size = 11
- <index> Is the element index
RESERVED when size = 00
H:L:M when size = 01
H:L when size = 10
RESERVED when size = 11

Operation

```

CheckFPAdvSIMDEnabled64();
bits(datasize) operand1 = Vpart[n, part];
bits(idxsize) operand2 = V[m];
bits(2*datasize) operand3 = V[d];
bits(2*datasize) result;
integer element1;
integer element2;
bits(2*esize) product;

element2 = Int(Elem[operand2, index, esize], unsigned);
for e = 0 to elements-1
    element1 = Int(Elem[operand1, e, esize], unsigned);
    product = (element1 * element2)<2*esize-1:0>;
    if sub_op then
        Elem[result, e, 2*esize] = Elem[operand3, e, 2*esize] - product;
    else
        Elem[result, e, 2*esize] = Elem[operand3, e, 2*esize] + product;

V[d] = result;
    
```

C6.3.236 SMLSL, SMLSL2 (vector)

Signed multiply-subtract long (vector)

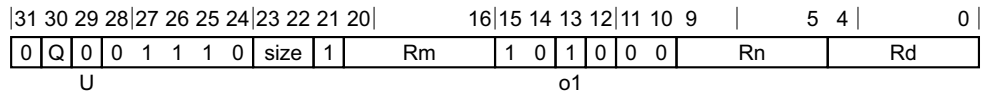

Three registers, not all the same type variant

SMLSL{2} <Vd>.<Ta>, <Vn>.<Tb>, <Vm>.<Tb>

```
integer d = UInt(Rd);
integer n = UInt(Rn);
integer m = UInt(Rm);

if size == '11' then ReservedValue();
integer esize = 8 << UInt(size);
integer datasize = 64;
integer part = UInt(Q);
integer elements = datasize DIV esize;
boolean sub_op = (o1 == '1');
boolean unsigned = (U == '1');
```

Assembler Symbols

- 2 Is the second and upper half specifier. If present it causes the operation to be performed on the upper 64 bits of the registers holding the narrower elements, and is
- [absent]** when Q = 0
 - [present]** when Q = 1
- <Vd> Is the name of the SIMD&FP destination register, encoded in the "Rd" field.
- <Ta> Is an arrangement specifier,
- 8H** when size = 00
 - 4S** when size = 01
 - 2D** when size = 10
 - RESERVED** when size = 11
- <Vn> Is the name of the first SIMD&FP source register, encoded in the "Rn" field.
- <Tb> Is an arrangement specifier,
- 8B** when size = 00, Q = 0
 - 16B** when size = 00, Q = 1
 - 4H** when size = 01, Q = 0
 - 8H** when size = 01, Q = 1
 - 2S** when size = 10, Q = 0
 - 4S** when size = 10, Q = 1
 - RESERVED** when size = 11, Q = x
- <Vm> Is the name of the second SIMD&FP source register, encoded in the "Rm" field.

Operation

```
CheckFPAdvSIMDEnabled64();
bits(datasize) operand1 = Vpart[n, part];
bits(datasize) operand2 = Vpart[m, part];
bits(2*datasize) operand3 = V[d];
bits(2*datasize) result;
integer element1;
integer element2;
bits(2*esize) product;
bits(2*esize) accum;

for e = 0 to elements-1
    element1 = Int(Elem[operand1, e, esize], unsigned);
    element2 = Int(Elem[operand2, e, esize], unsigned);
    product = (element1 * element2)<2*esize-1:0>;
    if sub_op then
        accum = Elem[operand3, e, 2*esize] - product;
    else
        accum = Elem[operand3, e, 2*esize] + product;
    Elem[result, e, 2*esize] = accum;

V[d] = result;
```

C6.3.237 SMOV

Signed move vector element to general-purpose register

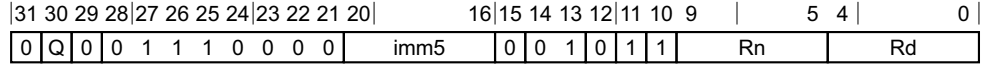

32-bit variant (Q = 0)

SMOV <Wd>, <Vn>.<Ts>[<index>]

64-bit variant (Q = 1)

SMOV <Xd>, <Vn>.<Ts>[<index>]

```
integer d = UInt(Rd);
integer n = UInt(Rn);

integer size;
case Q:imm5 of
    when 'xxxxx1' size = 0; // SMOV [WX]d, Vn.B
    when 'xxxx10' size = 1; // SMOV [WX]d, Vn.H
    when '1xx100' size = 2; // SMOV Xd, Vn.S
    otherwise UnallocatedEncoding();

integer idxsize = if imm5<4> == '1' then 128 else 64;
integer index = UInt(imm5<4:1>);
integer esize = 8 << size;
integer datasize = if Q == '1' then 64 else 32;
```

Assembler Symbols

- <Wd> Is the 32-bit name of the general-purpose destination register, encoded in the "Rd" field.
- <Xd> Is the 64-bit name of the general-purpose destination register, encoded in the "Rd" field.
- <Vn> Is the name of the SIMD&FP source register, encoded in the "Rn" field.
- <Ts> For the 32-bit variant: is an element size specifier,
RESERVED when imm5 = xxx00
B when imm5 = xxxx1
H when imm5 = xxx10
- <Ts> For the 64-bit variant: is an element size specifier,
RESERVED when imm5 = xx000
B when imm5 = xxxx1
H when imm5 = xxx10
S when imm5 = xx100
- <index> For the 32-bit variant: is the element index
RESERVED when imm5 = xxx00
imm5<4:1> when imm5 = xxxx1
imm5<4:2> when imm5 = xxx10
- <index> For the 64-bit variant: is the element index
RESERVED when imm5 = xx000

imm5<4:1> when imm5 = xxxx1

imm5<4:2> when imm5 = xxx10

imm5<4:3> when imm5 = xx100

Operation

```
CheckFPAdvSIMDEnabled64();  
bits(idxsize) operand = V[n];
```

```
X[d] = SignExtend(Elem[operand, index, esize], datasize);
```

C6.3.238 SMULL, SMULL2 (by element)

Signed multiply long (vector, by element)

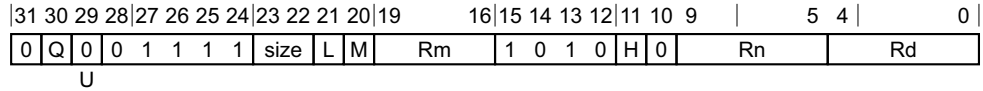

Vector variant

SMULL{2} <Vd>.<Ta>, <Vn>.<Tb>, <Vm>.<Ts>[<i>index</i>]

```

integer idxsize = if H == '1' then 128 else 64;
integer index;
bit Rmhi;
case size of
    when '01' index = UInt(H:L:M); Rmhi = '0';
    when '10' index = UInt(H:L); Rmhi = M;
    otherwise UnallocatedEncoding();

integer d = UInt(Rd);
integer n = UInt(Rn);
integer m = UInt(Rmhi:Rm);

integer esize = 8 << UInt(size);
integer datasize = 64;
integer part = UInt(Q);
integer elements = datasize DIV esize;
boolean unsigned = (U == '1');
    
```

Assembler Symbols

- 2 Is the second and upper half specifier. If present it causes the operation to be performed on the upper 64 bits of the registers holding the narrower elements, and is
 - [absent]** when Q = 0
 - [present]** when Q = 1
- <Vd> Is the name of the SIMD&FP destination register, encoded in the "Rd" field.
- <Ta> Is an arrangement specifier,
 - RESERVED** when size = 00
 - 4S** when size = 01
 - 2D** when size = 10
 - RESERVED** when size = 11
- <Vn> Is the name of the first SIMD&FP source register, encoded in the "Rn" field.
- <Tb> Is an arrangement specifier,
 - RESERVED** when size = 00, Q = x
 - 4H** when size = 01, Q = 0
 - 8H** when size = 01, Q = 1
 - 2S** when size = 10, Q = 0
 - 4S** when size = 10, Q = 1
 - RESERVED** when size = 11, Q = x

- <Vm> Is the name of the second SIMD&FP source register,
RESERVED when size = 00
0:Rm when size = 01
M:Rm when size = 10
RESERVED when size = 11
 Restricted to V0-V15 when element size <Ts> is H.
- <Ts> Is an element size specifier,
RESERVED when size = 00
H when size = 01
S when size = 10
RESERVED when size = 11
- <index> Is the element index
RESERVED when size = 00
H:L:M when size = 01
H:L when size = 10
RESERVED when size = 11

Operation

```

CheckFPAdvSIMDEnabled64();
bits(datasize) operand1 = Vpart[n, part];
bits(idxsize) operand2 = V[m];
bits(2*datasize) result;
integer element1;
integer element2;
bits(2*esize) product;

element2 = Int(Elem[operand2, index, esize], unsigned);
for e = 0 to elements-1
    element1 = Int(Elem[operand1, e, esize], unsigned);
    product = (element1 * element2) <2*esize-1:0>;
    Elem[result, e, 2*esize] = product;

V[d] = result;
    
```

C6.3.239 SMULL, SMULL2 (vector)

Signed multiply long (vector)

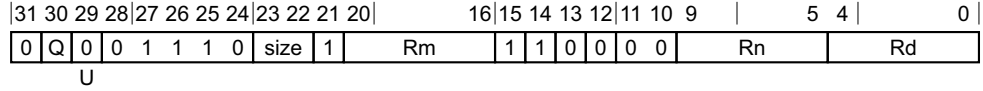

Three registers, not all the same type variant

SMULL{2} <Vd>.<Ta>, <Vn>.<Tb>, <Vm>.<Tb>

```
integer d = UInt(Rd);
integer n = UInt(Rn);
integer m = UInt(Rm);

if size == '11' then ReservedValue();
integer esize = 8 << UInt(size);
integer datasize = 64;
integer part = UInt(Q);
integer elements = datasize DIV esize;

boolean unsigned = (U == '1');
```

Assembler Symbols

- 2 Is the second and upper half specifier. If present it causes the operation to be performed on the upper 64 bits of the registers holding the narrower elements, and is
 - [absent]** when Q = 0
 - [present]** when Q = 1
- <Vd> Is the name of the SIMD&FP destination register, encoded in the "Rd" field.
- <Ta> Is an arrangement specifier,
 - 8H** when size = 00
 - 4S** when size = 01
 - 2D** when size = 10
 - RESERVED** when size = 11
- <Vn> Is the name of the first SIMD&FP source register, encoded in the "Rn" field.
- <Tb> Is an arrangement specifier,
 - 8B** when size = 00, Q = 0
 - 16B** when size = 00, Q = 1
 - 4H** when size = 01, Q = 0
 - 8H** when size = 01, Q = 1
 - 2S** when size = 10, Q = 0
 - 4S** when size = 10, Q = 1
 - RESERVED** when size = 11, Q = x
- <Vm> Is the name of the second SIMD&FP source register, encoded in the "Rm" field.

Operation

```
CheckFPAdvSIMDEnabled64();
bits(datasize) operand1 = Vpart[n, part];
bits(datasize) operand2 = Vpart[m, part];
bits(2*datasize) result;
integer element1;
integer element2;

for e = 0 to elements-1
    element1 = Int(Elem[operand1, e, esize], unsigned);
    element2 = Int(Elem[operand2, e, esize], unsigned);
    Elem[result, e, 2*esize] = (element1 * element2)<2*esize-1:0>;

V[d] = result;
```

C6.3.240 SQABS

Signed saturating absolute value

It has encodings from 2 classes: *Scalar* and *Vector*

Scalar

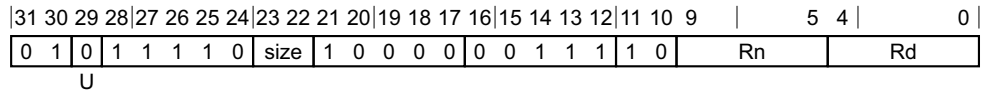

Scalar variant

SQABS <V><d>, <V><n>

```
integer d = UInt(Rd);
integer n = UInt(Rn);
```

```
integer esize = 8 << UInt(size);
integer datasize = esize;
integer elements = 1;
```

```
boolean neg = (U == '1');
```

Vector

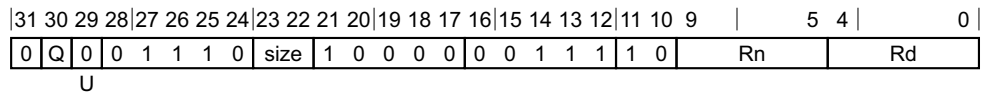

Vector variant

SQABS <Vd>.<T>, <Vn>.<T>

```
integer d = UInt(Rd);
integer n = UInt(Rn);
```

```
if size:Q == '110' then ReservedValue();
integer esize = 8 << UInt(size);
integer datasize = if Q == '1' then 128 else 64;
integer elements = datasize DIV esize;
```

```
boolean neg = (U == '1');
```

Assembler Symbols

<V> Is a width specifier,

B when size = 00

H when size = 01

S when size = 10

D when size = 11

<d> Is the number of the SIMD&FP destination register, encoded in the "Rd" field.

<n> Is the number of the SIMD&FP source register, encoded in the "Rn" field.

<Vd> Is the name of the SIMD&FP destination register, encoded in the "Rd" field.

<T> Is an arrangement specifier,

- 8B** when size = 00, Q = 0
- 16B** when size = 00, Q = 1
- 4H** when size = 01, Q = 0
- 8H** when size = 01, Q = 1
- 2S** when size = 10, Q = 0
- 4S** when size = 10, Q = 1
- RESERVED** when size = 11, Q = 0
- 2D** when size = 11, Q = 1

<Vn> Is the name of the SIMD&FP source register, encoded in the "Rn" field.

Operation for all classes

```
CheckFPAdvSIMDEnabled64();
bits(datasize) operand = V[n];
bits(datasize) result;
integer element;
boolean sat;

for e = 0 to elements-1
    element = SInt(Elem[operand, e, esize]);
    if neg then
        element = -element;
    else
        element = Abs(element);
    (Elem[result, e, esize], sat) = SignedSatQ(element, esize);
    if sat then FPSR.QC = '1';

V[d] = result;
```

C6.3.241 SQADD

Signed saturating add

It has encodings from 2 classes: *Scalar* and *Vector*

Scalar

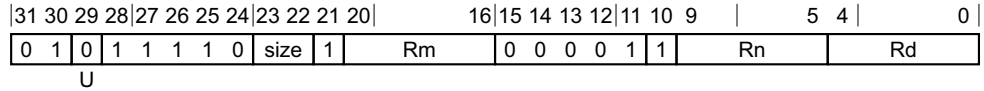

Scalar variant

SQADD <V><d>, <V><n>, <V><m>

```
integer d = UInt(Rd);
integer n = UInt(Rn);
integer m = UInt(Rm);
integer esize = 8 << UInt(size);
integer datasize = esize;
integer elements = 1;
boolean unsigned = (U == '1');
```

Vector

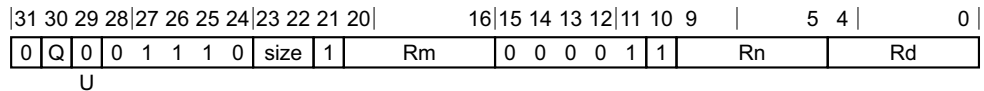

Vector variant

SQADD <Vd>.<T>, <Vn>.<T>, <Vm>.<T>

```
integer d = UInt(Rd);
integer n = UInt(Rn);
integer m = UInt(Rm);
if size:Q == '110' then ReservedValue();
integer esize = 8 << UInt(size);
integer datasize = if Q == '1' then 128 else 64;
integer elements = datasize DIV esize;
boolean unsigned = (U == '1');
```

Assembler Symbols

- <V> Is a width specifier,
 - B** when size = 00
 - H** when size = 01
 - S** when size = 10
 - D** when size = 11
- <d> Is the number of the SIMD&FP destination register, in the "Rd" field.
- <n> Is the number of the first SIMD&FP source register, encoded in the "Rn" field.
- <m> Is the number of the second SIMD&FP source register, encoded in the "Rm" field.
- <Vd> Is the name of the SIMD&FP destination register, encoded in the "Rd" field.

- <T> Is an arrangement specifier,
- 8B** when size = 00, Q = 0
 - 16B** when size = 00, Q = 1
 - 4H** when size = 01, Q = 0
 - 8H** when size = 01, Q = 1
 - 2S** when size = 10, Q = 0
 - 4S** when size = 10, Q = 1
 - RESERVED** when size = 11, Q = 0
 - 2D** when size = 11, Q = 1
- <Vn> Is the name of the first SIMD&FP source register, encoded in the "Rn" field.
- <Vm> Is the name of the second SIMD&FP source register, encoded in the "Rm" field.

Operation for all classes

```
CheckFPAdvSIMDEnabled64();
bits(datasize) operand1 = V[n];
bits(datasize) operand2 = V[m];
bits(datasize) result;
integer element1;
integer element2;
integer sum;
boolean sat;

for e = 0 to elements-1
    element1 = Int(Elem[operand1, e, esize], unsigned);
    element2 = Int(Elem[operand2, e, esize], unsigned);
    sum = element1 + element2;
    (Elem[result, e, esize], sat) = SatQ(sum, esize, unsigned);
    if sat then FPSR.QC = '1';

V[d] = result;
```

C6.3.242 SQDMLAL, SQDMLAL2 (by element)

Signed saturating doubling multiply-add long (by element)

It has encodings from 2 classes: *Scalar* and *Vector*

Scalar

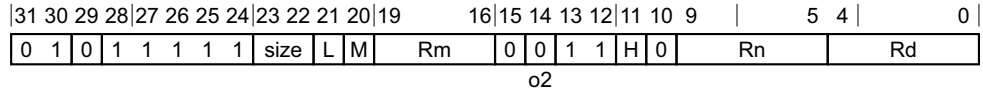

Scalar variant

SQDMLAL <Va><d>, <Vb><n>, <Vm>.<Ts>[<index>]

```

integer idxdsize = if H == '1' then 128 else 64;
integer index;
bit Rmhi;
case size of
    when '01' index = UInt(H:L:M); Rmhi = '0';
    when '10' index = UInt(H:L); Rmhi = M;
    otherwise UnallocatedEncoding();

integer d = UInt(Rd);
integer n = UInt(Rn);
integer m = UInt(Rmhi:Rm);

integer esize = 8 << UInt(size);
integer datasize = esize;
integer elements = 1;
integer part = 0;

boolean sub_op = (o2 == '1');
```

Vector

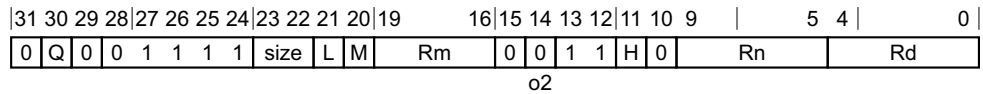

Vector variant

SQDMLAL{2} <Vd>.<Ta>, <Vn>.<Tb>, <Vm>.<Ts>[<index>]

```

integer idxdsize = if H == '1' then 128 else 64;
integer index;
bit Rmhi;
case size of
    when '01' index = UInt(H:L:M); Rmhi = '0';
    when '10' index = UInt(H:L); Rmhi = M;
    otherwise UnallocatedEncoding();

integer d = UInt(Rd);
integer n = UInt(Rn);
integer m = UInt(Rmhi:Rm);

integer esize = 8 << UInt(size);
integer datasize = 64;
integer part = UInt(Q);
integer elements = datasize DIV esize;

boolean sub_op = (o2 == '1');
```

Assembler Symbols

2	Is the second and upper half specifier. If present it causes the operation to be performed on the upper 64 bits of the registers holding the narrower elements, and is [absent] when Q = 0 [present] when Q = 1
<Vd>	Is the name of the SIMD&FP destination register, encoded in the "Rd" field.
<Ta>	Is an arrangement specifier, RESERVED when size = 00 4S when size = 01 2D when size = 10 RESERVED when size = 11
<Vn>	Is the name of the first SIMD&FP source register, encoded in the "Rn" field.
<Tb>	Is an arrangement specifier, RESERVED when size = 00, Q = x 4H when size = 01, Q = 0 8H when size = 01, Q = 1 2S when size = 10, Q = 0 4S when size = 10, Q = 1 RESERVED when size = 11, Q = x
<Va>	Is the destination width specifier, RESERVED when size = 00 S when size = 01 D when size = 10 RESERVED when size = 11
<d>	Is the number of the SIMD&FP destination register, encoded in the "Rd" field.
<Vb>	Is the source width specifier, RESERVED when size = 00 H when size = 01 S when size = 10 RESERVED when size = 11
<n>	Is the number of the first SIMD&FP source register, encoded in the "Rn" field.
<Vm>	Is the name of the second SIMD&FP source register, RESERVED when size = 00 0:Rm when size = 01 M:Rm when size = 10 RESERVED when size = 11 Restricted to V0-V15 when element size <Ts> is H.
<Ts>	For the scalar variant: is the element width specifier, RESERVED when size = 00 H when size = 01 S when size = 10

RESERVED when size = 11

<Ts> For the vector variant: is an element size specifier,
RESERVED when size = 00
H when size = 01
S when size = 10
RESERVED when size = 11

<index> For the scalar variant: is the element index,
RESERVED when size = 00
H:L:M when size = 01
H:L when size = 10
RESERVED when size = 11

<index> For the vector variant: is the element index
RESERVED when size = 00
H:L:M when size = 01
H:L when size = 10
RESERVED when size = 11

Operation for all classes

```

CheckFPAdvSIMDEnabled64();
bits(datasize) operand1 = Vpart[n, part];
bits(idxsized) operand2 = V[m];
bits(2*datasize) operand3 = V[d];
bits(2*datasize) result;
integer element1;
integer element2;
bits(2*esize) product;
integer accum;
boolean sat1;
boolean sat2;

element2 = SInt(Elem[operand2, index, esize]);
for e = 0 to elements-1
    element1 = SInt(Elem[operand1, e, esize]);
    (product, sat1) = SignedSatQ(2 * element1 * element2, 2*esize);
    if sub_op then
        accum = SInt(Elem[operand3, e, 2*esize]) - SInt(product);
    else
        accum = SInt(Elem[operand3, e, 2*esize]) + SInt(product);
    (Elem[result, e, 2*esize], sat2) = SignedSatQ(accum, 2*esize);
    if sat1 || sat2 then FPSR.QC = '1';

V[d] = result;
    
```

C6.3.243 SQDMLAL, SQDMLAL2 (vector)

Signed saturating doubling multiply-add long

It has encodings from 2 classes: *Scalar* and *Vector*

Scalar

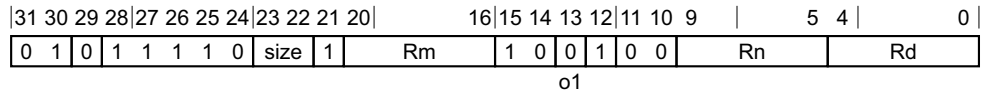

Scalar variant

SQDMLAL <Va><d>, <Vb><n>, <Vb><m>

```
integer d = UInt(Rd);
integer n = UInt(Rn);
integer m = UInt(Rm);

if size == '00' || size == '11' then ReservedValue();
integer esize = 8 << UInt(size);
integer datasize = esize;
integer elements = 1;
integer part = 0;

boolean sub_op = (o1 == '1');
```

Vector

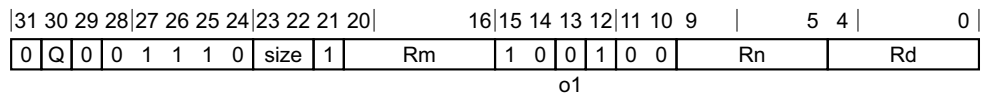

Vector variant

SQDMLAL{2} <Vd>.<Ta>, <Vn>.<Tb>, <Vm>.<Tb>

```
integer d = UInt(Rd);
integer n = UInt(Rn);
integer m = UInt(Rm);

if size == '00' || size == '11' then ReservedValue();
integer esize = 8 << UInt(size);
integer datasize = 64;
integer part = UInt(Q);
integer elements = datasize DIV esize;

boolean sub_op = (o1 == '1');
```

Assembler Symbols

- 2 Is the second and upper half specifier. If present it causes the operation to be performed on the upper 64 bits of the registers holding the narrower elements, and is
- [absent]** when Q = 0
 - [present]** when Q = 1
- <Vd> Is the name of the SIMD&FP destination register, encoded in the "Rd" field.
- <Ta> Is an arrangement specifier,
- RESERVED** when size = 00

- 4S** when size = 01
2D when size = 10
RESERVED when size = 11
- <Vn> Is the name of the first SIMD&FP source register, encoded in the "Rn" field.
- <Tb> Is an arrangement specifier,
RESERVED when size = 00, Q = x
4H when size = 01, Q = 0
8H when size = 01, Q = 1
2S when size = 10, Q = 0
4S when size = 10, Q = 1
RESERVED when size = 11, Q = x
- <Vm> Is the name of the second SIMD&FP source register, encoded in the "Rm" field.
- <Va> Is the destination width specifier,
RESERVED when size = 00
S when size = 01
D when size = 10
RESERVED when size = 11
- <d> Is the number of the SIMD&FP destination register, encoded in the "Rd" field.
- <Vb> Is the source width specifier,
RESERVED when size = 00
H when size = 01
S when size = 10
RESERVED when size = 11
- <n> Is the number of the first SIMD&FP source register, encoded in the "Rn" field.
- <m> Is the number of the second SIMD&FP source register, encoded in the "Rm" field.

Operation for all classes

```

CheckFPAdvSIMDEnabled64();
bits(datasize) operand1 = Vpart[n, part];
bits(datasize) operand2 = Vpart[m, part];
bits(2*datasize) operand3 = V[d];
bits(2*datasize) result;
integer element1;
integer element2;
bits(2*esize) product;
integer accum;
boolean sat1;
boolean sat2;

for e = 0 to elements-1
  element1 = SInt(Elem[operand1, e, esize]);
  element2 = SInt(Elem[operand2, e, esize]);
  (product, sat1) = SignedSatQ(2 * element1 * element2, 2*esize);
  if sub_op then
    accum = SInt(Elem[operand3, e, 2*esize]) - SInt(product);
  else
    accum = SInt(Elem[operand3, e, 2*esize]) + SInt(product);
  (Elem[result, e, 2*esize], sat2) = SignedSatQ(accum, 2*esize);

```

```
if sat1 || sat2 then FPSR.QC = '1';  
V[d] = result;
```

C6.3.244 SQDMLSL, SQDMLSL2 (by element)

Signed saturating doubling multiply-subtract long (by element)

It has encodings from 2 classes: *Scalar* and *Vector*

Scalar

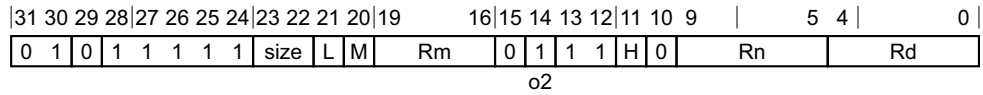

Scalar variant

SQDMLSL <Va><d>, <Vb><n>, <Vm>.<Ts>[<index>]

```

integer idxdsize = if H == '1' then 128 else 64;
integer index;
bit Rmhi;
case size of
    when '01' index = UInt(H:L:M); Rmhi = '0';
    when '10' index = UInt(H:L); Rmhi = M;
    otherwise UnallocatedEncoding();

integer d = UInt(Rd);
integer n = UInt(Rn);
integer m = UInt(Rmhi:Rm);

integer esize = 8 << UInt(size);
integer datasize = esize;
integer elements = 1;
integer part = 0;

boolean sub_op = (o2 == '1');
```

Vector

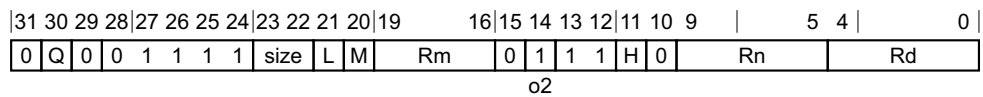

Vector variant

SQDMLSL{2} <Vd>.<Ta>, <Vn>.<Tb>, <Vm>.<Ts>[<index>]

```

integer idxdsize = if H == '1' then 128 else 64;
integer index;
bit Rmhi;
case size of
    when '01' index = UInt(H:L:M); Rmhi = '0';
    when '10' index = UInt(H:L); Rmhi = M;
    otherwise UnallocatedEncoding();

integer d = UInt(Rd);
integer n = UInt(Rn);
integer m = UInt(Rmhi:Rm);

integer esize = 8 << UInt(size);
integer datasize = 64;
integer part = UInt(Q);
integer elements = datasize DIV esize;

boolean sub_op = (o2 == '1');
```

Assembler Symbols

- 2 Is the second and upper half specifier. If present it causes the operation to be performed on the upper 64 bits of the registers holding the narrower elements, and is
[absent] when Q = 0
[present] when Q = 1
- <Vd> Is the name of the SIMD&FP destination register, encoded in the "Rd" field.
- <Ta> Is an arrangement specifier,
RESERVED when size = 00
4S when size = 01
2D when size = 10
RESERVED when size = 11
- <Vn> Is the name of the first SIMD&FP source register, encoded in the "Rn" field.
- <Tb> Is an arrangement specifier,
RESERVED when size = 00, Q = x
4H when size = 01, Q = 0
8H when size = 01, Q = 1
2S when size = 10, Q = 0
4S when size = 10, Q = 1
RESERVED when size = 11, Q = x
- <Va> Is the destination width specifier,
RESERVED when size = 00
S when size = 01
D when size = 10
RESERVED when size = 11
- <d> Is the number of the SIMD&FP destination register, encoded in the "Rd" field.
- <Vb> Is the source width specifier,
RESERVED when size = 00
H when size = 01
S when size = 10
RESERVED when size = 11
- <n> Is the number of the first SIMD&FP source register, encoded in the "Rn" field.
- <Vm> Is the name of the second SIMD&FP source register,
RESERVED when size = 00
0:Rm when size = 01
M:Rm when size = 10
RESERVED when size = 11
 Restricted to V0-V15 when element size <Ts> is H.
- <Ts> For the scalar variant: is the element width specifier,
RESERVED when size = 00
H when size = 01
S when size = 10

RESERVED when size = 11

<Ts> For the vector variant: is an element size specifier,
RESERVED when size = 00
H when size = 01
S when size = 10
RESERVED when size = 11

<index> For the scalar variant: is the element index,
RESERVED when size = 00
H:L:M when size = 01
H:L when size = 10
RESERVED when size = 11

<index> For the vector variant: is the element index
RESERVED when size = 00
H:L:M when size = 01
H:L when size = 10
RESERVED when size = 11

Operation for all classes

```

CheckFPAdvSIMDEnabled64();
bits(datasize) operand1 = Vpart[n, part];
bits(idxsized) operand2 = V[m];
bits(2*datasize) operand3 = V[d];
bits(2*datasize) result;
integer element1;
integer element2;
bits(2*esize) product;
integer accum;
boolean sat1;
boolean sat2;

element2 = SInt(Elem[operand2, index, esize]);
for e = 0 to elements-1
  element1 = SInt(Elem[operand1, e, esize]);
  (product, sat1) = SignedSatQ(2 * element1 * element2, 2*esize);
  if sub_op then
    accum = SInt(Elem[operand3, e, 2*esize]) - SInt(product);
  else
    accum = SInt(Elem[operand3, e, 2*esize]) + SInt(product);
  (Elem[result, e, 2*esize], sat2) = SignedSatQ(accum, 2*esize);
  if sat1 || sat2 then FPSR.QC = '1';

V[d] = result;

```

C6.3.245 SQDMLSL, SQDMLSL2 (vector)

Signed saturating doubling multiply-subtract long

It has encodings from 2 classes: *Scalar* and *Vector*

Scalar

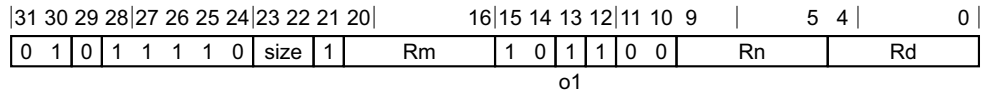

Scalar variant

SQDMLSL <Va><d>, <Vb><n>, <Vb><m>

```
integer d = UInt(Rd);
integer n = UInt(Rn);
integer m = UInt(Rm);
```

```
if size == '00' || size == '11' then ReservedValue();
integer esize = 8 << UInt(size);
integer datasize = esize;
integer elements = 1;
integer part = 0;
```

```
boolean sub_op = (o1 == '1');
```

Vector

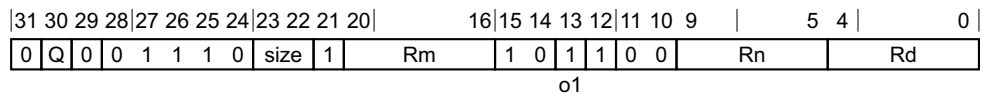

Vector variant

SQDMLSL{2} <Vd>.<Ta>, <Vn>.<Tb>, <Vm>.<Tb>

```
integer d = UInt(Rd);
integer n = UInt(Rn);
integer m = UInt(Rm);
```

```
if size == '00' || size == '11' then ReservedValue();
integer esize = 8 << UInt(size);
integer datasize = 64;
integer part = UInt(Q);
integer elements = datasize DIV esize;
```

```
boolean sub_op = (o1 == '1');
```

Assembler Symbols

- 2 Is the second and upper half specifier. If present it causes the operation to be performed on the upper 64 bits of the registers holding the narrower elements, and is
 - [absent]** when Q = 0
 - [present]** when Q = 1
- <Vd> Is the name of the SIMD&FP destination register, encoded in the "Rd" field.
- <Ta> Is an arrangement specifier,
 - RESERVED** when size = 00

- 4S** when size = 01
2D when size = 10
RESERVED when size = 11
- <Vn> Is the name of the first SIMD&FP source register, encoded in the "Rn" field.
- <Tb> Is an arrangement specifier,
RESERVED when size = 00, Q = x
4H when size = 01, Q = 0
8H when size = 01, Q = 1
2S when size = 10, Q = 0
4S when size = 10, Q = 1
RESERVED when size = 11, Q = x
- <Vm> Is the name of the second SIMD&FP source register, encoded in the "Rm" field.
- <Va> Is the destination width specifier,
RESERVED when size = 00
S when size = 01
D when size = 10
RESERVED when size = 11
- <d> Is the number of the SIMD&FP destination register, encoded in the "Rd" field.
- <Vb> Is the source width specifier,
RESERVED when size = 00
H when size = 01
S when size = 10
RESERVED when size = 11
- <n> Is the number of the first SIMD&FP source register, encoded in the "Rn" field.
- <m> Is the number of the second SIMD&FP source register, encoded in the "Rm" field.

Operation for all classes

```

CheckFPAdvSIMDEnabled64();
bits(datasize) operand1 = Vpart[n, part];
bits(datasize) operand2 = Vpart[m, part];
bits(2*datasize) operand3 = V[d];
bits(2*datasize) result;
integer element1;
integer element2;
bits(2*esize) product;
integer accum;
boolean sat1;
boolean sat2;

for e = 0 to elements-1
  element1 = SInt(Elem[operand1, e, esize]);
  element2 = SInt(Elem[operand2, e, esize]);
  (product, sat1) = SignedSatQ(2 * element1 * element2, 2*esize);
  if sub_op then
    accum = SInt(Elem[operand3, e, 2*esize]) - SInt(product);
  else
    accum = SInt(Elem[operand3, e, 2*esize]) + SInt(product);
  (Elem[result, e, 2*esize], sat2) = SignedSatQ(accum, 2*esize);

```

```
if sat1 || sat2 then FPSR.QC = '1';  
V[d] = result;
```

C6.3.246 SQDMULH (by element)

Signed saturating doubling multiply returning high half (by element)

It has encodings from 2 classes: *Scalar* and *Vector*

Scalar

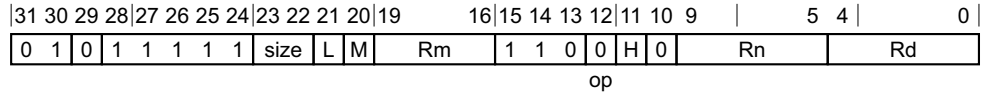

Scalar variant

SQDMULH <V><d>, <V><n>, <Vm>.<Ts>[<index>]

```
integer idxdsize = if H == '1' then 128 else 64;
integer index;
bit Rmhi;
case size of
    when '01' index = UInt(H:L:M); Rmhi = '0';
    when '10' index = UInt(H:L); Rmhi = M;
    otherwise UnallocatedEncoding();
```

```
integer d = UInt(Rd);
integer n = UInt(Rn);
integer m = UInt(Rmhi:Rm);
```

```
integer esize = 8 << UInt(size);
integer datasize = esize;
integer elements = 1;
```

```
boolean round = (op == '1');
```

Vector

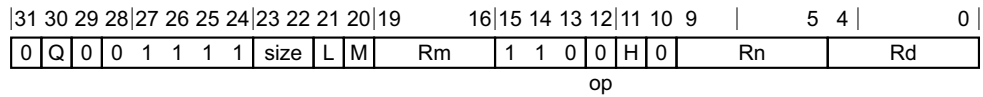

Vector variant

SQDMULH <Vd>.<T>, <Vn>.<T>, <Vm>.<Ts>[<index>]

```
integer idxdsize = if H == '1' then 128 else 64;
integer index;
bit Rmhi;
case size of
    when '01' index = UInt(H:L:M); Rmhi = '0';
    when '10' index = UInt(H:L); Rmhi = M;
    otherwise UnallocatedEncoding();
```

```
integer d = UInt(Rd);
integer n = UInt(Rn);
integer m = UInt(Rmhi:Rm);
```

```
integer esize = 8 << UInt(size);
integer datasize = if Q == '1' then 128 else 64;
integer elements = datasize DIV esize;
```

```
boolean round = (op == '1');
```

Assembler Symbols

<V>	Is a width specifier, RESERVED when size = 00 H when size = 01 S when size = 10 RESERVED when size = 11
<d>	Is the number of the SIMD&FP destination register, encoded in the "Rd" field.
<n>	Is the number of the first SIMD&FP source register, encoded in the "Rn" field.
<Vd>	Is the name of the SIMD&FP destination register, encoded in the "Rd" field.
<T>	Is an arrangement specifier, RESERVED when size = 00, Q = x 4H when size = 01, Q = 0 8H when size = 01, Q = 1 2S when size = 10, Q = 0 4S when size = 10, Q = 1 RESERVED when size = 11, Q = x
<Vn>	Is the name of the first SIMD&FP source register, encoded in the "Rn" field.
<Vm>	Is the name of the second SIMD&FP source register, RESERVED when size = 00 0:Rm when size = 01 M:Rm when size = 10 RESERVED when size = 11 Restricted to V0-V15 when element size <Ts> is H.
<Ts>	For the scalar variant: is the element width specifier, RESERVED when size = 00 H when size = 01 S when size = 10 RESERVED when size = 11
<Ts>	For the vector variant: is an element size specifier, RESERVED when size = 00 H when size = 01 S when size = 10 RESERVED when size = 11
<iindex>	For the scalar variant: is the element index, RESERVED when size = 00 H:L:M when size = 01 H:L when size = 10 RESERVED when size = 11
<iindex>	For the vector variant: is the element index RESERVED when size = 00 H:L:M when size = 01

H:L when size = 10
RESERVED when size = 11

Operation for all classes

```
CheckFPAdvSIMDEnabled64();
bits(datasize) operand1 = V[n];
bits(idxsizesize) operand2 = V[m];
bits(datasize) result;
integer round_const = if round then 1 << (esize - 1) else 0;
integer element1;
integer element2;
integer product;
boolean sat;

element2 = SInt(Elem[operand2, index, esize]);
for e = 0 to elements-1
    element1 = SInt(Elem[operand1, e, esize]);
    product = (2 * element1 * element2) + round_const;
    // The following only saturates if element1 and element2 equal -(2^(esize-1))
    (Elem[result, e, esize], sat) = SignedSatQ(product >> esize, esize);
    if sat then FPSR.QC = '1';

V[d] = result;
```

C6.3.247 SQDMULH (vector)

Signed saturating doubling multiply returning high half

It has encodings from 2 classes: *Scalar* and *Vector*

Scalar

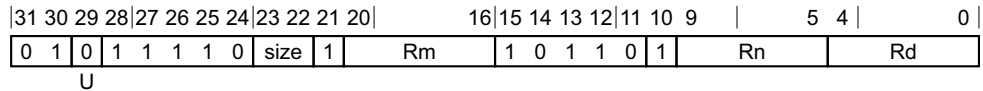

Scalar variant

SQDMULH <V><d>, <V><n>, <V><m>

```
integer d = UInt(Rd);
integer n = UInt(Rn);
integer m = UInt(Rm);
if size == '11' || size == '00' then ReservedValue();
integer esize = 8 << UInt(size);
integer datasize = esize;
integer elements = 1;
boolean rounding = (U == '1');
```

Vector

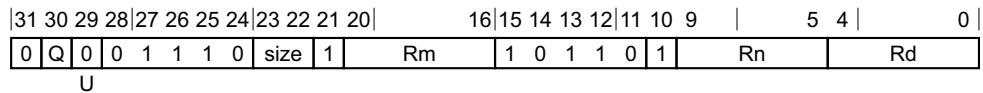

Vector variant

SQDMULH <Vd>.<T>, <Vn>.<T>, <Vm>.<T>

```
integer d = UInt(Rd);
integer n = UInt(Rn);
integer m = UInt(Rm);
if size == '11' || size == '00' then ReservedValue();
integer esize = 8 << UInt(size);
integer datasize = if Q == '1' then 128 else 64;
integer elements = datasize DIV esize;
boolean rounding = (U == '1');
```

Assembler Symbols

- <V> Is a width specifier,
RESERVED when size = 00
H when size = 01
S when size = 10
RESERVED when size = 11
- <d> Is the number of the SIMD&FP destination register, in the "Rd" field.
- <n> Is the number of the first SIMD&FP source register, encoded in the "Rn" field.
- <m> Is the number of the second SIMD&FP source register, encoded in the "Rm" field.
- <Vd> Is the name of the SIMD&FP destination register, encoded in the "Rd" field.

- <T> Is an arrangement specifier,
RESERVED when size = 00, Q = x
4H when size = 01, Q = 0
8H when size = 01, Q = 1
2S when size = 10, Q = 0
4S when size = 10, Q = 1
RESERVED when size = 11, Q = x
- <Vn> Is the name of the first SIMD&FP source register, encoded in the "Rn" field.
- <Vm> Is the name of the second SIMD&FP source register, encoded in the "Rm" field.

Operation for all classes

```
CheckFPAdvSIMDEnabled64();
bits(datasize) operand1 = V[n];
bits(datasize) operand2 = V[m];
bits(datasize) result;
integer round_const = if rounding then 1 << (esize - 1) else 0;
integer element1;
integer element2;
integer product;
boolean sat;

for e = 0 to elements-1
    element1 = SInt(Elm[operand1, e, esize]);
    element2 = SInt(Elm[operand2, e, esize]);
    product = (2 * element1 * element2) + round_const;
    (Elm[result, e, esize], sat) = SignedSatQ(product >> esize, esize);
    if sat then FPSR.QC = '1';

V[d] = result;
```

C6.3.248 SQDMULL, SQDMULL2 (by element)

Signed saturating doubling multiply long (by element)

It has encodings from 2 classes: *Scalar* and *Vector*

Scalar

31	30	29	28	27	26	25	24	23	22	21	20	19	16	15	14	13	12	11	10	9	5	4	0
0	1	0	1	1	1	1	1	size	L	M	Rm	1	0	1	1	H	0	Rn	Rd				

Scalar variant

SQDMULL <Va><d>, <Vb><n>, <Vm>.<Ts>[<index>]

```
integer idxsize = if H == '1' then 128 else 64;
integer index;
bit Rmhi;
case size of
    when '01' index = UInt(H:L:M); Rmhi = '0';
    when '10' index = UInt(H:L); Rmhi = M;
    otherwise UnallocatedEncoding();

integer d = UInt(Rd);
integer n = UInt(Rn);
integer m = UInt(Rmhi:Rm);

integer esize = 8 << UInt(size);
integer datasize = esize;
integer elements = 1;
integer part = 0;
```

Vector

31	30	29	28	27	26	25	24	23	22	21	20	19	16	15	14	13	12	11	10	9	5	4	0
0	Q	0	0	1	1	1	1	size	L	M	Rm	1	0	1	1	H	0	Rn	Rd				

Vector variant

SQDMULL{2} <Vd>.<Ta>, <Vn>.<Tb>, <Vm>.<Ts>[<index>]

```
integer idxsize = if H == '1' then 128 else 64;
integer index;
bit Rmhi;
case size of
    when '01' index = UInt(H:L:M); Rmhi = '0';
    when '10' index = UInt(H:L); Rmhi = M;
    otherwise UnallocatedEncoding();

integer d = UInt(Rd);
integer n = UInt(Rn);
integer m = UInt(Rmhi:Rm);

integer esize = 8 << UInt(size);
integer datasize = 64;
integer part = UInt(Q);
integer elements = datasize DIV esize;
```

Assembler Symbols

2	Is the second and upper half specifier. If present it causes the operation to be performed on the upper 64 bits of the registers holding the narrower elements, and is [absent] when Q = 0 [present] when Q = 1
<Vd>	Is the name of the SIMD&FP destination register, encoded in the "Rd" field.
<Ta>	Is an arrangement specifier, RESERVED when size = 00 4S when size = 01 2D when size = 10 RESERVED when size = 11
<Vn>	Is the name of the first SIMD&FP source register, encoded in the "Rn" field.
<Tb>	Is an arrangement specifier, RESERVED when size = 00, Q = x 4H when size = 01, Q = 0 8H when size = 01, Q = 1 2S when size = 10, Q = 0 4S when size = 10, Q = 1 RESERVED when size = 11, Q = x
<Va>	Is the destination width specifier, RESERVED when size = 00 S when size = 01 D when size = 10 RESERVED when size = 11
<d>	Is the number of the SIMD&FP destination register, encoded in the "Rd" field.
<Vb>	Is the source width specifier, RESERVED when size = 00 H when size = 01 S when size = 10 RESERVED when size = 11
<n>	Is the number of the first SIMD&FP source register, encoded in the "Rn" field.
<Vm>	Is the name of the second SIMD&FP source register, RESERVED when size = 00 0:Rm when size = 01 M:Rm when size = 10 RESERVED when size = 11 Restricted to V0-V15 when element size <Ts> is H.
<Ts>	For the scalar variant: is the element width specifier, RESERVED when size = 00 H when size = 01 S when size = 10

RESERVED when size = 11

<Ts> For the vector variant: is an element size specifier,
RESERVED when size = 00
H when size = 01
S when size = 10
RESERVED when size = 11

<index> For the scalar variant: is the element index,
RESERVED when size = 00
H:L:M when size = 01
H:L when size = 10
RESERVED when size = 11

<index> For the vector variant: is the element index
RESERVED when size = 00
H:L:M when size = 01
H:L when size = 10
RESERVED when size = 11

Operation for all classes

```

CheckFPAdvSIMDEnabled64();

bits(datasize) operand1 = Vpart[n, part];
bits(idxsize) operand2 = V[m];
bits(2*datasize) result;
integer element1;
integer element2;
bits(2*esize) product;
boolean sat;

element2 = SInt(Elem[operand2, index, esize]);
for e = 0 to elements-1
  element1 = SInt(Elem[operand1, e, esize]);
  (product, sat) = SignedSatQ(2 * element1 * element2, 2*esize);
  Elem[result, e, 2*esize] = product;
  if sat then FPSR.QC = '1';

V[d] = result;
  
```

C6.3.249 SQDMULL, SQDMULL2 (vector)

Signed saturating doubling multiply long

It has encodings from 2 classes: *Scalar* and *Vector*

Scalar

31	30	29	28	27	26	25	24	23	22	21	20	16	15	14	13	12	11	10	9	5	4	0
0	1	0	1	1	1	1	0	size	1	Rm	1	1	0	1	0	0	Rn	Rd				

Scalar variant

SQDMULL <Va><d>, <Vb><n>, <Vb><m>

```
integer d = UInt(Rd);
integer n = UInt(Rn);
integer m = UInt(Rm);
```

```
if size == '00' || size == '11' then ReservedValue();
integer esize = 8 << UInt(size);
integer datasize = esize;
integer elements = 1;
integer part = 0;
```

Vector

31	30	29	28	27	26	25	24	23	22	21	20	16	15	14	13	12	11	10	9	5	4	0
0	Q	0	0	1	1	1	0	size	1	Rm	1	1	0	1	0	0	Rn	Rd				

Vector variant

SQDMULL{2} <Vd>.<Ta>, <Vn>.<Tb>, <Vm>.<Tb>

```
integer d = UInt(Rd);
integer n = UInt(Rn);
integer m = UInt(Rm);
```

```
if size == '00' || size == '11' then ReservedValue();
integer esize = 8 << UInt(size);
integer datasize = 64;
integer part = UInt(Q);
integer elements = datasize DIV esize;
```

Assembler Symbols

2 Is the second and upper half specifier. If present it causes the operation to be performed on the upper 64 bits of the registers holding the narrower elements, and is

[absent] when Q = 0

[present] when Q = 1

<Vd> Is the name of the SIMD&FP destination register, encoded in the "Rd" field.

<Ta> Is an arrangement specifier,
RESERVED when size = 00

4S when size = 01

2D when size = 10

- RESERVED** when size = 11
- <Vn> Is the name of the first SIMD&FP source register, encoded in the "Rn" field.
- <Tb> Is an arrangement specifier,
RESERVED when size = 00, Q = x
4H when size = 01, Q = 0
8H when size = 01, Q = 1
2S when size = 10, Q = 0
4S when size = 10, Q = 1
RESERVED when size = 11, Q = x
- <Vm> Is the name of the second SIMD&FP source register, encoded in the "Rm" field.
- <Va> Is the destination width specifier,
RESERVED when size = 00
S when size = 01
D when size = 10
RESERVED when size = 11
- <d> Is the number of the SIMD&FP destination register, encoded in the "Rd" field.
- <Vb> Is the source width specifier,
RESERVED when size = 00
H when size = 01
S when size = 10
RESERVED when size = 11
- <n> Is the number of the first SIMD&FP source register, encoded in the "Rn" field.
- <m> Is the number of the second SIMD&FP source register, encoded in the "Rm" field.

Operation for all classes

```

CheckFPAdvSIMDEnabled64();
bits(datasize) operand1 = Vpart[n, part];
bits(datasize) operand2 = Vpart[m, part];
bits(2*datasize) result;
integer element1;
integer element2;
bits(2*esize) product;
boolean sat;

for e = 0 to elements-1
  element1 = SInt(Elm[operand1, e, esize]);
  element2 = SInt(Elm[operand2, e, esize]);
  (product, sat) = SignedSatQ(2 * element1 * element2, 2*esize);
  Elm[result, e, 2*esize] = product;
  if sat then FPSR.QC = '1';

V[d] = result;
  
```

C6.3.250 SQNEG

Signed saturating negate

It has encodings from 2 classes: *Scalar* and *Vector*

Scalar

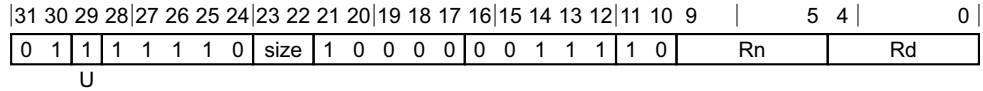

Scalar variant

SQNEG <V><d>, <V><n>

```
integer d = UInt(Rd);
integer n = UInt(Rn);
```

```
integer esize = 8 << UInt(size);
integer datasize = esize;
integer elements = 1;
```

```
boolean neg = (U == '1');
```

Vector

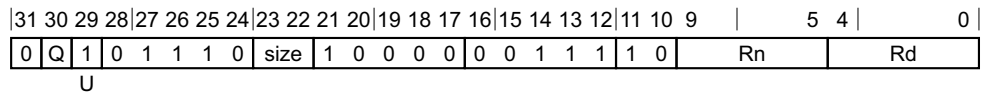

Vector variant

SQNEG <Vd>.<T>, <Vn>.<T>

```
integer d = UInt(Rd);
integer n = UInt(Rn);
```

```
if size:Q == '110' then ReservedValue();
integer esize = 8 << UInt(size);
integer datasize = if Q == '1' then 128 else 64;
integer elements = datasize DIV esize;
```

```
boolean neg = (U == '1');
```

Assembler Symbols

<V> Is a width specifier,

B when size = 00

H when size = 01

S when size = 10

D when size = 11

<d> Is the number of the SIMD&FP destination register, encoded in the "Rd" field.

<n> Is the number of the SIMD&FP source register, encoded in the "Rn" field.

<Vd> Is the name of the SIMD&FP destination register, encoded in the "Rd" field.

<T> Is an arrangement specifier,

8B	when size = 00, Q = 0
16B	when size = 00, Q = 1
4H	when size = 01, Q = 0
8H	when size = 01, Q = 1
2S	when size = 10, Q = 0
4S	when size = 10, Q = 1
RESERVED	when size = 11, Q = 0
2D	when size = 11, Q = 1

<Vn> Is the name of the SIMD&FP source register, encoded in the "Rn" field.

Operation for all classes

```
CheckFPAdvSIMDEnabled64();
bits(datasize) operand = V[n];
bits(datasize) result;
integer element;
boolean sat;

for e = 0 to elements-1
    element = SInt(Elem[operand, e, esize]);
    if neg then
        element = -element;
    else
        element = Abs(element);
    (Elem[result, e, esize], sat) = SignedSatQ(element, esize);
    if sat then FPSR.QC = '1';

V[d] = result;
```

C6.3.251 SQRDMULH (by element)

Signed saturating rounding doubling multiply returning high half (by element)

It has encodings from 2 classes: *Scalar* and *Vector*

Scalar

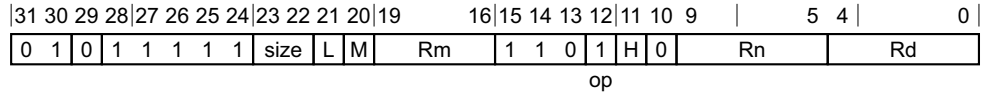

Scalar variant

SQRDMULH <V><d>, <V><n>, <Vm>.<Ts>[<index>]

```

integer idxdsize = if H == '1' then 128 else 64;
integer index;
bit Rmhi;
case size of
    when '01' index = UInt(H:L:M); Rmhi = '0';
    when '10' index = UInt(H:L); Rmhi = M;
    otherwise UnallocatedEncoding();

integer d = UInt(Rd);
integer n = UInt(Rn);
integer m = UInt(Rmhi:Rm);

integer esize = 8 << UInt(size);
integer datasize = esize;
integer elements = 1;

boolean round = (op == '1');
```

Vector

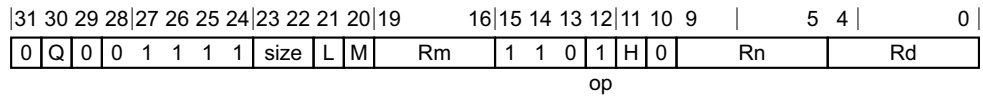

Vector variant

SQRDMULH <Vd>.<T>, <Vn>.<T>, <Vm>.<Ts>[<index>]

```

integer idxdsize = if H == '1' then 128 else 64;
integer index;
bit Rmhi;
case size of
    when '01' index = UInt(H:L:M); Rmhi = '0';
    when '10' index = UInt(H:L); Rmhi = M;
    otherwise UnallocatedEncoding();

integer d = UInt(Rd);
integer n = UInt(Rn);
integer m = UInt(Rmhi:Rm);

integer esize = 8 << UInt(size);
integer datasize = if Q == '1' then 128 else 64;
integer elements = datasize DIV esize;

boolean round = (op == '1');
```

Assembler Symbols

<V>	Is a width specifier, RESERVED when size = 00 H when size = 01 S when size = 10 RESERVED when size = 11
<d>	Is the number of the SIMD&FP destination register, encoded in the "Rd" field.
<n>	Is the number of the first SIMD&FP source register, encoded in the "Rn" field.
<Vd>	Is the name of the SIMD&FP destination register, encoded in the "Rd" field.
<T>	Is an arrangement specifier, RESERVED when size = 00, Q = x 4H when size = 01, Q = 0 8H when size = 01, Q = 1 2S when size = 10, Q = 0 4S when size = 10, Q = 1 RESERVED when size = 11, Q = x
<Vn>	Is the name of the first SIMD&FP source register, encoded in the "Rn" field.
<Vm>	Is the name of the second SIMD&FP source register, RESERVED when size = 00 0:Rm when size = 01 M:Rm when size = 10 RESERVED when size = 11 Restricted to V0-V15 when element size <Ts> is H.
<Ts>	For the scalar variant: is the element width specifier, RESERVED when size = 00 H when size = 01 S when size = 10 RESERVED when size = 11
<Ts>	For the vector variant: is an element size specifier, RESERVED when size = 00 H when size = 01 S when size = 10 RESERVED when size = 11
<iindex>	For the scalar variant: is the element index, RESERVED when size = 00 H:L:M when size = 01 H:L when size = 10 RESERVED when size = 11
<iindex>	For the vector variant: is the element index RESERVED when size = 00 H:L:M when size = 01

H:L when size = 10
RESERVED when size = 11

Operation for all classes

```
CheckFPAdvSIMDEnabled64();
bits(datasize) operand1 = V[n];
bits(idxsizesize) operand2 = V[m];
bits(datasize) result;
integer round_const = if round then 1 << (esize - 1) else 0;
integer element1;
integer element2;
integer product;
boolean sat;

element2 = SInt(Elem[operand2, index, esize]);
for e = 0 to elements-1
    element1 = SInt(Elem[operand1, e, esize]);
    product = (2 * element1 * element2) + round_const;
    // The following only saturates if element1 and element2 equal -(2^(esize-1))
    (Elem[result, e, esize], sat) = SignedSatQ(product >> esize, esize);
    if sat then FPSR.QC = '1';

V[d] = result;
```

C6.3.252 SQRDMULH (vector)

Signed saturating rounding doubling multiply returning high half

It has encodings from 2 classes: *Scalar* and *Vector*

Scalar

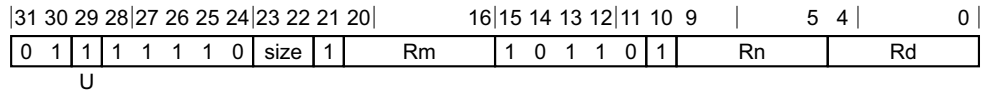

Scalar variant

SQRDMULH <V><d>, <V><n>, <V><m>

```
integer d = UInt(Rd);
integer n = UInt(Rn);
integer m = UInt(Rm);
if size == '11' || size == '00' then ReservedValue();
integer esize = 8 << UInt(size);
integer datasize = esize;
integer elements = 1;
boolean rounding = (U == '1');
```

Vector

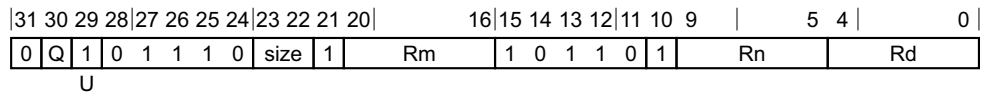

Vector variant

SQRDMULH <Vd>.<T>, <Vn>.<T>, <Vm>.<T>

```
integer d = UInt(Rd);
integer n = UInt(Rn);
integer m = UInt(Rm);
if size == '11' || size == '00' then ReservedValue();
integer esize = 8 << UInt(size);
integer datasize = if Q == '1' then 128 else 64;
integer elements = datasize DIV esize;
boolean rounding = (U == '1');
```

Assembler Symbols

- <V> Is a width specifier,
RESERVED when size = 00
H when size = 01
S when size = 10
RESERVED when size = 11
- <d> Is the number of the SIMD&FP destination register, in the "Rd" field.
- <n> Is the number of the first SIMD&FP source register, encoded in the "Rn" field.
- <m> Is the number of the second SIMD&FP source register, encoded in the "Rm" field.
- <Vd> Is the name of the SIMD&FP destination register, encoded in the "Rd" field.

- <T> Is an arrangement specifier,
RESERVED when size = 00, Q = x
4H when size = 01, Q = 0
8H when size = 01, Q = 1
2S when size = 10, Q = 0
4S when size = 10, Q = 1
RESERVED when size = 11, Q = x
- <Vn> Is the name of the first SIMD&FP source register, encoded in the "Rn" field.
- <Vm> Is the name of the second SIMD&FP source register, encoded in the "Rm" field.

Operation for all classes

```
CheckFPAdvSIMDEnabled64();
bits(datasize) operand1 = V[n];
bits(datasize) operand2 = V[m];
bits(datasize) result;
integer round_const = if rounding then 1 << (esize - 1) else 0;
integer element1;
integer element2;
integer product;
boolean sat;

for e = 0 to elements-1
    element1 = SInt(Elem[operand1, e, esize]);
    element2 = SInt(Elem[operand2, e, esize]);
    product = (2 * element1 * element2) + round_const;
    (Elem[result, e, esize], sat) = SignedSatQ(product >> esize, esize);
    if sat then FPSR.QC = '1';

V[d] = result;
```

C6.3.253 SQRSHL

Signed saturating rounding shift left (register)

It has encodings from 2 classes: *Scalar* and *Vector*

Scalar

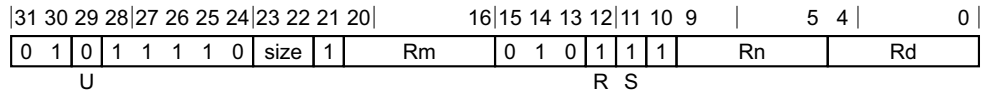

Scalar variant

SQRSHL <V><d>, <V><n>, <V><m>

```
integer d = UInt(Rd);
integer n = UInt(Rn);
integer m = UInt(Rm);
integer esize = 8 << UInt(size);
integer datasize = esize;
integer elements = 1;
boolean unsigned = (U == '1');
boolean rounding = (R == '1');
boolean saturating = (S == '1');
if S == '0' && size != '11' then ReservedValue();
```

Vector

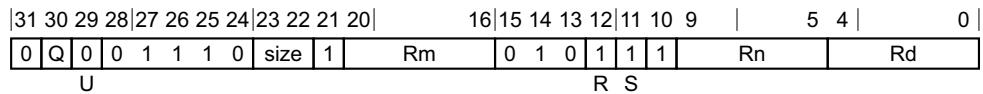

Vector variant

SQRSHL <Vd>.<T>, <Vn>.<T>, <Vm>.<T>

```
integer d = UInt(Rd);
integer n = UInt(Rn);
integer m = UInt(Rm);
if size:Q == '110' then ReservedValue();
integer esize = 8 << UInt(size);
integer datasize = if Q == '1' then 128 else 64;
integer elements = datasize DIV esize;
boolean unsigned = (U == '1');
boolean rounding = (R == '1');
boolean saturating = (S == '1');
```

Assembler Symbols

- <V> Is a width specifier,
- B** when size = 00
 - H** when size = 01
 - S** when size = 10
 - D** when size = 11
- <d> Is the number of the SIMD&FP destination register, in the "Rd" field.
- <n> Is the number of the first SIMD&FP source register, encoded in the "Rn" field.
- <m> Is the number of the second SIMD&FP source register, encoded in the "Rm" field.

- <Vd> Is the name of the SIMD&FP destination register, encoded in the "Rd" field.
- <T> Is an arrangement specifier,
8B when size = 00, Q = 0
16B when size = 00, Q = 1
4H when size = 01, Q = 0
8H when size = 01, Q = 1
2S when size = 10, Q = 0
4S when size = 10, Q = 1
RESERVED when size = 11, Q = 0
2D when size = 11, Q = 1
- <Vn> Is the name of the first SIMD&FP source register, encoded in the "Rn" field.
- <Vm> Is the name of the second SIMD&FP source register, encoded in the "Rm" field.

Operation for all classes

```
CheckFPAdvSIMDEnabled64();
bits(datasize) operand1 = V[n];
bits(datasize) operand2 = V[m];
bits(datasize) result;

integer round_const = 0;
integer shift;
integer element;
boolean sat;

for e = 0 to elements-1
    shift = SInt(Elem[operand2, e, esize]<7:0>);
    if rounding then
        round_const = 1 << (-shift - 1); // 0 for left shift, 2^(n-1) for right shift
    element = (Int(Elem[operand1, e, esize], unsigned) + round_const) << shift;
    if saturating then
        (Elem[result, e, esize], sat) = SatQ(element, esize, unsigned);
        if sat then FPSR.QC = '1';
    else
        Elem[result, e, esize] = element<esize-1:0>;

V[d] = result;
```

C6.3.254 SQRSHRN, SQRSHRN2

Signed saturating rounded shift right narrow (immediate)

It has encodings from 2 classes: *Scalar* and *Vector*

Scalar

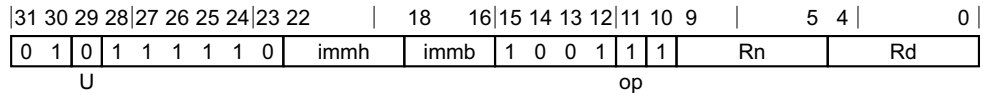

Scalar variant

SQRSHRN <Vb><d>, <Va><n>, #<shift>

```
integer d = UInt(Rd);
integer n = UInt(Rn);

if immh == '0000' then ReservedValue();
if immh<3> == '1' then ReservedValue();
integer esize = 8 << HighestSetBit(immh);
integer datasize = esize;
integer elements = 1;
integer part = 0;

integer shift = (2 * esize) - UInt(immh:immb);
boolean round = (op == '1');
boolean unsigned = (U == '1');
```

Vector

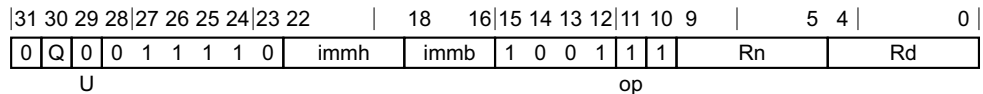

Vector variant

SQRSHRN{2} <Vd>.<Tb>, <Vn>.<Ta>, #<shift>

```
integer d = UInt(Rd);
integer n = UInt(Rn);

if immh == '0000' then AdvSIMD modified immediate;
if immh<3> == '1' then ReservedValue();
integer esize = 8 << HighestSetBit(immh);
integer datasize = 64;
integer part = UInt(Q);
integer elements = datasize DIV esize;

integer shift = (2 * esize) - UInt(immh:immb);
boolean round = (op == '1');
boolean unsigned = (U == '1');
```

Assembler Symbols

- 2 Is the second and upper half specifier. If present it causes the operation to be performed on the upper 64 bits of the registers holding the narrower elements, and is
 - [absent]** when Q = 0
 - [present]** when Q = 1
- <Vd> Is the name of the SIMD&FP destination register, encoded in the "Rd" field.

- <Tb> Is an arrangement specifier,
 See **AdvSIMD modified immediate**, when immh = 0000, Q = x
8B when immh = 0001, Q = 0
16B when immh = 0001, Q = 1
4H when immh = 001x, Q = 0
8H when immh = 001x, Q = 1
2S when immh = 01xx, Q = 0
4S when immh = 01xx, Q = 1
RESERVED when immh = 1xxx, Q = x
- <Vn> Is the name of the SIMD&FP source register, encoded in the "Rn" field.
- <Ta> Is an arrangement specifier,
 See **AdvSIMD modified immediate**, when immh = 0000
8H when immh = 0001
4S when immh = 001x
2D when immh = 01xx
RESERVED when immh = 1xxx
- <Vb> Is the destination width specifier,
RESERVED when immh = 0000
B when immh = 0001
H when immh = 001x
S when immh = 01xx
RESERVED when immh = 1xxx
- <d> Is the number of the SIMD&FP destination register, in the "Rd" field.
- <Va> Is the source width specifier,
RESERVED when immh = 0000
H when immh = 0001
S when immh = 001x
D when immh = 01xx
RESERVED when immh = 1xxx
- <n> Is the number of the first SIMD&FP source register, encoded in the "Rn" field.
- <shift> For the scalar variant: is the shift amount, in the range 1 to element bits,
RESERVED when immh = 0000
(16-UInt(immh:immb)) when immh = 0001
(32-UInt(immh:immb)) when immh = 001x
(64-UInt(immh:immb)) when immh = 01xx
RESERVED when immh = 1xxx
- <shift> For the vector variant: is a shift amount, in the range 1 to element bits,
 See **AdvSIMD modified immediate**, when immh = 0000
(16-UInt(immh:immb)) when immh = 0001
(32-UInt(immh:immb)) when immh = 001x
(64-UInt(immh:immb)) when immh = 01xx
RESERVED when immh = 1xxx

Operation for all classes

```
CheckFPAdvSIMDEnabled64();
bits(datasize*2) operand = V[n];
bits(datasize) result;
integer round_const = if round then (1 << (shift - 1)) else 0;
integer element;
boolean sat;

for e = 0 to elements-1
    element = (Int(Elem[operand, e, 2*esize], unsigned) + round_const) >> shift;
    (Elem[result, e, esize], sat) = SatQ(element, esize, unsigned);
    if sat then FPSR.QC = '1';

Vpart[d, part] = result;
```

C6.3.255 SQRSHRUN, SQRSHRUN2

Signed saturating rounded shift right unsigned narrow (immediate)

It has encodings from 2 classes: *Scalar* and *Vector*

Scalar

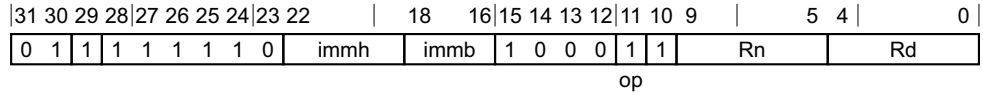

Scalar variant

SQRSHRUN <Vb><d>, <Va><n>, #<shift>

```
integer d = UInt(Rd);
integer n = UInt(Rn);

if immh == '0000' then ReservedValue();
if immh<3> == '1' then ReservedValue();
integer esize = 8 << HighestSetBit(immh);
integer datasize = esize;
integer elements = 1;
integer part = 0;

integer shift = (2 * esize) - UInt(immh:immb);
boolean round = (op == '1');
```

Vector

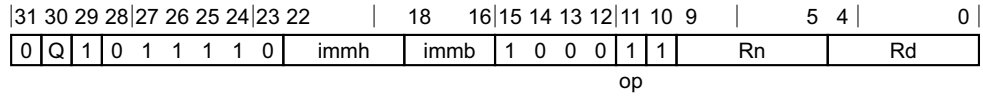

Vector variant

SQRSHRUN{2} <Vd>.<Tb>, <Vn>.<Ta>, #<shift>

```
integer d = UInt(Rd);
integer n = UInt(Rn);

if immh == '0000' then AdvSIMD modified immediate;
if immh<3> == '1' then ReservedValue();
integer esize = 8 << HighestSetBit(immh);
integer datasize = 64;
integer part = UInt(Q);
integer elements = datasize DIV esize;

integer shift = (2 * esize) - UInt(immh:immb);
boolean round = (op == '1');
```

Assembler Symbols

- 2 Is the second and upper half specifier. If present it causes the operation to be performed on the upper 64 bits of the registers holding the narrower elements, and is
 - [absent]** when Q = 0
 - [present]** when Q = 1
- <Vd> Is the name of the SIMD&FP destination register, encoded in the "Rd" field.

- <Tb> Is an arrangement specifier,
See AdvSIMD modified immediate. when immh = 0000, Q = x
8B when immh = 0001, Q = 0
16B when immh = 0001, Q = 1
4H when immh = 001x, Q = 0
8H when immh = 001x, Q = 1
2S when immh = 01xx, Q = 0
4S when immh = 01xx, Q = 1
RESERVED when immh = 1xxx, Q = x
- <Vn> Is the name of the SIMD&FP source register, encoded in the "Rn" field.
- <Ta> Is an arrangement specifier,
See AdvSIMD modified immediate. when immh = 0000
8H when immh = 0001
4S when immh = 001x
2D when immh = 01xx
RESERVED when immh = 1xxx
- <Vb> Is the destination width specifier,
RESERVED when immh = 0000
B when immh = 0001
H when immh = 001x
S when immh = 01xx
RESERVED when immh = 1xxx
- <d> Is the number of the SIMD&FP destination register, in the "Rd" field.
- <Va> Is the source width specifier,
RESERVED when immh = 0000
H when immh = 0001
S when immh = 001x
D when immh = 01xx
RESERVED when immh = 1xxx
- <n> Is the number of the first SIMD&FP source register, encoded in the "Rn" field.
- <shift> For the scalar variant: is the shift amount, in the range 1 to element bits,
RESERVED when immh = 0000
(16-UInt(immh:immb)) when immh = 0001
(32-UInt(immh:immb)) when immh = 001x
(64-UInt(immh:immb)) when immh = 01xx
RESERVED when immh = 1xxx
- <shift> For the vector variant: is a shift amount, in the range 1 to element bits,
See AdvSIMD modified immediate. when immh = 0000
(16-UInt(immh:immb)) when immh = 0001
(32-UInt(immh:immb)) when immh = 001x
(64-UInt(immh:immb)) when immh = 01xx
RESERVED when immh = 1xxx

Operation for all classes

```
CheckFPAdvSIMDEnabled64();
bits(datasize*2) operand = V[n];
bits(datasize) result;
integer round_const = if round then (1 << (shift - 1)) else 0;
integer element;
boolean sat;

for e = 0 to elements-1
    element = (SInt(Elem[operand, e, 2*esize]) + round_const) >> shift;
    (Elem[result, e, esize], sat) = UnsignedSatQ(element, esize);
    if sat then FPSR.QC = '1';

Vpart[d, part] = result;
```

C6.3.256 SQSHL (immediate)

Signed saturating shift left (immediate)

It has encodings from 2 classes: *Scalar* and *Vector*

Scalar

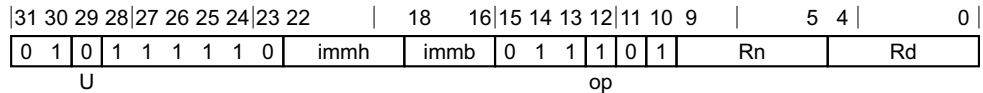

Scalar variant

SQSHL <V><d>, <V><n>, #<shift>

```
integer d = UInt(Rd);
integer n = UInt(Rn);

if immh == '0000' then ReservedValue();
integer esize = 8 << HighestSetBit(immh);
integer datasize = esize;
integer elements = 1;

integer shift = UInt(immh:immb) - esize;

boolean src_unsigned;
boolean dst_unsigned;
case op:U of
    when '00' UnallocatedEncoding();
    when '01' src_unsigned = FALSE; dst_unsigned = TRUE;
    when '10' src_unsigned = FALSE; dst_unsigned = FALSE;
    when '11' src_unsigned = TRUE; dst_unsigned = TRUE;
```

Vector

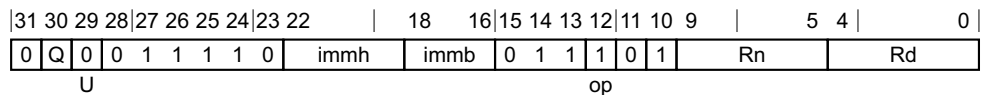

Vector variant

SQSHL <Vd>.<T>, <Vn>.<T>, #<shift>

```
integer d = UInt(Rd);
integer n = UInt(Rn);

if immh == '0000' then AdvSIMD modified immediate;
if immh<3>:Q == '10' then ReservedValue();
integer esize = 8 << HighestSetBit(immh);
integer datasize = if Q == '1' then 128 else 64;
integer elements = datasize DIV esize;

integer shift = UInt(immh:immb) - esize;

boolean src_unsigned;
boolean dst_unsigned;
case op:U of
    when '00' UnallocatedEncoding();
    when '01' src_unsigned = FALSE; dst_unsigned = TRUE;
    when '10' src_unsigned = FALSE; dst_unsigned = FALSE;
    when '11' src_unsigned = TRUE; dst_unsigned = TRUE;
```

Assembler Symbols

<V>	Is a width specifier, RESERVED when immh = 0000 B when immh = 0001 H when immh = 001x S when immh = 01xx D when immh = 1xxx
<d>	Is the number of the SIMD&FP destination register, in the "Rd" field.
<n>	Is the number of the first SIMD&FP source register, encoded in the "Rn" field.
<Vd>	Is the name of the SIMD&FP destination register, encoded in the "Rd" field.
<T>	Is an arrangement specifier, See AdvSIMD modified immediate. when immh = 0000, Q = x 8B when immh = 0001, Q = 0 16B when immh = 0001, Q = 1 4H when immh = 001x, Q = 0 8H when immh = 001x, Q = 1 2S when immh = 01xx, Q = 0 4S when immh = 01xx, Q = 1 RESERVED when immh = 1xxx, Q = 0 2D when immh = 1xxx, Q = 1
<Vn>	Is the name of the SIMD&FP source register, encoded in the "Rn" field.
<shift>	For the scalar variant: is the shift amount, in the range 0 to element bits - 1, RESERVED when immh = 0000 (UInt(immh:immb)-8) when immh = 0001 (UInt(immh:immb)-16) when immh = 001x (UInt(immh:immb)-32) when immh = 01xx (UInt(immh:immb)-64) when immh = 1xxx
<shift>	For the vector variant: is a shift amount, in the range 0 to element bits - 1, See AdvSIMD modified immediate. when immh = 0000 (UInt(immh:immb)-8) when immh = 0001 (UInt(immh:immb)-16) when immh = 001x (UInt(immh:immb)-32) when immh = 01xx (UInt(immh:immb)-64) when immh = 1xxx

Operation for all classes

```

CheckFPAdvSIMDEnabled64();
bits(datasize) operand = V[n];
bits(datasize) result;
integer element;
boolean sat;

for e = 0 to elements-1
  element = Int(Elem[operand, e, esize], src_unsigned) << shift;
  (Elem[result, e, esize], sat) = SatQ(element, esize, dst_unsigned);

```



```
if sat then FPSR.QC = '1';  
V[d] = result;
```

C6.3.257 SQSHL (register)

Signed saturating shift left (register)

It has encodings from 2 classes: *Scalar* and *Vector*

Scalar

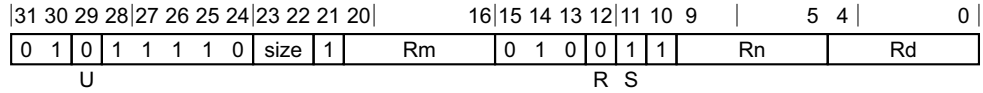

Scalar variant

SQSHL <V><d>, <V><n>, <V><m>

```
integer d = UInt(Rd);
integer n = UInt(Rn);
integer m = UInt(Rm);
integer esize = 8 << UInt(size);
integer datasize = esize;
integer elements = 1;
boolean unsigned = (U == '1');
boolean rounding = (R == '1');
boolean saturating = (S == '1');
if S == '0' && size != '11' then ReservedValue();
```

Vector

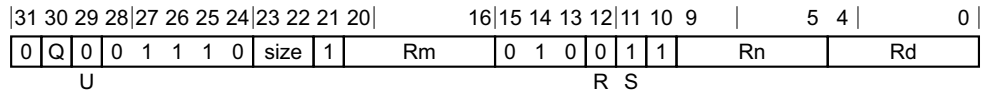

Vector variant

SQSHL <Vd>.<T>, <Vn>.<T>, <Vm>.<T>

```
integer d = UInt(Rd);
integer n = UInt(Rn);
integer m = UInt(Rm);
if size:Q == '110' then ReservedValue();
integer esize = 8 << UInt(size);
integer datasize = if Q == '1' then 128 else 64;
integer elements = datasize DIV esize;
boolean unsigned = (U == '1');
boolean rounding = (R == '1');
boolean saturating = (S == '1');
```

Assembler Symbols

- <V> Is a width specifier,
 - B** when size = 00
 - H** when size = 01
 - S** when size = 10
 - D** when size = 11
- <d> Is the number of the SIMD&FP destination register, in the "Rd" field.
- <n> Is the number of the first SIMD&FP source register, encoded in the "Rn" field.
- <m> Is the number of the second SIMD&FP source register, encoded in the "Rm" field.

- <Vd> Is the name of the SIMD&FP destination register, encoded in the "Rd" field.
- <T> Is an arrangement specifier,
8B when size = 00, Q = 0
16B when size = 00, Q = 1
4H when size = 01, Q = 0
8H when size = 01, Q = 1
2S when size = 10, Q = 0
4S when size = 10, Q = 1
RESERVED when size = 11, Q = 0
2D when size = 11, Q = 1
- <Vn> Is the name of the first SIMD&FP source register, encoded in the "Rn" field.
- <Vm> Is the name of the second SIMD&FP source register, encoded in the "Rm" field.

Operation for all classes

```

CheckFPAdvSIMDEnabled64();
bits(datasize) operand1 = V[n];
bits(datasize) operand2 = V[m];
bits(datasize) result;

integer round_const = 0;
integer shift;
integer element;
boolean sat;

for e = 0 to elements-1
  shift = SInt(Elem[operand2, e, esize]<7:0>);
  if rounding then
    round_const = 1 << (-shift - 1); // 0 for left shift, 2^(n-1) for right shift
  element = (Int(Elem[operand1, e, esize], unsigned) + round_const) << shift;
  if saturating then
    (Elem[result, e, esize], sat) = SatQ(element, esize, unsigned);
    if sat then FPSR.QC = '1';
  else
    Elem[result, e, esize] = element<esize-1:0>;

V[d] = result;

```

C6.3.258 SQSHLU

Signed saturating shift left unsigned (immediate)

It has encodings from 2 classes: *Scalar* and *Vector*

Scalar

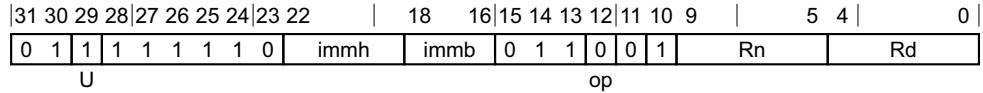

Scalar variant

SQSHLU <V><d>, <V><n>, #<shift>

```
integer d = UInt(Rd);
integer n = UInt(Rn);

if immh == '0000' then ReservedValue();
integer esize = 8 << HighestSetBit(immh);
integer datasize = esize;
integer elements = 1;

integer shift = UInt(immh:immb) - esize;

boolean src_unsigned;
boolean dst_unsigned;
case op:U of
    when '00' UnallocatedEncoding();
    when '01' src_unsigned = FALSE; dst_unsigned = TRUE;
    when '10' src_unsigned = FALSE; dst_unsigned = FALSE;
    when '11' src_unsigned = TRUE; dst_unsigned = TRUE;
```

Vector

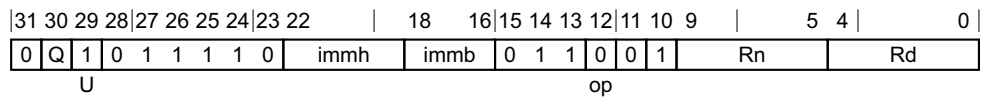

Vector variant

SQSHLU <Vd>.<T>, <Vn>.<T>, #<shift>

```
integer d = UInt(Rd);
integer n = UInt(Rn);

if immh == '0000' then AdvSIMD modified immediate;
if immh<3>:Q == '10' then ReservedValue();
integer esize = 8 << HighestSetBit(immh);
integer datasize = if Q == '1' then 128 else 64;
integer elements = datasize DIV esize;

integer shift = UInt(immh:immb) - esize;

boolean src_unsigned;
boolean dst_unsigned;
case op:U of
    when '00' UnallocatedEncoding();
    when '01' src_unsigned = FALSE; dst_unsigned = TRUE;
    when '10' src_unsigned = FALSE; dst_unsigned = FALSE;
    when '11' src_unsigned = TRUE; dst_unsigned = TRUE;
```

Assembler Symbols

<V>	Is a width specifier, RESERVED when immh = 0000 B when immh = 0001 H when immh = 001x S when immh = 01xx D when immh = 1xxx
<d>	Is the number of the SIMD&FP destination register, in the "Rd" field.
<n>	Is the number of the first SIMD&FP source register, encoded in the "Rn" field.
<Vd>	Is the name of the SIMD&FP destination register, encoded in the "Rd" field.
<T>	Is an arrangement specifier, See AdvSIMD modified immediate. when immh = 0000, Q = x 8B when immh = 0001, Q = 0 16B when immh = 0001, Q = 1 4H when immh = 001x, Q = 0 8H when immh = 001x, Q = 1 2S when immh = 01xx, Q = 0 4S when immh = 01xx, Q = 1 RESERVED when immh = 1xxx, Q = 0 2D when immh = 1xxx, Q = 1
<Vn>	Is the name of the SIMD&FP source register, encoded in the "Rn" field.
<shift>	For the scalar variant: is the shift amount, in the range 0 to element bits - 1, RESERVED when immh = 0000 (UInt(immh:immb)-8) when immh = 0001 (UInt(immh:immb)-16) when immh = 001x (UInt(immh:immb)-32) when immh = 01xx (UInt(immh:immb)-64) when immh = 1xxx
<shift>	For the vector variant: is a shift amount, in the range 0 to element bits - 1, See AdvSIMD modified immediate. when immh = 0000 (UInt(immh:immb)-8) when immh = 0001 (UInt(immh:immb)-16) when immh = 001x (UInt(immh:immb)-32) when immh = 01xx (UInt(immh:immb)-64) when immh = 1xxx

Operation for all classes

```

CheckFPAdvSIMDEnabled64();
bits(datasize) operand = V[n];
bits(datasize) result;
integer element;
boolean sat;

for e = 0 to elements-1
  element = Int(Elem[operand, e, esize], src_unsigned) << shift;
  (Elem[result, e, esize], sat) = SatQ(element, esize, dst_unsigned);

```

```
    if sat then FPSR.QC = '1';  
V[d] = result;
```

C6.3.259 SQSHRN, SQSHRN2

Signed saturating shift right narrow (immediate)

It has encodings from 2 classes: *Scalar* and *Vector*

Scalar

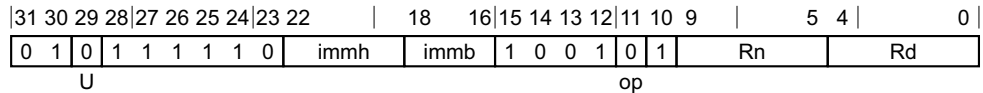

Scalar variant

SQSHRN <Vb><d>, <Va><n>, #<shift>

```
integer d = UInt(Rd);
integer n = UInt(Rn);

if immh == '0000' then ReservedValue();
if immh<3> == '1' then ReservedValue();
integer esize = 8 << HighestSetBit(immh);
integer datasize = esize;
integer elements = 1;
integer part = 0;

integer shift = (2 * esize) - UInt(immh:immb);
boolean round = (op == '1');
boolean unsigned = (U == '1');
```

Vector

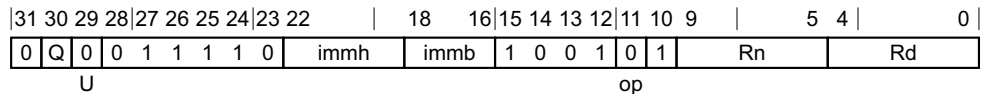

Vector variant

SQSHRN{2} <Vd>.<Tb>, <Vn>.<Ta>, #<shift>

```
integer d = UInt(Rd);
integer n = UInt(Rn);

if immh == '0000' then AdvSIMD modified immediate;
if immh<3> == '1' then ReservedValue();
integer esize = 8 << HighestSetBit(immh);
integer datasize = 64;
integer part = UInt(Q);
integer elements = datasize DIV esize;

integer shift = (2 * esize) - UInt(immh:immb);
boolean round = (op == '1');
boolean unsigned = (U == '1');
```

Assembler Symbols

- 2 Is the second and upper half specifier. If present it causes the operation to be performed on the upper 64 bits of the registers holding the narrower elements, and is
- [absent]** when Q = 0
 - [present]** when Q = 1
- <Vd> Is the name of the SIMD&FP destination register, encoded in the "Rd" field.

<Tb>	Is an arrangement specifier, See AdvSIMD modified immediate. when immh = 0000, Q = x 8B when immh = 0001, Q = 0 16B when immh = 0001, Q = 1 4H when immh = 001x, Q = 0 8H when immh = 001x, Q = 1 2S when immh = 01xx, Q = 0 4S when immh = 01xx, Q = 1 RESERVED when immh = 1xxx, Q = x
<Vn>	Is the name of the SIMD&FP source register, encoded in the "Rn" field.
<Ta>	Is an arrangement specifier, See AdvSIMD modified immediate. when immh = 0000 8H when immh = 0001 4S when immh = 001x 2D when immh = 01xx RESERVED when immh = 1xxx
<Vb>	Is the destination width specifier, RESERVED when immh = 0000 B when immh = 0001 H when immh = 001x S when immh = 01xx RESERVED when immh = 1xxx
<d>	Is the number of the SIMD&FP destination register, in the "Rd" field.
<Va>	Is the source width specifier, RESERVED when immh = 0000 H when immh = 0001 S when immh = 001x D when immh = 01xx RESERVED when immh = 1xxx
<n>	Is the number of the first SIMD&FP source register, encoded in the "Rn" field.
<shift>	For the scalar variant: is the shift amount, in the range 1 to element bits, RESERVED when immh = 0000 (16-UInt(immh:immb)) when immh = 0001 (32-UInt(immh:immb)) when immh = 001x (64-UInt(immh:immb)) when immh = 01xx RESERVED when immh = 1xxx
<shift>	For the vector variant: is a shift amount, in the range 1 to element bits, See AdvSIMD modified immediate. when immh = 0000 (16-UInt(immh:immb)) when immh = 0001 (32-UInt(immh:immb)) when immh = 001x (64-UInt(immh:immb)) when immh = 01xx RESERVED when immh = 1xxx

Operation for all classes

```
CheckFPAdvSIMDEnabled64();
bits(datasize*2) operand = V[n];
bits(datasize) result;
integer round_const = if round then (1 << (shift - 1)) else 0;
integer element;
boolean sat;

for e = 0 to elements-1
    element = (Int(Elem[operand, e, 2*esize], unsigned) + round_const) >> shift;
    (Elem[result, e, esize], sat) = SatQ(element, esize, unsigned);
    if sat then FPSR.QC = '1';

Vpart[d, part] = result;
```

C6.3.260 SQSHRUN, SQSHRUN2

Signed saturating shift right unsigned narrow (immediate)

It has encodings from 2 classes: *Scalar* and *Vector*

Scalar

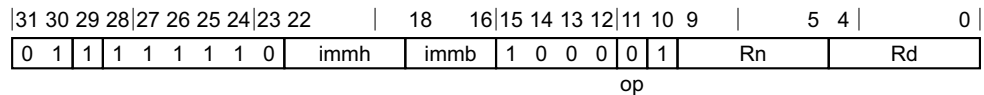

Scalar variant

SQSHRUN <Vb><d>, <Va><n>, #<shift>

```
integer d = UInt(Rd);
integer n = UInt(Rn);

if immh == '0000' then ReservedValue();
if immh<3> == '1' then ReservedValue();
integer esize = 8 << HighestSetBit(immh);
integer datasize = esize;
integer elements = 1;
integer part = 0;

integer shift = (2 * esize) - UInt(immh:immb);
boolean round = (op == '1');
```

Vector

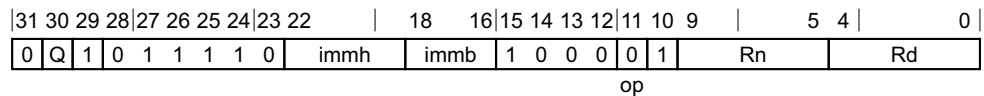

Vector variant

SQSHRUN{2} <Vd>.<Tb>, <Vn>.<Ta>, #<shift>

```
integer d = UInt(Rd);
integer n = UInt(Rn);

if immh == '0000' then AdvSIMD modified immediate;
if immh<3> == '1' then ReservedValue();
integer esize = 8 << HighestSetBit(immh);
integer datasize = 64;
integer part = UInt(Q);
integer elements = datasize DIV esize;

integer shift = (2 * esize) - UInt(immh:immb);
boolean round = (op == '1');
```

Assembler Symbols

- 2 Is the second and upper half specifier. If present it causes the operation to be performed on the upper 64 bits of the registers holding the narrower elements, and is
- [absent]** when Q = 0
 - [present]** when Q = 1
- <Vd> Is the name of the SIMD&FP destination register, encoded in the "Rd" field.

- <Tb> Is an arrangement specifier,
 See **AdvSIMD modified immediate**, when immh = 0000, Q = x
8B when immh = 0001, Q = 0
16B when immh = 0001, Q = 1
4H when immh = 001x, Q = 0
8H when immh = 001x, Q = 1
2S when immh = 01xx, Q = 0
4S when immh = 01xx, Q = 1
RESERVED when immh = 1xxx, Q = x
- <Vn> Is the name of the SIMD&FP source register, encoded in the "Rn" field.
- <Ta> Is an arrangement specifier,
 See **AdvSIMD modified immediate**, when immh = 0000
8H when immh = 0001
4S when immh = 001x
2D when immh = 01xx
RESERVED when immh = 1xxx
- <Vb> Is the destination width specifier,
RESERVED when immh = 0000
B when immh = 0001
H when immh = 001x
S when immh = 01xx
RESERVED when immh = 1xxx
- <d> Is the number of the SIMD&FP destination register, in the "Rd" field.
- <Va> Is the source width specifier,
RESERVED when immh = 0000
H when immh = 0001
S when immh = 001x
D when immh = 01xx
RESERVED when immh = 1xxx
- <n> Is the number of the first SIMD&FP source register, encoded in the "Rn" field.
- <shift> For the scalar variant: is the shift amount, in the range 1 to element bits,
RESERVED when immh = 0000
(16-UInt(immh:immb)) when immh = 0001
(32-UInt(immh:immb)) when immh = 001x
(64-UInt(immh:immb)) when immh = 01xx
RESERVED when immh = 1xxx
- <shift> For the vector variant: is a shift amount, in the range 1 to element bits,
 See **AdvSIMD modified immediate**, when immh = 0000
(16-UInt(immh:immb)) when immh = 0001
(32-UInt(immh:immb)) when immh = 001x
(64-UInt(immh:immb)) when immh = 01xx
RESERVED when immh = 1xxx

Operation for all classes

```
CheckFPAdvSIMDEnabled64();
bits(datasize*2) operand = V[n];
bits(datasize) result;
integer round_const = if round then (1 << (shift - 1)) else 0;
integer element;
boolean sat;

for e = 0 to elements-1
    element = (SInt(Elem[operand, e, 2*esize]) + round_const) >> shift;
    (Elem[result, e, esize], sat) = UnsignedSatQ(element, esize);
    if sat then FPSR.QC = '1';

Vpart[d, part] = result;
```

C6.3.261 SQSUB

Signed saturating subtract

It has encodings from 2 classes: *Scalar* and *Vector*

Scalar

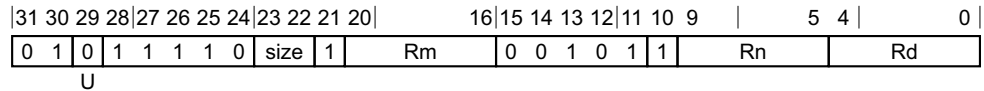

Scalar variant

SQSUB <V><d>, <V><n>, <V><m>

```
integer d = UInt(Rd);
integer n = UInt(Rn);
integer m = UInt(Rm);
integer esize = 8 << UInt(size);
integer datasize = esize;
integer elements = 1;
boolean unsigned = (U == '1');
```

Vector

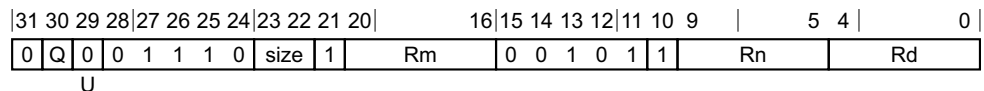

Vector variant

SQSUB <Vd>.<T>, <Vn>.<T>, <Vm>.<T>

```
integer d = UInt(Rd);
integer n = UInt(Rn);
integer m = UInt(Rm);
if size:Q == '110' then ReservedValue();
integer esize = 8 << UInt(size);
integer datasize = if Q == '1' then 128 else 64;
integer elements = datasize DIV esize;
boolean unsigned = (U == '1');
```

Assembler Symbols

- <V> Is a width specifier,
- B** when size = 00
 - H** when size = 01
 - S** when size = 10
 - D** when size = 11
- <d> Is the number of the SIMD&FP destination register, in the "Rd" field.
- <n> Is the number of the first SIMD&FP source register, encoded in the "Rn" field.
- <m> Is the number of the second SIMD&FP source register, encoded in the "Rm" field.
- <Vd> Is the name of the SIMD&FP destination register, encoded in the "Rd" field.

<T>	Is an arrangement specifier, 8B when size = 00, Q = 0 16B when size = 00, Q = 1 4H when size = 01, Q = 0 8H when size = 01, Q = 1 2S when size = 10, Q = 0 4S when size = 10, Q = 1 RESERVED when size = 11, Q = 0 2D when size = 11, Q = 1
<Vn>	Is the name of the first SIMD&FP source register, encoded in the "Rn" field.
<Vm>	Is the name of the second SIMD&FP source register, encoded in the "Rm" field.

Operation for all classes

```
CheckFPAdvSIMDEnabled64();
bits(datasize) operand1 = V[n];
bits(datasize) operand2 = V[m];
bits(datasize) result;
integer element1;
integer element2;
integer diff;
boolean sat;

for e = 0 to elements-1
    element1 = Int(Elem[operand1, e, esize], unsigned);
    element2 = Int(Elem[operand2, e, esize], unsigned);
    diff = element1 - element2;
    (Elem[result, e, esize], sat) = SatQ(diff, esize, unsigned);
    if sat then FPSR.QC = '1';

V[d] = result;
```

C6.3.262 SQXTN, SQXTN2

Signed saturating extract narrow

It has encodings from 2 classes: *Scalar* and *Vector*

Scalar

31	30	29	28	27	26	25	24	23	22	21	20	19	18	17	16	15	14	13	12	11	10	9				5	4			0
0	1	0	1	1	1	1	0	size	1	0	0	0	0	1	0	1	0	0	1	0	Rn			Rd						
U																														

Scalar variant

SQXTN <Vb><d>, <Va><n>

```
integer d = UInt(Rd);
integer n = UInt(Rn);
```

```
if size == '11' then ReservedValue();
integer esize = 8 << UInt(size);
integer datasize = esize;
integer part = 0;
integer elements = 1;
```

```
boolean unsigned = (U == '1');
```

Vector

31	30	29	28	27	26	25	24	23	22	21	20	19	18	17	16	15	14	13	12	11	10	9				5	4			0
0	Q	0	0	1	1	1	0	size	1	0	0	0	0	1	0	1	0	0	1	0	Rn			Rd						
U																														

Vector variant

SQXTN{2} <Vd>.<Tb>, <Vn>.<Ta>

```
integer d = UInt(Rd);
integer n = UInt(Rn);
```

```
if size == '11' then ReservedValue();
integer esize = 8 << UInt(size);
integer datasize = 64;
integer part = UInt(Q);
integer elements = datasize DIV esize;
```

```
boolean unsigned = (U == '1');
```

Assembler Symbols

2 Is the second and upper half specifier. If present it causes the operation to be performed on the upper 64 bits of the registers holding the narrower elements, and is

[absent] when Q = 0

[present] when Q = 1

<Vd> Is the name of the SIMD&FP destination register, encoded in the "Rd" field.

<Tb> Is an arrangement specifier,

8B when size = 00, Q = 0

16B when size = 00, Q = 1

	4H	when size = 01, Q = 0
	8H	when size = 01, Q = 1
	2S	when size = 10, Q = 0
	4S	when size = 10, Q = 1
	RESERVED	when size = 11, Q = x
<Vn>		Is the name of the SIMD&FP source register, encoded in the "Rn" field.
<Ta>		Is an arrangement specifier,
	8H	when size = 00
	4S	when size = 01
	2D	when size = 10
	RESERVED	when size = 11
<Vb>		Is the destination width specifier,
	B	when size = 00
	H	when size = 01
	S	when size = 10
	RESERVED	when size = 11
<d>		Is the number of the SIMD&FP destination register, encoded in the "Rd" field.
<Va>		Is the source width specifier,
	H	when size = 00
	S	when size = 01
	D	when size = 10
	RESERVED	when size = 11
<n>		Is the number of the SIMD&FP source register, encoded in the "Rn" field.

Operation for all classes

```

CheckFPAdvSIMDEnabled64();
bits(2*datasize) operand = V[n];
bits(datasize) result;
bits(2*esize) element;
boolean sat;

for e = 0 to elements-1
  element = Elem[operand, e, 2*esize];
  (Elem[result, e, esize], sat) = SatQ(Int(element, unsigned), esize, unsigned);
  if sat then FPSR.QC = '1';

Vpart[d, part] = result;

```

C6.3.263 SQXTUN, SQXTUN2

Signed saturating extract unsigned narrow

It has encodings from 2 classes: *Scalar* and *Vector*

Scalar

31	30	29	28	27	26	25	24	23	22	21	20	19	18	17	16	15	14	13	12	11	10	9				5	4				0
0	1	1	1	1	1	1	0	size	1	0	0	0	0	1	0	0	1	0	1	0	1	0				Rn				Rd	

Scalar variant

SQXTUN <Vb><d>, <Va><n>

```
integer d = UInt(Rd);
integer n = UInt(Rn);
```

```
if size == '11' then ReservedValue();
integer esize = 8 << UInt(size);
integer datasize = esize;
integer part = 0;
integer elements = 1;
```

Vector

31	30	29	28	27	26	25	24	23	22	21	20	19	18	17	16	15	14	13	12	11	10	9				5	4				0
0	Q	1	0	1	1	1	0	size	1	0	0	0	0	1	0	0	1	0	1	0	1	0				Rn				Rd	

Vector variant

SQXTUN{2} <Vd>.<Tb>, <Vn>.<Ta>

```
integer d = UInt(Rd);
integer n = UInt(Rn);
```

```
if size == '11' then ReservedValue();
integer esize = 8 << UInt(size);
integer datasize = 64;
integer part = UInt(Q);
integer elements = datasize DIV esize;
```

Assembler Symbols

- 2 Is the second and upper half specifier. If present it causes the operation to be performed on the upper 64 bits of the registers holding the narrower elements, and is
- [absent]** when Q = 0
 - [present]** when Q = 1
- <Vd> Is the name of the SIMD&FP destination register, encoded in the "Rd" field.
- <Tb> Is an arrangement specifier,
- 8B** when size = 00, Q = 0
 - 16B** when size = 00, Q = 1
 - 4H** when size = 01, Q = 0
 - 8H** when size = 01, Q = 1
 - 2S** when size = 10, Q = 0

	4S	when size = 10, Q = 1
	RESERVED	when size = 11, Q = x
<Vn>		Is the name of the SIMD&FP source register, encoded in the "Rn" field.
<Ta>		Is an arrangement specifier,
	8H	when size = 00
	4S	when size = 01
	2D	when size = 10
	RESERVED	when size = 11
<Vb>		Is the destination width specifier,
	B	when size = 00
	H	when size = 01
	S	when size = 10
	RESERVED	when size = 11
<d>		Is the number of the SIMD&FP destination register, encoded in the "Rd" field.
<Va>		Is the source width specifier,
	H	when size = 00
	S	when size = 01
	D	when size = 10
	RESERVED	when size = 11
<n>		Is the number of the SIMD&FP source register, encoded in the "Rn" field.

Operation for all classes

```
CheckFPAdvSIMDEnabled64();
bits(2*datasize) operand = V[n];
bits(datasize) result;
bits(2*esize) element;
boolean sat;

for e = 0 to elements-1
    element = Elem[operand, e, 2*esize];
    (Elem[result, e, esize], sat) = UnsignedSatQ(SInt(element), esize);
    if sat then FPSR.QC = '1';

Vpart[d, part] = result;
```

C6.3.264 SRHADD

Signed rounding halving add

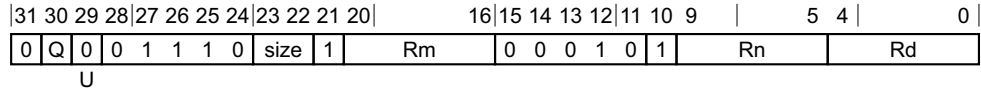

Three registers of the same type variant

SRHADD <Vd>.<T>, <Vn>.<T>, <Vm>.<T>

```
integer d = UInt(Rd);
integer n = UInt(Rn);
integer m = UInt(Rm);
if size == '11' then ReservedValue();
integer esize = 8 << UInt(size);
integer datasize = if Q == '1' then 128 else 64;
integer elements = datasize DIV esize;

boolean unsigned = (U == '1');
```

Assembler Symbols

- <Vd> Is the name of the SIMD&FP destination register, encoded in the "Rd" field.
- <T> Is an arrangement specifier,
- 8B** when size = 00, Q = 0
 - 16B** when size = 00, Q = 1
 - 4H** when size = 01, Q = 0
 - 8H** when size = 01, Q = 1
 - 2S** when size = 10, Q = 0
 - 4S** when size = 10, Q = 1
 - RESERVED** when size = 11, Q = x
- <Vn> Is the name of the first SIMD&FP source register, encoded in the "Rn" field.
- <Vm> Is the name of the second SIMD&FP source register, encoded in the "Rm" field.

Operation

```
CheckFPAdvSIMDEnabled64();
bits(datasize) operand1 = V[n];
bits(datasize) operand2 = V[m];
bits(datasize) result;
integer element1;
integer element2;

for e = 0 to elements-1
    element1 = Int(Elem[operand1, e, esize], unsigned);
    element2 = Int(Elem[operand2, e, esize], unsigned);
    Elem[result, e, esize] = (element1 + element2 + 1)<esize:1>;

V[d] = result;
```

C6.3.265 SRI

Shift right and insert (immediate)

It has encodings from 2 classes: *Scalar* and *Vector*

Scalar

31	30	29	28	27	26	25	24	23	22	18	16	15	14	13	12	11	10	9	5	4	0
0	1	1	1	1	1	1	1	0	immh	immb	0	1	0	0	0	1	Rn		Rd		

Scalar variant

SRI <V><d>, <V><n>, #<shift>

```
integer d = UInt(Rd);
integer n = UInt(Rn);
```

```
if immh<3> != '1' then ReservedValue();
integer esize = 8 << 3;
integer datasize = esize;
integer elements = 1;
```

```
integer shift = (esize * 2) - UInt(immh:immb);
```

Vector

31	30	29	28	27	26	25	24	23	22	18	16	15	14	13	12	11	10	9	5	4	0
0	Q	1	0	1	1	1	1	0	immh	immb	0	1	0	0	0	1	Rn		Rd		

Vector variant

SRI <Vd>.<T>, <Vn>.<T>, #<shift>

```
integer d = UInt(Rd);
integer n = UInt(Rn);
```

```
if immh == '0000' then AdvSIMD modified immediate;
if immh<3>:Q == '10' then ReservedValue();
integer esize = 8 << HighestSetBit(immh);
integer datasize = if Q == '1' then 128 else 64;
integer elements = datasize DIV esize;
```

```
integer shift = (esize * 2) - UInt(immh:immb);
```

Assembler Symbols

- <V> Is a width specifier,
RESERVED when immh = 0xxx
D when immh = 1xxx
- <d> Is the number of the SIMD&FP destination register, in the "Rd" field.
- <n> Is the number of the first SIMD&FP source register, encoded in the "Rn" field.
- <Vd> Is the name of the SIMD&FP destination register, encoded in the "Rd" field.
- <T> Is an arrangement specifier,
See AdvSIMD modified immediate. when immh = 0000, Q = x

8B	when immh = 0001, Q = 0
16B	when immh = 0001, Q = 1
4H	when immh = 001x, Q = 0
8H	when immh = 001x, Q = 1
2S	when immh = 01xx, Q = 0
4S	when immh = 01xx, Q = 1
RESERVED	when immh = 1xxx, Q = 0
2D	when immh = 1xxx, Q = 1
<Vn>	Is the name of the SIMD&FP source register, encoded in the "Rn" field.
<shift>	For the scalar variant: is the shift amount, in the range 1 to 64, RESERVED when immh = 0xxx (128-UInt(immh:immb)) when immh = 1xxx
<shift>	For the vector variant: is a shift amount, in the range 1 to element bits, See AdvSIMD modified immediate. when immh = 0000 (16-UInt(immh:immb)) when immh = 0001 (32-UInt(immh:immb)) when immh = 001x (64-UInt(immh:immb)) when immh = 01xx (128-UInt(immh:immb)) when immh = 1xxx

Operation for all classes

```

CheckFPAdvSIMDEnabled64();
bits(datasize) operand = V[n];
bits(datasize) operand2 = V[d];
bits(datasize) result;
bits(esize) mask = LSR(Ones(esize), shift);
bits(esize) shifted;

for e = 0 to elements-1
    shifted = LSR(Elem[operand, e, esize], shift);
    Elem[result, e, esize] = (Elem[operand2, e, esize] AND NOT(mask)) OR shifted;
V[d] = result;
    
```

C6.3.266 SRSHL

Signed rounding shift left (register)

It has encodings from 2 classes: *Scalar* and *Vector*

Scalar

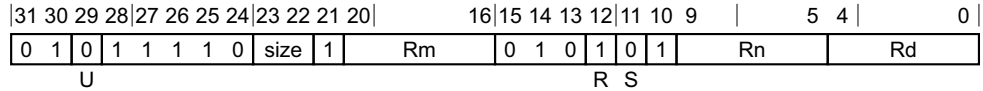

Scalar variant

SRSHL <V><d>, <V><n>, <V><m>

```
integer d = UInt(Rd);
integer n = UInt(Rn);
integer m = UInt(Rm);
integer esize = 8 << UInt(size);
integer datasize = esize;
integer elements = 1;
boolean unsigned = (U == '1');
boolean rounding = (R == '1');
boolean saturating = (S == '1');
if S == '0' && size != '11' then ReservedValue();
```

Vector

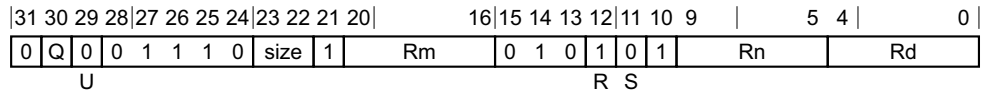

Vector variant

SRSHL <Vd>.<T>, <Vn>.<T>, <Vm>.<T>

```
integer d = UInt(Rd);
integer n = UInt(Rn);
integer m = UInt(Rm);
if size:Q == '110' then ReservedValue();
integer esize = 8 << UInt(size);
integer datasize = if Q == '1' then 128 else 64;
integer elements = datasize DIV esize;
boolean unsigned = (U == '1');
boolean rounding = (R == '1');
boolean saturating = (S == '1');
```

Assembler Symbols

- <V> Is a width specifier,
RESERVED when size = 0x
RESERVED when size = 10
D when size = 11
- <d> Is the number of the SIMD&FP destination register, in the "Rd" field.
- <n> Is the number of the first SIMD&FP source register, encoded in the "Rn" field.
- <m> Is the number of the second SIMD&FP source register, encoded in the "Rm" field.

- <Vd> Is the name of the SIMD&FP destination register, encoded in the "Rd" field.
- <T> Is an arrangement specifier,
8B when size = 00, Q = 0
16B when size = 00, Q = 1
4H when size = 01, Q = 0
8H when size = 01, Q = 1
2S when size = 10, Q = 0
4S when size = 10, Q = 1
RESERVED when size = 11, Q = 0
2D when size = 11, Q = 1
- <Vn> Is the name of the first SIMD&FP source register, encoded in the "Rn" field.
- <Vm> Is the name of the second SIMD&FP source register, encoded in the "Rm" field.

Operation for all classes

```

CheckFPAdvSIMDEnabled64();
bits(datasize) operand1 = V[n];
bits(datasize) operand2 = V[m];
bits(datasize) result;

integer round_const = 0;
integer shift;
integer element;
boolean sat;

for e = 0 to elements-1
  shift = SInt(Elem[operand2, e, esize]<7:0>);
  if rounding then
    round_const = 1 << (-shift - 1); // 0 for left shift, 2^(n-1) for right shift
  element = (Int(Elem[operand1, e, esize], unsigned) + round_const) << shift;
  if saturating then
    (Elem[result, e, esize], sat) = SatQ(element, esize, unsigned);
    if sat then FPSR.QC = '1';
  else
    Elem[result, e, esize] = element<esize-1:0>;

V[d] = result;

```

C6.3.267 SRSHR

Signed rounding shift right (immediate)

It has encodings from 2 classes: *Scalar* and *Vector*

Scalar

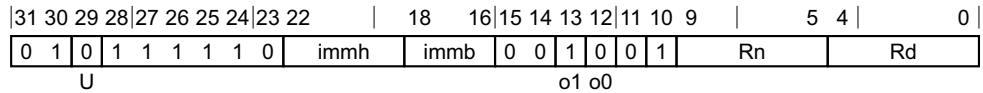

Scalar variant

SRSHR <V><d>, <V><n>, #<shift>

```
integer d = UInt(Rd);
integer n = UInt(Rn);

if immh<3> != '1' then ReservedValue();
integer esize = 8 << 3;
integer datasize = esize;
integer elements = 1;

integer shift = (esize * 2) - UInt(immh:immb);
boolean unsigned = (U == '1');
boolean round = (o1 == '1');
boolean accumulate = (o0 == '1');
```

Vector

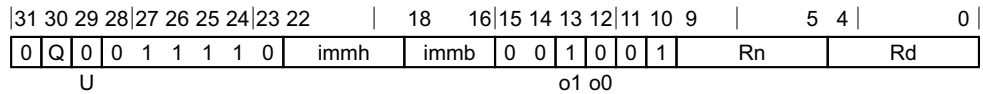

Vector variant

SRSHR <Vd>.<T>, <Vn>.<T>, #<shift>

```
integer d = UInt(Rd);
integer n = UInt(Rn);

if immh == '0000' then AdvSIMD modified immediate;
if immh<3>:Q == '10' then ReservedValue();
integer esize = 8 << HighestSetBit(immh);
integer datasize = if Q == '1' then 128 else 64;
integer elements = datasize DIV esize;

integer shift = (esize * 2) - UInt(immh:immb);
boolean unsigned = (U == '1');
boolean round = (o1 == '1');
boolean accumulate = (o0 == '1');
```

Assembler Symbols

- <V> Is a width specifier,
RESERVED when immh = 0xxx
D when immh = 1xxx
- <d> Is the number of the SIMD&FP destination register, in the "Rd" field.
- <n> Is the number of the first SIMD&FP source register, encoded in the "Rn" field.

- <Vd> Is the name of the SIMD&FP destination register, encoded in the "Rd" field.
- <T> Is an arrangement specifier,
 See **AdvSIMD modified immediate**, when immh = 0000, Q = x
8B when immh = 0001, Q = 0
16B when immh = 0001, Q = 1
4H when immh = 001x, Q = 0
8H when immh = 001x, Q = 1
2S when immh = 01xx, Q = 0
4S when immh = 01xx, Q = 1
RESERVED when immh = 1xxx, Q = 0
2D when immh = 1xxx, Q = 1
- <Vn> Is the name of the SIMD&FP source register, encoded in the "Rn" field.
- <shift> For the scalar variant: is the shift amount, in the range 1 to 64,
RESERVED when immh = 0xxx
(128-UInt(immh:immb)) when immh = 1xxx
- <shift> For the vector variant: is a shift amount, in the range 1 to element bits,
 See **AdvSIMD modified immediate**, when immh = 0000
(16-UInt(immh:immb)) when immh = 0001
(32-UInt(immh:immb)) when immh = 001x
(64-UInt(immh:immb)) when immh = 01xx
(128-UInt(immh:immb)) when immh = 1xxx

Operation for all classes

```

CheckFPAdvSIMDEnabled64();
bits(datasize) operand = V[n];
bits(datasize) operand2;
bits(datasize) result;
integer round_const = if round then (1 << (shift - 1)) else 0;
integer element;

operand2 = if accumulate then V[d] else Zeros();
for e = 0 to elements-1
    element = (Int(Elem[operand, e, esize], unsigned) + round_const) >> shift;
    Elem[result, e, esize] = Elem[operand2, e, esize] + element<esize-1:0>;

V[d] = result;
    
```

C6.3.268 SRSRA

Signed rounding shift right and accumulate (immediate)

It has encodings from 2 classes: *Scalar* and *Vector*

Scalar

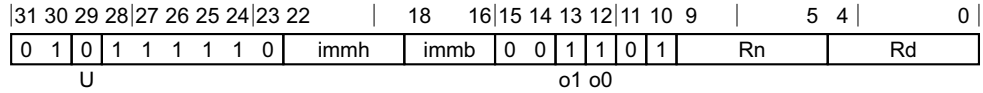

Scalar variant

SRSRA <V><d>, <V><n>, #<shift>

```
integer d = UInt(Rd);
integer n = UInt(Rn);

if immh<3> != '1' then ReservedValue();
integer esize = 8 << 3;
integer datasize = esize;
integer elements = 1;

integer shift = (esize * 2) - UInt(immh:immb);
boolean unsigned = (U == '1');
boolean round = (o1 == '1');
boolean accumulate = (o0 == '1');
```

Vector

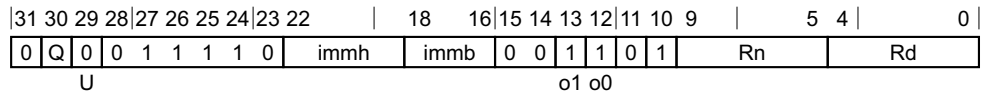

Vector variant

SRSRA <Vd>.<T>, <Vn>.<T>, #<shift>

```
integer d = UInt(Rd);
integer n = UInt(Rn);

if immh == '0000' then AdvSIMD modified immediate;
if immh<3>:Q == '10' then ReservedValue();
integer esize = 8 << HighestSetBit(immh);
integer datasize = if Q == '1' then 128 else 64;
integer elements = datasize DIV esize;

integer shift = (esize * 2) - UInt(immh:immb);
boolean unsigned = (U == '1');
boolean round = (o1 == '1');
boolean accumulate = (o0 == '1');
```

Assembler Symbols

- <V> Is a width specifier,
RESERVED when immh = 0xxx
D when immh = 1xxx
- <d> Is the number of the SIMD&FP destination register, in the "Rd" field.
- <n> Is the number of the first SIMD&FP source register, encoded in the "Rn" field.

- <Vd> Is the name of the SIMD&FP destination register, encoded in the "Rd" field.
- <T> Is an arrangement specifier,
 See **AdvSIMD modified immediate**, when immh = 0000, Q = x
8B when immh = 0001, Q = 0
16B when immh = 0001, Q = 1
4H when immh = 001x, Q = 0
8H when immh = 001x, Q = 1
2S when immh = 01xx, Q = 0
4S when immh = 01xx, Q = 1
RESERVED when immh = 1xxx, Q = 0
2D when immh = 1xxx, Q = 1
- <Vn> Is the name of the SIMD&FP source register, encoded in the "Rn" field.
- <shift> For the scalar variant: is the shift amount, in the range 1 to 64,
RESERVED when immh = 0xxx
(128-UInt(immh:immb)) when immh = 1xxx
- <shift> For the vector variant: is a shift amount, in the range 1 to element bits,
 See **AdvSIMD modified immediate**, when immh = 0000
(16-UInt(immh:immb)) when immh = 0001
(32-UInt(immh:immb)) when immh = 001x
(64-UInt(immh:immb)) when immh = 01xx
(128-UInt(immh:immb)) when immh = 1xxx

Operation for all classes

```

CheckFPAdvSIMDEnabled64();
bits(datasize) operand = V[n];
bits(datasize) operand2;
bits(datasize) result;
integer round_const = if round then (1 << (shift - 1)) else 0;
integer element;

operand2 = if accumulate then V[d] else Zeros();
for e = 0 to elements-1
    element = (Int(Elem[operand, e, esize], unsigned) + round_const) >> shift;
    Elem[result, e, esize] = Elem[operand2, e, esize] + element<esize-1:0>;

V[d] = result;
  
```

C6.3.269 SSHL

Signed shift left (register)

It has encodings from 2 classes: *Scalar* and *Vector*

Scalar

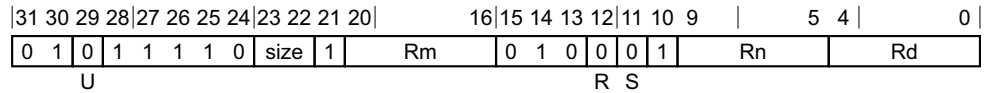

Scalar variant

SSHL <V><d>, <V><n>, <V><m>

```
integer d = UInt(Rd);
integer n = UInt(Rn);
integer m = UInt(Rm);
integer esize = 8 << UInt(size);
integer datasize = esize;
integer elements = 1;
boolean unsigned = (U == '1');
boolean rounding = (R == '1');
boolean saturating = (S == '1');
if S == '0' && size != '11' then ReservedValue();
```

Vector

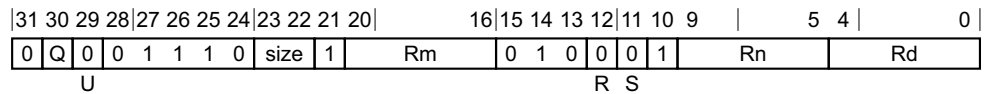

Vector variant

SSHL <Vd>.<T>, <Vn>.<T>, <Vm>.<T>

```
integer d = UInt(Rd);
integer n = UInt(Rn);
integer m = UInt(Rm);
if size:Q == '110' then ReservedValue();
integer esize = 8 << UInt(size);
integer datasize = if Q == '1' then 128 else 64;
integer elements = datasize DIV esize;
boolean unsigned = (U == '1');
boolean rounding = (R == '1');
boolean saturating = (S == '1');
```

Assembler Symbols

- <V> Is a width specifier,
RESERVED when size = 0x
RESERVED when size = 10
D when size = 11
- <d> Is the number of the SIMD&FP destination register, in the "Rd" field.
- <n> Is the number of the first SIMD&FP source register, encoded in the "Rn" field.
- <m> Is the number of the second SIMD&FP source register, encoded in the "Rm" field.

- <Vd> Is the name of the SIMD&FP destination register, encoded in the "Rd" field.
- <T> Is an arrangement specifier,
8B when size = 00, Q = 0
16B when size = 00, Q = 1
4H when size = 01, Q = 0
8H when size = 01, Q = 1
2S when size = 10, Q = 0
4S when size = 10, Q = 1
RESERVED when size = 11, Q = 0
2D when size = 11, Q = 1
- <Vn> Is the name of the first SIMD&FP source register, encoded in the "Rn" field.
- <Vm> Is the name of the second SIMD&FP source register, encoded in the "Rm" field.

Operation for all classes

```

CheckFPAdvSIMDEnabled64();
bits(datasize) operand1 = V[n];
bits(datasize) operand2 = V[m];
bits(datasize) result;

integer round_const = 0;
integer shift;
integer element;
boolean sat;

for e = 0 to elements-1
    shift = SInt(Elem[operand2, e, esize]<7:0>);
    if rounding then
        round_const = 1 << (-shift - 1); // 0 for left shift, 2^(n-1) for right shift
    element = (Int(Elem[operand1, e, esize], unsigned) + round_const) << shift;
    if saturating then
        (Elem[result, e, esize], sat) = SatQ(element, esize, unsigned);
        if sat then FPSR.QC = '1';
    else
        Elem[result, e, esize] = element<esize-1:0>;

V[d] = result;
    
```

C6.3.270 SSHLL, SSHLL2

Signed shift left long (immediate)

This instruction is used by the alias *SXTL*. See the *Alias conditions* table for details of when each alias is preferred.

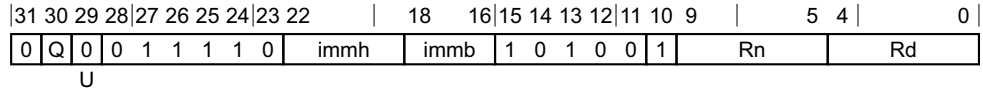

Vector variant

SSHLL{2} <Vd>.<Ta>, <Vn>.<Tb>, #<shift>

```
integer d = UInt(Rd);
integer n = UInt(Rn);

if immh == '0000' then AdvSIMD modified immediate;
if immh<3> == '1' then ReservedValue();
integer esize = 8 << HighestSetBit(immh);
integer datasize = 64;
integer part = UInt(Q);
integer elements = datasize DIV esize;

integer shift = UInt(immh:immb) - esize;
boolean unsigned = (U == '1');
```

Alias conditions

Alias	is preferred when
<i>SXTL</i>	BitCount(immh) == 1 && immb == '000'

Assembler Symbols

- 2 Is the second and upper half specifier. If present it causes the operation to be performed on the upper 64 bits of the registers holding the narrower elements, and is
 - [absent]** when Q = 0
 - [present]** when Q = 1
- <Vd> Is the name of the SIMD&FP destination register, encoded in the "Rd" field.
- <Ta> Is an arrangement specifier,
 - See **AdvSIMD modified immediate**, when immh = 0000
 - 8H** when immh = 0001
 - 4S** when immh = 001x
 - 2D** when immh = 01xx
 - RESERVED** when immh = 1xxx
- <Vn> Is the name of the SIMD&FP source register, encoded in the "Rn" field.
- <Tb> Is an arrangement specifier,
 - See **AdvSIMD modified immediate**, when immh = 0000, Q = x
 - 8B** when immh = 0001, Q = 0
 - 16B** when immh = 0001, Q = 1

4H when immh = 001x, Q = 0
8H when immh = 001x, Q = 1
2S when immh = 01xx, Q = 0
4S when immh = 01xx, Q = 1
RESERVED when immh = 1xxx, Q = x

<shift> Is a shift amount, in the range 0 to element bits - 1,
See [AdvSIMD modified immediate](#), when immh = 0000
(UInt(immh:immb)-8) when immh = 0001
(UInt(immh:immb)-16) when immh = 001x
(UInt(immh:immb)-32) when immh = 01xx
RESERVED when immh = 1xxx

Operation

```
CheckFPAdvSIMDEnabled64();
bits(datasize) operand = Vpart[n, part];
bits(datasize*2) result;
integer element;

for e = 0 to elements-1
    element = Int(Elem[operand, e, esize], unsigned) << shift;
    Elem[result, e, 2*esize] = element<2*esize-1:0>;

V[d] = result;
```

C6.3.271 SSHR

Signed shift right (immediate)

It has encodings from 2 classes: *Scalar* and *Vector*

Scalar

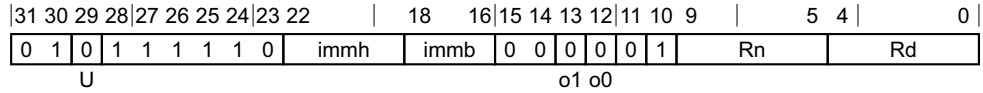

Scalar variant

SSHR <V><d>, <V><n>, #<shift>

```
integer d = UInt(Rd);
integer n = UInt(Rn);

if immh<3> != '1' then ReservedValue();
integer esize = 8 << 3;
integer datasize = esize;
integer elements = 1;

integer shift = (esize * 2) - UInt(immh:immb);
boolean unsigned = (U == '1');
boolean round = (o1 == '1');
boolean accumulate = (o0 == '1');
```

Vector

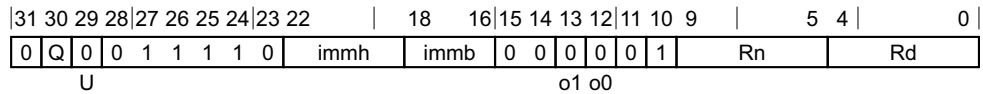

Vector variant

SSHR <Vd>.<T>, <Vn>.<T>, #<shift>

```
integer d = UInt(Rd);
integer n = UInt(Rn);

if immh == '0000' then AdvSIMD modified immediate;
if immh<3>:Q == '10' then ReservedValue();
integer esize = 8 << HighestSetBit(immh);
integer datasize = if Q == '1' then 128 else 64;
integer elements = datasize DIV esize;

integer shift = (esize * 2) - UInt(immh:immb);
boolean unsigned = (U == '1');
boolean round = (o1 == '1');
boolean accumulate = (o0 == '1');
```

Assembler Symbols

- <V> Is a width specifier,
RESERVED when immh = 0xxx
D when immh = 1xxx
- <d> Is the number of the SIMD&FP destination register, in the "Rd" field.
- <n> Is the number of the first SIMD&FP source register, encoded in the "Rn" field.

- <Vd> Is the name of the SIMD&FP destination register, encoded in the "Rd" field.
- <T> Is an arrangement specifier,
 See **AdvSIMD modified immediate**, when immh = 0000, Q = x
8B when immh = 0001, Q = 0
16B when immh = 0001, Q = 1
4H when immh = 001x, Q = 0
8H when immh = 001x, Q = 1
2S when immh = 01xx, Q = 0
4S when immh = 01xx, Q = 1
RESERVED when immh = 1xxx, Q = 0
2D when immh = 1xxx, Q = 1
- <Vn> Is the name of the SIMD&FP source register, encoded in the "Rn" field.
- <shift> For the scalar variant: is the shift amount, in the range 1 to 64,
RESERVED when immh = 0xxx
(128-UInt(immh:immb)) when immh = 1xxx
- <shift> For the vector variant: is a shift amount, in the range 1 to element bits,
 See **AdvSIMD modified immediate**, when immh = 0000
(16-UInt(immh:immb)) when immh = 0001
(32-UInt(immh:immb)) when immh = 001x
(64-UInt(immh:immb)) when immh = 01xx
(128-UInt(immh:immb)) when immh = 1xxx

Operation for all classes

```

CheckFPAdvSIMDEnabled64();
bits(datasize) operand = V[n];
bits(datasize) operand2;
bits(datasize) result;
integer round_const = if round then (1 << (shift - 1)) else 0;
integer element;

operand2 = if accumulate then V[d] else Zeros();
for e = 0 to elements-1
    element = (Int(Elem[operand, e, esize], unsigned) + round_const) >> shift;
    Elem[result, e, esize] = Elem[operand2, e, esize] + element<esize-1:0>;

V[d] = result;
  
```

C6.3.272 SSRA

Signed shift right and accumulate (immediate)

It has encodings from 2 classes: *Scalar* and *Vector*

Scalar

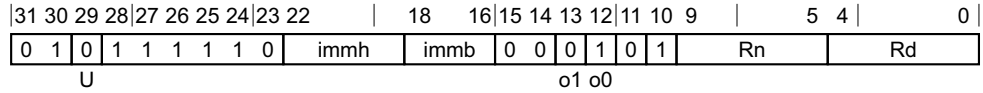

Scalar variant

SSRA <V><d>, <V><n>, #<shift>

```
integer d = UInt(Rd);
integer n = UInt(Rn);

if immh<3> != '1' then ReservedValue();
integer esize = 8 << 3;
integer datasize = esize;
integer elements = 1;

integer shift = (esize * 2) - UInt(immh:immb);
boolean unsigned = (U == '1');
boolean round = (o1 == '1');
boolean accumulate = (o0 == '1');
```

Vector

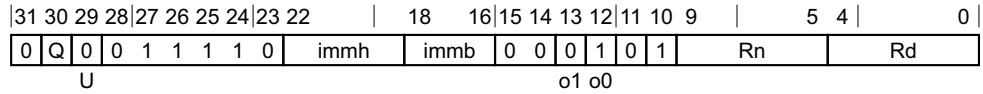

Vector variant

SSRA <Vd>.<T>, <Vn>.<T>, #<shift>

```
integer d = UInt(Rd);
integer n = UInt(Rn);

if immh == '0000' then AdvSIMD modified immediate;
if immh<3>:Q == '10' then ReservedValue();
integer esize = 8 << HighestSetBit(immh);
integer datasize = if Q == '1' then 128 else 64;
integer elements = datasize DIV esize;

integer shift = (esize * 2) - UInt(immh:immb);
boolean unsigned = (U == '1');
boolean round = (o1 == '1');
boolean accumulate = (o0 == '1');
```

Assembler Symbols

- <V> Is a width specifier,
RESERVED when immh = 0xxx
D when immh = 1xxx
- <d> Is the number of the SIMD&FP destination register, in the "Rd" field.
- <n> Is the number of the first SIMD&FP source register, encoded in the "Rn" field.

- <Vd> Is the name of the SIMD&FP destination register, encoded in the "Rd" field.
- <T> Is an arrangement specifier,
 See **AdvSIMD modified immediate**, when immh = 0000, Q = x
8B when immh = 0001, Q = 0
16B when immh = 0001, Q = 1
4H when immh = 001x, Q = 0
8H when immh = 001x, Q = 1
2S when immh = 01xx, Q = 0
4S when immh = 01xx, Q = 1
RESERVED when immh = 1xxx, Q = 0
2D when immh = 1xxx, Q = 1
- <Vn> Is the name of the SIMD&FP source register, encoded in the "Rn" field.
- <shift> For the scalar variant: is the shift amount, in the range 1 to 64,
RESERVED when immh = 0xxx
(128-UInt(immh:immb)) when immh = 1xxx
- <shift> For the vector variant: is a shift amount, in the range 1 to element bits,
 See **AdvSIMD modified immediate**, when immh = 0000
(16-UInt(immh:immb)) when immh = 0001
(32-UInt(immh:immb)) when immh = 001x
(64-UInt(immh:immb)) when immh = 01xx
(128-UInt(immh:immb)) when immh = 1xxx

Operation for all classes

```

CheckFPAdvSIMDEnabled64();
bits(datasize) operand = V[n];
bits(datasize) operand2;
bits(datasize) result;
integer round_const = if round then (1 << (shift - 1)) else 0;
integer element;

operand2 = if accumulate then V[d] else Zeros();
for e = 0 to elements-1
    element = (Int(Elem[operand, e, esize], unsigned) + round_const) >> shift;
    Elem[result, e, esize] = Elem[operand2, e, esize] + element<esize-1:0>;

V[d] = result;
    
```

C6.3.273 SSUBL, SSUBL2

Signed subtract long

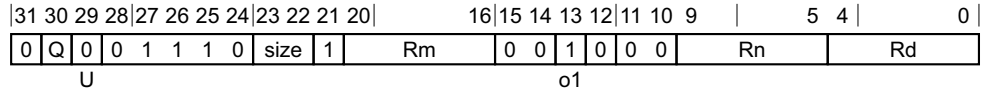

Three registers, not all the same type variant

SSUBL{2} <Vd>.<Ta>, <Vn>.<Tb>, <Vm>.<Tb>

```
integer d = UInt(Rd);
integer n = UInt(Rn);
integer m = UInt(Rm);

if size == '11' then ReservedValue();
integer esize = 8 << UInt(size);
integer datasize = 64;
integer part = UInt(Q);
integer elements = datasize DIV esize;

boolean sub_op = (o1 == '1');
boolean unsigned = (U == '1');
```

Assembler Symbols

- 2 Is the second and upper half specifier. If present it causes the operation to be performed on the upper 64 bits of the registers holding the narrower elements, and is
 - [absent]** when Q = 0
 - [present]** when Q = 1
- <Vd> Is the name of the SIMD&FP destination register, encoded in the "Rd" field.
- <Ta> Is an arrangement specifier,
 - 8H** when size = 00
 - 4S** when size = 01
 - 2D** when size = 10
 - RESERVED** when size = 11
- <Vn> Is the name of the first SIMD&FP source register, encoded in the "Rn" field.
- <Tb> Is an arrangement specifier,
 - 8B** when size = 00, Q = 0
 - 16B** when size = 00, Q = 1
 - 4H** when size = 01, Q = 0
 - 8H** when size = 01, Q = 1
 - 2S** when size = 10, Q = 0
 - 4S** when size = 10, Q = 1
 - RESERVED** when size = 11, Q = x
- <Vm> Is the name of the second SIMD&FP source register, encoded in the "Rm" field.

Operation

```
CheckFPAdvSIMDEnabled64();
bits(datasize) operand1 = Vpart[n, part];
bits(datasize) operand2 = Vpart[m, part];
bits(2*datasize) result;
integer element1;
integer element2;
integer sum;

for e = 0 to elements-1
    element1 = Int(Elem[operand1, e, esize], unsigned);
    element2 = Int(Elem[operand2, e, esize], unsigned);
    if sub_op then
        sum = element1 - element2;
    else
        sum = element1 + element2;
    Elem[result, e, 2*esize] = sum<2*esize-1:0>;

V[d] = result;
```

C6.3.274 SSUBW, SSUBW2

Signed subtract wide

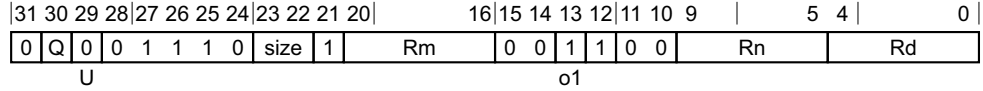

Three registers, not all the same type variant

SSUBW{2} <Vd>.<Ta>, <Vn>.<Ta>, <Vm>.<Tb>

```
integer d = UInt(Rd);
integer n = UInt(Rn);
integer m = UInt(Rm);

if size == '11' then ReservedValue();
integer esize = 8 << UInt(size);
integer datasize = 64;
integer part = UInt(Q);
integer elements = datasize DIV esize;

boolean sub_op = (o1 == '1');
boolean unsigned = (U == '1');
```

Assembler Symbols

- 2 Is the second and upper half specifier. If present it causes the operation to be performed on the upper 64 bits of the registers holding the narrower elements, and is
 - [absent]** when Q = 0
 - [present]** when Q = 1
- <Vd> Is the name of the SIMD&FP destination register, encoded in the "Rd" field.
- <Ta> Is an arrangement specifier,
 - 8H** when size = 00
 - 4S** when size = 01
 - 2D** when size = 10
 - RESERVED** when size = 11
- <Vn> Is the name of the first SIMD&FP source register, encoded in the "Rn" field.
- <Vm> Is the name of the second SIMD&FP source register, encoded in the "Rm" field.
- <Tb> Is an arrangement specifier,
 - 8B** when size = 00, Q = 0
 - 16B** when size = 00, Q = 1
 - 4H** when size = 01, Q = 0
 - 8H** when size = 01, Q = 1
 - 2S** when size = 10, Q = 0
 - 4S** when size = 10, Q = 1
 - RESERVED** when size = 11, Q = x

Operation

```
CheckFPAdvSIMDEnabled64();
bits(2*datasize) operand1 = V[n];
bits(datasize) operand2 = Vpart[m, part];
bits(2*datasize) result;
integer element1;
integer element2;
integer sum;

for e = 0 to elements-1
    element1 = Int(Elem[operand1, e, 2*esize], unsigned);
    element2 = Int(Elem[operand2, e, esize], unsigned);
    if sub_op then
        sum = element1 - element2;
    else
        sum = element1 + element2;
    Elem[result, e, 2*esize] = sum<2*esize-1:0>;

V[d] = result;
```

C6.3.275 ST1 (multiple structures)

Store multiple 1-element structures from one, two three or four registers

It has encodings from 2 classes: *No offset* and *Post-index*

No offset

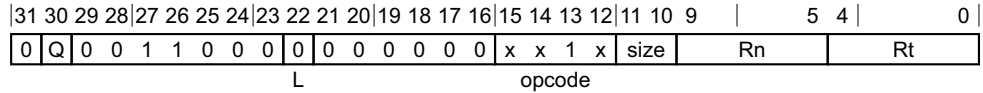

One register variant (opcode = 0111)

ST1 { <Vt>.<T> }, [<Xn|SP>]

Two registers variant (opcode = 1010)

ST1 { <Vt>.<T>, <Vt2>.<T> }, [<Xn|SP>]

Three registers variant (opcode = 0110)

ST1 { <Vt>.<T>, <Vt2>.<T>, <Vt3>.<T> }, [<Xn|SP>]

Four registers variant (opcode = 0010)

ST1 { <Vt>.<T>, <Vt2>.<T>, <Vt3>.<T>, <Vt4>.<T> }, [<Xn|SP>]

```
integer t = UInt(Rt);
integer n = UInt(Rn);
integer m = integer UNKNOWN;
boolean wback = FALSE;
```

Post-index

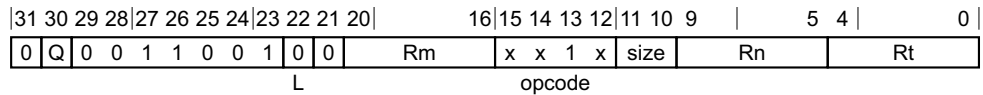

One register, immediate offset variant (Rm = 11111, opcode = 0111)

ST1 { <Vt>.<T> }, [<Xn|SP>], <imm>

One register, register offset variant (Rm != 11111, opcode = 0111)

ST1 { <Vt>.<T> }, [<Xn|SP>], <Xm>

Two registers, immediate offset variant (Rm = 11111, opcode = 1010)

ST1 { <Vt>.<T>, <Vt2>.<T> }, [<Xn|SP>], <imm>

Two registers, register offset variant (Rm != 11111, opcode = 1010)

ST1 { <Vt>.<T>, <Vt2>.<T> }, [<Xn|SP>], <Xm>

Three registers, immediate offset variant (Rm = 11111, opcode = 0110)

ST1 { <Vt>.<T>, <Vt2>.<T>, <Vt3>.<T> }, [<Xn|SP>], <imm>

Three registers, register offset variant (Rm != 11111, opcode = 0110)

ST1 { <Vt>.<T>, <Vt2>.<T>, <Vt3>.<T> }, [<Xn|SP>], <Xm>

Four registers, immediate offset variant (Rm = 11111, opcode = 0010)

ST1 { <Vt>.<T>, <Vt2>.<T>, <Vt3>.<T>, <Vt4>.<T> }, [<Xn|SP>], <imm>

Four registers, register offset variant (Rm != 11111, opcode = 0010)

ST1 { <Vt>.<T>, <Vt2>.<T>, <Vt3>.<T>, <Vt4>.<T> }, [<Xn|SP>], <Xm>

```
integer t = UInt(Rt);
integer n = UInt(Rn);
integer m = UInt(Rm);
boolean wback = TRUE;
```

Assembler Symbols

<Vt>	Is the name of the first or only SIMD&FP register to be transferred, encoded in the "Rt" field.																
<T>	Is an arrangement specifier, <table> <tr> <td>8B</td> <td>when size = 00, Q = 0</td> </tr> <tr> <td>16B</td> <td>when size = 00, Q = 1</td> </tr> <tr> <td>4H</td> <td>when size = 01, Q = 0</td> </tr> <tr> <td>8H</td> <td>when size = 01, Q = 1</td> </tr> <tr> <td>2S</td> <td>when size = 10, Q = 0</td> </tr> <tr> <td>4S</td> <td>when size = 10, Q = 1</td> </tr> <tr> <td>1D</td> <td>when size = 11, Q = 0</td> </tr> <tr> <td>2D</td> <td>when size = 11, Q = 1</td> </tr> </table>	8B	when size = 00, Q = 0	16B	when size = 00, Q = 1	4H	when size = 01, Q = 0	8H	when size = 01, Q = 1	2S	when size = 10, Q = 0	4S	when size = 10, Q = 1	1D	when size = 11, Q = 0	2D	when size = 11, Q = 1
8B	when size = 00, Q = 0																
16B	when size = 00, Q = 1																
4H	when size = 01, Q = 0																
8H	when size = 01, Q = 1																
2S	when size = 10, Q = 0																
4S	when size = 10, Q = 1																
1D	when size = 11, Q = 0																
2D	when size = 11, Q = 1																
<Vt2>	Is the name of the second SIMD&FP register to be transferred, encoded as "Rt" plus 1 modulo 32.																
<Vt3>	Is the name of the third SIMD&FP register to be transferred, encoded as "Rt" plus 2 modulo 32.																
<Vt4>	Is the name of the fourth SIMD&FP register to be transferred, encoded as "Rt" plus 3 modulo 32.																
<Xn SP>	Is the 64-bit name of the general-purpose base register or stack pointer, encoded in the "Rn" field.																
<imm>	For the one register, immediate offset variant: is the post-index immediate offset, <table> <tr> <td>#8</td> <td>when Q = 0</td> </tr> <tr> <td>#16</td> <td>when Q = 1</td> </tr> </table>	#8	when Q = 0	#16	when Q = 1												
#8	when Q = 0																
#16	when Q = 1																
<imm>	For the two registers, immediate offset variant: is the post-index immediate offset, <table> <tr> <td>#16</td> <td>when Q = 0</td> </tr> <tr> <td>#32</td> <td>when Q = 1</td> </tr> </table>	#16	when Q = 0	#32	when Q = 1												
#16	when Q = 0																
#32	when Q = 1																
<imm>	For the three registers, immediate offset variant: is the post-index immediate offset, <table> <tr> <td>#24</td> <td>when Q = 0</td> </tr> <tr> <td>#48</td> <td>when Q = 1</td> </tr> </table>	#24	when Q = 0	#48	when Q = 1												
#24	when Q = 0																
#48	when Q = 1																
<imm>	For the four registers, immediate offset variant: is the post-index immediate offset, <table> <tr> <td>#32</td> <td>when Q = 0</td> </tr> <tr> <td>#64</td> <td>when Q = 1</td> </tr> </table>	#32	when Q = 0	#64	when Q = 1												
#32	when Q = 0																
#64	when Q = 1																
<Xm>	Is the 64-bit name of the general-purpose post-index register, excluding XZR, encoded in the "Rm" field.																

Shared decode for all variants

```
MemOp memop = if L == '1' then MemOp_LOAD else MemOp_STORE;
integer datasize = if Q == '1' then 128 else 64;
integer esize = 8 << UInt(size);
integer elements = datasize DIV esize;

integer rpt; // number of iterations
integer selem; // structure elements

case opcode of
  when '0000' rpt = 1; selem = 4; // LD/ST4 (4 registers)
```

```
when '0010' rpt = 4; selem = 1; // LD/ST1 (4 registers)
when '0100' rpt = 1; selem = 3; // LD/ST3 (3 registers)
when '0110' rpt = 3; selem = 1; // LD/ST1 (3 registers)
when '0111' rpt = 1; selem = 1; // LD/ST1 (1 register)
when '1000' rpt = 1; selem = 2; // LD/ST2 (2 registers)
when '1010' rpt = 2; selem = 1; // LD/ST1 (2 registers)
otherwise UnallocatedEncoding();

// .1D format only permitted with LD1 & ST1
if size:Q == '110' && selem != 1 then ReservedValue();
```

Operation for all classes

```
CheckFPAdvSIMDEnabled64();

bits(64) address;
bits(64) offs;
bits(datasize) rval;
integer e, r, s, tt;
constant integer ebytes = esize DIV 8;

if n == 31 then
    CheckSPAlignment();
    address = SP[];
else
    address = X[n];

offs = Zeros();
for r = 0 to rpt-1
    for e = 0 to elements-1
        tt = (t + r) MOD 32;
        for s = 0 to selem-1
            rval = V[tt];
            if memop == MemOp_LOAD then
                Elem[rval, e, esize] = Mem[address + offs, ebytes, AccType_VEC];
                V[tt] = rval;
            else // memop == MemOp_STORE
                Mem[address + offs, ebytes, AccType_VEC] = Elem[rval, e, esize];
            offs = offs + ebytes;
            tt = (tt + 1) MOD 32;

if wback then
    if m != 31 then
        offs = X[m];
    if n == 31 then
        SP[] = address + offs;
    else
        X[n] = address + offs;
```

C6.3.276 ST1 (single structure)

Store single 1-element structure from one lane of one register

It has encodings from 2 classes: *No offset* and *Post-index*

No offset

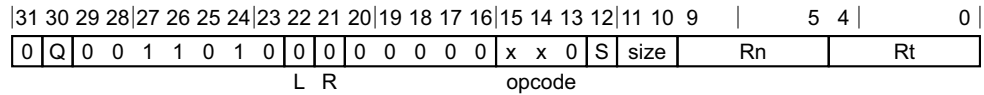

8-bit variant (opcode = 000)

ST1 { <Vt>.B }[<index>], [<Xn|SP>]

16-bit variant (opcode = 010, size = x0)

ST1 { <Vt>.H }[<index>], [<Xn|SP>]

32-bit variant (opcode = 100, size = 00)

ST1 { <Vt>.S }[<index>], [<Xn|SP>]

64-bit variant (opcode = 100, S = 0, size = 01)

ST1 { <Vt>.D }[<index>], [<Xn|SP>]

```
integer t = UInt(Rt);
integer n = UInt(Rn);
integer m = integer UNKNOWN;
boolean wback = FALSE;
```

Post-index

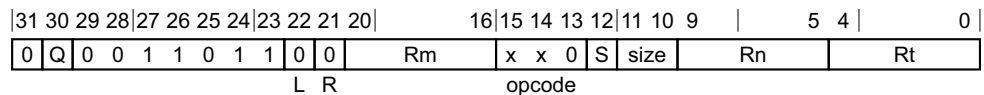

8-bit, immediate offset variant (Rm = 11111, opcode = 000)

ST1 { <Vt>.B }[<index>], [<Xn|SP>], #1

8-bit, register offset variant (Rm != 11111, opcode = 000)

ST1 { <Vt>.B }[<index>], [<Xn|SP>], <Xm>

16-bit, immediate offset variant (Rm = 11111, opcode = 010, size = x0)

ST1 { <Vt>.H }[<index>], [<Xn|SP>], #2

16-bit, register offset variant (Rm != 11111, opcode = 010, size = x0)

ST1 { <Vt>.H }[<index>], [<Xn|SP>], <Xm>

32-bit, immediate offset variant (Rm = 11111, opcode = 100, size = 00)

ST1 { <Vt>.S }[<index>], [<Xn|SP>], #4

32-bit, register offset variant (Rm != 11111, opcode = 100, size = 00)

ST1 { <Vt>.S }[<index>], [<Xn|SP>], <Xm>

64-bit, immediate offset variant (Rm = 11111, opcode = 100, S = 0, size = 01)

ST1 { <Vt>.D }[<index>], [<Xn|SP>], #8

64-bit, register offset variant (Rm != 11111, opcode = 100, S = 0, size = 01)

```
ST1 { <Vt>.D }[<i>index>], [<Xn|SP>], <Xm>
```

```
integer t = UInt(Rt);
integer n = UInt(Rn);
integer m = UInt(Rm);
boolean wback = TRUE;
```

Assembler Symbols

<Vt>	Is the name of the first or only SIMD&FP register to be transferred, encoded in the "Rt" field.
<i>index>	For the 8-bit variant: is the element index, encoded in "Q:S:size".
<i>index>	For the 16-bit variant: is the element index, encoded in "Q:S:size<1>".
<i>index>	For the 32-bit variant: is the element index, encoded in "Q:S".
<i>index>	For the 64-bit variant: is the element index, encoded in "Q".
<Xn SP>	Is the 64-bit name of the general-purpose base register or stack pointer, encoded in the "Rn" field.
<Xm>	Is the 64-bit name of the general-purpose post-index register, excluding XZR, encoded in the "Rm" field.

Shared decode for all variants

```
integer scale = UInt(opcode<2:1>);
integer selem = UInt(opcode<0>:R) + 1;
boolean replicate = FALSE;
integer index;

case scale of
  when 3
    // load and replicate
    if L == '0' || S == '1' then UnallocatedEncoding();
    scale = UInt(size);
    replicate = TRUE;
  when 0
    index = UInt(Q:S:size); // B[0-15]
  when 1
    if size<0> == '1' then UnallocatedEncoding();
    index = UInt(Q:S:size<1>); // H[0-7]
  when 2
    if size<1> == '1' then UnallocatedEncoding();
    if size<0> == '0' then
      index = UInt(Q:S); // S[0-3]
    else
      if S == '1' then UnallocatedEncoding();
      index = UInt(Q); // D[0-1]
      scale = 3;

MemOp memop = if L == '1' then MemOp_LOAD else MemOp_STORE;
integer datasize = if Q == '1' then 128 else 64;
integer esize = 8 << scale;
```

Operation for all classes

```
CheckFPAdvSIMDEnabled64();

bits(64) address;
bits(64) offs;
bits(128) rval;
bits(esize) element;
integer s;
```

```

constant integer ebytes = esize DIV 8;

if n == 31 then
    CheckSPAlignment();
    address = SP[];
else
    address = X[n];

offs = Zeros();
if replicate then
    // load and replicate to all elements
    for s = 0 to selem-1
        element = Mem[address + offs, ebytes, AccType_VEC];
        // replicate to fill 128- or 64-bit register
        V[t] = Replicate(element, datasize DIV esize);
        offs = offs + ebytes;
        t = (t + 1) MOD 32;
else
    // load/store one element per register
    for s = 0 to selem-1
        rval = V[t];
        if memop == MemOp_LOAD then
            // insert into one lane of 128-bit register
            Elem[rval, index, esize] = Mem[address + offs, ebytes, AccType_VEC];
            V[t] = rval;
        else // memop == MemOp_STORE
            // extract from one lane of 128-bit register
            Mem[address + offs, ebytes, AccType_VEC] = Elem[rval, index, esize];
        offs = offs + ebytes;
        t = (t + 1) MOD 32;

if wback then
    if m != 31 then
        offs = X[m];
    if n == 31 then
        SP[] = address + offs;
    else
        X[n] = address + offs;

```

C6.3.277 ST2 (multiple structures)

Store multiple 2-element structures from two registers

It has encodings from 2 classes: *No offset* and *Post-index*

No offset

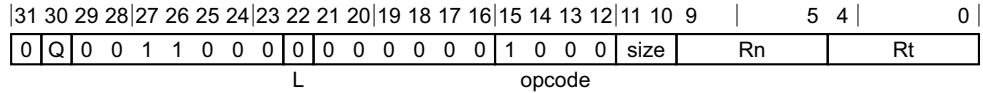

No offset variant

ST2 { <Vt>.<T>, <Vt2>.<T> }, [<Xn|SP>]

```
integer t = UInt(Rt);
integer n = UInt(Rn);
integer m = integer UNKNOWN;
boolean wback = FALSE;
```

Post-index

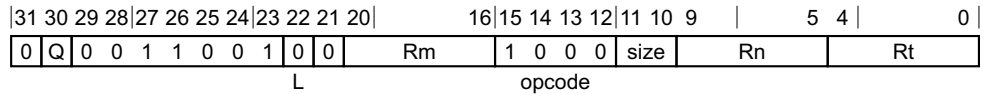

Immediate offset variant (Rm = 11111)

ST2 { <Vt>.<T>, <Vt2>.<T> }, [<Xn|SP>], <imm>

Register offset variant (Rm != 11111)

ST2 { <Vt>.<T>, <Vt2>.<T> }, [<Xn|SP>], <Xm>

```
integer t = UInt(Rt);
integer n = UInt(Rn);
integer m = UInt(Rm);
boolean wback = TRUE;
```

Assembler Symbols

<Vt> Is the name of the first or only SIMD&FP register to be transferred, encoded in the "Rt" field.

<T> Is an arrangement specifier,

8B	when size = 00, Q = 0
16B	when size = 00, Q = 1
4H	when size = 01, Q = 0
8H	when size = 01, Q = 1
2S	when size = 10, Q = 0
4S	when size = 10, Q = 1
RESERVED	when size = 11, Q = 0
2D	when size = 11, Q = 1

<Vt2> Is the name of the second SIMD&FP register to be transferred, encoded as "Rt" plus 1 modulo 32.

<Xn|SP> Is the 64-bit name of the general-purpose base register or stack pointer, encoded in the "Rn" field.

<imm> Is the post-index immediate offset,
 #16 when Q = 0
 #32 when Q = 1

<Xm> Is the 64-bit name of the general-purpose post-index register, excluding XZR, encoded in the "Rm" field.

Shared decode for all variants

```
MemOp memop = if L == '1' then MemOp_LOAD else MemOp_STORE;
integer datasize = if Q == '1' then 128 else 64;
integer esize = 8 << UInt(size);
integer elements = datasize DIV esize;

integer rpt; // number of iterations
integer selem; // structure elements

case opcode of
    when '0000' rpt = 1; selem = 4; // LD/ST4 (4 registers)
    when '0010' rpt = 4; selem = 1; // LD/ST1 (4 registers)
    when '0100' rpt = 1; selem = 3; // LD/ST3 (3 registers)
    when '0110' rpt = 3; selem = 1; // LD/ST1 (3 registers)
    when '0111' rpt = 1; selem = 1; // LD/ST1 (1 register)
    when '1000' rpt = 1; selem = 2; // LD/ST2 (2 registers)
    when '1010' rpt = 2; selem = 1; // LD/ST1 (2 registers)
    otherwise UnallocatedEncoding();

// .LD format only permitted with LD1 & ST1
if size:Q == '110' && selem != 1 then ReservedValue();
```

Operation for all classes

```
CheckFPAdvSIMDEnabled64();

bits(64) address;
bits(64) offs;
bits(datasize) rval;
integer e, r, s, tt;
constant integer ebytes = esize DIV 8;

if n == 31 then
    CheckSPAlignment();
    address = SP[];
else
    address = X[n];

offs = Zeros();
for r = 0 to rpt-1
    for e = 0 to elements-1
        tt = (t + r) MOD 32;
        for s = 0 to selem-1
            rval = V[tt];
            if memop == MemOp_LOAD then
                Elem[rval, e, esize] = Mem[address + offs, ebytes, AccType_VEC];
                V[tt] = rval;
            else // memop == MemOp_STORE
                Mem[address + offs, ebytes, AccType_VEC] = Elem[rval, e, esize];
            offs = offs + ebytes;
            tt = (tt + 1) MOD 32;

if wback then
    if m != 31 then
        offs = X[m];
    if n == 31 then
```

```
    SP[] = address + ofs;  
else  
    X[n] = address + ofs;
```

C6.3.278 ST2 (single structure)

Store single 2-element structure from one lane of two registers

It has encodings from 2 classes: *No offset* and *Post-index*

No offset

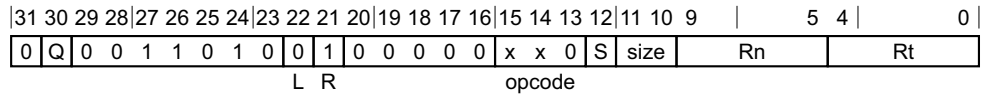

8-bit variant (opcode = 000)

ST2 { <Vt>.B, <Vt2>.B }[<index>], [<Xn|SP>]

16-bit variant (opcode = 010, size = x0)

ST2 { <Vt>.H, <Vt2>.H }[<index>], [<Xn|SP>]

32-bit variant (opcode = 100, size = 00)

ST2 { <Vt>.S, <Vt2>.S }[<index>], [<Xn|SP>]

64-bit variant (opcode = 100, S = 0, size = 01)

ST2 { <Vt>.D, <Vt2>.D }[<index>], [<Xn|SP>]

```
integer t = UInt(Rt);
integer n = UInt(Rn);
integer m = integer UNKNOWN;
boolean wback = FALSE;
```

Post-index

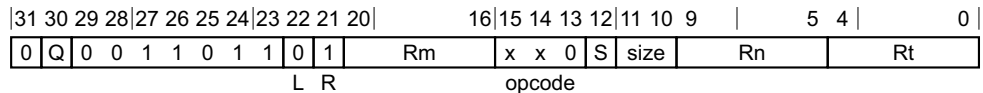

8-bit, immediate offset variant (Rm = 11111, opcode = 000)

ST2 { <Vt>.B, <Vt2>.B }[<index>], [<Xn|SP>], #2

8-bit, register offset variant (Rm != 11111, opcode = 000)

ST2 { <Vt>.B, <Vt2>.B }[<index>], [<Xn|SP>], <Xm>

16-bit, immediate offset variant (Rm = 11111, opcode = 010, size = x0)

ST2 { <Vt>.H, <Vt2>.H }[<index>], [<Xn|SP>], #4

16-bit, register offset variant (Rm != 11111, opcode = 010, size = x0)

ST2 { <Vt>.H, <Vt2>.H }[<index>], [<Xn|SP>], <Xm>

32-bit, immediate offset variant (Rm = 11111, opcode = 100, size = 00)

ST2 { <Vt>.S, <Vt2>.S }[<index>], [<Xn|SP>], #8

32-bit, register offset variant (Rm != 11111, opcode = 100, size = 00)

ST2 { <Vt>.S, <Vt2>.S }[<index>], [<Xn|SP>], <Xm>

64-bit, immediate offset variant (Rm = 11111, opcode = 100, S = 0, size = 01)

ST2 { <Vt>.D, <Vt2>.D }[<index>], [<Xn|SP>], #16

64-bit, register offset variant (Rm != 11111, opcode = 100, S = 0, size = 01)

```
ST2 { <Vt>.D, <Vt2>.D }[<index>], [<Xn|SP>], <Xm>
```

```
integer t = UInt(Rt);
integer n = UInt(Rn);
integer m = UInt(Rm);
boolean wback = TRUE;
```

Assembler Symbols

<Vt>	Is the name of the first or only SIMD&FP register to be transferred, encoded in the "Rt" field.
<Vt2>	Is the name of the second SIMD&FP register to be transferred, encoded as "Rt" plus 1 modulo 32.
<index>	For the 8-bit variant: is the element index, encoded in "Q:S:size".
<index>	For the 16-bit variant: is the element index, encoded in "Q:S:size<1>".
<index>	For the 32-bit variant: is the element index, encoded in "Q:S".
<index>	For the 64-bit variant: is the element index, encoded in "Q".
<Xn SP>	Is the 64-bit name of the general-purpose base register or stack pointer, encoded in the "Rn" field.
<Xm>	Is the 64-bit name of the general-purpose post-index register, excluding XZR, encoded in the "Rm" field.

Shared decode for all variants

```
integer scale = UInt(opcode<2:1>);
integer selem = UInt(opcode<0>:R) + 1;
boolean replicate = FALSE;
integer index;

case scale of
    when 3
        // load and replicate
        if L == '0' || S == '1' then UnallocatedEncoding();
        scale = UInt(size);
        replicate = TRUE;
    when 0
        index = UInt(Q:S:size); // B[0-15]
    when 1
        if size<0> == '1' then UnallocatedEncoding();
        index = UInt(Q:S:size<1>); // H[0-7]
    when 2
        if size<1> == '1' then UnallocatedEncoding();
        if size<0> == '0' then
            index = UInt(Q:S); // S[0-3]
        else
            if S == '1' then UnallocatedEncoding();
            index = UInt(Q); // D[0-1]
            scale = 3;

MemOp memop = if L == '1' then MemOp_LOAD else MemOp_STORE;
integer datasize = if Q == '1' then 128 else 64;
integer esize = 8 << scale;
```

Operation for all classes

```
CheckFPAdvSIMDEnabled64();

bits(64) address;
bits(64) offs;
bits(128) rval;
```

```

bits(eseize) element;
integer s;
constant integer ebytes = esize DIV 8;

if n == 31 then
    CheckSPAAlignment();
    address = SP[];
else
    address = X[n];

offs = Zeros();
if replicate then
    // load and replicate to all elements
    for s = 0 to selem-1
        element = Mem[address + offs, ebytes, AccType_VEC];
        // replicate to fill 128- or 64-bit register
        V[t] = Replicate(element, datasize DIV esize);
        offs = offs + ebytes;
        t = (t + 1) MOD 32;
else
    // load/store one element per register
    for s = 0 to selem-1
        rval = V[t];
        if memop == MemOp_LOAD then
            // insert into one lane of 128-bit register
            Elem[rval, index, esize] = Mem[address + offs, ebytes, AccType_VEC];
            V[t] = rval;
        else // memop == MemOp_STORE
            // extract from one lane of 128-bit register
            Mem[address + offs, ebytes, AccType_VEC] = Elem[rval, index, esize];
            offs = offs + ebytes;
            t = (t + 1) MOD 32;

if wback then
    if m != 31 then
        offs = X[m];
    if n == 31 then
        SP[] = address + offs;
    else
        X[n] = address + offs;
    
```

C6.3.279 ST3 (multiple structures)

Store multiple 3-element structures from three registers

It has encodings from 2 classes: *No offset* and *Post-index*

No offset

31	30	29	28	27	26	25	24	23	22	21	20	19	18	17	16	15	14	13	12	11	10	9				5	4			0
0	Q	0	0	1	1	0	0	0	0	0	0	0	0	0	0	0	1	0	0	size	Rn			Rt						
L											opcode																			

No offset variant

ST3 { <Vt>.<T>, <Vt2>.<T>, <Vt3>.<T> }, [<Xn|SP>]

```
integer t = UInt(Rt);
integer n = UInt(Rn);
integer m = integer UNKNOWN;
boolean wback = FALSE;
```

Post-index

31	30	29	28	27	26	25	24	23	22	21	20					16	15	14	13	12	11	10	9				5	4			0
0	Q	0	0	1	1	0	0	1	0	0	Rm						0	1	0	0	size	Rn			Rt						
L											opcode																				

Immediate offset variant (Rm = 11111)

ST3 { <Vt>.<T>, <Vt2>.<T>, <Vt3>.<T> }, [<Xn|SP>], <imm>

Register offset variant (Rm != 11111)

ST3 { <Vt>.<T>, <Vt2>.<T>, <Vt3>.<T> }, [<Xn|SP>], <Xm>

```
integer t = UInt(Rt);
integer n = UInt(Rn);
integer m = UInt(Rm);
boolean wback = TRUE;
```

Assembler Symbols

- <Vt> Is the name of the first or only SIMD&FP register to be transferred, encoded in the "Rt" field.
- <T> Is an arrangement specifier,
 - 8B** when size = 00, Q = 0
 - 16B** when size = 00, Q = 1
 - 4H** when size = 01, Q = 0
 - 8H** when size = 01, Q = 1
 - 2S** when size = 10, Q = 0
 - 4S** when size = 10, Q = 1
 - RESERVED** when size = 11, Q = 0
 - 2D** when size = 11, Q = 1
- <Vt2> Is the name of the second SIMD&FP register to be transferred, encoded as "Rt" plus 1 modulo 32.
- <Vt3> Is the name of the third SIMD&FP register to be transferred, encoded as "Rt" plus 2 modulo 32.
- <Xn|SP> Is the 64-bit name of the general-purpose base register or stack pointer, encoded in the "Rn" field.

<imm> Is the post-index immediate offset,
 #24 when Q = 0
 #48 when Q = 1

<Xm> Is the 64-bit name of the general-purpose post-index register, excluding XZR, encoded in the "Rm" field.

Shared decode for all variants

```
MemOp memop = if L == '1' then MemOp_LOAD else MemOp_STORE;
integer datasize = if Q == '1' then 128 else 64;
integer esize = 8 << UInt(size);
integer elements = datasize DIV esize;

integer rpt; // number of iterations
integer selem; // structure elements

case opcode of
    when '0000' rpt = 1; selem = 4; // LD/ST4 (4 registers)
    when '0010' rpt = 4; selem = 1; // LD/ST1 (4 registers)
    when '0100' rpt = 1; selem = 3; // LD/ST3 (3 registers)
    when '0110' rpt = 3; selem = 1; // LD/ST1 (3 registers)
    when '0111' rpt = 1; selem = 1; // LD/ST1 (1 register)
    when '1000' rpt = 1; selem = 2; // LD/ST2 (2 registers)
    when '1010' rpt = 2; selem = 1; // LD/ST1 (2 registers)
    otherwise UnallocatedEncoding();

// .LD format only permitted with LD1 & ST1
if size:Q == '110' && selem != 1 then ReservedValue();
```

Operation for all classes

```
CheckFPAdvSIMDEnabled64();

bits(64) address;
bits(64) offs;
bits(datasize) rval;
integer e, r, s, tt;
constant integer ebytes = esize DIV 8;

if n == 31 then
    CheckSPAlignment();
    address = SP[];
else
    address = X[n];

offs = Zeros();
for r = 0 to rpt-1
    for e = 0 to elements-1
        tt = (t + r) MOD 32;
        for s = 0 to selem-1
            rval = V[tt];
            if memop == MemOp_LOAD then
                Elem[rval, e, esize] = Mem[address + offs, ebytes, AccType_VEC];
                V[tt] = rval;
            else // memop == MemOp_STORE
                Mem[address + offs, ebytes, AccType_VEC] = Elem[rval, e, esize];
            offs = offs + ebytes;
            tt = (tt + 1) MOD 32;

if wback then
    if m != 31 then
        offs = X[m];
    if n == 31 then
```

```
    SP[] = address + ofs;  
else  
    X[n] = address + ofs;
```

C6.3.280 ST3 (single structure)

Store single 3-element structure from one lane of three registers

It has encodings from 2 classes: *No offset* and *Post-index*

No offset

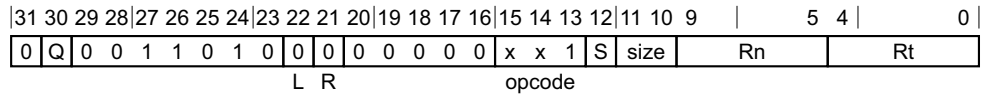

8-bit variant (opcode = 001)

ST3 { <Vt>.B, <Vt2>.B, <Vt3>.B }[<index>], [<Xn|SP>]

16-bit variant (opcode = 011, size = x0)

ST3 { <Vt>.H, <Vt2>.H, <Vt3>.H }[<index>], [<Xn|SP>]

32-bit variant (opcode = 101, size = 00)

ST3 { <Vt>.S, <Vt2>.S, <Vt3>.S }[<index>], [<Xn|SP>]

64-bit variant (opcode = 101, S = 0, size = 01)

ST3 { <Vt>.D, <Vt2>.D, <Vt3>.D }[<index>], [<Xn|SP>]

```
integer t = UInt(Rt);
integer n = UInt(Rn);
integer m = integer UNKNOWN;
boolean wback = FALSE;
```

Post-index

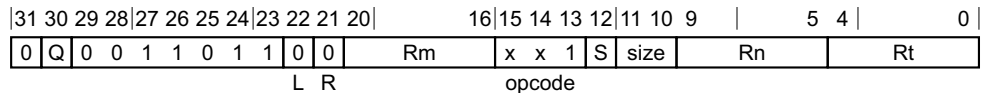

8-bit, immediate offset variant (Rm = 11111, opcode = 001)

ST3 { <Vt>.B, <Vt2>.B, <Vt3>.B }[<index>], [<Xn|SP>], #3

8-bit, register offset variant (Rm != 11111, opcode = 001)

ST3 { <Vt>.B, <Vt2>.B, <Vt3>.B }[<index>], [<Xn|SP>], <Xm>

16-bit, immediate offset variant (Rm = 11111, opcode = 011, size = x0)

ST3 { <Vt>.H, <Vt2>.H, <Vt3>.H }[<index>], [<Xn|SP>], #6

16-bit, register offset variant (Rm != 11111, opcode = 011, size = x0)

ST3 { <Vt>.H, <Vt2>.H, <Vt3>.H }[<index>], [<Xn|SP>], <Xm>

32-bit, immediate offset variant (Rm = 11111, opcode = 101, size = 00)

ST3 { <Vt>.S, <Vt2>.S, <Vt3>.S }[<index>], [<Xn|SP>], #12

32-bit, register offset variant (Rm != 11111, opcode = 101, size = 00)

ST3 { <Vt>.S, <Vt2>.S, <Vt3>.S }[<index>], [<Xn|SP>], <Xm>

64-bit, immediate offset variant (Rm = 11111, opcode = 101, S = 0, size = 01)

ST3 { <Vt>.D, <Vt2>.D, <Vt3>.D }[<index>], [<Xn|SP>], #24

64-bit, register offset variant (Rm != 11111, opcode = 101, S = 0, size = 01)

```
ST3 { <Vt>.D, <Vt2>.D, <Vt3>.D } [<index>], [<Xn|SP>], <Xm>
```

```
integer t = UInt(Rt);
integer n = UInt(Rn);
integer m = UInt(Rm);
boolean wback = TRUE;
```

Assembler Symbols

<Vt>	Is the name of the first or only SIMD&FP register to be transferred, encoded in the "Rt" field.
<Vt2>	Is the name of the second SIMD&FP register to be transferred, encoded as "Rt" plus 1 modulo 32.
<Vt3>	Is the name of the third SIMD&FP register to be transferred, encoded as "Rt" plus 2 modulo 32.
<index>	For the 8-bit variant: is the element index, encoded in "Q:S:size".
<index>	For the 16-bit variant: is the element index, encoded in "Q:S:size<1>".
<index>	For the 32-bit variant: is the element index, encoded in "Q:S".
<index>	For the 64-bit variant: is the element index, encoded in "Q".
<Xn SP>	Is the 64-bit name of the general-purpose base register or stack pointer, encoded in the "Rn" field.
<Xm>	Is the 64-bit name of the general-purpose post-index register, excluding XZR, encoded in the "Rm" field.

Shared decode for all variants

```
integer scale = UInt(opcode<2:1>);
integer selem = UInt(opcode<0>:R) + 1;
boolean replicate = FALSE;
integer index;

case scale of
  when 3
    // load and replicate
    if L == '0' || S == '1' then UnallocatedEncoding();
    scale = UInt(size);
    replicate = TRUE;
  when 0
    index = UInt(Q:S:size); // B[0-15]
  when 1
    if size<0> == '1' then UnallocatedEncoding();
    index = UInt(Q:S:size<1>); // H[0-7]
  when 2
    if size<1> == '1' then UnallocatedEncoding();
    if size<0> == '0' then
      index = UInt(Q:S); // S[0-3]
    else
      if S == '1' then UnallocatedEncoding();
      index = UInt(Q); // D[0-1]
      scale = 3;

MemOp memop = if L == '1' then MemOp_LOAD else MemOp_STORE;
integer datasize = if Q == '1' then 128 else 64;
integer esize = 8 << scale;
```

Operation for all classes

```
CheckFPAdvSIMDEnabled64();
```

```
bits(64) address;
```



```

bits(64) offs;
bits(128) rval;
bits(esize) element;
integer s;
constant integer ebytes = esize DIV 8;

if n == 31 then
    CheckSPAlignment();
    address = SP[];
else
    address = X[n];

offs = Zeros();
if replicate then
    // load and replicate to all elements
    for s = 0 to selem-1
        element = Mem[address + offs, ebytes, AccType_VEC];
        // replicate to fill 128- or 64-bit register
        V[t] = Replicate(element, datasize DIV esize);
        offs = offs + ebytes;
        t = (t + 1) MOD 32;
else
    // load/store one element per register
    for s = 0 to selem-1
        rval = V[t];
        if memop == MemOp_LOAD then
            // insert into one lane of 128-bit register
            Elem[rval, index, esize] = Mem[address + offs, ebytes, AccType_VEC];
            V[t] = rval;
        else // memop == MemOp_STORE
            // extract from one lane of 128-bit register
            Mem[address + offs, ebytes, AccType_VEC] = Elem[rval, index, esize];
        offs = offs + ebytes;
        t = (t + 1) MOD 32;

if wback then
    if m != 31 then
        offs = X[m];
    if n == 31 then
        SP[] = address + offs;
    else
        X[n] = address + offs;
    
```

C6.3.281 ST4 (multiple structures)

Store multiple 4-element structures from four registers

It has encodings from 2 classes: *No offset* and *Post-index*

No offset

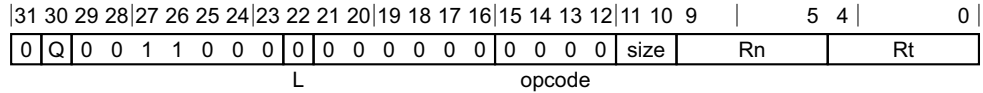

No offset variant

ST4 { <Vt>.<T>, <Vt2>.<T>, <Vt3>.<T>, <Vt4>.<T> }, [<Xn|SP>]

```
integer t = UInt(Rt);
integer n = UInt(Rn);
integer m = integer UNKNOWN;
boolean wback = FALSE;
```

Post-index

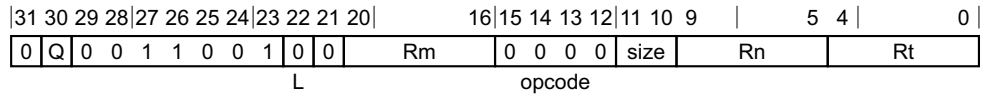

Immediate offset variant (Rm = 11111)

ST4 { <Vt>.<T>, <Vt2>.<T>, <Vt3>.<T>, <Vt4>.<T> }, [<Xn|SP>], <imm>

Register offset variant (Rm != 11111)

ST4 { <Vt>.<T>, <Vt2>.<T>, <Vt3>.<T>, <Vt4>.<T> }, [<Xn|SP>], <Xm>

```
integer t = UInt(Rt);
integer n = UInt(Rn);
integer m = UInt(Rm);
boolean wback = TRUE;
```

Assembler Symbols

- <Vt> Is the name of the first or only SIMD&FP register to be transferred, encoded in the "Rt" field.
- <T> Is an arrangement specifier,
 - 8B** when size = 00, Q = 0
 - 16B** when size = 00, Q = 1
 - 4H** when size = 01, Q = 0
 - 8H** when size = 01, Q = 1
 - 2S** when size = 10, Q = 0
 - 4S** when size = 10, Q = 1
 - RESERVED** when size = 11, Q = 0
 - 2D** when size = 11, Q = 1
- <Vt2> Is the name of the second SIMD&FP register to be transferred, encoded as "Rt" plus 1 modulo 32.
- <Vt3> Is the name of the third SIMD&FP register to be transferred, encoded as "Rt" plus 2 modulo 32.
- <Vt4> Is the name of the fourth SIMD&FP register to be transferred, encoded as "Rt" plus 3 modulo 32.

<Xn|SP> Is the 64-bit name of the general-purpose base register or stack pointer, encoded in the "Rn" field.

<imm> Is the post-index immediate offset,
 #32 when Q = 0
 #64 when Q = 1

<Xm> Is the 64-bit name of the general-purpose post-index register, excluding XZR, encoded in the "Rm" field.

Shared decode for all variants

```
MemOp memop = if L == '1' then MemOp_LOAD else MemOp_STORE;
integer datasize = if Q == '1' then 128 else 64;
integer esize = 8 << UInt(size);
integer elements = datasize DIV esize;

integer rpt; // number of iterations
integer selem; // structure elements

case opcode of
    when '0000' rpt = 1; selem = 4; // LD/ST4 (4 registers)
    when '0010' rpt = 4; selem = 1; // LD/ST1 (4 registers)
    when '0100' rpt = 1; selem = 3; // LD/ST3 (3 registers)
    when '0110' rpt = 3; selem = 1; // LD/ST1 (3 registers)
    when '0111' rpt = 1; selem = 1; // LD/ST1 (1 register)
    when '1000' rpt = 1; selem = 2; // LD/ST2 (2 registers)
    when '1010' rpt = 2; selem = 1; // LD/ST1 (2 registers)
    otherwise UnallocatedEncoding();

// .1D format only permitted with LD1 & ST1
if size:Q == '110' && selem != 1 then ReservedValue();
```

Operation for all classes

```
CheckFPAdvSIMDEnabled64();

bits(64) address;
bits(64) offs;
bits(datasize) rval;
integer e, r, s, tt;
constant integer ebytes = esize DIV 8;

if n == 31 then
    CheckSPAlignment();
    address = SP[];
else
    address = X[n];

offs = Zeros();
for r = 0 to rpt-1
    for e = 0 to elements-1
        tt = (t + r) MOD 32;
        for s = 0 to selem-1
            rval = V[tt];
            if memop == MemOp_LOAD then
                Elem[rval, e, esize] = Mem[address + offs, ebytes, AccType_VEC];
                V[tt] = rval;
            else // memop == MemOp_STORE
                Mem[address + offs, ebytes, AccType_VEC] = Elem[rval, e, esize];
            offs = offs + ebytes;
            tt = (tt + 1) MOD 32;

if wback then
    if m != 31 then
        offs = X[m];
```

```
if n == 31 then
    SP[] = address + offs;
else
    X[n] = address + offs;
```

C6.3.282 ST4 (single structure)

Store single 4-element structure from one lane of four registers

It has encodings from 2 classes: *No offset* and *Post-index*

No offset

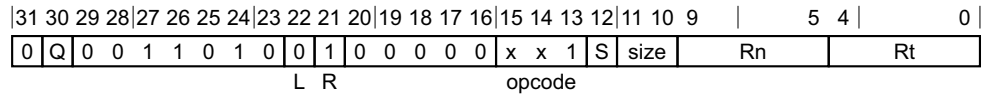

8-bit variant (opcode = 001)

ST4 { <Vt>.B, <Vt2>.B, <Vt3>.B, <Vt4>.B }[<index>], [<Xn|SP>]

16-bit variant (opcode = 011, size = x0)

ST4 { <Vt>.H, <Vt2>.H, <Vt3>.H, <Vt4>.H }[<index>], [<Xn|SP>]

32-bit variant (opcode = 101, size = 00)

ST4 { <Vt>.S, <Vt2>.S, <Vt3>.S, <Vt4>.S }[<index>], [<Xn|SP>]

64-bit variant (opcode = 101, S = 0, size = 01)

ST4 { <Vt>.D, <Vt2>.D, <Vt3>.D, <Vt4>.D }[<index>], [<Xn|SP>]

```
integer t = UInt(Rt);
integer n = UInt(Rn);
integer m = integer UNKNOWN;
boolean wback = FALSE;
```

Post-index

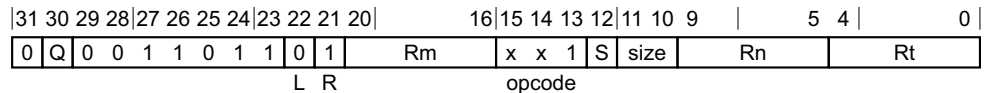

8-bit, immediate offset variant (Rm = 11111, opcode = 001)

ST4 { <Vt>.B, <Vt2>.B, <Vt3>.B, <Vt4>.B }[<index>], [<Xn|SP>], #4

8-bit, register offset variant (Rm != 11111, opcode = 001)

ST4 { <Vt>.B, <Vt2>.B, <Vt3>.B, <Vt4>.B }[<index>], [<Xn|SP>], <Xm>

16-bit, immediate offset variant (Rm = 11111, opcode = 011, size = x0)

ST4 { <Vt>.H, <Vt2>.H, <Vt3>.H, <Vt4>.H }[<index>], [<Xn|SP>], #8

16-bit, register offset variant (Rm != 11111, opcode = 011, size = x0)

ST4 { <Vt>.H, <Vt2>.H, <Vt3>.H, <Vt4>.H }[<index>], [<Xn|SP>], <Xm>

32-bit, immediate offset variant (Rm = 11111, opcode = 101, size = 00)

ST4 { <Vt>.S, <Vt2>.S, <Vt3>.S, <Vt4>.S }[<index>], [<Xn|SP>], #16

32-bit, register offset variant (Rm != 11111, opcode = 101, size = 00)

ST4 { <Vt>.S, <Vt2>.S, <Vt3>.S, <Vt4>.S }[<index>], [<Xn|SP>], <Xm>

64-bit, immediate offset variant (Rm = 11111, opcode = 101, S = 0, size = 01)

ST4 { <Vt>.D, <Vt2>.D, <Vt3>.D, <Vt4>.D }[<index>], [<Xn|SP>], #32

64-bit, register offset variant (Rm != 11111, opcode = 101, S = 0, size = 01)

ST4 { <Vt>.D, <Vt2>.D, <Vt3>.D, <Vt4>.D }[<index>], [<Xn|SP>], <Xm>

```
integer t = UInt(Rt);
integer n = UInt(Rn);
integer m = UInt(Rm);
boolean wback = TRUE;
```

Assembler Symbols

<Vt>	Is the name of the first or only SIMD&FP register to be transferred, encoded in the "Rt" field.
<Vt2>	Is the name of the second SIMD&FP register to be transferred, encoded as "Rt" plus 1 modulo 32.
<Vt3>	Is the name of the third SIMD&FP register to be transferred, encoded as "Rt" plus 2 modulo 32.
<Vt4>	Is the name of the fourth SIMD&FP register to be transferred, encoded as "Rt" plus 3 modulo 32.
<index>	For the 8-bit variant: is the element index, encoded in "Q:S:size".
<index>	For the 16-bit variant: is the element index, encoded in "Q:S:size<1>".
<index>	For the 32-bit variant: is the element index, encoded in "Q:S".
<index>	For the 64-bit variant: is the element index, encoded in "Q".
<Xn SP>	Is the 64-bit name of the general-purpose base register or stack pointer, encoded in the "Rn" field.
<Xm>	Is the 64-bit name of the general-purpose post-index register, excluding XZR, encoded in the "Rm" field.

Shared decode for all variants

```
integer scale = UInt(opcode<2:1>);
integer selem = UInt(opcode<0>:R) + 1;
boolean replicate = FALSE;
integer index;

case scale of
  when 3
    // load and replicate
    if L == '0' || S == '1' then UnallocatedEncoding();
    scale = UInt(size);
    replicate = TRUE;
  when 0
    index = UInt(Q:S:size); // B[0-15]
  when 1
    if size<0> == '1' then UnallocatedEncoding();
    index = UInt(Q:S:size<1>); // H[0-7]
  when 2
    if size<1> == '1' then UnallocatedEncoding();
    if size<0> == '0' then
      index = UInt(Q:S); // S[0-3]
    else
      if S == '1' then UnallocatedEncoding();
      index = UInt(Q); // D[0-1]
      scale = 3;

MemOp memop = if L == '1' then MemOp_LOAD else MemOp_STORE;
integer datasize = if Q == '1' then 128 else 64;
integer esize = 8 << scale;
```

Operation for all classes

```

CheckFPAdvSIMDEnabled64();

bits(64) address;
bits(64) offs;
bits(128) rval;
bits(esize) element;
integer s;
constant integer ebytes = esize DIV 8;

if n == 31 then
    CheckSPAlignment();
    address = SP[];
else
    address = X[n];

offs = Zeros();
if replicate then
    // load and replicate to all elements
    for s = 0 to selem-1
        element = Mem[address + offs, ebytes, AccType_VEC];
        // replicate to fill 128- or 64-bit register
        V[t] = Replicate(element, datasize DIV esize);
        offs = offs + ebytes;
        t = (t + 1) MOD 32;
else
    // load/store one element per register
    for s = 0 to selem-1
        rval = V[t];
        if memop == MemOp_LOAD then
            // insert into one lane of 128-bit register
            Elem[rval, index, esize] = Mem[address + offs, ebytes, AccType_VEC];
            V[t] = rval;
        else // memop == MemOp_STORE
            // extract from one lane of 128-bit register
            Mem[address + offs, ebytes, AccType_VEC] = Elem[rval, index, esize];
        offs = offs + ebytes;
        t = (t + 1) MOD 32;

if wback then
    if m != 31 then
        offs = X[m];
    if n == 31 then
        SP[] = address + offs;
    else
        X[n] = address + offs;
    
```

C6.3.283 STNP (SIMD&FP)

Store pair of SIMD&FP registers, with non-temporal hint

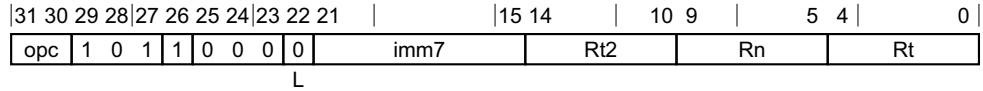

32-bit variant (opc = 00)

STNP <St1>, <St2>, [<Xn|SP>{, #<imm>}]

64-bit variant (opc = 01)

STNP <Dt1>, <Dt2>, [<Xn|SP>{, #<imm>}]

128-bit variant (opc = 10)

STNP <Qt1>, <Qt2>, [<Xn|SP>{, #<imm>}]

boolean wback = FALSE;
 boolean postindex = FALSE;

Assembler Symbols

- <Dt1> Is the 64-bit name of the first SIMD&FP register to be transferred, encoded in the "Rt" field.
- <Dt2> Is the 64-bit name of the second SIMD&FP register to be transferred, encoded in the "Rt2" field.
- <Qt1> Is the 128-bit name of the first SIMD&FP register to be transferred, encoded in the "Rt" field.
- <Qt2> Is the 128-bit name of the second SIMD&FP register to be transferred, encoded in the "Rt2" field.
- <St1> Is the 32-bit name of the first SIMD&FP register to be transferred, encoded in the "Rt" field.
- <St2> Is the 32-bit name of the second SIMD&FP register to be transferred, encoded in the "Rt2" field.
- <Xn|SP> Is the 64-bit name of the general-purpose base register or stack pointer, encoded in the "Rn" field.
- <imm> For the 32-bit variant: is the optional signed immediate byte offset, a multiple of 4 in the range -256 to 252, defaulting to 0 and encoded in the "imm7" field as <imm>/4.
- <imm> For the 64-bit variant: is the optional signed immediate byte offset, a multiple of 8 in the range -512 to 504, defaulting to 0 and encoded in the "imm7" field as <imm>/8.
- <imm> For the 128-bit variant: is the optional signed immediate byte offset, a multiple of 16 in the range -1024 to 1008, defaulting to 0 and encoded in the "imm7" field as <imm>/16.

Shared decode for all variants

```
integer n = UInt(Rn);
integer t = UInt(Rt);
integer t2 = UInt(Rt2);
AccType acctype = AccType_VECSTREAM;
MemOp memop = if L == '1' then MemOp_LOAD else MemOp_STORE;
if opc == '11' then UnallocatedEncoding();
integer scale = 2 + UInt(opc);
integer datasize = 8 << scale;
bits(64) offset = LSL(SignExtend(imm7, 64), scale);
```

Operation

```

CheckFPAdvSIMDEnabled64();

bits(64) address;
bits(datasize) data1;
bits(datasize) data2;
constant integer dbytes = datasize DIV 8;
boolean rt_unknown = FALSE;

if memop == MemOp_LOAD && t == t2 then
    Constraint c = ConstrainUnpredictable();
    assert c IN {Constraint_UNKNOWN, Constraint_UNDEF, Constraint_NOP};
    case c of
        when Constraint_UNKNOWN    rt_unknown = TRUE;    // result is UNKNOWN
        when Constraint_UNDEF      UnallocatedEncoding();
        when Constraint_NOP        EndOfInstruction();

if n == 31 then
    CheckSPAlignment();
    address = SP[];
else
    address = X[n];

if ! postindex then
    address = address + offset;

case memop of
    when MemOp_STORE
        data1 = V[t];
        data2 = V[t2];
        Mem[address + 0      , dbytes, acctype] = data1;
        Mem[address + dbytes, dbytes, acctype] = data2;

    when MemOp_LOAD
        data1 = Mem[address + 0      , dbytes, acctype];
        data2 = Mem[address + dbytes, dbytes, acctype];
        if rt_unknown then
            data1 = bits(datasize) UNKNOWN;
            data2 = bits(datasize) UNKNOWN;
        V[t] = data1;
        V[t2] = data2;

if wback then
    if postindex then
        address = address + offset;
    if n == 31 then
        SP[] = address;
    else
        X[n] = address;
    
```

C6.3.284 STP (SIMD&FP)

Store pair of SIMD&FP registers

It has encodings from 3 classes: *Post-index*, *Pre-index* and *Signed offset*

Post-index

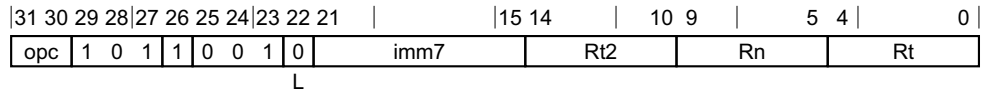

32-bit variant (opc = 00)

STP <St1>, <St2>, [<Xn|SP>], #<imm>

64-bit variant (opc = 01)

STP <Dt1>, <Dt2>, [<Xn|SP>], #<imm>

128-bit variant (opc = 10)

STP <Qt1>, <Qt2>, [<Xn|SP>], #<imm>

boolean wback = TRUE;
 boolean postindex = TRUE;

Pre-index

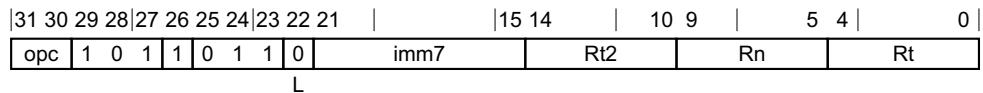

32-bit variant (opc = 00)

STP <St1>, <St2>, [<Xn|SP>, #<imm>]!

64-bit variant (opc = 01)

STP <Dt1>, <Dt2>, [<Xn|SP>, #<imm>]!

128-bit variant (opc = 10)

STP <Qt1>, <Qt2>, [<Xn|SP>, #<imm>]!

boolean wback = TRUE;
 boolean postindex = FALSE;

Signed offset

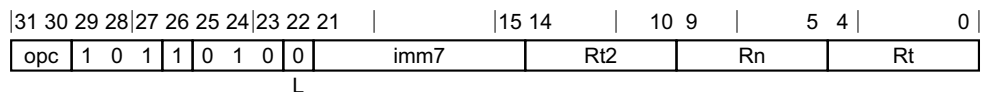

32-bit variant (opc = 00)

STP <St1>, <St2>, [<Xn|SP>{, #<imm>}]

64-bit variant (opc = 01)

STP <Dt1>, <Dt2>, [<Xn|SP>{, #<imm>}]

128-bit variant (opc = 10)

STP <Qt1>, <Qt2>, [<Xn|SP>{, #<imm>}]

```
boolean wback = FALSE;
boolean postindex = FALSE;
```

Assembler Symbols

<Dt1>	Is the 64-bit name of the first SIMD&FP register to be transferred, encoded in the "Rt" field.
<Dt2>	Is the 64-bit name of the second SIMD&FP register to be transferred, encoded in the "Rt2" field.
<Qt1>	Is the 128-bit name of the first SIMD&FP register to be transferred, encoded in the "Rt" field.
<Qt2>	Is the 128-bit name of the second SIMD&FP register to be transferred, encoded in the "Rt2" field.
<St1>	Is the 32-bit name of the first SIMD&FP register to be transferred, encoded in the "Rt" field.
<St2>	Is the 32-bit name of the second SIMD&FP register to be transferred, encoded in the "Rt2" field.
<Xn SP>	Is the 64-bit name of the general-purpose base register or stack pointer, encoded in the "Rn" field.
<imm>	For the 32-bit post-index and 32-bit pre-index variant: is the signed immediate byte offset, a multiple of 4 in the range -256 to 252, encoded in the "imm7" field as <imm>/4.
<imm>	For the 32-bit signed offset variant: is the optional signed immediate byte offset, a multiple of 4 in the range -256 to 252, defaulting to 0 and encoded in the "imm7" field as <imm>/4.
<imm>	For the 64-bit post-index and 64-bit pre-index variant: is the signed immediate byte offset, a multiple of 8 in the range -512 to 504, encoded in the "imm7" field as <imm>/8.
<imm>	For the 64-bit signed offset variant: is the optional signed immediate byte offset, a multiple of 8 in the range -512 to 504, defaulting to 0 and encoded in the "imm7" field as <imm>/8.
<imm>	For the 128-bit post-index and 128-bit pre-index variant: is the signed immediate byte offset, a multiple of 16 in the range -1024 to 1008, encoded in the "imm7" field as <imm>/16.
<imm>	For the 128-bit signed offset variant: is the optional signed immediate byte offset, a multiple of 16 in the range -1024 to 1008, defaulting to 0 and encoded in the "imm7" field as <imm>/16.

Shared decode for all variants

```
integer n = UInt(Rn);
integer t = UInt(Rt);
integer t2 = UInt(Rt2);
AccType acctype = AccType_VEC;
MemOp memop = if L == '1' then MemOp_LOAD else MemOp_STORE;
if opc == '11' then UnallocatedEncoding();
integer scale = 2 + UInt(opc);
integer datasize = 8 << scale;
bits(64) offset = LSL(SignExtend(imm7, 64), scale);
```

Operation for all classes

```
CheckFPAdvSIMDEnabled64();

bits(64) address;
bits(datasize) data1;
bits(datasize) data2;
constant integer dbytes = datasize DIV 8;
boolean rt_unknown = FALSE;

if memop == MemOp_LOAD && t == t2 then
  Constraint c = ConstrainUnpredictable();
  assert c IN {Constraint_UNKNOWN, Constraint_UNDEF, Constraint_NOP};
  case c of
    when Constraint_UNKNOWN    rt_unknown = TRUE;    // result is UNKNOWN
    when Constraint_UNDEF      UnallocatedEncoding();
```

```
        when Constraint_NOP      EndOfInstruction();

if n == 31 then
    CheckSPAlignment();
    address = SP[];
else
    address = X[n];

if ! postindex then
    address = address + offset;

case memop of
    when MemOp_STORE
        data1 = V[t];
        data2 = V[t2];
        Mem[address + 0      , dbytes, acctype] = data1;
        Mem[address + dbytes, dbytes, acctype] = data2;

    when MemOp_LOAD
        data1 = Mem[address + 0      , dbytes, acctype];
        data2 = Mem[address + dbytes, dbytes, acctype];
        if rt_unknown then
            data1 = bits(datasize) UNKNOWN;
            data2 = bits(datasize) UNKNOWN;
        V[t]   = data1;
        V[t2]  = data2;

if wback then
    if postindex then
        address = address + offset;
    if n == 31 then
        SP[] = address;
    else
        X[n] = address;
```

C6.3.285 STR (immediate, SIMD&FP)

Store SIMD&FP register (immediate offset)

It has encodings from 3 classes: *Post-index*, *Pre-index* and *Unsigned offset* on page C6-1288

Post-index



8-bit variant (size = 00, opc = 00)

STR <Bt>, [<Xn|SP>], #<sim>

16-bit variant (size = 01, opc = 00)

STR <Ht>, [<Xn|SP>], #<sim>

32-bit variant (size = 10, opc = 00)

STR <St>, [<Xn|SP>], #<sim>

64-bit variant (size = 11, opc = 00)

STR <Dt>, [<Xn|SP>], #<sim>

128-bit variant (size = 00, opc = 10)

STR <Qt>, [<Xn|SP>], #<sim>

```
boolean wback = TRUE;
boolean postindex = TRUE;
integer scale = UInt(opc<1>:size);
if scale > 4 then UnallocatedEncoding();
bits(64) offset = SignExtend(imm9, 64);
```

Pre-index

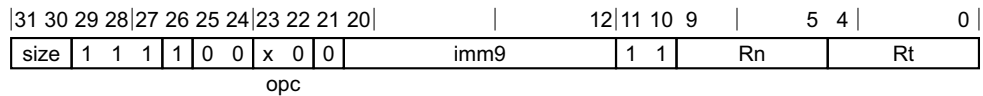

8-bit variant (size = 00, opc = 00)

STR <Bt>, [<Xn|SP>, #<sim>]!

16-bit variant (size = 01, opc = 00)

STR <Ht>, [<Xn|SP>, #<sim>]!

32-bit variant (size = 10, opc = 00)

STR <St>, [<Xn|SP>, #<sim>]!

64-bit variant (size = 11, opc = 00)

STR <Dt>, [<Xn|SP>, #<sim>]!

128-bit variant (size = 00, opc = 10)

STR <Qt>, [<Xn|SP>, #<sim>]!

```
boolean wback = TRUE;
boolean postindex = FALSE;
integer scale = UInt(opc<1>:size);
if scale > 4 then UnallocatedEncoding();
bits(64) offset = SignExtend(imm9, 64);
```

Unsigned offset

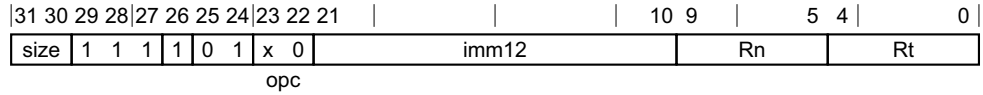

8-bit variant (size = 00, opc = 00)

STR <Bt>, [<Xn|SP>{, #<pimm>}]

16-bit variant (size = 01, opc = 00)

STR <Ht>, [<Xn|SP>{, #<pimm>}]

32-bit variant (size = 10, opc = 00)

STR <St>, [<Xn|SP>{, #<pimm>}]

64-bit variant (size = 11, opc = 00)

STR <Dt>, [<Xn|SP>{, #<pimm>}]

128-bit variant (size = 00, opc = 10)

STR <Qt>, [<Xn|SP>{, #<pimm>}]

```
boolean wback = FALSE;
boolean postindex = FALSE;
integer scale = UInt(opc<1>:size);
if scale > 4 then UnallocatedEncoding();
bits(64) offset = LSL(ZeroExtend(imm12, 64), scale);
```

Assembler Symbols

- <Bt> Is the 8-bit name of the SIMD&FP register to be transferred, encoded in the "Rt" field.
- <Dt> Is the 64-bit name of the SIMD&FP register to be transferred, encoded in the "Rt" field.
- <Ht> Is the 16-bit name of the SIMD&FP register to be transferred, encoded in the "Rt" field.
- <Qt> Is the 128-bit name of the SIMD&FP register to be transferred, encoded in the "Rt" field.
- <St> Is the 32-bit name of the SIMD&FP register to be transferred, encoded in the "Rt" field.
- <Xn|SP> Is the 64-bit name of the general-purpose base register or stack pointer, encoded in the "Rn" field.
- <sim> Is the signed immediate byte offset, in the range -256 to 255, encoded in the "imm9" field.
- <pimm> For the 8-bit variant: is the optional positive immediate byte offset, in the range 0 to 4095, defaulting to 0 and encoded in the "imm12" field.
- <pimm> For the 16-bit variant: is the optional positive immediate byte offset, a multiple of 2 in the range 0 to 8190, defaulting to 0 and encoded in the "imm12" field as <pimm>/2.
- <pimm> For the 32-bit variant: is the optional positive immediate byte offset, a multiple of 4 in the range 0 to 16380, defaulting to 0 and encoded in the "imm12" field as <pimm>/4.
- <pimm> For the 64-bit variant: is the optional positive immediate byte offset, a multiple of 8 in the range 0 to 32760, defaulting to 0 and encoded in the "imm12" field as <pimm>/8.
- <pimm> For the 128-bit variant: is the optional positive immediate byte offset, a multiple of 16 in the range 0 to 65520, defaulting to 0 and encoded in the "imm12" field as <pimm>/16.

Shared decode for all variants

```
integer n = UInt(Rn);
integer t = UInt(Rt);
AccType acctype = AccType_VEC;
MemOp memop = if opc<0> == '1' then MemOp_LOAD else MemOp_STORE;
integer datasize = 8 << scale;
```

Operation for all classes

```
CheckFPAdvSIMDEnabled64();

bits(64) address;
bits(datasize) data;

if n == 31 then
    CheckSPAlignment();
    address = SP[];
else
    address = X[n];

if ! postindex then
    address = address + offset;

case memop of
    when MemOp_STORE
        data = V[t];
        Mem[address, datasize DIV 8, acctype] = data;

    when MemOp_LOAD
        data = Mem[address, datasize DIV 8, acctype];
        V[t] = data;

if wback then
    if postindex then
        address = address + offset;
    if n == 31 then
        SP[] = address;
    else
        X[n] = address;
```

C6.3.286 STR (register, SIMD&FP)

Store SIMD&FP register (register offset)

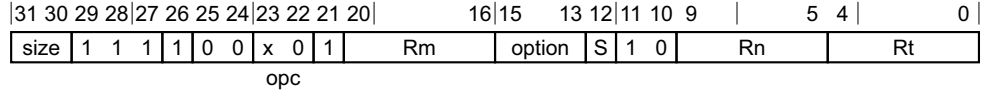

8-bit variant (size = 00, opc = 00)

STR <Bt>, [<Xn|SP>, <R><m>{, <extend> {<amount>}}]

16-bit variant (size = 01, opc = 00)

STR <Ht>, [<Xn|SP>, <R><m>{, <extend> {<amount>}}]

32-bit variant (size = 10, opc = 00)

STR <St>, [<Xn|SP>, <R><m>{, <extend> {<amount>}}]

64-bit variant (size = 11, opc = 00)

STR <Dt>, [<Xn|SP>, <R><m>{, <extend> {<amount>}}]

128-bit variant (size = 00, opc = 10)

STR <Qt>, [<Xn|SP>, <R><m>{, <extend> {<amount>}}]

```
boolean wback = FALSE;
boolean postindex = FALSE;
integer scale = UInt(opc<1>:size);
if scale > 4 then UnallocatedEncoding();
if option<1> == '0' then UnallocatedEncoding(); // sub-word index
ExtendType extend_type = DecodeRegExtend(option);
integer shift = if S == '1' then scale else 0;
```

Assembler Symbols

- <Bt> Is the 8-bit name of the SIMD&FP register to be transferred, encoded in the "Rt" field.
- <Dt> Is the 64-bit name of the SIMD&FP register to be transferred, encoded in the "Rt" field.
- <Ht> Is the 16-bit name of the SIMD&FP register to be transferred, encoded in the "Rt" field.
- <Qt> Is the 128-bit name of the SIMD&FP register to be transferred, encoded in the "Rt" field.
- <St> Is the 32-bit name of the SIMD&FP register to be transferred, encoded in the "Rt" field.
- <Xn|SP> Is the 64-bit name of the general-purpose base register or stack pointer, encoded in the "Rn" field.
- <R> Is the index width specifier,
 - RESERVED** when option = 00x
 - W** when option = x10
 - X** when option = x11
 - RESERVED** when option = 10x
- <m> Is the number [0-30] of the general-purpose index register or the name ZR (31), encoded in the "Rm" field.
- <extend> Is the index extend/shift specifier, defaulting to LSL and
 - RESERVED** when option = 00x
 - UXTW** when option = 010

LSL when option = 011
RESERVED when option = 10x
SXTW when option = 110
SXTX when option = 111

<amount> For the 8-bit variant: is the index shift amount, optional and defaulting to #0 when <extend> is not LSL,
[absent] when S = 0
#0 when S = 1

<amount> For the 16-bit variant: is the index shift amount, optional and defaulting to #0 when <extend> is not LSL,
#0 when S = 0
#1 when S = 1

<amount> For the 32-bit variant: is the index shift amount, optional and defaulting to #0 when <extend> is not LSL,
#0 when S = 0
#2 when S = 1

<amount> For the 64-bit variant: is the index shift amount, optional and defaulting to #0 when <extend> is not LSL,
#0 when S = 0
#3 when S = 1

<amount> For the 128-bit variant: is the index shift amount, optional and defaulting to #0 when <extend> is not LSL,
#0 when S = 0
#4 when S = 1

Shared decode for all variants

```
integer n = UInt(Rn);
integer t = UInt(Rt);
integer m = UInt(Rm);
AccType acctype = AccType_VEC;
MemOp memop = if opc<0> == '1' then MemOp_LOAD else MemOp_STORE;
integer datasize = 8 << scale;
```

Operation

```
bits(64) offset = ExtendReg(m, extend_type, shift);
CheckFPAdvSIMDEnabled64();

bits(64) address;
bits(datasize) data;

if n == 31 then
    CheckSPAlignment();
    address = SP[];
else
    address = X[n];

if ! postindex then
    address = address + offset;

case memop of
    when MemOp_STORE
```

```
        data = V[t];
        Mem[address, datasize DIV 8, acctype] = data;

    when MemOp_LOAD
        data = Mem[address, datasize DIV 8, acctype];
        V[t] = data;

    if wback then
        if postindex then
            address = address + offset;
        if n == 31 then
            SP[] = address;
        else
            X[n] = address;
```

C6.3.287 STUR (SIMD&FP)

Store SIMD&FP register (unscaled offset)



8-bit variant (size = 00, opc = 00)

STUR <Bt>, [<Xn|SP>{, #<sim>}]

16-bit variant (size = 01, opc = 00)

STUR <Ht>, [<Xn|SP>{, #<sim>}]

32-bit variant (size = 10, opc = 00)

STUR <St>, [<Xn|SP>{, #<sim>}]

64-bit variant (size = 11, opc = 00)

STUR <Dt>, [<Xn|SP>{, #<sim>}]

128-bit variant (size = 00, opc = 10)

STUR <Qt>, [<Xn|SP>{, #<sim>}]

```
boolean wback = FALSE;
boolean postindex = FALSE;
integer scale = UInt(opc<1>:size);
if scale > 4 then UnallocatedEncoding();
bits(64) offset = SignExtend(imm9, 64);
```

Assembler Symbols

- <Bt> Is the 8-bit name of the SIMD&FP register to be transferred, encoded in the "Rt" field.
- <Dt> Is the 64-bit name of the SIMD&FP register to be transferred, encoded in the "Rt" field.
- <Ht> Is the 16-bit name of the SIMD&FP register to be transferred, encoded in the "Rt" field.
- <Qt> Is the 128-bit name of the SIMD&FP register to be transferred, encoded in the "Rt" field.
- <St> Is the 32-bit name of the SIMD&FP register to be transferred, encoded in the "Rt" field.
- <Xn|SP> Is the 64-bit name of the general-purpose base register or stack pointer, encoded in the "Rn" field.
- <sim> Is the optional signed immediate byte offset, in the range -256 to 255, defaulting to 0 and encoded in the "imm9" field.

Shared decode for all variants

```
integer n = UInt(Rn);
integer t = UInt(Rt);
AccType acctype = AccType_VEC;
MemOp memop = if opc<0> == '1' then MemOp_LOAD else MemOp_STORE;
integer datasize = 8 << scale;
```

Operation

CheckFPAdvSIMDEnabled64();

bits(64) address;

```
bits(datasize) data;

if n == 31 then
    CheckSPAlignment();
    address = SP[];
else
    address = X[n];

if ! postindex then
    address = address + offset;

case memop of
    when MemOp_STORE
        data = V[t];
        Mem[address, datasize DIV 8, acctype] = data;

    when MemOp_LOAD
        data = Mem[address, datasize DIV 8, acctype];
        V[t] = data;

if wback then
    if postindex then
        address = address + offset;
    if n == 31 then
        SP[] = address;
    else
        X[n] = address;
```

C6.3.288 SUB (vector)

Subtract (vector)

It has encodings from 2 classes: *Scalar* and *Vector*

Scalar

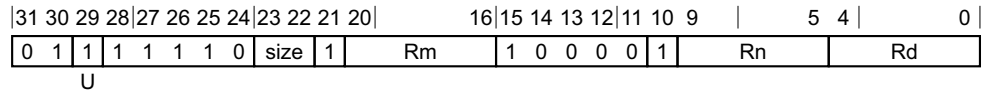

Scalar variant

SUB <V><d>, <V><n>, <V><m>

```
integer d = UInt(Rd);
integer n = UInt(Rn);
integer m = UInt(Rm);
if size != '11' then ReservedValue();
integer esize = 8 << UInt(size);
integer datasize = esize;
integer elements = 1;
boolean sub_op = (U == '1');
```

Vector

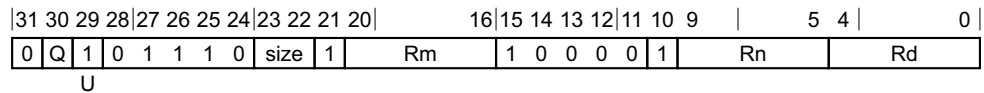

Vector variant

SUB <Vd>.<T>, <Vn>.<T>, <Vm>.<T>

```
integer d = UInt(Rd);
integer n = UInt(Rn);
integer m = UInt(Rm);
if size:Q == '110' then ReservedValue();
integer esize = 8 << UInt(size);
integer datasize = if Q == '1' then 128 else 64;
integer elements = datasize DIV esize;
boolean sub_op = (U == '1');
```

Assembler Symbols

<V>	Is a width specifier, RESERVED when size = 0x RESERVED when size = 10 D when size = 11
<d>	Is the number of the SIMD&FP destination register, in the "Rd" field.
<n>	Is the number of the first SIMD&FP source register, encoded in the "Rn" field.
<m>	Is the number of the second SIMD&FP source register, encoded in the "Rm" field.
<Vd>	Is the name of the SIMD&FP destination register, encoded in the "Rd" field.
<T>	Is an arrangement specifier, 8B when size = 00, Q = 0

16B when size = 00, Q = 1
4H when size = 01, Q = 0
8H when size = 01, Q = 1
2S when size = 10, Q = 0
4S when size = 10, Q = 1
RESERVED when size = 11, Q = 0
2D when size = 11, Q = 1

<Vn> Is the name of the first SIMD&FP source register, encoded in the "Rn" field.

<Vm> Is the name of the second SIMD&FP source register, encoded in the "Rm" field.

Operation for all classes

```
CheckFPAdvSIMDEnabled64();
bits(datasize) operand1 = V[n];
bits(datasize) operand2 = V[m];
bits(datasize) result;
bits(esize) element1;
bits(esize) element2;

for e = 0 to elements-1
    element1 = Elem[operand1, e, esize];
    element2 = Elem[operand2, e, esize];
    if sub_op then
        Elem[result, e, esize] = element1 - element2;
    else
        Elem[result, e, esize] = element1 + element2;

V[d] = result;
```

C6.3.289 SUBHN, SUBHN2

Subtract returning high narrow

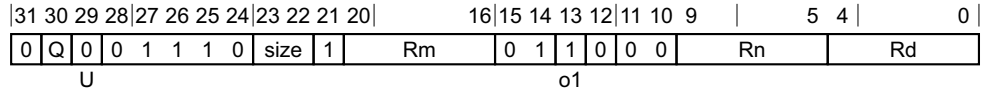

Three registers, not all the same type variant

SUBHN{2} <Vd>.<Tb>, <Vn>.<Ta>, <Vm>.<Ta>

```
integer d = UInt(Rd);
integer n = UInt(Rn);
integer m = UInt(Rm);

if size == '11' then ReservedValue();
integer esize = 8 << UInt(size);
integer datasize = 64;
integer part = UInt(Q);
integer elements = datasize DIV esize;

boolean sub_op = (o1 == '1');
boolean round = (U == '1');
```

Assembler Symbols

- 2 Is the second and upper half specifier. If present it causes the operation to be performed on the upper 64 bits of the registers holding the narrower elements, and is
- [absent]** when Q = 0
 - [present]** when Q = 1
- <Vd> Is the name of the SIMD&FP destination register, encoded in the "Rd" field.
- <Tb> Is an arrangement specifier,
- 8B** when size = 00, Q = 0
 - 16B** when size = 00, Q = 1
 - 4H** when size = 01, Q = 0
 - 8H** when size = 01, Q = 1
 - 2S** when size = 10, Q = 0
 - 4S** when size = 10, Q = 1
 - RESERVED** when size = 11, Q = x
- <Vn> Is the name of the first SIMD&FP source register, encoded in the "Rn" field.
- <Ta> Is an arrangement specifier,
- 8H** when size = 00
 - 4S** when size = 01
 - 2D** when size = 10
 - RESERVED** when size = 11
- <Vm> Is the name of the second SIMD&FP source register, encoded in the "Rm" field.

Operation

```
CheckFPAdvSIMDEnabled64();
bits(2*datasize) operand1 = V[n];
bits(2*datasize) operand2 = V[m];
bits(datasize) result;
integer round_const = if round then 1 << (esize - 1) else 0;
bits(2*esize) element1;
bits(2*esize) element2;
bits(2*esize) sum;

for e = 0 to elements-1
    element1 = Elem[operand1, e, 2*esize];
    element2 = Elem[operand2, e, 2*esize];
    if sub_op then
        sum = element1 - element2;
    else
        sum = element1 + element2;
    sum = sum + round_const;
    Elem[result, e, esize] = sum<2*esize-1:esize>;

Vpart[d, part] = result;
```

C6.3.290 SUQADD

Signed saturating accumulate of unsigned value

It has encodings from 2 classes: *Scalar* and *Vector*

Scalar

31	30	29	28	27	26	25	24	23	22	21	20	19	18	17	16	15	14	13	12	11	10	9				5	4			0
0	1	0	1	1	1	1	0	size	1	0	0	0	0	0	0	0	0	1	1	1	0	Rn			Rd					

U

Scalar variant

SUQADD <V><d>, <V><n>

```
integer d = UInt(Rd);
integer n = UInt(Rn);
```

```
integer esize = 8 << UInt(size);
integer datasize = esize;
integer elements = 1;
```

```
boolean unsigned = (U == '1');
```

Vector

31	30	29	28	27	26	25	24	23	22	21	20	19	18	17	16	15	14	13	12	11	10	9				5	4			0
0	Q	0	0	1	1	1	0	size	1	0	0	0	0	0	0	0	1	1	1	0	Rn			Rd						

U

Vector variant

SUQADD <Vd>.<T>, <Vn>.<T>

```
integer d = UInt(Rd);
integer n = UInt(Rn);
```

```
if size:Q == '110' then ReservedValue();
integer esize = 8 << UInt(size);
integer datasize = if Q == '1' then 128 else 64;
integer elements = datasize DIV esize;
```

```
boolean unsigned = (U == '1');
```

Assembler Symbols

<V>	Is a width specifier, B when size = 00 H when size = 01 S when size = 10 D when size = 11
<d>	Is the number of the SIMD&FP destination register, encoded in the "Rd" field.
<n>	Is the number of the SIMD&FP source register, encoded in the "Rn" field.
<Vd>	Is the name of the SIMD&FP destination register, encoded in the "Rd" field.

<T> Is an arrangement specifier,

- 8B** when size = 00, Q = 0
- 16B** when size = 00, Q = 1
- 4H** when size = 01, Q = 0
- 8H** when size = 01, Q = 1
- 2S** when size = 10, Q = 0
- 4S** when size = 10, Q = 1
- RESERVED** when size = 11, Q = 0
- 2D** when size = 11, Q = 1

<Vn> Is the name of the SIMD&FP source register, encoded in the "Rn" field.

Operation for all classes

```
CheckFPAdvSIMDEnabled64();
bits(datasize) operand = V[n];
bits(datasize) result;

bits(datasize) operand2 = V[d];
integer op1;
integer op2;
boolean sat;

for e = 0 to elements-1
    op1 = Int(Elem[operand, e, esize], !unsigned);
    op2 = Int(Elem[operand2, e, esize], unsigned);
    (Elem[result, e, esize], sat) = SatQ(op1 + op2, esize, unsigned);
    if sat then FPSR.QC = '1';
V[d] = result;
```

C6.3.291 SXTL

Signed extend long

This instruction is an alias of the [SSHLL](#), [SSHLL2](#) instruction.

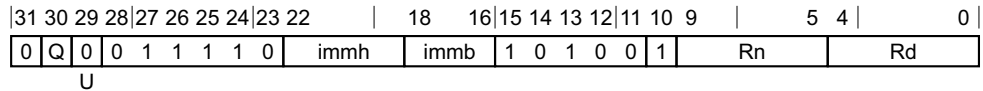

Vector variant

SXTL{2} <Vd>.<Ta>, <Vn>.<Tb>

is equivalent to

SSHLL{2} <Vd>.<Ta>, <Vn>.<Tb>, #0

and is the preferred disassembly when BitCount(immh) == 1 && immb == '000'.

Assembler Symbols

2 Is the second and upper half specifier. If present it causes the operation to be performed on the upper 64 bits of the registers holding the narrower elements, and is

[absent] when Q = 0

[present] when Q = 1

<Vd> Is the name of the SIMD&FP destination register, encoded in the "Rd" field.

<Ta> Is an arrangement specifier,

See [AdvSIMD modified immediate](#), when immh = 0000

8H when immh = 0001

4S when immh = 001x

2D when immh = 01xx

RESERVED when immh = 1xxx

<Vn> Is the name of the SIMD&FP source register, encoded in the "Rn" field.

<Tb> Is an arrangement specifier,

See [AdvSIMD modified immediate](#), when immh = 0000, Q = x

8B when immh = 0001, Q = 0

16B when immh = 0001, Q = 1

4H when immh = 001x, Q = 0

8H when immh = 001x, Q = 1

2S when immh = 01xx, Q = 0

4S when immh = 01xx, Q = 1

RESERVED when immh = 1xxx, Q = x

C6.3.292 TBL

Table vector lookup

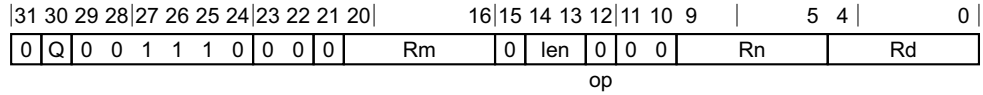

Two register table variant (len = 01)

TBL <Vd>.<Ta>, { <Vn>.16B, <Vn+1>.16B }, <Vm>.<Ta>

Three register table variant (len = 10)

TBL <Vd>.<Ta>, { <Vn>.16B, <Vn+1>.16B, <Vn+2>.16B }, <Vm>.<Ta>

Four register table variant (len = 11)

TBL <Vd>.<Ta>, { <Vn>.16B, <Vn+1>.16B, <Vn+2>.16B, <Vn+3>.16B }, <Vm>.<Ta>

Single register table variant (len = 00)

TBL <Vd>.<Ta>, { <Vn>.16B }, <Vm>.<Ta>

```
integer d = UInt(Rd);
integer n = UInt(Rn);
integer m = UInt(Rm);

integer datasize = if Q == '1' then 128 else 64;
integer elements = datasize DIV 8;
integer regs = UInt(len) + 1;
boolean is_tbl = (op == '0');
```

Assembler Symbols

- <Vd> Is the name of the SIMD&FP destination register, encoded in the "Rd" field.
- <Ta> Is an arrangement specifier,
 - 8B** when Q = 0
 - 16B** when Q = 1
- <Vn> For the four register table, three register table and two register table variant: is the name of the first SIMD&FP table register, encoded in the "Rn" field.
- <Vn> For the single register table variant: is the name of the SIMD&FP table register, encoded in the "Rn" field.
- <Vn+1> Is the name of the second SIMD&FP table register, encoded as "Rn" plus 1 modulo 32.
- <Vn+2> Is the name of the third SIMD&FP table register, encoded as "Rn" plus 2 modulo 32.
- <Vn+3> Is the name of the fourth SIMD&FP table register, encoded as "Rn" plus 3 modulo 32.
- <Vm> Is the name of the SIMD&FP index register, encoded in the "Rm" field.

Operation

```
CheckFPAdvSIMDEnabled64();
bits(datasize) indices = V[m];
bits(128*regs) table = Zeros();
bits(datasize) result;
integer index;
integer i;
```

```
// Create table from registers
for i = 0 to regs - 1
    table<128*i+127:128*i> = V[n];
    n = (n + 1) MOD 32;

result = if is_tbl then Zeros() else V[d];
for i = 0 to elements - 1
    index = UInt(Elem[indices, i, 8]);
    if index < 16 * regs then
        Elem[result, i, 8] = Elem[table, index, 8];

V[d] = result;
```

C6.3.293 TBX

Table vector lookup extension

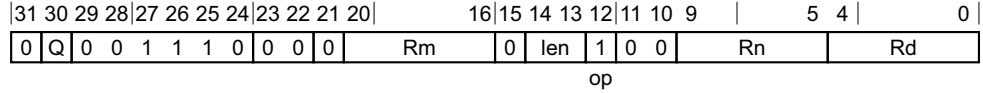

Two register table variant (len = 01)

TBX <Vd>.<Ta>, { <Vn>.16B, <Vn+1>.16B }, <Vm>.<Ta>

Three register table variant (len = 10)

TBX <Vd>.<Ta>, { <Vn>.16B, <Vn+1>.16B, <Vn+2>.16B }, <Vm>.<Ta>

Four register table variant (len = 11)

TBX <Vd>.<Ta>, { <Vn>.16B, <Vn+1>.16B, <Vn+2>.16B, <Vn+3>.16B }, <Vm>.<Ta>

Single register table variant (len = 00)

TBX <Vd>.<Ta>, { <Vn>.16B }, <Vm>.<Ta>

```
integer d = UInt(Rd);
integer n = UInt(Rn);
integer m = UInt(Rm);

integer datasize = if Q == '1' then 128 else 64;
integer elements = datasize DIV 8;
integer regs = UInt(len) + 1;
boolean is_tbl = (op == '0');
```

Assembler Symbols

- <Vd> Is the name of the SIMD&FP destination register, encoded in the "Rd" field.
- <Ta> Is an arrangement specifier,
 - 8B** when Q = 0
 - 16B** when Q = 1
- <Vn> For the four register table, three register table and two register table variant: is the name of the first SIMD&FP table register, encoded in the "Rn" field.
- <Vn> For the single register table variant: is the name of the SIMD&FP table register, encoded in the "Rn" field.
- <Vn+1> Is the name of the second SIMD&FP table register, encoded as "Rn" plus 1 modulo 32.
- <Vn+2> Is the name of the third SIMD&FP table register, encoded as "Rn" plus 2 modulo 32.
- <Vn+3> Is the name of the fourth SIMD&FP table register, encoded as "Rn" plus 3 modulo 32.
- <Vm> Is the name of the SIMD&FP index register, encoded in the "Rm" field.

Operation

```
CheckFPAdvSIMDEnabled64();
bits(datasize) indices = V[m];
bits(128*regs) table = Zeros();
bits(datasize) result;
integer index;
integer i;
```

```
// Create table from registers
for i = 0 to regs - 1
    table<128*i+127:128*i> = V[n];
    n = (n + 1) MOD 32;

result = if is_tbl then Zeros() else V[d];
for i = 0 to elements - 1
    index = UInt(Elem[indices, i, 8]);
    if index < 16 * regs then
        Elem[result, i, 8] = Elem[table, index, 8];

V[d] = result;
```

C6.3.294 TRN1

Transpose vectors (primary)

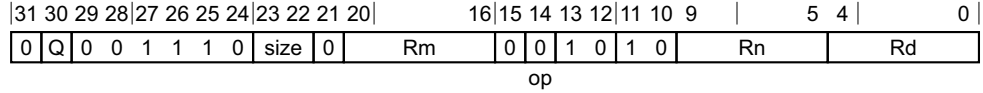

Advanced SIMD variant

TRN1 <Vd>.<T>, <Vn>.<T>, <Vm>.<T>

```
integer d = UInt(Rd);
integer n = UInt(Rn);
integer m = UInt(Rm);

if size:Q == '110' then ReservedValue();
integer esize = 8 << UInt(size);
integer datasize = if Q == '1' then 128 else 64;
integer elements = datasize DIV esize;
integer part = UInt(op);
integer pairs = elements DIV 2;
```

Assembler Symbols

- <Vd> Is the name of the SIMD&FP destination register, encoded in the "Rd" field.
- <T> Is an arrangement specifier,
- 8B** when size = 00, Q = 0
 - 16B** when size = 00, Q = 1
 - 4H** when size = 01, Q = 0
 - 8H** when size = 01, Q = 1
 - 2S** when size = 10, Q = 0
 - 4S** when size = 10, Q = 1
 - RESERVED** when size = 11, Q = 0
 - 2D** when size = 11, Q = 1
- <Vn> Is the name of the first SIMD&FP source register, encoded in the "Rn" field.
- <Vm> Is the name of the second SIMD&FP source register, encoded in the "Rm" field.

Operation

```
CheckFPAdvSIMDEnabled64();
bits(datasize) operand1 = V[n];
bits(datasize) operand2 = V[m];
bits(datasize) result;
integer p;

for p = 0 to pairs-1
    Elem[result, 2*p+0, esize] = Elem[operand1, 2*p+part, esize];
    Elem[result, 2*p+1, esize] = Elem[operand2, 2*p+part, esize];

V[d] = result;
```

C6.3.295 TRN2

Transpose vectors (secondary)

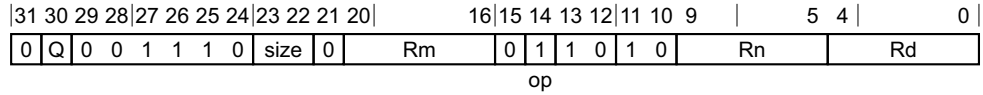

Advanced SIMD variant

TRN2 <Vd>.<T>, <Vn>.<T>, <Vm>.<T>

```
integer d = UInt(Rd);
integer n = UInt(Rn);
integer m = UInt(Rm);
```

```
if size:Q == '110' then ReservedValue();
integer esize = 8 << UInt(size);
integer datasize = if Q == '1' then 128 else 64;
integer elements = datasize DIV esize;
integer part = UInt(op);
integer pairs = elements DIV 2;
```

Assembler Symbols

- <Vd> Is the name of the SIMD&FP destination register, encoded in the "Rd" field.
- <T> Is an arrangement specifier,
- 8B** when size = 00, Q = 0
 - 16B** when size = 00, Q = 1
 - 4H** when size = 01, Q = 0
 - 8H** when size = 01, Q = 1
 - 2S** when size = 10, Q = 0
 - 4S** when size = 10, Q = 1
 - RESERVED** when size = 11, Q = 0
 - 2D** when size = 11, Q = 1
- <Vn> Is the name of the first SIMD&FP source register, encoded in the "Rn" field.
- <Vm> Is the name of the second SIMD&FP source register, encoded in the "Rm" field.

Operation

```
CheckFPAdvSIMDEnabled64();
bits(datasize) operand1 = V[n];
bits(datasize) operand2 = V[m];
bits(datasize) result;
integer p;

for p = 0 to pairs-1
    Elem[result, 2*p+0, esize] = Elem[operand1, 2*p+part, esize];
    Elem[result, 2*p+1, esize] = Elem[operand2, 2*p+part, esize];

V[d] = result;
```

C6.3.296 UABA

Unsigned absolute difference and accumulate

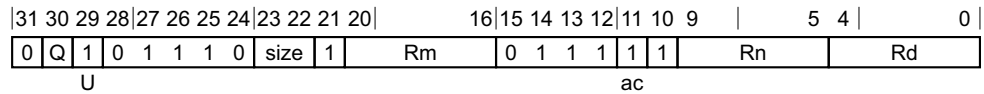

Three registers of the same type variant

UABA <Vd>.<T>, <Vn>.<T>, <Vm>.<T>

```
integer d = UInt(Rd);
integer n = UInt(Rn);
integer m = UInt(Rm);
if size == '11' then ReservedValue();
integer esize = 8 << UInt(size);
integer datasize = if Q == '1' then 128 else 64;
integer elements = datasize DIV esize;
```

```
boolean unsigned = (U == '1');
boolean accumulate = (ac == '1');
```

Assembler Symbols

- <Vd> Is the name of the SIMD&FP destination register, encoded in the "Rd" field.
- <T> Is an arrangement specifier,
- 8B** when size = 00, Q = 0
 - 16B** when size = 00, Q = 1
 - 4H** when size = 01, Q = 0
 - 8H** when size = 01, Q = 1
 - 2S** when size = 10, Q = 0
 - 4S** when size = 10, Q = 1
 - RESERVED** when size = 11, Q = x
- <Vn> Is the name of the first SIMD&FP source register, encoded in the "Rn" field.
- <Vm> Is the name of the second SIMD&FP source register, encoded in the "Rm" field.

Operation

```
CheckFPAdvSIMDEnabled64();
bits(datasize) operand1 = V[n];
bits(datasize) operand2 = V[m];
bits(datasize) result;
integer element1;
integer element2;
bits(esize) absdiff;

result = if accumulate then V[d] else Zeros();
for e = 0 to elements-1
    element1 = Int(Elem[operand1, e, esize], unsigned);
    element2 = Int(Elem[operand2, e, esize], unsigned);
    absdiff = Abs(element1 - element2)<esize-1:0>;
    Elem[result, e, esize] = Elem[result, e, esize] + absdiff;
V[d] = result;
```

C6.3.297 UABAL, UABAL2

Unsigned absolute difference and accumulate long

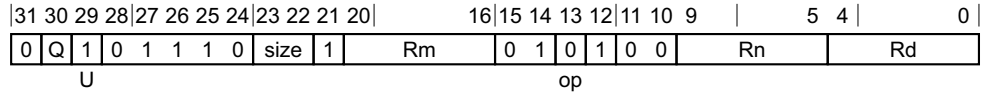

Three registers, not all the same type variant

UABAL{2} <Vd>.<Ta>, <Vn>.<Tb>, <Vm>.<Tb>

```
integer d = UInt(Rd);
integer n = UInt(Rn);
integer m = UInt(Rm);

if size == '11' then ReservedValue();
integer esize = 8 << UInt(size);
integer datasize = 64;
integer part = UInt(Q);
integer elements = datasize DIV esize;

boolean accumulate = (op == '0');
boolean unsigned = (U == '1');
```

Assembler Symbols

- 2 Is the second and upper half specifier. If present it causes the operation to be performed on the upper 64 bits of the registers holding the narrower elements, and is
- [absent]** when Q = 0
 - [present]** when Q = 1
- <Vd> Is the name of the SIMD&FP destination register, encoded in the "Rd" field.
- <Ta> Is an arrangement specifier,
- 8H** when size = 00
 - 4S** when size = 01
 - 2D** when size = 10
 - RESERVED** when size = 11
- <Vn> Is the name of the first SIMD&FP source register, encoded in the "Rn" field.
- <Tb> Is an arrangement specifier,
- 8B** when size = 00, Q = 0
 - 16B** when size = 00, Q = 1
 - 4H** when size = 01, Q = 0
 - 8H** when size = 01, Q = 1
 - 2S** when size = 10, Q = 0
 - 4S** when size = 10, Q = 1
 - RESERVED** when size = 11, Q = x
- <Vm> Is the name of the second SIMD&FP source register, encoded in the "Rm" field.

Operation

```
CheckFPAdvSIMDEnabled64();
bits(datasize) operand1 = Vpart[n, part];
bits(datasize) operand2 = Vpart[m, part];
bits(2*datasize) result;
integer element1;
integer element2;
bits(2*esize) absdiff;

result = if accumulate then V[d] else Zeros();
for e = 0 to elements-1
    element1 = Int(Elem[operand1, e, esize], unsigned);
    element2 = Int(Elem[operand2, e, esize], unsigned);
    absdiff = Abs(element1 - element2)<2*esize-1:0>;
    Elem[result, e, 2*esize] = Elem[result, e, 2*esize] + absdiff;
V[d] = result;
```

C6.3.298 UABD

Unsigned absolute difference (vector)

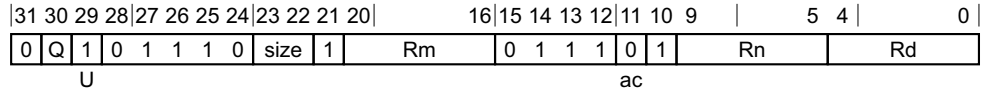

Three registers of the same type variant

UABD <Vd>.<T>, <Vn>.<T>, <Vm>.<T>

```
integer d = UInt(Rd);
integer n = UInt(Rn);
integer m = UInt(Rm);
if size == '11' then ReservedValue();
integer esize = 8 << UInt(size);
integer datasize = if Q == '1' then 128 else 64;
integer elements = datasize DIV esize;
```

```
boolean unsigned = (U == '1');
boolean accumulate = (ac == '1');
```

Assembler Symbols

- <Vd> Is the name of the SIMD&FP destination register, encoded in the "Rd" field.
- <T> Is an arrangement specifier,
- 8B** when size = 00, Q = 0
 - 16B** when size = 00, Q = 1
 - 4H** when size = 01, Q = 0
 - 8H** when size = 01, Q = 1
 - 2S** when size = 10, Q = 0
 - 4S** when size = 10, Q = 1
 - RESERVED** when size = 11, Q = x
- <Vn> Is the name of the first SIMD&FP source register, encoded in the "Rn" field.
- <Vm> Is the name of the second SIMD&FP source register, encoded in the "Rm" field.

Operation

```
CheckFPAdvSIMDEnabled64();
bits(datasize) operand1 = V[n];
bits(datasize) operand2 = V[m];
bits(datasize) result;
integer element1;
integer element2;
bits(esize) absdiff;

result = if accumulate then V[d] else Zeros();
for e = 0 to elements-1
    element1 = Int(Elem[operand1, e, esize], unsigned);
    element2 = Int(Elem[operand2, e, esize], unsigned);
    absdiff = Abs(element1 - element2)<esize-1:0>;
    Elem[result, e, esize] = Elem[result, e, esize] + absdiff;
V[d] = result;
```

C6.3.299 UABDL, UABDL2

Unsigned absolute difference long

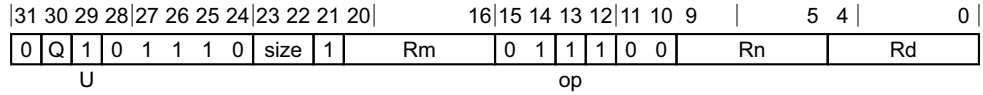

Three registers, not all the same type variant

UABDL{2} <Vd>.<Ta>, <Vn>.<Tb>, <Vm>.<Tb>

```
integer d = UInt(Rd);
integer n = UInt(Rn);
integer m = UInt(Rm);

if size == '11' then ReservedValue();
integer esize = 8 << UInt(size);
integer datasize = 64;
integer part = UInt(Q);
integer elements = datasize DIV esize;

boolean accumulate = (op == '0');
boolean unsigned = (U == '1');
```

Assembler Symbols

- 2 Is the second and upper half specifier. If present it causes the operation to be performed on the upper 64 bits of the registers holding the narrower elements, and is
 - [absent]** when Q = 0
 - [present]** when Q = 1
- <Vd> Is the name of the SIMD&FP destination register, encoded in the "Rd" field.
- <Ta> Is an arrangement specifier,
 - 8H** when size = 00
 - 4S** when size = 01
 - 2D** when size = 10
 - RESERVED** when size = 11
- <Vn> Is the name of the first SIMD&FP source register, encoded in the "Rn" field.
- <Tb> Is an arrangement specifier,
 - 8B** when size = 00, Q = 0
 - 16B** when size = 00, Q = 1
 - 4H** when size = 01, Q = 0
 - 8H** when size = 01, Q = 1
 - 2S** when size = 10, Q = 0
 - 4S** when size = 10, Q = 1
 - RESERVED** when size = 11, Q = x
- <Vm> Is the name of the second SIMD&FP source register, encoded in the "Rm" field.

Operation

```
CheckFPAdvSIMDEnabled64();
bits(datasize) operand1 = Vpart[n, part];
bits(datasize) operand2 = Vpart[m, part];
bits(2*datasize) result;
integer element1;
integer element2;
bits(2*esize) absdiff;

result = if accumulate then V[d] else Zeros();
for e = 0 to elements-1
    element1 = Int(Elem[operand1, e, esize], unsigned);
    element2 = Int(Elem[operand2, e, esize], unsigned);
    absdiff = Abs(element1 - element2)<2*esize-1:0>;
    Elem[result, e, 2*esize] = Elem[result, e, 2*esize] + absdiff;
V[d] = result;
```

C6.3.300 UADALP

Unsigned add and accumulate long pairwise

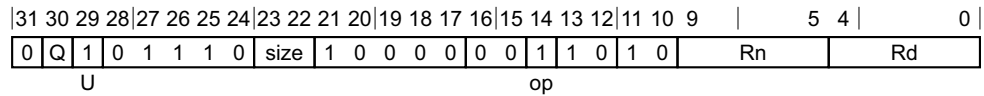

Vector variant

UADALP <Vd>.<Ta>, <Vn>.<Tb>

```
integer d = UInt(Rd);
integer n = UInt(Rn);

if size == '11' then ReservedValue();
integer esize = 8 << UInt(size);
integer datasize = if Q == '1' then 128 else 64;
integer elements = datasize DIV (2*esize);
boolean acc = (op == '1');
boolean unsigned = (U == '1');
```

Assembler Symbols

<Vd> Is the name of the SIMD&FP destination register, encoded in the "Rd" field.

<Ta> Is an arrangement specifier,

4H	when size = 00, Q = 0
8H	when size = 00, Q = 1
2S	when size = 01, Q = 0
4S	when size = 01, Q = 1
1D	when size = 10, Q = 0
2D	when size = 10, Q = 1
RESERVED	when size = 11, Q = x

<Vn> Is the name of the SIMD&FP source register, encoded in the "Rn" field.

<Tb> Is an arrangement specifier,

8B	when size = 00, Q = 0
16B	when size = 00, Q = 1
4H	when size = 01, Q = 0
8H	when size = 01, Q = 1
2S	when size = 10, Q = 0
4S	when size = 10, Q = 1
RESERVED	when size = 11, Q = x

Operation

```
CheckFPAdvSIMDEnabled64();
bits(datasize) operand = V[n];
bits(datasize) result;

bits(2*esize) sum;
integer op1;
```



```
integer op2;  
  
result = if acc then V[d] else Zeros();  
for e = 0 to elements-1  
    op1 = Int(Elem[operand, 2*e+0, esize], unsigned);  
    op2 = Int(Elem[operand, 2*e+1, esize], unsigned);  
    sum = (op1 + op2)<2*esize-1:0>;  
    Elem[result, e, 2*esize] = Elem[result, e, 2*esize] + sum;  
  
V[d] = result;
```

C6.3.301 UADDL, UADDL2

Unsigned add long (vector)

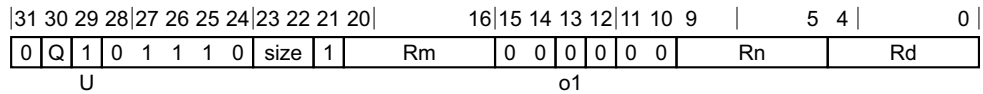

Three registers, not all the same type variant

UADDL{2} <Vd>.<Ta>, <Vn>.<Tb>, <Vm>.<Tb>

```
integer d = UInt(Rd);
integer n = UInt(Rn);
integer m = UInt(Rm);

if size == '11' then ReservedValue();
integer esize = 8 << UInt(size);
integer datasize = 64;
integer part = UInt(Q);
integer elements = datasize DIV esize;

boolean sub_op = (o1 == '1');
boolean unsigned = (U == '1');
```

Assembler Symbols

- 2 Is the second and upper half specifier. If present it causes the operation to be performed on the upper 64 bits of the registers holding the narrower elements, and is
- [absent]** when Q = 0
 - [present]** when Q = 1
- <Vd> Is the name of the SIMD&FP destination register, encoded in the "Rd" field.
- <Ta> Is an arrangement specifier,
- 8H** when size = 00
 - 4S** when size = 01
 - 2D** when size = 10
 - RESERVED** when size = 11
- <Vn> Is the name of the first SIMD&FP source register, encoded in the "Rn" field.
- <Tb> Is an arrangement specifier,
- 8B** when size = 00, Q = 0
 - 16B** when size = 00, Q = 1
 - 4H** when size = 01, Q = 0
 - 8H** when size = 01, Q = 1
 - 2S** when size = 10, Q = 0
 - 4S** when size = 10, Q = 1
 - RESERVED** when size = 11, Q = x
- <Vm> Is the name of the second SIMD&FP source register, encoded in the "Rm" field.

Operation

```
CheckFPAdvSIMDEnabled64();
bits(datasize) operand1 = Vpart[n, part];
bits(datasize) operand2 = Vpart[m, part];
bits(2*datasize) result;
integer element1;
integer element2;
integer sum;

for e = 0 to elements-1
    element1 = Int(Elem[operand1, e, esize], unsigned);
    element2 = Int(Elem[operand2, e, esize], unsigned);
    if sub_op then
        sum = element1 - element2;
    else
        sum = element1 + element2;
    Elem[result, e, 2*esize] = sum<2*esize-1:0>;

V[d] = result;
```

C6.3.302 UADDLP

Unsigned add long pairwise

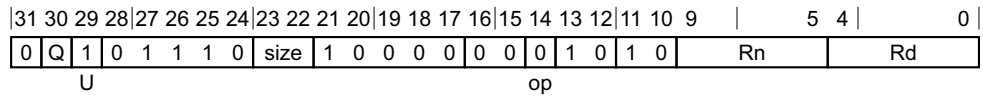

Vector variant

UADDLP <Vd>.<Ta>, <Vn>.<Tb>

```
integer d = UInt(Rd);
integer n = UInt(Rn);

if size == '11' then ReservedValue();
integer esize = 8 << UInt(size);
integer datasize = if Q == '1' then 128 else 64;
integer elements = datasize DIV (2*esize);
boolean acc = (op == '1');
boolean unsigned = (U == '1');
```

Assembler Symbols

<Vd> Is the name of the SIMD&FP destination register, encoded in the "Rd" field.

<Ta> Is an arrangement specifier,

4H	when size = 00, Q = 0
8H	when size = 00, Q = 1
2S	when size = 01, Q = 0
4S	when size = 01, Q = 1
1D	when size = 10, Q = 0
2D	when size = 10, Q = 1
RESERVED	when size = 11, Q = x

<Vn> Is the name of the SIMD&FP source register, encoded in the "Rn" field.

<Tb> Is an arrangement specifier,

8B	when size = 00, Q = 0
16B	when size = 00, Q = 1
4H	when size = 01, Q = 0
8H	when size = 01, Q = 1
2S	when size = 10, Q = 0
4S	when size = 10, Q = 1
RESERVED	when size = 11, Q = x

Operation

```
CheckFPAdvSIMDEnabled64();
bits(datasize) operand = V[n];
bits(datasize) result;

bits(2*esize) sum;
integer op1;
```

```
integer op2;  
  
result = if acc then V[d] else Zeros();  
for e = 0 to elements-1  
    op1 = Int(Elem[operand, 2*e+0, esize], unsigned);  
    op2 = Int(Elem[operand, 2*e+1, esize], unsigned);  
    sum = (op1 + op2)<2*esize-1:0>;  
    Elem[result, e, 2*esize] = Elem[result, e, 2*esize] + sum;  
  
V[d] = result;
```

C6.3.303 UADDLV

Unsigned sum long across vector

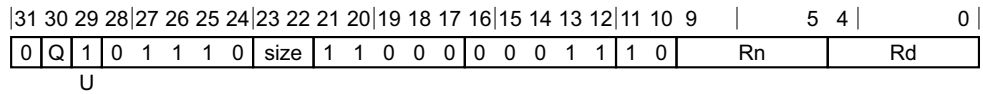

Advanced SIMD variant

UADDLV <V><d>, <Vn>.<T>

```
integer d = UInt(Rd);
integer n = UInt(Rn);

if size:Q == '100' then ReservedValue();
if size == '11' then ReservedValue();
integer esize = 8 << UInt(size);
integer datasize = if Q == '1' then 128 else 64;
integer elements = datasize DIV esize;

boolean unsigned = (U == '1');
```

Assembler Symbols

- <V> Is the destination width specifier,
H when size = 00
S when size = 01
D when size = 10
RESERVED when size = 11
- <d> Is the number of the SIMD&FP destination register, encoded in the "Rd" field.
- <Vn> Is the name of the SIMD&FP source register, encoded in the "Rn" field.
- <T> Is an arrangement specifier,
8B when size = 00, Q = 0
16B when size = 00, Q = 1
4H when size = 01, Q = 0
8H when size = 01, Q = 1
RESERVED when size = 10, Q = 0
4S when size = 10, Q = 1
RESERVED when size = 11, Q = x

Operation

```
CheckFPAdvSIMDEnabled64();
bits(datasize) operand = V[n];
integer sum;

sum = Int(Elem[operand, 0, esize], unsigned);
for e = 1 to elements-1
    sum = sum + Int(Elem[operand, e, esize], unsigned);

V[d] = sum<2*esize-1:0>;
```

C6.3.304 UADDW, UADDW2

Unsigned add wide

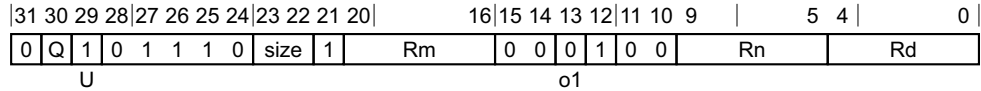

Three registers, not all the same type variant

UADDW{2} <Vd>.<Ta>, <Vn>.<Ta>, <Vm>.<Tb>

```
integer d = UInt(Rd);
integer n = UInt(Rn);
integer m = UInt(Rm);

if size == '11' then ReservedValue();
integer esize = 8 << UInt(size);
integer datasize = 64;
integer part = UInt(Q);
integer elements = datasize DIV esize;

boolean sub_op = (o1 == '1');
boolean unsigned = (U == '1');
```

Assembler Symbols

- 2 Is the second and upper half specifier. If present it causes the operation to be performed on the upper 64 bits of the registers holding the narrower elements, and is
- [absent]** when Q = 0
 - [present]** when Q = 1
- <Vd> Is the name of the SIMD&FP destination register, encoded in the "Rd" field.
- <Ta> Is an arrangement specifier,
- 8H** when size = 00
 - 4S** when size = 01
 - 2D** when size = 10
 - RESERVED** when size = 11
- <Vn> Is the name of the first SIMD&FP source register, encoded in the "Rn" field.
- <Vm> Is the name of the second SIMD&FP source register, encoded in the "Rm" field.
- <Tb> Is an arrangement specifier,
- 8B** when size = 00, Q = 0
 - 16B** when size = 00, Q = 1
 - 4H** when size = 01, Q = 0
 - 8H** when size = 01, Q = 1
 - 2S** when size = 10, Q = 0
 - 4S** when size = 10, Q = 1
 - RESERVED** when size = 11, Q = x

Operation

```
CheckFPAdvSIMDEnabled64();
bits(2*datasize) operand1 = V[n];
bits(datasize) operand2 = Vpart[m, part];
bits(2*datasize) result;
integer element1;
integer element2;
integer sum;

for e = 0 to elements-1
    element1 = Int(Elem[operand1, e, 2*esize], unsigned);
    element2 = Int(Elem[operand2, e, esize], unsigned);
    if sub_op then
        sum = element1 - element2;
    else
        sum = element1 + element2;
    Elem[result, e, 2*esize] = sum<2*esize-1:0>;

V[d] = result;
```

C6.3.305 UCVTF (vector, fixed-point)

Unsigned fixed-point convert to floating-point (vector)

It has encodings from 2 classes: *Scalar* and *Vector*

Scalar

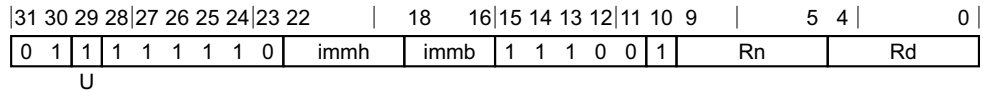

Scalar variant

UCVTF <V><d>, <V><n>, #<fbits>

```
integer d = UInt(Rd);
integer n = UInt(Rn);

if immh == '00xx' then ReservedValue();
integer esize = 32 << UInt(immh<3>);
integer datasize = esize;
integer elements = 1;

integer fracbits = (esize * 2) - UInt(immh:immb);
boolean unsigned = (U == '1');
FPRounding rounding = FPRoundingMode(FPCR);
```

Vector

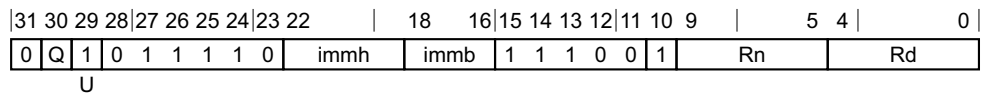

Vector variant

UCVTF <Vd>.<T>, <Vn>.<T>, #<fbits>

```
integer d = UInt(Rd);
integer n = UInt(Rn);

if immh == '0000' then AdvSIMD modified immediate;
if immh == '00xx' then ReservedValue();
if immh<3>:Q == '10' then ReservedValue();
integer esize = 32 << UInt(immh<3>);
integer datasize = if Q == '1' then 128 else 64;
integer elements = datasize DIV esize;

integer fracbits = (esize * 2) - UInt(immh:immb);
boolean unsigned = (U == '1');
FPRounding rounding = FPRoundingMode(FPCR);
```

Assembler Symbols

- <V> Is a width specifier,
 RESERVED when immh = 00xx
 S when immh = 01xx
 D when immh = 1xxx
- <d> Is the number of the SIMD&FP destination register, in the "Rd" field.

- <n> Is the number of the first SIMD&FP source register, encoded in the "Rn" field.
- <Vd> Is the name of the SIMD&FP destination register, encoded in the "Rd" field.
- <T> Is an arrangement specifier,
See AdvSIMD modified immediate. when immh = 0000, Q = x
RESERVED when immh = 0001, Q = x
RESERVED when immh = 001x, Q = x
2S when immh = 01xx, Q = 0
4S when immh = 01xx, Q = 1
RESERVED when immh = 1xxx, Q = 0
2D when immh = 1xxx, Q = 1
- <Vn> Is the name of the SIMD&FP source register, encoded in the "Rn" field.
- <fbits> For the scalar variant: is the number of fractional bits, in the range 1 to element bits,
RESERVED when immh = 00xx
(64-UInt(immh:immb)) when immh = 01xx
(128-UInt(immh:immb)) when immh = 1xxx
- <fbits> For the vector variant: is the number of fractional bits, in the range 1 to element bits,
See AdvSIMD modified immediate. when immh = 0000
RESERVED when immh = 0001
RESERVED when immh = 001x
(64-UInt(immh:immb)) when immh = 01xx
(128-UInt(immh:immb)) when immh = 1xxx

Operation for all classes

```
CheckFPAdvSIMDEnabled64();
bits(datasize) operand = V[n];
bits(datasize) result;
bits(esize) element;

for e = 0 to elements-1
    element = Elem[operand, e, esize];
    Elem[result, e, esize] = FixedToFP(element, fracbits, unsigned, FPCR, rounding);

V[d] = result;
```

C6.3.306 UCVTF (vector, integer)

Unsigned integer convert to floating-point (vector)

It has encodings from 2 classes: *Scalar* and *Vector*

Scalar

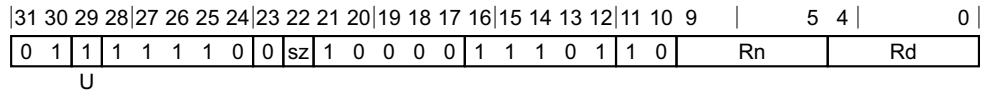

Scalar variant

UCVTF <V><d>, <V><n>

```
integer d = UInt(Rd);
integer n = UInt(Rn);
```

```
integer esize = 32 << UInt(sz);
integer datasize = esize;
integer elements = 1;
boolean unsigned = (U == '1');
```

Vector

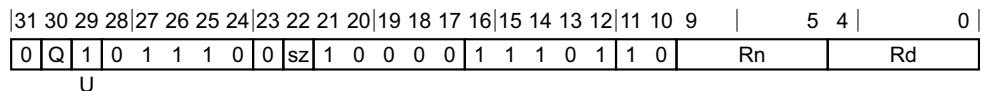

Vector variant

UCVTF <Vd>.<T>, <Vn>.<T>

```
integer d = UInt(Rd);
integer n = UInt(Rn);
```

```
if sz:Q == '10' then ReservedValue();
integer esize = 32 << UInt(sz);
integer datasize = if Q == '1' then 128 else 64;
integer elements = datasize DIV esize;
boolean unsigned = (U == '1');
```

Assembler Symbols

- <V> Is a width specifier,
 - S** when sz = 0
 - D** when sz = 1
- <d> Is the number of the SIMD&FP destination register, encoded in the "Rd" field.
- <n> Is the number of the SIMD&FP source register, encoded in the "Rn" field.
- <Vd> Is the name of the SIMD&FP destination register, encoded in the "Rd" field.
- <T> Is an arrangement specifier,
 - 2S** when sz = 0, Q = 0
 - 4S** when sz = 0, Q = 1
 - RESERVED** when sz = 1, Q = 0
 - 2D** when sz = 1, Q = 1

<Vn> Is the name of the SIMD&FP source register, encoded in the "Rn" field.

Operation for all classes

```
CheckFPAdvSIMDEnabled64();
bits(datasize) operand = V[n];
bits(datasize) result;
FPRounding rounding = FPRoundingMode(FPCR);
bits(esize) element;

for e = 0 to elements-1
    element = Elem[operand, e, esize];
    Elem[result, e, esize] = FixedToFP(element, 0, unsigned, FPCR, rounding);

V[d] = result;
```

C6.3.307 UCVTF (scalar, fixed-point)

Unsigned fixed-point convert to floating-point (scalar): $Vd = \text{unsigned_convertFromInt}(Rn/(2^{\text{fbits}}))$

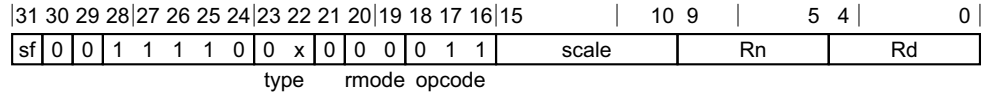

32-bit to single-precision variant (sf = 0, type = 00)

UCVTF <Sd>, <Wn>, #<fbits>

32-bit to double-precision variant (sf = 0, type = 01)

UCVTF <Dd>, <Wn>, #<fbits>

64-bit to single-precision variant (sf = 1, type = 00)

UCVTF <Sd>, <Xn>, #<fbits>

64-bit to double-precision variant (sf = 1, type = 01)

UCVTF <Dd>, <Xn>, #<fbits>

```
integer d = UInt(Rd);
integer n = UInt(Rn);

integer intsize = if sf == '1' then 64 else 32;
integer fltsize;
FPCConvOp op;
FPRounding rounding;
boolean unsigned;

case type of
    when '00' fltsize = 32;
    when '01' fltsize = 64;
    when '1x' UnallocatedEncoding();

if sf == '0' && scale<5> == '0' then UnallocatedEncoding();
integer fracbits = 64 - UInt(scale);

case opcode<2:1>:rmode of
    when '00 11' // FCVTZ
        rounding = FPRounding_ZERO;
        unsigned = (opcode<0> == '1');
        op = FPCConvOp_CVT_FtoI;
    when '01 00' // [US]CVTF
        rounding = FPRoundingMode(FPCR);
        unsigned = (opcode<0> == '1');
        op = FPCConvOp_CVT_ItoF;
    otherwise
        UnallocatedEncoding();
```

Assembler Symbols

- <Dd> Is the 64-bit name of the SIMD&FP destination register, encoded in the "Rd" field.
- <Sd> Is the 32-bit name of the SIMD&FP destination register, encoded in the "Rd" field.
- <Xn> Is the 64-bit name of the general-purpose source register, encoded in the "Rn" field.
- <Wn> Is the 32-bit name of the general-purpose source register, encoded in the "Rn" field.
- <fbits> For the 32-bit to double-precision and 32-bit to single-precision variant: is the number of bits after the binary point in the fixed-point source, in the range 1 to 32, encoded as 64 minus "scale".

<fbits> For the 64-bit to double-precision and 64-bit to single-precision variant: is the number of bits after the binary point in the fixed-point source, in the range 1 to 64, encoded as 64 minus "scale".

Operation

```
CheckFPAdvSIMDEnabled64();

bits(fltsize) fltval;
bits(intsize) intval;

case op of
  when FPConvOp_CVT_FtoI
    fltval = V[n];
    intval = FPToFixed(fltval, fracbits, unsigned, FPCR, rounding);
    X[d] = intval;
  when FPConvOp_CVT_ItoF
    intval = X[n];
    fltval = FixedToFP(intval, fracbits, unsigned, FPCR, rounding);
    V[d] = fltval;
```

C6.3.308 UCVTF (scalar, integer)

Unsigned integer convert to floating-point (scalar): Vd = unsigned_convertFromInt(Rn)

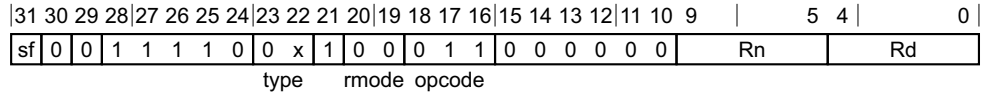

32-bit to single-precision variant (sf = 0, type = 00)

UCVTF <Sd>, <Wn>

32-bit to double-precision variant (sf = 0, type = 01)

UCVTF <Dd>, <Wn>

64-bit to single-precision variant (sf = 1, type = 00)

UCVTF <Sd>, <Xn>

64-bit to double-precision variant (sf = 1, type = 01)

UCVTF <Dd>, <Xn>

```
integer d = UInt(Rd);
integer n = UInt(Rn);

integer intsize = if sf == '1' then 64 else 32;
integer fltsize;
FPConvOp op;
FPRounding rounding;
boolean unsigned;
integer part;

case type of
    when '00'
        fltsize = 32;
    when '01'
        fltsize = 64;
    when '10'
        if opcode<2:1>:rmode != '11 01' then UnallocatedEncoding();
        fltsize = 128;
    when '11'
        UnallocatedEncoding();

case opcode<2:1>:rmode of
    when '00 xx' // FCVT[NPMZ][US]
        rounding = FPDecodeRounding(rmode);
        unsigned = (opcode<0> == '1');
        op = FPConvOp_CVT_FtoI;
    when '01 00' // [US]CVTF
        rounding = FPRoundingMode(FPCR);
        unsigned = (opcode<0> == '1');
        op = FPConvOp_CVT_ItoF;
    when '10 00' // FCVTA[US]
        rounding = FPRounding_TIEAWAY;
        unsigned = (opcode<0> == '1');
        op = FPConvOp_CVT_FtoI;
    when '11 00' // FMOV
        if fltsize != intsize then UnallocatedEncoding();
        op = if opcode<0> == '1' then FPConvOp_MOV_ItoF else FPConvOp_MOV_FtoI;
        part = 0;
    when '11 01' // FMOV D[1]
        if intsize != 64 || fltsize != 128 then UnallocatedEncoding();
        op = if opcode<0> == '1' then FPConvOp_MOV_ItoF else FPConvOp_MOV_FtoI;
```

```
        part = 1;  
    otherwise  
        UnallocatedEncoding();
```

Assembler Symbols

- <Dd> Is the 64-bit name of the SIMD&FP destination register, encoded in the "Rd" field.
- <Sd> Is the 32-bit name of the SIMD&FP destination register, encoded in the "Rd" field.
- <Xn> Is the 64-bit name of the general-purpose source register, encoded in the "Rn" field.
- <Wn> Is the 32-bit name of the general-purpose source register, encoded in the "Rn" field.

Operation

```
CheckFPAdvSIMDEnabled64();  
  
bits(floatsize) fltval;  
bits(intsize) intval;  
  
case op of  
    when FPConvOp_CVT_FtoI  
        fltval = V[n];  
        intval = FPToFixed(fltval, 0, unsigned, FPCR, rounding);  
        X[d] = intval;  
    when FPConvOp_CVT_ItoF  
        intval = X[n];  
        fltval = FixedToFP(intval, 0, unsigned, FPCR, rounding);  
        V[d] = fltval;  
    when FPConvOp_MOV_FtoI  
        intval = Vpart[n,part];  
        X[d] = intval;  
    when FPConvOp_MOV_ItoF  
        intval = X[n];  
        Vpart[d,part] = intval;
```

C6.3.309 UHADD

Unsigned halving add

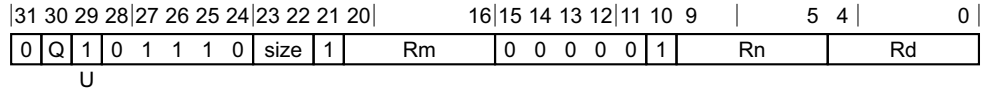

Three registers of the same type variant

UHADD <Vd>.<T>, <Vn>.<T>, <Vm>.<T>

```
integer d = UInt(Rd);
integer n = UInt(Rn);
integer m = UInt(Rm);
if size == '11' then ReservedValue();
integer esize = 8 << UInt(size);
integer datasize = if Q == '1' then 128 else 64;
integer elements = datasize DIV esize;
boolean unsigned = (U == '1');
```

Assembler Symbols

- <Vd> Is the name of the SIMD&FP destination register, encoded in the "Rd" field.
- <T> Is an arrangement specifier,
- 8B** when size = 00, Q = 0
 - 16B** when size = 00, Q = 1
 - 4H** when size = 01, Q = 0
 - 8H** when size = 01, Q = 1
 - 2S** when size = 10, Q = 0
 - 4S** when size = 10, Q = 1
 - RESERVED** when size = 11, Q = x
- <Vn> Is the name of the first SIMD&FP source register, encoded in the "Rn" field.
- <Vm> Is the name of the second SIMD&FP source register, encoded in the "Rm" field.

Operation

```
CheckFPAdvSIMDEnabled64();
bits(datasize) operand1 = V[n];
bits(datasize) operand2 = V[m];
bits(datasize) result;
integer element1;
integer element2;
integer sum;

for e = 0 to elements-1
    element1 = Int(Elem[operand1, e, esize], unsigned);
    element2 = Int(Elem[operand2, e, esize], unsigned);
    sum = element1 + element2;
    Elem[result, e, esize] = sum<esize:1>;

V[d] = result;
```

C6.3.310 UHSUB

Unsigned halving subtract

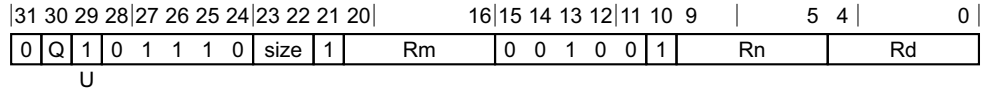

Three registers of the same type variant

UHSUB <Vd>.<T>, <Vn>.<T>, <Vm>.<T>

```
integer d = UInt(Rd);
integer n = UInt(Rn);
integer m = UInt(Rm);
if size == '11' then ReservedValue();
integer esize = 8 << UInt(size);
integer datasize = if Q == '1' then 128 else 64;
integer elements = datasize DIV esize;
boolean unsigned = (U == '1');
```

Assembler Symbols

- <Vd> Is the name of the SIMD&FP destination register, encoded in the "Rd" field.
- <T> Is an arrangement specifier,
 - 8B** when size = 00, Q = 0
 - 16B** when size = 00, Q = 1
 - 4H** when size = 01, Q = 0
 - 8H** when size = 01, Q = 1
 - 2S** when size = 10, Q = 0
 - 4S** when size = 10, Q = 1
 - RESERVED** when size = 11, Q = x
- <Vn> Is the name of the first SIMD&FP source register, encoded in the "Rn" field.
- <Vm> Is the name of the second SIMD&FP source register, encoded in the "Rm" field.

Operation

```
CheckFPAdvSIMDEnabled64();
bits(datasize) operand1 = V[n];
bits(datasize) operand2 = V[m];
bits(datasize) result;
integer element1;
integer element2;
integer diff;

for e = 0 to elements-1
    element1 = Int(Elem[operand1, e, esize], unsigned);
    element2 = Int(Elem[operand2, e, esize], unsigned);
    diff = element1 - element2;
    Elem[result, e, esize] = diff<esize:1>;

V[d] = result;
```

C6.3.311 UMAX

Unsigned maximum (vector)

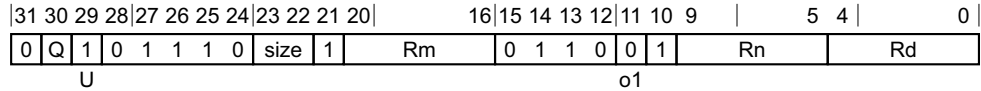

Three registers of the same type variant

UMAX <Vd>.<T>, <Vn>.<T>, <Vm>.<T>

```
integer d = UInt(Rd);
integer n = UInt(Rn);
integer m = UInt(Rm);
if size == '11' then ReservedValue();
integer esize = 8 << UInt(size);
integer datasize = if Q == '1' then 128 else 64;
integer elements = datasize DIV esize;
```

```
boolean unsigned = (U == '1');
boolean minimum = (o1 == '1');
```

Assembler Symbols

- <Vd> Is the name of the SIMD&FP destination register, encoded in the "Rd" field.
- <T> Is an arrangement specifier,
- 8B** when size = 00, Q = 0
 - 16B** when size = 00, Q = 1
 - 4H** when size = 01, Q = 0
 - 8H** when size = 01, Q = 1
 - 2S** when size = 10, Q = 0
 - 4S** when size = 10, Q = 1
 - RESERVED** when size = 11, Q = x
- <Vn> Is the name of the first SIMD&FP source register, encoded in the "Rn" field.
- <Vm> Is the name of the second SIMD&FP source register, encoded in the "Rm" field.

Operation

```
CheckFPAdvSIMDEnabled64();
bits(datasize) operand1 = V[n];
bits(datasize) operand2 = V[m];
bits(datasize) result;
integer element1;
integer element2;
integer maxmin;

for e = 0 to elements-1
    element1 = Int(Elem[operand1, e, esize], unsigned);
    element2 = Int(Elem[operand2, e, esize], unsigned);
    maxmin = if minimum then Min(element1, element2) else Max(element1, element2);
    Elem[result, e, esize] = maxmin<esize-1:0>;

V[d] = result;
```

C6.3.312 UMAXP

Unsigned maximum pairwise

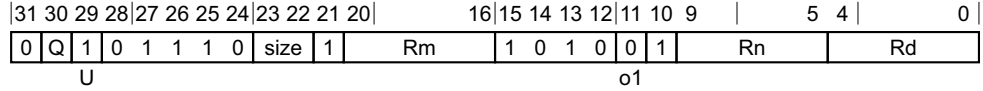

Three registers of the same type variant

UMAXP <Vd>.<T>, <Vn>.<T>, <Vm>.<T>

```
integer d = UInt(Rd);
integer n = UInt(Rn);
integer m = UInt(Rm);
if size == '11' then ReservedValue();
integer esize = 8 << UInt(size);
integer datasize = if Q == '1' then 128 else 64;
integer elements = datasize DIV esize;
```

```
boolean unsigned = (U == '1');
boolean minimum = (o1 == '1');
```

Assembler Symbols

- <Vd> Is the name of the SIMD&FP destination register, encoded in the "Rd" field.
- <T> Is an arrangement specifier,
- 8B** when size = 00, Q = 0
 - 16B** when size = 00, Q = 1
 - 4H** when size = 01, Q = 0
 - 8H** when size = 01, Q = 1
 - 2S** when size = 10, Q = 0
 - 4S** when size = 10, Q = 1
 - RESERVED** when size = 11, Q = x
- <Vn> Is the name of the first SIMD&FP source register, encoded in the "Rn" field.
- <Vm> Is the name of the second SIMD&FP source register, encoded in the "Rm" field.

Operation

```
CheckFPAdvSIMDEnabled64();
bits(datasize) operand1 = V[n];
bits(datasize) operand2 = V[m];
bits(datasize) result;
bits(2*datasize) concat = operand2:operand1;
integer element1;
integer element2;
integer maxmin;

for e = 0 to elements-1
    element1 = Int(Elem[concat, 2*e, esize], unsigned);
    element2 = Int(Elem[concat, (2*e)+1, esize], unsigned);
    maxmin = if minimum then Min(element1, element2) else Max(element1, element2);
    Elem[result, e, esize] = maxmin<esize-1:0>;

V[d] = result;
```

C6.3.313 UMAXV

Unsigned maximum across vector

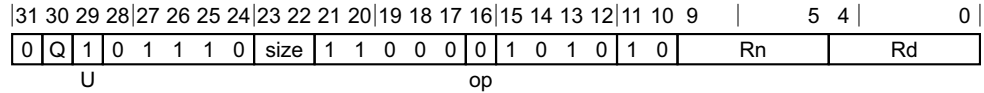

Advanced SIMD variant

UMAXV <V><d>, <Vn>.<T>

```
integer d = UInt(Rd);
integer n = UInt(Rn);

if size:Q == '100' then ReservedValue();
if size == '11' then ReservedValue();
integer esize = 8 << UInt(size);
integer datasize = if Q == '1' then 128 else 64;
integer elements = datasize DIV esize;

boolean unsigned = (U == '1');
boolean min = (op == '1');
```

Assembler Symbols

- <V> Is the destination width specifier,
B when size = 00
H when size = 01
S when size = 10
RESERVED when size = 11
- <d> Is the number of the SIMD&FP destination register, encoded in the "Rd" field.
- <Vn> Is the name of the SIMD&FP source register, encoded in the "Rn" field.
- <T> Is an arrangement specifier,
8B when size = 00, Q = 0
16B when size = 00, Q = 1
4H when size = 01, Q = 0
8H when size = 01, Q = 1
RESERVED when size = 10, Q = 0
4S when size = 10, Q = 1
RESERVED when size = 11, Q = x

Operation

```
CheckFPAdvSIMDEnabled64();
bits(datasize) operand = V[n];
integer maxmin;
integer element;

maxmin = Int(Elem[operand, 0, esize], unsigned);
for e = 1 to elements-1
    element = Int(Elem[operand, e, esize], unsigned);
```

```
maxmin = if min then Min(maxmin, element) else Max(maxmin, element);  
V[d] = maxmin<size-1:0>;
```

C6.3.314 UMIN

Unsigned minimum (vector)

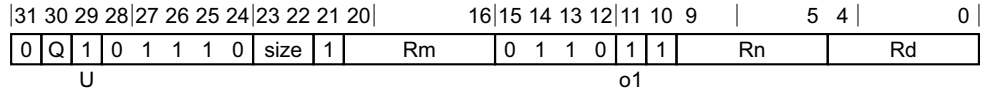

Three registers of the same type variant

UMIN <Vd>.<T>, <Vn>.<T>, <Vm>.<T>

```
integer d = UInt(Rd);
integer n = UInt(Rn);
integer m = UInt(Rm);
if size == '11' then ReservedValue();
integer esize = 8 << UInt(size);
integer datasize = if Q == '1' then 128 else 64;
integer elements = datasize DIV esize;
```

```
boolean unsigned = (U == '1');
boolean minimum = (o1 == '1');
```

Assembler Symbols

- <Vd> Is the name of the SIMD&FP destination register, encoded in the "Rd" field.
- <T> Is an arrangement specifier,
- 8B** when size = 00, Q = 0
 - 16B** when size = 00, Q = 1
 - 4H** when size = 01, Q = 0
 - 8H** when size = 01, Q = 1
 - 2S** when size = 10, Q = 0
 - 4S** when size = 10, Q = 1
 - RESERVED** when size = 11, Q = x
- <Vn> Is the name of the first SIMD&FP source register, encoded in the "Rn" field.
- <Vm> Is the name of the second SIMD&FP source register, encoded in the "Rm" field.

Operation

```
CheckFPAdvSIMDEnabled64();
bits(datasize) operand1 = V[n];
bits(datasize) operand2 = V[m];
bits(datasize) result;
integer element1;
integer element2;
integer maxmin;

for e = 0 to elements-1
    element1 = Int(Elem[operand1, e, esize], unsigned);
    element2 = Int(Elem[operand2, e, esize], unsigned);
    maxmin = if minimum then Min(element1, element2) else Max(element1, element2);
    Elem[result, e, esize] = maxmin<esize-1:0>;

V[d] = result;
```

C6.3.315 UMINP

Unsigned minimum pairwise

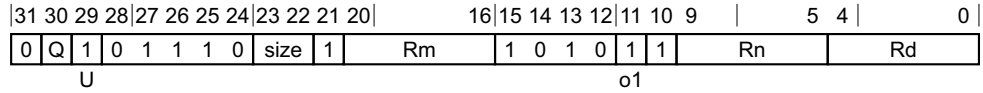

Three registers of the same type variant

UMINP <Vd>.<T>, <Vn>.<T>, <Vm>.<T>

```
integer d = UInt(Rd);
integer n = UInt(Rn);
integer m = UInt(Rm);
if size == '11' then ReservedValue();
integer esize = 8 << UInt(size);
integer datasize = if Q == '1' then 128 else 64;
integer elements = datasize DIV esize;
```

```
boolean unsigned = (U == '1');
boolean minimum = (o1 == '1');
```

Assembler Symbols

- <Vd> Is the name of the SIMD&FP destination register, encoded in the "Rd" field.
- <T> Is an arrangement specifier,
- 8B** when size = 00, Q = 0
 - 16B** when size = 00, Q = 1
 - 4H** when size = 01, Q = 0
 - 8H** when size = 01, Q = 1
 - 2S** when size = 10, Q = 0
 - 4S** when size = 10, Q = 1
 - RESERVED** when size = 11, Q = x
- <Vn> Is the name of the first SIMD&FP source register, encoded in the "Rn" field.
- <Vm> Is the name of the second SIMD&FP source register, encoded in the "Rm" field.

Operation

```
CheckFPAdvSIMDEnabled64();
bits(datasize) operand1 = V[n];
bits(datasize) operand2 = V[m];
bits(datasize) result;
bits(2*datasize) concat = operand2:operand1;
integer element1;
integer element2;
integer maxmin;

for e = 0 to elements-1
    element1 = Int(Elem[concat, 2*e, esize], unsigned);
    element2 = Int(Elem[concat, (2*e)+1, esize], unsigned);
    maxmin = if minimum then Min(element1, element2) else Max(element1, element2);
    Elem[result, e, esize] = maxmin<esize-1:0>;

V[d] = result;
```

C6.3.316 UMINV

Unsigned minimum across vector

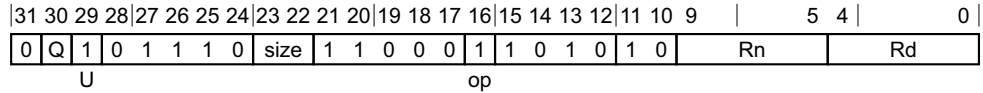

Advanced SIMD variant

UMINV <V><d>, <Vn>.<T>

```
integer d = UInt(Rd);
integer n = UInt(Rn);

if size:Q == '100' then ReservedValue();
if size == '11' then ReservedValue();
integer esize = 8 << UInt(size);
integer datasize = if Q == '1' then 128 else 64;
integer elements = datasize DIV esize;

boolean unsigned = (U == '1');
boolean min = (op == '1');
```

Assembler Symbols

- <V> Is the destination width specifier,
B when size = 00
H when size = 01
S when size = 10
RESERVED when size = 11
- <d> Is the number of the SIMD&FP destination register, encoded in the "Rd" field.
- <Vn> Is the name of the SIMD&FP source register, encoded in the "Rn" field.
- <T> Is an arrangement specifier,
8B when size = 00, Q = 0
16B when size = 00, Q = 1
4H when size = 01, Q = 0
8H when size = 01, Q = 1
RESERVED when size = 10, Q = 0
4S when size = 10, Q = 1
RESERVED when size = 11, Q = x

Operation

```
CheckFPAdvSIMDEnabled64();
bits(datasize) operand = V[n];
integer maxmin;
integer element;

maxmin = Int(Elem[operand, 0, esize], unsigned);
for e = 1 to elements-1
  element = Int(Elem[operand, e, esize], unsigned);
```

```
maxmin = if min then Min(maxmin, element) else Max(maxmin, element);  
V[d] = maxmin<size-1:0>;
```

C6.3.317 UMLAL, UMLAL2 (by element)

Unsigned multiply-add long (vector, by element)

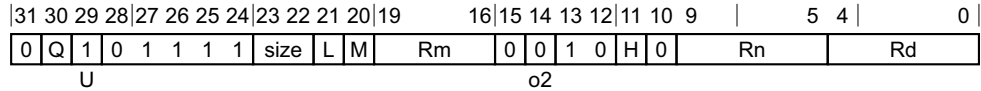

Vector variant

UMLAL{2} <Vd>.<Ta>, <Vn>.<Tb>, <Vm>.<Ts>[<index>]

```

integer idxsize = if H == '1' then 128 else 64;
integer index;
bit Rmhi;
case size of
    when '01' index = UInt(H:L:M); Rmhi = '0';
    when '10' index = UInt(H:L); Rmhi = M;
    otherwise UnallocatedEncoding();

integer d = UInt(Rd);
integer n = UInt(Rn);
integer m = UInt(Rmhi:Rm);

integer esize = 8 << UInt(size);
integer datasize = 64;
integer part = UInt(Q);
integer elements = datasize DIV esize;

boolean unsigned = (U == '1');
boolean sub_op = (o2 == '1');
```

Assembler Symbols

- 2 Is the second and upper half specifier. If present it causes the operation to be performed on the upper 64 bits of the registers holding the narrower elements, and is
- [absent]** when Q = 0
 - [present]** when Q = 1
- <Vd> Is the name of the SIMD&FP destination register, encoded in the "Rd" field.
- <Ta> Is an arrangement specifier,
- RESERVED** when size = 00
 - 4S** when size = 01
 - 2D** when size = 10
 - RESERVED** when size = 11
- <Vn> Is the name of the first SIMD&FP source register, encoded in the "Rn" field.
- <Tb> Is an arrangement specifier,
- RESERVED** when size = 00, Q = x
 - 4H** when size = 01, Q = 0
 - 8H** when size = 01, Q = 1
 - 2S** when size = 10, Q = 0
 - 4S** when size = 10, Q = 1
 - RESERVED** when size = 11, Q = x

<Vm> Is the name of the second SIMD&FP source register,
RESERVED when size = 00
0:Rm when size = 01
M:Rm when size = 10
RESERVED when size = 11
 Restricted to V0-V15 when element size <Ts> is H.

<Ts> Is an element size specifier,
RESERVED when size = 00
H when size = 01
S when size = 10
RESERVED when size = 11

<index> Is the element index
RESERVED when size = 00
H:L:M when size = 01
H:L when size = 10
RESERVED when size = 11

Operation

```

CheckFPAdvSIMDEnabled64();
bits(datasize) operand1 = Vpart[n, part];
bits(idxsize) operand2 = V[m];
bits(2*datasize) operand3 = V[d];
bits(2*datasize) result;
integer element1;
integer element2;
bits(2*esize) product;

element2 = Int(Elem[operand2, index, esize], unsigned);
for e = 0 to elements-1
  element1 = Int(Elem[operand1, e, esize], unsigned);
  product = (element1 * element2)<2*esize-1:0>;
  if sub_op then
    Elem[result, e, 2*esize] = Elem[operand3, e, 2*esize] - product;
  else
    Elem[result, e, 2*esize] = Elem[operand3, e, 2*esize] + product;

V[d] = result;
  
```

C6.3.318 UMLAL, UMLAL2 (vector)

Unsigned multiply-add long (vector)

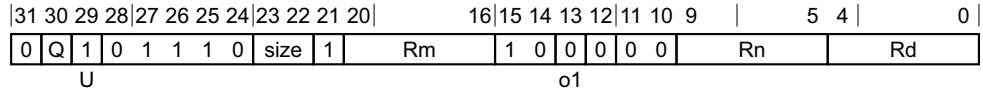

Three registers, not all the same type variant

UMLAL{2} <Vd>.<Ta>, <Vn>.<Tb>, <Vm>.<Tb>

```
integer d = UInt(Rd);
integer n = UInt(Rn);
integer m = UInt(Rm);

if size == '11' then ReservedValue();
integer esize = 8 << UInt(size);
integer datasize = 64;
integer part = UInt(Q);
integer elements = datasize DIV esize;
boolean sub_op = (o1 == '1');
boolean unsigned = (U == '1');
```

Assembler Symbols

- 2 Is the second and upper half specifier. If present it causes the operation to be performed on the upper 64 bits of the registers holding the narrower elements, and is
- [absent]** when Q = 0
 - [present]** when Q = 1
- <Vd> Is the name of the SIMD&FP destination register, encoded in the "Rd" field.
- <Ta> Is an arrangement specifier,
- 8H** when size = 00
 - 4S** when size = 01
 - 2D** when size = 10
 - RESERVED** when size = 11
- <Vn> Is the name of the first SIMD&FP source register, encoded in the "Rn" field.
- <Tb> Is an arrangement specifier,
- 8B** when size = 00, Q = 0
 - 16B** when size = 00, Q = 1
 - 4H** when size = 01, Q = 0
 - 8H** when size = 01, Q = 1
 - 2S** when size = 10, Q = 0
 - 4S** when size = 10, Q = 1
 - RESERVED** when size = 11, Q = x
- <Vm> Is the name of the second SIMD&FP source register, encoded in the "Rm" field.

Operation

```
CheckFPAdvSIMDEnabled64();
bits(datasize) operand1 = Vpart[n, part];
bits(datasize) operand2 = Vpart[m, part];
bits(2*datasize) operand3 = V[d];
bits(2*datasize) result;
integer element1;
integer element2;
bits(2*esize) product;
bits(2*esize) accum;

for e = 0 to elements-1
    element1 = Int(Elem[operand1, e, esize], unsigned);
    element2 = Int(Elem[operand2, e, esize], unsigned);
    product = (element1 * element2) <2*esize-1:0>;
    if sub_op then
        accum = Elem[operand3, e, 2*esize] - product;
    else
        accum = Elem[operand3, e, 2*esize] + product;
    Elem[result, e, 2*esize] = accum;

V[d] = result;
```

C6.3.319 UMLSL, UMLSL2 (by element)

Unsigned multiply-subtract long (vector, by element)

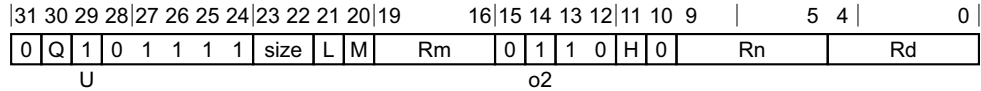

Vector variant

UMLSL{2} <Vd>.<Ta>, <Vn>.<Tb>, <Vm>.<Ts>[<index>]

```

integer idxsize = if H == '1' then 128 else 64;
integer index;
bit Rmhi;
case size of
    when '01' index = UInt(H:L:M); Rmhi = '0';
    when '10' index = UInt(H:L); Rmhi = M;
    otherwise UnallocatedEncoding();

integer d = UInt(Rd);
integer n = UInt(Rn);
integer m = UInt(Rmhi:Rm);

integer esize = 8 << UInt(size);
integer datasize = 64;
integer part = UInt(Q);
integer elements = datasize DIV esize;

boolean unsigned = (U == '1');
boolean sub_op = (o2 == '1');
```

Assembler Symbols

- 2 Is the second and upper half specifier. If present it causes the operation to be performed on the upper 64 bits of the registers holding the narrower elements, and is
- [absent]** when Q = 0
 - [present]** when Q = 1
- <Vd> Is the name of the SIMD&FP destination register, encoded in the "Rd" field.
- <Ta> Is an arrangement specifier,
- RESERVED** when size = 00
 - 4S** when size = 01
 - 2D** when size = 10
 - RESERVED** when size = 11
- <Vn> Is the name of the first SIMD&FP source register, encoded in the "Rn" field.
- <Tb> Is an arrangement specifier,
- RESERVED** when size = 00, Q = x
 - 4H** when size = 01, Q = 0
 - 8H** when size = 01, Q = 1
 - 2S** when size = 10, Q = 0
 - 4S** when size = 10, Q = 1
 - RESERVED** when size = 11, Q = x

<Vm> Is the name of the second SIMD&FP source register,
RESERVED when size = 00
0:Rm when size = 01
M:Rm when size = 10
RESERVED when size = 11
 Restricted to V0-V15 when element size <Ts> is H.

<Ts> Is an element size specifier,
RESERVED when size = 00
H when size = 01
S when size = 10
RESERVED when size = 11

<index> Is the element index
RESERVED when size = 00
H:L:M when size = 01
H:L when size = 10
RESERVED when size = 11

Operation

```

CheckFPAdvSIMDEnabled64();
bits(datasize) operand1 = Vpart[n, part];
bits(idxsize) operand2 = V[m];
bits(2*datasize) operand3 = V[d];
bits(2*datasize) result;
integer element1;
integer element2;
bits(2*esize) product;

element2 = Int(Elem[operand2, index, esize], unsigned);
for e = 0 to elements-1
  element1 = Int(Elem[operand1, e, esize], unsigned);
  product = (element1 * element2)<2*esize-1:0>;
  if sub_op then
    Elem[result, e, 2*esize] = Elem[operand3, e, 2*esize] - product;
  else
    Elem[result, e, 2*esize] = Elem[operand3, e, 2*esize] + product;

V[d] = result;
  
```

C6.3.320 UMLSL, UMLSL2 (vector)

Unsigned multiply-subtract long (vector)

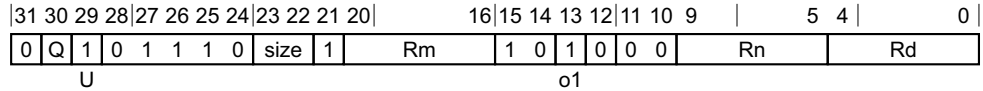

Three registers, not all the same type variant

UMLSL{2} <Vd>.<Ta>, <Vn>.<Tb>, <Vm>.<Tb>

```
integer d = UInt(Rd);
integer n = UInt(Rn);
integer m = UInt(Rm);

if size == '11' then ReservedValue();
integer esize = 8 << UInt(size);
integer datasize = 64;
integer part = UInt(Q);
integer elements = datasize DIV esize;
boolean sub_op = (o1 == '1');
boolean unsigned = (U == '1');
```

Assembler Symbols

- 2 Is the second and upper half specifier. If present it causes the operation to be performed on the upper 64 bits of the registers holding the narrower elements, and is
- [absent]** when Q = 0
 - [present]** when Q = 1
- <Vd> Is the name of the SIMD&FP destination register, encoded in the "Rd" field.
- <Ta> Is an arrangement specifier,
- 8H** when size = 00
 - 4S** when size = 01
 - 2D** when size = 10
 - RESERVED** when size = 11
- <Vn> Is the name of the first SIMD&FP source register, encoded in the "Rn" field.
- <Tb> Is an arrangement specifier,
- 8B** when size = 00, Q = 0
 - 16B** when size = 00, Q = 1
 - 4H** when size = 01, Q = 0
 - 8H** when size = 01, Q = 1
 - 2S** when size = 10, Q = 0
 - 4S** when size = 10, Q = 1
 - RESERVED** when size = 11, Q = x
- <Vm> Is the name of the second SIMD&FP source register, encoded in the "Rm" field.

Operation

```
CheckFPAdvSIMDEnabled64();
bits(datasize) operand1 = Vpart[n, part];
bits(datasize) operand2 = Vpart[m, part];
bits(2*datasize) operand3 = V[d];
bits(2*datasize) result;
integer element1;
integer element2;
bits(2*esize) product;
bits(2*esize) accum;

for e = 0 to elements-1
    element1 = Int(Elem[operand1, e, esize], unsigned);
    element2 = Int(Elem[operand2, e, esize], unsigned);
    product = (element1 * element2) <2*esize-1:0>;
    if sub_op then
        accum = Elem[operand3, e, 2*esize] - product;
    else
        accum = Elem[operand3, e, 2*esize] + product;
    Elem[result, e, 2*esize] = accum;

V[d] = result;
```

C6.3.321 UMOV

Unsigned move vector element to general-purpose register

This instruction is used by the alias [MOV \(to general\)](#). The alias is always the preferred disassembly.

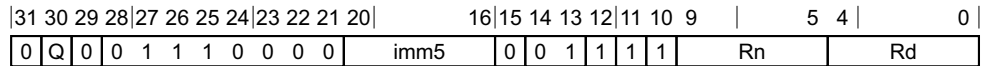

32-bit variant (Q = 0)

UMOV <Wd>, <Vn>.<Ts>[<index>]

64-bit variant (Q = 1)

UMOV <Xd>, <Vn>.<Ts>[<index>]

```
integer d = UInt(Rd);
integer n = UInt(Rn);

integer size;
case Q:imm5 of
    when '0xxx1' size = 0; // UMOV Wd, Vn.B
    when '0xxx10' size = 1; // UMOV Wd, Vn.H
    when '0xx100' size = 2; // UMOV Wd, Vn.S
    when '1x1000' size = 3; // UMOV Xd, Vn.D
    otherwise UnallocatedEncoding();

integer idxsize = if imm5<4> == '1' then 128 else 64;
integer index = UInt(imm5<4:size+1>);
integer esize = 8 << size;
integer datasize = if Q == '1' then 64 else 32;
```

Assembler Symbols

- <Wd> Is the 32-bit name of the general-purpose destination register, encoded in the "Rd" field.
- <Xd> Is the 64-bit name of the general-purpose destination register, encoded in the "Rd" field.
- <Vn> Is the name of the SIMD&FP source register, encoded in the "Rn" field.
- <Ts> For the 32-bit variant: is an element size specifier,
 - RESERVED** when imm5 = xx000
 - B** when imm5 = xxxx1
 - H** when imm5 = xxx10
 - S** when imm5 = xx100
- <Ts> For the 64-bit variant: is an element size specifier,
 - RESERVED** when imm5 = x0000
 - RESERVED** when imm5 = xxxx1
 - RESERVED** when imm5 = xxx10
 - RESERVED** when imm5 = xx100
 - D** when imm5 = x1000
- <index> For the 32-bit variant: is the element index
 - RESERVED** when imm5 = xx000
 - imm5<4:1>** when imm5 = xxxx1

imm5<4:2> when imm5 = xxx10

imm5<4:3> when imm5 = xx100

<index> For the 64-bit variant: is the element index encoded in "imm5<4>".

Operation

```
CheckFPAdvSIMDEnabled64();  
bits(idxsiz) operand = V[n];  
X[d] = ZeroExtend(Elm[operand, index, esize], datasize);
```

C6.3.322 UMULL, UMULL2 (by element)

Unsigned multiply long (vector, by element)

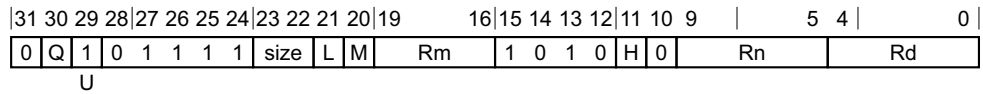

Vector variant

UMULL{2} <Vd>.<Ta>, <Vn>.<Tb>, <Vm>.<Ts>[<index>]

```

integer idxsize = if H == '1' then 128 else 64;
integer index;
bit Rmhi;
case size of
    when '01' index = UInt(H:L:M); Rmhi = '0';
    when '10' index = UInt(H:L); Rmhi = M;
    otherwise UnallocatedEncoding();

integer d = UInt(Rd);
integer n = UInt(Rn);
integer m = UInt(Rmhi:Rm);

integer esize = 8 << UInt(size);
integer datasize = 64;
integer part = UInt(Q);
integer elements = datasize DIV esize;
boolean unsigned = (U == '1');
```

Assembler Symbols

- 2 Is the second and upper half specifier. If present it causes the operation to be performed on the upper 64 bits of the registers holding the narrower elements, and is
- [absent]** when Q = 0
[present] when Q = 1
- <Vd> Is the name of the SIMD&FP destination register, encoded in the "Rd" field.
- <Ta> Is an arrangement specifier,
RESERVED when size = 00
4S when size = 01
2D when size = 10
RESERVED when size = 11
- <Vn> Is the name of the first SIMD&FP source register, encoded in the "Rn" field.
- <Tb> Is an arrangement specifier,
RESERVED when size = 00, Q = x
4H when size = 01, Q = 0
8H when size = 01, Q = 1
2S when size = 10, Q = 0
4S when size = 10, Q = 1
RESERVED when size = 11, Q = x

<Vm>	Is the name of the second SIMD&FP source register, RESERVED when size = 00 0:Rm when size = 01 M:Rm when size = 10 RESERVED when size = 11 Restricted to V0-V15 when element size <Ts> is H.
<Ts>	Is an element size specifier, RESERVED when size = 00 H when size = 01 S when size = 10 RESERVED when size = 11
<index>	Is the element index RESERVED when size = 00 H:L:M when size = 01 H:L when size = 10 RESERVED when size = 11

Operation

```
CheckFPAdvSIMDEnabled64();
bits(datasize) operand1 = Vpart[n, part];
bits(idxsize) operand2 = V[m];
bits(2*datasize) result;
integer element1;
integer element2;
bits(2*esize) product;

element2 = Int(Elem[operand2, index, esize], unsigned);
for e = 0 to elements-1
    element1 = Int(Elem[operand1, e, esize], unsigned);
    product = (element1 * element2)<2*esize-1:0>;
    Elem[result, e, 2*esize] = product;

V[d] = result;
```

C6.3.323 UMULL, UMULL2 (vector)

Unsigned multiply long (vector)

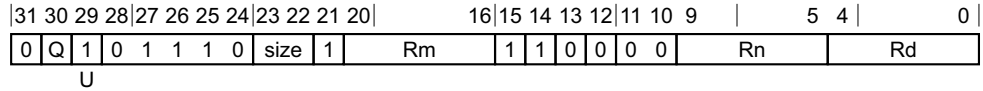

Three registers, not all the same type variant

UMULL{2} <Vd>.<Ta>, <Vn>.<Tb>, <Vm>.<Tb>

```
integer d = UInt(Rd);
integer n = UInt(Rn);
integer m = UInt(Rm);

if size == '11' then ReservedValue();
integer esize = 8 << UInt(size);
integer datasize = 64;
integer part = UInt(Q);
integer elements = datasize DIV esize;

boolean unsigned = (U == '1');
```

Assembler Symbols

- 2 Is the second and upper half specifier. If present it causes the operation to be performed on the upper 64 bits of the registers holding the narrower elements, and is
- [absent]** when Q = 0
 - [present]** when Q = 1
- <Vd> Is the name of the SIMD&FP destination register, encoded in the "Rd" field.
- <Ta> Is an arrangement specifier,
- 8H** when size = 00
 - 4S** when size = 01
 - 2D** when size = 10
 - RESERVED** when size = 11
- <Vn> Is the name of the first SIMD&FP source register, encoded in the "Rn" field.
- <Tb> Is an arrangement specifier,
- 8B** when size = 00, Q = 0
 - 16B** when size = 00, Q = 1
 - 4H** when size = 01, Q = 0
 - 8H** when size = 01, Q = 1
 - 2S** when size = 10, Q = 0
 - 4S** when size = 10, Q = 1
 - RESERVED** when size = 11, Q = x
- <Vm> Is the name of the second SIMD&FP source register, encoded in the "Rm" field.

Operation

```
CheckFPAdvSIMDEnabled64();
bits(datasize) operand1 = Vpart[n, part];
bits(datasize) operand2 = Vpart[m, part];
bits(2*datasize) result;
integer element1;
integer element2;

for e = 0 to elements-1
    element1 = Int(Elem[operand1, e, esize], unsigned);
    element2 = Int(Elem[operand2, e, esize], unsigned);
    Elem[result, e, 2*esize] = (element1 * element2)<2*esize-1:0>;

V[d] = result;
```

C6.3.324 UQADD

Unsigned saturating add

It has encodings from 2 classes: *Scalar* and *Vector*

Scalar

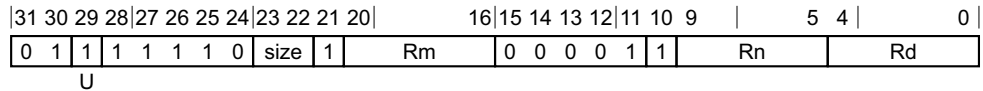

Scalar variant

UQADD <V><d>, <V><n>, <V><m>

```
integer d = UInt(Rd);
integer n = UInt(Rn);
integer m = UInt(Rm);
integer esize = 8 << UInt(size);
integer datasize = esize;
integer elements = 1;
boolean unsigned = (U == '1');
```

Vector

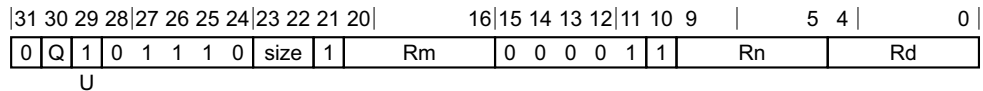

Vector variant

UQADD <Vd>.<T>, <Vn>.<T>, <Vm>.<T>

```
integer d = UInt(Rd);
integer n = UInt(Rn);
integer m = UInt(Rm);
if size:Q == '110' then ReservedValue();
integer esize = 8 << UInt(size);
integer datasize = if Q == '1' then 128 else 64;
integer elements = datasize DIV esize;
boolean unsigned = (U == '1');
```

Assembler Symbols

- <V> Is a width specifier,
 - B** when size = 00
 - H** when size = 01
 - S** when size = 10
 - D** when size = 11
- <d> Is the number of the SIMD&FP destination register, in the "Rd" field.
- <n> Is the number of the first SIMD&FP source register, encoded in the "Rn" field.
- <m> Is the number of the second SIMD&FP source register, encoded in the "Rm" field.
- <Vd> Is the name of the SIMD&FP destination register, encoded in the "Rd" field.

<T>	Is an arrangement specifier, 8B when size = 00, Q = 0 16B when size = 00, Q = 1 4H when size = 01, Q = 0 8H when size = 01, Q = 1 2S when size = 10, Q = 0 4S when size = 10, Q = 1 RESERVED when size = 11, Q = 0 2D when size = 11, Q = 1
<Vn>	Is the name of the first SIMD&FP source register, encoded in the "Rn" field.
<Vm>	Is the name of the second SIMD&FP source register, encoded in the "Rm" field.

Operation for all classes

```
CheckFPAdvSIMDEnabled64();
bits(datasize) operand1 = V[n];
bits(datasize) operand2 = V[m];
bits(datasize) result;
integer element1;
integer element2;
integer sum;
boolean sat;

for e = 0 to elements-1
    element1 = Int(Elem[operand1, e, esize], unsigned);
    element2 = Int(Elem[operand2, e, esize], unsigned);
    sum = element1 + element2;
    (Elem[result, e, esize], sat) = SatQ(sum, esize, unsigned);
    if sat then FPSR.QC = '1';

V[d] = result;
```

C6.3.325 UQRSHL

Unsigned saturating rounding shift left (register)

It has encodings from 2 classes: *Scalar* and *Vector*

Scalar

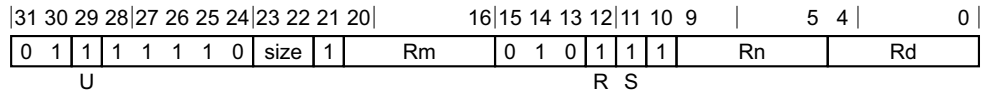

Scalar variant

UQRSHL <V><d>, <V><n>, <V><m>

```
integer d = UInt(Rd);
integer n = UInt(Rn);
integer m = UInt(Rm);
integer esize = 8 << UInt(size);
integer datasize = esize;
integer elements = 1;
boolean unsigned = (U == '1');
boolean rounding = (R == '1');
boolean saturating = (S == '1');
if S == '0' && size != '11' then ReservedValue();
```

Vector

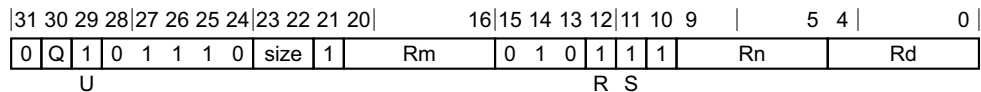

Vector variant

UQRSHL <Vd>.<T>, <Vn>.<T>, <Vm>.<T>

```
integer d = UInt(Rd);
integer n = UInt(Rn);
integer m = UInt(Rm);
if size:Q == '110' then ReservedValue();
integer esize = 8 << UInt(size);
integer datasize = if Q == '1' then 128 else 64;
integer elements = datasize DIV esize;
boolean unsigned = (U == '1');
boolean rounding = (R == '1');
boolean saturating = (S == '1');
```

Assembler Symbols

- <V> Is a width specifier,
 - B** when size = 00
 - H** when size = 01
 - S** when size = 10
 - D** when size = 11
- <d> Is the number of the SIMD&FP destination register, in the "Rd" field.
- <n> Is the number of the first SIMD&FP source register, encoded in the "Rn" field.
- <m> Is the number of the second SIMD&FP source register, encoded in the "Rm" field.

- <Vd> Is the name of the SIMD&FP destination register, encoded in the "Rd" field.
- <T> Is an arrangement specifier,
8B when size = 00, Q = 0
16B when size = 00, Q = 1
4H when size = 01, Q = 0
8H when size = 01, Q = 1
2S when size = 10, Q = 0
4S when size = 10, Q = 1
RESERVED when size = 11, Q = 0
2D when size = 11, Q = 1
- <Vn> Is the name of the first SIMD&FP source register, encoded in the "Rn" field.
- <Vm> Is the name of the second SIMD&FP source register, encoded in the "Rm" field.

Operation for all classes

```
CheckFPAdvSIMDEnabled64();
bits(datasize) operand1 = V[n];
bits(datasize) operand2 = V[m];
bits(datasize) result;

integer round_const = 0;
integer shift;
integer element;
boolean sat;

for e = 0 to elements-1
    shift = SInt(Elem[operand2, e, esize]<7:0>);
    if rounding then
        round_const = 1 << (-shift - 1); // 0 for left shift, 2^(n-1) for right shift
    element = (Int(Elem[operand1, e, esize], unsigned) + round_const) << shift;
    if saturating then
        (Elem[result, e, esize], sat) = SatQ(element, esize, unsigned);
        if sat then FPSR.QC = '1';
    else
        Elem[result, e, esize] = element<esize-1:0>;

V[d] = result;
```

C6.3.326 UQRSHRN, UQRSHRN2

Unsigned saturating rounded shift right narrow (immediate)

It has encodings from 2 classes: *Scalar* and *Vector*

Scalar

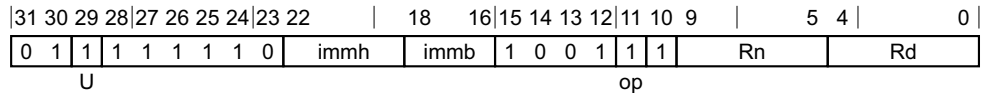

Scalar variant

UQRSHRN <Vb><d>, <Va><n>, #<shift>

```
integer d = UInt(Rd);
integer n = UInt(Rn);

if immh == '0000' then ReservedValue();
if immh<3> == '1' then ReservedValue();
integer esize = 8 << HighestSetBit(immh);
integer datasize = esize;
integer elements = 1;
integer part = 0;

integer shift = (2 * esize) - UInt(immh:immb);
boolean round = (op == '1');
boolean unsigned = (U == '1');
```

Vector

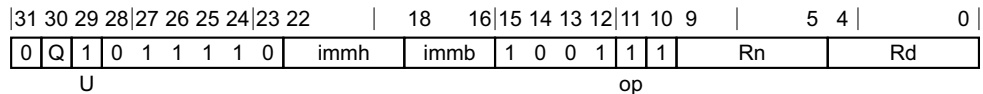

Vector variant

UQRSHRN{2} <Vd>.<Tb>, <Vn>.<Ta>, #<shift>

```
integer d = UInt(Rd);
integer n = UInt(Rn);

if immh == '0000' then AdvSIMD modified immediate;
if immh<3> == '1' then ReservedValue();
integer esize = 8 << HighestSetBit(immh);
integer datasize = 64;
integer part = UInt(Q);
integer elements = datasize DIV esize;

integer shift = (2 * esize) - UInt(immh:immb);
boolean round = (op == '1');
boolean unsigned = (U == '1');
```

Assembler Symbols

- 2 Is the second and upper half specifier. If present it causes the operation to be performed on the upper 64 bits of the registers holding the narrower elements, and is
- [absent]** when Q = 0
 - [present]** when Q = 1
- <Vd> Is the name of the SIMD&FP destination register, encoded in the "Rd" field.

- <Tb> Is an arrangement specifier,
 See **AdvSIMD modified immediate**, when immh = 0000, Q = x
8B when immh = 0001, Q = 0
16B when immh = 0001, Q = 1
4H when immh = 001x, Q = 0
8H when immh = 001x, Q = 1
2S when immh = 01xx, Q = 0
4S when immh = 01xx, Q = 1
RESERVED when immh = 1xxx, Q = x
- <Vn> Is the name of the SIMD&FP source register, encoded in the "Rn" field.
- <Ta> Is an arrangement specifier,
 See **AdvSIMD modified immediate**, when immh = 0000
8H when immh = 0001
4S when immh = 001x
2D when immh = 01xx
RESERVED when immh = 1xxx
- <Vb> Is the destination width specifier,
RESERVED when immh = 0000
B when immh = 0001
H when immh = 001x
S when immh = 01xx
RESERVED when immh = 1xxx
- <d> Is the number of the SIMD&FP destination register, in the "Rd" field.
- <Va> Is the source width specifier,
RESERVED when immh = 0000
H when immh = 0001
S when immh = 001x
D when immh = 01xx
RESERVED when immh = 1xxx
- <n> Is the number of the first SIMD&FP source register, encoded in the "Rn" field.
- <shift> For the scalar variant: is the shift amount, in the range 1 to element bits,
RESERVED when immh = 0000
(16-UInt(immh:immb)) when immh = 0001
(32-UInt(immh:immb)) when immh = 001x
(64-UInt(immh:immb)) when immh = 01xx
RESERVED when immh = 1xxx
- <shift> For the vector variant: is a shift amount, in the range 1 to element bits,
 See **AdvSIMD modified immediate**, when immh = 0000
(16-UInt(immh:immb)) when immh = 0001
(32-UInt(immh:immb)) when immh = 001x
(64-UInt(immh:immb)) when immh = 01xx
RESERVED when immh = 1xxx

Operation for all classes

```
CheckFPAdvSIMDEnabled64();
bits(datasize*2) operand = V[n];
bits(datasize) result;
integer round_const = if round then (1 << (shift - 1)) else 0;
integer element;
boolean sat;

for e = 0 to elements-1
    element = (Int(Elem[operand, e, 2*esize], unsigned) + round_const) >> shift;
    (Elem[result, e, esize], sat) = SatQ(element, esize, unsigned);
    if sat then FPSR.QC = '1';

Vpart[d, part] = result;
```

C6.3.327 UQSHL (immediate)

Unsigned saturating shift left (immediate)

It has encodings from 2 classes: *Scalar* and *Vector*

Scalar

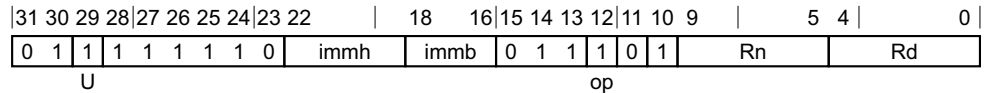

Scalar variant

UQSHL <V><d>, <V><n>, #<shift>

```
integer d = UInt(Rd);
integer n = UInt(Rn);
```

```
if immh == '0000' then ReservedValue();
integer esize = 8 << HighestSetBit(immh);
integer datasize = esize;
integer elements = 1;
```

```
integer shift = UInt(immh:immb) - esize;
```

```
boolean src_unsigned;
boolean dst_unsigned;
```

```
case op:U of
    when '00' UnallocatedEncoding();
    when '01' src_unsigned = FALSE; dst_unsigned = TRUE;
    when '10' src_unsigned = FALSE; dst_unsigned = FALSE;
    when '11' src_unsigned = TRUE; dst_unsigned = TRUE;
```

Vector

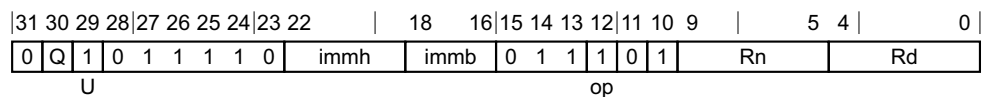

Vector variant

UQSHL <Vd>.<T>, <Vn>.<T>, #<shift>

```
integer d = UInt(Rd);
integer n = UInt(Rn);
```

```
if immh == '0000' then AdvSIMD modified immediate;
if immh<3>:Q == '10' then ReservedValue();
integer esize = 8 << HighestSetBit(immh);
integer datasize = if Q == '1' then 128 else 64;
integer elements = datasize DIV esize;
```

```
integer shift = UInt(immh:immb) - esize;
```

```
boolean src_unsigned;
boolean dst_unsigned;
```

```
case op:U of
    when '00' UnallocatedEncoding();
    when '01' src_unsigned = FALSE; dst_unsigned = TRUE;
    when '10' src_unsigned = FALSE; dst_unsigned = FALSE;
    when '11' src_unsigned = TRUE; dst_unsigned = TRUE;
```

Assembler Symbols

<V>	Is a width specifier, RESERVED when immh = 0000 B when immh = 0001 H when immh = 001x S when immh = 01xx D when immh = 1xxx
<d>	Is the number of the SIMD&FP destination register, in the "Rd" field.
<n>	Is the number of the first SIMD&FP source register, encoded in the "Rn" field.
<Vd>	Is the name of the SIMD&FP destination register, encoded in the "Rd" field.
<T>	Is an arrangement specifier, See AdvSIMD modified immediate . when immh = 0000, Q = x 8B when immh = 0001, Q = 0 16B when immh = 0001, Q = 1 4H when immh = 001x, Q = 0 8H when immh = 001x, Q = 1 2S when immh = 01xx, Q = 0 4S when immh = 01xx, Q = 1 RESERVED when immh = 1xxx, Q = 0 2D when immh = 1xxx, Q = 1
<Vn>	Is the name of the SIMD&FP source register, encoded in the "Rn" field.
<shift>	For the scalar variant: is the shift amount, in the range 0 to element bits - 1, RESERVED when immh = 0000 (UInt(immh:immb)-8) when immh = 0001 (UInt(immh:immb)-16) when immh = 001x (UInt(immh:immb)-32) when immh = 01xx (UInt(immh:immb)-64) when immh = 1xxx
<shift>	For the vector variant: is a shift amount, in the range 0 to element bits - 1, See AdvSIMD modified immediate . when immh = 0000 (UInt(immh:immb)-8) when immh = 0001 (UInt(immh:immb)-16) when immh = 001x (UInt(immh:immb)-32) when immh = 01xx (UInt(immh:immb)-64) when immh = 1xxx

Operation for all classes

```

CheckFPAdvSIMDEnabled64();
bits(datasize) operand = V[n];
bits(datasize) result;
integer element;
boolean sat;

for e = 0 to elements-1
    element = Int(Elem[operand, e, esize], src_unsigned) << shift;
    (Elem[result, e, esize], sat) = SatQ(element, esize, dst_unsigned);
    
```

```
    if sat then FPSR.QC = '1';  
V[d] = result;
```

C6.3.328 UQSHL (register)

Unsigned saturating shift left (register)

It has encodings from 2 classes: *Scalar* and *Vector*

Scalar

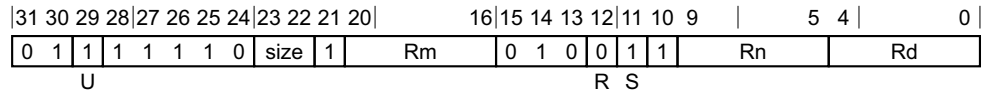

Scalar variant

UQSHL <V><d>, <V><n>, <V><m>

```
integer d = UInt(Rd);
integer n = UInt(Rn);
integer m = UInt(Rm);
integer esize = 8 << UInt(size);
integer datasize = esize;
integer elements = 1;
boolean unsigned = (U == '1');
boolean rounding = (R == '1');
boolean saturating = (S == '1');
if S == '0' && size != '11' then ReservedValue();
```

Vector

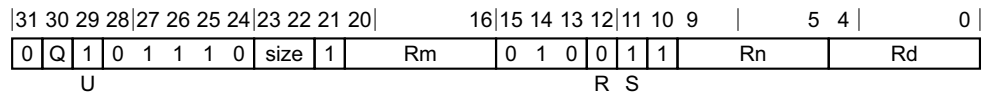

Vector variant

UQSHL <Vd>.<T>, <Vn>.<T>, <Vm>.<T>

```
integer d = UInt(Rd);
integer n = UInt(Rn);
integer m = UInt(Rm);
if size:Q == '110' then ReservedValue();
integer esize = 8 << UInt(size);
integer datasize = if Q == '1' then 128 else 64;
integer elements = datasize DIV esize;
boolean unsigned = (U == '1');
boolean rounding = (R == '1');
boolean saturating = (S == '1');
```

Assembler Symbols

- <V> Is a width specifier,
- B** when size = 00
 - H** when size = 01
 - S** when size = 10
 - D** when size = 11
- <d> Is the number of the SIMD&FP destination register, in the "Rd" field.
- <n> Is the number of the first SIMD&FP source register, encoded in the "Rn" field.
- <m> Is the number of the second SIMD&FP source register, encoded in the "Rm" field.

- <Vd> Is the name of the SIMD&FP destination register, encoded in the "Rd" field.
- <T> Is an arrangement specifier,
8B when size = 00, Q = 0
16B when size = 00, Q = 1
4H when size = 01, Q = 0
8H when size = 01, Q = 1
2S when size = 10, Q = 0
4S when size = 10, Q = 1
RESERVED when size = 11, Q = 0
2D when size = 11, Q = 1
- <Vn> Is the name of the first SIMD&FP source register, encoded in the "Rn" field.
- <Vm> Is the name of the second SIMD&FP source register, encoded in the "Rm" field.

Operation for all classes

```

CheckFPAdvSIMDEnabled64();
bits(datasize) operand1 = V[n];
bits(datasize) operand2 = V[m];
bits(datasize) result;

integer round_const = 0;
integer shift;
integer element;
boolean sat;

for e = 0 to elements-1
  shift = SInt(Elem[operand2, e, esize]<7:0>);
  if rounding then
    round_const = 1 << (-shift - 1); // 0 for left shift, 2^(n-1) for right shift
  element = (Int(Elem[operand1, e, esize], unsigned) + round_const) << shift;
  if saturating then
    (Elem[result, e, esize], sat) = SatQ(element, esize, unsigned);
    if sat then FPSR.QC = '1';
  else
    Elem[result, e, esize] = element<esize-1:0>;

V[d] = result;

```

C6.3.329 UQSHRN

Unsigned saturating shift right narrow (immediate)

It has encodings from 2 classes: *Scalar* and *Vector*

Scalar

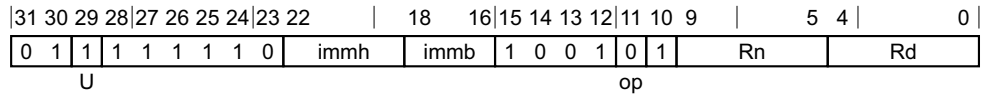

Scalar variant

UQSHRN <Vb><d>, <Va><n>, #<shift>

```
integer d = UInt(Rd);
integer n = UInt(Rn);

if immh == '0000' then ReservedValue();
if immh<3> == '1' then ReservedValue();
integer esize = 8 << HighestSetBit(immh);
integer datasize = esize;
integer elements = 1;
integer part = 0;

integer shift = (2 * esize) - UInt(immh:immb);
boolean round = (op == '1');
boolean unsigned = (U == '1');
```

Vector

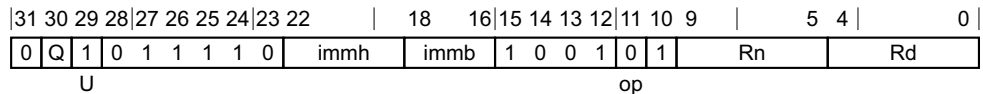

Vector variant

UQSHRN{2} <Vd>.<Tb>, <Vn>.<Ta>, #<shift>

```
integer d = UInt(Rd);
integer n = UInt(Rn);

if immh == '0000' then AdvSIMD modified immediate;
if immh<3> == '1' then ReservedValue();
integer esize = 8 << HighestSetBit(immh);
integer datasize = 64;
integer part = UInt(Q);
integer elements = datasize DIV esize;

integer shift = (2 * esize) - UInt(immh:immb);
boolean round = (op == '1');
boolean unsigned = (U == '1');
```

Assembler Symbols

- 2 Is the second and upper half specifier. If present it causes the operation to be performed on the upper 64 bits of the registers holding the narrower elements, and is
 - [absent]** when Q = 0
 - [present]** when Q = 1
- <Vd> Is the name of the SIMD&FP destination register, encoded in the "Rd" field.

<Tb>	Is an arrangement specifier, See AdvSIMD modified immediate. when immh = 0000, Q = x 8B when immh = 0001, Q = 0 16B when immh = 0001, Q = 1 4H when immh = 001x, Q = 0 8H when immh = 001x, Q = 1 2S when immh = 01xx, Q = 0 4S when immh = 01xx, Q = 1 RESERVED when immh = 1xxx, Q = x
<Vn>	Is the name of the SIMD&FP source register, encoded in the "Rn" field.
<Ta>	Is an arrangement specifier, See AdvSIMD modified immediate. when immh = 0000 8H when immh = 0001 4S when immh = 001x 2D when immh = 01xx RESERVED when immh = 1xxx
<Vb>	Is the destination width specifier, RESERVED when immh = 0000 B when immh = 0001 H when immh = 001x S when immh = 01xx RESERVED when immh = 1xxx
<d>	Is the number of the SIMD&FP destination register, in the "Rd" field.
<Va>	Is the source width specifier, RESERVED when immh = 0000 H when immh = 0001 S when immh = 001x D when immh = 01xx RESERVED when immh = 1xxx
<n>	Is the number of the first SIMD&FP source register, encoded in the "Rn" field.
<shift>	For the scalar variant: is the shift amount, in the range 1 to element bits, RESERVED when immh = 0000 (16-UInt(immh:immb)) when immh = 0001 (32-UInt(immh:immb)) when immh = 001x (64-UInt(immh:immb)) when immh = 01xx RESERVED when immh = 1xxx
<shift>	For the vector variant: is a shift amount, in the range 1 to element bits, See AdvSIMD modified immediate. when immh = 0000 (16-UInt(immh:immb)) when immh = 0001 (32-UInt(immh:immb)) when immh = 001x (64-UInt(immh:immb)) when immh = 01xx RESERVED when immh = 1xxx

Operation for all classes

```
CheckFPAdvSIMDEnabled64();
bits(datasize*2) operand = V[n];
bits(datasize) result;
integer round_const = if round then (1 << (shift - 1)) else 0;
integer element;
boolean sat;

for e = 0 to elements-1
    element = (Int(Elem[operand, e, 2*esize], unsigned) + round_const) >> shift;
    (Elem[result, e, esize], sat) = SatQ(element, esize, unsigned);
    if sat then FPSR.QC = '1';

Vpart[d, part] = result;
```

C6.3.330 UQSUB

Unsigned saturating subtract

It has encodings from 2 classes: *Scalar* and *Vector*

Scalar

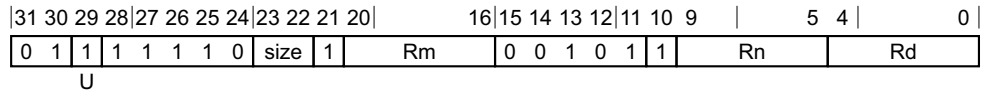

Scalar variant

UQSUB <V><d>, <V><n>, <V><m>

```
integer d = UInt(Rd);
integer n = UInt(Rn);
integer m = UInt(Rm);
integer esize = 8 << UInt(size);
integer datasize = esize;
integer elements = 1;
boolean unsigned = (U == '1');
```

Vector

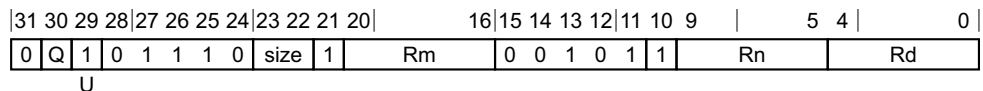

Vector variant

UQSUB <Vd>.<T>, <Vn>.<T>, <Vm>.<T>

```
integer d = UInt(Rd);
integer n = UInt(Rn);
integer m = UInt(Rm);
if size:Q == '110' then ReservedValue();
integer esize = 8 << UInt(size);
integer datasize = if Q == '1' then 128 else 64;
integer elements = datasize DIV esize;
boolean unsigned = (U == '1');
```

Assembler Symbols

- <V> Is a width specifier,
 - B** when size = 00
 - H** when size = 01
 - S** when size = 10
 - D** when size = 11
- <d> Is the number of the SIMD&FP destination register, in the "Rd" field.
- <n> Is the number of the first SIMD&FP source register, encoded in the "Rn" field.
- <m> Is the number of the second SIMD&FP source register, encoded in the "Rm" field.
- <Vd> Is the name of the SIMD&FP destination register, encoded in the "Rd" field.

- <T> Is an arrangement specifier,
- 8B** when size = 00, Q = 0
 - 16B** when size = 00, Q = 1
 - 4H** when size = 01, Q = 0
 - 8H** when size = 01, Q = 1
 - 2S** when size = 10, Q = 0
 - 4S** when size = 10, Q = 1
 - RESERVED** when size = 11, Q = 0
 - 2D** when size = 11, Q = 1
- <Vn> Is the name of the first SIMD&FP source register, encoded in the "Rn" field.
- <Vm> Is the name of the second SIMD&FP source register, encoded in the "Rm" field.

Operation for all classes

```
CheckFPAdvSIMDEnabled64();
bits(datasize) operand1 = V[n];
bits(datasize) operand2 = V[m];
bits(datasize) result;
integer element1;
integer element2;
integer diff;
boolean sat;

for e = 0 to elements-1
    element1 = Int(Elem[operand1, e, esize], unsigned);
    element2 = Int(Elem[operand2, e, esize], unsigned);
    diff = element1 - element2;
    (Elem[result, e, esize], sat) = SatQ(diff, esize, unsigned);
    if sat then FPSR.QC = '1';

V[d] = result;
```

C6.3.331 UQXTN, UQXTN2

Unsigned saturating extract narrow

It has encodings from 2 classes: *Scalar* and *Vector*

Scalar

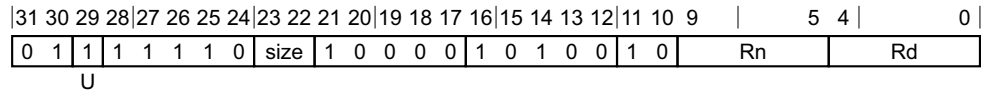

Scalar variant

UQXTN <Vb><d>, <Va><n>

```
integer d = UInt(Rd);
integer n = UInt(Rn);

if size == '11' then ReservedValue();
integer esize = 8 << UInt(size);
integer datasize = esize;
integer part = 0;
integer elements = 1;

boolean unsigned = (U == '1');
```

Vector

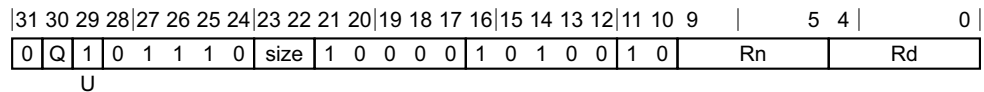

Vector variant

UQXTN{2} <Vd>.<Tb>, <Vn>.<Ta>

```
integer d = UInt(Rd);
integer n = UInt(Rn);

if size == '11' then ReservedValue();
integer esize = 8 << UInt(size);
integer datasize = 64;
integer part = UInt(Q);
integer elements = datasize DIV esize;

boolean unsigned = (U == '1');
```

Assembler Symbols

- 2 Is the second and upper half specifier. If present it causes the operation to be performed on the upper 64 bits of the registers holding the narrower elements, and is
 - [absent]** when Q = 0
 - [present]** when Q = 1
- <Vd> Is the name of the SIMD&FP destination register, encoded in the "Rd" field.
- <Tb> Is an arrangement specifier,
 - 8B** when size = 00, Q = 0
 - 16B** when size = 00, Q = 1

- 4H** when size = 01, Q = 0
8H when size = 01, Q = 1
2S when size = 10, Q = 0
4S when size = 10, Q = 1
RESERVED when size = 11, Q = x
- <Vn> Is the name of the SIMD&FP source register, encoded in the "Rn" field.
- <Ta> Is an arrangement specifier,
8H when size = 00
4S when size = 01
2D when size = 10
RESERVED when size = 11
- <Vb> Is the destination width specifier,
B when size = 00
H when size = 01
S when size = 10
RESERVED when size = 11
- <d> Is the number of the SIMD&FP destination register, encoded in the "Rd" field.
- <Va> Is the source width specifier,
H when size = 00
S when size = 01
D when size = 10
RESERVED when size = 11
- <n> Is the number of the SIMD&FP source register, encoded in the "Rn" field.

Operation for all classes

```

CheckFPAdvSIMDEnabled64();
bits(2*datasize) operand = V[n];
bits(datasize) result;
bits(2*esize) element;
boolean sat;

for e = 0 to elements-1
    element = Elem[operand, e, 2*esize];
    (Elem[result, e, esize], sat) = SatQ(Int(element, unsigned), esize, unsigned);
    if sat then FPSR.QC = '1';

Vpart[d, part] = result;
    
```

C6.3.332 URECPE

Unsigned reciprocal estimate

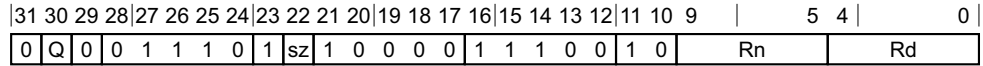

Vector variant

URECPE <Vd>.<T>, <Vn>.<T>

```
integer d = UInt(Rd);
integer n = UInt(Rn);

if sz == '1' then ReservedValue();
integer esize = 32;
integer datasize = if Q == '1' then 128 else 64;
integer elements = datasize DIV esize;
```

Assembler Symbols

- <Vd> Is the name of the SIMD&FP destination register, encoded in the "Rd" field.
- <T> Is an arrangement specifier,
2S when sz = 0, Q = 0
4S when sz = 0, Q = 1
RESERVED when sz = 1, Q = x
- <Vn> Is the name of the SIMD&FP source register, encoded in the "Rn" field.

Operation

```
CheckFPAdvSIMDEnabled64();
bits(datasize) operand = V[n];
bits(datasize) result;
bits(32) element;

for e = 0 to elements-1
    element = Elem[operand, e, 32];
    Elem[result, e, 32] = UnsignedRecipEstimate(element);

V[d] = result;
```

C6.3.333 URHADD

Unsigned rounding halving add

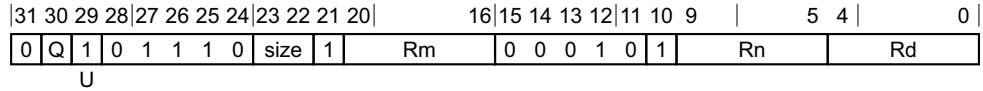

Three registers of the same type variant

URHADD <Vd>.<T>, <Vn>.<T>, <Vm>.<T>

```
integer d = UInt(Rd);
integer n = UInt(Rn);
integer m = UInt(Rm);
if size == '11' then ReservedValue();
integer esize = 8 << UInt(size);
integer datasize = if Q == '1' then 128 else 64;
integer elements = datasize DIV esize;

boolean unsigned = (U == '1');
```

Assembler Symbols

- <Vd> Is the name of the SIMD&FP destination register, encoded in the "Rd" field.
- <T> Is an arrangement specifier,
- 8B** when size = 00, Q = 0
 - 16B** when size = 00, Q = 1
 - 4H** when size = 01, Q = 0
 - 8H** when size = 01, Q = 1
 - 2S** when size = 10, Q = 0
 - 4S** when size = 10, Q = 1
 - RESERVED** when size = 11, Q = x
- <Vn> Is the name of the first SIMD&FP source register, encoded in the "Rn" field.
- <Vm> Is the name of the second SIMD&FP source register, encoded in the "Rm" field.

Operation

```
CheckFPAdvSIMDEnabled64();
bits(datasize) operand1 = V[n];
bits(datasize) operand2 = V[m];
bits(datasize) result;
integer element1;
integer element2;

for e = 0 to elements-1
    element1 = Int(Elem[operand1, e, esize], unsigned);
    element2 = Int(Elem[operand2, e, esize], unsigned);
    Elem[result, e, esize] = (element1 + element2 + 1)<esize:1>;

V[d] = result;
```

C6.3.334 URSHL

Unsigned rounding shift left (register)

It has encodings from 2 classes: *Scalar* and *Vector*

Scalar

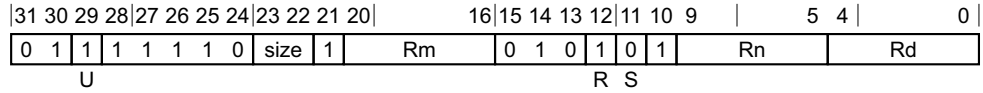

Scalar variant

URSHL <V><d>, <V><n>, <V><m>

```
integer d = UInt(Rd);
integer n = UInt(Rn);
integer m = UInt(Rm);
integer esize = 8 << UInt(size);
integer datasize = esize;
integer elements = 1;
boolean unsigned = (U == '1');
boolean rounding = (R == '1');
boolean saturating = (S == '1');
if S == '0' && size != '11' then ReservedValue();
```

Vector

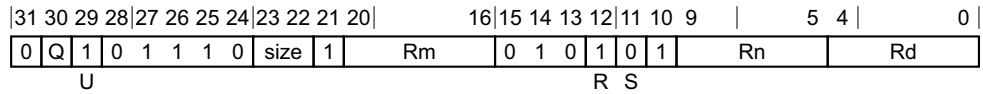

Vector variant

URSHL <Vd>.<T>, <Vn>.<T>, <Vm>.<T>

```
integer d = UInt(Rd);
integer n = UInt(Rn);
integer m = UInt(Rm);
if size:Q == '110' then ReservedValue();
integer esize = 8 << UInt(size);
integer datasize = if Q == '1' then 128 else 64;
integer elements = datasize DIV esize;
boolean unsigned = (U == '1');
boolean rounding = (R == '1');
boolean saturating = (S == '1');
```

Assembler Symbols

- <V> Is a width specifier,
RESERVED when size = 0x
RESERVED when size = 10
D when size = 11
- <d> Is the number of the SIMD&FP destination register, in the "Rd" field.
- <n> Is the number of the first SIMD&FP source register, encoded in the "Rn" field.
- <m> Is the number of the second SIMD&FP source register, encoded in the "Rm" field.

- <Vd> Is the name of the SIMD&FP destination register, encoded in the "Rd" field.
- <T> Is an arrangement specifier,
8B when size = 00, Q = 0
16B when size = 00, Q = 1
4H when size = 01, Q = 0
8H when size = 01, Q = 1
2S when size = 10, Q = 0
4S when size = 10, Q = 1
RESERVED when size = 11, Q = 0
2D when size = 11, Q = 1
- <Vn> Is the name of the first SIMD&FP source register, encoded in the "Rn" field.
- <Vm> Is the name of the second SIMD&FP source register, encoded in the "Rm" field.

Operation for all classes

```

CheckFPAdvSIMDEnabled64();
bits(datasize) operand1 = V[n];
bits(datasize) operand2 = V[m];
bits(datasize) result;

integer round_const = 0;
integer shift;
integer element;
boolean sat;

for e = 0 to elements-1
    shift = SInt(Elem[operand2, e, esize]<7:0>);
    if rounding then
        round_const = 1 << (-shift - 1); // 0 for left shift, 2^(n-1) for right shift
    element = (Int(Elem[operand1, e, esize], unsigned) + round_const) << shift;
    if saturating then
        (Elem[result, e, esize], sat) = SatQ(element, esize, unsigned);
        if sat then FPSR.QC = '1';
    else
        Elem[result, e, esize] = element<esize-1:0>;

V[d] = result;
    
```

C6.3.335 URSHR

Unsigned rounding shift right (immediate)

It has encodings from 2 classes: *Scalar* and *Vector*

Scalar

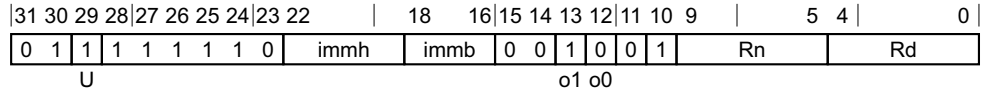

Scalar variant

URSHR <V><d>, <V><n>, #<shift>

```
integer d = UInt(Rd);
integer n = UInt(Rn);

if immh<3> != '1' then ReservedValue();
integer esize = 8 << 3;
integer datasize = esize;
integer elements = 1;

integer shift = (esize * 2) - UInt(immh:immb);
boolean unsigned = (U == '1');
boolean round = (o1 == '1');
boolean accumulate = (o0 == '1');
```

Vector

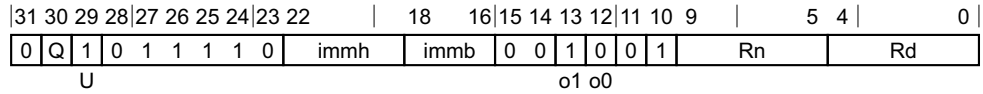

Vector variant

URSHR <Vd>.<T>, <Vn>.<T>, #<shift>

```
integer d = UInt(Rd);
integer n = UInt(Rn);

if immh == '0000' then AdvSIMD modified immediate;
if immh<3>:Q == '10' then ReservedValue();
integer esize = 8 << HighestSetBit(immh);
integer datasize = if Q == '1' then 128 else 64;
integer elements = datasize DIV esize;

integer shift = (esize * 2) - UInt(immh:immb);
boolean unsigned = (U == '1');
boolean round = (o1 == '1');
boolean accumulate = (o0 == '1');
```

Assembler Symbols

- <V> Is a width specifier,
RESERVED when immh = 0xxx
D when immh = 1xxx
- <d> Is the number of the SIMD&FP destination register, in the "Rd" field.
- <n> Is the number of the first SIMD&FP source register, encoded in the "Rn" field.

- <Vd> Is the name of the SIMD&FP destination register, encoded in the "Rd" field.
- <T> Is an arrangement specifier,
 See **AdvSIMD modified immediate**, when immh = 0000, Q = x
8B when immh = 0001, Q = 0
16B when immh = 0001, Q = 1
4H when immh = 001x, Q = 0
8H when immh = 001x, Q = 1
2S when immh = 01xx, Q = 0
4S when immh = 01xx, Q = 1
RESERVED when immh = 1xxx, Q = 0
2D when immh = 1xxx, Q = 1
- <Vn> Is the name of the SIMD&FP source register, encoded in the "Rn" field.
- <shift> For the scalar variant: is the shift amount, in the range 1 to 64,
RESERVED when immh = 0xxx
(128-UInt(immh:immb)) when immh = 1xxx
- <shift> For the vector variant: is a shift amount, in the range 1 to element bits,
 See **AdvSIMD modified immediate**, when immh = 0000
(16-UInt(immh:immb)) when immh = 0001
(32-UInt(immh:immb)) when immh = 001x
(64-UInt(immh:immb)) when immh = 01xx
(128-UInt(immh:immb)) when immh = 1xxx

Operation for all classes

```

CheckFPAdvSIMDEnabled64();
bits(datasize) operand = V[n];
bits(datasize) operand2;
bits(datasize) result;
integer round_const = if round then (1 << (shift - 1)) else 0;
integer element;

operand2 = if accumulate then V[d] else Zeros();
for e = 0 to elements-1
    element = (Int(Elem[operand, e, esize], unsigned) + round_const) >> shift;
    Elem[result, e, esize] = Elem[operand2, e, esize] + element<esize-1:0>;

V[d] = result;
  
```

C6.3.336 URSQRTE

Unsigned reciprocal square root estimate

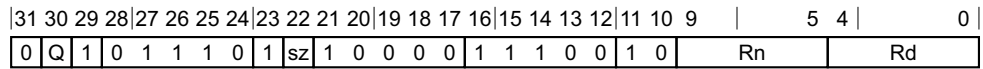

Vector variant

URSQRTE <Vd>.<T>, <Vn>.<T>

```
integer d = UInt(Rd);
integer n = UInt(Rn);
```

```
if sz == '1' then ReservedValue();
integer esize = 32;
integer datasize = if Q == '1' then 128 else 64;
integer elements = datasize DIV esize;
```

Assembler Symbols

- <Vd> Is the name of the SIMD&FP destination register, encoded in the "Rd" field.
- <T> Is an arrangement specifier,
2S when sz = 0, Q = 0
4S when sz = 0, Q = 1
RESERVED when sz = 1, Q = x
- <Vn> Is the name of the SIMD&FP source register, encoded in the "Rn" field.

Operation

```
CheckFPAdvSIMDEnabled64();
bits(datasize) operand = V[n];
bits(datasize) result;
bits(32) element;

for e = 0 to elements-1
    element = Elem[operand, e, 32];
    Elem[result, e, 32] = UnsignedRSqrtEstimate(element);

V[d] = result;
```

C6.3.337 URSRA

Unsigned rounding shift right and accumulate (immediate)

It has encodings from 2 classes: *Scalar* and *Vector*

Scalar

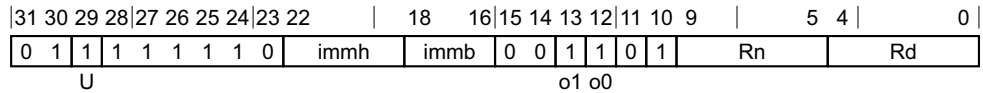

Scalar variant

URSRA <V><d>, <V><n>, #<shift>

```
integer d = UInt(Rd);
integer n = UInt(Rn);

if immh<3> != '1' then ReservedValue();
integer esize = 8 << 3;
integer datasize = esize;
integer elements = 1;

integer shift = (esize * 2) - UInt(immh:immb);
boolean unsigned = (U == '1');
boolean round = (o1 == '1');
boolean accumulate = (o0 == '1');
```

Vector

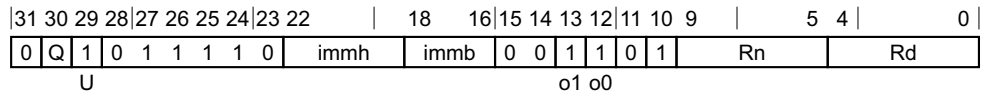

Vector variant

URSRA <Vd>.<T>, <Vn>.<T>, #<shift>

```
integer d = UInt(Rd);
integer n = UInt(Rn);

if immh == '0000' then AdvSIMD modified immediate;
if immh<3>:Q == '10' then ReservedValue();
integer esize = 8 << HighestSetBit(immh);
integer datasize = if Q == '1' then 128 else 64;
integer elements = datasize DIV esize;

integer shift = (esize * 2) - UInt(immh:immb);
boolean unsigned = (U == '1');
boolean round = (o1 == '1');
boolean accumulate = (o0 == '1');
```

Assembler Symbols

- <V> Is a width specifier,
RESERVED when immh = 0xxx
D when immh = 1xxx
- <d> Is the number of the SIMD&FP destination register, in the "Rd" field.
- <n> Is the number of the first SIMD&FP source register, encoded in the "Rn" field.

- <Vd> Is the name of the SIMD&FP destination register, encoded in the "Rd" field.
- <T> Is an arrangement specifier,
 See **AdvSIMD modified immediate**, when immh = 0000, Q = x
8B when immh = 0001, Q = 0
16B when immh = 0001, Q = 1
4H when immh = 001x, Q = 0
8H when immh = 001x, Q = 1
2S when immh = 01xx, Q = 0
4S when immh = 01xx, Q = 1
RESERVED when immh = 1xxx, Q = 0
2D when immh = 1xxx, Q = 1
- <Vn> Is the name of the SIMD&FP source register, encoded in the "Rn" field.
- <shift> For the scalar variant: is the shift amount, in the range 1 to 64,
RESERVED when immh = 0xxx
(128-UInt(immh:immb)) when immh = 1xxx
- <shift> For the vector variant: is a shift amount, in the range 1 to element bits,
 See **AdvSIMD modified immediate**, when immh = 0000
(16-UInt(immh:immb)) when immh = 0001
(32-UInt(immh:immb)) when immh = 001x
(64-UInt(immh:immb)) when immh = 01xx
(128-UInt(immh:immb)) when immh = 1xxx

Operation for all classes

```

CheckFPAdvSIMDEnabled64();
bits(datasize) operand = V[n];
bits(datasize) operand2;
bits(datasize) result;
integer round_const = if round then (1 << (shift - 1)) else 0;
integer element;

operand2 = if accumulate then V[d] else Zeros();
for e = 0 to elements-1
    element = (Int(Elem[operand, e, esize], unsigned) + round_const) >> shift;
    Elem[result, e, esize] = Elem[operand2, e, esize] + element<esize-1:0>;

V[d] = result;
  
```

C6.3.338 USHL

Unsigned shift left (register)

It has encodings from 2 classes: *Scalar* and *Vector*

Scalar

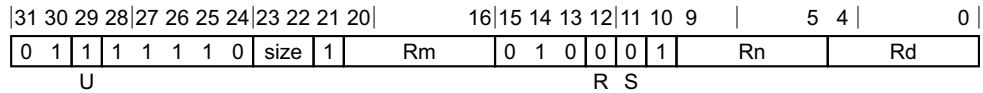

Scalar variant

USHL <V><d>, <V><n>, <V><m>

```
integer d = UInt(Rd);
integer n = UInt(Rn);
integer m = UInt(Rm);
integer esize = 8 << UInt(size);
integer datasize = esize;
integer elements = 1;
boolean unsigned = (U == '1');
boolean rounding = (R == '1');
boolean saturating = (S == '1');
if S == '0' && size != '11' then ReservedValue();
```

Vector

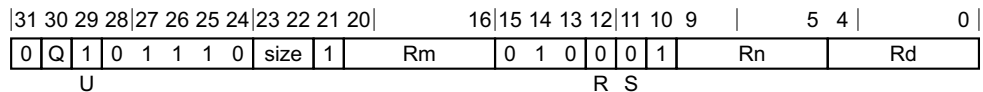

Vector variant

USHL <Vd>.<T>, <Vn>.<T>, <Vm>.<T>

```
integer d = UInt(Rd);
integer n = UInt(Rn);
integer m = UInt(Rm);
if size:Q == '110' then ReservedValue();
integer esize = 8 << UInt(size);
integer datasize = if Q == '1' then 128 else 64;
integer elements = datasize DIV esize;
boolean unsigned = (U == '1');
boolean rounding = (R == '1');
boolean saturating = (S == '1');
```

Assembler Symbols

- <V> Is a width specifier,
RESERVED when size = 0x
RESERVED when size = 10
D when size = 11
- <d> Is the number of the SIMD&FP destination register, in the "Rd" field.
- <n> Is the number of the first SIMD&FP source register, encoded in the "Rn" field.
- <m> Is the number of the second SIMD&FP source register, encoded in the "Rm" field.

- <Vd> Is the name of the SIMD&FP destination register, encoded in the "Rd" field.
- <T> Is an arrangement specifier,
8B when size = 00, Q = 0
16B when size = 00, Q = 1
4H when size = 01, Q = 0
8H when size = 01, Q = 1
2S when size = 10, Q = 0
4S when size = 10, Q = 1
RESERVED when size = 11, Q = 0
2D when size = 11, Q = 1
- <Vn> Is the name of the first SIMD&FP source register, encoded in the "Rn" field.
- <Vm> Is the name of the second SIMD&FP source register, encoded in the "Rm" field.

Operation for all classes

```

CheckFPAdvSIMDEnabled64();
bits(datasize) operand1 = V[n];
bits(datasize) operand2 = V[m];
bits(datasize) result;

integer round_const = 0;
integer shift;
integer element;
boolean sat;

for e = 0 to elements-1
    shift = SInt(Elem[operand2, e, esize]<7:0>);
    if rounding then
        round_const = 1 << (-shift - 1); // 0 for left shift, 2^(n-1) for right shift
    element = (Int(Elem[operand1, e, esize], unsigned) + round_const) << shift;
    if saturating then
        (Elem[result, e, esize], sat) = SatQ(element, esize, unsigned);
        if sat then FPSR.QC = '1';
    else
        Elem[result, e, esize] = element<esize-1:0>;

V[d] = result;
    
```

C6.3.339 USHLL, USHLL2

Unsigned shift left long (immediate)

This instruction is used by the alias [UXTL](#). See the [Alias conditions](#) table for details of when each alias is preferred.

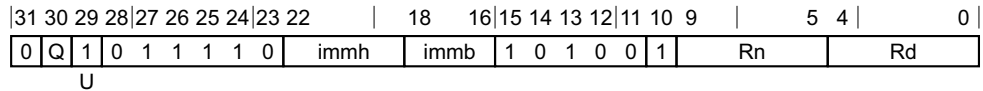

Vector variant

USHLL{2} <Vd>.<Ta>, <Vn>.<Tb>, #<shift>

```
integer d = UInt(Rd);
integer n = UInt(Rn);

if immh == '0000' then AdvSIMD modified immediate;
if immh<3> == '1' then ReservedValue();
integer esize = 8 << HighestSetBit(immh);
integer datasize = 64;
integer part = UInt(Q);
integer elements = datasize DIV esize;

integer shift = UInt(immh:immb) - esize;
boolean unsigned = (U == '1');
```

Alias conditions

Alias	is preferred when
UXTL	<code>BitCount(immh) == 1 && immb == '000'</code>

Assembler Symbols

- 2 Is the second and upper half specifier. If present it causes the operation to be performed on the upper 64 bits of the registers holding the narrower elements, and is
- [absent]** when Q = 0
 - [present]** when Q = 1
- <Vd> Is the name of the SIMD&FP destination register, encoded in the "Rd" field.
- <Ta> Is an arrangement specifier,
- See [AdvSIMD modified immediate](#), when immh = 0000
- 8H** when immh = 0001
 - 4S** when immh = 001x
 - 2D** when immh = 01xx
 - RESERVED** when immh = 1xxx
- <Vn> Is the name of the SIMD&FP source register, encoded in the "Rn" field.
- <Tb> Is an arrangement specifier,
- See [AdvSIMD modified immediate](#), when immh = 0000, Q = x
- 8B** when immh = 0001, Q = 0
 - 16B** when immh = 0001, Q = 1

4H when immh = 001x, Q = 0
8H when immh = 001x, Q = 1
2S when immh = 01xx, Q = 0
4S when immh = 01xx, Q = 1
RESERVED when immh = 1xxx, Q = x

<shift> Is a shift amount, in the range 0 to element bits - 1,
See [AdvSIMD modified immediate](#), when immh = 0000
(UInt(immh:immb)-8) when immh = 0001
(UInt(immh:immb)-16) when immh = 001x
(UInt(immh:immb)-32) when immh = 01xx
RESERVED when immh = 1xxx

Operation

```
CheckFPAdvSIMDEnabled64();
bits(datasize) operand = Vpart[n, part];
bits(datasize*2) result;
integer element;

for e = 0 to elements-1
    element = Int(Elem[operand, e, esize], unsigned) << shift;
    Elem[result, e, 2*esize] = element<2*esize-1:0>;

V[d] = result;
```

C6.3.340 USHR

Unsigned shift right (immediate)

It has encodings from 2 classes: *Scalar* and *Vector*

Scalar

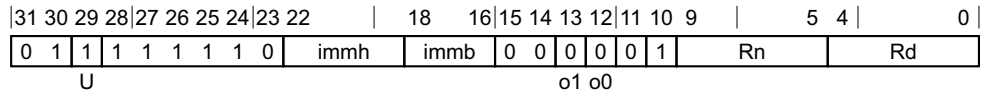

Scalar variant

USHR <V><d>, <V><n>, #<shift>

```
integer d = UInt(Rd);
integer n = UInt(Rn);

if immh<3> != '1' then ReservedValue();
integer esize = 8 << 3;
integer datasize = esize;
integer elements = 1;

integer shift = (esize * 2) - UInt(immh:immb);
boolean unsigned = (U == '1');
boolean round = (o1 == '1');
boolean accumulate = (o0 == '1');
```

Vector

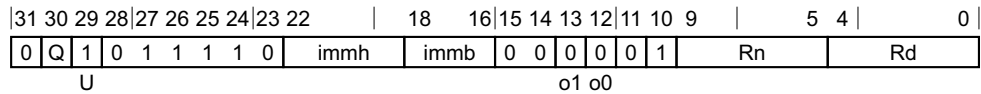

Vector variant

USHR <Vd>.<T>, <Vn>.<T>, #<shift>

```
integer d = UInt(Rd);
integer n = UInt(Rn);

if immh == '0000' then AdvSIMD modified immediate;
if immh<3>:Q == '10' then ReservedValue();
integer esize = 8 << HighestSetBit(immh);
integer datasize = if Q == '1' then 128 else 64;
integer elements = datasize DIV esize;

integer shift = (esize * 2) - UInt(immh:immb);
boolean unsigned = (U == '1');
boolean round = (o1 == '1');
boolean accumulate = (o0 == '1');
```

Assembler Symbols

- <V> Is a width specifier,
RESERVED when immh = 0xxx
D when immh = 1xxx
- <d> Is the number of the SIMD&FP destination register, in the "Rd" field.
- <n> Is the number of the first SIMD&FP source register, encoded in the "Rn" field.

- <Vd> Is the name of the SIMD&FP destination register, encoded in the "Rd" field.
- <T> Is an arrangement specifier,
 See **AdvSIMD modified immediate**, when immh = 0000, Q = x
8B when immh = 0001, Q = 0
16B when immh = 0001, Q = 1
4H when immh = 001x, Q = 0
8H when immh = 001x, Q = 1
2S when immh = 01xx, Q = 0
4S when immh = 01xx, Q = 1
RESERVED when immh = 1xxx, Q = 0
2D when immh = 1xxx, Q = 1
- <Vn> Is the name of the SIMD&FP source register, encoded in the "Rn" field.
- <shift> For the scalar variant: is the shift amount, in the range 1 to 64,
RESERVED when immh = 0xxx
(128-UInt(immh:immb)) when immh = 1xxx
- <shift> For the vector variant: is a shift amount, in the range 1 to element bits,
 See **AdvSIMD modified immediate**, when immh = 0000
(16-UInt(immh:immb)) when immh = 0001
(32-UInt(immh:immb)) when immh = 001x
(64-UInt(immh:immb)) when immh = 01xx
(128-UInt(immh:immb)) when immh = 1xxx

Operation for all classes

```

CheckFPAdvSIMDEnabled64();
bits(datasize) operand = V[n];
bits(datasize) operand2;
bits(datasize) result;
integer round_const = if round then (1 << (shift - 1)) else 0;
integer element;

operand2 = if accumulate then V[d] else Zeros();
for e = 0 to elements-1
    element = (Int(Elem[operand, e, esize], unsigned) + round_const) >> shift;
    Elem[result, e, esize] = Elem[operand2, e, esize] + element<esize-1:0>;

V[d] = result;
    
```

C6.3.341 USQADD

Unsigned saturating accumulate of signed value

It has encodings from 2 classes: *Scalar* and *Vector*

Scalar

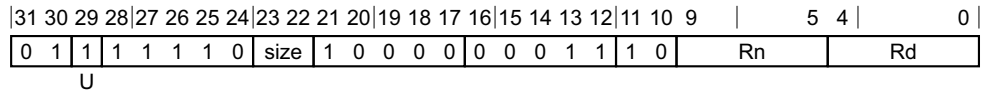

Scalar variant

USQADD <V><d>, <V><n>

integer d = UInt(Rd);
 integer n = UInt(Rn);

integer esize = 8 << UInt(size);
 integer datasize = esize;
 integer elements = 1;

boolean unsigned = (U == '1');

Vector

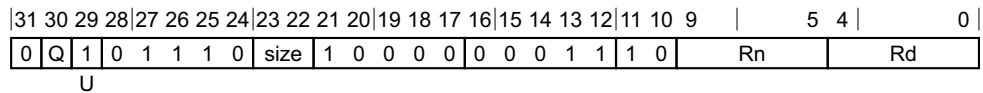

Vector variant

USQADD <Vd>.<T>, <Vn>.<T>

integer d = UInt(Rd);
 integer n = UInt(Rn);

if size:Q == '110' then ReservedValue();
 integer esize = 8 << UInt(size);
 integer datasize = if Q == '1' then 128 else 64;
 integer elements = datasize DIV esize;

boolean unsigned = (U == '1');

Assembler Symbols

- <V> Is a width specifier,
 - B** when size = 00
 - H** when size = 01
 - S** when size = 10
 - D** when size = 11
- <d> Is the number of the SIMD&FP destination register, encoded in the "Rd" field.
- <n> Is the number of the SIMD&FP source register, encoded in the "Rn" field.
- <Vd> Is the name of the SIMD&FP destination register, encoded in the "Rd" field.

<T> Is an arrangement specifier,

- 8B** when size = 00, Q = 0
- 16B** when size = 00, Q = 1
- 4H** when size = 01, Q = 0
- 8H** when size = 01, Q = 1
- 2S** when size = 10, Q = 0
- 4S** when size = 10, Q = 1
- RESERVED** when size = 11, Q = 0
- 2D** when size = 11, Q = 1

<Vn> Is the name of the SIMD&FP source register, encoded in the "Rn" field.

Operation for all classes

```
CheckFPAdvSIMDEnabled64();
bits(datasize) operand = V[n];
bits(datasize) result;

bits(datasize) operand2 = V[d];
integer op1;
integer op2;
boolean sat;

for e = 0 to elements-1
    op1 = Int(Elem[operand, e, esize], !unsigned);
    op2 = Int(Elem[operand2, e, esize], unsigned);
    (Elem[result, e, esize], sat) = SatQ(op1 + op2, esize, unsigned);
    if sat then FPSR.QC = '1';
V[d] = result;
```

C6.3.342 USRA

Unsigned shift right and accumulate (immediate)

It has encodings from 2 classes: *Scalar* and *Vector*

Scalar

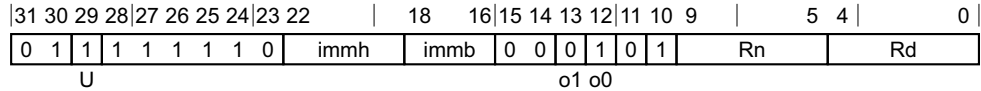

Scalar variant

USRA <V><d>, <V><n>, #<shift>

```
integer d = UInt(Rd);
integer n = UInt(Rn);

if immh<3> != '1' then ReservedValue();
integer esize = 8 << 3;
integer datasize = esize;
integer elements = 1;

integer shift = (esize * 2) - UInt(immh:immb);
boolean unsigned = (U == '1');
boolean round = (o1 == '1');
boolean accumulate = (o0 == '1');
```

Vector

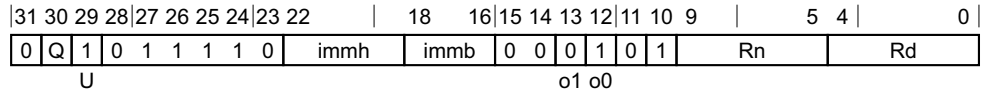

Vector variant

USRA <Vd>.<T>, <Vn>.<T>, #<shift>

```
integer d = UInt(Rd);
integer n = UInt(Rn);

if immh == '0000' then AdvSIMD modified immediate;
if immh<3>:Q == '10' then ReservedValue();
integer esize = 8 << HighestSetBit(immh);
integer datasize = if Q == '1' then 128 else 64;
integer elements = datasize DIV esize;

integer shift = (esize * 2) - UInt(immh:immb);
boolean unsigned = (U == '1');
boolean round = (o1 == '1');
boolean accumulate = (o0 == '1');
```

Assembler Symbols

- <V> Is a width specifier,
RESERVED when immh = 0xxx
D when immh = 1xxx
- <d> Is the number of the SIMD&FP destination register, in the "Rd" field.
- <n> Is the number of the first SIMD&FP source register, encoded in the "Rn" field.

- <Vd> Is the name of the SIMD&FP destination register, encoded in the "Rd" field.
- <T> Is an arrangement specifier,
 See **AdvSIMD modified immediate**, when immh = 0000, Q = x
8B when immh = 0001, Q = 0
16B when immh = 0001, Q = 1
4H when immh = 001x, Q = 0
8H when immh = 001x, Q = 1
2S when immh = 01xx, Q = 0
4S when immh = 01xx, Q = 1
RESERVED when immh = 1xxx, Q = 0
2D when immh = 1xxx, Q = 1
- <Vn> Is the name of the SIMD&FP source register, encoded in the "Rn" field.
- <shift> For the scalar variant: is the shift amount, in the range 1 to 64,
RESERVED when immh = 0xxx
(128-UInt(immh:immb)) when immh = 1xxx
- <shift> For the vector variant: is a shift amount, in the range 1 to element bits,
 See **AdvSIMD modified immediate**, when immh = 0000
(16-UInt(immh:immb)) when immh = 0001
(32-UInt(immh:immb)) when immh = 001x
(64-UInt(immh:immb)) when immh = 01xx
(128-UInt(immh:immb)) when immh = 1xxx

Operation for all classes

```

CheckFPAdvSIMDEnabled64();
bits(datasize) operand = V[n];
bits(datasize) operand2;
bits(datasize) result;
integer round_const = if round then (1 << (shift - 1)) else 0;
integer element;

operand2 = if accumulate then V[d] else Zeros();
for e = 0 to elements-1
    element = (Int(Elem[operand, e, esize], unsigned) + round_const) >> shift;
    Elem[result, e, esize] = Elem[operand2, e, esize] + element<esize-1:0>;

V[d] = result;
  
```

C6.3.343 USUBL, USUBL2

Unsigned subtract long

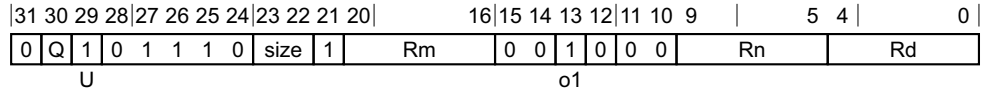

Three registers, not all the same type variant

USUBL{2} <Vd>.<Ta>, <Vn>.<Tb>, <Vm>.<Tb>

```
integer d = UInt(Rd);
integer n = UInt(Rn);
integer m = UInt(Rm);

if size == '11' then ReservedValue();
integer esize = 8 << UInt(size);
integer datasize = 64;
integer part = UInt(Q);
integer elements = datasize DIV esize;

boolean sub_op = (o1 == '1');
boolean unsigned = (U == '1');
```

Assembler Symbols

- 2 Is the second and upper half specifier. If present it causes the operation to be performed on the upper 64 bits of the registers holding the narrower elements, and is
- [absent]** when Q = 0
 - [present]** when Q = 1
- <Vd> Is the name of the SIMD&FP destination register, encoded in the "Rd" field.
- <Ta> Is an arrangement specifier,
- 8H** when size = 00
 - 4S** when size = 01
 - 2D** when size = 10
 - RESERVED** when size = 11
- <Vn> Is the name of the first SIMD&FP source register, encoded in the "Rn" field.
- <Tb> Is an arrangement specifier,
- 8B** when size = 00, Q = 0
 - 16B** when size = 00, Q = 1
 - 4H** when size = 01, Q = 0
 - 8H** when size = 01, Q = 1
 - 2S** when size = 10, Q = 0
 - 4S** when size = 10, Q = 1
 - RESERVED** when size = 11, Q = x
- <Vm> Is the name of the second SIMD&FP source register, encoded in the "Rm" field.

Operation

```
CheckFPAdvSIMDEnabled64();
bits(datasize) operand1 = Vpart[n, part];
bits(datasize) operand2 = Vpart[m, part];
bits(2*datasize) result;
integer element1;
integer element2;
integer sum;

for e = 0 to elements-1
    element1 = Int(Elem[operand1, e, esize], unsigned);
    element2 = Int(Elem[operand2, e, esize], unsigned);
    if sub_op then
        sum = element1 - element2;
    else
        sum = element1 + element2;
    Elem[result, e, 2*esize] = sum<2*esize-1:0>;

V[d] = result;
```

C6.3.344 USUBW, USUBW2

Unsigned subtract wide

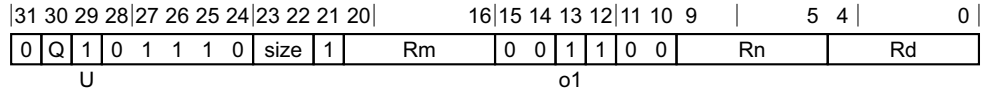

Three registers, not all the same type variant

USUBW{2} <Vd>.<Ta>, <Vn>.<Ta>, <Vm>.<Tb>

```
integer d = UInt(Rd);
integer n = UInt(Rn);
integer m = UInt(Rm);

if size == '11' then ReservedValue();
integer esize = 8 << UInt(size);
integer datasize = 64;
integer part = UInt(Q);
integer elements = datasize DIV esize;

boolean sub_op = (o1 == '1');
boolean unsigned = (U == '1');
```

Assembler Symbols

- 2 Is the second and upper half specifier. If present it causes the operation to be performed on the upper 64 bits of the registers holding the narrower elements, and is
- [absent]** when Q = 0
 - [present]** when Q = 1
- <Vd> Is the name of the SIMD&FP destination register, encoded in the "Rd" field.
- <Ta> Is an arrangement specifier,
- 8H** when size = 00
 - 4S** when size = 01
 - 2D** when size = 10
 - RESERVED** when size = 11
- <Vn> Is the name of the first SIMD&FP source register, encoded in the "Rn" field.
- <Vm> Is the name of the second SIMD&FP source register, encoded in the "Rm" field.
- <Tb> Is an arrangement specifier,
- 8B** when size = 00, Q = 0
 - 16B** when size = 00, Q = 1
 - 4H** when size = 01, Q = 0
 - 8H** when size = 01, Q = 1
 - 2S** when size = 10, Q = 0
 - 4S** when size = 10, Q = 1
 - RESERVED** when size = 11, Q = x

Operation

```
CheckFPAdvSIMDEnabled64();
bits(2*datasize) operand1 = V[n];
bits(datasize) operand2 = Vpart[m, part];
bits(2*datasize) result;
integer element1;
integer element2;
integer sum;

for e = 0 to elements-1
    element1 = Int(Elem[operand1, e, 2*esize], unsigned);
    element2 = Int(Elem[operand2, e, esize], unsigned);
    if sub_op then
        sum = element1 - element2;
    else
        sum = element1 + element2;
    Elem[result, e, 2*esize] = sum<2*esize-1:0>;

V[d] = result;
```

C6.3.345 UXTL

Unsigned extend long

This instruction is an alias of the [USHLL](#), [USHLL2](#) instruction.

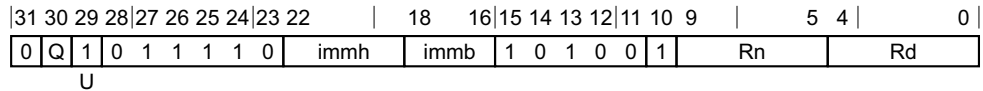

Vector variant

`UXTL{2} <Vd>.<Ta>, <Vn>.<Tb>`

is equivalent to

`USHLL{2} <Vd>.<Ta>, <Vn>.<Tb>, #0`

and is the preferred disassembly when `BitCount(immh) == 1 && immb == '000'`.

Assembler Symbols

2 Is the second and upper half specifier. If present it causes the operation to be performed on the upper 64 bits of the registers holding the narrower elements, and is

[absent] when `Q = 0`

[present] when `Q = 1`

<Vd> Is the name of the SIMD&FP destination register, encoded in the "Rd" field.

<Ta> Is an arrangement specifier,
 See [AdvSIMD modified immediate](#), when `immh = 0000`

8H when `immh = 0001`

4S when `immh = 001x`

2D when `immh = 01xx`

RESERVED when `immh = 1xxx`

<Vn> Is the name of the SIMD&FP source register, encoded in the "Rn" field.

<Tb> Is an arrangement specifier,
 See [AdvSIMD modified immediate](#), when `immh = 0000`, `Q = x`

8B when `immh = 0001`, `Q = 0`

16B when `immh = 0001`, `Q = 1`

4H when `immh = 001x`, `Q = 0`

8H when `immh = 001x`, `Q = 1`

2S when `immh = 01xx`, `Q = 0`

4S when `immh = 01xx`, `Q = 1`

RESERVED when `immh = 1xxx`, `Q = x`

C6.3.346 UZP1

Unzip vectors (primary)

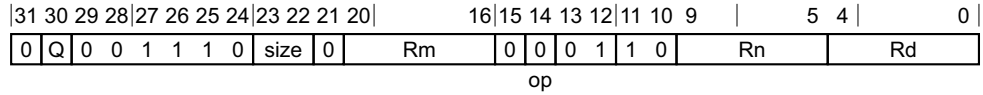

Advanced SIMD variant

UZP1 <Vd>.<T>, <Vn>.<T>, <Vm>.<T>

```
integer d = UInt(Rd);
integer n = UInt(Rn);
integer m = UInt(Rm);

if size:Q == '110' then ReservedValue();
integer esize = 8 << UInt(size);
integer datasize = if Q == '1' then 128 else 64;
integer elements = datasize DIV esize;
integer part = UInt(op);
```

Assembler Symbols

- <Vd> Is the name of the SIMD&FP destination register, encoded in the "Rd" field.
- <T> Is an arrangement specifier,
 - 8B** when size = 00, Q = 0
 - 16B** when size = 00, Q = 1
 - 4H** when size = 01, Q = 0
 - 8H** when size = 01, Q = 1
 - 2S** when size = 10, Q = 0
 - 4S** when size = 10, Q = 1
 - RESERVED** when size = 11, Q = 0
 - 2D** when size = 11, Q = 1
- <Vn> Is the name of the first SIMD&FP source register, encoded in the "Rn" field.
- <Vm> Is the name of the second SIMD&FP source register, encoded in the "Rm" field.

Operation

```
CheckFPAdvSIMDEnabled64();
bits(datasize) operandl = V[n];
bits(datasize) operandh = V[m];
bits(datasize) result;
integer e;

bits(datasize*2) zipped = operandh:operandl;
for e = 0 to elements-1
    Elem[result, e, esize] = Elem[zipped, 2*e+part, esize];

V[d] = result;
```

C6.3.347 UZP2

Unzip vectors (secondary)

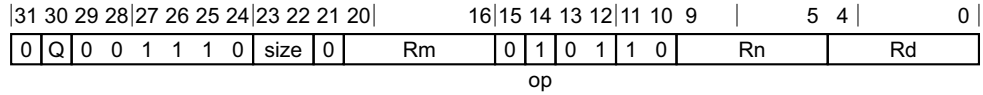

Advanced SIMD variant

UZP2 <Vd>.<T>, <Vn>.<T>, <Vm>.<T>

```
integer d = UInt(Rd);
integer n = UInt(Rn);
integer m = UInt(Rm);

if size:Q == '110' then ReservedValue();
integer esize = 8 << UInt(size);
integer datasize = if Q == '1' then 128 else 64;
integer elements = datasize DIV esize;
integer part = UInt(op);
```

Assembler Symbols

- <Vd> Is the name of the SIMD&FP destination register, encoded in the "Rd" field.
- <T> Is an arrangement specifier,
- 8B** when size = 00, Q = 0
 - 16B** when size = 00, Q = 1
 - 4H** when size = 01, Q = 0
 - 8H** when size = 01, Q = 1
 - 2S** when size = 10, Q = 0
 - 4S** when size = 10, Q = 1
 - RESERVED** when size = 11, Q = 0
 - 2D** when size = 11, Q = 1
- <Vn> Is the name of the first SIMD&FP source register, encoded in the "Rn" field.
- <Vm> Is the name of the second SIMD&FP source register, encoded in the "Rm" field.

Operation

```
CheckFPAdvSIMDEnabled64();
bits(datasize) operandl = V[n];
bits(datasize) operandh = V[m];
bits(datasize) result;
integer e;

bits(datasize*2) zipped = operandh:operandl;
for e = 0 to elements-1
  Elem[result, e, esize] = Elem[zipped, 2*e+part, esize];

V[d] = result;
```

C6.3.348 XTN, XTN2

Extract narrow

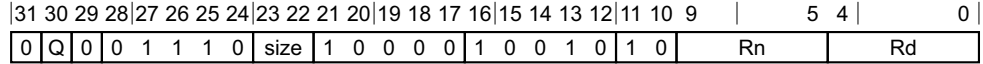

Vector variant

XTN{2} <Vd>.<Tb>, <Vn>.<Ta>

```
integer d = UInt(Rd);
integer n = UInt(Rn);
```

```
if size == '11' then ReservedValue();
integer esize = 8 << UInt(size);
integer datasize = 64;
integer part = UInt(Q);
integer elements = datasize DIV esize;
```

Assembler Symbols

2 Is the second and upper half specifier. If present it causes the operation to be performed on the upper 64 bits of the registers holding the narrower elements, and is

[absent] when Q = 0

[present] when Q = 1

<Vd> Is the name of the SIMD&FP destination register, encoded in the "Rd" field.

<Tb> Is an arrangement specifier,

8B when size = 00, Q = 0

16B when size = 00, Q = 1

4H when size = 01, Q = 0

8H when size = 01, Q = 1

2S when size = 10, Q = 0

4S when size = 10, Q = 1

RESERVED when size = 11, Q = x

<Vn> Is the name of the SIMD&FP source register, encoded in the "Rn" field.

<Ta> Is an arrangement specifier,

8H when size = 00

4S when size = 01

2D when size = 10

RESERVED when size = 11

Operation

```
CheckFPAdvSIMDEnabled64();
bits(2*datasize) operand = V[n];
bits(datasize) result;
bits(2*esize) element;
```

for e = 0 to elements-1

```
element = Elem[operand, e, 2*esize];  
Elem[result, e, esize] = element<esize-1:0>;  
Vpart[d, part] = result;
```

C6.3.349 ZIP1

Zip vectors (primary)

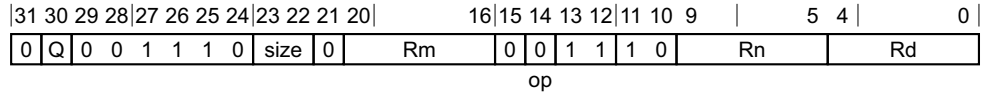

Advanced SIMD variant

ZIP1 <Vd>.<T>, <Vn>.<T>, <Vm>.<T>

```
integer d = UInt(Rd);
integer n = UInt(Rn);
integer m = UInt(Rm);

if size:Q == '110' then ReservedValue();
integer esize = 8 << UInt(size);
integer datasize = if Q == '1' then 128 else 64;
integer elements = datasize DIV esize;
integer part = UInt(op);
integer pairs = elements DIV 2;
```

Assembler Symbols

- <Vd> Is the name of the SIMD&FP destination register, encoded in the "Rd" field.
- <T> Is an arrangement specifier,
 - 8B** when size = 00, Q = 0
 - 16B** when size = 00, Q = 1
 - 4H** when size = 01, Q = 0
 - 8H** when size = 01, Q = 1
 - 2S** when size = 10, Q = 0
 - 4S** when size = 10, Q = 1
 - RESERVED** when size = 11, Q = 0
 - 2D** when size = 11, Q = 1
- <Vn> Is the name of the first SIMD&FP source register, encoded in the "Rn" field.
- <Vm> Is the name of the second SIMD&FP source register, encoded in the "Rm" field.

Operation

```
CheckFPAdvSIMDEnabled64();
bits(datasize) operand1 = V[n];
bits(datasize) operand2 = V[m];
bits(datasize) result;

integer base = part * pairs;
integer p;

for p = 0 to pairs-1
    Elem[result, 2*p+0, esize] = Elem[operand1, base+p, esize];
    Elem[result, 2*p+1, esize] = Elem[operand2, base+p, esize];

V[d] = result;
```

C6.3.350 ZIP2

Zip vectors (secondary)

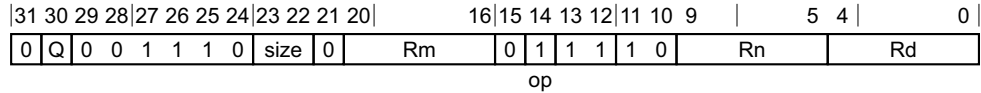

Advanced SIMD variant

ZIP2 <Vd>.<T>, <Vn>.<T>, <Vm>.<T>

```
integer d = UInt(Rd);
integer n = UInt(Rn);
integer m = UInt(Rm);

if size:Q == '110' then ReservedValue();
integer esize = 8 << UInt(size);
integer datasize = if Q == '1' then 128 else 64;
integer elements = datasize DIV esize;
integer part = UInt(op);
integer pairs = elements DIV 2;
```

Assembler Symbols

- <Vd> Is the name of the SIMD&FP destination register, encoded in the "Rd" field.
- <T> Is an arrangement specifier,
- 8B** when size = 00, Q = 0
 - 16B** when size = 00, Q = 1
 - 4H** when size = 01, Q = 0
 - 8H** when size = 01, Q = 1
 - 2S** when size = 10, Q = 0
 - 4S** when size = 10, Q = 1
 - RESERVED** when size = 11, Q = 0
 - 2D** when size = 11, Q = 1
- <Vn> Is the name of the first SIMD&FP source register, encoded in the "Rn" field.
- <Vm> Is the name of the second SIMD&FP source register, encoded in the "Rm" field.

Operation

```
CheckFPAdvSIMDEnabled64();
bits(datasize) operand1 = V[n];
bits(datasize) operand2 = V[m];
bits(datasize) result;

integer base = part * pairs;
integer p;

for p = 0 to pairs-1
    Elem[result, 2*p+0, esize] = Elem[operand1, base+p, esize];
    Elem[result, 2*p+1, esize] = Elem[operand2, base+p, esize];

V[d] = result;
```

Part D

The AArch64 System Level Architecture

Chapter D1

The AArch64 System Level Programmers' Model

This chapter describes the AArch64 system level programmers' model. It contains the following:

- *Exception levels* on page D1-1408.
- *Exception terminology* on page D1-1409.
- *Execution state* on page D1-1411.
- *Security state* on page D1-1412.
- *Virtualization* on page D1-1414.
- *Registers for instruction processing and exception handling* on page D1-1416.
- *Process state, PSTATE* on page D1-1421.
- *Program counter and stack pointer alignment* on page D1-1423.
- *Reset* on page D1-1426.
- *Exception entry* on page D1-1429.
- *Exception return* on page D1-1439.
- *The Exception level hierarchy* on page D1-1443.
- *Synchronous exception types, routing and priorities* on page D1-1450.
- *Asynchronous exception types, routing, masking and priorities* on page D1-1456.
- *Trapping functionality to higher Exception levels* on page D1-1462.
- *System calls* on page D1-1511.
- *Use of the ESR_EL1, ESR_EL2, and ESR_EL3* on page D1-1512.
- *Mechanisms for entering a low-power state* on page D1-1533.
- *Self-hosted debug* on page D1-1539.
- *Performance Monitors extension* on page D1-1541.
- *Interprocessing* on page D1-1542.
- *Supported configurations* on page D1-1554.

D1.1 Exception levels

The ARMv8-A architecture defines a set of Exception levels, EL0 to EL3, where:

- If EL_n is the Exception level, increased values of n indicate increased software execution privilege.
- Execution at EL0 is called *unprivileged execution*.
- EL2 provides support for virtualization of Non-secure operation.
- EL3 provides support for switching between two Security states, Secure state and Non-secure state.

An implementation might not include all of the Exception levels. All implementations must include EL0 and EL1. EL2 and EL3 are optional.

———— Note —————

A PE is not required to implement a contiguous set of Exception levels. For example, it is permissible for an implementation to include only EL0, EL1, and EL3.

[Supported configurations on page D1-1554](#) shows some example implementations.

When executing in AArch64 state, execution can move between Exception levels only on taking an exception or on returning from an exception:

- On taking an exception, the Exception level can only increase or remain the same.
- On returning from an exception, the Exception level can only decrease or remain the same.

The Exception level that execution changes to or remains in on taking an exception is called the *target Exception level* of the exception.

Each exception type has a target Exception level that is either:

- Implicit in the nature of the exception.
- Defined by configuration bits in the system control registers.

An exception cannot target EL0.

Exception levels exist within a particular Security state. [The ARMv8-A security model on page D1-1412](#) describes this. When executing at an Exception level, the PE can access both of the following:

- The resources that are available for the combination of the current Exception level and the current Security state.
- The resources that are available at all lower Exception levels, provided that those resources are available to the current Security state.

This means that if the implementation includes EL3, then when execution is at EL3, the PE can access all resources available at all Exception levels, for both Security states.

Each Exception level other than EL0 has its own translation regime and associated control registers. For information on the translation regimes, see [Chapter D5 The AArch64 Virtual Memory System Architecture](#).

D1.1.1 Typical Exception level usage model

The architecture does not specify what software uses which Exception level. Such choices are outside the scope of the architecture. However, the following is a common usage model for the Exception levels:

EL0	Applications.
EL1	OS kernel and associated functions that are typically described as <i>privileged</i> .
EL2	Hypervisor.
EL3	Secure monitor.

D1.2 Exception terminology

The following subsections define the terms used when describing exceptions:

- [Terminology for taking an exception.](#)
- [Terminology for returning from an exception.](#)
- [Exception levels.](#)
- [Definition of a precise exception.](#)
- [Definitions of synchronous and asynchronous exceptions on page D1-1410.](#)

D1.2.1 Terminology for taking an exception

An exception is *generated* when the PE first responds to an exceptional condition. The PE state at this time is the state the exception is *taken from*. The PE state immediately after taking the exception is the state the exception is *taken to*.

D1.2.2 Terminology for returning from an exception

To return from an exception, the PE must execute an exception return instruction. The PE state when an exception return instruction is committed for execution is the state the exception *returns from*. The PE state immediately after the execution of that instruction is the state the exception *returns to*.

D1.2.3 Exception levels

An Exception level, EL_n , with a larger value of n than another Exception level, is described as being a *higher* Exception level than the other Exception level. For example, EL_3 is a higher Exception level than EL_1 .

An Exception level with a smaller value of n than another Exception level is described as being a *lower* Exception level than the other Exception level. For example, EL_0 is a lower Exception level than EL_1 .

An Exception level is described as:

- *Using AArch64* when execution in that Exception level is in the AArch64 Execution state.
- *Using AArch32* when execution in that Exception level is in the AArch32 Execution state.

D1.2.4 Definition of a precise exception

An exception is described as *precise* when the exception handler receives the PE state and memory system state that is consistent with the PE having executed all of the instructions up to but not including the point in the instruction stream where the exception was taken, and none afterwards.

Where a synchronous exception is generated as part of an instruction that performs more than one single-copy atomic memory access, such as the AArch64 LDP and STP instructions, the definition of precise permits that the values in registers or memory affected by those instructions can be UNKNOWN, provided that:

- The accesses affecting those registers or memory locations do not, themselves, generate exceptions.
- The registers are not involved in the calculation of the memory address used by the instruction.

Other than the *SError interrupt*, all exceptions taken to AArch64 state are required to be precise.

For each occurrence of an SError interrupt, whether the interrupt is precise or imprecise is IMPLEMENTATION DEFINED.

———— **Note** —————

- For the definition of a single-copy atomic access, see [Single-copy atomicity on page B2-79](#).
 - SError interrupts are known as Asynchronous Aborts in AArch32 state.
 - By definition, all synchronous aborts are precise.
-

D1.2.5 Definitions of synchronous and asynchronous exceptions

An exception is described as *synchronous* if all of the following apply:

- The exception is generated as a result of direct execution or attempted execution of an instruction.
- The return address presented to the exception handler is guaranteed to indicate the instruction that caused the exception.
- The exception is precise.

For more information about synchronous exceptions, see [Synchronous exception types, routing and priorities on page D1-1450](#).

An exception is described as *asynchronous* if any of the following apply:

- The exception is not generated as a result of direct execution or attempted execution of the instruction stream.
- The return address presented to the exception handler is not guaranteed to indicate the instruction that caused the exception.
- The exception is imprecise.

For more information about asynchronous exceptions, see [Asynchronous exception types, routing, masking and priorities on page D1-1456](#).

D1.3 Execution state

The Execution states are:

AArch64 The 64-bit Execution state.

AArch32 The 32-bit Execution state. Operation in this state is compatible with ARMv7-A operation.

[Execution state on page A1-33](#) gives more information about them.

Exception levels *use* Execution states. For example, EL0, EL1 and EL2 might all be using AArch32, under EL3 using AArch64.

This means that:

- Different software layers, such as an application, an operating system kernel, and a hypervisor, executing at different Exception levels, can execute in different Execution states.
- The PE can change Execution states only either:
 - At reset.
 - On a change of Exception level.

Note

- [Typical Exception level usage model on page D1-1408](#) shows which Exception levels different software layers might typically use.
 - [Supported configurations on page D1-1554](#) gives information on supported configurations of Exception levels and Execution states.
-

The interaction between the AArch64 and AArch32 Execution states is called *interprocessing*. [Interprocessing on page D1-1542](#) describes this.

D1.4 Security state

The ARMv8-A architecture provides two Security states, each with an associated physical memory address space, as follows:

- | | |
|-------------------------|---|
| Secure state | When in this state, the PE can access both the Secure physical address space and the Non-secure physical address space. |
| Non-secure state | When in this state, the PE: <ul style="list-style-type: none">• Can access only the Non-secure physical address space.• Cannot access the Secure system control resources. |

For information on how virtual addresses translate onto Secure physical and Non-secure addresses, see [About the Virtual Memory System Architecture \(VMSA\)](#) on page D5-1708.

D1.4.1 The ARMv8-A security model

The general principles of the ARMv8-A security model are:

- If the implementation includes EL3 then it has two Security states, Secure and Non-secure, and:
 - EL3 exists only in Secure state.
 - A change from Non-secure state to Secure state can only occur on taking an exception to EL3.
 - A change from Secure state to Non-secure state can only occur on an exception return from EL3.
 - If EL2 is implemented, it exists only in Non-secure state.
- If the implementation does not include EL3 it has one Security state, that is:
 - IMPLEMENTATION DEFINED, if the implementation does not include EL2.
 - Non-secure state if the implementation includes EL2.

Security model when EL3 is using AArch64

Figure D1-1 on page D1-1413 shows the security model when EL3 is using AArch64. The figure shows how instances of EL0 and EL1 are present in both Security states. It also shows the expected software usage of the different Exception levels.

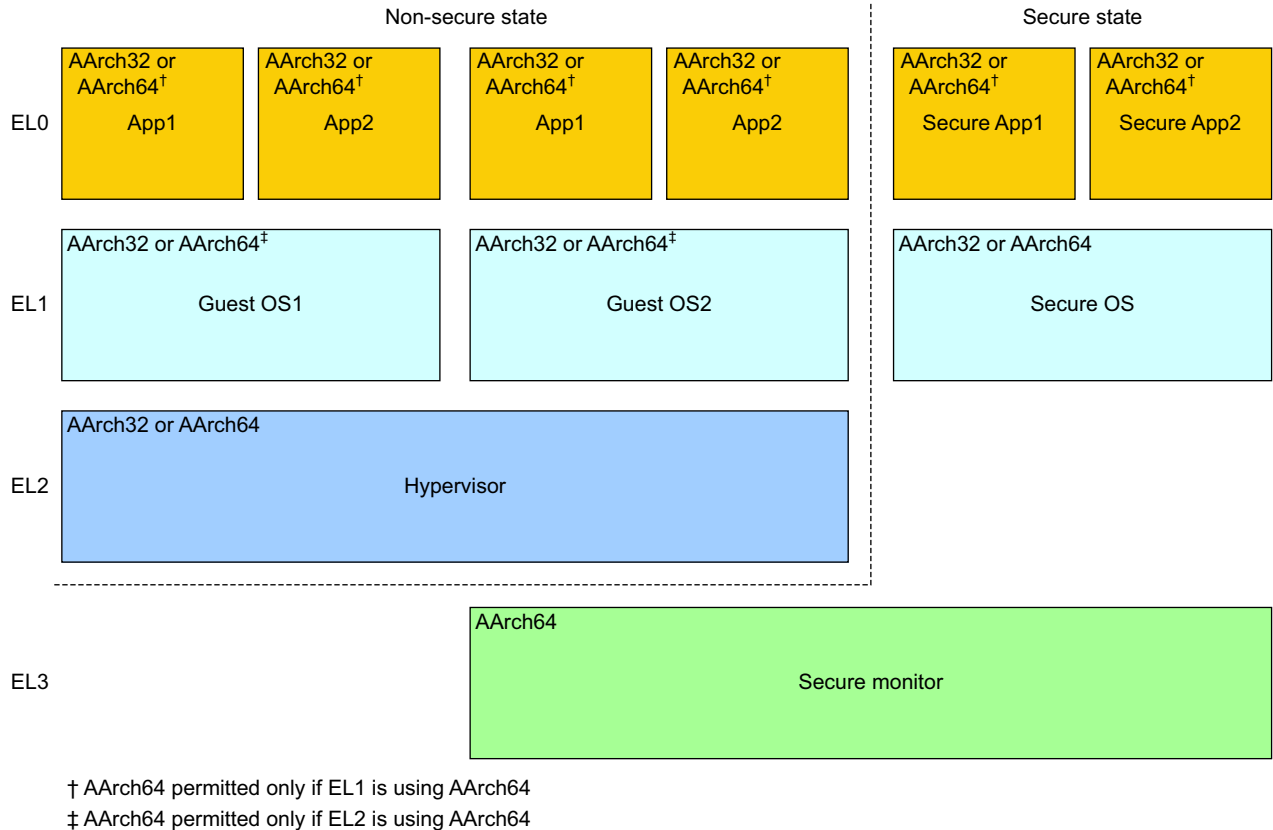

Figure D1-1 ARMv8-A security model when EL3 is using AArch64

For an overview of the Security model when EL3 is using AArch32, see [Figure G1-1 on page G1-3408](#).

D1.5 Virtualization

The support for virtualization described in this section applies only to an implementation that includes EL2.

EL2 provides a set of features that support virtualizing the Non-secure state of an ARMv8-A implementation. The basic model of a virtualized system involves:

- A hypervisor, running in EL2, that is responsible for switching between *virtual machines*. A virtual machine is comprised of Non-secure EL1 and Non-secure EL0.
- A number of Guest operating systems, that each run in Non-secure EL1, on a virtual machine.
- For each Guest operating system, applications, that usually run in Non-secure EL0, on a virtual machine.

———— Note ————

In some systems, a Guest OS is unaware that it is running on a virtual machine, and is unaware of any other Guest OS. In other systems, a hypervisor makes the Guest OS aware of these facts. The ARMv8-A architecture supports both of these models.

The hypervisor assigns a *virtual machine identifier* (VMID) to each virtual machine.

EL2 is implemented only in Non-secure state, to support Guest OS management. EL2 provides controls to:

- Provide virtual values for the contents of a small number of identification registers. A read of one of these registers by a Guest OS or the applications for a Guest OS returns the virtual value.
- *Trap* various operations, including memory management operations and accesses to many other registers. A trapped operation generates an exception that is taken to EL2. See [Trapping functionality to higher Exception levels on page D1-1462](#).
- Route interrupts to the appropriate one of:
 - The current Guest OS.
 - A Guest OS that is not currently running.
 - The hypervisor.

In Non-secure state:

- The implementation provides an independent *translation regime* for memory accesses from EL2.
- For the EL1&0 translation regime, address translation occurs in two stages:
 - Stage 1 maps the *Virtual Address* (VA) to an *Intermediate Physical Address* (IPA). This is managed at EL1, usually by a Guest OS. The Guest OS believes that the IPA is the *Physical Address* (PA).
 - Stage 2 maps the IPA to the PA. This is managed at EL2. The Guest OS might be completely unaware of this stage.

For more information on the translation regimes, see [Chapter D5 The AArch64 Virtual Memory System Architecture](#).

D1.5.1 The effect of implementing EL2 on the Exception model

An implementation that includes EL2 implements the following exceptions:

- Hypervisor Call (HVC) exception.
- Traps to EL2. [Trapping to EL2 using AArch64 on page D1-1474](#), describes these.
- All of the virtual interrupts:
 - Virtual SError.
 - Virtual IRQ.
 - Virtual FIQ.

HVC exceptions are always taken to EL2. All virtual interrupts are always taken to EL1, and can only be taken from Non-secure EL1 or EL0.

Each of the virtual interrupts can be independently enabled using controls at EL2.

Each of the virtual interrupts has a corresponding physical interrupt. See [Virtual interrupts on page D1-1415](#).

When a virtual interrupt is enabled, its corresponding physical exception is taken to EL2, unless EL3 has configured that physical exception to be taken to EL3.

For more information, see [Asynchronous exception types, routing, masking and priorities](#) on page D1-1456.

An implementation that includes EL2 also:

- Provides controls that can be used to route some synchronous exceptions, taken from Non-secure state, to EL2. For more information see:
 - [Routing general exceptions to EL2](#) on page D1-1451.
 - [Routing debug exceptions](#) on page D3-1652.
- Provides mechanisms to trap PE operations to EL2. See [Trapping to EL2 using AArch64](#) on page D1-1474. When an operation is trapped to EL2, the hypervisor typically either:
 - Emulates the required operation. The application running in the Guest OS is unaware of the trap.
 - Returns an error to the Guest OS.

Virtual interrupts

The virtual interrupts have names that correspond to the physical interrupts, as shown in [Table D1-1](#).

Table D1-1 The virtual interrupt

Physical interrupt	Corresponding virtual interrupt
SError	Virtual SError
IRQ	Virtual IRQ
FIQ	Virtual FIQ

Software executing in EL2 can use virtual interrupts to signal physical interrupts to Non-secure EL1 and Non-secure EL0. [Example D1-1](#) shows a usage model for virtual interrupts.

Example D1-1 Virtual interrupt usage model

A usage model is as follows:

1. Software executing at EL2 routes a physical interrupt to EL2.
2. When a physical interrupt of that type occurs, the exception handler executing in EL2 determines whether the interrupt can be handled in EL2 or requires routing to a Guest OS in EL1. If the interrupt requires routing to a Guest OS:
 - If the Guest OS is currently running, the hypervisor uses the appropriate virtual interrupt type to signal the physical interrupt to the Guest OS.
 - If the Guest OS is not currently running, the physical interrupt is marked as pending for the guest OS. When the hypervisor next switches to the virtual machine that is running that Guest OS, the hypervisor uses the appropriate virtual interrupt type to signal the physical interrupt to the Guest OS.

A hypervisor can prevent Non-secure EL1 and Non-secure EL0 from distinguishing a virtual interrupt from a physical interrupt.

For more information see:

- [Asynchronous exception types, routing, masking and priorities](#) on page D1-1456.
- [Virtual interrupts](#) on page D1-1459.

D1.6 Registers for instruction processing and exception handling

In the ARM architecture, registers fall into two main categories:

- Registers that provide system control or status reporting. These are described in [Chapter D8 AArch64 System Register Descriptions](#).
- Registers that are used in instruction processing, for example to accumulate a result, and in handling exceptions. This section introduces these registers, for execution in AArch64 state.

This section contains the following:

- [The general purpose registers, R0-R30](#).
- [The stack pointer registers](#).
- [The SIMD and floating-point registers, V0-V31](#) on page D1-1417.
- [Saved Program Status Registers \(SPSRs\)](#) on page D1-1417.
- [Exception Link Registers \(ELRs\)](#) on page D1-1420.

D1.6.1 The general purpose registers, R0-R30

The general purpose register bank is used when processing instructions in the base instruction set. It comprises 31 general purpose registers, R0-R30.

These registers can be accessed as 31 64-bit registers, X0-X30, or 31 32-bit registers, W0-W30. See [Register size](#) on page C5-387.

For information on the format of these registers, see [Registers in AArch64 state](#) on page B1-59.

D1.6.2 The stack pointer registers

In AArch64 state, in addition to the general purpose registers, a dedicated stack pointer register is implemented for each implemented Exception level. The stack pointer registers are:

- [SP_ELO](#) and [SP_EL1](#).
- If the implementation includes EL2, [SP_EL2](#).
- If the implementation includes EL3, [SP_EL3](#).

———— Note —————

The four stack pointer register names define an architecture state requirement for four registers. For information on how to access these registers, and access restrictions, see [PSTATE and special purpose registers](#) on page C4-251.

For information on stack pointer alignment restrictions, see [Stack pointer alignment checking](#) on page D1-1424.

Stack pointer register selection

When executing at EL0, the PE uses the EL0 stack pointer, [SP_ELO](#).

When executing at any other Exception level, the PE can be configured to use either [SP_ELO](#) or the stack pointer for that Exception level, [SP_ELx](#).

By default, taking an exception selects the stack pointer for the target Exception level, [SP_ELx](#). For example, taking an exception to EL1 selects [SP_EL1](#). Software executing at the target Exception level can then choose to change the stack pointer to [SP_ELO](#) by updating [PSTATE.SP](#).

This applies even if taking the exception does not change the Exception level. For example, if the PE is executing at EL1 and the PE is using the [SP_ELO](#) stack pointer, then on taking an exception that targets EL1, the stack pointer changes to [SP_EL1](#).

The selected stack pointer can be indicated by a suffix to the Exception level:

- | | |
|----------|--|
| t | Indicates use of the SP_ELO stack pointer. |
| h | Indicates use of the SP_ELx stack pointer. |

———— **Note** —————

The t and h suffixes are based on the terminology of *thread* and *handler*, introduced in ARMv7-M

Table D1-2 shows the set of stack pointer options.

Table D1-2 AArch64 stack pointer options

Exception level	AArch64 stack pointer options
EL0	EL0t
EL1	EL1t, EL1h
EL2	EL2t, EL2h
EL3	EL3t, EL3h

D1.6.3 The SIMD and floating-point registers, V0-V31

The SIMD and floating-point instructions share a common bank of registers for floating-point, vector, and other SIMD-related scalar operations.

The SIMD and floating-point register bank comprises 32 quadword (128-bit) registers, V0-V31.

These registers can be accessed as:

- 32 doubleword (64-bit) registers, D0-D31.
- 32 word (32-bit) registers, S0-S31.
- 32 halfword (16-bit) registers, H0-H31.
- 32 byte (8-bit) registers, B0-B31.

For information on the format of these registers, see *Registers in AArch64 state* on page B1-59.

D1.6.4 Saved Program Status Registers (SPSRs)

The *Saved Program Status Registers* (SPSRs) are used to save PE state on taking exceptions.

In AArch64 state, there is an SPSR at each Exception level exceptions can be taken to, as follows:

- [SPSR_EL1](#), for exceptions taken to EL1 using AArch64.
- If EL2 is implemented, [SPSR_EL2](#), for exceptions taken to EL2 using AArch64.
- If EL3 is implemented, [SPSR_EL3](#), for exceptions taken to EL3 using AArch64.

When the PE takes an exception, PE state is saved in the SPSR at the Exception level the exception is taken to. For example, if the PE takes an exception to EL1, PE state is saved in [SPSR_EL1](#).

When the PE returns from an exception, PE state is restored to the state stored in the SPSR at the Exception level the exception is returning from. For example, on returning from EL1, PE state is restored to the state stored in [SPSR_EL1](#).

———— **Note** —————

Exceptions cannot be taken to EL0.

SPSR format for exceptions taken to AArch64 state

Exceptions can be taken to AArch64 state from AArch64 state or AArch32 state.

For an exception taken to AArch64 state from AArch64 state, the SPSR bit assignments are:

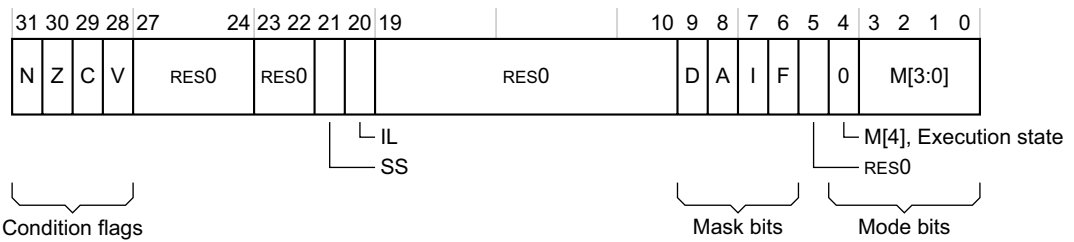

For an exception taken to AArch64 state from AArch32 state, the SPSR bit assignments are:

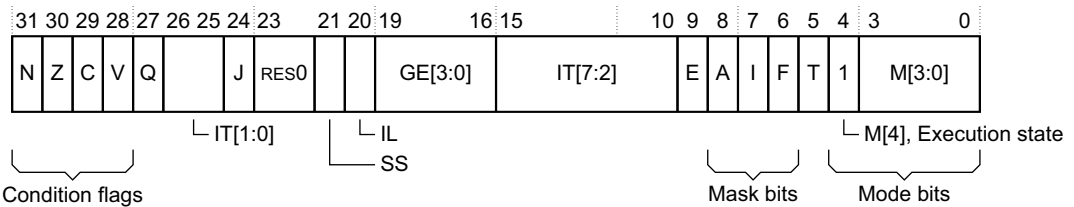

The following list describes the bit assignments:

Condition flags, bits[31:28]

Shows the values of the condition flags immediately before the exception was taken:

- N, bit[31]** Negative condition flag.
- Z, bit[30]** Zero condition flag.
- C, bit[29]** Carry condition flag.
- V, bit[28]** Overflow condition flag.

Bits[27:22] Reserved, RES0, for exceptions taken from AArch64 state.

For exceptions taken from AArch32 state:

- Q** Shows the value of *PSTATE.Q* immediately before the exception was taken.
- IT[1:0]** See [Bits\[19:10\]](#).
- J** Shows the value of *PSTATE.J* immediately before the exception was taken.

For the definitions of the Q, IT, and J fields, see [Format of the CPSR and SPSRs on page G1-3423](#).

Bit[21] SS, the Software Step bit.

[SPSR_ELx.SS](#) is used by a debugger to initiate a Software Step exception. The SS bit also indicates which software step state machine state the PE was in. See [Software Step exceptions on page D2-1634](#).

IL, bit[20] Illegal Execution State bit. Shows the value of *PSTATE.IL* immediately before the exception was taken. See [Illegal return events on page D1-1441](#).

Bits[19:10] Reserved, RES0, for exceptions taken from AArch64 state.

For exceptions taken from AArch32 state:

- GE[3:0]** Shows the value of *PSTATE.GE* immediately before the exception was taken.
- IT[7:2]** In conjunction with IT[1:0], shows the value of *PSTATE.IT* before the exception was taken.

For the definitions of the GE and IT fields, see [Format of the CPSR and SPSRs on page G1-3423](#).

Bit[9] D, the debug exception mask bit, for exceptions taken from AArch64 state. Shows the value of *PSTATE.D* immediately before the exception was taken. See [The PSTATE debug mask bit, D on page D1-1539](#).

E, for exceptions taken from AArch32 state. Shows the value of *PSTATE.E* immediately before the exception was taken. For the definition of the E bit, see [Format of the CPSR and SPSRs on page G1-3423](#).

Interrupt mask bits, bits[8:6]

Shows the values of the interrupt mask bits immediately before the exception was taken:

A, bit[8] SError interrupt mask bit.

I, bit[7] IRQ mask bit.

F, bit[6] FIQ mask bit.

See *Asynchronous exception masking* on page D1-1458.

Bit[5] Reserved, RES0, for exceptions taken from AArch64 state.

T, for exceptions taken from AArch32 state. Shows the value of **PSTATE.T** immediately before the exception was taken. For the definition of the T bit, see *Format of the CPSR and SPSRs* on page G1-3423.

M[4:0], bits[4:0]

Mode field.

———— **Note** —————

The name of this field is inherited from ARMv7, where the M field specified the PE *mode*.

For exceptions taken from AArch64 state:

M[4] The value of this is 0. M[4] encodes the value of **PSTATE.nRW**.

M[3:0] Encodes the Exception level and the stack pointer register selection, as shown in [Table D1-3](#).

Table D1-3 M[3:0] encodings, for exceptions taken from AArch64 state

M[3:0]^a	Exception level and stack pointer
0b1101	EL3h
0b1100	EL3t
0b1001	EL2h
0b1000	EL2t
0b0101	EL1h
0b0100	EL1t
0b0000	EL0t

a. All M[3:0] encodings not shown in the table are reserved.

The M[3:0] encoding comprises:

M[3:2] Encodes the Exception level, 0-3.

M[1] Reserved, RES0. If set to 1 at the time of an exception return, then that exception return is treated as an Illegal Execution State Exception Return.

M[0] Selects the SP:

0 **SP_ELO**. Indicated by a t suffix on the Exception level.

1 **SP_ELx**, where x is the value of M[3:2]. Indicated by an h suffix on the Exception level.

See *Stack pointer register selection* on page D1-1416.

For exceptions taken from AArch32 state:

M[4] The value of this is 1. M[4] encodes the value of **PSTATE.nRW**.

M[3:0] Encodes the AArch32 mode that the PE was in immediately before the exception was taken, as shown in [Table D1-4](#).

Table D1-4 M[3:0] encodings, for exceptions taken from AArch32 state

M[3:0]	AArch32 mode
0b0000	User
0b0001	FIQ
0b0010	IRQ
0b0011	Supervisor
0b0111	Abort
0b1011	Undefined
0b1111	System

Bits [27:22] and [19:10] of an SPSR are ignored on an exception return to AArch64 state.

D1.6.5 Exception Link Registers (ELRs)

Exception Link Registers hold preferred exception return addresses.

Whenever the PE takes an exception, the preferred return address is saved in the ELR at the Exception level the exception is taken to. For example, whenever the PE takes an exception to EL1, the preferred return address is saved in [ELR_EL1](#).

On an exception return, the PC is restored to the address stored in the ELR. For example, on returning from EL1, the PC is restored to the address stored in [ELR_EL1](#).

AArch64 state provides an ELR for each Exception level exceptions can be taken to. The ELRs that AArch64 state provides are:

- [ELR_EL1](#), for exceptions taken to EL1.
- If EL2 is implemented, [ELR_EL2](#), for exceptions taken to EL2.
- If EL3 is implemented, [ELR_EL3](#), for exceptions taken to EL3.

On taking an exception from AArch32 state to AArch64 state, bits[63:32] of the ELR are set to zero.

The preferred return address depends on the nature of the exception. For more information, see [Preferred exception return address on page D1-1429](#).

D1.7 Process state, PSTATE

In the ARMv8-A architecture, Process state or *PSTATE* is an abstraction of process state information. All of the instruction sets provide instructions that operate on elements of PSTATE.

PSTATE is defined in the ARMv8-A pseudocode as the PSTATE structure, of type ProcState. The definition of ProcState is:

```

type ProcState is (
    bits (1) N,      // Negative condition flag
    bits (1) Z,      // Zero condition flag
    bits (1) C,      // Carry condition flag
    bits (1) V,      // oVerflow condition flag
    bits (1) D,      // Debug mask bit                [AArch64 only]
    bits (1) A,      // Asynchronous abort mask bit
    bits (1) I,      // IRQ mask bit
    bits (1) F,      // FIQ mask bit
    bits (1) SS,     // Single-step bit
    bits (1) IL,     // Illegal state bit
    bits (2) EL,     // Exception Level (see above)
    bits (1) nRW,    // not Register Width: 0=64, 1=32
    bits (1) SP,     // Stack pointer select: 0=SP0, 1=SPx [AArch64 only]
    bits (1) Q,      // Cumulative saturation flag                [AArch32 only]
    bits (4) GE,     // Greater than or Equal flags                    [AArch32 only]
    bits (8) IT,     // If-then state                                  [AArch32 only]
    bits (1) J,      // Jazelle state                                  [AArch32 only]
    bits (1) T,      // Thumb state                                    [AArch32 only]
    bits (1) E,      // Endian state                                   [AArch32 only]
    bits (5) M       // Mode field (see above)                        [AArch32 only]
)

```

PSTATE includes both:

- Fields that are meaningful only in AArch32 state.
- Fields that hold AArch64 state.

The fields that hold AArch64 state are:

PSTATE.{N, Z, C, V} The condition flags. See [Process state, PSTATE](#) on page B1-63.

PSTATE.SS The Software Step bit. See [Software Step exceptions](#) on page D2-1634.

PSTATE.IL The Illegal Execution State bit. See [Illegal return events](#) on page D1-1441.

PSTATE.{D, A, I, F} The debug exception mask bit, D, and interrupt mask bits, A, I, and F. Software can modify the bits independently. See [The PSTATE debug mask bit, D](#) on page D1-1539 and [Asynchronous exception types, routing, masking and priorities](#) on page D1-1456.

PSTATE.nRW The current Execution state. See [Execution state](#) on page D1-1411.

PSTATE.EL The current Exception level. See [Exception levels](#) on page D1-1408.

PSTATE.SP The stack pointer register selection bit. See *Stack pointer register selection* on page D1-1416.

On taking an exception, the PSTATE values are preserved in the SPSR (*Saved Program Status Register*) at the Exception level the exception is taken to, so that the state information can be restored on the exception return.

The SPSRs are described in *Saved Program Status Registers (SPSRs)* on page D1-1417.

———— **Note** —————

Those PSTATE fields that are meaningful only in AArch32 state are visible in AArch64 state only in an **SPSR_ELx**, when an exception is taken from AArch32 state to AArch64 state.

Table D1-5 shows the instructions used to access the PSTATE fields that hold AArch64 state, when the PE is in AArch64 state. Unless otherwise stated, all instructions can be used at EL1 and higher, and are undefined at EL0.

Table D1-5 Accessibility of the PSTATE fields that hold AArch64 state

Field	Access in AArch64 state		Notes
	Direct read	Direct write	
NZCV	MRS	MSR (register)	Accessible at EL0. Accessed using the NZCV register.
SS	None	None	On a reset to AArch64 state, this bit is set to 0.
IL	None	None	On a reset to AArch64 state, this bit is set to 0.
DAIF	MRS	MSR (register) MSR (immediate)	Access at EL0 using AArch64 depends on SCTLR_EL1.UMA. See <i>Traps to EL1 of EL0 accesses to the PSTATE.{D, A, I, F} interrupt masks</i> on page D1-1467. Accessed using the DAIF register. MSR (immediate) can be used to modify these bits independently. On a reset to AArch64 state, each of these bits is set to 1.
nRW	None	None	On a reset to AArch64 state, this bit is set to 0. This bit is always 0 when in AArch64 state.
EL	MRS	None	Accessed using the CurrentEL register. On a reset to AArch64 state, this field holds the encoding for the highest implemented Exception level. ———— Note ————— The ARM architecture requires that a PE resets into the highest implemented Exception level.
SP	MRS	MSR (register) MSR (immediate)	Accessed using SPSel register. MSR (immediate) can be used to modify this bit. On a reset to AArch64 state, this bit is set to 1, meaning that SP_ELx is selected.

The A64 instruction set provides separate system accessing instructions to read and write the PSTATE fields that have direct read or write access. However, when an exception occurs, the saved PSTATE fields, for the Exception level that the exception was taken from, are accessed using the SPSR.

D1.8 Program counter and stack pointer alignment

This section contains the following:

- [PC alignment checking](#).
- [Stack pointer alignment checking on page D1-1424](#).

D1.8.1 PC alignment checking

PC alignment checking generates an exception associated with instruction fetch, when an instruction fetched with a misaligned PC in AArch64 is attempted to be architecturally executed. A misaligned PC is when bits[1:0] of the PC are not 0b00.

———— **Note** —————

As with Instruction Aborts, speculative fetching of an instruction does not generate an exception. An exception occurs only on an attempt to architecturally execute the instruction.

If an exception is generated as a result of an instruction fetch at EL0, it is taken to EL1, unless the exception occurs in Non-secure state and HCR_EL2.TGE bit is 1, when it is taken to EL2 instead. If an exception is generated as a result of an instruction fetch at any other Exception level, the Exception level is unchanged.

A PC misalignment sets the EC field in the *Exception Syndrome Register* (ESR) to 0x22, for the ESR associated with the target Exception level.

When the exception is taken to an Exception level using AArch64, the associated Exception Link Register holds the entire PC in its misaligned form, as does the FAR_ELx for the Exception level that the exception is taken to.

[Exception return and PC alignment on page D1-1440](#) gives more information on PC alignment checking associated with exception returns.

———— **Note** —————

A misalignment of the PC is a common indication of a serious error, for example software corruption of an address.

```
// AArch64.CheckPCAlignment()  
  
// =====  
  
AArch64.CheckPCAlignment()  
  
    bits(64) pc = ThisInstrAddr();  
    if pc<1:0> != '00' then  
        AArch64.PCAlignmentFault();  
  
// AArch64.PCAlignmentFault()  
  
// =====  
  
// Called on unaligned program counter in AArch64 state.  
  
AArch64.PCAlignmentFault()  
  
    exception = ExceptionSyndrome(Exception_PCAalignment);  
    exception.vaddress = ThisInstrAddr();
```

```
bits(64) preferred_exception_return = ThisInstrAddr();  
vect_offset = 0x0;  
  
if UInt(PSTATE.EL) > UInt(EL1) then  
    AArch64.TakeException(PSTATE.EL, exception, preferred_exception_return, vect_offset);  
elseif AArch64.GeneralExceptionsToEL2() then  
    AArch64.TakeException(EL2, exception, preferred_exception_return, vect_offset);  
else  
    AArch64.TakeException(EL1, exception, preferred_exception_return, vect_offset);
```

D1.8.2 Stack pointer alignment checking

A *misaligned stack pointer* is where bits[3:0] of the stack pointer are not 0b0000, when the stack pointer is used as the base address of the calculation, regardless of any offset applied by the instruction.

The PE can be configured so that if a load or store instruction uses a misaligned stack pointer, the PE generates an exception on the attempt to execute the instruction.

————— Note —————

- As with Data Aborts, a speculative data access to memory using the stack pointer does not generate the exception. The exception occurs only on an attempt to architecturally execute the instruction.
- Prefetch memory abort instructions do not cause synchronous exceptions. See [Prefetch memory on page C2-138](#).

Stack pointer alignment checking is only performed in AArch64, and can be enabled for each Exception level as follows:

- [SCTLR_EL1](#).{SA0, SA} controls EL0 and EL1, respectively
- [SCTLR_EL2](#).SA controls EL2
- [SCTLR_EL3](#).SA controls EL3.

If an exception is generated as a result of a load or store at EL0, it is taken as an exception to EL1 unless the [HCR_EL2](#).TGE bit is set in the Non-secure state, when it is taken to EL2. If an exception is generated as a result of a load or store at any other Exception level, the Exception level is unchanged.

A stack pointer misalignment sets the EC field to 0x26, in the ESR associated with the target Exception level. If memory alignment checking and stack pointer alignment checking are enabled, then a stack pointer alignment fault has priority in setting the value of the EC field, in the ESR associated with the target Exception level.

```
// CheckSPAignment()  
// =====  
// Check correct stack pointer alignment for AArch64 state.
```

```
CheckSPAignment()  
  
bits(64) sp = SP[];  
  
if PSTATE.EL == EL0 then  
    stack_align_check = (SCTLR_EL1.SA0 != '0');  
else
```

```
stack_align_check = (SCTLR[].SA != '0');  
  
if stack_align_check && sp != Align(sp, 16) then  
    AArch64.SPAlignmentFault();  
  
return;
```

D1.9 Reset

The ARMv8-A architecture supports the following resets:

- | | |
|-------------------|--|
| Cold reset | Resets the logic of the entire implementation, including the integrated debug functionality. |
| Warm reset | Resets the logic of the PE, but does not reset the integrated debug functionality. |

———— **Note** —————

The ARMv8-A architecture also supports an *external debug reset*. See [External debug register resets on page H8-4465](#).

The difference between a Cold reset and a Warm reset is relevant only to the debug functionality and the [RMR_ELx](#) register, if an [RMR_ELx](#) register is implemented:

- A Warm reset permits debugging across a reset of the PE logic.
- Writing 1 to [RMR_ELx.RR](#) requests a Warm reset.

An implementation can define other resets according to the requirements the implementation or system must fulfil. These other resets are outside the scope of the ARMv8-A architecture. However, they can be mapped on to the resets described here.

For PE operation, a Cold reset and a Warm reset are equivalent. In the description that follows, the term *reset* is used in contexts where there is no difference between the effect of a Cold reset and the effect of a Warm reset.

On a reset, the PE enters the highest implemented Exception level.

If the highest implemented Exception level can use either Execution state, then:

- The implementation must include a *Reset Management Register* (RMR). Only one RMR is implemented. The RMR implemented is the RMR is associated with the highest Exception level.
- On a Cold reset, the Execution state entered is determined by a configuration input signal.
- On a Warm reset, the Execution state entered is determined by [RMR_ELx.AA64](#).

If the highest implemented Exception level is configured to use AArch64 state, then on reset:

- The stack pointer for the highest implemented Exception level, [SP_ELx](#), is selected.
- Execution starts at an IMPLEMENTATION DEFINED address, anywhere in the physical address range. The RVBAR associated with the highest implemented Exception level, [RVBAR_EL1](#), [RVBAR_EL2](#), or [RVBAR_EL3](#), holds this address.

The remainder of this section contains the following:

- [PE state on reset to AArch64 state](#).
- [Code sequence to request a Warm reset as a result of RMR_ELx.RR on page D1-1428](#).

D1.9.1 PE state on reset to AArch64 state

Immediately after a reset, much of the PE state is UNKNOWN. However, some of the PE state is defined. If the PE resets to AArch64 state using either a Cold or a Warm reset, the PE state that is defined is as follows:

- Each of the [PSTATE](#).{D, A, I, F} interrupt masks is set to 1.
- The Software step control bit, [PSTATE.SS](#), is set to 0.
- The IL process state bit, [PSTATE.IL](#), is set to 0.
- All general-purpose, and SIMD and floating-point registers are UNKNOWN.
- The ELR and SPSR for each Exception level are UNKNOWN.
- The stack pointer register for each Exception level is UNKNOWN.

- Unless explicitly defined in this subsection, each system control register at each Exception level is in an IMPLEMENTATION DEFINED state, that might be UNKNOWN.
- The TLBs and caches are in an IMPLEMENTATION DEFINED state. This means that the TLBs, the caches, or both, might require invalidation using IMPLEMENTATION DEFINED invalidation sequences before the memory management system or any cache is enabled.

———— **Note** —————

- The implementation might include IMPLEMENTATION DEFINED resets. If it does, each of these resets might treat the cache and TLB state differently. The ARMv8-A architecture permits this.
- Different IMPLEMENTATION DEFINED invalidation sequences might be required for different IMPLEMENTATION DEFINED resets.
- In some implementations, the IMPLEMENTATION DEFINED invalidation sequence might be a NOP.

-
- In the `SCTLR_ELx` for the highest implemented Exception level:
 - Each of the {M, C, I} bits is set to 0
 - The EE bit is set to an IMPLEMENTATION DEFINED value, typically defined by a configuration input.
 - If an RMR is implemented, `RMR_ELx.RR` is set to 0. ELx in this context is the highest implemented Exception level.
 - The enables for the timers and the counter event stream are set to 0. This means that the following bits are set to 0:
 - `CNTV_CTL_EL0.ENABLE`
 - `CNTP_CTL_EL0.ENABLE`
 - `CNTPS_CTL_EL1.ENABLE`
 - `CNTKCTL_EL1.EVNTEN`
 - If the implementation includes EL2, `CNTHP_CTL_EL2.ENABLE`
 - If the implementation includes EL2, `CNTHCTL_EL2.EVNTEN`.
 - `PMCR_EL0.E` is set to 0.

———— **Note** —————

This means the Performance Monitors cannot assert interrupts at reset.

-
- `OSDLR_EL1.DLK` bit is set to 0.
 - `EDPRCR.CWRR` is set to 0.
 - Each of `MDCCINT_EL1.{TX, RX}` is set to 0.
 - `EDPRSR.SR` is set to 1.
 - If the implementation includes EL3, then each of `MDCR_EL3.{EPMAD, EDAD, SPME}` is set to 0.
 - If the implementation includes EL2, then `MDCR_EL2.HPMN` is set to the value of `PMCR_EL0.N`.
 - Each of `EDES.{SS, RC, OSUC}` is reset to the value of `EDECR.SS`.

Additionally, for a Cold reset into AArch64 state:

- If an RMR is implemented, `RMR_ELx.AA64` is set to 1. ELx in this context is the highest implemented Exception level.
- Each of `MDCCSR_EL0.{TXfull, RXfull}` is set to 0.
- The `DBGPRCR_EL1.CORENPRDRQ` is set to the value of `EDPRCR.COREPURQ`.
- `DBGCLAIMSET_EL1[7:0]` is set to 0.

- Each of `EDSCR`.{RXO, TXU, INTdis, TDA, MA, HDE, ERR, RXfull, TXfull} is set to 0.

———— **Note** —————

`MDCCSR_EL0`.{RXfull, TXfull} reflect the values in `EDSCR`.{RXfull, TXfull}.

- Each of `EDECCCR`.{NSE, SE} is set to 0.
- `OSLSR_EL1`.OSLK is set to 1.
- Each of `EDPRSR`.{SPMAD, SDAD} is set to 0.
- `EDPRSR`.SPD is set to 1.

D1.9.2 Code sequence to request a Warm reset as a result of RMR_ELx.RR

```
; in addition, interrupts and debug requests for this core should be disabled
; in the system before running this sequence to ensure the WFI suspends execution
MOV Wy, #3          ; for AArch64, #2 for AArch32; y is any register
DSB                 ; ensure all stores etc are complete
MSR RMR_ELx, Wy    ; request the reset
ISB                 ; synchronise change to the RMR
Loop
WFI                 ; enter a quiescent state
B Loop
```

D1.10 Exception entry

Exceptions are targeted at particular Exception levels. The Exception level that an exception targets is either programmed by software, or is determined by the nature of the exception.

Under no circumstances do exceptions cause execution to move to a lower Exception level.

If an asynchronous exception targets a lower Exception level, the exception is not taken and remains pending. See [Asynchronous exception routing on page D1-1457](#) and [Asynchronous exception masking on page D1-1458](#).

———— Note —————

The construction of the architecture means that usually, it is impossible for an exception to target a lower Exception level.

The Security state can only change on taking an exception if the exception is taken from Non-secure state to EL3.

———— Note —————

Taking an exception to EL3 from any Exception level has no effect on the value of the [SCR_EL3.NS](#) bit.

On taking an exception to AArch64 state:

- The PE state is saved in the [SPSR_ELx](#) at the Exception level the exception is taken to. See [Saved Program Status Registers \(SPSRs\) on page D1-1417](#).
- The preferred return address is saved in the [ELR_ELx](#) at the Exception level the exception is taken to. See [Exception Link Registers \(ELRs\) on page D1-1420](#).
- All of [PSTATE](#).{D, A, I, F} are set to 1. See [Process state, PSTATE on page D1-1421](#).
- If the exception is a synchronous exception or an SError interrupt, information characterizing the reason for the exception is saved in the [ESR_ELx](#) at the Exception level the exception is taken to. See [Use of the ESR_EL1, ESR_EL2, and ESR_EL3 on page D1-1512](#).
- Execution moves to the target Exception level, and starts at the address defined by the exception vector. Which exception vector is used is also an indicator of whether the exception came from a lower Exception level or the current Exception level. See [Exception vectors on page D1-1430](#).
- The stack pointer register selected is the dedicated stack pointer register for the target Exception level. See [The stack pointer registers on page D1-1416](#).

The remainder of this section contains the following:

- [Preferred exception return address](#).
- [Exception vectors on page D1-1430](#).
- [Pseudocode description of exception entry to AArch64 state on page D1-1431](#).
- [Exception classes on page D1-1435](#).

D1.10.1 Preferred exception return address

For an exception taken to an Exception level using AArch64, the Exception Link Register for that Exception level, [ELR_ELx](#), holds the preferred exception return address. The preferred exception return address depends on the nature of the exception, as follows:

- For asynchronous exceptions, it is the address of the instruction following the instruction boundary at which the interrupt occurs. Therefore, it is the address of the first instruction that did not execute, or did not complete execution, as a result of taking the interrupt.
- For synchronous exceptions other than system calls, it is the address of the instruction that generates the exception.
- For system calls, it is the address of the instruction that follows the system call instruction.

Note

- If a system call instruction is trapped, disabled, or is UNDEFINED because the Exception level has insufficient privilege to execute the instruction, the preferred exception return address is the address of the system call instruction.
- A system call is generated by the execution of an SVC, HVC, or SMC instruction.

When an exception is taken from an Exception level using AArch32 to an Exception level using AArch64, the top 32 bits of the modified `ELR_ELx` are 0.

D1.10.2 Exception vectors

When the PE takes an exception to an Exception level that is using AArch64, execution is forced to an address that is the *exception vector* for the exception. The exception vector exists in a *vector table* at the Exception level the exception is taken to.

A vector table occupies a number of consecutive word-aligned addresses in memory, starting at the *vector base address*.

Each Exception level has an associated *Vector Base Address Register* (VBAR), that defines the exception base address for the table at that Exception level.

For exceptions taken to AArch64 state, the vector table provides the following information:

- Whether the exception is one of the following:
 - Synchronous exception.
 - SError.
 - IRQ.
 - FIQ.
- Information about the Exception level that the exception came from, combined with information about the stack pointer in use, and the state of the register file.

Table D1-6 shows this:

Table D1-6 Vector offsets from vector table base address

Exception taken from	Offset for exception type			
	Synchronous	IRQ or vIRQ	FIQ or vFIQ	SError or vSError
Current Exception level with <code>SP_ELO</code> .	0x000	0x080	0x100	0x180
Current Exception level with <code>SP_ELx</code> , $x > 0$.	0x200	0x280	0x300	0x380
Lower Exception level, where the implemented level immediately lower than the target level is using AArch64. ^a	0x400	0x480	0x500	0x580
Lower Exception level, where the implemented level immediately lower than the target level is using AArch32. ^a	0x600	0x680	0x700	0x780

a. For exceptions taken to EL3, if EL2 is implemented, the level immediately lower than the target level is EL2 if the exception was taken from Non-secure state, but EL1 if the exception was taken from Secure EL1 or EL0.

Reset is treated as a special vector for the highest implemented Exception level. This special vector uses an IMPLEMENTATION DEFINED address that is typically set either by a hardwired configuration of the PE or by configuration input signals. The `RVBAR_ELx` register contains this reset vector address, where x is the number of the highest implemented Exception level.

D1.10.3 Pseudocode description of exception entry to AArch64 state

The following pseudocode shows behavior when the PE takes an exception to an Exception level that is using AArch64.

```
// AArch64.TakeException()
// =====
// Take an exception to an Exception Level using AArch64.

AArch64.TakeException(bits(2) target_el, ExceptionRecord exception,
                      bits(64) preferred_exception_return, integer vect_offset)

assert !ELUsingAArch32(target_el);
assert UInt(target_el) >= UInt(PSTATE.EL);

// If being routed to from AArch32 state, the top parts of the X[] registers may
// be set to zero
if UsingAArch32() then MaybeZeroRegisterUppers(target_el);

if UInt(target_el) > UInt(PSTATE.EL) then
    boolean lower_32;
    if target_el == EL3 then
        if !IsSecure() && HaveEL(EL2) then
            lower_32 = ELUsingAArch32(EL2);
        else
            lower_32 = ELUsingAArch32(EL1);
    else
        lower_32 = ELUsingAArch32(target_el - 1);
    vect_offset = vect_offset + (if lower_32 then 0x600 else 0x400);

elseif PSTATE.SP == '1' then
    vect_offset = vect_offset + 0x200;

spsr = GetSPSRFromPSTATE();

if !(exception.type IN {Exception_IRQ, Exception_FIQ}) then
    AArch64.ReportException(exception, target_el);

PSTATE.EL = target_el;
PSTATE.nRW = '0';
PSTATE.SP = '1';
```

```
SPSR[] = spsr;
ELR[] = preferred_exception_return;

PSTATE.<D,A,I,F> = '1111';
if spsr<4> == '1' then           // Coming from AArch32
    PSTATE.IT = '00000000';
    PSTATE.J = '0';
    PSTATE.T = '0';

BranchTo(VBAR[] + vect_offset, BranchType_EXCEPTION);
EndOfInstruction();

// AArch64.ReportException()
// =====
// Report syndrome information for exception taken to AArch64 state.

AArch64.ReportException(ExceptionRecord exception, bits(2) target_e1)

    Exception type = exception.type;

    (ec,il) = AArch64.ExceptionClass(type, target_e1);
    iss = exception.syndrome;

    // IL is not valid for Data Abort exceptions without valid instruction syndrome information
    if ec IN {0x24,0x25} && iss<24> == '0' then
        il = '1';

    ESR[target_e1] = ec<5:0>;il:iss;

    if type IN {Exception_InstructionAbort, Exception_PCAlignment, Exception_DataAbort,
                Exception_Watchpoint} then
        FAR[target_e1] = exception.vaddress;
    else
        FAR[target_e1] = bits(64) UNKNOWN;

    if target_e1 == EL2 && exception.ipavalid then
```

```

HPFAR_EL2<39:4> = exception.ipaddress<47:12>;

return;

// AArch64.ExceptionClass()
// =====
// Return the Exception Class and Instruction Length fields for reported in ESR

(integer,bit) AArch64.ExceptionClass(Exception type, bits(2) target_e1)

    il = if ThisInstrLength() == 32 then '1' else '0';
    from_32 = UsingAArch32();
    assert from_32 || il == '1';          // AArch64 instructions always 32-bit

case type of
    when Exception_Uncategorized      ec = 0x00; il = '1';
    when Exception_WFxTrap            ec = 0x01;
    when Exception_CP15RRTTrap        ec = 0x03;          assert from_32;
    when Exception_CP15RRTTrap        ec = 0x04;          assert from_32;
    when Exception_CP14RRTTrap        ec = 0x05;          assert from_32;
    when Exception_CP14DTTTrap        ec = 0x06;          assert from_32;
    when Exception_AdvSIMDFPAccessTrap ec = 0x07;
    when Exception_FPIDTrap           ec = 0x08;
    when Exception_CP14RRTTrap        ec = 0x0C;          assert from_32;
    when Exception_IllegalState       ec = 0x0E; il = '1';
    when Exception_SupervisorCall      ec = 0x11;
    when Exception_HypervisorCall     ec = 0x12;
    when Exception_MonitorCall        ec = 0x13;
    when Exception_SystemRegisterTrap ec = 0x18;          assert !from_32;
    when Exception_InstructionAbort    ec = 0x20; il = '1';
    when Exception_PCAalignment       ec = 0x22; il = '1';
    when Exception_DataAbort          ec = 0x24;
    when Exception_SPAalignment       ec = 0x26; il = '1'; assert !from_32;
    when Exception_FPtrappedException ec = 0x28;
    when Exception_SError              ec = 0x2F; il = '1';
    when Exception_Breakpoint         ec = 0x30; il = '1';
    when Exception_SoftwareStep       ec = 0x32; il = '1';

```

```
    when Exception_Watchpoint          ec = 0x34; i1 = '1';
    when Exception_SoftwareBreakpoint  ec = 0x38;
    when Exception_VectorCatch         ec = 0x3A; i1 = '1'; assert from_32;
    otherwise                           Unreachable();

if ec IN {0x20,0x24,0x30,0x32,0x34} && target_e1 == PSTATE.EL then
    ec = ec + 1;

if ec IN {0x11,0x12,0x13,0x28,0x38} && !from_32 then
    ec = ec + 4;

return (ec,i1);

// MaybeZeroRegisterUppers()
// =====
// On taking an exception to "handle_e1" using AArch64 from AArch32, it is CONSTRAINED
// UNPREDICTABLE whether the top 32 bits of registers visible at any lower Exception level
// using AArch32 are set to zero.

MaybeZeroRegisterUppers(bits(2) handle_e1)
    assert UsingAArch32() && !ELUsingAArch32(handle_e1);

SCR_RW = if HaveEL(EL3) then SCR_EL3.RW else '1';
HCR_RW = if CurrentStateHasEL2() && SCR_RW == '1' then HCR_EL2.RW else SCR_RW;

case SCR_RW:HCR_RW:handle_e1 of
    when '0011' first = 0; last = 30; include_R15 = TRUE;
    when '101x' first = 0; last = 30; include_R15 = FALSE;
    when '11xx' first = 0; last = 14; include_R15 = FALSE;
    otherwise   Unreachable();

for n = first to last
    if (n != 15 || include_R15) && ConstrainUnpredictableBool() then
        _R[n]<63:32> = Zeros();

return;
```

D1.10.4 Exception classes

If the exception is a synchronous exception or an SError interrupt, information characterizing the reason for the exception is saved in the `ESR_ELx` at the Exception level the exception is taken to. The information saved is determined at the time the exception is taken, and is not changed as a result of the explicit synchronization that takes place at the start of taking the exception. See *Synchronization requirements for system registers* on page D8-1866.

Table D1-7 shows the possible encodings of the `ESR_ELx.EC` Exception Class field, for exceptions taken to AArch64 state. For each EC encoding:

- Table D1-7 includes a reference to the corresponding Instruction Specific Syndrome field, `ESR_ELx.ISS`.
- Table D1-75 on page D1-1513 indicates:
 - Which of the `ESR_ELx` the fault can be reported in.
 - Which Execution states the fault can be taken from.

Table D1-7 `ESR_ELx.EC` field encodings

EC	Meaning, and information on the corresponding <i>Instruction Specific Syndrome</i> , <code>ESR_ELx.ISS</code> . encoding.
0x00	Unknown reason. Generally used for exceptions that are a result of erroneous execution, see <i>Exceptions with an unknown reason</i> on page D1-1517. <code>ESR_ELx.ISS</code> is <code>RES0</code> .
0x01	Caused by a WFI or WFE instruction. Occurred because of a configurable trap, or a configurable enable or disable. For the encoding of the ISS field, see <i>Exception from a WFI or WFE instruction, from AArch32 or AArch64 state</i> on page D1-1518.
0x03	Caused by an MCR or MRC access to CP15, that is not reported using <code>ESR_ELx.EC == 0x00</code> . Occurred because of a configurable trap, or a configurable enable or disable. This code is only valid for exceptions taken from AArch32 state. For the encoding of the ISS field, see <i>Exception from an MCR or MRC access from AArch32 state</i> on page D1-1518.
0x04	Caused by an MCRR or MRRC access to CP15, that is not reported using <code>ESR_ELx.EC == 0x00</code> . Occurred because of a configurable trap, or a configurable enable or disable. This code is only valid for exceptions taken from AArch32 state. For the encoding of the ISS field, see <i>Exception from an MCRR or MRRC access from AArch32 state</i> on page D1-1519.
0x05	Caused by an MCR or MRC access to CP14. Occurred because of a configurable trap, or a configurable enable or disable. This code is only valid for exceptions taken from AArch32 state. For the encoding of the ISS field, see <i>Exception from an MCR or MRC access from AArch32 state</i> on page D1-1518.
0x06	Caused by an LDC or STC access to CP14. Occurred because of a configurable trap, or a configurable enable or disable. This code is only valid for exceptions taken from AArch32 state. Only valid for exceptions taken from AArch32 state. For the encoding of the ISS field, see <i>Exception from an LDC or STC access to CP14 from AArch32 state</i> on page D1-1520.
0x07	Caused by an access to SIMD or floating-point register ^a . Occurred because of a configurable trap, or a configurable enable or disable. For the encoding of the ISS field, see <i>Exception from an access to SIMD or floating-point registers, from AArch32 or AArch64</i> on page D1-1521.
0x08	Caused by an MRC or VMRS access to CP10 for <code>MVFR0</code> , <code>MVFR1</code> , <code>MVFR2</code> , or <code>FPSID</code> , from an ID Group trap, that is not reported using <code>EC 0x07</code> . This code is only valid for exceptions taken from AArch32 state. For the encoding of the ISS field, see <i>Exception from an MCR or MRC access from AArch32 state</i> on page D1-1518.
0x0C	Caused by an MRRC access to CP14. Occurred because of a configurable trap, or a configurable enable or disable. This code is only valid for exceptions taken from AArch32 state. For the encoding of the ISS field, see <i>Exception from an MCRR or MRRC access from AArch32 state</i> on page D1-1519.
0x0E	Illegal Execution State exception. <code>SPSR_ELx.IL</code> is 1. <code>ESR_ELx.ISS</code> is <code>RES0</code> .

Table D1-7 ESR_ELx.EC field encodings (continued)

EC	Meaning, and information on the corresponding <i>Instruction Specific Syndrome</i> , ESR_ELx.ISS. encoding.
0x11	SVC instruction executed in AArch32 state. For the encoding of the ISS field, see Exception from HVC or SVC instruction execution on page D1-1522 .
0x12	HVC instruction executed in AArch32 state, when HVC instructions are not disabled ^b . For the encoding of the ISS field, see Exception from HVC or SVC instruction execution on page D1-1522 .
0x13	SMC instruction executed in AArch32 state, when SMC instructions are not disabled ^b . For the encoding of the ISS field, see Exception from SMC instruction execution in AArch32 state on page D1-1522 .
0x15	SVC instruction executed in AArch64 state. For the encoding of the ISS field, see Exception from HVC or SVC instruction execution on page D1-1522 .
0x16	HVC instruction executed in AArch64 state, when HVC instructions are not disabled ^b . For the encoding of the ISS field, see Exception from HVC or SVC instruction execution on page D1-1522 .
0x17	SMC instruction executed in AArch64 state, when SMC instructions are not disabled ^b . For the encoding of the ISS field, see Exception from SMC instruction execution in AArch64 state on page D1-1523 .
0x18	Caused by an MSR, MRS, or System instruction, that is not reported using EC == 0x00, 0x01, or 0x07. Occurred because of a configurable trap, or a configurable enable or disable. For the encoding of the ISS field, see Exception from MSR, MRS, or System instruction execution in AArch64 state on page D1-1523 .
0x20	Instruction Abort taken from a lower Exception level. Used for MMU faults generated by instruction accesses, and for synchronous external aborts, including synchronous parity errors. Not used for debug exceptions. For the encoding of the ISS field, see Exception from an Instruction abort on page D1-1524 .
0x21	Instruction Abort taken without a change of Exception level. Used for MMU faults generated by instruction accesses, and for synchronous external aborts, including synchronous parity errors. Not used for debug exceptions. For the encoding of the ISS field, see Exception from an Instruction abort on page D1-1524 .
0x22	Misaligned PC exception. See PC alignment checking on page D1-1423 . ESR_ELx.ISS is RES0.
0x24	Data Abort taken from a lower Exception level. Used for MMU faults generated by data accesses, alignment faults other than stack pointer alignment faults, and for synchronous external aborts, including synchronous parity errors. Not used for debug exceptions. For the encoding of the ISS field, see Exception from a Data abort on page D1-1525 .
0x25	Data Abort taken without a change of Exception level. Used for MMU faults generated by data accesses, alignment faults other than stack pointer alignment faults, and for synchronous external aborts, including synchronous parity errors. Not used for debug exceptions. For the encoding of the ISS field, see Exception from a Data abort on page D1-1525 .
0x26	Stack Pointer Alignment exception. See Stack pointer alignment checking on page D1-1424 . ESR_ELx.ISS is RES0.
0x28	Floating-point exception, if supported. Exceptions as a result of Floating-point exception traps, taken from AArch32 state. For the encoding of the ISS field, see Floating-point exceptions on page D1-1529 .
0x2C	Floating-point exception, if supported. Exceptions as a result of Floating-point exception traps, taken from AArch64 state. For the encoding of the ISS field, see Floating-point exceptions on page D1-1529 .

Table D1-7 ESR_ELx.EC field encodings (continued)

EC	Meaning, and information on the corresponding <i>Instruction Specific Syndrome</i> , ESR_ELx.ISS. encoding.
0x2F	SError interrupt. For the encoding of the ISS field, see SError interrupt on page D1-1530 .
0x30	Breakpoint exception taken from a lower Exception level. For the encoding of the ISS field, see Breakpoint exception or Vector Catch exception on page D1-1530 .
0x31	Breakpoint exception taken without a change of Exception level. For the encoding of the ISS field, see Breakpoint exception or Vector Catch exception on page D1-1530 .
0x32	Software Step exception taken from a lower Exception level. For the encoding of the ISS field, see Software Step exception on page D1-1532 .
0x33	Software Step exception taken without a change of Exception level. For the encoding of the ISS field, see Software Step exception on page D1-1532 .
0x34	Watchpoint exception taken from a lower Exception level. For the encoding of the ISS field, see Watchpoint exception on page D1-1531 .
0x35	Watchpoint exception taken without a change of Exception level. For the encoding of the ISS field, see Watchpoint exception on page D1-1531 .
0x38	BKPT instruction executed in AArch32 state. For the encoding of the ISS field, see Software Breakpoint Instruction exception on page D1-1532 .
0x3A	Vector Catch exception taken from AArch32 state. For the encoding of the ISS field, see Breakpoint exception or Vector Catch exception on page D1-1530 .
0x3C	BRK instruction executed in AArch64 state. For the encoding of the ISS field, see Software Breakpoint Instruction exception on page D1-1532 .
a.	Except if the access is trapped because HCR_EL2.TGE is 1, in which case, the exception is reported with EC code 0x00
b.	When HVC or SMC instructions are disabled, the resulting exceptions are reported with EC code 0x00.

EC encodings when routing general exceptions to EL2

When an exception is taken to EL2 because the exception routing control HCR_EL2.TGE is enabled, the EC encoding that would have been used if the exception had been taken to EL1 is recorded in ESR_EL2.EC instead, unless that encoding is 0x07.

Exceptions that use 0x07 when the HCR_EL2.TGE routing control is disabled use 0x00 when the HCR_EL2.TGE routing control is enabled.

Exceptions taken for an unknown reason, EC encoding 0x00

These are:

- Instruction-related encodings that are UNALLOCATED at all or the current Exception level, as follows:
 - UNALLOCATED instruction encodings.
 - Instruction encodings for instructions not implemented.
 - UNALLOCATED System register encodings. For example, System register encodings that are allocated for reads, or for writes, or for both reads and writes.
 - Debug state execution of instruction bit patterns that are UNALLOCATED in Debug state.
 - Non-debug state execution of instruction bit patterns that are UNALLOCATED in Non-debug state.
- An HVC instruction, when HVC instructions are disabled by SCR_EL3.HCE or HCR_EL2.HCD.

- An SMC instruction, when SMC instructions are disabled by [SCR_EL3.SMD](#).
- An MSR or MRS to [SP_ELO](#) when [SPSel](#) == 0.
- An HLT instruction, when HLT instructions are disabled by [EDSCR.HDE](#).
- Exceptions from Debug state, as a result of any of the following:
 - A DCPS1 executed in Non-secure EL0 when [HCR_EL2.TGE](#) is 1.
 - A DCPS2 executed in EL1 or EL0 when [SCR_EL3.NS](#) is 0, or when EL2 is not implemented.
 - A DCPS3 executed when [EDSCR.SDD](#) is 1, or when EL3 is not implemented.
 - An instruction that is trapped to EL3 in Non-debug state, that is executed in EL2, EL1, or EL0 when [EDSCR.SDD](#) is 1.
- Exceptions from AArch32 state, as follows:
 - Exceptions generated by any of the [SCTLR_EL1](#).{ITD, SED, CP15BEN, THEE} control bits.
 - SRS using R13_mon from Secure EL1 when EL3 is using AArch64. See [Traps to EL3 of monitor functionality from Secure EL1 using AArch32 on page D1-1500](#).
 - MRS or MSR (Banked register) to [SPSR_mon](#), [R13_mon](#), or [R14_mon](#).
 - Short vector VFP instructions.
 - A DCPS3 executed in Debug state when EL3 is using AArch32.
- Exceptions that would normally have an EC encoding of 0x07, but that instead are taken to EL2 because [HCR_EL2.TGE](#) is 1.

D1.11 Exception return

In the ARMv8-A architecture, an exception return is always to the same Exception level or a lower Exception level. An exception return is used for:

- A return to a previously executing thread.
- Entry to a new execution thread. For example:
 - The initialization of a hypervisor by a Secure monitor.
 - The initialization of an operating system by a hypervisor.
 - Application entry from an operating system or hypervisor.

An exception return requires the simultaneous restoration of the PC and [PSTATE](#) to values that are consistent with the desired state of execution on returning from the exception.

In AArch64 state, an ERET instruction causes an exception return. On an ERET instruction:

- The PC is restored with the value held in the [ELR_ELx](#).
- [PSTATE](#) is restored by using the contents of the [SPSR_ELx](#).

The [ELR_ELx](#) and [SPSR_ELx](#) are the [ELR_ELx](#) and [SPSR_ELx](#) at the Exception level the exception is returning from.

———— **Note** —————

When returning from an Exception level using AArch64 to an Exception level using AArch32, the top 32 bits of the [ELR_ELx](#) are ignored.

An ERET instruction also:

- Sets the Event Register for the PE executing the ERET instruction. See *Mechanisms for entering a low-power state* on page D1-1533.
- Resets the local exclusive monitor for the PE executing the ERET instruction. This removes the risk of errors that might be caused when a path to an exception return fails to include a CLREX instruction.

———— **Note** —————

This behavior prevents self-hosted debug from software stepping through an LDREX/STREX pair. However, when self-hosted debug is using software step, it is highly probable that the exclusive monitor state would be lost anyway, for other reasons. *Stepping code that uses exclusive monitors* on page D2-1645 describes this.

It is IMPLEMENTATION DEFINED whether the resetting of the local exclusive monitor also resets the global exclusive monitor.

The ERET instruction is UNDEFINED in EL0.

When returning from an Exception level using AArch64 to an Exception level using AArch32, the AArch32 context is restored. The ARMv8-A architecture defines the relationship between AArch64 state and AArch32 state, for:

- General purpose registers.
- Special purpose registers.
- System registers.

In an implementation that includes EL3, the Security state can only change on returning from an exception if the return is from EL3 to a lower Exception level.

The following sections give more information:

- *Pseudocode description of exception return* on page D1-1440.
- *Exception return and PC alignment* on page D1-1440.
- *Illegal return events* on page D1-1441.

D1.11.1 Pseudocode description of exception return

```
// AArch64.ExceptionReturn()
// =====

AArch64.ExceptionReturn(bits(64) new_pc, bits(32) spsr)

SetPSTATEFromSPSR(spsr);
ClearExclusiveLocal(ProcessorID());
EventRegisterSet();

if spsr<4> == '1' then // Attempted to change to AArch32 state
    // Align PC[1:0] according to the target instruction set state
    // If PSTATE.IL==1 then the state did not change, but the PC alignment might have occurred
    if PSTATE.IL == '0' || ConstrainUnpredictableBool() then
        if spsr<5> == '1' then // T32 or T32EE state
            new_pc = Align(new_pc, 2);
        else // A32 state
            new_pc = Align(new_pc, 4);

    // Zero the 32 most significant bits of the target PC
    if PSTATE.IL == '0' || ConstrainUnpredictableBool() then
        new_pc<63:32> = Zeros();

if PSTATE.nRW == '1' then
    BranchTo(new_pc<31:0>, BranchType_UNKNOWN);
else
    BranchTo(new_pc, BranchType_ERET);

return;
```

D1.11.2 Exception return and PC alignment

When returning to an Exception level using AArch64, as defined by `SPSR_ELx.M[4] == 0`, if the `ELR_ELx` contains a misaligned value, that value is transferred to the PC. Subsequent execution results in a Misaligned PC exception.

When returning from an Exception level using AArch64 to an Exception level using AArch32, as defined by `SPSR_ELx.M[4] == 1`, if the `ELR_ELx` contains a misaligned value, then:

- If `SPSR_ELx.T` is 0, `ELR_ELx[1:0]` are treated as being 0 for restoring the PC.
- If `SPSR_ELx.T` is 1, `ELR_ELx[0]` is treated as being 0 for restoring the PC.

This means that no Misaligned PC exception occurs after returning from AArch64 state to AArch32 state.

———— **Note** —————

An exception return with `SPSR_ELx.M[4] == 1` that generates an illegal exception return into AArch64 state is permitted to result in alignment of the PC.

D1.11.3 Illegal return events

An *illegal return event* means one of:

- An illegal exception return.
- An illegal return from Debug state.
- A DPRS instruction executed in Debug state, that causes an illegal exception return situation.

In the description that follows, the term *return* is used to mean an exception return, a return from Debug state, or a return as a result of a DPRS executed in Debug state.

———— **Note** —————

If return means a return from Debug state, it is the `DSPSR_EL0` that was used to save PE state, not the `SPSR_ELx`.

The following are illegal return events from AArch64 state:

- A return where the Exception level being returned to is higher than the current Exception level.
- A return to an Exception level that is not implemented, for example a return to EL2 when EL2 is not implemented.
- A return where the `SPSR_ELx` indicates a return to AArch32 state, but the Exception level being returned to is using AArch64, as programmed by `SCR_EL3.RW` or `HCR_EL2.RW` or as initialized from reset.
- A return to EL2 when `SCR_EL3.NS` is 0. The PE cannot return to Non-secure state when `SCR_EL3.NS` is 0.
- A return to Non-secure EL1 when `HCR_EL2.TGE` is 1.
- A return to AArch64 state when `SPSR_ELx.M[1]` is 1.
- If T32EE is implemented, a return to AArch32 state when both:
 - `SPSR_ELx.{J, T}` are 0b11.
 - `SCTLR.THEE` is 0 at the Exception level being returned to.If T32EE is not implemented, behavior is IMPLEMENTATION DEFINED on a return to AArch32 state when `SPSR_ELx.{J, T}` are 0b11 and `SCTLR.THEE` is 0 at the Exception level being returned to. Either:
 - The return is an illegal return.
 - `SPSR_ELx.J` is treated as 0.
- A return to AArch32 state using an `SPSR_ELx.M[3:0]` field value that is not allocated to a valid AArch32 mode.
- A return to EL0 using AArch64 when `SPSR_ELx.M[0]` is 1.
- Debug state exit from EL0 using AArch64, to EL0 using AArch32.

On an illegal return from an Exception level using AArch64:

- The IL bit, `PSTATE.IL`, is set to 1
- The Exception level, Execution state, and stack pointer selection are unchanged as a result of the return.
- The following `PSTATE` bits are restored using the contents of the `SPSR_ELx`:
 - The NZCV flag bits.
 - The DAIF mask bits.
- The PC is restored with the value held in the `ELR_ELx`.

- If the illegal return is an illegal exception return, the SS bit is handled as normal for an exception return. That is, the SS bit is handled in the same way as an exception return that is not an illegal exception return. See [Software Step exceptions on page D2-1634](#).

When the IL bit is 1, any attempt to execute any instruction results in an Illegal Execution State exception, and [ELR_ELx.EC](#) for the target Exception level takes the value 0b001110. For the priority of this exception class, see [Synchronous exception prioritization on page D1-1451](#).

On taking an exception, the value of the IL bit is copied into the SPSR associated with the Exception level that the exception is taken to, and then the IL bit is set to 0.

———— **Note** —————

This means that it is not possible for software to observe the value of [PSTATE.IL](#).

If an exception return from AArch64 state to AArch32 state, as defined by [SPSR_ELx.M\[4\] == 1](#), triggers an illegal exception return, it is CONSTRAINED UNPREDICTABLE whether the top 32 bits of the PC:

- Are all zero.
- Take the value held in the [ELR_ELx](#), or the value held in the [DLR_ELO](#) if returning from Debug state.

The implementation determines the choice of these two options, and the choice might vary dynamically. Therefore, software must tolerate both of these options.

Other than the effects described in this section, all other aspects of the return occur as normal.

D1.12 The Exception level hierarchy

The System registers provide controls that control PE behavior through the Exception level hierarchy.

If EL3 and EL2 are implemented, System registers at EL3 and EL2 provide controls that control the Execution state of lower Exception levels.

Table D1-8 shows the principal System control registers:

Table D1-8 Principal System control registers

EL3	EL2	EL1	Notes
SCTLR_EL3	SCTLR_EL2	SCTLR_EL1	Controls execution for its own Exception level.
SCR_EL3	HCR_EL2	-	Controls execution at lower Exception levels.
-	HSTR_EL2	-	Used only if at least one of EL1 and EL0 is using AArch32.

The following sections describe the Exception level hierarchy:

- [The hierarchy of configuration and routing control.](#)
- [Control of SIMD, floating-point and trace functionality on page D1-1448.](#)
- [Control of IMPLEMENTATION DEFINED features on page D1-1449.](#)
- [Routing general exceptions to EL2 on page D1-1451.](#)

D1.12.1 The hierarchy of configuration and routing control

The following subsections give a summary of the controls available at each Exception level for controlling execution at that Exception level and all lower Exception levels:

- [Controls provided at EL3.](#)
- [Controls provided at EL2 on page D1-1444.](#)
- [Controls provided at EL1 on page D1-1447.](#)

For information on how the controls summarized in these subsections affect PE behavior, see the definitions of the control bits in the register descriptions.

Controls provided at EL3

See:

- [Controls provided by the SCR_EL3.](#)
- [Controls provided by the SCTLR_EL3 on page D1-1444.](#)
- [Controls provided by the MDCR_EL3 on page D1-1444.](#)

Controls provided by the SCR_EL3

SCR_EL3.NS Determines the Security state of execution at EL1 and EL0.

SCR_EL3.RW Determines the Execution state of the next-lower Exception level.

SCR_EL3.{EA, FIQ, IRQ}

Route:

EA Physical SError interrupts and synchronous External Aborts to EL3.

FIQ Physical IRQ interrupts to EL3.

IRQ Physical IRQ interrupts to EL3.

SCR_EL3.SMD Disables the Secure Monitor Call exception.

SCR_EL3.HCE Enables the Hypervisor Call exception.

SCR_EL3.ST	Enables Secure EL1 access to the Secure timer.
SCR_EL3.SIF	Secure Instruction Fetch. When in Secure state, disables instruction fetches from Non-secure memory.
SCR_EL3.TWI	Trap Wait-For-Interrupt.
SCR_EL3.TWE	Trap Wait-For-Event.

Controls provided by the SCTLR_EL3

SCTLR_EL3.{A, SA} Enable alignment checking:

A	On data accesses from EL3.
SA	On the SP, when executing at EL3.

SCTLR_EL3.{M, C, I, WXN}

Memory system control bits:

M	Enables EL3 stage 1 address translation.
C	Enables data and unified caches for accesses from EL3.
I	Enables instruction caches for accesses from EL3.
WXN	For accesses from EL3, enables treating all writable memory regions as XN, execute never.

SCTLR_EL3.EE Defines the endianness of data accesses from EL3, including stage 1 translation table walks at EL3.

———— **Note** —————

Instruction fetches are always little-endian.

Controls provided by the MDCR_EL3

MDCR_EL3.{EPMAD, EDAD}

Enable external debugger accesses to:

EPMAD	Performance Monitors registers.
EDAD	Breakpoint and Watchpoint registers.

MDCR_EL3.{SPME, SDD, SPD32}

Secure debug controls:

SPME	Secure Performance Monitors enable. Enables event counting in Secure state.
SDD	Disables all debug exceptions taken from Secure state, if the <i>debug target Exception level</i> , EL_D , is using AArch64.
SPD32	Enables debug exceptions from Secure EL1 using AArch32.

MDCR_EL3.{TDOSA, TDA, TPM}

These are trap enable controls, that enable traps to EL3 of EL2, EL1, and EL0 accesses to the following:

TDOSA	The OS-related debug registers.
TDA	Those debug registers not included in the MDCR_EL3 .TDOSA trap.
TPM	The Performance Monitors registers.

For EL1 and EL0, these traps apply to accesses from both Security states.

Controls provided at EL2

EL2 is implemented only in Non-secure state, and its controls apply only to execution in Non-secure EL2, Non-secure EL1, and Non-secure EL0. See:

- [Controls provided by SCTLR_EL2 on page D1-1445.](#)

- [Controls provided by HCR_EL2.](#)
- [Controls provided by the HSTR_EL2 on page D1-1446.](#)
- [Controls provided by the MDCR_EL2 on page D1-1446.](#)

Controls provided by SCTLR_EL2

SCTLR_EL2.{A, SA} Enable alignment checking:

- A** On data accesses from EL2.
- SA** On the SP, when executing at EL2.

SCTLR_EL2.{M, C, I, WXN}

Memory system control bits:

- M** Enables EL2 stage 1 address translation.
- C** Enables data and unified caches for accesses from EL2.
- I** Enables instruction caches for accesses from EL2.
- WXN** For accesses from EL2, enables treating all writable memory regions as XN, execute never.

SCTLR_EL2.EE Defines the endianness of data accesses from EL2, including stage 1 translation table walks at EL2.

Also defines the endianness of stage 2 translation table walks at Non-secure EL1 and EL0.

———— **Note** —————

Instruction fetches are always little-endian.

Controls provided by HCR_EL2

HCR_EL2.RW Determines the Execution state of the next-lower Exception level.

HCR_EL2.{AMO, IMO, FMO}

Route physical interrupts to EL2 and enable virtual interrupts:

- AMO** Route physical SError interrupts to EL2 and enable virtual SError interrupts
- IMO** Route physical IRQ interrupts to EL2 and enable virtual IRQ interrupts.
- FMO** Route physical FIQ interrupts to EL2 and enable virtual FIQ interrupts.

———— **Note** —————

If a physical interrupt is routed to both EL3 and EL2, routing to EL3 takes precedence over routing to EL2.

HCR_EL2.{VSE, VI, VF}

Cause a virtual interrupt to be pending:

- VSE** Virtual SError interrupt.
- VI** Virtual IRQ interrupt.
- VF** Virtual FIQ interrupt.

HCR_EL2.VM Enable bit for Non-secure EL1&0 stage 2 address translations.

HCR_EL2.{SWIO, PTW, FB, BSU, DC, CD, ID}

Controls for memory system behavior for accesses made from Non-secure EL1 and EL0:

- SWIO** Set/Way Invalidate Override.
- PTW** Protect Table Walk.
- FB** Force broadcast of TLB and instruction cache maintenance operations.
- BSU** Barrier Shareability Upgrade.

- DC** Default Cacheable for EL1 and EL0 translations, when the EL1/EL0 stage translation regime is disabled.
- CD** Data Cache Disable, for stage 2 translations.
- ID** Instruction cache Disable, for stage 2 translations.

HCR_EL2.HCD Hypervisor Call Disable.

———— **Note** —————

If an implementation includes EL3, this bit is RES0.

HCR_EL2.{TRVM, TDZ, TVM, TTLB, TPU, TPC, TSW, TACR, TIDCP, TSC, TID1, TID2, TID3, TWE, TWI}

Trap operations performed at Non-secure EL1 or EL0 to EL2, as follows:

- TRVM** Trap Read of Virtual Memory controls.
- TDZ** Trap Data Cache Zero.
- TVM** Trap Virtual Memory controls.
- TTLB** Trap TLB maintenance instructions.
- TPU** Trap cache maintenance to the Point of Unification instructions.
- TPC** Trap data cache maintenance to the Point of Coherency instructions.
- TSW** Trap data cache maintenance by Set/Way instructions.
- TACR** Trap Auxiliary Control Register accesses.
- TIDCP** Trap Implementation-Dependent functionality.
- TSC** Trap Secure Monitor Call.
- TID0** Trap ID Group 0 register accesses.
- TID1** Trap ID Group 1 register accesses.
- TID2** Trap ID Group 2 register accesses.
- TID3** Trap ID Group 3 register accesses.
- TWI** Trap Wait-For-Interrupt.
- TWE** Trap Wait-For-Event.

———— **Note** —————

There are no AArch64 System registers in ID Group 0, therefore the TID0 trap is only relevant when Non-secure EL1 is using AArch32.

HCR_EL2.TGE Trap General Exceptions.

Controls provided by the HSTR_EL2

When EL2 is using AArch64 and at least one of Non-secure EL1 or EL0 is using AArch32, **HSTR_EL2** provides the following traps of Non-secure AArch32 operation to EL2:

HSTR_EL2.Tn, for values of *n* in the set {0-3, 5-13, 15}

Trap accesses to System registers in the AArch32 conceptual coprocessor CP15, by the coprocessor primary register number.

HSTR_EL2.TTEE Trap ThumbEE operations.

Controls provided by the MDCR_EL2

MDCR_EL2.{TDRA, TDOSA, TDA}

Trap enable controls, that enable traps to EL2 of Non-secure EL1 and EL0 System register accesses to the following:

- TDRA** The Debug ROM registers.
- TDOSA** The OS-related debug registers.

TDA Those debug registers not included in either of the [MDCR_EL2.TDRA](#) or [MDCR_EL2.TDOSA](#) traps.

MDCR_EL2.TDE Routes all debug exceptions taken from Non-secure EL1 and EL0 to EL2.

MDCR_EL2.{TPM, TPMCR}

These are trap enable controls, that enable traps to EL2 of Non-secure EL1 and EL0 accesses to the following registers:

TPM All Performance Monitors registers.

TPMCR The Performance Monitors Control Registers.

MDCR_EL2.HPMN Defines the number of Performance Monitors counters that are accessible from Non-secure EL1 and EL0.

Controls provided at EL1

See:

- [Controls provided by the SCTLR_EL1](#).
- [Controls provided by the MDSCR_EL1 on page D1-1448](#).

Controls provided by the SCTLR_EL1

SCTLR_EL1.{A, SA} Enable alignment checking:

A On data accesses from EL1 and EL0.

SA On the SP, when executing at EL1.

SCTLR_EL1.SA0 Enable alignment checking on the SP when executing at EL0.

SCTLR_EL1.{M, C, I, WXN}

Memory system control bits:

M Enables EL1&0 stage 1 address translation.

C Enables data and unified caches for accesses from EL1 and EL0.

I Enables instruction caches for accesses from EL1 and EL0.

WXN For accesses from EL1 and EL0, enables treating all writable memory regions as XN, execute never.

SCTLR_EL1.EE Defines the endianness of data accesses from EL1, including stage 1 translation table walks at EL1 and EL0.

———— **Note** —————

Instruction fetches are always little-endian.

SCTLR_EL1.E0E EL0 Endianness. Defines the endianness used for explicit data accesses made from EL0.

SCTLR_EL1.{UCI, UCT, DZE, nTWI, nTWE}

Trap enables:

UCI Unprivileged Cache maintenance Instruction enable.

UCT Unprivileged Cache Type access enable.

DZE Data cache Zero Enable.

nTWI Not Trap Wait-For-Interrupt.

nTWE Not Trap Wait-For-Event.

SCTLR_EL1.UMA Unprivileged Mask Access.

SCTLR_EL1.{**SED**, **ITD**, **THEE**, **CP15BEN**}

These bits control AArch32 functionality that is deprecated, or OPTIONAL and deprecated:

SED Disables use of the SETEND instruction.

ITD Disables use of the IT instruction.

THEE Enables use of the Thumb-EE instruction set.

CP15BEN Enables use of the CP15 DMB, DSB, and ISB barrier operations.

Controls provided by the MDSCR_EL1

MDSCR_EL1.{**MDE**, **SS**}

Enable controls for the debug exceptions:

MDE Enables Breakpoint exceptions, Watchpoint exceptions, and Vector Catch exceptions.

SS Enables Software Step exceptions.

There is no enable control for Software Breakpoint Instruction exceptions. Software Breakpoint Instruction exceptions are always enabled.

MDSCR_EL1.KDE Enables debug exceptions from EL_D when EL_D is using AArch64.

MDSCR_EL1.TDCC Enables a trap to EL1 of EL0 accesses to the Debug Communications Channel registers.

D1.12.2 Control of SIMD, floating-point and trace functionality

In addition to the controls described in *The hierarchy of configuration and routing control* on page D1-1443, the following registers provide a hierarchy of control of access to SIMD and floating-point functionality, and to trace functionality that is accessible using the System registers:

CPTR_EL3 Traps operation at lower Exception levels to EL3, if the operation is not trapped to EL2 by **CPTR_EL2** or is not trapped to EL1 by **CPACR_EL1**.

CPTR_EL2 Traps operation in Non-secure EL1 or EL0 to EL2, if the operation is not trapped to EL1 by **CPACR_EL1**.

The trap bits in the **CPTR_EL3** and **CPTR_EL2** are as follows:

TCPAC Traps accesses to the registers that control access to SIMD, floating-point, and trace functionality.

TTA Traps any System register access to trace functionality, unless that access is otherwise trapped to a lower Exception level.

TFP Traps any execution of an instruction that uses the SIMD and floating-point register bank, unless that access is otherwise trapped to a lower Exception level.

CPACR_EL1 Traps operation from EL1 or EL0 to EL1. Traps set in the **CPACR_EL1** take precedence over any traps set in the **CPTR_EL2** or **CPTR_EL3**. The trap fields are as follows:

TTA Traps to EL1 any System register access from EL0 or EL1 to trace functionality.

FPEN Traps to EL1 execution of instructions that uses the SIMD and floating-point register bank.

———— **Note** —————

In other context, the hierarchy of traps and routing controls is that controls that trap or route functionality to a higher Exception level take precedence over any control that would trap or route that functionality to a lower Exception level. However, the traps described in this subsection have the reverse precedence, with, for example, the **CPACR_EL1** traps to EL1 taking precedence over the corresponding traps to EL2 or EL3. This hierarchy supports lazy context switching.

D1.12.3 Control of IMPLEMENTATION DEFINED features

The hierarchy of configuration and routing control on page D1-1443 and Control of SIMD, floating-point and trace functionality on page D1-1448 describe the controls of the trapping of architecturally-defined functionality. However, the architecture also defines registers that can be used to provide IMPLEMENTATION DEFINED traps of IMPLEMENTATION DEFINED functionality to the different Exception levels. Table D1-9 shows these control registers, for AArch64 state controls:

Table D1-9 Control of traps of IMPLEMENTATION DEFINED functionality

Traps to EL3	Traps to EL2	Traps to EL1	Notes
ACTLR_EL3	ACTLR_EL2	ACTLR_EL1	Registers also provide IMPLEMENTATION DEFINED configuration controls for the appropriate Exception level.
-	HACR_EL2	-	Provides traps of IMPLEMENTATION DEFINED Non-secure EL1 and EL0 functionality to EL2.

D1.13 Synchronous exception types, routing and priorities

Synchronous exceptions are:

- UNDEFINED exceptions generated by:
 - Attempts to execute instructions at an inappropriate Exception level.
 - Attempts to execute instruction bit patterns that have not been allocated.
- Illegal Execution State exceptions. These are caused by attempts to execute an instruction when `PSTATE.IL` is 1, see [Illegal return events on page D1-1441](#).
- Exceptions caused by the use of a misaligned Stack Pointer.
- Exceptions caused by attempting to execute an instruction with a misaligned PC.
- Exceptions caused by the exception-generating instructions SVC, HVC, or SMC.
- Traps on attempts to execute instructions that the System Control registers define as instructions that are *trapped to a higher Exception level*. See [Trapping functionality to higher Exception levels on page D1-1462](#).
- Instruction Aborts generated by the memory address translation system, that are associated with attempts to execute instructions from areas of memory that generate Faults.
- Data Aborts generated by the memory address translation system, that are associated with attempts to read or write memory that generate Faults.
- Data Aborts caused by a misaligned address.
- All of the debug exceptions:
 - Software Breakpoint Instruction exceptions.
 - Breakpoint exceptions.
 - Watchpoint exceptions.
 - Vector Catch exceptions.
 - Software Step exceptions.
- In some implementations, exceptions caused by trapped IEEE floating-point exceptions, see [Floating-point Exception traps on page D1-1454](#).
- In some implementations, External aborts. External aborts are failed memory accesses, and include accesses to those parts of the memory system that occur during the address translation. The ARMv8 architecture permits, but does not require, implementations to treat such exceptions synchronously. See [External aborts on page D4-1694](#).

This remainder of this section contains the following:

- [Routing general exceptions to EL2 on page D1-1451](#).
- [Synchronous exception prioritization on page D1-1451](#).
- [Effect of Data Aborts on page D1-1453](#).
- [Floating-point Exception traps on page D1-1454](#).

D1.13.1 Routing general exceptions to EL2

When the [HCR_EL2.TGE](#) trap is enabled, any exception taken from Non-secure EL0 that would otherwise be taken to Non-secure EL1 is, instead, routed to EL2. This means that an application can execute at Non-secure EL0 without using any functionality at Non-secure EL1.

———— **Note** —————

In Non-secure state, typically an implementation uses the following Exception level and software hierarchy, in Non-secure state:

EL2	Hypervisor.
EL1	Operating system.
EL0	Application.

In such an implementation, enabling the [HCR_EL2.TGE](#) trap means an application can run at Non-secure EL0 under the direct control of a hypervisor, executing at EL2, without any operating system involvement.

D1.13.2 Synchronous exception prioritization

In principle, any single instruction can generate a number of different synchronous exceptions, between the fetching of the instruction, its decode, and eventual execution. These are prioritized as follows, with 1 indicating the highest priority:

1. Software Step exceptions. See [Software Step exceptions on page D2-1634](#).
2. Misaligned PC exceptions. See [PC alignment checking on page D1-1423](#).
3. Instruction abort exceptions. See [Exception from an Instruction abort on page D1-1524](#).
4. Hardware Breakpoint exceptions or Vector Catch exceptions. See:
 - [Breakpoint exceptions on page D2-1569](#).
 - [Vector Catch exceptions on page D2-1627](#).Vector Catch exceptions are only taken from AArch32 state.
5. Illegal Execution State exceptions. See [Illegal return events on page D1-1441](#).
6. Exceptions taken from EL1 to EL2 because of one of the following configuration settings:
 - For exceptions taken from AArch64 state:
 - [HSTR_EL2.Tn](#).
 - [HCR_EL2.TIDCP](#).
 - For exceptions taken from AArch32 state:
 - [HSTR.Tn](#).
 - [HCR.TIDCP](#).
7. UNDEFINED instruction exceptions that occur as a result of one or more of the following:
 - An attempt to execute an UNALLOCATED instruction encoding, including an encoding for an instruction that is not implemented in the PE implementation.
 - An attempt to execute an instruction that is defined never to be accessible at the current Exception level regardless of any enables or traps.
 - Debug state execution of an instruction encoding that is UNALLOCATED in Debug state.
 - Non-debug state execution of an instruction encoding that is UNALLOCATED in Non-debug state.
 - Execution of an HVC instruction, when HVC instructions are disabled by [SCR_EL3.HCE](#) or [HCR_EL2.HCD](#).
 - Execution of an MSR or MRS instruction to [SP_EL0](#) when the value of [SPSel](#) is 0.
 - Execution of a HLT instruction when HLT instructions are disabled by [EDSCR.HDE](#).

- In Debug state, execution of:
 - A DCPS1 instruction in Non-secure EL0 when [HCR_EL2.TGE](#) is 1.
 - A DCPS2 instruction in EL1 or EL0 when [SCR_EL3.NS](#) is 0 or when EL2 is not implemented.
 - A DCPS3 instruction when [EDSCR.SDD](#) is 1 or when EL3 is not implemented.
 - When the value of [EDSCR.SDD](#) is 1, execution in EL2, EL1, or EL0 of an instruction that is trapped to EL3.
 - When executing in AArch32 state, execution of an instruction that is UNDEFINED as a result of any of:
 - Being in an IT block when [SCTLR_EL1.ITD](#) or [SCTLR.ITD](#) is 1, or when [HSCTLR.ITD](#) is 1.
 - A SETEND instruction executed when [SCTLR_EL1.SED](#) or [SCTLR.SED](#) is 1.
 - A CP15 DMB, DSB, or ISB barrier operation performed when [SCTLR_EL1.CP15BEN](#) or [SCTLR.CP15BEN](#) is 0.

See [Traps to EL1 of EL0 accesses to AArch32 deprecated functionality on page D1-1468](#)
 - When executing in AArch32 state, execution of an instruction that is UNDEFINED because at least one of [FPCR.LEN](#) and [FPSCR.STRIDE](#) is nonzero when programming these bits to non-zero values is supported. See [Floating-point exception traps, serialization, and floating-point exception barriers on page G1-3501](#).
8. Exceptions taken to EL1, or taken to EL2 because the value of [HCR_EL2.TGE](#) or [HCR.TGE](#) is 1, that are generated because of configurable access to instructions, and that are not covered by any of priorities 1-7.
 9. Exceptions taken from EL0 to EL2 because of one of the following configuration settings:
 - For exceptions taken from AArch64 state:
 - [HSTR_EL2.Tn](#).
 - [HCR_EL2.TIDCP](#).
 - For exceptions taken from AArch32 state:
 - [HSTR.Tn](#).
 - [HCR.TIDCP](#).
 10. Exceptions taken to EL2 because of one of the following configuration settings:
 - For exceptions taken from AArch64 state, settings in the [CPTR_EL2](#).
 - For exceptions taken from AArch64 state, settings in the [HCPTR](#).
 11. Exceptions taken to EL2 because of one of the following configuration settings:
 - For exceptions taken from AArch64 state:
 - Any setting in [HCR_EL2](#), other than the TIDCP bit.
 - [HSTR_EL2.TEE](#), for exceptions taken from EL0 or EL1.
 - Any setting in [CNTHCTL_EL2](#).
 - AArch64 [MDCR_EL2](#) traps on register accesses from EL0 or EL1. See [Chapter H1 Introduction to External Debug](#)
 - For exceptions taken from AArch64 state:
 - Any setting in [HCR](#), other than the TIDCP bit.
 - [HSTR.TEE](#), for exceptions taken from EL0 or EL1.
 - Any setting in [CNTHCTL](#).
 - Any traps on register accesses set in the [HDCR](#).
 12. Exceptions taken to EL2 because of configurable access to instructions, and that are not covered by any of priorities 1-11.
 13. Exceptions caused by the SMC instruction being UNDEFINED because the value of [SCR_EL3.SMD](#) is 1.

14. Exceptions caused by the execution of an Exception generating instruction:
 - For exceptions taken from AArch64 state, [Branches, Exception generating, and System instructions on page C2-124](#) defines these instructions.
 - When executing in AArch32 state, the exception-generating instructions are SVC, HVC, SMC, and BKPT.
15. Exceptions taken to EL3 because of configuration settings in the [CPTR_EL3](#).
16. Exceptions taken to EL3 from Secure EL1 using AArch32, because of execution of the instructions listed in [Traps to EL3 of monitor functionality from Secure EL1 using AArch32 on page D1-1500](#).
17. Exceptions taken to EL3 because of configuration settings in the [MDCR_EL3](#). These might be taken from EL0, EL1, or EL2.
18. Exceptions taken to EL2 because of configurable access to instructions, and that are not covered by any of priorities 1-17.
19. Trapped floating-point exceptions, if supported. See [Floating-point Exception traps on page D1-1454](#).
20. Stack Pointer Alignment faults. See [Stack pointer alignment checking on page D1-1424](#).
21. Data abort exceptions. See [Exception from a Data abort on page D1-1525](#) and [Prioritization of synchronous aborts from a single stage of address translation on page D5-1801](#).
22. Watchpoint exceptions. See [Chapter H1 Introduction to External Debug](#).

———— **Note** ————

The exception trapping form of vector catch is outside of this list of priorities, because it causes a second exception entry as a result of an exception entry that was prioritized according to this list.

D1.13.3 Effect of Data Aborts

If an instruction that stores to memory generates a Data Abort, the value of each memory location that instruction stores to is either:

- Unchanged, if one of the following applies:
 - An MMU fault is generated.
 - A Watchpoint exception is generated.
 - An external abort is generated, if that external abort is taken synchronously.

———— **Note** ————

If an external abort is taken asynchronously, using the SError interrupt, it is outside the scope of the architecture to define the effect of the store on the memory location, because it depends on the system-specific nature of the external abort. However, in general, ARM recommends that such memory locations are not updated.

- UNKNOWN for any location for which no exception is generated.

For external aborts and Watchpoint exceptions, the size of a memory location is defined as being the size for which a memory access is single-copy atomic.

———— **Note** ————

For the definition of a single-copy atomic access, see [Single-copy atomicity on page B2-79](#).

For Data Aborts from load or store instructions executed in AArch64 state, if the:

Data Abort is taken synchronously

- If the load or store instruction specifies writeback of a new base address, the base address is restored to the original value on taking the exception.
- If the instruction was a load to either the base address register or the offset register, that register is restored to the original value. Any other destination registers become UNKNOWN.
- If the instruction was a load that does not load the base address register or the offset register, then the destination registers become UNKNOWN.

Data Abort is taken asynchronously, using the SError interrupt

If the instruction was a load, the destination registers of the load take an UNKNOWN value if the SError interrupt is taken at a point in the instruction stream after the load.

———— **Note** —————

Data Aborts taken asynchronously are known as Asynchronous Aborts in AArch32 state.

D1.13.4 Floating-point Exception traps

The ARMv8-A architecture supports synchronous exception generation in the event of any or all of the following floating-point exceptions:

- Input Denormal.
- Inexact.
- Underflow.
- Overflow.
- Divide by Zero.
- Invalid Operation.

Whether an implementation includes synchronous exception generation for these floating-point exceptions is IMPLEMENTATION DEFINED.

For implementations that do include this capability, [FPCR](#).{IDE, IXE, UFE, OFE, DZE, IOE} are the control bits that enable synchronous exception generation for each of the different floating-point exceptions.

For implementations that do not include this capability, the [FPCR](#).{IDE, IXE, UFE, OFE, DZE, IOE} bits are RAZ/WI.

———— **Note** —————

The ARMv8-A architecture does not support asynchronous reporting of floating-point exceptions.

When generating synchronous exceptions for one or more floating-point exceptions is enabled, the synchronous exceptions are taken to the lowest Exception level that can handle such an exception, while adhering to the rule that exceptions can never be taken to a lower Exception level. This means that trapped floating-point exceptions taken from:

- EL0 are taken to EL1, unless they are taken from Non-secure state when [HCR_EL2](#).TGE is 1, when they are taken to EL2 instead.
- EL1 are taken to EL1.
- EL2 are taken to EL2.
- EL3 are taken to EL3.

In an implementation that includes synchronous exception generation for floating-point exceptions:

- Synchronous exception generation applies to floating-point exceptions generated by scalar SIMD and floating-point instructions executed in AArch64 state.

- The registers that are presented to the exception handler are consistent with the state of the PE immediately before the instruction that caused the exception. An implementation is permitted not to restore the cumulative exception flags in the event of such an exception.
- When the execution of separate operations in separate SIMD elements causes multiple floating-point exceptions, the [ELR_ELx](#) reports one exception associated with one element that the instruction uses. The architecture does not specify which element is reported, however the element that is reported is identified in the [ELR_ELx](#).

```
// AArch64.FPTrappedException()
// =====

AArch64.FPTrappedException(boolean is_ase, integer element, bits(8) accumulated_exceptions)
    exception = ExceptionSyndrome(Exception_FPTrappedException);
    exception.syndrome<23> = '1'; // TFV
    exception.syndrome<7,4:0> = accumulated_exceptions<7,4:0>; // IDF,IXF,UFF,OFF,DZF,IOF

    bits(64) preferred_exception_return = ThisInstrAddr();
    vect_offset = 0x0;

    if UInt(PSTATE.EL) > UInt(EL1) then
        AArch64.TakeException(PSTATE.EL, exception, preferred_exception_return, vect_offset);
    elseif AArch64.GeneralExceptionsToEL2() then
        AArch64.TakeException(EL2, exception, preferred_exception_return, vect_offset);
    else
        AArch64.TakeException(EL1, exception, preferred_exception_return, vect_offset);

// FPPProcessException()
// =====
//
// The 'fpcr' argument supplies FPCR control bits. Status information is
// updated directly in the FPSR where appropriate.

FPPProcessException(FPExc exception, FPCRTYPE fpcr)
    // Determine the cumulative exception bit number
    case exception of
        when FPExc_InvalidOp      cumul = 0;
        when FPExc_DivideByZero   cumul = 1;
        when FPExc_Overflow       cumul = 2;
        when FPExc_Underflow      cumul = 3;
        when FPExc_Inexact        cumul = 4;
        when FPExc_InputDenorm    cumul = 7;
    enable = cumul + 8;
    if fpcr<enable> == '1' then
        // Trapping of the exception enabled.
        // It is IMPLEMENTATION DEFINED whether the enable bit may be set at all, and
        // if so then how exceptions may be accumulated before calling FPTrapException()
        IMPLEMENTATION_DEFINED "floating-point trap handling";
    else if UsingAArch32() then
        // Set the cumulative exception bit
        FPSR<cumul> = '1';
    else
        // Set the cumulative exception bit
        FPSR<cumul> = '1';
    return;
```

D1.14 Asynchronous exception types, routing, masking and priorities

In the ARMv8-A architecture, asynchronous exceptions that are taken to AArch64 state are also known as *interrupts*.

There are two types of interrupts:

Physical interrupts Are signals sent to the PE from outside the PE. They are:

- SError. System Error.
- IRQ.
- FIQ.

Virtual interrupts Are interrupts that a Hypervisor executing in EL2 can enable. When enabled, a virtual interrupt is taken from Non-secure ELO or Non-secure EL1 to a Guest OS running in Non-secure EL1.

Virtual interrupts have names that correspond to the physical interrupts:

- vSError.
- vIRQ.
- vFIQ.

Note

The AArch64 SError interrupt replaces the AArch32 asynchronous abort. The new name better describes the nature of the exception, and means that it is categorized as a unique exception class, with EC encoding 0x2F.

An external abort generated by the memory system might be taken asynchronously using the SError interrupt. The effect of a failed memory access is described in [Effect of Data Aborts on page D1-1453](#).

Each physical interrupt type can be assigned a target Exception level of EL1, EL2 or EL3, as shown in [Synchronous exception prioritization on page D1-1451](#).

When an interrupt occurs:

- On taking an SError or a virtual SError interrupt to an Exception level using AArch64, the Exception Syndrome register for that Exception level is updated with the encoding for an SError interrupt. See [Exception classes on page D1-1435](#).
- On taking an IRQ, vIRQ, FIQ or vFIQ interrupt to an Exception level using AArch64, the Exception Syndrome register for that Exception level is not updated.

The remainder of this section contains the following:

- [Asynchronous exception routing on page D1-1457](#).
- [Asynchronous exception masking on page D1-1458](#).
- [Virtual interrupts on page D1-1459](#).
- [Prioritization and recognition of asynchronous exceptions on page D1-1460](#).
- [Taking an interrupt during a multiple-register load or store on page D1-1461](#).

D1.14.1 Asynchronous exception routing

The following tables show the routing of physical interrupts when the highest implemented Exception level is using AArch64.

In the tables, P indicates that the interrupt is not taken and remains pending

Table D1-10 Routing when both EL3 and EL2 are implemented

SCR_EL3.EA SCR_EL3.IRQ SCR_EL3.FIQ	SCR_EL3.RW	AMO ^a IMO ^a FMO ^a	Target Exception level when executing in:					
			Non-secure			Secure		
			EL0	EL1	EL2	EL0	EL1	EL3
0	0	0	EL1	EL1	EL2	EL1	EL1	P
	X	1	EL2	EL2	EL2	EL1	EL1	P
	1	0	EL1	EL1	P	EL1	EL1	P
1	X	X	EL3	EL3	EL3	EL3	EL3	EL3

- a. If EL2 is using AArch64, these are the [HCR_EL2](#).{AMO, IMO, FMO} control bits. If EL2 is using AArch32, these are the [HCR](#){AMO, IMO, FMO} control bits. If [HCR_EL2.TGE](#) or [HCR.TGE](#) is 1, these bits are treated as being 1 other than for a direct read.

Table D1-11 Routing when EL3 is implemented and EL2 is not implemented

SCR_EL3.EA SCR_EL3.IRQ SCR_EL3.FIQ	Target Exception level when executing in:				
	Non-secure		Secure		
	EL0	EL1	EL0	EL1	EL3
0	EL1	EL1	EL1	EL1	P
1	EL3	EL3	EL3	EL3	EL3

Table D1-12 Routing when EL3 is not implemented and EL2 is implemented

HCR_EL2.AMO ^a HCR_EL2.IMO ^a HCR_EL2.FMO ^a	Target Exception level when executing in:		
	Non-secure		
	EL0	EL1	EL2
1	EL2	EL2	EL2
0	EL1	EL1	P

- a. If [HCR_EL2.TGE](#) is 1, these bits are treated as being 1 other than for a direct read.

D1.14.2 Asynchronous exception masking

When an interrupt is masked, it means that it cannot be taken. Instead, it remains pending.

When executing in AArch64 state, interrupts are masked implicitly when the target Exception level of the interrupt is lower than the current Exception level.

In addition, interrupts can be masked when the target Exception level is the current Exception level. The controls for this are:

Serror [PSTATE.A](#)
IRQ [PSTATE.I](#)
FIQ [PSTATE.F](#)

When the target Exception level is higher than the current Exception level:

- If the target Exception level is EL2 or EL3, the interrupt cannot be masked by the [PSTATE](#).{A, I, F} bits.
- If the target Exception level is EL1, the interrupt can be masked by the [PSTATE](#).{A, I, F} bits.

———— **Note** —————

- The ability to execute in EL0 with interrupts to EL1 masked is required by some user level driver code.
- The [PSTATE](#).{A, I, F} bits can mask both physical interrupts and virtual interrupts.
- The ARMv8-A architecture does not support *Non-maskable FIQ* (NMFI) operations. This means that it does not provide a configuration option to override the masking of FIQs by [PSTATE.F](#).

On taking any exception to an Exception level using AArch64, all of [PSTATE](#).{A, I, F} are set to 1, masking all interrupts that target that Exception level.

The following tables show the masking of physical interrupts when the highest implemented Exception level is using AArch64:

- For implementations that include both EL2 and EL3, see [Table D1-13](#).
- For implementations that include EL3 but not EL2, see [Table D1-14 on page D1-1459](#).
- For implementations that include EL2 but not EL3, see [Table D1-15 on page D1-1459](#).

For the masking of virtual interrupts, see [Virtual interrupts on page D1-1459](#).

In the tables:

M Indicates that the interrupt is subject to the relevant [PSTATE](#).{A, I, F} mask bit.
T Indicates that the interrupt is taken regardless of the mask.
P Indicates that the interrupt is pending.

Table D1-13 Physical interrupt masking when both EL3 and EL2 are implemented

SCR_EL3.EA SCR_EL3.IRQ SCR_EL3.FIQ	SCR_EL3.RW	AMO^a IMO^a FMO^a	Target EL	Effect of the interrupt mask when executing in:					
				Non-secure			Secure		
				EL0	EL1	EL2	EL0	EL1	EL3
0	0	0	EL1	M	M	M	M	M	P
		1	EL2	T	T	M	M	M	P
	1	0	EL1	M	M	P	M	M	P
		1	EL2	T	T	M	M	M	P
1	X	X	EL3	T	T	T	T	T	M

Table D1-14 Physical interrupt masking when EL3 is implemented and EL2 is not implemented

SCR_EL3.EA SCR_EL3.IRQ SCR_EL3.FIQ	Target EL	Effect of the interrupt mask when executing in:				
		Non-secure		Secure		
		EL0	EL1	EL0	EL1	EL3
0	EL1	M	M	M	M	P
1	EL3	T	T	T	T	M

Table D1-15 Physical interrupt masking when EL3 is not implemented and EL2 is implemented

HCR_EL2.AMO ^a HCR_EL2.IMO ^a HCR_EL2.FMO ^a	Target EL	Effect of the interrupt mask when executing in:		
		Non-secure		
		EL0	EL1	EL2
0	EL1	M	M	P
1	EL2	T	T	M

a. If HCR_EL2.TGE is 1, these bits are treated as being 1 other than for a direct read.

- a. If EL2 is using AArch64, these are the HCR_EL2.{AMO, IMO, FMO} control bits. If EL2 is using AArch32, these are the HCR{AMO, IMO, FMO} control bits. If HCR_EL2.TGE or HCR.TGE is 1, these bits are treated as being 1 other than a direct read.

D1.14.3 Virtual interrupts

Setting the HCR_EL2.{FMO, IMO, AMO} routing control bits to 1 enables the virtual interrupts, unless HCR_EL2.TGE is 1.

Virtual interrupts can only be taken from Non-secure EL0 to EL1 or from Non-secure EL1 to EL1. When a virtual interrupt type is enabled, that type of interrupt can be generated by:

- Software setting the corresponding virtual interrupt pending bit, HCR_EL2.{VSE, VI, VF}, to 1.
- For a vIRQ or a vFIQ, by an IMPLEMENTATION DEFINED mechanism. This might be a signal from an interrupt controller, for example from a Virtual GIC, as defined by the *ARM Generic Interrupt Controller Architecture Specification*.

———— **Note** ————

For a usage model for virtual interrupts, see *Virtual interrupt usage model on page D1-1415*.

Each virtual interrupt type can be masked when execution is in Non-secure EL1 or EL0, by using the same Process State mask bits that mask the physical interrupts, PSTATE.{A, I, F}.

When execution is in Secure state, or in EL3 or EL2, all types of virtual interrupt are always masked.

Table D1-16 summarizes the bits that enable virtual interrupts and the bits that cause virtual interrupts to be pending.

Table D1-16 HCR_EL2 interrupt control bits

Virtual interrupt type	Enable control	Cause a virtual interrupt to be pending
vSError	HCR_EL2.AMO	HCR_EL2.VSE
vIRQ	HCR_EL2.IMO	HCR_EL2.VI
vFIQ	HCR_EL2.FMO	HCR_EL2.VF

On taking a virtual IRQ or a virtual FIQ interrupt, the corresponding virtual interrupt pending bit in the HCR_EL2 retains its state.

On taking a virtual SError interrupt, HCR_EL2.VSE is cleared to 0.

———— **Note** ————

This means that if the virtual interrupt pending bits are used, the vIRQ or vFIQ exception handler must cause software executing in EL2 or EL3 to set their corresponding virtual interrupt pending bits to 0.

As with physical interrupts:

- Taking a virtual SError interrupt to an Exception level using AArch64 updates ESR_EL1 with the dedicated encoding for an SError interrupt. For the encoding, see *Exception classes* on page D1-1435.
- Taking a virtual IRQ or a virtual FIQ interrupt to an Exception level using AArch64 does not update the ESR_EL1.

The following table shows the masking of virtual interrupts when the highest implemented Exception level is using AArch64. In the table:

- M** Indicates that the interrupt is subject to the relevant PSTATE.{A, I, F} mask bit.
- P** Indicates that the interrupt is pending.

Table D1-17 Virtual interrupt masking

SCR_EL3.EA	FMO ^a	TGE ^a	Effect of the interrupt mask when executing in:					
			Non-secure			Secure		
			EL0	EL1	EL2	EL0	EL1	EL3
X	0	X	P	P	P	P	P	P
X	1	0	M	M	P	P	P	P
X	1	1	P	P	P	P	P	P

a. If EL2 is using AArch64, these are the HCR_EL2.{TGE, AMO, IMO, FMO} control bits. If EL2 is using AArch32, these are the HCR.{TGE, AMO, IMO, FMO} control bits.

D1.14.4 Prioritization and recognition of asynchronous exceptions

The ARMv8-A architecture does not define when interrupts are taken. The prioritization of interrupts, including virtual interrupts, is IMPLEMENTATION DEFINED.

Any interrupts that are pending prior to one of the following context synchronizing events, are taken before the first instruction after the context synchronizing event, provided that the interrupt is not masked:

- An ISB instruction.

- Exception entry.
- Exception return.
- Exit from Debug state.

Note

- If the first instruction after the context synchronizing event generates a synchronous exception, then the architecture does not define whether the PE takes the interrupt or the synchronous exception first.
- The `ISR_ELI` register indicates whether an interrupt is pending.
- Interrupts are masked when the PE is in Debug state, so this list of context synchronizing events does not include the DCPS and DRPS instructions.

In the absence of a specific requirement to take an interrupt, the architecture only requires that unmasked pending interrupts are taken in finite time.

D1.14.5 Taking an interrupt during a multiple-register load or store

In AArch64 state, interrupts can be taken during a sequence of memory accesses caused by a single load or store instruction. This is true regardless of the memory type being accessed.

Note

- This is in contrast to behavior in AArch32 state, when interrupts cannot be taken during a sequence of memory access caused by a single load or store instruction. This means that:
 - Behavior in AArch64 state is equivalent to ARMv7 behavior when the value of SCTL.R.FI is 1, except that setting SCTL.R.FI to 1 only permits this behavior for accesses to Normal memory.
 - Behavior in AArch32 state is equivalent to ARMv7 behavior when the value of SCTL.R.FI is 0, for all Exception levels.
- Software must avoid using multiple-register load and store instructions for Device memory, particularly non-Gathering, because an interrupt taken during the load or store can result in repeated accesses.

D1.15 Trapping functionality to higher Exception levels

Trapping refers to configuration that causes an instruction to generate an exception rather than complete normally. Typically, this means that an instruction that would normally be executed at a lower Exception level instead generates an exception that is taken to a higher Exception level. The instruction is said to be *trapped* to the higher Exception level.

Configuration options that trap instructions to higher Exception levels comprise:

- Trap enable controls, in System registers at EL1, EL2, and EL3. Setting a trap enable control to 1 enables the trap.
- Enable controls, in System registers at EL1 and EL3. These enable the use of particular instructions at particular Exception levels. If a particular instruction is disabled at a particular Exception level, any attempt to execute that instruction at that Exception level is trapped to a higher Exception level.
- Disable controls, in System registers at EL1, EL2, and EL3. These disable the use of particular instructions at some or all Exception levels. If a particular instruction is disabled at a particular Exception level, any attempt to execute that instruction at that Exception level is trapped to a higher Exception level.

———— Note ————

Routing is described elsewhere in this chapter:

- [Asynchronous exception routing on page D1-1457](#) describes the routing options for asynchronous exceptions.
- [Routing general exceptions to EL2 on page D1-1451](#) describes a control that routes exceptions from Non-secure EL0 to EL2.

This section is organized as follows:

- [Trapping to EL1 using AArch64](#).
- [Trapping to EL2 using AArch64 on page D1-1474](#).
- [Trapping to EL3 using AArch64 on page D1-1499](#).

———— Note ————

An implementation might provide additional controls, in IMPLEMENTATION DEFINED registers, to provide finer-grained control of control of trapping of IMPLEMENTATION DEFINED features.

D1.15.1 Trapping to EL1 using AArch64

Traps to EL1 using AArch64 are controlled using `_EL1` System registers, and the exception syndrome information is presented in `ESR_EL1`. The exceptions might be taken from AArch64 state or AArch32 state. The exception syndrome information indicates which Execution state the exception was taken from.

A trap to EL1 using AArch64 can only be generated if the instruction generating the trap does not also generate a higher priority exception. [Synchronous exception prioritization on page D1-1451](#) defines the prioritization of different exceptions on the same instruction.

[Table D1-18](#) shows the `_EL1` System registers that contain controls that control trapping to EL1.

Table D1-18 Summary of the registers that control trapping to EL1 using AArch64

Register description	Register name
System Control Register, EL1	<code>SCTLR_EL1</code>

Table D1-18 Summary of the registers that control trapping to EL1 using AArch64 (continued)

Register description	Register name
Architectural Feature Access Control Register	CPACR_EL1
Monitor System Debug Control Register	MDSCR_EL1
Performance Monitors User Enable Register	PMUSERENR_ELO

Table D1-19 summarizes the controls that control trapping to EL1 using AArch64.

Table D1-19 Summary of the EL1 controls that control trapping to EL1 using AArch64

Control	Type of control ^a	Trap
SCTLR_EL1.{UCI, UCT}	E	Traps to EL1 of EL0 accesses to cache maintenance operations on page D1-1464
SCTLR_EL1.{nTWE, nTWI}	E	Traps to EL1 of EL0 execution of WFE and WFI instructions on page D1-1465
SCTLR_EL1.DZE	E	Traps to EL1 of EL0 execution of DC ZVA instructions on page D1-1466
SCTLR_EL1.UMA	E	Traps to EL1 of EL0 accesses to the PSTATE.{D, A, I, F} interrupt masks on page D1-1467
SCTLR_EL1.{SED, ITD}	D	Traps to EL1 of EL0 accesses to AArch32 deprecated functionality on page D1-1468
SCTLR_EL1.{THEE, CP15BEN}	E	
CPACR_EL1.TTA	T	Traps to EL1 of EL1 and EL0 System register accesses to the trace registers on page D1-1470
CPACR_EL1.FPEN	T	Traps to EL1 of EL1 and EL0 accesses to SIMD and floating-point functionality on page D1-1471
MDSCR_EL1.TDCC	T	Traps to EL1 of EL0 accesses to the Debug Communications Channel (DCC) registers on page D1-1472
PMUSERENR_ELO.{ER, CR, SW, EN}	E	Traps to EL1 of EL0 accesses to Performance Monitors registers on page D1-1473

a. T indicates Trap, E indicates Enable, and D indicates Disable.

Traps to EL1 of EL0 accesses to cache maintenance operations

EL1 provides the following controls to enable accesses to cache maintenance functionality from EL0:

- **SCTLR_EL1.UCI:**
 - 1** Execution of cache maintenance instructions is enabled at EL0.
 - 0** Any attempt to execute a cache maintenance instruction at EL0 is trapped to EL1.
- **SCTLR_EL1.UCT:**
 - 1** EL0 accesses to the **CTR_EL0** are enabled.
 - 0** EL0 accesses to the **CTR_EL0** are trapped to EL1.

For:

- **SCTLR_EL1.UCI == 0**, [Table D1-20](#) shows the instructions that are trapped to EL1, and how the exceptions are reported in **ESR_EL1**.
- **SCTLR_EL1.UCT == 0**, [Table D1-21](#) shows how the exceptions are reported in **ESR_EL1**.

Table D1-20 Instructions trapped to EL1 when **SCTLR_EL1.UCI is 0**

Traps from	Trapped instructions	Syndrome reporting in ESR_EL1
AArch64 state	DC CVAU , DC CIVAC , DC CVAC , IC IVAU	Trapped AArch64 MSR, MRS, or system instruction, using EC value 0x18
AArch32 state	n/a	n/a

Table D1-21 Register accesses trapped to EL1 when **SCTLR_EL1.UCT is 0**

Traps from	Register	Syndrome reporting in ESR_EL1
AArch64	CTR_EL0	Trapped AArch64 MSR, MRS, or system instruction, using EC value 0x18
AArch32	n/a	n/a

Traps to EL1 of EL0 execution of WFE and WFI instructions

EL1 provides the following controls to enable WFE and WFI instruction execution at EL0:

- **SCTLR_EL1.nTWE:**
 - 1** WFE instruction execution is enabled at EL0.
 - 0** Any attempt to execute a WFE instruction at EL0 is trapped to EL1, if the instruction would otherwise have caused the PE to enter a low-power state.
- **SCTLR_EL1.nTWI:**
 - 1** WFI instruction execution is enabled at EL0.
 - 0** Any attempt to execute a WFI instruction at EL0 is trapped EL1, if the instruction would otherwise have caused the PE to enter a low-power state.

Table D1-22 shows how the exceptions are reported in [ESR_EL1](#).

Table D1-22 Instructions trapped to EL1 when [SCTLR_EL1](#).{TWE, TWI} are 0

Enable control	Traps from	Trapped instructions	Syndrome reporting in ESR_EL1
SCTLR_EL1.nTWE	AArch64 state and AArch32 state	WFE	Trapped WFI or WFE instruction, using EC value 0x01
SCTLR_EL1.nTWI		WFI	

The traps that [SCTLR_EL1](#).{TWE, TWI} enable trap the attempted execution of conditional WFE or WFI instructions only if the instructions pass their condition code check.

For more information about these instructions, and when they can cause the PE to enter a low-power state, see:

- [Wait for Event mechanism and Send event on page D1-1533](#).
- [Wait For Interrupt on page D1-1536](#).

Traps to EL1 of EL0 execution of DC ZVA instructions

[SCTLR_EL1.DZE](#) enables execution of DC ZVA instructions at EL0:

- 1** DC ZVA instruction execution is enabled at EL0.
- 0** Any attempt to execute a DC ZVA instruction at EL0 is trapped to EL1. Reading the [DCZID_EL0](#) returns a value that indicates that DC ZVA instructions are not supported.

[Table D1-23](#) shows how the exceptions are reported in [ESR_EL1](#).

Table D1-23 Instructions trapped to EL1 when [SCTLR_EL1.DZE](#) is 0

Traps from	Trapped instruction	Syndrome reporting in ESR_EL1
AArch64 state	DC ZVA	Trapped AArch64 MSR, MRS, or system instruction, using EC value 0x18.
AArch32 state	n/a	n/a

Traps to EL1 of EL0 accesses to the PSTATE.{D, A, I, F} interrupt masks

[SCTLR_EL1.UMA](#) enables access to the [PSTATE.{D, A, I, F}](#) masks from EL0:

- 1** Execution of MSR and MRS instructions that access the [DAIF](#) is enabled at EL0.
- 0** Any attempt at EL0 to execute an MSR or MRS that accesses the [DAIF](#) is trapped to EL1.

[Table D1-24](#) shows how the exceptions are reported in [ESR_EL1](#).

Table D1-24 Instructions trapped to EL1 when [SCTLR_EL1.UMA](#) is 0

Traps from	Trapped instructions	Syndrome reporting in ESR_EL1
AArch64 state	MRS , MSR (register) , MSR (immediate) , that access the DAIF	Exception for an unknown reason, using EC value 0x00.
AArch32 state	n/a	n/a

Traps to EL1 of EL0 accesses to AArch32 deprecated functionality

Table D1-25 shows the deprecated AArch32 functionality that can be trapped from EL0 using AArch32 to EL1 using AArch64.

When a particular functionality shown in Table D1-25 is disabled, any attempt to access that functionality at EL0 using AArch32 is trapped to EL1. The table shows how the exceptions are reported in [ESR_EL1](#).

Table D1-25 Traps to EL1 on EL0 accesses to deprecated functionality

Deprecated AArch32 functionality	Enable or disable control in the SCTLR_EL1	Trapped instructions, or trapped accesses	Syndrome reporting in ESR_EL1
SETEND instructions	SED ^a	SETEND instructions	Exception for an unknown reason, using EC value 0x00.
Some uses of IT instructions	ITD ^b	See <i>Trapped instructions when SCTLR_EL1.ITD is 1</i> .	
T32EE instructions	THEE ^c	See <i>Trapped instructions and accesses when SCTLR_EL1.THEE is 0</i> on page D1-1469.	
Accesses to the CP15 DMB, DSB, and ISB barrier operations.	CP15BEN ^d	MCR accesses to the CP15DMB , CP15DSB , and CP15ISB	

- SETEND disable control. SETEND instructions are disabled when this is 1.
- IT disable control. Some uses of IT instructions are disabled when this is 1.
- T32EE enable control. T32EE instructions are disabled when this is 0.
- CP15 barrier operation enable control. Accesses to the CP15 DMB, DSB, and ISB barrier operations are disabled when this is 0.

Trapped instructions when [SCTLR_EL1.ITD](#) is 1

When [SCTLR_EL1.ITD](#) is 1, any attempt at EL0 using AArch32 to execute any of the following is UNDEFINED.

- All encodings of the IT instruction with `hw1[3:0] != 1000`.
- All encodings of the subsequent instruction with the following values for `hw1`:

0b11xxxxxxxxxxxx

- All 32-bit instructions.
- All of the following 16-bit instructions:
 - B
 - UDF
 - SVC
 - LDM
 - STM

0b1011xxxxxxxxxxxx

All instructions in *Miscellaneous 16-bit instructions* on page F3-2440.

0b1x100xxxxxxxxxxx

ADD Rd, PC, #imm

0b01001xxxxxxxxxxx

LDR Rd, (PC, #imm)

0b0100x1xxx1111xxx

- ADD Rdn, PC
- CMP Rn, PC
- MOV Rd, PC
- BX, pc
- BLX, pc

0b010001xx1xxxx111

- ADD PC, Rm
- CMP PC, Rm
- MOV PC, Rm

———— **Note** ————

This encoding also covers UNPREDICTABLE cases with BLX Rn.

Trapped instructions and accesses when SCTLR_EL1.THEE is 0

When [SCTLR_EL1.THEE](#) is 0, all of the following apply:

- Any attempt at EL0 using AArch32 to execute any of the following is trapped to EL1 using AArch64:
 - ENTERX and LEAVEX
 - MCR and MRC accesses to the [TEECCR](#) and [TEEHBR](#).
- Any attempt at EL1 using AArch64 to access the [TEECCR32_EL1](#) or [TEEHBR32_EL1](#) is trapped to EL1 using AArch64.

In each of these cases, the trapped functionality is trapped as an Undefined Instruction exception taken to EL1.

Traps to EL1 of EL1 and EL0 System register accesses to the trace registers

[CPACR_EL1.TTA](#) enables a trap to EL1 of EL1 and EL0 System register accesses to the trace registers:

- 1** EL1 and EL0 System register accesses to the trace registers, except for accesses that the appropriate Trace Architecture Specification describes as UNPREDICTABLE or as UNDEFINED, are trapped to EL1.
- 0** EL1 and EL0 System register accesses to the trace registers are not trapped to EL1.

———— **Note** —————

- The ETMv4 architecture does not permit EL0 to access the trace registers. If the ARMv8-A architecture is implemented with an ETMv4 implementation, EL0 accesses to the trace registers are UNDEFINED.
- EL1 does not provide traps on trace register accesses through the Memory-mapped interface.

System register accesses to the trace registers can have side-effects. When a System register access is trapped to EL1 or generates an Undefined Instruction exception, no side-effects occur before the exception is taken, see [Traps to EL2 of System register access instructions](#) on page D1-1475.

[Table D1-26](#) shows the registers for which accesses are trapped to EL2 when [CPACR_EL1.TTA](#) is 1, and how the exceptions are reported in [ESR_EL1](#).

Table D1-26 Register accesses trapped to EL1 when [CPACR_EL1.TTA](#) is 1

Traps from	Registers	Syndrome reporting in ESR_EL1
AArch64 state	All implemented trace registers	Trapped AArch64 MSR, MRS, or system instruction, using EC value 0x18.
AArch32 state	All implemented trace registers	For accesses using: <ul style="list-style-type: none"> • MCR or MRC instructions, trapped MCR or MRC CP14 access, using EC value 0x05. • MCRR or MRRC instructions, trapped MCRR or MRRC CP14 access, using EC value 0x0C.

Traps to EL1 of EL1 and EL0 accesses to SIMD and floating-point functionality

[CPACR_EL1.FPEN](#) enables a trap to EL1 of EL1 and EL0 accesses to the SIMD and floating-point registers.

———— **Note** —————

For the definition of when the [CPACR_EL1.FPEN](#) trap is enabled, see the [CPACR_EL1](#) register description.

[Table D1-27](#) shows the registers for which accesses are trapped to EL1 when the [CPACR_EL1.FPEN](#) trap is enabled, and how the exception is reported in [ESR_EL1](#).

Table D1-27 Register accesses trapped to EL1 when the [CPACR_EL1.FPEN](#) trap is enabled

Traps from	Registers	Syndrome reporting in ESR_EL1
EL1 and EL0 using AArch64	FPCR , FPSR , and any of the SIMD and floating-point registers V0-V31, including their views as D0-D31 registers or S0-S31 registers. See <i>The SIMD and floating-point registers, V0-V31</i> on page D1-1417.	Trapped access to a SIMD or floating-point register, using EC value 0x07 ^a
EL0 using AArch32	FPSCR , and any of the SIMD and floating-point registers Q0-Q15, including their views as D0-D31 registers or S0-S31 registers. See <i>Advanced SIMD and floating-point system registers</i> on page G1-3500.	Trapped access to a SIMD or floating-point register, using EC value 0x07 ^a

- a. If [HCR_EL2.TGE](#) is 1 and the PE is in Non-secure state, these trap exceptions are routed to EL2 and are reported in [ESR_EL2](#) using EC value 0x00.

Traps to EL1 of EL0 accesses to the Debug Communications Channel (DCC) registers

[MDSCR_EL1](#).TDCC enables a trap to EL1 of EL0 accesses to the DCC registers:

- 1** EL0 accesses to the DCC registers are trapped to EL1
- 0** EL0 accesses to the DCC registers are not trapped to EL1.

[Table D1-28](#) shows the accesses that are trapped to EL1 when [MDSCR_EL1](#).TDCC is 1, and how the exception is reported in [ESR_EL1](#).

Table D1-28 Accesses trapped to EL1 when [MDSCR_EL1](#).TDCC is 1

Traps from	Trapped accesses	Syndrome reporting in ESR_EL1
AArch64 state	Accesses to the MDCCSR_EL0 , DBGDTR_EL0 , DBGDTRTX_EL0 and DBGDTRRX_EL0	Trapped AArch64 MSR, MRS, or system instruction, using EC value 0x18 ^a
AArch32 state	<ul style="list-style-type: none"> • MRC of DBGDSCRint, DBGDTRRXint, and, if implemented, DBGDIDR, DBGDSAR and DBGDRAR. • MCR to DBGDTRTXint. 	Trapped MCR or MRC CP14 access, using EC value 0x05 ^a
	<ul style="list-style-type: none"> • LDC of DBGDTRTXint. • STC of DBGDTRRXint. 	Trapped LDC or STC access to CP14, using EC value 0x06 ^a
	If implemented, MRRC of DBGDSAR and DBGDRAR .	Trapped MRRC or MRRC CP14 access, using EC value 0x0C ^a

- a. If [HCR_EL2](#).TGE is 1 and the PE is in Non-secure state, these trap exceptions are routed to EL2 and are reported in [ESR_EL2](#) using the same EC values as shown in the table.

Traps to EL1 of EL0 accesses to Performance Monitors registers

PMUSERENR_EL0.{ER, CR, SW, EN} enable EL0 accesses to the Performance Monitors registers. For each of these controls:

- 1** Accesses from EL0 are enabled.
- 0** Accesses from EL0 are not enabled.

The accesses that these controls enable might be reads, writes, or both.

Table D1-29 shows the registers for which EL0 accesses are trapped to EL1 when EL0 accesses are not enabled. For each register, the table shows the type of access trapped.

Table D1-29 Register accesses trapped to EL1 when disabled from EL0

Traps from	Enable control	Registers	Access type	Syndrome reporting in ESR_EL1
AArch64 state	ER	PMXVCNTR_EL0, PMEVCNTR<n>_EL0	R	Trapped AArch64 MSR, MRS, or system instruction, using EC value 0x18
		PMSELR_EL0	RW	
	CR	PMCCNTR_EL0	R	
	SW	PMSWINC_EL0	W	
	EN	PMCNTENSET_EL0, PMCNTENCLR_EL0, PMOVSLR_EL0, PMSWINC_EL0, PMSELR_EL0, PMCEID0_EL0, PMCEID1_EL0, PMCCNTR_EL0, PMXEVTYPER_EL0, PMXVCNTR_EL0, PMOVSSET_EL0, PMEVCNTR<n>_EL0, PMEVTYPER<n>_EL0, PMCCFILTR_EL0.	RW	
AArch32 state	ER	PMXVCNTR, PMEVCNTR<n>	R	Trapped MCR or MRC CP15 access, using EC value 0x03
		PMSELR	RW	
	CR	PMCCNTR, accessed using an MRC	R	Trapped MCR or MRC CP15 access, using EC value 0x04
	CR	PMCCNTR, accessed using an MRRC	R	
	SW	PMSWINC	W	
EN	PMCNTENSET, PMCNTENCLR, PMOVS, PMSWINC, PMSELR, PMCEID0, PMCEID1, PMCCNTR, PMXEVTYPER, PMXVCNTR, PMUSERENR, PMOVSSET, PMEVCNTR<n>, PMEVTYPER<n>, PMCCFILTR.	RW	Trapped MCR or MRC CP15 access, using EC value 0x03	

D1.15.2 Trapping to EL2 using AArch64

[Routing general exceptions to EL2 on page D1-1451](#) describes a control that routes exceptions from Non-secure EL0 to EL2. This control is `HCR_EL2.TGE`, and exceptions are routed from Non-secure EL0 to EL2 when it is 1.

To support different virtualization schemes, the architecture also provides a range of controls that enable traps to EL2 of Non-secure operations at EL1 and EL0. These traps can be used when `HCR_EL2.TGE` is 0. This section describes these controls and the traps that they enable.

Traps to EL2 using AArch64 are enabled using `_EL2` System registers, and the exception syndrome information is presented in [ESR_EL2](#). The exceptions might be taken from AArch64 state or AArch32 state. The exception syndrome information indicates which Execution state the exception was taken from.

A trap to EL2 can be generated only when all of the following apply:

- The PE is in Non-secure EL1 or EL0.
- The instruction that generates the trap does not also generate a higher priority exception. [Synchronous exception prioritization on page D1-1451](#) defines the prioritization of different exceptions on the same instruction.
- For traps from an Exception level using AArch32, the trapped instruction is not UNPREDICTABLE in the PE state it is executed in. UNPREDICTABLE instructions can generate a trap to EL2, but the architecture does not require them to do so.

[Table D1-30](#) shows the `_EL2` System registers that contain trap enable controls.

Table D1-30 Summary of the registers that control trapping to EL2 using AArch64

Register description	Register name
Hypervisor Configuration Register	<code>HCR_EL2</code>
Hypervisor System Trap Register	<code>HSTR_EL2</code>
Architectural Feature Trap Register, EL2	<code>CPTR_EL2</code>
Monitor Debug Configuration Register, EL2	<code>MDCR_EL2</code>

[Table D1-31](#) summarizes the trap enable controls that are in the `_EL2` System registers.

Table D1-31 Summary of the EL2 controls that control trapping to EL2 using AArch64

Control	Trap
<code>HCR_EL2.{TVRM, TVM}</code>	Traps to EL2 of Non-secure EL1 accesses to virtual memory control registers on page D1-1476
<code>HCR_EL2.HCD</code>	Disabling Non-secure state execution of HVC instructions on page D1-1477
<code>HCR_EL2.TDZ</code>	Traps to EL2 of Non-secure EL1 and EL0 execution of DC ZVA instructions on page D1-1478
<code>HCR_EL2.TTLB</code>	Traps to EL2 of Non-secure EL1 execution of TLB maintenance instructions on page D1-1479
<code>HCR_EL2.{TSW, TPC, TPU}</code>	Traps to EL2 of Non-secure EL1 and EL0 execution of cache maintenance instructions on page D1-1480
<code>HCR_EL2.TACR</code>	Traps to EL2 of Non-secure EL1 and EL0 accesses to the Auxiliary Control Register on page D1-1482
<code>HCR_EL2.TIDCP</code>	Traps to EL2 of Non-secure EL1 and EL0 accesses to lockdown, DMA, and TCM operations on page D1-1483

Table D1-31 Summary of the EL2 controls that control trapping to EL2 using AArch64 (continued)

Control	Trap
HCR_EL2.TSC	<i>Traps to EL2 of Non-secure EL1 execution of SMC instructions on page D1-1484</i>
HCR_EL2.{TID0, TID1, TID2, TID3}	<i>Traps to EL2 of Non-secure EL1 and EL0 reads of ID registers on page D1-1485</i>
HCR_EL2.{TWI, TWE}	<i>Traps to EL2 of Non-secure EL1 and EL0 execution of WFE and WFI instructions on page D1-1488</i>
CPTR_EL2.TCPAC	<i>Trapping to EL2 of Non-secure EL1 accesses to the CPAC_EL1 or CPACR on page D1-1489</i>
CPTR_EL2.TFP	<i>General trapping to EL2 of Non-secure EL1 and EL0 accesses to the SIMD and floating-point registers on page D1-1489</i>
CPTR_EL2.TTA	<i>Traps to EL2 of EL2, and Non-secure EL1 and EL0, System register accesses to the trace registers on page D1-1490</i>
HSTR_EL2.TTEE	<i>Traps to EL2 of Non-secure EL1 and EL0 accesses to the T32EE configuration registers, from AArch32 state only on page D1-1491</i>
HSTR_EL2.{T0-T3, T5-T13, T15}	<i>Generic trapping to EL2 of Non-secure EL1 and EL0 accesses to System registers, from AArch32 state only on page D1-1492</i>
MDCR_EL2.TDRA	<i>Traps to EL2 of Non-secure EL1 and EL0 System register accesses to Debug ROM registers on page D1-1494</i>
MDCR_EL2.TDOSA	<i>Traps to EL2 of Non-secure EL1 System register accesses to OS-related debug registers on page D1-1495</i>
MDCR_EL2.TDA	<i>Traps to EL2 of Non-secure EL1 and EL0 general System register accesses to debug registers on page D1-1495</i>
MDCR_EL2.{TPM, TPMCR}	<i>Traps to EL2 of Non-secure EL1 and EL0 accesses to Performance Monitors registers on page D1-1497</i>

Also see the following for more general information about traps to EL2:

- *Traps to EL2 of System register access instructions.*
- For traps from an Exception level using AArch32:
 - *Hyp traps on instructions that fail their condition code check on page G1-3505.*
 - *Hyp traps on instructions that are UNPREDICTABLE on page G1-3505.*

Traps to EL2 of System register access instructions

When an instruction is trapped to EL2, the trap is taken before execution of the instruction. This means that if the trapped instruction is a System register access instruction, none of the following happens before the exception is taken to EL2:

- The System register access.
- Any effects normally associated with the System register access.

Traps to EL2 of Non-secure EL1 accesses to virtual memory control registers

EL2 provides the following traps for reads and writes to the virtual memory control registers:

- [HCR_EL2](#).TRVM, for read accesses:
 - 1** Non-secure EL1 reads of the virtual memory control registers are trapped to EL2.
 - 0** Non-secure EL1 reads of the virtual memory control registers are not trapped to EL2.
- [HCR_EL2](#).TVM, for write access:
 - 1** Non-secure EL1 writes to the virtual memory control registers are trapped to EL2.
 - 0** Non-secure writes to the virtual memory control registers are not trapped to EL2.

Table D1-32 shows the registers for which:

- Reads are trapped to EL2 when [HCR_EL2](#).TRVM is 1.
- Writes are trapped to EL2 when [HCR_EL2](#).TVM is 1.

The table also shows how the exceptions are reported in [ESR_EL2](#).

Table D1-32 Register read and write accesses trapped when [HCR_EL2](#).{TRVM, TVM} are 1

Traps from	Registers	Syndrome reporting in ESR_EL2
AArch64 state	SCTLR_EL1 , TTBR0_EL1 , TTBR1_EL1 , TCR_EL1 , ESR_EL1 , FAR_EL1 , AFSR0_EL1 , AFSR1_EL1 , MAIR_EL1 , AMAIR_EL1 , CONTEXTIDR_EL1 .	Trapped AArch64 MSR, MRS, or system instruction, using EC value 0x18.
AArch32 state	SCTLR , TTBR0 , TTBR1 , TTBCR , DACR , DFSR , IFSR , DFAR , IFAR , ADFSR , AIFSR , PRRR , NMRR , MAIR0 , MAIR1 , AMAIR0 , AMAIR1 , CONTEXTIDR .	Trapped MCR or MRC CP15 access, using EC value 0x03. Trapped MCRR or MRRC CP15 access, using EC value 0x04.

———— **Note** —————

EL2 provides a second stage of address translation, that a hypervisor can use to remap the address map defined by a Guest OS. In addition, a hypervisor can trap attempts by a Guest OS to write to the registers that control the Non-secure memory system. A hypervisor might use this trap as part of its virtualization of memory management.

Disabling Non-secure state execution of HVC instructions

[HCR_EL2.HCD](#) is only implemented if EL3 is not implemented. Otherwise, it is RES0. See the [HCR_EL2](#) register description.

[HCR_EL2.HCD](#) disables HVC instruction execution in Non-secure state:

- 1** Any attempt to execute a HVC instruction in Non-secure state generates an exception that is taken without a change of Exception level. For example, an attempt to execute a HVC instruction at EL1 generates an exception that is taken to EL1.
- 0** HVC instruction execution is enabled at EL2 and Non-secure EL1.

———— **Note** —————

HVC instructions are always UNDEFINED at EL0.

[Table D1-33](#) shows how the exceptions are reported in [ESR_ELx](#).

Table D1-33 Instruction that causes exceptions when [HCR_EL2.HCD](#) is 1

Attempted execution in	Instruction	Syndrome reporting in ESR_ELx
AArch64 state	HVC	Exception for an unknown reason, using EC value 0x00
AArch32 state	HVC	

Traps to EL2 of Non-secure EL1 and EL0 execution of DC ZVA instructions

[HCR_EL2](#).TDZ enables a trap to EL2 of Non-secure EL1 and EL0 execution of DC ZVA instructions:

- 1** Any attempt to execute a DC ZVA instruction at Non-secure EL1 or EL0 is trapped to EL2. Reading the [DCZID_EL0](#) returns a value that indicates that DC ZVA instructions are not supported.
- 0** Non-secure EL1 and EL0 execution of DC ZVA instructions is not trapped to EL2.

[Table D1-34](#) shows how the exceptions are reported in [ESR_EL2](#).

Table D1-34 Instruction trapped to EL1 when [HCR_EL2](#).TDZ is 0

Traps from	Trapped instruction	Syndrome reporting in ESR_EL2
AArch64 state	DC ZVA	Trapped AArch64 MSR, MRS, or system instruction, using EC value 0x18.
AArch32 state	n/a	n/a

Traps to EL2 of Non-secure EL1 execution of TLB maintenance instructions

In the ARMv8-A architecture, the system instruction encoding space includes TLB maintenance instructions.

[HCR_EL2.TTLB](#) enables a trap to EL2 of Non-secure EL1 execution of TLB maintenance instructions:

- 1** Any attempt to execute a TLBI instruction at Non-secure EL1 is trapped to EL2.
- 0** Non-secure EL1 execution of TLBI instructions is not trapped to EL2.

[Table D1-35](#) shows the instructions that are trapped, and how the exceptions are reported in [ESR_EL2](#).

Table D1-35 Instructions trapped to EL2 when [HCR_EL2.TTLB](#) is 1

Traps from	Trapped instructions	Syndrome reporting in ESR_EL2
AArch64 state	TLBI VMALLE1IS , TLBI VAE1IS , TLBI ASIDE1IS , TLBI VAAE1IS , TLBI VALE1IS , TLBI VAALE1IS , TLBI VMALLE1 , TLBI VAE1 , TLBI ASIDE1 , TLBI VAAE1 , TLBI VALE1 , TLBI VAALE1	Trapped AArch64 MSR, MRS, or system instruction, using EC value 0x18
AArch32 state	TLBIALLIS , TLBIMVAIS , TLBIASIDIS , TLBIMVAAIS , TLBIMVAA , DTLBIALL , DTLBIMVA , DTLBIASID , ITLBIALL , ITLBIASID , ITLBIMVA	Trapped MCR or MRC CP15 access, using EC value 0x03

For more information about these instructions, see:

- [TLB maintenance instructions](#) on page D5-1808, for the AArch64 state instructions.
- [The scope of TLB maintenance operations](#) on page G3-3640, for the AArch32 state instructions.

Traps to EL2 of Non-secure EL1 and EL0 execution of cache maintenance instructions

Table D1-36 shows the [HCR_EL2](#) trap controls that trap cache maintenance instructions to EL2. When one of these controls is 1, any attempt to execute the corresponding cache maintenance instruction at Non-secure EL1, or at Non-secure EL0 if permitted by [SCTLR_EL1.UCI](#), is trapped to EL2.

Table D1-36 Controls for trapping cache maintenance instructions to EL2

Trap control	Trapped instructions
HCR_EL2.TSW	Data cache maintenance by set/way
HCR_EL2.TPC	Data cache maintenance to point of coherency
HCR_EL2.TPU	Cache maintenance to point of unification

For:

- [HCR_EL2.TSW == 1](#), [Table D1-37](#) shows the instructions that are trapped to EL2, and how the exceptions are reported in [ESR_EL2](#).
- [HCR_EL2.TPC == 1](#), [Table D1-38](#) shows the instructions that are trapped to EL2, and how the exceptions are reported in [ESR_EL2](#).
- [HCR_EL2.TPU == 1](#), [Table D1-39](#) shows the instructions that are trapped to EL2, and how the exceptions are reported in [ESR_EL2](#).

Table D1-37 Instructions trapped to EL2 when [HCR_EL2.TSW](#) is 1

Traps from	Trapped instructions	Syndrome reporting in ESR_EL2
AArch64 state	DC ISW , DC CSW , DC CISW	Trapped AArch64 MSR, MRS, or system instruction, using EC value 0x18
AArch32 state	DCISW , DCCSW , DCCISW	Trapped MCR or MRC CP15 access, using EC value 0x03

Table D1-38 Instructions trapped to EL2 when [HCR_EL2.TPC](#) is 1

Traps from	Trapped instructions	Syndrome reporting in ESR_EL2
AArch64 state	DC IVAC , DC CVAC , DC CIVAC	Trapped AArch64 MSR, MRS, or system instruction, using EC value 0x18
AArch32 state	DCIMVAC , DCCIMVAC , DCCMVAC	Trapped MCR or MRC CP15 access, using EC value 0x03

Table D1-39 Instructions trapped to EL2 when [HCR_EL2.TPU](#) is 1

Traps from	Trapped instructions	Syndrome reporting in ESR_EL2
AArch64 state	IC IALLUIS , IC IALLU , IC IVAU , DC CVAU	Trapped AArch64 MSR, MRS, or system instruction, using EC value 0x18
AArch32 state	ICIMVAU , ICIALLU , ICIALUIS , DCCMVAU	Trapped MCR or MRC CP15 access, using EC value 0x03

For more information about these instructions, see:

- [Cache maintenance instructions, and data cache zero](#) on page C4-237 for the AArch64 instructions.
- [Cache maintenance operations, functional group](#) on page G3-3743 for the AArch32 instructions.

———— **Note** ————

If virtualizing a uniprocessor system within an multiprocessor system, permitting a virtual machine to move between different PEs makes cache maintenance by set/way difficult. This is because a set/way operation might be interrupted part way through its operation, and therefore the hypervisor must reproduce the effect of the maintenance on both PEs

Traps to EL2 of Non-secure EL1 and EL0 accesses to the Auxiliary Control Register

[HCR_EL2.TACR](#) enables a trap to EL2 of accesses to the Auxiliary Control Register from Non-secure EL1 or EL0:

1 Non-secure EL1 or EL0 accesses to the Auxiliary Control Register are trapped to EL2.

0 Non-secure EL1 or EL0 accesses to the Auxiliary Control Register are not trapped to EL2.

[Table D1-40](#) shows the registers for which accesses are trapped to EL2, and how the exceptions are reported in [ESR_EL2](#):

Table D1-40 Register accesses trapped to EL2 when [HCR_EL2.TACR](#) is 1

Traps from	Registers	Syndrome reporting in ESR_EL2
AArch64 state	ACTLR_EL1	Trapped AArch64 MSR, MRS, or system instruction, using EC value 0x18
AArch32 state	ACTLR	Trapped MCR or MRC CP15 access, using EC value 0x03

———— **Note** —————

The Auxiliary Control Register is an IMPLEMENTATION DEFINED register that might implement global control bits for the PE. An attempt by a Guest OS to access the Auxiliary Control Register is a potential virtualization problem. Trapping these accesses to the hypervisor means the hypervisor can respond, typically by emulating the required function or signaling a virtualization error.

Traps to EL2 of Non-secure EL1 and EL0 accesses to lockdown, DMA, and TCM operations

The lockdown, DMA, and TCM features of the ARM architecture are IMPLEMENTATION DEFINED. The ARMv8-A architecture reserves the encodings of a number of system control registers for control of these features.

The [HCR_EL2.TIDCP](#) bit can be used as a trap enable control, to enable a trap that traps accesses to lockdown, DMA, and TCM operations from Non-secure EL1 and EL0 to EL2. Whether [HCR_EL2.TIDCP](#) is used as a trap enable control is IMPLEMENTATION DEFINED. If it is, then when it is 1:

- At Non-secure EL1, any attempt to execute a system control register access instruction with one of the reserved register encodings is trapped to EL2.
- At Non-secure EL0, on an attempt to execute a system control register access instruction with one of the reserved register encodings, it is IMPLEMENTATION DEFINED whether:
 - The instruction is trapped to EL2.
 - The instruction is UNDEFINED, and the PE takes an Undefined Instruction exception to EL1.

If [HCR_EL2.TIDCP](#) is used as a trap enable control, [Table D1-41](#) shows the register encodings for which accesses are trapped to EL2 when it is 1, and how the exceptions are reported in [ESR_EL2](#).

Table D1-41 Encodings trapped to EL2 when [HCR_EL2.TIDCP](#) is 1

Traps from	Register encodings	Syndrome reporting in ESR_EL2
AArch64 state	Any access to any of the encodings described in <i>Reserved control space for IMPLEMENTATION DEFINED functionality on page C4-250</i> .	Trapped AArch64 MSR, MRS, or system instruction, using EC value 0x18
AArch32 state	An access to any of the following encodings: <ul style="list-style-type: none"> • CRn==c9, opc1=={0-7}, CRm=={c0-c2, c5-c8}, opc2=={0-7}. See <i>VMSAv8-32 CP15 c9 register summary on page G3-3719</i>. • CRn==c10, opc1=={0-7}, CRm=={c0, c1, c4, c8}, opc2=={0-7}. See <i>VMSAv8-32 CP15 c10 register summary on page G3-3720</i>. • CRn==c11, opc1=={0-7}, CRm=={c0-c8, c15}, opc2=={0-7}. See <i>VMSAv8-32 CP15 c11 register summary on page G3-3721</i>. 	Trapped MCR or MRC CP15 access, using EC value 0x03

An implementation can also include IMPLEMENTATION DEFINED registers that provide additional controls, to give finer-grained control of the trapping of IMPLEMENTATION DEFINED features.

———— Note ————

The trapping of accesses to these registers from Non-secure EL1 is higher priority than Undefined Instruction exceptions.

Traps to EL2 of Non-secure EL1 execution of SMC instructions

[HCR_EL2.TSC](#) enables a trap to EL2 of Non-secure EL1 execution of SMC instructions:

- 1** Any attempt to execute an SMC instruction at Non-secure EL1 is trapped to EL2, regardless of the value of [SCR_EL3.SMD](#).
- 0** Non-secure EL1 execution of SMC instructions is not trapped to EL2.

Table D1-42 shows how the exceptions are reported in [ESR_EL2](#):

Table D1-42 SMC Instruction trapped to EL2 when [HCR_EL2.TSC](#) is 1

Traps from	Trapped instruction	Syndrome reporting in ESR_EL2
AArch64 state	SMC	Trapped SMC instruction execution in AArch64 state, using EC value 0x17
AArch32 state	SMC (previously SMI) on page F7-3058	Trapped SMC instruction execution in AArch32 state, using EC value 0x13

The trap that [HCR_EL2.TSC](#) enables traps the attempted execution of a conditional SMC instruction only if the instruction passes its condition code check.

For more information about SMC instructions, see [SMC on page C5-663](#).

———— **Note** ————

- This trap is implemented only if the implementation includes EL3.
- SMC instructions are UNDEFINED at EL0.

———— **Note** ————

Typically, a hypervisor determines whether a Guest OS can access Secure state directly. If the hypervisor does not permit a Guest OS to access Secure state directly, and that Guest OS attempts to change the PE Security state to Secure state, the hypervisor must either report a virtualization error or emulate the required Secure state operation.

Traps to EL2 of Non-secure EL1 and EL0 reads of ID registers

Other than the [MIDR_EL1](#) and [MPIDR_EL1](#), the ID registers are divided into groups, with a trap enable control in the [HCR_EL2](#) for each group.

When the value of one of these trap enable controls is 1, any attempt at Non-secure EL1 or EL0 to read any register in the corresponding group is trapped to EL2.

The trap enable controls have no effect on writes to the ID registers.

[Table D1-43](#) shows the trap enable controls for the ID register groups, and shows the subsections that list the ID registers in each group. Each subsection describes how the trap is reported in [ESR_EL2](#).

Table D1-43 ID register groups for traps of Non-secure EL1 and EL0 reads of the ID registers

Trap control	Register group
HCR_EL2.TID0	<i>ID group 0, Primary device identification registers</i>
HCR_EL2.TID1	<i>ID group 1, Implementation identification registers on page D1-1486</i>
HCR_EL2.TID2	<i>ID group 2, Cache identification registers on page D1-1486</i>
HCR_EL2.TID3	<i>ID group 3, Detailed feature identification registers on page D1-1487</i>

For the [MIDR_EL1](#) and [MPIDR_EL1](#) registers, EL2 provides read/write aliases of the registers. The original register becomes accessible only from EL2 or Secure state, and a read of the original register from Non-secure EL1 returns the value of the read/write alias. This register substitution is invisible to the software reading the register.

Table D1-44 ID register substitution provided by EL2 using AArch64

Register	Original	Alias, EL2 using AArch64
Main ID	MIDR_EL1	VPIDR_EL2
Multiprocessor Affinity	MPIDR_EL1	VMPIDR_EL2

Reads of the [MIDR_EL1](#) or [MPIDR_EL1](#) from EL2 or Secure state are unchanged by the implementation of [VPIDR_EL2](#) and [VMPIDR_EL2](#).

———— Note ————

- A hypervisor often has to virtualize one or both of the [MIDR_EL1](#) and [MPIDR_EL1](#) because:
 - The [MIDR_EL1](#) provides information about the implementation, the PE name, and revision information.
 - In a multiprocessor implementation, the [MPIDR_EL1](#) defines the position of a PE within a cluster.
- The PE ID registers that can be accessed from Non-secure state can present a virtualization hole, because system software can use them to determine information about the PE that a hypervisor might want to conceal. However, many uses of virtualization do not require the hypervisor to disguise the identity of the PE.

ID group 0, Primary device identification registers

In AArch32 state, these registers identify some top-level implementation choices.

In AArch64 state, there are no ID group 0 registers.

Table D1-45 shows the ID registers that are in ID group 0 for traps to EL2, and how the exceptions are reported in ESR_EL2.

Table D1-45 ID group 0 registers

Traps from	Group 0 registers	Syndrome reporting in ESR_EL2
AArch64 state	n/a	n/a
AArch32 state	FPSID	Trapped CP10 access, using EC value 0x08
	JIDR	Trapped CP14 access, using EC value 0x05

Note

If CPTR_EL2.TFP traps accesses to SIMD and floating-point functionality, then for a read of FPSID, that trap has priority over this trap.

ID group 1, Implementation identification registers

These registers often provide coarse-grained identification mechanisms for implementation-specific features.

Table D1-46 shows the ID registers that are in ID group 1 for traps to EL2, and how the exceptions are reported in ESR_EL2:

Table D1-46 ID group 1 registers

Traps from	Group 1 registers	Syndrome reporting in ESR_EL2
AArch64 state	AIDR_EL1, REVIDR_EL1	Trapped AArch64 MSR, MRS, or system instruction, using EC value 0x18
AArch32 state	TCMTR, TLBTR, REVIDR, AIDR	Trapped MCR or MRC CP15 access, using EC value 0x03

ID group 2, Cache identification registers

These registers describe and control the cache implementation.

Table D1-47 shows the ID registers that are in ID group 2 for traps to EL2, and how the exceptions are reported in ESR_EL2:

Table D1-47 ID group 2 registers

Traps from	Group 2 registers	Syndrome reporting in ESR_EL2
AArch64 state	CTR_ELO, CCSIDR_EL1, CLIDR_EL1, CSSELR_EL1	Trapped AArch64 MSR, MRS, or system instruction, using EC value 0x18
AArch32 state	CTR, CCSIDR, CLIDR, CSSELR	Trapped MCR or MRC CP15 access, using EC value 0x03

ID group 3, Detailed feature identification registers

These registers provide detailed information about the features of the implementation.

———— **Note** ————

In AArch32 state, these registers are called the CPUID registers. There is no requirement for this trap to apply to those registers that the CPUID Identification Scheme defines as reserved. See [The CPUID identification scheme on page G3-3737](#).

Table D1-48 shows the ID registers that are in ID group 3 for traps to EL2, and how the exceptions are reported in ESR_EL2:

Table D1-48 ID group 3 registers

Traps from	Group 3 registers	Syndrome reporting in ESR_EL2
AArch64 state	<p>ID_PFR0_EL1, ID_PFR1_EL1. ID_DFR0_EL1. ID_AFR0_EL1. ID_MMFR0_EL1, ID_MMFR1_EL1, ID_MMFR2_EL1, ID_MMFR3_EL1. ID_ISAR0_EL1, ID_ISAR1_EL1, ID_ISAR2_EL1, ID_ISAR3_EL1, ID_ISAR4_EL1, ID_ISAR5_EL1. MVFR0_EL1, MVFR1_EL1, MVFR2_EL1. ID_AA64PFR0_EL1, ID_AA64PFR1_EL1. ID_AA64DFR0_EL1, ID_AA64DFR1_EL1. ID_AA64MMFR0_EL1, ID_AA64MMFR1_EL1. ID_AA64ISAR0_EL1, ID_AA64ISAR1_EL1. ID_AA64AFR0_EL1, ID_AA64AFR1_EL1.</p>	Trapped AArch64 MSR, MRS, or system instruction, using EC value 0x18
AArch32 state	MVFR0, MVFR1.	Trapped CP10 access, using EC value 0x08
	<p>ID_PFR0, ID_PFR1. ID_DFR0. ID_AFR0. ID_MMFR0, ID_MMFR1, ID_MMFR2, ID_MMFR3. ID_ISAR0, ID_ISAR1, ID_ISAR2, ID_ISAR3, ID_ISAR4, ID_ISAR5.</p> <p>An MRC access to any of the following encodings:</p> <ul style="list-style-type: none"> • opc == 0, CRn == c0, CRm == {c3-c7}, opc2 == {0, 1}. • opc == 0, CRn == 0, CRm == {c3-c7}, opc2 == 2. • opc == 0, CRn == 0, CRm == 5, opc2 == {4, 5}. 	Trapped MCR or MRC CP15 access, using EC value 0x03

———— **Note** ————

If CPTR_EL2.TFP traps accesses to SIMD and floating-point functionality, then for reads of MVFR0_EL1, MVFR1_EL1, MVFR2_EL1, MVFR0, and MVFR1, that trap has priority over this trap.

Traps to EL2 of Non-secure EL1 and EL0 execution of WFE and WFI instructions

EL2 provides the following traps for WFE and WFI instructions:

- [HCR_EL2.TWE](#):
 - 1** Any attempt to execute a WFE instruction at Non-secure EL1 or EL0 is trapped to EL2, if the instruction would otherwise have caused the PE to enter a low-power state.
 - 0** Non-secure EL1 or EL0 execution of WFE instructions is not trapped to EL2.
- [HCR_EL2.TWI](#)
 - 1** Any attempt to execute a WFI instruction at Non-secure EL1 or EL0 is trapped to EL2, if the instruction would otherwise have caused the PE to enter a low-power state.
 - 0** Non-secure EL1 or EL0 execution of WFI instructions is not trapped to EL2.

Table D1-49 shows how the exceptions are reported in [ESR_EL2](#).

Table D1-49 Instructions trapped to EL2 when [HCR_EL2](#).{TWE, TWI} are 1

Trap control	Traps from	Trapped instructions	Syndrome reporting in ESR_EL2
HCR_EL2.TWE	AArch64 state and AArch32 state	WFE	Trapped WFI or WFE instruction, using EC value 0x01
HCR_EL2.TWI		WFI	

The traps that [HCR_EL2](#).{TWE, TWI} enable trap the attempted execution of conditional WFE or WFI instructions only if the instructions pass their condition code check.

For more information about these instructions, and when they can cause the PE to enter a low-power state, see:

- [Wait for Event mechanism and Send event on page D1-1533](#).
- [Wait For Interrupt on page D1-1536](#).

———— **Note** —————

An operating system can use WFI instructions to signal to the PE that the PE can enter a low-power state until it receives an interrupt. In a virtualized system, the hypervisor might use a WFI instruction as an indication that it can switch to another Guest OS.

Software can use WFE instructions to signal to the PE that the PE can suspend execution during polling of a variable, such as a spinlock. In a virtualized system, this signal might indicate an opportunity for the hypervisor to reschedule. However, WFE generally requires a shorter wait than WFI, and therefore there might be situations where rescheduling on a WFE entry request is not appropriate.

Traps to EL2 of Non-secure EL1 accesses to SIMD and floating-point functionality

This section comprises the following subsections:

- [Trapping to EL2 of Non-secure EL1 accesses to the CPACR_EL1 or CPACR.](#)
- [General trapping to EL2 of Non-secure EL1 and EL0 accesses to the SIMD and floating-point registers.](#)

Trapping to EL2 of Non-secure EL1 accesses to the CPACR_EL1 or CPACR

CPTR_EL2.TCPAC enables a trap to EL2 of Non-secure EL1 accesses to the CPACR_EL1 or CPACR:

- 1** Non-secure EL1 accesses to the CPACR_EL1 and CPACR are trapped to EL2.
- 0** Non-secure EL1 accesses to the CPACR_EL1 or CPACR are not trapped to EL2.

Table D1-50 shows how the exceptions are reported in ESR_EL2:

Table D1-50 Register accesses trapped to EL2 when CPTR_EL2.TCPAC is 1

Traps from	Registers	Syndrome reporting in ESR_EL2
AArch64 state	CPACR_EL1	Trapped AArch64 MSR, MRS, or system instruction, using EC value 0x18
AArch32 state	CPACR	Trapped MCR or MRC CP15 access, using EC value 0x03

Note

In ARMv7 and earlier versions of the ARM architecture, one function of the CPACR is as an ID register that identifies what coprocessor functionality is implemented. Legacy software might use this identification mechanism. A hypervisor can use this trap to emulate this mechanism.

General trapping to EL2 of Non-secure EL1 and EL0 accesses to the SIMD and floating-point registers

CPTR_EL2.TFP enables a trap to EL2 of Non-secure EL1 and EL0 accesses to SIMD and floating-point registers:

- 1** Any attempt at Non-secure EL1 or EL0 to execute an instruction that accesses the SIMD or floating-point registers is trapped to EL2
- 0** Non-secure EL1 or EL0 execution of instructions that access the SIMD or floating-point registers is not trapped to EL2.

Table D1-51 shows the registers for which accesses are trapped to EL2 when CPTR_EL2.TFP is 1, and how the exceptions are reported in ESR_EL2.

Table D1-51 Register accesses trapped to EL2 when MDCR_EL2.TFP is 1

Traps from	Registers	Syndrome reporting in ESR_EL2
AArch64 state	FPCR, FPSR, and any of the SIMD and floating-point registers V0-V31, including their views as D0-D31 registers or S0-S31 registers. See <i>The SIMD and floating-point registers, V0-V31</i> on page D1-1417.	Trapped access to a SIMD or floating-point register, using EC value 0x07
AArch32 state	FPSID, MVFR0, MVFR1, MVFR2, FPSCR, FPXCR, and any of the SIMD and floating-point registers Q0-Q15, including their views as D0-D31 registers or S0-S31 registers. See <i>Advanced SIMD and floating-point system registers</i> on page G1-3500.	Trapped access to a SIMD or floating-point register, using EC value 0x07 ^{ab}

- a. The architecture defines writes to the FPSID from EL1 as an access to a SIMD and floating-point register.
- b. Writes to the MVFR0, MVFR1, and MVFR2 from EL1 using AArch32 are UNPREDICTABLE. This means that it is IMPLEMENTATION DEFINED whether these writes are defined as accesses to SIMD and floating-point registers.

———— **Note** ————

- A hypervisor might use these traps when lazy switching between Guest OSs.
- If [CPACR_EL1.TTA](#) traps EL1 and EL0 accesses to SIMD and floating-point registers to EL1, that trap has priority over this trap.

Traps to EL2 of EL2, and Non-secure EL1 and EL0, System register accesses to the trace registers

[CPTR_EL2.TTA](#) enables a trap to EL2 of System register accesses to the trace registers, from both:

- EL2.
- Non-secure EL1 and EL0.

When [CPTR_EL2.TTA](#) is:

- | | |
|----------|---|
| 1 | EL2, and Non-secure EL1 and EL0, System register accesses to the trace registers, except for accesses that the appropriate Trace Architecture Specification describes as UNPREDICTABLE or as UNDEFINED, are trapped to EL2. |
| 0 | EL2, and Non-secure EL1 or EL0, System register accesses to the trace registers are not trapped to EL2. |

———— **Note** ————

- The ETMv4 architecture does not permit EL0 to access the trace registers. If the ARMv8-A architecture is implemented with an ETMv4 implementation, EL0 accesses to the trace registers are UNDEFINED.
- EL2 does not provide traps on trace register accesses through the Memory-mapped interface.

System register accesses to the trace registers can have side-effects. When a System register access is trapped to EL2 or generates an Undefined Instruction exception, no side-effects occur before the exception is taken, see [Traps to EL2 of System register access instructions on page D1-1475](#).

[Table D1-52](#) shows the registers for which accesses are trapped to EL2 when [CPTR_EL2.TTA](#) is 1, and how the exceptions are reported in [ESR_EL2](#).

Table D1-52 Register accesses trapped to EL2 when [CPTR_EL2.TTA](#) is 1

Traps from	Registers	Syndrome reporting in ESR_EL2
AArch64 state	All implemented trace registers	Trapped AArch64 MSR, MRS, or system instruction, using EC value 0x18.
AArch32 state	All implemented trace registers	For accesses using: <ul style="list-style-type: none"> • MCR or MRC instructions, trapped MCR or MRC CP14 access, using EC value 0x05. • MCRR or MRRC instructions, trapped MCRR or MRRC CP14 access, using EC value 0x0C.

———— **Note** ————

If [CPACR_EL1.TTA](#) traps EL1 and EL0 accesses to the [CPACR_EL1](#) or [CPACR](#) to EL1, that trap has priority over this trap.

Traps to EL2 of Non-secure EL1 and EL0 accesses to the T32EE configuration registers, from AArch32 state only

In an ARMv8-A implementation that supports T32EE, [HSTR_EL2.TTEE](#) enables a trap to EL2 of accesses to the T32EE configuration registers, from both:

- Non-secure EL1 using AArch32.
- Non-secure EL0 using AArch32.

When [HSTR_EL2.TTEE](#) is:

- 1** AArch32 state Non-secure EL1 and EL0 accesses to the T32EE configuration registers are trapped to EL2.
- 0** AArch32 state Non-secure EL1 and EL0 accesses to the T32EE configuration registers are not trapped to EL2.

[Table D1-53](#) shows the registers for which accesses are trapped to EL2, and how the exceptions are reported in [ESR_EL2](#):

Table D1-53 Register accesses trapped to EL2 when [HSTR_EL2.TTEE](#) is 1

Traps from	Registers	Syndrome reporting in ESR_EL2
AArch64 state	n/a	n/a
AArch32 state	TEECR , TEEHBR	Trapped CP14 access, using EC value 0x05

In an ARMv8-A implementation that does not support T32EE state, this trap is not supported and [HSTR_EL2.TTEE](#) is RES0.

———— **Note** ————

In ARMv8-A, support for T32EE is **OPTIONAL** and deprecated. ARM strongly recommends that ARMv8-A implementations do not include this support. Although this trap is included here for completeness, this manual does not describe T32EE state.

Generic trapping to EL2 of Non-secure EL1 and EL0 accesses to System registers, from AArch32 state only

[HSTR_EL2](#).{T0-T3, T5-T13, T15} enable traps to EL2 of accesses to the CP15 System registers, by the accessed primary CP15 register number, {c0-c3, c5-c13, c15}. These traps are from AArch32 state only, so are from both:

- Non-secure EL1 using AArch32.
- Non-secure EL0 using AArch32.

When the value of a [HSTR_EL2](#).Tx trap controls is:

- 1** Any AArch32 state Non-secure EL1 or EL0 access to the corresponding register is trapped to EL2.
- 0** AArch32 state Non-secure EL1 or EL0 accesses to the corresponding register are not trapped to EL2.

Table D1-54 shows the accesses that are trapped to EL2, and how the exceptions are reported in [ESR_EL2](#).

Table D1-54 Accesses trapped to EL2 when a [HSTR_EL2](#).Tx trap is enabled

Traps from	Trapped accesses	Syndrome reporting in ESR_EL2
AArch64 state	n/a	n/a
EL1 using AArch32	MCR and MRC instructions, where CRn in the instruction corresponds to the trapped primary CP15 register.	Trapped MCR or MRC CP15 access, using EC value 0x03.
	MCRR and MRRC instructions, where CRm in the instruction corresponds to the trapped primary CP15 register.	Trapped MCRR or MRRC CP15 access, using EC value 0x04.
EL0 using AArch32	MCR and MRC instructions, where CRn in the instruction corresponds to the trapped primary CP15 register.	See <i>Syndrome reporting in ESR_EL2 for accesses to primary CP15 registers from EL0 using AArch32 on page D1-1493</i>
	MCRR and MRRC instructions, where CRm in the instruction corresponds to the trapped primary CP15 register.	See <i>Syndrome reporting in ESR_EL2 for accesses to primary CP15 registers from EL0 using AArch32 on page D1-1493</i>

———— **Note** —————

Bit[14] of the [HSTR_EL2](#) is reserved, RES0, despite the Generic Timer control registers being implemented in CP15 c14. EL2 does not provide a trap on accesses to the Generic Timer CP15 registers.

———— **Note** —————

- Many of the traps to EL2 described in this section trap specific System register operations to EL2. However, because of the large number of possible usage models for virtualization, the traps on specific functions might not meet all possible requirements. Therefore, EL2 also provides a set of generic traps for trapping AArch32 System register accesses to EL2, as described in this section.
- ARM expects that trapping of Non-secure EL0 accesses to EL2 will be unusual, and used only when the hypervisor must virtualize EL0 operation. ARM recommends that, whenever possible, Non-secure EL0 accesses to the System registers behave as they would if the implementation did not include EL2. This means that, if the architecture does not support the Non-secure EL0 access, that access generates an Undefined Instruction exception that is taken to Non-secure EL1.

Syndrome reporting in ESR_EL2 for accesses to primary CP15 registers from EL0 using AArch32

For MCR and MRC instructions, syndrome reporting is as follows:

- If the architecture permits EL0 accesses to the CP15 register:
 - Trapped MCR or MRC CP15 access, using EC value 0x03.
- If the architecture defines EL0 accesses to the CP15 register as UNDEFINED:
 - Exception for an unknown reason, using EC value 0x00.
- If the architecture defines that it is IMPLEMENTATION DEFINED whether EL0 accesses to the CP15 register are UNDEFINED, then it is IMPLEMENTATION DEFINED whether the exception is reported as:
 - A trapped MCR or MRC CP15 access, using EC value 0x03.
 - An exception for an unknown reason, using EC value 0x00.

For MCRR and MRRC instructions, syndrome reporting is as follows:

- If the architecture permits EL0 accesses to the CP15 register:
 - Trapped MCRR or MRRC CP15 access, using EC value 0x04.
- If the architecture defines EL0 accesses to the CP15 register as UNDEFINED:
 - Exception for an unknown reason, using EC value 0x00.
- If the architecture defines that it is IMPLEMENTATION DEFINED whether EL0 accesses to the CP15 register are UNDEFINED, then it is IMPLEMENTATION DEFINED whether the exception is reported as:
 - Trapped MCRR or MRRC CP15 access, using EC value 0x04.
 - An exception for an unknown reason, using EC value 0x00.

Traps to EL2 of Non-secure EL1 and EL0 System register accesses to debug registers

EL2 provides traps to EL2 of Non-secure EL1 and EL0 System register accesses to the debug registers.

———— Note ————

EL2 does not provide traps on debug register accesses through the Memory-mapped or External debug interfaces.

System register accesses to the debug registers can have side-effects. When a System register access is trapped to EL2, no side-effects occur before the exception is taken to EL2. See [Traps to EL2 of System register access instructions on page D1-1475](#).

Table D1-55 shows the trap enable controls, and shows the subsections that list the accesses trapped. Each subsection describes how the trap is reported in [ESR_EL2](#).

Table D1-55 Traps of Non-secure EL1 and EL0 accesses to debug registers

Trap control	Trap
MDCR_EL2.TDRA	Traps to EL2 of Non-secure EL1 and EL0 System register accesses to debug registers
MDCR_EL2.TDOSA	Traps to EL2 of Non-secure EL1 System register accesses to OS-related debug registers on page D1-1495
MDCR_EL2.TDA	Traps to EL2 of Non-secure EL1 and EL0 general System register accesses to debug registers on page D1-1495

Traps to EL2 of Non-secure EL1 and EL0 System register accesses to Debug ROM registers

[MDCR_EL2.TDRA](#) enables a trap to EL2 of Non-secure EL1 and EL0 System register accesses to the Debug ROM registers:

- | | |
|----------|---|
| 1 | Non-secure EL1 or EL0 System register accesses to the Debug ROM registers are trapped to EL2. |
| 0 | Non-secure EL1 or EL0 System register accesses to the Debug ROM registers are not trapped to EL2. |

This trap applies to Non-secure EL0 only if it is using AArch32.

Table D1-56 shows the register accesses that are trapped to EL2 when [MDCR_EL2.TDRA](#) is 1, and how the exceptions are reported in [ESR_EL2](#):

Table D1-56 Register accesses trapped to EL2 when [MDCR_EL2.TDRA](#) is 1

Traps from	Registers	Syndrome reporting in ESR_EL2
AArch64 state	MDRAR_EL1	Trapped AArch64 MSR, MRS, or system instruction, using EC value 0x18.
AArch32 state	DBGDRAR , DBGDSAR	For accesses using: <ul style="list-style-type: none"> MCR or MRC instructions, trapped MCR or MRC CP14 access, using EC value 0x05. MCRR or MRRC instructions, trapped MCRR or MRRC CP14 access, using EC value 0x0C.

If [MDCR_EL2.TDE](#) or [HCR_EL2.TGE](#) is 1, behavior is as if [MDCR_EL2.TDRA](#) is 1 other than for the purpose of a direct read.

Traps to EL2 of Non-secure EL1 System register accesses to OS-related debug registers

MDCR_EL2.TDOSA enables a trap to EL2 of Non-secure EL1 System register accesses to the OS-related debug registers:

- 1** Non-secure EL1 System register accesses to the OS-related debug registers are trapped to EL2.
- 0** Non-secure EL1 System register accesses to the OS-related debug registers are not trapped to EL2.

[Table D1-57](#) shows the register accesses that are trapped to EL2 when **MDCR_EL2.TDOSA** is 1, and how the exceptions are reported in [ESR_EL2](#).

Table D1-57 Register accesses trapped to EL2 when **MDCR_EL2.TDOSA is 1**

Traps from	Registers	Syndrome reporting in ESR_EL2
AArch64 state	OSLAR_EL1 , OSLSR_EL1 , OSDLR_EL1 , DBGPRCR_EL1 .	Trapped AArch64 MSR, MRS, or system instruction, using EC value 0x18.
AArch32 state	DBGOSLSR , DBGOSLAR , DBGOSDLR , DBGPRCR .	For accesses using: <ul style="list-style-type: none"> • MCR or MRC instructions, trapped MCR or MRC CP14 access, using EC value 0x05. • MCRR or MRRC instructions, trapped MCRR or MRRC CP14 access, using EC value 0x0C.

If **MDCR_EL2.TDE** is 1, behavior is as if **MDCR_EL2.TDOSA** is 1 other than for the purpose of a direct read.

Traps to EL2 of Non-secure EL1 and EL0 general System register accesses to debug registers

MDCR_EL2.TDA enables a trap to EL2 of Non-secure EL1 and EL0 System register accesses to those debug System registers that are not mentioned in either of the following:

- [Traps to EL2 of Non-secure EL1 and EL0 System register accesses to debug registers on page D1-1494.](#)
- [Traps to EL2 of Non-secure EL1 System register accesses to OS-related debug registers.](#)

That is, **MDCR_EL2.TDA** enables a trap to EL2 of Non-secure EL1 and EL0 System register accesses to all debug System registers, except all of the following:

- Any access from:
 - AArch64 state to the [MDRAR_EL1](#).
 - AArch32 state to the [DBGDRAR](#) or [DBGDSAR](#).

These are the registers for which accesses from Non-secure EL1 and EL0 are trapped to EL2 when **MDCR_EL2.TDRA** is 1.

- Any access from:
 - AArch64 state to the [OSLAR_EL1](#), [OSLSR_EL1](#), [OSDLR_EL1](#) or [DBGPRCR_EL1](#).
 - AArch32 state to the [DBGOSLSR](#), [DBGOSLAR](#), [OSDLR_EL1](#) or [DBGPRCR](#).

These are the registers for which accesses from Non-secure EL1 and EL0 are trapped to EL2 when **MDCR_EL2.TDOSA** is 1.

When **MDCR_EL2.TDA** is:

- 1** Non-secure EL1 or EL0 System register accesses to any of the registers shown in [Table D1-58 on page D1-1496](#) are trapped to EL2.
- 0** Non-secure EL1 or EL0 System register accesses to the registers shown in [Table D1-58 on page D1-1496](#) are not trapped to EL2.

Table D1-58 shows how the exceptions are reported in [ESR_EL2](#).

Table D1-58 Accesses trapped to EL2 when [MDCR_EL2.TDA](#) is 1

Traps from	Trapped accesses	Syndrome reporting in ESR_EL2
AArch64 state	Accesses to the MDCCSR_EL0 , MDCCINT_EL1 , DBGDTR_EL0 , DBGDTRRX_EL0 , DBGDTRTX_EL0 , OSDTRRX_EL1 , MDSCR_EL1 , OSDTRTX_EL1 , OSECCR_EL1 , DBGBVR<n>_EL1 , DBGBCR<n>_EL1 , DBGWVR<n>_EL1 , DBGWCR<n>_EL1 , DBGCLAIMSET_EL1 , DBGCLAIMCLR_EL1 , and DBGAUTHSTATUS_EL1 .	Trapped AArch64 MSR, MRS, or system instruction, using EC value 0x18
AArch32 state	Accesses to the DBGDIDR , DBGDSCRint , DBGDCCINT , DBGDTRRXint , DBGDTRTXint , DBGWFAR , DBGVCR , DBGDSCRext , DBGDTRTXext , DBGDTRRXext , DBGBVR<n> , DBGBCR<n> , DBGBXVR<n> , DBGWCR<n> , DBGWVR<n> , DBGOSLAR , DBGCLAIMSET , DBGCLAIMCLR , DBGAUTHSTATUS , DBGDEVID , DBGDEVID1 , DBGDEVID2 , and DBGOSECCR .	For accesses using: <ul style="list-style-type: none"> MCR or MRC instructions, trapped MCR or MRC CP14 access, using EC value 0x05. MCRR or MRRC instructions, trapped MCRR or MRRC access, using EC value 0x0C.
	STC accesses to DBGDTRRXint . ^a LDC accesses to DBGDTRTXint . ^a	LDC or STC, trapped LDC or STC access to CP14, using EC value 0x06.

a. If the access would be permitted when [MDCR_EL2.TDA](#) is 0.

If [MDCR_EL2.TDE](#) or [HCR_EL2.TGE](#) is 1, behavior is as if [MDCR_EL2.TDA](#) is 1 other than for the purpose of a direct read.

Traps to EL2 of Non-secure EL1 and EL0 accesses to Performance Monitors registers

EL2 provides the following traps associated with the performance monitors:

- **MDCR_EL2.TPM:**
 - 1** Non-secure EL1 and EL0 accesses to all Performance Monitors registers are trapped to EL2.
 - 0** Non-secure EL1 and EL0 accesses to any Performance Monitors register is not trapped to EL2.
- **MDCR_EL2.TPMCR:**
 - 1** Non-secure EL1 and EL0 accesses to the Performance Monitors Control Registers are trapped to EL2.
 - 0** Non-secure EL1 and EL0 accesses to the Performance Monitors Control Registers are not trapped to EL2.

For:

- **MDCR_EL2.TPM == 1**, Table D1-59 shows the registers for which accesses are trapped to EL2, and how the exceptions are reported in [ESR_EL2](#).
- **MDCR_EL2.TPMCR == 1**, Table D1-60 shows the registers for which accesses are trapped to EL2, and how the exceptions are reported in [ESR_EL2](#).

Table D1-59 Register accesses trapped to EL2 when MDCR_EL2.TPM is 1

Traps from	Registers	Syndrome reporting in ESR_EL2
AArch64 state	All of the following registers, unless the register description states that the register encoding is UNALLOCATED. PMCR_ELO , PMCNTENSET_ELO , PMCNTENCLR_ELO , PMOVSLR_ELO , PMSWINC_ELO , PMSELR_ELO , PMCEID0_ELO , PMCEID1_ELO , PMCCNTR_ELO , PMXEVTYPER_ELO , PMXEVCNTR_ELO , PMUSERENR_ELO , PMINTENSET_EL1 , PMINTENCLR_EL1 , PMOVSSET_ELO , PMEVCNTR<n>_ELO , PMEVTYPER<n>_ELO , PMCCFILTR_ELO .	Trapped AArch64 MSR, MRS, or system instruction, using EC value 0x18
AArch32 state	All of the following registers, unless the register description indicates that the attempted access is UNDEFINED. PMCR , PMCNTENSET , PMINTENCLR , PMOVS , PMSWINC , PMSELR , PMCEID0 , PMCEID1 , PMCCNTR , PMXEVTYPER , PMXEVCNTR , PMUSERENR , PMINTENSET , PMINTENCLR , PMOVSSET , PMEVCNTR<n> , PMEVTYPER<n> , PMCCFILTR .	Trapped MCR or MRC CP15 access, using EC value 0x03

Table D1-60 Register accesses trapped to EL2 when MDCR_EL2.TPMCR is 1

Traps from	Registers	Syndrome reporting in ESR_EL2
AArch64 state	PMCR_ELO	Trapped AArch64 MSR, MRS, or system instruction, using EC value 0x18
AArch32 state	PMCR	Trapped MCR or MRC CP15 access, using EC value 0x03

———— **Note** —————

[MDCR_EL2.HPMN](#) affects whether a counter can be accessed from Non-secure EL1 or EL0. See the register description of [MDCR_EL2](#) for more information.

Note

- A hypervisor might assign Performance Monitors functionality to a particular Guest OS, or might virtualize performance monitoring. EL2 provides:
 - Trapping of all Non-secure accesses to the Performance Monitors to EL2. A hypervisor might use this as part of a lazy context switch that assigns the Performance Monitors to a particular Guest OS, or might use it as part of a virtualization approach.
 - Trapping of Non-secure accesses to the Performance Monitors Control Register, [PMCR_EL0](#) or [PMCR](#), to EL2. The hypervisor can use this in emulating the Performance Monitors identification bits.
-

D1.15.3 Trapping to EL3 using AArch64

Traps to EL3 using AArch64 are controlled using `_EL3` System registers, and the exception syndrome information is presented in `ESR_EL3`. The exceptions might be taken from AArch64 state or AArch32 state. The exception syndrome information indicates which Execution state the exception was taken from.

A trap to EL3 using AArch64 can only be generated if the instruction generating the trap does not also generate a higher priority exception. *Synchronous exception prioritization on page D1-1451* defines the prioritization of different exceptions on the same instruction.

Table D1-61 shows the `_EL3` System registers that contain controls that control trapping to EL3.

Table D1-61 Summary of the registers that control trapping to EL3 using AArch64

Register description	Register name
Secure Configuration Register	<code>SCR_EL3</code>
Architectural Feature Trap Register, EL3	<code>CPTR_EL3</code>
Monitor Debug Configuration Register, EL3	<code>MDCR_EL3</code>

Table D1-62 summarizes the controls that control trapping to EL3 using AArch64.

Table D1-62 Summary of the EL3 controls that control trapping to EL3 using AArch64

Control	Type of control ^a	Trap
<code>SCR_EL3</code> .{TWE, TWI}	T	<i>Traps to EL3 of EL2, EL1, and EL0 execution of WFE and WFI instructions on page D1-1501</i>
<code>SCR_EL3</code> .ST	E	<i>Traps to EL3 of Secure EL1 accesses to the Counter-timer Physical Secure timer registers on page D1-1502</i>
<code>SCR_EL3</code> .HCE	E	<i>Enabling EL3, EL2, and EL1 execution of HVC instructions on page D1-1503</i>
<code>SCR_EL3</code> .SMD	D	<i>Disabling EL3, EL2, and EL1 execution of SMC instructions on page D1-1504</i>
<code>CPTR_EL3</code> .TCPAC	T	<i>Trapping to EL3 of EL2 accesses to the <code>CPTR_EL2</code> or <code>HCPTR</code>, and EL1 and EL0 accesses to the <code>CPACR_EL1</code> or <code>CPACR</code> on page D1-1505</i>
<code>CPTR_EL3</code> .TTA	T	<i>Traps to EL3 of all System register accesses to the trace registers on page D1-1506</i>
<code>CPTR_EL3</code> .TFP	T	<i>Traps to EL3 of all accesses to the SIMD and floating-point registers on page D1-1507</i>
<code>MDCR_EL3</code> .TDOSA	T	<i>Traps to EL3 of EL2, EL1, and EL0 System register accesses to OS-related debug registers on page D1-1508</i>
<code>MDCR_EL3</code> .TDA	T	<i>Traps to EL3 of EL2, EL1, and EL0 general System register accesses to debug registers on page D1-1508</i>
<code>MDCR_EL3</code> .TPM	T	<i>Traps to EL3 of EL2, EL1, and EL0 accesses to Performance Monitors registers on page D1-1510</i>

a. T indicates Trap, E indicates Enable, and D indicates Disable.

Also see the following for more general information about traps to EL3:

- *Traps to EL3 of System register access instructions on page D1-1500.*

- [Traps to EL3 of monitor functionality from Secure EL1 using AArch32.](#)

Traps to EL3 of System register access instructions

When an instruction is trapped to EL3, the trap is taken before execution of the instruction. This means that if the trapped instruction is a System register access instruction, none of the following happens before the exception is taken to EL3:

- The System register access.
- Any effects normally associated with the System register access.

Traps to EL3 of monitor functionality from Secure EL1 using AArch32

If EL1 is using AArch32, all of the following are trapped to EL3:

- Secure EL1 reads and writes to any of the [SCR](#), [NSACR](#), [MVBAR](#) or [SDCR](#).
- Any attempt at Secure EL1 to execute any of the following:
 - ATS12NS0xx instructions.
 - SRS instructions that use the R13_mon banked register.
 - MRS or MSR instructions that access any of the SPSR_mon, R13_mon or R14_mon banked registers.

In addition, if EL1 is using AArch32:

- Secure EL1 write accesses to the [CNTFRQ](#) register are UNDEFINED. They are not trapped to EL3.
- Any attempt at Secure EL1 to change the mode to Monitor mode, by using a CPS or an MSR instruction, or by performing an exception return, is treated as an illegal change of the CPSR Mode field. See [Illegal changes to the CPSR.M field on page G1-3458](#).

[Table D1-63](#) shows the accesses that are trapped to EL3, and how the exceptions are reported in [ESR_EL3](#).

Table D1-63 Accesses trapped to EL3 from Secure EL1 using AArch32

Trapped instructions, or trapped accesses	Syndrome reporting in ESR_EL3
Secure EL1 reads and writes to any of the SCR , NSACR , MVBAR or SDCR	Trapped MCR or MRC CP15 access, using EC value 0x03.
ATS12NS0xx instructions.	
SRS instructions that use the R13_mon banked register.	Exception for an unknown reason, using EC value 0x00.
MRS or MSR instructions that accesses any of the SPSR_mon, R13_mon or R14_mon banked registers	

Note

- This functionality permits the scenario where 32-bit Secure Virtual Machine code executes in Secure EL1 and EL0 using AArch32, and EL3 using AArch64 allows Non-secure state to be in AArch64.
- Reads of the [NSACR](#) from either Non-secure EL1 using AArch32 or Non-secure EL2 using AArch32 return the value 0x00000C00. See [Restricted access System registers on page G3-3698](#).

Traps to EL3 of EL2, EL1, and EL0 execution of WFE and WFI instructions

EL3 provides the following traps for WFE and WFI instructions:

- [SCR_EL3.TWE](#):
 - 1** Any attempt to execute a WFE instruction at any Exception level lower than EL3 is trapped to EL3, if the instruction would otherwise have caused the PE to enter a low-power state.
 - 0** EL2, EL1, and EL0 execution of WFE instructions is not trapped to EL3.
- [SCR_EL3.TWI](#)
 - 1** Any attempt to execute a WFI instruction at any Exception level lower than EL3 is trapped to EL3, if the instruction would otherwise have caused the PE to enter a low-power state.
 - 0** EL2, EL1, and EL0 execution of WFI instructions is not trapped.

For EL1 and EL0, these traps apply to WFE and WFI instruction execution in both Security states.

[Table D1-64](#) shows how the exceptions are reported in [ESR_EL3](#).

Table D1-64 Instructions trapped to EL3 when [SCR_EL3](#).{TWE, TWI} are 1.

Trap control	Traps from	Trapped instructions	Syndrome reporting in ESR_EL3
SCR_EL3.TWE	AArch64 state and AArch32 state	WFE	Trapped WFI or WFE instruction, using EC value 0x01
SCR_EL3.TWI		WFI	

The traps that [SCR_EL3](#).{TWE, TWI} enable trap the attempted execution of conditional WFE or WFI instructions only if the instructions pass their condition code check.

For more information about these instructions, and when they can cause the PE to enter a low-power state, see:

- [Wait for Event mechanism and Send event on page D1-1533](#).
- [Wait For Interrupt on page D1-1536](#).

Traps to EL3 of Secure EL1 accesses to the Counter-timer Physical Secure timer registers

[SCR_EL3.ST](#) enables access to the Counter-timer Physical Secure timer registers from Secure EL1:

- 1** Accesses from Secure EL1 are enabled.
- 0** Secure EL1 accesses to the Counter-timer Physical Secure timer registers are trapped to EL3.

———— **Note** —————

Accesses to the Counter-timer Physical Secure timer registers are always enabled from EL3.

[Table D1-65](#) shows the registers for which accesses are trapped to EL3 when [SCR_EL3.ST](#) is 0, and how the exceptions are reported in [ESR_EL3](#).

Table D1-65 Register accesses trapped to EL3 when [SCR_EL3.ST](#) is 0

Traps from	Registers	Syndrome reporting in ESR_EL3
AArch64 state	CNTPS_TVAL_EL1 CNTPS_CTL_EL1 CNTPS_CVAL_EL1	Trapped AArch64 MSR, MRS, or system instruction, using EC value 0x18
AArch32 state	n/a	n/a

Enabling EL3, EL2, and EL1 execution of HVC instructions

[SCR_EL3.HCE](#) enables HVC instruction execution at EL1 and above:

- 1** HVC instruction execution is enabled at EL1 and above.
- 0** Any attempt to execute a HVC instruction at EL1 or above generates an exception that is taken without a change of Exception level. For example, an attempt to execute a HVC instruction at EL1 generates an exception that is taken to EL1.

For EL1, this enable applies to HVC instruction execution in Non-secure state only.

———— **Note** —————

HVC instructions are always UNDEFINED at EL0.

[Table D1-66](#) shows how the exceptions are reported in [ESR_ELx](#).

Table D1-66 Instruction that causes exceptions when [SCR_EL3.HCE](#) is 0

Attempted execution in	Instruction	Syndrome reporting in ESR_ELx
AArch64 state	HVC	Exception for an unknown reason, using EC value 0x00
AArch32 state	HVC	

Disabling EL3, EL2, and EL1 execution of SMC instructions

[SCR_EL3.SMD](#) disables SMC instruction execution at EL1 and above:

- 1** Any attempt to execute an SMC instruction at EL1 or above generates an exception without a change of Exception level. For example, an attempt to execute an SMC instruction at EL1 generates an exception that is taken to EL1.
- 0** SMC instructions are enabled at EL1 and above.

For EL1, this disable applies to SMC instruction execution in both Security states.

———— **Note** —————

SMC instructions are always UNDEFINED at EL0.

[Table D1-67](#) shows how the exceptions are reported in [ESR_ELx](#).

Table D1-67 Exceptions generated when [SCR_EL3.SMD](#) is 1

Attempted execution in	Instruction	Syndrome reporting in ESR_ELx
AArch64 state	SMC	Exception for an unknown reason, using EC value 0x00
AArch32 state	SMC	

———— **Note** —————

If [HCR_EL2.TSC](#) traps attempted EL1 execution of SMC instructions to EL2, that trap has priority over this disable.

Trapping to EL3 of EL2 accesses to the CPTR_EL2 or HCPTR, and EL1 and EL0 accesses to the CPACR_EL1 or CPACR

CPTR_EL3.TCPAC enables a trap to EL3 of all of the following:

- EL2 accesses to the CPTR_EL2 or HCPTR.
- EL1 and EL0 accesses to the CPACR_EL1 or CPACR.

When CPTR_EL3.TCPAC is:

- 1** EL2 accesses to the CPTR_EL2 or HCPTR, and EL1 and EL0 accesses to the CPACR_EL1 or CPACR, are trapped to EL3.
- 0** EL2 accesses to the CPTR_EL2 or HCPTR, and EL1 and EL0 accesses to the CPACR_EL1 or CPACR, are not trapped to EL3.

For EL1 and EL0, this trap applies to accesses from both Security states.

Table D1-68 shows how the exceptions are reported in ESR_EL3.

Table D1-68 Register accesses trapped to EL3 when CPTR_EL3.TCPAC is 1

Traps from	Registers	Syndrome reporting in ESR_EL3
AArch64 state	CPTR_EL2 CPACR_EL1	Trapped AArch64 MSR, MRS, or system instruction, using EC value 0x18
AArch32 state	HCPTR CPACR	Trapped MCR or MRC CP15 access, using EC value 0x03

———— **Note** —————

If CPTR_EL2.TCPAC traps EL1 accesses to the CPACR_EL1 or CPACR to EL2, that trap has priority over this trap.

Traps to EL3 of all System register accesses to the trace registers

[CPTR_EL3](#).TTA enables a trap to EL3 of System register accesses to the trace registers, from all Exception levels:

- 1** All System register accesses to the trace registers, except for any accesses that the appropriate Trace Architecture Specification describes as UNPREDICTABLE or as UNDEFINED, are trapped to EL3.
- 0** System register accesses to the trace registers are not trapped to EL3.

———— Note ————

- The ETMv4 architecture does not permit EL0 to access the trace registers. If the ARMv8-A architecture is implemented with an ETMv4 implementation, EL0 accesses to the trace registers are UNDEFINED.
- EL3 does not provide traps on trace register accesses through the Memory-mapped interface.

System register accesses to the trace registers can have side-effects. When a System register access is trapped to EL3 or generates an Undefined Instruction exception, no side-effects occur before the exception is taken, see [Traps to EL3 of System register access instructions](#) on page D1-1500.

For EL1 and EL0, this trap applies to accesses from both Security states.

[Table D1-69](#) shows the registers for which accesses are trapped to EL3 when [CPTR_EL3](#).TTA is 1, and how the exceptions are reported in [ESR_EL3](#).

Table D1-69 Register accesses trapped to EL3 when [CPTR_EL3](#).TTA is 1

Traps from	Registers	Syndrome reporting in ESR_EL3
AArch64 state	All implemented trace registers	Trapped AArch64 MSR, MRS, or system instruction, using EC value 0x18.
AArch32 state	All implemented trace registers	For accesses using: <ul style="list-style-type: none"> • MCR or MRC instructions, trapped MCR or MRC CP14 access, using EC value 0x05. • MCRR or MRRC instructions, trapped MCRR or MRRC CP14 access, using EC value 0x0C.

———— Note ————

If [CPTR_EL2](#).TTA traps EL2, EL1, and EL0 accesses to the [CPACR_EL1](#) or [CPACR](#) to EL2, or if [CPACR_EL1](#).TTA traps EL1 and EL0 accesses to the [CPACR_EL1](#) or [CPACR](#) to EL1, those traps have priority over this trap.

Traps to EL3 of all accesses to the SIMD and floating-point registers

[CPTR_EL3.TFP](#) enables a trap to EL3 of accesses to SIMD and floating-point registers, from all Exception levels:

- 1** Any attempt at any Exception level to execute an instruction that accesses the SIMD or floating-point registers is trapped to EL3
- 0** Execution of instructions that access the SIMD or floating-point registers is not trapped to EL3.

For EL1 and EL0, this trap applies to accesses from both Security states.

[Table D1-70](#) shows the registers for which accesses are trapped to EL3 when [CPTR_EL3.TFP](#) is 1, and how the exceptions are reported in [ESR_EL3](#).

Table D1-70 Register accesses trapped to EL3 when [CPTR_EL3.TFP](#) is 1

Traps from	Registers	Syndrome reporting in ESR_EL3
AArch64 state	FPCR , FPSR , and any of the SIMD and floating-point registers V0-V31, including their views as D0-D31 registers or S0-S31 registers. See <i>The SIMD and floating-point registers, V0-V31</i> on page D1-1417.	Trapped access to a SIMD or floating-point register, using EC value 0x07
AArch32 state	FPSID , MVFR0 , MVFR1 , MVFR2 , FPSCR , FPEXC , and any of the SIMD and floating-point registers Q0-Q15, including their views as D0-D31 registers or S0-S31 registers. See <i>Advanced SIMD and floating-point system registers</i> on page G1-3500.	Trapped access to a SIMD or floating-point register, using EC value 0x07 ^{ab}

- a. The architecture defines writes to the [FPSID](#) from EL1 as an access to a SIMD and floating-point register.
- b. Writes to the [MVFR0](#), [MVFR1](#), and [MVFR2](#) from EL1 using AArch32 are UNPREDICTABLE. This means that it is IMPLEMENTATION DEFINED whether these writes are defined as accesses to SIMD and floating-point registers.

———— Note —————

If [CPTR_EL2.TFP](#) traps EL2, EL1, and EL0 accesses to SIMD and floating-point registers to EL2, or if [CPACR_EL1.FPEN](#) traps EL1 and EL0 accesses to the SIMD and floating-point registers to EL1, those traps have priority over this trap.

Traps to EL3 of EL2, EL1, and EL0 System register accesses to debug registers

EL3 provides traps to EL3 of EL2, EL1, and EL0 System register accesses to the debug registers, from both Security states.

———— Note —————

EL3 does not provide traps on debug register accesses through the Memory-mapped or External debug interfaces.

System register accesses to the debug registers can have side-effects. When a System register access is trapped to EL3, no side-effects occur before the exception is taken to EL3. See [Traps to EL3 of System register access instructions](#) on page D1-1500.

Table D1-71 shows the trap controls, and shows the subsections that list the accesses trapped. Each subsection describes how the trap is reported in [ESR_EL3](#).

Table D1-71 Traps of EL2, EL1, and EL0 accesses to debug registers

Trap control	Trap
MDCR_EL3.TDOSA	Traps to EL3 of EL2, EL1, and EL0 System register accesses to OS-related debug registers
MDCR_EL3.TDA	Traps to EL3 of EL2, EL1, and EL0 general System register accesses to debug registers

Traps to EL3 of EL2, EL1, and EL0 System register accesses to OS-related debug registers

[MDCR_EL3.TDOSA](#) enables a trap to EL3 of EL2, EL1, and EL0 accesses to the OS-related debug registers:

- | | |
|----------|--|
| 1 | EL2, EL1, and EL0 System register accesses to the OS-related debug registers are trapped to EL3. |
| 0 | EL2, EL1, and EL0 System register accesses to the OS-related debug registers are not trapped to EL3. |

For EL1 and EL0, this trap applies to accesses from both Security states.

Table D1-72 shows the register accesses that are trapped to EL3 when [MDCR_EL3.TDOSA](#) is 1, and how the exceptions are reported in [ESR_EL3](#).

Table D1-72 Register accesses trapped to EL3 when [MDCR_EL3.TDOSA](#) is 1

Traps from	Registers	Syndrome reporting in ESR_EL3
AArch64 state	OSLAR_EL1 , OSLSR_EL1 , OSDLR_EL1 , DBGPRCR_EL1 .	Trapped AArch64 MSR, MRS, or system instruction, using EC value 0x18.
AArch32 state	DBGOSLSR , DBGOSLAR , DBGOSDLR , DBGPRCR .	For accesses using: <ul style="list-style-type: none"> MCR or MRC instructions, trapped MCR or MRC CP14 access, using EC value 0x05. MCRR or MRRC instructions, trapped MCRR or MRRC CP14 access, using EC value 0x0C.

Traps to EL3 of EL2, EL1, and EL0 general System register accesses to debug registers

[MDCR_EL3.TDA](#) enables a trap to EL3 of EL2, EL1, and EL0 System register accesses to those debug System registers that are not mentioned in [Traps to EL3 of EL2, EL1, and EL0 System register accesses to OS-related debug registers](#).

That is, [MDCR_EL3.TDA](#) enables a trap to EL3 of EL2, EL1, and EL0 System register accesses to all debug System registers except both of the following:

- Accesses from AArch64 state to the [OSLAR_EL1](#), [OSLSR_EL1](#), [OSDLR_EL1](#) or [DBGPRCR_EL1](#).
- Accesses from AArch32 state to the [DBGOSLSR](#), [DBGOSLAR](#), [OSDLR_EL1](#) or [DBGPRCR](#).

When `MDCR_EL3.TDA` is:

- 1** EL2, EL1, and EL0 System register accesses to any of the registers shown in [Table D1-73](#) are trapped to EL3.
- 0** EL2, EL1, and EL0 System register accesses to the registers shown in [Table D1-73](#) are not trapped to EL3.

For EL1 and EL0, this trap applies to accesses from both Security states.

[Table D1-73](#) shows how the exceptions are reported in [ESR_EL3](#).

Table D1-73 Accesses trapped to EL3 when `MDCR_EL3.TDA` is 1

Traps from	Trapped accesses	Syndrome reporting in ESR_EL3
AArch64 state	Accesses to the MDRAR_EL1 , MDCCSR_EL0 , MDCCINT_EL1 , DBGDTR_EL0 , DBGDTRRX_EL0 , DBGDTRTX_EL0 , OSDTRRX_EL1 , MDSCR_EL1 , OSDTRTX_EL1 , OSECCR_EL1 , DBGBVR<n>_EL1 , DBGBCR<n>_EL1 , DBGWVR<n>_EL1 , DBGWCR<n>_EL1 , DBGCLAIMSET_EL1 , DBGCLAIMCLR_EL1 , and DBGAUTHSTATUS_EL1 .	Trapped AArch64 MSR, MRS, or system instruction, using EC value 0x18
AArch32 state	Accesses to the DBGDRAR , DBGDSAR , DBGDIDR , DBGDSCRint , DBGDCCINT , DBGDTRRXint , DBGDTRTXint , DBGWFAR , DBGVCR , DBGDSCRext , DBGDTRTXext , DBGDTRRXext , DBGBVR<n> , DBGBCR<n> , DBGBXVR<n> , DBGWCR<n> , DBGWVR<n> , DBGOSLAR , DBGCLAIMSET , DBGCLAIMCLR , DBGAUTHSTATUS , DBGDEVID , DBGDEVID1 , DBGDEVID2 and DBGOSECCR .	For accesses using: <ul style="list-style-type: none"> • MCR or MRC instructions, trapped MCR or MRC CP14 access, using EC value 0x05. • MCRR or MRRC instructions, trapped MCRR or MRRC access, using EC value 0x0C.
	STC accesses to DBGDTRRXint . ^a LDC accesses to DBGDTRTXint . ^a	LDC or STC, trapped LDC or STC access to CP14, using EC value 0x06.

a. If the access would be permitted when `MDCR_EL3.TDA` is 0.

Traps to EL3 of EL2, EL1, and EL0 accesses to Performance Monitors registers

[MDCR_EL3.TPM](#) enables a trap to EL3 of EL2, EL1, and EL0 accesses to Performance Monitors registers:

- 1** EL2, EL1, and EL0 System register accesses to all Performance Monitors registers are trapped to EL3.
- 0** EL2, EL1, and EL0 System register accesses to Performance Monitors registers are not trapped to EL3.

For EL1 and EL0, this trap applies to accesses from both Security states.

[Table D1-74](#) shows the registers for which accesses are trapped to EL3, and how the exceptions are reported in [ESR_EL3](#).

Table D1-74 Register accesses trapped to EL3 when [MDCR_EL3.TPM](#) is 1

Traps from	Registers	Syndrome reporting in ESR_EL3
AArch64 state	All of the following registers, unless the register description states that the register encoding is UNALLOCATED. PMCR_EL0 , PMCNTENSET_EL0 , PMCNTENCLR_EL0 , PMOVSCLR_EL0 , PMSWINC_EL0 , PMSELR_EL0 , PMCEID0_EL0 , PMCEID1_EL0 , PMCCNTR_EL0 , PMXEVTYPER_EL0 , PMXEVCNTR_EL0 , PMUSERENR_EL0 , PMINTENSET_EL1 , PMINTENCLR_EL1 , PMOVSSET_EL0 , PMEVCNTR<n>_EL0 , PMEVTYPER<n>_EL0 , PMCCFILTR_EL0 .	Trapped AArch64 MSR, MRS, or system instruction, using EC value 0x18
AArch32 state	All of the following registers, unless the register description indicates that the attempted access is UNDEFINED. PMCR , PMCNTENSET , PMINTENCLR , PMOVS , PMSWINC , PMSELR , PMCEID0 , PMCEID1 , PMCCNTR , PMXEVTYPER , PMXEVCNTR , PMUSERENR , PMINTENSET , PMINTENCLR , PMOVSSET , PMEVCNTR<n> , PMEVTYPER<n> , PMCCFILTR .	Trapped MCR or MRC CP15 access, using EC value 0x03

D1.16 System calls

A system call is generated by the execution of an SVC, HVC, or SMC instruction:

- The SVC instruction generates a Supervisor Call exception. This provides a mechanism for software executing at EL0 to make a call to an operating system or other software executing at EL1.
- In an implementation that includes EL3, the SMC instruction generates a Secure Monitor Call exception, but only if execution is at EL1 or higher.
Software executing at EL0 cannot directly generate a Secure Monitor Call exception.
- In an implementation that includes EL2, the HVC instruction generates a Hypervisor Call exception, but only if executed in Non-secure state at EL1 or higher.
Software executing at EL0 cannot directly generate a Hypervisor Call exception.

D1.17 Use of the ESR_EL1, ESR_EL2, and ESR_EL3

An [ESR_ELx](#) holds the syndrome information for an exception that is taken to AArch64 state.

———— **Note** ————

This is also the reporting model used for exceptions taken to Hyp mode when they are taken to EL2 using AArch32.

The general format of the [ESR_ELx](#) registers is:

EC, bits[31:26]

The Exception class field, that indicates the cause of the exception.

IL, bit[25] The Instruction length bit, for synchronous exceptions, encoded as follows:

- | | |
|----------|---|
| 0 | 16-bit trapped instruction. |
| 1 | 32-bit trapped instruction. This value is also used when the exception is one of the following: |
- An SError interrupt.
 - An Instruction Abort exception.
 - A Misaligned PC exception.
 - A Misaligned Stack Pointer exception.
 - A Data abort exception, for which the value of the ISV bit is 0.
 - An Illegal Execution State exception.
 - Any debug exception except for Software Breakpoint Instruction exceptions.

———— **Note** ————

For Software Breakpoint Instruction exceptions this bit has its standard meaning:

- | | |
|----------|---|
| 0 | 16-bit T32 BKPT instruction. |
| 1 | 32-bit A32 BKPT instruction or A64 BRK instruction. |
- An exception reported using EC value 0x00.

ISS, bits[24:0] The Instruction specific syndrome field. Architecturally, this field can be defined independently for each defined Exception class. However, in practice, some ISS encodings are used for more than one Exception class.

Typically, an ISS encoding has a number of subfields. When an ISS subfield holds a register number, the value returned in that subfield is the AArch64 view of the register number, even if the reported exception was taken from AArch32 state. If the register number is AArch32 register R15, then:

- If the instruction that generated the exception was not UNPREDICTABLE, the subfield takes the value 0b11111.
- If the instruction that generated the exception was UNPREDICTABLE, the subfield takes an UNKNOWN value that must be either:
 - The AArch64 view of the register number of a register that might have been used at the Exception level from which the exception was taken.
 - The value 0b11111.

When the EC field is 0x00, indicating an exception with an unknown reason, the ISS field is not valid, RES0.

Figure D1-2 on page D1-1513 shows the format of the [ESR_ELx](#) registers.

For some ISS encodings, register bits[24:20] hold the condition code for the instruction that generated the exception, and a condition code valid bit. The ISS encoding descriptions indicate when this is the case, and [Encoding of ISS\[24:20\] when used for a condition code and valid bit](#) on page D1-1516 describes the encoding of those bits.

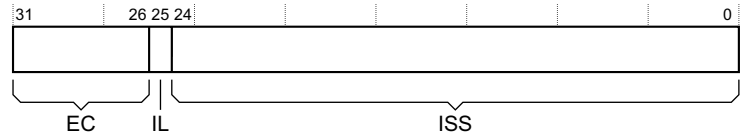

Figure D1-2 Overall format of the ESR_ELx registers

Table D1-75 shows the encoding of the ESR_ELx registers exception class field, EC. For each EC value, the table references a subsection that gives information about:

- The cause of the exception, for example the configuration required to enable the trap.
- The encoding of the associated ISS.

Table D1-75 ESR_ELx.EC field encoding

EC	Exception class	From, state		To, Exception level			ISS description, or notes
		AArch32	AArch64	EL1	EL2	EL3	
0x00	Unknown reason	Yes	Yes	Yes	Yes	Yes	Exceptions with an unknown reason on page D1-1517.
0x01	WFI or WFE instruction execution ^a	Yes	Yes	Yes	Yes	Yes	Exception from a WFI or WFE instruction, from AArch32 or AArch64 state on page D1-1518.
0x03	MCR or MRC access to CP15 ^a that is not reported using EC 0x00	Yes	No	Yes	Yes	Yes ^b	Exception from an MCR or MRC access from AArch32 state on page D1-1518.
0x04	MCRR or MRRC access to CP15 ^a that is not reported using EC 0x00	Yes	No	Yes	Yes	Yes ^c	Exception from an MCRR or MRRC access from AArch32 state on page D1-1519.
0x05	MCR or MRC access to CP14 ^a	Yes	No	Yes	Yes	Yes	Exception from an MCR or MRC access from AArch32 state on page D1-1518.
0x06	LDC or STC access to CP14 ^a	Yes	No	Yes	Yes	Yes	Exception from an LDC or STC access to CP14 from AArch32 state on page D1-1520.
0x07	Access to SIMD or floating-point registers ^a , excluding (HCR_EL2.TGE==1) traps	Yes	Yes	Yes	Yes	Yes	Exception from an access to SIMD or floating-point registers, from AArch32 or AArch64 on page D1-1521.
0x08	MCR or MRC access to CP10 that is not reported using EC 0x07. This applies only to ID Group traps ^d	Yes	No	No	Yes	No	Exception from an MCR or MRC access from AArch32 state on page D1-1518.
0x0C	MRRC access to CP14 ^a	Yes	No	Yes	Yes	Yes	Exception from an MCRR or MRRC access from AArch32 state on page D1-1519.
0x0E	Illegal Execution State	Yes	Yes	Yes	Yes	Yes	Exception from an illegal Execution state, misaligned PC, or misaligned stack pointer on page D1-1521.

Table D1-75 ESR_ELx.EC field encoding (continued)

EC	Exception class	From, state		To, Exception level			ISS description, or notes
		AArch32	AArch64	EL1	EL2	EL3	
0x11	SVC instruction execution	Yes	No	Yes	Yes ^e	No	<i>Exception from HVC or SVC instruction execution on page D1-1522.</i>
0x12	HVC instruction execution, when HVC is not disabled	Yes	No	No	Yes	No	
0x13	SMC instruction execution, when SMC is not disabled	Yes	No	No	Yes ^f	Yes	<i>Exception from SMC instruction execution in AArch32 state on page D1-1522.</i>
0x15	SVC instruction execution	No	Yes	Yes	Yes	Yes	<i>Exception from HVC or SVC instruction execution on page D1-1522.</i>
0x16	HVC instruction execution, when HVC is not disabled	No	Yes	No	Yes	Yes	
0x17	SMC instruction execution, when SMC is not disabled	No	Yes	No	Yes ^f	Yes	<i>Exception from SMC instruction execution in AArch64 state on page D1-1523.</i>
0x18	MSR, MRS, or System instruction execution, that is not reported using EC 0x00, 0x01, or 0x07	No	Yes	Yes	Yes	Yes	<i>Exception from MSR, MRS, or System instruction execution in AArch64 state on page D1-1523.</i>
0x20	Instruction Abort from a lower Exception level ^g	Yes	Yes	Yes	Yes	Yes	<i>Exception from an Instruction abort on page D1-1524.</i>
0x21	Instruction Abort taken without a change in Exception level ^g	Yes	Yes	Yes	Yes	Yes	
0x22	Misaligned PC exception	Yes	Yes	Yes	Yes	Yes	<i>Exception from an illegal Execution state, misaligned PC, or misaligned stack pointer on page D1-1521.</i>
0x24	Data Abort from a lower Exception level ^h	Yes	Yes	Yes	Yes	Yes	<i>Exception from a Data abort on page D1-1525.</i>
0x25	Data Abort taken without a change in Exception level ^h	Yes	Yes	Yes	Yes	Yes	
0x26	Stack Pointer Alignment exception	Yes	Yes	Yes	Yes	Yes	<i>Exception from an illegal Execution state, misaligned PC, or misaligned stack pointer on page D1-1521.</i>
0x28	Floating-point exception, if supported	Yes	No	Yes	Yes	No	<i>Floating-point exceptions on page D1-1529.</i>
0x2C	Floating-point exception, if supported	No	Yes	Yes	Yes	Yes	
0x2F	SError interrupt	Yes ⁱ	Yes	Yes	Yes	Yes	<i>SError interrupt on page D1-1530.</i>

Table D1-75 ESR_ELx.EC field encoding (continued)

EC	Exception class	From, state		To, Exception level			ISS description, or notes
		AArch32	AArch64	EL1	EL2	EL3	
0x30	Breakpoint exception from a lower Exception level	Yes	Yes	Yes	Yes ^j	No	<i>Breakpoint exception or Vector Catch exception on page D1-1530.</i>
0x31	Breakpoint exception taken without a change in Exception level	Yes	Yes	Yes	Yes ^j	No	
0x32	Software Step exception from a lower Exception level	Yes	Yes	Yes	Yes ^j	No	<i>Software Step exception on page D1-1532.</i>
0x33	Software Step exception taken without a change in Exception level	Yes	Yes	Yes	Yes ^j	No	
0x34	Watchpoint exception from a lower Exception level	Yes	Yes	Yes	Yes ^j	No	<i>Watchpoint exception on page D1-1531.</i>
0x35	Watchpoint exception taken without a change in Exception level	Yes	Yes	Yes	Yes ^j	No	
0x38	BKPT instruction execution	Yes	No	Yes	Yes ^j	No	<i>Software Breakpoint Instruction exception on page D1-1532.</i>
0x3A	Vector catch exception from AArch32 state	Yes	No	No	Yes ^j	No	<i>Breakpoint exception or Vector Catch exception on page D1-1530.</i>
0x3C	BRK instruction execution	No	Yes	Yes	Yes ^j	Yes ^k	<i>Software Breakpoint Instruction exception on page D1-1532.</i>

- a. Exceptions caused by configurable traps, enables, or disables.
- b. See *Traps to EL3 of monitor functionality from Secure EL1 using AArch32 on page D1-1500.*
- c. Only for MCRR or MRRC accesses to the PMCCNTR_EL0 or PMCCNTR.
- d. Applies only to traps of accesses to MVFR0, MVFR1, MVFR2, or FPSID. Includes traps of VMRS accesses. Because the registers are read-only, there are no MCR accesses that can be trapped with this EC value.
- e. Only as a result of HCR_EL2.TGE.
- f. Only as a result of HCR_EL2.TSC.
- g. Used for MMU faults generated by instruction accesses, and for synchronous external aborts, including synchronous parity errors. Not used for debug-related exceptions.
- h. Used for MMU faults generated by data accesses, alignment faults other than stack pointer alignment faults, and for synchronous external aborts, including synchronous parity errors. Not used for debug-related exceptions.
- i. In AArch32 state, these are known as Asynchronous aborts.
- j. Only as a result of HCR_EL2.TGE ==1 or MDCR_EL2.TDE ==1.
- k. Only if the BRK instruction is executed in EL3. This is the only debug exception that can be taken to EL3 when EL3 is using AArch64.

All EC encodings not shown in [Table D1-75 on page D1-1513](#) are reserved by ARM.

D1.17.1 Encoding of ISS[24:20] when used for a condition code and valid bit

For EC encodings that are nonzero and have the two most-significant bits 0b00, other than encoding 0x0E, ISS[24:20] provides the condition code field for the trapped instruction, together with a valid flag for the condition code field. The encoding is:

CV, ISS[24] Condition code valid flag. Possible values of this bit are:

- 0** The COND field is not valid.
- 1** The COND field is valid.

COND, ISS[23:20]

The condition code for the trapped instruction. This field is valid only when CV is 1.

If CV is 0, this field is UNK/SBZP.

On a trapped A32 instruction, CV is set to 1 and:

- If the instruction is unconditional, COND is set to 0x0E.
- If the instruction is conditional and known to fail its condition code check, COND is set to the condition code field value from the instruction.
- If the instruction is conditional and known to pass its condition code check, COND is set to either:
 - 0x0E
 - The condition code field value from the instruction.

On a trapped T32 instruction, it is IMPLEMENTATION DEFINED whether:

- CV set to 0 and COND is set to an UNKNOWN value.
- CV set to 1 and COND is set to the condition code for the condition that applied to the instruction.

When CV is 0, software must examine the [SPSR_ELx.IT](#) field to determine the conditionality of a T32 instruction.

Except for unconditional T32 instructions reported with CV set to 0, a trapped unconditional instruction is reported with CV set to 1 and a COND value of 0x0E, the condition code value for unconditional.

For an implementation that, for both A32 and T32 instructions, takes an exception on a trapped conditional instruction only if the instruction passes its condition code check, these definitions mean that when CV is set to 1 it is IMPLEMENTATION DEFINED whether the COND field is set to 0xE, or to the value of any condition that applied to the instruction.

———— **Note** —————

When trapping instructions from an Exception level that is using AArch32, in some circumstances, it is IMPLEMENTATION DEFINED whether a conditional instruction that fails its condition code check generates an Undefined Instruction exception, see [Hyp traps on instructions that fail their condition code check on page G1-3505](#).

D1.17.2 Exceptions with an unknown reason

These are the exceptions reported with an [ESR_ELx.EC](#) value of `0x00`

This encoding indicates an exception with an unknown reason. Any exception not covered by a nonzero EC value defined in [Table D1-75 on page D1-1513](#) returns this value.

When [ESR_ELx.EC](#) returns a value of `0x00`, all other fields of [ESR_ELx](#) are invalid, and defined as follows:

- [IL](#) is set to 1.
- [ISS\[24:0\]](#) is RES0.

An exception with an unknown reason occurs for the following reasons:

- The attempted execution of an instruction bit patterns that has no allocated instruction at the current Exception level, including:
 - A read access using a System register pattern that is not allocated for reads at the current Exception level.
 - A write access using a System register pattern that is not allocated for writes at the current Exception level.
 - Instruction encodings for instructions that are not implemented.
- In Debug state, the attempted execution of an instruction bit pattern that is UNALLOCATED in Debug state.
- In Non-debug state, the attempted execution of an instruction bit pattern that is UNALLOCATED in Non-debug state.
- In AArch32 state, attempted execution of a short vector floating-point instruction.
- An exception generated by any of the [SCTLR_EL1](#).{ITD, SED, CP15BEN, THEE} control bits.
- Attempted execution of:
 - An HVC instruction when disabled by [HCR_EL2.HCD](#) or [SCR_EL3.HCE](#).
 - An SMC instruction when disabled by [SCR_EL3.SMD](#).
 - An HLT instruction when disabled by [EDSCR.HDE](#).
- Attempted execution of an MSR or MRS to [SP_EL0](#) when the value of [SPSel.SP](#) is 0.
- Attempted execution, in Debug state, of:
 - A DCPS1 instruction in Non-secure state from EL0 when the value of [HCR_EL2.TGE](#) is 1.
 - A DCPS2 instruction from EL1 or EL0 when the value of [SCR_EL3.NS](#) is 0, or when EL2 is not implemented.
 - A DCPS3 instruction when the value of [EDSCR.SDD](#) is 1, or when EL3 is not implemented.
- When EL3 is using AArch64, attempted execution of an SRS instruction using R13_mon from Secure EL1. See [Traps to EL3 of monitor functionality from Secure EL1 using AArch32 on page D1-1500](#).
- In Debug state when the value of [EDSCR.SDD](#) is 1, the attempted execution at EL2, EL1, or EL0 of an instruction that is configured to trap to EL3.
- In AArch32 state, the attempted execution of an MRS (Banked register) or an MSR (Banked register) instruction to [SPSR_mon](#), [SP_mon](#), or [LR_mon](#).
- An exception that is taken to EL2 because the value of [HCR_EL2.TGE](#) is 1 that, if the value of [HCR_EL2.TGE](#) was 0 would have been reported with an [ESR_ELx.EC](#) value of `0x07`.

D1.17.3 Exception from a WFI or WFE instruction, from AArch32 or AArch64 state

This is the exception syndrome with EC value 0x01.

It reports exceptions from WFI or WFE instructions executed in either Execution state that result from configurable traps, enables, or disables.

When ESR_ELx.EC returns this value, the encoding of the ISS field is:



CV, COND, ISS[24:20]

For trapping from AArch32, see [Encoding of ISS\[24:20\] when used for a condition code and valid bit on page D1-1516](#).

Note

Conditional WFE and WFI instructions that fail their condition code check do not cause an exception.

For trapping from AArch64, this field returns 0x1E.

ISS[19:1] RES0.

Trapped instruction, ISS[0]

Indicates the trapped instruction. The possible values of this bit are:

- 0** WFI trapped.
- 1** WFE trapped.

The following sections describe configuration settings for generating this exception:

- [Trapping to EL1 using AArch64 on page D1-1462](#).
- [Traps to EL2 of Non-secure EL1 and EL0 execution of WFE and WFI instructions on page D1-1488](#).
- [Traps to EL3 of monitor functionality from Secure EL1 using AArch32 on page D1-1500](#).

D1.17.4 Exception from an MCR or MRC access from AArch32 state

These are the exception syndromes with the following EC values:

- 0x03, MRC or MCR access to CP15.
- 0x05, MRC or MCR access to CP14.
- 0x08, MRC or VMRS access to CP10.

These report exceptions from MRC, MCR, or VMRS instructions executed in AArch32 state that result from configurable traps, enables, or disables and are not reported using the EC code of 0x00.

When ESR_ELx.EC returns one of these values, the encoding of the ISS field is:

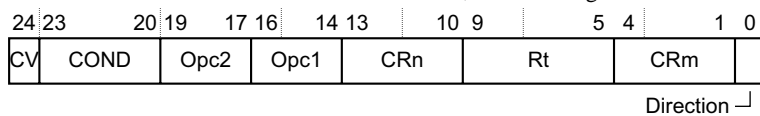

CV, COND, ISS[24:20]

See [Encoding of ISS\[24:20\] when used for a condition code and valid bit on page D1-1516](#).

Opc2, ISS[19:17] The Opc2 value from the issued instruction. For a trapped VMRS access, holds the value 0b000.

Opc1, ISS[16:14] The Opc1 value from the issued instruction. For a trapped VMRS access, holds the value 0b111.

CRn, ISS[13:10] The CRn value from the issued instruction, the coprocessor primary register value. For a trapped VMRS access, holds the reg_field from the VMRS instruction encoding.

Rt, ISS[9:5] The Rt value from the issued instruction, the general purpose register used for the transfer.

CRm, ISS[4:1] The CRm value from the issued instruction. For a trapped VMRS access, hold the value 0b0000.

Direction, ISS[0] Indicates the direction of the trapped instruction. The possible values of this bit are:

- 0** Write to coprocessor. MCR instruction.
- 1** Read from coprocessor. MRC or VMRS instruction.

The following sections describe configuration settings for generating exceptions that are reported using EC value 0x03:

- [Traps to EL2 of Non-secure EL1 and EL0 reads of ID registers on page D1-1485.](#)
- [Traps to EL2 of Non-secure EL1 and EL0 accesses to lockdown, DMA, and TCM operations on page D1-1483.](#)
- [Traps to EL2 of Non-secure EL1 and EL0 execution of cache maintenance instructions on page D1-1480.](#)
- [Traps to EL2 of Non-secure EL1 execution of TLB maintenance instructions on page D1-1479.](#)
- [Traps to EL2 of Non-secure EL1 and EL0 accesses to the Auxiliary Control Register on page D1-1482.](#)
- [Traps to EL2 of Non-secure EL1 and EL0 accesses to Performance Monitors registers on page D1-1497.](#)
- [Trapping to EL2 of Non-secure EL1 accesses to the CPACR_EL1 or CPACR on page D1-1489.](#)
- [Traps to EL2 of Non-secure EL1 accesses to virtual memory control registers on page D1-1476.](#)
- [Generic trapping to EL2 of Non-secure EL1 and EL0 accesses to System registers, from AArch32 state only on page D1-1492.](#)

The following sections describe configuration settings for generating exceptions that are reported using EC value 0x05:

- [Traps to EL2 of Non-secure EL1 and EL0 reads of ID registers on page D1-1485, for trapped accesses to the JIDR.](#)
- [Traps to EL2 of Non-secure EL1 and EL0 accesses to the T32EE configuration registers, from AArch32 state only on page D1-1491.](#)
- [Traps to EL2 of Non-secure EL1 and EL0 System register accesses to Debug ROM registers on page D1-1494.](#)
- [Traps to EL2 of Non-secure EL1 System register accesses to OS-related debug registers on page D1-1495.](#)
- [Traps to EL2 of Non-secure EL1 and EL0 general System register accesses to debug registers on page D1-1495.](#)
- [Traps to EL2 of EL2, and Non-secure EL1 and EL0, System register accesses to the trace registers on page D1-1490.](#)

[Traps to EL2 of Non-secure EL1 and EL0 reads of ID registers on page D1-1485](#) describes configuration settings for generating exceptions that are reported using EC value 0x08.

D1.17.5 Exception from an MCRR or MRRC access from AArch32 state

These are the exception syndromes with the following EC values:

- 0x04, MRRC or MCRR access to CP15.
- 0x0C, MRRC access to CP14.

These report exceptions from MCRR, or MRRC instructions executed in AArch32 state that result from configurable traps, enables, or disables and are not reported using the EC code of 0x00.

When [ESR_ELx.EC](#) returns one of these values, the encoding of the ISS field is:

24	23	20	19	16	15	14	10	9	5	4	1	0
CV	COND		Opc1		(0)	Rt2	Rt		CRm			

Direction ↴

CV, COND, ISS[24:20]

See [Encoding of ISS\[24:20\] when used for a condition code and valid bit on page D1-1516.](#)

Opc1, ISS[19:16] The Opc1 value from the issued instruction.

ISS[15] RES0.

- Rt2, ISS[14:10]** The Rt2 value from the issued instruction, one of the general-purpose registers for the transfer.
- Rt, ISS[9:5]** The Rt value from the issued instruction, one of the general-purpose registers for the transfer.
- CRm, ISS[4:1]** The CRm value from the issued instruction, the coprocessor primary register value.
- Direction, ISS[0]** Indicates the direction of the trapped instruction. The possible values of this bit are:
 - 0** Write to coprocessor, MCRR instruction.
 - 1** Read from coprocessor, MRRC instruction.

The following sections describe configuration settings for generating exceptions that are reported using EC value 0x04:

- [Traps to EL2 of Non-secure EL1 accesses to virtual memory control registers on page D1-1476.](#)
- [Generic trapping to EL2 of Non-secure EL1 and ELO accesses to System registers, from AArch32 state only on page D1-1492.](#)

The following sections describe configuration settings for generating exceptions that are reported using EC value 0x0C:

- [Traps to EL2 of Non-secure EL1 and ELO System register accesses to Debug ROM registers on page D1-1494.](#)
- [Traps to EL2 of EL2, and Non-secure EL1 and ELO, System register accesses to the trace registers on page D1-1490.](#)

D1.17.6 Exception from an LDC or STC access to CP14 from AArch32 state

This is the exception syndrome with EC value 0x06.

This reports exceptions from LDC, or STC instructions executed in AArch32 state that result from configurable traps, enables, or disables.

When [ESR_ELx.EC](#) returns this value, the encoding of the ISS field is:

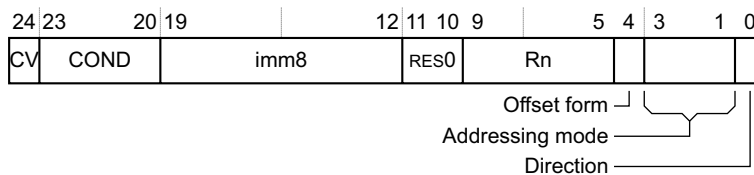

ISS[24:20] See [Encoding of ISS\[24:20\] when used for a condition code and valid bit on page D1-1516.](#)

imm8, ISS[19:12] The immediate value from the issued instruction.

ISS[11:10] RES0.

Rn, ISS[9:5] The Rn value from the issued instruction. Valid only when the Direction field is 0, indicating a trapped STC instruction.

When the Direction field is 1, indicating a trapped LDC instruction, this field is RES0.

Offset form, ISS[4] Indicates whether the offset is added or subtracted:

- 0** Subtract offset.
- 1** Add offset.

This bit corresponds to the U bit in the instruction encoding.

Addressing mode, ISS[3:1]

The permitted values of this field are:

- 0b000 Immediate unindexed.
- 0b001 Immediate post-indexed.

- 0b010 Immediate offset.
 - 0b011 Immediate pre-indexed.
 - 0b100 Literal unindexed.
A32 instruction set only.
For a trapped LDC or STC T32 instruction, this encoding is reserved.
 - 0b101 Reserved.
 - 0b110 Literal offset.
For the STC instruction, valid only in the A32 instruction set.
For a trapped STC T32 instruction, this encoding is reserved.
 - 0b111 Reserved.
- ISS[3] indicates the instruction form, immediate or literal. See the description of ISS[8:5].
ISS[2:1] correspond to the bits {P, W} in the instruction encoding.

Direction, ISS[0] Indicates the direction of the trapped instruction. The possible values of this bit are:

- 0** Write to coprocessor, STC instruction.
- 1** Read from coprocessor, LDC instruction.

———— **Note** —————

The only architected uses of these instructions to access CP14 are:

- An STC to write to [DBGDTRRX_EL0](#) or [DBGDTRRXint](#).
- An LDC to read [DBGDTRTX_EL0](#) or [DBGDTRTXint](#).

Traps to EL2 of Non-secure EL1 and EL0 general System register accesses to debug registers on page D1-1495 describes the configuration settings for generating the exception that is reported using EC value 0x06.

D1.17.7 Exception from an access to SIMD or floating-point registers, from AArch32 or AArch64

This is the exception syndrome with EC value 0x07.

This reports exceptions from accesses to the SIMD and floating-point register bank, or to SIMD and floating-point System registers, from either Execution state, that result from configurable traps, enables, other than exceptions that occur because the value of [HCR_EL2.TGE](#) is 1.

When [ESR_ELx.EC](#) returns this value, the encoding of the ISS field is:

24	23	20	19							0
CV	COND	RES0								

CV, COND, ISS[24:20]

For trapping from AArch32, see [Encoding of ISS\[24:20\] when used for a condition code and valid bit on page D1-1516](#).

For trapping from AArch64 this field returns 0x1E.

ISS[19:0] RES0.

General trapping to EL2 of Non-secure EL1 and EL0 accesses to the SIMD and floating-point registers on page D1-1489 describes the configuration settings for generating the exception that is reported using EC value 0x07.

D1.17.8 Exception from an illegal Execution state, misaligned PC, or misaligned stack pointer

These are the exception syndromes with the following EC values:

- 0x0E, Illegal Execution state.
- 0x22, Misaligned PC.
- 0x26, Misaligned stack pointer.

When [ESR_ELx.EC](#) returns one of these values, the ISS field does not return any syndrome information and the encoding of the ISS field is:

ISS[24:0] RES0.

There are no configuration settings for generating Illegal Execution State exceptions and Misaligned PC exceptions. [Stack pointer alignment checking on page D1-1424](#) describes the configuration settings for generating Misaligned Stack Pointer exceptions.

D1.17.9 Exception from HVC or SVC instruction execution

These are the exception syndromes with the following EC values:

- 0x11, SVC instruction executed in AArch32 state.
- 0x12, HVC instruction executed, when not disabled, in AArch32 state.
- 0x15, SVC instruction executed in AArch64 state.
- 0x16, HVC instruction executed, when not disabled, in AArch64 state.

When [ESR_ELx.EC](#) returns one of these values, the encoding of the ISS field is:

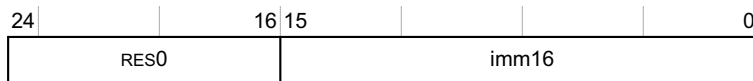

ISS[24:16] RES0.

imm16, ISS[15:0] The value of the immediate field from the executed instruction.

For an SVC instruction executed in AArch32 state:

- If the instruction is unconditional:
 - For the 16-bit T32 instruction, this field is zero-extended from the imm8 field of the instruction
 - For the A32 instruction, this field is the bottom 16 bits of the imm24 field of the instruction
- If the instruction is conditional, this field is UNKNOWN.

———— **Note** —————

In AArch32 state, the HVC instruction is unconditional, and a conditional SVC instruction generates an exception only if it passes its condition code check. Therefore, the syndrome information for these exceptions does not include conditionality information.

See [SVC on page C5-748](#) and [HVC on page C5-485](#).

D1.17.10 Exception from SMC instruction execution in AArch32 state

This is the exception syndrome with EC value 0x13.

This reports the exception from an SMC that is not disabled and is executed in AArch32 state.

When [ESR_ELx.EC](#) returns this value, the ISS field does not return any syndrome information, and the encoding of the ISS field is:

ISS[24:0] RES0.

———— **Note** —————

- An SMC instruction that fails its condition code check cannot generate this exception. Therefore, the syndrome information does not include conditionality information.
- The value of ISS[24:0] described here is used both:
 - When an SMC instruction is trapped from Non-secure EL1 modes.

- When an SMC instruction is not trapped, so completes normally and generates an exception that is taken to EL3.

[Traps to EL2 of Non-secure EL1 execution of SMC instructions on page D1-1484](#) describes the configuration settings for trapping SMC instructions from Non-secure EL1 modes.

D1.17.11 Exception from SMC instruction execution in AArch64 state

This is the exception syndrome with EC value 0x17.

This reports the exception from an SMC that is not disabled and is executed in AArch64 state.

When `ESR_ELx.EC` returns this value, the encoding of the ISS field is:



ISS[24:16] RES0.

imm16, ISS[15:0] The value of the immediate field from the instruction.

— Note —

The value of ISS[24:0] described here is used both:

- When an SMC instruction is trapped from Non-secure EL1.
- When an SMC instruction is not trapped, so completes normally and generates an exception that is taken to EL3.

[Traps to EL2 of Non-secure EL1 execution of SMC instructions on page D1-1484](#) describes the configuration settings for generating this exception, for instructions executed in Non-secure EL1 modes.

D1.17.12 Exception from MSR, MRS, or System instruction execution in AArch64 state

This is the exception syndrome with the EC value 0x18.

These report exceptions from MSR, MRS, or System instructions executed in AArch64 state that result from configurable traps, enables, or disables and are not reported using the EC codes of 0x00, 0x01, or 0x07.

— Note —

[The System instruction class encoding space on page C4-232](#) identifies the System instructions referred to in this description.

When `ESR_ELx.EC` returns one of these values, the encoding of the ISS field is:

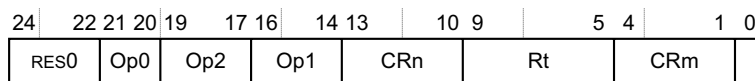

Direction ↵

ISS[24:22] RES0.

ISS[21:20] The Op0 value from the issued instruction.

ISS[19:17] The Op2 value from the issued instruction.

ISS[16:14] The Op1 value from the issued instruction.

ISS[13:10] The CRn value from the issued instruction.

ISS[9:5] The Rt value from the issued instruction, the register used for the transfer.

- ISS[4:1]** The CRm value from the issued instruction.
- ISS[0]** Indicates the direction of the instruction that caused the exception. The possible values of this bit are:
- 0** Write access, including MSR instructions.
 - 1** Read access, including MRS instructions.

For exceptions caused by System instructions, see [System on page C3-174](#) for the encoding values returned by an instruction.

The following sections describe configuration settings for generating the exception that is reported using EC value 0x18:

- [Traps to EL2 of Non-secure EL1 and EL0 reads of ID registers on page D1-1485.](#)
- [Traps to EL2 of Non-secure EL1 and EL0 execution of cache maintenance instructions on page D1-1480.](#)
- [Traps to EL2 of Non-secure EL1 execution of TLB maintenance instructions on page D1-1479.](#)
- [Traps to EL2 of Non-secure EL1 and EL0 accesses to the Auxiliary Control Register on page D1-1482.](#)
- [Traps to EL2 of Non-secure EL1 and EL0 accesses to Performance Monitors registers on page D1-1497.](#)
- [Trapping to EL2 of Non-secure EL1 accesses to the CPACR_EL1 or CPACR on page D1-1489.](#)
- [Traps to EL2 of Non-secure EL1 accesses to virtual memory control registers on page D1-1476.](#)
- [Traps to EL2 of Non-secure EL1 and EL0 System register accesses to Debug ROM registers on page D1-1494.](#)
- [Traps to EL2 of Non-secure EL1 System register accesses to OS-related debug registers on page D1-1495.](#)
- [Traps to EL2 of Non-secure EL1 and EL0 general System register accesses to debug registers on page D1-1495.](#)
- [Traps to EL2 of EL2, and Non-secure EL1 and EL0, System register accesses to the trace registers on page D1-1490.](#)

D1.17.13 Exception from an Instruction abort

These are the exception syndromes with the following EC values:

- 0x20, for an Instruction abort exception taken from a lower Exception level, that could be using AArch64 or AArch32.
- 0x21, for an Instruction abort exception taken without a change in Exception level, meaning it is taken from an Exception level that is using AArch64.

These syndromes are used for MMU faults and synchronous external aborts, including synchronous parity errors, that are generated by instruction accesses. They are not used for Debug exceptions.

When ESR_ELx.EC returns one of these values, the encoding of the ISS field is:

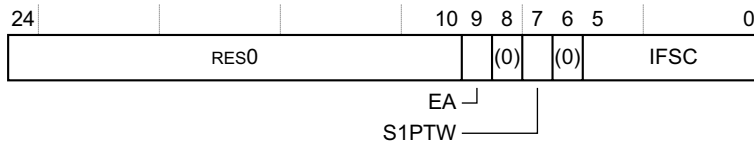

- ISS[24:10]** RES0.
- ISS[9]** EA, External abort type. This bit can provide an IMPLEMENTATION DEFINED classification of synchronous external aborts.
 For any abort other than a synchronous external abort this bit returns a value of 0.
- ISS[8]** RES0.

- ISS[7]** S1PTW. For a stage 2 fault, indicates whether the fault was a fault on the stage 2 translation of an address accessed during a stage 1 translation table walk:
0 . Fault not on a stage 2 translation for a stage 1 translation table walk.
1 . Fault on the stage 2 translation of an access for a stage 1 translation table walk.
For a stage 1 fault, this bit is RES0.
- ISS[6]** RES0.
- ISS[5:0]** IFSC, Instruction fault status code. Indicates the fault that caused the exception, using the codes shown in [Table D1-76](#).

Table D1-76 Fault status codes for Instruction aborts

Fault status	Fault that caused the exception
0b0000LL	Address Size fault. The LL bits indicate the level at which the fault occurred.
0b0001LL	Translation fault. The LL bits indicate the level at which the fault occurred.
0b0010LL	Access Flag fault. The LL bits indicate the level at which the fault occurred.
0b0011LL	Permission fault. The LL bits indicate the level at which the fault occurred.
0b010000	Synchronous External abort.
0b011000	Synchronous Parity error on a memory access.
0b0101LL	Synchronous External abort on a translation table walk. The LL bits indicate the level at which the fault occurred.
0b0111LL	Synchronous Parity error on a memory access on a translation table walk. The LL bits indicate the level at which the fault occurred.
0b100001	Alignment fault.
0b110000	TLB Conflict fault.

D1.17.14 Exception from a Data abort

These are the exception syndromes with the following EC values:

- 0x24, for a Data abort exception taken from a lower Exception level, that could be using AArch64 or AArch32.
- 0x25, for a Data abort exception taken without a change in Exception level, meaning it is taken from an Exception level that is using AArch64.

These syndromes are used for the following exceptions if the exception is generated by a data access:

- MMU faults.
- Alignment faults other than those caused by stack pointer misalignment.
- Synchronous external aborts, including synchronous parity errors.

They are not used for Debug exceptions.

When [ESR_ELx.EC](#) returns one of these values, the encoding of the ISS field is:

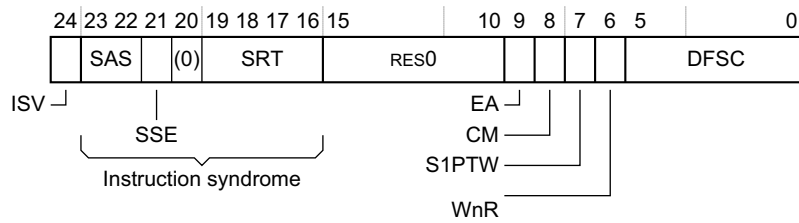

ISV, ISS[24] Instruction syndrome valid. Indicates whether ISS[23:14] provide a valid instruction syndrome, as part of the returned ISS. The possible values of this bit are:

- 0** No valid instruction syndrome. ISS[23:14] are RES0.
- 1** ISS[23:14] hold a valid instruction syndrome.

This bit is 1 only for Data aborts on a stage 2 address translation, reported in the [ELR_EL2](#), for accesses performed:

- In AArch64 state, by a load or store of a single general-purpose register, including a permitted load or store of a stack pointer or a zero register, including Load-Acquire and Store-Release instructions, but excluding:
 - Any instruction that performs register writeback.
 - Any Load-Exclusive or Store-Exclusive instruction.
- In AArch32 state, by an instruction to which all of the following apply:
 - The instruction is an LDA, LDAB, LDAH, LDR, LDRT, LDRSH, LDRSHT, LDRH, LDRHT, LDRSB, LDRSHT, LDRB, LDRBT, STL, STLB, STLH, STR, STRT, STRH, STRHT, STRB or STRBT
 - The instruction is not performing register writeback
 - The instruction is not using the PC as its destination register.

The value of ISV on a synchronous external abort on a stage 2 translation table walk is IMPLEMENTATION DEFINED.

This bit is 0 for:

- All other Data aborts reported in [ELR_EL2](#).
- Any Data abort reported in [ELR_EL1](#) or [ELR_EL3](#).

Note

- For ISS reporting, a stage 2 abort on a stage 1 translation table lookup is treated as a stage 1 Translation fault, and does not return a valid instruction syndrome.
- In the A32 instruction set, LDR*T and STR*T instructions always perform register writeback and therefore never return a valid instruction syndrome.
- A valid instruction syndrome provides information that can help a hypervisor to emulate the instruction efficiently. Instruction syndromes are returned for instructions for which such accelerated emulation is possible.

SAS, ISS[23:22]

Syndrome access size. When the value of ISV is 1, indicates the size of the access attempted by the faulted operation. The possible values of this field are:

- 0b00 Byte.
- 0b01 Halfword.
- 0b10 Word.
- 0b11 Doubleword.

When the value of ISV is 0, this field is RES0.

SSE, ISS[21] Syndrome sign extend. When the value of ISV is 1, for a byte, halfword, or word load operation, indicates whether the data item must be sign extended. For these cases, the possible values of this bit are:

- 0** Sign-extension not required.
- 1** Data item must be sign-extended.

For all other operations, when the value of ISV is 1, this bit is 0.

When the value of ISV is 0, this bit is RES0.

SRT, ISS[20:16]

Syndrome register transfer. When the value of ISV is 1, the value of the Rt operand of the faulting instruction. This specifies:

- The destination register for a load operation.
- The source register for a store operation.

———— **Note** —————

For an exception taken from an Exception level using AArch32, usually software emulating an instruction must consider both the Rt value and the Mode value saved in the SPSR, to determine the physical register to access.

When the value of ISV is 0, this field is RES0.

SF, ISS[15] Sixty-four. When the value of ISV is 1, indicates whether the instruction accessed a 32-bit or 64-bit register. For these cases, the possible values of this bit are:

- 0** Instruction accesses a 32-bit register.
- 1** Instruction accesses a 64-bit register.

———— **Note** —————

This is not the Execution state, but the width of the registers accessed by the instruction, as indicated by the instruction syntax.

When the value of ISV is 0, this bit is RES0.

AR, ISS[14] Acquire/release. When the value of ISV is 1, indicates whether the instruction has acquire/release semantics. For these cases, the possible values of this bit are:

- 0** Instruction did not have acquire/release semantics.
- 1** Instruction had acquire/release semantics.

When the value of ISV is 0, this bit is RES0.

ISS[13:10] RES0.

EA, ISS[9] External abort type. This bit can provide an IMPLEMENTATION DEFINED classification of synchronous external aborts.

For any abort other than a synchronous external abort this bit returns a value of 0.

CM, ISS[8] Cache maintenance. For a synchronous fault, this bit identifies whether the fault came from a cache maintenance or address translation operation. The possible values of this bit are:

- 0** Not a synchronous fault generated by a cache maintenance or address translation operation.
- 1** Synchronous fault generated by a cache maintenance or address translation operation.

For asynchronous faults, and for faults on a DC ZVA instruction, this bit is 0.

S1PTW, ISS[7] For a stage 2 fault, indicates whether the fault was a fault on the stage 2 translation of an address accessed during a stage 1 translation table walk. The possible values of this bit are:

- 0** Fault not a fault on a stage 2 translation for a stage 1 translation table walk.
- 1** Fault on the stage 2 translation of an access for a stage 1 translation table walk.

For all faults other than stage 2 faults, this bit is RES0.

WnR, ISS[6] Indicates whether a synchronous abort was caused by a write or a read operation. The possible values of this bit are:

0 Abort caused by a read operation.
1 Abort caused by a write operation.

For faults on cache maintenance and address translation operations, this bit always returns a value of 1.

———— **Note** —————

ISS[8] is set to 1 on a fault on a cache maintenance or address translation operation.

For an asynchronous abort exception this bit is UNKNOWN.

DFSC, ISS[5:0]

Data fault status code. Indicates the fault that caused the exception, using the codes shown in [Table D1-77](#).

Table D1-77 Fault status codes for Data aborts

Fault status	Fault that caused the exception
0b0000LL	Address size fault. The LL bits indicate the level at which the fault occurred.
0b0001LL	Translation fault. The LL bits indicate the level at which the fault occurred.
0b0010LL	Access flag fault. The LL bits indicate the level at which the fault occurred.
0b0011LL	Permission fault. The LL bits indicate the level at which the fault occurred.
0b010000	Synchronous External abort.
0b011000	Synchronous Parity error on a memory access.
0b0101LL	Synchronous External abort on a translation table walk. The LL bits indicate the level at which the fault occurred.
0b0111LL	Synchronous Parity error on a memory access on a translation table walk. The LL bits indicate the level at which the fault occurred.
0b100001	Alignment fault.
0b110000	TLB Conflict fault.
0b110100	IMPLEMENTATION DEFINED fault, Lockdown abort.
0b110101	IMPLEMENTATION DEFINED fault, Unsupported exclusive.
0b111101	First Level Domain fault ^a , used only for faults reported in the PAR_EL1 , see <i>Domain fault, Short-descriptor format translation tables only on page G3-3656</i> .
0b111110	Second Level Domain fault ^a , used only for faults reported in the PAR_EL1 , see <i>Domain fault, Short-descriptor format translation tables only on page G3-3656</i> .

a. This fault can occur only for the VMSAv8-32 translation scheme, and only when that scheme is using the Short-descriptor translation table format.

D1.17.15 Floating-point exceptions

These are the exception syndromes with the following EC values:

- 0x28, trapped floating-point exception from AArch32.
- 0x2C, trapped floating-point exception from AArch64.

These Exception classes are supported only when the SIMD and floating-point implementation supports the trapping of floating-point exceptions, see *Exception from an access to SIMD or floating-point registers, from AArch32 or AArch64* on page D1-1521. Otherwise, the 0x28 and 0x2C EC values are reserved. That is, these EC values are used to report the floating-point exceptions defined by IEE 754, and input denormal.

When ESR_ELx.EC returns one of these values, the encoding of the ISS field is:

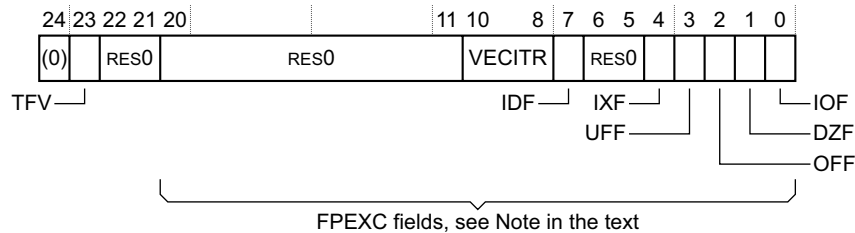

Note

Bits[20:0] correspond to bits[20:0] of the extensions to the FPEXC defined by version 3 of the Common VFP subarchitecture, as defined in the *ARM® Architecture Reference Manual, ARMv7-A and ARMv7-R edition*. However, ARMv8 does not support short vector operations for scalar floating-point instructions, and therefore although the VECITR field retains its subarchitecture name, its meaning is redefined.

ISS[24] RES0.

ISS[23] TFV, Trapped Fault Valid bit. Indicates whether bits[7, 4:0] of the ISS hold valid information about a trapped fault. The possible values of this bit are:

0 ISS[7, 4:0] do not hold valid information about a trapped fault and are UNKNOWN.

1 ISS[7, 4:0] hold valid information about one or more trapped faults. All floating-point exceptions indicated by these bits have occurred since the bits were last cleared to 0.

ISS[22:21] RES0.

ISS[20:11] RES0.

ISS[10:8] VECITR. Whether this field is valid depends on the value of the EC field, as follows:

0x28 Floating-point exception from an AArch32 SIMD instruction.

The VECITR field is RES0.

0x2C Floating-point exception from an AArch64 SIMD instruction.

The VECITR field specifies the source lane number that is being reported in the ESR. This is the vector element that generated the reported floating-point exception, and:

- If the instruction combines two adjacent elements to creating a single element, this field specifies the lower-numbered element. The pairwise instructions such as FPADD are examples of instructions that combine elements in this way.
- If the instruction produces a single value from all the elements of the input vector, the only possible floating-point exceptions are where an input operand causes either an Invalid operation exception because it is a signalling NaN, or an Input denormal exception. In this case the field specifies the element number that is being reported in the ISR. The all-lanes instructions such as FMAXV are examples of instructions that combine elements in this way.

ISS[7, 4:0] Latched floating-point exception bits.

When the TFV bit, [ISS\[23\]](#) on page D1-1529, is 0 these bits are UNKNOWN. Otherwise, the possible values of each bit are:

0 The corresponding floating-point exception has not occurred.

1 The corresponding floating-point exception has occurred since the bit was last set to 0.

When a bit is set to 1, it must be cleared to 0 by the exception-handling routine.

The latched floating-point exception bits, and corresponding floating-point exceptions, are:

ISS[7] IDF, Input Denormal floating-point exception trapped bit.

ISS[4] IXF, Inexact floating-point exception trapped bit.

ISS[3] UFF, Underflow floating-point exception trapped bit.

ISS[2] OFF, Overflow floating-point exception trapped bit.

ISS[1] DZF, Divide-by-zero floating-point exception trapped bit.

ISS[0] IOF, Invalid operation floating-point exception trapped bit.

ISS[6:5] RES0.

In an implementation where the SIMD and floating-point implementation supports the trapping of floating-point exceptions:

- From an Exception level using AArch64, the [FPCR](#).{IDE, IXE, UFE, OFE, DZE, IOE} bits enable each of the floating-point exception traps.
- From an Exception level using AArch32, the [FPSCR](#).{IDE, IXE, UFE, OFE, DZE, IOE} bits enable each of the floating-point exception traps.

D1.17.16 SError interrupt

This is the exception syndrome with EC value 0x2F.

It is used to report the exception caused by an SError interrupt.

When [ESR_ELx](#).EC returns this value, the encoding of the ISS field is:

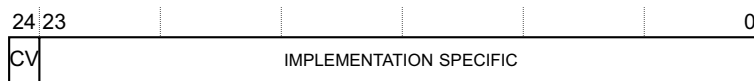

ISS[24] Indicates if the syndrome field is valid. The possible values of this bit are:

0 ISS[23:0] is not valid.

1 ISS[23:0] is valid.

ISS[23:0] The meaning of this field depends on the value of the ISS[24] bit as follows:

ISS[24]==0 RES0.

ISS[24]==1 Provides IMPLEMENTATION SPECIFIC syndrome information.

D1.17.17 Breakpoint exception or Vector Catch exception

These are the exception syndromes with the following EC values:

- 0x30, Breakpoint exception taken from a lower Exception level.
- 0x31, Breakpoint exception taken without a change of Exception level.
- 0x3A, AArch32 Vector Catch exception.

When `ESR_ELx.EC` returns one of these values, the encoding of the ISS field is:

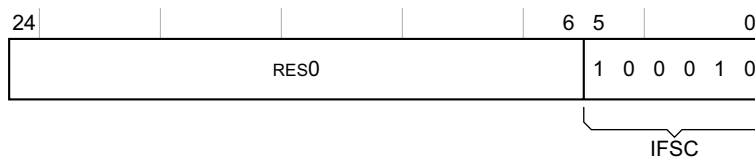

ISS[24:6] RES0.

ISS[5:0] IFSC, Instruction fault status code. Set to `0b100010`, Debug exception.

For more information about generating these exceptions, see:

- [Breakpoint exceptions on page D2-1569](#).
- [Vector Catch exceptions on page D2-1627](#).

D1.17.18 Watchpoint exception

These are the exception syndromes with the following EC values:

- `0x34`, Watchpoint exception taken from a lower Exception level.
- `0x35`, Watchpoint exception taken without a change of Exception level.

When `ESR_ELx.EC` returns one of these values, the encoding of the ISS field is:

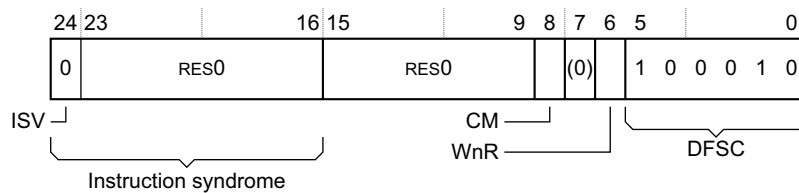

ISS[24] ISV, Instruction syndrome valid. Indicates whether ISS[24:14] provide a valid instruction syndrome, as part of the returned ISS. This field has the value 0, because watchpoints are not stage 2 aborts. This also indicates that ISS[23:14] are RES0.

ISS[23:9, 7] RES0.

ISS[8] CM, Cache maintenance. This bit identifies whether the watchpoint was on a cache maintenance operation. The possible values of this bit are:

- 0** Not a watchpoint generated on cache maintenance operation.
- 1** Watchpoint generated on a cache maintenance operation.

For a watchpoint on a DC ZVA instruction, this bit is 0.

ISS[6] WnR. Indicates whether the watchpointed access was a write or a read operation. The possible values of this bit are:

- 0** Watchpoint on a read operation.
- 1** Watchpoint on a write operation.

For watchpoints on cache maintenance operations, this bit always returns a value of 1.

———— Note ————

ISS[8] is set to 1 on a watchpoint on a cache maintenance operation.

ISS[5:0] DFSC, Data Fault Status Code. Set to `0b100010`, Debug exception.

For more information about generating these exceptions, see [Watchpoint exceptions on page D2-1606](#).

D1.17.19 Software Step exception

These are the exception syndromes with the following EC values:

- 0x32, Software Step exception taken from a lower Exception level.
- 0x33, Software Step exception taken without a change of Exception level.

When ESR_ELx.EC returns one of these values, the encoding of the ISS field is:

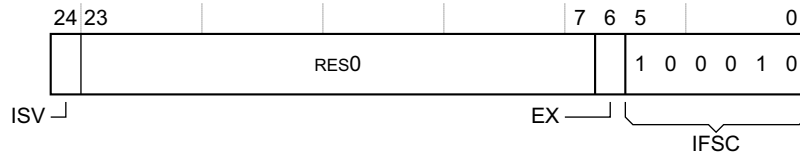

ISS[24] ISV, Instruction syndrome valid. Indicates whether the EX bit, ISS[6], is valid, as follows:

- 0** EX bit is RES0.
- 1** EX bit is valid.

See the ISS[6] description for more information.

ISS[23:7] RES0.

ISS[6] EX. Exclusive operation. Together with the ISV bit, ISS[24], indicates whether the stepped instruction was a Load-Exclusive, as [Table D1-78](#) shows:

Table D1-78 Possible syndrome information for Software Step exceptions

ISV	EX	Meaning
0	0	No syndrome data available
1	0	An instruction other than a Load-Exclusive instruction was stepped
1	1	A Load-Exclusive instruction was stepped

ISS[5:0] IFSC, Instruction fault status code. Set to 0b100010, Debug exception.

For more information about generating these exceptions, see [Software Step exceptions on page D2-1634](#).

D1.17.20 Software Breakpoint Instruction exception

These are the exception syndromes with the following EC values:

- 0x38, BKPT instruction executed in AArch32 state.
- 0x3C, BRK instruction executed in AArch64 state.

When ESR_ELx.EC returns one of these values, the encoding of the ISS field is:

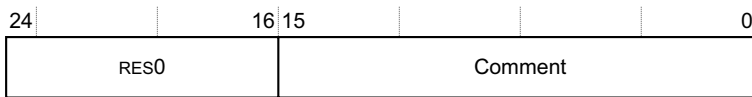

ISS[24:16] RES0.

ISS[15:0] Comment. Set to the instruction comment field, zero-extended as necessary.

For more information about generating these exceptions, see [Software Breakpoint Instruction exceptions on page D2-1566](#).

D1.18 Mechanisms for entering a low-power state

The ARM architecture provides mechanisms that software can use to indicate that the PE can enter a low-power state, if it supports that state. The following sections describe those mechanisms:

- [Wait for Event mechanism and Send event.](#)
- [Wait For Interrupt](#) on page D1-1536.

D1.18.1 Wait for Event mechanism and Send event

A PE can use the *Wait for Event* (WFE) mechanism to enter a low-power state, depending on the value of an Event Register for that PE. To enter the low-power state, the PE executes a Wait For Event instruction, WFE, and if the Event Register is clear, the PE can enter the low-power state.

If the PE does enter the low-power state, it remains in that low-power state until it receives a *WFE wake-up event*.

The architecture does not define the exact nature of the low-power state, except that the execution of a WFE instruction must not cause a loss of memory coherency.

WFE mechanism behavior depends on the interaction of all of the following, that are described in the subsections that follow:

- The Event Register for the PE. See subsection [The Event Register](#) on page D1-1534.
- The Wait For Event instruction, WFE. See subsection [The Wait For Event instruction](#) on page D1-1534.
- *WFE wake-up events*. See subsection [WFE wake-up events in AArch64 state](#) on page D1-1535
- The Send Event instructions, SEV and SEVL that can cause WFE wake-up events. See subsection [The Send Event instructions](#) on page D1-1535.

———— Note —————

Because the Wait for Event mechanism is associated with suspending execution on a PE for the purpose of power saving, ARM recommends that the Event Register is set only infrequently. However, software must only use the setting of the Event Register as a hint, and must not assume that any particular message is sent as a result of the setting of the Event Register.

[Example D1-2](#) describes how a spinlock implementation might use the WFE mechanism to save energy.

Example D1-2 Spinlock as an example of using Wait For Event and Send Event

A multiprocessor operating system requires locking mechanisms to protect data structures from being accessed simultaneously by multiple PEs. These mechanisms prevent the data structures becoming inconsistent or corrupted if different PEs try to make conflicting changes. If a lock is busy, because a data structure is being used by one PE, it might not be practical for another PE to do anything except wait for the lock to be released. For example, if a PE is handling an interrupt from a device, it might need to add data received from the device to a queue. If another PE is removing data from the same queue, it will have locked the memory area that holds the queue. The first PE cannot add the new data until the queue is in a consistent state and the second PE has released the lock. The first PE cannot return from the interrupt handler until the data has been added to the queue, so it must wait.

Typically, a spin-lock mechanism is used in these circumstances:

- A PE requiring access to the protected data attempts to obtain the lock using single-copy atomic synchronization primitives such as the Load-Exclusive and Store-Exclusive operations described in [Synchronization and semaphores](#) on page B2-100.
- If the PE obtains the lock it performs its memory operation and then releases the lock.
- If the PE cannot obtain the lock, it reads the lock value repeatedly in a tight loop until the lock becomes available. When the lock becomes available, the PE again attempts to obtain it.

A spin-lock mechanism is not ideal for all situations:

- In a low-power system the tight read loop is undesirable because it uses energy to no effect.
- In a multi-PE implementation the execution of spin-locks by multiple waiting PEs can degrade overall performance.

Using the Wait For Event and Send Event mechanism can improve the energy efficiency of a spinlock:

- A PE that fails to obtain a lock executes a WFE instruction to request entry to a low-power state, at the time when the exclusive monitor is set holding the address of the location holding the lock.
- When a PE releases a lock, the write to the lock location causes the exclusive monitor of any PE monitoring the lock location to be cleared. This clearing of the exclusive monitors generates a WFE wake-up event for each of those PEs. Then, these PEs can attempt to obtain the lock again.

For large systems, more advanced locking systems, such as ticket locks, can avoid unfairness caused by having multiple PEs simultaneously reading the lock. In such systems, the WFE mechanism can be used in a similar way to monitor the next ticket value.

The Event Register

The Event Register is a single bit register for each PE. When set, an Event Register indicates that an event has occurred since the register was last cleared, that might require some action by the PE. Therefore, when the Event Register is set, the PE must not suspend operation on executing a WFE instruction.

The reset value of the Event Register is UNKNOWN.

The Event Register for a PE is set by any of the following:

- A Send Event instruction, SEV, executed by any PE in the system.
- A Send Event Local instruction, SEVL, executed by the PE.
- The clearing of the global monitor for the PE.
- An exception return.
- An event sent by some IMPLEMENTATION DEFINED mechanism.

The Event Register is cleared only by a Wait For Event instruction.

———— Note —————

Software cannot read or write the value of the Event Register directly.

The Wait For Event instruction

The action of the Wait For Event instruction, WFE, depends on the state of the Event Register:

- If the Event Register is set, the instruction clears the register and completes immediately.
- If the Event Register is clear the PE can suspend execution and enter a low-power state. It remains in that state until the PE detects a WFE wake-up event, or earlier if the implementation chooses, or a until a reset. When the PE detects a WFE wake-up event, or earlier if chosen, the WFE instruction completes. If the wake-up event sets the Event Register, it is IMPLEMENTATION DEFINED whether on restarting execution, the Event Register is cleared.

The WFE is available at all Exception levels. Attempts to enter a low-power state made by software executing at EL0, EL1, or EL2 can be trapped to a higher Exception level. See:

- [Traps to EL1 of EL0 execution of WFE and WFI instructions on page D1-1465.](#)
- [Traps to EL2 of Non-secure EL1 and EL0 execution of WFE and WFI instructions on page D1-1488.](#)
- [Traps to EL3 of EL2, EL1, and EL0 execution of WFE and WFI instructions on page D1-1501.](#)

Note

Software using the Wait For Event mechanism must tolerate spurious wake-up events, including multiple wake-ups.

WFE wake-up events in AArch64 state

The following are WFE wake-up events:

- The execution of an SEV instruction on any PE in the multiprocessor system.
- The execution of an SEVL instruction by the PE.
- An SError interrupt received by the PE, unless masked by [PSTATE.A](#) or [EDSCR.INTdis](#).
- A physical IRQ interrupt received by the PE, unless masked by [PSTATE.I](#) or [EDSCR.INTdis](#).
- A physical FIQ interrupt received by the PE, unless masked by [PSTATE.F](#) or [EDSCR.INTdis](#).
- In Non-secure EL1 or EL1, all of the following:
 - When [HCR_EL2.FMO](#) is 1, a virtual FIQ interrupt, unless masked by [PSTATE.F](#) or [EDSCR.INTdis](#).
 - When [HCR_EL2.IMO](#) is 1, a virtual IRQ interrupt, unless masked by [PSTATE.I](#) or [EDSCR.INTdis](#).
 - When [HCR_EL2.AMO](#) is 1, a virtual SError interrupt, unless masked by [PSTATE.A](#) or [EDSCR.INTdis](#).
- An asynchronous External Debug Request debug event, if halting is allowed. For the definition of halting is allowed, see [Halting allowed and halting prohibited on page H2-4329](#). Also see [External Debug Request debug event on page H3-4380](#).
- An event sent by the timer event stream for the PE. See [Event streams on page D7-1859](#).
- An event caused by the clearing of the global monitor for the PE.
- An event sent by some IMPLEMENTATION DEFINED mechanism.

Not all of these wake-up events set the Event Register.

Note

- [EDSCR.INTdis](#) masking applies only when external debug is disabled.
 - For more information about the masking of physical and virtual interrupts see [Asynchronous exception types, routing, masking and priorities on page D1-1456](#). If the configuration of [HCR_EL2.{AMO, IMO, FMO}](#) or [HCR.{AMO, IMO, FMO}](#), or [SCR_EL3.{EA, TRQ, FIQ}](#), means that a [PSTATE](#) mask bit cannot mask a physical or virtual interrupt, then that interrupt is a WFE wake-up event, regardless of the value of the [PSTATE](#) mask bit.
-

The Send Event instructions

These are:

- | | |
|------|--|
| SEV | Send Event instruction. This causes an event to be signaled to all PEs in the multiprocessor system. |
| SEVL | Send Event Local instruction. This must set the local Event Register. It might signal an event to other PEs, but is not required to do so. |

The mechanism that signals an event to other PEs is IMPLEMENTATION DEFINED. The PE is not required to guarantee the ordering of this event with respect to the completion of memory accesses by instructions before the SEV instruction. Therefore, ARM recommends that software includes a DSB instruction before any SEV instruction.

The SEVL instruction appears to execute in program order relative to any subsequent WFE instruction executed on the same PE, without the need for any explicit insertion of barrier instructions.

———— **Note** ————

A DSB instruction ensures that no instructions, including any SEV instructions, that appear in program order after the DSB instruction, can execute until the DSB instruction has completed. See [Data Synchronization Barrier \(DSB\) on page B2-86](#).

The receipt of a signaled SEV or SEVL event by a PE sets the Event Register on that PE.

The SEV and SEVL instructions are available at all Exception levels.

Pseudocode details of the Wait For Event mechanism

This section defines pseudocode functions that describe the behavior of the Wait For Event mechanism.

The `ClearEventRegister()` pseudocode procedure clears the Event Register of the current PE.

```
ClearEventRegister();
```

The `EventRegistered()` pseudocode function returns TRUE if the Event Register of the current PE is set and FALSE if it is clear:

```
boolean EventRegistered();
```

The `WaitForEvent()` pseudocode procedure optionally suspends execution until a WFE wake-up event or reset occurs, or until some earlier time if the implementation chooses. It is IMPLEMENTATION DEFINED whether restarting execution after the period of suspension causes a `ClearEventRegister()` to occur.

```
WaitForEvent();
```

The `SendEvent()` pseudocode procedure sets the Event Register of every PE in the multiprocessor system.

```
SendEvent();
```

The `EventRegisterSet()` pseudocode procedure sets the event register for this PE.

```
EventRegisterSet();
```

D1.18.2 Wait For Interrupt

Software can use the *Wait for Interrupt* (WFI) instruction to cause the PE to enter a low-power state. The PE then remains in that low-power state until it receives a *WFI wake-up event*, or until some other IMPLEMENTATION DEFINED reason causes it to leave the low-power state. The architecture permits a PE to leave the low-power state for any reason, but requires that it must leave the low-power state on receipt of any architected WFI wake-up event.

———— **Note** ————

Because the architecture permits a PE to leave the low-power state for any reason, it is permissible for a PE to treat WFI as a NOP, but this is not recommended for lowest power operation.

When the PE leaves a low-power state that was entered as a result of a WFI instruction, that WFI instruction completes.

The architecture does not define the exact nature of the low-power state, except that the execution of a WFI instruction must not cause a loss of memory coherency.

Attempts to enter a low-power state made by software executing at EL0, EL1, or EL2 can be trapped to a higher Exception level. See:

- [Traps to EL1 of EL0 execution of WFE and WFI instructions on page D1-1465](#).
- [Traps to EL2 of Non-secure EL1 and EL0 execution of WFE and WFI instructions on page D1-1488](#).
- [Traps to EL3 of EL2, EL1, and EL0 execution of WFE and WFI instructions on page D1-1501](#).

WFI wake-up events

The following are *WFI wake-up events*:

- A SError interrupt, regardless of the value of `PSTATE.A` or `EDSCR.INTdis`.
- A physical IRQ interrupt, regardless of the value of `PSTATE.I` or `EDSCR.INTdis`.
- A physical FIQ interrupt, regardless of the value of `PSTATE.F` or `EDSCR.INTdis`.
- In Non-secure state when executing at EL0 or EL1:
 - When `HCR_EL2.AMO` is 1, a virtual SError interrupt, regardless of the value of `PSTATE.A` or `EDSCR.INTdis`.
 - When `HCR_EL2.IMO` is 1, a virtual IRQ interrupt, regardless of the value of `PSTATE.I` or `EDSCR.INTdis`.
 - When `HCR_EL2.FMO` is 1, a virtual FIQ interrupt, regardless of the value of `PSTATE.F` or `EDSCR.INTdis`.
- An asynchronous External Debug Request debug event, if halting is allowed. For the definition of halting is allowed, see *Halting allowed and halting prohibited* on page H2-4329. Also see *External Debug Request debug event* on page H3-4380.
- An event sent by some IMPLEMENTATION DEFINED mechanism.

Note

- Because debug events are WFI wake-up events, ARM recommends that Wait For Interrupt is used as part of an idle loop rather than waiting for a single specific interrupt event to occur and then moving forward. This ensures that the intervention of debug while waiting does not significantly change the function of the program being debugged.
- The WFI mechanism can be used while interrupts are masked. If it is, then an interrupt is still a WFI wake-up event, but the interrupt is not taken.
- Some implementations of the WFI mechanism drain down any pending memory activity before suspending execution. This increases power saving, by increasing the area over which clocks can be stopped. The architecture does not require this operation, therefore software must not rely on the WFI mechanism operating in this way.

Using WFI to indicate an idle state on bus interfaces

Software can use the WFI mechanism to force quiescence on a PE, and, combined with preventing any possible WFI wakeup events, this can be used to complete an entry into a powerdown state.

Because mechanisms for entering powerdown states are inherently IMPLEMENTATION DEFINED, whether an implementation uses the WFI mechanism is IMPLEMENTATION DEFINED. If it does, the WFI instruction forces the suspension of execution, and of all associated bus activity.

The control logic that does this also tracks the activity on the bus interfaces of the PE, so that when the PE has completed all current operations and any associated bus activity has completed, it can signal to an external power controller that there is no ongoing bus activity.

However, the PE must continue to process memory-mapped and external debug interface accesses to debug registers when in the WFI state. The indication of idle state to the system normally only applies to the non-debug functional interfaces used by the PE, not the debug interfaces.

When the OS Double Lock control, `OSDLR_EL1.DLK`, is 1, the PE must not signal this idle state to the control logic unless it can also guarantee that the debug interface is idle. For more information about the OS Double Lock, see *Debug behavior when the OS Double Lock is locked* on page H6-4432.

Note

In a PE that implements separate core and debug power domains, the debug interface referred to in this section is the interface between the core and debug power domains, since the signal to the power controller indicates that the core power domain is idle. For more information about the power domains see [Power domains and debug on page H6-4425](#).

The exact nature of this interface is IMPLEMENTATION DEFINED, but the use of Wait For Interrupt as the only architecturally-defined mechanism that completely suspends execution makes it very suitable as the preferred powerdown entry mechanism.

Pseudocode details of Wait For Interrupt

The `WaitForInterrupt()` pseudocode procedure optionally suspends execution until a WFI wake-up event or reset occurs, or until some earlier time if the implementation chooses.

D1.19 Self-hosted debug

The ARMv8-A architecture supports both of the following:

Self-hosted debug

The PE itself hosts a debugger. The debugger programs the PE to generate *debug exceptions*. Debug exceptions are accommodated in the ARMv8-A Exception model.

External debug

The PE is controlled by an external debugger. The debugger programs the PE to generate *Halting debug events*, that cause the PE to enter *Debug state*. In Debug state, the PE is halted.

This section describes self-hosted debug. It includes:

- [Debug exceptions](#).
- [The PSTATE debug mask bit, D](#).

For external debug, see part E.

D1.19.1 Debug exceptions

Debug exceptions occur during normal program flow, if a debugger has programmed the PE to generate them.

For example, a software developer might use a debugger contained in an operating system to debug an application. To do this, the debugger might enable one or more debug exceptions.

The possible debug exceptions are:

- Software Breakpoint Instruction exceptions.
- Breakpoint exceptions.
- Watchpoint exceptions.
- Vector Catch exceptions.
- Software Step exceptions.

[Chapter D2 Debug Exceptions](#) describes these in detail.

For the PE to generate a debug exception requires that:

- The debug exception is enabled. [The debug exceptions enable controls on page D3-1651](#) gives the controls for the different debug exceptions.
- Debug exceptions are enabled from the current Exception level and Security state. See [Enabling debug exceptions from current Exception level and Security state on page D3-1656](#).

Debug exceptions are synchronous exceptions, and are accommodated in the ARMv8 Exception model.

———— **Note** —————

Breakpoints and Watchpoints can cause entry to Debug state instead of causing debug exceptions. See [Chapter H1 Introduction to External Debug](#).

D1.19.2 The PSTATE debug mask bit, D

As with all other exceptions, when a debug exception is taken, software must take care to avoid generating another instance of an exception within the exception handler, to avoid recursive entry into the exception handler and loss of return state.

To help avoid this, the ARMv8 architecture provides a debug exception mask bit, [PSTATE.D](#), that can mask Watchpoint, Breakpoint, and Software Step exceptions when the target Exception level is the current Exception level.

PSTATE.D is set to 1 on taking an exception. This means that while handling an exception in AArch64 state, Watchpoint, Breakpoint, and Software Step exceptions are masked. This prevents recursive entry at the Exception level that debug exceptions are targeted to.

When execution is in AArch64 state, debug exceptions are also masked implicitly when the target Exception level is lower than the current Exception level.

When the target Exception level is higher than the current Exception level, debug exceptions cannot be masked by **PSTATE.D**.

Because debug exceptions are synchronous, the architecture requires that debug exceptions are not generated when **PSTATE.D** is 1. By preventing debug exception generation, debug exceptions cannot be taken at a subsequent time when the Process state D mask bit is cleared to 0.

———— **Note** —————

This differs from the behavior for interrupts, where the **PSTATE.{A, I, F}** mask has the effect of preventing the interrupt from being taken, but instead the interrupt remains pending.

D1.20 Performance Monitors extension

The System registers provide access to a Performance Monitors Unit (PMU), a non-invasive debug resource that provides information about the operation of the PE. The PMU provides:

- A 64-bit cycle counter.
- An IMPLEMENTATION DEFINED number of 32-bit event counters. Each event counter can be configured to count occurrences of a specified event. The events that can be counted are:
 - Architectural and microarchitectural events that are likely to be consistent across many microarchitectures. The PMU architecture uses event numbers to identify an event, and the PMU specification defines which event number must be used for each of these architectural and microarchitectural events.
 - Implementation-specific events. The PMU specification reserves event numbers for implementation-specific events. See [Appendix C Recommendations for Performance Monitors Event Numbers for IMPLEMENTATION DEFINED Events](#).

For more information, see [Chapter D6 The Performance Monitors Extension](#).

D1.21 Interprocessing

Interprocessing is the term used to describe moving between the AArch64 and AArch32 Execution states.

The Execution state can change only on a change of Exception level. This means that the Execution state can change only on taking an exception to a higher Exception level, or returning from an exception to a lower Exception level.

On taking an exception to a higher Exception level, the Execution state either:

- Remains unchanged.
- Changes from AArch32 state to AArch64 state.

On returning from an exception to a lower Exception level, the Execution state either:

- Remains unchanged.
- Changes from AArch64 state to AArch32 state.

———— **Note** —————

If, on taking or returning from an exception, the Exception level remains the same, the Execution state cannot change.

For the description of:

- Exception entry to an Exception level using AArch64, see [Exception entry on page D1-1429](#).
- Exception return from an Exception level using AArch64 state, see [Exception return on page D1-1439](#).
- Exception return to AArch32 state, see [Exception return to an Exception level using AArch32 on page G1-3454](#).

———— **Note** —————

The description in [Handling exceptions that are taken to an Exception level using AArch32 on page G1-3431](#) is outside the scope of interprocessing, because such exceptions must have been taken from an Exception level that is using AArch32, and therefore there is no change of Execution state.

The following sections describe the behavior associated with interprocessing.

- [Register mappings between AArch32 state and AArch64 state](#).
- [State of the general-purpose registers on taking an exception to AArch64 state on page D1-1551](#).
- [SPSR, ELR, and AArch64 SP relationships on changing Execution state on page D1-1552](#).

D1.21.1 Register mappings between AArch32 state and AArch64 state

This section defines the architectural mappings between AArch32 state registers and AArch64 state registers.

The mappings describe:

- For exceptions taken from AArch32 state to AArch64 state, where the AArch32 register content is found.
- For exception returns from AArch64 state to AArch32 state, how the AArch32 register content is derived.

The general model is:

- The AArch32 register contents are situated in the bottom 32 bits of the AArch64 registers.
- In AArch32 state, the upper 32 bits of AArch64 registers are inaccessible and are ignored.

———— **Note** —————

System software that executes in AArch64 state, such as an OS or Hypervisor, can use these mappings for context save and restore, or to interpret and modify the AArch32 registers of an application or virtual machine.

For more information see the following subsections:

- [Mapping of the general-purpose registers between the Execution states.](#)
- [Mapping of the SIMD and floating-point registers between the Execution states on page D1-1544.](#)
- [Mapping of the System registers between the Execution states on page D1-1545.](#)

Mapping of the general-purpose registers between the Execution states

Table D1-79 shows how each of the AArch32 general-purpose registers, R0-R12, SP, and LR, including the banked copies of these registers, maps to an AArch64 general-purpose register.

Table D1-79 Base instruction set register mapping between AArch32 state and AArch64 state

AArch32 register	AArch64 register
R0	X0
R1	X1
R2	X2
R3	X3
R4	X4
R5	X5
R6	X6
R7	X7
R8_usr	X8
R9_usr	X9
R10_usr	X10
R11_usr	X11
R12_usr	X12
SP_usr	X13
LR_usr	X14
SP_hyp	X15
LR_irq	X16
SP_irq	X17
LR_svc	X18
SP_svc	X19
LR_abt	X20
SP_abt	X21
LR_und	X22
SP_und	X23
R8_fiq	X24
R9_fiq	X25

Table D1-79 Base instruction set register mapping between AArch32 state and AArch64 state

AArch32 register	AArch64 register
R10_fiq	X26
R11_fiq	X27
R12_fiq	X28
SP_fiq	X29
LR_fiq	X30

Note

For a description of the banking of AArch32 general-purpose registers R8-R12, SP, and LR, see [AArch32 general-purpose registers, and the PC](#) on page G1-3418.

Mapping of the SIMD and floating-point registers between the Execution states

Table D1-80 shows the mapping between the AArch64 V registers and the AArch32 Q registers.

Table D1-80 SIMD and floating-point register mapping between AArch64 state and AArch32 state

AArch64 register	AArch32 register
V0	Q0
V1	Q1
V2	Q2
.	.
.	.
.	.
V15	Q15

The AArch64 registers V16-V31 are not accessible from AArch32 state.

The mapping between the V, D, and S registers in AArch64 state is not the same as the mapping between the Q, D, and S registers in AArch32 state:

- In AArch64 state, there are:
 - 32 128-bit V registers, V0-V31.
 - 32 64-bit D registers, D0-D31.
 - 32 32-bit S registers, S0-S31.

A smaller register occupies the least-significant bytes of the corresponding larger register. For example, S5 is the least-significant word of D5 and V5. [Figure D1-3](#) shows this mapping.

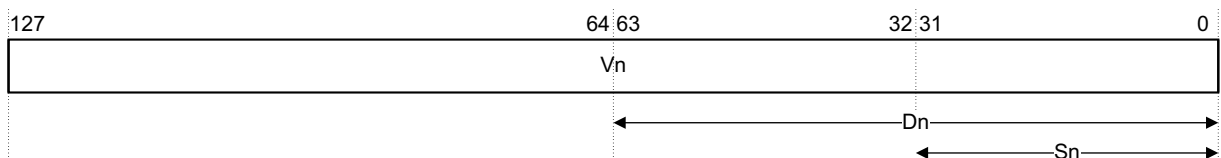

Figure D1-3 AArch64 state SIMD and floating-point register mappings

- In AArch 32 state, there are:
 - 16 128-bit Q registers, Q0-Q15.
 - 32 64-bit D registers, D0-D31.
 - 32 32-bit S registers, S0-S31.

Smaller registers are packed into larger registers. [Figure D1-4](#) shows this mapping.

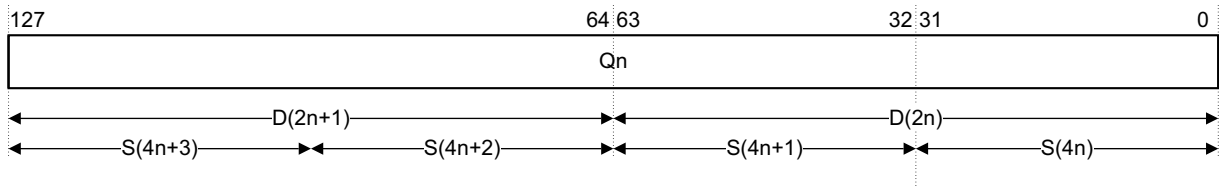

Figure D1-4 AArch32 state SIMD and floating-point register mappings

In AArch32 state:

- There are no S registers that correspond to Q8-Q15.
- D16-D31 pack into Q8-Q15. For example, D16 and D17 pack into Q8.

———— **Note** ————

A consequence of this mapping is that if software executing in AArch64 state interprets D or S registers from AArch32 state, it must unpack the D or S registers from the V registers before it uses them.

Mapping of the System registers between the Execution states

ARMv8 architecturally defines the relationship between the AArch64 System registers and the AArch32 System registers, to allow supervisory code such as a hypervisor, that is executing in AArch64 state, to save, restore, and interpret the System registers belonging to a lower Exception level that is using AArch32.

Any modifications made to AArch32 System registers affects only those parts of those AArch64 registers that are mapped to the AArch32 System registers. Bits[63:32] of AArch64 registers, where they are not mapped to AArch32 registers, are unchanged by AArch32 state execution.

———— **Note** ————

This model is different to the model for the general-purpose registers described in [Mapping of the general-purpose registers between the Execution states on page D1-1543](#). In this model, there are several cases where two AArch32 System registers are packed into a single AArch64 System register.

When EL3 is using AArch32, some System registers are banked between the two Security states. When a register is banked in this way, there is an instance of the register in Secure state, and another instance of the register in Non-secure state. This banking is not supported when EL3 is using AArch64. For the registers that are banked in this way when EL3 is using AArch32, the architected mapping is between the Non-secure AArch32 register and the AArch64 register. This use of the Non-secure instance of the AArch32 register applies in all cases where EL3 is using AArch64 state. This includes execution at EL1 or EL0, using AArch32, in Secure state.

———— **Note** ————

Although the architecture does not require this, because it is not architecturally visible, ARM expects that implementations will map many of the AArch64 registers for use by EL3 to the Secure instances of banked AArch32 registers. However, if EL2 and EL3 are implemented and both support use of AArch32, this is not possible for the following registers:

- IFAR** This is because when EL3 is using AArch32, **HIFAR** is an alias of the Secure **IFAR**.
- DFAR** This is because when EL3 is using AArch32, **HDFAR** is an alias of the Secure **DFAR**.

Table D1-81 shows the mappings between the writable AArch64 System registers and the AArch32 System registers.

Table D1-81 Mapping of writable AArch64 System registers to the AArch32 System registers

AArch64 register	AArch32 register
ACTLR_EL1	ACTLR ^a , Non-secure
AFSR0_EL1	ADFSR ^a , Non-secure
AFSR1_EL1	AIFSR ^a , Non-secure
AMAIR_EL1[31:0]	AMAIRO ^a , Non-secure
AMAIR_EL1[63:32]	AMAIR1 ^a , Non-secure
CONTEXTIDR_EL1	CONTEXTIDR ^a , Non-secure
CPACR_EL1	CPACR
CSSELR_EL1	CSSELR ^a , Non-secure
DACR32_EL2	DACR ^a , Non-secure
FAR_EL1[31:0]	DFAR ^a , Non-secure
ESR_EL1	DFSR ^a , Non-secure
HACR_EL2	HACR
ACTLR_EL2	HACTLR
AFSR0_EL2	HADFSR
AFSR1_EL2	HAIFSR
AMAIR_EL2[31:0]	HAMAIRO
AMAIR_EL2[63:32]	HAMAIR1
CPTR_EL2	HCPTR
HCR_EL2[31:0]	HCR
HCR_EL2[63:32]	HCR2
MDCR_EL2	HDCR
FAR_EL2[31:0]	HDFAR
FAR_EL2[63:32]	HIFAR
MAIR_EL2[31:0]	HMAIRO
MAIR_EL2[63:32]	HMAIR1
HPFAR_EL2[31:0]	HPFAR
SCTLR_EL2	HSCTLR
ESR_EL2	HSR
HSTR_EL2	HSTR
TCR_EL2	HTCR

Table D1-81 Mapping of writable AArch64 System registers to the AArch32 System registers

AArch64 register	AArch32 register
TPIDR_EL2[31:0]	HTPIDR
TTBR0_EL2	HTTBR
VBAR_EL2[31:0]	HVBAR
FAR_EL1[63:32]	IFAR ^a , Non-secure
IFSR32_EL2	IFSR ^a , Non-secure
MAIR_EL1[63:32]	NMRR or MAIR1 ^a , Non-secure
PAR_EL1	PAR ^a , Non-secure
MAIR_EL1[31:0]	PRRR or MAIR0 ^a , Non-secure
RMR_EL1	RMR (at EL1)
RMR_EL2	HRMR
RMR_EL3	RMR (at EL3)
SCTLR_EL1	SCTLR ^a , Non-secure
SDER32_EL3	SDER
TEECR32_EL1	TEECR
TEEHBR32_EL1	TEEHBR
TPIDR_EL1[31:0]	TPIDRPRW ^a , Non-secure
TPIDRRO_EL0[31:0]	TPIDRURO ^a , Non-secure
TPIDR_EL0[31:0]	TPIDRURW ^a , Non-secure
TCR_EL1[31:0]	TTBCR ^a , Non-secure
TTBR0_EL1	TTBR0 ^a , Non-secure
TTBR1_EL1	TTBR1 ^a , Non-secure
VBAR_EL1[31:0]	VBAR ^a , Non-secure
VMPIDR_EL2[31:0]	VMPIDR
VPIDR_EL2	VPIDR
VTCR_EL2	VTCR
VTTBR_EL2	VTTBR
Timer registers	
CNTFRQ_EL0	CNTFRQ
CNTHCTL_EL2	CNTHCTL
CNTHP_CTL_EL2	CNTHP_CTL
CNTHP_CVAL_EL2[63:0]	CNTHP_CVAL
CNTHP_TVAL_EL2	CNTHP_TVAL

Table D1-81 Mapping of writable AArch64 System registers to the AArch32 System registers

AArch64 register	AArch32 register
CNTKCTL_EL1	CNTKCTL
CNTP_CTL_EL0	CNTP_CTL ^a , Non-secure
CNTP_CVAL_EL0[63:0]	CNTP_CVAL ^a , Non-secure
CNTP_TVAL_EL0	CNTP_TVAL ^a , Non-secure
CNTPCT_EL0[63:0]	CNTPCT
CNTV_CTL_EL0	CNTV_CTL
CNTV_CVAL_EL0[63:0]	CNTV_CVAL
CNTV_TVAL_EL0	CNTV_TVAL
CNTVCT_EL0[63:0]	CNTVCT
CNTVOFF_EL2[63:0]	CNTVOFF
Debug System registers	
DBGAUTHSTATUS_EL1	DBGAUTHSTATUS
DBGBCR<n>_EL1	DBGBCR<n>
DBGBVR<n>_EL1[31:0]	DBGBVR<n>
DBGBVR<n>_EL1[63:32]	DBGXVR<n>
DBGCLAIMCLR_EL1	DBGCLAIMCLR
DBGCLAIMSET_EL1	DBGCLAIMSET
DBGDTR_EL0	DBGDTRRXint or the DBGDTRTXint
DBGDTRRX_EL0	DBGDTRRXint
DBGDTRTX_EL0	DBGDTRRXint
DBGPRCR_EL1	DBGPRCR
DBGVCR32_EL2	DBGVCR
DBGWCR<n>_EL1	DBGWCR<n>
DBGWVR<n>_EL1[31:0]	DBGWVR<n>
ID_DFR0_EL1	ID_DFR0
MDCCSR_EL0 ^b	DBGDSCRint ^b
MDCR_EL2	HDCR
MDRAR_EL1	DBGDRAR
MDSCR_EL1 ^b	DBGDSCRExt ^b
OSDLR_EL1	DBGOSDLR
OSDTRRX_EL1 ^b	DBGDTRRXExt ^b
OSDTRTX_EL1 ^b	DBGDTRTXExt ^b

Table D1-81 Mapping of writable AArch64 System registers to the AArch32 System registers

AArch64 register	AArch32 register
OSECCR_EL1	DBGOSECCR
OSLAR_EL1	DBGOSLAR
OSLSR_EL1	DBGOSLSR
SDER32_EL3	SDER
Performance Monitors System registers	
PMCCNTR_EL0[31:0]	PMCCNTR (MRC/MCR)
PMCEID0_EL0	PMCEID0
PMCEID1_EL0	PMCEID1
PMCNTENCLR_EL0	PMCNTENCLR
PMCNTENSET_EL0	PMCNTENSET
PMCR_EL0	PMCR
PMEVCNTR<n>_EL0	PMEVCNTR<n>
PMEVTYPER<n>_EL0	PMEVTYPER<n>
PMINTENCLR_EL1	PMINTENCLR
PMINTENSET_EL1	PMINTENSET
PMOVSLR_EL0	PMOVSRR
PMOVSSR_EL0	PMOVSSR
PMSELR_EL0	PMSELR
PMSWINC_EL0	PMSWINC
PMUSERENR_EL0	PMUSERENR
PMXVCNTR_EL0	PMXVCNTR
PMXEVTYPER_EL0	PMXEVTYPER

- a. As described in this section, AArch32 System register banking between Non-secure and Secure states is supported only when EL3 is using AArch32.
- b. These registers have overlapping register content. One or more bits of one register appear in the other register.

There are a small number of AArch32 System registers that are not mapped to any AArch64 System registers. The AArch64 registers listed in [Table D1-82 on page D1-1550](#) can be used to access these from a higher Exception level that is using AArch64. Of the registers shown in the table:

- [TEECR](#), [TEEHBR](#), [TEECR32_EL1](#), and [TEEHBR32_EL1](#) are UNDEFINED if either:
 - The implementation does not include support for T32EE.
 - Use of T32EE is disabled either because the value of [SCTLR.THEE](#) is 1 or because the value of [SCTLR_EL1.THEE](#) is 1.
- [TEECR32_EL1](#) and [TEEHBR32_EL1](#) are UNDEFINED if EL0 cannot use AArch32.
- The other registers are UNDEFINED if EL1 cannot use AArch32.

Table D1-82 AArch64 registers for accessing registers that are only used in AArch32 state

AArch32 register	AArch64 register provided for accessing the AArch32 register	Short description
DACR	DACR32_EL2	Domain Access Control Register
FPEXC	FPEXC32_EL2	Floating-Point Exception Control Register
IFSR	IFSR32_EL2	Instruction Fault Status Register
SDER	SDER32_EL3	AArch32 Secure Debug Enable Register
TEECR	TEECR32_EL1	ThumbEE Configuration Register
TEEHBR	TEEHBR32_EL1	ThumbEE Handler Base Register

Table D1-83 shows the AArch64 System registers that allow access from AArch64 state to the AArch32 ID registers. These registers are RAZ if no Exception level can use AArch32.

Table D1-83 AArch64 registers that access the AArch32 ID registers

AArch32 register	AArch64 register for access to the AArch32 register	Short description
ID_AFR0	ID_AFR0_EL1	AArch32 Auxiliary Feature Register 0
ID_DFR0	ID_DFR0_EL1	AArch32 Debug Feature Register 0
ID_ISAR0	ID_ISAR0_EL1	EL1, AArch32 Instruction Set Attribute Register 0
ID_ISAR1	ID_ISAR1_EL1	EL1, AArch32 Instruction Set Attribute Register 1
ID_ISAR2	ID_ISAR2_EL1	EL1, AArch32 Instruction Set Attribute Register 2
ID_ISAR3	ID_ISAR3_EL1	EL1, AArch32 Instruction Set Attribute Register 3
ID_ISAR4	ID_ISAR4_EL1	EL1, AArch32 Instruction Set Attribute Register 4
ID_ISAR5	ID_ISAR5_EL1	EL1, AArch32 Instruction Set Attribute Register 5
ID_MMFR0	ID_MMFR0_EL1	AArch32 Memory Model Feature Register 0
ID_MMFR1	ID_MMFR1_EL1	AArch32 Memory Model Feature Register 1
ID_MMFR2	ID_MMFR2_EL1	AArch32 Memory Model Feature Register 2
ID_MMFR3	ID_MMFR3_EL1	AArch32 Memory Model Feature Register 3
ID_PFR0	ID_PFR0_EL1	AArch32 PE Feature Register 0
ID_PFR1	ID_PFR1_EL1	AArch32 PE Feature Register 1

D1.21.2 State of the general-purpose registers on taking an exception to AArch64 state

When an exception is taken from AArch32 state to AArch64 state, the state of a general-purpose register depends on whether, immediately before the exception, the register was accessible from AArch32 state, as follows:

If the general-purpose register was accessible from AArch32 state

The upper 32 bits either become zero, or hold the value that the same architectural register held before any AArch32 execution. The choice between these two options is IMPLEMENTATION DEFINED, and might vary dynamically within an implementation. Correspondingly, software must regard the value as being a CONSTRAINED UNPREDICTABLE choice between these two values.

This behavior applies regardless of whether any execution occurred at the Exception level that was using AArch32. That is, this behavior applies even if AArch32 state was entered by an exception return from AArch64 state, and another exception was immediately taken to AArch64 state without any instruction execution in AArch32 state.

Which general-purpose registers have their upper 32 bits affected in this way depends on both:

- The AArch64 state target Exception level.
- The values of both:
 - [SCR_EL3.RW](#).
 - [HCR_EL2.RW](#) or [HCR.RW](#), where [HCR.RW](#) is a notional bit that is RES0.

[Table D1-84](#) shows which general-purpose registers can have their upper 32 bits set to zero.

Table D1-84 General-purpose registers that can have their upper 32 bits set to zero on taking an exception to AArch64 state from AArch32 state

SCR_EL3.RW	HCR_EL2.RW or HCR.RW ^a	Registers when the target Exception level is:		
		EL3	EL2	EL1
0	0	X0-X30	_b	_b
0	1	_c	_c	_c
1	0	X0-X14, X16-X30	X0-X14, X16-X30	_b
1	1	X0-X14	X0-X14	X0-X14

- a. [HCR.RW](#) is a notional bit that is RES0.
- b. The RW bit values are not valid for the targeted EL.
- c. Not valid because the RW bit values would imply that EL2 is AArch32 and EL1 is AArch64.

Note

If EL2 is not implemented, or the [SCR_EL3.NS](#) or [SCR.NS](#) bit prevents its use, then as described in *The effects of supporting fewer than four Exception levels* on page D1-1556, the behavior is consistent with [HCR_EL2.RW](#) taking the value of [SCR_EL3.RW](#).

If the general-purpose register was not accessible from AArch32 state

The general rule is that the register retains the state it had before any AArch32 execution.

There is one exception to this rule, that is when taking an exception to EL3 using AArch64 when either EL2 is not implemented or EL1 is in Secure state. In these cases, the X15 register must be treated as if it is accessible when the value of [SCR_EL3.RW](#) is 0, and therefore the upper bits of X15 might either be set to zero or retain their previous value.

Which general-purpose registers retain their state depends on both:

- The AArch64 state target Exception level.

- The values of both:
 - [SCR_EL3.RW](#).
 - [HCR_EL2.RW](#) or [HCR.RW](#), where [HCR.RW](#) is a notional bit that is RES0.

[Table D1-85](#) shows which general-purpose registers can retain their state.

Table D1-85 General-purpose registers that can retain their state on taking an exception to AArch64 from AArch32

SCR_EL3.RW	HCR_EL2.RW or HCR.RW ^a	Registers when the target Exception level is:		
		EL3	EL2	EL1
0	0	None	_b	_b
0	1	_c	_c	_c
1	0	X15	X15	_b
1	1	X15-X30	X15-X30	X15-X30

- [HCR.RW](#) is a notional bit that is RES0.
- The RW bit values are not valid for the targeted EL.
- Not valid because the RW bit values would imply that EL2 is AArch32 and EL1 is AArch64.

Note

If EL2 is not implemented, or the [SCR_EL3.NS](#) bit prevents its use, then as described in *The effects of supporting fewer than four Exception levels on page D1-1556*, the behavior is consistent with [HCR_EL2.RW](#) taking the value of [SCR_EL3.RW](#).

D1.21.3 SPSR, ELR, and AArch64 SP relationships on changing Execution state

[Table D1-86](#) shows the SPSR and ELR registers that are architecturally mapped between AArch32 state and AArch64 state.

Table D1-86 SPSR and ELR mappings between AArch32 state and AArch64 state

AArch32 register	AArch64 register
SPSR_svc	SPSR_EL1
SPSR_hyp	SPSR_EL2
ELR_hyp	ELR_EL2

On exception entry to EL3 using AArch64 state from an Exception level using AArch32 state, when EL2 has been using AArch32 state, the upper 32-bits of [ELR_EL2](#) are either set to zero or they retain the value before the AArch32 state execution. The implementation determines the choice between these two options, and the choice might vary dynamically within an implementation. Therefore, software must regard the upper 32-bits as being UNKNOWN.

On exception entry to an Exception level using AArch64 state from an Exception level using AArch32 state, the AArch64 Stack Pointers and Exception Link Registers associated with an Exception level that are not accessible during execution in AArch32 state at that Exception level, retain the state that they had before the execution in AArch32 state.

The following AArch32 registers are used only during execution in AArch32 state. However, they retain their state when there is execution at EL1 with EL1 using AArch64 state:

- [SPSR_abt](#)
- [SPSR_und](#)
- [SPSR_irq](#)
- [SPSR_fiq](#)

Note

- These registers are accessible during execution in AArch64 state at Exception levels higher than EL1, for context switching.
 - If EL1 does not support execution in AArch32 state then these registers are RES0.
-

D1.22 Supported configurations

ARMv8 supports three configuration choices:

- The number of Exception levels implemented.
- Which Exception levels support AArch32 and which Exception levels support AArch64.
- Whether SIMD and floating-point support is implemented.

The following subsections provide further information:

- [Implication of Exception levels implemented.](#)
- [Support for Exception levels and Execution states on page D1-1555.](#)
- [Implementations not including Advanced SIMD and floating-point instructions on page D1-1556.](#)
- [The effects of supporting fewer than four Exception levels on page D1-1556.](#)

D1.22.1 Implication of Exception levels implemented

All implementations must include EL0 and EL1.

EL2 and EL3 are optional. The architecture permits all combinations of EL2 and EL3.

See also [Implementations not including Advanced SIMD and floating-point instructions on page D1-1556](#) and [The effects of supporting fewer than four Exception levels on page D1-1556](#).

For an implementation that includes all of the Exception levels [Figure D1-5](#) shows the implemented Exception levels and the possible Execution states at lower Exception levels when EL3 is using AArch64. [Figure D1-5](#) applies regardless of whether EL3 also supports use of AArch32.

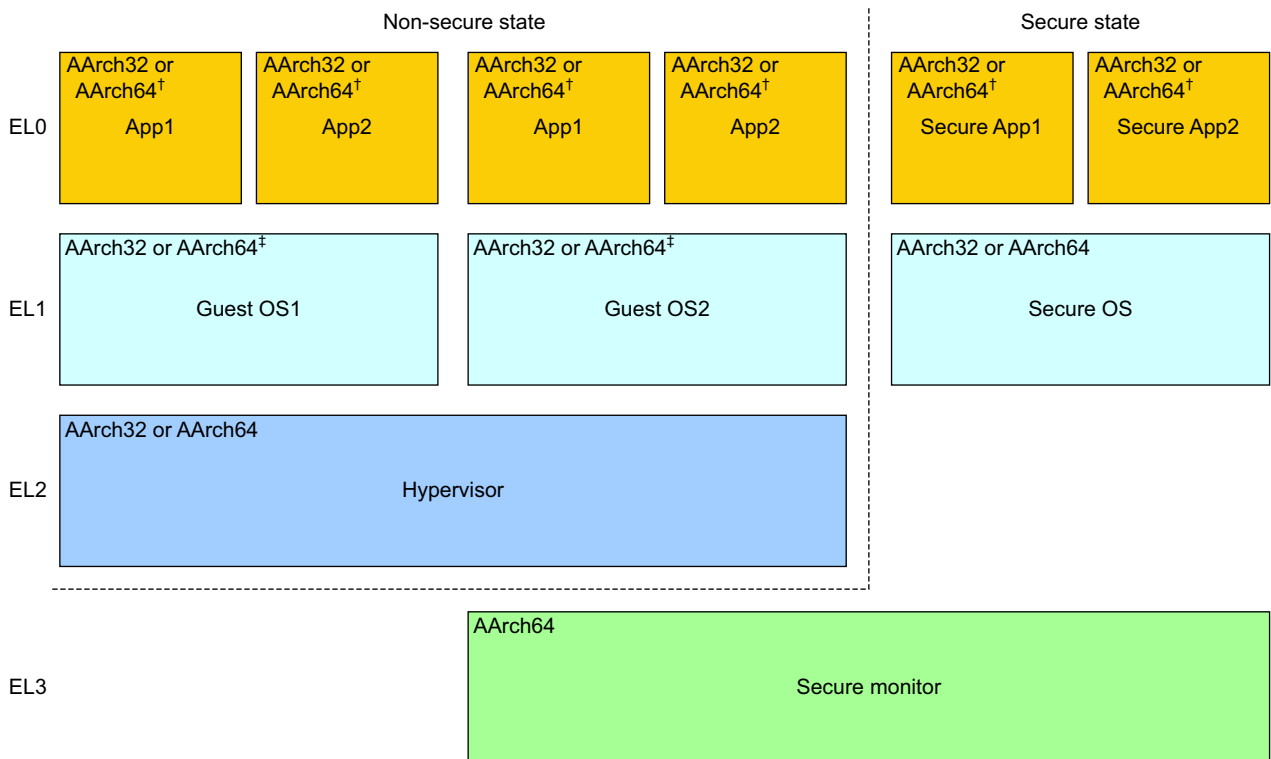

[†] AArch64 permitted only if EL1 is using AArch64

[‡] AArch64 permitted only if EL2 is using AArch64

Figure D1-5 ARMv8-A security model when EL3 is using AArch64

The possible combinations of Exception levels are as follows:

- EL0, EL1, and EL2. The implementation supports only Non-secure state.
- EL0, EL1, and EL3. The implementation does not support Virtualization. The Exception levels and Execution states depend on whether EL3 is using AArch64 state or AArch32 state, as follows:
 - If EL3 is using AArch64, the Exception levels and Execution states are as shown in [Figure D1-5 on page D1-1554](#) with EL2 removed and no Non-secure state virtualization of EL1 and EL0.
 - If EL3 is using AArch32, the Exception levels and Execution states are as shown in [Figure G1-1 on page G1-3408](#) with EL2 removed and no Non-secure state virtualization of EL1 and EL0.
- EL0 and EL1 only. The implementation supports only a single Security state. This might be either Secure state or Non-secure state, see [Behavior when only EL1 and EL0 are implemented on page D1-1557](#).
- EL0, EL1, EL2, and EL3, as described in this section.

For more information, see [The effects of supporting fewer than four Exception levels on page D1-1556](#).

D1.22.2 Support for Exception levels and Execution states

Subject to the interprocessing rules defined in [Interprocessing on page D1-1542](#), an implementation of the ARM architecture could support:

- AArch64 state only.
- AArch64 and AArch32 states.
- AArch32 state only.

This means the ARMv8-A architecture can, potentially, support implementations with very large number of combinations of Execution state and Exception level. ARM intends to license only a subset of the possible combinations [Table D1-87](#) shows the combinations of Exception levels and Execution states that are currently licensed.

Table D1-87 Supported combinations of Exception levels and Execution state

Number of Exception levels	Supported Security states	Exception levels, AArch64 state				Exception levels, AArch32 state			
		EL3	EL2	EL1	EL0	EL3	EL2	EL1	EL0
Four	Both	Yes	Yes	Yes	Yes	Yes	Yes	Yes	Yes
		Yes	Yes	Yes	Yes	No	No	Yes	Yes
		Yes	Yes	Yes	Yes	No	No	No	Yes
		Yes	Yes	Yes	Yes	No	No	No	No
Three	Both	Yes	No	Yes	Yes	No	No	No	Yes
		Yes	No	Yes	Yes	No	No	Yes	Yes
		Yes	No	Yes	Yes	No	No	No	No
	Non-secure only	No	Yes	Yes	Yes	No	No	Yes	Yes
		No	Yes	Yes	Yes	No	No	No	No
Two	Either	No	No	Yes	Yes	No	No	No	Yes
		No	No	Yes	Yes	No	No	No	No

D1.22.3 Implementations not including Advanced SIMD and floating-point instructions

In general, ARMv8-A requires the inclusion of the Floating-point and Advanced SIMD instructions in all instruction sets. Exceptionally, for implementations targeting specialized markets, ARM might produce or license an ARMv8-A implementation that does not provide any support for Floating-point and Advanced SIMD instructions. In such an implementation:

In AArch64 state

- The `CPACR_EL1.FPEN` field is RES0.
- The `CPTR_EL2.TFP` bit is RES1.
- The `CPTR_EL3.TFP` bit is RES1.
- Each of the `ID_AA64PFR0_EL1`.{AdvSIMD, FP} fields is 0b1111.

D1.22.4 The effects of supporting fewer than four Exception levels

[Supported configurations on page D1-1554](#) defines the permitted combinations of Exception levels in an ARMv8-A implementation.

In every implementation that supports the highest Exception level using either AArch64 state or AArch32 state, an IMPLEMENTATION DEFINED mechanism determines whether the highest implemented Exception level uses AArch64 state or AArch32 state from a Cold reset. Typically, this mechanism is a configuration input. When the highest level is configured to be AArch64 state, then after a Cold reset execution starts at the reset vector in that Exception level.

The unimplemented Exception levels have no effect on execution:

- No interrupts are routed to these Exception levels, and no virtual interrupts defined by these Exception levels are active.
- No traps that target these Exception levels are active.
- All systems calls to unimplemented Exception levels from lower Exception levels are treated as UNDEFINED.
- There is no support for address translation from these Exception levels.
- Any exception return that targets an unimplemented Exception level is treated as an illegal exception return as described in [Illegal return events on page D1-1441](#).
- Every accessible register associated with an unimplemented Exception level is RES0 unless the register is associated with the Exception level only to provide the ability to transfer execution to a lower Exception level.

———— Note ————

If, for example, EL3 is not implemented and EL2 is the highest implemented Exception level, then because none of the EL3 registers are accessible from EL2, the content of those registers is not architecturally visible.

The following subsections give more information about each of the permitted combinations of Exception levels that do not include all Exception levels.

Behavior when EL2 is not implemented

If EL2 is not implemented and EL3 is implemented:

- If EL1 can use AArch32 then the following registers are not RES0:
 - `DACR32_EL2`.
 - `IFSR32_EL2`.
 - `FPEXC32_EL2`.
 - `DBGVCR32_EL2`.

- The [VMPIDR_EL2](#) and [VPIDR_EL2](#) are RO and:
 - [VMPIDR_EL2](#) takes the value of [MPIDR_EL1](#).
 - [VPIDR_EL2](#) takes the value of [MIDR_EL1](#).
- Behavior is consistent with the [HCR_EL2.RW](#) bit taking the value of the [SCR_EL3.RW](#) bit for all purposes other than reading the [HCR_EL2](#).
- The following address translation and TLB invalidation instructions are UNDEFINED:
 - [AT S1E2R](#) and [AT S1E2W](#).
 - [TLBI VAE2](#), [TLBI VALE2](#), [TLBI VAE2IS](#), [TLBI VALE2IS](#), [TLBI ALLE2](#), [TLBI ALLE2IS](#).

———— **Note** —————

No other TLB or address translation instructions become UNDEFINED with this combination of Exception levels.

- The [SCR_EL3.HCE](#) bit is RES0.
- The [CNTHCTL_EL2](#)[1:0] bits are treated as if they have the value 0b11 for all purposes other than reading the [CNTHCTL_EL2](#) register.

Behavior when EL3 is not implemented

If EL3 is not implemented and EL2 is implemented, then:

- All memory transactions can only access a single physical memory address space.
- The PE behaves as if the value of the [SCR_EL3.NS](#) bit is 1, even though the [SCR_EL3](#) is not accessible.

This means that if the PE is part of a system that supports two Security states, it behaves as if it is in Non-secure state, and can only access Non-secure memory.

Behavior when only EL1 and EL0 are implemented

If EL3 and EL2 are not implemented, it is IMPLEMENTATION DEFINED whether the PE behaves as if the value of the [SCR_EL3.NS](#) bit is 1 or the PE behaves as if the value of the [SCR_EL3.NS](#) bit is 0.

This means that if the PE is part of a system that supports two Security states:

- If it behaves as if the value of the [SCR_EL3.NS](#) bit is 1, it can only access Non-secure memory.
- If it behaves as if the value of the [SCR_EL3.NS](#) bit is 0, it can access both Secure memory and Non-secure memory.

———— **Note** —————

- The behavior described in this subsection still applies if EL1 is configured to use AArch32.
 - The implementation can provide a configuration input that determines, from reset, whether the it behaves as if the value of the [SCR_EL3.NS](#) bit is 1, or as if the value of the [SCR_EL3.NS](#) bit is 0.
-

Chapter D2

Debug Exceptions

The PE generates *debug exceptions* when it is using self-hosted debug. This chapter describes the different debug exceptions that the PE can generate. It covers behavior in both Execution states, and is organized as follows:

- Introductory information:
 - [Introduction to debug exceptions on page D2-1560.](#)
 - [Legacy debug exceptions on page D2-1564.](#)
 - [Understanding the descriptions for AArch64 state and AArch32 state on page D2-1565.](#)
- The debug exceptions:
 - [Software Breakpoint Instruction exceptions on page D2-1566.](#)
 - [Breakpoint exceptions on page D2-1569.](#)
 - [Watchpoint exceptions on page D2-1606.](#)
 - [Vector Catch exceptions on page D2-1627.](#)
 - [Software Step exceptions on page D2-1634.](#)
- The behavior of self-hosted debug after changes to system registers, or after changes to the authentication interface, but before a *context synchronization operation* (CSO) guarantees the effects of the changes:
 - [Synchronization and debug exceptions on page D2-1647.](#)

D2.1 Introduction to debug exceptions

Debug exceptions occur during normal program flow, if a debugger has programmed the PE to generate them. For example, a software developer might use a debugger contained in an operating system to debug an application. To do this, the debugger might enable one or more debug exceptions. The debug exceptions are:

- Software Breakpoint Instruction exceptions.
- Breakpoint exceptions, generated by hardware breakpoints.
- Watchpoint exceptions, generated by hardware watchpoints.
- Vector Catch exceptions.
- Software Step exceptions.

The PE can only generate a particular debug exception if both:

- A debugger has enabled that particular debug exception.
- Debug exceptions are enabled from the current Exception level and Security state.

The debug exceptions enable controls on page D3-1651 give the enable controls for the different debug exceptions. For a description of when debug exceptions are enabled from the current Exception level and Security state, see *Enabling debug exceptions from current Exception level and Security state on page D3-1656*.

Debug exceptions are accommodated in the ARMv8-A Exception model. This is the basis of self-hosted debug.

If halting is allowed and `EDSCR.HDE` is 1, hardware breakpoints and watchpoints cause entry to Debug state instead of causing debug exceptions. In Debug state, the PE is halted. Only breakpoints and watchpoints can cause entry to Debug state. No other self-hosted debug resource can cause entry to Debug state.

———— Note ————

For the definition of halting is allowed, see *Halting allowed and halting prohibited on page H2-4329*.

The following list summarizes each of the debug exceptions:

Software Breakpoint Instruction exceptions

Breakpoint instructions generate these. Breakpoint instructions are instructions that software developers can use to cause exceptions at particular points in the program flow.

The breakpoint instructions are:

- In the A64 instruction set:
BRK #<immediate>
- In the A32 and T32 instruction sets:
BKPT #<immediate>

Whenever one of these instructions is committed for execution, a Software Breakpoint Instruction exception is generated.

Execution states

Software Breakpoint Instruction exceptions can be generated in both Execution states.

Enable control

None. Software Breakpoint Instruction exceptions are always enabled.

PE behavior

Software Breakpoint Instruction exceptions cannot be masked. The PE takes Software Breakpoint Instruction exceptions regardless of both of the following:

- The current Exception level.
- The current Security state.

For more information, see *Software Breakpoint Instruction exceptions on page D2-1566*.

Breakpoint exceptions

The ARMv8-A architecture provides 2-16 hardware breakpoints. These are resources that software developers can program to generate *Breakpoint exceptions* based on particular instruction addresses, or based on particular PE contexts, or both.

For example, a software developer might program a hardware breakpoint to generate a Breakpoint exception whenever the instruction with address 0x1000 is committed for execution.

Note

A hardware breakpoint can cause entry to Debug state instead of generating a Breakpoint exception. See *PE behavior* later in this section.

The ARMv8-A architecture supports the following types of hardware breakpoint:

- Address:
 - Address Match.
 - Address Mismatch. This type is only supported in an AArch32 stage 1 translation regime.Comparisons are made with the virtual address of each instruction in the program flow.
- Context:
 - Context ID Match. Matches with the Context ID held in the [CONTEXTIDR_EL1](#).
 - VMID Match. Matches with the VMID value held in the [VTTBR_EL2](#).
 - Context ID and VMID Match. Matches with both the Context ID and the VMID value.

An Address breakpoint can link to a Context breakpoint, so that the Address breakpoint only generates a Breakpoint exception if the PE is in a particular context when the address match or mismatch occurs.

In an AArch64 stage 1 translation regime, the smallest address size that an Address breakpoint can match on is a word. In an AArch32 stage 1 translation regime, the smallest address size that an Address breakpoint can match on is a halfword.

A breakpoint generates a Breakpoint exception whenever an instruction that causes a match is committed for execution.

Execution states

Breakpoint exceptions can be generated in both Execution states.

Enable control

[MDSCR_EL1.MDE](#) in AArch64 state, or [DBGDSCRext.MDBGen](#) in AArch32 state, plus an enable control for each breakpoint, [DBGBCR<n>_EL1.E](#).

PE behavior

If halting is allowed and [EDSCR.HDE](#) is 1, hardware breakpoints cause entry to Debug state. That is, they halt the PE. See [Chapter H2 Debug State](#).

Otherwise:

- If debug exceptions are enabled, hardware breakpoints cause Breakpoint exceptions.
- If debug exceptions are disabled, hardware breakpoints are ignored.

For more information, see [Breakpoint exceptions on page D2-1569](#).

Watchpoint exceptions

The ARMv8-A architecture provides 2-16 hardware watchpoints. These are resources that software developers can program to generate Watchpoint exceptions based on accesses to particular data addresses, or based on accesses to any address in a data address range.

For example, a software developer might program a hardware watchpoint to generate a Watchpoint exception on an access to any address in the data address range 0x1000 - 0x101F.

Note

A hardware watchpoint can cause entry to Debug state instead of generating a Watchpoint exception. See [PE behavior on page D2-1562](#) later in this section.

A hardware watchpoint can link to a hardware breakpoint, if the hardware breakpoint is a *Linked Context* type. In this case, the watchpoint only generates a Watchpoint exception if the PE is in a particular context when the address match occurs.

The smallest address size that a watchpoint can be programmed to match on is a byte. A single watchpoint can be programmed to match on one or more bytes.

A watchpoint generates a Watchpoint exception whenever an instruction that initiates an access that causes a match is committed for execution.

Execution states

Watchpoint exceptions can be generated in both Execution states.

Enable control

[MDSR_EL1.MDE](#) in AArch64 state, or [DBGDSCRext.MDBGen](#) in AArch32 state, plus an enable control for each watchpoint, [DBGWCR<n>_EL1.E](#).

PE behavior

If halting is allowed and [EDSCR.HDE](#) is 1, hardware watchpoints cause entry to Debug state. That is, they halt the PE. See [Chapter H2 Debug State](#).

Otherwise:

- If debug exceptions are enabled, hardware watchpoints cause Watchpoint exceptions.
- If debug exceptions are disabled, hardware watchpoints are ignored.

For more information, see [Watchpoint exceptions on page D2-1606](#).

Vector Catch exceptions

These are used to trap exceptions. The ARMv8-A architecture provides two forms of vector catch, *address-matching* and *exception-trapping*. Only one form can be implemented.

To use either form, a debugger must first enable Vector Catch exceptions for one or more exception vectors. The set of vectors that Vector Catch exceptions are enabled for is called the *vector address set*. Generation of Vector Catch exceptions is then as follows:

- For the address-matching form, a Vector Catch exception is generated whenever the virtual address of an instruction matches a vector in the vector address set.
- For the Exception-trapping form, a Vector Catch exception is generated as part of exception entry for exception types that correspond to vectors in the vector address set.

Execution states

Vector Catch exceptions can only be generated in an AArch32 stage 1 translation regime, regardless of which form is implemented. See [Legacy debug exceptions on page D2-1564](#).

Enable control

[MDSR_EL1.MDE](#) or [DBGDSCRext.MDBGen](#).

PE behavior

If debug exceptions are enabled, Vector Catch exceptions can be generated.

If debug exceptions are disabled, vector catch is ignored.

For more information, see [Vector Catch exceptions on page D2-1627](#).

Software Step exceptions

Software step is a resource that a debugger can use to make the PE single-step instructions.

For example, by using software step, debugger software executing at a higher Exception level can debug software executing at a lower Exception level, by making it single-step instructions.

After the software being debugged has single-stepped an instruction, it takes a Software Step exception.

Execution states

Software Step exceptions can be generated in both Execution states. However, software step is inactive if the debugger is executing in an Exception level that is using AArch32.

Enable control

[MDSCR_EL1.SS](#).

PE behavior

If debug exceptions are enabled, Software Step exceptions can be generated.

If debug exceptions are disabled, software step is inactive.

For more information, see [Software Step exceptions on page D2-1634](#).

[Table D2-1](#) summarizes PE behavior and shows where the pseudocode is for each of the debug exceptions.

Table D2-1 PE behavior and pseudocode for each type of debug exception

Debug exception	PE behavior		Pseudocode
	If debug exceptions are enabled	If debug exceptions are disabled	
Software Breakpoint Instruction exceptions	Takes the exception	Takes the exception	page D2-1568
Breakpoint exceptions	Takes the exception ^a	Ignored	page D2-1600
Watchpoint exceptions	Takes the exception ^a	Ignored	page D2-1621
Vector Catch exceptions	Takes the exception	Ignored	page D2-1633
Software Step exceptions	Takes the exception	Not applicable ^b	page D2-1645

- a. If halting is allowed and [EDSCR.HDE](#) is 1, hardware breakpoints and watchpoints cause the PE to enter Debug state instead of causing debug exceptions. See [Chapter H2 Debug State](#).
- b. Software step is inactive when debug exceptions are disabled.

D2.2 Legacy debug exceptions

Legacy debug exceptions are those debug exceptions that can only be generated in an AArch32 translation regime. They are:

- Vector Catch exceptions, regardless of which form is implemented.
- Breakpoint exceptions generated by Address Mismatch breakpoints.
- Breakpoint exceptions generated by any breakpoint type that is programmed to match in AArch32 User, Supervisor, or System modes. See *Execution conditions that a breakpoint generates Breakpoint exceptions for on page D2-1573*.

Because legacy debug exceptions can only be generated in an AArch32 translation regime, they are only supported if at least EL1 using AArch32 is supported.

Table D2-2 shows which Exception levels legacy debug exceptions are enabled from.

Table D2-2 Exception levels that legacy debug exceptions are enabled from

Exception levels using AArch32	EL0	EL1	EL2	EL3
None. The configuration is an AArch64 configuration.	Disabled	Disabled	Disabled	Disabled
EL0 only.	Disabled	Disabled	Disabled	Disabled
EL1 and EL0.	Enabled	Enabled	Disabled	Disabled
EL2, EL1, and EL0.	Enabled	Enabled	Disabled	Disabled
EL3, EL2, EL1, and EL0.	Enabled	Enabled	Disabled	Enabled

For Exception levels that are using an AArch64 stage 1 translation regime, behavior of legacy debug exceptions is as follows:

- Vector Catch exceptions are not generated.
- Address Mismatch breakpoints are evaluated as Address Match breakpoints.
- Breakpoints that are programmed to match only in AArch32 User, Supervisor, and System modes do not generate Breakpoint exceptions.

D2.3 Understanding the descriptions for AArch64 state and AArch32 state

In the sections that follow, including all subsections:

- Where a description is true for PE operation in both Execution states, the description refers to the AArch64 register first, followed by the AArch32 register.

For example:

— “The `DBGBCR<n>_EL1`.{BT, LBN, E} or `DBGBCR<n>`.{BT, LBN, E} fields for a breakpoint define the general properties of that breakpoint.”

In this example, the `DBGBCR<n>_EL1` is the AArch64 register and the `DBGBCR<n>` is the AArch32 register.

- Where a description is true for only AArch64 state, it begins with “In AArch64 state”.
- Where a description is true for only AArch32 state, it begins with “In AArch32 state”.

Each section begins with a list of AArch64 and AArch32 registers referred to in that section.

D2.4 Software Breakpoint Instruction exceptions

The following subsections describe Software Breakpoint Instruction exceptions:

- [About Software Breakpoint Instruction exceptions.](#)
- [Breakpoint instructions in the ARMv8-A architecture.](#)
- [Exception syndrome information provided by the PE on page D2-1567.](#)
- [Breakpoint instructions as the first instruction in an IT block on page D2-1568.](#)
- [Pseudocode description of Software Breakpoint Instruction exceptions on page D2-1568.](#)

D2.4.1 About Software Breakpoint Instruction exceptions

A *breakpoint* is a debug event that results from the execution of an instruction, based on either:

- The instruction address, the PE context, or both. This type of breakpoint is called a *hardware breakpoint*.
- The instruction itself. That is, the instruction is a *breakpoint instruction*. These can be included in the program that the PE executes. This type of breakpoint is called a *software breakpoint*.

Software Breakpoint Instruction exceptions, that this section describes, are software breakpoints. [Breakpoint exceptions on page D2-1569](#) describes hardware breakpoints.

There is no enable control for Software Breakpoint Instruction exceptions. They are always enabled, and cannot be masked.

A Software Breakpoint Instruction exception is generated whenever a breakpoint instruction is committed for execution, regardless of all of the following:

- The current Exception level.
- The current Security state.
- Whether the *debug target Exception level*, EL_D , is using AArch64 or AArch32.

———— **Note** ————

- EL_D is the Exception level that debug exceptions are targeting. [Routing debug exceptions on page D3-1652](#) describes how EL_D is derived.
- Debuggers using breakpoint instructions must be aware of the ARMv8 rules for concurrent modification and execution of instructions. See [Concurrent modification and execution of instructions on page B2-91](#).

D2.4.2 Breakpoint instructions in the ARMv8-A architecture

In the ARMv8-A architecture, the breakpoint instructions are:

- In the A64 instruction set:
BRK #<immediate>
- In the A32 and T32 instruction sets:
BKPT #<immediate>

For details of the A64 BRK instruction encoding, see [BRK on page C5-433](#).

For details of the A32 BKPT and T32 BKPT instruction encodings, see [BKPT on page F7-2575](#).

About whether breakpoint instructions are conditional

A64 BRK and T32 BKPT instructions

Are unconditional. This applies even for T32 BKPT instructions included inside an IT block.

A32 BKPT instructions

If the condition code field is AL, the instruction is unconditional.

If the condition code field is anything other than AL, behavior is CONSTRAINED UNPREDICTABLE, and is one of the following:

- The instruction is UNDEFINED.
- The instruction is treated as a NOP instruction.
- The instruction is executed unconditionally.
- The instruction is executed conditionally.

D2.4.3 Exception syndrome information provided by the PE

If a Software Breakpoint Instruction exception is taken to:

AArch64 state

The PE records the following in the *Exception Syndrome Register* (ESR) at the Exception level the exception is taken to, [ESR_ELx](#):

- The value contained in the immediate field of the breakpoint instruction, in [ESR_ELx.ISS\[15:0\]](#).
- Whether the breakpoint instruction was executed in AArch64 state or AArch32 state, in the *Exception Class* field, [ESR_ELx.EC](#):
 - 0x3C, if the instruction is an A64 BRK instruction.
 - 0x38, if the instruction is an A32 or T32 BKPT instruction.

———— Note —————

If debug exceptions are routed to EL2, it is the exception that is routed, not the instruction that is trapped. Therefore, the value that [ESR_EL2.EC](#) is set to is the same as it would have been if the exception was taken to EL1.

See [Software Breakpoint Instruction exception](#) on page D1-1532.

EL2 when EL2 is using AArch32

The PE records the exception as a Prefetch Abort exception that has been routed to Hyp mode, by setting [HSR.EC](#) to 0x20. The [HSR](#) is the *Hypervisor Syndrome Register*.

See [Reporting exceptions taken to Hyp mode](#) on page G3-3668.

EL1 when EL1 is using AArch32, or EL3 when EL3 is using AArch64

The PE records the exception as a Prefetch Abort exception, by using the *Instruction Fault Status Register* (IFSR). The PE sets [IFSR.FS](#) to 0b0010, to indicate a debug event.

See [Reporting exceptions taken to PL1 modes](#) on page G3-3660.

———— Note —————

For information about how debug exceptions can be routed to EL2, see [Routing debug exceptions](#) on page D3-1652.

D2.4.4 Breakpoint instructions as the first instruction in an IT block

If the first instruction in an IT block is a T32 BKPT instruction, then if the *IT Disable* bit (ITD) associated with the current Exception level is:

- 0** The BKPT instruction generates a Software Breakpoint Instruction exception.
- 1** The combination of IT instruction and BKPT instruction is UNDEFINED. Either the IT instruction or the BKPT instruction generates an Undefined Instruction exception.

To ensure consistent behavior when making the first instruction in one or more IT blocks a BKPT instruction, the debugger must replace the IT instruction.

———— **Note** —————

T32 BKPT instructions are always unconditional, even when they are inside an IT block.

D2.4.5 Pseudocode description of Software Breakpoint Instruction exceptions

AArch64.SoftwareBreakpoint() generates a Software Breakpoint Instruction exception that is taken to AArch64 state.

```
// AArch64.SoftwareBreakpoint()
// =====

AArch64.SoftwareBreakpoint(bits(16) immediate)

    route_to_el2 = (AArch64.GeneralExceptionsToEL2() ||
                  (HaveEL(EL2) && !IsSecure() && MDCR_EL2.TDE == '1'));

    exception = ExceptionSyndrome(Exception_SoftwareBreakpoint);
    exception.syndrome<15:0> = immediate;
    bits(64) preferred_exception_return = ThisInstrAddr();
    vect_offset = 0x0;

    if UInt(PSTATE.EL) > UInt(EL1) then
        AArch64.TakeException(PSTATE.EL, exception, preferred_exception_return, vect_offset);
    elseif route_to_el2 then
        AArch64.TakeException(EL2, exception, preferred_exception_return, vect_offset);
    else
        AArch64.TakeException(EL1, exception, preferred_exception_return, vect_offset);
```

AArch32.BKPTInstrDebugEvent() generates a Prefetch Abort exception that is taken from AArch32 state.

```
// AArch32.BKPTInstrDebugEvent()
// =====

AArch32.BKPTInstrDebugEvent(bits(16) immediate)

    route_to_hyp = (AArch32.GeneralExceptionsToHyp() ||
                  (HaveEL(EL2) && !IsSecure() && HDCR.TDE == '1'));

    if route_to_hyp && !ELUsingAArch32(EL2) then
        AArch64.SoftwareBreakpoint(immediate);

    vaddress = bits(32) UNKNOWN;
    acctype = AccType_IFETCH;           // Take as a Prefetch Abort
    iswrite = FALSE;
    entry = DebugException_BKPT;

    fault = AArch32.DebugFault(acctype, iswrite, entry);
    AArch32.Abort(vaddress, fault);
```

D2.5 Breakpoint exceptions

The following subsections describe Breakpoint exceptions:

- [About Breakpoint exceptions.](#)
- [Enable controls for Breakpoint exceptions on page D2-1571.](#)
- [Conditions for generating a Breakpoint exception on page D2-1572.](#)
- [About Breakpoint Control Registers on page D2-1573.](#)
- [Breakpoint types and linking of breakpoints on page D2-1576.](#)
- [Instruction address comparisons for Breakpoint exception generation on page D2-1582.](#)
- [Specifying the halfword-aligned address that an address comparison is successful on on page D2-1583.](#)
- [Context comparisons for Breakpoint exception generation on page D2-1587.](#)
- [Linked comparisons for Breakpoint exception generation on page D2-1588.](#)
- [Using breakpoints on page D2-1590.](#)
- [Summary of breakpoint matching for different breakpoint types on page D2-1595.](#)
- [Pseudocode descriptions of Breakpoint exceptions taken from AArch64 state on page D2-1600.](#)
- [Pseudocode descriptions of Breakpoint exceptions taken from AArch32 state on page D2-1603.](#)

D2.5.1 About Breakpoint exceptions

A *breakpoint* is a debug event that results from the execution of an instruction, based on either:

- The instruction address, the PE context, or both. This type of breakpoint is called a *Hardware Breakpoint*.
- The instruction itself. That is, the instruction is a *breakpoint instruction*. These can be included in the program that the PE executes. This type of breakpoint is called a *Software Breakpoint*.

Breakpoint exceptions, that this section describes, are Hardware Breakpoints. Software Breakpoints are described in [Software Breakpoint Instruction exceptions on page D2-1566](#).

An implementation can include between 2-16 hardware breakpoints. In an implementation, [ID_AA64DFR0_EL1.BRPs](#) or [DBGDIDR.BRPs](#) shows how many are implemented.

To use an implemented hardware breakpoint, a debugger programs one of the following sets of registers, depending on the Execution state:

In AArch64 state:

- A 32-bit *Breakpoint Control Register*, [DBGBCR<n>_EL1](#), that holds control information for the breakpoint, for example whether the breakpoint is enabled.
- A 64-bit *Breakpoint Value Register*, [DBGBVR<n>_EL1](#), that holds the value used for breakpoint matching. This value is one of:
 - An instruction address.
 - A Context ID.
 - A VMID value.
 - A concatenation of both a Context ID value and a VMID value.

In AArch32 state:

- A 32-bit *Breakpoint Control Register*, [DBGBCR<n>](#), that holds control information for the breakpoint, for example whether the breakpoint is enabled.
- A 32-bit *Breakpoint Value Register*, [DBGBVR<n>](#), that, depending on the breakpoint type, holds a value used for breakpoint matching. This value is one of:
 - An instruction address.
 - A Context ID.
- A 32-bit *Breakpoint Extended Value Register*, [DBGBXVR<n>](#), that, depending on the breakpoint type and whether EL2 is implemented, holds a VMID value used for breakpoint matching.

The registers are numbered, so for example in AArch64 state:

- DBGBCR1_EL1 and DBGBVR1_EL1 are for breakpoint number one.
- DBGBCR1_EL2 and DBGBVR2_EL1 are for breakpoint number two.
- ...
- ...
- DBGBCRn_EL1 and DBGBVRn_EL1 are for breakpoint number n.

Each implemented breakpoint is one of the following types:

- A *context-aware* breakpoint. This is a breakpoint that can be programmed to generate a Breakpoint exception on any one of the following:
 - An instruction address match.
 - An instruction address mismatch.
 - A Context ID match.
 - A VMID match.
 - Both a Context ID match and a VMID match.
- A breakpoint that is not context-aware. These can only be programmed to generate a Breakpoint exception on an instruction address match or an instruction address mismatch.

[ID_AA64DFR0_EL1.CTX_CMPs](#) or [DBGDIDR.CTX_CMPs](#) shows how many of the implemented breakpoints are context-aware breakpoints.

Any breakpoint that is programmed to generate a Breakpoint exception on an instruction address match or mismatch is categorized as an *Address breakpoint*. If a context-aware breakpoint is programmed to generate a Breakpoint exception on a Context ID match, a VMID match, or a Context ID and VMID match, it is categorized as a *Context breakpoint*. [Figure D2-1](#) shows this.

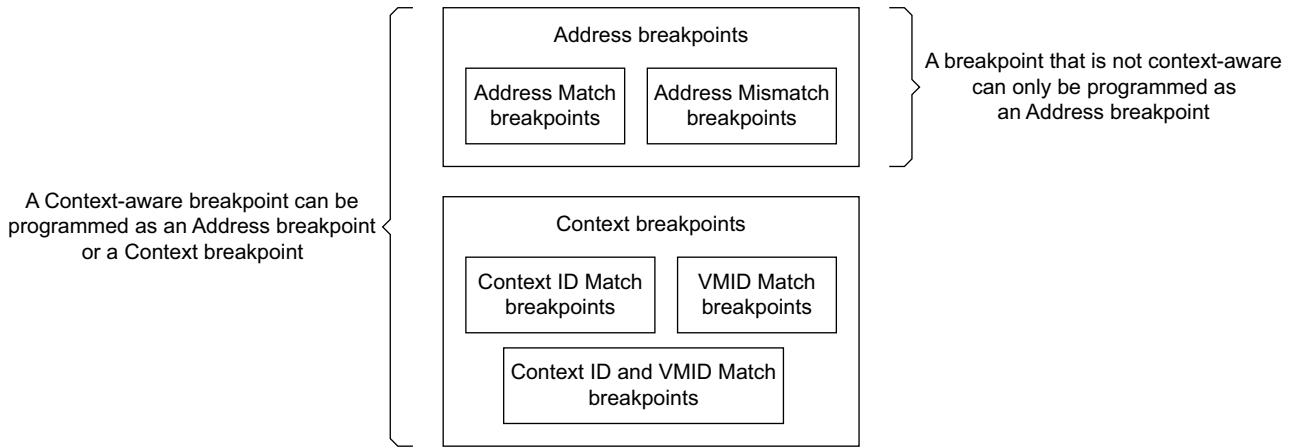

Figure D2-1 Categorization of breakpoints into Address breakpoints and Context breakpoints

An Address breakpoint must either:

- Be used in isolation, so that for example if it is an Address Match breakpoint, it generates a Breakpoint exception whenever the instruction address it is programmed with occurs in the program flow.
- Link to a Context breakpoint, so that it only generates a Breakpoint exception if the PE is in a particular context when the instruction address match or mismatch occurs.

A Context breakpoint must either:

- Be used in isolation, so that it generates a Breakpoint exception whenever the PE enters a particular context.
- Be linked to, by either or both:
 - One or more Address breakpoints.
 - One or more watchpoints.

The Address Mismatch breakpoint type is only supported in an AArch32 stage 1 translation regime. It is a reserved type in an AArch64 stage 1 translation regime. The behavior of a breakpoint that is programmed as an Address Mismatch breakpoint is as follows:

- In an AArch32 stage 1 translation regime, the breakpoint generates a Breakpoint exception on an address mismatch.
- In an AArch64 stage 1 translation regime, the breakpoint is evaluated as an Address Match breakpoint, so generates a Breakpoint exception on an address match.

Context breakpoints cannot be programmed to generate Breakpoint exceptions on context mismatches. They can only be programmed to generate Breakpoint exceptions on context matches.

[Breakpoint types and linking of breakpoints on page D2-1576](#) describes the different breakpoint types and their behaviors in more detail.

In an implementation supports AArch32 in at least one Exception level, Address breakpoints can be programmed to generate Breakpoint exceptions on addresses that are halfword-aligned but not word-aligned. This provides a debugger with a method of breakpointing on T32 instructions. This feature works as follows:

- The debugger programs the `DBGBVR<n>_EL1` or `DBGBVR<n>` for the Address breakpoint with an address. That address must be word-aligned.
- The debugger programs the *Byte Address Selection* field for the breakpoint, `DBGBCR<n>_EL1.BAS` or `DBGBCR<n>.BAS`, to select either:
 - The whole word starting at the address that the `DBGBVR<n>_EL1` or `DBGBVR<n>` is programmed with.
 - Either of the two halfwords that comprise the word.

For more information about programming the BAS field, see [Specifying the halfword-aligned address that an address comparison is successful on on page D2-1583](#).

D2.5.2 Enable controls for Breakpoint exceptions

To enable Breakpoint exceptions, a debugger must set `MDSCR_EL1.MDE` or `DBGDSCRExt.MDBGen` to 1. [The debug exceptions enable controls on page D3-1651](#) describes this.

In addition:

- Each implemented hardware breakpoint also has its own enable control, `DBGBCR<n>_EL1.E` or `DBGBCR<n>.E`.
- A Breakpoint exception can only be generated if debug exceptions are enabled from the current Exception level and Security state. See [Enabling debug exceptions from current Exception level and Security state on page D3-1656](#).

D2.5.3 Conditions for generating a Breakpoint exception

For each instruction in the program flow, the debug logic tests all of the breakpoints.

When a breakpoint is tested, it generates a *Breakpoint debug event* if all of the following are true:

- The conditions specified in the `DBGBCR<n>_EL1` or `DBGBCR<n>` for the breakpoint are met. See [About Breakpoint Control Registers](#) on page D2-1573.
- The comparison with the value held in the `DBGBVR<n>_EL1` is successful, or the comparisons with the values held in one or both of the `DBGBVR<n>` and `DBGBXVR<n>` are successful.
- If the breakpoint is linked to another breakpoint, the comparisons made by the other breakpoint are also successful. [Figure D2-3](#) on page D2-1578 shows this.
- The instruction is committed for execution.

If all of these conditions are met, the breakpoint generates the Breakpoint debug event regardless of both of the following:

- Whether the instruction passes its condition code check.
- The instruction type.

———— **Note** —————

The debug logic tests all breakpoints before the PE executes each instruction. The debug logic might test all breakpoints when an instruction is fetched speculatively. However, a breakpoint does not generate a Breakpoint debug event until the instruction is committed for execution.

A Breakpoint debug event generates a Breakpoint exception if both of the following are true:

- Breakpoint exceptions are enabled, that is, `MDSCR_EL1.MDE` or `DBGDSCRExt.MDBGen` is 1.
- Debug exceptions are enabled from the current Exception level and Security state. See [Enabling debug exceptions from current Exception level and Security state](#) on page D3-1656.

D2.5.4 About Breakpoint Control Registers

For each breakpoint, the Breakpoint Control Register, `DBGBCR<n>_EL1` or `DBGBCR<n>`, defines all of the following:

- General properties of the breakpoint. For example whether the breakpoint is enabled.
See *General properties of a breakpoint, defined by its control register*.
- Execution conditions for generating a Breakpoint exception. For example, the breakpoint might be programmed to only generate Breakpoint exceptions when the PE is executing at EL0 in Secure state.
See *Execution conditions that a breakpoint generates Breakpoint exceptions for*.
- For Address breakpoints, if the implementation supports AArch32 in any Exception level, whether the breakpoint matches on the whole word starting at the word-aligned address held in the `DBGBVR<n>_EL1` or `DBGBVR<n>`, or on one of the halfwords that comprise the word.
Specifying the halfword-aligned address that an address comparison is successful on on page D2-1583 describes this.

General properties of a breakpoint, defined by its control register

The `DBGBCR<n>_EL1`.{BT, LBN, E} or `DBGBCR<n>`.{BT, LBN, E} fields define the general properties of a breakpoint, as follows:

Breakpoint Type, BT

Controls the breakpoint type and whether the breakpoint is linked, as follows:

- BT[3,1]** Breakpoint type control. Controls the breakpoint type, for example a VMID Match breakpoint.
- BT[2]** Address mismatch control. An Address breakpoint is an Address Mismatch breakpoint if this is 1. For Context breakpoints, this is always 0. Context mismatching is not supported.
- BT[0]** Linking control. The breakpoint is a *Linked* breakpoint if this is 1. *Breakpoint types and linking of breakpoints* on page D2-1576 describes this.

———— Note —————

See *Reserved DBGBCR<n>_EL1.BT or DBGBCR<n>.BT values* on page D2-1592 for the behavior of breakpoints programmed with reserved `DBGBCR<n>_EL1.BT` or `DBGBCR<n>.BT` values.

Linked Breakpoint Number, LBN

For Linked Address breakpoints, selects the number of the Linked Context breakpoint that the Linked Address breakpoint links to.

This field is ignored if the breakpoint is an Unlinked Address breakpoint or a Context breakpoint.

Enable control, E

Controls whether the breakpoint is enabled. A disabled breakpoint never generates any Breakpoint exceptions.

Execution conditions that a breakpoint generates Breakpoint exceptions for

For each breakpoint, `DBGBCR<n>_EL1`.{SSC, HMC, PMC} or `DBGBCR<n>`.{SSC, HMC, PMC} define the execution conditions that the breakpoint generates Breakpoint exceptions for, as follows:

Security State Control, SSC

Controls whether the breakpoint generates Breakpoint exceptions only in Secure state, only in Non-secure state, or in both Security states. The comparison is made with the Security state of the PE, not the NS attribute of the physical instruction fetch address.

Higher Mode Control, HMC, and Privileged Mode Control, PMC

HMC and PMC together control which Exception levels the breakpoint generates Breakpoint exceptions in, and, in AArch32 state, which AArch32 modes the breakpoint generates Breakpoint exceptions in.

Table D2-3 shows the valid combinations of the values of HMC, SSC, and PMC, and for each combination shows which Exception levels breakpoints generate Breakpoint exceptions in.

In the table:

Y or - Means that a breakpoint programmed with the values of HMC, SSC and PMC shown in that row:
Y Can generate Breakpoint exceptions in that Exception level.
- Cannot generate Breakpoint exceptions in that Exception level.

Res Means that the combination of HMC, SSC, and PMC is reserved in the implementation. See [Reserved HMC, SSC, and PMC values on page D2-1592](#).

———— **Note** ————

If EL3 is implemented and is using AArch32, there is no Secure EL1. In this case, ignore the table entries for Secure EL1.

Table D2-3 Summary of breakpoint HMC, SSC, and PMC encodings

HMC	SSC	PMC	Security state breakpoint is programmed to match in	AArch64 stage 1 regime				AArch32 stage 1 regime				Implementation	
				EL3 ^a	EL2	EL1	EL0	EL3	EL2 ^a	EL1	EL0	No EL3	No EL2 or EL3
0	00	00	Both	-	-	-	-	Y ^b	-	Y ^b	Y ^b	-	-
0	00	01		-	-	Y	-	Y	-	Y	-	-	-
0	00	10		-	-	-	Y	-	-	-	Y	-	-
0	00	11		-	-	Y	Y	Y	-	Y	Y	-	-
0	01	00	Non-secure	-	-	-	-	-	-	Y ^b	Y ^b	Res	Res
0	01	01		-	-	Y	-	-	-	Y	-	Res	Res
0	01	10		-	-	-	Y	-	-	-	Y	Res	Res
0	01	11		-	-	Y	Y	-	-	Y	Y	Res	Res
0	10	00	Secure	-	-	-	-	Y ^b	-	Y ^b	Y ^b	Res	Res
0	10	01		-	-	Y	-	Y	-	Y	-	Res	Res
0	10	10		-	-	-	Y	-	-	-	Y	Res	Res
0	10	11		-	-	Y	Y	Y	-	Y	Y	Res	Res
1	00	01	Both	Y	Y	Y	-	Y	Y	Y	-	-	Res
1	00	11		Y	Y	Y	Y	Y	Y	Y	Y	-	Res
1	01	01	Non-secure	-	Y	Y	-	-	Y	Y	-	Res	Res
1	01	11		-	Y	Y	Y	-	Y	Y	Y	Res	Res

Table D2-3 Summary of breakpoint HMC, SSC, and PMC encodings (continued)

HMC	SSC	PMC	Security state breakpoint is programmed to match in	AArch64 stage 1 regime				AArch32 stage 1 regime				Implementation	
				EL3 ^a	EL2	EL1	EL0	EL3	EL2 ^a	EL1	EL0	No EL3	No EL2 or EL3
1	10	00	Secure	Y	-	-	-	-	-	-	-	Res	Res
1	10	01		Y	-	Y	-	Y	-	Y	-	Res	Res
1	10	11		Y	-	Y	Y	Y	-	Y	Y	Res	Res
1	11	00	Non-secure	-	Y	-	-	-	Y	-	-	Res	Res

- a. Debug exceptions are not generated at EL3 using AArch64 or EL2 using AArch32. This means that these combinations of HMC, SSC, and PMC are only relevant if breakpoints cause entry to Debug state. See [Breakpoint and Watchpoint debug events on page H2-4330](#). Self-hosted debuggers must avoid combinations of HMC, SSC, and PMC that generate Breakpoint exceptions at EL3 using AArch64 or at EL2 using AArch32.
- b. Only in User, System and Supervisor modes. If EL1 using AArch32 is not supported, these combinations of HMC, SSC and PMC are reserved.

Note

For the behavior of breakpoints programmed with HMC, SSC, and PMC combinations that this table does not show, see [Table D2-6 on page D2-1593](#).

D2.5.5 Breakpoint types and linking of breakpoints

Breakpoints are categorized into Address breakpoints and Context breakpoints. The possible breakpoint types in these categories are:

- Address breakpoints:
 - Address Match.
 - Address Mismatch. This type of breakpoint is only supported in an AArch32 stage 1 translation regime.
- Context breakpoints:
 - Context ID Match. Matches with the Context ID value held in the [CONTEXTIDR_EL1](#).
 - VMID Match. Matches with the VMID value held in the [VTTBR_EL2](#).
 - Context ID and VMID Match. Matches with both the Context ID value and the VMID value.

Each breakpoint must either be:

- Used in isolation. In this case the breakpoint is called an *Unlinked breakpoint*.
- Linked.

By linking two breakpoints together, a debugger can create a breakpoint pair that only generates a Breakpoint exception if the PE is in a particular context when an instruction address match or mismatch occurs.

For example, a debugger might:

1. Program breakpoint number one to be a *Linked Address Match breakpoint*.
2. Program breakpoint number five to be a *Linked Context ID Match breakpoint*.
3. Link these two breakpoints together. A Breakpoint exception is only generated if both the instruction address matches and the Context ID matches.

The *Breakpoint Type* field for a breakpoint, [DBGBCR<n>_EL1.BT](#) or [DBGBCR<n>.BT](#), controls the breakpoint type and whether the breakpoint is linked. See [General properties of a breakpoint, defined by its control register on page D2-1573](#). If BT[0] is 1, the breakpoint is enabled for linking and is called a *Linked breakpoint*.

[Figure D2-2 on page D2-1577](#) shows all of the possible breakpoint types the associated BT field values.

		Unlinked	Linked
Address breakpoints	Address Match	BT == 0b0000 Unlinked Address Match	BT == 0b0001 Linked Address Match
	Address Mismatch	BT == 0b0100 Unlinked Address Mismatch	BT == 0b0101 Linked Address Mismatch
Context breakpoints	Context ID Match	BT == 0b0010 Unlinked Context ID Match	BT == 0b0011 Linked Context ID Match
	VMID Match	BT == 0b1000 Unlinked VMID Match	BT == 0b1001 Linked VMID Match
	VMID and context ID Match	BT == 0b1010 Unlinked VMID and Context ID Match	BT == 0b1011 Linked VMID and Context ID Match

Figure D2-2 Breakpoint types and associated BT field values

The rules for breakpoint linking are as follows:

- Only Linked breakpoint types can be linked.
- Any type of Linked Address breakpoint can link to any type of Linked Context breakpoint. The *Linked Breakpoint Number* field, `DBGBCR<n>_EL1.LBN` or `DBGBCR<n>.LBN`, for the Linked Address breakpoint specifies the particular Linked Context breakpoint that the Linked Address breakpoint links to.
- A Linked Context breakpoint cannot link to another Linked Context breakpoint.
- A Linked Address breakpoint cannot link to any of the following:
 - Another Address breakpoint.
 - An Unlinked Context breakpoint.
 - A watchpoint.
- Multiple Linked Address breakpoints can link to a single Linked Context breakpoint.

Note

- `DBGBCR<n>_EL1.LBN` or `DBGBCR<n>.LBN` for Context breakpoints is ignored, regardless of whether they are Linked or Unlinked.
- Multiple Linked watchpoints can also link to a single Linked Context breakpoint.
- For a full description of the BT and LBN fields, see *General properties of a breakpoint, defined by its control register* on page D2-1573.

This means that a single Linked Context breakpoint might be linked to by all, or any combination of, the following:

- Multiple Linked Address Match breakpoints.

- Multiple Linked Address Mismatch breakpoints.
- Multiple Linked watchpoints.

It is also possible that a Linked Context breakpoint might have no breakpoints or watchpoints linked to it.

Figure D2-3 shows a single Linked Context breakpoint that is linked to by a number of Linked Address breakpoints and a number of Linked watchpoints.

Each Linked watchpoint can only generate a Watchpoint exception if the comparisons made by both it, and the Linked Context breakpoint, are successful.

Each Linked Address breakpoint can only generate a Breakpoint exception if the comparisons made by both it, and the Linked Context breakpoint, are successful.

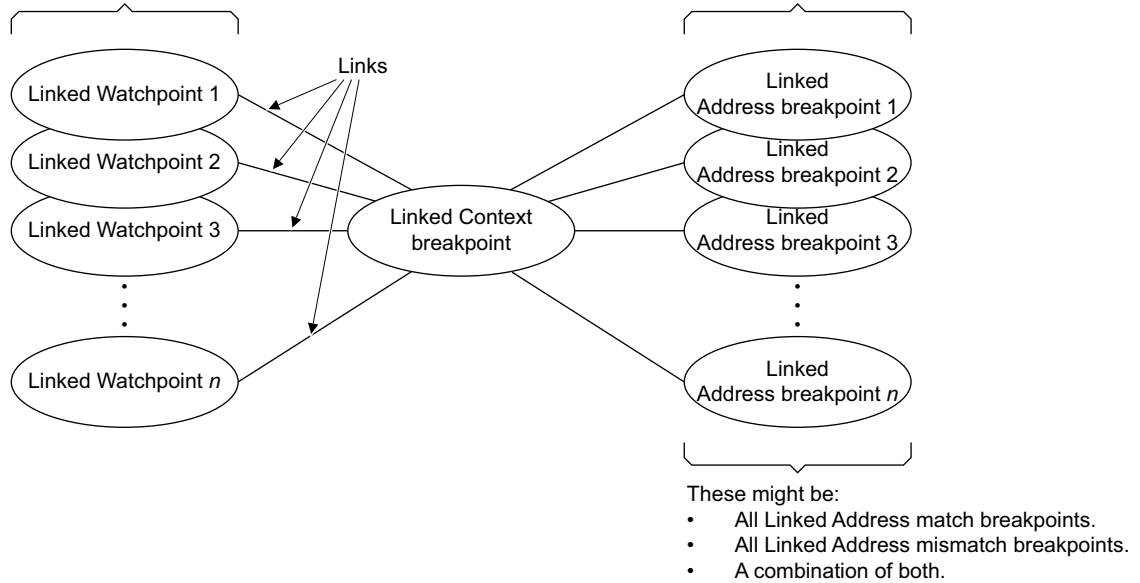

Figure D2-3 The role of linking in Breakpoint and Watchpoint exception generation

Table D2-4 shows a summary of the basic properties of Address and Context breakpoints.

Table D2-4 Summary of the basic properties of Address and Context breakpoints

Breakpoint	Linking	Programming for a mismatch
Address	<p>Can be used in isolation.</p> <p>If BT[0] is 1, is called a <i>Linked Address breakpoint</i>.</p> <p>A Linked Address breakpoint:</p> <ul style="list-style-type: none"> • Can link to one Linked Context breakpoint. • Cannot link to any Address breakpoints or watchpoints. 	<p>Can be programmed for an address mismatch. However, address mismatching is only supported in an AArch32 stage 1 translation regime.</p>
Context	<p>Can be used in isolation.</p> <p>If BT[0] is 1, is called a <i>Linked Context breakpoint</i>.</p> <p>A Linked Context breakpoint can be linked to by nothing, or by either or both of the following:</p> <ul style="list-style-type: none"> • One or more Linked Address breakpoints. These might be Linked Address Match breakpoints, or Linked Address Mismatch breakpoints, or a combination of both. • One or more Linked watchpoints. <p>A Linked Context breakpoint cannot be linked to by another Context breakpoint.</p>	<p>Cannot be programmed for a context mismatch.</p>

Breakpoint types defined by DBGBCRn_EL1.BT or DBGBCRn.BT

The following list provides more detail about each breakpoint type shown in [Figure D2-2 on page D2-1577](#):

0b0000, Unlinked Address Match breakpoint

Generation of a Breakpoint exception depends on both:

- The `DBGBCR<n>_EL1`.{SSC, HMC, PMC} or `DBGBCR<n>`.{SSC, HMC, PMC} controls. These define the PE conditions that the breakpoint generates a Breakpoint exception for. See [Execution conditions that a breakpoint generates Breakpoint exceptions for on page D2-1573](#).
- A successful address match, as described in [Instruction address comparisons for Breakpoint exception generation on page D2-1582](#).

`DBGBCR<n>_EL1.LBN` or `DBGBCR<n>.LBN` for this breakpoint is ignored.

0b0001, Linked Address Match breakpoint

Generation of a Breakpoint exception depends on all of the following:

- The `DBGBCR<n>_EL1`.{SSC, HMC, PMC} or `DBGBCR<n>`.{SSC, HMC, PMC} controls for this breakpoint. These define the PE conditions that the breakpoint generates a Breakpoint exception for. See [Execution conditions that a breakpoint generates Breakpoint exceptions for on page D2-1573](#).
- A successful address match defined by this breakpoint, as described in [Instruction address comparisons for Breakpoint exception generation on page D2-1582](#).
- A successful context match defined by the Linked Context breakpoint that this breakpoint links to.

`DBGBCR<n>_EL1.LBN` or `DBGBCR<n>.LBN` for this breakpoint identifies the Linked Context breakpoint that this breakpoint links to.

0b0010, Unlinked Context ID Match breakpoint

BT == 0b0010 is a reserved value if the breakpoint is not a context-aware breakpoint.

For context-aware breakpoints, generation of a Breakpoint exception depends on both:

- The `DBGBCR<n>_EL1`.{SSC, HMC, PMC} or `DBGBCR<n>`.{SSC, HMC, PMC} controls. These define the PE conditions that the breakpoint generates a Breakpoint exception for. See [Execution conditions that a breakpoint generates Breakpoint exceptions for on page D2-1573](#).
- A successful Context ID match, as described in [Context comparisons for Breakpoint exception generation on page D2-1587](#).

`DBGBCR<n>_EL1`.{LBN, BAS} or `DBGBCR<n>`.{LBN, BAS} for this breakpoint are ignored

0b0011, Linked Context ID Match breakpoint

BT == 0b0011 is a reserved value if the breakpoint is not a context-aware breakpoint.

For context-aware breakpoints, either:

- This breakpoint does not generate any Breakpoint exceptions, if no Linked breakpoints or Linked watchpoints link to it.
- Generation of a Breakpoint exception depends on both:
 - A successful instruction address match, defined by a Linked Address breakpoint that links to this breakpoint, see [Instruction address comparisons for Breakpoint exception generation on page D2-1582](#).
 - A successful Context ID match defined by this breakpoint, as described in [Context comparisons for Breakpoint exception generation on page D2-1587](#).
- Generation of a Watchpoint exception depends on both:
 - A successful data address match, defined by a Linked watchpoint that links to this breakpoint, see [Data address comparisons for Watchpoint exception generation on page D2-1612](#).

- A successful Context ID match defined by this breakpoint, as described in *Context comparisons for Breakpoint exception generation* on page D2-1587.

`DBGBCR<n>_EL1`.{LBN, SSC, HMC, BAS, PMC} or `DBGBCR<n>`.{LBN, SSC, HMC, BAS, PMC} for this breakpoint are ignored.

0b0100, Unlinked Address Mismatch breakpoint

AArch64 state does not support Address Mismatch breakpoints. `BT == 0b0100` is a reserved value. In an AArch64 stage 1 translation regime, if a breakpoint is programmed to be this type, it is evaluated as an Unlinked Address Match breakpoint, described in *0b0000, Unlinked Address Match breakpoint* on page D2-1579.

In an AArch32 stage 1 translation regime:

- Generation of a Breakpoint exception depends on both:
 - The `DBGBCR<n>`.{SSC, HMC, PMC} controls. These define the PE conditions that the breakpoint generates a Breakpoint exception for. See *Execution conditions that a breakpoint generates Breakpoint exceptions for* on page D2-1573.
 - A successful address mismatch, as described in *Instruction address comparisons for Breakpoint exception generation* on page D2-1582.
- `DBGBCR<n>`.LBN is for this breakpoint is ignored.

0b0101, Linked Address Mismatch breakpoint

AArch64 state does not support Address Mismatch breakpoints. `BT == 0b0101` is a reserved value. In an AArch64 stage 1 translation regime, if a breakpoint is programmed to be this type, it is evaluated as a Linked Address Match breakpoint, described in *0b0001, Linked Address Match* on page D2-1579.

In an AArch32 stage 1 translation regime, generation of a Breakpoint exception depends on all of the following:

- The `DBGBCR<n>`.{SSC, HMC, PMC} controls. These define the PE conditions that the breakpoint generates a Breakpoint exception for. See *Execution conditions that a breakpoint generates Breakpoint exceptions for* on page D2-1573.
- A successful address mismatch defined by this breakpoint, as described in *Instruction address comparisons for Breakpoint exception generation* on page D2-1582.
- A successful context match defined by the Linked Context breakpoint that this breakpoint links to.

`DBGBCR<n>_EL1`.LBN or `DBGBCR<n>`.LBN for this breakpoint identifies the Linked Context breakpoint that this breakpoint links to.

0b1000, Unlinked VMID Match breakpoint

`BT == 0b1000` is a reserved value if either:

- The breakpoint is not a context-aware breakpoint.
- EL2 is not implemented.

For context-aware breakpoints, generation of a Breakpoint exception depends on both:

- The `DBGBCR<n>_EL1`.{SSC, HMC, PMC} or `DBGBCR<n>`.{SSC, HMC, PMC} controls. These define the PE conditions that the breakpoint generates a Breakpoint exception for. See *Execution conditions that a breakpoint generates Breakpoint exceptions for* on page D2-1573.
- A successful VMID match, as described in *Context comparisons for Breakpoint exception generation* on page D2-1587.

`DBGBCR<n>_EL1`.{LBN, BAS} or `DBGBCR<n>`.{LBN, BAS} for this breakpoint are ignored.

0b1001, Linked VMID Match breakpoint

`BT == 0b1001` is a reserved value if either:

- The breakpoint is not a context-matching breakpoint.
- EL2 is not implemented.

For context-aware breakpoints, either:

- This breakpoint does not generate any Breakpoint exceptions, if no Linked breakpoints or Linked watchpoints link to it.
- Generation of a Breakpoint exception depends on both:
 - A successful instruction address match, defined by a Linked Address Match breakpoint that links to this breakpoint. See [Instruction address comparisons for Breakpoint exception generation on page D2-1582](#).
 - A successful VMID match defined by this breakpoint, as described in [Context comparisons for Breakpoint exception generation on page D2-1587](#).
- Generation of a Watchpoint exception depends on both:
 - A successful data address match, defined by a Linked watchpoint that links to this breakpoint, see [Data address comparisons for Watchpoint exception generation on page D2-1612](#).
 - A successful VMID match defined by this breakpoint, as described in [Context comparisons for Breakpoint exception generation on page D2-1587](#).

DBGBCR<n>_EL1.{LBN, SSC, HMC, BAS, PMC} or **DBGBCR<n>**.{LBN, SSC, HMC, BAS, PMC} for this breakpoint are ignored.

0b1010, Unlinked Context ID and VMID Match breakpoint

BT == 0b1010 is a reserved value if either:

- The breakpoint is not a context-matching breakpoint.
- EL2 is not implemented.

For context-matching breakpoints, generation of a Breakpoint exception depends on all of the following:

- The **DBGBCR<n>_EL1**.{SSC, HMC, PMC} or **DBGBCR<n>**.{SSC, HMC, PMC} controls. These define the PE conditions that the breakpoint generates a Breakpoint exception for. See [Execution conditions that a breakpoint generates Breakpoint exceptions for on page D2-1573](#).
- A successful Context ID match.
- A successful VMID match.

[Context comparisons for Breakpoint exception generation on page D2-1587](#) describes the requirements for a successful Context ID match and a successful VMID match.

DBGBCR<n>_EL1.{LBN, BAS} or **DBGBCR<n>**.{LBN, BAS} for this breakpoint are ignored.

0b1011, Linked Context ID and VMID Match breakpoint

BT == 0b1011 is a reserved value if either:

- The breakpoint is not a context-matching breakpoint.
- EL2 is not implemented.

For context-matching breakpoints, either:

- This breakpoint does not generate any Breakpoint exceptions, if no Linked breakpoints or Linked watchpoints link to it.
- Generation of a Breakpoint exception depends on all of the following:
 - A successful instruction address match, defined by a Linked Address breakpoint that links to this breakpoint, see [Instruction address comparisons for Breakpoint exception generation on page D2-1582](#).
 - A successful Context ID match defined by this breakpoint.
 - A successful VMID match defined by this breakpoint.
- Generation of a Watchpoint exception depends on all of the following:
 - A successful data address match, defined by a Linked watchpoint that links to this breakpoint, see [Data address comparisons for Watchpoint exception generation on page D2-1612](#).

- A successful Context ID match defined by this breakpoint.
- A successful VMID match defined by this breakpoint.

Context comparisons for Breakpoint exception generation on page D2-1587 describes the requirements for a successful Context ID match and a successful VMID match by this breakpoint.

`DBGBCR<n>_EL1`.{LBN, SSC, HMC, BAS, PMC} or `DBGBCR<n>`.{LBN, SSC, HMC, BAS, PMC} for this breakpoint are ignored.

D2.5.6 Instruction address comparisons for Breakpoint exception generation

The following subsections describe the address comparisons that are made for each instruction in the program flow, for:

- *Address Match breakpoints.*
- *Address Mismatch breakpoints in an AArch32 stage 1 translation regime.*

Address Match breakpoints

For Unlinked and Linked Address Match breakpoints:

In an AArch64 stage 1 translation regime:

An address comparison is successful if both:

- Bits [48:2] of the current instruction address are equal to `DBGBVR<n>_EL1`[48:2].
- `DBGBCR<n>_EL1`.BAS is programmed with either `0b0011` or `0b1111`. See *Specifying the halfword-aligned address that an address comparison is successful on* on page D2-1583.

Note

- `DBGBVR<n>_EL1` is a 64-bit register. The most significant bits of this register are sign-extension bits.
- If the implementation is an AArch64-only implementation, `DBGBCR<n>_EL1`.BAS is programmed by default with `0b1111`, because it is RES1.

In an AArch32 stage 1 translation regime:

An address comparison is successful if both:

- Bits [31:2] of the current instruction address are equal to `DBGBVR<n>`[31:2].
- Either:
 - `DBGBCR<n>`.BAS is programmed with `0b0011` or `0b1111`, and the instruction is at a word-aligned address.
 - `DBGBCR<n>`.BAS is programmed with `0b1100`, and the instruction is not at a word-aligned address.

See *Specifying the halfword-aligned address that an address comparison is successful on* on page D2-1583.

Address Mismatch breakpoints in an AArch32 stage 1 translation regime

For Unlinked and Linked Address Mismatch breakpoints in an AArch32 stage 1 translation regime, an address comparison is successful if both:

- Bits [31:2] of the current instruction address value are not equal to `DBGBVR<n>`[31:2].
- Either:
 - `DBGBCR<n>`.BAS is programmed with `0b0011` or `0b1111`, and the instruction is at a word-aligned address.
 - `DBGBCR<n>`.BAS is programmed with `0b1100`, and the instruction is not at a word-aligned address.

See [Using the BAS field in Address Mismatch breakpoints, in an AArch32 stage 1 translation regime on page D2-1586](#).

Note

Address Mismatch breakpoints can be used to single-step through code. See [Using an Address Mismatch breakpoint to single-step an instruction on page D2-1590](#).

D2.5.7 Specifying the halfword-aligned address that an address comparison is successful on

If the implementation supports AArch32 state in any Exception level, then for an Address breakpoint, a debugger can use the *Byte Address Selection* field, `DBGBCR<n>_EL1.BAS` or `DBGBCR<n>.BAS`, so that the address comparison is successful on either:

- The instruction starting at the address held in the `DBGBVR<n>_EL1` or `DBGBVR<n>`.
- The instruction starting at the halfword-aligned address immediately after the address held in the `DBGBVR<n>_EL1` or `DBGBVR<n>`.

Note

The address programmed into the `DBGBVR<n>_EL1` or `DBGBVR<n>` must be word-aligned.

This provides a debugger with a method of programming breakpoints on T32 instructions.

In AArch64-only implementations this feature is not supported. In this case, `DBGBCR<n>_EL1.BAS` is RES1 and the smallest instruction size a debugger can program a breakpoint to match on is a word, that starts at the address held in the `DBGBVR<n>_EL1`.

For Context breakpoints, `DBGBCR<n>_EL1.BAS` or `DBGBCR<n>.BAS` is RES1 and is ignored.

Where `DBGBCR<n>_EL1.BAS` or `DBGBCR<n>.BAS` is supported, it can be used in both Address Match breakpoints and Address Mismatch breakpoints, as follows:

- For an Address Match breakpoint, that can be Linked or Unlinked, the BAS field selects which halfword-aligned address the breakpoint must generate a Breakpoint exception for. This means that an address comparison is successful only if both of the following match:
 - The instruction address held in bits [48:2] of the `DBGBVR<n>_EL1`, or bits [31:2] of the `DBGBVR<n>`.
 - The halfword defined by the BAS field.

[Table D2-9 on page D2-1597](#) also shows the set of conditions required. The conditions for a successful address match comparison are:

Equals[address] AND **selected**[BAS]

- For an Address Mismatch breakpoint, that can be Linked or Unlinked, the BAS field selects which halfword-aligned address the breakpoint must not generate a Breakpoint exception for. This means that an address comparison is successful if either or both of the following do not match:
 - The instruction address held in bits [48:2] of the `DBGBVR<n>_EL1`, or bits [31:2] of the `DBGBVR<n>`.
 - The halfword defined by the BAS field.

[Table D2-9 on page D2-1597](#) also shows the set of conditions required. The conditions for a successful address mismatch comparison are:

Not (equals[address] AND **selected**[BAS])

Note

Address Mismatch breakpoints are not supported in an AArch64 stage 1 translation regime. See [Breakpoint types defined by DBGBCRn_EL1.BT or DBGBCRn.BT on page D2-1579](#).

The following two subsections show the supported BAS values:

- [Using the BAS field in Address Match breakpoints.](#)
- [Using the BAS field in Address Mismatch breakpoints, in an AArch32 stage 1 translation regime on page D2-1586.](#)

Using the BAS field in Address Match breakpoints

The supported BAS values are:

- 0b0000** This value is reserved. Behavior is a CONSTRAINED UNPREDICTABLE choice of:
- The breakpoint is disabled.
 - The breakpoint behaves as if BAS is 0b0011, 0b1100, or 0b1111.
- 0b0011** Generates a Breakpoint exception if an instruction with an address described as follows is committed for execution:
- Bits [48:2] of the address equals `DBGVVR<n>_EL1[48:2]`, or bits [31:2] of the address equals `DBGVVR<n>[31:2]`.
 - Bits [1:0] of the address are 0b00.
- This means that breakpoints programmed with this BAS value generate Breakpoint exceptions for all of the following:
- 32-bit T32 instructions at word-aligned addresses.
 - 16-bit T32 instructions at word-aligned addresses.
 - A64 or A32 instructions. These are always at word-aligned addresses.
- However, ARM recommends that a debugger uses this BAS value only for T32 instructions. It is CONSTRAINED UNPREDICTABLE whether a breakpoint programmed with this BAS value generates a Breakpoint exception on the second halfword of a 32-bit T32 instruction starting at the halfword-aligned address (`(DBGVVR<n>[31:2]:00) - 2`).
- 0b1100** Generates a Breakpoint exception if an instruction with an address described as follows is committed for execution:
- Bits [48:2] of the address equals `DBGVVR<n>_EL1[48:2]`, or bits [31:2] of the address equals `DBGVVR<n>[31:2]`.
 - Bits [1:0] of the address are 0b10.
- This means that breakpoints programmed with this BAS value generate Breakpoint exceptions for both of the following:
- 32-bit T32 instructions at addresses that are halfword-aligned but not word-aligned.
 - 16-bit T32 instructions at addresses that are halfword-aligned but not word-aligned.
- It is CONSTRAINED UNPREDICTABLE whether a breakpoint programmed with this BAS value generates a Breakpoint exception on the second halfword of a 32-bit T32, A32, or A64 instruction starting at a word-aligned address.
- 0b1111** Generates a Breakpoint exception if an instruction with an address described as follows is committed for execution:
- Bits [48:2] of the address equals `DBGVVR<n>_EL1[48:2]`, or bits [31:2] of the address equals `DBGVVR<n>[31:2]`.
 - Bits [1:0] of the address are 0b00.
- This means that breakpoints programmed with this BAS value generate Breakpoint exceptions for all of the following:
- 32-bit T32 instructions at word-aligned addresses.
 - 16-bit T32 instructions at word-aligned addresses.
 - A64 or A32 instructions. These are always at word-aligned addresses.
- However, ARM recommends that a debugger uses this BAS value only for A64 and A32 instructions.

It is CONSTRAINED UNPREDICTABLE whether a breakpoint programmed with this BAS value generates a Breakpoint exception on the second halfword of a 32-bit T32 instruction starting at the halfword-aligned address ((DBGBVR<n>[31:2]:00) - 2).

It is CONSTRAINED UNPREDICTABLE whether a breakpoint programmed with this BAS value generates a Breakpoint exception on a 32-bit T32 instruction or a 16-bit T32 instruction at the halfword-aligned address DBGBVR<n>[31:2]:10.

All other BAS values are reserved. For these reserved other BAS values, DBGBCR<n>_EL1.BAS[3,1] or DBGBCR<n>.BAS[3,1] ignore writes and read the same values as DBGBCR<n>_EL1[2,0] or DBGBCR<n>[2,0] respectively. This means that the smallest instruction size a debugger can program a breakpoint to match on is a halfword.

Figure D2-4 shows a summary of when breakpoints programmed with particular BAS values generate Breakpoint exceptions.

The figure contains four parts:

- A column showing the row number, on the left.
- An instruction set and instruction size table.
- A location of instruction figure.
- A BAS field values table, on the right.

To use the figure, read across the rows. For example:

- Row 2 shows that a breakpoint with a BAS value of 0b1100 generates Breakpoint exceptions for 16-bit T32 instructions starting at the halfword-aligned address immediately after the word aligned address held in the DBGBVR<n>_EL1 or DBGBVR<n>.
- Row 7 shows that a breakpoint with a BAS value of either 0b0011 or 0b1111 generates Breakpoint exceptions for A64 instructions. A64 instructions are always at word-aligned addresses.

In the figure:

- Yes** Means that the breakpoint generates a Breakpoint exception.
No Means that the breakpoint does not generate a Breakpoint exception.
UNP Means that is it CONSTRAINED UNPREDICTABLE whether the breakpoint generates a Breakpoint exception.

	Instruction set	Size	Location of instruction ^a							BAS[3:0]				
			-2	-1	0	+1	+2	+3	+4	+5	0b0011	0b1100	0b1111	
Row 1	T32	16-bit			■							Yes	No	Yes
Row 2		16-bit							■			No	Yes	UNP
Row 3	T32	32-bit	■	■	■							UNP	No	UNP
Row 4		32-bit			■	■	■					Yes	UNP	Yes
Row 5		32-bit						■	■	■		No	Yes	UNP
Row 6	A32	32-bit			■	■	■					Yes	UNP	Yes
Row 7	A64	32-bit			■	■	■					Yes	UNP	Yes

- a. 0 means the word-aligned address held in the DBGBVRn_EL1 or DBGBVRn.
The other locations are as follows:
- +1 means DBGBVRn_EL1[48:2]:01 or DBGBVRn[31:2]:01.
 - +2 means DBGBVRn_EL1[48:2]:10 or DBGBVRn[31:2]:10.
 - +3 means DBGBVRn_EL1[48:2]:11 or DBGBVRn[31:2]:11.
 - ...
- The solid areas show the location of the instruction.

Figure D2-4 Summary of BAS field meanings for Address Match breakpoints

Using the BAS field in Address Mismatch breakpoints, in an AArch32 stage 1 translation regime

An Address Mismatch breakpoint generates Breakpoint exceptions for all instructions committed for execution, apart from the instruction whose address matches the address held in the `DBGVVR<n>`. The following list shows when an Address Mismatch breakpoint does not generate Breakpoint exceptions.

The supported BAS values are:

`0b0000` The breakpoint ignores the address held in the `DBGVVR<n>` and generates Breakpoint exceptions for all instruction addresses.

`0b0011` Does not generate a Breakpoint exception if an instruction with an address described as follows is committed for execution:

- Bits [31:2] of the address equals `DBGVVR<n>`[31:2].
- Bits [1:0] of the address are `0b00`.

This means that breakpoints programmed with this BAS value do not generate Breakpoint exceptions for any of the following:

- 32-bit T32 instructions at word-aligned addresses.
- 16-bit T32 instructions at word-aligned addresses.
- A32 instructions. These are always at word-aligned addresses.

However, ARM recommends that a debugger uses this BAS value only for T32 instructions.

It is CONstrained UNPREDICTABLE whether a breakpoint programmed with this BAS value does not generate a Breakpoint exception on the second halfword of a 32-bit T32 instruction starting at the halfword-aligned address (`DBGVVR<n>`[31:2]:00) - 2)).

`0b1100` Does not generate a Breakpoint exception if an instruction with an address described as follows is committed for execution:

- Bits [31:2] equals `DBGVVR<n>`[31:2].
- Bits [1:0] of the address are `0b10`.

This means that breakpoints programmed with this BAS value do not generate Breakpoint exceptions for either of the following:

- 32-bit T32 instructions at addresses that are halfword-aligned but not word-aligned.
- 16-bit T32 instructions at addresses that are halfword-aligned but not word-aligned.

It is CONstrained UNPREDICTABLE whether a breakpoint programmed with this BAS value does not generate a Breakpoint exception on the second halfword of a 32-bit T32, A32, or A64 instruction at a word-aligned address.

`0b1111` Does not generate a Breakpoint exception if an instruction with an address described as follows is committed for execution:

- Bits [31:2] of the address equals `DBGVVR<n>`[31:2].
- Bits [1:0] of the address are `0b00`.

This means that breakpoints programmed with this BAS value do not generate Breakpoint exceptions for any of the following:

- 32-bit T32 instructions at word-aligned addresses.
- 16-bit T32 instructions at word-aligned addresses.
- A32 instructions. These are always at word-aligned addresses.

However, ARM recommends that a debugger uses this BAS value only for A32 instructions.

It is CONstrained UNPREDICTABLE whether a breakpoint programmed with this BAS value does not generate a Breakpoint exception on the second halfword of a 32-bit T32 instruction starting at the halfword-aligned address (`DBGVVR<n>`[31:2]:00) - 2)).

It is CONstrained UNPREDICTABLE whether a breakpoint programmed with this BAS value does not generate a Breakpoint exception on a 32-bit T32 instruction or a 16-bit T32 instruction at the halfword-aligned address `DBGVVR<n>`[31:2]:10.

All other BAS values are reserved. For any of these reserved other BAS values, `DBGBCR<n>.BAS[3,1]` ignore writes and read the same values as `DBGBCR<n>[2,0]` respectively. This means that the smallest instruction size that a breakpoint can never generate a Breakpoint exception for is a halfword.

Figure D2-4 on page D2-1585 shows a summary of when breakpoints programmed with particular BAS values generate Breakpoint exceptions.

The figure contains four parts:

- A column showing the row number, on the left.
- An instruction set and instruction size table.
- A location of instruction figure.
- A BAS field values table, on the right.

To use the figure, read across the rows. For example:

- Row 1 shows that a breakpoint with a BAS value of `0b1100` generates Breakpoint exceptions for 16-bit T32 instructions starting at the word-aligned address held in the `DBGBVR<n>`.
- Row 5 shows that a breakpoint with a BAS value of `0b0011` generates Breakpoint exceptions for 32-bit T32 instructions starting at the halfword-aligned address immediately after the word aligned address held in the `DBGBVR<n>`.

In the figure:

Yes Means that the breakpoint does generate a Breakpoint exception.

No Means that the breakpoint does not generate a Breakpoint exception.

UNP Means that is it CONSTRAINED UNPREDICTABLE whether the breakpoint generates a Breakpoint exception.

	Instruction set	Size	Location of instruction ^a								BAS[3:0]				
			-2	-1	0	+1	+2	+3	+4	+5	0b0000	0b0011	0b1100	0b1111	
Row 1	T32	16-bit			■							Yes	No	Yes	No
Row 2		16-bit						■				Yes	Yes	No	UNP
Row 3	T32	32-bit	■	■	■	■						Yes	UNP	Yes	UNP
Row 4		32-bit			■	■	■	■				Yes	No	UNP	No
Row 5		32-bit					■	■	■	■		Yes	Yes	No	UNP
Row 6	A32	32-bit			■	■	■	■				Yes	No	UNP	No

a. 0 means the word-aligned address held in the `DBGBVRn`. The other locations are as follows:

- +1 means `DBGBVRn[31:2]:01`.
- +2 means `DBGBVRn[31:2]:10`.
- +3 means `DBGBVRn[31:2]:11`.
- ...

The solid areas show the location of the instruction.

Figure D2-5 Summary of BAS field meanings for Address Mismatch breakpoints

D2.5.8 Context comparisons for Breakpoint exception generation

This section describes the context comparisons that are made for each instruction in the program flow, for Context breakpoints.

In an AArch64 stage 1 translation regime:

A context comparison is successful if, depending on the breakpoint type set by `DBGBCR<n>_EL1.BT[3,1]`, one of the following is true:

- The current Context ID value is equal to `DBGBVR<n>_EL1[31:0]`.
- The current VMID value is equal to `DBGBVR<n>_EL1[39:32]`.

- The current Context ID value is equal to `DBGBVR<n>_EL1[31:0]`, and the current VMID value is equal to `DBGBVR<n>_EL1[39:32]`.

In an AArch32 stage 1 translation regime:

A context comparison is successful if, depending on the breakpoint type set by `DBGBCR<n>.BT[3,1]`, one of the following is true:

- The current Context ID value is equal to `DBGBVR<n>[31:0]`.
- The current VMID value is equal to `DBGBXVR<n>[7:0]`.
- The current Context ID value is equal to `DBGBVR<n>[31:0]`, and the current VMID value is equal to `DBGBXVR<n>[7:0]`.

For Context breakpoints, `DBGBCR<n>_EL1.BAS` or `DBGBCR<n>.BAS` is RES1 and ignored. If the Context breakpoint is a Linked Context breakpoint, then `DBGBCR<n>_EL1.{LBN, SSC, HMC, PMC}` or `DBGBCR<n>.{LBN, SSC, HMC, PMC}` are RES0 and ignored.

D2.5.9 Linked comparisons for Breakpoint exception generation

In the following description:

- Breakpoint *n* is a Linked Address Match or a Linked Address Mismatch breakpoint.
- Watchpoint *n* is a Linked watchpoint.
- Breakpoint *m* is a Linked Context breakpoint, that is one of the following:
 - A Linked Context ID Match breakpoint.
 - A Linked VMID Match breakpoint.
 - A Linked VMID and Context ID Match breakpoint.

For a linked comparison, either:

- A breakpoint *n* links to a breakpoint *m*. In this case, if breakpoint *n* matches, it only generates a Breakpoint exception if breakpoint *m* also matches.
- A watchpoint *n* links to a breakpoint *m*. In this case, if watchpoint *n* matches, it only generates a Watchpoint exception if breakpoint *m* also matches.

If no breakpoints or watchpoints link to breakpoint *m*, breakpoint *m* cannot generate any Breakpoint exceptions.

The following subsections describe linked comparisons for Breakpoint exception generation:

- [A linked comparison for an address match and a context match.](#)
- [A linked comparison for an address mismatch and a context match, in an AArch32 stage 1 translation regime on page D2-1589.](#)

Note

- A Linked Context breakpoint *m* might be linked to by more than one Linked Address breakpoint, and might also be linked to one or more Linked watchpoint. See [Breakpoint types and linking of breakpoints on page D2-1576](#).
 - For more information about linked comparisons for Watchpoint exception generation, see [Linked comparisons for Watchpoint exception generation on page D2-1616](#).
-

A linked comparison for an address match and a context match

This comparison is made for a Linked Address Match breakpoint and a Linked Context breakpoint, that are linked together by using `DBGBCR<n>_EL1.BT[0]` and `DBGBCR<n>_EL1.LBN`, or `DBGBCR<n>.BT[0]` and `DBGBCR<n>.LBN`, for the Linked Address Match breakpoint.

A Breakpoint exception is generated only if both:

- The instruction address comparison is successful.

- The context comparison is successful.

In an AArch64 stage 1 translation regime:

The address comparison is successful if the conditions described for an AArch64 stage 1 translation regime in [Address Match breakpoints on page D2-1582](#) are met.

The context comparison is successful if the conditions described for an AArch64 stage 1 translation regime in [Context comparisons for Breakpoint exception generation on page D2-1587](#) are met.

In an AArch32 stage 1 translation regime:

The address comparison is successful if the conditions described for an AArch32 stage 1 translation regime in [Address Match breakpoints on page D2-1582](#) are met.

The context comparison is successful if the conditions described for an AArch32 stage 1 translation regime in [Context comparisons for Breakpoint exception generation on page D2-1587](#) are met.

———— **Note** ————

For the Linked Context breakpoint, [DBGBCR<n>_EL1](#).{LBN, SSC, HMC, BAS, PMC} or [DBGBCR<n>](#).{LBN, SSC, HMC, BAS, PMC} are ignored.

A linked comparison for an address mismatch and a context match, in an AArch32 stage 1 translation regime

The comparison described is made for a Linked Address Mismatch breakpoint and a Linked Context breakpoint, that are linked together by using [DBGBCR<n>](#).BT[0] and [DBGBCR<n>](#).LBN for the Linked Address Mismatch breakpoint.

A Breakpoint exception is generated only if both:

- The instruction address comparison is successful.
- The context comparison is successful.

The address comparison is successful if the conditions described for an AArch32 stage 1 translation regime in [Address Mismatch breakpoints in an AArch32 stage 1 translation regime on page D2-1582](#) are met.

The context comparison is successful if the conditions described for an AArch32 stage 1 translation regime in [Context comparisons for Breakpoint exception generation on page D2-1587](#) are met.

———— **Note** ————

For the Linked Context breakpoint, [DBGBCR<n>_EL1](#).{LBN, SSC, HMC, BAS, PMC} or [DBGBCR<n>](#).{LBN, SSC, HMC, BAS, PMC} are ignored.

D2.5.10 Using breakpoints

This section contains the following:

- [Using an Address Mismatch breakpoint to single-step an instruction.](#)
- [Address breakpoints on the first instruction in an IT block on page D2-1591.](#)
- [Constraints on programming hardware breakpoints on page D2-1591.](#)

Using an Address Mismatch breakpoint to single-step an instruction

The following description applies only for an AArch32 stage 1 translation regime.

In execution conditions that an Address Mismatch breakpoint matches, the breakpoint generates Breakpoint exceptions for all instructions committed for execution, except the instruction whose address the breakpoint is programmed with. See [Figure D2-6](#) for an example of Address Mismatch breakpoint operation, for an Address Mismatch breakpoint programmed with address 0x1014.

———— Note ————

When a debugger programs an Address Mismatch breakpoint, it programs the breakpoint to match only in certain execution conditions. For example, a debugger might program an Address Mismatch breakpoint to generate Breakpoint exceptions only when execution is in Secure EL0. For more information, see [Execution conditions that a breakpoint generates Breakpoint exceptions for on page D2-1573.](#)

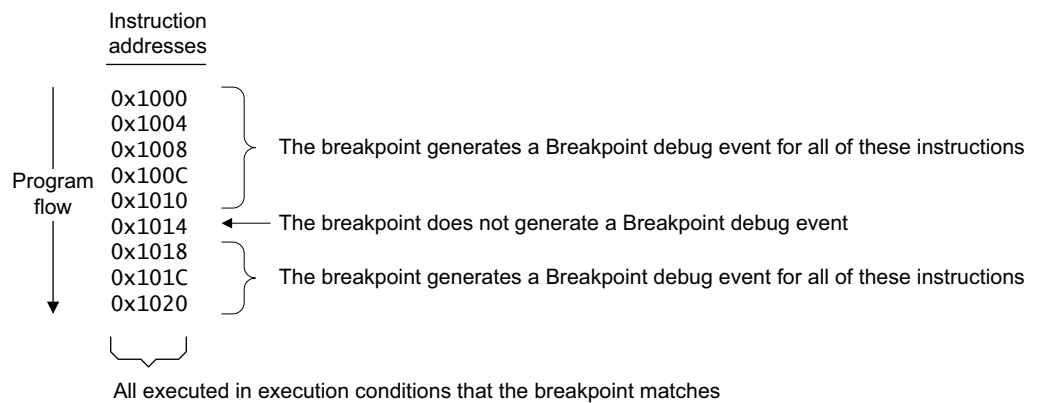

Figure D2-6 Operation of an Address Mismatch breakpoint

This means that an Address Mismatch breakpoint can be used to single-step an instruction.

In the example shown in [Figure D2-6](#):

- If the target of a branch is any instruction other than the instruction at address 0x1014, the breakpoint generates a Breakpoint exception when the target is committed for execution.
- If the target of a branch is the instruction at address 0x1014, the PE executes the instruction at 0x1014 and the breakpoint does not generate a Breakpoint exception until the instruction at address 0x1018 is committed for execution. The instruction at address 0x1014 is therefore single-stepped.

However, if the instruction at address 0x1014 is single-stepped and causes a synchronous exception, or if an asynchronous exception occurs while the instruction is being stepped, the breakpoint is evaluated again after taking the exception. This means that behavior is as follows:

- If the exception handler executes in execution conditions that the breakpoint matches, the breakpoint generates a Breakpoint exception for the exception vector, because the exception vector is not address 0x1014. This means that software execution on the PE steps into the exception.

- If the exception handler executes in execution conditions that the breakpoint does not match, the breakpoint does not generate any Breakpoint exceptions after the PE has taken the exception, until the PE returns from the exception. The effect is to step over the exception. Whether the instruction is stepped again depends on whether the preferred exception return for the exception, and hence the target of the exception return instruction, is the instruction at 0x1014 or the instruction at 0x1018.

If the instruction at address 0x1014 is single-stepped and branches to itself, it is CONSTRAINED UNPREDICTABLE whether the breakpoint generates a Breakpoint exception after the PE has executed the branch.

This means that an instruction is only single-stepped if it is the target of a branch instruction and its address matches the address the breakpoint is programmed for. In the example shown in [Figure D2-6 on page D2-1590](#), this is 0x1014.

Because Address Mismatch breakpoints can single-step instructions, the behavior of an address mismatch Breakpoint exception is similar to the behavior of a Software Step exception.

Note

- The example shown in [Figure D2-6 on page D2-1590](#) assumes an A32 instruction. The same behavior applies for both 32-bit and 16-bit T32 instructions.
 - Software Step exceptions are the highest priority exception. Breakpoint exceptions are lower priority. See [Synchronous exception prioritization on page D1-1451](#).
 - In AArch64 state, if `EDSCR.HDE` is 1 and halting is allowed, the Address Mismatch breakpoint type is reserved. In these cases, Address Mismatch breakpoints are evaluated as Address Match breakpoints. This behavior might change in future revisions of the architecture. For this reason, software must not rely on this behavior.
-

Address breakpoints on the first instruction in an IT block

This section applies to AArch32 state only.

The ARMv8-A architecture permits a combination of an IT instruction and another 16-bit T32 instruction to comprise one 32-bit instruction, if the ITD bit associated with the current Exception level is 1.

It is IMPLEMENTATION DEFINED whether:

- The debug logic considers one of these 32-bit instructions to be one instruction.
- The debug logic considers one of these 32-bit instructions to be two instructions.

Because an Address breakpoint might not generate a Breakpoint exception if an address match occurs only on the second halfword of a 32-bit instruction, a debugger that wants to program a breakpoint to match on the first instruction in an IT block must instead program the breakpoint to match on the IT instruction itself, even if ITD is zero.

Note

- The ITD bit is the IT Disable bit. See [Trapped instructions when SCTLR_ELI.ITD is 1 on page D1-1468](#).
 - [Constraints on programming hardware breakpoints](#) describes that Address breakpoints might not generate Breakpoint exceptions for address matches that occur on the second halfword of an instruction.
-

Constraints on programming hardware breakpoints

For the conditions described in the following subsections, breakpoint behavior is one of the following:

- The breakpoint does not generate any Breakpoint exceptions.
- The breakpoint is evaluated as a different breakpoint type, or to match in different PE execution conditions.
- It is CONSTRAINED UNPREDICTABLE whether the breakpoint generates a Breakpoint exception.

The subsections are:

- [Reserved `DBGBCR<n>_ELI.BT` or `DBGBCR<n>.BT` values on page D2-1592](#).

- *Reserved HMC, SSC, and PMC values.*
- *Constraints that apply to all breakpoint types on page D2-1593.*
- *Constraints that apply only to Address breakpoints on page D2-1593.*
- *Constraints that apply only to Context breakpoints on page D2-1594.*

Reserved DBGBCR<n>_EL1.BT or DBGBCR<n>.BT values

Table D2-5 shows when particular DBGBCR<n>_EL1.BT or DBGBCR<n>.BT values are reserved, and for the corresponding breakpoint types, shows behavior when the value is reserved.

Table D2-5 Behaviors of breakpoints programmed with reserved BT values

BT value	Breakpoint type	Reserved	Breakpoint behavior when the BT value is reserved
0b011x	-	Always.	The breakpoint behaves as if it is disabled.
0b11xx	-		
0b001x	Context ID Match	For non context-aware breakpoints.	BT[3, 1] are RES0, therefore the breakpoint behaves as an Address Match breakpoint.
0b100x	VMID Match		
0b101x	Context ID and VMID Match		
0b100x	VMID Match	If EL2 is not implemented.	BT[3] is RES0, therefore the breakpoint behaves as an Address Match breakpoint.
0b101x	Context ID and VMID Match		
0b010x	Address Mismatch	In an AArch64 stage 1 translation regime, or if EL1 using AArch32 is not supported, or if EDSCR.HDE is 1 and halting is allowed.	BT[2] is RES0, therefore the breakpoint behaves as an Address Match breakpoint.

The behavior of breakpoints with reserved BT values might change in future revisions of the architecture. For this reason, software must not rely on the behavior described here.

Reserved HMC, SSC, and PMC values

Table D2-6 on page D2-1593 shows when particular combinations of DBGBCR<n>_EL1.{HMC, SSC, PMC} or DBGBCR<n>.{HMC, SSC, PMC} are reserved, and shows behavior when the combination is reserved, for all breakpoint types except Linked Context breakpoints.

Linked Context breakpoints ignore the HMC, SSC, and PMC fields.

Table D2-6 Behaviors for reserved HMC, SSC, and PMC combinations

HMC	SSC	PMC	Reserved	Behavior when reserved
0	00	00	In an AArch64 stage 1 translation regime, or if EL1 using AArch32 is not supported.	The breakpoint never generates any Breakpoint exceptions.
0	01	00		
0	10	00		
All combinations with SSC set to 0b01 or 0b10.			When EL3 is not implemented and EL2 is implemented.	SSC[1] is RO and returns the same value as SSC[0]. If the combination with SSC == 0b00 or SSC == 0b11 is then a combination that Table D2-3 on page D2-1574 : <ul style="list-style-type: none"> Includes, the breakpoint matches for those execution conditions. Does not include, the breakpoint never generates any Breakpoint exceptions.
Any combination where HMC or SSC is nonzero.			When both of EL2 and EL3 are not implemented.	SSC and HMC are RES0. This means that the breakpoint matches for different execution conditions. See Table D2-3 on page D2-1574 .
Combinations not included in Table D2-3 on page D2-1574 .			Always	The breakpoint never generates any Breakpoint exceptions ^a

- a. A breakpoint programmed with a combination that [Table D2-3 on page D2-1574](#) does not include might be affected by a behavior listed in this table, so that it then has a combination that [Table D2-3 on page D2-1574](#) does include.

The behavior of breakpoints with reserved combinations of HMC, SSC, and PMC might change in future revisions of the architecture. For this reason, software must not rely on the behavior described here.

Constraints that apply to all breakpoint types

Constraints that apply to all breakpoint types are as follows:

- Address masking and Context ID masking are not supported.
- If the implementation is an AArch64-only implementation, `DBGBCR<n>_EL1.BAS` for all breakpoints is RES1.
- For all Unlinked breakpoint types, `DBGBCR<n>_EL1.LBN` or `DBGBCR<n>.LBN` reads UNKNOWN and is ignored.

Constraints that apply only to Address breakpoints

As follows:

For Address Match breakpoints

For enabled Address Match breakpoints:

- `DBGBVR<n>_EL1[1:0]` or `DBGBVR<n>[1:0]` are RES0 and are ignored.
- In AArch32 state, the `DBGXVR<n>` is ignored.
- For 32-bit instructions, if a breakpoint matches on the address of the second halfword but not the address of the first halfword, it is CONSTRAINED UNPREDICTABLE whether the breakpoint generates a Breakpoint exception.
- If `DBGBCR<n>_EL1.BAS` or `DBGBCR<n>.BAS` is 0b1111, it is CONSTRAINED UNPREDICTABLE whether the breakpoint generates a Breakpoint exception for a T32 instruction starting at address `DBGBVR<n>_EL1[48:2]:10` or `DBGBVR<n>[31:2]:10`. For T32 instructions, ARM recommends that the debugger programs the BAS field with either 0b0011 or 0b1100.

- The BAS value 0b0000 is reserved. A breakpoint programmed with this BAS value behaves either as if the breakpoint is disabled, or as if the BAS field is programmed as 0b0011, 0b1100, or 0b1111.

If the Address Match breakpoint is a Linked Address Match breakpoint, the following conditions also apply:

- If it links to a breakpoint that is not implemented, or a breakpoint that is not context-aware, then behavior is CONSTRAINED UNPREDICTABLE. Either:
 - The Linked Address Match breakpoint never generates any Breakpoint exceptions, and `DBGBCR<n>_EL1.LBN` or `DBGBCR<n>.LBN` for the breakpoint reads UNKNOWN.
 - The breakpoint behaves as if it is linked to an UNKNOWN context-aware breakpoint. In this case, the breakpoint generates Breakpoint exceptions, and `DBGBCR<n>_EL1.LBN` or `DBGBCR<n>.LBN` indicates the context-matching breakpoint.
- If it links to any of the following, it never generates any Breakpoint exceptions:
 - A breakpoint that is implemented and that is context-aware, but that is not programmed as a Linked Context breakpoint.
 - A breakpoint that is implemented but that is not enabled.

See also *Constraints that apply to all breakpoint types on page D2-1593*.

For Address Mismatch breakpoints

The constraints are the same as those described in *For Address Match breakpoints on page D2-1593*, except that:

- If `DBGBCR<n>_EL1.BAS` or `DBGBCR<n>.BAS` is programmed with 0b0000, the breakpoint matches on all addresses, even for the address held in the `DBGBVR<n>_EL1` or `DBGBVR<n>`.
That is, if `DBGBCR<n>_EL1.BAS` or `DBGBCR<n>.BAS` is programmed with 0b0000, the Address Mismatch breakpoint ignores the address held in the `DBGBVR<n>_EL1` or `DBGBVR<n>`.

See also *Constraints that apply to all breakpoint types on page D2-1593*.

Constraints that apply only to Context breakpoints

For enabled Context breakpoints:

- `DBGBCR<n>_EL1.BAS` or `DBGBCR<n>.BAS` is RES1 and is ignored.
- Any bits of `DBGBVR<n>_EL1` or `DBGBVR<n>` that are not used to specify Context ID or VMID are RES0 and are ignored.
- In AArch32 state:
 - Context ID Match breakpoints ignore the `DBGXVR<n>`.
 - VMID Match breakpoints ignore the `DBGBVR<n>`.

If the Context breakpoint is a Linked Context breakpoint, the following condition also applies:

- `DBGBCR<n>_EL1.{LBN, SSC, HMC, PMC}` or `DBGBCR<n>.{LBN, SSC, HMC, PMC}` are ignored.

See also *Constraints that apply to all breakpoint types on page D2-1593*.

D2.5.11 Summary of breakpoint matching for different breakpoint types

The tables in this section each show a summary of breakpoint matching. See:

- [Table D2-7](#) for an AArch64-only implementation.
- [Table D2-8 on page D2-1596](#) for breakpoint matching in an AArch64 stage 1 translation regime, in an implementation that supports AArch32 in at least one Exception level.
- [Table D2-9 on page D2-1597](#) for breakpoint matching in an AArch32 stage 1 translation regime.

For the meanings of the conditions given in bold in the tables, see [Condition definitions on page D2-1598](#). Also see [Using the tables on page D2-1597](#).

Table D2-7 Summary of breakpoint matching for an AArch64-only implementation

Breakpoint type	Comparisons made					Linking
	Address	BAS	Context ID	VMID	PE state	
0b0000 Unlinked Address Match	Equals	-	-	-	AND match	-
0b0001 Linked Address Match	Equals	-	-	-	AND match	AND link^a
0b0010 Unlinked Context ID Match	-	-	Equals	-	AND match	-
0b0011 Linked Context ID Match	-	-	AND equals	-	-	AND link^b
0b0100 Unlinked Address Mismatch	Equals	-	-	-	AND match	-
0b0101 Linked Address Mismatch	Equals	-	-	-	AND match	AND link^a
0b1000 Unlinked VMID Match	-	-	-	Equals	AND match	-
0b1001 Linked VMID Match	-	-	-	AND equals	-	AND link^b
0b1010 Unlinked Context ID and VMID Match	-	-	Equals	AND equals	AND match	-
0b1011 Linked Context ID and VMID Match	-	-	AND equals	AND equals	-	AND link^b

a. Links to one of:

Breakpoint type 0b0011.

Breakpoint type 0b1001.

Breakpoint type 0b1011.

See [Breakpoint types and linking of breakpoints on page D2-1576](#).

- b. One of the following is true:
 No breakpoints or watchpoints link to it.
 Either or both:
 One or more of breakpoint type 0b0001 links to it.
 One or more of breakpoint type 0b0101 links to it.
 Might also be linked to one or more watchpoints. See [Breakpoint types and linking of breakpoints on page D2-1576](#).

Table D2-8 Summary of breakpoint matching in an AArch64 stage 1 translation regime, for an implementation that supports AArch32 in at least one Exception level

Breakpoint type	Comparisons made					Linking
	Address	BAS	Context ID	VMID	PE state	
0b0000 Unlinked Address Match	Equals	AND selected	-	-	AND match	-
0b0001 Linked Address Match	Equals	AND selected	-	-	AND match	AND link ^a
0b0010 Unlinked Context ID Match	-	-	Equals	-	AND match	-
0b0011 Linked Context ID Match	-	-	AND equals	-	-	AND link ^b
0b0100 Unlinked Address Mismatch	Equals	AND selected	-	-	AND match	-
0b0101 Linked Address Mismatch	Equals	AND selected	-	-	AND match	AND link ^a
0b1000 Unlinked VMID Match	-	-	-	Equals	AND match	-
0b1001 Linked VMID Match	-	-	-	AND equals	-	AND link ^b
0b1010 Unlinked Context ID and VMID Match	-	-	Equals	AND equals	AND match	-
0b1011 Linked Context ID and VMID Match	-	-	AND equals	AND equals	-	AND link ^b

- a. Links to one of:
 Breakpoint type 0b0011.
 Breakpoint type 0b1001.
 Breakpoint type 0b1011.
 See [Breakpoint types and linking of breakpoints on page D2-1576](#).
- b. One of the following is true:
 No breakpoints or watchpoints link to it.
 Either or both:
 One or more of breakpoint type 0b0001 links to it.
 One or more of breakpoint type 0b0101 links to it.
 Might also be linked to one or more watchpoints. See [Breakpoint types and linking of breakpoints on page D2-1576](#).

Table D2-9 Summary of breakpoint matching in an AArch32 stage 1 translation regime

Breakpoint type	Comparisons made					Linking
	Address	BAS	Context ID	VMID	PE state	
0b0000 Unlinked Address Match	Equals	AND selected	-	-	AND match	-
0b0001 Linked Address Match	Equals	AND selected	-	-	AND match	AND link ^a
0b0010 Unlinked Context ID Match	-	-	Equals	-	AND match	-
0b0011 Linked Context ID Match	-	-	AND equals	-	-	AND link ^b
0b0100 Unlinked Address Mismatch	Not (equals	AND selected)	-	-	AND match	-
0b0101 Linked Address Mismatch	Not (equals	AND selected)	-	-	AND match	AND link ^a
0b1000 Unlinked VMID Match	-	-	-	Equals	AND match	-
0b1001 Linked VMID Match	-	-	-	AND equals	-	AND link ^b
0b1010 Unlinked Context ID and VMID Match	-	-	Equals	AND equals	AND match	-
0b1011 Linked Context ID and VMID Match	-	-	AND equals	AND equals	-	AND link ^b

a. Links to one of:

Breakpoint type 0b0011.

Breakpoint type 0b1001.

Breakpoint type 0b1011.

See [Breakpoint types and linking of breakpoints on page D2-1576](#).

b. One of the following is true:

No breakpoints or watchpoints link to it.

Either or both:

One or more of breakpoint type 0b0001 links to it.

One or more of breakpoint type 0b0101 links to it.

Might also be linked to one or more watchpoints. See [Breakpoint types and linking of breakpoints on page D2-1576](#).

Using the tables

Reading across the columns gives the comparisons that are made for each breakpoint type. For example, in [Table D2-9](#):

- For a Linked Address Mismatch breakpoint, 0b0101, that links to a Linked VMID Match breakpoint, 0b1001, the comparisons made are:
 - A comparison of the instruction address, by the Linked Address Mismatch breakpoint. This comparison considers the BAS field.

- A comparison of the PE state, by the Linked Address Mismatch breakpoint.
- A comparison of the VMID, by the Linked VMID Match breakpoint.

Therefore, in this example, the conditions that are required are:

Not (equals[address] AND selected[BAS]) AND match[PE state] AND equals[VMID]

- For an Unlinked Context ID and VMID Match breakpoint type, 0b1010, the comparisons that are made are:
 - A comparison of the Context ID.
 - A comparison of the VMID.
 - A comparison of the PE state.

By reading across the columns, the conditions required are:

Equals[Context ID] AND equals[VMID] AND match[PE state].

For the meanings of the **Equals**, **selected**, **match** and **link** conditions, see [Condition definitions](#).

Condition definitions

For each breakpoint type, the tables show all of the following:

- Whether the breakpoint compares an instruction address value, or a context value or context values.
- Whether the breakpoint takes the BAS field into account.
- Whether the breakpoint makes a PE state comparison.
- Whether the breakpoint is linked to a watchpoint or another breakpoint.

For each of these items, see the subsections that follow.

Whether the breakpoint compares an instruction address value, or a context value or context values

For this comparison, the table entry shows the condition required for the breakpoint to generate a Breakpoint exception. The possible conditions are:

Equals

The value compared must be equal.

If the comparison is an instruction address comparison:

- In AArch64 state, bits [48:2] of the current instruction address value must equal [DBGBVR<n>_EL1](#)[48:2].
- In AArch32 state, bits [31:2] of the current instruction address value must equal [DBGBVR<n>](#)[31:2].

If the comparison is a Context ID comparison:

- In AArch64 state, bits [31:0] of the current Context ID value must equal [DBGBVR<n>_EL1](#)[31:0].
- In AArch32 state, bits [31:0] of the current Context ID value must equal [DBGBVR<n>](#)[31:0].

If the comparison is a VMID comparison:

- In AArch64 state, bits [39:32] of the current VMID value must equal [DBGBVR<n>_EL1](#)[39:32].
- In AArch32 state, bits [7:0] of the current VMID value must equal [DBGBXVR<n>](#)[7:0].

Not equals

The value compared must not be equal.

This condition applies only to instruction address mismatch comparisons:

- In AArch64 state, bits [48:2] of the current instruction address value must not equal [DBGBVR<n>_EL1](#) [48:2].
- In AArch32 state, bits [31:2] of the current instruction address value must not equal [DBGBVR<n>](#)[31:2].

Not (equals)

This is the beginning of a Boolean function that continues in the BAS column of the table. It applies only to Address Mismatch breakpoints. See *AND selected*.

Whether the breakpoint takes the BAS field into account

The BAS field is only used for Address comparisons, and is only supported if the implementation supports AArch32 state in at least one Exception level. If the implementation is an AArch64-only implementation, the BAS field for all breakpoints is RES1.

The BAS field selects a particular halfword-aligned address, that is either:

- The word-aligned address held in the `DBGBVR<n>_EL1` or `DBGBVR<n>`.
- The halfword-aligned address at `DBGBVR<n>_EL1[48:2]:10` or `DBGBVR<n>[31:2]:10`.

For breakpoint types that take the BAS field into account, the table entry shows either:

AND selected

This means that the halfword-aligned address specified by the BAS field must match.

This means that:

- In AArch64 state, an address comparison is successful only if both:
 - Bits [48:2] of the current instruction address value equals `DBGBVR<n>_EL1[48:2]`.
 - Bits [1:0] of the current instruction address value matches the halfword-aligned address defined by the BAS field.
- in AArch32 state, an address comparison is successful only if both:
 - Bits [31:2] of the current instruction address value equals `DBGBVR<n>[31:2]`.
 - Bits [1:0] of the current instruction address value matches the halfword-aligned address defined by the BAS field.

See *Using the BAS field in Address Match breakpoints on page D2-1584*.

AND selected)

This is the end of a Boolean function that started in the Address column. The Boolean function applies only to Address Mismatch breakpoints in an AArch32 stage 1 translation regime. This condition means that the halfword-aligned address specified by the BAS field must not match.

An address comparison is successful if either or both:

- Bits [31:2] of the current instruction address value do not equal `DBGBVR<n>[31:2]`.
- Bits [1:0] of the current instruction address value do not match the halfword-aligned address defined by the BAS field.

See *Using the BAS field in Address Mismatch breakpoints, in an AArch32 stage 1 translation regime on page D2-1586*.

Whether the breakpoint makes a PE state comparison

If it does, the table entry shows:

AND Match

This means that the PE state must match for the breakpoint to generate a Breakpoint exception:

- In AArch64 state, the current PE state must match the conditions defined by the `DBGBCR<n>_EL1`.{SSC, HMC, PMC} fields.
- In AArch32 state, the current PE state must match the conditions defined by the `DBGBCR<n>`.{SSC, HMC, PMC} fields.

See *Execution conditions that a breakpoint generates Breakpoint exceptions for on page D2-1573*.

This condition is in addition to other successful comparisons, for example either or both of the following:

- A successful address match, that might or might not take the BAS field into account, depending on whether the implementation is AArch64 only or supports AArch32 in any state.
- A successful context match, that might be a Context ID match, a VMID match, or both.

Whether the breakpoint is linked to a watchpoint or another breakpoint

If it is linked, the footnote in the table entry shows what it might be linked to.

D2.5.12 Pseudocode descriptions of Breakpoint exceptions taken from AArch64 state

AArch64.BreakpointValueMatch() tests the value in `DBGBVR<n>_EL1`.

```
// AArch64.BreakpointValueMatch()
// =====

boolean AArch64.BreakpointValueMatch(integer n, bits(64) vaddress, boolean linked_to)

// "n" is the identity of the breakpoint unit to match against
// "vaddress" is the current instruction address, ignored if linked_to is TRUE and Context
// matching breakpoints.
// "linked_to" is TRUE if this is a call from StateMatch for linking.

// If a non-existent breakpoint then it is CONSTRAINED UNPREDICTABLE whether this gives
// no match or the breakpoint is mapped to another UNKNOWN implemented breakpoint.
if n > UInt(ID_AA64DFR0_EL1.BRPs) then
    (c, n) = ConstrainUnpredictableInteger(0, UInt(ID_AA64DFR0_EL1.BRPs));
    assert c IN {Constraint_NONE, Constraint_UNKNOWN};
    if c == Constraint_NONE then return FALSE;

// If this breakpoint is not enabled, it cannot generate a match. (This could also happen on a
// call from StateMatch for linking.)
if DBGBCR_EL1[n].E == '0' then return FALSE;

// Return FALSE if BT is set to a reserved type.
if DBGBCR_EL1[n].BT IN {'011x', '11xx'} then return FALSE;

// Determine what to compare against.
match_addr = DBGBCR_EL1[n].BT<3,1> == '00';
match_vmid = DBGBCR_EL1[n].BT<3> == '1';
match_cid = DBGBCR_EL1[n].BT<1> == '1';
linked      = DBGBCR_EL1[n].BT<0> == '1';

// Assertions based on the definition of DBGBCR_EL1[n].BT.
// Unless this breakpoint is context-aware, BT<3,1> are RAZ, and
// doesn't match VMID or CONTEXTIDR
assert (n >= UInt(ID_AA64DFR0_EL1.BRPs) - UInt(ID_AA64DFR0_EL1.CTX_CMPs)) ||
    (IsZero(DBGBCR_EL1[n].BT<3,1>) && !match_vmid && !match_cid);

// Must be matching either address, or one or both of CONTEXTIDR and VMID. This assertion is
// obviously true given the definition of these variables.
assert ((match_addr && !match_cid && !match_vmid) ||
    (!match_addr && match_cid) || (!match_addr && match_vmid));

// VMID matching is not possible/allowable if no EL2 support.
assert HaveEL(EL2) || !match_vmid;

// If this is a call from StateMatch, return FALSE if the breakpoint is not programmed for a
// VMID and/or context ID match, or if not context-aware. The above assertions mean that the
// code can just test for match_addr == TRUE to confirm all these things.
if linked_to && (!linked || match_addr) then return FALSE;

// If this is a call from BreakpointMatch return FALSE for Linked context ID and/or
// VMID matches.
if !linked_to && linked && !match_addr then return FALSE;
```

```
// Do the comparison.
if match_addr then
    top = AddrTop(vaddress);
    byte_select_match = (DBGBCR_EL1[n].BAS<0> != '0');
    BVR_match = vaddress<top:2> == DBGBVR_EL1[n]<top:2> && byte_select_match;
elseif match_cid then
    BVR_match = (PSTATE.EL IN {EL0,EL1} && CONTEXTIDR_EL1 == DBGBVR_EL1[n]<31:0>);
if match_vmid then
    BXVR_match = (CurrentStateHasEL2() && PSTATE.EL IN {EL1,EL0} &&
        VTTBR_EL2.VMID == DBGBVR_EL1[n]<39:32>);

match = (!match_vmid || BXVR_match) && (!(match_addr || match_cid) || BVR_match);
return match;
```

AArch64.StateMatch() tests the values in [DBGBCR<n>_EL1](#).{SSC, HMC, PMC}, and if the breakpoint is Linked, also tests the Linked Context breakpoint that it links to.

For a watchpoint, AArch64.StateMatch() tests the values in [DBGWCR<n>_EL1](#).{SSC, HMC, PAC}, and if the watchpoint is Linked, also tests the Linked Context breakpoint that it links to.

```
// AArch64.StateMatch()
// =====

boolean AArch64.StateMatch(bits(2) SSC, bit HMC, bits(2) PxC, boolean linked, bits(4) LBN,
    boolean ispriv)
// Function used in both Breakpoint and Watchpoint matching to determine whether the point is
// enabled in the current mode and state.
// "SSC", "HMC", "PxC" and "LBN" are the control fields from the DBGBCRn_EL1 or DBGWCRn_EL1
// register.
// "ispriv" is only valid for watchpoints, and selects between privileged and unprivileged
// accesses.
// "linked" is TRUE if this is a linked breakpoint/watchpoint address type.
// Return FALSE if parameters are set to a reserved type.

if (HMC:SSC:PxC) IN {'100x0', '101x0', '11010', '011xx', '111x1', '11110'} then return FALSE;

EL3_match = HaveEL(EL3) && HMC == '1' && SSC<0> == '0';
EL2_match = HaveEL(EL2) && HMC == '1';
EL1_match = PxC<0> == '1';
EL0_match = PxC<1> == '1';

case PSTATE.EL of
    when EL3 priv_match = EL3_match;
    when EL2 priv_match = EL2_match;
    when EL1 priv_match = if ispriv then EL1_match else EL0_match;
    when EL0 priv_match = EL0_match;

// The determination of security_state_match relies on these assertions to avoid reserved cases.
if !HaveEL(EL3) then assert SSC<0> == SSC<1>;
if SSC == '11' then assert HMC == '1';
case SSC of
    when '00' security_state_match = TRUE; // Both
    when '01' security_state_match = !IsSecure(); // Non-secure only
    when '10' security_state_match = IsSecure(); // Secure only
    when '11' security_state_match = TRUE; // Both

if linked then
    // "LBN" must be an enabled context-aware breakpoint unit. If it is not context-aware
    // then it is CONSTRAINED UNPREDICTABLE whether this gives no match, or LBN is mapped to
    // some UNKNOWN breakpoint that is context-aware.
    lbn = UInt(LBN);
    first_ctx_cmp = (UInt(ID_AA64DFR0_EL1.BRPs) - UInt(ID_AA64DFR0_EL1.CTX_CMPs));
    last_ctx_cmp = UInt(ID_AA64DFR0_EL1.BRPs);
    if (lbn < first_ctx_cmp || lbn > last_ctx_cmp) then
        (c, lbn) = ConstrainUnpredictableInteger(first_ctx_cmp, last_ctx_cmp);
        assert c IN {Constraint_NONE, Constraint_UNKNOWN};
        if c == Constraint_NONE then return FALSE;
```

```
    vaddress = bits(64) UNKNOWN;
    linked_to = TRUE;
    linked_match = AArch64.BreakpointValueMatch(lbn, vaddress, linked_to);

    return priv_match && security_state_match && (!linked || linked_match);
```

AArch64.CheckBreakpoint() tests a committed instruction against all breakpoints. If all of the following are true, a Breakpoint exception is generated:

- MDSCR_EL1.MDE is 1.
- Debug exceptions are enabled from the current Exception level and Security state. See [Enabling debug exceptions from current Exception level and Security state on page D3-1656](#).
- All of the conditions required for Breakpoint exception generation are met. See [Conditions for generating a Breakpoint exception on page D2-1572](#).

AArch64.CheckBreakpoint() might halt the PE and cause it to enter Debug state. External debug uses Debug state.

```
// AArch64.CheckBreakpoint()
// =====
// Called before executing the instruction of length "size" bytes at "vaddress" in an AArch64
// translation regime.
// The breakpoint can in fact be evaluated well ahead of execution, for example, at instruction
// fetch. This is the simple sequential execution of the program.
```

```
FaultRecord AArch64.CheckBreakpoint(bits(64) vaddress, integer size)
    assert !ELUsingAArch32(TranslationRegime());
    assert (UsingAArch32() && size IN {2,4}) || size == 4;

    match = FALSE;

    for i = 0 to UInt(ID_AA64DFR0_EL1.BRPs)
        match_i = AArch64.BreakpointMatch(i, vaddress, size);
        match = match || match_i;

    if match && HaltOnBreakpointOrWatchpoint() then
        reason = DebugHalt_Breakpoint;
        Halt(reason);
    elsif match && MDSCR_EL1.MDE == '1' && AArch64.GenerateDebugExceptions() then
        acctype = AccType_IFETCH;
        iswrite = FALSE;
        return AArch64.DebugFault(acctype, iswrite);
    else
        return AArch64.NoFault();
```

AArch64.BreakpointException() is called to generate a Breakpoint exception.

```
// AArch64.BreakpointException()
// =====

AArch64.BreakpointException(FaultRecord fault)
    assert PSTATE.EL != EL3;

    route_to_el2 = (AArch64.GeneralExceptionsToEL2() ||
        (HaveEL(EL2) && !IsSecure() && MDCR_EL2.TDE == '1'));

    vaddress = bits(64) UNKNOWN;
    exception = AArch64.AbortSyndrome(Exception_Breakpoint, fault, vaddress);
    bits(64) preferred_exception_return = ThisInstrAddr();
    vect_offset = 0x0;

    if PSTATE.EL == EL2 || route_to_el2 then
        AArch64.TakeException(EL2, exception, preferred_exception_return, vect_offset);
    else
        AArch64.TakeException(EL1, exception, preferred_exception_return, vect_offset);
```

D2.5.13 Pseudocode descriptions of Breakpoint exceptions taken from AArch32 state

AArch32.BreakpointValueMatch() returns a pair of results:

- A result for Address Match and Context breakpoints.
- A result for Address Mismatch breakpoints.

```
// AArch32.BreakpointValueMatch()
// =====
// The first result is whether an Address Match or Context breakpoint is programmed
// on the instruction at "address".
// The second result is whether an Address Mismatch breakpoint is programmed on the instruction,
// that is, whether the instruction is one which has a "mismatch" step pending on it. This only
// applies in an AArch32 code translation regime, for v7-A compatibility.

(boolean,boolean) AArch32.BreakpointValueMatch(integer n, bits(32) vaddress, boolean linked_to)

// "n" is the identity of the breakpoint unit to match against
// "vaddress" is the current instruction address, ignored if linked_to is TRUE and Context
// matching breakpoints.
// "linked_to" is TRUE if this is a call from StateMatch for linking.

// If a non-existent breakpoint then it is CONSTRAINED UNPREDICTABLE whether this gives
// no match or the breakpoint is mapped to another UNKNOWN implemented breakpoint.
if n > UInt(DBGDIDR.BRPs) then
    (c, n) = ConstrainUnpredictableInteger(0, UInt(DBGDIDR.BRPs));
    assert c IN {Constraint_NONE, Constraint_UNKNOWN};
    if c == Constraint_NONE then return (FALSE,FALSE);

// If this breakpoint is not enabled, it cannot generate a match. (This could also happen on a
// call from StateMatch for linking.)
if DBGBCR[n].E == '0' then return (FALSE,FALSE);

// Return FALSE if BT is set to a reserved type.
if DBGBCR[n].BT IN {'011x','11xx'} then return (FALSE,FALSE);

// Determine what to compare against.
match_addr = DBGBCR[n].BT<3,1> == '00';
match_vmid = DBGBCR[n].BT<3> == '1';
mismatch   = DBGBCR[n].BT<2> == '1' && !HaltOnBreakpointOrWatchpoint();
match_cid  = DBGBCR[n].BT<1> == '1';
linked     = DBGBCR[n].BT<0> == '1';

// Assertions based on the definition of DBGBCR[n].BT.
// Unless this breakpoint is context-aware, BT<3,1> are RAZ, and
// doesn't match VMID or CONTEXTIDR
assert (n >= UInt(DBGDIDR.BRPs) - UInt(DBGDIDR.CTX_CMPs) ||
        (IsZero(DBGBCR[n].BT<3,1>) && !match_vmid && !match_cid));

// Unless EL1 using AArch32 is supported, BT<2> is RAZ, and doesn't support mismatch
assert HaveAArch32EL(EL1) || (IsZero(DBGBCR[n].BT<2>) && !mismatch);

// Must be matching either address, or one or both of CONTEXTIDR and VMID. This assertion is
// obviously true given the definition of these variables.
assert ((match_addr && !match_cid && !match_vmid) ||
        (!match_addr && match_cid) || (!match_addr && match_vmid));

// VMID matching is not possible/allowable if no EL2 support.
assert HaveEL(EL2) || !match_vmid;

// If this is a call from StateMatch, return FALSE if the breakpoint is not programmed for a
// VMID and/or context ID match, or if not context-aware. The above assertions mean that the
// code can just test for match_addr == TRUE to confirm all these things.
if linked_to && (!linked || match_addr) then return (FALSE,FALSE);

// If this is a call from BreakpointMatch return FALSE for Linked context ID and/or
// VMID matches.
if !linked_to && linked && !match_addr then return (FALSE,FALSE);
```

```
// Do the comparison.
if match_addr then
    assert vaddress<0> == '0'; // Direct execution of Java bytecodes not supported in v8-A.
    byte = UInt(vaddress<1:0>); assert byte IN {2,0};
    assert DBGBCR[n].BAS<byte+1> == DBGBCR[n].BAS<byte>;
    byte_select_match = (DBGBCR[n].BAS<byte> != '0');
    BVR_match = vaddress<31:2> == DBGBVR[n]<31:2> && byte_select_match;
elseif match_cid then
    BVR_match = ((PSTATE.EL != EL3 || ELUsingAArch32(EL3)) && PSTATE.EL != EL2 &&
        CONTEXTIDR_GEN[] == DBGBVR[n]<31:0>);
if match_vmid then
    BXVR_match = (CurrentStateHasEL2() && PSTATE.EL IN {EL1,EL0} &&
        VTTBR_EL2.VMID == DBGXVR[n]<7:0>);

match = (!match_vmid || BXVR_match) && (!(match_addr || match_cid) || BVR_match);
return (match && !mismatch, !match && mismatch);
```

AArch32.StateMatch() tests the values in [DBGBCR<n>](#).{SSC, HMC, PMC}, and if the breakpoint is Linked, also tests the Linked Context breakpoint that it links to.

For a watchpoint, AArch32.StateMatch() tests the values in [DBGWCR<n>](#).{SSC, HMC, PAC}, and if the watchpoint is Linked, also tests the Linked Context breakpoint that it links to.

```
// AArch32.StateMatch()
// =====

boolean AArch32.StateMatch(bits(2) SSC, bit HMC, bits(2) PxC, boolean linked, bits(4) LBN,
    boolean isbreakpnt, boolean ispriv)
// Function used in both Breakpoint and Watchpoint matching to determine whether the point is
// enabled in the current mode and state.
// "SSC", "HMC", "PxC" and "LBN" are the control fields from the DBGBCRn_EL1 or DBGWCRn_EL1
// register.
// "ispriv" is only valid for watchpoints, and selects between privileged and unprivileged
// accesses.
// "linked" is TRUE if this is a linked breakpoint/watchpoint address type.
// "isbreakpnt" is TRUE for breakpoints if any of EL3, EL2 or EL1 is using AArch32, FALSE for
// watchpoints. It allows selection of the "Svs/Sys/User" match in AArch32 modes.
// Return FALSE if parameters are set to a reserved type.

if (HMC:SSC:PxC) IN {'100x0', '101x0', '11010', '011xx', '111x1', '11110'} then return FALSE;

PL3_match = HaveEL(EL3) && HMC == '1' && SSC<0> == '0';
PL2_match = HaveEL(EL2) && HMC == '1';
PL1_match = PxC<0> == '1';
PL0_match = PxC<1> == '1';
SSU_match = HMC == '0' && PxC == '00' && SSC != '11';

// no Sys/Svc/Usr matching for watchpoints or for breakpoints when EL1 is using AArch64.
if !isbreakpnt && SSU_match then return FALSE;

if SSU_match then
    priv_match = PSTATE.M IN {M32_User,M32_Svc,M32_System};
else
    case PSTATE.EL of
        when EL3, EL1 priv_match = if ispriv then PL1_match else PL0_match;
        when EL2 priv_match = PL2_match;
        when EL0 priv_match = PL0_match;

// The determination of security_state_match relies on these assertions to avoid reserved cases.
if !HaveEL(EL3) then assert SSC<0> == SSC<1>;
if SSC == '11' then assert HMC == '1';
case SSC of
    when '00' security_state_match = TRUE; // Both
    when '01' security_state_match = !IsSecure(); // Non-secure only
    when '10' security_state_match = IsSecure(); // Secure only
    when '11' security_state_match = TRUE; // Both
```

```

if linked then
    // "LBN" must be an enabled context-aware breakpoint unit. If it is not context-aware
    // then it is CONSTRAINED UNPREDICTABLE whether this gives no match, or LBN is mapped to
    // some UNKNOWN breakpoint that is context-aware.
    lbn = UInt(LBN);
    first_ctx_cmp = (UInt(DBGDIDR.BRPs) - UInt(DBGDIDR.CTX_CMPs));
    last_ctx_cmp = UInt(DBGDIDR.BRPs);
    if (lbn < first_ctx_cmp || lbn > last_ctx_cmp) then
        (c, lbn) = ConstrainUnpredictableInteger(first_ctx_cmp, last_ctx_cmp);
        assert c IN {Constraint_NONE, Constraint_UNKNOWN};
        if c == Constraint_NONE then return FALSE;
    vaddress = bits(32) UNKNOWN;
    linked_to = TRUE;
    (linked_match,-) = AArch32.BreakpointValueMatch(lbn, vaddress, linked_to);

return priv_match && security_state_match && (!linked || linked_match);

```

AArch32.CheckBreakpoint() tests a committed instruction against all breakpoints. If all of the following are true, a Breakpoint exception is generated:

- [DBGDSCRExt.MDBGGen](#) is 1.
- Debug exceptions are enabled from the current Exception level and Security state. See [Enabling debug exceptions from current Exception level and Security state](#) on page D3-1656.
- All of the conditions required for Breakpoint exception generation are met. See [Conditions for generating a Breakpoint exception](#) on page D2-1572.

AArch64.CheckBreakpoint() might halt the PE and cause it to enter Debug state. External debug uses Debug state.

```

// AArch32.CheckBreakpoint()
// =====
// Called before executing the instruction of length "size" bytes at "vaddress" in an AArch32
// translation regime.
// The breakpoint can in fact be evaluated well ahead of execution, for example, at instruction
// fetch. This is the simple sequential execution of the program.

```

```

FaultRecord AArch32.CheckBreakpoint(bits(32) vaddress, integer size)
    assert ELUsingAArch32(TranslationRegime());
    assert size IN {2,4};

    match = FALSE;
    mismatch = FALSE;

    for i = 0 to UInt(DBGDIDR.BRPs)
        (match_i, mismatch_i) = AArch32.BreakpointMatch(i, vaddress, size);
        match = match || match_i;
        mismatch = mismatch || mismatch_i;

    if match && HaltOnBreakpointOrWatchpoint() then
        reason = DebugHalt_Breakpoint;
        Halt(reason);
    elsif (match || mismatch) && DBGDSCRExt.MDBGGen == '1' && AArch32.GenerateDebugExceptions() then
        acctype = AccType_IFETCH;
        iswrite = FALSE;
        debugmoe = DebugException_Breakpoint;
        return AArch32.DebugFault(acctype, iswrite, debugmoe);
    else
        return AArch32.NoFault();

```

There is no AArch32.BreakpointException() because Breakpoint exceptions are handled by AArch32.TakePrefetchAbortException(). See [Pseudocode description of taking the Prefetch Abort exception](#) on page G1-3482.

D2.6 Watchpoint exceptions

The following subsections describe Watchpoint exceptions:

- [About Watchpoint exceptions.](#)
- [Enable controls for Watchpoint exceptions on page D2-1607.](#)
- [Conditions for generating a Watchpoint exception on page D2-1608.](#)
- [About Watchpoint Control Registers on page D2-1609.](#)
- [Linking of watchpoints on page D2-1611.](#)
- [Data address comparisons for Watchpoint exception generation on page D2-1612.](#)
- [Taking into account the size of the data access on page D2-1612.](#)
- [Programming a watchpoint with eight bytes or fewer on page D2-1613.](#)
- [Programming a watchpoint with eight or more bytes on page D2-1615.](#)
- [Programming dependencies of the BAS and MASK fields on page D2-1616.](#)
- [Linked comparisons for Watchpoint exception generation on page D2-1616.](#)
- [Determining the memory location that caused a Watchpoint debug event on page D2-1617.](#)
- [Using watchpoints on page D2-1618.](#)
- [Summary of watchpoint matching on page D2-1620.](#)
- [Pseudocode description of Watchpoint exceptions taken from AArch64 state on page D2-1621.](#)
- [Pseudocode description of Watchpoint exceptions taken from AArch32 state on page D2-1624.](#)

D2.6.1 About Watchpoint exceptions

A *watchpoint* is a debug event that results from the execution of an instruction, based on a data address. Watchpoints are also known as *data breakpoints*.

A watchpoint operates as follows:

1. A debugger programs the watchpoint with a data address, or a data address range.
2. The watchpoint generates a Watchpoint exception whenever an instruction that initiates an access to the address, or any address in the programmed range, is committed for execution.

A watchpoint never generates a Watchpoint exception on an instruction fetch.

An implementation can include between 2-16 watchpoints. In an implementation, [ID_AA64DFR0_EL1.WRPs](#) or [DBGDIDR.WRPs](#) shows how many are implemented.

To use an implemented watchpoint, a debugger programs one of the following pairs of registers, depending on the Execution state:

In AArch64 state:

- A 32-bit *Watchpoint Control Register*, [DBGWCR<n>_EL1](#), that holds control information for the watchpoint, for example whether the watchpoint is enabled.
- A 64-bit *Watchpoint Value Register*, [DBGWVR<n>_EL1](#), that holds the data address value used for watchpoint matching.

In AArch32 state:

- A 32-bit *Watchpoint Control Register*, [DBGWCR<n>](#), that holds control information for the watchpoint, for example whether the watchpoint is enabled.
- A 32-bit *Watchpoint Value Register*, [DBGWVR<n>](#), that holds the data address value used for watchpoint matching.

The registers are numbered, so for example in AArch64 state:

- [DBGWCR1_EL1](#) and [DBGWVR1_EL1](#) are for watchpoint number one.
- [DBGWCR1_EL2](#) and [DBGWVR2_EL1](#) are for watchpoint number two.
- ...
- ...

- DBGWCRn_EL1 and DBGWVRn_EL1 are for watchpoint number n.

Each watchpoint must either:

- Be used in isolation, so that it generates a Watchpoint exception whenever an instruction accesses any data address it is programmed with.
- Link to a Linked Context breakpoint, so that it only generates a Watchpoint exception if the PE is in a particular context when a data address match occurs. See [Linking of watchpoints on page D2-1611](#).

A single watchpoint can be programmed to match on one or more data address bytes, and generates a Watchpoint exception if an instruction accesses any byte that it is watching. The number of bytes a single watchpoint is watching is either:

- One to eight bytes, provided that these bytes are contiguous, and that they are all in the same naturally-aligned doubleword. A debugger uses `DBGWCR<n>_EL1.BAS` or `DBGWCR<n>.BAS` to select the one to eight bytes. See [Programming a watchpoint with eight bytes or fewer on page D2-1613](#).
- Eight bytes to 2GB, provided that both of the following are true:
 - The number of bytes is a power-of-two.
 - The range starts at an address that is aligned to the range size.

A debugger uses `DBGWCR<n>_EL1.MASK` or `DBGWCR<n>.MASK` to program a watchpoint with eight bytes to 2GB. See [Programming a watchpoint with eight or more bytes on page D2-1615](#).

A debugger must use either the BAS field or the MASK field. If it uses both, whether the watchpoint generates Watchpoint exceptions is CONSTRAINED UNPREDICTABLE. See [Programming dependencies of the BAS and MASK fields on page D2-1616](#).

For each watchpoint, Watchpoint exception generation can be made conditional on whether the memory access is a load or a store. Each watchpoint can be programmed to match on any one of the following:

- Only data store accesses to the programmed address, or any address in the programmed range.
- Only data load accesses to the programmed address, or any address in the programmed range.
- Data load and data store accesses to the programmed address, or any address in the programmed range.

D2.6.2 Enable controls for Watchpoint exceptions

To enable Watchpoint exceptions, a debugger must set `MDSCR_EL1.MDE` or `DBGDSCRExt.MDBGen` to 1. [The debug exceptions enable controls on page D3-1651](#) describes this.

In addition:

- Each implemented watchpoint also has its own enable control, `DBGWCR<n>_EL1.E` or `DBGWCR<n>.E`.
- A Watchpoint exception can only be generated if debug exceptions are enabled from the current Exception level and Security state. See [Enabling debug exceptions from current Exception level and Security state on page D3-1656](#).

D2.6.3 Conditions for generating a Watchpoint exception

For each memory access, the debug logic tests all of the watchpoints.

When a watchpoint is tested, it generates a *Watchpoint debug event* if all of the following are true:

- The conditions specified in the `DBGWCR<n>_EL1` or `DBGWCR<n>` for the watchpoint are met. See [About Watchpoint Control Registers](#) on page D2-1609.
- The comparison with the address held in the `DBGWVR<n>_EL1` or `DBGWVR<n>` is successful.
- If the watchpoint links to a Linked Context breakpoint, the comparison or comparisons made by the Linked Context breakpoint are successful. [Figure D2-3](#) on page D2-1578 shows this. See also [Context comparisons for Breakpoint exception generation](#) on page D2-1587.
- The instruction that initiates the memory access is committed for execution.
- The instruction that initiates the memory access passes its condition code check.

———— **Note** —————

The debug logic tests all watchpoints before the execution of each instruction that initiates a memory access. The debug logic might test all watchpoints when data is fetched speculatively. However, a watchpoint does not generate a Watchpoint debug event unless the instruction that initiates the memory access passes its condition code check and is committed for execution.

—————

A Watchpoint debug event generates a Watchpoint exception if both of the following are true:

- Watchpoint exceptions are enabled, that is, `MDSR_EL1.MDE` or `DBGDSCRext.MDBGen` is 1.
- Debug exceptions are enabled from the current Exception level and Security state. See [Enabling debug exceptions from current Exception level and Security state](#) on page D3-1656.

D2.6.4 About Watchpoint Control Registers

For each watchpoint, the Watchpoint Control Register, [DBGWCR<n>_EL1](#) or [DBGWCR<n>](#), defines all of the following:

- General properties of the watchpoint. For example whether the watchpoint is enabled.
See *General properties of a watchpoint, defined by its control register*.
- Execution conditions for generating a Watchpoint exception. For example, the watchpoint might be programmed to only generate Watchpoint exceptions for unprivileged accesses made in the Secure EL1&0 translation regime.
See *Execution conditions a watchpoint generates Watchpoint exceptions for*.
- How many bytes the watchpoint is programmed to generate Watchpoint exceptions for.
See both:
 - *Programming a watchpoint with eight bytes or fewer on page D2-1613*.
 - *Programming a watchpoint with eight or more bytes on page D2-1615*.

General properties of a watchpoint, defined by its control register

The [DBGWCR<n>_EL1](#).{WT, LBN, LSC, E} or [DBGWCR<n>](#).{WT, LBN, LSC, E} fields define the general properties of a watchpoint, as follows:

Watchpoint type, WT

Controls whether the watchpoint is linked:

- 0** Unlinked. The watchpoint is called an *Unlinked watchpoint*.
- 1** Linked. The watchpoint is called a *Linked watchpoint*, and it links to a Linked Context breakpoint.

Linked breakpoint number, LBN

For Linked watchpoints, selects the number of the Linked Context breakpoint that the Linked watchpoint links to.

For Unlinked watchpoints, this field is ignored.

Load/store control, LSC

Controls whether the watchpoint generates a Watchpoint exception based on a data load, a data store, or both.

Enable control, E

Controls whether the watchpoint is enabled. A disabled watchpoint never generates any Watchpoint exceptions.

Execution conditions a watchpoint generates Watchpoint exceptions for

For each watchpoint, [DBGWCR<n>_EL1](#).{SSC, HMC, PAC} or [DBGWCR<n>](#).{SSC, HMC, PAC} define the execution conditions that the watchpoint generates Watchpoint exceptions for. These fields are:

Security State Control, SSC

Controls whether the watchpoint generates Watchpoint exceptions only in Secure state, only in Non-secure state, or in both Security states. The comparison is made with the Security state of the PE, not the NS attribute of the physical instruction fetch address.

Higher Mode Control, HMC, and Privileged Access Control, PAC

HMC and PMC together control which Exception levels the watchpoint generates Watchpoint exceptions in, and, in AArch32 state, which AArch32 modes the watchpoint generates Watchpoint exceptions in.

Table D2-10 shows the valid combinations of HMC, SSC, and PAC, and for each combination shows which Exception levels watchpoints generate Watchpoint exceptions in.

In the table:

Y or - Means that a watchpoint programmed with the values of HMC, SSC, and PAC shown in that row:
Y Can generate Watchpoint exceptions in that Exception level.
- Cannot generate Watchpoint exceptions in that Exception level.

Res Means that the combination of HMC, SSC, and PAC is reserved in the implementation. See Table D2-13 on page D2-1619.

———— **Note** ————

If EL3 is implemented and is using AArch32, there is no Secure EL1. In this case, ignore the table entries for Secure EL1.

Table D2-10 Summary of watchpoint HMC, SSC, and PAC encodings

HMC	SSC	PAC	Security state watchpoint is programmed to match in	AArch64 stage 1 regime				AArch32 stage 1 regime				Implementation	
				EL3 ^a	EL2	EL1	EL0	EL3	EL2 ^a	EL1	EL0	No EL3	No EL2 or EL3
0	00	01	Both	-	-	Y	-	Y	-	Y	-	-	-
0	00	10		-	-	-	Y	-	-	-	Y	-	-
0	00	11		-	-	Y	Y	Y	-	Y	Y	-	-
0	01	01	Non-secure	-	-	Y	-	-	-	Y	-	Res	Res
0	01	10		-	-	-	Y	-	-	-	Y	Res	Res
0	01	11		-	-	Y	Y	-	-	Y	Y	Res	Res
0	10	01	Secure	-	-	Y	-	Y	-	Y	-	Res	Res
0	10	10		-	-	-	Y	-	-	-	Y	Res	Res
0	10	11		-	-	Y	Y	Y	-	Y	Y	Res	Res
1	00	01	Both	Y	Y	Y	-	Y	Y	Y	-	-	Res
1	00	11		Y	Y	Y	Y	Y	Y	Y	Y	-	Res
1	01	01	Non-secure	-	Y	Y	-	-	Y	Y	-	Res	Res
1	01	11		-	Y	Y	Y	-	Y	Y	Y	Res	Res
1	10	00	Secure	Y	-	-	-	-	-	-	-	Res	Res
1	10	01		Y	-	Y	-	Y	-	Y	-	Res	Res
1	10	11		Y	-	Y	Y	Y	-	Y	Y	Res	Res
1	11	00	Non-secure	-	Y	-	-	-	Y	-	-	-	Res

a. Debug exceptions are not generated in EL3 using AArch64 or EL2 using AArch32. This means that these combinations of HMC, SSC, and PAC are only relevant if watchpoints cause entry to Debug state. See *Breakpoint and Watchpoint debug events* on page H2-4330. Self-hosted debuggers must avoid combinations of HMC, SSC, and PMC that generate Breakpoint exceptions at EL3 using AArch64 or EL2 using AArch32.

Note

For the behavior of watchpoints programmed with HMC, SSC, and PAC combinations that this table does not show, see [Table D2-13 on page D2-1619](#).

D2.6.5 Linking of watchpoints

By linking a Linked watchpoint to a Linked Context breakpoint, a debugger can create a watchpoint-breakpoint pair that only generates a Watchpoint exception if the PE is in a particular context when the data address match occurs.

For example, a debugger might:

1. Program watchpoint number one with a data address.
2. Program breakpoint number five to be a Linked VMID Match breakpoint.
3. Link the watchpoint and the breakpoint together. A Watchpoint exception is only generated if both the data address matches and the VMID matches.

The rules for watchpoint linking are as follows:

- Only Linked watchpoints can be linked.
- A Linked watchpoint can link to any type of Linked Context breakpoint. The *Linked Breakpoint Number* field `DBGWCR<n>_EL1.LBN` or `DBGWCR<n>.LBN`, for the Linked watchpoint specifies the particular Linked Context breakpoint that the Linked watchpoint links to.
- A Linked watchpoint cannot link to any of the following:
 - Another watchpoint.
 - An UnLinked Context breakpoint.
 - An Address breakpoint.
- Multiple Linked watchpoints can link to a single Linked Context breakpoint.

Note

- Multiple Address breakpoints can also link to a single Linked Context breakpoint.
 - For a full description of the WT and LBN fields, see [General properties of a watchpoint, defined by its control register on page D2-1609](#).
-

D2.6.6 Data address comparisons for Watchpoint exception generation

For each data address comparison, a watchpoint generates a Watchpoint exception only if the address comparison is successful, and all of the other conditions defined in the `DBGWCR<n>_EL1` or `DBGWCR<n>` are met.

In an AArch64 stage 1 translation regime:

An address comparison is successful if bits [48:2] of the current data address are equal to `DBGWVR<n>_EL1`[48:2], taking into account any byte masking indicated by `DBGWVR<n>_EL1.BAS` and any address ranges indicated by `DBGWVR<n>_EL1.MASK`.

———— **Note** —————

`DBGWVR<n>_EL1` is a 64-bit register. The most significant bits of this register are sign-extension bits.

In an AArch32 stage 1 translation regime:

An address comparison is successful if bits [31:2] of the current data address are equal to `DBGWVR<n>`[31:2], taking into account any byte masking indicated by `DBGWVR<n>.BAS` and any address ranges indicated by `DBGWVR<n>.MASK`.

D2.6.7 Taking into account the size of the data access

The debug logic must take into account the size of each data access that the PE performs.

This is because watchpoints can be programmed to only generate Watchpoint exceptions on accesses to particular bytes.

For example:

1. A debugger programs a watchpoint to only generate Watchpoint exceptions when the byte at address `0x1004` is accessed.
2. The PE accesses the doubleword starting at address `0x1000`.

In this scenario, the watchpoint must generate a Watchpoint exception.

———— **Note** —————

- The size of data accesses initiated by data cache maintenance instructions is IMPLEMENTATION DEFINED, and some cache maintenance instructions can generate Watchpoint exceptions. See *Watchpoint behavior on accesses caused by cache maintenance instructions* on page D2-1618.
- Also see both:
 - *Programming a watchpoint with eight bytes or fewer* on page D2-1613.
 - *Programming a watchpoint with eight or more bytes* on page D2-1615

D2.6.8 Programming a watchpoint with eight bytes or fewer

The Byte Address Select field, `DBGWCR<n>_EL1.BAS` or `DBGWCR<n>.BAS`, selects which bytes in the doubleword starting at the address contained in the `DBGWVR<n>_EL1` or `DBGWVR<n>` the watchpoint generates exceptions for.

If the address programmed into the `DBGWVR<n>_EL1` or `DBGWVR<n>` is:

- Doubleword-aligned:
 - All eight bits of `DBGWCR<n>_EL1.BAS` or `DBGWCR<n>.BAS` are used, and the descriptions given in [Table D2-11](#) apply.
- Word-aligned but not doubleword-aligned:
 - Only `DBGWCR<n>_EL1.BAS[3:0]` or `DBGWCR<n>.BAS[3:0]` are used, and the descriptions given in [Table D2-12](#) apply. In this case, `DBGWCR<n>_EL1.BAS[7:4]` or `DBGWCR<n>.BAS[7:4]` are RES0.

Table D2-11 Supported BAS values when the `DBGWVRn_EL1` or `DBGWVRn` address alignment is doubleword

BAS value	Description
<code>0b00000000</code>	Watchpoint never generates a Watchpoint exception
<code>BAS[0] == 1</code>	Generates a Watchpoint exception if byte at address <code>DBGWVR<n>_EL1[48:3]:000</code> or <code>DBGWVR<n>[31:3]:000</code> is accessed
<code>BAS[1] == 1</code>	Generates a Watchpoint exception if byte at address <code>DBGWVR<n>_EL1[48:3]:001</code> or <code>DBGWVR<n>[31:3]:001</code> is accessed
<code>BAS[2] == 1</code>	Generates a Watchpoint exception if byte at address <code>DBGWVR<n>_EL1[48:3]:010</code> or <code>DBGWVR<n>[31:3]:010</code> is accessed
<code>BAS[3] == 1</code>	Generates a Watchpoint exception if byte at address <code>DBGWVR<n>_EL1[48:3]:011</code> or <code>DBGWVR<n>[31:3]:011</code> is accessed
<code>BAS[4] == 1</code>	Generates a Watchpoint exception if byte at address <code>DBGWVR<n>_EL1[48:3]:100</code> or <code>DBGWVR<n>[31:3]:100</code> is accessed
<code>BAS[5] == 1</code>	Generates a Watchpoint exception if byte at address <code>DBGWVR<n>_EL1[48:3]:101</code> or <code>DBGWVR<n>[31:3]:101</code> is accessed
<code>BAS[6] == 1</code>	Generates a Watchpoint exception if byte at address <code>DBGWVR<n>_EL1[48:3]:110</code> or <code>DBGWVR<n>[31:3]:110</code> is accessed
<code>BAS[7] == 1</code>	Generates a Watchpoint exception if byte at address <code>DBGWVR<n>_EL1[48:3]:111</code> or <code>DBGWVR<n>[31:3]:111</code> is accessed

Table D2-12 Supported BAS values when the `DBGWVRn_EL1` or `DBGWVRn` address alignment is word

BAS value ^a	Description
<code>0b00000000</code>	Watchpoint never generates a Watchpoint exception
<code>BAS[0] == 1</code>	Generates a Watchpoint exception if byte at address <code>DBGWVR<n>_EL1[48:2]:00</code> or <code>DBGWVR<n>[31:2]:00</code> is accessed

Table D2-12 Supported BAS values when the DBGWVRn_EL1 or DBGWVRn address alignment is word (continued)

BAS value ^a	Description
BAS[1] == 1	Generates a Watchpoint exception if byte at address <code>DBGWVR<n>_EL1[48:2]:01</code> or <code>DBGWVR<n>[31:2]:01</code> is accessed
BAS[2] == 1	Generates a Watchpoint exception if byte at address <code>DBGWVR<n>_EL1[48:2]:10</code> or <code>DBGWVR<n>[31:2]:10</code> is accessed
BAS[3] == 1	Generates a Watchpoint exception if byte at address <code>DBGWVR<n>_EL1[48:2]:11</code> or <code>DBGWVR<n>[31:2]:11</code> is accessed

a. `DBGWCR<n>_EL1.BAS[7:4]` or `DBGWCR<n>.BAS[7:4]` are RES0.

If the BAS field is programmed with more than one byte, the bytes that it is programmed with must be contiguous. For watchpoint behavior when its BAS field is programmed with non-contiguous bytes, see *Constraints that apply to all watchpoints* on page D2-1619.

When programming the BAS field with anything other than `0b11111111`, a debugger must also program `DBGWCR<n>_EL1.MASK` or `DBGWCR<n>.MASK` to be `0b00000`. See *Programming dependencies of the BAS and MASK fields* on page D2-1616.

In cases where the BAS field is programmed with a single byte or a set of contiguous bytes, the watchpoint generates a Watchpoint exception whenever a watched byte is accessed, even if:

- The access size is smaller or larger than the address region being watched.
- The access is misaligned, and the base address of the access is not in the doubleword or word of memory addressed by the `DBGWVR<n>_EL1[48:3]` or `DBGWVR<n>[31:3]`.

This means that, for example, if a debugger programs a watchpoint to generate a Watchpoint exception when any byte in the doubleword starting at `0x1000` is accessed, the watchpoint generates a Watchpoint exception on a doubleword access at the misaligned address `0x0FF9`, because both the doubleword being watched and the doubleword accessed contain the watched byte at `0x1000`.

The following are some example configurations of the BAS field:

- To program a watchpoint to generate a Watchpoint exception on the byte at address `0x1003`, program:
 - `DBGWVR<n>_EL1` or `DBGWVR<n>` to hold `0x1000`.
 - `DBGWCR<n>_EL1.BAS` or `DBGWCR<n>_EL1.BAS` to be `0b00001000`.
- To program a watchpoint to generate a Watchpoint exception on the bytes at addresses `0x2003`, `0x2004` and `0x2005`, program:
 - `DBGWVR<n>_EL1` or `DBGWVR<n>` to hold `0x2000`.
 - `DBGWCR<n>_EL1.BAS` or `DBGWCR<n>_EL1.BAS` to be `0b00111000`.
- If the address programmed into the `DBGWVR<n>_EL1` or `DBGWVR<n>` is doubleword-aligned:
 - To program the watchpoint to generate a Watchpoint exception when any byte in the word starting at the doubleword-aligned address is accessed, program `DBGWCR<n>_EL1.BAS` or `DBGWCR<n>.BAS` to be `0b00001111`.
 - To program the watchpoint to generate a Watchpoint exception when any byte in the word starting at address `DBGWVR<n>_EL1[31:3]:100` or `DBGWVR<n>[31:3]:100` is accessed, program `DBGWCR<n>_EL1.BAS` or `DBGWCR<n>.BAS` to be `0b11110000`.

Note

ARM deprecates programming a `DBGWVR<n>_EL1` or `DBGWVR<n>` with an address that is not doubleword-aligned.

D2.6.9 Programming a watchpoint with eight or more bytes

A single watchpoint can be programmed with a data address range that meets all of the following criteria:

- It is a size that is both:
 - A power-of-two.
 - Eight bytes to 2GB.
- It starts at an address that is aligned to the size.

To do this, a debugger programs the MASK field, `DBGWCR<n>_EL1.MASK` or `DBGWCR<n>.MASK`. The MASK field specifies the number of least significant bits of the address held in the `DBGWVR<n>_EL1` or `DBGWVR<n>` that must be masked whenever an address comparison takes place.

Up to 31 least significant bits can be masked. A minimum of three must be masked:

MASK	Selects how many bits, if any, are masked.
0b00000	No bits are masked.
0b00001	Reserved.
0b00010	Reserved.
0b00011	Three least significant bits are masked.
0b00100	Four least significant bits are masked.
0b00101	Five least significant bits are masked.
...	...
0b11111	31 least significant bits are masked.

If n least significant bits of `DBGWVR<n>_EL1` or `DBGWVR<n>` are masked, the watchpoint generates a Watchpoint exception on all of the following:

- Address `DBGWVR<n>_EL1[48:n]:000...` or `DBGWVR<n>[31:n]:000...`
- Address `DBGWVR<n>_EL1[48:n]:111...` or `DBGWVR<n>[31:n]:111...`
- Any address between these two addresses.

For example, if the four least significant bits of an address held in `DBGWVR<n>_EL1` or `DBGWVR<n>` are masked, then:

- In AArch64 state, Watchpoint exceptions are generated for all addresses between `DBGWVR<n>_EL1[48:4]:0000` and `DBGWVR<n>_EL1[48:4]:1111`, including these addresses.
- In AArch32 state, Watchpoint exceptions are generated for all addresses between `DBGWVR<n>[31:4]:0000` and `DBGWVR<n>[31:4]:1111`, including these addresses.

————— Note —————

- The full address cannot be masked in either Execution state:
 - In AArch64 state, the 17 most significant bits cannot be masked.
 - In AArch32 state, the most significant bit cannot be masked.
- If `DBGWCR<n>_EL1.MASK` or `DBGWCR<n>.MASK` is programmed with a reserved value, no address bits are masked, therefore no address range is specified.

When masking address bits, a debugger must both:

- Set the masked address bits to 0. If any of the masked address bits are not 0, the watchpoint never generates any Watchpoint exceptions.
- Program the *Byte Address Select* field for the watchpoint, `DBGWCR<n>_EL1.BAS` or `DBGWCR<n>.BAS`, to be 0b11111111. See *Programming dependencies of the BAS and MASK fields* on page D2-1616.

D2.6.10 Programming dependencies of the BAS and MASK fields

When programming a watchpoint, a debugger must use either:

- The MASK field, to program the watchpoint with an address range that can be eight bytes to 2GB.
- The BAS field, to select which bytes in the doubleword or word starting at the address contained in the [DBGWVR<n>_EL1](#) or [DBGWVR<n>](#) the watchpoint must generate Watchpoint exceptions for.

If the debugger uses the:

- MASK field, it must program the BAS field to be `0b11111111`, so that all bytes in the doubleword or word are selected.
- BAS field, it must program the MASK field to be `0b000000`, so that the MASK field does not indicate any address ranges.

If the debugger uses both of these fields, then behavior of the watchpoint is CONstrained UNPREDICTABLE. The watchpoint must do one of the following:

- Treat the MASK field as if it is programmed with `0b000000`. In this case, the watchpoint is programmed with a single address and it generates Watchpoint exceptions only for those bytes that the BAS field indicates.
- Treat the BAS field as if it is programmed with `0b11111111`. In this case, the watchpoint generates Watchpoint exceptions for all bytes included in the range that the MASK field indicates.
- Apply `BAS[7:0]` to every doubleword in the address range that the MASK field indicates.

D2.6.11 Linked comparisons for Watchpoint exception generation

This comparison is made for a Linked watchpoint and a Linked Context breakpoint, that are linked together by using [DBGWCR<n>_EL1.WT](#) and [DBGWCR<n>_EL1.LBN](#), or [DBGWCR<n>.WT](#) and [DBGWCR<n>.LBN](#), for the Linked watchpoint.

A Watchpoint exception is only generated if both:

- The data address comparison is successful.
- The context comparison is successful.

In an AArch64 stage 1 translation regime:

The address comparison is successful if the conditions described for an AArch64 stage 1 translation regime in [Data address comparisons for Watchpoint exception generation on page D2-1612](#) are met.

The context comparison is successful if the conditions described for an AArch64 stage 1 translation regime in [Context comparisons for Breakpoint exception generation on page D2-1587](#) are met.

In an AArch32 stage 1 translation regime:

The address comparison is successful if the conditions described for an AArch32 stage 1 translation regime in [Data address comparisons for Watchpoint exception generation on page D2-1612](#) are met.

The context comparison is successful if the conditions described for an AArch32 stage 1 translation regime in [Context comparisons for Breakpoint exception generation on page D2-1587](#) are met.

D2.6.12 Determining the memory location that caused a Watchpoint debug event

On a Watchpoint debug event, the PE records an address that the debugger can use to determine the memory location that triggered the watchpoint.

If the debug event:

- Generates a Watchpoint exception, the PE records the address in one of the following *Fault Address Registers*:
 - [FAR_EL1](#) or [DFAR](#), if the exception is taken to EL1.
 - [FAR_EL2](#) or [HDFAR](#), if the exception is taken to EL2.
- Causes entry to Debug state, the PE records the address in the *External Debug Watchpoint Address Register*, [EDWAR](#).

In cases where multiple watchpoints each generate a separate Watchpoint debug event for one memory access, only one address is recorded.

Address recorded for Watchpoint debug events generated by instructions other than Data Cache instructions

The address recorded must be both:

- From the inclusive range between:
 - The lowest address accessed by the memory access that triggered the watchpoint.
 - The highest *watchpointed address* accessed by the memory access. A watchpointed address is an address that the watchpoint is watching.
- Within a naturally-aligned block of memory that is all of the following:
 - A power-of-two size.
 - No larger than the DC ZVA block size.
 - Contains a watchpointed address accessed by the memory access.

This means that the address recorded is guaranteed to be the same as or lower than the address of the location that triggered the watchpoint.

Example D2-1

A debugger programs a watchpoint to generate a Watchpoint debug event on any access to the byte 0x8019.

An A32 load multiple instruction then loads nine registers starting from address 0x8004 upwards. This triggers the watchpoint.

If the DC ZVA block size is:

- 32 bytes, the address that the PE records must be between 0x8004 and 0x8019 inclusive.
 - 16 bytes, the address that the PE records must be between 0x8010 and 0x8019 inclusive.
-

Address recorded for Watchpoint debug events generated by Data Cache instructions

The address recorded is the address passed to the instruction. This means that the address recorded might be higher than the address of the location that triggered the watchpoint.

D2.6.13 Using watchpoints

This section contains the following:

- [Watchpoint behavior on accesses caused by prefetch instructions.](#)
- [Watchpoint behavior on accesses caused by Store-Exclusive instructions.](#)
- [Watchpoint behavior on accesses caused by cache maintenance instructions.](#)
- [Constraints on programming watchpoints.](#)

Watchpoint behavior on accesses caused by prefetch instructions

Memory prefetch instructions never cause Watchpoint exceptions.

Watchpoint behavior on accesses caused by Store-Exclusive instructions

If a watchpoint matches on a data access caused by a Store-Exclusive instruction, then:

- If the write to memory is successful, the watchpoint generates a Watchpoint exception.
- If the write to memory fails because the Store-Exclusive instruction does not have possession of the exclusive monitors, it is IMPLEMENTATION DEFINED whether the watchpoint generates a Watchpoint exception.

Watchpoint behavior on accesses caused by cache maintenance instructions

In AArch64 state:

DC IVAC and DC ZVA operations are treated as data stores. This means that for a watchpoint to match on an access caused by one of these instructions, the debugger must program [DBGWCR<n>_EL1.LSC](#) or [DBGWCR<n>.LSC](#) to be one of the following:

- 10** Match on data stores only.
- 11** Match on data stores and data loads.

No other data cache maintenance operations can generate Watchpoint exceptions.

Instruction cache maintenance operations never generate Watchpoint exceptions.

———— Note ————

The size of accesses performed by cache maintenance instructions is IMPLEMENTATION DEFINED. See [Taking into account the size of the data access on page D2-1612](#)

In AArch32 state:

It is IMPLEMENTATION DEFINED whether DCIMVAC operations can generate Watchpoint exceptions. If they can, they are treated as data stores. This means that for a watchpoint to match on an access caused by a DCIMVAC instruction, the debugger must program [DBGWCR<n>_EL1.LSC](#) or [DBGWCR<n>.LSC](#) to be one of the following:

- 10** Match on data stores only.
- 11** Match on data stores and data loads.

No other data cache operations can generate Watchpoint exceptions.

Instruction cache maintenance operations never generate Watchpoint exceptions.

———— Note ————

The size of accesses performed by cache maintenance instructions is IMPLEMENTATION DEFINED. See [Taking into account the size of the data access on page D2-1612](#).

Constraints on programming watchpoints

For the conditions described in the following subsections, watchpoint behavior is one of the following:

- The watchpoint does not generate a Watchpoint exception.

- The watchpoint is evaluated to match for different PE execution conditions.
- It is CONSTRAINED UNPREDICTABLE whether the watchpoint generates a Watchpoint exception.

The subsections are:

- [Reserved HMC, SSC, and PAC values.](#)
- [Constraints that apply to all watchpoints.](#)
- [Constraints that apply to only Linked watchpoints on page D2-1620.](#)

Reserved HMC, SSC, and PAC values

Table D2-13 shows when particular combinations of `DBGWCR<n>_EL1`.{HMC, SSC, PAC} or `DBGWCR<n>.`{HMC, SSC, PAC} are reserved, and shows behavior when the combination is reserved.

Table D2-13 Behaviors for reserved HMC, SSC, and PAC combinations

HMC	SSC	PAC	Reserved	Behavior when reserved
All combinations with SSC set to 0b01 or 0b10.			When EL3 is not implemented and EL2 is implemented.	SSC[1] is RO and returns the same value as SSC[0]. If the combination with SSC == 0b00 or 0b11 is then a combination that Table D2-10 on page D2-1610 : <ul style="list-style-type: none"> • Includes, the watchpoint matches for those execution conditions. • Does not include, the watchpoint never generates any Watchpoint exceptions.
All combinations where HMC or SSC is nonzero.			When both of EL2 and EL3 are not implemented.	SSC and HMC are RES0. This means that the watchpoint matches for different execution conditions. See Table D2-10 on page D2-1610 .
Combinations not included in Table D2-10 on page D2-1610 .			Always	The watchpoint never generates any Watchpoint exceptions ^a .

- a. A watchpoint programmed with a combination that [Table D2-10 on page D2-1610](#) does not include might be affected by a behavior listed in this table, so that it then has a combination that [Table D2-10 on page D2-1610](#) does include.

The behavior of breakpoints with reserved combinations of HMC, SSC, and PAC might change in future revisions of the architecture. For this reason, software must not rely on the behavior described here.

Constraints that apply to all watchpoints

As follows:

- `DBGWVR<n>_EL1[1:0]` or `DBGWVR<n>[1:0]` are RES0 and are ignored.
- If `DBGWVR<n>_EL1[2]` or `DBGWVR<n>[2]` is 1, `DBGWCR<n>_EL1.BAS[7:4]` or `DBGWCR<n>.BAS[7:4]` is RES0 and is ignored.
- If `DBGWCR<n>_EL1.LSC` or `DBGWCR<n>.LSC` is 0b00, the watchpoint never generates any Watchpoint exceptions.
- If `DBGWCR<n>_EL1.BAS` or `DBGWCR<n>.BAS` is programmed with non-contiguous bytes of memory, then it is CONSTRAINED UNPREDICTABLE whether the Watchpoint generates a Watchpoint exception for each byte in the doubleword or word of memory addressed by the `DBGWCR<n>_EL1` or `DBGWCR<n>`. See [Programming a watchpoint with eight bytes or fewer on page D2-1613](#).
- If a debugger programs `DBGWCR<n>_EL1.MASK` or `DBGWCR<n>.MASK` so that a number of least significant bits of `DBGWVR<n>_EL1` or `DBGWVR<n>` are masked, and `DBGWCR<n>_EL1.BAS` or `DBGWCR<n>.BAS` is not 0b11111111, it is CONSTRAINED UNPREDICTABLE whether the watchpoint generates any Watchpoint exceptions. See [Programming dependencies of the BAS and MASK fields on page D2-1616](#).
- If any masked bits of `DBGWVR<n>_EL1` or `DBGWVR<n>` are not 0, the watchpoint never generates any Watchpoint exceptions.

- If `DBGWCR<n>_EL1.MASK` or `DBGWCR<n>.MASK` is programmed with a reserved value, the watchpoint never generates any Watchpoint exceptions.
- If the watchpoint is an Unlinked watchpoint, `DBGBCR<n>_EL1.LBN` or `DBGBCR<n>.LBN` reads UNKNOWN and is ignored.

Constraints that apply to only Linked watchpoints

As follows:

- If a Linked watchpoint links to a breakpoint that is not implemented, or a breakpoint that is not context-aware, then behavior is CONSTRAINED UNPREDICTABLE. Either:
 - The watchpoint never generates any Watchpoint exceptions, and `DBGWCR<n>_EL1.LBN` or `DBGWCR<n>.LBN` for the watchpoint reads UNKNOWN.
 - The watchpoint behaves as if it is linked to an UNKNOWN context-aware breakpoint. In this case, the watchpoint generates Watchpoint exceptions, and `DBGWCR<n>_EL1.LBN` or `DBGWCR<n>.LBN` indicates the context-matching breakpoint.
- If a Linked watchpoint links to any of the following, it never generates any Watchpoint exceptions:
 - A breakpoint that is implemented and that is context-aware, but that is not programmed as a Linked Context breakpoint.
 - A breakpoint that is implemented but that is not enabled.

See also [Constraints that apply to all watchpoints on page D2-1619](#).

D2.6.14 Summary of watchpoint matching

[Table D2-14](#) shows a summary of watchpoint matching. For the meanings of the conditions given in bold in the table, see [Condition definitions on page D2-1621](#).

Table D2-14 Summary of watchpoint matching

Watchpoint	Comparisons made			Linking
	Address	BAS	PE state	
Unlinked watchpoint	Equals	AND selected	AND match	-
Linked watchpoint	Equals	AND selected	AND match	AND link^a

a. Links to a Linked Context breakpoint.

Using the table

Reading across the columns gives the comparisons that are made. For example:

- For a Linked watchpoint that links to a Linked Context ID Match breakpoint type, `0b0011`, the comparisons that are made are:
 - A comparison of the data address, taking into account the BAS field, by the Linked watchpoint.
 - A comparison of the PE state, by the Linked watchpoint.
 - A comparison of the Context ID, by the Linked Context ID Match breakpoint. [Table D2-9 on page D2-1597](#) shows this comparison.

Therefore, the conditions that are required are:

Equals[address] AND **selected**[BAS] AND **match**[state] AND **equals**[Context ID]

Condition definitions

Table D2-14 on page D2-1620 shows, for watchpoints:

- In the Address column:
 - Equals** This means that the value compared must be equal:
 - In AArch64 state, bits [48:2] of the data address access must equal `DBGWVR<n>_EL1[48:2]`.
 - In AArch32 state, bits [31:2] of the data address access must equal `DBGWVR<n>[31:2]`.
- In the BAS column:
 - AND selected** This means that the memory access must match what `DBGWCR<n>_EL1.BAS` or `DBGWCR<n>.BAS` indicates. See *Programming a watchpoint with eight bytes or fewer* on page D2-1613. This condition is in addition to a successful address match.
- In the PE state column:
 - AND Match** This means that the PE state must match for the watchpoint to generate a Watchpoint exception:
 - In AArch64 state, the current PE state must match the conditions defined by the `DBGWCR<n>_EL1.{SSC, HMC, PAC}` fields.
 - In AArch32 state, the current PE state must match the conditions defined by the `DBGWCR<n>.{SSC, HMC, PAC}` fields.
 See *Execution conditions a watchpoint generates Watchpoint exceptions for* on page D2-1609. This condition is in addition to other successful comparisons, as follows:
 - A successful data address match, that takes the BAS field into account.
 - If the watchpoint links to a Linked Context breakpoint, a successful context match, that might be a Context ID match, a VMID match, or both.
- In the Linking column, whether the watchpoint links to a Linked Context breakpoint.

D2.6.15 Pseudocode description of Watchpoint exceptions taken from AArch64 state

AArch64.WatchpointMatch() tests the value in `DBGWVR<n>_EL1`.

```
// AArch64.WatchpointMatch()
// =====
// Watchpoint matching in an AArch64 translation regime.

boolean AArch64.WatchpointMatch(integer n, bits(64) vaddress, integer size, boolean ispriv,
                                boolean iswrite)
assert !ELUsingAArch32(TranslationRegime());
assert n <= UInt(ID_AA64DFR0_EL1.WRPs);

// "ispriv" is FALSE for LDTR/STTR instructions executed at EL1 and all
// load/stores at EL0, TRUE for all other load/stores. "iswrite" is TRUE for stores, FALSE for
// loads.
enabled = DBGWCR_EL1[n].E == '1';
linked = DBGWCR_EL1[n].WT == '1';

state_match = AArch64.StateMatch(DBGWCR_EL1[n].SSC, DBGWCR_EL1[n].HMC, DBGWCR_EL1[n].PAC,
                                linked, DBGWCR_EL1[n].LBN, ispriv);

ls_match = (DBGWCR_EL1[n].LSC<(if iswrite then 1 else 0)> == '1');

value_match = FALSE;
for byte = 0 to size - 1
    value_match = value_match || AArch64.WatchpointByteMatch(n, vaddress + byte);

return value_match && state_match && ls_match && enabled;
```

AArch64.StateMatch() tests the values in `DBGWCR<n>_EL1`.{HMC, SSC, PAC}, and if the watchpoint is Linked, also tests the Linked Context breakpoint that the watchpoint links to.

For a breakpoint, AArch64.StateMatch() tests the values in `DBGBCR<n>_EL1`.{HMC, SSC, PMC}, and if the breakpoint is Linked, also tests the Linked Context breakpoint that it links to.

```
// AArch64.StateMatch()
// =====

boolean AArch64.StateMatch(bits(2) SSC, bit HMC, bits(2) PxC, boolean linked, bits(4) LBN,
                           boolean ispriv)
// Function used in both Breakpoint and Watchpoint matching to determine whether the point is
// enabled in the current mode and state.
// "SSC", "HMC", "PxC" and "LBN" are the control fields from the DBGBCRn_EL1 or DBGWCRn_EL1
// register.
// "ispriv" is only valid for watchpoints, and selects between privileged and unprivileged
// accesses.
// "linked" is TRUE if this is a linked breakpoint/watchpoint address type.
// Return FALSE if parameters are set to a reserved type.

if (HMC:SSC:PxC) IN {'100x0', '101x0', '11010', '011xx', '111x1', '11110'} then return FALSE;

EL3_match = HaveEL(EL3) && HMC == '1' && SSC<0> == '0';
EL2_match = HaveEL(EL2) && HMC == '1';
EL1_match = PxC<0> == '1';
EL0_match = PxC<1> == '1';

case PSTATE.EL of
  when EL3 priv_match = EL3_match;
  when EL2 priv_match = EL2_match;
  when EL1 priv_match = if ispriv then EL1_match else EL0_match;
  when EL0 priv_match = EL0_match;

// The determination of security_state_match relies on these assertions to avoid reserved cases.
if !HaveEL(EL3) then assert SSC<0> == SSC<1>;
if SSC == '11' then assert HMC == '1';
case SSC of
  when '00' security_state_match = TRUE; // Both
  when '01' security_state_match = !IsSecure(); // Non-secure only
  when '10' security_state_match = IsSecure(); // Secure only
  when '11' security_state_match = TRUE; // Both

if linked then
  // "LBN" must be an enabled context-aware breakpoint unit. If it is not context-aware
  // then it is CONSTRAINED UNPREDICTABLE whether this gives no match, or LBN is mapped to
  // some UNKNOWN breakpoint that is context-aware.
  lbn = UInt(LBN);
  first_ctx_cmp = (UInt(ID_AA64DFR0_EL1.BRPs) - UInt(ID_AA64DFR0_EL1.CTX_CMPs));
  last_ctx_cmp = UInt(ID_AA64DFR0_EL1.BRPs);
  if (lbn < first_ctx_cmp || lbn > last_ctx_cmp) then
    (c, lbn) = ConstrainUnpredictableInteger(first_ctx_cmp, last_ctx_cmp);
    assert c IN {Constraint_NONE, Constraint_UNKNOWN};
    if c == Constraint_NONE then return FALSE;
  vaddress = bits(64) UNKNOWN;
  linked_to = TRUE;
  linked_match = AArch64.BreakpointValueMatch(lbn, vaddress, linked_to);

return priv_match && security_state_match && (!linked || linked_match);
```

AArch64.WatchpointByteMatch() tests an individual byte accessed by an operation.

```
// AArch64.WatchpointByteMatch()
// =====

boolean AArch64.WatchpointByteMatch(integer n, bits(64) vaddress)

top = AddrTop(vaddress);
bottom = if DBGWVR_EL1[n]<2> == '1' then 2 else 3;
```

```

byte_select_match = (DBGWCR_EL1[n].BAS<UInt(vaddress<bottom-1:0>)> != '0');
mask = UInt(DBGWCR_EL1[n].MASK);

// If the address mask is set to a reserved value, no address masking is performed.
if mask <= 2 then mask = bottom;

// If masked bits of DBGWVR_EL1[n] are not zero, no Watchpoint debug event is generated.
if mask > bottom then
    WVR_match = vaddress<top:mask>:Zeros(mask - bottom) == DBGWVR_EL1[n]<top:bottom>;
else
    WVR_match = vaddress<top:bottom> == DBGWVR_EL1[n]<top:bottom>;

// If DBGWCR_EL1[n].MASK is set to a non-zero (not reserved) value, DBGWCR_EL1[n].BAS is not set
// to '11111111', the generation of Watchpoint debug events by that watchpoint is CONSTRAINED
// UNPREDICTABLE.
if UInt(DBGWCR_EL1[n].MASK) > 2 && !IsOnes(DBGWCR_EL1[n].BAS) then
    // See Constraints on programming Watchpoint debug events.
    c = ConstrainUnpredictable();
    case c of
        when Constraint_IGNOREMASK
            WVR_match = vaddress<top:bottom> == DBGWVR_EL1[n]<top:bottom>;
        when Constraint_IGNOREBAS
            byte_select_match = TRUE;
        when Constraint_REPEATBAS
            /*do nothing*/
        otherwise Unreachable();
    else
        // If DBGWCR_EL1[n].BAS specifies a non-contiguous set of bytes, the generation of
        // Watchpoint debug events for the doubleword is CONSTRAINED UNPREDICTABLE.
        LSB = (DBGWCR_EL1[n].BAS AND NOT(DBGWCR_EL1[n].BAS - 1)); MSB = (DBGWCR_EL1[n].BAS + LSB);
        if !IsZero(MSB AND (MSB - 1)) && vaddress<top:3> == DBGWVR_EL1[n]<top:3> then
            byte_select_match = ConstrainUnpredictableBool();

return WVR_match && byte_select_match;

```

AArch64.CheckWatchpoint() tests a committed instruction against all watchpoints. If all of the following are true, a Watchpoint exception is generated:

- [MDSCR_EL1.MDE](#) is 1.
- Debug exceptions are enabled from the current Exception level and Security state. See [Enabling debug exceptions from current Exception level and Security state on page D3-1656](#).
- All of the conditions required for Watchpoint exception generation are met. See [Conditions for generating a Watchpoint exception on page D2-1608](#).

AArch64.CheckWatchpoint() might halt the PE and cause it to enter Debug state. External debug uses Debug state.

```

// AArch64.CheckWatchpoint()
// =====
// Called before accessing the memory location of "size" bytes at "address".

FaultRecord AArch64.CheckWatchpoint(bits(64) vaddress, AccType acctype,
                                     boolean iswrite, integer size)
    assert !ELUsingAArch32(TranslationRegime());

    match = FALSE;
    ispriv = PSTATE.EL != EL0 && !(PSTATE.EL == EL1 && acctype == AccType_UNPRIV);

    for i = 0 to UInt(ID_AA64DFR0_EL1.WRPs)
        match = match || AArch64.WatchpointMatch(i, vaddress, size, ispriv, iswrite);

    if match && HaltOnBreakpointOrWatchpoint() then
        reason = DebugHalt_Watchpoint;
        Halt(reason);
    elsif match && MDSCR_EL1.MDE == '1' && AArch64.GenerateDebugExceptions() then
        return AArch64.DebugFault(acctype, iswrite);
    else

```

```

        return AArch64.NoFault();

AArch32.WatchpointException() is called to generate a Watchpoint exception.

// AArch64.WatchpointException()
// =====

AArch64.WatchpointException(bits(64) vaddress, FaultRecord fault)
    assert PSTATE.EL != EL3;

    route_to_el2 = (AArch64.GeneralExceptionsToEL2() ||
                    (HaveEL(EL2) && !IsSecure() && MDCR_EL2.TDE == '1'));

    exception = AArch64.AbortSyndrome(Exception_Watchpoint, fault, vaddress);

    bits(64) preferred_exception_return = ThisInstrAddr();
    vect_offset = 0x0;

    if PSTATE.EL == EL2 || route_to_el2 then
        AArch64.TakeException(EL2, exception, preferred_exception_return, vect_offset);
    else
        AArch64.TakeException(EL1, exception, preferred_exception_return, vect_offset);

```

D2.6.16 Pseudocode description of Watchpoint exceptions taken from AArch32 state

AArch32.WatchpointMatch() tests the value in [DBGWVR<n>_EL1](#).

```

// AArch32.WatchpointMatch()
// =====
// Watchpoint matching in an AArch32 translation regime.

boolean AArch32.WatchpointMatch(integer n, bits(32) vaddress, integer size, boolean ispriv,
                                boolean iswrite)
    assert ELUsingAArch32(TranslationRegime());
    assert n <= UInt(DBGDIDR.WRPs);

    // "ispriv" is FALSE for LDRT/STRT instructions executed at EL1 and all
    // load/stores at EL0, TRUE for all other load/stores. "iswrite" is TRUE for stores, FALSE for
    // loads.
    enabled = DBGWCR[n].E == '1';
    linked = DBGWCR[n].WT == '1';
    isbreakpnt = FALSE;

    state_match = AArch32.StateMatch(DBGWCR[n].SSC, DBGWCR[n].HMC, DBGWCR[n].PAC,
                                    linked, DBGWCR[n].LBN, isbreakpnt, ispriv);

    ls_match = (DBGWCR[n].LSC<(if iswrite then 1 else 0)> == '1');

    value_match = FALSE;
    for byte = 0 to size - 1
        value_match = value_match || AArch32.WatchpointByteMatch(n, vaddress + byte);

    return value_match && state_match && ls_match && enabled;

```

AArch32.StateMatch() tests the values in [DBGWCR<n>.{HMC, SSC, PAC}](#), and if the watchpoint is Linked, also tests the Linked Context breakpoint that the watchpoint links to.

For a breakpoint, AArch32.StateMatch() tests the values in [DBGBCR<n>.{HMC, SSC, PMC}](#), and if the breakpoint is Linked, also tests the Linked Context breakpoint that it links to.

```

// AArch32.StateMatch()
// =====

boolean AArch32.StateMatch(bits(2) SSC, bit HMC, bits(2) PxC, boolean linked, bits(4) LBN,
                            boolean isbreakpnt, boolean ispriv)
    // Function used in both Breakpoint and Watchpoint matching to determine whether the point is
    // enabled in the current mode and state.
    // "SSC", "HMC", "PxC" and "LBN" are the control fields from the DBGBCRn_EL1 or DBGWCRn_EL1

```

```

// register.
// "ispriv" is only valid for watchpoints, and selects between privileged and unprivileged
// accesses.
// "linked" is TRUE if this is a linked breakpoint/watchpoint address type.
// "isbreakpnt" is TRUE for breakpoints if any of EL3, EL2 or EL1 is using AArch32, FALSE for
// watchpoints. It allows selection of the "Svs/Sys/User" match in AArch32 modes.
// Return FALSE if parameters are set to a reserved type.

if (HMC:SSC:PxC) IN {'100x0', '101x0', '11010', '011xx', '111x1', '11110'} then return FALSE;

PL3_match = HaveEL(EL3) && HMC == '1' && SSC<0> == '0';
PL2_match = HaveEL(EL2) && HMC == '1';
PL1_match = PxC<0> == '1';
PL0_match = PxC<1> == '1';
SSU_match = HMC == '0' && PxC == '00' && SSC != '11';

// no Sys/Svc/Usr matching for watchpoints or for breakpoints when EL1 is using AArch64.
if !isbreakpnt && SSU_match then return FALSE;

if SSU_match then
    priv_match = PSTATE.M IN {M32_User, M32_Svc, M32_System};
else
    case PSTATE.EL of
        when EL3, EL1 priv_match = if ispriv then PL1_match else PL0_match;
        when EL2      priv_match = PL2_match;
        when EL0      priv_match = PL0_match;

// The determination of security_state_match relies on these assertions to avoid reserved cases.
if !HaveEL(EL3) then assert SSC<0> == SSC<1>;
if SSC == '11' then assert HMC == '1';
case SSC of
    when '00' security_state_match = TRUE; // Both
    when '01' security_state_match = !IsSecure(); // Non-secure only
    when '10' security_state_match = IsSecure(); // Secure only
    when '11' security_state_match = TRUE; // Both

if linked then
    // "LBN" must be an enabled context-aware breakpoint unit. If it is not context-aware
    // then it is CONSTRAINED UNPREDICTABLE whether this gives no match, or LBN is mapped to
    // some UNKNOWN breakpoint that is context-aware.
    lbn = UInt(LBN);
    first_ctx_cmp = (UInt(DBGDIDR.BRPs) - UInt(DBGDIDR.CTX_CMPs));
    last_ctx_cmp = UInt(DBGDIDR.BRPs);
    if (lbn < first_ctx_cmp || lbn > last_ctx_cmp) then
        (c, lbn) = ConstrainUnpredictableInteger(first_ctx_cmp, last_ctx_cmp);
        assert c IN {Constraint_NONE, Constraint_UNKNOWN};
        if c == Constraint_NONE then return FALSE;
    vaddress = bits(32) UNKNOWN;
    linked_to = TRUE;
    (linked_match, -) = AArch32.BreakpointValueMatch(lbn, vaddress, linked_to);

return priv_match && security_state_match && (!linked || linked_match);

AArch32.WatchpointByteMatch() tests an individual byte accessed by an operation.

// AArch32.WatchpointByteMatch()
// =====

boolean AArch32.WatchpointByteMatch(integer n, bits(32) vaddress)

    bottom = if DBGWVR[n]<2> == '1' then 2 else 3;
    byte_select_match = (DBGWCR[n].BAS<UInt(vaddress<bottom-1:0>)> != '0');
    mask = UInt(DBGWCR[n].MASK);

// If the address mask is set to a reserved value, no address masking is performed.
if mask <= 2 then mask = bottom;

// If masked bits of DBGWVR[n] are not zero, no Watchpoint debug event is generated.

```

```

if mask > bottom then
    WVR_match = vaddress<31:mask>:Zeros(mask - bottom) == DBGWVR[n]<31:bottom>;
else
    WVR_match = vaddress<31:bottom> == DBGWVR[n]<31:bottom>;

// If DBGWCR[n].MASK is set to a non-zero (not reserved) value, DBGWCR[n].BAS is not set
// to '1111111', the generation of Watchpoint debug events by that watchpoint is CONSTRAINED
// UNPREDICTABLE.
if UInt(DBGWCR[n].MASK) > 2 && !IsOnes(DBGWCR[n].BAS) then
    // See Constraints on programming Watchpoint debug events.
    c = ConstrainUnpredictable();
    case c of
        when Constraint_IGNOREMASK
            WVR_match = vaddress<31:bottom> == DBGWVR[n]<31:bottom>;
        when Constraint_IGNOREBAS
            byte_select_match = TRUE;
        when Constraint_REPEATBAS
            /*do nothing*/
        otherwise Unreachable();
    else
        // If DBGWCR[n].BAS specifies a non-contiguous set of bytes, the generation of
        // Watchpoint debug events for the doubleword is CONSTRAINED UNPREDICTABLE.
        LSB = (DBGWCR[n].BAS AND NOT(DBGWCR[n].BAS - 1)); MSB = (DBGWCR[n].BAS + LSB);
        if !IsZero(MSB AND (MSB - 1)) && vaddress<31:3> == DBGWVR[n]<31:3> then
            byte_select_match = ConstrainUnpredictableBool();

return WVR_match && byte_select_match;

```

AArch32.CheckWatchpoint() tests a committed instruction against all watchpoints. If all of the following are true, a Watchpoint exception is generated:

- [DBGDSCRExt.MDBGGen](#) is 1.
- Debug exceptions are enabled from the current Exception level and Security state. See [Enabling debug exceptions from current Exception level and Security state on page D3-1656](#).
- All of the conditions required for Watchpoint exception generation are met. See [Conditions for generating a Watchpoint exception on page D2-1608](#).

AArch32.CheckWatchpoint() might halt the PE and cause it to enter Debug state. External debug uses Debug state.

```

// AArch32.CheckWatchpoint()
// =====
// Called before accessing the memory location of "size" bytes at "address".

FaultRecord AArch32.CheckWatchpoint(bits(32) vaddress, AccType acctype,
                                     boolean iswrite, integer size)
    assert ELUsingAArch32(TranslationRegime());

    match = FALSE;
    ispriv = PSTATE.EL != EL0 && !(PSTATE.EL == EL1 && acctype == AccType_UNPRIV);

    for i = 0 to UInt(DBGDIDR.WRPs)
        match = match || AArch32.WatchpointMatch(i, vaddress, size, ispriv, iswrite);

    if match && HaltOnBreakpointOrWatchpoint() then
        reason = DebugHalt_Watchpoint;
        Halt(reason);
    elseif match && DBGDSCRExt.MDBGGen == '1' && AArch32.GenerateDebugExceptions() then
        debugmoe = DebugException_Watchpoint;
        return AArch32.DebugFault(acctype, iswrite, debugmoe);
    else
        return AArch32.NoFault();

```

There is no AArch32.WatchpointException() because Watchpoint exceptions are handled by AArch32.TakeDataAbortException(). See [Pseudocode description of taking the Data Abort exception on page G1-3484](#).

D2.7 Vector Catch exceptions

The following subsections describe Vector Catch exceptions:

- [About Vector Catch exceptions.](#)
- [Enable controls for Vector Catch exceptions on page D2-1629.](#)
- [Exception vectors that Vector Catch exceptions can be enabled for on page D2-1629.](#)
- [Generation of Vector Catch exceptions on page D2-1631.](#)
- [Constraints to consider when programming vector catch on page D2-1632.](#)
- [Pseudocode description of Vector Catch exceptions on page D2-1633.](#)

D2.7.1 About Vector Catch exceptions

Vector Catch exceptions are only supported in an AArch32 stage 1 translation regime. This means that they are only supported if at least EL1 using AArch32 is supported.

Whenever the PE takes an exception to an Exception level that is using AArch32, execution is forced to an address that is the *exception vector* for that type of exception. A unique exception vector exists for each exception type. A debugger can enable Vector Catch exceptions for one or more exception vectors, so that whenever an exception is taken that uses one of those vectors, a Vector Catch exception is generated.

———— Note ————

For more information on exception handling, see [Chapter G1 The AArch32 System Level Programmers' Model](#).

The ARMv8-A architecture supports two forms of vector catch, *address-matching* and *exception-trapping*. For the address-matching form, the execution of an instruction that is fetched from an exception vector generates a Vector Catch exception. For the exception-trapping form, an exception entry generates a Vector Catch exception.

Address-matching

For vectors that Vector Catch exceptions are enabled for, a Vector Catch exception is generated whenever the virtual address of an instruction matches the vector. That is:

1. The debugger enables Vector Catch exceptions for one or more exception vectors.
2. The vectors that Vector Catch exceptions are enabled for are the *vector address set*.
3. For each instruction in the program flow, the virtual address of the instruction is compared with some or all of the addresses in the vector address set. The comparisons that are made depend on whether EL3 is implemented. [Generation of Vector Catch exceptions on page D2-1631](#) describes this.
4. If a match occurs, a Vector Catch exception is generated. The exception is generated when the instruction that caused the match is committed for execution.

Because Vector Catch exceptions are only supported in an AArch32 stage 1 translation regime, they can only be generated as a result of instructions executed in AArch32 state.

Exception-trapping

For exception types that correspond to the vectors that Vector Catch exceptions are enabled for, a Vector Catch exception is generated as part exception entry. That is:

1. The debugger enables Vector Catch exceptions for one or more exception vectors.
2. The vectors that Vector Catch exceptions are enabled for are the *vector address set*.
3. Whenever the PE takes an exception, if the exception type is handled by branching to a vector in the vector address set, a Vector Catch exception is generated. The Vector Catch exception is generated as part of the entry to the exception, before the exception handler either executes any instructions or takes any further exceptions.

Because Vector Catch exceptions are only generated in an AArch32 stage 1 translation regime, they can only be generated as a result of exceptions taken to AArch32 state.

When Vector Catch exceptions are enabled for an exception vector, this is called an *enabled vector catch*.

———— **Note** ————

In this section, including in all subsections, “Vector Catch”, where the initial letters are capitalized, means a Vector Catch exception, and “vector catch”, where the initial letters are not capitalized, means the ARMv8-A vector catch resource.

Table D2-15 summarizes the differences between the address-matching and exception-trapping forms.

Table D2-15 Differences in behavior of the address-matching and exception-trapping forms of vector catch

Address-matching	Exception-trapping
<p>An enabled vector catch generates a Vector Catch exception when an instruction that is fetched from the exception vector is committed for execution.</p> <p>This means that spurious Vector Catch exceptions might occur, where the Vector Catch exception does not result from an exception entry, but is instead caused by a branch to the exception vector.</p> <p>A branch to the exception vector might occur, for example, on a return from a nested exception or when simulating an exception entry.</p>	<p>An enabled vector catch generates a Vector Catch exception immediately after the PE takes the exception that is associated with the exception vector.</p> <p>This means that Vector Catch exceptions always result from exception entry, and not from branches to vector addresses.</p>
<p>A Vector Catch exception is generated as a result of an instruction fetch. This means that the Vector Catch exception has a priority relative to the other synchronous exceptions that result from an instruction fetch.</p> <p>Synchronous exception prioritization on page D1-1451 describes this prioritization.</p>	<p>A Vector Catch exception is generated as a result of an exception entry. This means that the Vector Catch exception is considered to be part of the exception that caused the Vector Catch exception. Therefore, the Vector Catch exception has no priority associated with it.</p> <p>For this reason, Vector Catch exceptions are outside the scope of the prioritization that Synchronous exception prioritization on page D1-1451 describes.</p>
<p>A Vector Catch exception can be preempted by another exception. If this happens, the Vector Catch exception is generated again when the exception handler branches back to the vector address.</p>	<p>Vector Catch exceptions must be taken before other exceptions.</p>
<p>A Vector Catch exception can be taken as a result of a fetch instruction executed in any AArch32 mode.</p>	<p>Because a Vector Catch exception is generated as the result of an exception entry, the Vector Catch exception is only generated when the PE is in the exception handling mode.</p>

Only one form of vector catch can be implemented. Which form is implemented is IMPLEMENTATION DEFINED. The [DBGDEVID](#) indicates which form is implemented.

For both forms, a debugger enables Vector Catch exceptions for exception vectors by programming the [DBGVCR](#). The [DBGVCR](#) contains *vector catch enable bits*. Each vector catch enable bit corresponds to a different exception vector. When a debugger sets a vector catch enable bit to 1, Vector Catch exceptions are enabled for that vector.

———— **Note** ————

EL2 using AArch64 or EL3 using AArch64 can enable Vector Catch exceptions for exception vectors by programming the [DBGVCR32_EL2](#). The [DBGVCR32_EL2](#) is architecturally mapped to the [DBGVCR](#).

Depending on the implementation, some vector catch enable bits might not exist in the [DBGVCR](#). For example, if EL3 is not implemented, or is implemented and is using AArch64, Monitor mode does not exist, and so the enable bits for exception vectors for exceptions taken to Monitor mode are RES0. See the register description for the vector catch enable bits that exist for different implementation options. Also see [Exception vectors that Vector Catch exceptions can be enabled for on page D2-1629](#).

———— **Note** ————

- The ARMv8-A architecture does not provide vector catch enable bits for exceptions taken to EL2.

- A warm PE reset resets the [DBGVCR](#).

D2.7.2 Enable controls for Vector Catch exceptions

To enable Vector Catch exceptions, a debugger must set [DBGDSCRExt.MDBGGen](#) to 1. [The debug exceptions enable controls on page D3-1651](#) describes this.

In addition, a Vector Catch exception can only be generated if debug exceptions are enabled from the current Exception level and Security state. See [Enabling debug exceptions from current Exception level and Security state on page D3-1656](#).

D2.7.3 Exception vectors that Vector Catch exceptions can be enabled for

When the PE takes an exception to EL1 using AArch32 or EL3 using AArch32:

If the implementation does not include EL3

The PE uses a single vector table, that contains *Local vector addresses*.

If the implementation includes EL3

The PE uses one of three vector tables:

- The table for exceptions taken to Monitor mode, if EL3 is using AArch32. This table contains *Monitor vector addresses*.
- The table for exceptions taken to one of:
 - Secure EL1 modes, if EL3 is using AArch64.
 - Secure PL1 modes other than Monitor mode, if EL3 is using AArch32.
 This table contains *Secure Local vector addresses*.
- The table for exceptions taken to Non-secure EL1 modes, regardless of whether EL3 is using AArch64 or AArch32. This table contains *Non-secure Local vector addresses*.

[Table D2-16](#) shows which vector table is used.

Table D2-16 Vector tables used for different target AArch32 modes

Implementation	Target AArch32 mode	Vector table used
EL3 is not implemented	Any EL1 mode	Local vector addresses
EL3 is implemented, and is using AArch64	Any Secure EL1 mode	Secure Local vector addresses
	Any Non-secure EL1 mode	Non-secure Local vector addresses
EL3 is implemented, and is using AArch32	Monitor mode	Monitor vector addresses
	Any Secure PL1 mode other than Monitor mode	Secure Local vector addresses
	Any Non-secure EL1 mode	Non-secure Local vector addresses

The following tables show all of the exception vectors that Vector Catch exceptions can be enabled for, and their corresponding vector catch enable bits in the [DBGVCR](#):

- [Table D2-17 on page D2-1630](#) shows the Local vector addresses.
- [Table D2-18 on page D2-1630](#) shows the Monitor vector addresses.
- [Table D2-19 on page D2-1630](#) shows the Secure Local vector addresses.

- [Table D2-20 on page D2-1631](#) shows the Non-secure Local vector addresses.

Table D2-17 Local vector addresses, for if EL3 is not implemented

Vector catch enable bit	Exception type	Local vector addresses	
		Normal. SCTLR.V is 0.	High. SCTLR.V is 1.
SF	FIQ interrupt	0x0000001C	0xFFFF001C
SI	IRQ interrupt	0x00000018	0xFFFF0018
SD	Data Abort	0x00000010	0xFFFF0010
SA	Prefetch Abort	0x0000000C	0xFFFF000C
SS	Supervisor Call	0x00000008	0xFFFF0008
SU	Undefined Instruction	0x00000004	0xFFFF0004

Table D2-18 Monitor vector addresses, for if EL3 is implemented and is using AArch32

Vector catch enable bit	Exception type	Monitor vector addresses
MF	FIQ interrupt	MVBAR + 0x0000001C
MI	IRQ interrupt	MVBAR + 0x00000018
MD	Data Abort	MVBAR + 0x00000010
MP	Prefetch Abort	MVBAR + 0x0000000C
MS	Secure Monitor Call	MVBAR + 0x00000008

Table D2-19 Secure Local vector addresses, for Secure EL1 modes if EL3 is implemented and is using AArch64, or for Secure PL1 modes other than Monitor mode if EL3 is implemented and is using AArch32

Vector catch enable bit	Exception type	Secure Local vector addresses	
		Normal. SCTLR_S.V is 0.	High. SCTLR_S.V is 1.
SF	FIQ interrupt	VBAR_S + 0x0000001C	0xFFFF001C
SI	IRQ interrupt	VBAR_S + 0x00000018	0xFFFF0018
SD	Data Abort	VBAR_S + 0x00000010	0xFFFF0010
SA	Prefetch Abort	VBAR_S + 0x0000000C	0xFFFF000C
SS	Supervisor Call	VBAR_S + 0x00000008	0xFFFF0008
SU	Undefined Instruction	VBAR_S + 0x00000004	0xFFFF0004

Table D2-20 Non-secure Local vector addresses, for if EL3 is implemented, regardless of which Exception level it is using

Vector catch enable bit	Exception type	Non-secure Local vector addresses	
		Normal. SCTLR_{NS}.V is 0.	High. SCTLR_{NS}.V is 1.
NSF	FIQ interrupt	$VBAR_{NS} + 0x0000001C$	0xFFFF001C
NSI	IRQ interrupt	$VBAR_{NS} + 0x00000018$	0xFFFF0018
NSD	Data Abort	$VBAR_{NS} + 0x00000010$	0xFFFF0010
NSA	Prefetch Abort	$VBAR_{NS} + 0x0000000C$	0xFFFF000C
NSS	Supervisor Call	$VBAR_{NS} + 0x00000008$	0xFFFF0008
NSU	Undefined Instruction	$VBAR_{NS} + 0x00000004$	0xFFFF0004

———— **Note** ————

If EL3 is implemented and is using AArch64, $VBAR$ is not banked, therefore $VBAR_S$ and $VBAR_{NS}$ are the same register, $VBAR_{EL1}$.

D2.7.4 Generation of Vector Catch exceptions

How Vector Catch exceptions are generated depends on which form is implemented:

- [Address-matching](#).
- [Exception-trapping on page D2-1632](#).

Address-matching

The virtual address of each instruction in the program flow is compared with some or all of the addresses in the vector address set, as follows:

- If EL3 is not implemented, the vector address set contains only Local vector addresses. The virtual address of each instruction in the program flow, including those executed at EL0, is compared with all addresses in the vector address set.
- If EL3 is implemented, the vector address set might contain addresses of one or more of the following types:
 - Monitor vector addresses, if EL3 is using AArch32.
 - Secure Local vector addresses.
 - Non-secure Local vector addresses.

In this case, [Table D2-21](#) shows which addresses, in the vector address set, the virtual address of each instruction in the program flow is compared with.

Table D2-21 Comparisons made if the implementation includes EL3

EL3 is using	For exceptions taken to:	
	Secure privileged modes	Non-secure EL1 modes
AArch64	Secure Local vector addresses	Non-secure Local vector addresses
AArch32	Secure Local vector addresses and Monitor vector addresses	

For example, for exceptions taken to a Secure PL1 mode when EL3 is using AArch64, the virtual address of each instruction in the program flow is compared with each Secure Local vector address in the vector address set.

For each instruction in the program flow, the PE tests for any possible Vector Catch exceptions before executing the instruction. If a match occurs, a Vector Catch exception is generated when the instruction is committed for execution, regardless of all of the following:

- Whether the instruction passes its condition code check.
- Whether the instruction is executed as part of exception entry.
- If EL2 is implemented, what [HCR_EL2](#).{IMO, FMO, AMO} or [HCR](#).{IMO, FMO, AMO} are set to.
- If EL3 is implemented, what [SCR_EL3](#).{IRQ, FIQ, EA} or [SCR](#).{IRQ, FIQ, EA} are set to.

Exception-trapping

When the PE takes an exception, if the exception is by branching to an exception vector that is included in the vector address set, a Vector Catch exception is generated as part of exception entry. That is, a Vector Catch exception is generated instead of the exception handler executing its first instruction.

D2.7.5 Constraints to consider when programming vector catch

See the following subsections:

- [Conditions that apply to both forms of vector catch.](#)
- [Conditions that apply only to the address-matching form.](#)

Conditions that apply to both forms of vector catch

For Vector Catch exceptions enabled for either the Prefetch Abort exception vector or the Data Abort exception vector, if one of these exception types is taken to the Exception level that debug exceptions target, behavior is CONSTRAINED UNPREDICTABLE. Either:

- Vector catch is ignored, therefore a Vector Catch exception is not generated.
- Vector catch generates a Prefetch Abort debug exception. For Vector Catch exceptions enabled for the Prefetch Abort exception vector, the PE might enter a recursive loop of Prefetch Abort exceptions causing Vector Catch exceptions and Vector Catch exceptions causing Prefetch Abort exceptions.

———— Note —————

The Exception level that debug exceptions target is called the *debug target Exception level*. [Routing debug exceptions on page D3-1652](#) describes the derivation of this.

Conditions that apply only to the address-matching form

Exception vectors are at word-aligned addresses, and:

- It is CONSTRAINED UNPREDICTABLE whether an enabled vector catch generates a Vector Catch exception for a T32 instruction starting at the halfword-aligned address immediately prior to the vector address.
- T32 instructions that start at the halfword-aligned address immediately after the exception vector do not generate Vector Catch exceptions.

For the address-matching form, Vector Catch exceptions have the same priority as Breakpoint exceptions. If a single instruction causes both a Vector Catch exception and a Breakpoint exception, it is CONSTRAINED UNPREDICTABLE which of these debug exceptions the PE takes.

See also [Conditions that apply to both forms of vector catch.](#)

D2.7.6 Pseudocode description of Vector Catch exceptions

The AArch32.VCRMatch() pseudocode function checks whether the instruction at address generates a Vector Catch exception.

```
// AArch32.VCRMatch()
// =====

boolean AArch32.VCRMatch(bits(32) vaddress)

    if UsingAArch32() && ELUsingAArch32(EL1) && IsZero(vaddress<1:0>) && PSTATE.EL != EL2 then
        // Each bit position in this string corresponds to a bit in DBGVCR and an exception vector.
        match_word = Zeros(32);

        if vaddress<31:5> == ExcVectorBase()<31:5> then
            if HaveEL(EL3) && !IsSecure() then
                match_word<UInt(vaddress<4:2>) + 24> = '1';    // Non-secure vectors
            else
                match_word<UInt(vaddress<4:2>) + 0> = '1';    // Secure vectors (or no EL3)
            if HaveEL(EL3) && ELUsingAArch32(EL3) && IsSecure() && vaddress<31:5> == MVBAR<31:5> then
                match_word<UInt(vaddress<4:2>) + 8> = '1';    // Monitor vectors

        // Mask out bits not corresponding to vectors.
        if !HaveEL(EL3) then
            mask = '00000000':'00000000':'00000000':'11011110'; // DBGVCR[31:8] are RES0
        elseif !ELUsingAArch32(EL3) then
            mask = '11011110':'00000000':'00000000':'11011110'; // DBGVCR[15:8] are RES0
        else
            mask = '11011110':'00000000':'11011100':'11011110';

        match_word = match_word AND DBGVCR AND mask;
        match = !IsZero(match_word);

        // Check for UNPREDICTABLE case - match on Prefetch Abort and Data Abort vectors
        if !IsZero(match_word<28:27,12:11,4:3>) && DebugTarget() == PSTATE.EL then
            match = ConstrainUnpredictableBool();
    else
        match = FALSE;

    return match;
```

The AArch32.CheckVectorCatch() pseudocode function uses VCRMatch() to test whether the instruction generates a Vector Catch exception, and if VCRMatch() returns TRUE it generates that event.

```
// AArch32.CheckVectorCatch()
// =====
// Called before executing the instruction of length "size" bytes at "vaddress" in an AArch32
// translation regime.
// Vector Catch can in fact be evaluated well ahead of execution, for example, at instruction
// fetch. This is the simple sequential execution of the program.

FaultRecord AArch32.CheckVectorCatch(bits(32) vaddress, integer size)
    assert ELUsingAArch32(TranslationRegime());

    match = AArch32.VCRMatch(vaddress);
    if size == 4 && !match && AArch32.VCRMatch(vaddress + 2) then
        match = ConstrainUnpredictableBool();

    if match && DBGDSCRExt.MDBGen == '1' && AArch32.GenerateDebugExceptions() then
        acctype = AccType_IFETCH;
        iswrite = FALSE;
        debugmoe = DebugException_VectorCatch;
        return AArch32.DebugFault(acctype, iswrite, debugmoe);
    else
        return AArch32.NoFault();
```

D2.8 Software Step exceptions

The following subsections describe Software Step exceptions:

- [About Software Step exceptions](#).
- [Enable controls for software step](#).
- [The software step state machine](#) on page D2-1635.
- [Rules for enabling software step](#) on page D2-1636.
- [Entering the active-not-pending state](#) on page D2-1637.
- [Behavior in the active-not-pending state](#) on page D2-1640.
- [Entering the active-pending state](#) on page D2-1641.
- [Behavior in the active-pending state](#) on page D2-1642.
- [Stepping T32 IT instructions](#) on page D2-1642.
- [Syndrome information that the PE provides](#) on page D2-1643.
- [Additional considerations](#) on page D2-1644.
- [Pseudocode description of Software Step exceptions](#) on page D2-1645.

D2.8.1 About Software Step exceptions

Software step is an ARMv8-A resource that a debugger can use to make the PE single-step instructions.

For example, by using software step, debugger software executing at a higher Exception level can single-step instructions at a lower Exception level.

Operation is as follows:

1. The debugger software:
 - a. Enables software step.
 - b. Executes an exception return instruction, ERET, to branch to the instruction to be single-stepped in the software being debugged.
2. The software being debugged then:
 - a. Executes the instruction to be single-stepped.
 - b. Takes a Software Step exception on the next instruction, returning control to the debugger software.

A state machine describes the behavior of software step, shown in [The software step state machine](#) on page D2-1635.

In the following subsections, EL_D is used to mean the Exception level that Software Step exceptions target. EL_D is the *debug target Exception level*. See [Routing debug exceptions](#) on page D3-1652.

D2.8.2 Enable controls for software step

To enable software step, a debugger must set `MDSCR_EL1.SS` to 1. [The debug exceptions enable controls](#) on page D3-1651 describes this.

In addition, a Software Step exception can only be generated if debug exceptions are enabled from the current Exception level and Security state. See [Enabling debug exceptions from current Exception level and Security state](#) on page D3-1656.

D2.8.3 The software step state machine

Figure D2-7 shows the software step state machine.

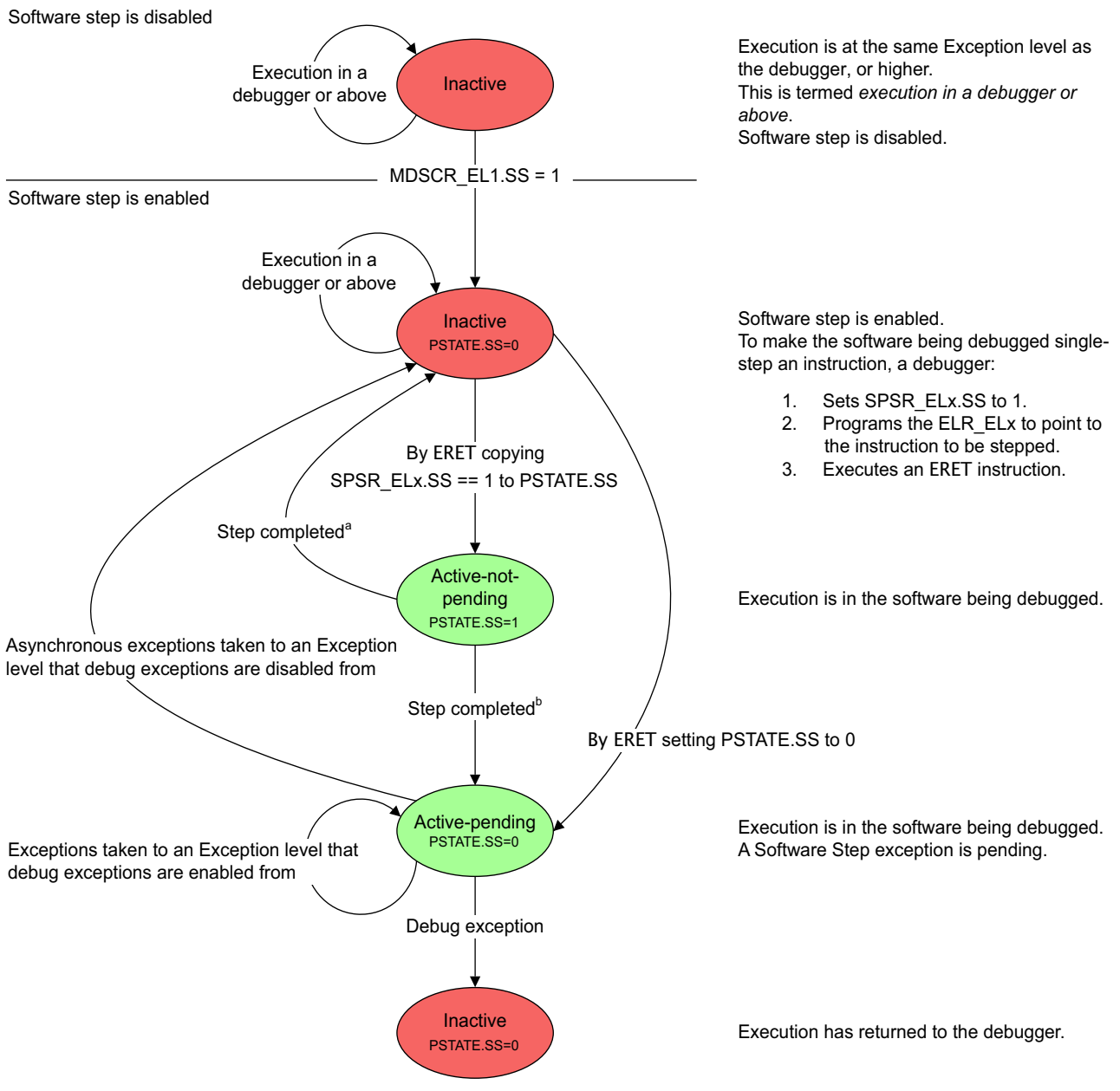

a. The step is the software being debugged taking an exception to an Exception level that debug exceptions are disabled from. Software step is inactive when debug exceptions are disabled from the current Exception level.

b. The step is the software being debugged either:

- Executing the instruction to be stepped without taking an exception.
- Taking an exception to an Exception level that debug exceptions are enabled from. The Exception level might be using AArch64 or AArch32.

Figure D2-7 Software step state machine

For a description of when debug exceptions are enabled or disabled from an Exception level, see [Enabling debug exceptions from current Exception level and Security state on page D3-1656](#).

For more information about how a step is completed, see [Behavior in the active-not-pending state on page D2-1640](#).

The software step states are:

Inactive Software step is inactive. It cannot generate any Software Step exceptions or affect PE execution. Software step is inactive whenever any of the following are true:

- It is disabled. That is, `MDSCR_EL1.SS` is 0.
- `ELD` is using AArch32.
- Debug exceptions are disabled from the current Exception level or Security state.

Active-not-pending

None of the conditions mentioned in *Inactive* are true, therefore software step is active.

The current instruction is the instruction to be stepped.

Active-pending

None of the conditions mentioned in *Inactive* are true, therefore software step is active.

A Software Step exception is pending on the current instruction.

Whenever software step is active, whether the state machine is in the active-not pending state or the active-pending state depends on `PSTATE.SS`. Table D2-22 shows this.

Table D2-22 State machine states

<code>MDSCR_EL1.SS</code>	<code>EL_D</code> is using:	Debug exceptions enabled or disabled from the current Exception level and Security state	<code>PSTATE.SS</code>	State
0	X	X	X	Inactive
1	AArch32	X	X	Inactive
1	AArch64	Disabled	X	Inactive
1	AArch64	Enabled	1	Active-not-pending
1	AArch64	Enabled	0	Active-pending

D2.8.4 Rules for enabling software step

Debugger software must be executing in an Exception level and Security state that debug exceptions are disabled from when it enables software step.

The Exception level that hosts the debugger software must be using AArch64.

D2.8.5 Entering the active-not-pending state

Software step can only enter the active-not-pending state on an ERET instruction that copies 1 from `SPSR_ELx.SS` to `PSTATE.SS`, and:

- If `SPSR_ELx.SS` is 1, an ERET only copies it to `PSTATE.SS` if all of the following are true:
 - Software step is enabled.
 - `ELD` is using AArch64.
 - Debug exceptions are disabled from the current Exception level
 - Debug exceptions are enabled from the Exception level that the ERET instruction targets.

Otherwise, ERET instructions set `PSTATE.SS` to 0, regardless of the value of `SPSR_ELx.SS`.

Table D2-23 shows this. In the table:

- Lock** Means the value of (`OSLSR_EL1.OSLK` OR `EDPRSR.DLK`).
- NS** Is `SCR_EL3.NS`.
- SDD** Is `MDCR_EL3.SDD`. See *Enabling debug exceptions from the current Security state on page D3-1657*.
- TDE** Is `MDCR_EL2.TDE`. See *Routing debug exceptions on page D3-1652*.

Table D2-23 Value an ERET writes to `PSTATE.SS`

<code>MDCR_EL1.SS</code>	Lock	NS	SDD	TDE	EL1 is using	EL2 is using	Value an ERET writes to <code>PSTATE.SS</code>
0	X	X	X	X	X	X	0
1	1	X	X	X	X	X	0
	0	X	AArch32	n/a	0		
						AArch64	n/a
	1	X	0	AArch32	X		
						AArch64	AArch64
	1	AArch32	AArch32	0			
					X	AArch64	See Table D2-25 on page D2-1639

For:

- `SCR_EL3.NS == 0` or `MDCR_EL3.TDE == 0`, and EL1 using AArch64, so that `ELD` is EL1 using AArch64, Table D2-24 on page D2-1638 shows the value an ERET writes to `PSTATE.SS`.
- `SCR_EL3.NS == 1` and `MDCR_EL3.TDE == 1` and EL2 using AArch64, so that `ELD` is EL2 using AArch64, Table D2-25 on page D2-1639 shows the value an ERET writes to `PSTATE.SS`.

In both tables:

- From EL** Means the Exception level that the PE executes the ERET at.
- Target EL** Is the target Exception level of the ERET.

Note

If the ERET is an illegal exception return, the target Exception level of the ERET is the current Exception level. See *Illegal return events on page D1-1441*.

KDE Is `MDSCR_EL1.KDE`. See *Enabling debug exceptions from the current Exception level on page D3-1656*.

Table D2-24 Value an ERET writes to `PSTATE.SS` if `ELD` is `EL1` using `AArch64`

From EL	Target EL	KDE	PSTATE.D	SPSR_ELx.D	Software Step exceptions are enabled or disabled		Value an ERET writes to PSTATE.SS
					From EL	Target EL	
EL3	EL3	X	X	X	Disabled	Disabled	0
	EL2	X	X	X	Disabled	Disabled	0
	EL1	0	X	X	Disabled	Disabled	0
		1	X	1	Disabled	Disabled	0
				0	Disabled	Enabled	<code>SPSR_EL3.SS</code>
EL0	X	X	X	Disabled	Enabled	<code>SPSR_EL3.SS</code>	
EL2	EL2	X	X	X	Disabled	Disabled	0
	EL1	0	X	X	Disabled	Disabled	0
		1	X	1	Disabled	Disabled	0
				0	Disabled	Enabled	<code>SPSR_EL2.SS</code>
EL0	X	X	X	Disabled	Enabled	<code>SPSR_EL2.SS</code>	
EL1	EL1	0	X	X	Disabled	Disabled	0
		1	0	X	Enabled ^a	- ^b	0
			1	1	Disabled	Disabled	0
				0	Disabled	Enabled	<code>SPSR_EL1.SS</code>
	EL0	0	X	X	Disabled	Enabled	<code>SPSR_EL1.SS</code>
		1	0	X	Enabled ^a	Enabled	0
			1	X	Disabled	Enabled	<code>SPSR_EL1.SS</code>

a. Because `MDSCR_EL1.SS == 1`, it means that the ERET is itself being stepped.

b. Depends on `SPSR_EL1.D`.

Table D2-25 Value an ERET writes to **PSTATE.SS** if **EL_D** is **EL2** using **AArch64**

From EL	Target EL	KDE	PSTATE.D	SPSR_ELx.D	Software Step exceptions are enabled or disabled		Value an ERET writes to PSTATE.SS
					From EL	Target EL	
EL3	EL3	X	X	X	Disabled	Disabled	0
	EL2	0	X	X	Disabled	Disabled	0
		1	X	1	Disabled	Disabled	0
				0	Disabled	Enabled	SPSR_EL3.SS
	EL1	X	X	X	Disabled	Enabled	SPSR_EL3.SS
	EL0	X	X	X	Disabled	Enabled	SPSR_EL3.SS
EL2	EL2	0	X	X	Disabled	Disabled	0
		1	0	X	Enabled ^a	. ^b	0
			1	1	Disabled	Disabled	0
				0	Disabled	Enabled	SPSR_EL2.SS
	EL1	0	X	X	Disabled	Enabled	SPSR_EL2.SS
		1	0	X	Enabled ^a	Enabled	0
			1	X	Disabled	Enabled	SPSR_EL2.SS
	EL0	0	X	X	Disabled	Enabled	SPSR_EL2.SS
		1	0	X	Enabled ^a	Enabled	0
			1	X	Disabled	Enabled	SPSR_EL2.SS
EL1	EL1	X	X	X	Enabled ^a	Enabled	0
	EL0	X	X	X	Enabled ^a	Enabled	0

- a. Because **MDSCR_EL1.SS** == 1, it means that the ERET is itself being stepped.
b. Depends on **SPSR_EL1.D**.

Note

No AArch32 instruction that can update the **CPSR** can set **PSTATE.SS** to 1.

D2.8.6 Behavior in the active-not-pending state

In this state, the software being debugged either:

- Executes the instruction to be stepped and either:
 - Completes it without taking a synchronous exception.
 - Takes a synchronous exception if the instruction generates one.
- Takes an asynchronous exception without executing any instructions.

If the software being debugged takes either a synchronous or an asynchronous exception, behavior is as described in one of the following:

- *If an exception is taken to an Exception level that is using AArch64.*
- *If the exception is taken to an Exception level that is using AArch32.*

If the software being debugged executes the instruction without taking any exceptions, then after executing the instruction, it sets `PSTATE.SS` to 0 and software step advances to the active-pending state. See *Behavior in the active-pending state* on page D2-1642.

If an exception is taken to an Exception level that is using AArch64

As part of exception entry, the software being debugged does both of the following:

- Sets `SPSR_ELx.SS` to 0 or 1, depending on the exception. See [Table D2-26](#).
- Sets `PSTATE.SS` to 0. This causes software step to enter either the active-pending state or the inactive state. Which state software step enters depends on whether debug exceptions are enabled or disabled from the Exception level that the exception is taken to:
 - Enabled** Software step enters the active-pending state.
 - Disabled** Software step enters the inactive state.

In either case, on taking the exception, a step is complete.

Table D2-26 Categorization of exceptions, for setting `SPSR_ELx.SS` to 0 or 1

Exception description	Exceptions	<code>SPSR_ELx.SS</code>
Exceptions whose preferred return address is for the instruction that follows the instruction to be stepped.	Supervisor Call (SVC) exceptions. Hypervisor Call (HVC) exceptions. Secure Monitor Call (SMC) exceptions.	0
Exceptions whose preferred return address is the address of the instruction to be stepped.	All other synchronous exceptions, and asynchronous exceptions that occur before the instruction to be stepped.	1

If the exception is taken to an Exception level that is using AArch32

This can only happen when both of the following are true:

- EL2 is implemented and is using AArch64, the PE is in Non-secure state, and `MDCR_EL2.TDE` is 1. Because `MDCR_EL2.TDE` is 1, `ELD` is EL2.
- The exception is taken to Non-secure EL1 using AArch32.

As part of exception entry, if the exception is a Supervisor Call (SVC) exception, the software being debugged sets `SPSR_svc[21]` to 0.

————— Note —————

- `SPSR_svc[21]` is a RES0 bit that is architecturally mapped to `SPSR_EL1.SS`.

- For exception types other than the SVC exception, `SPSR_<mode>[21]` is a RES0 bit, and because it is not architecturally mapped to any AArch64 register, it is hardwired to 0.

Also as part of exception entry, the software being debugged sets `PSTATE.SS` to 0, regardless of the exception type. This causes software step to enter the active-pending state rather than the inactive state because the exception is taken to an Exception level that debug exceptions are enabled from, EL1.

Note

Debug exceptions are enabled from EL1 because `ELD` is EL2. Debug exceptions are always enabled from Exception levels that are lower than `ELD`.

Summary of behavior in the active-not-pending state

Table D2-27 summarizes behavior in the active-not-pending state.

Table D2-27 Summary of behavior in the active-not-pending state

Event	Value written to <code>PSTATE.SS</code>	Execution state of the target Exception level	Exception type	Value written to <code>SPSR_ELx.SS</code>	Next state
No exception	0	n/a	n/a	n/a	Active-pending
Exception	0	AArch64	Supervisor Call (SVC) Hypervisor Call (HVC) Secure Monitor Call (SMC)	0	Active-pending or inactive ^a
			Other	1	
		AArch32	All	0 ^b	Active-pending

a. Which state software step enters depends on whether debug exceptions are enabled or disabled from the target Exception level. See Figure D2-7 on page D2-1635.

b. `SPSR_<mode>[21]` is RES0. For `SPSR_svc`, it is architecturally mapped to `SPSR_EL1.SS` so is implemented as read/write. For all other AArch32 EL1 modes, it is implemented as RAZ/WI.

D2.8.7 Entering the active-pending state

Software step enters the active-pending state after any of the following operations, provided that both:

- It is enabled. That is, `MDSCR_EL1.SS` is 1.
- Debug exceptions are enabled from the Exception level and Security state that execution is in after the operation.

The operations are:

While software step is in the active-not-pending state

The software being debugged either:

- Executing the instruction to be stepped without taking any exceptions.
- Taking an exception.

Note

If entry to the active-pending state is because of the software being debugged taking an exception, it means that the exception is one that is taken to Non-secure EL1 when `MDCR_EL2.TDE` is 1. Otherwise, debug exceptions are masked by `PSTATE.D`, therefore they would be disabled from the target Exception level of the exception.

While software step is in the inactive state

Any of:

- Executing an ERET instruction when `SPSR_ELx.SS` is 0.
- Exiting Debug state when `DSPSR_EL0.SS` or `DSPSR.SS` is 0.
- If `MDSCR_EL1.KDE` is 1, executing an MSR DAIF or MSR DAIFC1r instruction that clears `PSTATE.D` to 0.

In addition, software step might enter the active-pending state following a direct write to a system register, for example a write to `MDSCR_EL1.KDE` or `MDSCR_EL1.SS`. These writes require explicit synchronization to guarantee their effect. See *Synchronization and the software step state machine* on page D2-1645.

D2.8.8 Behavior in the active-pending state

In this state, a Software Step exception is pending, and the software being debugged takes it on the current instruction.

Software Step exceptions have priority over all other exceptions except asynchronous exceptions taken to an Exception level or Security state that debug exceptions are disabled from. This means that there are some asynchronous exceptions that Software Step exceptions have priority over.

———— Note ————

- This is the only case where a synchronous exception explicitly has a higher priority than asynchronous exceptions.
- For a description of when debug exceptions are enabled or disabled from an Exception level, see *Enabling debug exceptions from current Exception level and Security state* on page D3-1656.

In cases where both a Software Step exception, and an asynchronous exception taken to an Exception level or Security state that debug exceptions are disabled from, are pending, the architecture does not define which exception the PE takes first.

———— Note ————

If, in the active-pending state, the current instruction is in an exception handler, it is the responsibility of the software step exception handler to set `SPSR_ELx.SS` or `SPSR_svc[21]` for the original exception handler to 0, so that software step returns to the active-pending state when the original exception returns.

D2.8.9 Stepping T32 IT instructions

The ARMv8-A architecture permits a combination of an IT instruction and another 16-bit T32 instruction to comprise one 32-bit instruction.

For the purpose of stepping an item, it is IMPLEMENTATION DEFINED whether:

- The PE considers this combination to be one instruction.
- The PE considers this combination to be two instructions.

It is then IMPLEMENTATION DEFINED whether this behavior depends on the value of the applicable IT Disable bit, ITD. For example:

- The PE might consider this combination to be one instruction, regardless of the state of the applicable ITD bit.
- The PE might consider this combination to be two instructions, regardless of the state of the applicable ITD bit.
- The PE might consider this combination to be one instruction when the applicable ITD bit is 1, and two instructions when it is 0.

The applicable ITD bit is either:

- `SCTLR_EL1.ITD` if execution is in EL0 using AArch32 when EL1 is using AArch64.

- [SCTLR.ITD](#) if execution is in EL1 using AArch32.
- [HSCTLR.ITD](#) if execution is in EL2 using AArch32.

D2.8.10 Syndrome information that the PE provides

On taking a Software Step exception, the PE records syndrome information about the cause of the exception in the applicable Exception Syndrome Register (ESR), [ESR_EL1](#) or [ESR_EL2](#). In this section, the applicable ESR is referred to as [ESR_ELx](#). The syndrome information that the PE records is as follows:

- The Exception Class, in [ESR_ELx.EC](#). The Exception Class is either:
 - 0x32, if exception entry is from a lower Exception level.
 - 0x33, if exception entry is from the current Exception level.
- The PE might record whether the instruction that was stepped was a Load-Exclusive class of instruction. If it does, debugger software can use this information when stepping code that uses exclusive monitors. See [Stepping code that uses exclusive monitors on page D2-1645](#).

The PE records this as follows:

- The Instruction Syndrome Valid bit, [ESR_ELx.ISV](#), indicates whether [ESR_ELx.EX](#) is valid:
 - 0** Not valid.
 - 1** Valid.
- [ESR_ELx.EX](#), if valid, indicates whether the instruction stepped was a Load-Exclusive class of instruction:
 - 0** The stepped instruction was not a Load-Exclusive instruction.
 - 1** The stepped instruction was a Load-Exclusive instruction.

The PE only sets [ESR_ELx.ISV](#) to 1 if an instruction was stepped. If the PE sets [ESR_ELx.ISV](#) to 1, it must also set [ESR_ELx.EX](#) to indicate whether the instruction stepped was a Load-Exclusive class of instruction.

If no instruction was stepped because software step entered the active-pending state from the inactive state without passing through the active-not-pending state, the PE sets both [ESR_ELx.{ISV, EX}](#) to 0.

———— **Note** —————

An implementation that always sets [ESR_ELx.ISV](#) to 0 and never sets [ESR_ELx.EX](#) is not compliant.

[Table D2-28](#) shows the permitted scenarios.

Table D2-28 Values that the PE can record in [ESR_ELx.{ISV, EX}](#)

Description	ESR_ELx.ISV	ESR_ELx.EX
Syndrome data is not available because no instruction was stepped.	0	0
Syndrome data is available because an instruction was stepped. The instruction stepped was an instruction other than a Load-Exclusive class of instruction.	1	0
Syndrome data is available because an instruction was stepped. The instruction stepped was a Load-Exclusive class of instruction.	1	1

———— **Note** —————

- A Load-Exclusive class of instruction is any one of the following:
 - In the A64 instruction set, any instruction that has a mnemonic starting with either LDX or LDAX.
 - In the A32 and T32 instruction sets, any instruction that has a mnemonic starting with either LDREX or LDRAEX.
- [ESR_ELx.EX](#) is UNKNOWN if the stepped instruction was a conditional Load-Exclusive instruction that failed its condition code test.

- For debug exceptions, [ESR_ELx.ISV](#) is a bit in the Instruction Specific Syndrome (ISS) field of the ESR, [ESR_ELx.ISS\[24\]](#). For all other exception types, [ESR_ELx.ISS\[24\]](#) has a different meaning.
-

D2.8.11 Additional considerations

This section contains the following:

- [Behavior when an ERET instruction is an illegal exception return.](#)
- [Behavior when the instruction stepped writes a misaligned PC value.](#)
- [Stepping code that uses exclusive monitors on page D2-1645.](#)
- [Synchronization and the software step state machine on page D2-1645.](#)

Behavior when an ERET instruction is an illegal exception return

If the conditions for entering the active-not-pending state in [Entering the active-not-pending state on page D2-1637](#) are met, but the PE executes an ERET instruction that is an illegal exception return, the exception return must be taken to the same Exception level that it was taken from. In this scenario, even though the Exception level remains the same before and after the ERET, software step can advance from the inactive state to one of the active states. Consider the following case:

1. Software step is enabled and inactive. The current Exception level is EL1 using AArch64, the OS Lock and OS Double Lock are unlocked, and [MDSCR_EL2.TDE](#) is 0, [MDSCR_EL1.KDE](#) is 1, and [PSTATE.D](#) is 1. [PSTATE.D == 1](#) is the reason why software step is inactive, because [PSTATE.D == 1](#) means that debug exceptions are disabled from the current Exception level.
2. The PE executes an ERET instruction.
3. The target of the ERET is EL2. This means that the ERET is an illegal exception return because the target of the ERET is higher than the Exception level it is executed at. In this case, the ERET must target EL1 instead of EL2. If [SPSR_EL1.D](#) is 0, then on the ERET [PSTATE.D](#) becomes 0 and debug exceptions become enabled from the current Exception level. Software step therefore advances from the inactive state to one of the active states.

The case described gives a scenario where debug exceptions are disabled from the Exception level that an ERET is executed at and enabled from the Exception level that the ERET is targeting, even though both Exception levels are EL1. This means that software step advances from the inactive state to one of the active states on executing the ERET. Which active state software step advances to depends on whether [SPSR_ELx.SS](#) is 1 or 0:

- If [SPSR_ELx.SS](#) is 1, software step advances to the active-not-pending state.
In this case, an Illegal State exception is pending on the instruction to be stepped, and the software being debugged takes the Illegal State exception instead of executing the instruction to be stepped.
- If [SPSR_ELx.SS](#) is 0, software step advances to the active-pending state.
In this case, a Software Step exception and an Illegal State exception are both pending. The Software Step exception has higher priority. On taking the Software Step exception, the software being debugged sets [SPSR_ELx.IL](#) to 1.

Note

[Synchronous exception prioritization on page D1-1451](#) shows the relative priorities of synchronous exceptions.

Behavior when the instruction stepped writes a misaligned PC value

An indirect branch that writes a misaligned PC value might generate a Misaligned PC exception at the target of the branch. However, if the indirect branch is stepped using software step, the software being debugged takes a Software Step exception instead, because the Software Step exception has higher priority. Behavior on returning from the Software Step exception depends on which Execution state the Exception level being returned to is using:

AArch64 A Misaligned PC exception is generated.

AArch32 The return from the Software Step exception forces the PC to the correct alignment, and no Misaligned PC exception is generated.

Debugger software must therefore take care when using software step to single-step an indirect branch instruction executed in AArch32 state, that it does not hide a Misaligned PC exception.

Stepping code that uses exclusive monitors

The ARMv8-A architecture provides no mechanism for preserving the state of the exclusive monitors when a Load-Exclusive or a Store-Exclusive instruction is stepped.

However, for certain progressions through the software step state machine, on taking a Software Step exception, the PE provides an indication of whether the instruction stepped was a Load-Exclusive class of instruction.

Debugger software can use this to detect the state of the exclusive monitors. For example, if the PE reports that the instruction stepped was a Load-Exclusive class of instruction, the debugger is aware that the next Store-Exclusive operation will fail, because all exclusive monitors are cleared on returning from the Software Step exception. The debugger must then take action to ensure that the code being stepped makes forwards progress.

For more information on how the PE reports whether the instruction stepped was a Load-Exclusive instruction, see [Syndrome information that the PE provides on page D2-1643](#).

Synchronization and the software step state machine

Any of the following can cause transitions between software step states:

- A direct write to a system register.
- A write to an external debug register that affects the routing of debug exceptions.

Because the software step state machine indirectly reads these registers, it is not guaranteed to observe any new values until after a Context Synchronization Operation (CSO) has occurred.

In the time between a write to one of these registers and the next CSO, state machine behavior is CONstrained UNPREDICTABLE. Either:

- It uses the state of the PE before the write.
- It uses the state of the PE after the write.

After a CSO, the state machine must use the state of the PE after the write.

For example:

1. Software changes `MDSCR_ELI.SS` from 0 to 1 when debug exceptions are enabled.
2. The PE executes some instructions.
3. A CSO occurs.

During step 2, it is CONstrained UNPREDICTABLE whether software step remains in the inactive state, as if `MDSCR_ELI.SS` is 0, or has entered the active-pending state because `MDSCR_ELI.SS` is 1. If it is in the:

- Inactive state, then after the CSO, it must enter the active-pending state.
- Active-pending state, the PE might take a Software Step exception before the CSO.

D2.8.12 Pseudocode description of Software Step exceptions

`SSAdvance()` advances software step from the active-not-pending state to the active-pending state, by setting `PSTATE.SS` to 0. It is called on completing execution of each instruction.

```
// SSAdvance()
// =====
// Advance the Software Step state machine.
```

```
SSAdvance()
```

```
// A simpler implementation of this function just clears PSTATE.SS to zero regardless of the
// current Software Step state machine. However, this check is made to illustrate that the
// processor only needs to consider advancing the state machine from the active-not-pending
```

```
// state.  
target = DebugTarget();  
step_enabled = !ELUsingAArch32(target) && MDSCR_EL1.SS == '1';  
active_not_pending = step_enabled && PSTATE.SS == '1';  
  
if active_not_pending then PSTATE.SS = '0';  
  
return;
```

CheckSoftwareStep() checks whether software step is in the active-pending state, and if it is, generates a Software Step exception. It is called before each instruction executed, before checking for any other synchronous exceptions.

```
// CheckSoftwareStep()  
// =====  
// Take a Software Step exception if in the active-pending state
```

```
CheckSoftwareStep()
```

```
if (!ELUsingAArch32(DebugTarget()) && AArch64.GenerateDebugExceptions() &&  
    MDSCR_EL1.SS == '1' && PSTATE.SS == '0') then  
    AArch64.SoftwareStepException();
```

DebugExceptionReturnSS() returns the value to write to `PSTATE.SS` on an exception return or a return from Debug state. See [Entering the active-not-pending state on page D2-1637](#).

```
// DebugExceptionReturnSS()  
// =====  
// Returns value to write to PSTATE.SS on an exception return or Debug state exit.
```

```
bit DebugExceptionReturnSS(bits(32) spsr)  
    assert Halted() || Restarting() || PSTATE.EL != EL0;  
  
    SS_bit = '0';  
  
    if MDSCR_EL1.SS == '1' then  
        if Restarting() then  
            enabled_at_source = FALSE;  
        elsif UsingAArch32() then  
            enabled_at_source = AArch32.GenerateDebugExceptions();  
        else  
            enabled_at_source = AArch64.GenerateDebugExceptions();  
  
        if IllegalExceptionReturn(spsr) then  
            dest = PSTATE.EL;  
        else  
            (valid, dest) = ELFromSPSR(spsr); assert valid;  
  
        secure = IsSecureBelowEL3() || dest == EL3;  
  
        if ELUsingAArch32(dest) then  
            enabled_at_dest = AArch32.GenerateDebugExceptionsFrom(dest, secure);  
        else  
            mask = spsr<9>;  
            enabled_at_dest = AArch64.GenerateDebugExceptionsFrom(dest, secure, mask);  
  
        ELd = DebugTargetFrom(secure);  
        if !ELUsingAArch32(ELd) && !enabled_at_source && enabled_at_dest then  
            SS_bit = spsr<21>;  
  
    return SS_bit;
```

D2.9 Synchronization and debug exceptions

The behavior of debug depends on all of the following:

- The state of the external debug authentication interface.
- Indirect reads of:
 - External debug registers.
 - System registers, including system debug registers.
 - Special purpose registers.

If a change is made to any of these, the effect of that change on debug exception generation cannot be relied on until after a *Context Synchronization Operation* (CSO) has occurred. Similarly, the effect of the change on the software step state machine cannot be relied on until after a CSO has occurred.

For any instructions executed between the time when the change is made and the time when the next CSO occurs, it is CONstrained UNPREDICTABLE whether debug uses the state of the PE before the change, or the state of the PE after the change.

The following gives examples:

- Example one:
 1. Software changes [MDSCR_ELI.MDE](#) from 0 to 1.
 2. An instruction occurs, that would cause a Breakpoint exception if self-hosted debug uses the state of the PE after the change.
 3. A CSO occurs.

In this case, it is CONstrained UNPREDICTABLE whether the instruction causes a Breakpoint exception.

- Example two:
 1. Software unlocks the OS lock.
 2. The PE executes some instructions.
 3. A CSO occurs.

During the time when the PE is executing some instructions, step 2, it is CONstrained UNPREDICTABLE whether debug exceptions other than Software Breakpoint Instruction exceptions can be generated.

Note

- See [Context synchronization operation](#) for the definition of this term.
 - Some register updates are self synchronizing. Others require an explicit CSO. For more information, see both:
 - [Synchronization requirements for system registers on page D8-1866](#).
 - [Synchronization of changes to the external debug registers on page H8-4445](#).
-

D2.9.1 State and mode changes without explicit context synchronization operations

Most changes to the Execution state, the AArch32 mode in AArch32 state, and the Security state if EL3 is implemented, happen as a result of operations that are an explicit CSO. This is because taking an exception and returning from an exception are both CSOs, and:

- The Execution state can only change as a result of taking or returning from an exception.

However, in AArch32 state, some state and mode changes can happen because of operations that are not an explicit CSO. These are:

- Execution state and AArch32 mode changes caused by MSR and CPS instructions.
- If EL3 is using AArch32, a Security state change caused by a direct write to the [SCR](#) in a privileged mode other than Monitor mode, to set [SCR.NS](#) to 1.

Chapter D3

The Debug Exception Model

When the PE is using self-hosted debug, it generates *debug exceptions*. This chapter describes the behavior of debug exceptions. It is organized as follows:

- [About debug exceptions on page D3-1650.](#)
- [The debug exceptions enable controls on page D3-1651.](#)
- [Routing debug exceptions on page D3-1652.](#)
- [Enabling debug exceptions from current Exception level and Security state on page D3-1656.](#)
- [The effect of powerdown on debug exceptions on page D3-1661.](#)
- [Summary of permitted routing and enabling of debug exceptions on page D3-1662.](#)
- [Debug exception behavior on page D3-1665.](#)
- [Pseudocode descriptions of debug exceptions on page D3-1669.](#)

D3.1 About debug exceptions

The following description is true for both AArch64 state and AArch32 state.

The debug exceptions are:

- [Software Breakpoint Instruction exceptions](#) on page D2-1566.
- [Breakpoint exceptions](#) on page D2-1569.
- [Watchpoint exceptions](#) on page D2-1606.
- [Vector Catch exceptions](#) on page D2-1627.
- [Software Step exceptions](#) on page D2-1634.

The PE can only generate a particular debug exception when both:

1. Debug exceptions are enabled from the current Exception level and Security state.
2. That particular debug exception is enabled. All of the software debug exceptions except for Software Breakpoint Instruction exceptions have an enable control contained in the [MDSCR_EL1](#) or [DBGDSCRExt](#).

This chapter comprises:

- [The debug exceptions enable controls](#) on page D3-1651.
- [Routing debug exceptions](#) on page D3-1652.
- [Enabling debug exceptions from current Exception level and Security state](#) on page D3-1656.
- [The effect of powerdown on debug exceptions](#) on page D3-1661.
- [Summary of permitted routing and enabling of debug exceptions](#) on page D3-1662.
- [Debug exception behavior](#) on page D3-1665.
- [Pseudocode descriptions of debug exceptions](#) on page D3-1669.

D3.2 The debug exceptions enable controls

Software Breakpoint Instruction exceptions are always enabled. The enable controls for the other debug exceptions are as follows:

Monitor debug exceptions enable control, [MDSCR_EL1.MDE](#)

Enables all of the following:

- Breakpoint exceptions.
- Watchpoint exceptions.
- Vector Catch exceptions.

Breakpoint exceptions and Watchpoint exceptions can be taken from both Execution states. Vector Catch exceptions can only be taken from AArch32 state.

Software step exceptions enable control, [MDSCR_EL1.SS](#)

Enables Software Step exceptions.

Software step is an ARMv8-A resource that a debugger can use to make the PE single-step instructions. A Software Step exception is generated after the PE has single-stepped an instruction.

Software step can only be used by a debugger executing in an Exception level that is using AArch64. However, the instruction stepped might be executed in either Execution state, and therefore Software Step exceptions can be taken from either Execution state.

D3.3 Routing debug exceptions

The following description is true for both AArch64 state and AArch32 state.

The Exception level that debug exceptions target is called the *debug target Exception level*, EL_D . EL_D is usually $EL1$. However:

- If $EL3$ is implemented and is using AArch32, all debug exceptions taken from Secure state are taken to $EL3$.

———— **Note** ————

This is because in this case there is no Secure $EL1$. Secure Abort mode exists only in $EL3$.

- If $EL3$ is implemented and is using AArch64, Software Breakpoint Instruction exceptions taken from $EL3$ are taken to $EL3$.
The ARMv8-A architecture does not support taking any other debug exceptions to $EL3$ using AArch64. Only Software Breakpoint Instruction exceptions taken from $EL3$ using AArch64 can be taken to $EL3$ using AArch64.
- If $EL2$ is implemented:
 - Debug exceptions taken from $EL2$ are taken to $EL2$.
 - A hypervisor can choose to route all debug exceptions taken from Non-secure $EL1$ and $EL0$ to $EL2$, by using [MDCR_EL2.TDE](#) or [HDCR.TDE](#). [Figure D3-1](#) shows this. In the figure, TGE is [HCR_EL2.TGE](#) or [HCR.TGE](#).

		TGE	
		0	1
TDE	0	Do not route general exceptions to $EL2$ Route debug exceptions taken from Non-secure $EL1$ and $EL0$ to Non-secure $EL1$	Route general exceptions to $EL2$ Route debug exceptions taken from Non-secure $EL1$ and $EL0$ to $EL2$
	1	Do not route general exceptions to $EL2$ Route debug exceptions taken from Non-secure $EL1$ and $EL0$ to $EL2$	

Figure D3-1 The effect of the TGE and TDE control bits on debug exception routing

———— **Note** ————

- If TGE is 1, TDE is treated as being 1 except for the purpose of a direct read.
- If $EL2$ is not implemented, all of the following apply:
 - The PE behaves as if both TDE and TGE are 0.
 - The [HCR_EL2](#) or [HCR](#), that contains the TGE bit, is RES0.
 - The [MDCR_EL2](#) or [HDCR](#), that contains the TDE bit, is RES0.

Debug exceptions that are taken to an Exception level using AArch32 are taken to either Abort mode or Hyp mode.

The following tables show the routing of debug exceptions when the highest implemented Exception level is using AArch64:

Table D3-1 Routing when both EL3 and EL2 are implemented

MDCR_EL2.TDE or HDCR.TDE^a	EL_D when executing in:					
	Non-secure			Secure		
	EL0	EL1	EL2	EL0	EL1	EL3
0	EL1	EL1	EL2	EL1	EL1	EL3 ^b
1	EL2	EL2	EL2	EL1	EL1	EL3 ^b

- a. If **HCR_EL2.TGE** or **HCR.TGE** is 1, this bit is treated as being 1 other than for the purpose of a direct read. See [Figure D3-1 on page D3-1652](#).
- b. Only Software Breakpoint Instruction exceptions can be taken to EL3 if EL3 is using AArch64, and only if they are taken from EL3.

Table D3-2 Routing when EL3 is implemented and EL2 is not implemented

EL_D when executing in:					
Non-secure			Secure		
EL0	EL1		EL0	EL1	EL3
EL1	EL1		EL1	EL1	EL3 ^a

- a. Only Software Breakpoint Instruction exceptions can be taken to EL3 if EL3 is using AArch64, and only if they are taken from EL3.

Table D3-3 Routing when EL3 is not implemented and EL2 is implemented

MDCR_EL2.TDE^a	EL_D when executing in:		
	Non-secure		
	EL0	EL1	EL2
0	EL1	EL1	EL2
1	EL2	EL2	EL2

- a. If **HCR_EL2.TGE** is 1, this bit is treated as being 1 other than for the purpose of a direct read. See [Figure D3-1 on page D3-1652](#).

The following tables show the routing of debug exceptions when the highest implemented Exception level is using AArch32:

Table D3-4 Routing when both EL3 and EL2 are implemented

HDCR.TDE ^a	EL _D when executing in:				
	Non-secure			Secure	
	EL0	EL1	EL2	EL0	EL3
0	EL1	EL1	EL2	EL3	EL3
1	EL2	EL2	EL2	EL3	EL3

a. If HCR.TGE is 1, this bit is treated as being 1 other than for the purpose of a direct read. See [Figure D3-1 on page D3-1652](#).

Table D3-5 Routing when EL3 is implemented and EL2 is not implemented

EL _D when executing in:				
Non-secure			Secure	
EL0	EL1		EL0	EL3
EL1	EL1		EL3	EL3

Table D3-6 Routing when EL3 is not implemented and EL2 is implemented

HDCR.TDE ^a	EL _D when executing in:		
	Non-secure		
	EL0	EL1	EL2
0	EL1	EL1	EL2
1	EL2	EL2	EL2

a. If HCR.TGE is 1, this bit is treated as being 1 other than for the purpose of a direct read. See [Figure D3-1 on page D3-1652](#).

D3.3.1 Pseudocode description of routing debug exceptions

DebugTarget() returns the current debug target Exception level.

```
// DebugTarget()
// =====
```

```
bits(2) DebugTarget()
    secure = IsSecure();
    return DebugTargetFrom(secure);
```

DebugTargetFrom() returns the debug target Exception level for the specified Security state.

```
// DebugTargetFrom()
// =====
```

```
bits(2) DebugTargetFrom(boolean secure)
    // Returns the debug exception target EL
    route_to_e12 = HaveEL(EL2) && !secure && (MDCR_EL2.TDE == '1' || HCR_EL2.TGE == '1');
```

```
if route_to_e12 then
    target = EL2;
elsif HaveEL(EL3) && HighestELUsingAArch32() && secure then
    target = EL3;
else
    target = EL1;
return target;
```

D3.4 Enabling debug exceptions from current Exception level and Security state

This section is organized as follows:

- [Enabling debug exceptions from the current Exception level.](#)
- [Enabling debug exceptions from the current Security state on page D3-1657.](#)
- [Pseudocode descriptions of enabling debug exceptions on page D3-1659.](#)

D3.4.1 Enabling debug exceptions from the current Exception level

Whether debug exceptions are enabled from the current Exception level depends on the position of the current Exception level relative to EL_D :

- Debug exceptions are enabled from all Exception levels that are lower than EL_D . Therefore, if the current Exception level is lower than EL_D , debug exceptions are enabled from the current Exception level.
- Debug exceptions are disabled from all Exception levels that are higher than EL_D . Therefore, if the current Exception level is higher than EL_D , debug exceptions are disabled from the current Exception level.
- If the current Exception level is EL_D , behavior depends on whether EL_D is using AArch64 or AArch32:
 - If EL_D is using AArch64, software must explicitly enable all debug exceptions other than Software Breakpoint Instruction debug exceptions. See [If the current Exception level is \$EL_D\$ using AArch64.](#)
 - If EL_D is using AArch32, all debug exceptions are enabled. See [If the current Exception level is \$EL_D\$ is using AArch32 on page D3-1657.](#)

If the current Exception level is EL_D using AArch64

Software Breakpoint Instruction exceptions are enabled from EL_D .

All other debug exceptions are disabled from EL_D by default.

To explicitly enable all debug exceptions other than Software Breakpoint exceptions, a debugger must set both:

- The Kernel Debug Enable bit, `MDSR_EL1.KDE`, to 1.
- The Debug exception mask bit, `PSTATE.D`, to 0.

————— Note —————

- `PSTATE.D` is set to 1 on exception entry.
- If EL3 is implemented and is using AArch64, there is an additional control, `MDCR_EL3.SDD`, that must be 0 to enable debug exceptions from Secure state. See [Enabling debug exceptions from the current Security state on page D3-1657.](#)

If the current Exception level is EL_D is using AArch32

All debug exceptions are enabled from EL_D by default.

Both [MDCR_EL1.KDE](#) and [PSTATE.D](#) are ignored. The PE behaves as if:

- [MDCR_EL1.KDE](#) is 0, if EL_D is EL2.
- [MDCR_EL1.KDE](#) is 1, otherwise.
- [PSTATE.D](#) is 0.

———— **Note** —————

If EL3 is implemented, there are two additional controls, [MDCR_EL3.SPD32](#) or [SDCR.SPD](#), and [SDER32_EL3.SUIDEN](#) or [SDER.SUIDEN](#), that affect whether debug exceptions are enabled from Secure EL1 and EL0. See [Figure D3-2 on page D3-1658](#) and accompanying text.

D3.4.2 Enabling debug exceptions from the current Security state

Whether debug exceptions are enabled from the current Security state depends on whether EL_D is using AArch64 or AArch32. [Table D3-7](#) shows this. In the table, Y means that debug exceptions are enabled.

Table D3-7 Whether debug exceptions are enabled from the current Security state

EL _D is using:		Software Breakpoint instruction exceptions	All other debug exceptions
AArch64	Non-secure	Y	Y
	Secure	Y	Enabled if MDCR_EL3.SDD is 0. See <i>The secure debug disable bit</i> .
AArch32	Non-secure	Y	Enabled from EL1 and EL0 only.
	Secure	Y	Whether all other debug exceptions are enabled depends on MDCR_EL3.SPD32 or SDCR.SPD , and SDER32_EL3.SUIDEN or SDER.SUIDEN . See <i>The Secure Privileged Debug and Secure User Invasive Debug Enable fields</i> on page D3-1658.

The ARMv8-A architecture does not support disabling debug in Non-secure state.

The secure debug disable bit

The Secure Debug Disable bit is [MDCR_EL3.SDD](#).

If EL3 is implemented and EL_D is using AArch64, a Secure monitor can use [MDCR_EL3.SDD](#) to disable all debug exceptions taken from Secure state, other than Software Breakpoint Instruction exceptions:

- 0** All debug exceptions enabled from Secure state.
- 1** Debug exceptions other than Software Breakpoint Instruction exceptions disabled from Secure state.

The debug exceptions that [MDCR_EL3.SDD](#) applies to are those taken from:

- Secure EL0 using AArch32 to Secure EL1 using AArch64.
- Secure EL0 using AArch64 to Secure EL1 using AArch64.
- Secure EL1 using AArch64 to Secure EL1 using AArch64.

If EL3 and EL2 are not implemented, and the implementation is a Secure state only implementation, the PE behaves as if [MDCR_EL3.SDD](#) is 0.

Note

- If the Reset exception handler sets `MDCR_EL3.SDD` to 1, software operating at EL3 never has to switch the debug registers between Secure state and Non-secure state.
- `SDER32_EL3.SUIDEN` or `SDER.SUIDEN`, and `MDCR_EL3.SPD32` or `SDCR.SPD`, are ignored if `ELD` is using AArch64.

The Secure Privileged Debug and Secure User Invasive Debug Enable fields

If EL3 is implemented and `ELD` is using AArch32, whether debug exceptions other than Software Breakpoint Instruction exceptions are enabled from Secure state depends on both of the following controls:

The Secure Privileged Debug field, `MDCR_EL3.SPD32` or `SDCR.SPD`

This enables debug exceptions from either:

- Secure EL1 using AArch32, if EL3 is using AArch64. In this case, `ELD` is EL1.
- Secure EL3 using AArch32. In this case, `ELD` is EL3.

The Secure User Invasive Debug Enable bit, `SDER32_EL3.SUIDEN` or `SDER.SUIDEN`

This enables debug exceptions from Secure EL0 if `ELD` is either EL1 using AArch32 or EL3 using AArch32.

Figure D3-2 shows the permitted values of these controls. In the figure:

- **SPIDEN** is the Secure Privileged Invasive Debug Enable signal, that is an external input signal to the recommended external debug interface.
- Y means that debug exceptions are enabled, and N means that debug exceptions are disabled. For example, when `SPD32` or `SPD` is `0b10` and `SUIDEN` is 1, debug exceptions are disabled from Secure EL1 and EL3, and enabled from Secure EL0.

		SPD32 or SPD		
		0b00	0b10	0b11
SUIDEN	0	If SPIDEN is high: <ul style="list-style-type: none"> • Secure EL1 or EL3: Y • Secure EL0: Y If SPIDEN is low: <ul style="list-style-type: none"> • Secure EL1 or EL3: N • Secure EL0: N 	Secure EL1 and EL3: N Secure EL0: N	Secure EL1 and EL3: Y Secure EL0: Y
	1	If SPIDEN is high: <ul style="list-style-type: none"> • Secure EL1 or EL3: Y Regardless of SPIDEN : <ul style="list-style-type: none"> • Secure EL0: Y 	Secure EL1 and EL3: N Secure EL0: Y	Secure EL1 and EL3: Y Secure EL0: Y

Figure D3-2 Using SPD and SUIDEN to enable debug exceptions taken from Secure state when `ELD` is using AArch32

Figure D3-2 shows that if debug exceptions are enabled from Secure EL1, debug exceptions are also enabled from Secure EL0. If debug exceptions are disabled from Secure EL1, whether debug exceptions are enabled from EL0 depends on `SUIDEN`.

`SPD32` or `SPD` == `0b01` is reserved, but must have the same behavior as `SPD32` or `SPD` == `0b00`.

———— **Note** ————

Software must not use SPD32 or SPD == 0b01, because in future revisions of the architecture 0b01 might not have the same behavior as 0b00.

The possible debug exceptions that these controls apply to are as follows:

If EL3 is using AArch32

- Those taken from Secure EL0 to EL3.
- Those taken from Secure EL1 to EL3.
- Those taken from EL3 to EL3.

In this case, EL_D is EL3.

If EL3 is using AArch64

- Those taken from Secure EL0 using AArch32 to Secure EL1 using AArch32.
- Those taken and handled in Secure EL1 using AArch32.

In this case, EL_D is EL1.

If EL3 and EL2 are not implemented, and the implementation is a Secure state only implementation:

- The **SDER** is implemented.
- The **SDCR** is not implemented. The PE behaves as if SPD32 or SPD is 0b11.

———— **Note** ————

- If the Reset exception handler configures SUIDEN, and SPD32 or SPD, so that all debug exceptions are disabled from Secure state, software operating at EL3 never has to switch any of the debug registers between Secure state and Non-secure state.
- **MDCR_EL3.SDD** is ignored if EL_D is using AArch32.

D3.4.3 Pseudocode descriptions of enabling debug exceptions

See:

- [From AArch64 state.](#)
- [From AArch32 state on page D3-1660.](#)

From AArch64 state

AArch64.GenerateDebugExceptions() determines whether debug exceptions are enabled from the current Exception level and Security state.

```
// AArch64.GenerateDebugExceptions()  
// =====
```

```
boolean AArch64.GenerateDebugExceptions()  
    return AArch64.GenerateDebugExceptionsFrom(PSTATE.EL, IsSecure(), PSTATE.D);
```

AArch64.GenerateDebugExceptionsFrom() determines whether debug exceptions are enabled from the specified Exception level and Security state.

```
// AArch64.GenerateDebugExceptionsFrom()  
// =====
```

```
boolean AArch64.GenerateDebugExceptionsFrom(bits(2) from, boolean secure, bit mask)  
  
    if OSLSR_EL1.OSLK == '1' || DoubleLockStatus() || Halted() then  
        return FALSE;  
  
    route_to_e12 = HaveEL(EL2) && !secure && (HCR_EL2.TGE == '1' || MDCR_EL2.TDE == '1');
```

```

if HaveEL(EL3) && secure then
    enabled = MDCR_EL3.SDD == '0' && from != EL3;
else
    enabled = TRUE;

if (route_to_e12 && from == EL2) || (!route_to_e12 && from == EL1) then
    enabled = enabled && (MDSCR_EL1.KDE == '1' && mask == '0');

return enabled;

```

From AArch32 state

AArch32.GenerateDebugExceptions() determines whether debug exceptions are enabled from the current Exception level and Security state.

```

// AArch32.GenerateDebugExceptions()
// =====

```

```

boolean AArch32.GenerateDebugExceptions()
    return AArch32.GenerateDebugExceptionsFrom(PSTATE.EL, IsSecure());

```

AArch32.GenerateDebugExceptionsFrom() determines whether debug exceptions are enabled from the specified Exception level and Security state.

```

// AArch32.GenerateDebugExceptionsFrom()
// =====

```

```

boolean AArch32.GenerateDebugExceptionsFrom(bits(2) from, boolean secure)

    if OLSR_EL1.OSLK == '1' || DoubleLockStatus() || Halted() then
        return FALSE;

    if from == EL0 && !ELStateUsingAArch32(EL1, secure) then
        mask = bit UNKNOWN; // PSTATE.D mask, unused for EL0 case
        return AArch64.GenerateDebugExceptionsFrom(from, secure, mask);

    route_to_hyp = HaveEL(EL2) && !secure && (HCR.TGE == '1' || HDCR.TDE == '1');

    if HaveEL(EL3) && secure then
        spd = (if ELUsingAArch32(EL3) then SDCR.SPD else MDCR_EL3.SPD32);
        if spd<1> == '1' then
            enabled = spd<0> == '1';
        else
            // SPD == 0b01 is reserved, but behaves the same as 0b00.
            enabled = AArch32SelfHostedSecurePrivilegedInvasiveDebugEnabled();
        if from == EL0 then enabled = enabled || SDER.SUIDEN == '1';
    else
        enabled = from != EL2;

    return enabled;

```

D3.5 The effect of powerdown on debug exceptions

The following description is true for both AArch64 state and AArch32 state.

[Debug OS Save and Restore sequences on page H6-4430](#) describes the powerdown save routine and the restore routine.

When executing either of these routines, software must use the OS Lock and OS Double Lock to disable all of the following:

- Breakpoint exceptions.
- Watchpoint exceptions.
- Vector Catch exceptions.
- Software Step exceptions.

Software Breakpoint Instruction exceptions are enabled regardless of the state of the OS Lock and the OS Double Lock.

Debug exceptions other than Software Breakpoint Instruction exceptions must be disabled because the generation of them depends on the state of the debug registers, and the state of the debug registers might be lost over the powerdown save routine or the restore routine.

Debug exceptions other than Software Breakpoint Instruction exceptions are enabled only if both the OS Lock and OS Double Lock are unlocked.

The masking of debug exceptions when the OS Lock is locked depends on the OS Lock status bit, [OSLSR_EL1.OSLK](#) or [DBGOSLSR.OSLK](#).

The masking of debug exceptions when the OS Double Lock is locked depends on the OS Double Lock status bit, [EDPRSR.DLK](#). The [EDPRSR](#) is an external register.

D3.6 Summary of permitted routing and enabling of debug exceptions

Software Breakpoint Instruction debug exceptions are always enabled, regardless of all of the following:

- The current Exception level.
- The current Security state.
- Whether EL_D is using AArch64 or AArch32.

Table D3-8 and Table D3-9 show the routing of Software Breakpoint Instruction exceptions. In the tables, n/a means not applicable.

Table D3-8 Routing of Software Breakpoint Instruction exceptions taken to AArch64 state

Current Security state	EL _D is ^a	EL _D when enabled from:			
		EL0	EL1	EL2	EL3
Secure	X	Secure EL1	Secure EL1	n/a	EL3
Non-secure	EL1	Non-secure EL1	Non-secure EL1	EL2	n/a
	EL2	EL2	EL2	EL2	n/a

a. The tables in [Routing debug exceptions on page D3-1652](#) show how EL_D is defined.

Table D3-9 Routing of Software Breakpoint Instruction exceptions taken to AArch32 state

Current Security state	EL _D is ^a	EL _D when enabled from:			
		EL0	EL1	EL2	EL3
Secure	X	Secure Abort mode ^b	Secure Abort mode	n/a	Secure Abort mode
Non-secure	EL1	Non-secure Abort mode	Non-secure Abort mode	Hyp mode	n/a
	EL2	Hyp mode	Hyp mode	Hyp mode	n/a

a. The tables in [Routing debug exceptions on page D3-1652](#) show how EL_D is defined.

b. If EL3 is implemented and is using AArch32, Secure Abort mode is at EL3. Otherwise, Secure Abort mode is at EL1.

For all other debug exceptions, behavior depends on whether EL_D is using AArch64 or AArch32:

- [If ELD is using AArch64](#).
- [If ELD is using AArch32 on page D3-1663](#).

D3.6.1 If EL_D is using AArch64

For all debug exceptions except Software Breakpoint Instruction exceptions, [Table D3-10 on page D3-1663](#) shows the valid combinations of MDCR_EL3.SDD, MDSCR_EL1.KDE and PSTATE.D, and for each combination shows where debug exceptions are enabled from and where they are taken to.

In the table, n/a means not applicable and a dash, -, means that debug exceptions are disabled from that Exception level.

Table D3-10 Breakpoint, Watchpoint, Software Step, and Vector Catch exceptions, taken to AArch64state

Debug state	Lock ^a	Current Security state	EL _D is ^b	SDD	KDE	D	EL _D when enabled from:			
							EL0	EL1	EL2	EL3
Yes	X	X	X	X	X	X	-	-	-	-
No	1	X	X	X	X	X	-	-	-	-
No	0	Secure	EL1	1	X	X	-	-	n/a	-
No	0	Secure	EL1	0	0	X	Secure EL1	-	n/a	-
No	0	Secure	EL1	0	1	1	Secure EL1	-	n/a	-
No	0	Secure	EL1	0	1	0	Secure EL1	Secure EL1	n/a	-
No	0	Non-secure	EL1	X	0	X	Non-secure EL1	-	-	n/a
No	0	Non-secure	EL1	X	1	1	Non-secure EL1	-	-	n/a
No	0	Non-secure	EL1	X	1	0	Non-secure EL1	Non-secure EL1	-	n/a
No	0	Non-secure	EL2	X	0	X	EL2	EL2	-	n/a
No	0	Non-secure	EL2	X	1	1	EL2	EL2	-	n/a
No	0	Non-secure	EL2	X	1	0	EL2	EL2	EL2	n/a

a. The value of (OSLSR_EL1.OSLK OR EDPRSR.DLK).

b. The tables in [Routing debug exceptions on page D3-1652](#) show how EL_D is defined.

D3.6.2 If EL_D is using AArch32

For all debug exceptions except Software Breakpoint Instruction exceptions, the enabling of debug exceptions, and the permitted routing, is controlled by all of the following:

- [MDCR_EL3.SPD32](#) or [SDCR.SPD](#).
- **SPIDEN**.
- [SDER32_EL3.SUIDEN](#) or [SDER.SUIDEN](#).

[Table D3-11 on page D3-1664](#) shows the valid combinations of the values of SPD32 or SPD, **SPIDEN**, and SUIDEN, and for each combination shows where debug exceptions are enabled from and where they are taken to.

In the table, n/a means not applicable and a dash, -, means that debug exceptions are disabled from that Exception level.

Table D3-11 Breakpoint, Watchpoint, Software Step, and Vector Catch exceptions, taken to AArch32 state

Debug state	Lock ^a	Security state	EL _D ^b	SPD32 or SPD ^c	SPIDEN	SUIDEN	EL _D when enabled from:			
							EL0	EL1	EL2	EL3
Yes	X	X	X	0bXX	X	X	-	-	-	-
No	1	X	X	0bXX	X	X	-	-	-	-
No	0	Secure	X	0b0X	LOW	0	-	-	n/a	-
No	0	Secure	X	0b0X	LOW	1	Secure Abort mode ^d	-	n/a	-
No	0	Secure	X	0b0X	HIGH	X	Secure Abort mode ^d	Secure Abort mode	n/a	Secure Abort mode
No	0	Secure	X	0b10	X	0	-	-	n/a	-
No	0	Secure	X	0b10	X	1	Secure Abort mode ^d	-	n/a	-
No	0	Secure	X	0b11	X	X	Secure Abort mode ^d	Secure Abort mode	n/a	Secure Abort mode
No	0	Non-secure	EL1	0bXX	X	X	Non-secure Abort mode	Non-secure Abort mode	-	n/a
No	0	Non-secure	EL2	0bXX	X	X	Hyp mode	Hyp mode	-	n/a

- a. The value of (OSLSR_EL1.OSLK OR EDPRSR.DLK).
- b. The tables in [Routing debug exceptions on page D3-1652](#) show how EL_D is defined.
- c. If EL3 is not implemented, behavior is as if the Secure Privileged Disable field is 0b11.
- d. If EL3 is implemented and is using AArch32, Secure Abort mode is at EL3. Otherwise, Secure Abort mode is at EL1

D3.7 Debug exception behavior

Breakpoint exceptions, Watchpoint exceptions, and Software Step exceptions are never taken from EL3. Vector Catch exceptions can be taken from EL3 only if EL3 is using AArch32. Software Breakpoint Instruction exceptions can be taken from any Exception level, and from either Security state.

This section contains the following subsections:

- [The effect of taking debug exceptions to AArch64 on system registers.](#)
- [Preferred return addresses on page D3-1667.](#)

D3.7.1 The effect of taking debug exceptions to AArch64 on system registers

On taking a debug exception to an Exception level that is using AArch64, the PE records information about the exception in the *Exception Syndrome Register* (ESR) at that Exception level. For example, if a debug exception is taken to EL1 using AArch64, the PE records information about the exception in [ESR_EL1](#).

The information recorded:

- Includes the type of debug exception. The PE records this in the *Exception Class* field, [ESR_ELx.EC](#). See [Table D3-12](#).
- Might include other syndrome information, for example:
 - An indication of the length of instruction that caused the debug exception, recorded in the *Instruction Length* field, [ESR_ELx.IL](#).
 - Other information specific to the type of debug exception, recorded in the *Instruction Specific Syndrome* field, [ESR_ELx.ISS](#).

See [Table D3-13 on page D3-1666](#).

For Watchpoint exceptions, the PE also records an address in a *Fault Address Register* (FAR), that the debugger can use to determine the memory location that caused the Watchpoint exception. The FAR register used is either:

- [FAR_EL1](#), if the exception is taken to EL1.
- [FAR_EL2](#), if the exception is taken to EL2.

FARs are only updated for Watchpoint exceptions. They are UNKNOWN for all other debug exceptions.

———— **Note** —————

For information on how a debugger can use the address recorded in the FAR, see [Determining the memory location that caused a Watchpoint debug event on page D2-1617](#).

[Table D3-12](#) shows, for each type of debug exception:

- The [ESR_ELx.EC](#) encoding.
- Which ESRs the [ESR_ELx.EC](#) encoding can be encoded in.
- Whether a FAR is updated.

Table D3-12 ESR_ELx.EC encodings for debug exceptions

ESR_ELx.EC encoding	Description Debug exception	Taken from ^a	Can be Encoded in:			Update FAR
			ESR_EL3	ESR_EL2	ESR_EL1	
0x30	Breakpoint	A lower EL	-	Y	Y	-
0x31	Breakpoint	The same EL	-	Y	Y	-
0x32	Software Step	A lower EL	-	Y	Y	-

Table D3-12 **ESR_ELx.EC** encodings for debug exceptions (continued)

ESR_ELx.EC encoding	Description Debug exception	Taken from ^a	Can be Encoded in:			Update FAR
			ESR_EL3	ESR_EL2	ESR_EL1	
0x33	Software Step	The same EL	-	Y	Y	-
0x34	Watchpoint	A lower EL	-	Y	Y	Y
0x35	Watchpoint	The same EL	-	Y	Y	Y
0x38	Software Breakpoint Instruction, caused by a BKPT instruction executed in AArch32 state	Any EL	-	Y	Y	-
0x3A	Vector catch exception ^b	Any EL	-	Y	- ^c	-
0x3C	Software Breakpoint Instruction, caused by a BRK instruction executed in AArch64 state	Any EL	Y ^d	Y	Y	-

- a. EL means Exception level.
- b. Vector Catch exception can only be taken from AArch32 state.
- c. Cannot occur because Vector Catch exceptions are never generated under EL1 using AArch64. However, Vector Catch exceptions can be routed to EL2 using AArch64.
- d. The only debug exceptions that can be taken to EL3 using AArch64 are those caused by Software Breakpoint Instruction exceptions, that are taken from EL3.

Table D3-13 shows, for each debug exception, the **ESR_ELx.{IL, ISS}** encodings that the PE uses to record information about a debug exception.

Table D3-13 **ESR_ELx.{IL, ISS}** encodings for debug exceptions

Debug exception	ESR_ELx.IL encoding	ESR_ELx.ISS encodings	
Software Breakpoint Instruction	0, if the instruction is a T32 BKPT instruction. 1, if the instruction is an A64 BRK or an A32 BKPT instruction.	ISS[15:0]	The Comment field. The PE copies the instruction Comment field value into here, zero extended as necessary.
Breakpoint	1	ISS[5:0]	IFSC, The <i>Instruction Fault Status Code</i> (IFSC) field. The PE sets this to 0b100010, to indicate a debug exception.

Table D3-13 ESR_ELx.{IL, ISS} encodings for debug exceptions (continued)

Debug exception	ESR_ELx.IL encoding	ESR_ELx.ISS encodings	
Watchpoint	1	ISS[24]	The <i>Instruction Syndrome Valid</i> (ISV) bit. The PE does not set this. It is 0, because Watchpoint exceptions are not stage two aborts.
		ISS[8]	The <i>Cache Maintenance</i> (CM) bit. The PE configures this to indicate whether the exception was caused by a cache maintenance instruction other than a DC ZVA instruction.
		ISS[6]	The <i>write-not-read</i> (WnR) bit. The PE configures this to indicate whether the access was a read or a write.
		ISS[5:0]	The <i>Data Fault Status Code</i> (DFSC) field. The PE sets this to 0b100010, to indicate a debug exception.
Vector Catch	The same as for Breakpoint exceptions.	The same as for Breakpoint exceptions.	
Software Step	1	ISS[24]	The <i>Instruction Syndrome Valid</i> (ISV) bit. The PE configures this to indicate whether ISS[6], the EX bit, is valid.
		ISS[6]	The <i>Exclusive Access</i> (EX) bit. The PE configures this to indicate whether it was a load-exclusive class of instruction that was stepped.
		ISS[5:0]	The <i>Instruction Fault Status Code</i> (IFSC) field. The PE sets this to 0b100010, to indicate a debug exception.

D3.7.2 Preferred return addresses

The following description is true for both AArch64 state and AArch32 state.

The preferred return address of all debug exceptions is the address of the instruction that was not executed because the PE took the debug exception instead.

This means that for:

Software Breakpoint Instruction exceptions

The preferred return address is the address of the breakpoint instruction itself, not the next instruction. This is different to the behavior of other exception-generating instructions, like SVC.

Breakpoint exceptions

The preferred return address is the address of the instruction that caused the Breakpoint exception.

Watchpoint exceptions

The preferred return address is the address of the instruction that caused Watchpoint exception.

Vector Catch exceptions

The preferred return address is the exception vector. This is true regardless of whether the address-matching form or the exception trapping form is implemented.

Software Step exceptions

When it is using software step, the PE progresses through states that are defined by the software step state machine shown in [Figure D2-7 on page D2-1635](#). The PE takes Software Step exceptions from the active-pending state.

Usually, this means that the PE takes the Software Step exception instead of executing the instruction that occurs in the program flow after the instruction to be single-stepped. This means that the preferred return address is the address of the instruction after the instruction to be stepped.

However, because the software step state machine permits non-debug exceptions caused by the instruction to be stepped to be taken, the instruction that occurs in the program flow after the instruction to be stepped is not necessarily the instruction intended in the original program flow. Instead, it might be the address that a non-debug exception handler returns to.

In addition:

- It is possible for the PE to take a Software Step exception from the active-pending state even though the instruction to be stepped has not been stepped.
- The PE might take a Software Step exception from the active-pending state following a transition from the inactive state that occurred because software set `PSTATE.D` to 0 while an exception was being handled.

Table D3-14 describes some example scenarios.

Table D3-14 Preferred return addresses for Software Step exceptions

Example scenario	Progression through the software step state machine states, from the active-not-pending state	The preferred return address is:
The PE executes the instruction to be stepped and no exception occurs.	<ol style="list-style-type: none"> 1. Active-not-pending state. This is where the PE executes the instruction to be stepped. 2. Active-pending state. This is where the PE takes the Software Step exception. 	The address of the instruction after the instruction to be stepped, as intended in the original program flow.
The PE executes the instruction to be stepped, and the instruction to be stepped causes an SVC exception that is handled in an Exception level that debug exceptions are disabled from.	<ol style="list-style-type: none"> 1. Active-not-pending state. This is where the PE executes the instruction to be stepped. 2. Inactive state. The PE enters this state on taking the SVC exception. 3. Active-pending state. The PE enters this state on returning from the SVC exception. This is where the PE takes the Software Step exception. 	The address that the SVC exception handler returns to.
<p>An asynchronous exception occurs before the PE can execute the instruction to be stepped. The asynchronous exception is handled in an Exception level that debug exceptions are enabled from.</p> <p>The PE takes a Software step exception on the first instruction executed by the asynchronous exception handler.</p> <p>In this scenario, the instruction to be stepped has not been stepped.</p>	<ol style="list-style-type: none"> 1. Active-not-pending state. This is where the PE takes the asynchronous exception. 2. Active-pending state. The PE enters this state on taking the asynchronous exception. This is where the PE takes the Software step exception. 	The address of the first instruction executed by the handler handling the asynchronous exception.
<p>The PE executes the instruction to be stepped, and the instruction to be stepped causes a synchronous exception^a that is handled in <code>EL_D</code> using AArch64 when <code>MDCR_EL1.KDE</code> is 1. While the exception is being handled, software sets <code>PSTATE.D</code> to 0.</p>	<ol style="list-style-type: none"> 1. Active-not-pending state. This is where the PE executes the instruction to be stepped. 2. Inactive state. The PE enters this state on taking the type 1 exception. 3. Active-pending state. The PE enters this state on executing the instruction that sets <code>PSTATE.D</code> to 0. 	The address of the instruction after the instruction that set <code>PSTATE.D</code> to 0.

a. Whose preferred return address is the address of the instruction to be stepped.

D3.8 Pseudocode descriptions of debug exceptions

DebugFault() returns a FaultRecord() that indicates that a memory access has generated a debug exception:

```
// AArch64.DebugFault()
// =====

FaultRecord AArch64.DebugFault(AccType acctype, boolean iswrite)

    ipaddress = bits(48) UNKNOWN;
    level = integer UNKNOWN;
    extflag = bit UNKNOWN;
    secondstage = FALSE;
    s2fs1walk = FALSE;

    return AArch64.CreateFaultRecord(Fault_Debug, ipaddress, level, acctype, iswrite,
                                     extflag, secondstage, s2fs1walk);

// AArch32.DebugFault()
// =====

FaultRecord AArch32.DebugFault(AccType acctype, boolean iswrite, bits(4) debugmoe)

    ipaddress = bits(40) UNKNOWN;
    domain = bits(4) UNKNOWN;
    level = integer UNKNOWN;
    extflag = bit UNKNOWN;
    secondstage = FALSE;
    s2fs1walk = FALSE;

    return AArch32.CreateFaultRecord(Fault_Debug, ipaddress, domain, level, acctype, iswrite,
                                     extflag, debugmoe, secondstage, s2fs1walk);
```

The Abort() function processes FaultRecord(), as described in:

- [Abort exceptions on page D4-1703](#) for AArch64 state.
- [Abort exceptions on page G2-3555](#) for AArch32 state.

For debug exceptions taken to AArch32 state, the Abort() function generates:

- Data Abort exceptions for watchpoints.
- Prefetch Abort exceptions for all other debug exceptions.

For debug exceptions taken to AArch64 state, Abort() calls one of the following:

```
// AArch64.BreakpointException()
// =====

AArch64.BreakpointException(FaultRecord fault)
    assert PSTATE.EL != EL3;

    route_to_el2 = (AArch64.GeneralExceptionsToEL2() ||
                  (HaveEL(EL2) && !IsSecure() && MDCR_EL2.TDE == '1'));

    vaddress = bits(64) UNKNOWN;
    exception = AArch64.AbortSyndrome(Exception_Breakpoint, fault, vaddress);
    bits(64) preferred_exception_return = ThisInstrAddr();
    vect_offset = 0x0;

    if PSTATE.EL == EL2 || route_to_el2 then
        AArch64.TakeException(EL2, exception, preferred_exception_return, vect_offset);
    else
        AArch64.TakeException(EL1, exception, preferred_exception_return, vect_offset);

// AArch64.WatchpointException()
// =====

AArch64.WatchpointException(bits(64) vaddress, FaultRecord fault)
```

```
assert PSTATE.EL != EL3;

route_to_e12 = (AArch64.GeneralExceptionsToEL2() ||
               (HaveEL(EL2) && !IsSecure() && MDCR_EL2.TDE == '1'));

exception = AArch64.AbortSyndrome(Exception_Watchpoint, fault, vaddress);

bits(64) preferred_exception_return = ThisInstrAddr();
vect_offset = 0x0;

if PSTATE.EL == EL2 || route_to_e12 then
    AArch64.TakeException(EL2, exception, preferred_exception_return, vect_offset);
else
    AArch64.TakeException(EL1, exception, preferred_exception_return, vect_offset);

// AArch64.VectorCatchException()
// =====
// Vector Catch taken from EL0 or EL1 to EL2. This can only be called when debug exceptions are
// being routed to EL2, as Vector Catch is a legacy debug event.

AArch64.VectorCatchException(FaultRecord fault)
    assert PSTATE.EL != EL2;
    assert AArch64.GeneralExceptionsToEL2() || (HaveEL(EL2) && !IsSecure() && MDCR_EL2.TDE == '1');

    vaddress = bits(64) UNKNOWN;
    exception = AArch64.AbortSyndrome(Exception_VectorCatch, fault, vaddress);
    bits(64) preferred_exception_return = ThisInstrAddr();
    vect_offset = 0x0;

    AArch64.TakeException(EL2, exception, preferred_exception_return, vect_offset);
```

Software Step exceptions can only be taken to AArch64 state. The pseudocode for Software Step exceptions is:

```
// AArch64.SoftwareStepException()
// =====

AArch64.SoftwareStepException()
    assert PSTATE.EL != EL3;

    route_to_e12 = (AArch64.GeneralExceptionsToEL2() ||
                   (HaveEL(EL2) && !IsSecure() && MDCR_EL2.TDE == '1'));

    ExceptionRecord exception;
    exception = ExceptionSyndrome(Exception_SoftwareStep);
    if SoftwareStep_DidNotStep() then
        exception.syndrome<24> = '0';
    else
        exception.syndrome<24> = '1';
        exception.syndrome<6> = if SoftwareStep_SteppedEX() then '1' else '0';
    bits(64) preferred_exception_return = ThisInstrAddr();
    vect_offset = 0x0;

    if PSTATE.EL == EL2 || route_to_e12 then
        AArch64.TakeException(EL2, exception, preferred_exception_return, vect_offset);
    else
        AArch64.TakeException(EL1, exception, preferred_exception_return, vect_offset);
```

Chapter D4

The AArch64 System Level Memory Model

This chapter provides a system level view of the general features of the memory system. It contains the following sections:

- *About the memory system architecture* on page D4-1672.
- *Address space* on page D4-1673.
- *Mixed-endian support* on page D4-1674.
- *Cache support* on page D4-1675.
- *External aborts* on page D4-1694.
- *Memory barrier instructions* on page D4-1696.
- *Pseudocode details of general memory system instructions* on page D4-1697.

D4.1 About the memory system architecture

The ARM architecture supports different implementation choices for the memory system microarchitecture and memory hierarchy, depending on the requirements of the system being implemented. In this respect, the memory system architecture describes a design space in which an implementation is made. The architecture does not prescribe a particular form for the memory systems. Key concepts are abstracted in a way that permits implementation choices to be made while enabling the development of common software routines that do not have to be specific to a particular microarchitectural form of the memory system. For more information about the concept of a hierarchical memory system see [Memory hierarchy on page B2-70](#).

D4.1.1 Form of the memory system architecture

The ARMv8 A-profile architecture includes a *Virtual Memory System Architecture* (VMSA), described in [Chapter D5 The AArch64 Virtual Memory System Architecture](#).

D4.1.2 Memory attributes

[Memory types and attributes on page B2-89](#) describes the memory attributes, including how different memory types have different attributes. Each location in memory has a set of memory attributes, and the translation tables define the virtual memory locations, and the attributes for each location.

[Table D4-1](#) shows the memory attributes that are visible at the system level.

Table D4-1 Memory attribute summary

Memory type	Shareability	Cacheability
Device ^a	Outer Shareable	Non-cacheable.
Normal	One of: <ul style="list-style-type: none">Non-shareable.Inner Shareable.Outer Shareable.	One of: <ul style="list-style-type: none">Non-cacheable^b.Write-Through Cacheable.Write-Back Cacheable.

a. Takes additional attributes, see [Device memory on page B2-92](#).

b. See also [Cacheability, cache allocation hints, and cache transient hints on page D4-1677](#).

For more information on cacheability and shareability see [Shareable Normal memory on page B2-90](#), [Non-shareable Normal memory on page B2-91](#), and [Caches and memory hierarchy on page B2-70](#).

D4.2 Address space

The ARMv8 architecture is designed to support a wide range of applications with different memory requirements. It supports a range of *physical address* (PA) sizes, and provides associated control and identification mechanisms. For more information, see [Address size configuration on page D5-1715](#).

D4.2.1 Address space overflow or underflow

When a PE performs a normal, sequential execution of instructions, it calculates:

$$(\text{address_of_current_instruction}) + (\text{size_of_executed_instruction})$$

This calculation is performed after each instruction to determine which instruction to execute next.

Instruction address space overflow

If the address calculation performed after executing an instruction overflows `0xFFFF_FFFF_FFFF_FFFF`, the program counter becomes UNKNOWN.

———— **Note** —————

Address tags are not propagated to the program counter, so the tag does not affect the address calculation.

Where an instruction accesses a sequential set of bytes that crosses the `0xFFFF_FFFF_FFFF_FFFF` boundary when tagged addresses are not used, or the `0xxxFF_FFFF_FFFF_FFFF` boundary when tagged addresses are used, then the virtual address accessed for the bytes above this boundary is UNKNOWN. When tagged addresses are used, the value of the tag associated with the address also becomes UNKNOWN.

D4.3 Mixed-endian support

A control bit, [SCTLR_EL1.E0E](#) is provided to allow the endianness of explicit data accesses made while executing at EL0 to be controlled independently of those made while executing at EL1. [Table D4-2](#) shows the endianness of explicit data accesses and translation table walks.

Table D4-2 Endianness support

Exception level	Explicit data accesses	Stage 1 translation table walks	Stage 2 translation table walks
EL0	SCTLR_EL1.E0E	SCTLR_EL1.EE	SCTLR_EL2.EE
EL1	SCTLR_EL1.EE	SCTLR_EL1.EE	SCTLR_EL2.EE
EL2	SCTLR_EL2.EE	SCTLR_EL2.EE	N/A
EL3	SCTLR_EL3.EE	SCTLR_EL3.EE	N/A

———— **Note** ————

[SCTLR_EL1.E0E](#) has no effect on the endianness of the [LDTR](#), [LDTRH](#), [LDTRSH](#), and [LDTRSW](#) instructions, or on the endianness of the [STTR](#) and [STTRH](#) instructions, when these are executed at EL1.

ARMv8 provides the following options for endianness support:

- All Exception levels support mixed-endianness:
 - [SCTLR_ELx.EE](#) is R/W and [SCTLR_EL1](#) is R/W.
- Only EL0 supports mixed-endianness and EL1, EL2, and EL3 support only little-endianness:
 - [SCTLR_ELx](#) is RES0 and [SCTLR_EL1.E0E](#) is R/W.
- Only EL0 supports mixed-endianness and EL1, EL2, and EL3 support only big-endianness:
 - [SCTLR_ELx](#) is RES1 and [SCTLR_EL1.E0E](#) is R/W.
- All Exception levels support only little-endianness:
 - [SCTLR_ELx](#) is RES0 and [SCTLR_EL1.E0E](#) is RES0.
- All Exception levels support only big-endianness:
 - [SCTLR_ELx](#) is RES1 and [SCTLR_EL1.E0E](#) is RES1.

If mixed endian support is implemented for an Exception level using AArch32, endianness is controlled by [PSTATE.E](#). For exception returns to AArch32 state, [PSTATE.E](#) is copied from [SPSR_ELx.E](#). If the target Exception level supports only little-endian accesses, [SPSR_ELx.E](#) is RES0. If the target Exception level supports only big-endian accesses, [SPSR_ELx.E](#) is RES1. [PSTATE.E](#) is ignored in AArch64 state.

The `BigEndian()` function determines whether the current Exception level and Execution state is using big-endian data:

```
// BigEndian()
// =====

boolean BigEndian()
    boolean bigend;
    if UsingAArch32() then
        bigend = (PSTATE.E != '0');
    elsif PSTATE.EL == EL0 then
        bigend = (SCTLR_EL1.E0E != '0');
    else
        bigend = (SCTLR[.EE != '0');
    return bigend;
```

D4.4 Cache support

This section describes the ARMv8 cache identification and control mechanisms, and the cache maintenance instructions, in the following sections:

- [General behavior of the caches](#)
- [Cache identification on page D4-1676.](#)
- [Cacheability, cache allocation hints, and cache transient hints on page D4-1677.](#)
- [Behavior of caches at reset on page D4-1677](#)
- [Cache enabling and disabling on page D4-1678.](#)
- [Non-cacheable accesses and instruction caches on page D4-1679.](#)
- [Cache maintenance operations on page D4-1680.](#)
- [Cache maintenance instructions on page D4-1684](#)
- [Data cache zero instruction on page D4-1690.](#)
- [Cache lockdown on page D4-1691.](#)
- [System level caches on page D4-1692.](#)
- [Branch prediction on page D4-1693.](#)

See also [Caches in a VMSA implementation on page D5-1818.](#)

D4.4.1 General behavior of the caches

When a memory location is marked with a Normal Cacheable memory attribute, determining whether a copy of the memory location is held in a cache still depends on many aspects of the implementation. The following non-exhaustive list of factors might be involved:

- The size, line length, and associativity of the cache.
- The cache allocation algorithm.
- Activity by other elements of the system that can access the memory.
- Speculative instruction fetching algorithms.
- Speculative data fetching algorithms.
- Interrupt behaviors.

Given this range of factors, and the large variety of cache systems that might be implemented, the architecture cannot guarantee whether:

- A memory location present in the cache remains in the cache.
- A memory location not present in the cache is brought into the cache.

Instead, the following principles apply to the behavior of caches:

- The architecture has a concept of an entry locked down in the cache. How lockdown is achieved is IMPLEMENTATION DEFINED, and lockdown might not be supported by:
 - A particular implementation.
 - Some memory attributes.
- An unlocked entry in a cache might not remain in that cache. The architecture does not guarantee that an unlocked cache entry remains in the cache or remains incoherent with the rest of memory. Software must not assume that an unlocked item that remains in the cache remains dirty.
- A locked entry in a cache is guaranteed to remain in that cache. The architecture does not guarantee that a locked cache entry remains incoherent with the rest of memory, that is, it might not remain dirty.

———— **Note** —————

For more information, see [The interaction of cache lockdown with cache maintenance instructions on page D4-1691.](#)

- If a memory location both has permissions that mean it can be accessed, either by reads or by writes, for the translation regime at either the current Exception level or at a higher Exception level, and is marked as Cacheable for that translation regime, then there is no mechanism that can guarantee that the memory location cannot be allocated to an enabled cache at any time.
Any application must assume that any memory location with such access permissions and cacheability attributes can be allocated to any enabled cache at any time.
- It is guaranteed that no memory location that does not have a Cacheable attribute is allocated into the cache.
- It is guaranteed that no memory location is allocated to the cache if the access permissions for that location are such that the location cannot be accessed by reads and cannot be accessed by writes in both:
 - The translation regime at the current Exception level.
 - The translation regime at a higher Exception level.
- For data accesses, any memory location that is marked as Normal Shareable is guaranteed to be coherent with all masters in that shareability domain.
- Any memory location is not guaranteed to remain incoherent with the rest of memory.
- The eviction of a cache entry from a cache level can overwrite memory that has been written by another observer only if the entry contains a memory location that has been written to by an observer in the shareability domain of that memory location. The maximum size of the memory that can be overwritten is called the *Cache Write-back Granule*. In some implementations the `CTR_ELO` identifies the Cache Write-back Granule.
- The allocation of a memory location into a cache cannot cause the most recent value of that memory location to become invisible to an observer, if it was previously visible to that observer.

For the purpose of these principles, a cache entry covers at least 16 bytes and no more than 2KB of contiguous address space, aligned to its size.

In the following situations it is UNPREDICTABLE whether the location is returned from cache or from memory:

- The location is not marked as Cacheable but is contained in the cache. This situation can occur if a location is marked as Non-cacheable after it has been allocated into the cache.
- The location is marked as Cacheable and might be contained in the cache, but the cache is disabled.

D4.4.2 Cache identification

The ARMv8 cache identification registers describe the implemented caches that are under the control of the PE:

- The Cache Type Register, `CTR_ELO`, defines:
 - The minimum line length of any of the instruction caches affected by the instruction cache maintenance instructions.
 - The minimum line length of any of the data or unified caches, affected by the data cache maintenance instructions.
 - The cache indexing and tagging policy of the Level 1 instruction cache.
- A single Cache Level ID Register defines:
 - The type of cache implemented at each cache level, up to the maximum of seven levels.
 - The Level of Coherence for the caches. See [Terms used in describing the maintenance instructions on page D4-1680](#) for a definition of these terms.
 - The Level of Unification for the caches. See [Terms used in describing the maintenance instructions on page D4-1680](#) for a definition of these terms.

For more information, see [CLIDR_ELI, Cache Level ID Register on page D8-1885](#).

- A single Cache Size Selection Register selects the cache level and cache type of the current Cache Size Identification Register, see [CSSELR_ELI, Cache Size Selection Register on page D8-1894](#).
- For each implemented cache, across all the levels of caching, a Cache Size Identification Register defines:
 - Whether the cache supports Write-Through, Write-Back, Read-Allocate and Write-Allocate.

- The number of sets, associativity and line length of the cache. See *Terms used in describing the maintenance instructions* on page D4-1680 for a definition of these terms.

For more information, see *CCSIDR_EL1, Current Cache Size ID Register* on page D8-1883.

D4.4.3 Cacheability, cache allocation hints, and cache transient hints

Cacheability only applies to Normal memory, and can be defined independently for Inner and Outer cache locations.

As described in *Memory types and attributes* on page B2-89, the memory attributes include a cacheability attribute that is one of:

- Non-cacheable.
- Write-Through cacheable.
- Write-Back cacheable.

Cacheability attributes other than Non-cacheable can be complemented by a *cache allocation hint*. This is an indication to the memory system of whether allocating a value to a cache is likely to improve performance. A *cache transient hint* provides a hint to the memory system that an access is non-temporal or streaming, and unlikely to be repeated in the near future.

The following cache allocation hints can be used in ARMv8:

- Read-Allocate, Transient Read-Allocate, or No Read-Allocate.
- Write-Allocate, Transient Write-Allocate, or No Write-Allocate.

————— **Note** —————

A Cacheable location with both no Read-Allocate and no Write-Allocate hints is not the same as a Non-cacheable location. A Non-cacheable location has coherency guarantees for all observers within the system that do not apply for a location that is Cacheable, no Read-Allocate, no Write-Allocate.

The architecture does not require an implementation to make any use of cache allocation hints. This means an implementation might not make any distinction between memory locations with attributes that differ only in their cache allocation hint.

D4.4.4 Behavior of caches at reset

In ARMv8:

- All caches are disabled at reset.
- An implementation can require the use of a specific cache initialization routine to invalidate its storage array before it is enabled. The exact form of any required initialization routine is IMPLEMENTATION DEFINED, and the routine must be documented clearly as part of the documentation of the device.
- If an implementation permits cache hits when the cache is disabled the cache initialization routine must:
 - Provide a mechanism to ensure the correct initialization of the caches.
 - Be documented clearly as part of the documentation of the device.

In particular, if an implementation permits cache hits when the cache is disabled and the cache contents are not invalidated at reset, the initialization routine must avoid any possibility of running from an uninitialized cache. It is acceptable for an initialization routine to require a fixed instruction sequence to be placed in a restricted range of memory.

- ARM recommends that whenever an invalidation routine is required, it is based on the ARMv8 cache maintenance instructions.

When it is enabled, the state of a cache is UNPREDICTABLE if the appropriate initialization routine has not been performed.

D4.4.5 Cache enabling and disabling

When a data cache or unified cache is disabled for a translation regime, data accesses and translation table walks from that translation regime to all Normal memory types behave as Non-cacheable for all levels of data caches and unified caches.

For the EL1&0 translation regime:

- When `SCTLR_EL1.C == 0`, this makes all stage 1 translations for data accesses to Normal memory Non-cacheable. It also makes all accesses to the EL1&0 stage 1 translation tables Non-cacheable.
- When `HCR_EL2.CD == 1`, this makes all stage 2 translations for data accesses to Normal memory Non-cacheable. It also makes all accesses to the EL1&0 stage 2 translation tables Non-cacheable.

———— **Note** —————

- In Non-secure state, the stage 1 and stage 2 cacheability attributes are combined as described in [Combining the stage 1 and stage 2 cacheability attributes for Normal memory on page D5-1794](#).
- The `SCTLR_EL1.C` bit has no effect on the EL2 and EL3 translation regimes.
- The `HCR_EL2.CD` bit affects only stage 2 of the Non-secure EL1&0 translation regime.

- When `HCR_EL2.DC == 1`, this makes all stage 1 translations for data accesses and all accesses to the EL1&0 stage 1 translation tables Normal Non-shareable Inner Write-Back Cacheable Read Allocate Write Allocate, Outer Write-Back Cacheable Read Allocate Write Allocate.

For the EL2 translation regime:

- When `SCTLR_EL2.C == 0`, all data accesses to Normal memory using the EL2 translation regime are Non-cacheable. This means all accesses made by the EL2 translation table walks are Non-cacheable.

———— **Note** —————

The `SCTLR_EL2.C` bit has no effect on the EL1&0 and EL3 translation regimes.

For the EL3 translation regime:

- When `SCTLR_EL3.C == 0`, all data accesses to Normal memory using the EL3 translation regime are Non-cacheable. It also makes all accesses made by the EL3 translation table walks are Non-cacheable.

———— **Note** —————

The `SCTLR_EL3.C` bit has no effect on the EL1&0 and EL2 translation regimes.

The effect of `SCTLR_ELx.C`, `HCR_EL2.DC` and `HCR_EL2.CD` is reflected in the result of the address translation operations in the PAR when these bits have an effect on the stages of translation being reported in the PAR.

When an instruction cache is disabled for a translation regime, data accesses and translation table walks from that translation regime to all Normal memory types behave as Non-cacheable for all levels of data caches and unified caches

For the EL1&0 translation regime:

- When `SCTLR_EL1.I == 0`, this makes all stage 1 translations for instruction accesses to Normal memory Non-cacheable. It also makes all accesses to the EL1&0 stage 1 translation tables Non-cacheable.
- When `HCR_EL2.CD == 1`, this makes all stage 2 translations for instruction accesses to Normal memory Non-cacheable. It also makes all accesses to the EL1&0 stage 2 translation tables Non-cacheable.

———— **Note** —————

- In Non-secure state, the stage 1 and stage 2 cacheability attributes are combined as described in [Combining the stage 1 and stage 2 cacheability attributes for Normal memory on page D5-1794](#).
- The `SCTLR_EL1.C` bit has no effect on the EL2 and EL3 translation regimes.

— The `HCR_EL2.CD` bit affects only stage 2 of the Non-secure EL1&0 translation regime.

- If `HCR_EL2.DC == 1`, then the Non-secure stage 1 EL1&0 translation regime is cacheable regardless of the value of `SCTLR_EL1.I`.

For the EL2 translation regime:

- When `SCTLR_EL2.I == 0`, all instruction accesses to Normal memory using the EL2 translation regime are Non-cacheable.

———— **Note** —————

The `SCTLR_EL2.I` bit has no effect on the EL1&0 and EL3 translation regimes.

For the EL3 translation regime:

- When `SCTLR_EL3.I == 0`, all instruction accesses to Normal memory using the EL3 translation regime are Non-cacheable.

———— **Note** —————

The `SCTLR_EL3.I` bit has no effect on the EL1&0 and EL2 translation regimes

In addition, when `SCTLR_ELx.M == 0`, indicating that the stage 1 translations are disabled for that translation regime, the `SCTLR_ELx.I` bit has the following effect:

- If `SCTLR_ELx.I == 0`, instruction accesses to Normal memory from stage 1 of that translation regime are Outer Shareable, Inner Non-cacheable, Outer Non-cacheable.
- If `SCTLR_ELx.I == 1`, instruction accesses to Normal memory from stage 1 of that translation regime are Outer Shareable, Inner Write-Through, Outer Write-Through.

When the MMU is off, all instruction accesses are to Normal memory and:

- If `SCTLR_ELx.I == 0`, the behavior is Normal Non-cacheable.
- If `SCTLR_ELx.I == 1`, the behavior is Normal Outer Shareable, Inner Write-Through Cacheable, Outer Write-Through Cacheable.

For the Non-secure EL1 translation regime, when the MMU is off and `SCTLR_EL1.M == 0` and `HCR_EL2.DC == 0`, all instruction accesses are to Normal memory and:

- If `SCTLR_ELx.I == 0`, the behavior is Normal Non-cacheable.
- If `SCTLR_ELx.I == 1`, the behavior is Normal Outer Shareable, Inner Write-Through Cacheable, Outer Write-Through Cacheable.

———— **Note** —————

In conjunction with the requirements in *Non-cacheable accesses and instruction caches*, this means that the architecturally required effect of `SCTLR_ELx.I` is limited to its effect on caching instruction accesses in unified caches.

D4.4.6 Non-cacheable accesses and instruction caches

Instruction accesses to Non-cacheable Normal memory can be held in instruction caches.

Correspondingly, the sequence for ensuring that modifications to instructions are available for execution must include invalidation of the modified locations from the instruction cache, even if the instructions are held in Normal Non-cacheable memory. This includes cases where the instruction cache is disabled.

Therefore when using self-modified code in non-cacheable space in a uniprocessor system, the following sequence is required:

```
; Enter this code with <Wt> containing the new 32-bit instruction  
; to be held at a location pointed to by <Xn> in Normal Non-cacheable memory.  
STR <Wt>, [Xn]  
DSB ; Ensure visibility of the data stored  
IC IVAU, Xn] ; Invalidate instruction cache by VA to PoU  
DSB ; Ensure completion of the invalidations  
ISB ;
```

In a multiprocessor system, the **IC IVAU** is broadcast to all PEs within the Inner Shareable domain of the PE running this sequence, but additional software steps might be required to synchronize the threads with other PEs. This might be necessary so that the PEs executing the modified instructions can execute an ISB after completing the invalidation, and to avoid issues associated with concurrent modification and execution of instruction sequences.

Larger blocks of instructions can be modified using the **IC IALLU** instruction for a uniprocessor system, or a **IC IALLUIS** for a multiprocessor system.

———— **Note** —————

This section applies even when the instruction cache is disabled in AArch64, as described in [Cache enabling and disabling on page D4-1678](#).

D4.4.7 Cache maintenance operations

The following sections give general information about cache maintenance:

- [Terms used in describing the maintenance instructions](#).
- [The ARMv8 abstraction of the cache hierarchy on page D4-1683](#).

The following sections describe cache maintenance instruction:

- [Instruction cache maintenance instructions \(IC*\) on page D4-1684](#).
- [Data cache maintenance instructions \(DC*\) on page D4-1685](#).

Terms used in describing the maintenance instructions

Cache maintenance instructions are defined to act on particular memory locations. Instructions can be defined:

- By the address of the memory location to be maintained, referred to as operating *by VA*.
- By a mechanism that describes the location in the hardware of the cache, referred to as operating *by set/way*.

In addition, for instruction caches, there are instructions that invalidate all entries.

The following subsections define the terms used in the descriptions of the cache maintenance instructions:

- [Terminology for cache maintenance instruction operating by virtual address, VA](#).
- [Terminology for cache maintenance instructions operating by set/way on page D4-1681](#).
- [Terminology for Clean, Invalidate, and Clean and Invalidate instructions on page D4-1681](#).

Terminology for cache maintenance instruction operating by virtual address, VA

The addresses used by the PE are VAs. When all applicable stages of translation are disabled, the virtual address is identical to the physical address.

———— **Note** —————

For more information about memory system behavior when MMUs are disabled, see [The effects of disabling a stage of address translation on page D5-1743](#).

For the cache maintenance instruction, any instruction described as operating by VA includes as part of any required VA to PA translation:

- For an instruction executed at EL1, the current system *Address Space Identifier (ASID)*.
- The current Security state.
- Whether the instruction was performed from Hyp mode, or from Non-secure EL1 state.

- For an instruction executed from a Non-secure EL1 state, the *Virtual Machine Identifier*, VMID.

For a data or unified cache operation by VA, the operation cannot generate a Data Abort exception for a Permission fault, except for the Permission fault cases described in:

- [Effects of virtualization and security on the cache maintenance instructions on page D4-1687.](#)
- [Stage 2 fault on a stage 1 translation table walk on page D5-1801.](#)

For an instruction cache operation by VA:

- It is IMPLEMENTATION DEFINED whether the operation can generate a Data Abort exception for a Translation fault or an Access flag fault.
- The operation cannot generate a Data Abort exception for a Permission fault, except for the Permission fault case described in [Stage 2 fault on a stage 1 translation table walk on page D5-1801.](#)

For more information about these faults, see [MMU faults on page D5-1796.](#)

Terminology for cache maintenance instructions operating by set/way

Cache maintenance instruction that operate by set/way refer to the particular structures in a cache. Three parameters describe the location in a cache hierarchy that an instruction works on. These parameters are:

Level	The cache level of the hierarchy. The number of levels of cache is IMPLEMENTATION DEFINED and can be determined from the Cache Level ID register. See CLIDR_EL1, Cache Level ID Register on page D8-1885. In the ARM architecture, the lower numbered levels are those closest to the PE. See Memory hierarchy on page B2-70.
Set	Each level of a cache is split up into a number of <i>sets</i> . Each set is a set of locations in a cache level to which an address can be assigned. Usually, the set number is an IMPLEMENTATION DEFINED function of an address. In the ARM architecture, sets are numbered from 0.
Way	The associativity of a cache is the number of locations in a set to which a specific address can be assigned. The <i>way</i> number specifies one of these locations. In the ARM architecture, ways are numbered from 0.

———— **Note** ————

Because the allocation of a memory address to a cache location is entirely IMPLEMENTATION DEFINED, ARM expects that most portable software will use only the cache maintenance instructions by set/way as single steps in a routine to perform maintenance on the entire cache.

Terminology for Clean, Invalidate, and Clean and Invalidate instructions

Caches introduce coherency problems in two possible directions:

1. An update to a memory location by a PE that accesses a cache might not be visible to other observers that can access memory. This can occur because new updates are still in the cache and are not visible yet to the other observers that do not access that cache.
2. Updates to memory locations by other observers that can access memory might not be visible to a PE that accesses a cache. This can occur when the cache contains an old, or *stale*, copy of the memory location that has been updated.

The *Clean* and *Invalidate* instructions address these two issues. The definitions of these instructions are:

Clean	A cache clean instruction ensures that updates made by an observer that controls the cache are made visible to other observers that can access memory at the point to which the instruction is performed. Once the Clean has completed, the new memory values are guaranteed to be visible to the point to which the instruction is performed, for example to the point of unification.
--------------	---

The cleaning of a cache entry from a cache can overwrite memory that has been written by another observer only if the entry contains a location that has been written to by an observer in the shareability domain of that memory location.

Invalidate A cache invalidate instruction ensures that updates made visible by observers that access memory at the point to which the invalidate is defined, are made visible to an observer that controls the cache. This might result in the loss of updates to the locations affected by the invalidate instruction that have been written by observers that access the cache, if those updates have not been cleaned from the cache since they were made.

If the address of an entry on which the invalidate instruction operates does not have a Normal Cacheable attribute, or if the cache is disabled, then an invalidate instruction also ensures that this address is not present in the cache.

———— **Note** —————

Entries for addresses with a Normal Cacheable attribute can be allocated to an enabled cache at any time, and so the cache invalidate instruction cannot ensure that the address is not present in an enabled cache.

Clean and Invalidate

A cache *clean and invalidate* instruction behaves as the execution of a clean instruction followed immediately by an invalidate instruction. Both instructions are performed to the same location.

The points to which a cache maintenance instruction can be defined differ depending on whether the instruction operates by VA or by set/way:

- For instructions operating by set/way, the point is defined to be to the next level of caching. For the All operations, the point is defined as the point of unification for each location held in the cache.
- For instruction operating by VA, two conceptual points are defined:

Point of coherency (PoC)

For a particular VA, the PoC is the point at which all agents that can access memory are guaranteed to see the same copy of a memory location. In many cases, this is effectively the main system memory, although the architecture does not prohibit the implementation of caches beyond the PoC that have no effect on the coherence between memory system agents.

Point of unification (PoU)

The PoU for a PE is the point by which the instruction and data caches and the translation table walks of that PE are guaranteed to see the same copy of a memory location. In many cases, the point of unification is the point in a uniprocessor memory system by which the instruction and data caches and the translation table walks have merged.

The PoU for an Inner Shareable shareability domain is the point by which the instruction and data caches and the translation table walks of all the PEs in that Inner Shareable shareability domain are guaranteed to see the same copy of a memory location. Defining this point permits self-modifying software to ensure future instruction fetches are associated with the modified version of the software by using the standard correctness policy of:

1. Clean data cache entry by address.
2. Invalidate instruction cache entry by address.

The following fields in the [CLIDR_EL1](#) relate to these conceptual points:

LoC, Level of coherence

This field defines the last level of cache that must be cleaned or invalidated when cleaning or invalidating to the point of coherency. The LoC value is a cache level, so, for example, if LoC contains the value 3:

- A clean to the point of coherency operation requires the level 1, level 2 and level 3 caches to be cleaned.
- Level 4 cache is the first level that does not have to be maintained.

If the LoC field value is 0x0, this means that no levels of cache need to be cleaned or invalidated when cleaning or invalidating to the point of coherency.

If the LoC field value is a nonzero value that corresponds to a level that is not implemented, this indicates that all implemented caches are before the point of coherency.

LoUU, Level of unification, uniprocessor

This field defines the last level of cache that must be cleaned or invalidated when cleaning or invalidating to the point of unification for the PE. As with LoC, the LoUU value is a cache level.

If the LoUU field value is 0x0, this means that no levels of cache need to be cleaned or invalidated when cleaning or invalidating to the point of unification.

If the LoUU field value is a nonzero value that corresponds to a level that is not implemented, this indicates that all implemented caches are before the point of unification.

LoUIS, Level of unification, Inner Shareable

In any implementation:

- This field defines the last level of cache that must be cleaned or invalidated when cleaning or invalidating to the point of unification for the Inner Shareable shareability domain. As with LoC, the LoUIS value is a cache level.
- If the LoUIS field value is 0x0, this means that no levels of cache need to be cleaned or invalidated when cleaning or invalidating to the point of unification for the Inner Shareable shareability domain.
- If the LoUIS field value is a nonzero value that corresponds to a level that is not implemented, this indicates that all implemented caches are before the point of unification.

For more information, see [CLIDR_ELI, Cache Level ID Register on page D8-1885](#).

The ARMv8 abstraction of the cache hierarchy

The following subsections describe the ARMv8 abstraction of the cache hierarchy:

- [Cache maintenance instructions that operate by address](#).
- [Cache maintenance instructions that operate by set/way](#).

Cache maintenance instructions that operate by address

The address-based cache maintenance instructions are described as operating by VA. Each of these instructions is always qualified as being either:

- Performed to the point of coherency.
- Performed to the point of unification.

See [Terms used in describing the maintenance instructions on page D4-1680](#) for definitions of point of coherency and point of unification, and more information about possible meanings of VA.

[Cache maintenance instructions on page D4-1684](#) lists the address-based maintenance instructions.

The [CTR_ELO](#) holds minimum line length values for:

- The instruction caches.
- The data and unified caches.

These values support efficient invalidation of a range of addresses, because this value is the most efficient address stride to use to apply a sequence of address-based maintenance instructions to a range of addresses.

For the Invalidate data or unified cache line by VA instruction, the Cache Write-back Granule field of the [CTR_ELO](#) defines the maximum granule that a single invalidate instruction can invalidate. This meaning of the Cache Write-back Granule is in addition to its defining the maximum size that can be written back.

Cache maintenance instructions that operate by set/way

[Cache maintenance instructions on page D4-1684](#) lists the set/way-based maintenance instructions. Some encodings of these instructions include a required field that specifies the cache level for the instruction:

- A clean instruction cleans from the level of cache specified through to at least the next level of cache, moving further from the PE.

- An invalidate instruction invalidates only at the level specified.

D4.4.8 Cache maintenance instructions

Cache maintenance instructions that are performed using the A64 instruction set are a part of the system instruction class in the register encoding space. For encoding details and other general information on system instructions, see [System instructions on page C2-126](#), [SYS on page C5-752](#) and [Cache maintenance instructions, and data cache zero on page C4-237](#).

The instruction and data cache maintenance instructions have the same functionality in AArch32 state and in AArch64 state. [Table D4-3](#) shows these system instructions. Instructions that take an argument include Xt in the instruction description.

———— **Note** —————

In [Table D4-3](#) the point of unification is the point of unification of the PE executing the cache maintenance instruction.

Table D4-3 System instructions for cache maintenance

Register	Instruction	Notes
Instruction cache maintenance instructions, see System instructions on page C2-126		
IC IALLUIS	Invalidate all to point of unification, Inner Shareable	EL1 or higher access.
IC IALLU	Invalidate all to point of unification	EL1 or higher access.
IC IVAU , Xt	Invalidate by virtual address to point of unification	When SCTLR_EL1.UCI == 1, EL0 access. Otherwise, EL1 or higher access.
Data cache maintenance instructions, see System instructions on page C2-126		
DC IVAC , Xt	Invalidate by virtual address to point of coherency	EL1 or higher access.
DC ISW , Xt	Invalidate by set/way	EL1 or higher access.
DC CVAC , Xt	Clean by virtual address to point of coherency	When SCTLR_EL1.UCI == 1, EL0 access. Otherwise EL1 or higher access.
DC CSW , Xt	Clean by set/way	EL1 or higher access.
DC CVAU , Xt	Clean by virtual address to point of unification	When SCTLR_EL1.UCI == 1, EL0 access. Otherwise EL1 or higher access.
DC CIVAC , Xt	Clean and invalidate by virtual address to point of coherency	When SCTLR_EL1.UCI == 1, EL0 access. Otherwise EL1 or higher access.
DC CISW , Xt	Clean and invalidate by set/way	EL1 or higher access.

Instruction cache maintenance instructions (IC*)

The A64 assembly syntax for these instructions is described in [System instructions on page C2-126](#).

Where an address argument for these instructions is required, it takes the form of a 64-bit register that holds the virtual address argument. No restrictions apply for this address.

All instruction cache maintenance instructions can execute in any order relative to other instruction cache maintenance instructions, data cache maintenance instructions, and loads and stores, unless a DSB is executed between the instructions.

An instruction cache maintenance instruction can complete at any time after it is executed, but is only guaranteed to be complete, and its effects visible to other observers, following a DSB instruction executed by the PE that executed the cache maintenance instruction.

Data cache maintenance instructions (DC*)

The A64 assembly syntax for these instructions is described in [System instructions on page C2-126](#).

Where an address argument for these instructions is required, it takes the form of a 64-bit register that holds the virtual address argument. No alignment restrictions apply for this address.

Data cache maintenance instructions that take a set/way/level argument take a 64-bit register, the upper 32 bits of which are RES0.

DC IVAC requires write permission or else a Permission fault is generated.

DC IVAC and DC ISW at EL1 is performed by the PE as clean and invalidate, that is DC CIVAC or DC CISW, if all of the following apply:

- EL2 is implemented.
- HCR_EL2.VM is set to 1 to enable the second stage of address translation, meaning that execution is in Non-secure state.
- SCR_EL3.NS is set to 1 or EL3 is not implemented.

Note

This also applies to the AArch32 cache maintenance instructions DCIMVAC and DCISW. see [Data cache maintenance instructions \(DC*\) on page G2-3535](#).

If a memory fault that sets the FAR for the translation regime applicable for the cache maintenance instruction is generated from a data cache maintenance instruction, the FAR holds the address specified in the register argument of the instruction.

Note

Despite its mnemonic, DC ZVA is not a cache maintenance instruction. For more information, see [DC ZVA, Data Cache Zero by VA on page C4-317](#)

EL0 accessibility to cache maintenance instructions

The SCTLR_EL1.UCI bit enables EL0 access for the DC CVAU, DC CVAC, DC CIVAC, and IC IVAU instructions.

For these instructions read access permission is required. If the address specified in the argument cannot be read at EL0, executing the instruction at EL0 generates a Permission fault. When disabled, SCTLR_EL1.UCI == 0, these instructions generate a trap to EL1, that is reported using EC = 0x18.

In addition, SCTLR_EL1.UCT bit enables EL0 access to the Cache Type register, CTR_EL0. When software accesses the CTR_EL0 it can discover the stride necessary for cache maintenance instructions. When EL0 access to the Cache Type register is disabled, the instruction is trapped to EL1 using EC = 0x18.

General requirements for the scope of maintenance instructions

The ARMv8 specification of the cache maintenance instructions describes what each instruction is guaranteed to do in a system. It does not limit other behaviors that might occur, provided they are consistent with the requirements described in [General behavior of the caches on page D4-1675](#), [Behavior of caches at reset on page D4-1677](#), and [Preloading caches on page B2-73](#).

This means that as a side-effect of a cache maintenance instruction:

- Any location in the cache might be cleaned.
- Any unlocked location in the cache might be cleaned and invalidated.

———— **Note** ————

ARM recommends that, for best performance, such side-effects are kept to a minimum. ARM strongly recommends that the side-effects of operations performed in Non-secure state do not have a significant performance impact on execution in Secure state.

Effects of instructions that operate to the point of coherency

For Normal memory that is not Inner Non-cacheable, Outer Non-cacheable, these instructions must affect the caches of other PEs in the shareability domain described by the shareability attributes of the VA supplied with the instruction.

For Device memory and Normal memory that is Inner Non-cacheable, Outer Non-cacheable, these instructions must affect the caches of all PEs in the Outer Shareable shareability domain of the PE on which the instruction is operating.

In all cases, for any affected PE, these instructions affect all data and unified caches to the point of coherency.

[Table D4-4](#) shows the scope of the Data and unified cache operations.

Table D4-4 PEs affected by Data and unified cache operations

Shareability	PEs affected	Effective to
Non-shareable	The PE performing the operation	The point of coherency of the entire system
Inner Shareable	All PEs in the same Inner Shareable shareability domain as the PE performing the operation	The point of coherency of the entire system
Outer Shareable	All PEs in the same Outer Shareable shareability domain as the PE performing the operation	The point of coherency of the entire system

Effects of instructions that do not operate to the point of coherency

For these instructions, [Table D4-5](#) shows how, for a VA in a Normal or Device memory location, the shareability attribute of the VA determines the minimum set of PEs affected, and the point to which the instruction must be effective.

Table D4-5 PEs affected by address-based cache maintenance instructions

Shareability	PEs affected	Effective to
Non-shareable	The PE executing the instruction	The point of unification of instruction cache fills, data cache fills and write-backs, and translation table walks, on the PE executing the instruction
Inner Shareable or Outer Shareable	All PEs in the same Inner Shareable shareability domain as the PE executing the instruction	The point of unification of instruction cache fills, data cache fills and write-backs, and translation table walks, of all PEs in the same Inner Shareable shareability domain as the PE executing the instruction

———— **Note** ————

The set of PEs guaranteed to be affected is never greater than the PEs in the Inner Shareable shareability domain containing the PE executing the instruction.

Effects of virtualization and security on the cache maintenance instructions

Each Security state has its own physical address space, and therefore cache entries are associated with physical address space. In addition, cache maintenance instructions performed in Non-secure state have to take account of:

- Whether the instruction was performed at EL1 or at EL2.
- For instructions that operate by VA, the current VMID.

Table D4-6 shows the effects of virtualization and security on these maintenance instructions.

Table D4-6 Effects of virtualization and security on the maintenance instructions

Cache maintenance instructions	Security state	Targeted entry
Data or unified cache maintenance instructions		
Invalidate, Clean, or Clean and Invalidate by VA: IVAC, CVAC, CVAU, CIVAC	Either	All lines that hold the PA that, in the current Security state, is mapped to by the combination of all of: <ul style="list-style-type: none"> • The specified VA. • For an instruction executed at EL1 or EL0, the current ASID. • For an instruction executed at Non-secure EL1 or Non-secure EL0, the current VMID^b.
Invalidate, Clean, or Clean and Invalidate by set/way: ISW, CSW, CISW	Non-secure	Line specified by set/way provided that the entry comes from the Non-secure PA space.
	Secure	Line specified by set/way regardless of the PA space that the entry has come from.
Instruction cache maintenance instructions		
Invalidate by VA: IVAU	Either	Implementation without the IVIPT Extension ^a :
		All Lines that match the specified VA and, for an instruction executed at EL1 or EL0, the current ASID, and come from the same VA space as the current Security state. For an instruction executed in Non-secure state, lines are invalidated only if they also match the current VMID ^b and security level, EL1 or EL2.
		Implementation with the IVIPT extension ^a :
		All lines that hold the PA that, in the current Security state, is mapped to by the combination of all of: <ul style="list-style-type: none"> • The specified VA. • For an instruction executed at EL1 or EL0, the current ASID. • For an instruction executed in Non-secure EL1 or Non-secure EL0, the current VMID^b
Invalidate All: IALLU, IALLUIS		<ul style="list-style-type: none"> • Can invalidate any unlocked entry in the instruction cache. • Are required to invalidate any entries relevant to the software component that executed it. The Non-secure and Secure descriptions give more information:
		<p>Non-secure</p> <p>An instruction executed at EL1 must operate on all instruction cache lines that contain entries associated with the current virtual machine, meaning any entry with the current VMID^b. An instruction executed at EL2 must operate on all instruction cache lines that contain entries that can be accessed from Non-secure state.</p> <p>Secure</p> <p>The instruction must invalidate all instruction cache lines.</p>

- a. See [The IVIPT Extension on page D5-1820](#).
- b. Dependencies on the VMID apply even when `HCR_EL2.VM` is set to 0. However, `VTTBR_EL2.VMID` resets to zero, meaning there is a valid VMID from reset.

For locked entries and entries that might be locked, the behavior of cache maintenance instructions described in [The interaction of cache lockdown with cache maintenance instructions on page D4-1691](#) applies.

With an implementation that generates aborts if entries are locked or might be locked in the cache, when the use of lockdown aborts is enabled, these aborts can occur on any cache maintenance instructions.

In an implementation that includes EL2:

- The architecture does not require cache cleaning when switching between virtual machines. Cache invalidation by set/way must not present an opportunity for one virtual machine to corrupt state associated with a second virtual machine. To ensure this requirement is met, Non-secure clean by set/way operations can be upgraded to clean and invalidate by set/way.
- The AArch64 Data Cache Invalidate instructions, `DC IVAC` and `DC ISW`, at EL1 and EL0, and the AArch32 Data Cache Invalidate instructions `DCIMVAC` and `DCISW`, perform a cache clean as well as a cache invalidation if all of the following apply:
 - EL2 is implemented.
 - `HCR.VM` is set.
 - `SCR.NS` is set or EL3 is not implemented.
- When the value of `HCR_EL2.FB` is 1, TLB and instruction cache invalidate instructions executed in the Non-secure EL1 Exception level are broadcast across the Inner Shareable domain. When Non-secure EL1 is using AArch64, this applies to the `TLBI VMALLE1`, `TLBI VAE1`, `TLBI ASIDE1`, `TLBI VAAE1`, `TLBI VALE1`, `TLBI VAALE1`, and `IC IALLU` instructions. This means the instruction is upgraded to the corresponding Inner Shareable instruction, for example `IC IALLU` is upgraded to `IC IALLUIS`.
- When the value of `HCR_EL2.SWIO` is 1, a cache invalidate by set/way instructions executed in the Non-secure EL1 Exception level is upgraded to a clean and invalidate by set/way. When Non-secure EL1 is using AArch64, this means the `DC ISW` instruction is upgraded to `DC CISW`.

For more information about the cache maintenance instructions, see [Cache maintenance operations on page D4-1680](#), [Cache maintenance instructions on page D4-1684](#), and [Chapter D5 The AArch64 Virtual Memory System Architecture](#).

Boundary conditions for cache maintenance instructions

Cache maintenance instructions operate on the caches when the caches are enabled or when they are disabled.

For address-based cache maintenance instructions, the instructions operate on the caches regardless of the memory type and cacheability attributes marked for the memory address in the VMSA translation table entries. This means that the effects of the cache maintenance instructions can apply regardless of:

- Whether the address accessed:
 - Is Normal memory or Device memory.
 - Has the Cacheable attribute or the Non-cacheable attribute.
- Any applicable domain control of the address accessed.
- The access permissions for the address accessed, other than the effect of the stage two write permission on data or unified cache invalidation instructions.

Ordering and completion of data and instruction cache instructions

All data cache instructions, other than [DC ZVA](#), that specify an address:

- Execute in program order relative to loads or stores that access an address in Normal memory with either Inner Write Through or Inner Write Back attributes within the same cache line of minimum size, as indicated by [CTR_EL0.DMinLine](#).
- Can execute in any order relative to loads or stores that access any address with the Device memory attribute, or with Normal memory with Inner Non-cacheable attribute unless a DMB or DSB is executed between the instructions.
- Execute in program order relative to other data cache maintenance instructions, other than [DC ZVA](#), that specify an address within the same cache line of minimum size, as indicated by [CTR_EL0.DMinLine](#).
- Can execute in any order relative to loads or stores that access an address in a different cache line of minimum size, as indicated by [CTR_EL0.DMinLine](#), unless a DMB or DSB is executed between the instructions.
- Can execute in any order relative to other data cache maintenance instructions, other than [DC ZVA](#), that specify an address in a different cache line of minimum size, as indicated by [CTR_EL0.DMinLine](#), unless a DMB or DSB is executed between the instructions.
- Can execute in any order relative to data cache maintenance instructions that do not specify an address unless a DMB or DSB is executed between the instructions.
- Can execute in any order relative to instruction cache maintenance instructions unless a DSB is executed between the instructions.

Note

[Data cache zero instruction on page D4-1690](#) describes the ordering and completion rules for Data Cache Zero.

All data cache maintenance instructions that do not specify an address:

- Can execute in any order relative to data cache maintenance instructions that do not specify an address unless a DMB or DSB is executed between the instructions.
- Can execute in any order relative to data cache maintenance instructions that specify an address, other than Data Cache Zero, unless a DMB or DSB is executed between the instructions.
- Can execute in any order relative to loads or stores unless a DMB or DSB is executed between the instructions.

A cache maintenance instruction can complete at any time after it is executed, but is only guaranteed to be complete, and its effects visible to other observers, following a DSB instruction executed by the PE that executed the cache maintenance instruction.

Note

In all cases, where the text in this section refers to a DMB or a DSB, this means a DMB or DSB whose required access type is both loads and stores.

Performing cache maintenance instructions

To ensure all cache lines in a block of address space are maintained through all levels of cache ARM strongly recommends that software:

- For data or unified cache maintenance, uses the [CTR_EL0.DMinLine](#) value to determine the loop increment size for a loop of data cache maintenance by VA instructions.
- For instruction cache maintenance, uses the [CTR_EL0.IMinLine](#) value to determine the loop increment size for a loop of instruction cache maintenance by VA instructions.

Example code for cache maintenance instructions

The cache maintenance instructions by set/way can clean or invalidate, or both, the entirety of one or more levels of cache attached to a processing element. However, unless all processing elements attached to the caches regard all memory locations as Non-cacheable, it is not possible to prevent locations being allocated into the cache during such a sequence of the cache maintenance instructions.

———— Note ————

In multi-processing environments, the cache maintenance instructions that operate by set/way are not broadcast within the shareability domains, and so allocations can occur from other, unmaintained, locations, in caches in other locations. For this reason, the use of cache maintenance instructions that operate by set/way for the maintenance of large buffers of memory is not recommended in the architectural sequence. The expected usage of the cache maintenance instructions that operate by set/way is associated with the cache maintenance instructions associated with the powerdown and powerup of caches, if this is required by the implementation.

The following example code for cleaning a data or unified cache to the point of coherency illustrates a generic mechanism for cleaning the entire data or unified cache to the point of coherency.

```

MRS    X0, CLIDR_EL1
AND    W3, W0, #0x07000000    // get 2 x level of coherency
LSR    W3, W3, #23
CBZ    W3, Finished
MOV    W10, #0                // W10 = 2 x cache level
MOV    W8, #1                 // W8 = constant 0b1
Loop1: ADD    W2, W10, W10, LSR #1 // calculate 3 x cache level
LSR    W1, W0, W2             // extract 3-bit cache type for this level
AND    W1, W1, #0x7
CMP    W1, #2
B.LT   Skip                  // no data or unified cache at this level
MSR    CSSELR_EL1, X10       // select this cache level
ISB                               // sync change of CSSELR
MRS    X1, CCSIDR_EL1        // read CCSIDR
AND    W2, W1, #7             // W2 = log2(lineLen)-4
ADD    W2, W2, #4             // W2 = log2(lineLen)
UBFX   W4, W1, #3, #10        // W4 = max way number, right aligned
CLZ    W5, W4                 // W5 = 32-log2(ways), bit position of way in DC operand
LSL    W9, W4, W5             // W9 = max way number, aligned to position in DC operand
LSL    W16, W8, W5            // W16 = amount to decrement way number per iteration
Loop2: UBFX   W7, W1, #13, #15 // W7 = max set number, right aligned
LSL    W7, W7, W2             // W7 = max set number, aligned to position in DC operand
LSL    W17, W8, W2            // W17 = amount to decrement set number per iteration
Loop3: ORR    W11, W10, W9      // W11 = combine way number and cache number ...
ORR    W11, W11, W7           // ... and set number for DC operand
DC     CSW, X11               // do data cache clean by set and way
SUBS   W7, W7, W17            // decrement set number
B.GE   Loop3
SUBS   X9, X9, X16            // decrement way number
B.GE   Loop2
Skip:  ADD    W10, W10, #2     // increment 2 x cache level
CMP    W3, W10
B.GT   Loop1
DSB
Finished:

```

Similar approaches can be used for all cache maintenance instructions.

D4.4.9 Data cache zero instruction

The Data Cache Zero by Address instruction, **DC ZVA**, writes 0b00 to each of a block of N bytes, aligned in memory to N bytes in size, where the block in memory is identified by the address passed. There are no alignment restrictions on the address supplied. The **DCZID_EL0** register indicates the block size that is written with byte values of zero.

Software can restrict access to this operation. See [Trapping functionality to higher Exception levels on page D1-1462](#).

If disabled, the operation at EL0 is trapped to EL1.

The DC ZVA instruction behaves as a set of stores to the location being accessed, and:

- Generates a Permission fault if the translation regime being used when the instruction is executed does not permit writes to the locations.
- Requires the same considerations for ordering and the management of coherency as any other store instruction.

In addition:

- When the instruction is executed, it can generate memory faults or watchpoints that are prioritized in the same way as other memory related faults or watchpoints. Where a synchronous Data Abort fault or a watchpoint is generated, the CM bit in the syndrome field is not set to 1, which would be the case for all other cache maintenance instructions. See [Exception from a Data abort on page D1-1525](#) for more information about the encoding of `ESR_ELx` and the associated ISS field.
- If the memory region being zeroed is any type of Device memory, then DC ZVA generates an Alignment fault which is prioritized in the same way as other alignment faults that are determined by the memory type.

———— **Note** —————

The architecture makes no statements about whether or not a DC ZVA instruction causes allocation to any particular level of the cache, for addresses that have a cacheable attribute for those levels of cache.

D4.4.10 Cache lockdown

The concept of an entry locked in a cache is allowed, but not architecturally defined. How lockdown is achieved is IMPLEMENTATION DEFINED and might not be supported by:

- An implementation.
- Some memory attributes.

An unlocked entry in a cache might not remain in that cache. The architecture does not guarantee that an unlocked cache entry remains in the cache or remains incoherent with the rest of memory. Software must not assume that an unlocked item that remains in the cache remains dirty.

A locked entry in a cache is guaranteed to remain in that cache. The architecture does not guarantee that a locked cache entry remains incoherent with the rest of memory, that is, it might not remain dirty.

The interaction of cache lockdown with cache maintenance instructions

The interaction of cache lockdown and cache maintenance instructions is IMPLEMENTATION DEFINED. However, an architecturally-defined cache maintenance instruction on a locked cache line must comply with the following general rules:

- The effect of the following instructions on locked cache entries is IMPLEMENTATION DEFINED:
 - Cache clean by set/way, [DC CSW](#).
 - Cache invalidate by set/way, [DC ISW](#).
 - Cache clean and invalidate by set/way, [DC CISW](#).
 - Instruction cache invalidate all, [IC IALLU](#) and [IC IALLUIS](#).

However, one of the following approaches must be adopted in all these cases:

1. If the instruction specified an invalidation, a locked entry is not invalidated from the cache.
2. If the instruction specified a clean it is IMPLEMENTATION DEFINED whether locked entries are cleaned.
3. If an entry is locked down, or could be locked down, an IMPLEMENTATION DEFINED Data Abort exception is generated, using the fault status code defined for this purpose. See [Exception from a Data abort on page D1-1525](#).

This permits a usage model for cache invalidate routines to operate on a large range of addresses by performing the required operation on the entire cache, without having to consider whether any cache entries are locked.

The effect of the following instructions is IMPLEMENTATION DEFINED:

- Cache clean by virtual address, [DC CVAC](#) and [DC CVAU](#).
- Cache invalidate by virtual address, [DC IVAC](#).
- Cache clean and invalidate by virtual address, [DC CIVAC](#).

However, one of the following approaches must be adopted in all these cases:

1. If the instruction specified an invalidation, a locked entry is invalidated from the cache. For the clean and invalidate instructions, the entry must be cleaned before it is invalidated.
2. If the instruction specified an invalidation, a locked entry is not invalidated from the cache. If the instruction specified a clean it is IMPLEMENTATION DEFINED whether locked entries are cleaned.
3. If an entry is locked down, or could be locked down, an IMPLEMENTATION DEFINED Data Abort exception is generated, using the fault status code defined for this purpose. See [ESR_ELx on page AppxJ-5091](#).

In an implementation that includes EL2, if [HCR_EL2.TIDCP](#) is set to 1, any exception relating to lockdown of an entry associated with Non-secure memory is routed to EL2.

———— **Note** —————

An implementation that uses an abort mechanisms for entries that can be locked down but are not actually locked down must:

- Document the IMPLEMENTATION DEFINED instruction sequences that perform the required operations on entries that are not locked down.
- Implement one of the other permitted alternatives for the locked entries.

ARM recommends that, when possible, such IMPLEMENTATION DEFINED instruction sequences use architecturally-defined instructions. This minimizes the number of customized instructions required.

In addition, an implementation that uses an abort to handle cache maintenance instructions for entries that might be locked must provide a mechanism that ensures that no entries are locked in the cache.

The reset setting of the cache must be that no cache entries are locked.

Additional cache functions for the implementation of lockdown

An implementation can add additional cache maintenance functions for the handling of lockdown in the IMPLEMENTATION DEFINED spaces reserved for Cache Lockdown, see [Reserved control space for IMPLEMENTATION DEFINED functionality on page C4-250](#).

D4.4.11 System level caches

The system level architecture might define further aspects of the software view of caches and the memory model that are not defined by the ARMv8 architecture. These aspects of the system level architecture can affect the requirements for software management of caches and coherency. For example, a system design might introduce additional levels of caching that cannot be managed using the architecturally-defined maintenance instructions. Such caches are referred to as *system caches* and are managed through the use of memory-mapped operations. The ARMv8 architecture does not forbid the presence of system caches that are outside the scope of the architecture, but ARM strongly recommends that such caches are always placed after the point of coherency for all memory locations that might be held in a cache. Placing such system caches after the point of coherency means that coherency management does not require maintenance of these system caches.

ARM also strongly recommends:

- For the maintenance of any such system cache:
 - Physical, rather than virtual, addresses are used for address-based cache maintenance instructions.

- Any IMPLEMENTATION DEFINED system cache maintenance instruction includes at least the set of maintenance options defined by *Cache maintenance instructions* on page D4-1684, with the number of levels of system cache operated on by the cache maintenance instructions being IMPLEMENTATION DEFINED.
- Wherever possible, all caches that require maintenance to ensure coherency are included in the caches affected by the architecturally-defined cache maintenance instructions, so that the architecturally-defined software sequences for managing the memory model and coherency are sufficient for managing all caches in the system.

D4.4.12 Branch prediction

ARMv8 does not define any branch predictor maintenance instructions for AArch64 state.

If branch prediction is architecturally visible, cache maintenance must also apply to branch prediction.

D4.5 External aborts

The ARM architecture defines external aborts as errors that occur in the memory system, other than those that are detected by the MMU or debug logic. External aborts include parity errors detected by the caches or other parts of the memory system. For example, an uncorrectable parity or ECC failure on a Level 2 Memory structure might generate an external abort.

An external abort is one of the following:

- Synchronous.
- Precise asynchronous.
- Imprecise asynchronous.

For more information, see [Exception terminology on page D1-1409](#).

The ARM architecture does not provide any method to distinguish between precise asynchronous and imprecise asynchronous aborts.

In AArch64 state, asynchronous aborts are reported using the SError interrupt exception. See [Asynchronous exception types, routing, masking and priorities on page D1-1456](#).

Synchronous external aborts are reported using the Instruction Abort and Data Abort exceptions. See [Synchronous exception types, routing and priorities on page D1-1450](#).

VMSAv8-64 permits external aborts on data accesses, translation table walks, and instruction fetches to be either synchronous or asynchronous.

It is IMPLEMENTATION DEFINED which external aborts, if any, are supported.

Normally, external aborts are rare. An imprecise asynchronous external abort is likely to be fatal to the process that is running, ARM recommends that implementations make external aborts precise wherever possible.

The following subsections give more information about possible external aborts:

- [External abort on an instruction fetch](#).
- [External abort on data read or write](#).
- [Provision for the classification of external aborts](#).
- [Parity error reporting on page D4-1695](#).

D4.5.1 External abort on an instruction fetch

An external abort on an instruction fetch can be either synchronous or asynchronous.

A synchronous external abort on an instruction fetch is taken precisely using the Instruction Abort exception.

An implementation can report the external abort asynchronously from the instruction that it applies to. In such an implementation the abort is taken using the SError interrupt exception.

D4.5.2 External abort on data read or write

Externally-generated errors that occur during a data read or write can be either synchronous or asynchronous.

A synchronous external abort on a data read or write is taken precisely using the Data Abort exception.

An implementation can report the external abort asynchronously from the instruction that generated the access. In such an implementation the abort is taken using the SError interrupt exception.

D4.5.3 Provision for the classification of external aborts

In AArch64 state, an implementation can use [ESR_ELx.EA, ISS\[9\]](#), to provide more information about synchronous external aborts. For more information, see [Exception from an Instruction abort on page D1-1524](#) and [Exception from a Data abort on page D1-1525](#).

For all aborts other than synchronous external aborts reported using the EC values 0x20, 0x21, 0x24, and 0x25, [ESR_ELx.EA, ISS\[9\]](#), returns a value of 0.

D4.5.4 Parity error reporting

The ARM architecture supports the reporting of both synchronous and asynchronous parity errors from the cache system. It is IMPLEMENTATION DEFINED what parity errors in the cache systems, if any, result in synchronous or asynchronous parity errors.

A fault code is defined for reporting parity errors, see [Use of the ESR_EL1, ESR_EL2, and ESR_EL3 on page D1-1512](#). However, when parity error reporting is implemented, it is IMPLEMENTATION DEFINED whether a parity error is reported using the assigned fault code or using another appropriate encoding.

For all purposes other than the fault status encoding, parity errors are treated as external aborts.

D4.6 Memory barrier instructions

[Memory barriers on page B2-85](#) describes the memory barrier instructions. This section describes the system level controls of those instructions.

D4.6.1 EL2 control of the shareability of data barrier instructions executed at Non-secure EL0 or EL1

In an implementation that includes EL2 and supports shareability limitations on the data barrier instructions, the [HCR_EL2.BSU](#) field can upgrade the required shareability of an instruction that is executed at EL0 or EL1 in Non-secure state. [Table D4-7](#) shows the encoding of this field:

Table D4-7 EL2 control of shareability of barrier instructions executed at Non-secure EL0 or EL1

HCR_EL2.BSU	Minimum shareability of barrier instructions
00	No effect, shareability is as specified by the instruction
01	Inner Shareable
10	Outer Shareable
11	Full system

For an instruction executed at EL0 or EL1 in Non-secure state, [Table D4-8](#) shows how the [HCR_EL2.BSU](#) is combined with the shareability specified by the argument of the DMB or DSB instruction to give the scope of the instruction:

Table D4-8 Effect of [HCR_EL2.BSU](#) on barrier instructions executed at Non-secure EL1 or EL0

Shareability specified by the DMB or DSB argument	HCR_EL2.BSU	Resultant shareability
Full system	Any	Full system
	00, 01, or 10	Outer Shareable
Outer Shareable	11, Full system	Full system
	00 or 01	Inner Shareable
	10, Outer Shareable	Outer Shareable
Inner Shareable	11, Full system	Full system
	00, No effect	Non-shareable
	01, Inner Shareable	Inner Shareable
Non-shareable	10, Outer Shareable	Outer Shareable
	11, Full system	Full system
	10, Outer Shareable	Outer Shareable
	11, Full system	Full system

D4.7 Pseudocode details of general memory system instructions

This section contains the following pseudocode describing general memory operations:

- [Memory data type definitions.](#)
- [Basic memory access on page D4-1698.](#)
- [Aligned memory access on page D4-1698.](#)
- [Unaligned memory access on page D4-1699.](#)
- [Exclusive monitors operations on page D4-1700.](#)
- [Access permission checking on page D4-1702.](#)
- [Abort exceptions on page D4-1703.](#)
- [Memory barriers on page D4-1705.](#)

D4.7.1 Memory data type definitions

This section describes the memory data type definitions.

The address descriptor type is defined as follows:

```
type AddressDescriptor is (
    FaultRecord    fault,    // fault.type indicates whether the address is valid
    MemoryAttributes memattrs,
    FullAddress    paddress
)
```

The full address type is defined as follows:

```
type FullAddress is (
    bits(48) physicaladdress,
    bit      NS                // '0' = Secure, '1' = Non-secure
)
```

The memory attributes types are defined as follows:

```
type MemoryAttributes is (
    MemType        type,

    DeviceType    device,    // For Device memory types
    MemAttrHints  inner,    // Inner hints and attributes
    MemAttrHints  outer,    // Outer hints and attributes

    boolean       shareable,
    boolean       outershareable
)
```

The memory type is defined as follows.

```
enumeration MemType {MemType_Normal, MemType_Device};
```

The Device memory types are defined as follows:

```
enumeration DeviceType {DeviceType_GRE, DeviceType_nGRE, DeviceType_nGnRE, DeviceType_nGnRnE};
```

For Normal memory, the inner and outer attributes are defined as follows:

```
type MemAttrHints is (
    bits(2) attrs, // The possible encodings for each attributes field are as below
    bits(2) hints, // The possible encodings for the hints are below
    boolean transient
)
```

The cacheability attributes are defined as follows:

```
constant bits(2) MemAttr_NC = '00';    // Non-cacheable
constant bits(2) MemAttr_WT = '10';    // Write-through
```

```
constant bits(2) MemAttr_WB = '11';    // Write-back
```

The allocation hints are defined as follows:

```
constant bits(2) MemHint_No = '00';    // No allocate
constant bits(2) MemHint_WA = '01';    // Write-allocate, Read-no-allocate
constant bits(2) MemHint_RA = '10';    // Read-allocate, Write-no-allocate
constant bits(2) MemHint_RWA = '11';   // Read-allocate and Write-allocate
```

The access permissions type is defined as follows:

```
type Permissions is (
    bits(3) ap,    // Access permission bits
    bit    xn,    // Execute-never bit
    bit    pxn    // Privileged execute-never bit
)
```

D4.7.2 Basic memory access

The two `_Mem[]` accessors, Non-assignment (memory read) and Assignment (memory write), are the operations that perform single-copy atomic, aligned, little-endian memory accesses of size bytes to or from the underlying physical memory array of bytes.

```
bits(8*size) _Mem[AddressDescriptor desc, integer size, AccType acctype];
_Mem[AddressDescriptor desc, integer size, AccType acctype] = bits(8*size) value;
```

The functions address the array using `desc.paddress` which supplies:

- A 48-bit physical address.
- A single NS bit to select between Secure and Non-secure parts of the array.

The `AccType` parameter describes the access type, such as normal, exclusive, ordered, and streaming. For a definition of `AccType`, see [Address space on page B2-68](#).

The actual implemented array of memory might be smaller than the 2^{48} bytes implied. In this case the scheme for aliasing is IMPLEMENTATION DEFINED, or some parts of the address space might give rise to external aborts or a System Error.

The attributes in `memaddrdesc.memattrs` are used by the memory system to determine caching and ordering behaviors as described in [Memory types and attributes on page B2-89](#), [Memory ordering on page B2-82](#), and [Atomicity in the ARM architecture on page B2-79](#).

`PAMax()` returns the IMPLEMENTATION DEFINED size of the physical address.

```
integer PAMax();
```

D4.7.3 Aligned memory access

The `MemSingle[]` function makes an atomic, little-endian accesses of size bytes.

```
// MemSingle[] - non-assignment (read) form
// =====
bits(size*8) MemSingle[bits(64) address, integer size, AccType acctype, boolean wasaligned]
    assert size IN {1, 2, 4, 8, 16};
    assert address == Align(address, size);

    AddressDescriptor memaddrdesc;
    bits(size*8) value;
    iswrite = FALSE;

    // MMU or MPU
```



```

memaddrdesc = AArch64.TranslateAddress(address, acctype, iswrite, wasaligned, size);

// Check for aborts or debug exceptions
if IsFault(memaddrdesc) then
    AArch64.Abort(address, memaddrdesc.fault);

// Memory array access
value = _Mem[memaddrdesc, size, acctype];
return value;

// MemSingle[] - assignment (write) form
// =====

MemSingle[bits(64) address, integer size, AccType acctype, boolean wasaligned] = bits(size*8) value
assert size IN {1, 2, 4, 8, 16};
assert address == Align(address, size);

AddressDescriptor memaddrdesc;
iswrite = TRUE;

// MMU or MPU
memaddrdesc = AArch64.TranslateAddress(address, acctype, iswrite, wasaligned, size);

// Check for aborts or debug exceptions
if IsFault(memaddrdesc) then
    AArch64.Abort(address, memaddrdesc.fault);

// Effect on exclusives
if memaddrdesc.memattrs.shareable then
    ClearExclusiveByAddress(memaddrdesc.paddress, ProcessorID(), size);

// Memory array access
_Mem[memaddrdesc, size, acctype] = value;
return;

```

D4.7.4 Unaligned memory access

The Mem[] function makes an access of the required type. If that access is not architecturally defined to be atomic, it synthesizes accesses from multiple calls to MemSingle[]. It also reverses the byte order if the access is big-endian.

```

// Mem[] - non-assignment (read) form
// =====

bits(size*8) Mem[bits(64) address, integer size, AccType acctype]
assert size IN {1, 2, 4, 8, 16};
bits(size*8) value;
integer i;
boolean iswrite = FALSE;

aligned = AArch64.CheckAlignment(address, size, acctype, iswrite);
atomic = (aligned && !(acctype IN {AccType_VEC, AccType_VECSTREAM})) || size == 1;

if !atomic then
    assert size > 1;
    value<7:0> = MemSingle[address, 1, acctype, aligned];

    // For subsequent bytes it is CONSTRAINED UNPREDICTABLE whether an unaligned Device memory
    // access will generate an Alignment Fault, as to get this far means the first byte did
    // not, so we must be changing to a new translation page.
    if !aligned then
        c = ConstrainUnpredictable();
        assert c IN {Constraint_FAULT, Constraint_NONE};
        if c == Constraint_NONE then aligned = TRUE;

    for i = 1 to size-1
        value<8*i+7:8*i> = MemSingle[address+i, 1, acctype, aligned];
else

```

```
        value = MemSingle[address, size, acctype, aligned];

    if BigEndian() then
        value = BigEndianReverse(value);
    return value;

// Mem[] - assignment (write) form
// =====

Mem[bits(64) address, integer size, AccType acctype] = bits(size*8) value
integer i;
boolean iswrite = TRUE;

if BigEndian() then
    value = BigEndianReverse(value);

aligned = AArch64.CheckAlignment(address, size, acctype, iswrite);
atomic = (aligned && !(acctype IN {AccType_VEC, AccType_VECSTREAM})) || size == 1;

if !atomic then
    assert size > 1;
    MemSingle[address, 1, acctype, aligned] = value<7:0>;

    // For subsequent bytes it is CONSTRAINED UNPREDICTABLE whether an unaligned Device memory
    // access will generate an Alignment Fault, as to get this far means the first byte did
    // not, so we must be changing to a new translation page.
    if !aligned then
        c = ConstrainUnpredictable();
        assert c IN {Constraint_FAULT, Constraint_NONE};
        if c == Constraint_NONE then aligned = TRUE;

    for i = 1 to size-1
        MemSingle[address+i, 1, acctype, aligned] = value<8*i+7:8*i>;
else
    MemSingle[address, size, acctype, aligned] = value;
return;
```

The CheckAlignment() function is:

```
// AArch64.CheckAlignment()
// =====

boolean AArch64.CheckAlignment(bits(64) address, integer size, AccType acctype, boolean iswrite)

    aligned = (address == Align(address, size));
    A = SCTLRL[.A];

    if !aligned && (acctype == AccType_ATOMIC || acctype == AccType_ORDERED || A == '1') then
        secondstage = FALSE;
        AArch64.Abort(address, AArch64.AlignmentFault(acctype, iswrite, secondstage));

    return aligned;
```

D4.7.5 Exclusive monitors operations

The SetExclusiveMonitors() function sets the exclusive monitors for a block of bytes, the size of which is determined by size, at the virtual address defined by address.

```
// AArch64.SetExclusiveMonitors()
// =====

// Sets the Exclusive Monitors for the current PE to record the addresses associated
// with the virtual address region of size bytes starting at address.

AArch64.SetExclusiveMonitors(bits(64) address, integer size)

    acctype = AccType_ATOMIC;
```

```

iswrite = FALSE;
aligned = (address != Align(address, size));

memaddrdesc = AArch64.TranslateAddress(address, acctype, iswrite, aligned, size);

// Check for aborts or debug exceptions
if IsFault(memaddrdesc) then
    return;

if memaddrdesc.memattrs.shareable then
    MarkExclusiveGlobal(memaddrdesc.paddress, ProcessorID(), size);

MarkExclusiveLocal(memaddrdesc.paddress, ProcessorID(), size);

AArch64.MarkExclusiveVA(address, ProcessorID(), size);

```

The ExclusiveMonitorsPass() function checks whether the exclusive monitors are set to include the location of a number of bytes specified by size, at the virtual address defined by address. The atomic write that follows after the exclusive monitors have been set must be to the same physical address. It is permitted, but not required, for this function to return FALSE if the virtual address is not the same as that used in the previous call to SetExclusiveMonitors().

```

// AArch64.ExclusiveMonitorsPass()
// =====

// Return TRUE if the Exclusive Monitors for the current PE include all of the addresses
// associated with the virtual address region of size bytes starting at address.
// The immediately following memory write must be to the same addresses.

boolean AArch64.ExclusiveMonitorsPass(bits(64) address, integer size)

    // It is IMPLEMENTATION DEFINED whether the detection of memory aborts happens
    // before or after the check on the local Exclusive Monitor. As a result a failure
    // of the local monitor can occur on some implementations even if the memory
    // access would give an memory abort.

    acctype = AccType_ATOMIC;
    iswrite = TRUE;
    aligned = (address == Align(address, size));

    if !aligned then
        secondstage = FALSE;
        AArch64.Abort(address, AArch64.AlignmentFault(acctype, iswrite, secondstage));

    passed = AArch64.IsExclusiveVA(address, ProcessorID(), size);
    if !passed then
        return FALSE;

    memaddrdesc = AArch64.TranslateAddress(address, acctype, iswrite, aligned, size);

    // Check for aborts or debug exceptions
    if IsFault(memaddrdesc) then
        AArch64.Abort(address, memaddrdesc.fault);

    passed = IsExclusiveLocal(memaddrdesc.paddress, ProcessorID(), size);
    if passed && memaddrdesc.memattrs.shareable then
        passed = IsExclusiveGlobal(memaddrdesc.paddress, ProcessorID(), size);

    if passed then
        ClearExclusiveLocal(ProcessorID());

    return passed;

```

The ExclusiveMonitorsStatus() function returns 0 if the previous atomic write was to the same physical memory locations selected by ExclusiveMonitorsPass() and therefore succeeded. Otherwise the function returns 1, indicating that the address translation delivered a different physical address.

```
bit ExclusiveMonitorsStatus();
```

The `MarkExclusiveGlobal()` procedure takes as arguments a `FullAddress` `address`, the PE identifier `processorid` and the size of the transfer. The procedure records that the PE `processorid` has requested exclusive access covering at least `size` bytes from address `address`. The size of the location marked as exclusive is IMPLEMENTATION DEFINED, up to a limit of 2KB and no smaller than two words, and aligned in the address space to the size of the location. It is UNPREDICTABLE whether this causes any previous request for exclusive access to any other address by the same PE to be cleared.

```
MarkExclusiveGlobal(FullAddress address, integer processorid, integer size);
```

The `MarkExclusiveLocal()` procedure takes as arguments a `FullAddress` `address`, the PE identifier `processorid` and the size of the transfer. The procedure records in a local record that PE `processorid` has requested exclusive access to an address covering at least `size` bytes from address `address`. The size of the location marked as exclusive is IMPLEMENTATION DEFINED, and can at its largest cover the whole of memory but is no smaller than two words, and is aligned in the address space to the size of the location. It is IMPLEMENTATION DEFINED whether this procedure also performs a `MarkExclusiveGlobal()` using the same parameters.

```
MarkExclusiveLocal(FullAddress address, integer processorid, integer size);
```

The `IsExclusiveGlobal()` function takes as arguments a `FullAddress` `address`, the PE identifier `processorid` and the size of the transfer. The function returns TRUE if the PE `processorid` has marked in a global record an address range as exclusive access requested that covers at least `size` bytes from address `address`. It is IMPLEMENTATION DEFINED whether it returns TRUE or FALSE if a global record has marked a different address as exclusive access requested. If no address is marked in a global record as exclusive access, `IsExclusiveGlobal()` returns FALSE.

```
boolean IsExclusiveGlobal(FullAddress address, integer processorid, integer size);
```

The `IsExclusiveLocal()` function takes as arguments a `FullAddress` `address`, the PE identifier `processorid` and the size of the transfer. The function returns TRUE if the PE `processorid` has marked an address range as exclusive access requested that covers at least the `size` bytes from address `address`. It is IMPLEMENTATION DEFINED whether this function returns TRUE or FALSE if the address marked as exclusive access requested does not cover all of `size` bytes from address `address`. If no address is marked as exclusive access requested, then this function returns FALSE. It is IMPLEMENTATION DEFINED whether this result is ANDed with the result of `IsExclusiveGlobal()` with the same parameters.

```
boolean IsExclusiveLocal(FullAddress address, integer processorid, integer size);
```

The `ClearExclusiveByAddress()` procedure takes as arguments a `FullAddress` `address`, the PE identifier `processorid` and the size of the transfer. The procedure clears the global records of all PEs, other than `processorid`, for which an address region including any of `size` bytes starting from `address` has had a request for an exclusive access. It is IMPLEMENTATION DEFINED whether the equivalent global record of the PE `processorid` is also cleared if any of `size` bytes starting from `address` has had a request for an exclusive access, or if any other address has had a request for an exclusive access.

```
ClearExclusiveByAddress(FullAddress address, integer processorid, integer size);
```

The `ClearExclusiveLocal()` procedure takes as arguments the PE identifier `processorid`. The procedure clears the local record of PE `processorid` for which an address has had a request for an exclusive access. It is IMPLEMENTATION DEFINED whether this operation also clears the global record of PE `processorid` that an address has had a request for an exclusive access.

```
ClearExclusiveLocal(integer processorid);
```

D4.7.6 Access permission checking

The function `CheckPermission()` is used by the architecture to perform access permission checking based on attributes derived from the translation tables or location descriptors. It returns the result of the call to `AArch64.NoFault()`.

The interpretation of access permission is shown in [Memory access control on page D5-1781](#).

The pseudocode function for checking access permissions is as follows:

```
// AArch64.CheckPermission()
// =====
// Function used for permission checking from AArch64 stage 1 translations

FaultRecord AArch64.CheckPermission(Permissions perms, bits(64) vaddress, integer level,
                                     bit NS, AccType acctype, boolean iswrite)
    assert !ELUsingAArch32(TranslationRegime());

    wxn = SCTRL[].WXN == '1';

    if PSTATE.EL IN {EL0,EL1} then
        priv_r = TRUE;
        priv_w = perms.ap<2> == '0';
        user_r = perms.ap<1> == '1';
        user_w = perms.ap<2:1> == '01';
        user_x = perms.xn == '0' && !(user_w && wxn);
        priv_x = perms.pxn == '0' && !(priv_w && wxn) && !user_w;
        ispriv = PSTATE.EL == EL1 && acctype != AccType_UNPRIV;

        if ispriv then
            (r, w, x) = (priv_r, priv_w, priv_x);
        else
            (r, w, x) = (user_r, user_w, user_x);
    else
        // Access from EL2 or EL3
        r = TRUE;
        w = perms.ap<2> == '0';
        x = perms.xn == '0' && !(w && wxn);

        secure_instr_fetch = SCR_EL3.SIF; // Restriction on Secure instruction fetch
        if HaveEL(EL3) && IsSecure() && NS == '1' && secure_instr_fetch == '1' then
            x = FALSE;

        if acctype == AccType_IFETCH then
            fail = !x;
        elseif iswrite then
            fail = !w;
        else
            fail = !r;

        if fail then
            secondstage = FALSE;
            s2fs1walk = FALSE;
            ipaddress = bits(48) UNKNOWN;
            return AArch64.PermissionFault(ipaddress, level, acctype, iswrite, secondstage,
                                           s2fs1walk);
        else
            return AArch64.NoFault();
```

D4.7.7 Abort exceptions

The `Abort()` function generates either a Data Abort or an Instruction Abort exception by calling `AArch64.DataAbort()` or `AArch64.InstructionAbort()`. It also can generate a debug exception for debug related faults, see [Chapter D3 The Debug Exception Model](#).

```
// AArch64.Abort()
// =====
// Abort and Debug exception handling in an AArch64 translation regime.

AArch64.Abort(bits(64) vaddress, FaultRecord fault)

    if IsDebugException(fault) then
        if fault.acctype == AccType_IFETCH then
```

```
        if UsingAArch32() && fault.debugmoe == DebugException_VectorCatch then
            AArch64.VectorCatchException(fault);
        else
            AArch64.BreakpointException(fault);
        else
            AArch64.WatchpointException(vaddress, fault);
    elseif fault.acctype == AccType_IFETCH then
        AArch64.InstructionAbort(vaddress, fault);
    else
        AArch64.DataAbort(vaddress, fault);
```

The DataAbort() function generates a Data Abort exception, routes the exception to EL2 or EL3, and records the information required for the Exception Syndrome registers, [ESR_ELx](#). See [Exception from a Data abort on page D1-1525](#). A second stage abort might also record the intermediate physical address, IPA, but this depends on the type of the abort.

For a synchronous abort, DataAbort() also sets the FAR to the VA of the abort.

The pseudocode for the DataAbort() function is as follows:

```
// AArch64.DataAbort()
// =====

AArch64.DataAbort(bits(64) vaddress, FaultRecord fault)

    route_to_e13 = HaveEL(EL3) && SCR_EL3.EA == '1' && IsExternalAbort(fault);
    route_to_e12 = AArch64.GeneralExceptionsToEL2() || IsSecondStage(fault);

    bits(64) preferred_exception_return = ThisInstrAddr();
    exception = AArch64.AbortSyndrome(Exception_DataAbort, fault, vaddress);
    vect_offset = 0x0;

    if PSTATE.EL == EL3 || route_to_e13 then
        AArch64.TakeException(EL3, exception, preferred_exception_return, vect_offset);
    elseif PSTATE.EL == EL2 || route_to_e12 then
        AArch64.TakeException(EL2, exception, preferred_exception_return, vect_offset);
    else
        AArch64.TakeException(EL1, exception, preferred_exception_return, vect_offset);
```

The InstructionAbort() function generates an Instruction Abort exception, routes the exception to EL2 or EL3, and records the information required for the Exception Syndrome registers, [ESR_ELx](#). See [Exception from an Instruction abort on page D1-1524](#). A second stage abort might also record the intermediate physical address, IPA, but this depends on the type of the abort.

For a synchronous abort, InstructionAbort() also sets the FAR to the VA of the abort.

The pseudocode for the InstructionAbort() function is as follows:

```
// AArch64.InstructionAbort()
// =====

AArch64.InstructionAbort(bits(64) vaddress, FaultRecord fault)

    route_to_e13 = HaveEL(EL3) && SCR_EL3.EA == '1' && IsExternalAbort(fault);
    route_to_e12 = AArch64.GeneralExceptionsToEL2() || IsSecondStage(fault);

    bits(64) preferred_exception_return = ThisInstrAddr();
    exception = AArch64.AbortSyndrome(Exception_InstructionAbort, fault, vaddress);
    vect_offset = 0x0;

    if PSTATE.EL == EL3 || route_to_e13 then
        AArch64.TakeException(EL3, exception, preferred_exception_return, vect_offset);
    elseif PSTATE.EL == EL2 || route_to_e12 then
        AArch64.TakeException(EL2, exception, preferred_exception_return, vect_offset);
    else
        AArch64.TakeException(EL1, exception, preferred_exception_return, vect_offset);
```

The FaultRecord type describes a fault. Functions that check for faults return a record of this type appropriate to the type of fault. *Pseudocode details of the MMU faults on page D5-1803* provides a number of wrappers to generate FaultRecords.

The NoFault() function returns a null record that indicates no fault. The IsFault() function tests whether a FaultRecord contains a fault.

```

enumeration Fault {Fault_None,
                    Fault_AccessFlag,
                    Fault_Alignment,
                    Fault_Background,
                    Fault_Domain,
                    Fault_Permission,
                    Fault_Translation,
                    Fault_AddressSize,
                    Fault_SyncExternal,
                    Fault_SyncExternalOnWalk,
                    Fault_SyncParity,
                    Fault_SyncParityOnWalk,
                    Fault_AsyncParity,
                    Fault_AsyncExternal,
                    Fault_Debug,
                    Fault_TLBConflict,
                    Fault_Lockdown,
                    Fault_Coproc,
                    Fault_ICacheMaint};

type FaultRecord is (Fault   type,           // Fault Status
                    AccType  acctype,       // Type of access that faulted
                    bits(48) ipaddress,     // Intermediate physical address
                    boolean  s2fs1walk,    // Is on a Stage 1 page table walk
                    boolean  write,        // TRUE for a read, FALSE for a write
                    integer  level,        // For translation, access flag and permission faults
                    bit      extflag,      // IMPLEMENTATION DEFINED syndrome for external aborts
                    boolean  secondstage,  // Is a Stage 2 abort
                    bits(4)  domain,       // Domain number, AArch32 only
                    bits(4)  debugmoe)     // Debug method of entry, from AArch32 only

// AArch64.NoFault()
// =====

FaultRecord AArch64.NoFault()

    ipaddress = bits(48) UNKNOWN;
    level = integer UNKNOWN;
    acctype = AccType_NORMAL;
    iswrite = boolean UNKNOWN;
    extflag = bit UNKNOWN;
    secondstage = FALSE;
    s2fs1walk = FALSE;

    return AArch64.CreateFaultRecord(Fault_None, ipaddress, level, acctype, iswrite,
                                     extflag, secondstage, s2fs1walk);

// IsFault()
// =====
// Return true if a fault is associated with an address descriptor

boolean IsFault(AddressDescriptor addrdesc)
    return addrdesc.fault.type != Fault_None;

```

D4.7.8 Memory barriers

The definition for the memory barrier functions is:

```

enumeration MBReqDomain {MBReqDomain_Nonshareable, MBReqDomain_InnerShareable,
                        MBReqDomain_OuterShareable, MBReqDomain_FullSystem};

enumeration MBReqTypes {MBReqTypes_Reads, MBReqTypes_Writes, MBReqTypes_All};

```

These functions define the required shareability domains and required access types used as arguments for DMB and DSB instructions.

The following procedures perform the memory barriers:

```
DataMemoryBarrier(MBReqDomain domain, MBReqTypes types);
```

```
DataSynchronizationBarrier(MBReqDomain domain, MBReqTypes types);
```

```
InstructionSynchronizationBarrier();
```

Chapter D5

The AArch64 Virtual Memory System Architecture

This chapter provides a system level view of the AArch64 Virtual Memory System Architecture (VMSA), the memory system architecture of an ARMv8 implementation that is executing in AArch64 state. It contains the following sections:

- *About the Virtual Memory System Architecture (VMSA) on page D5-1708.*
- *The VMSAv8-64 address translation system on page D5-1710.*
- *Translation table walk examples on page D5-1760.*
- *VMSAv8-64 translation table format descriptors on page D5-1772.*
- *Access controls and memory region attributes on page D5-1781.*
- *MMU faults on page D5-1796.*
- *Translation Lookaside Buffers (TLBs) on page D5-1804.*
- *Caches in a VMSA implementation on page D5-1818.*

D5.1 About the Virtual Memory System Architecture (VMSA)

This chapter describes the *Virtual Memory System Architecture* (VMSA) that applies to a PE executing in AArch64 state. This is VMSAv8-64, as defined in [ARMv8 VMSA naming on page D5-1712](#).

A VMSA provides a *Memory Management Unit* (MMU), that controls address translation, access permissions, and memory attribute determination and checking, for memory accesses made by the PE.

The process of address translation maps the *virtual addresses* (VAs) used by the PE onto the *physical addresses* (PAs) of the physical memory system. These translations are defined independently for different Exception levels and Security states, and [Figure D5-1](#) shows:

Address translations when EL3 is using AArch64

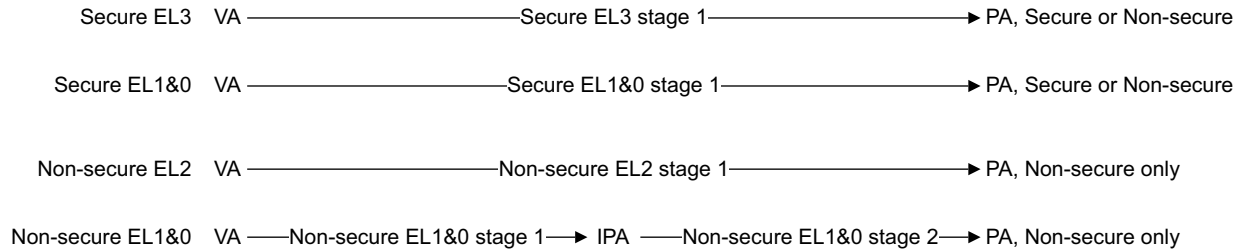

Figure D5-1 Address translations for different Exception levels and Security states

VMSAv8-64 supports tagging of VAs, as described in [Address tagging in AArch64 state](#). As that section describes, this address tagging has no effect on the address translation process.

The remainder of this chapter gives a full description of VMSAv8-64 for an implementation that includes all of the Exception levels. [The implemented Exception levels and the resulting translation stages and regimes on page D5-1745](#) describes the differences in the VMSA if some Exception levels are not implemented.

D5.1.1 Address tagging in AArch64 state

In AArch64 state, the ARMv8 architecture supports tagged addresses for data values. In these cases the top eight bits of the virtual address are ignored when determining:

- Whether the address causes a Translation fault from being out of range if the translation system is enabled.
- Whether the address causes an Address size fault from being out of range if the translation system is not enabled.
- Whether the address requires invalidation when performing a TLB invalidation instruction by address.

The use of address tags is controlled as follows:

For addresses using the VMSAv8-64 EL1&0 translation regime

By [TCR_EL1.TBI0](#) when [TTBR0_EL1](#) holds the base address of the translation tables used to translate the address.

By [TCR_EL1.TBI1](#) when [TTBR1_EL1](#) holds the base address of the translation tables used to translate the address.

For addresses using the VMSAv8-64 EL2 translation regime

By [TCR_EL2.TBI](#). In this case, [TTBR0_EL2](#) holds the base address of the translation tables used to translate the address.

For addresses using the VMSAv8-64 EL3 translation regime

By [TCR_EL3.TBI](#). In this case, [TTBR0_EL3](#) holds the base address of the translation tables used to translate the address.

An address tag enable bit also has an effect on the PC value in the following cases:

- Any branch or procedure return within the controlled Exception level.
- On taking an exception to the controlled Exception level, regardless of whether this is also the Exception level from which the exception was taken.
- On performing an exception return to the controlled Exception level, regardless of whether this is also the Exception level from which the exception return was performed.
- Exiting from debug state to the controlled Exception level.

———— **Note** ————

As an example of what is meant by the *controlled Exception level*, [TCR_EL2.TBI](#) controls this effect for:

- A branch or procedure return within EL2
- Taking an exception to EL2.
- Performing an exception return or a debug state exit to EL2.

The effect of the controlling $TBI\{n\}$ bit is:

For EL0 or EL1 If the controlling TBI_n bit for the address being loaded into the PC is set to 1, then bits[63:56] of the PC are forced to be a sign extension of bit[55] of that address.

For EL2 or EL3 If the controlling TBI bit for the address being loaded into the PC is set to 1, then bits[63:56] of the PC are forced to be 0x00.

The `AddrTop()` pseudocode function shows the algorithm determining the most significant bit of the VA, and therefore whether the virtual address is using tagging. For the EL1&0 translation regime, this pseudocode included the selection between [TTBR0_EL1](#) and [TTBR1_EL1](#) described in [Selection between TTBR0 and TTBR1 on page D5-1736](#).

```
// AddrTop()
// =====

integer AddrTop(bits(64) address)
// Return the MSB number of a virtual address in the current stage 1 translation
// regime. If EL1 is using AArch64 then addresses from EL0 using AArch32
// are zero-extended to 64 bits.
if UsingAArch32() && !(PSTATE.EL == EL0 && !ELUsingAArch32(EL1)) then
    // AArch32 translation regime.
    return 31;
else
    // AArch64 translation regime.
    case PSTATE.EL of
        when EL0, EL1
            tbi = if address<55> == '1' then TCR_EL1.TBI1 else TCR_EL1.TBI0;
        when EL2
            tbi = TCR_EL2.TBI;
        when EL3
            tbi = TCR_EL3.TBI;
    return (if tbi == '1' then 55 else 63);
```

———— **Note** ————

- The required behavior prevents a tagged address being propagated to the program counter.
- The [TCR_ELx.TBI_n](#) bits have an effect whether that translation regime is enabled or not.

D5.2 The VMSAv8-64 address translation system

This section describes the VMSAv8-64 address translation system, that maps VAs to PAs. Related to this:

- [Translation table walk examples on page D5-1760](#) gives detailed descriptions of typical examples of translating a VA to a final PA, and obtaining the memory attributes of that PA.
- [VMSAv8-64 translation table format descriptors on page D5-1772](#) describes the translation table entries.
- [Access controls and memory region attributes on page D5-1781](#) describes the attributes that are held in the translation table entries, including how different attributes can interact.
- [Translation Lookaside Buffers \(TLBs\) on page D5-1804](#) describes the caching of translation table lookups in TLBs, and the architected instructions for maintaining TLBs.

In this section, the following subsections describe the VMSAv8-64 address translation system:

- [About the VMSAv8-64 address translation system.](#)
- [Controlling address translation stages on page D5-1714.](#)
- [Memory translation granule size on page D5-1716.](#)
- [Translation tables and the translation process on page D5-1721.](#)
- [Overview of the VMSAv8-64 address translation stages on page D5-1724.](#)
- [The VMSAv8-64 translation table format on page D5-1733.](#)
- [The algorithm for finding the translation table entries on page D5-1739.](#)
- [The effects of disabling a stage of address translation on page D5-1743.](#)
- [The implemented Exception levels and the resulting translation stages and regimes on page D5-1745.](#)
- [Pseudocode details of VMSAv8-64 address translation on page D5-1745.](#)
- [Address translation operations on page D5-1756.](#)

D5.2.1 About the VMSAv8-64 address translation system

The *Memory Management Unit* (MMU) controls address translation, memory access permissions, and memory attribute determination and checking, for memory accesses made by the PE.

The general model of MMU operation is that the MMU takes information about a required memory access, including an *input address* (IA), and either:

- Returns an associated *output address* (OA), and the *memory attributes* for that address.
- Is unable to perform the translation for one of a number of reasons, and therefore causes an exception to be generated. This exception is called an MMU fault. An MMU fault is generated by a particular stage of translation, and can be described as either a stage 1 MMU fault or a stage 2 MMU fault.

The process of mapping an IA to an OA is an *address translation*, or more precisely a single stage of address translation.

The architecture defines a number of *translation regimes*, where a translation regime comprises either:

- A single stage of address translation.
This maps an input *Virtual Address* (VA) to an output *Physical Address* (PA).
- Two, sequential, stages of address translation, where:
 - Stage 1 maps an input VA to an output *Intermediate Physical Address* (IPA).
 - Stage 2 maps an input IPA to an output PA.

The *translation granule* specifies the granularity of the mapping from IA to OA. That is, it defines both:

- The *page size* for a stage of address translation, where a page is the smallest block of memory for which an IA to OA mapping can be specified.
- The size of a complete translation table for that stage of address translation.

The MMU is controlled by System registers, that provide independent control of each address translation stage, including a control to disable the stage of address translation. [The effects of disabling a stage of address translation on page D5-1743](#) defines how the MMU handles an access for which a required address translation stage is disabled.

Note

- In the ARM architecture, a software agent, such as an operating system, that uses or defines stage 1 memory translations, might be unaware of the second stage of translation, and of the distinction between IPA and PA.
- A more generalized description of the translation regimes is that a regime always comprises two sequential stages of translation, but in some regimes the stage 2 translation both:
 - Returns an OA that equals the IA. This is called a *flat mapping* of the IA to the OA.
 - Does not change the memory attributes returned by the stage 1 address translation.

For an access to a stage of address translation that does not generate an MMU fault, the MMU translates the IA to the corresponding OA. System control registers are used to report any faults that occur on a memory access.

This section describes the address translation system for an implementation that includes all of the Exception levels, and gives a complete description of translations that are controlled by an Exception level that is using AArch64.

[Figure D5-2](#) shows these translation stages and translation regimes when EL3 is using AArch64.

Translation regimes, when EL3 is using AArch64

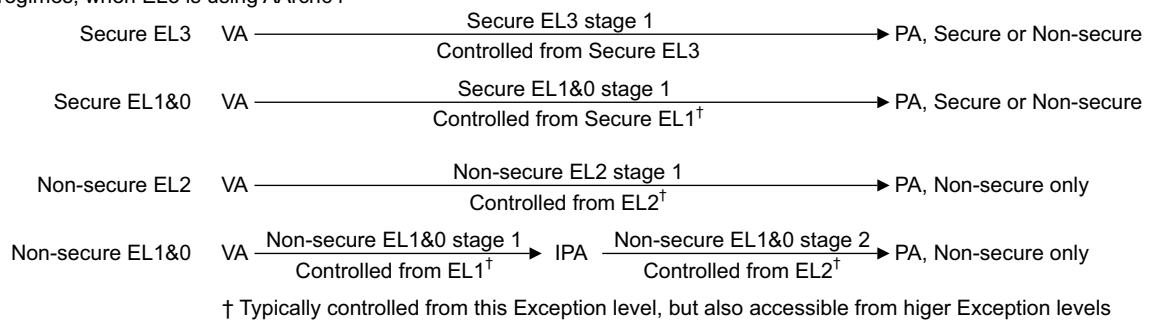

Figure D5-2 VMSAv8 AArch64 translation regimes, translation stages, and associated controls

[ARMv8 VMSA naming on page D5-1712](#) gives more information about the options for the different stages of address translation shown in [Figure D5-2](#), and:

- [Chapter G3 The AArch32 Virtual Memory System Architecture](#) describes:
 - The translation stages and translation regimes when EL3 is using AArch32.
 - Any stages of address translation that are using VMSAv8-32 when EL3 is using AArch64.
- [The implemented Exception levels and the resulting translation stages and regimes on page D5-1745](#) describes the effect on the address translation model when some Exception levels are not implemented.

Each enabled stage of address translation uses a set of address translations and associated memory properties held in memory mapped tables called *translation tables*. A single translation table lookup can resolve only a limited number of bits of the IA, and therefore a single address translation can require multiple lookups. These are described as different *levels* of lookup.

Translation table entries can be cached in a *Translation Lookaside Buffer (TLB)*.

As well as defining the OA that corresponds to the IA, the translation table entries define the following properties:

- Access to the Secure or Non-secure address map, for accesses made from Secure state.
- Memory access permission control.
- Memory region attributes.

For more information, see [Memory attribute fields in the VMSAv8-64 translation table format descriptors on page D5-1776](#).

The following subsections give more information:

- [ARMv8 VMSA naming](#).
- [VMSA address types and address spaces](#).
- [About address translation on page D5-1713](#).
- [The VMsAv8-64 translation table format on page D5-1713](#).

ARMv8 VMSA naming

The ARMv8 VMSA naming model reflects the possible stages of address translation, as follows:

- VMsAv8** The overall translation scheme, within which an address translation has one or two stages.
- VMsAv8-32** The translation scheme for a single stage of address translation that is managed from an Exception level that is using AArch32.
- VMsAv8-64** The translation scheme for a single stage of address translation that is managed from an Exception level that is using AArch64.

VMSA address types and address spaces

A description of the VMSA refers to the following address types.

———— Note —————

These descriptions relate to the VMsAv8 description and therefore give more detail than the generic definitions given in the glossary.

Virtual Address (VA)

An address used in an instruction, as a data or instruction address, is a Virtual Address (VA).

———— Note —————

This means that an address held in the PC, LR, an ELR, or SP, is a VA.

In AArch64 state, the VA address space has a maximum address width of 48 bits. With a single VA range this gives a maximum VA space of 256TB, with VA range of 0x0000_0000_0000_0000 to 0x0000_FFFF_FFFF_FFFF.

However, for the EL1&0 translation stage the VA range is split into two subranges, one at the bottom of the full 64-bit address range of the PC, and one at the top, as follows:

- The bottom VA range runs up from address 0x0000_0000_0000_0000. With the maximum address width of 48 bits this gives a VA range of 0x0000_0000_0000_0000 to 0x0000_FFFF_FFFF_FFFF.
- The top VA subrange runs up to address 0xFFFF_FFFF_FFFF_FFFF. With the maximum address width of 48 bits this gives a VA range of 0xFFFF_0000_0000_0000 to 0xFFFF_FFFF_FFFF_FFFF. Reducing the address width for this subrange increases the bottom address of the range.

This means that there are two VA subranges, each of up to 256TB.

Each translation regime, that takes a VA as an input address, can be configured to support fewer than 48 bits of virtual address space, see [Address size configuration on page D5-1715](#).

Intermediate Physical Address (IPA)

In a translation regime that provides two stages of address translation, the IPA is:

- The OA from the stage 1 translation.
- The IA for the stage 2 translation.

In a translation regime that provides only one stage of address translation, the IPA is identical to the PA. Alternatively, the translation regime can be considered as having no concept of IPAs.

The IPA address space has a maximum address width of 48 bits, see [Address size configuration on page D5-1715](#).

Physical Address (PA)

The address of a location in a physical memory map. That is, an output address from the PE to the memory system.

The EL3 and Secure EL1 Exception levels provide independent definition of physical address spaces for Secure and Non-secure operation. This means they provide two independent address spaces, where:

- A VA accessed in Secure state can be translated to either the Secure or the Non-secure physical address space.
- When in Non-secure state, a virtual address is always mapped to the Non-secure physical address space.

Each PA address space has a maximum address width of 48 bits, but an implementation can implement fewer than 48 bits of physical address. See [Address size configuration on page D5-1715](#).

About address translation

For a single stage of address translation, a *Translation table base register (TTBR)* indicates the start of the first translation table required for that mapping. Each implemented translation stage shown in [VMSAv8 AArch64 translation regimes, translation stages, and associated controls on page D5-1711](#) requires its own set of translation tables.

For the EL1&0 stage 1 translation, the split of the VA mapping into two subranges requires two tables, one for the lower part of the VA space, and the other for the upper part of the VA space. [Example use of the split VA range, and the TTBR0_EL1 and TTBR1_EL1 controls on page D5-1736](#) shows how these ranges might be used.

[Controlling address translation stages on page D5-1714](#) summarizes the system control registers that control address translation by the MMU.

A full translation table lookup is called a *translation table walk*. It is performed automatically by hardware, and can have a significant cost in execution time. To support fine granularity of the VA to PA mapping, a single IA to OA translation can require multiple accesses to the translation tables, with each access giving finer granularity. Each access is described as a *level* of address lookup. The final level of the lookup defines:

- The high bits of the required output address.
- The *attributes* and *access permissions* of the addressed memory.

Translation table entries can be cached in a *Translation Lookaside Buffer*, see [Translation Lookaside Buffers \(TLBs\) on page D5-1804](#).

The VMSAv8-64 translation table format

Stages of address translation that are controlled by an Exception level that is using AArch64 use the VMSAv8-64 translation table format. This format uses 64-bit descriptor entries in the translation tables.

————— Note —————

This format is an extension of the VMSAv8-32 Long-descriptor translation table format originally defined by the ARMv7 Large Physical Address Extension, and extended slightly by ARMv8. VMSAv8-32 also supports a Short-descriptor translation table format. [Chapter G3 The AArch32 Virtual Memory System Architecture](#) describes both of these formats.

The VMSAv8-64 translation table format provides:

- Up to four levels of address lookup.
- Input addresses of up to 48 bits.
- Output addresses of up to 48 bits.
- A translation granule size of 4KB, 16KB, or 64KB.

D5.2.2 Controlling address translation stages

The implemented *Exception levels and the resulting translation stages and regimes* on page D5-1745 defines the translation regimes and stages. For each supported address translation stage:

- A system control register bit enables the stage of address translation.
- A system control register bit determines the endianness of the translation table lookups.
- A *Translation Control Register (TCR)* controls the stage of address translation.
- If a stage of address translation supports splitting the VA range into two subranges then that stage of translation provides a *Translation Table Base Register (TTBR)* for each VA subrange, and the stage of address translation has:
 - A single **TCR**.
 - A **TTBR** for each VA subrange.

Otherwise, a single **TTBR** holds the address of the translation table that must be used for the first lookup for the stage of address translation.

For address translation stages controlled from AArch64:

- [Table D5-1](#) shows the endianness bit and the enable bit for each stage of address translation. Each register entry in the table gives the endianness bit followed by the enable bit. Except for the Non-secure EL1&0 stage 2 translation, these two bits are in the same register.

Table D5-1 Enable and endianness bits for the AArch64 translation stages

Translation stage	Controlled from	Controlling register
Secure EL3 stage 1	EL3	SCTLR_EL3 .{EE, M}
Secure EL1&0 stage 1	Secure EL1	SCTLR_EL1 .{EE, M}
Non-secure EL2 stage 1	EL2	SCTLR_EL2 .{EE, M}
Non-secure EL1&0 stage 2	EL2	SCTLR_EL2 .EE, HCR_EL2 .VM
Non-secure EL1&0 stage 1	Non-secure EL1	SCTLR_EL1 .{EE, M}

Note

If the PA of the software that enables or disables a particular stage of address translation differs from its VA, speculative instruction fetching can cause complications. ARM strongly recommends that the PA and VA of any software that enables or disables a stage of address translation are identical if that stage of translation controls translations that apply to the software currently being executed.

- [Table D5-2](#) shows the **TCR** and **TTBR**, or **TTBRs**, for each stage of address translation. In the table, each *Controlling registers* entry gives the **TCR** followed by the **TTBR** or **TTBRs**.

Table D5-2 TCrs and TTBRs for the AArch64 translation stages

Translation stage	Controlled from	Controlling registers
Secure EL3 stage 1	EL3	TCR_EL3 , TTBR0_EL3
Secure EL1&0 stage 1	Secure EL1	TCR_EL1 , TTBR0_EL1 , TTBR1_EL1
Non-secure EL2 stage 1	EL2	TCR_EL2 , TTBR0_EL2
Non-secure EL1&0 stage 2	EL2	VTCR_EL2 , VTTBR_EL2
Non-secure EL1&0 stage 1	Non-secure EL1	TCR_EL1 , TTBR0_EL1 , TTBR1_EL1

System control registers relevant to MMU operation

In AArch64 state, system control registers have a suffix, that indicates the lowest Exception level from which they can be accessed. In some general descriptions of MMU control and address translation, this chapter uses a *Common abbreviation* for each of the system control registers that affects MMU operation, as [Table D5-3](#) shows. The common abbreviation is used when describing features that apply to all the translation regimes.

———— **Note** —————

The only translation regime that supports a stage 2 translation is the Non-secure EL1&0 translation regime.

Table D5-3 Abbreviations for system control registers used in this chapter

Common abbreviation	Translation stage	Exception level		
		EL1	EL2	EL3
HCR	-	-	HCR_EL2	-
SCTLR	-	SCTLR_EL1	SCTLR_EL2	SCTLR_EL3
TCR	Stage 1	TCR_EL1	TCR_EL2	TCR_EL3
	Stage 2	-	VTCR_EL2	-
TTBR	Stage 1	TTBR0_EL1, TTBR1_EL1	TTBR0_EL2	TTBR0_EL3
	Stage 2	-	VTTBR_EL2	-

Address size configuration

The following subsections specify the configuration of the physical address size and of the input and output address sizes for each of the stages of address translation.

Physical address size

The [ID_AA64MMFR0_EL1.PARange](#) field indicates the implemented physical address size, as [Table D5-4](#) shows:

Table D5-4 Physical address size implementation options

ID_AA64MMFR0_EL1.PARange	Total PA size	PA address size
0000	4 GB	32 bits, PA[31:0]
0001	64 GB	36 bits, PA[35:0]
0010	1 TB	40 bits, PA[39:0]
0011	4 TB	42 bits, PA[41:0]
0100	16 TB	44 bits, PA[43:0]
0101	256 TB	48 bits, PA[47:0]

Output address size

For each enabled stage of address translation, [TCR.{I}PS](#) must be programmed to maximum output address size for that stage of translation, using the same encodings as shown in [Table D5-4](#).

Note

- This field is called IPS in the [TCR_EL1](#), and PS in the other [TCRs](#).
 - The {I}PS fields are 3-bit fields, corresponding to the least-significant PARange bits shown in [Table D5-4](#) on page [D5-1715](#).
-

This field is used to check that translation table entries and the [TTBR](#) for the stage of address translation have the address bits above the specified PA size set to zero. If this is not the case, an Address size fault is generated for the level of translation that caused the fault. An Address size fault from the [TTBR](#) is reported as a Level 0 fault.

If the specified output address size is larger than the implemented physical address size then an Address size fault is generated for the translation stage and level that generates the output address. When stage 2 translation is disabled, if the output address from the stage 1 translation is larger than the implemented physical address size this is reported as a Stage 1 Address size fault.

If stage 1 translation is disabled, if the input address is larger than the implemented physical address size then an Address size fault is generated and reported as a Stage 1 level 0 fault.

Input address size

For each enabled stage of address translation, the [TCR.TxSZ](#) fields specify the input address size:

- [TCR_EL1](#) has two TxSZ fields, corresponding to the two VA subranges:
 - [TCR_EL1.T0SZ](#) specifies the size for the lower VA range, translated using [TTBR0_EL1](#).
 - [TCR_EL1.T1SZ](#) specifies the size for the upper VA range, translated using [TTBR1_EL1](#).
- Each of the other [TCRs](#) has a single T0SZ field.

For the Non-secure EL1&0 translation regime, when both stages of translation are enabled, if the output address from the stage 1 translation does not generate a stage 1 address size fault, and is larger than the input address specified by [VTCCR_EL2.T0SZ](#), then the input address size check for the stage 2 translation generates a Translation fault. This check is not affected by the implemented physical address size.

D5.2.3 Memory translation granule size

The memory translation granule size defines both:

- The maximum size of a single translation table.
- The memory *page* size. That is, the granularity of a translation table lookup.

VMSAv8-64 supports translation granule sizes of 4KB, 16KB, and 64KB, and each translation stage is configured to use one of these granule sizes.

Note

Using a larger granule size can reduce the maximum required number of levels of address lookup because:

- The increased translation table size means the translation table holds more entries. This means a single lookup can resolve more bits of the input address.
 - The increased page size means more of the least-significant address bits are required to address a page. These address bits are flat mapped from the input address to the output address, and therefore do not require translation.
-

Table D5-5 summarizes the effects of the different granule sizes.

Table D5-5 Effect of granule size on a stage of address translation

Property	4KB granule	16KB granule	64KB granule	Notes
Maximum number of entries in a translation table	512	2048 (2K)	8192 (8K)	-
Address bits resolved in one level of lookup	9	11	13	$2^9=512$, $2^{11}=2K$, $2^{13}=8K$
Page size	4KB	16KB	64KB	-
Page address range	VA[11:0]= PA[11:0]	VA[13:0]= PA[13:0]	VA[15:0]= PA[15:0]	$2^{12}=4K$, $2^{14}=16K$, $2^{16}=64K$

How the granule size affects the address translation process

As Table D5-5 shows, the translation granule determines the number of address bits:

- Required to address a memory page.
- That can be resolved in a single translation table lookup.

This means the translation granule determines how the *input address* (IA) is resolved to an *output address* (OA) by the translation process.

Because a single translation table lookup can resolve only a limited number of address bits, the IA to OA resolution requires multiple *levels* of lookup.

Considering the resolution of the maximum IA range of 48 bits, with a translation granule size of 2^n bytes:

- The least-significant n bits of the IA address the memory page. This means $OA[(n-1):0]=IA[(n-1):0]$.
- The remaining $(48-n)$ bits of the IA, $IA[47:n]$, must be resolved by the address translation.
- A translation table descriptor is 8 bytes. Therefore:
 - A complete translation table holds $2^{(n-3)}$ descriptors.
 - A single level of translation can resolve a maximum of $(n-3)$ bits of address.

Consider the translation process, working back from the final level of lookup, that resolves the least significant of the address bits that require translation. Because a level of lookup can resolve $(n-3)$ bits of address:

- The final level of lookup resolves $IA[(2n-4):n]$.
- The previous level of lookup resolves $IA[(3n-7):(2n-3)]$.

However, the level of lookup that resolves the most significant bits of the IA might not require a full-sized translation table. Therefore, in general, the address bits resolved in a level of lookup are:

$IA[\text{Min}(47, ((x-3)(n-3)+2n-4)): (n+(x-3)(n-3))]$, where:

Min(a , b) Is a function that returns the minimum of a and b .

x Indicates the level of lookup. This is defined so that the level that resolves the least significant of the translated IA bits is the third level.

The following diagrams show this model, for each of the permitted granule sizes.

Figure D5-3 on page D5-1718 shows how a 48-bit IA is resolved when using the 4KB translation granule.

Using the 4KB translation granule

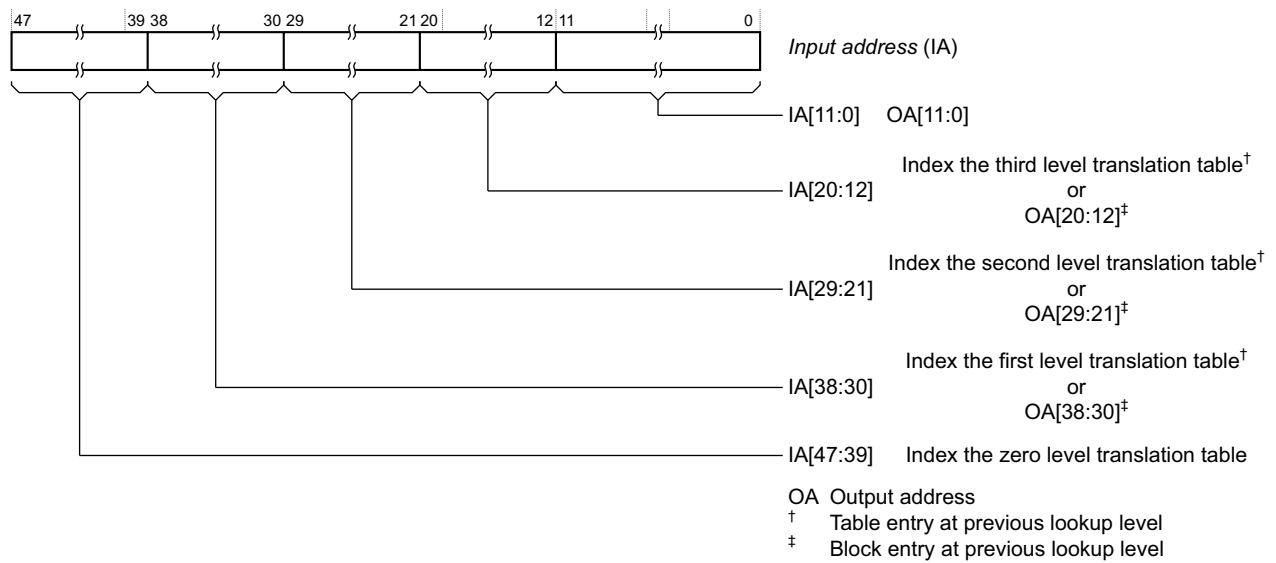

Figure D5-3 How the IA is resolved when using the 4KB translation granule

Figure D5-4 shows how a 48-bit IA is resolved when using the 16KB translation granule.

Using the 16KB translation granule

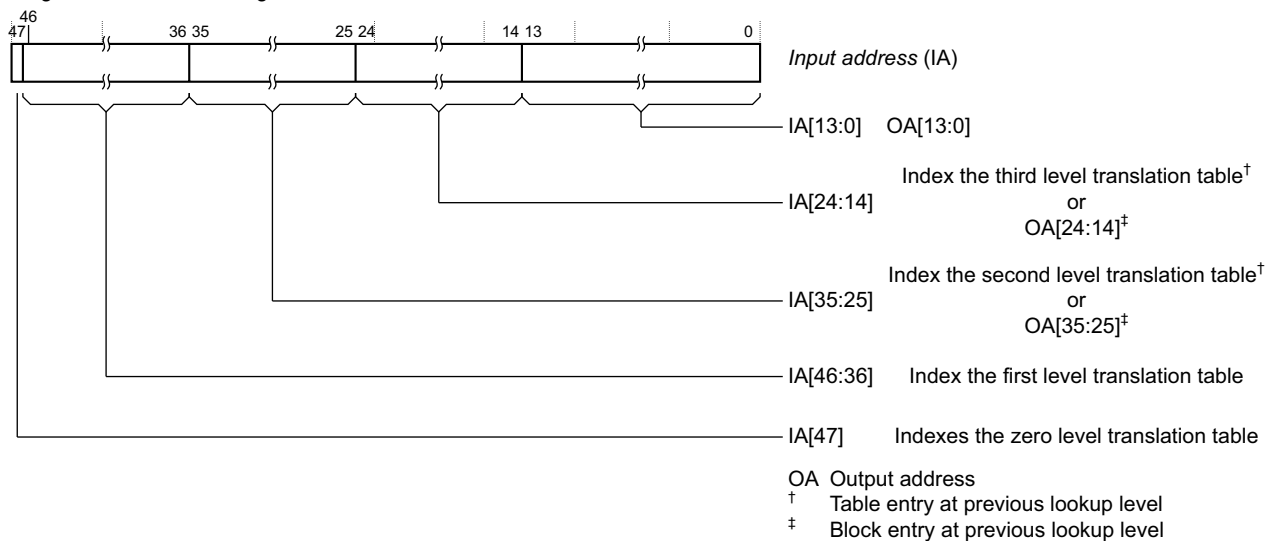

Figure D5-4 How the IA is resolved when using the 16KB translation granule

Figure D5-5 on page D5-1719 shows how a 48-bit IA is resolved when using the 64KB translation granule.

Using the 64KB translation granule

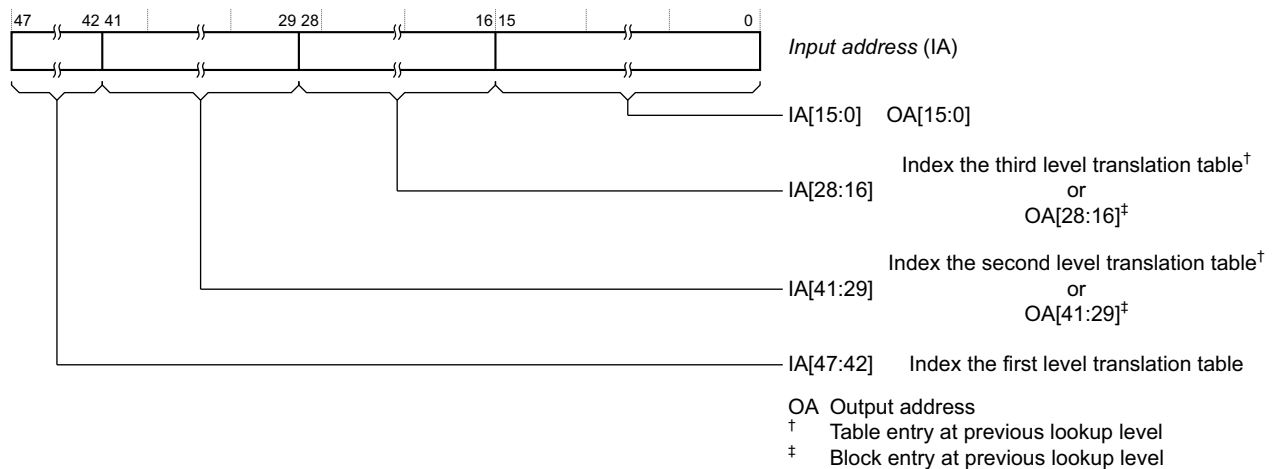

Figure D5-5 How the IA is resolved when using the 64KB translation granule

Later sections of this chapter give more information about the translation process, and explain the terminology used in these figures.

Effect of granule size on translation table addressing and indexing

Table D5-6 shows the effect of the translation granule size on the addressing and indexing of the TTBR, and on the input address range that must be resolved:

Table D5-6 The effect of translation granule size on the translation tables

Granule size	Translation table		Translation resolves ^a	Notes
	Addressed by	Indexed by ^b		
4KB	TTBR[47:12]	IA[(x + 8):x]	IA[47:12]	One level of lookup resolves up to ^c 9 bits of IA
16KB	TTBR[47:14]	IA[(x + 10):x]	IA[47:14]	One level of lookup resolves up to ^c 11 bits of IA
64KB	TTBR[47:16]	IA[(x + 12):x]	IA[47:16]	One level of lookup resolves up to ^c 13 bits of IA

- When translating a maximum-sized input address of 48 bits, and accessing a page of memory.
- Where the value of x depends on the lookup level, see Table D5-7.
- Depending on the IA size, the initial lookup might resolve fewer bits of the IA.

Table D5-7 shows the IA bits resolved at each level of lookup, and how these correspond to the possible values of x in Table D5-6.

Table D5-7 IA bits resolved at different levels of lookup

Lookup level	4KB granule size	16KB granule size	64KB granule size
Zero	IA[47:39], $x = 39$	IA[47 ^a], $x = 47$	- ^b
First	IA[38:30], $x = 30$	IA[46:36], $x = 36$	IA[47 ^a :42], $x = 42$
Second	IA[29:21], $x = 21$	IA[35:25], $x = 25$	IA[41:29], $x = 29$
Third	IA[20:12], $x = 12$	IA[24:14], $x = 14$	IA[28:16], $x = 16$

- Smaller value than indicated in Table D5-6, as explained in this section.

- b. Zero-level lookup not possible with 64KB granule size

Table D5-6 on page D5-1719 refers to accessing a complete translation table, of 4KB, 16KB, or 64KB. However, the ARMv8 translation system supports the following possible variations from the information in Table D5-6 on page D5-1719:

Reduced IA width

Depending on the configuration and implementation choices, the required input address width for the initial level of lookup might be smaller than the number of address bits that can be resolved at that level. This means that, for this initial level of lookup:

- The translation table size is reduced. For each 1 bit reduction in the input address size the size of the translation table is halved.

Note

- This has no effect on the translation table size for subsequent levels of lookup, for which the lookups always use full-sized translation tables.
- For a stage 2 translation, it might be possible to start the translation at a lower level, see *Concatenated translation tables*.

- More low-order TTBR bits are needed to hold the translation table base address.

Example D5-1 shows how this applies to translating a 35-bit input address range using the 4KB granule.

Example D5-1 Effect of an IA width of 35 bits when using the 4KB granule size

With a 4KB granule size, a single level of lookup can resolve up to 9 bits of IA. If an implementation has a 35-bit input address range, IA[34:0], Table D5-7 on page D5-1719 shows that lookup must start at the first level, and that the initial lookup must resolve IA[34:30], meaning it resolves 5 bits of address: This 4-bit reduction in the required resolution means:

- The translation table size is divided by 2^4 , giving a size of 256B.
- The TTBR requires 4 more bits for the translation table base address, which becomes TTBR[47:8].

When using the 64KB translation granule to translate the maximum IA size of 48 bits, Table D5-7 on page D5-1719 shows that a first level lookup must resolve only IA[47:42]. This is 6 bits of address, compared to the 13 bits that can be resolved at a single level of lookup. This 7-bit reduction in the required resolution means:

- The translation table size is divided by 2^7 , giving a size of 512B.
- The TTBR requires 7 more bits for the translation table base address, which becomes TTBR[47:9].

Concatenated translation tables

For stage 2 address translations, for the initial lookup, up to 16 translation tables can be concatenated. This means additional IA bits can be resolved at that lookup level. Each additional IA bit resolved:

- Doubles the number of translation tables required. Resolving an additional n bits requires 2^n concatenated translation tables at the initial lookup level.
- Reduces by 1 bit the width of the translation table base address held in the TTBR.

This means that, for the initial lookup of a stage 2 translation table, the IA ranges shown in Table D5-7 on page D5-1719 can be extended by up to 4 bits. Example D5-2 on page D5-1721 shows how concatenation can be used to resolve a 40-bit IA when using the 4KB translation granule.

Example D5-2 Concatenating translation tables to resolve a 40-bit IA range, with the 4K granule

Table D5-7 on page D5-1719 shows that, when using the 4KB translation granule, a first-level lookup can resolve a 39-bit IA, with the first lookup resolving IA[38:30]. For a stage 2 translation, to extend the IA width to 40 bits and resolve IA[39:30] with the first lookup:

- Two translation tables are concatenated, giving a total size of 8KB.
- The **TTBR** requires 1 fewer bit for the translation table base address, which becomes **TTBR**[47:13].

For more information, see *Concatenated translation tables for the initial stage 2 lookup* on page D5-1737.

In all cases, the translation table, or block of concatenated translation tables, must be aligned to the actual size of the table or block of concatenated tables.

The translation table base address held in the **TTBR** is defined in the OA map for that stage of address translation. The information given in this section assumes this stage of translation has an OA size of 48 bits, meaning the translation table base address is:

- **TTBR**[47:12] if using the 4KB translation granule.
- **TTBR**[47:14] if using the 16KB translation granule.
- **TTBR**[47:16] if using the 64KB translation granule.

If the OA address is smaller than 48 bits then the upper bits of this field must be written as zero. For example, for a 40-bit OA range:

- If using the 4KB translation granule:
 - **TTBR**[39:12] holds the translation table base address.
 - **TTBR**[47:40] must be set to zero.
- If using the 16KB translation granule:
 - **TTBR**[39:14] holds the translation table base address.
 - **TTBR**[47:40] must be set to zero.
- If using the 64KB translation granule:
 - **TTBR**[39:16] holds the translation table base address.
 - **TTBR**[47:40] must be set to zero.

In all cases, if **TTBR**[47:40] is not zero, any attempt to access the translation table generates an Address size fault.

D5.2.4 Translation tables and the translation process

The following subsections describe general properties of the translation tables and translation table walks, that are largely independent of the translation table format:

- *Translation table walks.*
- *Security state of translation table lookups* on page D5-1723.
- *Control of translation table walks* on page D5-1724.
- *Security state of translation table lookups* on page D5-1723.

See also *Selection between TTBR0 and TTBR1* on page D5-1736.

Translation table walks

A *translation table walk* comprises one or more *translation table lookups*. The translation table walk is the set of lookups that are required to translate the virtual address to the physical address. For the Non-secure EL1&0 translation regime, this set includes lookups for both the stage 1 translation and the stage 2 translation. The information returned by a successful translation table walk is:

- The required physical address. If the access is from Secure state this includes identifying whether the access is to the Secure physical address space or the Non-secure physical address space, see *Security state of translation table lookups* on page D5-1723.

- The memory attributes for the target memory region, as described in *Memory types and attributes* on page B2-89. For more information about how the translation table descriptors specify these attributes see *Memory region attributes* on page D5-1788.
- The access permissions for the target memory regions. For more information about how the translation table descriptors specify these permissions see *Memory access control* on page D5-1781.

The translation table walk starts with a read of the translation table for the initial lookup. The TTBR for the stage of translation holds the base address of this table. Each translation table lookup returns a descriptor, that indicates one of the following:

- The entry is the final entry of the walk. In this case, the entry contains the OA, and the permissions and attributes for the access.
- An additional level of lookup is required. In this case, the entry contains the translation table base address for that lookup. In addition:
 - The descriptor provides hierarchical attributes that are applied to the final translation, see *Hierarchical control of Secure or Non-secure memory accesses* on page D5-1780 and *Hierarchical control of data access permissions* on page D5-1783.
 - If the translation is in a Secure translation regime, the descriptor indicates whether that base address is in the Secure or Non-secure address space, unless a hierarchical control at a previous level of lookup has indicated that it must be in the Non-secure address space.
- The descriptor is invalid. In this case, the memory access generates a Translation fault.

Figure D5-6 gives a generalized view of a single stage of address translation, where three levels of lookup are required.

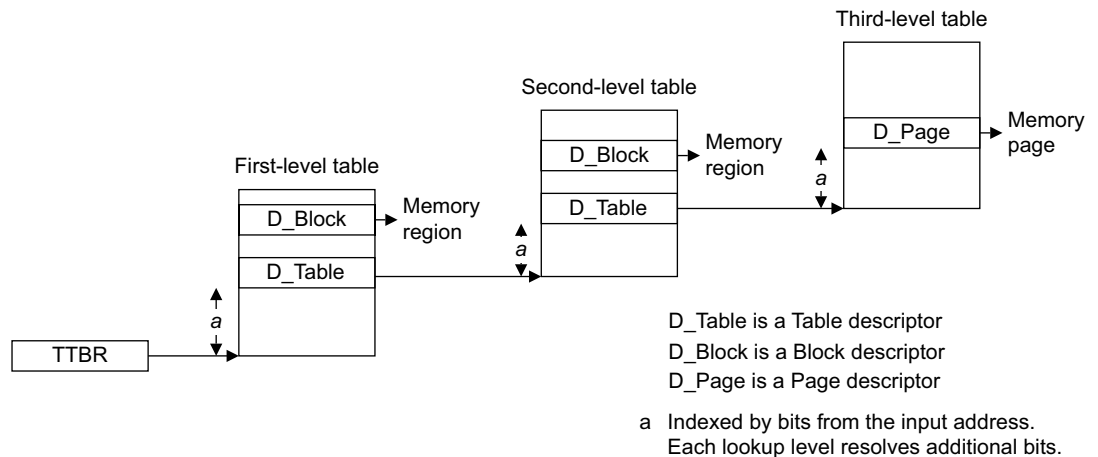

Figure D5-6 Generalized view of a stage of address translation

A translation table lookup from VMSAv8-64 performs a single-copy atomic 64-bit access to the translation table entry. This means the translation table entry is treated as a 64-bit object for the purpose of endianness. SCTLR.EE determines the endianness of the translation table lookups.

Note

Dynamically changing translation table endianness

Because any change to an SCTLR.EE, bit requires synchronization before it is visible to subsequent operations, ARM strongly recommends that any EE bit is changed only when either:

- Executing at an Exception level that does not use the translation tables affected by the EE bit being changed.
- Executing with address translation disabled for any stage of translation affected by the EE bit being changed.

Address translation stages are disabled by setting an [SCTLR.M](#) bit to 0. See the appropriate register description for more information.

The appropriate [TTBR](#) holds the output address of the base of the translation table used for the initial lookup, and:

- For all address translation stages other than Non-secure EL1&0 stage 1 translations, the output address held in the [TTBR](#), and any translation table base address returned by a translation table descriptor, is the PA of the base of the translation table.
- For Non-secure EL1&0 stage 1 translations, the output address held in the [TTBR](#), and any translation table base address returned by a translation table descriptor, is the IPA of the base of the translation table. This means that if stage 2 address translation is enabled, each of these OAs is subject to second stage translation.

Note

TLB caching can be used to minimise the number of translation table lookups that must be performed. Because each stage 1 OA generated during a translation table walk is subject to a stage 2 translation, if the caching of translation table entries is ineffective, a VA to PA address translation with two stages of translation can give rise to multiple translation table lookups. The number of lookups required is given by the following equation:

$$(S1+1)*(S2+1) - 1$$

Where, for the Non-secure EL1&0 translation regime, S1 is the number of levels of lookup required for at stage 1 translation, and S2 is the number of levels of lookup required for a stage 2 translation.

The [TTBR](#) also determines the memory cacheability and shareability attributes that apply, for that stage of translation, to all translation table lookups generated by that stage of translation.

The Normal memory type is the memory type defined for a translation table lookup for a stage of translation.

Note

- In a two stage translation system, a translation table lookup from stage 1, that has the Normal memory type defined at stage 1 by this rule, can still be given the Device memory type as part of the stage 2 translation of that address. ARM strongly recommends against such a remapping of the memory type, and the architecture includes a trap of this behavior to EL2. For more information, see [Stage 2 fault on a stage 1 translation table walk on page D5-1801](#).
- The rules about mismatched attributes given in [Mismatched memory attributes on page B2-98](#) apply to the relationship between translation table walks and explicit memory accesses to the translation tables in the same way that they apply to the relationship between different explicit memory accesses to the same location. For this reason, ARM strongly recommends that the attributes that the [TTBR](#) applies to the translation tables are the same as the attributes that are applied for explicit accesses to the memory that holds the translation tables.

For more information see [Overview of the VMSAv8-64 address translation stages on page D5-1724](#).

See also [Selection between TTBR0 and TTBR1 on page D5-1736](#).

Security state of translation table lookups

For a Non-secure translation regime, all translation table lookups are performed to Non-secure output addresses.

For a Secure translation regimes, the initial translation table lookup is performed to a Secure output address.

If the translation table descriptor returned as a result of that initial lookup points to a second translation table, then the NSTable bit in that descriptor determines whether that translation table lookup is made to Secure or to Non-secure output addresses.

This applies for all subsequent translation table lookups as part of that translation table walk, with the additional rule that any translation table descriptor that is returned from Non-secure memory is treated as if the NSTable bit in that descriptor indicates that the subsequent translation table lookup is to Non-secure memory.

Control of translation table walks

For the first stage of the EL1&0 translation regime, the `TCR_EL1`.{EPD0, EPD1} bits determine whether the translation tables for that regime are valid. EPD0 indicates whether the table that `TTBR0_EL1` points to is valid, and EPD1 indicates whether the table that `TTBR1_EL1` points to is valid. The effect of these bits is:

- EPDn == 0** The translation table is valid, and can be used for a translation table lookup.
- EPDn == 1** If a TLB miss occurs based on `TTBRn`, a Translation fault is returned, and no translation table walk is performed. The fault is reported at the level of the initial lookup, for example:
 - If translation starts with a zero-level lookup then the fault is a Zero level fault.
 - If translation starts with a first-level lookup then the fault is a First level fault.

D5.2.5 Overview of the VMSAv8-64 address translation stages

As shown in *Memory translation granule size on page D5-1716*, the granule size determines significant aspects of the address translation process. *Effect of granule size on translation table addressing and indexing on page D5-1719* shows, for each granule size:

- How the required input address range determines the required initial lookup levels.
- For stage 2 translations, the possible effect described in *Concatenated translation tables on page D5-1720*.
- The `TTBR` addressing and indexing for the initial lookup.

The following subsections summarize the multiple levels of lookup that can be required for a single stage of address translation that might require the maximum number of lookups:

- *Overview of VMSAv8-64 address translation using the 4KB translation granule.*
- *Overview of VMSAv8-64 address translation using the 16KB translation granule on page D5-1727.*
- *Overview of VMSAv8-64 address translation using the 64KB translation granule on page D5-1731.*

Overview of VMSAv8-64 address translation using the 4KB translation granule

The requirements for the level of the initial lookup are different for stage 1 and stage 2 translations.

Overview of stage 1 translations, 4KB granule

For a stage 1 translation, the required initial lookup level is determined only by the required input address range specified by the corresponding `TCR.TxSZ` field. When using the 4KB translation granule, [Table D5-8](#) shows this requirement.

Table D5-8 TCR.TnSZ values and IA ranges when there is no concatenation of translation tables

Initial lookup level	TnSZ values for and input address ranges ^a for starting at this level			
	TnSZ _{min}	IA _{max}	TnSZ _{max}	IA _{min}
Zero	16	IA[47:12]	24	IA[39:12]
First	25	IA[38:12]	33	IA[30:12]
Second	34	IA[29:12]	39	IA[24:12]

a. The IAs show the address bits to be resolved when addressing a page of memory, see the *Note* that follows.

These configuration options are also permitted for stage 2 translations.

————— Note —————

- When using the 4KB translation granule, the initial lookup cannot be at the third level.
- Some bits of the IA do not require resolution by the translation table lookup, because they always map directly to the OA. When using the 4KB translation granule, IA[11:0] = OA[11:0] for all translations.

Figure D5-7 shows the stage 1 address translation, for an address translation using the 4KB granule with an input address size greater than 39 bits.

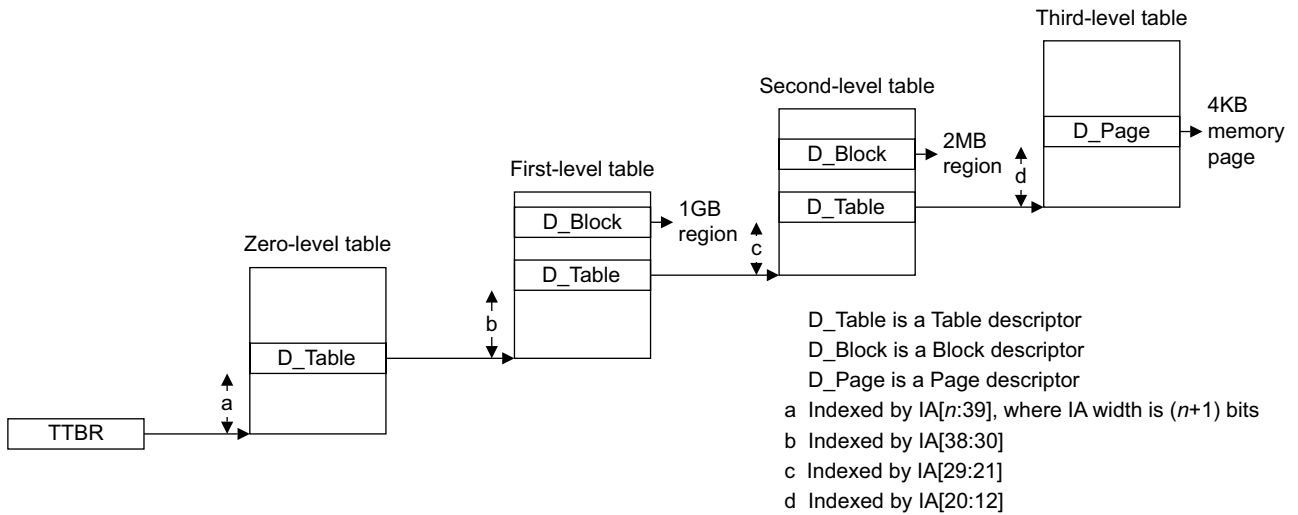

Figure D5-7 General view of VMSAv8-64 stage 1 address translation, 4KB granule

Overview of stage 2 translations, 4KB granule

For a stage 2 translation, up to 16 translation tables can be concatenated at the initial lookup level. For certain input address sizes, concatenating tables in this way means that the lookup starts at a lower level than would otherwise be the case. For more information see [Concatenated translation tables for the initial stage 2 lookup on page D5-1737](#).

When using the 4KB translation granule, [Table D5-9](#) shows all possibilities for the initial lookup for a stage 2 translation.

Table D5-9 VTCR_EL2.T0SZ values and IA ranges, including cases where translation tables are concatenated

Tables ^a	1	2		4		8		16		
Initial lookup level	T0SZ values and input address ranges ^b for starting at this level									
	T0SZ	IA	T0SZ	IA	T0SZ	IA	T0SZ	IA	T0SZ	IA
Zero	16-24	IA[47:12]- IA[39:12]	-	-	-	-	-	-	--	-
First	25-33	IA[38:12]- IA[30:12]	24	IA[39:12]	23	IA[40:12]	22	IA[41:12]	20	IA[42:12]
Second	34-39	IA[29:12]- IA[24:12]	33	IA[30:12]	32	IA[31:12]	31	IA[32:12]	30	IA[33:12]

a. Number of concatenated translation tables at the initial lookup level. 1 table corresponds to no concatenation, see [Table D5-8 on page D5-1724](#).
b. The IAs shown in the table indicate the address bits to be resolved by an address translation addressing a page of memory, see the Note that follows.

Note

- When using the 4KB translation granule, the initial lookup cannot be at the third level.
- Because concatenating translation tables reduces the number of levels of lookup required, when using the 4KB translation granule, tables cannot be concatenated at the zero level.
- Some bits of the IA do not require resolution by the translation table lookup, because they always map directly to the OA. When using the 4KB translation granule, $IA[11:0] = OA[11:0]$ for all translations.

In addition, `VTCR_EL2.SL0` indicates the required initial lookup level, as [Table D5-10](#) shows.

Table D5-10 `VTCR_EL2.SL0` values, 4KB granule

Initial lookup level	<code>VTCR_EL2.SL0</code>
Zero	0b10
First	0b01
Second	0b00

Because the maximum number of concatenated translation tables is 16, there is a relationship between the permitted `VTCR_EL2.{TOSZ, SL0}` values. If, when a translation table walk is started, the `TOSZ` value is not consistent with the `SL0` value, a stage 2 level zero translation fault is generated.

[Figure D5-8 on page D5-1727](#) shows the stage 2 address translation, for an input address size of between 40 and 43 bits. This means the lookup can start at either the zero-level or the first-level.

VTCR_EL2.SL0 defines the start level.

Starting at zero level

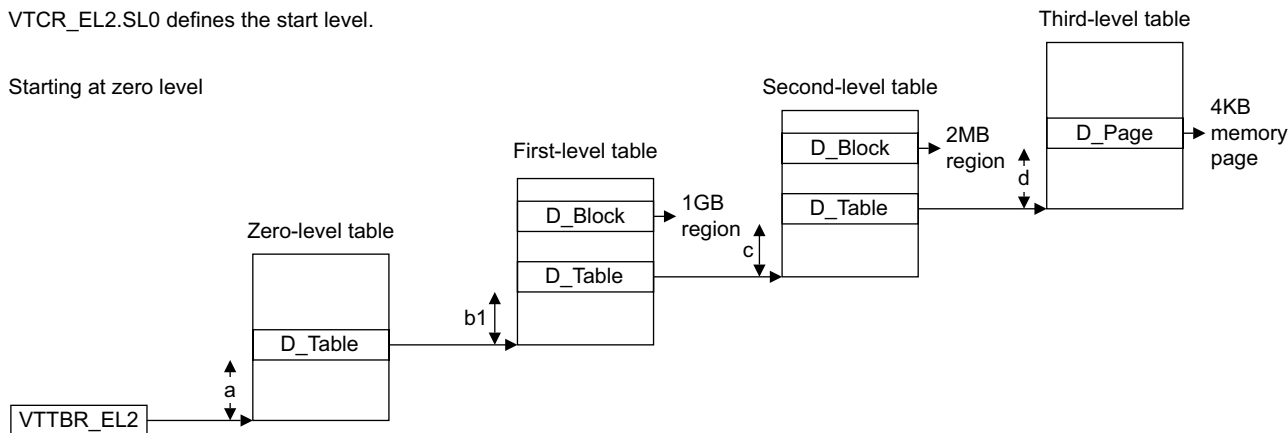

Starting at first level

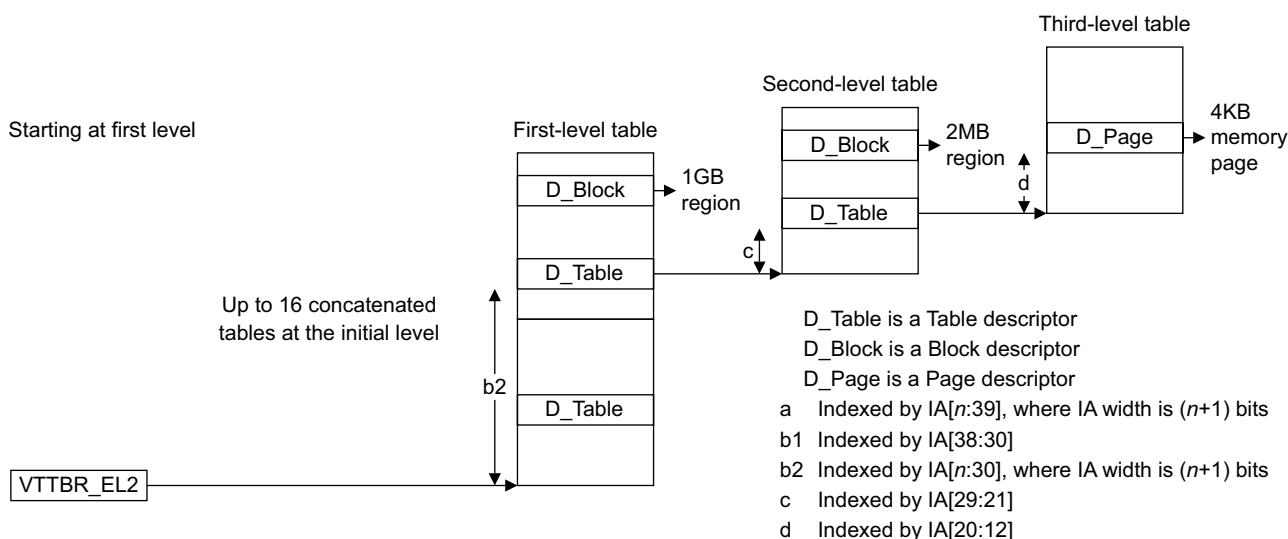

Figure D5-8 General view of VMSAv8-64 stage 2 address translation, 4KB granule

Overview of VMSAv8-64 address translation using the 16KB translation granule

The requirements for the level of the initial lookup are different for stage 1 and stage 2 translations.

Overview of stage 1 translations, 16KB granule

For a stage 1 translation, the required initial lookup level is determined only by the required input address range specified by the corresponding TCR.TxSZ field. When using the 4KB translation granule, Table D5-8 on page D5-1724 shows this requirement.

Table D5-11 TCR.TnSZ values and IA ranges when there is no concatenation of translation tables

Initial lookup level	TnSZ values for and input address ranges ^a for starting at this level			
	TnSZ _{min}	IA _{max}	TnSZ _{max}	IA _{min}
Zero	16	IA[47:14]	-	-
First	17	IA[46:14]	27	IA[36:14]
Second	28	IA[35:14]	38	IA[25:14]
Third	39	IA[24:14]	-	-

- a. The IAs show the address bits to be resolved when addressing a page of memory, see the *Note* that follows.

The configuration options for an initial lookup at the first, second, or third level are also permitted for stage 2 translations, but stage 2 translation does not permit an initial lookup at level zero.

———— **Note** ————

- When using the 16KB translation granule, a maximum of 1 bit of IA is resolved by a level 0 lookup.
- Some bits of the IA do not require resolution by the translation table lookup, because they always map directly to the OA. When using the 16KB translation granule, $IA[13:0] = OA[13:0]$ for all translations.

Figure D5-9 shows the stage 1 address translation, for an address translation using the 16KB granule with an input address size of 48 bits.

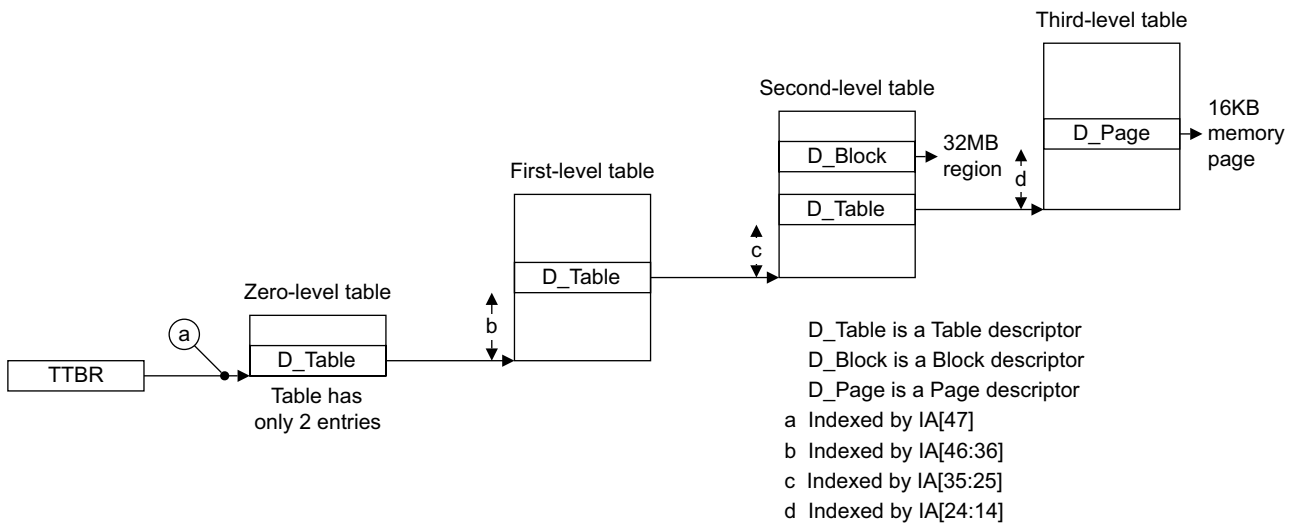

Figure D5-9 General view of VMSAv8-64 stage 1 address translation, 16KB granule

Overview of stage 2 translations, 16KB granule

For a stage 2 translation, up to 16 translation tables can be concatenated at the initial lookup level. For certain input address sizes, concatenating tables in this way means that the lookup starts at a lower level than would otherwise be the case. For more information see *Concatenated translation tables for the initial stage 2 lookup* on page D5-1737.

When using the 16KB granule, for a stage 2 translation with an input address sized of 48 bits, the initial lookup must be at level 1, with two concatenated translation tables at this level.

When using the 4KB translation granule, [Table D5-9 on page D5-1725](#) shows all possibilities for the initial lookup for a stage 2 translation.

Table D5-12 VTCR_EL2.T0SZ values and IA ranges, including cases where translation tables are concatenated

Tables ^a	1		2		4		8		16	
Initial lookup level	T0SZ values and input address ranges ^b for starting at this level									
	T0SZ	IA	T0SZ	IA	T0SZ	IA	T0SZ	IA	T0SZ	IA
First	17-27	IA[46:14]-IA[36:14]	16	IA[47:14]	-	-	-	-	-	-
Second	28-38	IA[35:14]-IA[25:14]	27	IA[36:14]	26	IA[37:14]	25	IA[38:14]	24	IA[39:14]
Third	39	IA[24:14]	38	IA[25:14]	37	IA[26:14]	36	IA[27:14]	35	IA[28:14]

- a. Number of concatenated translation tables at the initial lookup level. *1 table* corresponds to no concatenation, see [Table D5-8 on page D5-1724](#).
- b. The IAs shown in the table indicate the address bits to be resolved by an address translation addressing a page of memory, see the *Note* that follows.

Note

- When using the 16KB translation granule for a stage 2 translation, the initial lookup cannot be at the zero level. When a 48-bit input address is required, translation must start with first level lookup using two concatenated translation tables.
- Some bits of the IA do not require resolution by the translation table lookup, because they always map directly to the OA. When using the 16KB translation granule, IA[13:0] = OA[13:0] for all translations.

In addition, [VTCR_EL2.SL0](#) indicates the required initial lookup level, as [Table D5-10 on page D5-1726](#) shows.

Table D5-13 VTCR_EL2.SL0 values, 16KB granule

Initial lookup level	VTCR_EL2.SL0
First	0b10
Second	0b01
Third	0b00

Because the maximum number of concatenated translation tables is 16, there is a relationship between the permitted [VTCR_EL2.{T0SZ, SL0}](#) values. If, when a translation table walk is started, the T0SZ value is not consistent with the SL0 value, a stage 2 level zero translation fault is generated.

When stage 2 translation supports a 48-bit input address range, translation must start with a first level lookup using two concatenated translation tables. Figure D5-10 shows the translation for this case.

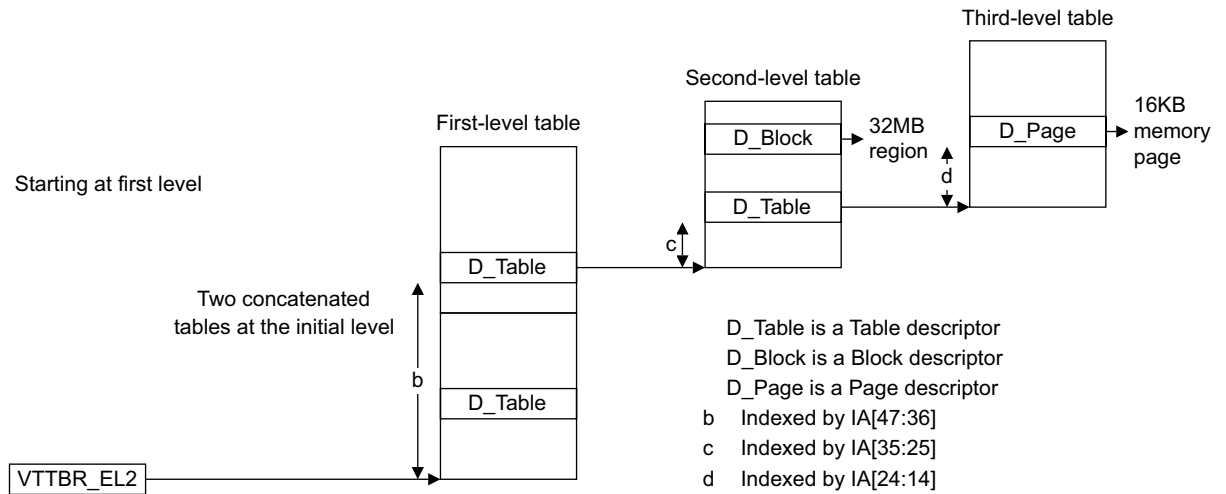
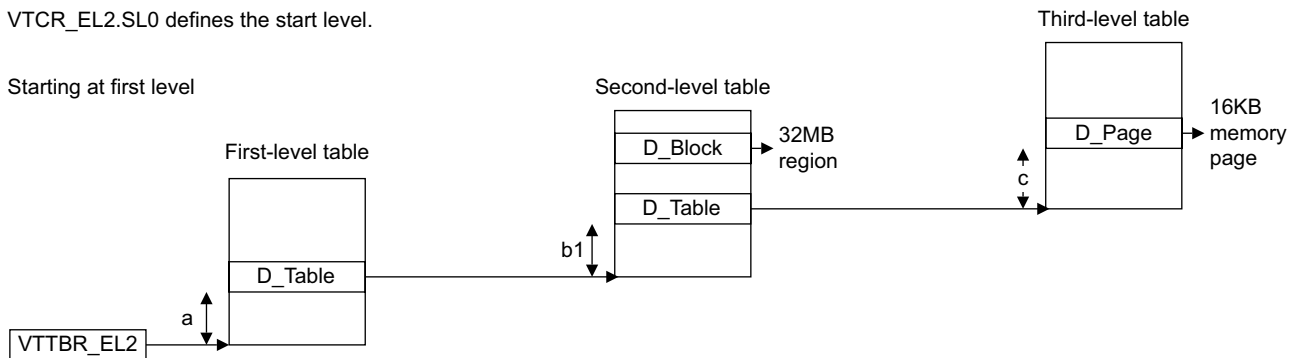

Figure D5-10 VMSAv8-64 stage 2 address translation, 16KB granule, 48 bit input address

However, for an input address size of between 37 and 40 bits, Table D5-12 on page D5-1729 shows that translation can start with either a first level lookup or a second level lookup, and Figure D5-11 shows these options.

VTCR_EL2.SL0 defines the start level.

Starting at first level



Starting at second level

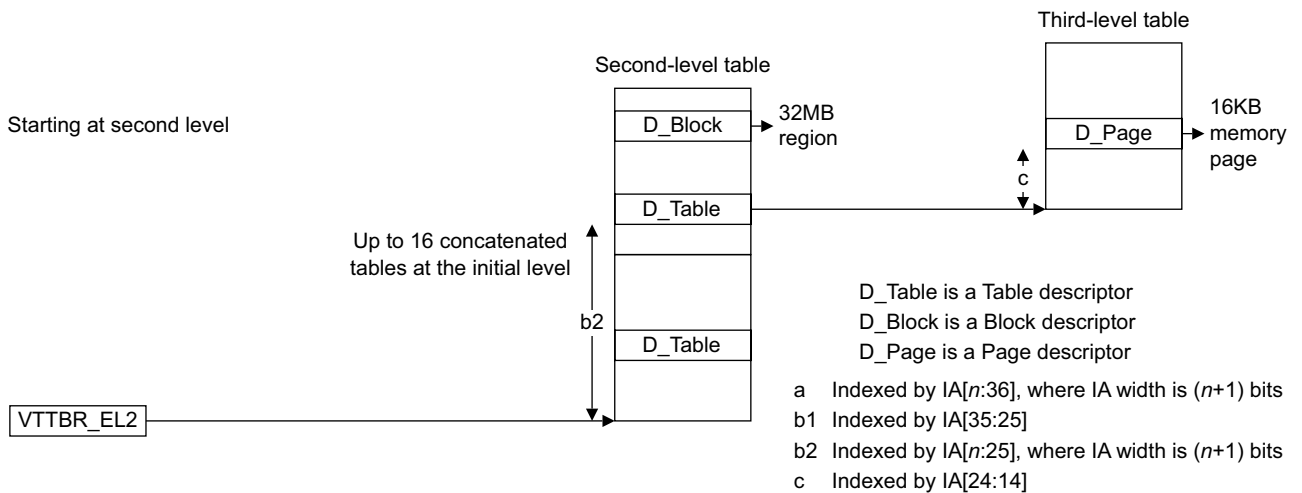

Figure D5-11 General view of VMSAv8-64 stage 2 address translation, 16KB granule

Overview of VMSAv8-64 address translation using the 64KB translation granule

The requirements for the level of the initial lookup are different for stage 1 and stage 2 translations.

Overview of stage 1 translations, 64KB granule

For a stage 1 translation, the required initial lookup level is determined only by the required input address range specified by the corresponding `TCR.TnSZ` field. When using the 64KB translation granule, Table D5-14 shows this requirement.

Table D5-14 `TCR.TnSZ` values and IA ranges when there is no concatenation of translation tables

Lookup level	<code>TnSZ</code> values for and input address ranges ^a for starting at this level			
	<code>TnSZ_{min}</code>	<code>IA_{max}</code>	<code>TnSZ_{max}</code>	<code>IA_{min}</code>
First	16	IA[47:16]	21	IA[42:16]
Second	22	IA[41:16]	34	IA[29:16]
Third	35	IA[28:16]	39	IA[24:16]

a. The IAs show the address bits to be resolved when addressing a page of memory, see the *Note* that follows.

These configuration options are also permitted for stage 2 translations.

Note

- When using the 64KB translation granule, there are no zero-level lookups.
- Some bits of the IA do not require resolution by the translation table lookup, because they always map directly to the OA. When using the 64KB translation granule, `IA[15:0] = OA[15:0]` for all translations.

Figure D5-12 shows the stage 1 address translation, for an address translation using the 64KB granule with an input address size greater than 42 bits.

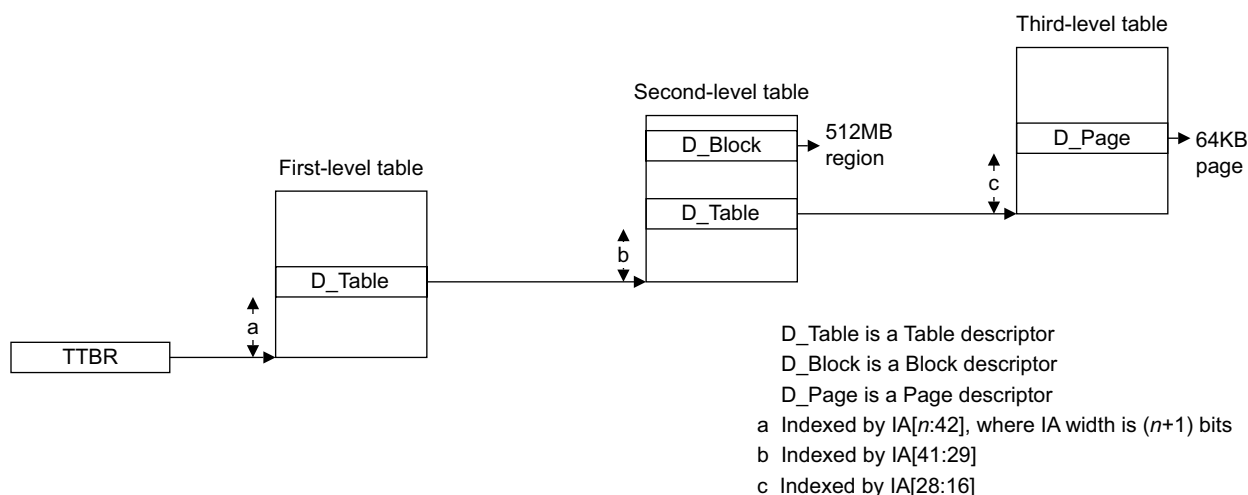

Figure D5-12 General view of VMSAv8-64 stage 1 address translation, 64KB granule

Overview of stage 2 translations, 64KB granule

For a stage 2 translation, up to 16 translation tables can be concatenated at the initial lookup level. For certain input address sizes, concatenating tables in this way means that the lookup starts at a lower level than would otherwise be the case. For more information see [Concatenated translation tables for the initial stage 2 lookup on page D5-1737](#).

When using the 64KB translation granule, [Table D5-15](#) shows all possibilities for the initial lookup for a stage 2 translation.

Table D5-15 VTCR_EL2.T0SZ values and IA ranges when translation tables are concatenated

Tables ^a	T0SZ values and input address ranges ^b for starting at this level									
Initial lookup level	1		2		4		8		16	
	T0SZ	IA	T0SZ	IA	T0SZ	IA	T0SZ	IA	T0SZ	IA
First	16-21	IA[47:16]-IA[42:16]	-	-	-	-	-	-	-	-
Second	22-34	IA[41:16]-IA[29:16]	21	IA[42:16]	20	IA[43:16]	19	IA[44:16]	18	IA[45:16]
Third	35-39	IA[28:16]-IA[24:16]	34	IA[29:16]	33	IA[30:16]	32	IA[31:16]	31	IA[32:16]

- a. Number of concatenated translation tables at the initial lookup level. *1 table* corresponds to no concatenation, see [Table D5-14 on page D5-1731](#).
- b. The IAs shown in the table indicate the address bits to be resolved by an address translation addressing a page of memory, see the *Note* that follows.

———— **Note** —————

- When using the 64KB translation granule, there are no zero-level lookups.
- Because concatenating translation tables reduces the number of levels of lookup required, when using the 64KB translation granule, tables cannot be concatenated at the first level.
- Some bits of the IA do not require resolution by the translation table lookup, because they always map directly to the OA. When using the 64KB translation granule, IA[15:0] = OA[15:0] for all translations.

VTCR_EL2.SL0 indicates the required initial lookup level, as [Table D5-16](#) shows.

Table D5-16 VTCR_EL2.SL0 values, 64K granule

Initial lookup level	VTCR_EL2.SL0
First	0b10
Second	0b01
Third	0b00

Because the maximum number of concatenated translation tables is 16, there is a relationship between the permitted VTCR_EL2.{T0SZ, SL0} values. If, when a translation table walk is started, the T0SZ value is not consistent with the SL0 value, a stage 2 level zero translation fault is generated.

Figure D5-13 shows the stage 2 address translation, for an input address size of between 43 and 46 bits. This means the lookup can start at either the first-level or the second-level.

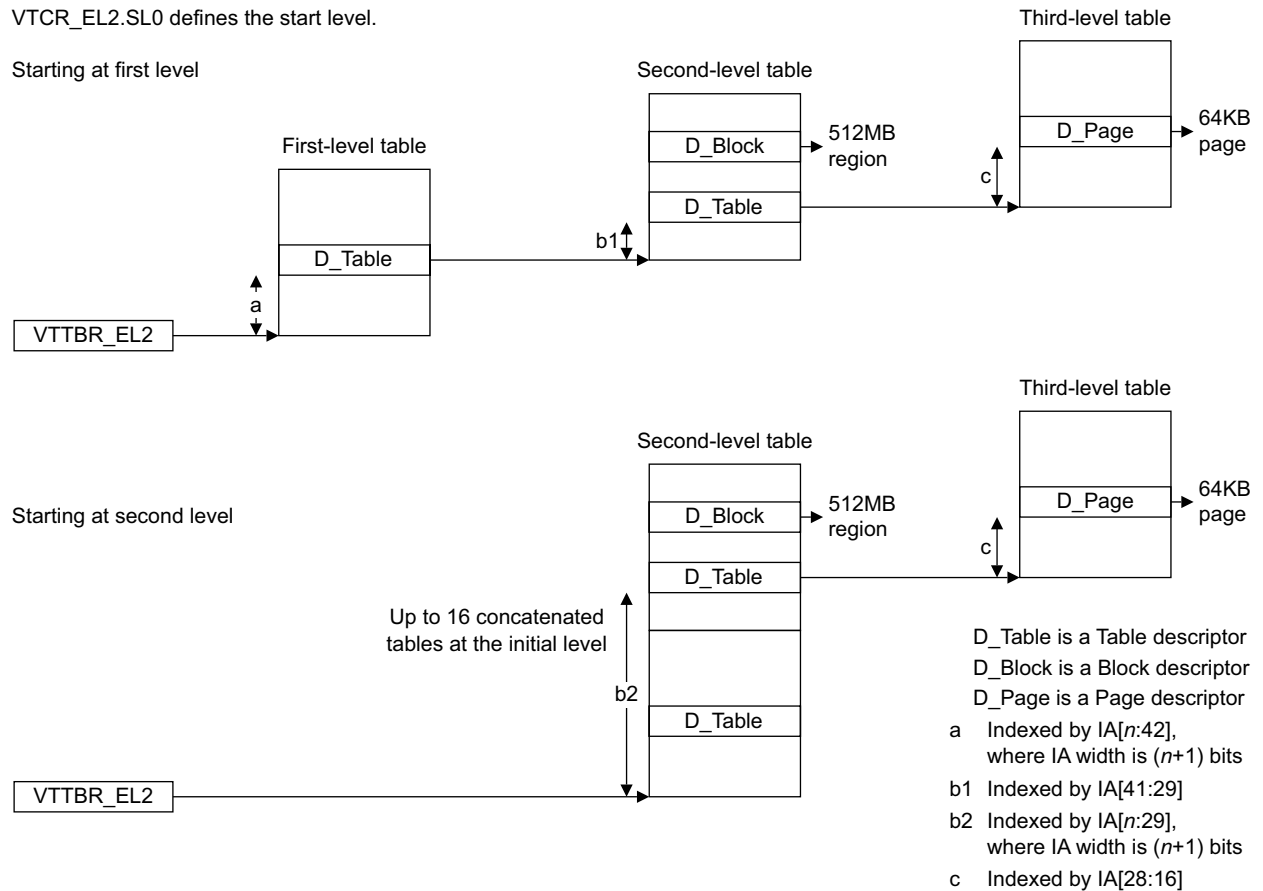

Figure D5-13 General view of VMSAv8-64 stage 2 address translation, 64KB granule

D5.2.6 The VMSAv8-64 translation table format

This section provides the full description of the VMSAv8-64 translation table format, its use for address translations that are controlled by an Exception level using AArch64.

For the address translations that are controlled by an Exception level that is using AArch64:

- The `TCR_EL1`.{SH0, ORGN0, IRGN0, SH1, ORGN1, IRGN1} fields define memory region attributes for the translation table walk, for each of `TTBR0_EL1` and `TTBR1_EL1`.
- For the Secure and Non-secure EL1&0 stage 1 translations, each of `TTBR0_EL1` and `TTBR1_EL1` contains an ASID field, and the `TCR_EL1`.A1 field selects which ASID to use.

For this translation table format, *Overview of the VMSAv8-64 address translation stages* on page D5-1724 summarizes the lookup levels, and *Descriptor encodings, ARMv8 zero-level, first-level, and second-level formats* on page D5-1773 describes the translation table entries.

The following subsections describe the use of this translation table format:

- *Translation granule size and associate block and page sizes* on page D5-1734.
- *Selection between TTBR0 and TTBR1* on page D5-1736.
- *Concatenated translation tables for the initial stage 2 lookup* on page D5-1737.
- *Possible translation table registers programming errors* on page D5-1738.

Translation granule size and associate block and page sizes

Table D5-17 shows the supported granule sizes, block sizes and page sizes, for the different granule sizes. For completeness, this table includes information for AArch32 state. In the table, the OA bit ranges are the OA bits that the translation table descriptor specifies to address the block or page of memory, in an implementation that supports a 48-bit OA range.

Table D5-17 Translation table granule sizes, with block and page sizes, and output address ranges

Granule size	Table level	Block size and OA bit range	Page size and OA bit range
4KB	Zero	-	-
	First	1GB, OA[47:30]	-
	Second	2MB, OA[47:21]	-
	Third	-	4KB, OA[47:12]
16KB	Zero	-	-
	First	-	-
	Second	32MB, OA[47:25]	-
	Third	-	16KB, OA[47:14]
64KB	First	-	-
	Second	512MB, OA[47:29]	-
	Third	-	64KB, OA[47:16]

Bit[1] of a translation table descriptor identifies whether the descriptor is a block descriptor, and:

- The 4KB granule size supports block descriptors only in first level and second level translation tables.
- The 16KB and 64KB granule sizes support block descriptors only in second level translation tables,

Setting bit[1] of a descriptor to 1 in a translation table that does not support block descriptors gives a Translation fault.

For translations managed from AArch64 state, the following tables expand the information for each granule size, showing for each lookup level and when accessing a single translation table:

- The maximum IA size, and the address bits that are resolved for that maximum size.
- The maximum OA range resolved by the translation table descriptors at this level, and the corresponding memory region size.
- The maximum size of the translation table. This is the size required for the maximum IA size.

Table D5-18 shows this information for the 4KB translation granule size, Table D5-19 on page D5-1735 shows this information for the 16KB translation granule size, and Table D5-20 on page D5-1735 shows this information for the 64KB translation granule size.

Table D5-18 Properties of the address lookup levels, 4KB granule size

Level	Maximum input address		Maximum output address		Number of entries	Block entries supported?
	Size	Address range	Address range	Size of addressed region ^a		
Zero	256TB	Address[47:39]	Address[47:39]	512GB	Up to 512	No
First	512GB	Address[38:30]	Address[47:30]	1GB	Up to 512	Yes

Table D5-18 Properties of the address lookup levels, 4KB granule size (continued)

Level	Maximum input address		Maximum output address		Number of entries	Block entries supported?
	Size	Address range	Address range	Size of addressed region ^a		
Second	1GB	Address[29:21]	Address[47:21]	2MB	Up to 512	Yes
Third	2MB	Address[20:12]	Address[47:12]	4KB	512	Page only

a. That is, the size of the region either addressed by descriptors at this level or to be resolved at this and the subsequent levels of lookup.

Table D5-19 Properties of the address lookup levels, 16KB granule size

Level	Maximum input address		Maximum output address		Number of entries	Block entries supported?
	Size	Address range	Address range	Size of addressed region ^a		
Zero	256TB	Address[47]	Address[47]	128TB	2 ^b	No
First	128TB	Address[46:36]	Address[47:36]	64GB	Up to 2048	No
Second	64GB	Address[35:25]	Address[47:25]	32MB	Up to 2048	Yes
Third	32MB	Address[24:14]	Address[47:14]	16KB	2048	Page only

a. That is, the size of the region either addressed by descriptors at this level or to be resolved at this and the subsequent levels of lookup.

b. The translation table size is less than the maximum for this granule size, and therefore the number of entries is reduced.

Table D5-20 Properties of the address lookup levels, 64KB granule size

Level	Maximum input address		Maximum output address		Number of entries	Block entries supported?
	Size	Address range	Address range	Size of addressed region ^a		
First	256TB	Address[47:42]	Address[47:42]	4TB	Up to 64 ^b	No
Second	4TB	Address[41:29]	Address[47:29]	512MB	Up to 8192	Yes
Third	512MB	Address[28:16]	Address[47:16]	64KB	8192	Page only

a. That is, the size of the region either addressed by descriptors at this level or to be resolved at this and the subsequent levels of lookup.

b. The translation table size is less than the maximum for this granule size, and therefore the number of entries is reduced.

For the initial lookup level:

- If the IA range specified by the **TCR.TxSZ** field is smaller than the maximum size shown in these table then this reduces the number of addresses in the table and therefore reduces the table size. The smaller translation table is aligned to its table size.
- For stage 2 translations, multiple translation tables can be concatenated to extend the maximum IA size beyond that shown in these tables. For more information see the stage 2 translation overviews in [Overview of the VMSAv8-64 address translation stages on page D5-1724](#) and [Concatenated translation tables for the initial stage 2 lookup on page D5-1737](#).

If a supplied input address is larger than the configured input address size, a Translation fault is generated.

———— **Note** ————

Larger translation granule sizes typically requires fewer levels of translation tables to translate a particular size of virtual address.

For the TCR programming requirements for the initial lookup, see [Overview of the VMSAv8-64 address translation stages on page D5-1724](#).

Selection between TTBR0 and TTBR1

Every translation table walk starts by accessing the translation table addressed by the TTBR for the stage 1 translation for the required translation regime.

For the EL1&0 translation regime, the VA range is split into two subranges as shown in [Figure D5-14](#), and:

- **TTBR0_EL1** points to the initial translation table for the lower VA subrange, that starts at address `0x0000_0000_0000_0000`,
- **TTBR1_EL1** points to the initial translation table for the upper VA subrange, that runs up to address `0xFFFF_FFFF_FFFF_FFFF`.

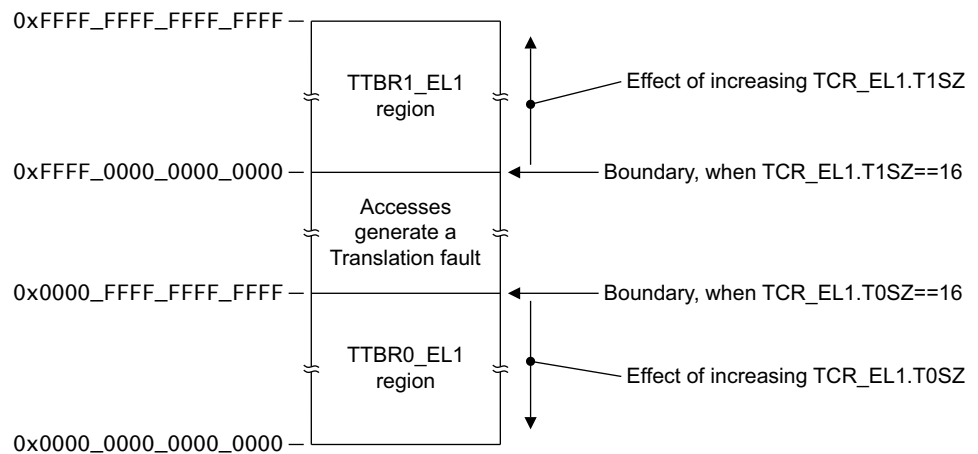

Figure D5-14 AArch64 TTBR boundaries and VA ranges

Which TTBR is used depends only on the VA presented for translation:

- If the top bits of the VA are zero, then **TTBR0_EL1** is used.
- If the top bits of the VA are one, then **TTBR1_EL1** is used.

It is configurable whether this determination depends on the values of VA[63:56] or on the values of VA[63:48], see [Address tagging in AArch64 state on page D5-1708](#).

[Example D5-3](#) shows a typical application of this VA split.

Example D5-3 Example use of the split VA range, and the TTBR0_EL1 and TTBR1_EL1 controls

An example of using the split VA range is:

TTBR0_EL1 Used for process-specific addresses.

Each process maintains a separate first-level translation table. On a context switch:

- **TTBR0_EL1** is updated to point to the first-level translation table for the new context
- **TCR_EL1** is updated if this change changes the size of the translation table
- **CONTEXTIDR_EL1** is updated.

TTBR1_EL1 Used for operating system and I/O addresses, that do not change on a context switch.

For each VA subrange, the input address size is $2^{(64-TnSZ)}$, where $TnSZ$ is one of **TCR_EL1**.{T0SZ, T1SZ},

This means the two VA subranges are:

Lower VA subrange $0x0000_0000_0000_0000$ to $(2^{(64-T0SZ)} - 1)$.

Upper VA subrange $(2^{64} - 2^{(64-T1SZ)})$ to $0xFFFF_FFFF_FFFF_FFFF$.

The minimum $TnSZ$ value is 16, corresponding to the maximum input address range of 48 bits. [Example D5-4](#) shows the two VA subranges when $T0SZ$ and $T1SZ$ are both set to this minimum value.

Example D5-4 Maximum VA ranges for EL1&0 stage 1 translations

The maximum VA subranges correspond to $T0SZ$ and $T1SZ$ each having the minimum value of 16. In this case the subranges are:

Lower VA subrange $0x0000_0000_0000_0000$ to $0x0000_FFFF_FFFF_FFFF$.

Upper VA subrange $0xFFFF_0000_0000_0000$ to $0xFFFF_FFFF_FFFF_FFFF$.

[Figure D5-14 on page D5-1736](#) indicates the effect of varying the $TnSZ$ values.

As described in [Overview of the VMSEA8-64 address translation stages on page D5-1724](#), the $TnSZ$ values also determine the initial lookup level for the translation.

Concatenated translation tables for the initial stage 2 lookup

[Overview of the VMSEA8-64 address translation stages on page D5-1724](#) introduced the ability to concatenate translation tables for the initial stage 2 translation lookup. This section gives more information about that concatenation.

Where a stage 2 translation would require 16 entries or fewer in its top-level translation table, the system designer can instead:

- Require the corresponding number of concatenated translation tables at the next translation level, aligned to the size of the block of concatenated translation tables.
- Start the translation at that next translation level.

In addition, when using the 16KB translation granule and requiring a 48-bit input address size for the stage 2 translations, lookup must start with two concatenated translation tables at the first level.

———— **Note** —————

This translation scheme:

- Avoids the overhead of an additional level of translation.
 - Requires the software that is defining the translation to:
 - Define the concatenated translation tables with the required overall alignment.
 - Program [VTTBR_EL2](#) to hold the address of the first of the concatenated translation tables.
 - Program [VTCR_EL2](#) to indicate the required input address range and initial lookup level.
-

Concatenating additional translation tables at the initial level of look up resolves additional address bits at that level. To resolve n additional address bits requires 2^n concatenated translation tables. [Example D5-5 on page D5-1738](#) shows how, for first level lookups using the 4KB translation granule, translation tables can be concatenated to resolve three additional address bits.

Example D5-5 Adding three bits of address resolution at first level lookup, using the 4KB granule

When using the 4KB translation granule, a first level lookup with a single translation table resolves address bits[38:30]. To add three more address bits requires 2^3 translation tables, that is, eight translation tables. This means:

- The total size of the concatenated translation tables is $8 \times 4\text{KB} = 32\text{KB}$.
- This block of concatenated translation tables must be aligned to 32KB.
- The address range resolved at this lookup level is A[41:30], of which:
 - Bits A[41:38] select the 4KB translation table.
 - Bits A[38:30] index a descriptor within that translation table.

As an example of the concatenation of translation tables at the initial lookup level, when using the 4KB translation granule, [Table D5-21](#) shows the possible uses of concatenated translation tables to permit lookup to start at the first level rather than at the zero level. For completeness, the table starts with the case where the required IPA range means lookup starts at the first level with a single translation table at that level.

Table D5-21 Possible uses of concatenated translation tables for first-level lookup, 4KB granule

Configured stage 2 IA size		Lookup starts at zero level		Lookup starts at first level	
IPA range	Size	Required zero-level entries	Number of concatenated tables	Required alignment ^a	
IPA[38:0]	2^{36} bytes	-	1	4KB	
IPA[39:0]	2^{37} bytes	2	2	8KB	
IPA[40:0]	2^{38} bytes	4	4	16KB	
IPA[41:0]	2^{39} bytes	8	8	32KB	
IPA[42:0]	2^{40} bytes	16	16	64KB	

a. Required alignment of the set of concatenated second-level tables.

———— Note —————

Because concatenation is permitted only for a stage 2 translation, the input addresses in the table are IPAs.

[Overview of the VMSAv8-64 address translation stages on page D5-1724](#) identifies all of the possible uses of concatenation. In all cases, the block of concatenated translation tables must be aligned to the block size.

Possible translation table registers programming errors

For a stage 2 translation, the programming of the `VTCR_EL2.{T0SZ, SL0}` fields must be consistent, see [Overview of the VMSAv8-64 address translation stages on page D5-1724](#).

Where the contiguous bit is used to mark a set of blocks as contiguous, if the address range translated by a set of blocks marked as contiguous is larger than the size of the input address supported at a stage of translation used to translate that address at that stage of translation, as defined by the `TCR.TxSZ` field, then this is a programming error. An implementation is permitted, but not required, to:

- Treat such a block within a contiguous set of blocks as causing a Translation fault, even though the block is valid, and the address accessed within that block is within the size of the input address supported at a stage of translation, as defined by the `TCR.TxSZ` field.

- Treat such a block within a contiguous set of blocks as not causing a Translation fault, even though the address accessed within that block is outside the size of the input address supported at a stage of translation, as defined by the **TCR.TxSZ** field, provided that both of the following apply:
 - The block is valid.
 - At least one address within the block, or contiguous set of blocks, is within the size of the input address supported at a stage of translation.

The contiguous bit must apply:

- When using the 4KB translation granule, to 16 adjacent translation table entries, aligned so that the upper five bits of the input address range required to index the table entries are all the same.
- When using the 16KB translation granule, to:
 - 128 adjacent translation table entries, aligned so that the upper four bits of the input address range required to index the table entries are all the same, for entries in a level three translation table.
 - 32 adjacent translation table entries, aligned so that the upper six bits of the input address range required to index the table entries are all the same, for entries in a level two translation table.
- When using the 64KB translation granule, to 32 adjacent translation table entries, aligned so that the upper eight bits of the input address range required to index the table entries are all the same.

For more information about the contiguous bit see [The Contiguous bit on page D5-1792](#).

D5.2.7 The algorithm for finding the translation table entries

This subsection gives the algorithms for finding the translation table entry that corresponds to a given IA, for each required level of lookup. The algorithms encode the descriptions of address translation given earlier in this section. The algorithm details depend on the translation granule size for the stage of address translation, see:

- [Finding the translation table entry when using the 4KB translation granule on page D5-1740](#).
- [Finding the translation table entry when using the 16KB translation granule on page D5-1741](#).
- [Finding the translation table descriptor when using the 64KB translation granule on page D5-1742](#).

Each subsection uses the following terms:

BaseAddress The base address for the level of lookup, as defined by:

- For the initial lookup level, the appropriate **TTBR**.
- Otherwise, the translation table address returned by the previous level of lookup.

PAMax The supported PA width, in bits.

IA The supplied IA for this stage of translation.

TnSZ The translation table size for this stage of translation:

For EL1&0 stage 1 **TCR_EL1.T0SZ** or **TCR_EL1.T1SZ**, as appropriate.

For EL1&0 stage 2 **VTCR_EL2.T0SZ**.

For EL2 stage 1 **TCR_EL2.T0SZ**.

For EL3 stage 1 **TCR_EL3.T0SZ**.

SL0 **VTCR_EL2.SL0**. Applies to the Non-secure EL1&0 stage 2 translation only.

These subsections show only architecturally-valid programming of the **TCR**. See also [Possible translation table registers programming errors on page D5-1738](#).

Finding the translation table entry when using the 4KB translation granule

Table D5-22 shows the translation table descriptor address, for each level of lookup, when using the 4KB translation granule. See the start of *The algorithm for finding the translation table entries* on page D5-1739 for more information about terms used in the table.

Table D5-22 Translation table entry addresses when using the 4KB translation granule

Lookup level	Entry address and conditions		General conditions
	Stage 1 translation	Stage 2 translation	
Zero	BaseAddr[PAMax-1:x]:IA[y:39]:0b000 if ^a $16 \leq TnSZ \leq 24$ then $x = (28 - TnSZ)$	BaseAddr[PAMax-1:x]:IA[y:39]:0b000 if $SL0^b == 2$ then if ^a $16 \leq TOSZ \leq 24$ then $x = (28 - TOSZ)$	if $TnSZ < 16$ then $x = 12$ $y = (x + 35)$
First	BaseAddr[PAMax-1:x]:IA[y:30]:0b000 if ^a $25 \leq TnSZ \leq 33$ then $x = (37 - TnSZ)$ else ^c $x = 12$	BaseAddr[PAMax-1:x]:IA[y:30]:0b000 if $SL0^b == 1$ then if ^a $21 \leq TOSZ \leq 33$ then $x = (37 - TOSZ)$ elseif $SL0^b == 2$ then $x = 12$	$y = (x + 26)$
Second	BaseAddr[PAMax-1:x]:IA[y:30]:0b000 if ^a $34 \leq TnSZ \leq 39$ then $x = (46 - TnSZ)$ elseif $39 < TnSZ$ then $x = 7$ else ^c $x = 12$	BaseAddr[PAMax-1:x]:IA[y:30]:0b000 if $SL0^b == 0$ then if ^a $30 \leq TOSZ \leq 39$ then $x = (46 - TOSZ)$ elseif $39 < TOSZ$ then $x = 7$ elseif $0 < SL0^b$ then $x = 12$	$y = (x + 17)$
Third	BaseAddr[PAMax-1:12]:IA[20:30]:0b000	BaseAddr[PAMax-1:12]:IA[20:30]:0b000	-

- This line indicates the range of permitted values for $TnSZ$, for a lookup that starts at this level.
- $SL0 == 0$ if the initial lookup is second level, $SL0 == 1$ if the initial lookup is first level, and $SL0 == 2$ if the initial lookup level is zero level.
- This is the case where this level of lookup is not the initial level of lookup.

Identifying support for the 4KB granule

The [ID_AA64MMFR0_EL1.4Kgranule](#) identifies whether an implementation supports the 4KB translation granule, as follows:

- 0b0000** 4KB granule size supported.
- 0b1111** 4KB granule size not supported.

Finding the translation table entry when using the 16KB translation granule

Table D5-22 on page D5-1740 shows the translation table descriptor address, for each level of lookup, when using the 16KB translation granule. See the start of *The algorithm for finding the translation table entries* on page D5-1739 for more information about terms used in the table.

Table D5-23 Translation table entry addresses when using the 16KB translation granule

Lookup level	Entry address and conditions		General conditions
	Stage 1 translation	Stage 2 translation	
Zero	BaseAddr[PAMax-1:4]:IA[47]:0b000 ^a $16 \leq TnSZ$	-	Only applies to stage 1
First	BaseAddr[PAMax-1:x]:IA[y:36]:0b000 if ^a $17 \leq TnSZ \leq 27$ then $x = (31 - TnSZ)$ else ^b $x = 14$	BaseAddr[PAMax-1:x]:IA[y:36]:0b000 if $SL0^c == 2$ then if ^a $T0SZ \leq 27$ then $x = (31 - T0SZ)$	$y = (x + 32)$
Second	BaseAddr[PAMax-1:x]:IA[y:25]:0b000 if ^a $28 \leq TnSZ \leq 38$ then $x = (42 - TnSZ)$ else ^b $x = 14$	BaseAddr[PAMax-1:x]:IA[y:25]:0b000 if $SL0^c == 1$ then if ^a $24 \leq T0SZ \leq 38$ then $x = (42 - T0SZ)$ elseif $39 < T0SZ$ then $x = 7$ elseif $SL0^c == 2$ then $x = 14$	$y = (x + 21)$
Third	BaseAddr[PAMax-1:14]:IA[24:14]:0b000	BaseAddr[PAMax-1:14]:IA[y:14]:0b000 if $SL0^c == 0$ then if ^a $35 \leq T0SZ \leq 39$ then $x = (53 - T0SZ)$ elseif $SL0^c > 0$ then $x = 14$	$y = (x + 10)$

a. This line indicates the range of permitted values for $TnSZ$, for a lookup that starts at this level.

b. This is the case where this level of lookup is not the initial level of lookup.

c. $SL0 == 0$ if the initial lookup is third level, $SL0 == 1$ if the initial lookup is second level, and $SL0 == 2$ if the initial lookup level is first level.

Identifying support for the 16KB granule

The `ID_AA64MMFR0_EL1.16Kgranule` identifies whether an implementation supports the 4KB translation granule, as follows:

0b0000 16KB granule size not supported.
0b0001 16KB granule size supported.

Finding the translation table descriptor when using the 64KB translation granule

Table D5-24 shows the translation table descriptor address, for each level of lookup, when using the 64KB translation granule. See the start of *The algorithm for finding the translation table entries* on page D5-1739 for more information about terms used in the table.

Table D5-24 Translation table entry addresses when using the 64KB translation granule

Lookup level	Entry address and conditions		General conditions
	Stage 1 translation	Stage 2 translation	
First	BaseAddr[PAMax-1:x]:IA[y:42]:0b000 if ^a $16 \leq TnSZ \leq 21$ then $x = (25 - TnSZ)$ elseif $TnSZ < 16$ then $x = 9$	BaseAddr[PAMax-1:x]:IA[y:42]:0b000 if $SL0^b == 2$ then if ^a $16 \leq T0SZ \leq 21$ then $x = (25 - T0SZ)$ elseif $TnSZ < 16$ then $x = 9$	$y = (x + 38)$
Second	BaseAddr[PAMax-1:x]:IA[y:29]:0b000 if ^a $22 \leq TnSZ \leq 34$ then $x = (38 - TnSZ)$ else ^c $x = 16$	BaseAddr[PAMax-1:x]:IA[y:29]:0b000 if $SL0^b == 1$ then if ^a $18 \leq T0SZ \leq 34$ then $x = (38 - T0SZ)$ elseif $SL0^b == 2$ then $x = 16$	$y = (x + 25)$
Third	BaseAddr[PAMax-1:x]:IA[y:16]:0b000 if ^a $35 \leq TnSZ \leq 39$ then $x = (51 - TnSZ)$ elseif $39 < TnSZ$ then $x = 12$ else ^c $x = 16$	BaseAddr[PAMax-1:x]:IA[y:16]:0b000 if $SL0^b == 0$ then if ^a $31 \leq T0SZ \leq 39$ then $x = (51 - T0SZ)$ elseif $39 < T0SZ$ then $x = 12$ elseif $0 < SL0^b$ then $x = 16$	$y = (x + 12)$

- a. This line indicates the range of permitted values for $TnSZ$, for a lookup that starts at this level.
- b. $SL0 == 0$ if the initial lookup is third level, $SL0 == 1$ if the initial lookup is second level, and $SL0 == 2$ if the initial lookup level is first level.
- c. This is the case where this level of lookup is not the initial level of lookup.

Identifying support for the 64KB granule

The ID_AA64MMFR0_EL1.64Kgranule identifies whether an implementation supports the 4KB translation granule, as follows:

- 0b0000** 64KB granule size supported.
- 0b1111** 64KB granule size not supported.

D5.2.8 The effects of disabling a stage of address translation

The following sections describe the effect on MMU behavior of disabling each stage of translation:

- [Behavior when stage 1 address translation is disabled](#)
- [Behavior when stage 2 address translation is disabled on page D5-1744](#)
- [Behavior of instruction fetches when all associated stages of translation are disabled on page D5-1744.](#)

Behavior when stage 1 address translation is disabled

When a stage 1 address translation is disabled, memory accesses that would otherwise be translated by that stage of translation are treated as follows:

Non-secure EL1 and EL0 accesses if the [HCR_EL2.DC](#) bit is set to 1

For the Non-secure EL1&0 translation regime, when the value of [HCR_EL2.DC](#) is 1, the stage 1 translation assigns the Normal Non-shareable, Inner Write-Back Read-Write-Allocate, Outer Write-Back Read-Write-Allocate memory attributes.

———— **Note** —————

This applies for both instruction and data accesses.

—————

All other accesses

For all other accesses, when stage 1 address translation is disabled, the assigned attributes depend on whether the access is a data access or an instruction access, as follows:

Data access

The stage 1 translation assigns the Device-nGnRnE memory type.

Instruction access

The stage 1 translation assigns the Normal memory attribute, with the cacheability and shareability attributes determined by the value of the [SCTLR.I](#) bit for the translation regime, as follows:

When the value of I is 0

The stage 1 translation assigns the Non-cacheable and Outer Shareable attributes.

When the value of I is 1

The stage 1 translation assigns the Cacheable, Inner Write-Through no Write-Allocate Read-Allocate, Outer Write-Through no Write-Allocate Read Allocate Non-shareable attribute.

For this stage of translation, no memory access permission checks are performed, and therefore no MMU faults can be generated for this stage of address translation.

———— **Note** —————

Alignment checking is performed, and therefore Alignment faults can occur.

—————

For every access, the input address of the stage 1 translation is flat-mapped to the output address.

For a Non-secure EL1 or EL0 access, if EL1&0 stage 2 address translation is enabled, the stage 1 memory attribute assignments and output address can be modified by the stage 2 translation.

When the value of [HCR_EL2.DC](#) is 1, in Non-secure state:

- The [SCTLR_EL1.M](#) bit behaves as if it is 0, for all purposes other than reading the value of the bit. This means Non-secure EL1&0 stage 1 address translation is disabled.
- The [HCR_EL2.VM](#) bit behaves as if it is 1, for all purposes other than reading the value of the bit. This means that Non-secure EL1&0 stage 2 address translation is enabled.

See also [Behavior of instruction fetches when all associated stages of translation are disabled on page D5-1744.](#)

Effect of disabling address translation on maintenance and address translation operations

Cache maintenance instructions act on the target cache regardless of whether any stages of address translation are disabled, and regardless of the values of the memory attributes. However, if a stage of address translation is disabled, they use the flat address mapping for that translation stage.

TLB invalidate operations act on the target TLB regardless of whether any stage of address translation is disabled.

The value of `HCR_EL2.DC` affect some address translation instructions, see [Address translation instructions, AT*](#) on page D5-1757.

Behavior when stage 2 address translation is disabled

When stage 2 address translation is disabled:

- The IPA output from the stage 1 translation maps flat to the PA.
- The memory attributes and permissions from the stage 1 translation apply to the PA.

When both stages of address translation are disabled, see also [Behavior of instruction fetches when all associated stages of translation are disabled](#).

Behavior of instruction fetches when all associated stages of translation are disabled

When EL3 is using AArch64, this section applies to:

- The Secure EL1&0 translation regime when Secure EL1&0 stage 1 address translation is disabled.
- The Secure EL3 translation regime, when Secure EL3 stage 1 address translation is disabled.
- The Non-secure EL2 translation regime, when Non-secure EL2 stage 1 address translation is disabled
- The Non-secure EL1&0 translation regime, when both stages of address translation are disabled.

Note

- The behaviors in Non-secure state apply regardless of the Execution state that EL3 is using.
- When the value of `HCR_EL2.DC` is 1, then the behavior of the Non-secure EL1&0 translation regime is as if stage 1 translation is disabled and stage 2 translation is enabled, as described in [Behavior when stage 1 address translation is disabled on page D5-1743](#).

In these cases, a memory location might be accessed as a result of an instruction fetch if one of the following conditions is met:

- The memory location is in the same block of memory, of the translation granule size, as an instruction that a simple sequential execution of the program requires to be fetched, or is in the block of memory of the translation granule size immediately following such a block.
- The memory location is in the same block of memory of the translation granule size from which a simple sequential execution of the program with all associated stages of address translation disabled has previously required an instruction to be fetched, or is in the block of the translation granule size immediately following such a block.

Each block of memory referred to in this section must be aligned to the translation granule size. These accesses can be caused by speculative instruction fetches, regardless of whether the prefetched instruction is committed for execution.

———— **Note** ————

To ensure architectural compliance, software must ensure that both of the following apply:

- Instructions that will be executed when all associated stages of address translation are disabled are located in blocks of the address space, of the translation granule size, that contain only memory that is tolerant to speculative accesses.
- Each block of the address space, of the translation granule size, that immediately follows a similar block that holds instructions that will be executed when all associated stages address translation are disabled, contains only memory that is tolerant to speculative accesses.

D5.2.9 The implemented Exception levels and the resulting translation stages and regimes

Elsewhere, this chapter describes an implementation that includes all Exception levels, and describes the control of address translation by Exception levels that are using AArch64. This subsection describes how the address translation scheme changes if an implementation does not include all of the Exception levels.

If an implementation does not include EL3, it has only a single Security state, with MMU controls equivalent to the Secure state MMU controls.

If an implementation does not include EL2 then:

- If it also does not include EL3, the MMU provides only a single EL1&0 stage 1 translation regime.
- If it includes EL3, the MMU provides an EL1&0 stage 1 translation regime in each Security state.

[Figure D5-2 on page D5-1711](#) shows the set of translation regimes for an implementation that implements all of the Exception levels. [Table D5-25](#) shows how the supported translation stages depend on the implemented Exception levels, and in some cases on the Execution state being used by the highest implemented Exception level:

Table D5-25 The relation between the implemented translation stages and Exception levels for AArch64

Translation stage	Requires
Secure EL3 stage 1	EL3 implemented and using AArch64.
Secure EL1&0 stage 1	Either: <ul style="list-style-type: none"> • EL3 implemented and using AArch64. • Only EL1 and EL0 implemented, all operation is in Secure state, and EL1 is using AArch64.
Non-secure EL2 stage 1	EL2 implemented.
Non-secure EL1&0 stage 2	EL2 implemented.
Non-secure EL1&0 stage 1	Any implementation except: <ul style="list-style-type: none"> • Only EL1 and EL0 implemented, with all operation in the Secure state.

D5.2.10 Pseudocode details of VMSAv8-64 address translation

The following subsections gives a pseudocode description of the translation table walk:

- [Definitions required for address translation on page D5-1746.](#)
- [Performing the full address translation on page D5-1746.](#)
- [Stage 1 translation on page D5-1746.](#)
- [Stage 2 translation on page D5-1748.](#)
- [Translation table walk on page D5-1749.](#)
- [Support functions on page D5-1754.](#)

Definitions required for address translation

In pseudocode, the result of a translation table lookup, in either Execution state, is returned in a TLBRecord structure.

```
type TLBRecord is (  
    Permissions      perms,  
    bit              nG,           // '0' = Global, '1' = not Global  
    bits(4)          domain,       // AArch32 only  
    boolean          contiguous,    // Contiguous bit from page table  
    integer          level,         // In AArch32 Short-descriptor format, indicates Section/Page  
    integer          blocksize,     // Describes size of memory translated in KBytes  
    AddressDescriptor addrdesc  
)
```

[Memory data type definitions on page D4-1697](#) includes definitions of the Permissions and AddressDescriptor parameters.

Performing the full address translation

The function AArch64.FullTranslate() performs a full translation table walk. For any translation regime it performs a stage 1 translation for the supplied virtual address, and for the Non-secure EL1&0 translation regime it then performs a stage 2 translation of the returned address.

```
// AArch64.FullTranslate()  
// =====  
// This function is called to perform both stage 1 and stage 2 translation walks for the current  
// translation regime. The function used by Address Translation operations is similar except it uses  
// the translation regime specified for the instruction.
```

```
AddressDescriptor AArch64.FullTranslate(bits(64) vaddress, AccType acctype, boolean iswrite,  
                                       boolean wasaligned, integer size)
```

```
    // First Stage Translation  
    S1 = AArch64.FirstStageTranslate(vaddress, acctype, iswrite, wasaligned, size);  
  
    if !IsFault(S1) && HaveEL(EL2) && !IsSecure() && PSTATE.EL != EL2 then  
        s2fs1walk = FALSE;  
        result = AArch64.SecondStageTranslate(S1, vaddress, acctype, iswrite, wasaligned, s2fs1walk,  
                                             size);  
    else  
        result = S1;  
  
    return result;
```

Stage 1 translation

The function AArch64.FirstStageTranslate() performs a stage 1 translation, calling the function AArch64.TranslationTableWalk(), described in [Translation table walk on page D5-1749](#), to perform the required translation table walk. However, if stage 1 translation is disabled, it calls the function AArch64.TranslateAddressS10ff(), described in this section, to set the memory attributes.

```
// AArch64.FirstStageTranslate()  
// =====  
// This function is called to perform a stage 1 translation walk. If necessary,  
// it calls SecondStageTranslate to perform the stage 2 translation walk.  
// The function used by Address Translation operations is similar except it uses  
// the translation regime specified for the instruction.
```

```
AddressDescriptor AArch64.FirstStageTranslate(bits(64) vaddress, AccType acctype, boolean iswrite,  
                                             boolean wasaligned, integer size)
```

```
    s1_enabled = SCTRL[.M] == '1';  
  
    ipaddress = bits(48) UNKNOWN;  
    secondstage = FALSE;  
    s2fs1walk = FALSE;
```



```

boolean permissioncheck = TRUE;           // By default, permissions will need to be checked

if s1_enabled then                       // First stage enabled
    S1 = AArch64.TranslationTableWalk(ipaddress, vaddress, acctype, iswrite, secondstage,
                                       s2fs1walk, size);
else
    S1 = AArch64.TranslateAddressS1Off(vaddress, acctype, iswrite);
    permissioncheck = FALSE;

// Check for unaligned data accesses to Device memory
if (!wasaligned && !IsFault(S1.addrdesc) && S1.addrdesc.memattrs.type == MemType_Device &&
    acctype != AccType_IFETCH) then
    S1.addrdesc.fault = AArch64.AlignmentFault(acctype, iswrite, secondstage);

if !IsFault(S1.addrdesc) && permissioncheck then
    S1.addrdesc.fault = AArch64.CheckPermission(S1.perms, vaddress, S1.level,
                                                S1.addrdesc.paddress.NS,
                                                acctype, iswrite);

// Check for instruction fetches from Device memory not marked as execute-never. If there has
// not been a Permission Fault then the memory is not marked execute-never.
if (!IsFault(S1.addrdesc) && S1.addrdesc.memattrs.type == MemType_Device &&
    acctype == AccType_IFETCH) then
    S1.addrdesc = AArch64.InstructionDevice(S1.addrdesc, vaddress, ipaddress, S1.level,
                                             acctype, iswrite,
                                             secondstage, s2fs1walk);

return S1.addrdesc;

```

When stage 1 translation is disabled, the function AArch64.TranslateAddressS1Off() sets the memory attributes.

```

// AArch64.TranslateAddressS1Off()
// =====
// Called for stage 1 translations when translation is disabled to supply a default translation.
// Note that there are additional constraints on instruction prefetching that are not described in
// this pseudocode.

TLBRecord AArch64.TranslateAddressS1Off(bits(64) vaddress, AccType acctype, boolean iswrite)
    assert !ELUsingAArch32(TranslationRegime());

    TLBRecord result;

    Top = AddrTop(vaddress);
    if !IsZero(vaddress<Top:PAMax(>)) then
        level = 0;
        ipaddress = bits(48) UNKNOWN;
        secondstage = FALSE;
        s2fs1walk = FALSE;
        result.addrdesc.fault = AArch64.AddressSizeFault(ipaddress, level, acctype,
                                                         iswrite, secondstage, s2fs1walk);

    return result;

if HaveEL(EL2) && !IsSecure() && PSTATE.EL != EL2 && HCR_EL2.DC == '1' then
    // Use default cacheable settings
    result.addrdesc.memattrs.type = MemType_Normal;
    result.addrdesc.memattrs.device = DeviceType UNKNOWN;
    result.addrdesc.memattrs.inner.attrs = MemAttr_WB;           // Write-back
    result.addrdesc.memattrs.inner.hints = MemHint_RWA;
    result.addrdesc.memattrs.shareable = FALSE;
    result.addrdesc.memattrs.outershareable = FALSE;
    if HCR_EL2.VM != '1' then UNPREDICTABLE;
elseif acctype != AccType_IFETCH then
    // Treat data as Device
    result.addrdesc.memattrs.type = MemType_Device;
    result.addrdesc.memattrs.device = DeviceType_nGnRnE;
    result.addrdesc.memattrs.inner = MemAttrHints UNKNOWN;
    result.addrdesc.memattrs.shareable = TRUE;

```

```
        result.addrdesc.memattrs.outershareable = TRUE;
    else
        // Instruction cacheability controlled by SCTLRLx.I
        cacheable = SCTLRLx.I == '1';
        result.addrdesc.memattrs.type = MemType_Normal;
        result.addrdesc.memattrs.device = DeviceType_UNKNOWN;
        if cacheable then
            result.addrdesc.memattrs.inner.attrs = MemAttr_WT;
            result.addrdesc.memattrs.inner.hints = MemHint_RA;
        else
            result.addrdesc.memattrs.inner.attrs = MemAttr_NC;
            result.addrdesc.memattrs.inner.hints = MemHint_No;
        result.addrdesc.memattrs.shareable = TRUE;
        result.addrdesc.memattrs.outershareable = TRUE;

    result.addrdesc.memattrs.outer = result.addrdesc.memattrs.inner;

    result.perms.ap = bits(3) UNKNOWN;
    result.perms.xn = '0';
    result.perms.pxn = '0';

    result.nG = bit UNKNOWN;
    result.contiguous = boolean UNKNOWN;
    result.domain = bits(4) UNKNOWN;
    result.level = integer UNKNOWN;
    result.blocksize = integer UNKNOWN;
    result.addrdesc.paddress.physicaladdress = vaddress<47:0>;
    result.addrdesc.paddress.NS = if IsSecure() then '0' else '1';
    result.addrdesc.fault = AArch64.NoFault();

    return result;
```

Stage 2 translation

In the Non-secure EL1&0 translation regime, a descriptor address returned by stage 1 lookup is in the IPA address space, and must be mapped to a PA by a stage 2 translation. Function `AArch64.SecondStageWalk()` performs this translation, by calling the `AArch64.SecondStageTranslate()` function.

```
// AArch64.SecondStageWalk()
// =====
// This function is called from a stage 1 translation table walk when
// the accesses generated from that requires a second stage of translation

AddressDescriptor AArch64.SecondStageWalk(AddressDescriptor S1, bits(64) vaddress, AccType acctype,
                                          integer size)
    assert HaveEL(EL2) && !IsSecure() && PSTATE.EL != EL2;

    iswrite = FALSE;
    s2fs1walk = TRUE;
    wasaligned = TRUE;
    return AArch64.SecondStageTranslate(S1, vaddress, acctype, iswrite, wasaligned, s2fs1walk,
                                       size);
```

The `AArch64.SecondStageTranslate()` function performs the stage 2 address translation.

```
// AArch64.SecondStageTranslate()
// =====
// This function is called to perform a stage 2 translation walk.

AddressDescriptor AArch64.SecondStageTranslate(AddressDescriptor S1, bits(64) vaddress,
                                              AccType acctype, boolean iswrite, boolean wasaligned,
                                              boolean s2fs1walk, integer size)
    assert HaveEL(EL2) && !IsSecure() && PSTATE.EL != EL2;

    s2_enabled = HCR_EL2.VM == '1';
    secondstage = TRUE;
```

```

if s2_enabled then
    // Second stage enabled
    ipaddress = S1.paddress.physicaladdress<47:0>;
    S2 = AArch64.TranslationTableWalk(ipaddress, vaddress, acctype, iswrite, secondstage,
    s2fs1walk, size);

    // Check for unaligned data accesses to Device memory
    if (!wasaligned && !IsFault(S2.addrdesc) && S2.addrdesc.memattrs.type == MemType_Device &&
    acctype != AccType_IFETCH) then
        S2.addrdesc.fault = AArch64.AlignmentFault(acctype, iswrite, secondstage);

    if !IsFault(S2.addrdesc) then
        S2.addrdesc.fault = AArch64.CheckS2Permission(S2.perms, vaddress, ipaddress, S2.level,
        acctype, iswrite, s2fs1walk);

    // Check for instruction fetches from Device memory not marked as execute-never. As there
    // has not been a Permission Fault then the memory is not marked execute-never.
    if (!IsFault(S2.addrdesc) && S2.addrdesc.memattrs.type == MemType_Device &&
    acctype == AccType_IFETCH) then
        S2.addrdesc = AArch64.InstructionDevice(S2.addrdesc, vaddress, ipaddress, S2.level,
        acctype, iswrite,
        secondstage, s2fs1walk);

    // Check for protected table walk
    if (s2fs1walk && !IsFault(S2.addrdesc) && HCR_EL2.PTW == '1' &&
    S2.addrdesc.memattrs.type == MemType_Device) then
        S2.addrdesc.fault = AArch64.PermissionFault(ipaddress, S2.level, acctype,
        iswrite, secondstage, s2fs1walk);

    result = CombineS1S2Desc(S1, S2.addrdesc);
else
    result = S1;

return result;

```

Translation table walk

The function `AArch64.TranslationTableWalk()` returns the result, in the form of a `TLBRecord`, of a translation table walk made for a memory access from an Exception level that is using `AArch64`.

```

// AArch64.TranslationTableWalk()
// =====
// Returns a result of a translation table walk
//
// Implementations might cache information from memory in any number of non-coherent TLB
// caching structures, and so avoid memory accesses that have been expressed in this
// pseudocode. The use of such TLBs is not expressed in this pseudocode.

TLBRecord AArch64.TranslationTableWalk(bits(48) ipaddress, bits(64) vaddress,
    AccType acctype, boolean iswrite, boolean secondstage,
    boolean s2fs1walk, integer size)

    if !secondstage then
        assert !ELUsingAArch32(TranslationRegime());
    else
        assert HaveEL(EL2) && !IsSecure() && !ELUsingAArch32(EL2) && PSTATE.EL != EL2;

    TLBRecord result;
    AddressDescriptor descaddr;

    domain = bits(4) UNKNOWN;
    baseaddress = Zeros(48);
    basefound = FALSE;
    bits(64) base;

    descaddr.memattrs.type = MemType_Normal;

    // Determine parameters for the page table walk:
    // grainsize = Log2(Size of Table) - one of 4KB, 16KB or 64KB
    // stride = Log2(Address per level)

```

```

// firstblocklevel = first level where a block entry is allowed
// psize = Physical Address size as encoded in TCR_EL1.IPS or TCR_ELx/VTOR_EL2.PS
// tablesize = Log2(Address Size)
// level = level to start walk from
// This means that the number of levels after start level = 3-level

if !secondstage then
    // First stage translation
    bits(64) inputaddr = ZeroExtend(vaddress);
    if PSTATE.EL == EL3 then
        tablesize = 64 - UInt(TCR_EL3.T0SZ);
        if tablesize > 48 then tablesize = 48;
        if tablesize < 25 then tablesize = 25;
        largegrain = TCR_EL3.TG0 == '01';
        midgrain = TCR_EL3.TG0 == '10';
        reversedescriptors = SCTLR_EL3.EE == '1';
        psize = TCR_EL3.PS;
        top = AddrTop(inputaddr);
        basefound = tablesize == 48 || IsZero(inputaddr<top:tablesize>);
        base = TTBR0_EL3;
        descaddr.memattrs = WalkAttrDecode(TCR_EL3.SH0, TCR_EL3.ORGNO, TCR_EL3.IRGN0);
        lookupsecure = TRUE;
        singlepriv = TRUE;
    elseif PSTATE.EL == EL2 then
        tablesize = 64 - UInt(TCR_EL2.T0SZ);
        if tablesize > 48 then tablesize = 48;
        if tablesize < 25 then tablesize = 25;
        largegrain = TCR_EL2.TG0 == '01';
        midgrain = TCR_EL2.TG0 == '10';
        psize = TCR_EL2.PS;
        top = AddrTop(inputaddr);
        basefound = tablesize == 48 || IsZero(inputaddr<top:tablesize>);
        base = TTBR0_EL2;
        descaddr.memattrs = WalkAttrDecode(TCR_EL2.SH0, TCR_EL2.ORGNO, TCR_EL2.IRGN0);
        reversedescriptors = SCTLR_EL2.EE == '1';
        lookupsecure = FALSE;
        singlepriv = TRUE;
    else
        psize = TCR_EL1.IPS;
        top = AddrTop(inputaddr);
        if inputaddr<top> == '0' then
            tablesize = 64 - UInt(TCR_EL1.T0SZ);
            if tablesize > 48 then tablesize = 48;
            if tablesize < 25 then tablesize = 25;
            largegrain = TCR_EL1.TG0 == '01';
            midgrain = TCR_EL1.TG0 == '10';
            basefound = IsZero(inputaddr<top:tablesize>) && TCR_EL1.EPD0 == '0';
            base = TTBR0_EL1;
            descaddr.memattrs = WalkAttrDecode(TCR_EL1.SH0, TCR_EL1.ORGNO, TCR_EL1.IRGN0);
        else
            tablesize = 64 - UInt(TCR_EL1.T1SZ);
            if tablesize > 48 then tablesize = 48;
            if tablesize < 25 then tablesize = 25;
            largegrain = TCR_EL1.TG1 == '11'; // TG1 and TG0 encodings differ
            midgrain = TCR_EL1.TG1 == '01';
            basefound = IsOnes(inputaddr<top:tablesize>) && TCR_EL1.EPD1 == '0';
            base = TTBR1_EL1;
            descaddr.memattrs = WalkAttrDecode(TCR_EL1.SH1, TCR_EL1.ORGNO, TCR_EL1.IRGN1);
            reversedescriptors = SCTLR_EL1.EE == '1';
            lookupsecure = IsSecure();
            singlepriv = FALSE;

    if largegrain then // 64KB pages
        grainsize = 16;
        stride = grainsize - 3;
        if tablesize > (grainsize + 2*stride) then level = 1;
        elseif tablesize > (grainsize + stride) then level = 2;
        else level = 3;

```

```

        firstblocklevel = 2;
    elsif midgrain then                // 16KB pages
        grainsize = 14;
        stride = grainsize - 3;
        if tablesize > (grainsize + 3*stride) then level = 0;
        elsif tablesize > (grainsize + 2*stride) then level = 1;
        elsif tablesize > (grainsize + stride) then level = 2;
        else level = 3;
        firstblocklevel = 2;
    else                                // Small grain, 4KB pages
        grainsize = 12;
        stride = grainsize - 3;
        if tablesize > (grainsize + 3*stride) then level = 0;
        elsif tablesize > (grainsize + 2*stride) then level = 1;
        else level = 2;
        firstblocklevel = 1;
else
    // Second stage translation
    bits(64) inputaddr = ZeroExtend(ipaddress);
    lookupsecure = FALSE;
    singlepriv = TRUE;
    tablesize = 64 - UInt(VTCR_EL2.T0SZ);
    if tablesize > 48 then tablesize = 48;
    if tablesize < 25 then tablesize = 25;
    largegrain = VTCR_EL2.TG0 == '01';
    midgrain = VTCR_EL2.TG0 == '10';
    base = VTTBR_EL2;
    basefound = IsZero(inputaddr<63:tablesize>);
    descaddr.memattrs = WalkAttrDecode(VTCR_EL2.IRGN0, VTCR_EL2.ORGNO, VTCR_EL2.SH0);
    reversedescriptors = SCTLR_EL2.EE == '1';
    psize = VTCR_EL2.PS;

    startlevel = UInt(VTCR_EL2.SL0);

    // Limits on IPA controls based on implemented PA size
    if startlevel == 3 then basefound = FALSE;
    if midgrain then
        if PAMax() < 41 && startlevel == 2 then basefound = FALSE;
    else
        if PAMax() < 43 && startlevel == 2 then basefound = FALSE;

    // force the tablesize not to exceed the PAMax value
    if tablesize > PAMax() then tablesize = PAMax();

    if largegrain then
        grainsize = 16;
        stride = grainsize - 3;
        level = 3 - startlevel;
        firstblocklevel = 2;
    elsif midgrain then
        grainsize = 14;
        stride = grainsize - 3;
        level = 3 - startlevel;
        firstblocklevel = 2;
    else
        grainsize = 12;
        stride = grainsize - 3;
        level = 2 - startlevel;
        firstblocklevel = 1;

    // Check for Translation Table of fewer than 2 entries or more than 16*(2^grainsize/8)
    // entries
    // Number entries in start table level =
    // (Address Size)/((Address per level)^Num of levels after start + Size of Table)
    // Upper bound check is
    // (tablesize - stride*(3-level) - grainsize > (grainsize - 3) + 4)
    // Lower bound check is
    // (tablesize - stride*(3-level) - grainsize < 1

```

```

        if ((tablesize > stride*(3-level) + 2*grainsize + 1) ||
            (tablesize < stride*(3-level) + grainsize + 1)) then
            basefound = FALSE;

    if !basefound then
        result.addrdesc.fault = AArch64.TranslationFault(ipaddress, 0, acctype, iswrite,
            secondstage, s2fslwalk);
        return result;

    case psize of
        when '000' cpamax = 32;
        when '001' cpamax = 36;
        when '010' cpamax = 40;
        when '011' cpamax = 42;
        when '100' cpamax = 44;
        when '101' cpamax = 48;
        otherwise cpamax = 48;

    if cpamax > PAMax() then cpamax = PAMax();

    if cpamax != 48 && !IsZero(base<47:cpamax>) then
        result.addrdesc.fault = AArch64.AddressSizeFault(ipaddress, 0, acctype, iswrite,
            secondstage, s2fslwalk);
        return result;

    // Bottom bound of the Base address is:
    //   log2(8 bytes per entry)+log2(num of entries in start table level)
    // Number of entries in start table level =
    //   (Address Size)/((Address per level)^Num of levels after start level + Size of Table)

    baselowerbound = 3 + tablesize - stride*(3-level) - grainsize;
    baseaddress = base<47:baselowerbound>:Zeros(baselowerbound);

    ns_table = if lookupsecure then '0' else '1';
    ap_table = if singlepriv then '10' else '11';
    xn_table = '0';
    pxn_table = '0';

    addrselecttop = tablesize - 1;

    repeat
        addrselectbottom = (3-level)*stride + grainsize;

        bits(48) index = ZeroExtend(inputaddr<addrselecttop:addrselectbottom>:'000');
        descaddr.paddress.physicaladdress = baseaddress OR index;
        descaddr.paddress.NS = ns_table;

        // If there are two stages of translation, then the first stage table walk addresses
        // are themselves subject to translation
        if !HaveEL(EL2) || secondstage || IsSecure() || PSTATE.EL == EL2 then
            descaddr2 = descaddr;
        else
            descaddr2 = AArch64.SecondStageWalk(descaddr, vaddress, acctype, 8);
        desc = _Mem[descaddr2, 8, AccType_PTW];
        if reversedescriptors then
            desc = BigEndianReverse(desc);

        // Process descriptor
        case desc<1:0> of
            when 'x0' // Fault or reserved
                result.addrdesc.fault = AArch64.TranslationFault(ipaddress,
                    level, acctype, iswrite,
                    secondstage, s2fslwalk);
                return result;

            when '01'
                if level == 3 then // Invalid at level 3
                    result.addrdesc.fault = AArch64.TranslationFault(ipaddress,

```

```

level, acctype, iswrite,
secondstage, s2fs1walk);

return result;
else // Block
blocktranslate = TRUE;

when '11'
if level != 3 then // Table
if cpamax != 48 && !IsZero(desc<47:cpamax>) then
result.addrdesc.fault = AArch64.AddressSizeFault(ipaddress,
level, acctype,
iswrite, secondstage,
s2fs1walk);

return result;

baseaddress = desc<47:grainsize>:Zeros(grainsize);

if !secondstage then
// Unpack the upper and lower table attributes
// pxn_table and ap_table[0] apply only in EL0&1 translation regimes
ns_table = ns_table AND desc<63>;
ap_table<1> = ap_table<1> AND desc<62>;
xn_table = xn_table OR desc<60>;
if !singlepriv then
ap_table<0> = ap_table<0> AND desc<61>;
pxn_table = pxn_table OR desc<59>;

level = level + 1;
addrselecttop = addrselectbottom - 1;
blocktranslate = FALSE;
else // Page
blocktranslate = TRUE;
until blocktranslate;

// Check block size is supported at this level
if level < firstblocklevel then
result.addrdesc.fault = AArch64.TranslationFault(ipaddress, level, acctype,
iswrite, secondstage, s2fs1walk);

return result;

if cpamax != 48 && !IsZero(desc<47:cpamax>) then
result.addrdesc.fault = AArch64.AddressSizeFault(ipaddress, level, acctype,
iswrite, secondstage, s2fs1walk);

return result;

physicaladdress = desc<47:addrselectbottom>:inputaddr<addrselectbottom-1:0>;

// check for misprogramming of the contiguous bit
if largegrain then
contiguousbitcheck = level == 2 && tablesize < 34;
elseif midgrain then
contiguousbitcheck = level == 2 && tablesize < 38;
else
contiguousbitcheck = level == 1 && tablesize < 34;

if contiguousbitcheck && desc<52> == '1' then
if boolean IMPLEMENTATION_DEFINED "Translation fault on misprogrammed contiguous bit" then
result.addrdesc.fault = AArch64.TranslationFault(ipaddress, level,
acctype, iswrite,
secondstage, s2fs1walk);

return result;

// Check the access flag
if desc<10> == '0' then
result.addrdesc.fault = AArch64.AccessFlagFault(ipaddress, level,
acctype, iswrite,
secondstage, s2fs1walk);

return result;

```

```

// Unpack the upper and lower block attributes
xn = desc<54>;
pxn = desc<53>;
contiguousbit = desc<52>;
nG = desc<11>;
sh = desc<9:8>;
ap = desc<7:6>:'1';
memattr = desc<5:2>; // AttrIndx and NS bit in stage 1

result.domain = bits(4) UNKNOWN; // Domains not used
result.level = level;
result.blocksize = 2^((3-level)*stride + grainsize);

// Stage 1 translation regimes also inherit attributes from the tables
if !secondstage then
    result.perms.xn = xn OR xn_table;
    result.perms.ap<2> = ap<2> OR ap_table<1>;

    // PXN, nG and AP[1] apply only in EL0&1 stage 1 translation regimes
    if !singlepriv then
        result.perms.ap<1> = ap<1> OR NOT(ap_table<0>);
        result.perms.pxn = pxn OR pxn_table;
        // Pages from Non-secure tables are marked Global in Secure EL0&1
        if IsSecure() then
            result.nG = nG OR ns_table;
        else
            result.nG = nG;
    else
        result.perms.ap<1> = '1';
        result.perms.pxn = '0';
        result.nG = '0';
    result.perms.ap<0> = '1';
    result.addrdesc.memattrs = AArch64.S1AttrDecode(sh, memattr<2:0>, acctype);
    result.addrdesc.paddress.NS = if lookupsecure then (memattr<3> OR ns_table) else '1';
else
    result.perms.ap<2:1> = ap<2:1>;
    result.perms.ap<0> = '1';
    result.perms.xn = xn;
    result.perms.pxn = '0';
    result.nG = '0';
    result.addrdesc.memattrs = S2AttrDecode(sh, memattr, acctype);
    result.addrdesc.paddress.NS = '1';

result.addrdesc.paddress.physicaladdress = physicaladdress;
result.addrdesc.fault = AArch64.NoFault();
result.contiguous = contiguousbit == '1';

return result;

```

Support functions

In the translation table walk functions, the WalkAttrDecode() function determines the attributes for a translation table lookup.

```

// WalkAttrDecode()
// =====

MemoryAttributes WalkAttrDecode(bits(2) SH, bits(2) ORGN, bits(2) IRGN)

MemoryAttributes memattrs;

AccType acctype = AccType_NORMAL;

memattrs.type = MemType_Normal;
memattrs.device = DeviceType_UNKNOWN;
memattrs.inner = ShortConvertAttrHints(IRGN, acctype);

```



```

memattrs.outer = ShortConvertAttrsHints(ORGN, acctype);
memattrs.shareable = SH<1> == '1';
memattrs.outershareable = SH == '10';

return memattrs;

```

The function AArch64.S1AttrDecode() decodes the attributes from a stage 1 translation table lookup.

```

// AArch64.S1AttrDecode()
// =====
// Converts the Stage 1 attribute fields, using the MAIR, to orthogonal
// attributes and hints.

MemoryAttributes AArch64.S1AttrDecode(bits(2) SH, bits(3) attr, AccType acctype)

MemoryAttributes memattrs;

mair = MAIR[];
index = 8 * UInt(attr);
attrfield = mair<index+7:index>;

if ((attrfield<7:4> != '0000' && attrfield<3:0> == '0000') ||
    (attrfield<7:4> == '0000' && !(attrfield<3:0> IN {'000x', '1x00'}))) then
    // Reserved, maps to an allocated value
    (-, attrfield) = ConstrainUnpredictableBits();

if attrfield<7:4> == '0000' then // Device
    memattrs.type = MemType_Device;
    memattrs.inner = MemAttrHints UNKNOWN;
    memattrs.outer = MemAttrHints UNKNOWN;
    memattrs.shareable = TRUE;
    memattrs.outershareable = TRUE;
    case attrfield<3:0> of
        when '0000' memattrs.device = DeviceType_nGnRnE;
        when '0001' memattrs.device = DeviceType_nGnRE;
        when '1000' memattrs.device = DeviceType_nGRE;
        when '1100' memattrs.device = DeviceType_GRE;
        otherwise Unreachable(); // Reserved, handled above

elseif attrfield<3:0> != '0000' then // Normal
    memattrs.type = MemType_Normal;
    memattrs.outer = LongConvertAttrsHints(attrfield<7:4>, acctype);
    memattrs.inner = LongConvertAttrsHints(attrfield<3:0>, acctype);
    memattrs.device = DeviceType UNKNOWN;
    memattrs.shareable = SH<1> == '1';
    memattrs.outershareable = SH == '10';

else
    Unreachable(); // Reserved, handled above

return memattrs;

```

The function AArch64.CheckPermission() checks the access permissions returned by a stage 1 translation table lookup, see [Access permission checking on page D4-1702](#).

The function AArch64.CheckS2Permission() checks the access permissions returned by a stage 2 translation table lookup.

```

// AArch64.CheckS2Permission()
// =====
// Function used for permission checking from AArch64 stage 2 translations

FaultRecord AArch64.CheckS2Permission(Permissions perms, bits(64) vaddress, bits(48) ipaddress,
                                       integer level, AccType acctype, boolean iswrite,
                                       boolean s2fs1walk)
assert HaveEL(EL2) && !IsSecure() && !ELUsingAArch32(EL2) && PSTATE.EL != EL2;

r = perms.ap<1> == '0';

```

```
w = perms.ap<2> == '0';  
x = perms.xn == '0';  
  
// Stage 1 walk is checked as a read, regardless of the original type  
if acctype == AccType_IFETCH && !s2fs1walk then  
    fail = !x;  
elseif iswrite && !s2fs1walk then  
    fail = !w;  
else  
    fail = !r;  
  
if fail then  
    domain = bits(4) UNKNOWN;  
    secondstage = TRUE;  
    return AArch64.PermissionFault(ipaddress, level, acctype, iswrite, secondstage,  
                                   s2fs1walk);  
else  
    return AArch64.NoFault();
```

The AddrTop() function returns the bit number of the most significant valid bit of a VA in the current translation regime. If EL1 is using AArch64 and EL0 is using AArch32 then an address from EL0 is zero-extended to 64 bits.

```
integer AddrTop(bits(64) address);
```

D5.2.11 Address translation operations

Each of the ARMv8 instruction sets provides instructions that return the result of translating an input address, supplied as an argument to the instruction, using a specified translation stage or regime.

The available instructions only perform translations that are accessible from the Security state and Exception level at which the instruction is executed. That is:

- No instruction executed in Non-secure state can return the result of a Secure address translation stage.
- No instruction can return the result of an address translation stage that is controlled by an Exception level that is higher than the Exception level at which the instruction is executed.

[Address translation instructions, AT*](#) on page D5-1757 summarizes the A64 address translation instructions.

See also [A64 system instructions for address translation](#) on page C4-322.

Address translation instructions, AT*

The A64 assembly language syntax for address translation instructions is:

AT <operation>, <Xt>

Where:

<operation>. Is one of S1E1R, S1E1W, S1E0R, S1E0W, S12E1R, S12E1W, S12E0R, S12E0W, S1E2R, S1E2W, S1E3R, or S1E3W.

<operation> has a structure of <stages><level><read|write>, where:

<stages>. Is one of:

S1. Stage 1 translation.

S12. Stage 1 translation followed by stage 2 translation.

<level>. Describes the Exception Level that the translation applies to. Is one of:

E0. EL0.

E1. EL1.

E2. EL2.

E3. EL3.

If <level> is higher than the current Exception Level the instruction is UNDEFINED.

<read|write>

Is one of:

R. Read.

W. Write.

<Xt>. The address to be translated. No alignment restrictions apply for the address.

If EL2 is not implemented, the AT S1E2R and AT S1E2W instructions are UNDEFINED.

———— Note ————

If EL2 is not implemented but EL3 is implemented, the AT S12E* instructions are not UNDEFINED, but behave the same way as the equivalent AT S1E* instructions. This is consistent with the behavior if EL2 is implemented but stage 2 translation is disabled.

In each case, the address being translated is held in the 64-bit address argument register, Xt. If the address translation instruction uses a translation regime that is using AArch32, meaning it requires a VA of only 32 bits, then VA[63:32] is RES0.

If the address translation is successful, the resulting PA is returned in [PAR_EL1.PA](#), and [PAR_EL1.F](#) is set to 0 to indicate that the translation was successful. Otherwise, see [Synchronous faults generated by address translation instructions on page D5-1758](#).

———— Note ————

The architecture provides a single PAR, [PAR_EL1](#), that is used regardless of:

- The Exception level at which the instruction was executed.
- The Exception level that controls the stage or stages of translation used by the instruction.

For all of these instructions, the current context information determines which entries in TLB caching structures are used, and how the translation table walk is performed.

When Non-secure EL1&0 stage 1 address translation is disabled, any AT S1E0*, AT S1E1*, AT S12E0*, or AT S12E1* address translation operation that accesses the Non-secure state translation reflects the effect of the [HCR_EL2.DC](#) bit as described in [Behavior when stage 1 address translation is disabled on page D5-1743](#).

Executing AT S1E2R or AT S1E2W at EL3 with [SCR_EL3.NS](#)==0 is UNDEFINED.

———— Note ————

AT S12E* instructions at EL3 with [SCR_EL3.NS](#)==0 are not UNDEFINED but behave the same way as the equivalent AT S1E* instructions. This is consistent with the behavior if EL2 is implemented but stage 2 translation is disabled.

Synchronous faults generated by address translation instructions

The address translation instructions use the translation mechanism, and that mechanism can generate the following synchronous faults:

- Translation fault.
- Access flag fault.
- Permission fault.
- Domain fault, when translating using the AArch32 translation systems.
- Address size fault.
- TLB conflict fault.
- Synchronous external aborts during a translation table walk.

In addition:

- If the address translation instruction requires two stages of translation then these faults could arise from either stage 1 or stage 2.
- For a stage 1 translation for the Non-secure EL1&0 translation regime, the fault might be generated on the stage 2 translation of an address accessed as part of the stage 1 translation table walk, see [Stage 2 fault on a stage 1 translation table walk on page D5-1801](#).

Except as described in this section, these faults are not taken as an exception for the address translation instructions, but instead the `PAR_EL1.FST` field holds the fault status information. In these cases the `PAR_EL1.PA` field does not hold the output address of the translation.

The exceptions to this reporting the fault in `PAR_EL1` are:

- Synchronous external aborts during a translation table walk are taken as a Data Abort exception.
For an address translation instruction executed at a particular Exception level, if the synchronous external abort is generated on a stage 1 translation table walk, the Data Abort exception is taken to the Exception level to which a synchronous external abort on a stage 1 translation table walk for a memory access from that Exception level would be taken.
If the synchronous external abort is generated on a stage 2 translation table walk then:
 - If the address translation instruction was executed at EL3, the synchronous Data Abort exception is taken to EL3.
 - If the address translation instruction was executed at EL2 or EL1, the Data Abort exception is taken to the Exception level to which a synchronous external abort on a stage 2 translation table walk for a memory access from that Exception level would be taken.In any case where the address translation instruction causes a synchronous Data Abort exception to be taken:
 - The `PAR_EL1` is UNKNOWN.
 - The `ESR_ELx` of the target Exception Level of the exception indicates that the fault was due to a translation table walk for a cache maintenance instruction.
 - The `FAR_ELx` of the target Exception Level holds the virtual address for the translation request.
- For the AT S1E0* and AT S1E1* instructions executed from the Non-secure EL1 Exception level, if there is a stage 2 fault on a memory access made as part of the translation table walk. If `SCR_EL3.EA==1` then a synchronous external abort on a stage 2 translation table walk is taken to EL3. In all other cases, the fault is taken as an exception to EL2, and:
 - `PAR_EL1` is UNKNOWN
 - `ESR_EL2` indicates that the fault occurred on a translation table walk, and that the operation that faulted was a cache maintenance instruction.
 - `HPFAR_EL2` holds the IPA that faulted
 - `FAR_EL2` holds the VA that the executing software supplied to the address translation operation.
 - For any exception other than the synchronous external abort on a stage 2 translation table walk, the `HPFAR_EL2` holds the IPA that faulted.

This fault can occur for any of the following reasons:

- Stage 2 Translation fault.
- Stage 2 Access fault.
- Stage 2 Permission fault.
- Stage 2 Address size fault.
- Synchronous external abort on a stage 2 translation table walk.

Synchronization requirements of the address translation instructions

Where an instruction results in an update to a system register, as is the case with the AT * address translation instructions, explicit synchronization must be performed before the result is guaranteed to be visible to subsequent direct reads of the [PAR_EL1](#).

———— **Note** —————

This is consistent with the AArch32 requirement, where the VA to PA translation instructions are expressed as CP15 register writes, and the effect of those writes to other registers require explicit synchronization before the result is guaranteed to be visible to subsequent instructions.

D5.3 Translation table walk examples

Figure D5-2 on page D5-1711 shows the VMSAv8 address translation stages that are controlled by an Exception level that is using AArch64. *The VMSAv8-64 address translation system on page D5-1710* describes the VMSAv8-64 address translation scheme. This section gives examples of the use of that scheme, for common translation requirements.

System control registers relevant to MMU operation on page D5-1715 specifies the relevant registers, including the TCR and TTBR, or TTBRs, for each stage of address translation.

For any stage of translation, a TCR.TnSZ field indicates the supported input address size. For a stage of address translation controlled from an Exception level using AArch64, the supported input address size is $2^{(64-TnSZ)}$.

This section describes:

- Performing the initial lookup, for an address for which the initial lookup is either:
 - At the highest lookup level used for the appropriate translation granule size.
 - Because of the concatenation of translation tables at the initial lookup level, one level down from the highest level used for the translation granule size.

These descriptions take account of the following cases:

- The IA size is smaller than the largest size for the translation level, see *Reduced IA width on page D5-1720*.
- For a stage 2 translation, translation tables are concatenated, to move the initial lookup level down by one level, see *Concatenated translation tables on page D5-1720*.

For examples of performing the initial lookup, see *Examples of performing the initial lookup*.

- The full translation flow for resolving a page of memory. These examples describe resolving the largest IA size supported by the initial lookup level. For these examples, see *Full translation flows for VMSAv8-64 address translation on page D5-1766*.

D5.3.1 Examples of performing the initial lookup

The address ranges used for the initial translation table lookup depend on the translation granule, as described in:

- *Performing the initial lookup using the 4KB translation granule*.
- *Performing the initial lookup using the 16KB granule on page D5-1762*.
- *Performing the initial lookup using the 64KB translation granule on page D5-1764*.

Performing the initial lookup using the 4KB translation granule

This subsection describes examples of the initial lookup when using the 4KB translation granule that *Table D5-9 on page D5-1725* shows as starting at the zero level or at the first level. It includes those stage 2 translations where concatenation of translation tables is required for the lookup to start at the first level. This means that it gives specific examples of the mechanisms described in *The VMSAv8-64 address translation system on page D5-1710*.

————— Note —————

For stage 2 translations, the same principles apply to an initial lookup that *Table D5-9 on page D5-1725* shows as starting at the first level. In this case, for some IA sizes concatenation of translation tables means the lookup can, instead, start at the second level.

The following subsections describe these examples of the initial lookup:

- *Initial lookup at the zero level, 4KB translation granule on page D5-1761*.
- *Initial lookup at the first level, 4KB translation granule on page D5-1761*.

In all cases, for a stage 2 translation, the VTCR_EL2.SL0 field must indicate the required initial lookup level, and this level must be consistent with the value of the VTCR_EL2.T0SZ field, see *Overview of stage 2 translations, 4KB granule on page D5-1725*.

Initial lookup at the zero level, 4KB translation granule

This subsection describes initial lookups with an input address width of $(n+1)$ bits, meaning the input address is $IA[n:0]$. As Table D5-9 on page D5-1725 shows, a stage 1 or stage 2 initial lookup at the zero level is required when $39 \leq n \leq 47$. For these lookups:

- $TTBR[47:(n-35)]$ specify the translation table base address.
- $Bits[n:39]$ of the input address are $bits[(n-36):3]$ of the descriptor offset in the translation table.

———— **Note** ————

This means that, when the input address width is less than 48 bits

- The size of the translation table is reduced.
- More low-order bits of the **TTBR** are required to specify the translation table base address.
- Fewer input address bit are used to specify the descriptor offset in the translation table.

For example, if the input address width is 46 bits:

- The translation table size is 1KB,
- **TTBR** bits[47:10] specify the translation table base address.
- Input address bits[45:39] specify bits[9:3] of the descriptor offset.

Figure D5-15 shows this lookup.

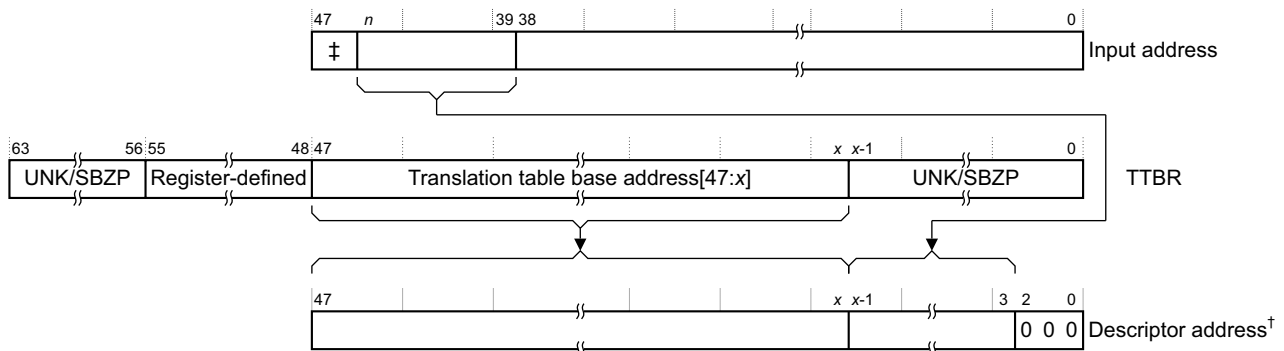

Supported input address range is $IA[n:0]$, $4 \leq x \leq 12$, $n = x + 35$. When n is 47 the field marked ‡ is absent.

† For a Non-secure EL1&0 stage 1 translation, the IPA of the descriptor. Otherwise, the PA of the descriptor.

Figure D5-15 Initial lookup for VMSAv8-64 using the 4KB granule, starting at the zero level

Initial lookup at the first level, 4KB translation granule

This subsection describes initial lookups with an input address width of $(n+1)$ bits, meaning the input address is $IA[n:0]$.

For a stage 1 or stage 2 initial lookup at the first level, without use of concatenated translation tables

As Table D5-9 on page D5-1725 shows, this applies to $IA[n:0]$, where $30 \leq n \leq 38$. For these lookups:

- There is a single translation table at this level.
- $TTBR[47:(n-26)]$ specify the translation table base address.
- $Bits[n:30]$ of the input address are $bits[(n-27):3]$ of the descriptor offset in the translation table.

Figure D5-16 on page D5-1762 shows this lookup.

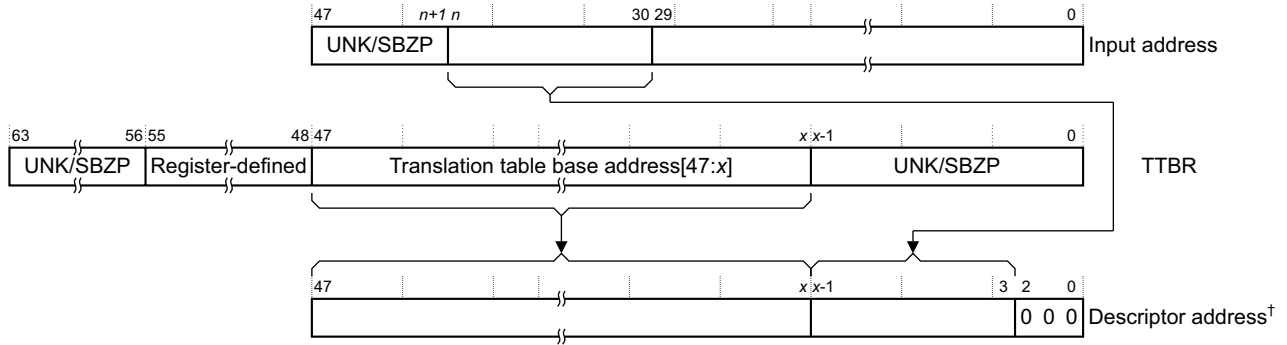

Supported input address range is $IA[n:0]$, $4 \leq x \leq 12$, $n = x + 26$.

† For a Non-secure EL1&0 stage 1 translation, the IPA of the descriptor. Otherwise, the PA of the descriptor.

Figure D5-16 Initial lookup for VMSAv8-64 using the 4KB granule, starting at the first level, without concatenation

For a stage 2 initial lookup at the first level, with concatenated translation tables

As Table D5-9 on page D5-1725 shows, this applies to $IA[n:0]$, where $39 \leq n \leq 42$. For these lookups:

- There are $2^{(n-38)}$ concatenated translation tables at this level.
- These concatenated translation tables must be aligned to $2^{(n-38)} \times 4\text{KB}$. This means $TTBR[(n-27):12]$ must be zero.
- $TTBR[47:(n-26)]$ specify the base address of the block of concatenated translation tables.
- Bits $[n:30]$ of the input address are bits $[(n-27):3]$ of the descriptor offset from the base address of the block of concatenated translation tables.

Figure D5-17 shows this lookup.

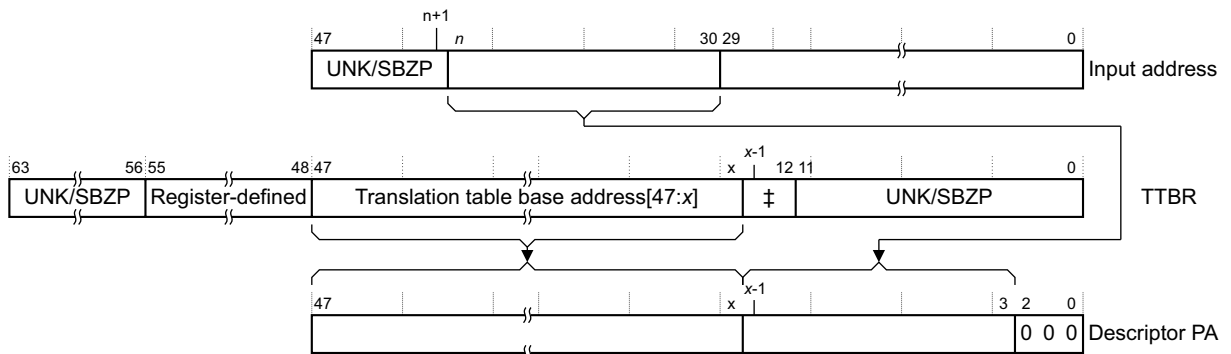

Supported input address range is $IPA[n:0]$, $13 \leq x \leq 16$, $n = x + 26$. The field marked ‡ must be zero.

Figure D5-17 Initial lookup for VMSAv8-64 using the 4KB granule, starting at the first level, with concatenation

Performing the initial lookup using the 16KB granule

This subsection describes examples of the initial lookup when using the 16KB translation granule that Table D5-12 on page D5-1729 shows as starting at the zero level or at the first level. It includes those stage 2 translations where concatenation of translation tables is required for the lookup to start at the first level. This means that it gives specific examples of the mechanisms described in *The VMSAv8-64 address translation system* on page D5-1710.

Note

For stage 2 translations, the same principles apply to an initial lookup that Table D5-12 on page D5-1729 shows as starting at the first level. In this case, for some IA sizes concatenation of translation tables means the lookup can, instead, start at the second level.

The following subsections describe these examples of the initial lookup:

- *Initial lookup at the zero level, 16KB translation granule.*
- *Initial lookup at the first level, 16KB translation granule.*

In all cases, for a stage 2 translation, the `VTCR_EL2.SL0` field must indicate the required initial lookup level, and this level must be consistent with the value of the `VTCR_EL2.T0SZ` field, see *Overview of stage 2 translations, 16KB granule* on page D5-1728.

Initial lookup at the zero level, 16KB translation granule

This subsection describes initial lookups with an input address width of $(n+1)$ bits, meaning the input address is $IA[n:0]$. As Table D5-11 on page D5-1727 shows, the only case where an address translation using the 16KB granule starts at level 0 is a stage 1 translation of a 48-bit input address, $IA[47:0]$. For this lookup:

- The required translation table has only two entries, meaning its size is 16bytes, and it must be aligned to 16 bytes.
- `TTBR[47:4]` specify the translation table base address.
- Bit[47] of the input address is bits[3] of the descriptor offset in the translation table.

Figure D5-18 shows this lookup.

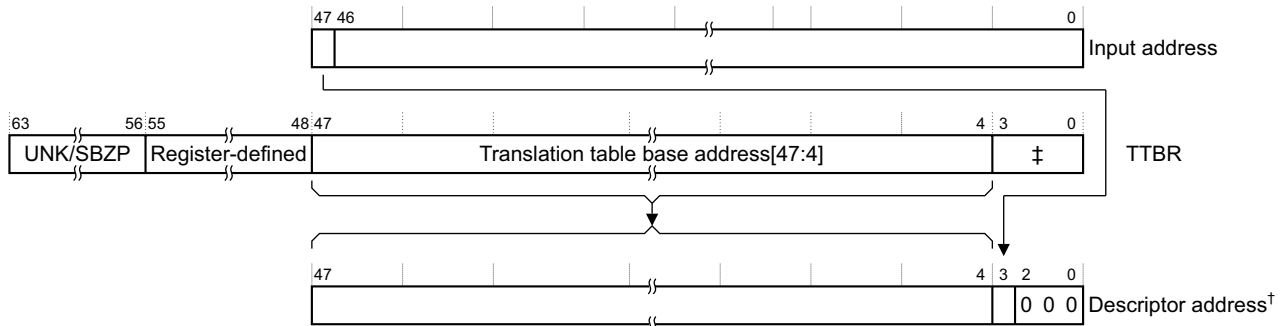

Supported input address range is $IA[47:0]$. The field marked ‡ is UNK/SBZP.

† For a Non-secure EL1&0 stage 1 translation, the IPA of the descriptor. Otherwise, the PA of the descriptor.

Figure D5-18 Initial lookup for VMSAv8-64 using the 16KB granule, starting at the zero level

Initial lookup at the first level, 16KB translation granule

This subsection describes initial lookups with an input address width of $(n+1)$ bits, meaning the input address is $IA[n:0]$.

For a stage 1 or stage 2 initial lookup at the first level, without use of concatenated translation tables

As Table D5-12 on page D5-1729 shows, this applies to $IA[n:0]$, where $36 \leq n \leq 46$. For these lookups:

- There is a single translation table at this level.
- `TTBR[47:(n-32)]` specify the translation table base address.
- Bits $[n:36]$ of the input address are bits $[(n-33):3]$ of the descriptor offset in the translation table.

Figure D5-19 on page D5-1764 shows this lookup.

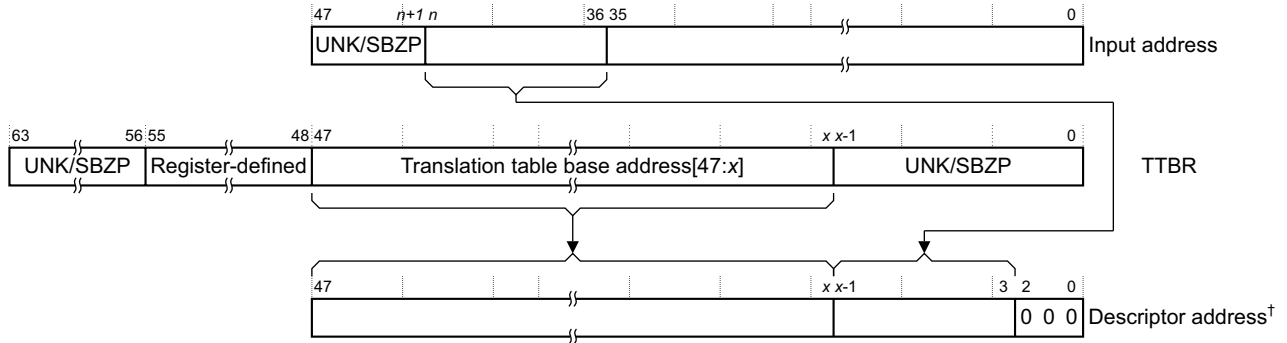

Supported input address range is IA[n:0], $4 \leq x \leq 14$, $n = x + 32$.

[†] For a Non-secure EL1&0 stage 1 translation, the IPA of the descriptor. Otherwise, the PA of the descriptor.

Figure D5-19 Initial lookup for VMSAv8-64 using the 16KB granule, starting at the first level, without concatenation

For a stage 2 initial lookup at the first level, with concatenated translation tables

As Table D5-12 on page D5-1729 shows, the only case where an address translation using the 16KB granule starts at the first level because of concatenation of translation tables is a stage 2 translation of a 48-bit input address, IA[47:0]. For this lookup:

- There are two concatenated translation tables at this level.
- These concatenated translation tables must be aligned to $2 \times 16\text{KB}$. This means TTBR[14] must be zero.
- TTBR[47:15] specify the base address of the block of two concatenated translation tables.
- Bits[47:36] of the input address are bits[14:3] of the descriptor offset from the base address of the block of concatenated translation tables.

Figure D5-20 shows this lookup.

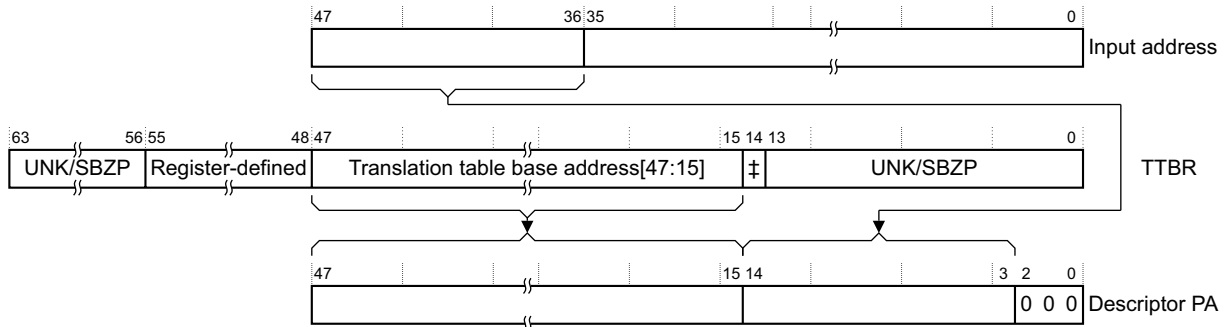

Supported input address range is IPA[47:0]. The bit marked ‡ must be zero.

Figure D5-20 Initial lookup for VMSAv8-64 using the 16KB granule, starting at the first level, with concatenation

Performing the initial lookup using the 64KB translation granule

This subsection describes examples of the initial lookup when using the 64KB translation granule that Table D5-15 on page D5-1732 shows as starting at the first level or at the second level. It includes those stage 2 translations where concatenation of translation tables is required for the lookup to start at the second level. This means that it gives specific examples of the mechanisms described in *The VMSAv8-64 address translation system on page D5-1710*.

Note

For stage 2 translations, the same principles apply to an initial lookup that Table D5-15 on page D5-1732 shows as starting at the second level. In this case, for some IA sizes concatenation of translation tables means the lookup can, instead, start at the third level.

The following subsections describe these examples of the initial lookup:

- *Initial lookup at the first level, 64KB translation granule.*
- *Initial lookup at the second level, 64KB translation granule.*

In all cases, for a stage 2 translation, the `VTCR_EL2.SL0` field must indicate the required initial lookup level, and this level must be consistent with the value of the `VTCR_EL2.T0SZ` field, see *Overview of stage 2 translations, 64KB granule* on page D5-1732.

Initial lookup at the first level, 64KB translation granule

This subsection describes initial lookups with an input address width of $(n+1)$ bits, meaning the input address is `IA[n:0]`. As Table D5-15 on page D5-1732 shows, a stage 1 or stage 2 initial lookup at the first level is required when $42 \leq n \leq 47$. For these lookups:

- The size of the translation table is $2^{(n-39)}$ bytes. This means the size of the translation table, at this level, is always less than the granule size. The address of this translation table must align to the size of the table.
- Bits `[n:42]` of the input address are bits `[(n-39):3]` of the descriptor offset in the translation table.
- Bits `[47:(n-38)]` of the `TTBR` specify the translation table base address.

Figure D5-21 shows this lookup.

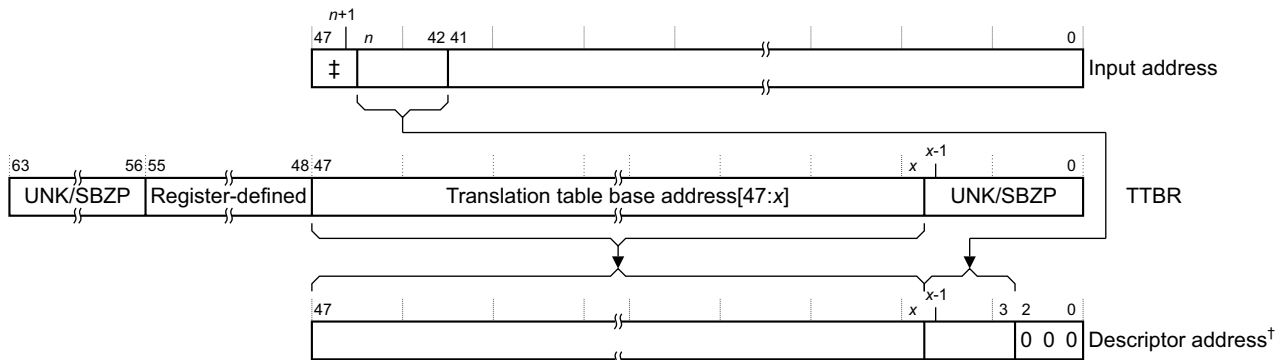

Supported input address range is `IA[n:0]`, $42 \leq n \leq 47$, $x = n-38$. When n is 47 the field marked ‡ is absent.

† For a Non-secure EL1&0 stage 1 translation, the IPA of the descriptor. Otherwise, the PA of the descriptor.

Figure D5-21 Initial lookup for VMSAv8-64 using the 64KB granule, starting at the first level

Initial lookup at the second level, 64KB translation granule

This subsection describes initial lookups with an input address width of $(n+1)$ bits, meaning the input address is `IA[n:0]`.

For a stage 1 or stage 2 initial lookup at the second level, without the use of concatenated translation tables

As Table D5-15 on page D5-1732 shows, this applies to `IA[n:0]`, where $29 \leq n \leq 41$. For these lookups:

- There is a single translation table at this level.
- `TTBR[47:(n-25)]` of the specify the translation table base address.
- Bits `[n:29]` of the input address are bits `[(n-26):3]` of the descriptor offset in the translation table.

Figure D5-22 on page D5-1766 shows this lookup.

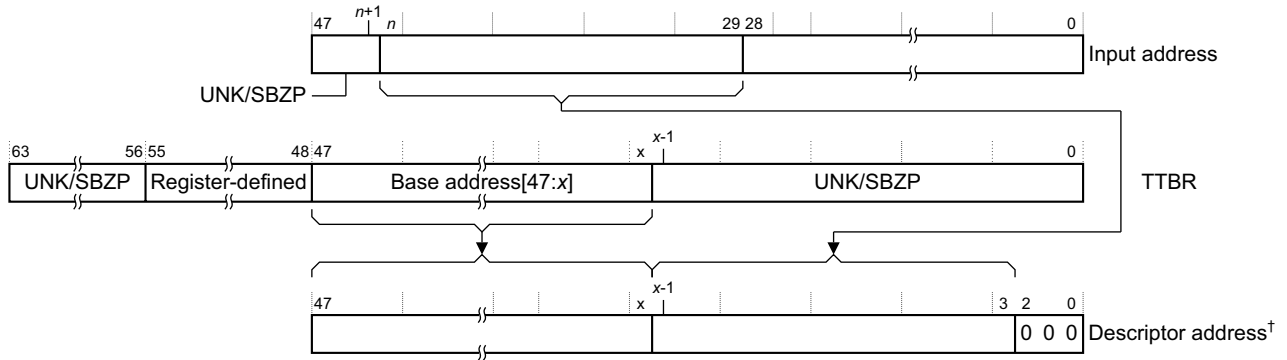

Supported input address range is IA[n:0]. $4 \leq x \leq 16$, $n = x + 25$.

[†] For a Non-secure EL1&0 stage 1 translation, the IPA of the descriptor. Otherwise, the PA of the descriptor.

Figure D5-22 Initial lookup for VMSAv8-64 using the 64KB granule, starting at second level, without concatenation

For a stage 2 initial lookup at the second level, with concatenated translation tables

As Table D5-15 on page D5-1732 shows, this applies to IA[n:0], where $42 \leq n \leq 45$. For these lookups:

- There are $2^{(m-41)}$ concatenated translation tables at this level.
- These concatenated translation tables must be aligned to $2^{(m-41)} \times 64\text{KB}$. This means $\text{TTBR}[(n-26):16]$ must be zero.
- $\text{TTBR}[47:(n-25)]$ specify the base address of the block of translation tables.
- Bits[n:42] of the input address are bits[(n-26):16] of the descriptor offset from the base address of the block of translation tables.

Figure D5-23 shows this lookup.

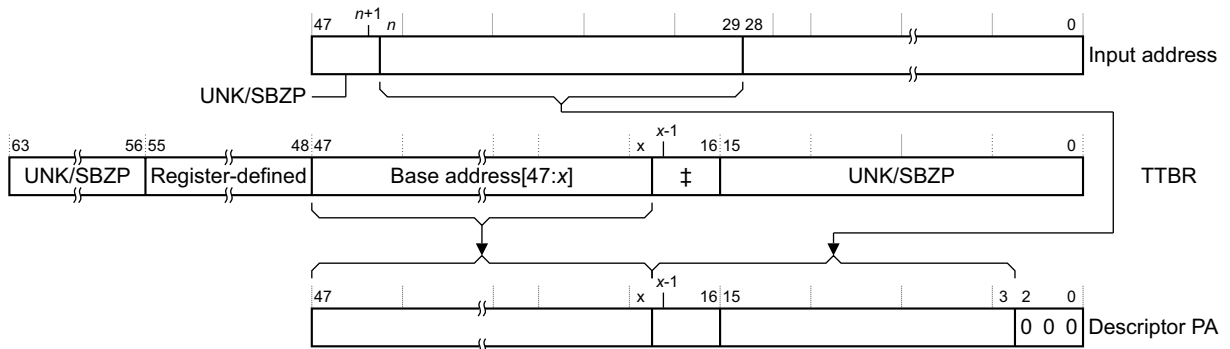

Supported input address range is IPA[n:0], $17 \leq x \leq 20$, $n = x + 25$. The field marked ‡ must be zero.

Figure D5-23 Initial lookup for VMSAv8-64 using the 64KB granule, starting at second level, with concatenation

D5.3.2 Full translation flows for VMSAv8-64 address translation

In a translation table walk, only the first lookup uses the translation table base address from the appropriate TTBR. Subsequent lookups use a combination of address information from:

- The table descriptor read in the previous lookup.
- The input address.

This section describes example full translation flows, from the initial lookup to the address of a memory page. The described flows:

- Resolve the maximum-sized IA range supported by the initial lookup level.
- Do not have any concatenation of translation tables.

[Examples of performing the initial lookup on page D5-1760](#) described how either reducing the IA range or concatenating translation tables affects the initial lookup.

———— **Note** —————

Reducing the IA range or concatenating translation tables affects only the initial lookup.

The following sections describe full VMSAv8-64 translation flows, down to an entry for a memory page:

- [The address and properties fields shown in the translation flows.](#)
- [Full translation flow using the 4KB granule and starting at the zero level on page D5-1768.](#)
- [Full translation flow using the 4KB granule and starting at the first level on page D5-1769.](#)
- [Full translation flow using the 64KB granule and starting at the first level on page D5-1770.](#)
- [Full translation flow using the 64KB granule and starting at the second level on page D5-1771.](#)

The address and properties fields shown in the translation flows

For the Non-secure EL1&0 stage 1 translation:

- Any descriptor address is the IPA of the required descriptor.
- The final output address is the IPA of the block or page.

In these cases, an EL1&0 stage 2 translation is performed to translate the IPA to the required PA.

For all other translations, the final output address is the PA of the block or page, and any descriptor address is the PA of the descriptor.

Properties indicates register or translation table fields that return information, other than address information, about the translation or the targeted memory region. For more information see [Memory attribute fields in the VMSAv8-64 translation table format descriptors on page D5-1776](#).

Full translation flow using the 4KB granule and starting at the zero level

Figure D5-24 shows the complete translation flow for a stage 1 translation table walk for a 48-bit input address. This lookup must start with a zero-level lookup. For more information about the fields shown in the figure see *The address and properties fields shown in the translation flows on page D5-1767*.

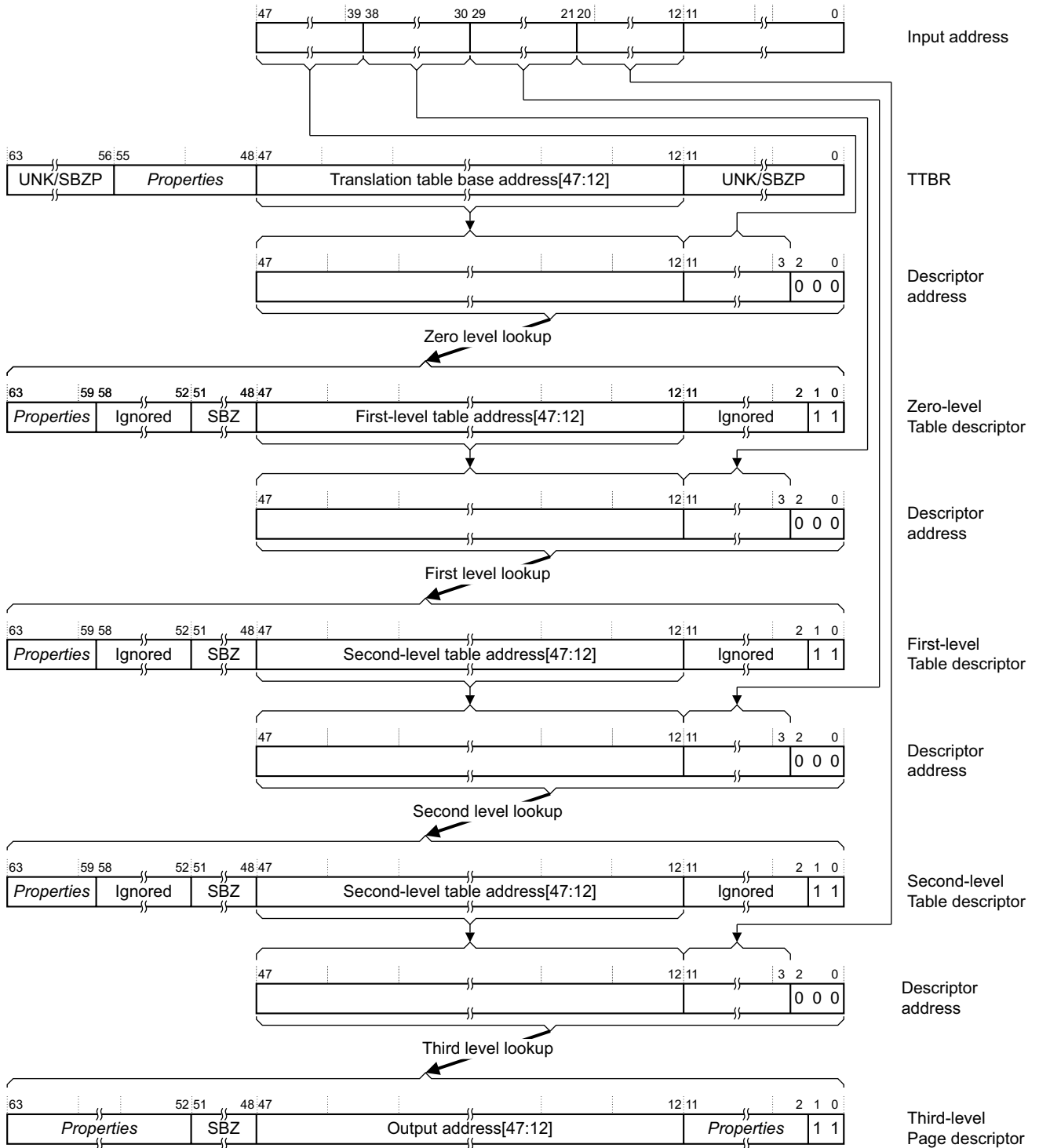

Figure D5-24 Complete stage 1 translation of a 48-bit address using the 4KB translation granule

If the first-level lookup or second-level lookup returns a block descriptor then the translation table walk completes at that level.

Figure D5-24 on page D5-1768 shows a stage 1 translation. The only difference for a stage 2 translation is that bits[63:58] of the Table descriptors are SBZ.

Full translation flow using the 4KB granule and starting at the first level

Figure D5-25 shows the complete translation flow for a stage 1 translation table walk for a 39-bit input address. This lookup must start with a first-level lookup. For more information about the fields shown in the figure see *The address and properties fields shown in the translation flows on page D5-1767*.

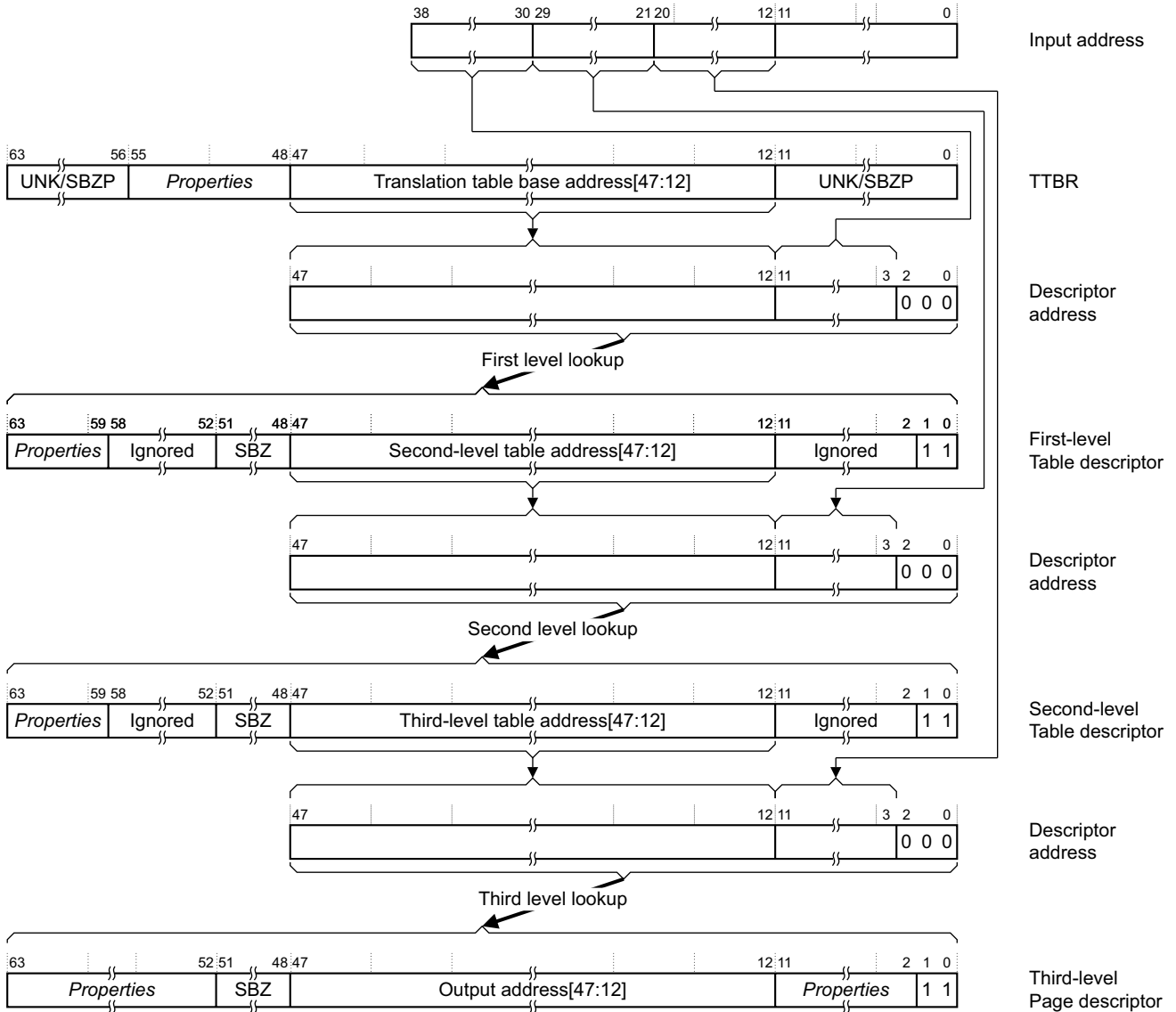

For details of *Properties* fields, see the register or descriptor description.

Figure D5-25 Complete stage 1 translation of a 39-bit address using the 4KB translation granule

If the first-level lookup or the second-level lookup returns a block descriptor then the translation table walk completes at that level.

Figure D5-25 on page D5-1769 shows a stage 1 translation. The only difference for a stage 2 translation is that bits[63:58] of the Table descriptors are SBZ.

Comparing this translation with the translation for a 48-bit address, shown in Figure D5-24 on page D5-1768, shows how the translation for the 42-bit address start the same lookup process one stage later.

Full translation flow using the 64KB granule and starting at the first level

Figure D5-24 on page D5-1768 shows the complete translation flow for a stage 1 translation table walk for a 48-bit input address. This lookup must start with a zero-level lookup. For more information about the fields shown in the figure see *The address and properties fields shown in the translation flows on page D5-1767.*

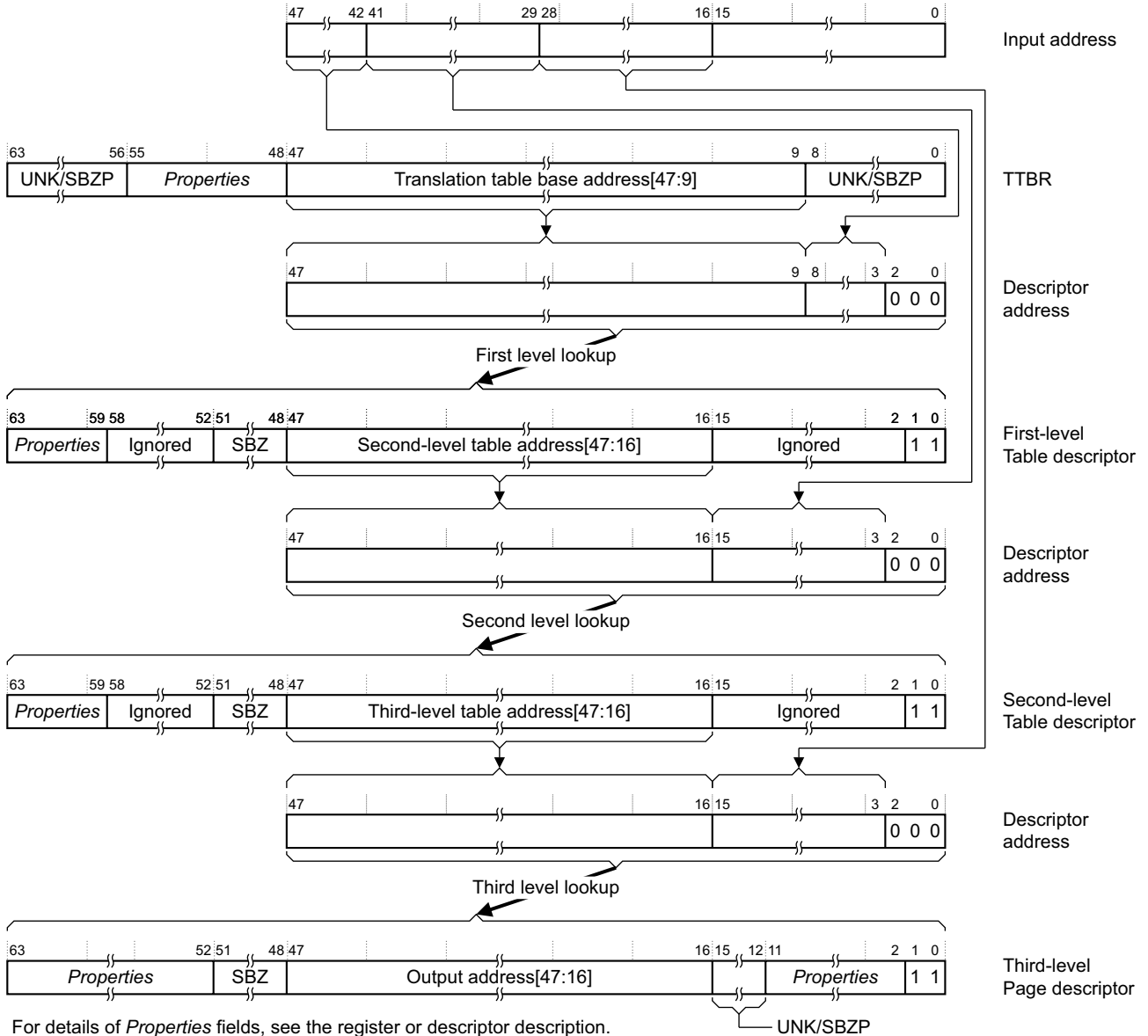

Figure D5-26 Complete stage 1 translation of a 48-bit address using the 64KB translation granule

If the second-level lookup returns a block descriptor then the translation table walk completes at that level.

Figure D5-26 shows a stage 1 translation. The only difference for a stage 2 translation is that bits[63:58] of the Table descriptors are SBZ.

The first-level lookup resolves only 6 bits of the input address. As described in *Performing the initial lookup using the 64KB translation granule on page D5-1764*, this means:

- The translation table size for this level is only 512 bytes.
- The required translation table alignment for this level is 512 bytes.
- The Base address field in the **TTBR** is extended, at the low-order end, to be bits[47:9].

Full translation flow using the 64KB granule and starting at the second level

Figure D5-25 on page D5-1769 shows the complete translation flow for a stage 1 translation table walk for a 42-bit input address. This lookup must start with a second-level lookup. For more information about the fields shown in the figure see *The address and properties fields shown in the translation flows on page D5-1767*.

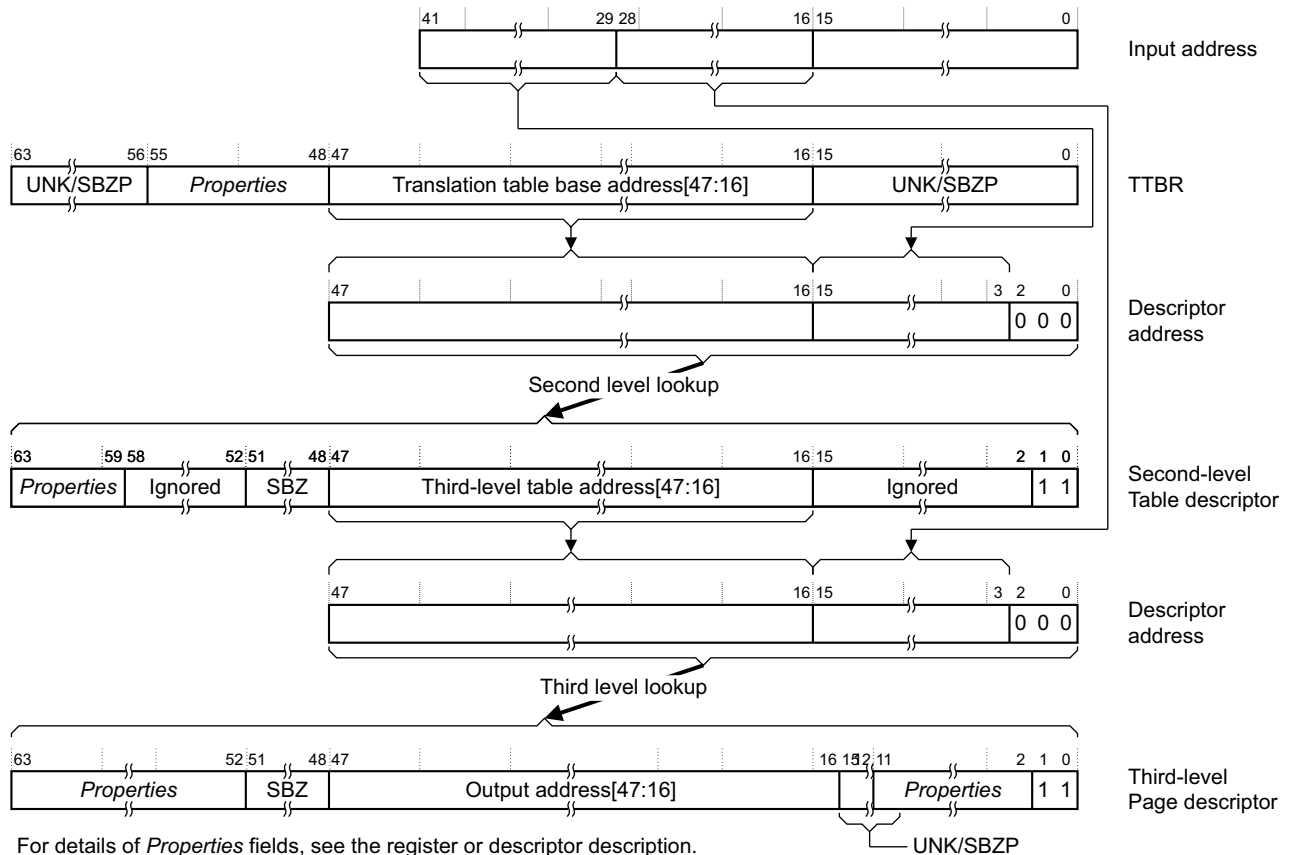

Figure D5-27 Complete stage 1 translation of a 42-bit address using the 64KB translation granule

If the second-level lookup returns a block descriptor then the translation table walk completes at that level.

Figure D5-27 shows a stage 1 translation. The only difference for a stage 2 translation is that bits[63:58] of the Table descriptors are SBZ.

Comparing this translation with the translation for a 48-bit address, shown in Figure D5-26 on page D5-1770, shows:

- The translation for the 42-bit address starts the same lookup process one stage later.
- Because the initial lookup resolves 13 bits of address:
 - The translation table size for this level is 64KB.
 - The required translation table alignment for this level is 64KB.
 - The Base address field in the **TTBR** is bits[47:16].

D5.4 VMSAv8-64 translation table format descriptors

In general, a descriptor is one of:

- An invalid or fault entry.
- A table entry, that points to the next-level translation table.
- A block entry, that defines the memory properties for the access.
- A reserved format.

Bit[1] of the descriptor indicates the descriptor type, and bit[0] indicates whether the descriptor is valid.

The following sections describe the ARMv8 translation table descriptor formats:

- [VMSAv8-64 translation table zero-level, first-level, and second-level descriptor formats](#).
- [ARMv8 translation table third-level descriptor formats on page D5-1775](#).

[Memory attribute fields in the VMSAv8-64 translation table format descriptors on page D5-1776](#) then gives more information about the descriptor attribute fields, and [Control of Secure or Non-secure memory access on page D5-1779](#) describe how the NS and NSTable together control whether a memory access from Secure state accesses the Secure memory map or the Non-secure memory map.

D5.4.1 VMSAv8-64 translation table zero-level, first-level, and second-level descriptor formats

In the VMSAv8-64 translation table format, the difference in the formats of the zero-level, first-level and second-level descriptors is:

- Whether a block entry is permitted.
- If a block entry is permitted, the size of the memory region described by that entry.

These differences depend on the translation granule, as follows:

4KB granule A zero-level descriptor does not support block translation.

A block entry:

- In a first-level table describes the mapping of the associated 1GB input address range.
- In a second-level table describes the mapping of the associated 2MB input address range.

16KB granule Zero-level and first-level descriptors do not support block translation.

A block entry in a second-level table describes the mapping of the associated 32MB input address range.

64KB granule Zero-level lookup is not supported.

A first-level descriptor does not support block translation.

A block entry in a second-level table describes the mapping of the associated 512MB input address range.

[Figure D5-28 on page D5-1773](#) shows the ARMv8 zero-level, first-level and second-level descriptor formats:

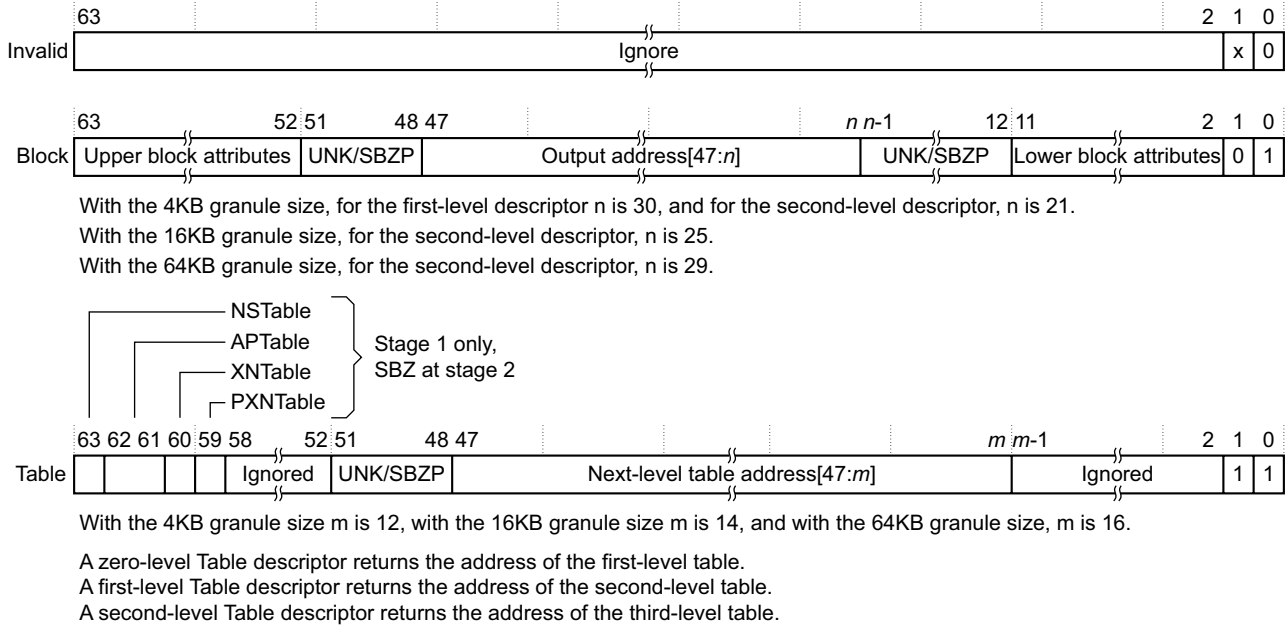

Figure D5-28 VMSAv8-64 zero-level, first-level, and second-level descriptor formats

Descriptor encodings, ARMv8 zero-level, first-level, and second-level formats

Descriptor bit[0] identifies whether the descriptor is valid, and is 1 for a valid descriptor. If a lookup returns an invalid descriptor, the associated input address is unmapped, and any attempt to access it generates a Translation fault.

Descriptor bit[1] identifies the descriptor type, and is encoded as:

- 0, Block** The descriptor gives the base address of a block of memory, and the attributes for that memory region.
- 1, Table** The descriptor gives the address of the next level of translation table, and for a stage 1 translation, some attributes for that translation.

The other fields in the valid descriptors are:

Block descriptor

Gives the base address and attributes of a block of memory, as follows:

4KB translation granule

- For a first-level Block descriptor, bits[47:30] are bits[47:30] of the output address. This output address specifies a 1GB block of memory.
- For a second-level descriptor, bits[47:21] are bits[47:21] of the output address. This output address specifies a 2MB block of memory.

16KB translation granule

For a second-level Block descriptor, bits[47:25] are bits[47:25] of the output address. This output address specifies a 32MB block of memory.

64KB translation granule

For a second-level Block descriptor, bits[47:29] are bits[47:29] of the output address. This output address specifies a 512MB block of memory.

Bits[63:52, 11:2] provide attributes for the target memory block, see [Memory attribute fields in the VMSAv8-64 translation table format descriptors on page D5-1776](#). The position and contents of these bits are identical in the second-level block descriptor and in the third-level page descriptor.

Table descriptor

Gives the translation table address for the next-level lookup, as follows:

4KB translation granule

- Bits[47:12] are bits[47:12] of the address of the required next-level table, which is:
 - For a zero-level Table descriptor, the address of a first-level table.
 - For a first-level Table descriptor, the address of a second-level table.
 - For a second-level Table descriptor, the address of a third-level table.
- Bits[11:0] of the table address are zero.

16KB translation granule

- Bits[47:14] are bits[47:14] of the address of the required next-level table, which is:
 - For a zero-level Table descriptor, the address of a first-level table.
 - For a first-level Table descriptor, the address of a second-level table.
 - For a second-level Table descriptor, the address of a third-level table.
- Bits[13:0] of the table address are zero.

64KB translation granule

- Bits[47:16] are bits[47:16] of the address of the required next-level table, which is:
 - For a first-level Table descriptor, the address of a second-level table.
 - For a second-level Table descriptor, the address of a third-level table.
- Bits[15:0] of the table address are zero.

For a stage 1 translation only, bits[63:59] provide attributes for the next-level lookup, see [Memory attribute fields in the VMSAv8-64 translation table format descriptors on page D5-1776](#).

If the translation table defines the Non-secure EL1&0 stage 1 translations, then the output address in the descriptor is the IPA of the target block or table. Otherwise, it is the PA of the target block or table.

D5.4.2 ARMv8 translation table third-level descriptor formats

For the 4KB granule size, each entry in a third-level table describes the mapping of the associated 4KB input address range.

For the 16KB granule size, each entry in a third-level table describes the mapping of the associated 16KB input address range.

For the 64KB granule size, each entry in a third-level table describes the mapping of the associated 64KB input address range.

Figure D5-29 shows the ARMv8 third-level descriptor formats.

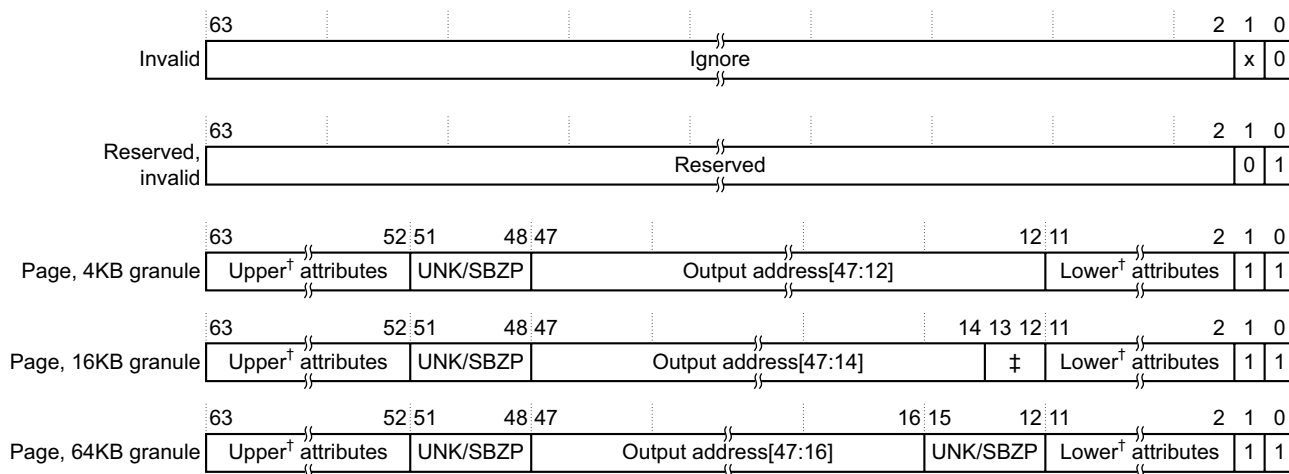

† Upper page attributes and Lower page attributes

‡ Field is UNK/SBZP

Figure D5-29 VMSAv8-64 third-level descriptor format

Descriptor bits[1:0] identify whether the descriptor is valid, and the descriptor type of a valid descriptor, encoded as:

0bx0, Invalid If a lookup returns an invalid descriptor, the associated input address is unmapped, and any attempt to access it generates a Translation fault.

0b01, Reserved, invalid

Behaves identically to encodings of 0bx0.

This encoding must not be used in third-level translation tables.

0b11, Page Gives the address and attributes of a 4KB, 16KB, or 64KB page of memory.

At this level, the only valid format is the Page descriptor. The other fields in the Page descriptor are:

Page descriptor

Gives the output address of a page of memory, as follows:

4KB translation granule

Bits[47:12] are bits[47:12] of the output address for a page of memory.

16KB translation granule

Bits[47:14] are bits[47:14] of the output address for a page of memory.

64KB translation granule

Bits[47:16] are bits[47:16] of the output address for a page of memory.

Bits[63:52, 11:2] provide attributes for the target memory page, see [Memory attribute fields in the VMSAv8-64 translation table format descriptors on page D5-1776](#).

———— **Note** ————

The position and contents of bits[63:52, 11:2] are identical to bits[63:52, 11:2] in the zero-level, first-level, and second-level block descriptors.

For the Non-secure EL1&0 stage 1 translations, the output address in the descriptor is the IPA of the target page. Otherwise, it is the PA of the target page.

D5.4.3 Memory attribute fields in the VMSAv8-64 translation table format descriptors

Memory region attributes on page D5-1788 describes the region attribute fields. The following subsections summarize the descriptor attributes as follows:

Table descriptor

Table descriptors for stage 2 translations do not include any attribute field. For a summary of the attribute fields in a stage 1 table descriptor, that define the attributes for the next lookup level, see *Next-level attributes in stage 1 VMSAv8-64 Table descriptors*.

Block and page descriptors

These descriptors define memory attributes for the target block or page of memory. Stage 1 and stage 2 translations have some differences in these attributes, see:

- *Attribute fields in stage 1 VMSAv8-64 Block and Page descriptors* on page D5-1777
- *Attribute fields in stage 2 VMSAv8-64 Block and Page descriptors* on page D5-1778.

Next-level attributes in stage 1 VMSAv8-64 Table descriptors

In a Table descriptor for a stage 1 translation, bits[63:59] of the descriptor define the attributes for the next-level translation table access, and bits[58:52] are ignored:

Next-level descriptor attributes, stage 1 only

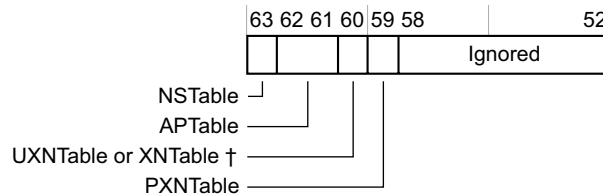

† UXNTable for the EL1&0 translation regime, XNTable for the other regimes.

These attributes are:

NSTable, bit[63]

For memory accesses from Secure state, specifies the security level for subsequent levels of lookup, see *Hierarchical control of Secure or Non-secure memory accesses* on page D5-1780.

For memory accesses from Non-secure state, this bit is ignored.

APTable, bits[62:61]

Access permissions limit for subsequent levels of lookup, see *Hierarchical control of data access permissions* on page D5-1783.

APTable[0] is reserved, SBZ:

- In the EL2 translation regime.
- In the EL3 translation regime.

UXNTable or XNTable, bit[60]

XN limit for subsequent levels of lookup, see [Hierarchical control of instruction fetching on page D5-1786](#).

This bit is called UXNTable in the EL1&0 translation regime, where it only determines whether execution at EL0 of instructions fetched from the region identified at a lower level of lookup permitted. In the other translation regimes the bit is called XNTable.

PXNTable, bit[59]

PXN limit for subsequent levels of lookup, see [Hierarchical control of instruction fetching on page D5-1786](#).

This bit is reserved, SBZ:

- In the EL2 translation regime.
- In the EL3 translation regime.

Attribute fields in stage 1 VMSAv8-64 Block and Page descriptors

In Block and Page descriptors, the memory attributes are split into an upper block and a lower block, as shown for a stage 1 translation:

Attribute fields for VMSAv8-64 stage 1 Block and Page descriptors

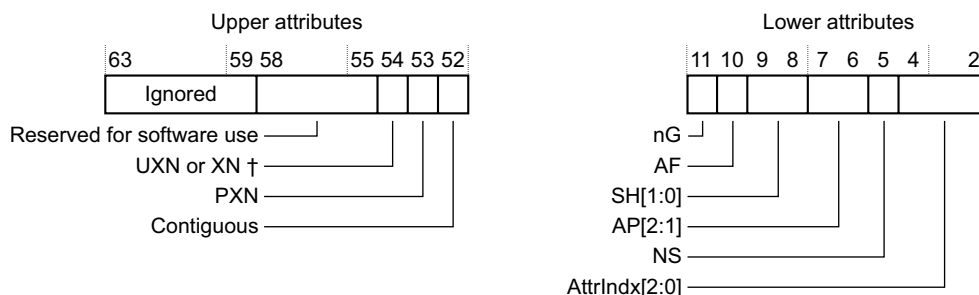

† UXN for the EL1&0 translation regime, XN for the other regimes.

For a stage 1 descriptor, the attributes are:

UXN or XN, bit[54]

The Execute-never bit. Determines whether the region is executable, see [Access permissions for instruction execution on page D5-1784](#).

This bit is called UXN in the EL1&0 translation regime, where it only determines whether execution at EL0 of instructions fetched from the region is permitted. In the other translation regimes the bit is called XN.

PXN, bit[53] The Privileged execute-never bit. Determines whether the region is executable at EL1, see [Access permissions for instruction execution on page D5-1784](#).

This bit is reserved, SBZ, in the EL2 and EL3 translation regimes.

Contiguous, bit[52]

A hint bit indicating that the translation table entry is one of a contiguous set or entries, that might be cached in a single TLB entry, see [The Contiguous bit on page D5-1792](#).

nG, bit[11] The not global bit. Determines whether the TLB entry applies to all ASID values, or only to the current ASID value, see [Global and process-specific translation table entries on page D5-1805](#).

Valid only to the EL1&0 translation regime. This bit is reserved, SBZ, in all other translation regimes.

AF, bit[10] The Access flag, see [The Access flag on page D5-1788](#).

SH, bits[9:8] Shareability field, see [Memory region attributes on page D5-1788](#).

AP[2:1], bits[7:6]

Data Access Permissions bits, see [Memory access control on page D5-1781](#).

———— **Note** —————

The ARMv8 translation table descriptor format defines AP[2:1] as the Access Permissions bits, and does not define an AP[0] bit.

AP[1] is reserved, SBO, in the Non-secure EL2 translation regime.

NS, bit[5]

Non-secure bit. For memory accesses from Secure state, specifies whether the output address is in the Secure or Non-secure address map, see [Control of Secure or Non-secure memory access on page D5-1779](#).

For memory accesses from Non-secure state, this bit is ignored.

AttrIndx[2:0], bits[4:2]

Stage 1 memory attributes index field, for the MAIR_ELx, see [Memory region type and attributes, for stage 1 translations on page D5-1789](#).

In the upper attributes block, the architecture guarantees that PE makes no use of the fields marked as *Ignored* and *Reserved for software use*. For more information see [Other fields in the VMSAv8-64 translation table format descriptors on page D5-1791](#).

Attribute fields in stage 2 VMSAv8-64 Block and Page descriptors

In Block and Page descriptors, the memory attributes are split into an upper block and a lower block, as shown for a stage 2 translation:

Attribute fields for VMSAv8-64 stage 2 Block and Page descriptors

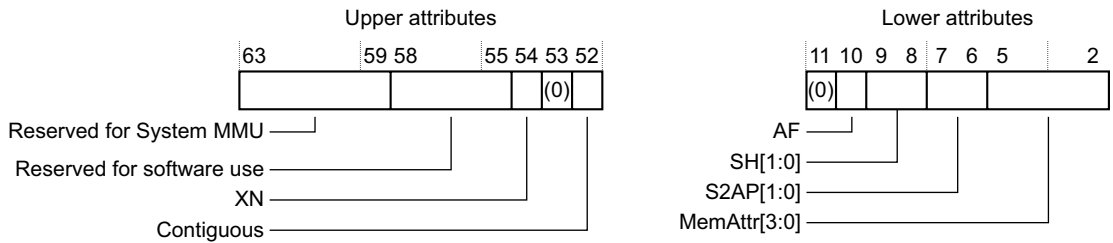

For a stage 2 descriptor, the attributes are:

XN, bit[54] The Execute-never bit. Determines whether the region is executable, see [Access permissions for instruction execution on page D5-1784](#).

Contiguous, bit[52]

A hint bit indicating that the translation table entry is one of a contiguous set or entries, that might be cached in a single TLB entry, see [The Contiguous bit on page D5-1792](#).

AF, bit[10] The Access flag, see [The Access flag on page D5-1788](#).

SH, bits[9:8] Shareability field, see [The memory region attributes for stage 2 translations, EL1&0 translation regime on page D5-1790](#).

S2AP, bits[7:6]

Stage 2 data Access Permissions bits, see [The S2AP data access permissions, Non-secure EL1&0 translation regime on page D5-1783](#).

———— **Note** ————

In the original VMSAv7-32 Long-descriptor attribute definition, this field was called HAP[2:1], for consistency with the AP[2:1] field in the stage 1 descriptors and despite there being no HAP[0] bit. ARMv8 renames the field for greater clarity.

MemAttr, bits[5:2]

Stage 2 memory attributes, see *The memory region attributes for stage 2 translations, EL1 & 0 translation regime* on page D5-1790.

In the upper attributes block:

- The field marked as *Reserved for System MMU use* must be ignored by the PE.
- The architecture guarantees that the PE makes no use of the fields marked as *Reserved for System MMU* and *Reserved for software use*.

For more information see *Other fields in the VMSAv8-64 translation table format descriptors* on page D5-1791.

D5.4.4 Control of Secure or Non-secure memory access

As this section describes, the NS bit in the translation table entries:

- For accesses from Secure state, if the translation table entry was held in secure memory, determines whether the access is to Secure or Non-secure memory.
- Is ignored by:
 - Accesses from Non-secure state.
 - Accesses from Secure state if the translation table entry was held in Non-secure memory.

In the VMSAv8-64 translation table format:

- The NS bit relates only to the memory block or page at the output address defined by the descriptor.
- The descriptors also include an NSTable bit, that affects accesses at lower levels of lookup, see *Hierarchical control of Secure or Non-secure memory accesses* on page D5-1780.

The NS and NSTable bits are valid only for memory accesses from Secure state described by translation table descriptors that are fetched from Secure memory, and:

- In the translation table descriptors in a Non-secure translation table, the NS and NSTable bits are SBZ.
- Memory accesses from Non-secure state, including all accesses from EL2, ignore the values of these bits.

In the Secure translation regimes, for translation table descriptors that are fetched from Secure memory, the NS bit in a descriptor indicates whether the descriptor refers to the Secure or the Non-secure address map, as follows:

NS == 0 Access the Secure physical address space.

NS == 1 Access the Non-secure physical address space.

For Non-secure translation regimes, and for translation table descriptors fetched from Non-secure memory, the corresponding bit is SBZ and is ignored by the PE. The access is made to Non-secure memory, regardless of the value of the bit.

Hierarchical control of Secure or Non-secure memory accesses

For VMSAv8-64 table descriptors for stage 1 translations, the descriptor includes an NSTable bit, that indicates whether the table identified in the descriptor is in Secure or Non-secure memory. For accesses from Secure state, the meaning of the NSTable bit is:

NSTable == 0 The defined table address is in the Secure physical address space. In the descriptors in that translation table, NS bits and NSTable bits have their defined meanings.

NSTable == 1 The defined table address is in the Non-secure physical address space. Because this table is fetched from the Non-secure address space, the NS and NSTable bits in the descriptors in this table must be ignored. This means that, for this table:

- The value of the NS bit in any block or page descriptor is ignored. The block or page address refers to Non-secure memory.
- The value of the NSTable bit in any table descriptor is ignored, and the table address refers to Non-secure memory. When this table is accessed, the NS bit in any block or page descriptor is ignored, and all descriptors in the table refer to Non-secure memory.

In addition, an entry fetched in Secure state is treated as non-global if either:

- NSTable is set to 1.
- The fetch ignores the values of NS and NSTable, because of a higher-level fetch with NSTable set to 1.

That is, these entries must be treated as if nG==1, regardless of the value of the nG bit. For more information about the nG bit, see [Global and process-specific translation table entries on page D5-1805](#).

D5.5 Access controls and memory region attributes

In addition to an output address, a translation table entry that refers to a page or region of memory includes fields that define properties of the target memory region. These fields can be classified as address map control, access control, and region attribute fields. *Control of Secure or Non-secure memory access on page D5-1779* describes the address map control, and the following sections describe the other fields:

- *Memory access control.*
- *Memory region attributes on page D5-1788.*
- *Combining the stage 1 and stage 2 attributes, Non-secure EL1&0 translation regime on page D5-1793.*

Note

This section describes the access controls and memory region attributes for each of the translation regimes, and for both stages of translation in the Non-secure EL1&0 translation regime. In general, attribute assignment is simpler in the EL2 and EL3 translation regimes, and in these regimes behavior is consistent fields in the translation tables being treated as follows:

- APTable[0] is ignored by hardware and is treated as if it is 0.
 - AP[1] is ignored by hardware and is treated as if it is 1.
 - the PXNTable bit is ignored by hardware and is treated as if it is 0.
 - the PXN field is ignored by hardware and is treated as if it is 0.
-

D5.5.1 Memory access control

The access control fields in the translation table descriptors determine whether the PE, in its current state, is permitted to perform the required access to the output address given in the translation table descriptor. If a translation stage does not permit the access then an MMU fault is generated for that translation stage, and no memory access is performed.

The following sections describe the memory access controls:

- *About the access permissions.*
- *The data access permission controls on page D5-1782.*
- *Access permissions for instruction execution on page D5-1784.*
- *The Access flag on page D5-1788.*

About the access permissions

Note

This section gives a general description of memory access permissions. In an implementation that includes EL2, software executing at EL1 in Non-secure state can see only the access permissions defined by the Non-secure EL1&0 stage 1 translations. However, software executing at EL2 can modify these permissions. This modification is invisible to the Non-secure software executing at EL1 or EL0.

The access permission bits control access to the corresponding memory region. The VMSAv8-64 translation table format:

- In stage 1 translations, uses AP[2:1] to define the data access permissions, see *The AP[2:1] data access permissions, for stage 1 translations on page D5-1782.*

Note

The description of the access permission field as AP[2:1] is for consistency with the VMSAv8-32 Short-descriptor translation table format, see *The VMSAv8-32 Short-descriptor translation table format on page G3-3578*. The VMSAv8-64 translation table format does not define an AP[0] bit.

- In stage 2 translations, uses S2AP[1:0] to define the data access permissions, see [The S2AP data access permissions, Non-secure EL1&0 translation regime on page D5-1783](#).
- Uses the UXN, XN and PXN bits to define access controls for instruction fetches, see [Access permissions for instruction execution on page D5-1784](#).

An attempt to perform a memory access that the translation table access permission bits do not permit generates a Permission fault, for the corresponding stage of translation.

———— **Note** —————

In an implementation that includes EL2, each stage of the translation of a memory access made from Non-secure EL1 or EL0 has its own, independent, permission check.

The data access permission controls

The following subsections describe the data access permission controls:

- [The AP\[2:1\] data access permissions, for stage 1 translations](#).
- [The S2AP data access permissions, Non-secure EL1&0 translation regime on page D5-1783](#).
- [Hierarchical control of data access permissions on page D5-1783](#).

The AP[2:1] data access permissions, for stage 1 translations

For the VMSAv8-64 EL1&0 translation regime, the AP[2:1] bits control the stage 1 data access permissions, and:

- AP[2]** Selects between read-only and read/write access.
- AP[1]** Selects between Application level (EL0) and System level (EL1) control.

This provides four permission settings for data accesses:

- Read-only at all levels.
- Read/write at all levels.
- Read-only at EL1, no access by software executing at EL0.
- Read/write at EL1, no access by software executing at EL0.

For translation regimes other than the EL1&0 translation regimes, AP[2] determines the stage 1 data access permissions, and AP[1] is:

- SBO.
- Ignored by hardware and is treated as if it is 1.

[Table D5-26](#) shows the effect of the data access permission bits for stage 1 of the EL1&0 translation regime. In this table, an entry of None indicates that any access from that Exception level faults.

Table D5-26 Data access permissions for stage 1 of the EL1&0 translation regime,

AP[2:1]	Access from EL1	Access from EL0
00	Read/write	None
01	Read/write	Read/write
10	Read-only	None
11	Read-only	Read-only

For the Non-secure EL1&0 translation regime:

- The stage 2 translation also defines data access permissions, see [The S2AP data access permissions, Non-secure EL1&0 translation regime on page D5-1783](#).
- When both stages of translation are enabled, [Combining the stage 1 and stage 2 data access permissions on page D5-1793](#) describes how these permissions are combined.

Table D5-27 shows the effect of the AP[2] data access permission bit for the EL2 and EL3 translation regimes:

Table D5-27 Data access permissions for the EL2 or EL3 translation regime

AP[2]	Access from EL2 or EL3
0	Read/write
1	Read-only

The S2AP data access permissions, Non-secure EL1&0 translation regime

In the Non-secure EL1&0 translation regime, when stage 2 address translation is enabled, the S2AP field in the stage 2 translation table descriptors define the data access permissions as Table D5-28 shows. In this table, an entry of None indicates that any access generates a permission fault:

Table D5-28 Data access permissions for stage 2 of the Non-secure EL1&0 translation regime,

S2AP	Access from Non-secure EL1 or Non-secure EL0
00	None
01	Read-only
10	Write-only
11	Read/write

The S2AP access permissions make no distinction between Non-secure accesses from EL1 and Non-secure accesses from EL0. However, when both stages of address translation are enabled, these permissions are combined with the stage 1 access permissions defined by AP[2:1], see [Combining the stage 1 and stage 2 data access permissions on page D5-1793](#).

[Combining the stage 1 and stage 2 attributes, Non-secure EL1&0 translation regime on page D5-1793](#) gives more information about the use of the stage 1 and stage 2 access permissions in an implementation of virtualization.

Hierarchical control of data access permissions

The VMSAv8-64 translation table format includes mechanisms by which entries at one level of translation table lookup can set limits on the permitted entries at subsequent levels of lookup. This subsection describes how these controls apply to the data access permissions.

Note

Similar hierarchical controls apply to instruction fetching, see [Hierarchical control of instruction fetching on page D5-1786](#).

The restrictions apply only to subsequent levels of lookup for the same stage of translation. The APTable[1:0] field restricts the access permissions, as Table D5-29 shows.

As stated in the table footnote, for the EL2 translation regime, APTable[0] is reserved, SBZ, and is ignored by the hardware.

Table D5-29 Effect of APTable[1:0] on subsequent levels of lookup

APTable[1:0]	Effect
00	No effect on permissions in subsequent levels of lookup.
01 ^a	Access at EL0 not permitted, regardless of permissions in subsequent levels of lookup.
10	Write access not permitted, at any Exception level, regardless of permissions in subsequent levels of lookup.

Table D5-29 Effect of APTable[1:0] on subsequent levels of lookup (continued)

APTable[1:0]	Effect
11 ^a	<p>Regardless of permissions in subsequent levels of lookup:</p> <ul style="list-style-type: none"> • Write access not permitted, at any Exception level. • Read access not permitted at EL0.

a. Not valid for the EL2 translation regime. In the translation tables for that regime, APTable[0] is SBZ and is ignored by hardware.

———— **Note** ————

The APTable[1:0] settings are combined with the translation table access permissions in the translation tables descriptors accessed in subsequent levels of lookup. They do not restrict or change the values entered in those descriptors.

The VMSAv8-64 provides APTable[1:0] control only for the stage 1 translations. The corresponding bits are SBZ in the stage 2 translation table descriptors.

When APTable[1:0] is not set to 0b00, its effects might be held in one or more TLB entries. Therefore, a change to APTable[1:0] might require coarse-grained invalidation of the TLB to ensure that the effect of the change is visible to subsequent memory transactions.

Access permissions for instruction execution

Execute-never (XN) controls determine whether an instruction fetched from the memory region can be executed. These controls are:

UXN, Unprivileged Execute never

Defined only for stage 1 of the EL1&0 translation regime.

PXN, Privileged execute never

Used only for stage 1 of the EL1&0 translation regime:

- For the EL2 and EL3 translation regimes, the descriptors define a PXN bit that is reserved, SBZ, and is ignored by hardware.
- For stage 2 of the Non-secure EL1&0 translation regime, the corresponding bit position is reserved, SBZ, and is ignored by hardware.

XN, Unprivileged Execute never

Defined only for stage 1 of the EL2 and EL3 translation regimes.

Each of these bits is set to 1 to indicate that instructions cannot be executed from the target memory region. In addition:

- For the EL1&0 translation regime, if the value of the AP[2:1] bits is 0b01, permitting write access from EL0, then the PXN bit is treated as if it has the value 1, regardless of its actual value.
- For each translation regime, if the value of the corresponding [SCTLR_ELx.WXN](#) bit is 1 then any memory region that is writable is treated as XN, regardless of the value of the corresponding UXN, XN, or PXN bit. For more information see [Preventing execution from writable locations on page D5-1787](#).
- The [SCR_EL3.SIF](#) bit prevents execution in Secure state of any instruction fetched from Non-secure memory, see [Restriction on Secure instruction fetch on page D5-1788](#).

The execute-never controls apply to speculative instruction fetching, meaning speculative instruction fetch from a memory region that is execute-never at the current Exception level is prohibited.

Note

- Although the execute-never controls apply to speculative fetching, on a speculative instruction fetch from an execute-never location, no Permission fault is generated unless the PE attempts to execute the instruction fetched from that location. This means that, if a speculative fetch from an execute-never location is attempted, but there is no attempt to execute the corresponding instruction, a Permission fault is not generated.
- The software that defines a translation table must mark any region of memory that is read-sensitive as execute-never, to avoid the possibility of a speculative fetch accessing the memory region. This means it must mark any memory region that corresponds to a read-sensitive peripheral as execute-never.
- When no stage of address translation for the translation regime is enabled, memory regions cannot have UXN, XN, or PXN attributes assigned. *Behavior of instruction fetches when all associated stages of translation are disabled* on page D5-1744 describes how disabling all stages of address translation affects instruction fetching.

The following subsections describe the data access permission controls:

- *Instruction execution permissions for stage 1 translations.*
- *Instruction execution permissions for stage 2 translations* on page D5-1786.
- *Hierarchical control of instruction fetching* on page D5-1786.
- *Preventing execution from writable locations* on page D5-1787.
- *Restriction on Secure instruction fetch* on page D5-1788.

Instruction execution permissions for stage 1 translations

Table D5-30 shows the access permissions for instruction execution for stage 1 of the EL1&0 translation regime.

Table D5-30 Access permissions for instruction execution for stage 1 of the EL1&0 translation regime

UXN	PXN	AP[2:1] ^a	SCTLR_EL1.WXN	Access from EL1	Access from EL0
0	0	00	0	Executable	Executable
			1	Not executable ^b	Executable
		01	0	Not executable ^c	Executable
			1	Not executable	Not executable ^d
1x	x	Executable	Executable		
0	1	00	x	Not executable	Executable
			01	0	Not executable
		1x	1	Not executable	Not executable ^d
			x	Not executable	Executable
1	0	00	0	Executable	Not executable
			1	Not executable ^b	Not executable
		01	x	Not executable ^c	Not executable
			1x	x	Executable
	1	xx	x	Not executable	Not executable

a. See Table D5-26 on page D5-1782. 0b00 indicates writable from EL1 only, 0b01 indicates writable from EL1 and EL0, 0b1x indicates not writable from EL1 or EL0.

- b. Not executable because of `SCTLR_EL1.WXN` control, because region is writable at EL1.
- c. Not executable, because AArch64 execution treats all regions writable at EL0 as being PXN.
- d. Not executable because of `SCTLR_EL1.WXN` control, because region is writable at EL0.

Table D5-31 shows the access permissions for instruction execution for the EL2 and EL3 translation regimes:

Table D5-31 Access permissions for instruction execution, EL2 and EL3 translation regimes

XN	AP[2] ^a	SCTLR_EL2.WXN or ^b SCTLR_EL3.WXN	Access from EL2 or EL3
0	0	0	Executable
		1	Not executable ^c
1	1	0	Executable
	x	x	Not executable

- a. See Table D5-27 on page D5-1783. 0 indicates writable from this Exception level, and 1 indicates not writable.
- b. `SCTLR_EL2` for the EL2 translation regime, `SCTLR_EL3` for the EL3 translation regime.
- c. Not executable because of the `SCTLR_ELx.WXN` control, because region is writable at this Exception level.

Instruction execution permissions for stage 2 translations

For the Non-secure EL1&0 stage 2 translation, the XN bit in the stage 2 translation table descriptors controls the execution permission, and this control is completely independent of the S2AP access permissions.

Table D5-32 Access permissions for instruction execution for stage 2 of the Non-secure EL1&0 translation regime,

XN	Access from Non-secure EL1 or Non-secure EL0
0	Executable
1	Not executable

The stage 2 XN access permissions make no distinction between Non-secure accesses from EL1 and Non-secure accesses from EL0. However, when both stages of address translation are enabled, these permissions are combined with the stage 1 access permissions defined at stage 1 of the translation, see [Combining the stage 1 and stage 2 instruction execution permissions on page D5-1793](#).

Hierarchical control of instruction fetching

The VMSAv8-64 translation table format includes mechanisms by which entries at one level of table lookup can set limits on the permitted entries at subsequent levels of lookup. This subsection describes how these controls apply to the data access permissions.

The VMSAv8-64 translation table format includes mechanisms by which entries at one level of translation table lookup can set limits on the permitted entries at subsequent levels of lookup. This subsection describes how these controls apply to the instruction fetching controls.

Note

Similar hierarchical controls apply to data accesses, see [Hierarchical control of data access permissions on page D5-1783](#).

The restrictions apply only to subsequent levels of lookup at the same stage of translation, and:

- UXNtable or XNtable restricts the XN control:
 - When the value of the XNtable bit is 1, the XN bit is treated as 1 in all subsequent levels of lookup, regardless of its actual value.
 - When the value of the UXNtable bit is 1, the UXN bit is treated as 1 in all subsequent levels of lookup, regardless of its actual value.
 - When the value of a UXNtable or XNtable bit is 0 the bit has no effect.
- For the EL1&0 translation regime, PXNtable restricts the PXN control:
 - When PXNtable is set to 1, the PXN bit is treated as 1 in all subsequent levels of lookup, regardless of the actual value of the bit.
 - When PXNtable is set to 0 it has no effect.

Note

The UXNtable, XNtable and PXNtable settings are combined with the UXN, XN and PXN bits in the translation table descriptors accessed at subsequent levels of lookup. They do not restrict or change the values entered in those descriptors.

The UXNtable, XNtable and PXNtable controls are provided only for stage 1 translations. The corresponding bits are SBZ in the stage 2 translation table descriptors.

When the value of UXNtable, XNtable, or PXNtable, is 1, its effects might be held in one or more TLB entries. Therefore, a change to UXNtable, XNtable or PXNtable might require coarse-grained invalidation of the TLB to ensure that the effect of the change is visible to subsequent memory transactions.

Preventing execution from writable locations

ARMv8 provides control bits that, when corresponding stage 1 address translation is enabled, force writable memory to be treated as UXN, PXN, or XN, regardless of the value of the UXN, PXN, or XN bit:

- For the EL1&0 translation regime, when the value of [SCTLR_EL1.WXN](#) is 1:
 - All regions that are writable from EL0 at stage 1 of the address translation are treated as UXN.
 - All regions that are writable from EL1 at stage 1 of the address translation are treated as PXN
- For the EL2 translation regime, when the value of [SCTLR_EL2.WXN](#) is 1, all regions that are writable at stage 1 of the address translation are treated as XN.
- For the EL3 translation regime, when the value of [SCTLR_EL3.WXN](#) is 1, all regions that are writable at stage 1 of the address translation are treated as XN.

Note

- The [SCTLR_ELx.WXN](#) controls are intended to be used in systems with very high security requirements.
- Setting a WXN bit to 1 changes the interpretation of the translation table entry, overriding a zero value of a UXN, XN, or PXN field. It does not cause any change to the translation table entry.

For any given virtual machine, ARM expects WXN to remain static in normal operation. In particular, it is IMPLEMENTATION DEFINED whether TLB entries associated with a particular VMID reflect the effect of the values of these bits. This means that any change of these bits without a corresponding change of VMID might require synchronization and TLB invalidation, as described in [TLB maintenance requirements and the TLB maintenance instructions on page D5-1807](#).

Restriction on Secure instruction fetch

EL3 provides a Secure instruction fetch bit, [SCR_EL3.SIF](#). When the value of this bit is 1, and execution is using the EL3 translation regime or the Secure EL1 translation regime, any attempt to execute an instruction fetched from Non-secure physical memory causes a Permission fault. TLB entries might reflect the value of this bit, and therefore any change to the value of this bit requires synchronization and TLB invalidation, as described in [TLB maintenance requirements and the TLB maintenance instructions on page D5-1807](#).

The Access flag

The Access flag indicates when a page or section of memory is accessed for the first time since the Access flag in the corresponding translation table descriptor was set to 0.

The AF bit in the translation table descriptors is the Access flag.

Software management of the Access flag

ARMv8 requires that software manages the Access flag. This means an Access flag fault is generated whenever an attempt is made to read into the TLB a translation table descriptor entry for which the value of Access flag is 0.

The Access flag mechanism expects that, when an Access flag fault occurs, software resets the Access flag to 1 in the translation table entry that caused the fault. This prevents the fault occurring the next time that memory location is accessed. Entries with the Access flag set to 0 are never held in the TLB, meaning software does not have to flush the entry from the TLB after setting the flag.

———— Note —————

If a system incorporates a System MMU that implements the ARM SMMUv3 architecture and software shares translation tables between the ARM PE and the SMMUv3, then the software must be aware of the possibility that the System MMU update the access flag in hardware.

In such a system, system software should perform any changes of translation table entries with an Access flag of 0, other than changes to the Access flag value, by using an Load-Exclusive/Store-Exclusive loop, to allow for the possibility of simultaneous updates.

D5.5.2 Memory region attributes

The memory region attribute fields control the memory type, accesses to the caches, and whether the memory region is Shareable and therefore is coherent. This section also describes some additional translation table fields, that this manual groups with the memory region attributes.

In the EL1&0 translation regime, each enabled stage of address translation assigns memory region attributes, as described in this section. When both stages of translation are enabled, [Combining the stage 1 and stage 2 attributes, Non-secure EL1&0 translation regime on page D5-1793](#) describes how the assignments from the two stages are combined.

———— Note —————

In a virtualization implementation, a hypervisor, executing at EL2, might usefully:

- Reduce the permitted cacheability of a region.
- Increase the required shareability of a region.

The combining of attributes from stage 1 and stage 2 translations supports both of these options.

The following sections describe these attributes:

- [The memory region attributes for stage 1 translations on page D5-1789](#).
- [The memory region attributes for stage 2 translations, EL1&0 translation regime on page D5-1790](#).
- [Other fields in the VMSAv8-64 translation table format descriptors on page D5-1791](#).

The memory region attributes for stage 1 translations

The description of the memory region attributes in a translation descriptor divides into:

Memory type and attributes

These are described indirectly, by registers referenced by bits in the table descriptor. This is described as *remapping* the memory type and attribute description. [Memory region type and attributes, for stage 1 translations](#) describes this encoding.

Shareability The SH[1:0] field in the translation table descriptor encodes shareability information. [Shareability for Normal memory, for stage 1 translations](#) describes this encoding.

Memory region type and attributes, for stage 1 translations

In the VMSAv8-64 translation table format, the AttrIdx[2:0] field in a block or page translation table descriptor for a stage 1 translation indicates the 8-bit field in the MAIR_ELx that specifies the attributes for the corresponding memory region. The required field is Attrn, where $n = \text{AttrIdx}[2:0]$. For more information about AttrIdx[2:0] see [Attribute fields in stage 1 VMSAv8-64 Block and Page descriptors on page D5-1777](#)

———— Note ————

Each MAIR_ELx is a 64-bit register that is architecturally mapped to a pair of AArch32 registers. See the MAIR_ELx register descriptions for more information.

Each MAIR_ELx.Attrn field defines, for the corresponding memory region:

- The memory type, Device or Normal.
- For Device memory, the Device memory type, one of:
 - Device-nGnRnE.
 - Device-nGnRE.
 - Device-nGRE.
 - Device-GRE.
- For Normal memory:
 - The inner and outer cacheability, Non-cacheable, Write-Through, or Write-Back
 - For Write-Through Cacheable and Write-Back Cacheable regions, the Read-Allocate and Write-Allocate policy hints, each of which is *Allocate* or *Do not allocate*, and the Transient allocation hints.

For more information about the memory type and attributes, see [Memory types and attributes on page B2-89](#).

Shareability for Normal memory, for stage 1 translations

When using the VMSAv8-64 translation table format, the SH[1:0] field in a block or page translation table descriptor specifies the Shareability attributes of the corresponding memory region. [Table D5-33](#) shows the encoding of this field.

Table D5-33 SH[1:0] field encoding for Normal memory, VMSAv8-64 translation table format

SH[1:0]	Normal memory
00	Non-shareable
01	UNPREDICTABLE
10	Outer Shareable
11	Inner Shareable

Note

The shareability field is only relevant if the memory is a Normal Cacheable memory type. All Device and Normal Non-cacheable memory regions are always treated as Outer Shareable, regardless of the translation table shareability attributes

See [Combining the stage 1 and stage 2 shareability attributes for Normal memory on page D5-1795](#) for constraints on the Shareability attributes of a Normal memory region that is Inner Non-cacheable, Outer Non-cacheable.

The memory region attributes for stage 2 translations, EL1&0 translation regime

In the stage 2 translation table descriptors for memory regions and pages, the MemAttr[3:0] and SH[1:0] fields describe the stage 2 memory region attributes:

- [Memory region type and attributes for stage 2 translations](#) describes how the MemAttr[3:0] field defines these attributes.
- The SH[1:0] field in the translation table descriptor encodes shareability information. [Shareability for Normal memory, for stage 2 translations on page D5-1791](#) describes this encoding.

The following sections describe how, when both stages of address translation are enabled, the memory region attributes assigned at stage 2 of the translation are combined with those assigned at stage 1:

- [Combining the stage 1 and stage 2 memory type attributes on page D5-1794](#)
- [Combining the stage 1 and stage 2 cacheability attributes for Normal memory on page D5-1794](#)
- [Combining the stage 1 and stage 2 shareability attributes for Normal memory on page D5-1795](#).

Memory region type and attributes for stage 2 translations

[Table D5-34](#) shows how MemAttr[3:2] gives a top-level definition of the memory type, and of the outer cacheability of a Normal memory region:

Table D5-34 VMSAv8-64 MemAttr[3:2] encoding, stage 2 translation

MemAttr[3:2]	Memory type	Outer cacheability
00	Device. MemAttr[1:0] encodes the Device memory type.	Not applicable
01	Normal. MemAttr[1:0] encodes the Inner Cacheability.	Outer Non-cacheable
10		Outer Write-Through Cacheable
11		Outer Write-Back Cacheable

The encoding of MemAttr[1:0] depends on the Memory type indicated by MemAttr[3:2]:

- When MemAttr[3:2]==0b00, indicating Device memory, [Table D5-35](#) shows the encoding of MemAttr[1:0]:

Table D5-35 MemAttr[1:0] encoding for Strongly-ordered or Device memory

MemAttr[1:0]	Meaning when MemAttr[3:2] == 0b00
00	Region is Device-nGnRnE memory
01	Region is Device-nGnRE memory
10	Region is Device-nGRE memory
11	Region is Device-GRE memory

- When MemAttr[3:2] != 0b00, indicating Normal memory, [Table D5-36](#) shows the encoding of MemAttr[1:0]:

Table D5-36 MemAttr[1:0] encoding for Normal memory

MemAttr[1:0]	Meaning when MemAttr[3:2] != 0b00
00	UNPREDICTABLE
01	Inner Non-cacheable
10	Inner Write-Through Cacheable
11	Inner Write-Back Cacheable

———— **Note** —————

The stage 2 translation does not assign any allocation hints.

———— **Note** —————

The following stage 2 translation table attribute settings leave the stage 1 settings unchanged:

- MemAttr[3:2] == 0b11, Normal memory, Outer Write-Back Cacheable
- MemAttr[1:0] == 0b11, Inner Write-Back Cacheable.

Shareability for Normal memory, for stage 2 translations

When using the VMSAv8-64 translation table format, the SH[1:0] field in a block or page translation table descriptor specifies the Shareability attributes of the corresponding memory region. [Table D5-37](#) shows the encoding of this field.

Table D5-37 SH[1:0] field encoding for Normal memory, VMSAv8-64 translation table format

SH[1:0]	Normal memory
00	Non-shareable
01	UNPREDICTABLE
10	Outer Shareable
11	Inner Shareable

———— **Note** —————

- This encoding is the same as the shareability encoding described in [Shareability for Normal memory, for stage 1 translations on page D5-1789](#).
- The shareability field is only relevant if the memory is a Normal Cacheable memory type. All Device and Normal Non-cacheable memory regions are always treated as Outer Shareable, regardless of the translation table shareability attributes

See [Combining the stage 1 and stage 2 shareability attributes for Normal memory on page D5-1795](#) for constraints on the Shareability attributes of a Normal memory region that is Inner Non-cacheable, Outer Non-cacheable.

Other fields in the VMSAv8-64 translation table format descriptors

The following subsections describe the other fields in the translation table block and page descriptors:

- [The Contiguous bit on page D5-1792](#)
- [Field reserved for software use on page D5-1792](#)

- [Ignored fields on page D5-1793](#).

The Contiguous bit

When the value of the Contiguous bit is 1, it indicates that the entry is one of a number of adjacent translation table entries that point to a *contiguous output address range*. The required number of adjacent entries depends on the current translation granule size, as follows:

4KB granule 16 adjacent translation table entries point to a contiguous output address range that has the same permissions and attributes. These 16 entries must be aligned in the translation table. If accessing a full-sized 4KB translation table, this means that the top 5 of the 9 input addresses bits that index the descriptor positions in the translation table are the same for all of the entries.

The contiguous output address range must be aligned to size of 16 translation table entries at the same translation table level.

16KB granule This bit indicates that adjacent translation table entries point to contiguous output address range that has the same permissions and attributes. With the 16KB granule, the number of contiguous entries indicated by setting this bit to 1 depends on the lookup level of the translation table:

Second level lookup The bit indicates 32 contiguous entries, giving a 1GB block of memory. These entries must be aligned in the translation table. When accessing a full-sized 16KB translation table, this means the top 6 of the 11 input addresses bits that index the descriptor positions in the translation table are the same for all of the entries.

The contiguous output address range must be aligned to size of 32 translation table entries at the same translation table level.

Third level lookup The bit indicates 128 contiguous entries, giving a 2MB block of memory. These entries must be aligned in the translation table. When accessing a full-sized 16KB translation table, this means the top 4 of the 11 input addresses bits that index the descriptor positions in the translation table are the same for all of the entries.

The contiguous output address range must be aligned to size of 128 translation table entries at the same translation table level.

64KB granule 32 adjacent translation table entries point to a contiguous output address range that has the same permissions and attributes. These 32 entries must be aligned in the translation table. If accessing a full-sized 64KB translation table, this means that the top 8 of the 13 input addresses bits that index the descriptor positions in the translation table are the same for all of the entries.

The contiguous output address range must be aligned to size of 32 translation table entries at the same translation table level.

Setting this bit to 1 means that the TLB can cache a single entry to cover the contiguous translation table entries.

This section defines the requirements for programming the contiguous bit. [Possible translation table registers programming errors on page D5-1738](#) describes the effect of not meeting these requirements.

The architecture does not require a PE to cache TLB entries in this way. To avoid TLB coherency issues, any TLB maintenance by address must not assume any optimization of the TLB tables that might result from use of the contiguous bit.

TLB maintenance must be performed based on the size of the underlying translation table entries, to avoid TLB coherency issues.

Field reserved for software use

The architecture reserves a 4-bit field in the Block and Page table descriptors for software use. The architecture guarantees that hardware makes no use of this field.

———— Note ————

This means there is no need to invalidate the TLB if these bits are changed.

Ignored fields

For stage 1 translation descriptors, the architecture defines a 4-bit Ignored field in the Block and Page table descriptors, bit[63:59], and guarantees that hardware makes no use of this field. For stage 2 translation descriptors, the corresponding field is reserved for use by a System MMU control, and the ARMv8 architecture requires a PE to ignore this field.

D5.5.3 Combining the stage 1 and stage 2 attributes, Non-secure EL1&0 translation regime

The Non-secure EL1&0 translation regime comprises two stage of translation, each of which can be enabled independently:

- Stage 1 translation is configured and controlled from EL1. When enabled, stage 1 translation can define access permissions independently for access from EL0 and for accesses from EL1.
Stage 1 MMU faults are taken to EL1.
- When stage 2 translation is enabled, the stage 2 access controls defined at EL2:
 - Affect only the Non-secure stage 1 access permissions settings.
 - Take no account of whether the accesses are at EL1 or EL0.
 - Permit software executing at EL2 to assign a write-only attribute to a memory region.Stage 2 MMU faults are taken to EL2.

————— Note —————

In an implementation of virtualization, the attributes defined in the stage 2 translation tables mean a hypervisor can define additional access restrictions to those defined by a Guest OS in the stage 1 translation tables. For a particular access, the actual access permission is the more restrictive of the permissions defined by:

- The Guest OS, in the stage 1 translation tables.
- The hypervisor, in the stage 2 translation tables.

The effects of the combination of attributes defined by the Hypervisor are functionally transparent to the Guest OS.

Combining the stage 1 and stage 2 data access permissions

When both stages of translation are enabled, the following access permissions are combined:

- The stage 1 permissions described in *The AP[2:1] data access permissions, for stage 1 translations on page D5-1782*.
- The stage 2 permissions described in *The S2AP data access permissions, Non-secure EL1&0 translation regime on page D5-1783*.

The stage 1 and stage 2 permissions are combined as follows:

1. If an access is not permitted by the stage 1 permissions, then it generates a Stage 1 Permission fault, regardless of the stage 2 permissions.
2. If an access is permitted by the stage 1 permissions, but is not permitted by the stage 2 Permissions, then it generates a Stage 2 Permission fault.
3. If an access is permitted by both the stage 1 permissions and the stage 2 permissions, then it does not generate a Permission fault.

Combining the stage 1 and stage 2 instruction execution permissions

When both stages of translation are enabled, the following access permissions are combined:

- The stage 1 permissions described in *Instruction execution permissions for stage 1 translations on page D5-1785*.

- The stage 2 permissions described in [Instruction execution permissions for stage 2 translations on page D5-1786](#).

The stage 1 and stage 2 permissions are combined as follows:

1. If an instruction fetch is not permitted by the stage 1 permissions, then it generates a Stage 1 Permission fault, regardless of the stage 2 permissions.
2. If an instruction fetch is permitted by the stage 1 permissions, but is not permitted by the stage 2 Permissions, then it generates a Stage 2 Permission fault.
3. If an instruction fetch is permitted by both the stage 1 permissions and the stage 2 permissions, then it does not generate a Permission fault.

Combining the stage 1 and stage 2 memory type attributes

Table D5-38 shows the rules for combining the stage 1 and stage 2 memory type assignments:

Table D5-38 Combining the stage 1 and stage 2 memory type assignments

Rule	If either stage of translation assigns:	The resultant memory type is:
Device has precedence over Normal	Any Device memory type	A Device memory type
Non-Gathering has precedence over Gathering	A Device-nGxx memory type	A Device-nGxx memory type
Non-Reordering has precedence over Reordering	A Device-nGnRx memory type	A Device-nGnRx memory type
No Early write acknowledge has precedence over Early write acknowledge	The Device-nGnRnE memory type	The Device-nGnRnE memory type

Regardless of any shareability attribute obtained as described in [Combining the stage 1 and stage 2 shareability attributes for Normal memory on page D5-1795](#):

- Any location for which the resultant memory type is any type of Device memory is always treated as Outer shareable.
- Any location for which the resultant memory type is Normal Inner Non-cacheable, Outer Non-cacheable is always treated as Outer shareable.

For information about how the cacheability attribute is obtained from the attributes assigned at each stage of translation see [Combining the stage 1 and stage 2 cacheability attributes for Normal memory](#).

The combining of the memory type attributes from the two stages of translation means a translation table walk for a stage 1 translation can be made to Device memory. This is likely to indicate a Guest OS error, and if the value of `HCR_EL2.PTW` is 1 such an access is trapped to EL2.

Combining the stage 1 and stage 2 cacheability attributes for Normal memory

For a Normal memory region, Table D5-39 shows how the stage 1 and stage 2 cacheability assignments are combined. This combination applies, independently, for the Inner cacheability and Outer cacheability attributes:

Table D5-39 Combining the stage 1 and stage 2 cacheability assignments for Normal memory

Assignment in stage 1	Assignment in stage 2	Resultant cacheability
Non-cacheable	Any	Non-cacheable
Any	Non-cacheable	Non-cacheable

Table D5-39 Combining the stage 1 and stage 2 cacheability assignments for Normal memory (continued)

Assignment in stage 1	Assignment in stage 2	Resultant cacheability
Write-Through Cacheable	Write-Through or Write-Back Cacheable	Write-Through Cacheable
Write-Through or Write-Back Cacheable	Write-Through Cacheable	Write-Through Cacheable
Write-Back Cacheable	Write-Back Cacheable	Write-Back Cacheable

Combining the stage 1 and stage 2 shareability attributes for Normal memory

A memory region is treated as Outer Shareable, regardless of any shareability assignments at either stage of translation, if either:

- The resultant memory type attribute, described in *Combining the stage 1 and stage 2 memory type attributes on page D5-1794*, is any type of Device memory.
- The resultant memory type attribute, described in *Combining the stage 1 and stage 2 memory type attributes on page D5-1794*, is Normal memory, and the resultant cacheability, described in *Combining the stage 1 and stage 2 cacheability attributes for Normal memory on page D5-1794*, is Inner Non-cacheable, Outer Non-cacheable.

For a memory region with a resultant memory type attribute of Normal, that is not Inner Non-cacheable, Outer Non-cacheable, [Table D5-40](#) shows how the stage 1 and stage 2 shareability assignments are combined:

Table D5-40 Combining the stage 1 and stage 2 shareability assignments for Normal memory^a

Assignment in stage 1	Assignment in stage 2	Resultant shareability
Outer Shareable	Any	Outer Shareable
Inner Shareable	Outer Shareable	Outer Shareable
Inner Shareable	Inner Shareable	Inner Shareable
Inner Shareable	Non-shareable	Inner Shareable
Non-shareable	Outer Shareable	Outer Shareable
Non-shareable	Inner Shareable	Inner Shareable
Non-shareable	Non-shareable	Non-shareable

a. Applies only if the Normal memory is not Inner Non-cacheable, Outer Non-cacheable, see text.

D5.6 MMU faults

In a VMSAv8-64 implementation, the following mechanisms cause a PE to take an exception on a failed memory access:

Debug exception	An exception caused by the debug configuration, see Chapter D3 The Debug Exception Model .
Alignment fault	An Alignment fault is generated if the address used for a memory access does not have the required alignment for the operation. For more information see Alignment support on page B2-75 .
MMU fault	An MMU fault is a fault generated by the fault checking sequence for the current translation regime. The remainder of this section describes MMU faults.
External abort	Any memory system fault other than a Debug exception, an Alignment fault, or an MMU fault.

Collectively, these mechanisms are called *aborts*.

MMU faults are synchronous exceptions that fall into two categories in AArch64:

- Data Aborts.
- Instruction Aborts

Note

The Instruction Abort exception applies to any synchronous memory abort on an instruction fetch. It is not restricted to speculative instruction fetches.

External aborts can be reported synchronously or asynchronously. In AArch64 state, asynchronous external aborts are reported using the SError interrupt.

An access that causes an abort is said to be aborted, and uses the *Fault Address Registers* (FARs) and *Exception Syndrome Registers* (ESRs) to record context information.

For more information, see [Synchronous exception types, routing and priorities on page D1-1450](#).

The Exception level that the MMU fault is taken to depends on the translation regime that generated the fault. The fault context saved in the appropriate `ESR_ELx` register, where ELx is the Exception level that the fault is taken to, is dependent on whether:

- The MMU fault is due to an Instruction or Data Abort.
- The exception is taken from the same or a lower Exception level.

Software stepping, a debug feature, and a misaligned PC exception are the only exceptions that are higher than an Instruction Abort. Only watchpoints are at a lower priority than Data Aborts in the exception priority hierarchy. For details on the exception model priorities, see [Synchronous exception prioritization on page D1-1451](#).

The following sections describe the abort mechanisms:

- [Types of MMU faults on page D5-1797](#).
- [The MMU fault-checking sequence on page D5-1799](#).
- [Prioritization of synchronous aborts from a single stage of address translation on page D5-1801](#).
- [Pseudocode details of the MMU faults on page D5-1803](#).

D5.6.1 Types of MMU faults

This section describes the faults that might be detected during one of the fault-checking sequences described in *The MMU fault-checking sequence* on page D5-1799.

The following list includes all the types of exceptions that can occur:

- Alignment fault.
- Permission fault.
- Translation fault.
- Address size fault.
- Synchronous external abort on a translation table walk.
- Access flag fault.
- TLB conflict abort.

When an MMU fault generates an abort for a region of memory, no memory access is made if that region is or could be marked as Device.

The following subsections describe the MMU faults:

- *Permission fault.*
- *Translation fault.*
- *Address size fault* on page D5-1798.
- *External abort on a translation table walk* on page D5-1798.
- *Access flag fault* on page D5-1798.

Permission fault

A Permission fault can be generated at any level of lookup, and the reported fault code identifies the lookup level. See *About the access permissions* on page D5-1781 for information about conditions that cause a Permission fault.

A TLB might hold a translation table entry that cause a Permission fault. Therefore, if the handling of a Permission fault results in an update to the associated translation tables, the software that updates the translation tables must invalidate the appropriate TLB entry, to prevent the stale information in the TLB being used on a subsequent memory access.

This maintenance requirement applies to Permission faults in both stage 1 and stage 2 translations.

Cache maintenance instructions cannot cause a Permission fault, except that:

- A stage 1 translation table walk performed as part of a cache maintenance instruction can generate a stage 2 Permission fault as described in *Stage 2 fault on a stage 1 translation table walk* on page D5-1801.
- A DC IVAC issued in Non-secure state that attempts to update data in a location for which it does not have stage 2 write access can generate a stage 2 Permission fault, as described in *Effects of virtualization and security on the cache maintenance instructions* on page D4-1687.

Translation fault

A Translation fault can be generated at any level of lookup, and the reported fault code identifies the lookup level. A Translation fault is generated if bits[1:0] of a translation table descriptor identify the descriptor as either a Fault encoding or a reserved encoding. For more information see *VMSAv8-64 translation table format descriptors* on page D5-1772.

In addition, a Translation fault is generated if the input address for a translation either does not map on to an address range of a Translation Table Base Register, or the Translation Table Base Register range that it maps on to is disabled. In these cases the fault is reported as a first level Translation fault on the translation stage at which the mapping to a region described by a Translation Table Base Register failed.

The architecture guarantees that any translation table entry that causes a Translation fault is not cached, meaning the TLB never holds such an entry. Therefore, when a Translation fault occurs, the fault handler does not have to perform any TLB maintenance instructions to remove the faulting entry.

A data or unified cache maintenance by VA instruction can generate a Translation fault. Whether an instruction cache invalidate by VA operation can generate a Translation fault is IMPLEMENTATION DEFINED, because it is IMPLEMENTATION DEFINED whether the operation requires an address translation. If the instruction cache invalidate by VA operation requires an address translation then the operation can generate a Translation fault, otherwise it cannot generate a Translation fault.

Address size fault

An Address size fault can be generated at any level of lookup, and the reported fault code identifies the lookup level.

An Address size fault is generated if one of the following applies:

- The translation table entries or the [TTBR](#) for the stage of translation have address bits above the most significant bit of the specified PA size as non zero.
- The specified output address size is larger than the implemented PA.

The architecture guarantees that any translation table entry that causes an Address size fault is not cached, meaning the TLB never holds such an entry. Therefore, when an Address size fault occurs, the fault handler does not have to perform any TLB maintenance operations to remove the faulting entry.

For more information on Address size faults, see [Output address size on page D5-1715](#).

External abort on a translation table walk

An external abort on a translation table walk can be either synchronous or asynchronous. An external abort on a translation table walk is reported:

- If the external abort is synchronous, using:
 - A synchronous Instruction Abort exception if the translation table walk is for an instruction fetch.
 - A synchronous Data Abort exception if the translation table walk is for a data access.
- If the external abort is asynchronous, using the SError interrupt exception.

Behavior of external aborts on a translation table walk caused by address translation operations

The address translation operations summarized in [Address translation operations, functional group on page G3-3745](#) require translation table walks. An external abort can occur in the translation table walk. This is reported as follows:

- If the external abort is synchronous, using a synchronous Data Abort exception.
- If the external abort is asynchronous, using the SError interrupt exception.

For more information, see [Synchronous faults generated by address translation instructions on page D5-1758](#).

Access flag fault

An Access flag fault can be generated at any level of lookup, and the reported fault code identifies the lookup level. An Access flag fault is generated only if a translation table descriptor with the Access flag bit set to 0 is used.

For more information about the Access flag bit, see [VMSAv8-64 translation table format descriptors on page D5-1772](#).

The architecture guarantees that any translation table entry that causes an Access flag fault is not cached, meaning the TLB never holds such an entry. Therefore, when an Access flag fault occurs, the fault handler does not have to execute any TLB maintenance instructions to remove the faulting entry.

Whether any cache maintenance by VA instructions can generate Access flag faults is IMPLEMENTATION DEFINED.

For more information, see [The Access flag on page D5-1788](#).

D5.6.2 The MMU fault-checking sequence

This section describes the MMU checks made for the memory accesses required for instruction fetches and for explicit memory accesses:

- if an instruction fetch faults it generates an Instruction Abort.
- if an data memory access faults it generates a Data Abort.

MMU fault checking is performed for each stage of address translation.

The fault-checking sequence shows a translation from an Input address to an Output address. For more information about this terminology, see [About address translation on page D5-1713](#).

———— Note ————

The descriptions in this section do not include the possibility that the attempted address translation generates a TLB conflict abort, as described in [TLB conflict aborts on page D5-1807](#).

[Types of MMU faults on page D5-1797](#) describes the faults that an MMU fault-checking sequence can report.

Figure D5-30 shows the process of fetching a descriptor from the translation table. For the top-level fetch for any translation, the descriptor is fetched only if the input address passes any required alignment check. As the figure shows, if the translation is stage 1 of the Non-secure EL1&0 translation regime, then the descriptor address is in the IPA address space, and is subject to a stage 2 translation to obtain the required PA. This stage 2 translation requires a recursive entry to the fault checking sequence.

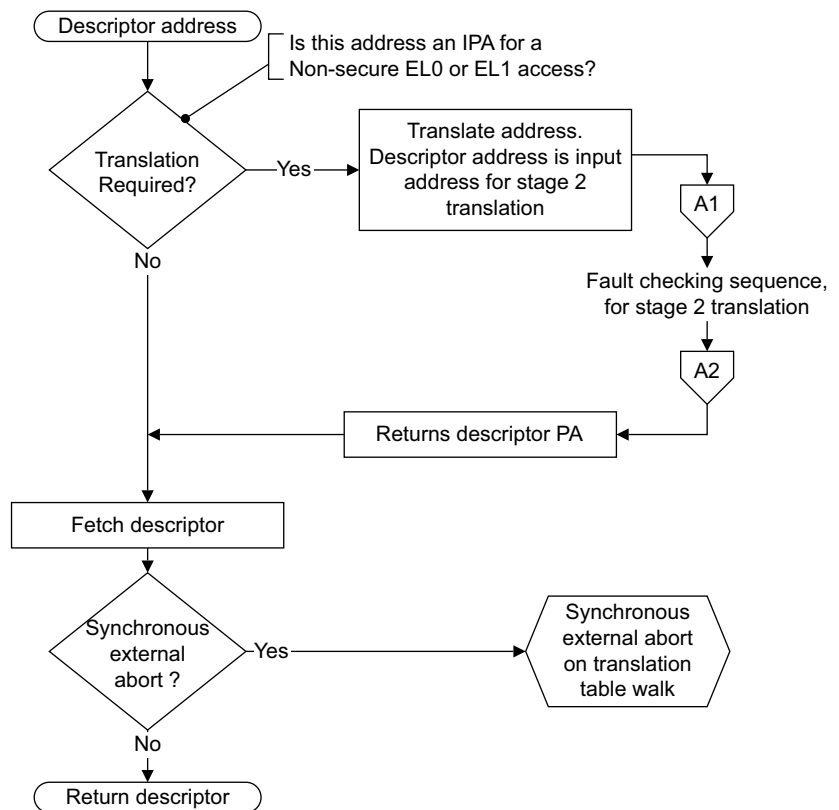
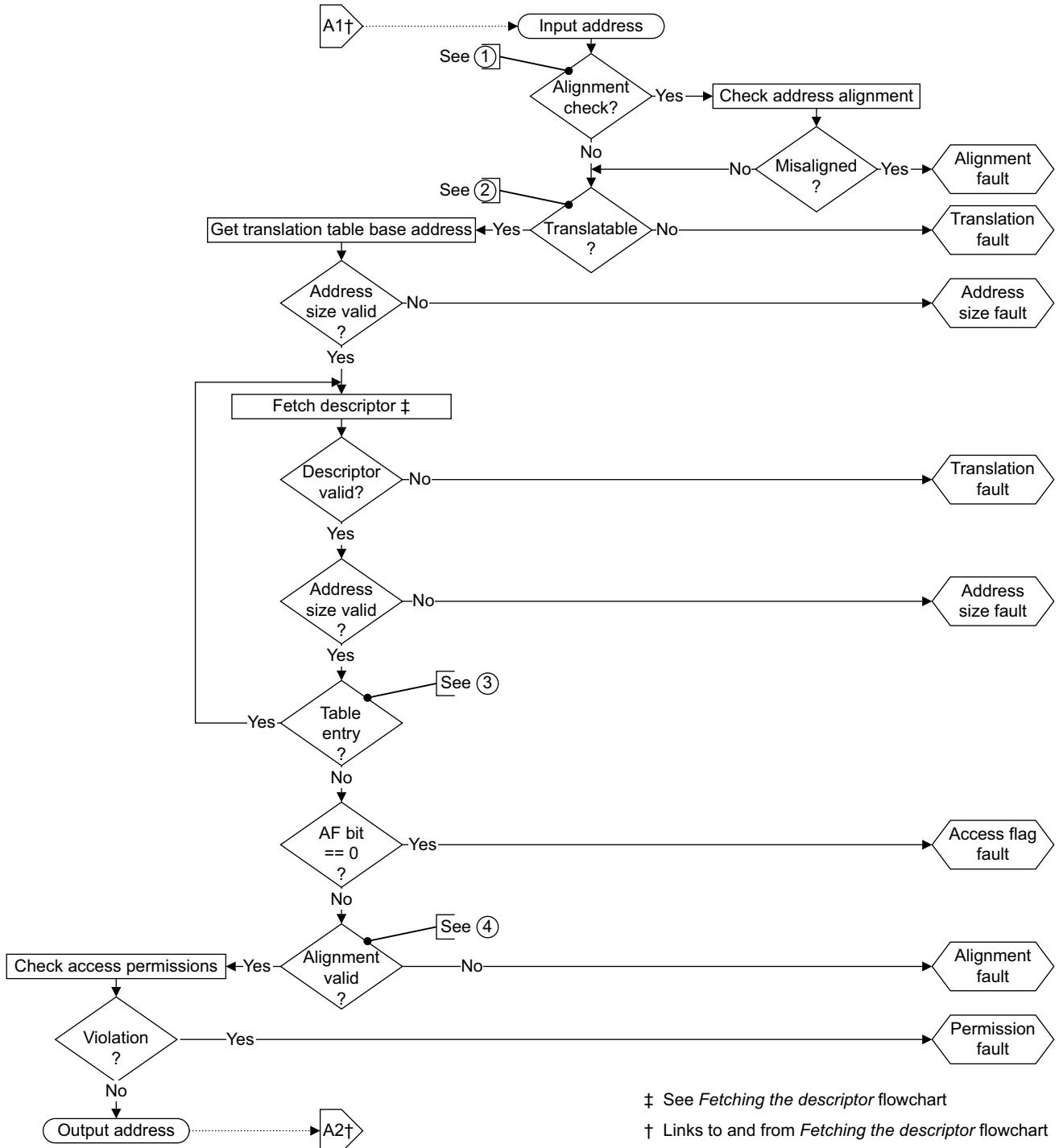

Figure D5-30 Fetching the descriptor in a VMSAv8-64 translation table walk

Figure D5-31 on page D5-1800 shows the full VMSA fault checking sequence, including the alignment check on the initial access.



‡ See *Fetching the descriptor* flowchart
‡ Links to and from *Fetching the descriptor* flowchart
① Is the access subject to an alignment check?
② Does the address map to a TTBR?
③ Not permitted at the lowest lookup level
④ Fault any unaligned access to Device memory

Figure D5-31 VMSAv8-64 fault checking sequence

Stage 2 fault on a stage 1 translation table walk

On performing a translation table walk for the stage 1 translations, the descriptor addresses must be translated from IPA to PA, using a stage 2 translation. This means that a memory access made as part of a stage 1 translation table lookup might generate, on a stage 2 translation:

- A Translation fault, Access flag fault, or Permission fault.
- A synchronous external abort on the memory access.

If [SCR_EL3.EA](#) is set to 1, a synchronous external abort is taken to Secure Monitor mode., Otherwise, these faults are reported as stage 2 memory aborts. [ESR_EL2.ISS\[7\]](#) is set to 1, to indicate a stage 2 fault during a stage 1 translation table walk, and the part of the ISS field that might contain details of the instruction is invalid. For more information see [Use of the ESR_EL1, ESR_EL2, and ESR_EL3 on page D1-1512](#).

Alternatively, a memory access made as part of a stage 1 translation table lookup might target an area of memory with the Device or Strongly-ordered attribute assigned on the stage 2 translation of the address accessed. When the [HCR_EL2.PTW](#) bit is set to 1, such an access generates a stage 2 Permission fault.

————— Note —————

On most systems, such a mapping to Strongly-ordered or Device memory on the stage 2 translation is likely to indicate a Guest OS error, where the stage 1 translation table is corrupted. Therefore, it is appropriate to trap this access to the hypervisor.

A TLB might hold entries that depend on the effect of [HCR_EL2.PTW](#). Therefore, if [HCR_EL2.PTW](#) is changed without changing the current VMID, the TLBs must be invalidated before executing in a Non-secure EL1 or EL0 mode. For more information see [Changing HCR_EL2.PTW on page D5-1816](#).

A cache maintenance instruction executed at Non-secure EL1 can cause a stage 1 translation table walk that might generate a stage 2 Permission fault, as described in this section. This is an exception to the general rule that a cache maintenance instruction cannot generate a Permission fault.

D5.6.3 Prioritization of synchronous aborts from a single stage of address translation

For a single stage of translation, the priority of the memory management faults on a memory access is as follows, ordered from highest priority to lowest priority. For memory accesses that undergo two stages of translation, the *italic entries show where the faults from second stage translations can occur*. A second stage fault within a second stage translation follows the same priority of faults:

1. Alignment fault not caused by memory type, possible for stage 1 translation only.
2. Translation fault due to the input address being out of the address range to be translated or requiring a [TTBR](#) that is disabled. This includes [VTCR_EL2.T0SZ](#) being inconsistent with [VTCR_EL2.SL0](#).
3. Address Size fault on a [TTBR](#) caused by either:
 - The check on [TCR_EL1.IPS](#), [TCR_ELx.PS](#), or [VTCR_EL2.PS](#).
 - The physical address being out of the range implemented.
4. *Second stage abort on a level zero lookup of a stage 1 table walk. When stage 2 address translation is enabled this includes an address size fault caused by the physical address being out of the range implemented.* This is second stage abort during a first stage translation table walk.
5. Synchronous parity fault on a level zero lookup of a translation table walk.
6. Synchronous external abort on a level zero lookup level of a translation table walk.
7. Translation fault on a level zero translation table entry.
8. Address Size fault a level zero lookup translation table entry caused by either:
 - The check on [TCR_EL1.IPS](#), [TCR_ELx.PS](#), or [VTCR_EL2.PS](#).
 - The output address being out of the range implemented.

9. *Second stage abort on a level one lookup of a stage 1 table walk. When stage 2 address translation is enabled this includes an address size fault caused by the physical address being out of the range implemented.* This is second stage abort during a first stage translation table walk.
10. Synchronous parity fault on a level one lookup of a translation table walk.
11. Synchronous external abort on a level one lookup level of a translation table walk.
12. Translation fault on a level one translation table entry.
13. Address Size fault on a level one lookup translation table entry caused by either:
 - The check on `TCR_EL1.IPS`, `TCR_ELx.PS`, or `VTCR_EL2.PS`.
 - The output address being out of the range implemented.
14. *Second stage abort on a level two lookup of a stage 1 table walk. When stage 2 address translation is enabled this includes an address size fault caused by the physical address being out of the range implemented.* This is second stage abort during a first stage translation table walk.
15. Synchronous parity fault on a level two lookup of a translation table walk.
16. Synchronous external abort on a level two lookup level of a translation table walk.
17. Translation fault on a level two translation table entry.
18. Address Size fault on a level two lookup translation table entry caused by either:
 - The check on `TCR_EL1.IPS`, `TCR_ELx.PS`, or `VTCR_EL2.PS`.
 - The output address being out of the range implemented.
19. *Second stage abort on a level three lookup of a stage 1 table walk. When stage 2 address translation is enabled this includes an address size fault caused by the physical address being out of the range implemented.* This is second stage abort during a first stage translation table walk.
20. Synchronous parity fault on a level three lookup of a translation table walk.
21. Synchronous external abort on a level three lookup level of a translation table walk.
22. Translation fault on a level three translation table entry.
23. Address Size fault on a level three lookup translation table entry caused by either:
 - The check on `TCR_EL1.IPS`, `TCR_ELx.PS`, or `VTCR_EL2.PS`.
 - The output address being out of the range implemented.
24. Access Flag fault.
25. Alignment fault caused by the memory type.
26. Permission fault.
27. *A fault from the state 2 translation of the memory access. When stage 2 address translation is enabled this includes an address size fault caused by the physical address being out of the range implemented.*
28. Synchronous parity fault on the memory access.
29. Synchronous External Abort on the memory access.

———— **Note** ————

The prioritization of TLB Conflict aborts is IMPLEMENTATION DEFINED, as the exact cause of these aborts depends on the form of TLBs implemented.

—————

D5.6.4 Pseudocode details of the MMU faults

The following functions generate fault records that describe MMU faults.

```
FaultRecord AArch64.AlignmentFault(Acctype acctype, boolean iswrite, boolean secondstage);
```

```
FaultRecord AArch64.TranslationFault(bits(48) ipaddress, integer level,  
                                     Acctype acctype, boolean iswrite, boolean secondstage,  
                                     boolean s2fs1walk);
```

```
FaultRecord AArch64.AccessFlagFault(bits(48) ipaddress, integer level,  
                                     Acctype acctype, boolean iswrite, boolean secondstage,  
                                     boolean s2fs1walk);
```

```
FaultRecord AArch64.AddressSizeFault(bits(48) ipaddress, integer level,  
                                     Acctype acctype, boolean iswrite, boolean secondstage,  
                                     boolean s2fs1walk);
```

```
FaultRecord AArch64.PermissionFault(bits(48) ipaddress, integer level,  
                                     Acctype acctype, boolean iswrite, boolean secondstage,  
                                     boolean s2fs1walk);
```

[Abort exceptions on page D4-1703](#) describes how fault records are used.

D5.7 Translation Lookaside Buffers (TLBs)

Translation Lookaside Buffers (TLBs) reduce the average cost of a memory access by caching the results of translation table walks. TLBs behave as caches of the translation table information, and the VMSA provides TLB maintenance instructions for the management of TLB contents.

———— **Note** ————

The ARM architecture permits TLBs to hold any translation table entry that does not directly cause a Translation fault, an Address Size fault, or an Access flag fault.

To reduce the need for TLB maintenance on context switches, for EL1&0 stage 1 translations the VMSA can distinguish between *Global pages* and *Process-specific pages*. The *Address Space Identifier (ASID)* identifies pages associated with a specific process and provides a mechanism for changing process-specific tables without having to maintain the TLB structures. Similarly, for the Non-secure EL1&0 translation regime, the *virtual machine identifier (VMID)* identifies the current virtual machine, with its own independent ASID space. The TLB entries include this VMID information, meaning TLBs do not require explicit invalidation when changing from one virtual machine to another, if the virtual machines have different VMIDs.

The following sections describe the architectural requirements for Translation Lookaside Buffers (TLBs) and their maintenance:

- [About ARMv8 Translation Lookaside Buffers \(TLBs\)](#).
- [TLB maintenance requirements and the TLB maintenance instructions on page D5-1807](#).

In these descriptions, TLB entries for a translation regime for a particular Exception level are *out of context* when executing at a higher Exception level.

D5.7.1 About ARMv8 Translation Lookaside Buffers (TLBs)

Translation Lookaside Buffers (TLBs) are an implementation technique that caches translations or translation table entries. TLBs avoid the requirement for every memory access to perform a translation table walk in memory. The ARM architecture does not specify the exact form of the TLB structures for any design. In a similar way to the requirements for caches, the architecture only defines certain principles for TLBs:

- The architecture has a concept of an entry locked down in the TLB. The method by which lockdown is achieved is IMPLEMENTATION DEFINED, and an implementation might not support lockdown.
- The architecture does not guarantee that an unlocked TLB entry remains in the TLB.
- The architecture guarantees that a locked TLB entry remains in the TLB. However, a locked TLB entry might be updated by subsequent updates to the translation tables. Therefore, when a change is made to the translation tables, the architecture does not guarantee that a locked TLB entry remains incoherent with an entry in the translation table.
- The architecture guarantees that a translation table entry that generates a Translation fault, an Address size fault, or an Access flag fault is not held in the TLB. However a translation table entry that generates a Permission fault might be held in the TLB.
- Any translation table entry that does not generate a Translation or Access flag fault and is not out of context might be allocated to an enabled TLB at any time.

———— **Note** ————

An enabled TLB can hold a translation table entry that does not itself generate a Translation fault but that points to a subsequent table in the translation table walk. This is referred to as *intermediate caching* of TLB entries.

- Software can rely on the fact that between disabling and re-enabling a stage of address translation, entries in the TLB relating to that stage of translation have not have been corrupted to give incorrect translations.

The following sections give more information about TLB implementation:

- [Global and process-specific translation table entries on page D5-1805](#)

- [TLB matching on page D5-1806](#)
- [TLB behavior at reset on page D5-1806](#)
- [TLB lockdown on page D5-1806](#)
- [TLB conflict aborts on page D5-1807](#).

See also [TLB maintenance requirements and the TLB maintenance instructions on page D5-1807](#).

Global and process-specific translation table entries

In a VMSA implementation, system software can divide the virtual memory map used by memory accesses at EL1 and EL0 into global and non-global regions, indicated by the nG bit in the translation table descriptors:

nG == 0 The translation is global, meaning the region is available for all processes.

nG == 1 The translation is non-global, or process-specific, meaning it relates to the current ASID, as defined in either the [TTBR0_EL1](#) or the [TTBR1_EL1](#).

As indicated by the nG field definitions, each non-global region has an associated *Address Space Identifier* (ASID). These identifiers mean different translation table mappings can co-exist in a caching structure such as a TLB. This means that software can create a new mapping of a non-global memory region without removing previous mappings.

[TTBR0_EL1](#) and [TTBR1_EL1](#) each have an ASID field, and [TCR_EL1.A1](#) determines which of these fields defines the current ASID. See also [ASID size](#).

———— Note ————

The selected ASID applies to the translation of any address for which the value of the nG bit is 1, regardless of whether the address is translated based on [TTBR0_EL1](#) or on [TTBR1_EL1](#).

For a symmetric multiprocessor cluster where a single operating system is running on the set of processing elements, the ARM architecture requires all ASID values to be assigned uniquely within any single Inner Shareable domain. In other words, each ASID value must have the same meaning to all processing elements in the system.

The EL2 translation regime and the EL3 translation regime do not support ASIDs, and all descriptors in these regimes are treated as global.

When a PE is using the VMSAv8-64 translation table format, and is in Secure state, a translation must be treated as non-global, regardless of the value of the nG bit, if NSTable is set to 1 at any level of the translation table walk.

For more information see [Control of Secure or Non-secure memory access on page D5-1779](#).

ASID size

In VMSAv8-64, the ASID size is an IMPLEMENTATION DEFINED choice of 8 bits or 16 bits, and [ID_AA64MMFR0_EL1.ASID](#) identifies the supported size. When an implementation supports a 16 bit ASID, [TCR_EL1.AS](#) selects whether the top 8 bits of the ASID are used. When the value of [TCR_EL1.AS](#) is 0, ASID[15:8]:

- Are ignored by hardware for every purpose other than reads of [ID_AA64MMFR0_EL1](#).
- Are treated as if they are all zeros when used for allocating and matching entries in the TLB.

———— Note ————

ARMv7 and VMSAv8-32 use an 8-bit ASID. For backwards compatibility, when executing using translations controlled from an Exception level that is using AArch32, the ASID size remains at 8 bits. If the implementation supports 16-bit ASIDS, the 8-bit ASID used is zero-extended to 16 bits.

TLB matching

A TLB is a hardware caching structure for translation table information. Like other hardware caching structures, it is mostly invisible to software. However, there are some situations where it can become visible. These are associated with coherency problems caused by an update to the translation table that has not been reflected in the TLB. Use of the TLB maintenance instructions described in [TLB maintenance requirements and the TLB maintenance instructions on page D5-1807](#) can prevent any TLB incoherency becoming a problem.

A particular case where the presence of the TLB can become visible is if the translation table entries that are in use under a particular ASID and VMID are changed without suitable invalidation of the TLB. This is an issue regardless of whether the translation table entries are global. In some cases, the TLB can hold two mappings for the same address, and this:

- Might generate a Data abort reported using the TLB Conflict fault code, see [TLB conflict aborts on page D5-1807](#).
- Might lead to UNPREDICTABLE behavior. In this case, behavior will be consistent with one of the mappings held in the TLB, or with some amalgamation of the values held in the TLB, but cannot give access to regions of memory with permissions or attributes that could not be assigned by valid translation table entries in the translation regime being used for the access. For more information see [Appendix A Architectural Constraints on UNPREDICTABLE behaviors](#).

TLB behavior at reset

The ARM architecture does not require a reset to invalidate the TLBs. The architecture recognizes that an implementation might require caches, including TLBs, to maintain their contents over a system reset. Possible reasons for doing so include power management and debug requirements.

For ARMv8:

- All TLBs are disabled from reset. All stages of address translation are disabled from reset, and the contents of the TLBs have no effect on address translation. For more information see [Controlling address translation stages on page D5-1714](#).
- An implementation can require the use of a specific TLB *invalidation routine*, to invalidate the TLB arrays before they are enabled after a reset. The exact form of this routine is IMPLEMENTATION DEFINED, but if an invalidation routine is required it must be documented clearly as part of the documentation of the device.
ARM recommends that if an invalidation routine is required for this purpose, the routine is based on the TLB maintenance instructions described in [TLB maintenance instructions on page D5-1808](#).
- When TLBs that have not been invalidated by some mechanism since reset are enabled, the state of those TLBs is UNPREDICTABLE.

Similar rules apply to cache behavior, see [Behavior of caches at reset on page D4-1677](#).

TLB lockdown

The ARM architecture recognizes that any TLB lockdown scheme is heavily dependent on the microarchitecture, making it inappropriate to define a common mechanism across all implementations. This means that:

- VMSAv8-64 does not require TLB lockdown support.
- If TLB lockdown support is implemented, the lockdown mechanism is IMPLEMENTATION DEFINED. However, key properties of the interaction of lockdown with the architecture must be documented as part of the implementation documentation.

This means that a region of the system instruction encoding space is reserved for IMPLEMENTATION DEFINED functions, see [Reserved control space for IMPLEMENTATION DEFINED functionality on page C4-250](#). An implementation might use some of these encodings to implement TLB lockdown functions. These functions might include:

- Unlock all locked TLB entries.
- Preload into a specific level of TLB. This is beyond the scope of the PLI and PLD hint instructions.

In an implementation that includes EL2, exceptions generated by problems related to TLB lockdown in a Non-secure EL1 mode, can be routed to either:

- Non-secure EL1, as a Data Abort exception.
- Non-secure EL2, as a Hyp Trap exception.

For more information, see [Traps to EL2 of Non-secure EL1 and EL0 accesses to lockdown, DMA, and TCM operations on page D1-1483](#).

TLB conflict aborts

ARMv8 includes the concept of a TLB conflict abort, and defines fault status encodings for such an abort, see [Exception from an Instruction abort on page D1-1524](#) and [Exception from a Data abort on page D1-1525](#).

An implementation can generate a TLB conflict abort if it detects that the address being looked up in the TLB hits multiple entries. This can happen if the TLB has been invalidated inappropriately, for example if TLB invalidation required by the architecture has not been performed. If it happens, the resulting behavior is UNPREDICTABLE, but must not permit access to regions of memory with permissions or attributes that mean they cannot be accessed in the current Security state at the current Exception level.

In some implementations, multiple hits in the TLB can generate a synchronous Data Abort or Prefetch Abort exception. In any case where this is possible it is IMPLEMENTATION DEFINED whether the abort is a stage 1 abort or a stage 2 abort.

———— **Note** —————

A stage 2 abort cannot be generated if stage 2 of the Non-secure EL1&0 translation regime is disabled.

The priority of the TLB conflict abort is IMPLEMENTATION DEFINED, because it depends on the form of a TLB that can generate the abort.

———— **Note** —————

The TLB conflict abort must have higher priority than any abort that depends on a value held in the TLB.

An implementation can generate TLB conflict aborts on either or both instruction fetches and data accesses.

On a TLB conflict abort, the returned syndrome includes the address that generated the fault. That is, it includes the address that was being looked up in the TLB.

D5.7.2 TLB maintenance requirements and the TLB maintenance instructions

Translation Lookaside Buffers (TLBs) are an implementation mechanism that caches translations or translation table entries. The ARM architecture does not specify the form of any TLB structures, but defines the mechanisms by which TLBs can be maintained. The following sections describe the VMSA TLB maintenance instructions:

- [General TLB maintenance requirements](#).
- [TLB maintenance instructions on page D5-1808](#).
- [Maintenance requirements on changing System register values on page D5-1816](#).
- [Atomicity of register changes on changing virtual machine on page D5-1816](#).

General TLB maintenance requirements

TLB maintenance instructions provide a mechanism for invalidating entries from TLB caching structures to ensure that changes to the translation tables are reflected correctly in those TLB caching structures.

The architecture permits the caching of any translation table entry that has been returned from memory without a fault, provided that the entry does not, itself, cause a Translation fault, an Address size fault, or an Access Flag fault. This means that the entries that can be cached include:

- Entries in translation tables that point to subsequent tables to be used in that stage of translation.
- Stage 2 translation table entries used as part of a stage 1 translation table walk

- Stage 2 translation table entries used to translate the output address of the stage 1 translation.

Such entries might be held in intermediate TLB caching structures that are used during a translation table walk and that are distinct from the data caches in that they are not required to be invalidated as the result of writes of the data. The architecture makes no restriction of the form of these intermediate TLB caching structures.

The architecture does not intend to restrict the form of TLB caching structures used for holding translation table entries, and in particular for translation regimes that involve two stages of translation, it is recognized that such caching structures might contain:

- Entries containing information from stage 1 translation table entries, at any level of the translation table walk.
- Entries containing information from stage 2 translation table entries, at any level of the translation table walk.
- Entries that combine information from stage 1 and stage 2 translation table entries, at any level of the translation table walk.

Where a TLB maintenance instruction is:

- Required to apply to stage 1 entries, then it must apply to any cached entries in caching structures that include any stage 1 information that are used to translate the address being invalidated.

———— **Note** —————

ARM expects that, in at least some implementations, cached copies of levels of the translation table walk other than the last level are tagged with their ASID, regardless of whether the final level is global. This means that TLB invalidations that involve the ASID require the ASID to match such entries to perform the required invalidation.

- Required to apply to stage 2 entries only, then:
 - It is not required to apply to caching structures that combine stage 1 and stage 2 translation table entries.
 - It must apply to caching structures that contain information only from stage 2 translation table entries.

Whenever translation tables entries associated with a particular VMID or ASID are changed, the corresponding entries must be invalidated from the TLB to ensure that these changes are visible to subsequent execution, including speculative execution, that uses the changed translation table entries.

Some system register bit descriptions state that the effect of the bit is permitted to be cached in a TLB. This means that all TLB entries that might be affected by a change in one of these bits must be invalidated whenever that bit is changed, to ensure that the effect of the change of that control bit is visible to subsequent execution including speculative execution, that uses those control bits. This invalidation is required in addition to, and after, the normal synchronization of the system registers described in [Synchronization requirements for system registers on page D8-1866](#), and applies to any stage of address translation that is implemented for the translation regime, and VMID if appropriate, that is affected by that control bit.

In addition to any TLB maintenance requirement, when changing the cacheability attributes of an area of memory, software must ensure that any cached copies of affected locations are removed from the caches. For more information see [Cache maintenance requirement created by changing translation table attributes on page D5-1820](#).

TLB maintenance instructions

The architecture defines TLB maintenance instructions, that provide the following:

- Invalidate all entries in the TLB.
- Invalidate a single TLB entry by ASID for a non-global entry.
- Invalidate all TLB entries that match a specified ASID.
- Invalidate all TLB entries that match a specified VA, regardless of the ASID.

Each instruction can be specified as applying only to the PE that executes the instruction, or as applying to all PEs in the same Inner Shareable shareability domain as the PE that executes the instruction.

The following subsections describe these instructions:

- [TLB maintenance instruction syntax on page D5-1809](#).
- [Operation of the TLB maintenance instructions on page D5-1810](#).

- [Scope of the TLB maintenance instructions on page D5-1811.](#)
- [Broadcast TLB maintenance between AArch32 and AArch64 on page D5-1813.](#)
- [Ordering and completion of TLB maintenance instructions on page D5-1814.](#)
- [TLB maintenance in the event of TLB conflict on page D5-1815.](#)
- [The interaction of TLB lockdown with TLB maintenance instructions on page D5-1815.](#)

[TLB maintenance instructions on page C4-239](#) describes the encoding of the TLB maintenance instructions.

TLB maintenance instruction syntax

The A64 syntax for TLB maintenance instructions is:

```
TLBI <operation>{, <Xt>}
```

Where:

<operation> Is one of VMALLE1, VA{L}E1, ASIDE1, VAA{L}E1, VMALLE1IS, VA{L}E1IS, ASIDE1IS, VAA{L}E1IS, VA{L}E2, VA{L}E2IS, VA{L}E3, VA{L}E3IS, ALLE1, ALLE1IS, ALLE2, ALLE2IS, ALLE3, ALLE3IS, VMALLS12E1, VMALLS12E1IS, IPAS2{L}E1, or IPAS2{L}E1IS.

<operation> has a structure of <type>{L}<level>{,IS} where:

<type> Is one of:

- | | |
|----------|--|
| ALL | All translations used at <level>. For level == E1, this applies with any VMID. |
| VMALL | All stage 1 translations used at <level> with the current VMID. |
| VMALLS12 | All stage 1 and stage 2 translations used at EL1 with the current VMID. VMALLS12 is only valid when level == E1. |
| ASID | All translations used at EL1 with the current VMID and the supplied ASID. ASID is only valid when level == E1. |
| VA{L} | Translations used at <level> for the specified address and ASID, if appropriate, and the current VMID, if appropriate. |
| VAA{L} | Translations used at <level> for the specified address and for all ASID values, if appropriate, and the current VMID, if appropriate. |
| IPAS2{L} | Translations used at <level> for the specified IPA for the current VMID, if appropriate, held in stage 2 only caching structures. |
| L | Indicates that the invalidation only applies to caching of entries returned from the last level of translation table walk of the stage 1 translation. See Scope of the TLB maintenance instructions on page D5-1811 . As shown in this list, L is an optional additional parameter to some of the <type> parameters. |

<level> Describes the Exception level of the translation regime that the invalidation applies to. Is one of:

- | | |
|----|------|
| E1 | EL1. |
| E2 | EL2. |
| E3 | EL3. |

Instructions applying to the translation regime of an Exception level other than the Exception level at which the instruction is executed is UNDEFINED.

TLBI ALLE1{IS}, TLBI IPAS2{L}E1{IS} and TLBI VMALLS12E1{IS} are UNDEFINED at EL1.

————— Note —————

All TLB maintenance instructions are UNDEFINED at EL0.

IS When present, it indicates that the function applies to all TLBs in the Inner Shareable domain.

<Xt> Passes an address or ASID argument, where required. <Xt> is required for the TLB ASID, TLB VA{L}, TLB VAA{L}, and TLB IPAS2{L} instructions.

If EL2 is not implemented, the TLBI VA{L}E2, TLBI VA{L}E2IS, TLBI ALLE2, and TLBI ALLE2IS instructions are UNDEFINED.

In VMSAv8-64, the TLB instructions that take a register argument that holds a virtual address, an ASID, or both, use the following register argument format:

Bits[63:48] ASID. However, these bits are RES0 if the instruction does not require an ASID argument.

Bits[47:44] RES0.

Bits[43:0] VA[55:12]. For an instruction that requires a VA argument, the treatment of the low-order bits of this field depends on the translation granule size, as follows:

4KB granule size All bits are valid and used for the invalidation.

16KB granule size Bits[1:0] RES0 and ignored when the instruction is executed, because VA[13:12] have no effect on the operation of the instruction.

64KB granule size Bits[3:0] are RES0 and ignored when the instruction is executed, because VA[15:12] have no effect on the operation of the instruction.

These bits are RES0 if the instruction does not require a VA argument.

For TLB maintenance instructions that take an address, the maintenance of VA[63:56] is interpreted as being the same as the maintenance of VA[55].

If a TLB maintenance instruction targets a translation regime that is using AArch32, meaning the VA is only 32-bit, then software must treat VA[55:32] as RES0, and these bits are ignored when the instruction is executed.

If the implementation supports 16 bits of ASID then the upper bits are RES0 when the context being invalidated only uses 8 bits.

In VMSAv8-64, the TLB instructions that take a register argument that holds an IPA, use the following register argument format:

Bits[63:36] RES0.

Bits[35:0] IPA[47:12]. For an instruction that requires a VA argument, the treatment of the low-order bits of this field depends on the translation granule size, as follows:

4KB granule size All bits are valid and used for the invalidation.

16KB granule size Bits[1:0] RES0 and ignored when the instruction is executed, because IPA[13:12] have no effect on the operation of the instruction.

64KB granule size Bits[3:0] are RES0 and ignored when the instruction is executed, because IPA[15:12] have no effect on the operation of the instruction.

Operation of the TLB maintenance instructions

Any TLB maintenance instruction can affect any TLB entries that are not locked down.

The TLB maintenance instructions specify the Exception level of the translation regime to which they apply.

Note

Because there is no guarantee that an unlocked TLB entry remains in the cache, architecturally it is not possible to tell whether a TLB maintenance instruction has affected any TLB entries that were not specified by the instruction.

If a TLB maintenance instruction specifies a VA, and a data or instruction access to that VA would generate an MMU abort, the TLB maintenance instruction does not generate an abort. VAs for which a TLB maintenance instruction does not generate an abort include VAs that are not in the range of VAs that can be translated.

When EL3 is implemented:

- The TLB maintenance instructions that apply to the EL1&0 translation regime take account of the current Security state, as part of the address translation required for the TLB operation.

- **SCR_EL3.NS** modifies the effect of the TLB maintenance instructions as follows:
 - For instructions that apply to the EL1&0 translation regime, the **SCR_EL3.NS** bit identifies whether the maintenance instructions apply to the Secure or Non-secure EL1&0 translation regime.

———— **Note** —————

If EL3 is not implemented, then there is only a single EL1&0 translation regime.

- For instructions that apply to the EL2 translation regime, the **SCR_EL3.NS** bit must be 1 or the instruction is UNDEFINED.
- For instructions that apply to the EL3 translation regime, the **SCR_EL3.NS** bit has no effect.

———— **Note** —————

- An address-based TLB maintenance instruction that applies to the Inner Shareable domain does so regardless of the Shareability attributes of the address supplied as an argument to the operation.
- Previous versions of the ARM architecture included TLB maintenance instructions that operated only on instruction TLBs, or only on data TLBs. From the introduction of ARMv7, ARM deprecated any use of these instructions. In ARMv8:
 - AArch64 state does not include any of these instructions.
 - AArch32 state includes some of these instructions, but ARM deprecates their use.

The ARM architecture does not dictate the form in which the TLB stores translation table entries. However, when a TLB maintenance instruction is executed, the minimum size of the table entry that is invalidated from the TLB must be at least the size that appears in the translation table entry.

———— **Note** —————

The Contiguous bit does not affect the minimum size of entry that must be invalidated from the TLB

Scope of the TLB maintenance instructions

The TLB invalidation instruction <type> affects the different possible levels of caching in the TLB as follows:

VAL, VAAL	The invalidation applies to all cached copies of the final level of translation table walk of stage 1 translation that would be used with the Security state specified by SCR_EL3.NS , current VMID (for the Non-secure EL1&0 translation regime), and, if appropriate, the specified ASID, during a translation table walk to translate the address specified in the invalidation instruction at the specified Exception Level.
VA, VAA	The invalidation applies to all cached copies of the stage 1 translation table entries, at any table level that would be used with the state specified by SCR_EL3.NS , current VMID (for the Non-secure EL1&0 translation regime), and, if appropriate, the specified ASID, during a translation table walk to translate the address specified in the invalidation instruction at the specified Exception Level.
ASID	The invalidation applies to all cached copies of the stage 1 translation table entries, at any table level that would be used with the state specified by SCR_EL3.NS , current VMID (for the Non-secure EL1&0 translation regime), and the specified ASID during a translation table walk to translate any address at the specified Exception Level.
VMALL	The invalidation applies to all cached copies of the stage 1 translation table entries, at any table level, that would be used with the state specified by SCR_EL3.NS and current VMID (for the Non-secure EL1&0 translation regime) during a translation table walk to translate any address at the specified Exception Level.
VMALLS12	The invalidation applies to all cached copies of the stage 1 and stage 2 translation table entries, at any table level, that would be used with the state specified by SCR_EL3.NS and current VMID (for the Non-secure EL1&0 translation regime) during a translation table walk to translate any address at the specified Exception Level.

———— **Note** ————

If EL2 is not implemented, or if the TLBI VMALLS12 instruction is executed with `SCR_EL3.NS==0`, the instruction is not UNDEFINED but it has the same effect as TLBI VMALL. This is because there are no stage 2 translations to invalidate.

IPAS2 The invalidation applies to cached copies of the stage 2 translation table entries held in TLB caching structures holding stage 2 only entries, at any table level, that would be used with the current VMID during a translation table walk to translate any address at the specified Exception Level. It is not required that this instruction invalidates TLB caching structures holding stage 1 and stage 2 entries combined.

The only translation regime to which this instruction can apply is the Non-secure EL1&0 translation regime.

When executed with the `SCR_EL3.NS==0`, or in an implementation that does not implement EL2, this instruction is a NOP.

The architectural requirements of this instruction are that:

1. The following code is sufficient to invalidate all cached copies of the stage 2 translation of the IPA held in Xt for the current VMID, with the corresponding requirement for the broadcast versions of the instructions:

```
TLBI IPAS2E1, Xt
DSB
TLBI VMALLE1
```

2. The following code is sufficient to invalidate all cached copies of the stage 2 translations of the IPA held in Xt used to translate the virtual address VA (and ASID when executing TLBI VAE1) held in Xt2, with the corresponding requirement for the broadcast versions of the instructions:

```
TLBI IPAS2E1, Xt
DSB
TLBI VAE1, Xt2 ; or TLBI VAAE1, Xt2
```

3. The following code is sufficient to invalidate all cached copies of the stage 2 translations of the IPA held in Xt used to translate the IPA produced by the last level of stage 1 translation table lookup for the virtual address VA (and ASID when executing TLBI VAE1) held in Xt2, with the corresponding requirement for the broadcast versions of the instructions:

```
TLBI IPAS2E1, Xt
DSB
TLBI VALE1, Xt2 ; or TLBI VAALE1, Xt2
```

IPAS2L The invalidation applies to cached copies of the stage 2 translation table entries held in TLB caching structures holding stage 2 only entries, at the final level of the stage 2 translation table walk, that would be used with the current VMID during a translation table walk to translate any address at the specified Exception Level. It is not required that this instruction invalidates TLB caching structures holding combined (stage 1 and stage 2) entries.

The only translation regime to which this instruction can apply is the Non-secure EL1&0 translation regime.

When executed with the `SCR_EL3.NS==0`, or in an implementation that does not implement EL2, this instruction is a NOP.

The architecture requirements for TLBI IPAS2L instructions correspond to those for the TLBI IPAS2 instructions, but only for cached copies of the final level of the stage 2 translation.

ALL The invalidation applies to all cached copies of the stage 1 and stage 2 translation table entries, at any table level, that would be used with the state specified by `SCR_EL3.NS`, and any VMID during a translation table walk to translate any address at the specified Exception Level.

The entries that the invalidations apply to are not affected by the state of any other control bits involved in the translation process. Therefore, the following is a non-exhaustive list of control bits that do not affect how a TLB maintenance instruction updates the TLB entries:

In AArch64 [SCTLR_EL1.M](#), [SCTLR_EL2.M](#), [SCTLR_EL3](#).{M, RW}, [HCR_EL2](#).{VM, RW}, [TCR_EL1](#).{TG1, EPD1, T1SZ, TG0, EPD0, T0SZ, AS, A1}, [TCR_EL2](#).{TG0, T0SZ}, [TCR_EL3](#).{TG0, T0SZ}, [VTCR_EL2](#).{SL0, T0SZ}, [TTBR0_EL1](#).ASID, [TTBR1_EL1](#).ASID.

In AArch32 [SCTLR.M](#), [HCR.VM](#), [TTBCR](#).{EAE, PD1, PD0, N, EPD1, T1SZ, EPD0, T0SZ, A1}, [HTCR.T0SZ](#), [VTCR](#).{SL0, T0SZ}, [TTBR0](#).ASID, [TTBR1](#).ASID, [CONTEXTIDR](#).ASID.

Note

- ARM expects most TLB maintenance performed by an operating system to occur to the last level entries of the stage 1 translation table walks, and the purpose of the address-based TLB invalidation instructions where the invalidation need only apply to caching of entries returned from the last level of translation table walk of stage 1 translation is to avoid unnecessary loss of the intermediate caching of the translation table entries. Similarly, for stage 2 translations ARM expects that most TLB maintenance performed by a hypervisor for a given Guest operation system will affect only the last level entries of the stage 2 translations. Therefore, similar capability is provided for instructions that invalidate single stage 2 entries.
- The architecture permits the invalidation of entries in TLB caching structures at any time, so for each of these instructions the definition is in terms of the minimum set of entries that must be invalidated from TLB caching structures, and an implementation might choose to invalidate more entries. In general, for best performance, ARM recommends not invalidating entries that are not required to be invalidated.
- Dependencies on the VMID for the Non-secure EL1&0 translation regime apply even when [HCR_EL2.VM](#) is set to 0. Because the architecture does not require the [VTTBR_EL2.VMID](#) field to be reset in hardware, the reset routine of each active PE must initialize [VTTBR_EL2.VMID\[7:0\]](#) to a common value such as 0, even if stage 2 translation is not in use.

Broadcast TLB maintenance between AArch32 and AArch64

In most cases, the TLB maintenance instructions affecting the Inner Shareable domain executed by a PE in an Exception level that is using AArch64 also affects another PE in the same Inner Shareable domain that is executing at the same Exception level and is using AArch32, provided that the virtual address, ASID, and VMID match.

Note

The requirement to match means that the invalidation only occurs on the PE that is using AArch32 if, for the PE that executed the TLB maintenance instruction at an Exception level that is using AArch64, both of the following apply:

- The VA is in the bottom 4GB.
- If it uses a 16-bit ASID, then the top 8 bits of the ASID are zero.

Except for the cases identified here, the TLB maintenance instructions affecting the Inner Shareable domain executed by a PE in an Exception level that is using AArch32 also affects another PE in the same Inner Shareable domain that is executing at the same Exception level and is using AArch64, provided that the virtual address, ASID, and VMID match. The virtual address from the instruction executed in AArch32 state is zero-extended, and the ASID is zero-extended if the PE executing in AArch64 state is using a 16-bit ASID. The exceptions to this general rule are as follows:

1. An ARMv7 PE in the same Inner Shareable domain is treated in the same way as an ARMv8 PE for which EL3 is using AArch32, except that if an ARMv8 PE issues an instruction that does not exist in ARMv7, then that instruction is not required to have an effect on the TLBs of the ARMv7 PE. The instructions that do not exist in ARMv7 include the following TLB maintenance instructions that ARMv8 adds to the T32 and A32 instruction sets:
 - The following instructions that operate on TLB entries for the final level of translation table walk for stage 1 translations:
TLBIMVALIS, TLBIMVAALIS, TLBIMVALHIS, TLBIMVAL, TLBIMVAAL, and TLBIMVALH.

- The following instructions that operate by IPA on TLB entries for stage 2 translations: TLBIIPAS2IS, TLBIIPAS2LIS, TLBIIPAS2, and TLBIIPAS2L.
2. The number of Exception levels in Secure state depends on whether EL3 is using AArch32 or EL3 is using AArch64. This means that, within the Inner Shareable domain, there might be PEs with different numbers of Exception levels in Secure state. Therefore, the following exceptions are made to this principle:
- If a PE that has EL3 using AArch32 issues an AArch32 TLB maintenance instruction affecting Secure entries, and the Inner Shareable domain also contains PEs with EL3 using AArch64, then the architecture does not require that the AArch32 TLB maintenance instruction has any effect on either:
 - The EL3 translation regime of the PEs with EL3 using AArch64.
 - The Secure EL1 translation regime of the PEs with EL3 using AArch64, regardless of whether the Secure EL1 translation regime is using AArch64 or AArch32.
 - If a PE that has EL3 using AArch64 issues an AArch64 TLB maintenance instruction affecting EL3 entries, and the Inner Shareable domain also contains PEs with EL3 using AArch32, then the architecture does not require that the AArch64 TLB maintenance instruction has any effect on the EL3 translation regime of the PEs with EL3 using AArch32.
 - If a PE that has EL3 using AArch64 issues an AArch64 TLB maintenance instruction affecting Secure EL1 entries, and the Inner Shareable domain also contains PEs with EL3 using AArch32 then the architecture does not require that the AArch64 TLB maintenance instruction has any effect on the EL3 translation regime of the PEs with EL3 using AArch32.

———— **Note** —————

While the architecture does not require such an effect, the architecture also does not require that entries in the TLB remain in the TLB at any time, and so it is permissible that such instructions affect these translation regimes.

Ordering and completion of TLB maintenance instructions

For AArch64 execution, a TLB maintenance instruction can be executed in any order relative to:

- Loads and stores, unless a DSB is executed between the instructions.

———— **Note** —————

In the ARM architecture, a translation table walk is considered to be a separate observer, and a store to translation tables can be observed by that separate observer at any time after the instruction has been executed, but is only guaranteed to be observable after the execution of a DSB instruction by the PE that executed the TLB maintenance instruction.

- Another TLB maintenance instruction, unless a DSB is executed between the instructions.
- A data or instruction cache maintenance instruction, unless a DSB is executed between the instructions.

For AArch64 execution, the completion rules are:

- A TLB maintenance instruction is complete when all memory accesses using the TLB entries that have been invalidated have been observed by all observers to the extent that those accesses are required to be observed, as determined by the shareability and cacheability of the memory locations accessed by the accesses. In addition, after the TLB invalidate instruction is complete, no new memory accesses that can be observed by those observers using those TLB entries are performed.

———— **Note** —————

For TLB maintenance instructions that affect other PEs, the memory accesses from those PEs that used the TLB entries that have been invalidated are included in the set of memory accesses that must have been observed when the TLB maintenance instruction is complete.

- A TLB maintenance instruction can complete at any time after it is issued, but is only guaranteed to be complete after the execution of DSB by the PE that executed the TLB maintenance instruction.

- A completed TLB maintenance instruction is only guaranteed to have its effects visible on the PE that executed the instruction after the execution of an ISB instruction by the PE that executed the TLB maintenance instruction.

Note

In all cases in this section, where a DMB or DSB is referred to, it refers to a DMB or DSB whose required access type is both loads and stores.

TLB maintenance in the event of TLB conflict

In the event of a TLB conflict abort, which indicates that multiple entries in the TLB are being used to translate the same address, the TLB invalidation of the address (including ASID, VMID and Security state, as appropriate) for the translation regime that gave rise to the fault is required to clear the conflict.

In some implementations with complex caching structures, to clear the conflict might require more extensive invalidation of the TLB, by using the ALL or VMALL types for the affected translation regimes. The need for such requirements is IMPLEMENTATION DEFINED.

The interaction of TLB lockdown with TLB maintenance instructions

The precise interaction of TLB lockdown with the TLB maintenance instructions is IMPLEMENTATION DEFINED. However, the architecturally-defined TLB maintenance instructions must comply with these rules:

- The effect on a locked TLB entry of a TLB invalidate all operation that would invalidate that entry if the entry was not locked is IMPLEMENTATION DEFINED. However, the operation must implement one of the following options:
 - The operation has no effect on entries that are locked down.
 - The operation generates an IMPLEMENTATION DEFINED Data Abort exception if an entry is locked down, or might be locked down.

Any such exceptions taken from Non-secure EL1 can be trapped to EL2, see [Traps to EL2 of Non-secure EL1 and EL0 accesses to lockdown, DMA, and TCM operations on page D1-1483](#).
- This permits a usage model for TLB invalidate routines, where the routine invalidates a large range of addresses, without considering whether any entries are locked in the TLB.
- The effect on a locked TLB entry of a TLB invalidate by VA or invalidate by ASID match operation that would invalidate that entry if the entry was not locked is IMPLEMENTATION DEFINED. However, the operation must implement one of the following options:
 - The locked entry is invalidated in the TLB.
 - The operation has no effect on any locked entry in the TLB. In the case of an invalidate single entry by VA, this means the PE treats the operation as a NOP.
 - The operation generates an IMPLEMENTATION DEFINED Data Abort exception if it operates on an entry that is locked down, or might be locked down.

The exception syndrome definitions include a fault code for cache and TLB lockdown faults, see [Use of the ESR_EL1, ESR_EL2, and ESR_EL3 on page D1-1512](#).

Note

Any implementation that uses an abort mechanism for entries that can be locked down but are not actually locked down must:

- Document the IMPLEMENTATION DEFINED instruction sequences that perform the required operations on entries that are not locked down.
- Implement one of the other specified alternatives for the locked entries.

ARM recommends that, when possible, such IMPLEMENTATION DEFINED instruction sequences use the architecturally-defined operations. This minimizes the number of customized operations required.

In addition, an implementation that uses an abort mechanism for handling the effect of TLB maintenance instructions on entries that can be locked down but are not actually locked down must also provide a mechanism that ensures that no TLB entries are locked.

Similar rules apply to cache lockdown, see [The interaction of cache lockdown with cache maintenance instructions on page D4-1691](#).

The architecture does not guarantee that any unlocked entry in the TLB remains in the TLB. This means that, as a side-effect of any TLB maintenance instruction, any unlocked entry in the TLB might be invalidated.

Maintenance requirements on changing System register values

The TLB contents can be influenced by control bits in a number of system control registers. This means the TLB must be invalidated after any changes to these bits, unless the changes are accompanied by a change to the VMID or ASID that defines the context to which the bits apply. The general form of the required invalidation sequence is as follows:

```
; Change control bits in system control registers
ISB          ; Synchronize changes to the control bits
; Perform TLB invalidation of all entries that might be affected by the changed control bits
```

The system control register changes that this applies to are:

- Any change to the [MAIR_EL1](#), [MAIR_EL2](#), or [MAIR_EL3](#) registers.
- Any change to the [AMAIR_EL1](#), [AMAIR_EL2](#), or [AMAIR_EL3](#) registers.
- Any change to [SCTLR_EL1.EE](#), [SCTLR_EL2.EE](#), or [SCTLR_EL3.EE](#).
- Any change to [SCTLR_EL1.WXN](#), [SCTLR_EL2.WXN](#), or [SCTLR_EL3.WXN](#).
- Any change to any of the [SCR_EL3](#).{RW, SIF} bits.
- Any change to any of the [HCR_EL2](#).{RW, DC, PTW, VM} bits. See also [Changing HCR_EL2.PTW](#).
- Any changes to the registers that control address translation:
 - Any change to any of the [TCR_EL1](#), [TCR_EL2](#), [TCR_EL3](#), or [VTCR_EL2](#) registers.
 - Any change to the [TTBR0_EL1](#), [TTBR1_EL1](#), [TTBR0_EL2](#), [TTBR0_EL3](#), or [VTTBR_EL2](#) registers.

Changing HCR_EL2.PTW

When the value of the Protected table walk bit, [HCR_EL2.PTW](#), is 1, a stage 1 translation table access in the Non-secure EL1&0 translation regime, to an address that is mapped to any type of Device memory by its stage 2 translation, generates a stage 2 Permission fault. A TLB associated with a particular VMID might hold entries that depend on the effect of [HCR_EL2.PTW](#). Therefore, if the value of [HCR_EL2.PTW](#) is changed without a change to the VMID value, all TLB entries associated with the current VMID must be invalidated before executing software at Non-secure EL1 or EL0. If this is not done, behavior is UNPREDICTABLE.

Atomicity of register changes on changing virtual machine

From the viewpoint of software executing at Non-secure EL1 or EL0, when there is a switch from one virtual machine to another, the registers that control or affect address translation must be changed atomically. This applies to the registers for the Non-secure EL1&0 translation regime. This means that all of the following register must change atomically:

- The registers associated with the stage 1 translations:
 - [MAIR_EL1](#) and [AMAIR_EL1](#).
 - [TTBR0_EL1](#), [TTBR1_EL1](#), [TCR_EL1](#), and [CONTEXTIDR_EL1](#).
 - [SCTLR_EL1](#).
- The registers associated with the stage 2 translations:
 - [VTTBR_EL2](#) and [VTCR_EL2](#).
 - [MAIR_EL2](#) and [AMAIR_EL2](#).
 - [SCTLR_EL2](#).

Note

Only some bits of [SCTLR_EL1](#) affect the stage1 translation, and only some bits of [SCTLR_EL2](#) affect the stage 2 translation. However, in each case, changing these bits requires a write to the register, and that write must be atomic with the other register updates.

These registers apply to execution using the Non-secure EL1&0 translation regime. However, when updated as part of a switch of virtual machines they are updated by software executing at EL2. This means the registers are *out of context* when they are updated, and no synchronization precautions are required.

The architecture requires that, when executing at EL3, EL2, or Secure EL1, an implementation must not use the registers associated with the Non-secure EL1&0 translation regime for speculative memory accesses.

D5.8 Caches in a VMSA implementation

The ARM architecture describes the required behavior of an implementation of the architecture. As far as possible it does not restrict the implemented microarchitecture, or the implementation techniques that might achieve the required behavior.

In particular, maintaining this level of abstraction is difficult when describing the relationship between memory address translation and caches, especially regarding the indexing and tagging policy of caches. This section:

- Summarizes the architectural requirements for the interaction between caches and address translation.
- Gives some information about the likely implementation impact of the required behavior.

The following sections give this information:

- [Data and unified caches](#)
- [Instruction caches](#)

In addition, [Cache maintenance requirement created by changing translation table attributes on page D5-1820](#) describes the cache maintenance required after updating the translation tables to change the attributes of an area of memory.

For more information about cache maintenance see [Cache maintenance instructions on page D4-1684](#), that describes the cache maintenance instructions in the A64 instruction set.

D5.8.1 Data and unified caches

For data and unified caches, the use of address translation is entirely transparent to any data access that is not UNPREDICTABLE.

This means that the behavior of accesses from the same observer to different VAs, that are translated to the same PA with the same memory attributes, is fully coherent. This means these accesses behave as follows, regardless of which VA is accessed:

- Two writes to the same PA occur in program order.
- A read of a PA returns the value of the last successful write to that PA.
- A write to a PA that occurs, in program order, after a read of that PA, has no effect on the value returned by that read.

The memory system behaves in this way without any requirement to use barrier or cache maintenance instructions.

In addition, if cache maintenance is performed on a memory location, the effect of that cache maintenance is visible to all aliases of that physical memory location.

These properties are consistent with implementing all caches that can handle data accesses as *Physically-indexed, physically-tagged* (PIPT) caches.

D5.8.2 Instruction caches

In the ARM architecture, an instruction cache is a cache that is accessed only as a result of an instruction fetch. Therefore, an instruction cache is never written to by any load or store instruction executed by the PE.

The ARM architecture supports three different behaviors for instruction caches. For ease of reference and description these are identified by descriptions of the associated expected implementation, as follows:

- PIPT instruction caches
- *Virtually-indexed, physically-tagged* (VIPT) instruction caches
- ASID and VMID tagged *Virtually-indexed, virtually-tagged* (VIVT) instruction caches.

The [CTR_EL0.L1Ip](#) field identifies the form of the instruction caches.

The following subsections describe the behavior associated with these cache types, including any occasions where explicit cache maintenance is required to make the use of address translation transparent to the instruction cache:

- [PIPT instruction caches](#).
- [VIPT instruction caches](#).
- [ASID and VMID tagged VIVT instruction caches](#).
- [The IIVIPT Extension on page D5-1820](#).

Note

For software to be portable between implementations that might use any of PIPT instruction caches, VIPT instruction caches, or ASID and VMID tagged VIVT instruction caches, the software must invalidate the instruction cache whenever any condition occurs that would require instruction cache maintenance for at least one of the instruction cache types.

PIPT instruction caches

For PIPT instruction caches, the use of memory address translation is entirely transparent to all instruction fetches that are not UNPREDICTABLE.

If cache maintenance is performed on a memory location, the effect of that cache maintenance is visible to all aliases of that physical memory location.

An implementation that provides PIPT instruction caches implements the IIVIPT extension, see [The IIVIPT Extension on page D5-1820](#).

VIPT instruction caches

For VIPT instruction caches, the use of memory address translation is transparent to all instruction fetches that are not UNPREDICTABLE, except for the effect of memory address translation on instruction cache invalidate by address operations.

Note

Cache invalidation is the only cache maintenance that can be performed on an instruction cache.

If instruction cache invalidation by address is performed on a memory location, the effect of that invalidation is visible only to the virtual address supplied with the operation. The effect of the invalidation might not be visible to any other aliases of that physical memory location.

The only architecturally-guaranteed way to invalidate all aliases of a physical address from a VIPT instruction cache is to invalidate the entire instruction cache.

An implementation that provides VIPT instruction caches implements the IIVIPT extension, see [The IIVIPT Extension on page D5-1820](#).

ASID and VMID tagged VIVT instruction caches

For ASID and VMID tagged VIVT instruction caches, if the instructions at any virtual address change, for a given translation regime and a given ASID and VMID, as appropriate, then instruction cache maintenance is required to ensure that the change is visible to subsequent execution. This maintenance is required when writing new values to instruction locations. It can also be required as a result of any of the following situations that change the translation of a virtual address to a physical address, if, as a result of the change to the translation, the instructions at the virtual addresses change:

- Enabling or disabling the stage of address translation.
- Writing new mappings to the translation tables.

- Any change to the [TCR](#) or [TTBR](#) for the current translation regime:
 - For a change to the Secure EL1&0 translation regime, a change to the ContextID.
 - For a change to the stage 1 translations of the Non-secure EL1&0 translation regime, a change to the ContextID or VMID.
 - For a change to the stage 2 translations of the Non-secure EL1&0 translation regime, a change to the VMID.

———— **Note** —————

For ASID and VMID tagged VIVT instruction caches only, invalidation is not required if the changes to the translations are such that the instructions associated with the non-faulting translations of a virtual address, for a given translation regime and a given ASID and VMID, as appropriate, remain unchanged, through the sequence of changes to the translations. Examples of translation changes to which this applies are:

- Changing a valid translation to a translation that generates a stage of address translation fault.
- Changing a translation that generates a stage of address translation fault to a valid translation.

This does not apply for VIPT or PIPT instruction caches.

If instruction cache invalidation by address is performed on a memory location, the effect of that invalidation is visible only to the virtual address supplied with the operation. The effect of the invalidation might not be visible to any other aliases of that physical memory location.

The only architecturally-guaranteed way to invalidate all aliases of a physical address from an ASID and VMID tagged VIVT instruction cache is to invalidate the entire instruction cache.

The IVIPT Extension

An implementation in which the instruction cache exhibits the behaviors described in [PIPT instruction caches on page D5-1819](#), or those described in [VIPT instruction caches on page D5-1819](#), is said to implement the *IVIPT Extension* to the ARM architecture.

The formal definition of the IVIPT extension to the ARM architecture is that it reduces the instruction cache maintenance requirement to the following condition:

- Instruction cache maintenance is required only after writing new data to a physical address that holds an instruction.

D5.8.3 Cache maintenance requirement created by changing translation table attributes

Any change to the translation tables to change the attributes of an area of memory can require maintenance of the translation tables, as described in [General TLB maintenance requirements on page D5-1807](#). If the change affects the cacheability attributes of the area of memory, including any change between Write-Through and Write-Back attributes, software must ensure that any cached copies of affected locations are removed from the caches, typically by cleaning and invalidating the locations from the levels of cache that might hold copies of the locations affected by the attribute change. Any of the following changes to the inner cacheability or outer cacheability attribute creates this maintenance requirement:

- Write-Back to Write-Through
- Write-Back to Non-cacheable
- Write-Through to Non-cacheable
- Write-Through to Write-Back.

The cache clean and invalidate avoids any possible coherency errors caused by mismatched memory attributes.

Similarly, to avoid possible coherency errors caused by mismatched memory attributes, the following sequence must be followed when changing the shareability attributes of a cacheable memory location:

1. Make the memory location Non-cacheable, Outer Shareable.
2. Clean and invalidate the location from them cache.
3. Change the shareability attributes to the required new values.

Chapter D6

The Performance Monitors Extension

This chapter describes the ARMv8 implementation of the ARM Performance Monitors, that are an optional non-invasive debug component. It describes version 3 of the *Performance Monitor Unit* (PMU) architecture, PMUv3, and contains the following sections:

- *About the Performance Monitors* on page D6-1822.
- *Accuracy of the Performance Monitors* on page D6-1824.
- *Behavior on overflow* on page D6-1826.
- *Attributability* on page D6-1828.
- *Effect of EL3 and EL2* on page D6-1829.
- *Event filtering* on page D6-1831
- *Performance Monitors and Debug state* on page D6-1832.
- *Counter enables* on page D6-1833.
- *Counter access* on page D6-1834.
- *Event numbers and mnemonics* on page D6-1836.
- *Performance Monitors Extension registers* on page D6-1851.
- *Pseudocode details* on page D6-1854.

Note

Table J-1 on page AppxJ-5088 disambiguates the general register references used in this chapter.

D6.1 About the Performance Monitors

In ARMv8-A, the Performance Monitors Extension is an OPTIONAL feature of an implementation, but ARM strongly recommends that ARMv8-A implementations include version 3 of the Performance Monitors extension, PMUv3.

———— **Note** —————

No previous versions of the Performance Monitor extension can be implemented in ARMv8.

The basic form of the Performance Monitors is:

- A 64-bit cycle counter.
- A number of 32-bit event counters. The event counted by each counter is programmable. ARMv8 provides space for up to 31 counters. The actual number of counters is IMPLEMENTATION DEFINED, and the specification includes an identification mechanism.

———— **Note** —————

ARM recommends that at least two counters are implemented, and that hypervisors provide at least this many counters to guest operating systems.

- Controls for:
 - Enabling and resetting counters.
 - Flagging overflows.
 - Enabling interrupts on overflow.

Monitoring software can enable the cycle counter independently of the event counters.

The events that can be monitored split into:

- Architectural and microarchitectural events that are likely to be consistent across many microarchitectures.
- Implementation-specific events.

The PMU architecture uses event numbers to identify an event. It:

- Defines event numbers for common events, for use across many architectures and microarchitectures.

———— **Note** —————

Implementations that include PMUv3 must, as a minimum requirement, implement a subset of the common events. See [Common event numbers on page D6-1839](#).

- Reserves a large event number space for IMPLEMENTATION DEFINED events.

The full set of events for an implementation is IMPLEMENTATION DEFINED. ARM recommends that implementations include all of the events that are appropriate to the architecture profile and microarchitecture of the implementation.

The event numbers of the common events are reserved for the specified events. Each of these event numbers must either:

- Be used for its assigned event.
- Not be used.

When a implementation supports monitoring of an event that is assigned a common event number, ARM strongly recommends that it uses that number for the event. However, software might encounter implementations where an event assigned a number in this range is monitored using an event number from the IMPLEMENTATION DEFINED range.

———— **Note** —————

ARM might define other common event numbers. This is one reason why software must not assume that an event with an assigned common event number is never monitored using an event number from the IMPLEMENTATION DEFINED range.

When an implementation includes the Performance Monitors extension, ARMv8 defines the following possible interfaces to the Performance Monitors registers:

- A system register interface. This interface is mandatory.
- An external debug interface which optionally supports memory-mapped accesses. This interface is OPTIONAL. See [Chapter I3 Recommended Memory-mapped Interfaces to the Performance Monitors](#)

An operating system can use the System registers to access the counters. This supports a number of uses, including:

- Dynamic compilation techniques.
- Energy management.

Also, if required, the operating system can enable application software to access the counters. This enables an application to monitor its own performance with fine-grain control without requiring operating system support. For example, an application might implement per-function performance monitoring.

There are many situations where performance monitoring features integrated into the implementation are valuable for applications and for application development. When an operating system does not use the Performance Monitors itself, ARM recommends that the operating system enables application software to access the Performance Monitors.

A hypervisor running on the PE can limit the access of a Non-secure operating system to the Performance Monitors.

To enable interaction with external monitoring, an implementation might consider additional enhancements, such as providing:

- A set of events, from which a selection can be exported onto a bus for use as external events.
- The ability to count external events. This enhancement requires the implementation to include a set of external event input signals.

The Performance Monitors extension is common to AArch64 operation and AArch32 operation. This means the ARMv8 architecture defines both AArch64 and AArch32 system registers to access the Performance Monitors. For example, the Performance Monitors Cycle Count Register is accessible as:

- When executing in AArch64 state, [PMCCNTR_ELO](#), see [PMCCNTR_ELO, Performance Monitors Cycle Count Register on page D8-2136](#).
- When executing in AArch32 state, [PMCCNTR](#), see [PMCCNTR, Performance Monitors Cycle Count Register on page G4-4172](#).

D6.1.1 Interaction with trace

It is IMPLEMENTATION DEFINED whether the implementation exports counter events to a Trace extension, or other external monitoring agent, to provide triggering information. The form of any exporting is also IMPLEMENTATION DEFINED. If implemented, this exporting might be enabled as part of the performance monitoring control functionality.

ARM recommends system designers include a mechanism for importing a set of external events to be counted, but such a feature is IMPLEMENTATION DEFINED. When implemented, this feature enables the Trace extension to pass in events to be counted.

D6.1.2 Interaction with power saving operations

All counters are subject to any changes in clock frequency, including clock stopping caused by the WFI and WFE instructions.

D6.2 Accuracy of the Performance Monitors

The Performance Monitors:

- Are a non-invasive debug component. See [Non-invasive behavior](#).
- Must provide approximately accurate count information.

However, the Performance Monitors allow for:

- A reasonable degree of inaccuracy in the counts to keep the implementation and validation cost low. See [A reasonable degree of inaccuracy](#).
- A IMPLEMENTATION DEFINED controls, such as those in ACTLR registers, to put the PE in an operating state that might do one or both of the following:
 - Change the level of non-invasiveness of the Performance Monitors so that enabling an event counter can impact the performance or behavior of the PE.
 - Allow inaccurate counts. This includes, but is not limited to, cycle counts.

D6.2.1 Non-invasive behavior

The performance monitors are a non-invasive debug component. A non-invasive feature permits the observation of data and program flow.

Enabling an event counter must not severely alter the performance or behavior of the PE. Otherwise, the usefulness of event counters for performance measurement and profiling is reduced.

Because there is a software overhead to include use of the Performance Monitors, the overall performance is changed. As such, a small variation in performance from enabling an event counter is permissible. ARM recommends that such a variation is kept within 5% of normal operating performance, when averaged across a suite of code representative of the application workload, not including the software overhead.

If an implementation requires more performance-invasive techniques to count an event, ARM recommends that the implementer defines an IMPLEMENTATION DEFINED event, and documents the impact on behavior accordingly.

D6.2.2 A reasonable degree of inaccuracy

The Performance Monitors provide approximately accurate count information. To keep the implementation and validation cost low, a reasonable degree of inaccuracy in the counts is acceptable. ARM does not define a *reasonable degree of inaccuracy* but recommends the following guidelines:

- Under normal operating conditions, the counters must present an accurate value of the count.
- In exceptional circumstances, such as a change in Security state or other boundary condition, it is acceptable for the count to be inaccurate.
- Under very unusual non-repeating pathological cases the counts can be inaccurate. These cases are likely to occur as a result of asynchronous exceptions, such as interrupts, where the chance of a systematic error in the count is very unlikely.

————— Note —————

An implementation must not introduce inaccuracies that can be triggered systematically by the execution of normal pieces of software. For example, dropping a branch count in a loop due to the structure of the loop gives a systematic error that makes the count of branch behavior very inaccurate, and this is not reasonable. However, dropping a single branch count as the result of a rare interaction with an interrupt is acceptable.

The permitted inaccuracy limits the possible uses of the Performance Monitors. In particular, the architecture does not define the point in a pipeline where the event counter is incremented, relative to the point where a read of the event counters is made. This means that pipelining effects can cause some imprecision.

A change of Security state can affect the accuracy of the Performance Monitors, see [Interaction with EL3 on page D6-1829](#).

Entry to and exit from Debug state can also disturb the normal running of the PE, causing additional inaccuracy in the Performance Monitors. Disabling the counters while in Debug state limits the extent of this inaccuracy. An implementation can limit this inaccuracy to a greater extent, for example by disabling the counters as soon as possible during the Debug state entry sequence.

An implementation must document any particular scenarios where significant inaccuracies are expected.

D6.3 Behavior on overflow

All events are counted in 32-bit wrapping counters, that overflow when they wrap. The cycle counter, [PMCCNTR](#), is a 64-bit wrapping counter, that is configured by [PMCR.LC](#) to either:

- Signal an overflow when bit [PMCCNTR\[63\]](#) overflows.
- Signal an overflow when bit [PMCCNTR\[31\]](#) overflows into bit [PMCCNTR\[32\]](#).

On a Performance Monitors counter overflow:

- An overflow status bit is set to 1. See [PMOVSCLR](#).
- An interrupt request is generated if the PE is configured to generate counter overflow interrupts. For more information, see [Generating overflow interrupt requests](#).
- The counter continues counting events.

D6.3.1 Generating overflow interrupt requests

Software can program the Performance Monitors so that an overflow interrupt request is generated when a counter overflows. See [PMINTENSET](#) on page [AppxJ-5090](#) and [PMINTENCLR](#) on page [AppxJ-5090](#).

The overflow interrupt request is a level-sensitive request.

———— Note ————

- The mechanism by which an interrupt request from the Performance Monitors generates an FIQ or IRQ exception is IMPLEMENTATION DEFINED.
- ARM recommends that the overflow interrupt requests:
 - Translate on to the [PMUIRQ](#) bus, so that they are observable to external devices.
 - Connect to inputs on an IMPLEMENTATION DEFINED generic interrupt controller of type, *Private Peripheral Interrupt* (PPI). See the *ARM Generic Interrupt Controller Architecture Specification* for information about PPIs.
 - Connect to a *Cross Trigger Interface* (CTI), see [Chapter H5 The Embedded Cross Trigger Interface](#).

Counters overflow when counting one or more events generates an unsigned carry out. Software can write to the counters to control the frequency at which interrupt requests occur. For counters other than the cycle counter, the counter is always a 32-bit unsigned wrapping value. For example, software might set a counter to `0xFFFF0000`, to generate another counter overflow after 65 536 increments, and reset it to this value every time an overflow interrupt occurs.

———— Note ————

If an event can occur multiple times in a single clock cycle then counter overflow can occur without the counter registering a value of zero.

For the cycle counter, software can program [PMCR.LC](#) to treat the counter as either a 64-bit or a 32-bit unsigned value.

The PE signals a request for:

- Any given [PMNx](#) counter, when the value of [PMOVSSET\[x\]](#) is 1, the value of [PMINTENSET\[x\]](#) is 1, and one of the following is true:
 - EL2 is not implemented and the value of [PMCR.E](#) is 1.
 - EL2 is implemented, *x* is less than the value of [HDCR.HPMN](#), and the value of [PMCR.E](#) is 1.
 - EL2 is implemented, *x* is greater than or equal to the value of [HDCR.HPMN](#), and the value of [HDCR.HPME](#) is 1.
- The cycle counter, when the values of [PMOVSSET\[31\]](#), [PMINTENSET\[31\]](#), and [PMCR.E](#) are all 1.

The overflow interrupt request is active in both Secure and Non-secure states. In particular, if EL3 and EL2 are implemented, overflow events from PMN_x where *x* is greater than or equal to the value of `HDCR.HPMN` can be signaled from all modes and states but only if the value of `HDCR.HPME` is 1.

The interrupt handler for the counter overflow request must cancel the interrupt request, by writing to `PMOVSCLR_EL0[x]` to clear the overflow bit to 0.

D6.3.2 Pseudocode details overflow interrupt requests

The `CheckForPMUoverflow()` pseudocode function signals PMU overflow interrupt requests to an interrupt controller and PMU overflow trigger events to the cross-trigger interface. The pseudocode function is as follows:

```
// CheckForPMUoverflow()
// =====
// Signal Performance Monitors overflow IRQ and CTI overflow events

CheckForPMUoverflow()

    pmuirq = (PMCR_EL0.E == '1' && PMINTENSET_EL1<31> == '1' && PMOVSSET_EL0<31> == '1');
    for n = 0 to UInt(PMCR_EL0.N) - 1
        E = (if !HaveEL(EL2) || n < UInt(MDCR_EL2.HPMN) then PMCR_EL0.E else MDCR_EL2.HPME);
        if E == '1' && PMINTENSET_EL1<n> == '1' && PMOVSSET_EL0<n> == '1' then pmuirq = TRUE;

    SetInterruptRequestLevel(InterruptID_PMUIRQ, if pmuirq then HIGH else LOW);

    CTI_SetEventLevel(CrossTriggerIn_PMUoverflow, if pmuirq then HIGH else LOW);

// The request remains set until the condition is cleared. (For example, an interrupt handler
// or cross-triggered event handler clears the overflow status flag by writing to PMOVSCLR_EL0.)

return;
```

D6.4 Attributability

An event caused by the PE counting the event is Attributable. If an agent other than the PE that is counting the events causes an event, these events are Unattributable.

An event is defined as being either Attributable or Unattributable. An event can be defined as the combination of multiple subevents, which can be either Attributable or Unattributable.

All architecturally defined events are Attributable.

Unattributable events might be counted when Attributable events are not counted. See:

- [Interaction with EL3 on page D6-1829.](#)
- [Event filtering on page D6-1831.](#)
- [Performance Monitors and Debug state on page D6-1832.](#)

Table D6-1 Counting events

Counter and PMU enabled	State	Allowed or prohibited	Filtered	Event type	
				Attributable	Unattributable
Yes	Non-debug	Allowed	Not filtered	Count	Count
			Filtered	Do not count	IMPLEMENTATION DEFINED
		Prohibited	X	Do not count	IMPLEMENTATION DEFINED
	Debug	X	X	Do not count	IMPLEMENTATION DEFINED
No	X	X	X	Do not count	Do not count

D6.5 Effect of EL3 and EL2

This section describes the effects of implementing EL3 and EL2 on the Performance Monitors. It contains the following subsections:

- [Interaction with EL3](#).
- [Interaction with EL2 on page D6-1830](#).

D6.5.1 Interaction with EL3

Counting events is never prohibited in Non-secure state. From reset, counting Attributable events is prohibited in Secure state. Software can set `SDCR.SPME` to 1 to permit event counting in Secure state. This enables a secure monitor to permit profiling within Secure state without having to configure a debug authentication interface.

The system can use the external authentication interface to override `SPME`. For example, if `SPNIDEN` and `NIDEN` are HIGH then this permits event counting in Secure state, irrespective of the value in `SDCR.SPME`.

If EL3 is not implemented, the behavior is as if the value of `SDCR.SPME` is 1.

In summary, counting Attributable events in Secure state is prohibited unless any one of the following is true:

- EL3 is not implemented.
- EL3 is implemented and `SDCR.SPME == 1`.
- EL3 is implemented, EL3 or EL1 is using AArch32, executing at EL0, and the value of `SDER.SUNIDEN` is 1.
- EL3 is implemented, and counting is permitted by an IMPLEMENTATION DEFINED authentication interface, `ExternalSecureNoninvasiveDebugEnabled() == TRUE`.

———— **Note** —————

Software can read the Authentication Status register, `DBGAUTHSTATUS`, to determine the state of an IMPLEMENTATION DEFINED authentication interface.

The cycle counter, `PMCCNTR`, counts even when event counting is prohibited, unless `PMCR.DP` is set to 1 or the PE is in Debug state.

For each Unattributable event it is IMPLEMENTATION DEFINED whether it is counted when counting Attributable events is prohibited.

———— **Note** —————

- Additional controls in `PMCR`, `HDCR`, `PMCNTENSET`, and `PMINTENCLR` can also disable the event counters and the cycle counter.
- Controls in `PMEVTYPER<n>` and `PMCCFILTR` can filter out events based on Exception level and Security state.

This disabling of counters or filtering of events takes precedence over the authentication controls.

See `ProfilingProhibited()` and `CountEvents()` in the [Pseudocode details on page D6-1854](#) for more details.

In AArch32 state, the Performance Monitors registers are Common registers, see [Classification of System registers on page G3-3696](#).

The Performance Monitors registers are always accessible regardless of the values of the authentication signals and the `SDER.SUNIDEN` bit. Authentication controls whether the counters count events, it does not control access to the Performance Monitors registers.

The Performance Monitors are not intended to be completely accurate, see [Accuracy of the Performance Monitors on page D6-1824](#). In particular, some inaccuracy is permitted at the point of changing Security state. However, to avoid the leaking of information from the Secure state, the permitted inaccuracy is that transactions that are not prohibited can be uncounted. Where possible, prohibited transactions must not be counted but if they are counted then that counting must not degrade security.

D6.5.2 Interaction with EL2

In an implementation that includes EL2, Non-secure software executing at EL2 can:

- Trap any attempt by the Guest OS to access the PMU. This means the hypervisor can identify which Guest OSs are using the PMU and intelligently employ switching of the PMU state.
- Trap accesses to the [PMCR](#), so that it can fully virtualize the PMU identity registers, [PMCR.IMP](#) and [PMCR.IDCODE](#).
- Reserve the highest-numbered counters for its own use by overriding the value of [PMCR.N](#) seen by the Guest OS. The implementation must not permit a Guest OS to access the reserved counters.

[HDCR](#) controls Performance Monitors virtualization.

For more information see:

- [Counter enables on page D6-1833](#).
- [Counter access on page D6-1834](#).

D6.6 Event filtering

The PMU can filter events by various combination of Exception level and Security state. This gives software more flexibility for counting events across multiple processes.

D6.6.1 Filtering by Exception level and state

For each event counter [PMEVTYPER<n>](#) specifies the Exception levels in which the counter counts Attributable events.

[PMCCFILTR](#) specifies the Exception levels in which the cycle counter counts.

For each Unattributable event, it is IMPLEMENTATION DEFINED whether the filtering applies.

For more information, see the individual register descriptions.

D6.6.2 Accuracy of event filtering

The PMU architecture does not require event filtering to be accurate.

For most events, it is acceptable that, during a transition between states, events generated by instructions executed in one state are counted in the other state. The following sections describe the cases where event counts must not be counted in the wrong state:

- [Exception-related events](#).
- [Software increment events](#).

Exception-related events

The PMU must filter events related to exceptions and exception handling according to the Exception level from which the exception was taken. These events are:

- Exception taken.
- Instruction architecturally executed, condition code check pass, exception return.
- Instruction architecturally executed, condition code check pass, write to [CONTEXTIDR](#).
- Instruction architecturally executed, condition code check pass, write to translation table base.

The PMU must not count an exception after it has been taken because this could systematically report a result of zero exceptions at EL0. Similarly, it is not acceptable for the PMU to count exception returns or writes to [CONTEXTIDR](#) after the return from the exception.

———— **Note** ————

Unprivileged software cannot write to [CONTEXTIDR](#).

Software increment events

The PMU must filter software increment events according to the Exception level in which the software increment occurred. Software increment counting must also be precise, meaning the PMU must count every architecturally executed software increment event, and must not count any speculatively executed software increment.

Software increment events must also be counted without the need for explicit synchronization. For example, two software increments executed without an intervening context synchronization operation must increment the event counter twice.

Pseudocode details of event filtering

The pseudocode for the `CountEvents()` function can be found in [Pseudocode details on page D6-1854](#).

D6.7 Performance Monitors and Debug state

Attributable events are not counted in Debug state.

For each Unattributable event, it is IMPLEMENTATION DEFINED whether it is counted when the counting processor is in Debug state. If the event might be counted, then the rules in [Filtering by Exception level and state on page D6-1831](#) apply for the current Security state in Debug state.

D6.8 Counter enables

Table D6-2 shows an implementation that does not include EL2, and where the `PMCR.E` bit is a global counter enable bit, and `PMCNTENSET` provides an enable bit for each counter.

Table D6-2 Event counter enables when an implementation does not include EL2

<code>PMCR.E</code>	<code>PMCNTENSET[x] == 0</code>	<code>PMCNTENSET[x] == 1</code>
0	PMN _x disabled	PMN _x disabled
1	PMN _x disabled	PMN _x enabled

If the implementation includes EL2, then in addition to the `PMCR.E` and `PMCNTENSET` enable bits:

- `HDCR.HPME` overrides the value of `PMCR.E` for counters configured for access in Hyp mode.
- `HDCR.HPMN` specifies the number of performance counters that the Guest OS can access. The minimum permitted value of `HDCR.HPMN` is 1, meaning there must be at least one counter that the Guest OS can access.

Table D6-3 shows the combined effect of all the counter enable controls.

Table D6-3 Event counter enables when an implementation includes EL2

<code>HDCR.HPME</code>	<code>PMCR.E</code>	<code>PMCNTENSET[x] == 0</code>	<code>PMCNTENSET[x] == 1</code>	
			<code>x < HDCR.HPMN</code>	<code>x ≥ HDCR.HPMN</code>
0	0	PMN _x disabled	PMN _x disabled	PMN _x disabled
0	1	PMN _x disabled	PMN _x enabled	PMN _x disabled
1	0	PMN _x disabled	PMN _x disabled	PMN _x enabled
1	1	PMN _x disabled	PMN _x enabled	PMN _x enabled

Note

The effect of `HDCR.{HPME, HPMN}` on the counter enables applies in both Security states. However, in Secure state the value returned for `PMCR.N` is not affected by `HDCR.HPMN`.

EL2 does not affect the enabling of `PMCCNTR`. Table D6-4 shows the `PMCCNTR` enables, for all implementations.

Table D6-4 Cycle counter enables

<code>PMCR.E</code>	<code>PMCNTENSET[31] == 0</code>	<code>PMCNTENSET[31] == 1</code>
0	<code>PMCCNTR</code> disabled	<code>PMCCNTR</code> disabled
1	<code>PMCCNTR</code> disabled	<code>PMCCNTR</code> enabled

D6.9 Counter access

Counters are accessible in EL3, Secure EL1 and EL2. If software executing at EL2 uses `HDCR.HPMN` to reserve an event counter, software cannot access that counter from Non-secure EL1 modes or from Non-secure EL0.

Note

This section describes a counter as being accessible from a particular Exception level and state. However, access to the registers are subject to the access permissions described in [Access permissions on page D6-1851](#). In particular, accesses from EL0 might be UNDEFINED and accesses from Non-secure EL1 and EL0 might be trapped to EL2.

D6.9.1 Access at EL0

Software can use `PMUSERENR`.{EN, ER, CR, SW} to enable code executing at EL0 to use the Performance Monitors. For more information, see [Traps to EL1 of EL0 accesses to Performance Monitors registers on page D1-1473](#).

D6.9.2 PMNx event counters

For an implementation that includes EL2 and EL3, [Table D6-5](#) shows how the values of the `HDCR.HPMN` field control the behavior of accesses to the PMNx event counter registers.

Note

Access to the Performance Monitors registers is also subject to the access permissions described in [Access permissions on page D6-1851](#). In particular, accesses might be trapped to EL1 or EL2.

Table D6-5 Result of PMNx event counter accesses

Condition	Secure state			Non-secure state		
	EL3	EL1	EL0	EL2	EL1	EL0
$x < \text{HDCR.HPM}$	Succeeds	Succeeds	Succeeds	Succeeds	Succeeds	Succeeds
$x \geq \text{HDCR.HPM}$	Succeeds	Succeeds	Succeeds	Succeeds	No access	No access

Where [Table D6-5](#) shows no access:

- If `PMSELR.SEL` is x then:
 - A direct read of `PMXEVTYPER` or `PMXEVCNTR` is CONSTRAINED UNPREDICTABLE.
 - A direct write to `PMXEVTYPER` or `PMXEVCNTR` is CONSTRAINED UNPREDICTABLE.
- A direct read of `PMEVTYPER<n>` or `PMEVCNTR<n>` is CONSTRAINED UNPREDICTABLE.
- A direct write of `PMEVTYPER<n>` or `PMEVCNTR<n>` is CONSTRAINED UNPREDICTABLE.
- For direct reads and direct writes, `PMOVSCLR[x]`, `PMOVSSSET[x]`, `PMCNTENSET[x]`, `PMCNTENCLR[x]`, `PMINTENSET[x]`, and `PMINTENCLR[x]` are RAZ/WI
- Direct writes to `PMSWINC[x]` are ignored.
- A direct write of 1 to `PMCR.P` does not reset PMNx.

Note

In Secure state, and in the Non-secure EL2 mode, the value of `HDCR2.HPMN` does not affect the value returned for `PMCR.N`.

D6.9.3 CCNT cycle counter

The PMU does not provide any control that a hypervisor can use to reserve the cycle counter for its own use. The only control over the cycle counter is an access permission control for EL0. See [Access permissions on page D6-1851](#).

D6.10 Event numbers and mnemonics

The following sections describe the event numbers, and the mnemonics for the events:

- [Definition of terms.](#)
- [Common event numbers on page D6-1839.](#)
- [Common architectural event numbers on page D6-1840.](#)
- [Common microarchitectural event numbers on page D6-1843.](#)
- [Required events on page D6-1848.](#)
- [IMPLEMENTATION DEFINED event numbers on page D6-1849.](#)

D6.10.1 Definition of terms

Speculatively executed

Many events relate to speculatively executed operations. Here, speculatively executed means the PE did some work associated with one or more instructions but the instructions were not necessarily architecturally executed.

An instruction might create one or more *microarchitectural operations* (μ -ops) at any point in the execution pipeline. For the purpose of event counting, the μ -ops are counted. The definition of a μ -op is implementation specific. An architecture instruction might create more than one μ -op for each instruction. μ -ops might also be removed or merged in the execution stream, so an architecture instruction might create no μ -ops for an instruction. Any arbitrary translation of instructions to an equivalent sequence of μ -ops is permitted.

This means there is no architecturally guaranteed relationship between a speculatively executed μ -op and an architecturally executed instruction. The results of such an operation can also be discarded, if it transpires that the operation was not required, such as a mispredicted branch. Therefore, ARMv8-A defines these events as *operation speculatively executed*, where appropriate.

The counting of operations can indicate the workload on the PE. However, there is no requirement for operations to represent similar amounts of work, and direct comparisons between different microarchitectures are not meaningful.

For example, an implementation might split an A32 or T32 LDM instruction of six registers into six μ -ops, one for each load, and a seventh address-generation operation to determine the base address or writeback address. Also, for doubleword alignment, the six load μ -ops might combine into four operations, that is, a word load, two doubleword loads, and a second word load. This single instruction can then be counted as five, or possibly six, events:

- Four (Operation speculatively executed - Load) events.
- One (Operation speculatively executed - Integer data processing) event.
- One (Operation speculatively executed - Software change of the PC) event, if the PC was one of the six registers in the LDM instruction.

Different groups of events can have different IMPLEMENTATION DEFINED definitions of speculatively executed. Such groups share a common base type, which the event name denotes. Each of the events in the previous example are of the base type, operation speculatively executed.

For groups of events with a common base type, speculatively executed operations are all counted on the same basis, which normally means at the same point in the pipeline. It is possible to compare the counts and make meaningful observations about the program being profiled.

Within these groups, events are commonly defined with reference to a particular architecture instruction or group of instructions. In the case of speculatively executed operations this means operations with semantics that map to that type of instruction.

Instruction memory access

A PE acquires instructions for execution through instruction fetches. Instruction fetches might be due to:

- Fetching instructions that are architecturally executed.
- The result of the execution of an instruction preload instruction, PLI.
- Speculation that a particular instruction might be executed in the future.

The relationship between the fetch of an individual instruction and an instruction memory access is IMPLEMENTATION DEFINED. For example, an implementation might fetch many instructions including a non-integer number of instructions in a single instruction memory access.

Memory-read operations

A PE accesses memory through memory-read and memory-write operations. A memory-read operation might be due to:

- The result of an architecturally executed memory-reading instructions.
- The result of a speculatively executed memory-reading instructions.
- A translation table walk.

For levels of cache hierarchy beyond the Level 1 caches, memory-read operations also include accesses made as part of a refill of another cache closer to the PE. Such refills might be due to:

- Memory-read operations or memory-write operations that miss in the cache
- The execution of a data preload instruction.
- The execution of an instruction preload instruction on a unified cache.
- The execution of a cache maintenance operation.

———— **Note** ————

A preload instruction or cache maintenance operation is not, in itself, an access to that cache. However, it might generate cache refills which are then treated as memory-read operations beyond that cache.

- Speculation that a future instruction might access the memory location.

This list is not exhaustive.

The relationship between memory-read instructions and memory-read operations is IMPLEMENTATION DEFINED. For example, for some implementations an LDP instruction that reads two 64-bit registers might generate one memory-read operation if the address is quadword-aligned, but for other addresses it generates two or more memory-read operations.

Memory-write operations

Memory-write operations might be due to:

- The result of an architecturally executed memory-writing instructions.
- The result of a speculatively executed memory-writing instructions.

———— **Note** ————

Speculatively executed memory-writing instructions that do not become architecturally executed must not alter the architecturally defined view of memory. They can, however, generate a memory-write operation that is later undone in some implementation specific way.

For levels of cache hierarchy beyond the Level 1 caches, memory-write operations also include accesses made as part of a write-back from another cache closer to the PE. Such write-backs might be due to:

- Evicting a dirty line from the cache, to allocate a cache line for a cache refill, see memory-read operations.
- The execution of a cache maintenance operation.

———— **Note** ————

A cache maintenance operation is not in itself an access to that cache. However, it might generate write-backs which are then treated as memory-write operations beyond that cache.

- The result of a coherency request from another PE.

This list is not exhaustive.

The relationship between memory-writing instructions and memory-write operations is IMPLEMENTATION DEFINED. For example, for some implementations an STP instruction that writes two 64-bit registers might generate one memory-write operation if the address is quadword-aligned, but for other addresses it generates two or more memory-write operations. In some implementations, the result of two STR instructions that write to adjacent memory might be merged into a single memory-write operation.

———— **Note** ————

The data written back from a cache that is shared with other PEs might not be data that was written by the PE that performs the operation that leads to the write-back. Nevertheless, the event is counted as a write-back event for that PE.

Instruction architecturally executed

Instruction architecturally executed is a class of event that counts for each instruction of the specified type. Architecturally executed means that the program flow is such that the counted instruction would be executed in a sequential execution of the program. Therefore an instruction that has been executed and retired is defined to be *architecturally executed*. When a PE can perform speculative execution, an instruction is not architecturally executed if the PE discards the results of the speculative execution.

Each architecturally executed instruction is counted once, even if the implementation splits the instruction into multiple operations. Instructions that have no visible effect on the architectural state of the PE are architecturally executed if they form part of the architecturally executed program flow. The point where such instructions are retired is IMPLEMENTATION DEFINED.

Examples of instructions that have no visible effect are:

- A NOP.
- A conditional instruction that fails its condition code check.
- A Compare and Branch on Zero, CBZ, instruction that does not branch.
- A Compare and Branch on Nonzero, CBNZ, instruction that does not branch.

The point at which an event causes an event counter to be updated is not defined.

Unless otherwise stated, all instructions of the specified type are counted even if they have no visible effect on the architectural state of the PE. This includes a conditional instruction that fails its condition code check.

For events that count only the execution of instructions that update context state, such as writes to the [CONTEXTIDR](#), if such an instruction is executed twice without an intervening context synchronization operation, it is CONstrained UNPREDICTABLE whether the first instruction is counted.

———— **Note** ————

See [Context synchronization operation](#) for the definition of this term.

Instruction architecturally executed, condition code check pass

Instruction architecturally executed, condition code check pass is a class of events that explicitly do not occur for:

- A conditional instruction that fails its condition code check.
- A Compare and Branch on Zero, CBZ, instruction that does not branch.
- A Compare and Branch on Nonzero, CBNZ, instruction that does not branch.
- A Test and Branch on Zero, TBZ, instruction that does not branch.
- A Test and Branch on Nonzero, TBNZ, instruction that does not branch.
- A Store-Exclusive instruction that does not write to memory.

Otherwise, the definition of architecturally executed is the same as for *Instruction architecturally executed*.

D6.10.2 Common event numbers

Table D6-6 lists the PMU architectural and microarchitectural event numbers in event number order.

Table D6-6 PMU event numbers

Event number	Event type	Event mnemonic	Description
0x00	Architectural	SW_INCR	Instruction architecturally executed, condition code check pass, software increment
0x01	Microarchitectural	L1I_CACHE_REFILL	Level 1 instruction cache refill
0x02	Microarchitectural	L1I_TLB_REFILL	Level 1 instruction TLB refill
0x03	Microarchitectural	L1D_CACHE_REFILL	Level 1 data cache refill
0x04	Microarchitectural	L1D_CACHE	Level 1 data cache access
0x05	Microarchitectural	L1D_TLB_REFILL	Level 1 data TLB refill
0x06	Architectural	LD_RETIRED	Instruction architecturally executed, condition code check pass, load
0x07	Architectural	ST_RETIRED	Instruction architecturally executed, condition code check pass, store
0x08	Architectural	INST_RETIRED	Instruction architecturally executed
0x09	Architectural	EXC_TAKEN	Exception taken
0x0A	Architectural	EXC_RETURN	Instruction architecturally executed, condition code check pass, exception return
0x0B	Architectural	CID_WRITE_RETIRED	Instruction architecturally executed, condition code check pass, write to CONTEXTIDR
0x0C	Architectural	PC_WRITE_RETIRED	Instruction architecturally executed, condition code check pass, software change of the PC
0x0D	Architectural	BR_IMMED_RETIRED	Instruction architecturally executed, immediate branch
0x0E	Architectural	BR_RETURN_RETIRED	Instruction architecturally executed, condition code check pass, procedure return
0x0F	Architectural	UNALIGNED_LDST_RETIRED	Instruction architecturally executed, condition code check pass, unaligned load or store
0x10	Microarchitectural	BR_MIS_PRED	Mispredicted or not predicted branch speculatively executed
0x11	Microarchitectural	CPU_CYCLES	Cycle
0x12	Microarchitectural	BR_PRED	Predictable branch speculatively executed
0x13	Microarchitectural	MEM_ACCESS	Data memory access
0x14	Microarchitectural	L1I_CACHE	Level 1 instruction cache access
0x15	Microarchitectural	L1D_CACHE_WB	Level 1 data cache write-back
0x16	Microarchitectural	L2D_CACHE	Level 2 data cache access
0x17	Microarchitectural	L2D_CACHE_REFILL	Level 2 data cache refill
0x18	Microarchitectural	L2D_CACHE_WB	Level 2 data cache write-back

Table D6-6 PMU event numbers (continued)

Event number	Event type	Event mnemonic	Description
0x19	Microarchitectural	BUS_ACCESS	Bus access
0x1A	Microarchitectural	MEMORY_ERROR	Local memory error
0x1B	Microarchitectural	INST_SPEC	Operation speculatively executed
0x1C	Architectural	TTBR_WRITE_RETIRED	Instruction architecturally executed, condition code check pass, write to TTBR
0x1D	Microarchitectural	BUS_CYCLES	Bus cycle
0x1E	Architectural	CHAIN	For odd-numbered counters, increments the count by one for each overflow of the preceding even-numbered counter. For even-numbered counters there is no increment.
0x1F	Microarchitectural	L1D_CACHE_ALLOCATE	Level 1 data cache allocation without refill
0x20	Microarchitectural	L2D_CACHE_ALLOCATE	Level 2 data cache allocation without refill

D6.10.3 Common architectural event numbers

This section describes the defined common architectural event numbers.

For the common features, normally the counters must increment only once for each event. The event descriptions include any exceptions to this rule.

In these definitions, the term *architecturally executed* means that the instruction flow is such that the counted instruction would have been executed in a simple sequential execution model.

The common architectural event numbers are:

0x00, Instruction architecturally executed, condition code check pass, software increment

The counter increments on writes to the [PMSWINC](#) register.

If the PE performs two architecturally executed writes to the [PMSWINC](#) register without an intervening context synchronization operation, then the event is counted twice.

0x06, Instruction architecturally executed, condition code check pass, load

The counter increments for every executed memory-reading instruction.

———— **Note** —————

Event 0x06 does not count the return status value of a Store-Exclusive instruction.

Whether the preload instructions PRFM, PLD, PLDW, PLI, count as memory-reading instructions is IMPLEMENTATION DEFINED. ARM recommends that if the instruction is not implemented as a NOP then it is counted as a memory-reading instruction.

0x07, Instruction architecturally executed, condition code check pass, store

The counter increments for every executed memory-writing instruction.

DC ZVA is counted as a store.

The counter does not increment for a Store-Exclusive instruction that fails.

0x08, Instruction architecturally executed

The counter increments for every architecturally executed instruction.

0x09, Exception taken

The counter increments for each exception taken. See [Exception-related events on page D6-1831](#).

———— **Note** —————

The counter counts the PE exceptions described in:

- For exceptions taken to an Exception level using AArch64, [Exception entry on page D1-1429](#).
- For exceptions taken to an Exception level using AArch32, [AArch32 state exception descriptions on page G1-3475](#).

It does not count untrapped floating-point exceptions. In an implementation that includes support for T32EE state, it does not count T32EE null checks and index checks.

0x0A, Instruction architecturally executed, condition code check pass, exception return

The counter increments for each executed exception return instruction. See also [Exception-related events on page D6-1831](#). The following sections define the counted instructions:

- For an exception return to an Exception level using AArch64, [Exception return on page D1-1439](#).
- For an exception return to an Exception level using AArch32, [Exception return to an Exception level using AArch32 on page G1-3454](#).

0x0B, Instruction architecturally executed, condition code check pass, write to CONTEXTIDR

The counter increments for every write to [CONTEXTIDR](#). See [Exception-related events on page D6-1831](#).

In an AArch32 state translation regime, if [TTBCR.EAE](#) is 0, every write to [CONTEXTIDR](#) updates the ASID field. Therefore, this event can count the ASID field.

———— **Note** —————

The value of the [TTBCR.EAE](#) bit has no effect on this event.

If the PE performs two architecturally-executed writes to [CONTEXTIDR](#) without an intervening context synchronization operation, it is CONstrained UNPREDICTABLE whether the first write is counted.

0x0C, Instruction architecturally executed, condition code check pass, software change of the PC

The counter increments for every software change of the PC. This includes all:

- Branch instructions, B, BL, BR, and BLR.
- Memory-reading instructions that explicitly write to the PC.
- Data processing instructions that explicitly write to the PC.
- Exception return instructions, ERET and RET.
- Exception-generating instructions, SVC, HVC and SMC.

It is IMPLEMENTATION DEFINED whether the counter increments for either or both of:

- BRK and BKPT instructions.
- Undefined Instruction exceptions.

It is IMPLEMENTATION DEFINED whether an ISB is counted as a software change of the PC.

The counter does not increment for exceptions other than those explicitly identified in these lists.

———— **Note** —————

Conditional branches are only counted if the branch is taken.

0x0D, Instruction architecturally executed, immediate branch

The counter counts all immediate branch instructions that are architecturally executed.

In AArch32 state, the counter increments each time the PE executes one of the following instructions:

- B <label>.
- BL <label>.
- BLX <label>.
- CBZ <Rn>, <label>.
- CBNZ <label>.

In AArch64 state, the counter increments each time the PE executes an immediate branch instructions:

- B <label>.
- B.cond <label>.
- BL <label>.
- CBZ <Rn>, <label>.
- CBNZ <Rn>, <label>.
- TBZ <Rn>, <label>.
- TBNZ <Rn>, <label>.

———— **Note** ————

Conditional branches are always counted, regardless of whether the branch is taken.

If an ISB is counted as a software change of the PC instruction then it is IMPLEMENTATION DEFINED whether an ISB is counted as an immediate branch instruction.

0x0E, Instruction architecturally executed, condition code check pass, procedure return

In AArch 32 state, the counter counts the following procedure return instructions:

- BX R14.
- MOV PC, LR.
- POP {..., PC}.
- LDR PC, [SP], #offset.
- In an implementation that includes support for T32EE state, in T32EE state only:
 - LDMIA R9!, {..., PC}.
 - LDR PC, [R9], #offset.

———— **Note** ————

The counter counts only the listed instructions as procedure returns. For example, it does not count the following as procedure return instructions:

- BX R0, because Rm != R14.
- MOV PC, R0, because Rm != R14.
- LDM SP, {..., PC}, because writeback is not specified.
- LDR PC, [SP, #offset], because this specifies the wrong addressing mode.

In AArch64 state, the counter counts all architecturally executed RET instructions.

0x0F, Instruction architecturally executed, condition code check pass, unaligned load or store

The counter counts each memory-reading instruction or memory-writing instruction that accesses an unaligned address. It is IMPLEMENTATION DEFINED whether this event also counts each Alignment fault Data Abort exception.

See [Unaligned data access on page E2-2341](#) for more information.

0x1C, Instruction architecturally executed, condition code check pass, write to TTBR

The counter counts writes to [TTBR0_EL1](#) and [TTBR1_EL1](#) in AArch64 state and [TTBR0](#) and [TTBR1](#) in AArch32 state. See [Exception-related events on page D6-1831](#).

In an AArch32 state translation regime, if the `TTBCR.EAE` bit is 1, this count includes all updates to the ASID field in the `CONTEXTIDR`.

———— **Note** ————

The value of the `TTBCR.EAE` bit has no effect on this event. If a count of the number of ASID updates is required, then this event and the Instruction architecturally executed condition code check pass, write to `CONTEXTIDR` event must be counted. Software can choose which event to monitor.

If the PE executes two writes to a `TTBR`, without an intervening context synchronization operation, it is `CONSTRAINED UNPREDICTABLE` whether the first write to the `TTBR`, is counted.

If EL3 is implemented and using AArch64, the counter does not count writes to `TTBR0_EL3`.

If EL3 is implemented and using AArch32, the counter counts writes to both Banked copies of `TTBR0`.

If EL2 is implemented and using AArch64, the counter does not count writes to `TTBR0_EL2` and to `VTTBR_EL2`.

If EL 2 implemented and using AArch32, the counter does not count writes to `HTTBR` and to `VTTBR`.

0x1E, Chain

An odd-numbered counter increments when an overflow occurs on the preceding even-numbered counter. This event no effect on the count of an even-numbered counter.

The CHAIN event enables a system to provide either N 32-bit counters or $N/2$ 64-bit counters. There is no atomic access to a pair of counters, so if software reads a counter-pair that is enabled, it must use a high-low-high read sequence or employ reasonable heuristics, to avoid tearing.

D6.10.4 Common microarchitectural event numbers

This section describes the defined common microarchitectural event numbers.

The common microarchitectural events are features that are likely to be implemented across a wide range of implementations. Unlike the common architectural events, there can be some `IMPLEMENTATION DEFINED` variation between definitions on different implementations.

Unless otherwise stated, the common microarchitectural features relate only to events resulting from the operation of the PE counting the events. Events resulting from the operation of other PEs that might share a resource must not be counted. Where a resource can be subject to events that do not result from the operation of any of the PEs that share it, ARM recommends that the resource implements its own event counters. An example of a resource that might require its own event counters is a shared Level 2 cache that is subject to accesses from a system coherency port on that cache.

The event definitions relating to Level 2 caches generally assume the Level 2 cache is shared. The event definitions relating to Level 1 caches generally assume the Level 1 cache is not shared.

The common microarchitectural event numbers are:

0x01, Level 1 instruction cache refill

The counter counts instruction memory accesses that cause a refill of at least the Level 1 instruction or unified cache. This includes each instruction memory access that causes a refill from outside the cache. It excludes accesses that do not cause a new cache refill but are satisfied from refilling data of a previous miss.

A refill includes any access that causes data to be fetched from outside the cache, even if the data is ultimately not allocated into the cache. For example, data might be fetched into a buffer but then discarded, rather than being allocated into a cache. These buffers are treated as part of the cache.

CP15 cache maintenance operations do not count as events.

0x02, Level 1 instruction TLB refill

The counter counts instruction memory accesses that cause a TLB refill of at least the Level 1 instruction TLB. This includes each instruction memory access that causes an access to a level of memory system due to a translation table walk or an access to another level of TLB caching. It is IMPLEMENTATION DEFINED whether the count increments when:

- A refill results in a Translation fault.
- A refill is not allocated in the TLB.

The counter does not count:

- A TLB miss that does not cause a refill but does generate a translation table walk.
- CP15 TLB maintenance operations.

0x03, Level 1 data cache refill

The counter counts each memory-read operation or memory-write operation that causes a refill of at least the Level 1 data or unified cache from outside the Level 1 cache. Each access to a cache line that causes a new linefill is counted, including those from instructions that generate multiple accesses, such as load or store multiples, and PUSH and POP instructions. In particular, the counter counts accesses to the Level 1 cache that cause a refill that is satisfied by another Level 1 data or unified cache, or a Level 2 cache, or memory.

A refill includes any access that causes data to be fetched from outside the cache, even if the data is ultimately not allocated into the cache. For example, data might be fetched into a buffer but then discarded, rather than being allocated into a cache. These buffers are treated as part of the cache.

The counter does not count:

- Accesses that do not cause a new Level 1 cache refill but are satisfied from refilling data of a previous miss.
- Accesses to a cache line that generate a memory access but not a new linefill, such as write-through writes that hit in the cache.
- CP15 cache maintenance operations.
- A write that writes an entire line to the cache and does not fetch any data from outside the Level 1 cache, for example:
 - A write of a full cache line from a coalescing buffer.
 - A DC ZVA operation.
- A write that misses in the cache, and writes through the cache without allocating a line.

0x04, Level 1 data cache access

The counter counts each memory-read operation or memory-write operation that causes a cache access to at least the Level 1 data or unified cache. Each access to a cache line is counted including the multiple accesses of instructions, such as LDM or STM. Each access to other Level 1 data or unified memory structures, for example refill buffers, write buffers, and write-back buffers, is also counted. CP15 cache maintenance operations do not count as events.

0x05, Level 1 data TLB refill

The counter counts each memory-read operation or memory-write operation that causes a TLB refill of at least the Level 1 data or unified TLB. It counts each read or write that causes a refill, in the form of a translation table walk or an access to another level of TLB caching. It is IMPLEMENTATION DEFINED whether the count increments when:

- A refill results in a Translation fault.
- A refill is not allocated in the TLB.

The counter does not count:

- A TLB miss that does not cause a refill but does generate a translation table walk.
- CP15 TLB maintenance operations.

0x10, Mispredicted or not predicted branch speculatively executed

The counter counts each correction to the predicted program flow that occurs because of a misprediction from, or no prediction from, the branch prediction resources and that relates to instructions that the branch prediction resources are capable of predicting.

If no program-flow prediction resources are implemented, ARM recommends that the counter counts all branches that are not taken.

0x11, Cycle The counter increments on every cycle.

All counters are subject to changes in clock frequency, including when a WFI or WFE instruction stops the clock. This means that it is CONstrained UNPREDICTABLE whether or not CPU_CYCLES continues to increment when the clocks are stopped by WFI and WFE instructions.

———— **Note** —————

Unlike [PMCCNTR](#), this count is not affected by [PMCR.DP](#), [PMCR.D](#), or [PMCR.C](#):

- The counter is not incremented in prohibited regions, so is not affected by [PMCR.DP](#).
- The counter increments on every cycle, regardless of the setting of [PMCR.D](#).
- The counter is reset when event counters are reset by [PMCR.P](#), never by [PMCR.C](#).

0x12, Predictable branch speculatively executed

The counter counts every branch or other change in the program flow that the branch prediction resources are capable of predicting.

If all branches are subject to prediction, for example a BTB or BTAC, then all branches are predictable branches.

If branches are decoded before the predictor, so that the branch prediction logic dynamically predicts only some branches, for example conditional and indirect branches, then it is IMPLEMENTATION DEFINED whether other branches are counted as predictable branches. ARM recommends that all branches are counted.

An implementation might include other structures that predict branches, such as a loop buffer that predicts short backwards direct branches as taken. Each execution of such a branch is a predictable branch. Terminating the loop might generate a misprediction event that is counted by BR_MIS_PRED.

If no program-flow prediction resources are implemented, ARM recommends that BR_PRED counts all branches.

0x13, Data memory access

The counter counts memory-read or memory-write operations that the PE made. The counter increments whether the access results in an access to a Level 1 data or unified cache, a Level 2 data or unified cache, or neither of these.

The counter does not increment as a result of:

- Instruction memory accesses, see [Definition of terms on page D6-1836](#).
- Translation table walks.
- CP15 cache maintenance operations.
- Write-back from any cache.
- Refilling of any cache.

0x14, Level 1 instruction cache access

The counter counts instruction memory accesses that access at least the Level 1 instruction or unified cache. Each access to other Level 1 instruction memory structures, such as refill buffers, is also counted.

0x15, Level 1 data cache write-back

The counter counts every write-back of data from the Level 1 data or unified cache. The counter counts each write-back that causes data to be written from the Level 1 cache to outside of the Level 1 cache. For example, the counter counts the following cases:

- A write-back that causes data to be written to a Level 2 cache or memory.
- A write-back of a recently fetched cache line that has not been allocated to the Level 1 cache.
- Transfer of data from the Level 1 cache to outside of this cache made as a result of a coherency request. The conditions determining which of these are counted for transfers to other Level 1 caches within the same multiprocessor cluster are IMPLEMENTATION DEFINED.

Each write-back is counted once, even if multiple accesses are required to complete the write-back.

Whether this also includes write-backs made as a result of CP15 cache maintenance operations is IMPLEMENTATION DEFINED.

The counter does not count:

- The invalidation of a cache line without any write-back to a Level 2 cache or memory.
- Writes from the PE that write through the Level 1 cache to outside of the Level 1 cache.

An Unattributable write-back event occurs when a requestor outside the PE makes a coherency request that results in write-back.

If the cache is shared, then an Unattributable write-back event is not counted. If the cache is not shared, then the event is counted. See [Attributability on page D6-1828](#).

It is IMPLEMENTATION DEFINED whether a write of a whole cache line that is not the result of the eviction of a line from the cache, is counted. For example, this applies when the PE determines streaming writes to memory and does not allocate lines to the cache, or by a DC ZVA operation.

0x16, Level 2 data cache access

The counter counts memory-read or memory-write operations, that the PE made, that access at least the Level 2 data or unified cache. Each access to a cache line is counted including refills of and write-backs from the Level 1 data, instruction, or unified caches. Each access to other Level 2 data or unified memory structures, such as refill buffers, write buffers, and write-back buffers, is also counted.

The counter does not count:

- Operations made by other PEs that share this cache.
- CP15 cache maintenance operations.

0x17, Level 2 data cache refill

The counter counts memory-read or memory-write operations, that the PE made, that access at least the Level 2 data or unified cache and cause a refill of a Level 1 data, instruction, or unified cache or of the Level 2 data or unified cache. Each read from or write to the cache that causes a refill from outside the Level 1 and Level 2 caches is counted.

A refill includes any access that causes data to be fetched from outside the cache, even if the data is ultimately not allocated into the cache. For example, data might be fetched into a buffer but then discarded, rather than being allocated into a cache. These buffers are treated as part of the cache.

For example, the counter counts:

- Accesses to the Level 2 cache that cause a refill that is satisfied by another Level 2 cache, a Level 3 cache, or memory.
- Refills of and write-backs from any Level 1 data, instruction or unified cache that cause a refill from outside the Level 1 and Level 2 caches.
- Accesses to the Level 2 cache that cause a refill of a Level 1 cache from outside of the Level 1 and Level 2 caches, even if there is no refill of the Level 2 cache.

The counter does not count:

- Accesses that do not cause a new cache refill but are satisfied from refilling data of a previous miss.

- Accesses to the Level 2 cache that generate a memory access but not a new linefill, such as write-through writes that hit in the Level 2 cache.
- Accesses to the Level 2 cache that are part of a Level 1 cache refill or write-back that hit in the Level 2 cache so do not cause a refill from outside of the Level 1 and Level 2 caches.
- Operations made by other PEs that share this cache, as events on this PE.
- CP15 cache maintenance operations.
- A write that writes an entire line to the cache and does not fetch any data from outside the Level 1 and Level 2 caches, for example:
 - A write-back from a Level 1 cache to a Level 2 cache.
 - A write from a coalescing buffer of a full cache line.
 - A DC ZVA operation.
- A write that misses in the cache, and writes through the cache without allocating a line.

0x18, Level 2 data cache write-back

The counter counts every write-back of data from the Level 2 data or unified cache that occurs as a result of an operation by this PE. It counts each write-back that causes data to be written from the Level 2 cache to outside the Level 1 and Level 2 caches. For example, the counter counts:

- A write-back that causes data to be written to a Level 3 cache or memory.
- A write-back of a recently fetched cache line that has not been allocated to the Level 2 cache.

Each write-back is counted once, even if it requires multiple accesses to complete the write-back.

It is IMPLEMENTATION DEFINED whether the counter counts:

- A transfer of data from the Level 2 cache to outside the Level 1 and Level 2 cache made as a result of a coherency request, but:
 - If the Level 2 cache is shared then the transfer is not counted because it is not caused by an operation by this PE.
 - If the Level 2 cache is not shared then the conditions that determine which of these transfers are counted, for transfers to other Level 2 caches within the same multiprocessor cluster, are IMPLEMENTATION DEFINED.
- Write-backs made as a result of CP15 cache maintenance operations.

The counter does not count:

- The invalidation of a cache line without any write-back to a Level 3 cache or memory.
- Writes from the PE or Level 1 data or unified cache that write through the Level 2 cache to outside the Level 1 and Level 2 caches.
- Transfers of data from the Level 2 cache to a Level 1 cache, to satisfy a Level 1 cache refill.

An Unattributable write-back event occurs when a requestor outside the PE makes a coherency request that results in write-back.

If the cache is shared, then an Unattributable write-back event is not counted. If the cache is not shared, then the event is counted. See [Attributability](#) on page D6-1828.

It is IMPLEMENTATION DEFINED whether a write of a whole cache line that is not the result of the eviction of a line from the cache, is counted. For example, this applies when the PE determines streaming writes to memory and does not allocate lines to the cache, or by a DC ZVA operation.

0x19, Bus access

The counter counts memory-read or memory-write operations that access outside of the boundary of the PE and its closely-coupled caches. Where this boundary lies with respect to any implemented caches is IMPLEMENTATION DEFINED. It must count accesses beyond the cache furthest from the PE for which accesses can be counted.

This means that:

- If Level 2 cache access events are implemented and no IMPLEMENTATION DEFINED events can count accesses for any caches outside a Level 2 cache, this counter increments for an access beyond the Level 2 cache.

- If Level 2 cache access events are not implemented and Level 1 cache access events are implemented, this counter increments for an access beyond the Level 1 cache.
- If neither Level 1 or Level 2 cache access events are implemented, this counter increments for all data accesses that the PE made.

The definition of a bus access is IMPLEMENTATION DEFINED but physically is a single beat rather than a burst. That is, for each bus cycle for which the bus is active.

Bus accesses include refills of and write-backs from Level 1 and Level 2 data, instruction, and unified caches. Whether bus accesses include operations that do use the bus but not explicitly transfer data, such as barrier operations, is IMPLEMENTATION DEFINED.

Where an implementation has multiple external buses, this event counts the sum of accesses across all buses.

If a bus supports multiple accesses per cycle, for example through multiple channels, the counter increments once for each channel that is active on a cycle, and so it might increment by more than one in any given cycle.

0x1A, Local memory error

The counter counts every occurrence of a memory error signaled by a memory closely coupled to this PE. The definition of local memories is IMPLEMENTATION DEFINED but includes caches, tightly-coupled memories, and TLB arrays.

Memory error refers to a physical error detected by the hardware, such as a parity error. It includes errors that are correctable and those that are not. It does not include errors as defined in the architecture, such as MMU faults.

0x1B, Operation speculatively executed

The counter counts instructions that are speculatively executed by the PE. This includes instructions that are subsequently not architecturally executed. As a result, this event counts a larger number of instructions than the number of instructions architecturally executed. The definition of speculatively executed is IMPLEMENTATION DEFINED.

0x1D, Bus cycle

The counter increments on every cycle of the external memory interface of the PE.

———— Note —————

If the implementation clocks the external memory interface at the same rate as the processor hardware, the counter counts every cycle.

0x01F, Level 1 data cache allocation without refill

The counter increments on every writes that writes an entire line into the Level 1 cache without fetching from outside the cache, for example:

- A write from a coalescing buffer of a full cache line.
- A DC ZVA operation.

0x020, Level 2 data cache allocation without refill

The counter increments on every writes that writes an entire line into the Level 2 cache without fetching from outside the Level 1 or Level 2 caches, for example:

- A write-back from a Level 1 to Level 2 cache.
- A write from a coalescing buffer of a full cache line.
- A DC ZVA operation.

D6.10.5 Required events

A implementation that includes PMUv3 must implement the following common events:

- 0x00, Instruction architecturally executed, condition code check pass, software increment
- 0x03, Level 1 data cache refill.

———— **Note** —————

Event 0x03 is only required if the implementation includes a Level 1 data or unified cache.

- 0x04, Level 1 data cache access.

———— **Note** —————

Event 0x04 is only required if the implementation includes a Level 1 data or unified cache.

- 0x10, Mispredicted or not predicted branch speculatively executed.

———— **Note** —————

Event 0x10 is only required if the implementation includes program-flow prediction.

- 0x11, Cycle.
- 0x12, Predictable branch speculatively executed.

———— **Note** —————

Event 0x12 is only required if the implementation includes program-flow prediction.

- At least one of:
 - 0x08, Instruction architecturally executed.
 - 0x1B, Operation speculatively executed.

———— **Note** —————

ARM recommends that events 0x08 and 0x1B are implemented.

D6.10.6 IMPLEMENTATION DEFINED event numbers

For IMPLEMENTATION DEFINED event numbers, each counter is defined, independently, to either:

- Increment only once for each event.
- Count the duration for which an event occurs.

ARM recommends that implementers establish a standardized numbering scheme for their IMPLEMENTATION DEFINED events, with common definitions, and common count numbers, applied to all of their implementations. In general, the recommended approach is for standardization across implementations with common features. However, ARM recognizes that attempting to standardize the encoding of microarchitectural features across too wide a range of implementations is not productive.

ARM strongly recommends that at least the following classes of event are identified in the IMPLEMENTATION DEFINED events:

- Cumulative duration of stalls resulting from the holes in the instruction availability, separating out counts for key buffering points that might exist.
- Cumulative duration data-dependent stalls, separating out counts for key dependency classes that might exist.
- Cumulative duration of stalls due to unavailability of execution resources, including, for example, write buffers, separating out counts for key resources that might exist.
- Missed superscalar issue opportunities, if relevant, separating out counts for key classes of issue that might exist.
- Miss rates for different levels of caches and TLBs.
- Any external events passed to the PE through an IMPLEMENTATION DEFINED mechanism.
- Cumulative durations:
 - For which the [CPSR.I](#) and [CPSR.F](#) interrupt mask bits are set to 1, in AArch32 state.

- For which the `PSTATE.I` and `PSTATE.F` interrupt mask bits are set to 1, in AArch64 state.
- Any other microarchitectural features that the implementer considers are valuable to count.

The IMPLEMENTATION DEFINED event numbers are 0x40 to 0xFF. [Appendix C Recommendations for Performance Monitors Event Numbers for IMPLEMENTATION DEFINED Events](#) lists the ARM recommended standardized numbering scheme for these events.

D6.11 Performance Monitors Extension registers

The following section describes the Performance Monitors Extension registers.

The following subsections give general information about the Performance Monitors Extension registers, that apply for both Execution states:

- [Relationship between AArch32 and AArch64 Performance Monitors registers.](#)
- [Access permissions.](#)

[Performance Monitors Extension registers, functional group on page G3-3747](#) summarizes the Performance Monitors Extension registers in AArch32 state, and shows the CP15 encodings of these registers.

[Op0=0b11, Moves to and from non-debug System registers and special-purpose registers on page C4-242](#) summarized the Performance Monitors Extension in AArch64 state.

D6.11.1 Relationship between AArch32 and AArch64 Performance Monitors registers

[Table J-2 on page AppxJ-5090](#) lists the Performance Monitors register names for AArch32 and AArch64 states.

D6.11.2 Access permissions

Each Exception level is able to control the system register accesses, to the Performance Monitors registers, at lower Exception levels. The access control flow is:

1. If at EL0:
 - Writes to [PMUSERENR](#) are UNALLOCATED.
 - Reads and writes of [PMINTENSET](#) and [PMINTENCLR](#) are UNALLOCATED.
 - [PMUSERENR.EN == 0](#):
 - If [PMUSERENR.SW == 0](#) then writes to [PMSWINC](#) are trapped to EL1.
 - If [PMUSERENR.CR == 0](#) then reads of [PMCCNTR](#) are trapped to EL1.
 - If [PMUSERENR.ER == 0](#) then reads of [PMEVCNTR<n>](#) and [PMXVCNTR](#), and reads and writes of [PMSELR](#), are trapped to EL1.
 - Otherwise, for all other Performance Monitors registers, other than reads of [PMUSERENR](#), reads and writes are trapped to EL1.

———— **Note** —————

If [HCR.TGE==1](#), then all exceptions that would be taken to EL1 are instead taken to EL2.

2. Otherwise, at EL1 and EL0 in Non-secure state, if EL2 is implemented:
 - If [HDCR.TPMCR == 1](#) then accesses to [PMCR](#) are trapped to EL2.
 - If [HDCR.TPM == 1](#) then accesses to all Performance Monitors registers, including [PMCR](#), are trapped to EL2.
3. Otherwise, at EL2, EL1 and EL0, if EL3 is implemented and using AArch64, and if [MDCR_EL3.TPM == 1](#) then accesses to all Performance Monitors registers are trapped to EL3.

———— **Note** —————

These traps are not possible if EL3 is using AArch32.

4. Otherwise, the access is permitted.

———— **Note** —————

These traps and enables only apply to system register accesses using system register access instructions. For accesses through the optional memory-mapped or external debug interfaces, see [Access permissions for memory-mapped views of the Performance Monitors on page I3-4695](#).

For details of the headings used in [Table D6-7](#), see [Trapping functionality to higher Exception levels on page D1-1462](#). In addition, the following terms are used:

Instruction This shows the access instruction, read (MRS), write (MSR), or both (-). In AArch32 state, the equivalent instructions are MRC and MCR.

Default access

If the *Default access* is - then the access is trapped from EL0 to EL1 unless the [PMUSERENR enables](#) are set to 1.

Resultant access permission

This indicates the resulting access permission provided the enables at EL0 are enabled and the traps to EL2 or EL3 are disabled.

[Table D6-7](#) shows the access permissions for system register accesses to the Performance Monitor registers.

Table D6-7 Access permissions for the Performance Monitors system registers

Register	Instruction	Default access	At EL0:	Traps from below to:		Resultant access permission
			PMUSERENR enables	EL2	EL3 ^a	
PMCR	-	-	EN	TPMCR or TPM	TPM	RW
PMCNTENSET	-	-	EN	TPM	TPM	RW
PMCNTENCLR	-	-	EN	TPM	TPM	RW
PMOVSCLR	-	-	EN	TPM	TPM	RW
PMSWINC	-	-	EN or SW	TPM	TPM	WO
PMSELR	-	-	EN or ER	TPM	TPM	RW
PMCEID0	-	-	EN	TPM	TPM	RO
PMCEID1	-	-	EN	TPM	TPM	RO
PMCCNTR	Read	-	EN or CR	TPM	TPM	RW
	Write	-	EN			
PMXEVTYPER	-	-	EN	TPM	TPM	RW
PMXEVCNTR	Read	-	EN or ER	TPM	TPM	RW
	Write	-	EN			
PMUSERENR	Read	RO	-	TPM	TPM	RW
	Write	UND	-			
PMINTENSET	-	UND	-	TPM	TPM	RW
PMINTENCLR	-	UND	-	TPM	TPM	RW
PMOVSSET	-	-	EN	TPM	TPM	RW

Table D6-7 Access permissions for the Performance Monitors system registers (continued)

Register	Instruction	Default access	At EL0:	Traps from below to:		Resultant access permission
			PMUSERENR enables	EL2	EL3 ^a	
PMEVCNTR<n>	Read	-	EN or ER	TPM	TPM	RW
	Write	-	EN			
PMEVTYPER<n>	-	-	EN	TPM	TPM	RW
PMCCFILTR	-	-	EN	TPM	TPM	RW

a. Only if EL3 is using AArch64.

D6.12 Pseudocode details

The pseudocode function for ProfilingProhibited() is as follows:

```
// ProfilingProhibited()
// =====
// Determine whether Performance Monitors counting is prohibited in the current state.

boolean ProfilingProhibited(boolean secure, bits(2) el)
// Events are always counted in Non-secure state.
if !secure then return FALSE;

// Counting events in Secure state is prohibited unless any one of:
// * EL3 is not implemented
if !HaveEL(EL3) then return FALSE;

// * EL3 is using AArch64 and MDCR_EL3.SPME == 1
// * EL3 is using AArch32 and SDCR.SPME == 1
spme = (if ELUsingAArch32(EL3) then SDCR.SPME else MDCR_EL3.SPME);
if spme == '1' then return FALSE;

// * Allowed by the IMPLEMENTATION DEFINED authentication interface
if ExternalSecureNoninvasiveDebugEnabled() then return FALSE;

// * EL3 or EL1 is using AArch32, executing at EL0, and SDCR32_EL3.SUNIDEN == 1.
if el == EL0 && ELUsingAArch32(EL1) && SDCR32_EL3.SUNIDEN == '1' then return FALSE;

return TRUE;
```

The CountEvents() function returns TRUE if PMN_x counts events in the current mode and state. The pseudocode function is as follows:

```
// CountEvents()
// =====

boolean CountEvents(integer n)
assert(n == 31 || n < UInt(PMCR_EL0.N));

filter = (if n == 31 then PMCCFILTR_EL0<31:26> else PMEVTYPER_EL0[n]<31:26>);

M = if !HaveEL(EL3) then '0' else (filter<5> EOR filter<0>);
H = if !HaveEL(EL2) then '0' else filter<1>;
P = filter<5>; U = filter<4>;
if !IsSecure() && HaveEL(EL3) then
    P = P EOR filter<3>; U = U EOR filter<2>;

prohibited = ProfilingProhibited(TRUE, PSTATE.EL);
if prohibited && n == 31 && PMCR_EL0.DP == '0' then prohibited = FALSE;

E = (if !HaveEL(EL2) || n == 31 || n < UInt(MDCR_EL2.HPMN) then PMCR_EL0.E else MDCR_EL2.HPME);
enabled = (E == '1' && PMCNTENSET_EL0<n> == '1');
```

```
case PSTATE.EL of
    when EL0 filtered = U == '1';
    when EL1 filtered = P == '1';
    when EL2 filtered = H == '0';           // assert kpmuen; assert HaveEL(EL2);
    when EL3 filtered = M == '1';         // assert HaveEL(EL3);

return !prohibited && !filtered && enabled && !Halted();
```

Chapter D7

The Generic Timer

This chapter describes the implementation of the ARM Generic Timer as an extension to an ARMv8 implementation. It includes the definition of the system control register interface to an ARM Generic Timer.

It contains the following sections:

- [About the Generic Timer on page D7-1856.](#)
- [About the Generic Timer registers on page D7-1864.](#)

[Chapter I2 System Level Implementation of the Generic Timer](#) describes the system level implementation of the Generic Timer.

D7.1 About the Generic Timer

Figure D7-1 shows an example system-on-chip that uses the Generic Timer as a system timer. In this figure:

- This manual defines the architecture of the individual PEs in the multiprocessor blocks.
- The *ARM Generic Interrupt Controller Architecture Specification* defines a possible architecture for the GICs.
- Generic Timer functionality is distributed across multiple components.

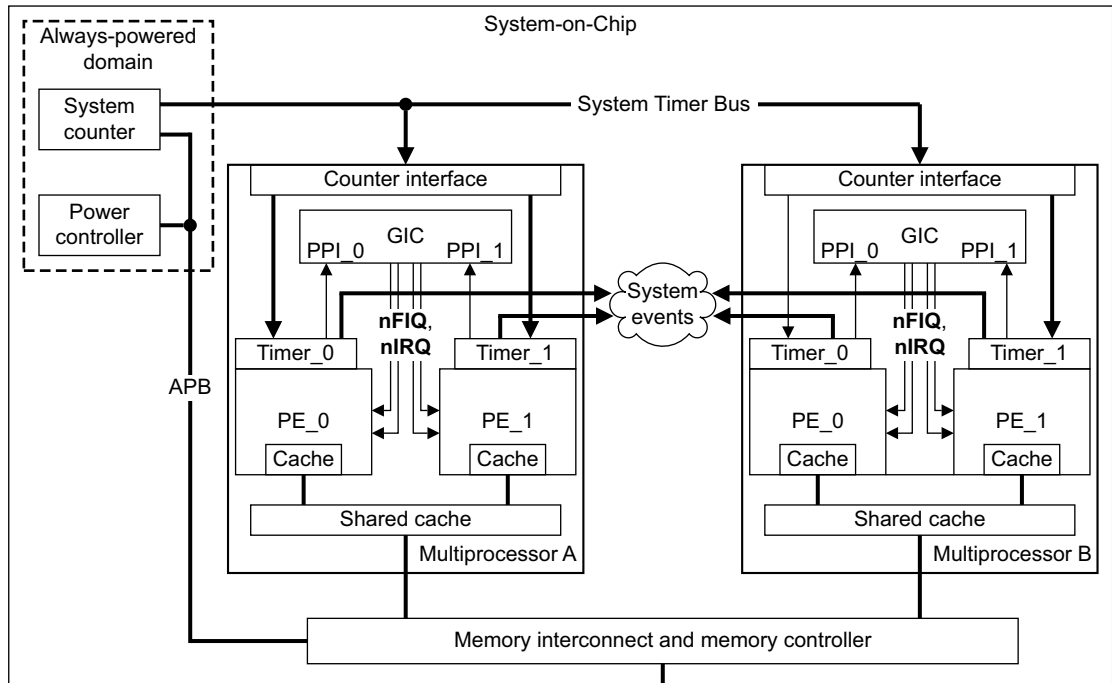

Figure D7-1 Generic Timer example

This chapter:

- Gives a general description of the Generic Timer.
- Defines the system control register interface to the Generic Timer. Each PE shown in Figure D7-1 includes an implementation of this interface.

The Generic Timer:

- Provides a system counter, that measures the passing of time in real-time.
- Supports *virtual counters* that measure the passing of virtual-time. That is, a virtual counter can measure the passing of time on a particular virtual machine.
- Timers, that can trigger events after a period of time has passed. The timers:
 - Can be used as count-up or as count-down timers.
 - Can operate in real-time or in virtual-time.

D7.1.1 System counter

The Generic Timer provides a system counter with the following specification:

Width	At least 56 bits wide. The value returned by any 64-bit read of the counter is zero-extended to 64 bits.
Frequency	Increments at a fixed frequency, typically in the range 1-50MHz. Can support one or more alternative operating modes in which it increments by larger amounts at a lower frequency, typically for power-saving.
Roll-over	Roll-over time of not less than 40 years.
Accuracy	ARM does not specify a required accuracy, but recommends that the counter does not gain or lose more than ten seconds in a 24-hour period. Use of lower-frequency modes must not affect the implemented accuracy.
Start-up	Starts operating from zero.

The system counter must provide a uniform view of system time. More precisely, it must be impossible for the following sequence of events to show system time going backwards:

1. Device A reads the time from the system counter.
2. Device A communicates with another agent in the system, Device B.
3. After recognizing the communication from Device A, Device B reads the time from the system counter.

The system counter must be implemented in an always-on power domain.

To support lower-power operating modes, the counter can increment by larger amounts at a lower frequency. For example, a 10MHz system counter might either increment either:

- By 1 at 10MHz.
- By 500 at 20KHz, when the system lowers the clock frequency, to reduce power consumption.

In this case, the counter must support transitions between high-frequency, high-precision operation, and lower-frequency, lower-precision operation, without any impact on the required accuracy of the counter.

Software can access the [CNTFRQ](#) register to read or modify the clock frequency of the system counter, see [Initializing and reading the system counter frequency](#).

The mechanism by which the count from the system counter is distributed to system components is IMPLEMENTATION DEFINED, but each PE with a system control register interface to the system counter must have a counter input that can capture each increment of the counter.

———— Note —————

So that the system counter can be clocked independently from the PE hardware, the count value might be distributed using a Gray code sequence. [Gray-count scheme for timer distribution scheme on page I2-4692](#) gives more information about this possibility.

Initializing and reading the system counter frequency

Typically, the system counter frequency is set, using the system control register interface, only during the system boot process. It is set by writing the system counter frequency to the [CNTFRQ](#) register. Only software executing in a Secure EL1 mode can write to [CNTFRQ](#).

———— Note —————

The [CNTFRQ](#) register is UNKNOWN at reset, and therefore the counter frequency must be set as part of the system boot process.

Software can read the [CNTFRQ](#) register, to determine the current system counter frequency, in the following states and modes:

- Non-secure EL2 mode.
- Secure and Non-secure EL1 modes.
- When [CNTKCTL.EL0PCTEN](#) is set to 1, Secure and Non-secure EL0 modes.

Memory-mapped controls of the system counter

Some system counter controls are accessible only through the memory-mapped interface to the system counter. These controls are:

- Enabling and disabling the counter.
- Setting the counter value.
- Changing the operating mode, to change the update frequency and increment value.
- Enabling Halt-on-debug, that a debugger can then use to suspend counting.

For descriptions of these controls, see [Chapter I2 System Level Implementation of the Generic Timer](#).

D7.1.2 The physical counter

The PE includes a physical counter that contains the count value of the system counter. The `CNTPCT` register holds the current physical counter value.

Accessing the physical counter

Software with sufficient privilege can read `CNTPCT` using a 64-bit system control register read.

In all implementations, `CNTPCT`:

- Is always accessible from Secure EL1 modes, and from Non-secure Hyp mode.
- Is accessible from Non-secure EL1 modes only when `CNTHCTL.EL1PCTEN` is set to 1. When `CNTHCTL.EL1PCTEN` is set to 0, any attempt to access `CNTPCT` from Non-secure EL1 generates a Hyp Trap exception, see [Hyp Trap exception on page G1-3478](#).

In addition, when `CNTKCTL.EL0PCTEN` is set to 1, if `CNTPCT` is accessible from EL1 in the current Security state then it is also accessible from EL0 in that Security state.

When `CNTKCTL.EL0PCTEN` is set to 0, any attempt to access `CNTPCT` from EL0 is UNDEFINED.

In all implementations:

- The `CNTKCTL` control has priority over the `CNTHCTL` control. When both of the following apply, this means that an attempt to access `CNTPCT` from Non-secure EL0 is UNDEFINED:
 - `CNTHCTL.EL1PCTEN` is set to 0, to disable accesses from Non-secure EL1.
 - `CNTKCTL.EL0PCTEN` is set to 0, to disable accesses from EL0.
- When EL0 accesses are enabled, the `CNTHCTL` applies to Non-secure EL0 accesses. When both of the following apply, this means that an attempt to access `CNTPCT` from Non-secure EL0 generates a Hyp Trap exception:
 - `CNTHCTL.EL1PCTEN` is set to 0, to disable accesses from Non-secure EL1.
 - `CNTKCTL.EL0PCTEN` is set to 1, to enable accesses from EL0.

Reads of `CNTPCT` can occur speculatively and out of order relative to other instructions executed on the same PE.

For example, if a read from memory is used to obtain a signal from another agent that indicates that `CNTPCT` must be read, an ISB must be used to ensure that the read of `CNTPCT` occurs after the signal has been read from memory, as shown in the following code sequence:

```
loop                ; polling for some communication to indicate a requirement to read the timer
  LDR R1, [R2]
  CMP R1, #1
  BNE loop
  ISB                ; without this, the CNTPCT could be read before the memory location in [R2]
                    ; has had the value 1 written to it
  MRS R1, CNTPCT
```

D7.1.3 The virtual counter

An implementation of the Generic Timer always includes a virtual counter, that indicates virtual time:

The virtual counter contains the value of the physical counter minus a 64-bit virtual offset. When executing in a Non-secure EL1 or EL0 mode, the virtual offset value relates to the current virtual machine.

The `CNTVOFF` register contains the virtual offset. `CNTVOFF` is only accessible from EL2, or from EL3 when `SCR.NS` is set to 1. See *Status of the CNTVOFF register on page D7-1864* for more information.

The `CNTVCT` register holds the current virtual counter value.

Accessing the virtual counter

Software with sufficient privilege can read `CNTVCT` using a 64-bit system control register read.

`CNTVCT` is always accessible from Secure EL3, from Secure EL1 when EL3 is using AArch64, and from Non-secure EL1 and EL2.

In addition, when `CNTKCTL.ELOVCTEN` is set to 1, `CNTVCT` is accessible from EL0.

When `CNTKCTL.ELOVCTEN` is set to 0, any attempt to access `CNTVCT` from EL0 is UNDEFINED.

Reads of `CNTVCT` can occur speculatively and out of order relative to other instructions executed on the same PE.

For example, if a read from memory is used to obtain a signal from another agent that indicates that `CNTVCT` must be read, an ISB must be used to ensure that the read of `CNTVCT` occurs after the signal has been read from memory, as shown in the following code sequence:

```

loop                ; polling for some communication to indicate a requirement to read the timer
    LDR R1, [R2]
    CMP R1, #1
    BNE loop
    ISB              ; without this, the CNTVCT could be read before the memory location in [R2]
                    ; has had the value 1 written to it
    MRS R1, CNTVCT

```

D7.1.4 Event streams

An implementation that includes the Generic Timer can use the system counter to generate one or more *event streams*, to generate periodic wake-up events as part of the mechanism described in *Wait for Event mechanism and Send event on page D1-1533*.

———— Note ————

An event stream might be used:

- To impose a time-out on a Wait For Event polling loop.
- To safeguard against any programming error that means an expected event is not generated.

An event stream is configured by:

- Selecting which bit, from the bottom 16 bits of a counter, triggers the event. This determines the frequency of the events in the stream.
- Selecting whether the event is generated on each 0 to 1 transition, or each 1 to 0 transition, of the selected counter bit.

The `CNTKCTL`.{`EVNTEN`, `EVNTDIR`, `EVNTI`} fields define an event stream that is generated from the virtual counter.

In all implementations the `CNTHCTL`.{`EVNTEN`, `EVNTDIR`, `EVNTI`} fields define an event stream that is generated from the physical counter.

The operation of an event stream is as follows:

- The pseudocode variables PreviousCNTVCT and PreviousCNPCT are initialized as:
// Variables used for generation of the timer event stream.
bits(64) PreviousCNTVCT = bits(64) UNKNOWN;
bits(64) PreviousCNPCT = bits(64) UNKNOWN;
- The pseudocode functions TestEventCNTV() and TestEventCNP() are called on each cycle of the PE clock.

- The TestEventCNTx() pseudocode template defines the functions TestEventCNTV() and TestEventCNP():

```
// TestEventCNTx()
// =====

// Template for the TestEventCNTV() and TestEventCNP() functions:
// CNTxCT      is CNTVCT      or CNPCT      64-bit count value
// CNTxCTL     is CNTVCTL     or CNPCTL     Control register
// PreviousCNTxCT is PreviousCNTVCT or PreviousCNPCT

TestEventCNTx()
    if CNTxCTL.EVNTEN == '1' then
        n = UInt(CNTxCTL.EVNTI);
        SampleBit = CNTxCT<n>;
        PreviousBit = PreviousCNTxCT<n>;

        if CNTxCTL.EVNTDIR == '0' then
            if PreviousBit == '0' && SampleBit == '1' then SendEvent();
        else
            if PreviousBit == '1' && SampleBit == '0' then SendEvent();

    PreviousCNTxCT = CNTxCT;

    return;
```

D7.1.5 Timers

The following timers are provided by an implementation of the Generic Timer Extension:

- A Non-secure EL1 physical timer.
- A Secure EL1 physical timer.
- A Non-secure EL2 physical timer.
- A virtual timer.

The output of each implemented timer:

- Provides an output signal to the system.
- If the PE interfaces to a *Generic Interrupt Controller (GIC)*, signals a *Private Peripheral Interrupt (PPI)* to that GIC. In a multiprocessor implementation, each PE must use the same interrupt number for each timer.

Each timer is implemented as three registers:

- A 64-bit CompareValue register, that provides a 64-bit unsigned upcounter.
- A 32-bit TimerValue register, that provides a 32-bit signed downcounter.
- A 32-bit Control register.

In all implementations, the registers for the EL1 physical timer are Banked, to provide the Secure and Non-secure implementations of the timer. [Table D7-1](#) shows the Timer registers.

Table D7-1 Timer registers summary for the Generic Timer

	EL1 physical timer ^a	EL2 physical timer	Virtual timer
CompareValue register	CNTP_CVAL	CNTHP_CVAL	CNTV_CVAL
TimerValue register	CNTP_TVAL	CNTHP_TVAL	CNTV_TVAL
Control register	CNTP_CTL	CNTHP_CTL	CNTV_CTL

a. In AArch32 state, the registers are Banked.

[Table J-3 on page AppxJ-5090](#) disambiguates these general names to the AArch64 and AArch32 descriptions of these registers.

The following sections describe:

- [Accessing the timer registers](#)
- [Operation of the CompareValue views of the timers on page D7-1862](#)
- [Operation of the TimerValue views of the timers on page D7-1862.](#)

Accessing the timer registers

For each timer, all timer registers have the same access permissions, as follows:

- EL1 physical timer** Accessible from EL1 modes, except that Non-secure software executing at EL2 controls access from Non-secure EL1 modes.
- When access from EL1 modes is permitted, [CNTKCTL.ELOPTEN](#) determines whether the registers are accessible from EL0 modes. If an access is not permitted because [CNTKCTL.ELOPTEN](#) is set to 0, an attempted access from EL0 is UNDEFINED.
- In all implementations:
- Except for accesses from Monitor mode, accesses are to the registers for the current Security state.
 - For accesses from Monitor mode, the value of [SCR_EL3.NS](#) determines whether accesses are to the Secure or the Non-secure registers.
 - The Non-secure registers are accessible from Hyp mode.
 - [CNTHCTL.NSEL1TPEN](#) determines whether the Non-secure registers are accessible from Non-secure EL1 modes. If this bit is set to 1, to enable access from Non-secure EL1 modes, [CNTKCTL.ELOPTEN](#) determines whether the registers are accessible from Non-secure EL0 modes.
- If an access is not permitted because [CNTHCTL.NSEL1TPEN](#) is set to 0, an attempted access from a Non-secure EL1 or EL0 mode generates a Hyp Trap exception. However, if [CNTKCTL.ELOPTEN](#) is set to 0, this control takes priority, and an attempted access from EL0 is UNDEFINED.
- Virtual timer** Accessible from Secure and Non-secure EL1 modes, and from Hyp mode.
- [CNTKCTL.EL0VTEN](#) determines whether the registers are accessible from EL0 modes. If an access is not permitted because [CNTKCTL.EL0VTEN](#) is set to 0, an attempted access from an EL0 is UNDEFINED.
- EL2 physical timer** Accessible from Non-secure Hyp mode, and from Secure Monitor mode when [SCR_EL3.NS](#) is set to 1.

Operation of the CompareValue views of the timers

The CompareValue view of a timer operates as a 64-bit upcounter. The timer triggers when the appropriate counter reaches the value programmed into a CompareValue register. When the timer triggers, it generates an interrupt if the interrupt is enabled in the corresponding timer control register, [CNTP_CTL](#), [CNTHP_CTL](#), or [CNTV_CTL](#).

The operation of this view of a timer is:

$$\text{EventTriggered} = (((\text{Counter}[63:0] - \text{Offset}[63:0])[63:0] - \text{CompareValue}[63:0]) \geq 0)$$

Where:

EventTriggered Is TRUE if the event for this timer must be triggered, and FALSE otherwise.

Counter The physical counter value, that can be read from the [CNTPCT](#) register.

———— **Note** ————

The virtual counter value, that can be read from the [CNTVCT](#) register, is the value:

$$(\text{Counter} - \text{Offset})$$

Offset For a physical timer it is zero, and for the virtual timer it is the virtual offset, held in the [CNTVOFF](#) register.

CompareValue The value of the appropriate CompareValue register, [CNTP_CVAL](#), [CNTHP_CTL](#), or [CNTV_CVAL](#).

In this view of a timer, Counter, Offset, and CompareValue are all 64-bit unsigned values.

———— **Note** ————

This means that a timer with a CompareValue of, or close to, `0xFFFF_FFFF_FFFF_FFFF` might never trigger. However, there is no practical requirement to use values close to the counter wrap value.

Operation of the TimerValue views of the timers

The TimerValue view of a timer operates as a signed 32-bit downcounter. A TimerValue register is programmed with a count value. This value decrements on each increment of the appropriate counter, and the timer triggers when the value reaches zero. When the timer triggers, it generates an interrupt if the interrupt is enabled in the corresponding timer control register, [CNTP_CTL](#), [CNTHP_CTL](#), or [CNTV_CTL](#).

This view of a timer depends on the following behavior of accesses to TimerValue registers:

Reads $\text{TimerValue} = (\text{CompareValue} - (\text{Counter} - \text{Offset}))[31:0]$

Writes $\text{CompareValue} = ((\text{Counter} - \text{Offset})[63:0] + \text{SignExtend}(\text{TimerValue}))[63:0]$

Where the arguments have the definitions used in *Operation of the CompareValue views of the timers*, and in addition:

TimerValue The value of a TimerValue register, [CNTP_TVAL](#), [CNTHP_TVAL](#), or [CNTV_TVAL](#).

The operation of this view of a timer is, effectively:

$$\text{EventTriggered} = (\text{TimerValue} \leq 0)$$

In this view of a timer, all values are signed, in standard two's complement form.

After an event has triggered, a read of a TimerValue register indicates the time since the event triggered.

———— **Note** ————

Programming TimerValue to a negative number with magnitude greater than (Counter–Offset) can lead to an arithmetic overflow that causes the CompareValue to be an extremely large positive value. This potentially delays the resultant interrupt for an extremely long period of time.

D7.2 About the Generic Timer registers

This chapter uses general names to refer to the Generic Timers registers. [Table J-3 on page AppxJ-5090](#) disambiguates these general names to either the AArch64 System registers or the AArch32 System registers.

D7.2.1 Status of the CNTVOFF register

All implementations of the Generic Timers Extension include the virtual counter. Therefore, conceptually, all implementations include the **CNTVOFF** register that defines the *virtual offset* between the physical count and the virtual count. **CNTVOFF** is defined as an EL2-mode register, see [Banked EL2-mode CP15 read/write registers on page G3-3700](#). This means:

- In an implementation that includes EL2, **CNTVOFF** is a RW register, accessible from Non-secure EL2, and from EL3 when **SCR.NS** is set to 1. Any access to the **CNTVOFF** encoding is UNDEFINED if executed at EL3 when **SCR.NS** is set to 0.
- In an implementation that includes EL3 but does not include EL2, **CNTVOFF** is RW and RES0.
- Any access to the **CNTVOFF** encoding other than the accesses from EL2 and EL3 described in this list is UNDEFINED.
- In an implementation that does not include EL3, although the register is conceptually present, there is no way of accessing it. The instruction encodings for accessing the register are UNDEFINED.

In all cases where the **CNTVOFF** register is not defined as a RW register, the virtual counter uses a fixed virtual offset value of zero.

Chapter D8

AArch64 System Register Descriptions

This chapter defines the AArch64 System registers. It contains the following sections:

- *About the AArch64 System registers* on page D8-1866.
- *General system control registers* on page D8-1870.
- *Debug registers* on page D8-2077.
- *Performance Monitors registers* on page D8-2134.
- *Generic Timer registers* on page D8-2170.
- *Generic Interrupt Controller CPU interface registers* on page D8-2194.

D8.1 About the AArch64 System registers

This section describes common features of the AArch64 registers.

D8.1.1 Fixed values in the System register descriptions

See *Fixed values in instruction and register descriptions* on page C4-230. This section defines the terms *RAZ* on page C4-230, *RES0*, *RAO* on page C4-230, and *RES1*, as used in the System register descriptions,

D8.1.2 General behavior of accesses to the System registers

This section gives general information about the behavior of accesses to the System registers.

Synchronization requirements for system registers

Reads of the System registers can occur out of order with respect to earlier instructions executed on the same PE, provided that any data dependencies between the instructions are respected.

———— Note —————

In particular, system registers that hold self-incrementing counts such as the performance counters or the Generic Timer counter or timers, can be read early. For example, where a memory access is used to communicate a read of such counters, an ISB must be inserted between the read of the memory location and the read of the Generic Timer counter, where it is necessary that the Generic Timer counter returns a count value after the memory communication.

Direct writes using the instructions in [Table C4-7 on page C4-243](#) require synchronization before software can rely on the effects of changes to the system registers to affect instructions appearing in program order after the direct write to the system register. Direct writes to these registers are not allowed to affect any instructions appearing in program order before the direct write. The only exceptions are:

- All direct writes to the same register, that use the same encoding for that register, are guaranteed to occur in program order relative to each other
- All direct writes to a register occur in program order with respect to all direct reads to the same register using the same encoding.

Explicit synchronization occurs as a result a *Context synchronization operation*, which is of one of the following events:

- Execution of an ISB instruction.
- Exception entry.
- Exception return.
- Execution of a DCPS instruction in Debug state.
- Execution of a DRPS instruction in Debug state.
- Exit from Debug state.

———— Note —————

The ISB, exception entry, or exception return events are applicable either in Debug state or not in Debug state.

Conceptually, explicit synchronization occurs as the first step of each of these events, so that if the event uses state that has previously been changed but was not synchronized by the time of the event, the event is guaranteed to use the state as if it had been synchronized.

———— Note —————

This explicit synchronization applies as the first step of the execution of the events, and does not apply to any effect of system registers that apply to the fetch and decode of the instructions that cause these events, such as breakpoints or changes to the translation table.

In addition, any system instructions that cause a write to a system register must be synchronized before the result is guaranteed to be visible to subsequent direct reads of that system register.

Direct reads to any one of the following registers, using the same encoding, occur in program order relative to each other:

- [ISR_EL1](#)
- The Generic Timer registers, that is, [CNTPCT_EL0](#) and [CNTVCT_EL0](#), and the Counter registers [CNTPTVAL_EL0](#), [CNTV_TVAL_EL0](#), [CNTHTP_TVAL_EL2](#), and [CNTPTS_TVAL_EL1](#).
- [DBGCLAIMCLR_EL1](#).
- The PMU Counters, that is, [PMCCNTR_EL0](#), [PMEVCNTR<n>_EL0](#), [PMXVCNTR_EL0](#), [PMOVSCLR_EL0](#), and [PMOVSSET_EL0](#).
- The Debug Communications Channel registers, that is, [DBGDTRTX_EL0](#), [DBGDTRRX_EL0](#), [DBGDTR_EL0](#), [MDCCSR_EL0](#) or [EDSCR](#).

All other direct reads of system registers can occur in any order if synchronization has not been performed.

[Table D8-1](#) describes the synchronization requirements between two successive read/write accesses to the same register, where the ordering of the read/write is:

1. Program order, in the event that the read or write is caused by an instruction executed on this PE, other than one caused by a memory access by this PE.
2. The order of arrival of asynchronous reads and writes by the PE relative to the execution of instructions.

Table D8-1 Synchronization requirements

First read-write	Second read-write	Synchronization requirement
Direct read	Direct read	None
	Direct write	None
	Indirect read	None
	Indirect write	None, see Notes on page D8-1868
Direct write	Direct read	None
	Direct write	None
	Indirect read	Required
	Indirect write	None, see Notes on page D8-1868
Indirect read	Direct read	None
	Direct write	None
	Indirect read	None
	Indirect write	None
Indirect write	Direct read	Required, see Notes on page D8-1868
	Direct write	None, see Notes on page D8-1868
	Indirect read	Required, see Notes on page D8-1868
	Indirect write	None, see Notes on page D8-1868

Notes

In Table D8-1 on page D8-1867:

- Direct read** Where software uses a system register access instruction to read the register, see *Instructions for accessing non-debug System registers on page C4-242*. Where a direct read of a register has a side-effect that changes the contents of a register, the effect of a direct read on that register is defined to be an indirect write. In this case, the indirect write is only guaranteed to have occurred, and be visible to subsequent direct or indirect reads or writes, if synchronization is performed after the direct read.
- Direct write** Where software uses a system register access instruction to write to the register, see *Instructions for accessing non-debug System registers on page C4-242*. Where a direct write to a register has an effect on the register that means that the value in the register is not always the last value that is written (as is the case with set and clear registers), the effect of a direct write on that register is defined to be an indirect write. In this case, the indirect write is only guaranteed to be visible to subsequent direct or indirect reads or writes if synchronization is performed after the direct write and before the subsequent direct or indirect reads or writes.
- Indirect read** Where an instruction uses a system register to establish operating conditions, for example, translation table base register addresses or whether the cache is enabled, for the instruction. This includes situations where the contents of one system register selects what value is read using a different register. Indirect reads also include reads of the system register by external agents such as debuggers. Where an indirect read of a register has a side-effect that changes the contents of that register, that is defined to be an indirect write.
- Indirect write** Where a system register is written as the consequence of some other instruction, exception, operation, or by the asynchronous operation of such some external agent, including the passage of time as seen in counters, timers, or performance counters, the assertion of interrupts, or writes from an external debugger.

———— **Note** —————

Since an exception is context synchronizing, registers such as the Exception Syndrome registers that are indirectly written as part of exception entry do not require additional synchronization.

Where a direct read or write to a register is followed by an indirect write caused by an external agent, autonomous asynchronous event, or as a result of memory mapped write, synchronization is required to guarantee the order of those two accesses.

Where an indirect write caused by a direct write is followed by an indirect write caused by an external agent, autonomous asynchronous event, or as a result of memory mapped write, synchronization is required to guarantee the order of those two indirect accesses.

Where a direct read to one register causes a bit or field in a different register (or the same register using a different encoding) to be updated, the change to the different register (or same register using a different encoding) is defined to be an indirect write. In this case, the indirect write is only guaranteed to be visible to subsequent direct or indirect reads or writes if synchronization is performed after the direct read and before the subsequent direct or indirect reads or writes.

Where a direct write to one register causes a bit or field in a different register (or the same register using a different encoding) to be updated as a side-effect of that direct write (as opposed to simply being a direct write to the different encoding), the change to the different register (or same register using a different encoding) is defined to be an indirect write. In this case, the indirect write is only guaranteed to be visible to subsequent direct or indirect reads or writes if synchronization is performed after the direct write and before the subsequent direct or indirect reads or writes.

Where indirect writes are caused by the actions of external agents such as debuggers, or by memory-mapped reads or writes by the PE, then an indirect write by that agent and mechanism to a register, followed by an indirect read by that agent and mechanism to the same register using the same address, does not require synchronization.

Indirect writes to the following registers caused by external agents, autonomous asynchronous events, or as a result of memory-mapped writes, are required to be observable to:

- Direct reads in finite time without explicit synchronization.
- Subsequent indirect reads without explicit synchronization:
 - [ISR_EL1](#).
 - The Generic Timer registers, that is, [CNTPCT_EL0](#) and [CNTVCT_EL0](#), and the Counter registers [CNTP_TVAL_EL0](#), [CNTV_TVAL_EL0](#), [CNTHP_TVAL_EL2](#), and [CNTPS_TVAL_EL1](#).
 - The debug claim registers, [DBGCLAIMCLR_EL1](#) and [DBGCLAIMSET_EL1](#).
 - The PMU Counters, that is, [PMCCNTR_EL0](#), [PMEVCNTR<n>_EL0](#), [PMXVCNTR_EL0](#), [PMOVSCLR_EL0](#), and [PMOVSSET_EL0](#).
 - The Debug Communications Channel registers, that is, [DBGDTRTX_EL0](#), [DBGDTRRX_EL0](#), [DBGDTR_EL0](#), [MDCCSR_EL0](#) or [EDSCR](#).

Note

- The provision of explicit synchronization requirements to system registers is provided to allow the direct access to these registers to be implemented in a small number of cycles, and that updates to multiple registers can be performed quickly with the synchronization penalty being paid only when the updates have occurred.
 - Since toolkits might use registers such as the thread-local storage registers within compiled code, it is recommended that access to these registers is implemented to take a small number of cycles.
 - While no synchronization is required between a direct write and a direct read, or between a direct read and an indirect write, this does not imply that a direct read causes synchronization of a previous direct write. That is, the sequence direct write → direct read → indirect read, with no intervening context synchronization, does not guarantee that the indirect read observes the result of the direct write.
-

D8.2 General system control registers

This section lists the system control registers in AArch64 that are not part of one of the other listed groups.

D8.2.1 ACTLR_EL1, Auxiliary Control Register (EL1)

The ACTLR_EL1 characteristics are:

Purpose

Provides IMPLEMENTATION DEFINED configuration and control options for EL1.

This register is part of:

- the Other system control registers functional group
- the IMPLEMENTATION DEFINED functional group.

Usage constraints

This register is accessible as shown below:

EL0	EL1 (NS)	EL1 (S)	EL2	EL3 (SCR.NS=1)	EL3 (SCR.NS=0)
-	RW	RW	RW	RW	RW

Configurations

ACTLR_EL1 is architecturally mapped to AArch32 register [ACTLR](#) (NS).

Attributes

ACTLR_EL1 is a 32-bit register.

The ACTLR_EL1 bit assignments are:



Accessing the ACTLR_EL1:

To access the ACTLR_EL1:

MRS <Xt>, ACTLR_EL1 ; Read ACTLR_EL1 into Xt
MSR ACTLR_EL1, <Xt> ; Write Xt to ACTLR_EL1

Register access is encoded as follows:

op0	op1	CRn	CRm	op2
11	000	0001	0000	001

D8.2.2 ACTLR_EL2, Auxiliary Control Register (EL2)

The ACTLR_EL2 characteristics are:

Purpose

Provides IMPLEMENTATION DEFINED configuration and control options for EL2.

This register is part of:

- the Virtualization registers functional group
- the Other system control registers functional group
- the IMPLEMENTATION DEFINED functional group.

Usage constraints

This register is accessible as shown below:

EL0	EL1 (NS)	EL1 (S)	EL2	EL3 (SCR.NS=1)	EL3 (SCR.NS=0)
-	-	-	RW	RW	RW

Configurations

ACTLR_EL2 is architecturally mapped to AArch32 register [HACTLR](#).

If EL2 is not implemented, this register is RES0 from EL3.

Attributes

ACTLR_EL2 is a 32-bit register.

The ACTLR_EL2 bit assignments are:



Accessing the ACTLR_EL2:

To access the ACTLR_EL2:

MRS <Xt>, ACTLR_EL2 ; Read ACTLR_EL2 into Xt
MSR ACTLR_EL2, <Xt> ; Write Xt to ACTLR_EL2

Register access is encoded as follows:

op0	op1	CRn	CRm	op2
11	100	0001	0000	001

D8.2.3 ACTLR_EL3, Auxiliary Control Register (EL3)

The ACTLR_EL3 characteristics are:

Purpose

Provides IMPLEMENTATION DEFINED configuration and control options for EL3.

This register is part of:

- the Other system control registers functional group
- the Security registers functional group
- the IMPLEMENTATION DEFINED functional group.

Usage constraints

This register is accessible as shown below:

EL0	EL1 (NS)	EL1 (S)	EL2	EL3 (SCR.NS=1)	EL3 (SCR.NS=0)
-	-	-	-	RW	RW

Configurations

ACTLR_EL3 can be mapped to AArch32 register [ACTLR](#) (S), but this is not architecturally mandated.

Attributes

ACTLR_EL3 is a 32-bit register.

The ACTLR_EL3 bit assignments are:



Accessing the ACTLR_EL3:

To access the ACTLR_EL3:

MRS <Xt>, ACTLR_EL3 ; Read ACTLR_EL3 into Xt
MSR ACTLR_EL3, <Xt> ; Write Xt to ACTLR_EL3

Register access is encoded as follows:

op0	op1	CRn	CRm	op2
11	110	0001	0000	001

D8.2.4 AFSR0_EL1, Auxiliary Fault Status Register 0 (EL1)

The AFSR0_EL1 characteristics are:

Purpose

Provides additional IMPLEMENTATION DEFINED fault status information for exceptions taken to EL1.

This register is part of:

- the Exception and fault handling registers functional group
- the IMPLEMENTATION DEFINED functional group.

Usage constraints

This register is accessible as shown below:

EL0	EL1 (NS)	EL1 (S)	EL2	EL3 (SCR.NS=1)	EL3 (SCR.NS=0)
-	RW	RW	RW	RW	RW

Configurations

AFSR0_EL1 is architecturally mapped to AArch32 register [ADFSR](#) (NS).

Attributes

AFSR0_EL1 is a 32-bit register.

The AFSR0_EL1 bit assignments are:



Accessing the AFSR0_EL1:

To access the AFSR0_EL1:

MRS <Xt>, AFSR0_EL1 ; Read AFSR0_EL1 into Xt
MSR AFSR0_EL1, <Xt> ; Write Xt to AFSR0_EL1

Register access is encoded as follows:

op0	op1	CRn	CRm	op2
11	000	0101	0001	000

D8.2.5 AFSR0_EL2, Auxiliary Fault Status Register 0 (EL2)

The AFSR0_EL2 characteristics are:

Purpose

Provides additional IMPLEMENTATION DEFINED fault status information for exceptions taken to EL2.

This register is part of:

- the Virtualization registers functional group
- the Exception and fault handling registers functional group
- the IMPLEMENTATION DEFINED functional group.

Usage constraints

This register is accessible as shown below:

EL0	EL1 (NS)	EL1 (S)	EL2	EL3 (SCR.NS=1)	EL3 (SCR.NS=0)
-	-	-	RW	RW	RW

Configurations

AFSR0_EL2 is architecturally mapped to AArch32 register [HADFSR](#).

If EL2 is not implemented, this register is RES0 from EL3.

Attributes

AFSR0_EL2 is a 32-bit register.

The AFSR0_EL2 bit assignments are:



Accessing the AFSR0_EL2:

To access the AFSR0_EL2:

MRS <Xt>, AFSR0_EL2 ; Read AFSR0_EL2 into Xt
MSR AFSR0_EL2, <Xt> ; Write Xt to AFSR0_EL2

Register access is encoded as follows:

op0	op1	CRn	CRm	op2
11	100	0101	0001	000

D8.2.6 AFSR0_EL3, Auxiliary Fault Status Register 0 (EL3)

The AFSR0_EL3 characteristics are:

Purpose

Provides additional IMPLEMENTATION DEFINED fault status information for exceptions taken to EL3.

This register is part of:

- the Exception and fault handling registers functional group
- the Security registers functional group
- the IMPLEMENTATION DEFINED functional group.

Usage constraints

This register is accessible as shown below:

EL0	EL1 (NS)	EL1 (S)	EL2	EL3 (SCR.NS=1)	EL3 (SCR.NS=0)
-	-	-	-	RW	RW

Configurations

AFSR0_EL3 can be mapped to AArch32 register [ADFSR](#) (S), but this is not architecturally mandated.

Attributes

AFSR0_EL3 is a 32-bit register.

The AFSR0_EL3 bit assignments are:



Accessing the AFSR0_EL3:

To access the AFSR0_EL3:

MRS <Xt>, AFSR0_EL3 ; Read AFSR0_EL3 into Xt
MSR AFSR0_EL3, <Xt> ; Write Xt to AFSR0_EL3

Register access is encoded as follows:

op0	op1	CRn	CRm	op2
11	110	0101	0001	000

D8.2.7 AFSR1_EL1, Auxiliary Fault Status Register 1 (EL1)

The AFSR1_EL1 characteristics are:

Purpose

Provides additional IMPLEMENTATION DEFINED fault status information for exceptions taken to EL1.

This register is part of:

- the Exception and fault handling registers functional group
- the IMPLEMENTATION DEFINED functional group.

Usage constraints

This register is accessible as shown below:

EL0	EL1 (NS)	EL1 (S)	EL2	EL3 (SCR.NS=1)	EL3 (SCR.NS=0)
-	RW	RW	RW	RW	RW

Configurations

AFSR1_EL1 is architecturally mapped to AArch32 register [AIFSR](#) (NS).

Attributes

AFSR1_EL1 is a 32-bit register.

The AFSR1_EL1 bit assignments are:



Accessing the AFSR1_EL1:

To access the AFSR1_EL1:

MRS <Xt>, AFSR1_EL1 ; Read AFSR1_EL1 into Xt
MSR AFSR1_EL1, <Xt> ; Write Xt to AFSR1_EL1

Register access is encoded as follows:

op0	op1	CRn	CRm	op2
11	000	0101	0001	001

D8.2.8 AFSR1_EL2, Auxiliary Fault Status Register 1 (EL2)

The AFSR1_EL2 characteristics are:

Purpose

Provides additional IMPLEMENTATION DEFINED fault status information for exceptions taken to EL2.

This register is part of:

- the Virtualization registers functional group
- the Exception and fault handling registers functional group
- the IMPLEMENTATION DEFINED functional group.

Usage constraints

This register is accessible as shown below:

EL0	EL1 (NS)	EL1 (S)	EL2	EL3 (SCR.NS=1)	EL3 (SCR.NS=0)
-	-	-	RW	RW	RW

Configurations

AFSR1_EL2 is architecturally mapped to AArch32 register [HAIFSR](#).

If EL2 is not implemented, this register is RES0 from EL3.

Attributes

AFSR1_EL2 is a 32-bit register.

The AFSR1_EL2 bit assignments are:



Accessing the AFSR1_EL2:

To access the AFSR1_EL2:

MRS <Xt>, AFSR1_EL2 ; Read AFSR1_EL2 into Xt
MSR AFSR1_EL2, <Xt> ; Write Xt to AFSR1_EL2

Register access is encoded as follows:

op0	op1	CRn	CRm	op2
11	100	0101	0001	001

D8.2.9 AFSR1_EL3, Auxiliary Fault Status Register 1 (EL3)

The AFSR1_EL3 characteristics are:

Purpose

Provides additional IMPLEMENTATION DEFINED fault status information for exceptions taken to EL3.

This register is part of:

- the Exception and fault handling registers functional group
- the Security registers functional group
- the IMPLEMENTATION DEFINED functional group.

Usage constraints

This register is accessible as shown below:

EL0	EL1 (NS)	EL1 (S)	EL2	EL3 (SCR.NS=1)	EL3 (SCR.NS=0)
-	-	-	-	RW	RW

Configurations

AFSR1_EL3 can be mapped to AArch32 register [AIFSR](#) (S), but this is not architecturally mandated.

Attributes

AFSR1_EL3 is a 32-bit register.

The AFSR1_EL3 bit assignments are:



Accessing the AFSR1_EL3:

To access the AFSR1_EL3:

MRS <Xt>, AFSR1_EL3 ; Read AFSR1_EL3 into Xt
MSR AFSR1_EL3, <Xt> ; Write Xt to AFSR1_EL3

Register access is encoded as follows:

op0	op1	CRn	CRm	op2
11	110	0101	0001	001

D8.2.10 AIDR_EL1, Auxiliary ID Register

The AIDR_EL1 characteristics are:

Purpose

Provides IMPLEMENTATION DEFINED identification information.

This register is part of:

- the Identification registers functional group
- the IMPLEMENTATION DEFINED functional group.

Usage constraints

This register is accessible as shown below:

EL0	EL1 (NS)	EL1 (S)	EL2	EL3 (SCR.NS=1)	EL3 (SCR.NS=0)
-	RO	RO	RO	RO	RO

The value of this register must be interpreted in conjunction with the value of [MIDR_EL1](#).

Configurations

AIDR_EL1 is architecturally mapped to AArch32 register [AIDR](#).

Attributes

AIDR_EL1 is a 32-bit register.

The AIDR_EL1 bit assignments are:



Accessing the AIDR_EL1:

To access the AIDR_EL1:

MRS <Xt>, AIDR_EL1 ; Read AIDR_EL1 into Xt

Register access is encoded as follows:

op0	op1	CRn	CRm	op2
11	001	0000	0000	111

D8.2.11 AMAIR_EL1, Auxiliary Memory Attribute Indirection Register (EL1)

The AMAIR_EL1 characteristics are:

Purpose

Provides IMPLEMENTATION DEFINED memory attributes for the memory regions specified by [MAIR_EL1](#).

This register is part of:

- the Virtual memory control registers functional group
- the IMPLEMENTATION DEFINED functional group.

Usage constraints

This register is accessible as shown below:

EL0	EL1 (NS)	EL1 (S)	EL2	EL3 (SCR.NS=1)	EL3 (SCR.NS=0)
-	RW	RW	RW	RW	RW

AMAIR_EL1 is permitted to be cached in a TLB.

Configurations

AMAIR_EL1[31:0] is architecturally mapped to AArch32 register [AMAIR0](#) (NS).

AMAIR_EL1[63:32] is architecturally mapped to AArch32 register [AMAIR1](#) (NS).

Attributes

AMAIR_EL1 is a 64-bit register.

The AMAIR_EL1 bit assignments are:

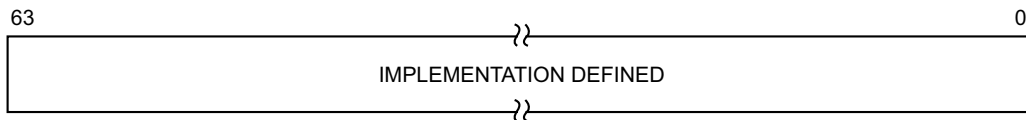

Accessing the AMAIR_EL1:

To access the AMAIR_EL1:

MRS <Xt>, AMAIR_EL1 ; Read AMAIR_EL1 into Xt

MSR AMAIR_EL1, <Xt> ; Write Xt to AMAIR_EL1

Register access is encoded as follows:

op0	op1	CRn	CRm	op2
11	000	1010	0011	000

D8.2.12 AMAIR_EL2, Auxiliary Memory Attribute Indirection Register (EL2)

The AMAIR_EL2 characteristics are:

Purpose

Provides IMPLEMENTATION DEFINED memory attributes for the memory regions specified by [MAIR_EL2](#).

This register is part of:

- the Virtualization registers functional group
- the Virtual memory control registers functional group
- the IMPLEMENTATION DEFINED functional group.

Usage constraints

This register is accessible as shown below:

EL0	EL1 (NS)	EL1 (S)	EL2	EL3 (SCR.NS=1)	EL3 (SCR.NS=0)
-	-	-	RW	RW	RW

AMAIR_EL2 is permitted to be cached in a TLB.

Configurations

AMAIR_EL2[31:0] is architecturally mapped to AArch32 register [HAMAIRO](#).

AMAIR_EL2[63:32] is architecturally mapped to AArch32 register [HAMAIR1](#).

If EL2 is not implemented, this register is RES0 from EL3.

Attributes

AMAIR_EL2 is a 64-bit register.

The AMAIR_EL2 bit assignments are:

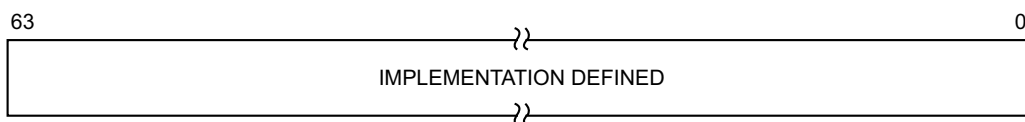

Accessing the AMAIR_EL2:

To access the AMAIR_EL2:

MRS <Xt>, AMAIR_EL2 ; Read AMAIR_EL2 into Xt

MSR AMAIR_EL2, <Xt> ; Write Xt to AMAIR_EL2

Register access is encoded as follows:

op0	op1	CRn	CRm	op2
11	100	1010	0011	000

D8.2.13 AMAIR_EL3, Auxiliary Memory Attribute Indirection Register (EL3)

The AMAIR_EL3 characteristics are:

Purpose

Provides IMPLEMENTATION DEFINED memory attributes for the memory regions specified by [MAIR_EL3](#).

This register is part of:

- the Virtual memory control registers functional group
- the Security registers functional group
- the IMPLEMENTATION DEFINED functional group.

Usage constraints

This register is accessible as shown below:

EL0	EL1 (NS)	EL1 (S)	EL2	EL3 (SCR.NS=1)	EL3 (SCR.NS=0)
-	-	-	-	RW	RW

AMAIR_EL3 is permitted to be cached in a TLB.

Configurations

AMAIR_EL3[31:0] can be mapped to AArch32 register [AMAIR0](#) (S), but this is not architecturally mandated.

AMAIR_EL3[63:32] can be mapped to AArch32 register [AMAIR1](#) (S), but this is not architecturally mandated.

Attributes

AMAIR_EL3 is a 64-bit register.

The AMAIR_EL3 bit assignments are:

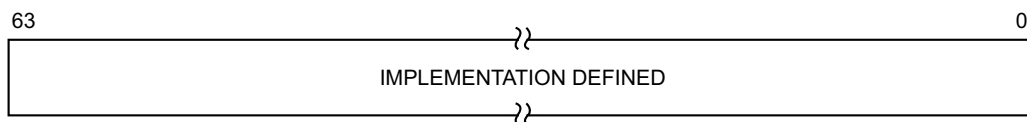

Accessing the AMAIR_EL3:

To access the AMAIR_EL3:

MRS <Xt>, AMAIR_EL3 ; Read AMAIR_EL3 into Xt
MSR AMAIR_EL3, <Xt> ; Write Xt to AMAIR_EL3

Register access is encoded as follows:

op0	op1	CRn	CRm	op2
11	110	1010	0011	000

D8.2.14 CCSIDR_EL1, Current Cache Size ID Register

The CCSIDR_EL1 characteristics are:

Purpose

Provides information about the architecture of the currently selected cache.
This register is part of the Identification registers functional group.

Usage constraints

This register is accessible as shown below:

EL0	EL1 (NS)	EL1 (S)	EL2	EL3 (SCR.NS=1)	EL3 (SCR.NS=0)
-	RO	RO	RO	RO	RO

Configurations

CCSIDR_EL1 is architecturally mapped to AArch32 register [CCSIDR](#).

The implementation includes one CCSIDR_EL1 for each cache that it can access. [CSSELR_EL1](#) selects which Cache Size ID Register is accessible.

Attributes

CCSIDR_EL1 is a 32-bit register.

The CCSIDR_EL1 bit assignments are:

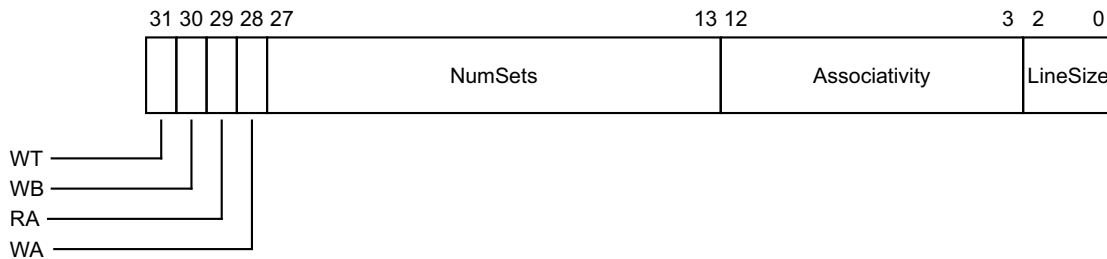

WT, bit [31]

Indicates whether the selected cache level supports write-through. Permitted values are:

- 0 Write-through not supported.
- 1 Write-through supported.

WB, bit [30]

Indicates whether the selected cache level supports write-back. Permitted values are:

- 0 Write-back not supported.
- 1 Write-back supported.

RA, bit [29]

Indicates whether the selected cache level supports read-allocation. Permitted values are:

- 0 Read-allocation not supported.
- 1 Read-allocation supported.

WA, bit [28]

Indicates whether the selected cache level supports write-allocation. Permitted values are:

- 0 Write-allocation not supported.

1 Write-allocation supported.

NumSets, bits [27:13]

(Number of sets in cache) - 1, therefore a value of 0 indicates 1 set in the cache. The number of sets does not have to be a power of 2.

Associativity, bits [12:3]

(Associativity of cache) - 1, therefore a value of 0 indicates an associativity of 1. The associativity does not have to be a power of 2.

LineSize, bits [2:0]

($\text{Log}_2(\text{Number of bytes in cache line})$) - 4. For example:

For a line length of 16 bytes: $\text{Log}_2(16) = 4$, LineSize entry = 0. This is the minimum line length.

For a line length of 32 bytes: $\text{Log}_2(32) = 5$, LineSize entry = 1.

Accessing the CCSIDR_EL1:

To access the CCSIDR_EL1:

MRS <Xt>, CCSIDR_EL1 ; Read CCSIDR_EL1 into Xt

Register access is encoded as follows:

op0	op1	CRn	CRm	op2
11	001	0000	0000	000

D8.2.15 CLIDR_EL1, Cache Level ID Register

The CLIDR_EL1 characteristics are:

Purpose

Identifies the type of cache, or caches, implemented at each level, up to a maximum of seven levels. Also identifies the Level of Coherency and Level of Unification for the cache hierarchy.

This register is part of the Identification registers functional group.

Usage constraints

This register is accessible as shown below:

EL0	EL1 (NS)	EL1 (S)	EL2	EL3 (SCR.NS=1)	EL3 (SCR.NS=0)
-	RO	RO	RO	RO	RO

Configurations

CLIDR_EL1 is architecturally mapped to AArch32 register [CLIDR](#).

Attributes

CLIDR_EL1 is a 32-bit register.

The CLIDR_EL1 bit assignments are:

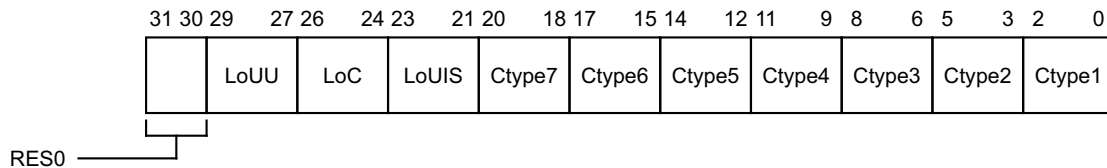

Bits [31:30]

Reserved, RES0.

LoUU, bits [29:27]

Level of Unification Uniprocessor for the cache hierarchy.

LoC, bits [26:24]

Level of Coherency for the cache hierarchy.

LoUIS, bits [23:21]

Level of Unification Inner Shareable for the cache hierarchy.

Ctype<n>, bits [3(n-1)+2:3(n-1)], for n = 1 to 7

Cache Type fields. Indicate the type of cache implemented at each level, from Level 1 up to a maximum of seven levels of cache hierarchy. Possible values of each field are:

- 000 No cache.
 - 001 Instruction cache only.
 - 010 Data cache only.
 - 011 Separate instruction and data caches.
 - 100 Unified cache.
- All other values are reserved.

If software reads the Cache Type fields from Ctype1 upwards, once it has seen a value of 0b000, no caches exist at further-out levels of the hierarchy. So, for example, if Ctype3 is the first Cache Type field with a value of 0b000, the values of Ctype4 to Ctype7 must be ignored.

Accessing the CLIDR_EL1:

To access the CLIDR_EL1:

MRS <Xt>, CLIDR_EL1 ; Read CLIDR_EL1 into Xt

Register access is encoded as follows:

op0	op1	CRn	CRm	op2
11	001	0000	0000	001

D8.2.16 CONTEXTIDR_EL1, Context ID Register

The CONTEXTIDR_EL1 characteristics are:

Purpose

Identifies the current Process Identifier.

This register is part of the Virtual memory control registers functional group.

Usage constraints

This register is accessible as shown below:

EL0	EL1 (NS)	EL1 (S)	EL2	EL3 (SCR.NS=1)	EL3 (SCR.NS=0)
-	RW	RW	RW	RW	RW

The value of the whole of this register is called the Context ID and is used by:

- The debug logic, for Linked and Unlinked Context ID matching.
- The trace logic, to identify the current process.

The significance of this register is for debug and trace use only.

Configurations

CONTEXTIDR_EL1 is architecturally mapped to AArch32 register [CONTEXTIDR](#) (NS).

Attributes

CONTEXTIDR_EL1 is a 32-bit register.

The CONTEXTIDR_EL1 bit assignments are:

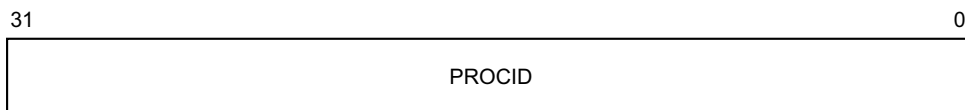

PROCID, bits [31:0]

Process Identifier. This field must be programmed with a unique value that identifies the current process. The bottom 8 bits of this register are not used to hold the ASID.

Accessing the CONTEXTIDR_EL1:

To access the CONTEXTIDR_EL1:

MRS <Xt>, CONTEXTIDR_EL1 ; Read CONTEXTIDR_EL1 into Xt
MSR CONTEXTIDR_EL1, <Xt> ; Write Xt to CONTEXTIDR_EL1

Register access is encoded as follows:

op0	op1	CRn	CRm	op2
11	000	1101	0000	001

D8.2.17 CPACR_EL1, Architectural Feature Access Control Register

The CPACR_EL1 characteristics are:

Purpose

Controls access to Trace, Floating-point, and Advanced SIMD functionality.
This register is part of the Other system control registers functional group.

Usage constraints

This register is accessible as shown below:

EL0	EL1 (NS)	EL1 (S)	EL2	EL3 (SCR.NS=1)	EL3 (SCR.NS=0)
-	RW	RW	RW	RW	RW

Configurations

CPACR_EL1 is architecturally mapped to AArch32 register [CPACR](#).

Attributes

CPACR_EL1 is a 32-bit register.

The CPACR_EL1 bit assignments are:

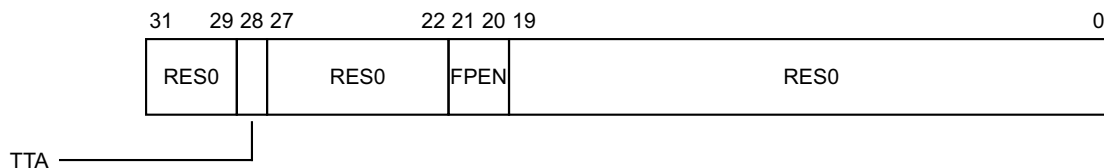

Bits [31:29]

Reserved, RES0.

TTA, bit [28]

Causes access to the Trace functionality to trap to EL1 when executed from EL0 or EL1.

0 Does not cause System register access to the Trace functionality to be trapped.
1 Causes System register access to the Trace functionality to be trapped.

If system register access to trace functionality is not implemented, this bit is RES0.

Bits [27:22]

Reserved, RES0.

FPEN, bits [21:20]

Causes instructions that access the registers associated with Floating Point and Advanced SIMD execution to trap to EL1 when executed from EL0 or EL1.

- 00 Causes any instructions in EL0 or EL1 that use the registers associated with Floating Point and Advanced SIMD execution to be trapped.
- 01 Causes any instructions in EL0 that use the registers associated with Floating Point and Advanced SIMD execution to be trapped, but does not cause any instruction in EL1 to be trapped.
- 10 Causes any instructions in EL0 or EL1 that use the registers associated with Floating Point and Advanced SIMD execution to be trapped.
- 11 Does not cause any instruction to be trapped.

Bits [19:0]

Reserved, RES0.

Accessing the CPACR_EL1:

To access the CPACR_EL1:

MRS <Xt>, CPACR_EL1 ; Read CPACR_EL1 into Xt
MSR CPACR_EL1, <Xt> ; Write Xt to CPACR_EL1

Register access is encoded as follows:

op0	op1	CRn	CRm	op2
11	000	0001	0000	010

D8.2.18 CPTR_EL2, Architectural Feature Trap Register (EL2)

The CPTR_EL2 characteristics are:

Purpose

Controls trapping to EL2 of access to [CPACR](#), [CPACR_EL1](#), Trace functionality and registers associated with Floating Point and Advanced SIMD execution. Also controls EL2 access to this functionality.

This register is part of the Virtualization registers functional group.

Usage constraints

This register is accessible as shown below:

ELO	EL1 (NS)	EL1 (S)	EL2	EL3 (SCR.NS=1)	EL3 (SCR.NS=0)
-	-	-	RW	RW	RW

Configurations

CPTR_EL2 is architecturally mapped to AArch32 register [HCPTR](#).

If EL2 is not implemented, this register is RES0 from EL3.

Attributes

CPTR_EL2 is a 32-bit register.

The CPTR_EL2 bit assignments are:

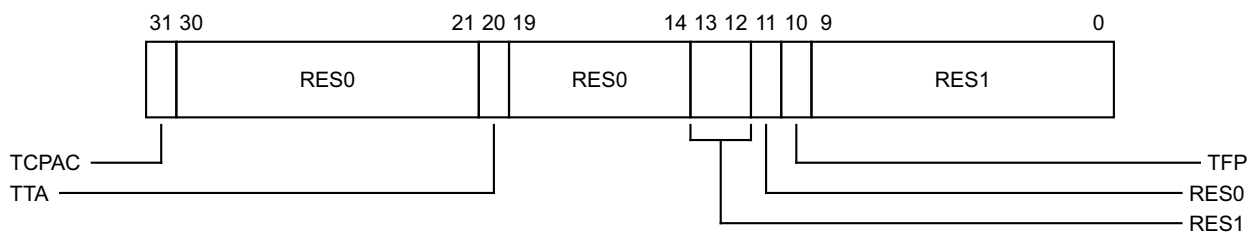

TCPAC, bit [31]

This causes a direct access to [CPACR](#) or [CPACR_EL1](#) from EL1 to trap to EL2. Possible values of this bit are:

- 0 Does not cause access to [CPACR](#) or [CPACR_EL1](#) to be trapped.
- 1 Causes access to [CPACR](#) or [CPACR_EL1](#) to be trapped.

Bits [30:21]

Reserved, RES0.

TTA, bit [20]

This causes access to the Trace functionality to trap to EL2 when executed from EL0, EL1, or EL2, unless already trapped to EL1. Possible values of this bit are:

- 0 Does not cause System register access to the Trace Functionality to be trapped.
- 1 Causes System register access to the Trace Functionality to be trapped.

If system register access to trace functionality is not supported, this bit is RES0.

Bits [19:14]

Reserved, RES0.

Bits [13:12]

Reserved, RES1.

Bit [11]

Reserved, RES0.

TFP, bit [10]

This causes instructions that access the registers associated with Floating Point and Advanced SIMD execution to trap to EL2 when executed from EL0, EL1, or EL2, unless trapped to EL1. Possible values of this bit are:

- 0 Does not cause any instruction to be trapped.
- 1 Causes any instructions that use the registers associated with Floating Point and Advanced SIMD execution to be trapped.

Bits [9:0]

Reserved, RES1.

Accessing the CPTR_EL2:

To access the CPTR_EL2:

MRS <Xt>, CPTR_EL2 ; Read CPTR_EL2 into Xt
MSR CPTR_EL2, <Xt> ; Write Xt to CPTR_EL2

Register access is encoded as follows:

op0	op1	CRn	CRm	op2
11	100	0001	0001	010

D8.2.19 CPTR_EL3, Architectural Feature Trap Register (EL3)

The CPTR_EL3 characteristics are:

Purpose

Controls trapping to EL3 of access to [CPACR_EL1](#), Trace functionality and registers associated with Floating Point and Advanced SIMD execution. Also controls EL3 access to this functionality.

This register is part of the Security registers functional group.

Usage constraints

This register is accessible as shown below:

EL0	EL1 (NS)	EL1 (S)	EL2	EL3 (SCR.NS=1)	EL3 (SCR.NS=0)
-	-	-	-	RW	RW

Configurations

There are no configuration notes.

Attributes

CPTR_EL3 is a 32-bit register.

The CPTR_EL3 bit assignments are:

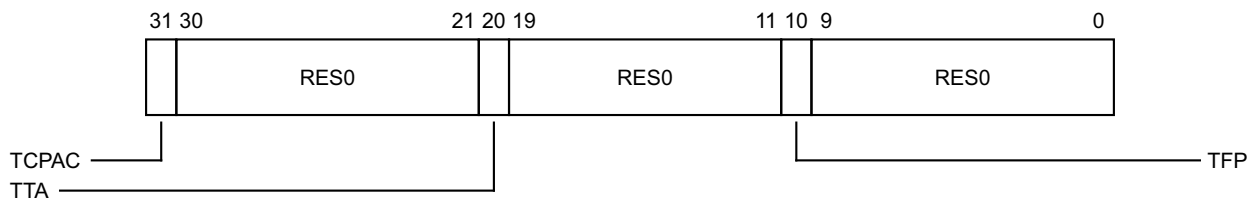

TCPAC, bit [31]

This causes a direct access to the [CPACR_EL1](#) from EL1 or the [CPTR_EL2](#) from EL2 to trap to EL3 unless it is trapped at EL2. Possible values of this bit are:

- 0 Does not cause access to the [CPACR_EL1](#) or [CPTR_EL2](#) to be trapped.
- 1 Causes access to the [CPACR_EL1](#) or [CPTR_EL2](#) to be trapped.

Bits [30:21]

Reserved, RES0.

TTA, bit [20]

This causes access to the Trace functionality to trap to EL3 when executed from EL0, EL1, EL2, or EL3, unless already trapped to EL1 or EL2. Possible values of this bit are:

- 0 Does not cause System register access to the Trace Functionality to be trapped.
- 1 Causes System register access to the Trace Functionality to be trapped.

If system register access to trace functionality is not supported, this bit is RES0.

Bits [19:11]

Reserved, RES0.

TFP, bit [10]

This causes instructions that access the registers associated with Floating Point and Advanced SIMD execution to trap to EL3 when executed from any exception level, unless trapped to EL1 or EL2. Possible values of this bit are:

- 0 Does not cause any instruction to be trapped.
- 1 Causes any instructions that use the registers associated with Floating Point and Advanced SIMD execution to be trapped.

Bits [9:0]

Reserved, RES0.

Accessing the CPTR_EL3:

To access the CPTR_EL3:

MRS <Xt>, CPTR_EL3 ; Read CPTR_EL3 into Xt
MSR CPTR_EL3, <Xt> ; Write Xt to CPTR_EL3

Register access is encoded as follows:

op0	op1	CRn	CRm	op2
11	110	0001	0001	010

D8.2.20 CSSELR_EL1, Cache Size Selection Register

The CSSELR_EL1 characteristics are:

Purpose

Selects the current Cache Size ID Register, [CCSIDR_EL1](#), by specifying the required cache level and the cache type (either instruction or data cache).

This register is part of the Identification registers functional group.

Usage constraints

This register is accessible as shown below:

EL0	EL1 (NS)	EL1 (S)	EL2	EL3 (SCR.NS=1)	EL3 (SCR.NS=0)
-	RW	RW	RW	RW	RW

Configurations

CSSELR_EL1 is architecturally mapped to AArch32 register [CSSELR](#) (NS).

Attributes

CSSELR_EL1 is a 32-bit register.

The CSSELR_EL1 bit assignments are:

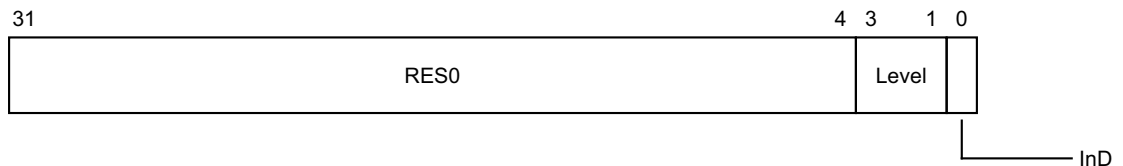

Bits [31:4]

Reserved, RES0.

Level, bits [3:1]

Cache level of required cache. Permitted values are from 0b000, indicating Level 1 cache, to 0b110 indicating Level 7 cache.

InD, bit [0]

Instruction not Data bit. Permitted values are:

- 0 Data or unified cache.
- 1 Instruction cache.

Accessing the CSSELR_EL1:

To access the CSSELR_EL1:

MRS <Xt>, CSSELR_EL1 ; Read CSSELR_EL1 into Xt
MSR CSSELR_EL1, <Xt> ; Write Xt to CSSELR_EL1

Register access is encoded as follows:

op0	op1	CRn	CRm	op2
11	010	0000	0000	000

D8.2.21 CTR_EL0, Cache Type Register

The CTR_EL0 characteristics are:

Purpose

Provides information about the architecture of the caches.

This register is part of the Identification registers functional group.

Usage constraints

This register is accessible as shown below:

EL0	EL1 (NS)	EL1 (S)	EL2	EL3 (SCR.NS=1)	EL3 (SCR.NS=0)
Config-RO	RO	RO	RO	RO	RO

This register is accessible at EL0 when [SCTLR_EL1.UCT](#) is set to 1.

Configurations

CTR_EL0 is architecturally mapped to AArch32 register [CTR](#).

Attributes

CTR_EL0 is a 32-bit register.

The CTR_EL0 bit assignments are:

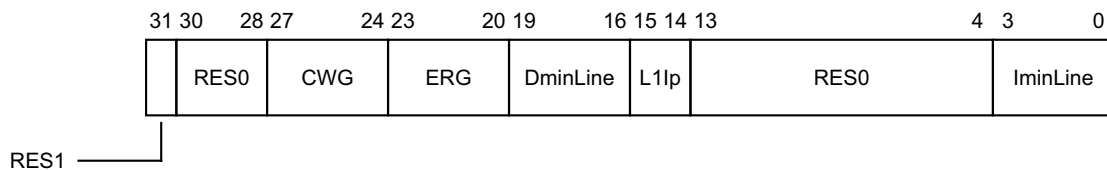

Bit [31]

Reserved, RES1.

Bits [30:28]

Reserved, RES0.

CWG, bits [27:24]

Cache Writeback Granule. \log_2 of the number of words of the maximum size of memory that can be overwritten as a result of the eviction of a cache entry that has had a memory location in it modified.

A value of `0b0000` indicates that this register does not provide Cache Writeback Granule information and either:

- The architectural maximum of 512 words (2Kbytes) must be assumed.
- The Cache Writeback Granule can be determined from maximum cache line size encoded in the Cache Size ID Registers.

Values greater than `0b1001` are reserved.

ERG, bits [23:20]

Exclusives Reservation Granule. \log_2 of the number of words of the maximum size of the reservation granule that has been implemented for the Load-Exclusive and Store-Exclusive instructions.

A value of `0b0000` indicates that this register does not provide Exclusives Reservation Granule information and the architectural maximum of 512 words (2Kbytes) must be assumed.

Values greater than 0b1001 are reserved.

DminLine, bits [19:16]

Log₂ of the number of words in the smallest cache line of all the data caches and unified caches that are controlled by the processor.

L1Ip, bits [15:14]

Level 1 instruction cache policy. Indicates the indexing and tagging policy for the L1 instruction cache. Possible values of this field are:

- 01 ASID-tagged Virtual Index, Virtual Tag (AIVIVT)
- 10 Virtual Index, Physical Tag (VIPT)
- 11 Physical Index, Physical Tag (PIPT)

Other values are reserved.

Bits [13:4]

Reserved, RES0.

IminLine, bits [3:0]

Log₂ of the number of words in the smallest cache line of all the instruction caches that are controlled by the processor.

Accessing the CTR_EL0:

To access the CTR_EL0:

MRS <Xt>, CTR_EL0 ; Read CTR_EL0 into Xt

Register access is encoded as follows:

op0	op1	CRn	CRm	op2
11	011	0000	0000	001

D8.2.22 DACR32_EL2, Domain Access Control Register

The DACR32_EL2 characteristics are:

Purpose

Allows access to the AArch32 [DACR](#) register from AArch64 state only. Its value has no effect on execution in AArch64 state.

This register is part of the Virtual memory control registers functional group.

Usage constraints

This register is accessible as shown below:

EL0	EL1 (NS)	EL1 (S)	EL2	EL3 (SCR.NS=1)	EL3 (SCR.NS=0)
-	-	-	RW	RW	RW

Configurations

DACR32_EL2 is architecturally mapped to AArch32 register [DACR](#) (NS).

If EL1 is AArch64 only, this register is UNDEFINED.

Attributes

DACR32_EL2 is a 32-bit register.

The DACR32_EL2 bit assignments are:

31	30	29	28	27	26	25	24	23	22	21	20	19	18	17	16	15	14	13	12	11	10	9	8	7	6	5	4	3	2	1	0	
D15	D14	D13	D12	D11	D10	D9	D8	D7	D6	D5	D4	D3	D2	D1	D0																	

D<n>, bits [2n+1:2n], for n = 0 to 15

Domain n access permission, where n = 0 to 15. Permitted values are:

00 No access. Any access to the domain generates a Domain fault.

01 Client. Accesses are checked against the permission bits in the translation tables.

11 Manager. Accesses are not checked against the permission bits in the translation tables.

The value 0b10 is reserved.

Accessing the DACR32_EL2:

To access the DACR32_EL2:

MRS <Xt>, DACR32_EL2 ; Read DACR32_EL2 into Xt

MSR DACR32_EL2, <Xt> ; Write Xt to DACR32_EL2

Register access is encoded as follows:

op0	op1	CRn	CRm	op2
11	100	0011	0000	000

D8.2.23 DCZID_EL0, Data Cache Zero ID register

The DCZID_EL0 characteristics are:

Purpose

Indicates the block size that is written with byte values of 0 by the [DC ZVA](#) (Data Cache Zero by Address) system instruction.

This register is part of the Identification registers functional group.

Usage constraints

This register is accessible as shown below:

EL0	EL1 (NS)	EL1 (S)	EL2	EL3 (SCR.NS=1)	EL3 (SCR.NS=0)
RO	RO	RO	RO	RO	RO

Configurations

There are no configuration notes.

Attributes

DCZID_EL0 is a 32-bit register.

The DCZID_EL0 bit assignments are:

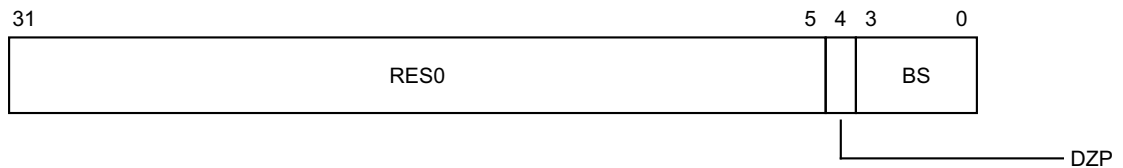

Bits [31:5]

Reserved, RES0.

DZP, bit [4]

Data Zero prohibited. Permitted values are:

0 [DC ZVA](#) instruction is permitted.

1 [DC ZVA](#) instruction is prohibited.

The value read from this field is governed by the access state and the values of the [HCR_EL2.TDZ](#) and [SCTLR_EL1.DZE](#) bits.

BS, bits [3:0]

\log_2 of the block size in words. The maximum size supported is 2 Kbytes (value == 9).

Accessing the DCZID_EL0:

To access the DCZID_EL0:

MRS <Xt>, DCZID_EL0 ; Read DCZID_EL0 into Xt

Register access is encoded as follows:

op0	op1	CRn	CRm	op2
11	011	0000	0000	111

D8.2.24 ESR_EL1, Exception Syndrome Register (EL1)

The ESR_EL1 characteristics are:

Purpose

Holds syndrome information for an exception taken to EL1.

This register is part of the Exception and fault handling registers functional group.

Usage constraints

This register is accessible as shown below:

ELO	EL1 (NS)	EL1 (S)	EL2	EL3 (SCR.NS=1)	EL3 (SCR.NS=0)
-	RW	RW	RW	RW	RW

When an UNPREDICTABLE instruction is treated as UNDEFINED, and the exception is taken to EL1, the value of ESR_EL1 is UNKNOWN. The value written to ESR_EL1 must be consistent with a value that could be created as a result of an exception from the same exception level that generated the exception as a result of a situation that is not UNPREDICTABLE at that exception level, in order to avoid the possibility of a privilege violation.

Configurations

ESR_EL1 is architecturally mapped to AArch32 register [DFSR](#) (NS).

Attributes

ESR_EL1 is a 32-bit register.

The ESR_EL1 bit assignments are:

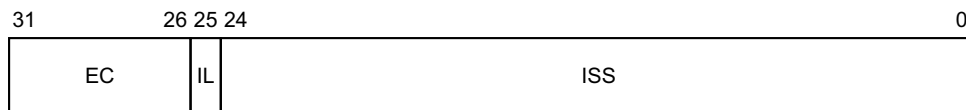

EC, bits [31:26]

Exception Class. Indicates the reason for the exception that this register holds information about. [Table D8-2](#) shows the encoding of this field. For each EC value, the table references a subsection of the section [Use of the ESR_EL1, ESR_EL2, and ESR_EL3](#) on page D1-1512 that gives information about:

- The cause of the exception, for example the configuration required to enable the trap.
- The encoding of the associated ISS.

Table D8-2 ESR_ELx.EC field encoding

EC	Exception class	From, state		To, Exception level			ISS description, or notes
		AArch32	AArch64	EL1	EL2	EL3	
0x00	Unknown reason	Yes	Yes	Yes	Yes	Yes	<i>Exceptions with an unknown reason on page D1-1517.</i>
0x01	WFI or WFE instruction execution ^a	Yes	Yes	Yes	Yes	Yes	<i>Exception from a WFI or WFE instruction, from AArch32 or AArch64 state on page D1-1518.</i>

Table D8-2 ESR_ELx.EC field encoding (continued)

EC	Exception class	From, state		To, Exception level			ISS description, or notes
		AArch32	AArch64	EL1	EL2	EL3	
0x03	MCR or MRC access to CP15 ^a that is not reported using EC 0x00	Yes	No	Yes	Yes	Yes ^b	<i>Exception from an MCR or MRC access from AArch32 state on page D1-1518.</i>
0x04	MCRR or MRRC access to CP15 ^a that is not reported using EC 0x00	Yes	No	Yes	Yes	Yes ^c	<i>Exception from an MCRR or MRRC access from AArch32 state on page D1-1519.</i>
0x05	MCR or MRC access to CP14 ^a	Yes	No	Yes	Yes	Yes	<i>Exception from an MCR or MRC access from AArch32 state on page D1-1518.</i>
0x06	LDC or STC access to CP14 ^a	Yes	No	Yes	Yes	Yes	<i>Exception from an LDC or STC access to CP14 from AArch32 state on page D1-1520.</i>
0x07	Access to SIMD or floating-point registers ^a , excluding (HCR_EL2.TGE==1) traps	Yes	Yes	Yes	Yes	Yes	<i>Exception from an access to SIMD or floating-point registers, from AArch32 or AArch64 on page D1-1521.</i>
0x08	MCR or MRC access to CP10 that is not reported using EC 0x07. This applies only to ID Group traps ^d	Yes	No	No	Yes	No	<i>Exception from an MCR or MRC access from AArch32 state on page D1-1518.</i>
0x0C	MRRC access to CP14 ^a	Yes	No	Yes	Yes	Yes	<i>Exception from an MCRR or MRRC access from AArch32 state on page D1-1519.</i>
0x0E	Illegal Execution State	Yes	Yes	Yes	Yes	Yes	<i>Exception from an illegal Execution state, misaligned PC, or misaligned stack pointer on page D1-1521.</i>
0x11	SVC instruction execution	Yes	No	Yes	Yes ^e	No	<i>Exception from HVC or SVC instruction execution on page D1-1522.</i>
0x12	HVC instruction execution, when HVC is not disabled	Yes	No	No	Yes	No	<i>Exception from HVC or SVC instruction execution on page D1-1522.</i>
0x13	SMC instruction execution, when SMC is not disabled	Yes	No	No	Yes ^f	Yes	<i>Exception from SMC instruction execution in AArch32 state on page D1-1522.</i>
0x15	SVC instruction execution	No	Yes	Yes	Yes	Yes	<i>Exception from HVC or SVC instruction execution on page D1-1522.</i>
0x16	HVC instruction execution, when HVC is not disabled	No	Yes	No	Yes	Yes	<i>Exception from HVC or SVC instruction execution on page D1-1522.</i>
0x17	SMC instruction execution, when SMC is not disabled	No	Yes	No	Yes ^f	Yes	<i>Exception from SMC instruction execution in AArch64 state on page D1-1523.</i>
0x18	MSR, MRS, or System instruction execution, that is not reported using EC 0x00, 0x01, or 0x07	No	Yes	Yes	Yes	Yes	<i>Exception from MSR, MRS, or System instruction execution in AArch64 state on page D1-1523.</i>

Table D8-2 ESR_ELx.EC field encoding (continued)

EC	Exception class	From, state		To, Exception level			ISS description, or notes
		AArch32	AArch64	EL1	EL2	EL3	
0x20	Instruction Abort from a lower Exception level ^g	Yes	Yes	Yes	Yes	Yes	<i>Exception from an Instruction abort on page D1-1524.</i>
0x21	Instruction Abort taken without a change in Exception level ^g	Yes	Yes	Yes	Yes	Yes	
0x22	Misaligned PC exception	Yes	Yes	Yes	Yes	Yes	<i>Exception from an illegal Execution state, misaligned PC, or misaligned stack pointer on page D1-1521.</i>
0x24	Data Abort from a lower Exception level ^h	Yes	Yes	Yes	Yes	Yes	<i>Exception from a Data abort on page D1-1525.</i>
0x25	Data Abort taken without a change in Exception level ^h	Yes	Yes	Yes	Yes	Yes	
0x26	Stack Pointer Alignment exception	Yes	Yes	Yes	Yes	Yes	<i>Exception from an illegal Execution state, misaligned PC, or misaligned stack pointer on page D1-1521.</i>
0x28	Floating-point exception, if supported	Yes	No	Yes	Yes	No	<i>Floating-point exceptions on page D1-1529.</i>
0x2C	Floating-point exception, if supported	No	Yes	Yes	Yes	Yes	
0x2F	SError interrupt	Yes ⁱ	Yes	Yes	Yes	Yes	<i>SError interrupt on page D1-1530.</i>
0x30	Breakpoint exception from a lower Exception level	Yes	Yes	Yes	Yes ^j	No	<i>Breakpoint exception or Vector Catch exception on page D1-1530.</i>
0x31	Breakpoint exception taken without a change in Exception level	Yes	Yes	Yes	Yes ^j	No	
0x32	Software Step exception from a lower Exception level	Yes	Yes	Yes	Yes ^j	No	<i>Software Step exception on page D1-1532.</i>
0x33	Software Step exception taken without a change in Exception level	Yes	Yes	Yes	Yes ^j	No	
0x34	Watchpoint exception from a lower Exception level	Yes	Yes	Yes	Yes ^j	No	<i>Watchpoint exception on page D1-1531.</i>
0x35	Watchpoint exception taken without a change in Exception level	Yes	Yes	Yes	Yes ^j	No	
0x38	BKPT instruction execution	Yes	No	Yes	Yes ^j	No	<i>Software Breakpoint Instruction exception on page D1-1532.</i>

Table D8-2 **ESR_ELx.EC** field encoding (continued)

EC	Exception class	From, state		To, Exception level			ISS description, or notes
		AArch32	AArch64	EL1	EL2	EL3	
0x3A	Vector catch exception from AArch32 state	Yes	No	No	Yes ^j	No	<i>Breakpoint exception or Vector Catch exception on page D1-1530.</i>
0x3C	BRK instruction execution	No	Yes	Yes	Yes ^j	Yes ^k	<i>Software Breakpoint Instruction exception on page D1-1532.</i>

- a. Exceptions caused by configurable traps, enables, or disables.
- b. See *Traps to EL3 of monitor functionality from Secure EL1 using AArch32* on page D1-1500.
- c. Only for MCRR or MRRC accesses to the **PMCCNTR_ELO** or **PMCCNTR**.
- d. Applies only to traps of accesses to **MVFR0**, **MVFR1**, **MVFR2**, or **FPSID**. Includes traps of VMRS accesses. Because the registers are read-only, there are no MCR accesses that can be trapped with this EC value.
- e. Only as a result of **HCR_EL2.TGE**.
- f. Only as a result of **HCR_EL2.TSC**.
- g. Used for MMU faults generated by instruction accesses, and for synchronous external aborts, including synchronous parity errors. Not used for debug-related exceptions.
- h. Used for MMU faults generated by data accesses, alignment faults other than stack pointer alignment faults, and for synchronous external aborts, including synchronous parity errors. Not used for debug-related exceptions.
- i. In AArch32 state, these are known as Asynchronous aborts.
- j. Only as a result of **HCR_EL2.TGE** ==1 or **MDCR_EL2.TDE** ==1.
- k. Only if the BRK instruction is executed in EL3. This is the only debug exception that can be taken to EL3 when EL3 is using AArch64.

Other EC values are reserved.

IL, bit [25]

Instruction Length for synchronous exceptions. Possible values of this bit are:

- | | | | | | |
|---|--|---|------------------------------|---|---|
| 0 | 16-bit instruction trapped. | | | | |
| 1 | 32-bit instruction trapped. This value also applies to the following exceptions: <ul style="list-style-type: none"> • An SError interrupt. • An Instruction Abort exception. • A Misaligned PC exception. • A Misaligned Stack Pointer exception. • A Data Abort for which the value of the ISV bit is 0. • An Illegal Execution State exception. • Any debug exception except for Software Breakpoint Instruction exceptions. For Software Breakpoint Instruction exceptions, this bit has its standard meaning: <table border="0" style="margin-left: 20px;"> <tr> <td style="padding-right: 20px;">0</td> <td>16-bit T32 BKPT instruction.</td> </tr> <tr> <td>1</td> <td>32-bit A32 BKPT instruction or A64 BRK instruction.</td> </tr> </table> • An exception reported using EC value 0b000000. | 0 | 16-bit T32 BKPT instruction. | 1 | 32-bit A32 BKPT instruction or A64 BRK instruction. |
| 0 | 16-bit T32 BKPT instruction. | | | | |
| 1 | 32-bit A32 BKPT instruction or A64 BRK instruction. | | | | |

ISS, bits [24:0]

Instruction Specific Syndrome. Architecturally, this field can be defined independently for each defined Exception class. However, in practice, some ISS encodings are used for more than one Exception class. See the description of the EC field for more information about the ISS formats. [Table D8-2 on page D8-1899](#) includes links to the ISS format descriptions.

Accessing the ESR_EL1:

To access the ESR_EL1:

MRS <Xt>, ESR_EL1 ; Read ESR_EL1 into Xt
MSR ESR_EL1, <Xt> ; Write Xt to ESR_EL1

Register access is encoded as follows:

op0	op1	CRn	CRm	op2
11	000	0101	0010	000

D8.2.25 ESR_EL2, Exception Syndrome Register (EL2)

The ESR_EL2 characteristics are:

Purpose

Holds syndrome information for an exception taken to EL2.

This register is part of:

- the Virtualization registers functional group
- the Exception and fault handling registers functional group.

Usage constraints

This register is accessible as shown below:

EL0	EL1 (NS)	EL1 (S)	EL2	EL3 (SCR.NS=1)	EL3 (SCR.NS=0)
-	-	-	RW	RW	RW

When an UNPREDICTABLE instruction is treated as UNDEFINED, and the exception is taken to EL2, the value of ESR_EL2 is UNKNOWN. The value written to ESR_EL2 must be consistent with a value that could be created as a result of an exception from the same exception level that generated the exception as a result of a situation that is not UNPREDICTABLE at that exception level, in order to avoid the possibility of a privilege violation.

Configurations

ESR_EL2 is architecturally mapped to AArch32 register [HSR](#).

If EL2 is not implemented, this register is RES0 from EL3.

Attributes

ESR_EL2 is a 32-bit register.

The ESR_EL2 bit assignments are:

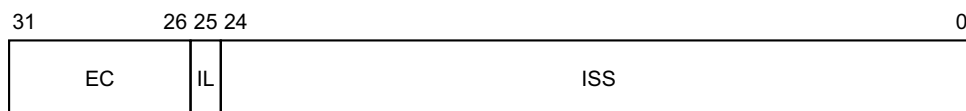

EC, bits [31:26]

Exception Class. Indicates the reason for the exception that this register holds information about. [Table D8-3](#) shows the encoding of this field. For each EC value, the table references a subsection of the section *Use of the ESR_EL1, ESR_EL2, and ESR_EL3* on page D1-1512 that gives information about:

- The cause of the exception, for example the configuration required to enable the trap.
- The encoding of the associated ISS.

Table D8-3 ESR_ELx.EC field encoding

EC	Exception class	From, state		To, Exception level			ISS description, or notes
		AArch32	AArch64	EL1	EL2	EL3	
0x00	Unknown reason	Yes	Yes	Yes	Yes	Yes	<i>Exceptions with an unknown reason on page D1-1517.</i>

Table D8-3 **ESR_ELx.EC** field encoding (continued)

EC	Exception class	From, state		To, Exception level			ISS description, or notes
		AArch32	AArch64	EL1	EL2	EL3	
0x01	WFI or WFE instruction execution ^a	Yes	Yes	Yes	Yes	Yes	<i>Exception from a WFI or WFE instruction, from AArch32 or AArch64 state on page D1-1518.</i>
0x03	MCR or MRC access to CP15 ^a that is not reported using EC 0x00	Yes	No	Yes	Yes	Yes ^b	<i>Exception from an MCR or MRC access from AArch32 state on page D1-1518.</i>
0x04	MCRR or MRRC access to CP15 ^a that is not reported using EC 0x00	Yes	No	Yes	Yes	Yes ^c	<i>Exception from an MCRR or MRRC access from AArch32 state on page D1-1519.</i>
0x05	MCR or MRC access to CP14 ^a	Yes	No	Yes	Yes	Yes	<i>Exception from an MCR or MRC access from AArch32 state on page D1-1518.</i>
0x06	LDC or STC access to CP14 ^a	Yes	No	Yes	Yes	Yes	<i>Exception from an LDC or STC access to CP14 from AArch32 state on page D1-1520.</i>
0x07	Access to SIMD or floating-point registers ^a , excluding (HCR_EL2.TGE==1) traps	Yes	Yes	Yes	Yes	Yes	<i>Exception from an access to SIMD or floating-point registers, from AArch32 or AArch64 on page D1-1521.</i>
0x08	MCR or MRC access to CP10 that is not reported using EC 0x07. This applies only to ID Group traps ^d	Yes	No	No	Yes	No	<i>Exception from an MCR or MRC access from AArch32 state on page D1-1518.</i>
0x0C	MRRC access to CP14 ^a	Yes	No	Yes	Yes	Yes	<i>Exception from an MCRR or MRRC access from AArch32 state on page D1-1519.</i>
0x0E	Illegal Execution State	Yes	Yes	Yes	Yes	Yes	<i>Exception from an illegal Execution state, misaligned PC, or misaligned stack pointer on page D1-1521.</i>
0x11	SVC instruction execution	Yes	No	Yes	Yes ^e	No	<i>Exception from HVC or SVC instruction execution on page D1-1522.</i>
0x12	HVC instruction execution, when HVC is not disabled	Yes	No	No	Yes	No	<i>Exception from HVC or SVC instruction execution on page D1-1522.</i>
0x13	SMC instruction execution, when SMC is not disabled	Yes	No	No	Yes ^f	Yes	<i>Exception from SMC instruction execution in AArch32 state on page D1-1522.</i>
0x15	SVC instruction execution	No	Yes	Yes	Yes	Yes	<i>Exception from HVC or SVC instruction execution on page D1-1522.</i>
0x16	HVC instruction execution, when HVC is not disabled	No	Yes	No	Yes	Yes	<i>Exception from HVC or SVC instruction execution on page D1-1522.</i>
0x17	SMC instruction execution, when SMC is not disabled	No	Yes	No	Yes ^f	Yes	<i>Exception from SMC instruction execution in AArch64 state on page D1-1523.</i>

Table D8-3 ESR_ELx.EC field encoding (continued)

EC	Exception class	From, state		To, Exception level			ISS description, or notes
		AArch32	AArch64	EL1	EL2	EL3	
0x18	MSR, MRS, or System instruction execution, that is not reported using EC 0x00, 0x01, or 0x07	No	Yes	Yes	Yes	Yes	<i>Exception from MSR, MRS, or System instruction execution in AArch64 state on page D1-1523.</i>
0x20	Instruction Abort from a lower Exception level ^g	Yes	Yes	Yes	Yes	Yes	<i>Exception from an Instruction abort on page D1-1524.</i>
0x21	Instruction Abort taken without a change in Exception level ^g	Yes	Yes	Yes	Yes	Yes	
0x22	Misaligned PC exception	Yes	Yes	Yes	Yes	Yes	<i>Exception from an illegal Execution state, misaligned PC, or misaligned stack pointer on page D1-1521.</i>
0x24	Data Abort from a lower Exception level ^h	Yes	Yes	Yes	Yes	Yes	<i>Exception from a Data abort on page D1-1525.</i>
0x25	Data Abort taken without a change in Exception level ^h	Yes	Yes	Yes	Yes	Yes	
0x26	Stack Pointer Alignment exception	Yes	Yes	Yes	Yes	Yes	<i>Exception from an illegal Execution state, misaligned PC, or misaligned stack pointer on page D1-1521.</i>
0x28	Floating-point exception, if supported	Yes	No	Yes	Yes	No	<i>Floating-point exceptions on page D1-1529.</i>
0x2C	Floating-point exception, if supported	No	Yes	Yes	Yes	Yes	
0x2F	SError interrupt	Yes ⁱ	Yes	Yes	Yes	Yes	<i>SError interrupt on page D1-1530.</i>
0x30	Breakpoint exception from a lower Exception level	Yes	Yes	Yes	Yes ^j	No	<i>Breakpoint exception or Vector Catch exception on page D1-1530.</i>
0x31	Breakpoint exception taken without a change in Exception level	Yes	Yes	Yes	Yes ^j	No	
0x32	Software Step exception from a lower Exception level	Yes	Yes	Yes	Yes ^j	No	<i>Software Step exception on page D1-1532.</i>
0x33	Software Step exception taken without a change in Exception level	Yes	Yes	Yes	Yes ^j	No	
0x34	Watchpoint exception from a lower Exception level	Yes	Yes	Yes	Yes ^j	No	<i>Watchpoint exception on page D1-1531.</i>
0x35	Watchpoint exception taken without a change in Exception level	Yes	Yes	Yes	Yes ^j	No	

Table D8-3 **ESR_ELx.EC** field encoding (continued)

EC	Exception class	From, state		To, Exception level			ISS description, or notes
		AArch32	AArch64	EL1	EL2	EL3	
0x38	BKPT instruction execution	Yes	No	Yes	Yes ^j	No	<i>Software Breakpoint Instruction exception on page D1-1532.</i>
0x3A	Vector catch exception from AArch32 state	Yes	No	No	Yes ^j	No	<i>Breakpoint exception or Vector Catch exception on page D1-1530.</i>
0x3C	BRK instruction execution	No	Yes	Yes	Yes ^j	Yes ^k	<i>Software Breakpoint Instruction exception on page D1-1532.</i>

- a. Exceptions caused by configurable traps, enables, or disables.
- b. See *Traps to EL3 of monitor functionality from Secure EL1 using AArch32* on page D1-1500.
- c. Only for MCRR or MRRC accesses to the **PMCCNTR_ELO** or **PMCCNTR**.
- d. Applies only to traps of accesses to **MVFR0**, **MVFR1**, **MVFR2**, or **FPSID**. Includes traps of VMRS accesses. Because the registers are read-only, there are no MCR accesses that can be trapped with this EC value.
- e. Only as a result of **HCR_EL2.TGE**.
- f. Only as a result of **HCR_EL2.TSC**.
- g. Used for MMU faults generated by instruction accesses, and for synchronous external aborts, including synchronous parity errors. Not used for debug-related exceptions.
- h. Used for MMU faults generated by data accesses, alignment faults other than stack pointer alignment faults, and for synchronous external aborts, including synchronous parity errors. Not used for debug-related exceptions.
- i. In AArch32 state, these are known as Asynchronous aborts.
- j. Only as a result of **HCR_EL2.TGE** == 1 or **MDCR_EL2.TDE** == 1.
- k. Only if the BRK instruction is executed in EL3. This is the only debug exception that can be taken to EL3 when EL3 is using AArch64.

Other EC values are reserved.

IL, bit [25]

Instruction Length for synchronous exceptions. Possible values of this bit are:

- | | |
|---|--|
| 0 | 16-bit instruction trapped. |
| 1 | 32-bit instruction trapped. This value also applies to the following exceptions: |
- An SError interrupt.
 - An Instruction Abort exception.
 - A Misaligned PC exception.
 - A Misaligned Stack Pointer exception.
 - A Data Abort for which the value of the ISV bit is 0.
 - An Illegal Execution State exception.
 - Any debug exception except for Software Breakpoint Instruction exceptions. For Software Breakpoint Instruction exceptions, this bit has its standard meaning:

0	16-bit T32 BKPT instruction.
1	32-bit A32 BKPT instruction or A64 BRK instruction.
 - An exception reported using EC value **0b000000**.

ISS, bits [24:0]

Instruction Specific Syndrome. Architecturally, this field can be defined independently for each defined Exception class. However, in practice, some ISS encodings are used for more than one Exception class. See the description of the EC field for more information about the ISS formats. [Table D8-2 on page D8-1899](#) includes links to the ISS format descriptions.

Accessing the ESR_EL2:

To access the ESR_EL2:

MRS <Xt>, ESR_EL2 ; Read ESR_EL2 into Xt
MSR ESR_EL2, <Xt> ; Write Xt to ESR_EL2

Register access is encoded as follows:

op0	op1	CRn	CRm	op2
11	100	0101	0010	000

D8.2.26 ESR_EL3, Exception Syndrome Register (EL3)

The ESR_EL3 characteristics are:

Purpose

Holds syndrome information for an exception taken to EL3.

This register is part of the Exception and fault handling registers functional group.

Usage constraints

This register is accessible as shown below:

ELO	EL1 (NS)	EL1 (S)	EL2	EL3 (SCR.NS=1)	EL3 (SCR.NS=0)
-	-	-	-	RW	RW

When an UNPREDICTABLE instruction is treated as UNDEFINED, and the exception is taken to EL3, the value of ESR_EL3 is UNKNOWN. The value written to ESR_EL3 must be consistent with a value that could be created as a result of an exception from the same exception level that generated the exception as a result of a situation that is not UNPREDICTABLE at that exception level, in order to avoid the possibility of a privilege violation.

Configurations

ESR_EL3 can be mapped to AArch32 register [DFSR](#) (S), but this is not architecturally mandated.

Attributes

ESR_EL3 is a 32-bit register.

The ESR_EL3 bit assignments are:

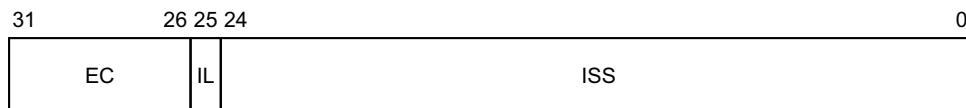

EC, bits [31:26]

Exception Class. Indicates the reason for the exception that this register holds information about. [Table D8-4](#) shows the encoding of this field. For each EC value, the table references a subsection of the section [Use of the ESR_EL1, ESR_EL2, and ESR_EL3](#) on page D1-1512 that gives information about:

- The cause of the exception, for example the configuration required to enable the trap.
- The encoding of the associated ISS.

Table D8-4 ESR_ELx.EC field encoding

EC	Exception class	From, state		To, Exception level			ISS description, or notes
		AArch32	AArch64	EL1	EL2	EL3	
0x00	Unknown reason	Yes	Yes	Yes	Yes	Yes	<i>Exceptions with an unknown reason on page D1-1517.</i>
0x01	WFI or WFE instruction execution ^a	Yes	Yes	Yes	Yes	Yes	<i>Exception from a WFI or WFE instruction, from AArch32 or AArch64 state on page D1-1518.</i>

Table D8-4 ESR_ELx.EC field encoding (continued)

EC	Exception class	From, state		To, Exception level			ISS description, or notes
		AArch32	AArch64	EL1	EL2	EL3	
0x03	MCR or MRC access to CP15 ^a that is not reported using EC 0x00	Yes	No	Yes	Yes	Yes ^b	<i>Exception from an MCR or MRC access from AArch32 state on page D1-1518.</i>
0x04	MCRR or MRRC access to CP15 ^a that is not reported using EC 0x00	Yes	No	Yes	Yes	Yes ^c	<i>Exception from an MCRR or MRRC access from AArch32 state on page D1-1519.</i>
0x05	MCR or MRC access to CP14 ^a	Yes	No	Yes	Yes	Yes	<i>Exception from an MCR or MRC access from AArch32 state on page D1-1518.</i>
0x06	LDC or STC access to CP14 ^a	Yes	No	Yes	Yes	Yes	<i>Exception from an LDC or STC access to CP14 from AArch32 state on page D1-1520.</i>
0x07	Access to SIMD or floating-point registers ^a , excluding (HCR_EL2.TGE==1) traps	Yes	Yes	Yes	Yes	Yes	<i>Exception from an access to SIMD or floating-point registers, from AArch32 or AArch64 on page D1-1521.</i>
0x08	MCR or MRC access to CP10 that is not reported using EC 0x07. This applies only to ID Group traps ^d	Yes	No	No	Yes	No	<i>Exception from an MCR or MRC access from AArch32 state on page D1-1518.</i>
0x0C	MRRC access to CP14 ^a	Yes	No	Yes	Yes	Yes	<i>Exception from an MCRR or MRRC access from AArch32 state on page D1-1519.</i>
0x0E	Illegal Execution State	Yes	Yes	Yes	Yes	Yes	<i>Exception from an illegal Execution state, misaligned PC, or misaligned stack pointer on page D1-1521.</i>
0x11	SVC instruction execution	Yes	No	Yes	Yes ^e	No	<i>Exception from HVC or SVC instruction execution on page D1-1522.</i>
0x12	HVC instruction execution, when HVC is not disabled	Yes	No	No	Yes	No	<i>Exception from HVC or SVC instruction execution on page D1-1522.</i>
0x13	SMC instruction execution, when SMC is not disabled	Yes	No	No	Yes ^f	Yes	<i>Exception from SMC instruction execution in AArch32 state on page D1-1522.</i>
0x15	SVC instruction execution	No	Yes	Yes	Yes	Yes	<i>Exception from HVC or SVC instruction execution on page D1-1522.</i>
0x16	HVC instruction execution, when HVC is not disabled	No	Yes	No	Yes	Yes	<i>Exception from HVC or SVC instruction execution on page D1-1522.</i>
0x17	SMC instruction execution, when SMC is not disabled	No	Yes	No	Yes ^f	Yes	<i>Exception from SMC instruction execution in AArch64 state on page D1-1523.</i>
0x18	MSR, MRS, or System instruction execution, that is not reported using EC 0x00, 0x01, or 0x07	No	Yes	Yes	Yes	Yes	<i>Exception from MSR, MRS, or System instruction execution in AArch64 state on page D1-1523.</i>

Table D8-4 ESR_ELx.EC field encoding (continued)

EC	Exception class	From, state		To, Exception level			ISS description, or notes
		AArch32	AArch64	EL1	EL2	EL3	
0x20	Instruction Abort from a lower Exception level ^g	Yes	Yes	Yes	Yes	Yes	<i>Exception from an Instruction abort on page D1-1524.</i>
0x21	Instruction Abort taken without a change in Exception level ^g	Yes	Yes	Yes	Yes	Yes	
0x22	Misaligned PC exception	Yes	Yes	Yes	Yes	Yes	<i>Exception from an illegal Execution state, misaligned PC, or misaligned stack pointer on page D1-1521.</i>
0x24	Data Abort from a lower Exception level ^h	Yes	Yes	Yes	Yes	Yes	<i>Exception from a Data abort on page D1-1525.</i>
0x25	Data Abort taken without a change in Exception level ^h	Yes	Yes	Yes	Yes	Yes	
0x26	Stack Pointer Alignment exception	Yes	Yes	Yes	Yes	Yes	<i>Exception from an illegal Execution state, misaligned PC, or misaligned stack pointer on page D1-1521.</i>
0x28	Floating-point exception, if supported	Yes	No	Yes	Yes	No	<i>Floating-point exceptions on page D1-1529.</i>
0x2C	Floating-point exception, if supported	No	Yes	Yes	Yes	Yes	
0x2F	SError interrupt	Yes ⁱ	Yes	Yes	Yes	Yes	<i>SError interrupt on page D1-1530.</i>
0x30	Breakpoint exception from a lower Exception level	Yes	Yes	Yes	Yes ^j	No	<i>Breakpoint exception or Vector Catch exception on page D1-1530.</i>
0x31	Breakpoint exception taken without a change in Exception level	Yes	Yes	Yes	Yes ^j	No	
0x32	Software Step exception from a lower Exception level	Yes	Yes	Yes	Yes ^j	No	<i>Software Step exception on page D1-1532.</i>
0x33	Software Step exception taken without a change in Exception level	Yes	Yes	Yes	Yes ^j	No	
0x34	Watchpoint exception from a lower Exception level	Yes	Yes	Yes	Yes ^j	No	<i>Watchpoint exception on page D1-1531.</i>
0x35	Watchpoint exception taken without a change in Exception level	Yes	Yes	Yes	Yes ^j	No	
0x38	BKPT instruction execution	Yes	No	Yes	Yes ^j	No	<i>Software Breakpoint Instruction exception on page D1-1532.</i>

Table D8-4 **ESR_ELx.EC** field encoding (continued)

EC	Exception class	From, state		To, Exception level			ISS description, or notes
		AArch32	AArch64	EL1	EL2	EL3	
0x3A	Vector catch exception from AArch32 state	Yes	No	No	Yes ^j	No	<i>Breakpoint exception or Vector Catch exception on page D1-1530.</i>
0x3C	BRK instruction execution	No	Yes	Yes	Yes ^j	Yes ^k	<i>Software Breakpoint Instruction exception on page D1-1532.</i>

- a. Exceptions caused by configurable traps, enables, or disables.
- b. See *Traps to EL3 of monitor functionality from Secure EL1 using AArch32* on page D1-1500.
- c. Only for MCRR or MRRC accesses to the **PMCCNTR_EL0** or **PMCCNTR**.
- d. Applies only to traps of accesses to **MVFR0**, **MVFR1**, **MVFR2**, or **FPSID**. Includes traps of VMRS accesses. Because the registers are read-only, there are no MCR accesses that can be trapped with this EC value.
- e. Only as a result of **HCR_EL2.TGE**.
- f. Only as a result of **HCR_EL2.TSC**.
- g. Used for MMU faults generated by instruction accesses, and for synchronous external aborts, including synchronous parity errors. Not used for debug-related exceptions.
- h. Used for MMU faults generated by data accesses, alignment faults other than stack pointer alignment faults, and for synchronous external aborts, including synchronous parity errors. Not used for debug-related exceptions.
- i. In AArch32 state, these are known as Asynchronous aborts.
- j. Only as a result of **HCR_EL2.TGE** ==1 or **MDCR_EL2.TDE** ==1.
- k. Only if the BRK instruction is executed in EL3. This is the only debug exception that can be taken to EL3 when EL3 is using AArch64.

Other EC values are reserved.

IL, bit [25]

Instruction Length for synchronous exceptions. Possible values of this bit are:

- 0 16-bit instruction trapped.
- 1 32-bit instruction trapped. This value also applies to the following exceptions:
 - An SError interrupt.
 - An Instruction Abort exception.
 - A Misaligned PC exception.
 - A Misaligned Stack Pointer exception.
 - A Data Abort for which the value of the ISV bit is 0.
 - An Illegal Execution State exception.
 - Any debug exception except for Software Breakpoint Instruction exceptions. For Software Breakpoint Instruction exceptions, this bit has its standard meaning:
 - 0 16-bit T32 BKPT instruction.
 - 1 32-bit A32 BKPT instruction or A64 BRK instruction.
 - An exception reported using EC value 0b000000.

ISS, bits [24:0]

Instruction Specific Syndrome. Architecturally, this field can be defined independently for each defined Exception class. However, in practice, some ISS encodings are used for more than one Exception class. See the description of the EC field for more information about the ISS formats. [Table D8-2 on page D8-1899](#) includes links to the ISS format descriptions.

Accessing the ESR_EL3:

To access the ESR_EL3:

MRS <Xt>, ESR_EL3 ; Read ESR_EL3 into Xt
MSR ESR_EL3, <Xt> ; Write Xt to ESR_EL3

Register access is encoded as follows:

op0	op1	CRn	CRm	op2
11	110	0101	0010	000

D8.2.27 FAR_EL1, Fault Address Register (EL1)

The FAR_EL1 characteristics are:

Purpose

Holds the faulting Virtual Address for all synchronous instruction or data aborts, or exceptions from a misaligned PC or a Watchpoint debug event, taken to EL1.

This register is part of the Exception and fault handling registers functional group.

Usage constraints

This register is accessible as shown below:

EL0	EL1 (NS)	EL1 (S)	EL2	EL3 (SCR.NS=1)	EL3 (SCR.NS=0)
-	RW	RW	RW	RW	RW

Configurations

FAR_EL1[31:0] is architecturally mapped to AArch32 register [DFAR](#) (NS).

FAR_EL1[63:32] is architecturally mapped to AArch32 register [IFAR](#) (NS).

Attributes

FAR_EL1 is a 64-bit register.

The FAR_EL1 bit assignments are:

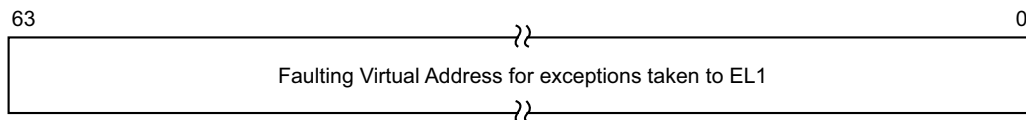

Bits [63:0]

Faulting Virtual Address for exceptions taken to EL1. Exceptions that set the FAR_EL1 are all synchronous instruction aborts or data aborts, an exception from a misaligned PC, or a Watchpoint debug event.

If a memory fault that sets FAR_EL1 is generated from one of the data cache instructions, this field holds the address specified in the register argument of the instruction.

Accessing the FAR_EL1:

To access the FAR_EL1:

MRS <Xt>, FAR_EL1 ; Read FAR_EL1 into Xt
MSR FAR_EL1, <Xt> ; Write Xt to FAR_EL1

Register access is encoded as follows:

op0	op1	CRn	CRm	op2
11	000	0110	0000	000

D8.2.28 FAR_EL2, Fault Address Register (EL2)

The FAR_EL2 characteristics are:

Purpose

Holds the faulting Virtual Address for all synchronous instruction or data aborts, or exceptions from a misaligned PC or a Watchpoint debug event, taken to EL2.

This register is part of:

- the Virtualization registers functional group
- the Exception and fault handling registers functional group.

Usage constraints

This register is accessible as shown below:

EL0	EL1 (NS)	EL1 (S)	EL2	EL3 (SCR.NS=1)	EL3 (SCR.NS=0)
-	-	-	RW	RW	RW

Configurations

FAR_EL2[31:0] is architecturally mapped to AArch32 register [HDFAR](#).

FAR_EL2[63:32] is architecturally mapped to AArch32 register [HIFAR](#).

FAR_EL2[31:0] is architecturally mapped to AArch32 register [DFAR](#) (S) when EL2 is implemented.

FAR_EL2[63:32] is architecturally mapped to AArch32 register [IFAR](#) (S) when EL2 is implemented.

If EL2 is not implemented, this register is RES0 from EL3.

Attributes

FAR_EL2 is a 64-bit register.

The FAR_EL2 bit assignments are:

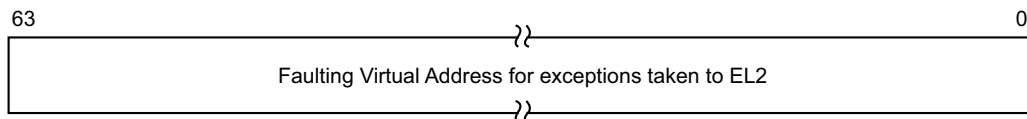

Bits [63:0]

Faulting Virtual Address for exceptions taken to EL2. Exceptions that set the FAR_EL2 are all synchronous instruction aborts or data aborts, an exception from a misaligned PC, or a Watchpoint debug event.

If a memory fault that sets FAR_EL2 is generated from one of the data cache instructions, this field holds the address specified in the register argument of the instruction.

Accessing the FAR_EL2:

To access the FAR_EL2:

MRS <Xt>, FAR_EL2 ; Read FAR_EL2 into Xt
MSR FAR_EL2, <Xt> ; Write Xt to FAR_EL2

Register access is encoded as follows:

op0	op1	CRn	CRm	op2
11	100	0110	0000	000

D8.2.29 FAR_EL3, Fault Address Register (EL3)

The FAR_EL3 characteristics are:

Purpose

Holds the faulting Virtual Address for all synchronous instruction or data aborts, or exceptions from a misaligned PC, taken to EL3.

This register is part of the Exception and fault handling registers functional group.

Usage constraints

This register is accessible as shown below:

EL0	EL1 (NS)	EL1 (S)	EL2	EL3 (SCR.NS=1)	EL3 (SCR.NS=0)
-	-	-	-	RW	RW

Configurations

FAR_EL3[31:0] can be mapped to AArch32 register [DFAR](#) (S) when EL2 is not implemented, but this is not architecturally mandated.

FAR_EL3[63:32] can be mapped to AArch32 register [IFAR](#) (S) when EL2 is not implemented, but this is not architecturally mandated.

Attributes

FAR_EL3 is a 64-bit register.

The FAR_EL3 bit assignments are:

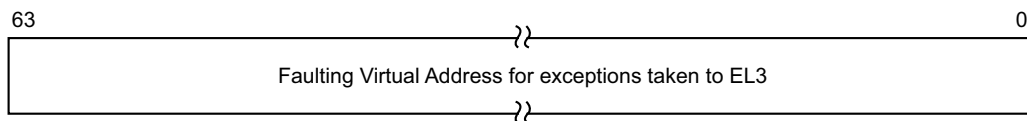

Bits [63:0]

Faulting Virtual Address for exceptions taken to EL3. Exceptions that set the FAR_EL3 are all synchronous instruction aborts or data aborts, or an exception from a misaligned PC.

If a memory fault that sets FAR_EL3 is generated from one of the data cache instructions, this field holds the address specified in the register argument of the instruction.

Accessing the FAR_EL3:

To access the FAR_EL3:

MRS <Xt>, FAR_EL3 ; Read FAR_EL3 into Xt
MSR FAR_EL3, <Xt> ; Write Xt to FAR_EL3

Register access is encoded as follows:

op0	op1	CRn	CRm	op2
11	110	0110	0000	000

D8.2.30 FPEXC32_EL2, Floating-point Exception Control register

The FPEXC32_EL2 characteristics are:

Purpose

Allows access to the AArch32 register [FPEXC](#) from AArch64 state only. Its value has no effect on execution in AArch64 state.

This register is part of the Floating-point registers functional group.

Usage constraints

This register is accessible as shown below:

EL0	EL1 (NS)	EL1 (S)	EL2	EL3 (SCR.NS=1)	EL3 (SCR.NS=0)
-	-	-	RW	RW	RW

If EL1 only supports AArch64 execution, this register is UNDEFINED.

Configurations

FPEXC32_EL2 is architecturally mapped to AArch32 register [FPEXC](#).

Attributes

FPEXC32_EL2 is a 32-bit register.

The FPEXC32_EL2 bit assignments are:

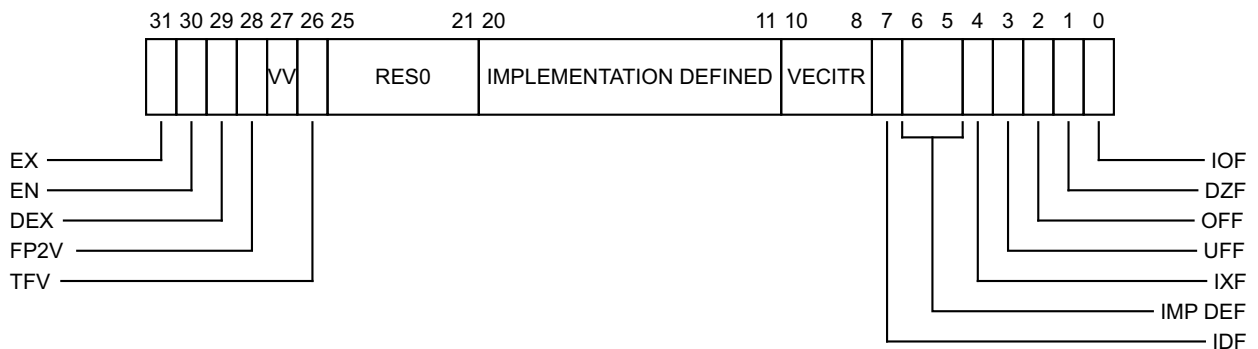

EX, bit [31]

Exception bit. A status bit that specifies how much information must be saved to record the state of the Advanced SIMD and VFP system:

- 0 The only significant state is the contents of the registers D0 - D31, [FPSCR](#), and [FPEXC](#). A context switch can be performed by saving and restoring the values of these registers.
- 1 There is additional state that must be handled by any context switch system.

In ARMv8, this bit must be RES0.

EN, bit [30]

Enable bit. A global enable for the Advanced SIMD and VFP extensions:

- 0 The Advanced SIMD and VFP extensions are disabled.
- 1 The Advanced SIMD and VFP extensions are enabled and operate normally.

This bit is made obsolete by the features in the CPACR when executing in AArch64.

When executing in EL0 using AArch32 with EL1 using AArch64, the behavior is as if the [FPEXC.EN](#) bit is set.

DEX, bit [29]

Defined synchronous instruction exception bit.

When a floating-point synchronous exception has occurred, if the exception was caused by an allocated floating-point instruction that is not implemented in hardware then it is IMPLEMENTATION DEFINED whether DEX is set to 0 or 1.

Otherwise, the meaning of this bit is:

- 0 A synchronous exception occurred when processing an unallocated floating-point or Advanced SIMD instruction.
- 1 A synchronous exception occurred on an allocated floating-point instruction that encountered an exceptional condition.

The exception-handling routine must clear DEX to 0.

In an implementation that does not require synchronous exception handling this bit is RES0.

FP2V, bit [28]

FPINST2 instruction valid bit. In ARMv8, this field is always RES0.

VV, bit [27]

VECITR valid bit. In ARMv8, this field is always RES0.

TFV, bit [26]

Trapped Fault Valid bit. Indicates whether FPEXC bits[7, 4:0] indicate trapped exceptions, or have an IMPLEMENTATION DEFINED meaning:

- 0 FPEXC bits[7, 4:0] have an IMPLEMENTATION DEFINED meaning
- 1 FPEXC bits[7, 4:0] indicate the presence of trapped exceptions that have occurred at the time of the exception. All trapped exceptions that occurred at the time of the exception have their bits set.

This bit has a fixed value and ignores writes.

Bits [25:21]

Reserved, RES0.

VECITR, bits [10:8]

Vector iteration count. In ARMv8, this field is always RES1.

IDF, bit [7]

Input Denormal trapped exception bit, or IMPLEMENTATION DEFINED. The meaning of this bit depends on the value of FPEXC.TFV.

If FPEXC.TFV is 0, this bit is IMPLEMENTATION DEFINED and can contain IMPLEMENTATION DEFINED information about the cause of an exception.

If FPEXC.TFV is 1, this bit is the Input Denormal trapped exception bit, and indicates whether an Input Denormal exception occurred while FPSCR.IDE was 1:

- 0 Input denormal exception has not occurred.
- 1 Input denormal exception has occurred.

Input Denormal exceptions can occur only when FPSCR.FZ is 1.

In both cases this bit must be cleared to 0 by the exception-handling routine.

IXF, bit [4]

Inexact trapped exception bit, or IMPLEMENTATION DEFINED. The meaning of this bit depends on the value of FPEXC.TFV.

If FPEXC.TFV is 0, this bit is IMPLEMENTATION DEFINED and can contain IMPLEMENTATION DEFINED information about the cause of an exception.

If FPEXC.TFV is 1, this bit is the Inexact trapped exception bit, and indicates whether an Inexact exception occurred while FPSCR.IXE was 1:

In this case, the meaning of this bit is:

0 Inexact exception has not occurred.

1 Inexact exception has occurred.

In both cases this bit must be cleared to 0 by the exception-handling routine.

UFF, bit [3]

Underflow trapped exception bit, or IMPLEMENTATION DEFINED. The meaning of this bit depends on the value of FPEXC.TFV.

If FPEXC.TFV is 0, this bit is IMPLEMENTATION DEFINED and can contain IMPLEMENTATION DEFINED information about the cause of an exception.

If FPEXC.TFV is 1, this bit is the Underflow trapped exception bit, and indicates whether an Underflow exception occurred while FPSCR.UFE was 1:

0 Underflow exception has not occurred.

1 Underflow exception has occurred.

Underflow trapped exceptions can occur only when FPSCR.FZ is 0.

In both cases this bit must be cleared to 0 by the exception-handling routine.

OFF, bit [2]

Overflow trapped exception bit, or IMPLEMENTATION DEFINED. The meaning of this bit depends on the value of FPEXC.TFV.

If FPEXC.TFV is 0, this bit is IMPLEMENTATION DEFINED and can contain IMPLEMENTATION DEFINED information about the cause of an exception.

If FPEXC.TFV is 1, this bit is the Overflow trapped exception bit, and indicates whether an Overflow exception occurred while FPSCR.OFE was 1:

0 Overflow exception has not occurred.

1 Overflow exception has occurred.

In both cases this bit must be cleared to 0 by the exception-handling routine.

DZF, bit [1]

Divide-by-zero trapped exception bit, or IMPLEMENTATION DEFINED. The meaning of this bit depends on the value of FPEXC.TFV.

If FPEXC.TFV is 0, this bit is IMPLEMENTATION DEFINED and can contain IMPLEMENTATION DEFINED information about the cause of an exception.

If FPEXC.TFV is 1, this bit is the Divide-by-zero trapped exception bit, and indicates whether a Divide-by-zero exception occurred while FPSCR.DZE was 1:

0 Divide-by-zero exception has not occurred.

1 Divide-by-zero exception has occurred.

In both cases this bit must be cleared to 0 by the exception-handling routine.

IOF, bit [0]

Invalid Operation trapped exception bit, or IMPLEMENTATION DEFINED. The meaning of this bit depends on the value of FPEXC.TFV.

If FPEXC.TFV is 0, this bit is IMPLEMENTATION DEFINED and can contain IMPLEMENTATION DEFINED information about the cause of an exception.

If FPEXC.TFV is 1, this bit is the Invalid Operation trapped exception bit, and indicates whether an Invalid Operation exception occurred while FPSCR.IOE was 1:

0 Invalid Operation exception has not occurred.

1 Invalid Operation exception has occurred.

In both cases this bit must be cleared to 0 by the exception-handling routine.

Accessing the FPEXC32_EL2:

To access the FPEXC32_EL2:

MRS <Xt>, FPEXC32_EL2 ; Read FPEXC32_EL2 into Xt
MSR FPEXC32_EL2, <Xt> ; Write Xt to FPEXC32_EL2

Register access is encoded as follows:

op0	op1	CRn	CRm	op2
11	100	0101	0011	000

D8.2.31 HACR_EL2, Hypervisor Auxiliary Control Register

The HACR_EL2 characteristics are:

Purpose

Controls trapping to EL2 of IMPLEMENTATION DEFINED aspects of Non-secure EL1 or EL0 operation.

This register is part of the Virtualization registers functional group.

Usage constraints

This register is accessible as shown below:

EL0	EL1 (NS)	EL1 (S)	EL2	EL3 (SCR.NS=1)	EL3 (SCR.NS=0)
-	-	-	RW	RW	RW

Configurations

HACR_EL2 is architecturally mapped to AArch32 register [HACR](#).

If EL2 is not implemented, this register is RES0 from EL3.

Attributes

HACR_EL2 is a 32-bit register.

The HACR_EL2 bit assignments are:



Accessing the HACR_EL2:

To access the HACR_EL2:

MRS <Xt>, HACR_EL2 ; Read HACR_EL2 into Xt
MSR HACR_EL2, <Xt> ; Write Xt to HACR_EL2

Register access is encoded as follows:

op0	op1	CRn	CRm	op2
11	100	0001	0001	111

D8.2.32 HCR_EL2, Hypervisor Configuration Register

The HCR_EL2 characteristics are:

Purpose

Provides configuration controls for virtualization, including defining whether various Non-secure operations are trapped to EL2.

This register is part of the Virtualization registers functional group.

Usage constraints

This register is accessible as shown below:

EL0	EL1 (NS)	EL1 (S)	EL2	EL3 (SCR.NS=1)	EL3 (SCR.NS=0)
-	-	-	RW	RW	RW

Configurations

HCR_EL2[31:0] is architecturally mapped to AArch32 register [HCR](#).

HCR_EL2[63:32] is architecturally mapped to AArch32 register [HCR2](#).

If EL2 is not implemented, this register is RES0 from EL3.

Attributes

HCR_EL2 is a 64-bit register.

The HCR_EL2 bit assignments are:

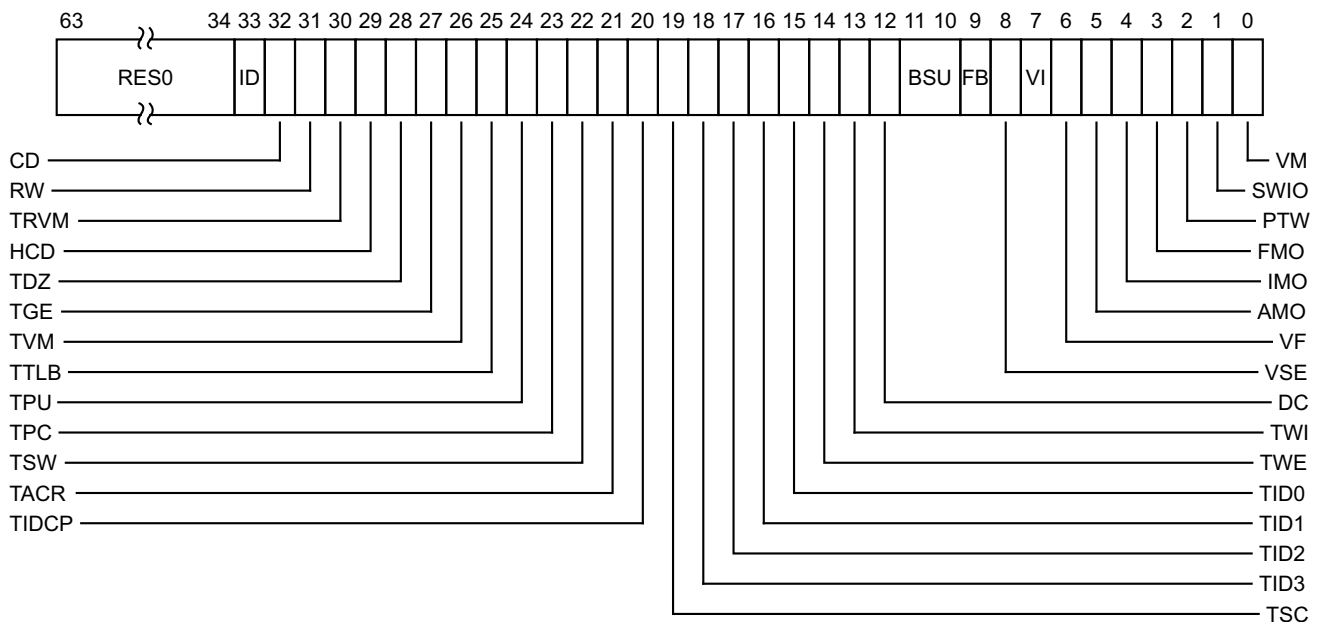

Bits [63:34]

Reserved, RES0.

ID, bit [33]

Stage 2 Instruction cache disable. When HCR_EL2.VM==1, this forces all stage 2 translations for instruction accesses to Normal memory to be Non-cacheable for the EL1&0 translation regime.

0 No effect on the stage 2 of the EL1&0 translation regime for instruction accesses.

- 1 Forces all stage 2 translations for instruction accesses to Normal memory to be Non-cacheable for the EL1&0 translation regime.

This bit has no effect on the EL2 or EL3 translation regimes.

CD, bit [32]

Stage 2 Data cache disable. When `HCR_EL2.VM==1`, this forces all stage 2 translations for data accesses and translation table walks to Normal memory to be Non-cacheable for the EL1&0 translation regime.

- 0 No effect on the stage 2 of the EL1&0 translation regime for data accesses and translation table walks.
- 1 Forces all stage 2 translations for data accesses and translation table walks to Normal memory to be Non-cacheable for the EL1&0 translation regime.

This bit has no effect on the EL2 or EL3 translation regimes.

RW, bit [31]

Register Width control for lower exception levels:

- 0 Lower levels are all AArch32.
- 1 EL1 is AArch64. EL0 is determined by the Register Width described in the current process state when executing at EL0.

When `SCR_EL3.NS==0`, this bit behaves as if it has the same value as the `SCR_EL3.RW` bit except for the value read back.

The RW bit is permitted to be cached in a TLB.

TRVM, bit [30]

Trap Read of Virtual Memory controls. When this bit is set to 1, this causes Reads to the EL1 virtual memory control registers from EL1 to be trapped to EL2. This covers the following registers:

AArch32: `SCTLR`, `TTBR0`, `TTBR1`, `TTBCR`, `DACR`, `DFSR`, `IFSR`, `DFAR`, `IFAR`, `ADFSR`, `AIFSR`, `PRRR/MAIR0`, `NMRR/MAIR1`, `AMAIRO`, `AMAIR1`, `CONTEXTIDR`.

AArch64: `SCTLR_EL1`, `TTBR0_EL1`, `TTBR1_EL1`, `TCR_EL1`, `ESR_EL1`, `FAR_EL1`, `AFSR0_EL1`, `AFSR1_EL1`, `MAIR_EL1`, `AMAIR_EL1`, `CONTEXTIDR_EL1`.

HCD, bit [29]

Hypervisor Call Disable, if EL3 is not implemented:

- 0 HVC instruction is enabled at EL1 or EL2.
- 1 HVC instruction is UNDEFINED at all exception levels.

If EL3 is implemented, this bit is RES0.

TDZ, bit [28]

Trap `DC ZVA` instruction:

- 0 The instruction is not trapped.
- 1 The instruction is trapped to EL2 when executed in Non-secure EL1 or EL0.

This bit also has an effect on the value read from the `DCZID_EL0` register. If this bit is 1, then reading `DCZID_EL0.DZP` will return 1 to indicate that `DC ZVA` is prohibited.

TGE, bit [27]

Trap General Exceptions. If this bit is set to 1, and `SCR_EL3.NS` is set to 1, then:

- All exceptions that would be routed to EL1 are routed to EL2.
- The `SCTLR_EL1.M` bit is treated as being 0 regardless of its actual state (for EL1 using AArch32 or AArch64) other than for the purpose of reading the bit.
- The `HCR_EL2.FMO`, `IMO` and `AMO` bits are treated as being 1 regardless of their actual state other than for the purpose of reading the bits.
- All virtual interrupts are disabled.

- Any implementation defined mechanisms for signalling virtual interrupts are disabled.
- An exception return to EL1 is treated as an illegal exception return.

Additionally, if `HCR_EL2.TGE == 1`, the `MDCR_EL2`.{`TDRA`,`TDOSA`,`TDA`} bits are ignored and the processor behaves as if they are set to 1, other than for the value read back from `MDCR_EL2`.

TVM, bit [26]

Trap Virtual Memory controls. When this bit is set to 1, this causes Writes to the EL1 virtual memory control registers from EL1 to be trapped to EL2. This covers the following registers:

AArch32: `SCTLR`, `TTBR0`, `TTBR1`, `TTBCR`, `DACR`, `DFSR`, `IFSR`, `DFAR`, `IFAR`, `ADFSR`, `AIFSR`, `PRRR/MAIR0`, `NMRR/MAIR1`, `AMAIRO`, `AMAIR1`, `CONTEXTIDR`.

AArch64: `SCTLR_EL1`, `TTBR0_EL1`, `TTBR1_EL1`, `TCR_EL1`, `ESR_EL1`, `FAR_EL1`, `AFSR0_EL1`, `AFSR1_EL1`, `MAIR_EL1`, `AMAIR_EL1`, `CONTEXTIDR_EL1`

TTLB, bit [25]

Trap TLB maintenance instructions. When this bit is set to 1, this causes TLB maintenance instructions executed from EL1 which are not UNDEFINED to be trapped to EL2. This covers the following instructions:

AArch32: `TLBIALLIS`, `TLBIMVAIS`, `TLBIASIDIS`, `TLBIMVAAIS`, `TLBIALL`, `TLBIMVA`, `TLBIASID`, `DTLBIALL`, `DTLBIMVA`, `DTLBIASID`, `ITLBIALL`, `ITLBIMVA`, `ITLBIASID`, `TLBIMVAA`, `TLBIMVALIS`, `TLBIMVAALIS`, `TLBIMVAL`, `TLBIMVAAL`

AArch64: `TLBI VMALLE1`, `TLBI VAE1`, `TLBI ASIDE1`, `TLBI VAAE1`, `TLBI VALE1`, `TLBI VAALE1`, `TLBI VMALLE1IS`, `TLBI VAE1IS`, `TLBI ASIDE1IS`, `TLBI VAAE1IS`, `TLBI VALE1IS`, `TLBI VAALE1IS`

TPU, bit [24]

Trap Cache maintenance instructions to Point of Unification. When this bit is set to 1, this causes Cache maintenance instructions to the point of unification executed from EL1 or EL0 which are not UNDEFINED to be trapped to EL2. This covers the following instructions:

AArch32: `ICIMVAU`, `ICIALLU`, `ICIALLUIS`, `DCCMVAU`.

AArch64: `IC IVAU`, `IC IALLU`, `IC IALLUIS`, `DC CVAU`.

TPC, bit [23]

Trap Data/Unified Cache maintenance operations to Point of Coherency. When this bit is set to 1, this causes Data or Unified Cache maintenance instructions by address to the point of coherency executed from EL1 or EL0 which are not UNDEFINED to be trapped to EL2. This covers the following instructions:

AArch32: `DCIMVAC`, `DCCIMVAC`, `DCCMVAC`.

AArch64: `DC IVAC`, `DC CIVAC`, `DC CVAC`.

TSW, bit [22]

Trap Data/Unified Cache maintenance operations by Set/Way. When this bit is set to 1, this causes Data or Unified Cache maintenance instructions by set/way executed from EL1 which are not UNDEFINED to be trapped to EL2. This covers the following instructions:

AArch32: `DCISW`, `DCCSW`, `DCCISW`.

AArch64: `DC ISW`, `DC CSW`, `DC CISW`.

TACR, bit [21]

Trap Auxiliary Control Register. When this bit is set to 1, this causes accesses to the following registers executed from EL1 to be trapped to EL2:

AArch32: `ACTLR`.

AArch64: `ACTLR_EL1`.

TIDCP, bit [20]

Trap Implementation Dependent functionality. When this bit is set to 1, this causes accesses to the following instruction set space executed from EL1 to be trapped to EL2.

AArch32: MCR and MRC instructions as follows:

- All CP15, CRn==9, Opcode1 = {0-7}, CRm == {c0-c2, c5-c8}, opcode2 == {0-7}.
- All CP15, CRn==10, Opcode1 =={0-7}, CRm == {c0, c1, c4, c8}, opcode2 == {0-7}.
- All CP15, CRn==11, Opcode1=={0-7}, CRm == {c0-c8, c15}, opcode2 == {0-7}.

AArch64: All encoding space reserved for IMPLEMENTATION DEFINED system operations (S1_<op1>_<Cn>_<Cm>_<op2>) and system registers (S3_<op1>_<Cn>_<Cm>_<op2>).

It is IMPLEMENTATION DEFINED whether any of this functionality accessed from EL0 is trapped to EL2 when the HCR_EL2.TIDCP bit is set. If it is not trapped to EL2, it results in an Undefined exception taken to EL1.

TSC, bit [19]

Trap SMC. When this bit is set to 1, this causes the following instructions executed from EL1 to be trapped to EL2:

AArch32: SMC.

AArch64: SMC.

If EL3 is not implemented, this bit is RES0.

TID3, bit [18]

Trap ID Group 3. When this bit is set to 1, this causes reads to the following registers executed from EL1 to be trapped to EL2:

AArch32: [ID_PFR0](#), [ID_PFR1](#), [ID_DFR0](#), [ID_AFR0](#), [ID_MMFR0](#), [ID_MMFR1](#), [ID_MMFR2](#), [ID_MMFR3](#), [ID_ISAR0](#), [ID_ISAR1](#), [ID_ISAR2](#), [ID_ISAR3](#), [ID_ISAR4](#), [ID_ISAR5](#), [MVFR0](#), [MVFR1](#), [MVFR2](#). Also MRC to any of the following encodings:

- CP15, CRn == 0, Opc1 == 0, CRm == {3-7}, Opc2 == {0,1}.
- CP15, CRn == 0, Opc1 == 0, CRm == 3, Opc2 == 2.
- CP15, CRn == 0, Opc1 == 0, CRm == 5, Opc2 == {4,5}.

AArch64: [ID_PFR0_EL1](#), [ID_PFR1_EL1](#), [ID_DFR0_EL1](#), [ID_AFR0_EL1](#), [ID_MMFR0_EL1](#), [ID_MMFR1_EL1](#), [ID_MMFR2_EL1](#), [ID_MMFR3_EL1](#), [ID_ISAR0_EL1](#), [ID_ISAR1_EL1](#), [ID_ISAR2_EL1](#), [ID_ISAR3_EL1](#), [ID_ISAR4_EL1](#), [ID_ISAR5_EL1](#), [MVFR0_EL1](#), [MVFR1_EL1](#), [MVFR2_EL1](#), [ID_AA64PFR0_EL1](#), [ID_AA64PFR1_EL1](#), [ID_AA64DFR0_EL1](#), [ID_AA64DFR1_EL1](#), [ID_AA64ISAR0_EL1](#), [ID_AA64ISAR1_EL1](#), [ID_AA64MMFR0_EL1](#), [ID_AA64MMFR1_EL1](#), [ID_AA64AFR0_EL1](#), [ID_AA64AFR1_EL1](#).

TID2, bit [17]

Trap ID Group 2. When this bit is set to 1, this causes reads (or writes to [CSSELR/CSSELR_EL1](#)) to the following registers executed from EL1 or EL0 if not UNDEFINED to be trapped to EL2:

AArch32: [CTR](#), [CCSIDR](#), [CLIDR](#), [CSSELR](#).

AArch64: [CTR_EL0](#), [CCSIDR_EL1](#), [CLIDR_EL1](#), [CSSELR_EL1](#).

TID1, bit [16]

Trap ID Group 1. When this bit is set to 1, this causes reads to the following registers executed from EL1 to be trapped to EL2:

AArch32: [TCMTR](#), [TLBTR](#), [AIDR](#), [REVIDR](#).

AArch64: [AIDR_EL1](#), [REVIDR_EL1](#).

TID0, bit [15]

Trap ID Group 0. When this bit is set to 1, this causes reads to the following registers executed from EL1 or EL0 if not UNDEFINED to be trapped to EL2:

AArch32: [FPSID](#), [JIDR](#).

AArch64: None.

TWE, bit [14]

Trap WFE. When this bit is set to 1, this causes the following instructions executed from EL1 or EL0 to be trapped to EL2 if the instruction would otherwise cause suspension of execution (i.e. if the event register is not set):

AArch32: WFE.

AArch64: WFE.

Conditional WFE instructions that fail their condition are not trapped if this bit is set to 1.

TWI, bit [13]

Trap WFI. When this bit is set to 1, this causes the following instructions executed from EL1 or EL0 to be trapped to EL2 if the instruction would otherwise cause suspension of execution (i.e. if there is not a pending WFI wakeup event):

AArch32: WFI.

AArch64: WFI.

Conditional WFI instructions that fail their condition are not trapped if this bit is set to 1.

DC, bit [12]

Default Cacheable. When this bit is set to 1, this causes:

- The `SCTLR_EL1.M` bit to behave as 0 for all purposes other than reading the value of the bit.
- The `HCR_EL2.VM` bit to behave as 1 for all purposes other than reading the value of the bit.

The memory type produced by the first stage of translation used by EL1 and EL0 is Normal Non-Shareable, Inner WriteBack Read-WriteAllocate, Outer WriteBack Read-WriteAllocate.

When this bit is 0 and the stage 1 MMU is disabled, the default memory attribute for Data accesses is Device-nGnRnE.

This bit is permitted to be cached in a TLB.

BSU, bits [11:10]

Barrier Shareability upgrade. The value in this field determines the minimum shareability domain that is applied to any barrier executed from EL1 or EL0:

00	No effect
01	Inner Shareable
10	Outer Shareable
11	Full system

This value is combined with the specified level of the barrier held in its instruction, using the same principles as combining the shareability attributes from two stages of address translation.

FB, bit [9]

Force broadcast. When this bit is set to 1, this causes the following instructions to be broadcast within the Inner Shareable domain when executed from Non-secure EL1:

AArch32: `BPIALL`, `TLBIALL`, `TLBIMVA`, `TLBIASID`, `DTLBIALL`, `DTLBIMVA`, `DTLBIASID`, `ITLBIALL`, `ITLBIMVA`, `ITLBIASID`, `TLBIMVAA`, `ICIALLU`, `TLBIMVAL`, `TLBIMVAAL`.

AArch64: `TLBI VMALLE1`, `TLBI VAE1`, `TLBI ASIDE1`, `TLBI VAAE1`, `TLBI VALE1`, `TLBI VAALE1`, `IC IALLU`.

VSE, bit [8]

Virtual System Error/Asynchronous Abort.

- | | |
|---|---|
| 0 | Virtual System Error/Asynchronous Abort is not pending by this mechanism. |
| 1 | Virtual System Error/Asynchronous Abort is pending by this mechanism. |

The virtual System Error/Asynchronous Abort is only enabled when the `HCR_EL2.AMO` bit is set.

VI, bit [7]

Virtual IRQ Interrupt.

- 0 Virtual IRQ is not pending by this mechanism.
- 1 Virtual IRQ is pending by this mechanism.

The virtual IRQ is only enabled when the HCR_EL2.IMO bit is set.

VF, bit [6]

Virtual FIQ Interrupt.

- 0 Virtual FIQ is not pending by this mechanism.
- 1 Virtual FIQ is pending by this mechanism.

The virtual FIQ is only enabled when the HCR_EL2.FMO bit is set.

AMO, bit [5]

Asynchronous abort and error interrupt routing.

- 0 Asynchronous External Aborts and SError Interrupts while executing at exception levels lower than EL2 are not taken in EL2. Virtual System Error/Asynchronous Abort is disabled.
- 1 Asynchronous External Aborts and SError Interrupts while executing at EL2 or lower are taken in EL2 unless routed by the [SCR_EL3.EA](#) bit to EL3. Virtual System Error/Asynchronous Abort is enabled.

IMO, bit [4]

Physical IRQ Routing.

- 0 Physical IRQ while executing at exception levels lower than EL2 are not taken in EL2. Virtual IRQ Interrupt is disabled.
- 1 Physical IRQ while executing at EL2 or lower are taken in EL2 unless routed by the [SCR_EL3.IRQ](#) bit to EL3. Virtual IRQ Interrupt is enabled.

FMO, bit [3]

Physical FIQ Routing.

- 0 Physical FIQ while executing at exception levels lower than EL2 are not taken in EL2. Virtual FIQ Interrupt is disabled.
- 1 Physical FIQ while executing at EL2 or lower are taken in EL2 unless routed by the [SCR_EL3.FIQ](#) bit to EL3. Virtual FIQ Interrupt is enabled.

PTW, bit [2]

Protected Table Walk. When this bit is set to 1, if the stage 2 translation of a translation table access made as part of a stage 1 translation table walk at EL0 or EL1 maps that translation table access to Strongly-ordered or Device memory, the access is faulted as a stage 2 Permission fault.

This bit is permitted to be cached in a TLB.

SWIO, bit [1]

Set/Way Invalidation Override. When this bit is set to 1, this causes EL1 execution of the data cache invalidate by set/way instruction to be treated as data cache clean and invalidate by set/way. That is:

AArch32: [DCISW](#) is executed as [DCCISW](#).

AArch64: [DCISW](#) is executed as [DC CISCW](#).

As a result of changes to the behavior of [DCISW](#), this bit is redundant in v8-A. It is permissible that an implementation makes this bit RES1.

VM, bit [0]

Virtualization MMU enable for EL1 and EL0 stage 2 address translation. Possible values of this bit are:

- 0 EL1 and EL0 stage 2 address translation disabled.
- 1 EL1 and EL0 stage 2 address translation enabled.

This bit is permitted to be cached in a TLB.

Accessing the HCR_EL2:

To access the HCR_EL2:

MRS <Xt>, HCR_EL2 ; Read HCR_EL2 into Xt
MSR HCR_EL2, <Xt> ; Write Xt to HCR_EL2

Register access is encoded as follows:

op0	op1	CRn	CRm	op2
11	100	0001	0001	000

D8.2.33 HPFAR_EL2, Hypervisor IPA Fault Address Register

The HPFAR_EL2 characteristics are:

Purpose

Holds the faulting IPA for some aborts on a stage 2 translation taken to EL2.

This register is part of:

- the Exception and fault handling registers functional group
- the Virtualization registers functional group.

Usage constraints

This register is accessible as shown below:

EL0	EL1 (NS)	EL1 (S)	EL2	EL3 (SCR.NS=1)	EL3 (SCR.NS=0)
-	-	-	RW	RW	RW

Configurations

HPFAR_EL2[31:0] is architecturally mapped to AArch32 register [HPFAR](#).

If EL2 is not implemented, this register is RES0 from EL3.

Attributes

HPFAR_EL2 is a 64-bit register.

The HPFAR_EL2 bit assignments are:

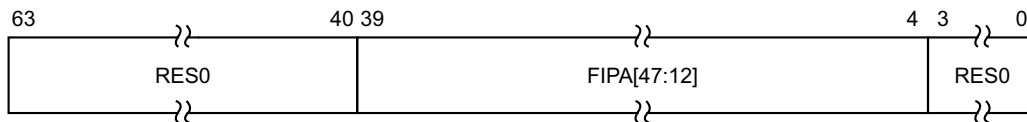

Bits [63:40]

Reserved, RES0.

FIPA[47:12], bits [39:4]

Bits [47:12] of the faulting intermediate physical address. For implementations with fewer than 48 physical address bits, the equivalent upper bits in this field are RES0.

Bits [3:0]

Reserved, RES0.

Accessing the HPFAR_EL2:

To access the HPFAR_EL2:

MRS <Xt>, HPFAR_EL2 ; Read HPFAR_EL2 into Xt
MSR HPFAR_EL2, <Xt> ; Write Xt to HPFAR_EL2

Register access is encoded as follows:

op0	op1	CRn	CRm	op2
11	100	0110	0000	100

D8.2.34 HSTR_EL2, Hypervisor System Trap Register

The HSTR_EL2 characteristics are:

Purpose

Controls access to T32EE and coprocessor registers at lower exception levels in AArch32.
This register is part of the Virtualization registers functional group.

Usage constraints

This register is accessible as shown below:

EL0	EL1 (NS)	EL1 (S)	EL2	EL3 (SCR.NS=1)	EL3 (SCR.NS=0)
-	-	-	RW	RW	RW

Configurations

HSTR_EL2 is architecturally mapped to AArch32 register [HSTR](#).
If EL2 is not implemented, this register is RES0 from EL3.

Attributes

HSTR_EL2 is a 32-bit register.

The HSTR_EL2 bit assignments are:

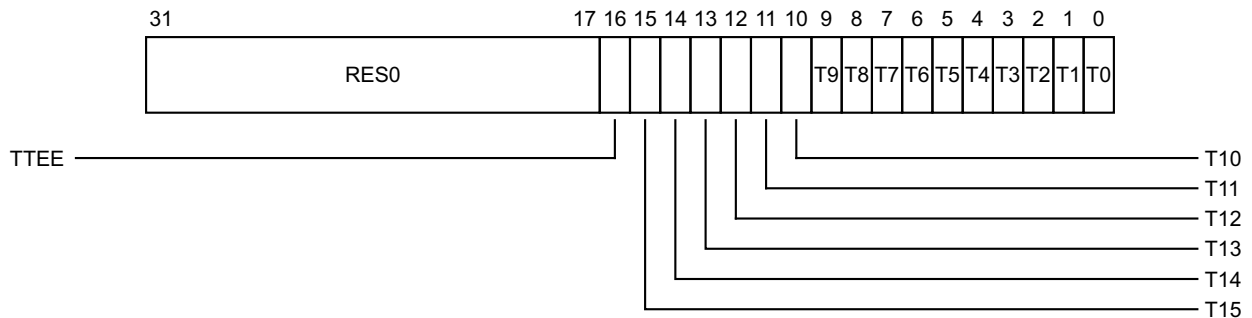

Bits [31:17]

Reserved, RES0.

TTEE, bit [16]

Trap T32EE. The possible values of this bit are:

- 0 Has no effect on accesses to the T32EE configuration registers.
- 1 Trap valid Non-secure accesses to T32EE configuration registers to Hyp mode.

When this bit is set to 1, any valid Non-secure access to the T32EE configuration registers is trapped to Hyp mode.

If T32EE is not implemented, then this bit is RES0.

T<n>, bit [n], for n = 0 to 15

Trap coprocessor primary register. For each field T<n>, the possible values of this bit are:

- 0 Has no effect on Non-secure accesses to CP15 coprocessor registers.
- 1 Trap valid Non-secure accesses to coprocessor primary register c<n> to Hyp mode.

When T<n> is set to 1, any valid Non-secure access to CP15 primary coprocessor register c<n> is trapped to Hyp mode. For example, when T7 is set to 1:

- Any valid Non-secure 32-bit CP15 accesses, using MRC or MCR instructions with CRn==c7, are trapped to Hyp mode.
- Any valid Non-secure 64-bit CP15 accesses, using MRRC or MCRR instructions with CRm==c7, are trapped to Hyp mode.

Fields T14 and T4 are RES0.

Accessing the HSTR_EL2:

To access the HSTR_EL2:

MRS <Xt>, HSTR_EL2 ; Read HSTR_EL2 into Xt
MSR HSTR_EL2, <Xt> ; Write Xt to HSTR_EL2

Register access is encoded as follows:

op0	op1	CRn	CRm	op2
11	100	0001	0001	011

D8.2.35 ID_AA64AFR0_EL1, AArch64 Auxiliary Feature Register 0

The ID_AA64AFR0_EL1 characteristics are:

Purpose

Provides information about the IMPLEMENTATION DEFINED features of the processor in AArch64.
This register is part of the Identification registers functional group.

Usage constraints

This register is accessible as shown below:

EL0	EL1 (NS)	EL1 (S)	EL2	EL3 (SCR.NS=1)	EL3 (SCR.NS=0)
-	RO	RO	RO	RO	RO

Configurations

There are no configuration notes.

Attributes

ID_AA64AFR0_EL1 is a 64-bit register.

The ID_AA64AFR0_EL1 bit assignments are:

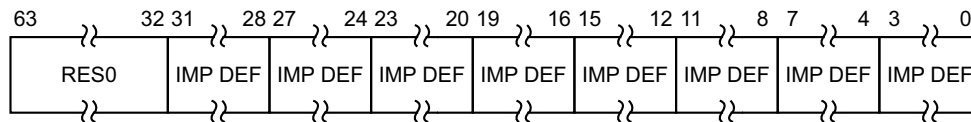

Bits [63:32]

Reserved, RES0.

Accessing the ID_AA64AFR0_EL1:

To access the ID_AA64AFR0_EL1:

MRS <Xt>, ID_AA64AFR0_EL1 ; Read ID_AA64AFR0_EL1 into Xt

Register access is encoded as follows:

op0	op1	CRn	CRm	op2
11	000	0000	0101	100

D8.2.36 ID_AA64AFR1_EL1, AArch64 Auxiliary Feature Register 1

The ID_AA64AFR1_EL1 characteristics are:

Purpose

Reserved for future expansion of information about the IMPLEMENTATION DEFINED features of the processor in AArch64.

This register is part of the Identification registers functional group.

Usage constraints

This register is accessible as shown below:

EL0	EL1 (NS)	EL1 (S)	EL2	EL3 (SCR.NS=1)	EL3 (SCR.NS=0)
-	RO	RO	RO	RO	RO

Configurations

There are no configuration notes.

Attributes

ID_AA64AFR1_EL1 is a 64-bit register.

The ID_AA64AFR1_EL1 bit assignments are:

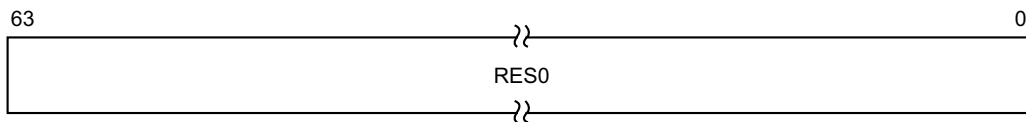

Bits [63:0]

Reserved, RES0.

Accessing the ID_AA64AFR1_EL1:

To access the ID_AA64AFR1_EL1:

MRS <Xt>, ID_AA64AFR1_EL1 ; Read ID_AA64AFR1_EL1 into Xt

Register access is encoded as follows:

op0	op1	CRn	CRm	op2
11	000	0000	0101	101

D8.2.37 ID_AA64DFR0_EL1, AArch64 Debug Feature Register 0

The ID_AA64DFR0_EL1 characteristics are:

Purpose

Provides top level information about the debug system in AArch64.
This register is part of the Identification registers functional group.

Usage constraints

This register is accessible as shown below:

ELO	EL1 (NS)	EL1 (S)	EL2	EL3 (SCR.NS=1)	EL3 (SCR.NS=0)
-	RO	RO	RO	RO	RO

Configurations

ID_AA64DFR0_EL1 is architecturally mapped to external register [ID_AA64DFR0_EL1](#).

Attributes

ID_AA64DFR0_EL1 is a 64-bit register.

The ID_AA64DFR0_EL1 bit assignments are:

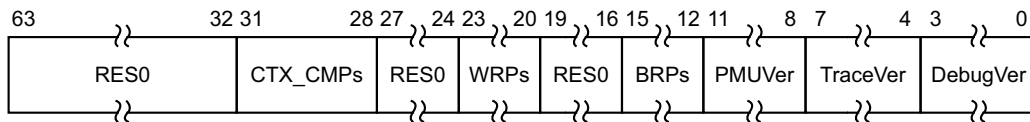

Bits [63:32]

Reserved, RES0.

CTX_CMPs, bits [31:28]

Number of breakpoints that are context-aware, minus 1. These are the highest numbered breakpoints.

Bits [27:24]

Reserved, RES0.

WRPs, bits [23:20]

Number of watchpoints, minus 1. The value of 0b0000 is reserved.

Bits [19:16]

Reserved, RES0.

BRPs, bits [15:12]

Number of breakpoints, minus 1. The value of 0b0000 is reserved.

PMUVer, bits [11:8]

Performance Monitors extension version. Indicates whether system register interface to Performance Monitors extension is implemented. Permitted values are:

- 0000 Performance Monitors extension system registers not implemented.
- 0001 Performance Monitors extension system registers implemented, PMUv3.
- 1111 IMPLEMENTATION DEFINED form of performance monitors supported, PMUv3 not supported.

All other values are reserved.

TraceVer, bits [7:4]

Trace extension. Indicates whether system register interface to Trace extension is implemented.
Permitted values are:

0000 Trace extension system registers not implemented.

0001 Trace extension system registers implemented.

All other values are reserved.

A value of 0b0000 only indicates that no system register interface to the trace extension is implemented. A trace extension may nevertheless be implemented without a system register interface.

DebugVer, bits [3:0]

Debug architecture version. Indicates presence of v8-A debug architecture.

0110 v8-A debug architecture.

All other values are reserved.

Accessing the ID_AA64DFR0_EL1:

To access the ID_AA64DFR0_EL1:

MRS <Xt>, ID_AA64DFR0_EL1 ; Read ID_AA64DFR0_EL1 into Xt

Register access is encoded as follows:

op0	op1	CRn	CRm	op2
11	000	0000	0101	000

D8.2.38 ID_AA64DFR1_EL1, AArch64 Debug Feature Register 1

The ID_AA64DFR1_EL1 characteristics are:

Purpose

Reserved for future expansion of top level information about the debug system in AArch64.
This register is part of the Identification registers functional group.

Usage constraints

This register is accessible as shown below:

EL0	EL1 (NS)	EL1 (S)	EL2	EL3 (SCR.NS=1)	EL3 (SCR.NS=0)
-	RO	RO	RO	RO	RO

Configurations

ID_AA64DFR1_EL1 is architecturally mapped to external register [ID_AA64DFR1_EL1](#).

Attributes

ID_AA64DFR1_EL1 is a 64-bit register.

The ID_AA64DFR1_EL1 bit assignments are:

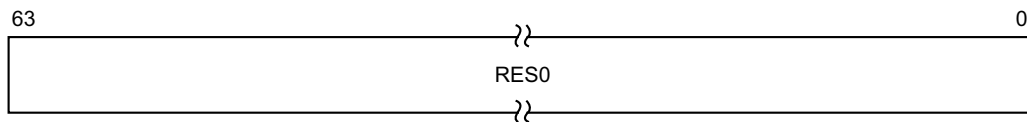

Bits [63:0]

Reserved, RES0.

Accessing the ID_AA64DFR1_EL1:

To access the ID_AA64DFR1_EL1:

MRS <Xt>, ID_AA64DFR1_EL1 ; Read ID_AA64DFR1_EL1 into Xt

Register access is encoded as follows:

op0	op1	CRn	CRm	op2
11	000	0000	0101	001

D8.2.39 ID_AA64ISAR0_EL1, AArch64 Instruction Set Attribute Register 0

The ID_AA64ISAR0_EL1 characteristics are:

Purpose

Provides information about the instructions implemented by the processor in AArch64.
This register is part of the Identification registers functional group.

Usage constraints

This register is accessible as shown below:

EL0	EL1 (NS)	EL1 (S)	EL2	EL3 (SCR.NS=1)	EL3 (SCR.NS=0)
-	RO	RO	RO	RO	RO

Configurations

ID_AA64ISAR0_EL1 is architecturally mapped to external register [ID_AA64ISAR0_EL1](#).

Attributes

ID_AA64ISAR0_EL1 is a 64-bit register.

The ID_AA64ISAR0_EL1 bit assignments are:

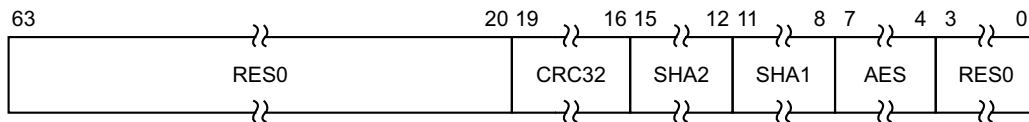

Bits [63:20]

Reserved, RES0.

CRC32, bits [19:16]

CRC32 instructions in AArch64. Possible values of this field are:

0000 No CRC32 instructions implemented.

0001 CRC32B, CRC32H, CRC32W, CRC32X, CRC32CB, CRC32CH, CRC32CW, and CRC32CX instructions implemented.

All other values are reserved.

This field must have the same value as [ID_ISAR5.CRC32](#). The architecture requires that if CRC32 is supported in one Execution state, it must be supported in both Execution states.

SHA2, bits [15:12]

SHA2 instructions in AArch64. Possible values of this field are:

0000 No SHA2 instructions implemented.

0001 SHA256H, SHA256H2, SHA256SU0, and SHA256SU1 instructions implemented.

All other values are reserved.

SHA1, bits [11:8]

SHA1 instructions in AArch64. Possible values of this field are:

0000 No SHA1 instructions implemented.

0001 SHA1C, SHA1P, SHA1M, SHA1H, SHA1SU0, and SHA1SU1 instructions implemented.

All other values are reserved.

AES, bits [7:4]

AES instructions in AArch64. Possible values of this field are:

- 0000 No AES instructions implemented.
- 0001 AESE, AESD, AESMC, and AESIMC instructions implemented.
- 0010 As for 0b0001, plus PMULL/PMULL2 instructions operating on 64-bit data quantities.

Bits [3:0]

Reserved, RES0.

Accessing the ID_AA64ISAR0_EL1:

To access the ID_AA64ISAR0_EL1:

MRS <Xt>, ID_AA64ISAR0_EL1 ; Read ID_AA64ISAR0_EL1 into Xt

Register access is encoded as follows:

op0	op1	CRn	CRm	op2
11	000	0000	0110	000

D8.2.40 ID_AA64ISAR1_EL1, AArch64 Instruction Set Attribute Register 1

The ID_AA64ISAR1_EL1 characteristics are:

Purpose

Reserved for future expansion of the information about the instruction sets implemented by the processor in AArch64.

This register is part of the Identification registers functional group.

Usage constraints

This register is accessible as shown below:

EL0	EL1 (NS)	EL1 (S)	EL2	EL3 (SCR.NS=1)	EL3 (SCR.NS=0)
-	RO	RO	RO	RO	RO

Configurations

ID_AA64ISAR1_EL1 is architecturally mapped to external register [ID_AA64ISAR1_EL1](#).

Attributes

ID_AA64ISAR1_EL1 is a 64-bit register.

The ID_AA64ISAR1_EL1 bit assignments are:

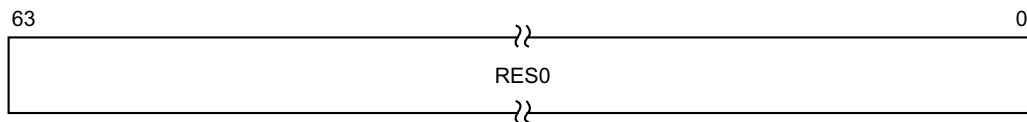

Bits [63:0]

Reserved, RES0.

Accessing the ID_AA64ISAR1_EL1:

To access the ID_AA64ISAR1_EL1:

MRS <Xt>, ID_AA64ISAR1_EL1 ; Read ID_AA64ISAR1_EL1 into Xt

Register access is encoded as follows:

op0	op1	CRn	CRm	op2
11	000	0000	0110	001

D8.2.41 ID_AA64MMFR0_EL1, AArch64 Memory Model Feature Register 0

The ID_AA64MMFR0_EL1 characteristics are:

Purpose

Provides information about the implemented memory model and memory management support in AArch64.

This register is part of the Identification registers functional group.

Usage constraints

This register is accessible as shown below:

EL0	EL1 (NS)	EL1 (S)	EL2	EL3 (SCR.NS=1)	EL3 (SCR.NS=0)
-	RO	RO	RO	RO	RO

Configurations

ID_AA64MMFR0_EL1 is architecturally mapped to external register [ID_AA64MMFR0_EL1](#).

Attributes

ID_AA64MMFR0_EL1 is a 64-bit register.

The ID_AA64MMFR0_EL1 bit assignments are:

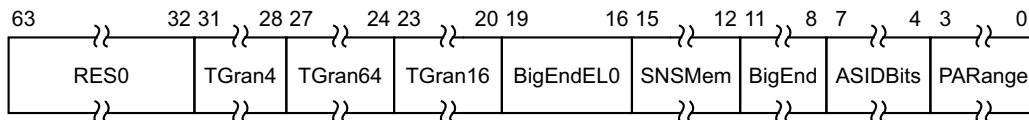

Bits [63:32]

Reserved, RES0.

TGran4, bits [31:28]

Support for 4 Kbyte memory translation granule size. Permitted values are:

0000 4 KB granule supported.

1111 4 KB granule not supported.

All other values are reserved.

TGran64, bits [27:24]

Support for 64 Kbyte memory translation granule size. Permitted values are:

0000 64 KB granule supported.

1111 64 KB granule not supported.

All other values are reserved.

TGran16, bits [23:20]

Support for 16 Kbyte memory translation granule size. Permitted values are:

0000 16 KB granule not supported.

0001 16 KB granule supported.

All other values are reserved.

BigEndEL0, bits [19:16]

Mixed-endian support at EL0 only. Permitted values are:

0000 No mixed-endian support at EL0. The [SCTLR_EL1.E0E](#) bit has a fixed value.

0001 Mixed-endian support at EL0. The [SCTLR_EL1.EOE](#) bit can be configured.
All other values are reserved.
This field is invalid and is RES0 if the BigEnd field, bits [11:8], is not 0b0000.

SNSMem, bits [15:12]

Secure versus Non-secure Memory distinction. Permitted values are:
0000 Does not support a distinction between Secure and Non-secure Memory.
0001 Does support a distinction between Secure and Non-secure Memory.
All other values are reserved.

BigEnd, bits [11:8]

Mixed-endian configuration support. Permitted values are:
0000 No mixed-endian support. The [SCTLR_ELx.EE](#) bits have a fixed value. See the [BigEndEL0](#) field, bits[19:16], for whether EL0 supports mixed-endian.
0001 Mixed-endian support. The [SCTLR_ELx.EE](#) and [SCTLR_EL1.EOE](#) bits can be configured.
All other values are reserved.

ASIDBits, bits [7:4]

Number of ASID bits. Permitted values are:
0000 8 bits.
0010 16 bits.
All other values are reserved.

PARange, bits [3:0]

Physical Address range supported. Permitted values are:
0000 32 bits, 4 GB.
0001 36 bits, 64 GB.
0010 40 bits, 1 TB.
0011 42 bits, 4 TB.
0100 44 bits, 16 TB.
0101 48 bits, 256 TB.
All other values are reserved.

Accessing the ID_AA64MMFR0_EL1:

To access the ID_AA64MMFR0_EL1:

MRS <Xt>, ID_AA64MMFR0_EL1 ; Read ID_AA64MMFR0_EL1 into Xt

Register access is encoded as follows:

op0	op1	CRn	CRm	op2
11	000	0000	0111	000

D8.2.42 ID_AA64MMFR1_EL1, AArch64 Memory Model Feature Register 1

The ID_AA64MMFR1_EL1 characteristics are:

Purpose

Reserved for future expansion of the information about the implemented memory model and memory management support in AArch64.

This register is part of the Identification registers functional group.

Usage constraints

This register is accessible as shown below:

EL0	EL1 (NS)	EL1 (S)	EL2	EL3 (SCR.NS=1)	EL3 (SCR.NS=0)
-	RO	RO	RO	RO	RO

Configurations

ID_AA64MMFR1_EL1 is architecturally mapped to external register [ID_AA64MMFR1_EL1](#).

Attributes

ID_AA64MMFR1_EL1 is a 64-bit register.

The ID_AA64MMFR1_EL1 bit assignments are:

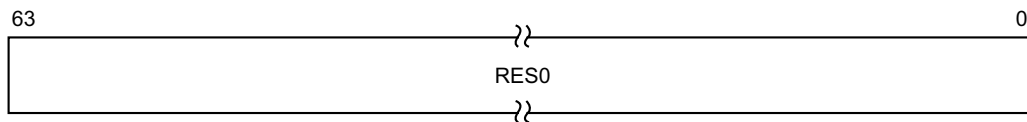

Bits [63:0]

Reserved, RES0.

Accessing the ID_AA64MMFR1_EL1:

To access the ID_AA64MMFR1_EL1:

MRS <Xt>, ID_AA64MMFR1_EL1 ; Read ID_AA64MMFR1_EL1 into Xt

Register access is encoded as follows:

op0	op1	CRn	CRm	op2
11	000	0000	0111	001

D8.2.43 ID_AA64PFR0_EL1, AArch64 Processor Feature Register 0

The ID_AA64PFR0_EL1 characteristics are:

Purpose

Provides additional information about implemented processor features in AArch64.
This register is part of the Identification registers functional group.

Usage constraints

This register is accessible as shown below:

EL0	EL1 (NS)	EL1 (S)	EL2	EL3 (SCR.NS=1)	EL3 (SCR.NS=0)
-	RO	RO	RO	RO	RO

Configurations

ID_AA64PFR0_EL1 is architecturally mapped to external register [ID_AA64PFR0_EL1](#).

Attributes

ID_AA64PFR0_EL1 is a 64-bit register.

The ID_AA64PFR0_EL1 bit assignments are:

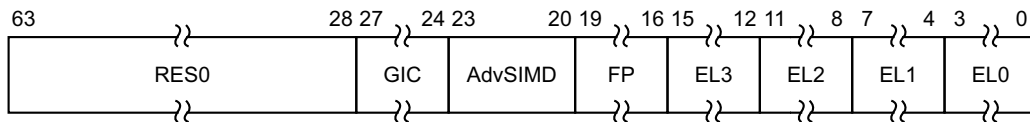

Bits [63:28]

Reserved, RES0.

GIC, bits [27:24]

GIC system register interface. Permitted values are:

0000 No GIC system registers are supported.

0001 GICv3 system registers are supported.

All other values are reserved.

AdvSIMD, bits [23:20]

Advanced SIMD. Permitted values are:

0000 Advanced SIMD is implemented.

1111 Advanced SIMD is not implemented.

All other values are reserved.

FP, bits [19:16]

Floating-point. Permitted values are:

0000 Floating-point is implemented.

1111 Floating-point is not implemented.

All other values are reserved.

EL3, bits [15:12]

EL3 exception level handling. Permitted values are:

0000 EL3 is not implemented.

0001 EL3 can be executed in AArch64 state only.
0010 EL3 can be executed in either AArch64 or AArch32 state.
All other values are reserved.

EL2, bits [11:8]

EL2 exception level handling. Permitted values are:
0000 EL2 is not implemented.
0001 EL2 can be executed in AArch64 state only.
0010 EL2 can be executed in either AArch64 or AArch32 state.
All other values are reserved.

EL1, bits [7:4]

EL1 exception level handling. Permitted values are:
0000 EL1 is not implemented.
0001 EL1 can be executed in AArch64 state only.
0010 EL1 can be executed in either AArch64 or AArch32 state.
All other values are reserved.

EL0, bits [3:0]

EL0 exception level handling. Permitted values are:
0000 EL0 is not implemented.
0001 EL0 can be executed in AArch64 state only.
0010 EL0 can be executed in either AArch64 or AArch32 state.
All other values are reserved.

Accessing the ID_AA64PFR0_EL1:

To access the ID_AA64PFR0_EL1:

MRS <Xt>, ID_AA64PFR0_EL1 ; Read ID_AA64PFR0_EL1 into Xt

Register access is encoded as follows:

op0	op1	CRn	CRm	op2
11	000	0000	0100	000

D8.2.44 ID_AA64PFR1_EL1, AArch64 Processor Feature Register 1

The ID_AA64PFR1_EL1 characteristics are:

Purpose

Reserved for future expansion of information about implemented processor features in AArch64.
This register is part of the Identification registers functional group.

Usage constraints

This register is accessible as shown below:

EL0	EL1 (NS)	EL1 (S)	EL2	EL3 (SCR.NS=1)	EL3 (SCR.NS=0)
-	RO	RO	RO	RO	RO

Configurations

ID_AA64PFR1_EL1 is architecturally mapped to external register [ID_AA64PFR1_EL1](#).

Attributes

ID_AA64PFR1_EL1 is a 64-bit register.

The ID_AA64PFR1_EL1 bit assignments are:

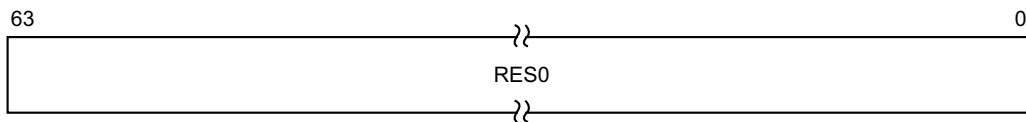

Bits [63:0]

Reserved, RES0.

Accessing the ID_AA64PFR1_EL1:

To access the ID_AA64PFR1_EL1:

MRS <Xt>, ID_AA64PFR1_EL1 ; Read ID_AA64PFR1_EL1 into Xt

Register access is encoded as follows:

op0	op1	CRn	CRm	op2
11	000	0000	0100	001

D8.2.45 ID_AFR0_EL1, AArch32 Auxiliary Feature Register 0

The ID_AFR0_EL1 characteristics are:

Purpose

Provides information about the IMPLEMENTATION DEFINED features of the processor in AArch32.
This register is part of the Identification registers functional group.

Usage constraints

This register is accessible as shown below:

ELO	EL1 (NS)	EL1 (S)	EL2	EL3 (SCR.NS=1)	EL3 (SCR.NS=0)
-	RO	RO	RO	RO	RO

Configurations

ID_AFR0_EL1 is architecturally mapped to AArch32 register [ID_AFR0](#).

In an AArch64-only implementation, this register is RES0.

Attributes

ID_AFR0_EL1 is a 32-bit register.

The ID_AFR0_EL1 bit assignments are:

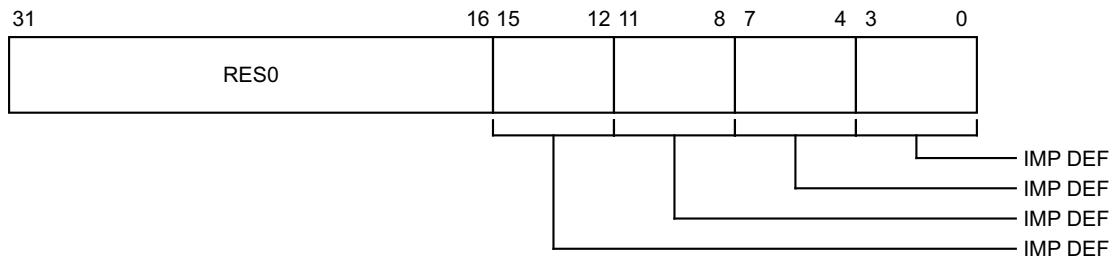

Bits [31:16]

Reserved, RES0.

Accessing the ID_AFR0_EL1:

To access the ID_AFR0_EL1:

MRS <Xt>, ID_AFR0_EL1 ; Read ID_AFR0_EL1 into Xt

Register access is encoded as follows:

op0	op1	CRn	CRm	op2
11	000	0000	0001	011

D8.2.46 ID_DFR0_EL1, AArch32 Debug Feature Register 0

The ID_DFR0_EL1 characteristics are:

Purpose

Provides top level information about the debug system in AArch32.
This register is part of the Identification registers functional group.

Usage constraints

This register is accessible as shown below:

EL0	EL1 (NS)	EL1 (S)	EL2	EL3 (SCR.NS=1)	EL3 (SCR.NS=0)
-	RO	RO	RO	RO	RO

Configurations

ID_DFR0_EL1 is architecturally mapped to AArch32 register [ID_DFR0](#).
In an AArch64-only implementation, this register is RES0.

Attributes

ID_DFR0_EL1 is a 32-bit register.

The ID_DFR0_EL1 bit assignments are:

31	28	27	24	23	20	19	16	15	12	11	8	7	4	3	0
RES0	PerfMon		MProfDbg		MMapTrc		CopTrc		MMapDbg		CopSDBG		CopDbg		

Bits [31:28]

Reserved, RES0.

PerfMon, bits [27:24]

Performance Monitors. Support for coprocessor-based ARM Performance Monitors Extension, for A and R profile processors. Possible values are:

- 0000 Performance Monitors Extension system registers not implemented.
- 0001 Support for Performance Monitors Extension version 1 (PMUv1) system registers. Not permitted in v8-A.
- 0010 Support for Performance Monitors Extension version 2 (PMUv2) system registers. Not permitted in v8-A.
- 0011 Support for Performance Monitors Extension version 3 (PMUv3) system registers.
- 1111 IMPLEMENTATION DEFINED form of Performance Monitors system registers supported. PMUv3 not supported.

All other values are reserved.

In v7, the value 0b0000 can mean that PMUv1 is implemented. PMUv1 is not permitted in a v8-A implementation.

MProfDbg, bits [23:20]

M Profile Debug. Support for memory-mapped debug model for M profile processors. Permitted values are:

- 0000 Not supported.
- 0001 Support for M profile Debug architecture, with memory-mapped access.

All other values are reserved. For v8-A, this field is 0b0000.

MMapTrc, bits [19:16]

Memory Mapped Trace. Support for memory-mapped trace model. Permitted values are:

0000 Not supported.

0001 Support for ARM trace architecture, with memory-mapped access.

All other values are reserved.

In the Trace registers, the ETMIDR gives more information about the implementation.

CopTrc, bits [15:12]

Coprocessor Trace. Support for coprocessor-based trace model. Permitted values are:

0000 Not supported.

0001 Support for ARM trace architecture, with CP14 access.

All other values are reserved.

In the Trace registers, the ETMIDR gives more information about the implementation.

MMapDbg, bits [11:8]

Memory Mapped Debug. Support for v7 memory-mapped debug model, for A and R profile processors.

In v8-A this field is RES0. The optional memory map defined by v8-A is not compatible with v7-A.

CopSDBG, bits [7:4]

Coprocessor Secure Debug. Support for coprocessor-based Secure debug model, for an A profile processor that includes the Security Extensions.

If EL3 is not implemented and the processor is Non-secure, this field is RES0. Otherwise, this field reads the same as bits [3:0].

CopDbg, bits [3:0]

Coprocessor Debug. Support for coprocessor based debug model, for A and R profile processors. Permitted values are:

0000 Not supported.

0010 Support for v6 Debug architecture, with CP14 access.

0011 Support for v6.1 Debug architecture, with CP14 access.

0100 Support for v7 Debug architecture, with CP14 access.

0101 Support for v7.1 Debug architecture, with CP14 access.

0110 Support for v8-A debug architecture, with CP14 access. This is the value that this field has in v8-A.

All other values are reserved.

Accessing the ID_DFR0_EL1:

To access the ID_DFR0_EL1:

MRS <Xt>, ID_DFR0_EL1 ; Read ID_DFR0_EL1 into Xt

Register access is encoded as follows:

op0	op1	CRn	CRm	op2
11	000	0000	0001	010

D8.2.47 ID_ISAR0_EL1, AArch32 Instruction Set Attribute Register 0

The ID_ISAR0_EL1 characteristics are:

Purpose

Provides information about the instruction sets implemented by the processor in AArch32.
This register is part of the Identification registers functional group.

Usage constraints

This register is accessible as shown below:

EL0	EL1 (NS)	EL1 (S)	EL2	EL3 (SCR.NS=1)	EL3 (SCR.NS=0)
-	RO	RO	RO	RO	RO

Configurations

ID_ISAR0_EL1 is architecturally mapped to AArch32 register [ID_ISAR0](#).
In an AArch64-only implementation, this register is RES0.

Attributes

ID_ISAR0_EL1 is a 32-bit register.

The ID_ISAR0_EL1 bit assignments are:

31	28 27	24 23	20 19	16 15	12 11	8 7	4 3	0
RES0	Divide	Debug	Coproc	CmpBranch	BitField	BitCount	Swap	

Bits [31:28]

Reserved, RES0.

Divide, bits [27:24]

Indicates the implemented Divide instructions. Permitted values are:

- 0000 None implemented.
 - 0001 Adds SDIV and UDIV in the T32 instruction set.
 - 0010 As for 0b0001, and adds SDIV and UDIV in the A32 instruction set.
- All other values are reserved.

Debug, bits [23:20]

Indicates the implemented Debug instructions. Permitted values are:

- 0000 None implemented.
 - 0001 Adds BKPT.
- All other values are reserved.

Coproc, bits [19:16]

Indicates the implemented Coprocessor instructions. Permitted values are:

- 0000 None implemented, except for instructions separately attributed by the architecture, including CP15, CP14, and Advanced SIMD and VFP.
- 0001 Adds generic CDP, LDC, MCR, MRC, and STC.
- 0010 As for 0b0001, and adds generic CDP2, LDC2, MCR2, MRC2, and STC2.
- 0011 As for 0b0010, and adds generic MCRR and MRRC.

0100 As for 0b0011, and adds generic MCRR2 and MRRC2.
All other values are reserved.

CmpBranch, bits [15:12]

Indicates the implemented combined Compare and Branch instructions in the T32 instruction set.
Permitted values are:

0000 None implemented.
0001 Adds CBNZ and CBZ.
All other values are reserved.

BitField, bits [11:8]

Indicates the implemented BitField instructions. Permitted values are:

0000 None implemented.
0001 Adds BFC, BFI, SBFX, and UBFX.
All other values are reserved.

BitCount, bits [7:4]

Indicates the implemented Bit Counting instructions. Permitted values are:

0000 None implemented.
0001 Adds CLZ.
All other values are reserved.

Swap, bits [3:0]

Indicates the implemented Swap instructions in the A32 instruction set. Permitted values are:

0000 None implemented.
0001 Adds SWP and SWPB.
All other values are reserved.

In v8-A this field is 0b0000. The SWP and SWPB instructions are not supported in v8-A.

Accessing the ID_ISAR0_EL1:

To access the ID_ISAR0_EL1:

MRS <Xt>, ID_ISAR0_EL1 ; Read ID_ISAR0_EL1 into Xt

Register access is encoded as follows:

op0	op1	CRn	CRm	op2
11	000	0000	0010	000

D8.2.48 ID_ISAR1_EL1, AArch32 Instruction Set Attribute Register 1

The ID_ISAR1_EL1 characteristics are:

Purpose

Provides information about the instruction sets implemented by the processor in AArch32.
This register is part of the Identification registers functional group.

Usage constraints

This register is accessible as shown below:

EL0	EL1 (NS)	EL1 (S)	EL2	EL3 (SCR.NS=1)	EL3 (SCR.NS=0)
-	RO	RO	RO	RO	RO

Configurations

ID_ISAR1_EL1 is architecturally mapped to AArch32 register [ID_ISAR1](#).

In an AArch64-only implementation, this register is RES0.

Attributes

ID_ISAR1_EL1 is a 32-bit register.

The ID_ISAR1_EL1 bit assignments are:

31	28	27	24	23	20	19	16	15	12	11	8	7	4	3	0
Jazelle	Interwork		Immediate		IfThen		Extend		Except_AR		Except		Endian		

Jazelle, bits [31:28]

Indicates the implemented Jazelle extension instructions. Permitted values are:

- 0000 No support for Jazelle.
- 0001 Adds the BXJ instruction, and the J bit in the PSR. This setting might indicate a trivial implementation of the Jazelle extension.

All other values are reserved.

Interwork, bits [27:24]

Indicates the implemented Interworking instructions. Permitted values are:

- 0000 None implemented.
- 0001 Adds the BX instruction, and the T bit in the PSR.
- 0010 As for 0b0001, and adds the BLX instruction. PC loads have BX-like behavior.
- 0011 As for 0b0010, and guarantees that data-processing instructions in the A32 instruction set with the PC as the destination and the S bit clear have BX-like behavior.

All other values are reserved.

Immediate, bits [23:20]

Indicates the implemented data-processing instructions with long immediates. Permitted values are:

- 0000 None implemented.
- 0001 Adds:
 - The MOVT instruction.
 - The MOV instruction encodings with zero-extended 16-bit immediates.

- The T32 ADD and SUB instruction encodings with zero-extended 12-bit immediates, and the other ADD, ADR, and SUB encodings cross-referenced by the pseudocode for those encodings.

All other values are reserved.

IfThen, bits [19:16]

Indicates the implemented If-Then instructions in the T32 instruction set. Permitted values are:

0000 None implemented.

0001 Adds the IT instructions, and the IT bits in the PSRs.

All other values are reserved.

Extend, bits [15:12]

Indicates the implemented Extend instructions. Permitted values are:

0000 No scalar sign-extend or zero-extend instructions are implemented, where scalar instructions means non-Advanced SIMD instructions.

0001 Adds the SXTB, SXTH, UXTB, and UXTH instructions.

0010 As for 0b0001, and adds the SXTB16, SXTAB, SXTAB16, SXTAH, UXTB16, UXTAB, UXTAB16, and UXTAH instructions.

All other values are reserved.

Except_AR, bits [11:8]

Indicates the implemented A and R profile exception-handling instructions. Permitted values are:

0000 None implemented.

0001 Adds the SRS and RFE instructions, and the A and R profile forms of the CPS instruction.

All other values are reserved.

Except, bits [7:4]

Indicates the implemented exception-handling instructions in the ARM instruction set. Permitted values are:

0000 Not implemented. This indicates that the User bank and Exception return forms of the LDM and STM instructions are not implemented.

0001 Adds the LDM (exception return), LDM (user registers), and STM (user registers) instruction versions.

All other values are reserved.

Endian, bits [3:0]

Indicates the implemented Endian instructions. Permitted values are:

0000 None implemented.

0001 Adds the SETEND instruction, and the E bit in the PSRs.

All other values are reserved.

Accessing the ID_ISAR1_EL1:

To access the ID_ISAR1_EL1:

MRS <Xt>, ID_ISAR1_EL1 ; Read ID_ISAR1_EL1 into Xt

Register access is encoded as follows:

op0	op1	CRn	CRm	op2
11	000	0000	0010	001

D8.2.49 ID_ISAR2_EL1, AArch32 Instruction Set Attribute Register 2

The ID_ISAR2_EL1 characteristics are:

Purpose

Provides information about the instruction sets implemented by the processor in AArch32.
This register is part of the Identification registers functional group.

Usage constraints

This register is accessible as shown below:

ELO	EL1 (NS)	EL1 (S)	EL2	EL3 (SCR.NS=1)	EL3 (SCR.NS=0)
-	RO	RO	RO	RO	RO

Configurations

ID_ISAR2_EL1 is architecturally mapped to AArch32 register [ID_ISAR2](#).

In an AArch64-only implementation, this register is RES0.

Attributes

ID_ISAR2_EL1 is a 32-bit register.

The ID_ISAR2_EL1 bit assignments are:

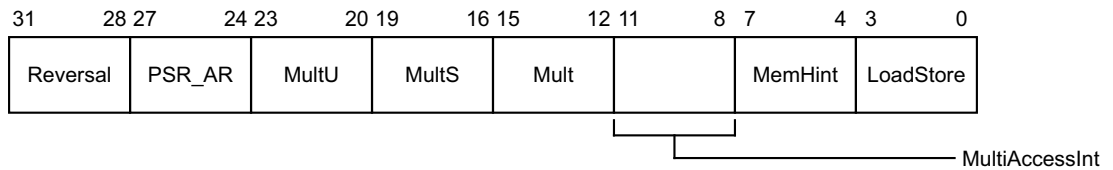

Reversal, bits [31:28]

Indicates the implemented Reversal instructions. Permitted values are:

- 0000 None implemented.
- 0001 Adds the REV, REV16, and REVSH instructions.
- 0010 As for 0b0001, and adds the RBIT instruction.

All other values are reserved.

PSR_AR, bits [27:24]

Indicates the implemented A and R profile instructions to manipulate the PSR. Permitted values are:

- 0000 None implemented.
- 0001 Adds the MRS and MSR instructions, and the exception return forms of data-processing instructions.

All other values are reserved.

The exception return forms of the data-processing instructions are:

- In the A32 instruction set, data-processing instructions with the PC as the destination and the S bit set. These instructions might be affected by the WithShifts attribute.
- In the T32 instruction set, the SUBS PC,LR,#N instruction.

MultU, bits [23:20]

Indicates the implemented advanced unsigned Multiply instructions. Permitted values are:

- 0000 None implemented.

- 0001 Adds the UMULL and UMLAL instructions.
 - 0010 As for 0b0001, and adds the UMAAL instruction.
- All other values are reserved.

MultS, bits [19:16]

Indicates the implemented advanced signed Multiply instructions. Permitted values are:

- 0000 None implemented.
- 0001 Adds the SMULL and SMLAL instructions.
- 0010 As for 0b0001, and adds the SMLABB, SMLABT, SMLALBB, SMLALBT, SMLALTB, SMLALTT, SMLATB, SMLATT, SMLAWB, SMLAWT, SMULBB, SMULBT, SMULTB, SMULTT, SMULWB, and SMULWT instructions. Also adds the Q bit in the PSRs.
- 0011 As for 0b0010, and adds the SMLAD, SMLADX, SMLALD, SMLALDX, SMLSd, SMLSdX, SMLSdL, SMLSdX, SMMLA, SMMLAR, SMMLS, SMMLSR, SMMUL, SMMULR, SMUAD, SMUADX, SMUSD, and SMUSDx instructions.

All other values are reserved.

Mult, bits [15:12]

Indicates the implemented additional Multiply instructions. Permitted values are:

- 0000 No additional instructions implemented. This means only MUL is implemented.
- 0001 Adds the MLA instruction.
- 0010 As for 0b0001, and adds the MLS instruction.

All other values are reserved.

MultiAccessInt, bits [11:8]

Indicates the support for interruptible multi-access instructions. Permitted values are:

- 0000 No support. This means the LDM and STM instructions are not interruptible.
- 0001 LDM and STM instructions are restartable.
- 0010 LDM and STM instructions are continuable.

All other values are reserved.

MemHint, bits [7:4]

Indicates the implemented Memory Hint instructions. Permitted values are:

- 0000 None implemented.
- 0001 Adds the PLD instruction.
- 0010 Adds the PLD instruction. (0b0001 and 0b0010 have identical effects.)
- 0011 As for 0b0001 (or 0b0010), and adds the PLI instruction.
- 0100 As for 0b0011, and adds the PLDW instruction.

All other values are reserved.

LoadStore, bits [3:0]

Indicates the implemented additional load/store instructions. Permitted values are:

- 0000 No additional load/store instructions implemented.
- 0001 Adds the LDRD and STRD instructions.
- 0010 As for 0b0001, and adds the Load Acquire (LDAB, LDAH, LDA, LDAEXB, LDAEXH, LDAEX, LDAEXD) and Store Release (STLB, STLH, STL, STLEXB, STLEXH, STLEX, STLEXD) instructions.

All other values are reserved.

Accessing the ID_ISAR2_EL1:

To access the ID_ISAR2_EL1:

MRS <Xt>, ID_ISAR2_EL1 ; Read ID_ISAR2_EL1 into Xt

Register access is encoded as follows:

op0	op1	CRn	CRm	op2
11	000	0000	0010	010

D8.2.50 ID_ISAR3_EL1, AArch32 Instruction Set Attribute Register 3

The ID_ISAR3_EL1 characteristics are:

Purpose

Provides information about the instruction sets implemented by the processor in AArch32.
This register is part of the Identification registers functional group.

Usage constraints

This register is accessible as shown below:

EL0	EL1 (NS)	EL1 (S)	EL2	EL3 (SCR.NS=1)	EL3 (SCR.NS=0)
-	RO	RO	RO	RO	RO

Configurations

ID_ISAR3_EL1 is architecturally mapped to AArch32 register [ID_ISAR3](#).

In an AArch64-only implementation, this register is RES0.

Attributes

ID_ISAR3_EL1 is a 32-bit register.

The ID_ISAR3_EL1 bit assignments are:

31	28	27	24	23	20	19	16	15	12	11	8	7	4	3	0
T32EE	TrueNOP		ThumbCopy		TabBranch		SynchPrim		SVC		SIMD		Saturate		

T32EE, bits [31:28]

Indicates the implemented TT32EE instructions. Permitted values are:

- 0000 None implemented.
- 0001 Adds the ENTERX and LEAVEX instructions, and modifies the load behavior to include null checking.

All other values are reserved.

This field can only have a value other than 0b0000 when the ID_PFR0.State3 field has a value of 0b0001.

TrueNOP, bits [27:24]

Indicates the implemented True NOP instructions. Permitted values are:

- 0000 None implemented. This means there are no NOP instructions that do not have any register dependencies.
- 0001 Adds true NOP instructions in both the T32 and A32 instruction sets. This also permits additional NOP-compatible hints.

All other values are reserved.

ThumbCopy, bits [23:20]

Indicates the support for T32 non flag-setting MOV instructions. Permitted values are:

- 0000 Not supported. This means that in the T32 instruction set, encoding T1 of the MOV (register) instruction does not support a copy from a low register to a low register.
- 0001 Adds support for T32 instruction set encoding T1 of the MOV (register) instruction, copying from a low register to a low register.

All other values are reserved.

TabBranch, bits [19:16]

Indicates the implemented Table Branch instructions in the T32 instruction set. Permitted values are:

- 0000 None implemented.
- 0001 Adds the TBB and TBH instructions.

All other values are reserved.

SynchPrim, bits [15:12]

Used in conjunction with ID_ISAR4.SynchPrim_frac to indicate the implemented Synchronization Primitive instructions. Permitted values are:

- 0000 If SynchPrim_frac == 0b0000, no Synchronization Primitives implemented.
- 0001 If SynchPrim_frac == 0b0000, adds the LDREX and STREX instructions.
If SynchPrim_frac == 0b0011, also adds the CLREX, LDREXB, STREXB, and STREXH instructions.
- 0010 If SynchPrim_frac == 0b0000, as for [0b0001, 0b0011] and also adds the LDREXD and STREXD instructions.

All other combinations of SynchPrim and SynchPrim_frac are reserved.

SVC, bits [11:8]

Indicates the implemented SVC instructions. Permitted values are:

- 0000 Not implemented.
- 0001 Adds the SVC instruction.

All other values are reserved.

SIMD, bits [7:4]

Indicates the implemented SIMD instructions. Permitted values are:

- 0000 None implemented.
- 0001 Adds the SSAT and USAT instructions, and the Q bit in the PSRs.
- 0011 As for 0b0001, and adds the PKHBT, PKHTB, QADD16, QADD8, QASX, QSUB16, QSUB8, QSAX, SADD16, SADD8, SASX, SEL, SHADD16, SHADD8, SHASX, SHSUB16, SHSUB8, SHSAX, SSAT16, SSUB16, SSUB8, SSAX, SXTAB16, SXTB16, UADD16, UADD8, UASX, UHADD16, UHADD8, UHASX, UHSUB16, UHSUB8, UHSAX, UQADD16, UQADD8, UQASX, UQSUB16, UQSUB8, UQSAX, USAD8, USADA8, USAT16, USUB16, USUB8, USAX, UXTAB16, and UXTB16 instructions. Also adds support for the GE[3:0] bits in the PSRs.

All other values are reserved.

The SIMD field relates only to implemented instructions that perform SIMD operations on the general-purpose registers. [MVFRO](#) and [MVFR1](#) give information about the SIMD instructions implemented by the optional Advanced SIMD Extension.

Saturate, bits [3:0]

Indicates the implemented Saturate instructions. Permitted values are:

- 0000 None implemented. This means no non-Advanced SIMD saturate instructions are implemented.
- 0001 Adds the QADD, QDADD, QDSUB, and QSUB instructions, and the Q bit in the PSRs.

All other values are reserved.

Accessing the ID_ISAR3_EL1:

To access the ID_ISAR3_EL1:

MRS <Xt>, ID_ISAR3_EL1 ; Read ID_ISAR3_EL1 into Xt

Register access is encoded as follows:

op0	op1	CRn	CRm	op2
11	000	0000	0010	011

D8.2.51 ID_ISAR4_EL1, AArch32 Instruction Set Attribute Register 4

The ID_ISAR4_EL1 characteristics are:

Purpose

Provides information about the instruction sets implemented by the processor in AArch32.
This register is part of the Identification registers functional group.

Usage constraints

This register is accessible as shown below:

ELO	EL1 (NS)	EL1 (S)	EL2	EL3 (SCR.NS=1)	EL3 (SCR.NS=0)
-	RO	RO	RO	RO	RO

Configurations

ID_ISAR4_EL1 is architecturally mapped to AArch32 register [ID_ISAR4](#).

In an AArch64-only implementation, this register is RES0.

Attributes

ID_ISAR4_EL1 is a 32-bit register.

The ID_ISAR4_EL1 bit assignments are:

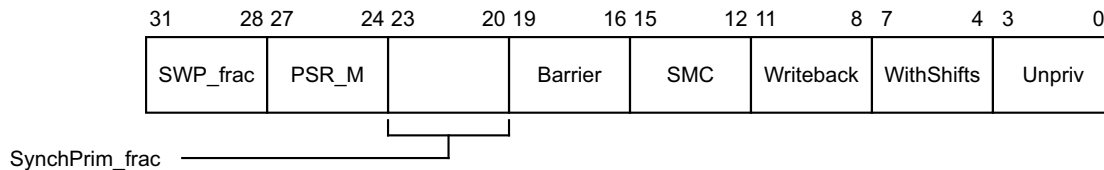

SWP_frac, bits [31:28]

Indicates support for the memory system locking the bus for SWP or SWPB instructions. Permitted values are:

0000 SWP or SWPB instructions not implemented.

0001 SWP or SWPB implemented but only in a uniprocessor context. SWP and SWPB do not guarantee whether memory accesses from other masters can come between the load memory access and the store memory access of the SWP or SWPB.

All other values are reserved. This field is valid only if the [ID_ISAR0.Swap_insts](#) field is 0b0000.

In v8-A this field is 0b0000. The SWP and SWPB instructions are not supported in v8-A.

PSR_M, bits [27:24]

Indicates the implemented M profile instructions to modify the PSRs. Permitted values are:

0000 None implemented.

0001 Adds the M profile forms of the CPS, MRS, and MSR instructions.

All other values are reserved.

SynchPrim_frac, bits [23:20]

Used in conjunction with ID_ISAR3.SynchPrim to indicate the implemented Synchronization Primitive instructions. Possible values are:

- 0000 If SynchPrim == 0b0000, no Synchronization Primitives implemented. If SynchPrim == 0b0001, adds the LDREX and STREX instructions. If SynchPrim == 0b0010, also adds the CLREX, LDREXB, LDREXH, STREXB, STREXH, LDREXD, and STREXD instructions.
- 0011 If SynchPrim == 0b0001, adds the LDREX, STREX, CLREX, LDREXB, LDREXH, STREXB, and STREXH instructions.

All other combinations of SynchPrim and SynchPrim_frac are reserved.

Barrier, bits [19:16]

Indicates the implemented Barrier instructions in the A32 and T32 instruction sets. Permitted values are:

- 0000 None implemented. Barrier operations are provided only as CP15 operations.
- 0001 Adds the DMB, DSB, and ISB barrier instructions.

All other values are reserved.

SMC, bits [15:12]

Indicates the implemented SMC instructions. Permitted values are:

- 0000 None implemented.
- 0001 Adds the SMC instruction.

All other values are reserved.

Writeback, bits [11:8]

Indicates the support for Writeback addressing modes. Permitted values are:

- 0000 Basic support. Only the LDM, STM, PUSH, POP, SRS, and RFE instructions support writeback addressing modes. These instructions support all of their writeback addressing modes.
- 0001 Adds support for all of the writeback addressing modes defined in ARMv7.

All other values are reserved.

WithShifts, bits [7:4]

Indicates the support for instructions with shifts. Permitted values are:

- 0000 Nonzero shifts supported only in MOV and shift instructions.
- 0001 Adds support for shifts of loads and stores over the range LSL 0-3.
- 0011 As for 0b0001, and adds support for other constant shift options, both on load/store and other instructions.
- 0100 As for 0b0011, and adds support for register-controlled shift options.

All other values are reserved.

Unpriv, bits [3:0]

Indicates the implemented unprivileged instructions. Permitted values are:

- 0000 None implemented. No T variant instructions are implemented.
- 0001 Adds the LDRBT, LDRT, STRBT, and STRT instructions.
- 0010 As for 0b0001, and adds the LDRHT, LDRSBT, LDRSHT, and STRHT instructions.

All other values are reserved.

Accessing the ID_ISAR4_EL1:

To access the ID_ISAR4_EL1:

MRS <Xt>, ID_ISAR4_EL1 ; Read ID_ISAR4_EL1 into Xt

Register access is encoded as follows:

op0	op1	CRn	CRm	op2
11	000	0000	0010	100

D8.2.52 ID_ISAR5_EL1, AArch32 Instruction Set Attribute Register 5

The ID_ISAR5_EL1 characteristics are:

Purpose

Provides information about the instruction sets implemented by the processor in AArch32.
This register is part of the Identification registers functional group.

Usage constraints

This register is accessible as shown below:

EL0	EL1 (NS)	EL1 (S)	EL2	EL3 (SCR.NS=1)	EL3 (SCR.NS=0)
-	RO	RO	RO	RO	RO

Configurations

ID_ISAR5_EL1 is architecturally mapped to AArch32 register [ID_ISAR5](#).

In an AArch64-only implementation, this register is RES0.

Attributes

ID_ISAR5_EL1 is a 32-bit register.

The ID_ISAR5_EL1 bit assignments are:

31	20 19	16 15	12 11	8 7	4 3	0
RES0	CRC32	SHA2	SHA1	AES	SEVL	

Bits [31:20]

Reserved, RES0.

CRC32, bits [19:16]

Indicates whether CRC32 instructions are implemented in AArch32.

0000 No CRC32 instructions implemented.

0001 CRC32B, CRC32H, CRC32W, CRC32CB, CRC32CH, and CRC32CW instructions implemented.

All other values are reserved.

This field must have the same value as [ID_AA64ISAR0_EL1.CRC32](#). The architecture requires that if CRC32 is supported in one Execution state, it must be supported in both Execution states.

SHA2, bits [15:12]

Indicates whether SHA2 instructions are implemented in AArch32.

0000 No SHA2 instructions implemented.

0001 SHA256H, SHA256H2, SHA256SU0, and SHA256SU1 implemented.

All other values are reserved.

SHA1, bits [11:8]

Indicates whether SHA1 instructions are implemented in AArch32.

0000 No SHA1 instructions implemented.

0001 SHA1C, SHA1P, SHA1M, SHA1H, SHA1SU0, and SHA1SU1 implemented.

All other values are reserved.

AES, bits [7:4]

Indicates whether AES instructions are implemented in AArch32.

0000 No AES instructions implemented.

0001 AESE, AESD, AESMC, and AESIMC implemented.

0010 As for 0b0001, plus PMULL/PMULL2 instructions operating on 64-bit data quantities.

All other values are reserved.

SEVL, bits [3:0]

Indicates whether the SEVL instruction is implemented in AArch32.

0000 SEVL is implemented as a NOP.

0001 SEVL is implemented as Send Event Local.

Accessing the ID_ISAR5_EL1:

To access the ID_ISAR5_EL1:

MRS <Xt>, ID_ISAR5_EL1 ; Read ID_ISAR5_EL1 into Xt

Register access is encoded as follows:

op0	op1	CRn	CRm	op2
11	000	0000	0010	101

D8.2.53 ID_MMFR0_EL1, AArch32 Memory Model Feature Register 0

The ID_MMFR0_EL1 characteristics are:

Purpose

Provides information about the implemented memory model and memory management support in AArch32.

This register is part of the Identification registers functional group.

Usage constraints

This register is accessible as shown below:

EL0	EL1 (NS)	EL1 (S)	EL2	EL3 (SCR.NS=1)	EL3 (SCR.NS=0)
-	RO	RO	RO	RO	RO

Configurations

ID_MMFR0_EL1 is architecturally mapped to AArch32 register [ID_MMFR0](#).

In an AArch64-only implementation, this register is RES0.

Attributes

ID_MMFR0_EL1 is a 32-bit register.

The ID_MMFR0_EL1 bit assignments are:

31	28 27	24 23	20 19	16 15	12 11	8 7	4 3	0
InnerShr	FCSE	AuxReg	TCM	ShareLvl	OuterShr	PMSA	VMSA	

InnerShr, bits [31:28]

Innermost Shareability. Indicates the innermost shareability domain implemented. Permitted values are:

- 0000 Implemented as Non-cacheable.
- 0001 Implemented with hardware coherency support.
- 1111 Shareability ignored.

All other values are reserved.

This field is valid only if the implementation distinguishes between Inner Shareable and Outer Shareable, by implementing two levels of shareability, as indicated by the value of the Shareability levels field, bits[15:12].

When the Shareability level field is zero, this field is UNK.

FCSE, bits [27:24]

Indicates whether the implementation includes the FCSE. Permitted values are:

- 0000 Not supported.
- 0001 Support for FCSE.

All other values are reserved.

The value of 0b0001 is only permitted when the VMSA field has a value greater than 0b0010.

AuxReg, bits [23:20]

Auxiliary Registers. Indicates support for Auxiliary registers. Permitted values are:

- 0000 None supported.

- 0001 Support for Auxiliary Control Register only.
 - 0010 Support for Auxiliary Fault Status Registers (AIFSR and ADFSR) and Auxiliary Control Register.
- All other values are reserved.

TCM, bits [19:16]

Indicates support for TCMs and associated DMAs. Permitted values are:

- 0000 Not supported.
- 0001 Support is IMPLEMENTATION DEFINED. ARMv7 requires this setting.
- 0010 Support for TCM only, ARMv6 implementation.
- 0011 Support for TCM and DMA, ARMv6 implementation.

All other values are reserved.

An ARMv7 implementation might include an ARMv6 model for TCM support. However, in ARMv7 this is an IMPLEMENTATION DEFINED option, and therefore it must be represented by the 0b0001 encoding in this field.

ShareLvl, bits [15:12]

Shareability Levels. Indicates the number of shareability levels implemented. Permitted values are:

- 0000 One level of shareability implemented.
- 0001 Two levels of shareability implemented.

All other values are reserved.

OuterShr, bits [11:8]

Outermost Shareability. Indicates the outermost shareability domain implemented. Permitted values are:

- 0000 Implemented as Non-cacheable.
- 0001 Implemented with hardware coherency support.
- 1111 Shareability ignored.

All other values are reserved.

PMSA, bits [7:4]

Indicates support for a PMSA. Permitted values are:

- 0000 Not supported.
- 0001 Support for IMPLEMENTATION DEFINED PMSA.
- 0010 Support for PMSAv6, with a Cache Type Register implemented.
- 0011 Support for PMSAv7, with support for memory subsections. ARMv7-R profile.

All other values are reserved.

When the PMSA field is set to a value other than 0b0000 the VMSA field must be set to 0b0000.

VMSA, bits [3:0]

Indicates support for a VMSA. Permitted values are:

- 0000 Not supported.
- 0001 Support for IMPLEMENTATION DEFINED VMSA.
- 0010 Support for VMSAv6, with Cache and TLB Type Registers implemented.
- 0011 Support for VMSAv7, with support for remapping and the Access flag. ARMv7-A profile.
- 0100 As for 0b0011, and adds support for the PXN bit in the Short-descriptor translation table format descriptors.
- 0101 As for 0b0100, and adds support for the Long-descriptor translation table format.

All other values are reserved.

When the VMISA field is set to a value other than 0b0000 the PMSA field must be set to 0b0000.

Accessing the ID_MMFR0_EL1:

To access the ID_MMFR0_EL1:

MRS <Xt>, ID_MMFR0_EL1 ; Read ID_MMFR0_EL1 into Xt

Register access is encoded as follows:

op0	op1	CRn	CRm	op2
11	000	0000	0001	100

D8.2.54 ID_MMFR1_EL1, AArch32 Memory Model Feature Register 1

The ID_MMFR1_EL1 characteristics are:

Purpose

Provides information about the implemented memory model and memory management support in AArch32.

This register is part of the Identification registers functional group.

Usage constraints

This register is accessible as shown below:

ELO	EL1 (NS)	EL1 (S)	EL2	EL3 (SCR.NS=1)	EL3 (SCR.NS=0)
-	RO	RO	RO	RO	RO

Configurations

ID_MMFR1_EL1 is architecturally mapped to AArch32 register [ID_MMFR1](#).

In an AArch64-only implementation, this register is RES0.

Attributes

ID_MMFR1_EL1 is a 32-bit register.

The ID_MMFR1_EL1 bit assignments are:

31	28	27	24	23	20	19	16	15	12	11	8	7	4	3	0
BPred	L1TstCln		L1Uni		L1Hvd		L1UniSW		L1HvdSW		L1UniVA		L1HvdVA		

BPred, bits [31:28]

Branch Predictor. Indicates branch predictor management requirements. Permitted values are:

0000 No branch predictor, or no MMU present. Implies a fixed MPU configuration.

0001 Branch predictor requires flushing on:

- Enabling or disabling the MMU.
- Writing new data to instruction locations.
- Writing new mappings to the translation tables.
- Any change to the [TTBR0](#), [TTBR1](#), or [TTBCR](#) registers.
- Changes of FCSE ProcessID or ContextID.

0010 Branch predictor requires flushing on:

- Enabling or disabling the MMU.
- Writing new data to instruction locations.
- Writing new mappings to the translation tables.
- Any change to the [TTBR0](#), [TTBR1](#), or [TTBCR](#) registers without a corresponding change to the FCSE ProcessID or ContextID.

0011 Branch predictor requires flushing only on writing new data to instruction locations.

0100 For execution correctness, branch predictor requires no flushing at any time.

All other values are reserved.

The branch predictor is described in some documentation as the Branch Target Buffer.

L1TstCln, bits [27:24]

Level 1 cache Test and Clean. Indicates the supported Level 1 data cache test and clean operations, for Harvard or unified cache implementations. Permitted values are:

- 0000 None supported. This is the required setting for ARMv7.
- 0001 Supported Level 1 data cache test and clean operations are:
 - Test and clean data cache.
- 0010 As for 0b0001, and adds:
 - Test, clean, and invalidate data cache.

All other values are reserved.

L1Uni, bits [23:20]

Level 1 Unified cache. Indicates the supported entire Level 1 cache maintenance operations, for a unified cache implementation. Permitted values are:

- 0000 None supported. This is the required setting for ARMv7, because ARMv7 requires a hierarchical cache implementation.
- 0001 Supported entire Level 1 cache operations are:
 - Invalidate cache, including branch predictor if appropriate.
 - Invalidate branch predictor, if appropriate.
- 0010 As for 0b0001, and adds:
 - Clean cache, using a recursive model that uses the cache dirty status bit.
 - Clean and invalidate cache, using a recursive model that uses the cache dirty status bit.

All other values are reserved.

If this field is set to a value other than 0b0000 then the L1 Harvard cache field, bits[19:16], must be set to 0b0000.

L1Hvd, bits [19:16]

Level 1 Harvard cache. Indicates the supported entire Level 1 cache maintenance operations, for a Harvard cache implementation. Permitted values are:

- 0000 None supported. This is the required setting for ARMv7, because ARMv7 requires a hierarchical cache implementation.
- 0001 Supported entire Level 1 cache operations are:
 - Invalidate instruction cache, including branch predictor if appropriate.
 - Invalidate branch predictor, if appropriate.
- 0010 As for 0b0001, and adds:
 - Invalidate data cache.
 - Invalidate data cache and instruction cache, including branch predictor if appropriate.
- 0011 As for 0b0010, and adds:
 - Clean data cache, using a recursive model that uses the cache dirty status bit.
 - Clean and invalidate data cache, using a recursive model that uses the cache dirty status bit.

All other values are reserved.

If this field is set to a value other than 0b0000 then the L1 unified cache field, bits[23:20], must be set to 0b0000.

L1UniSW, bits [15:12]

Level 1 Unified cache by Set/Way. Indicates the supported Level 1 cache line maintenance operations by set/way, for a unified cache implementation. Permitted values are:

- 0000 None supported. This is the required setting for ARMv7, because ARMv7 requires a hierarchical cache implementation.
- 0001 Supported Level 1 unified cache line maintenance operations by set/way are:
 - Clean cache line by set/way.
- 0010 As for 0b0001, and adds:
 - Clean and invalidate cache line by set/way.
- 0011 As for 0b0010, and adds:
 - Invalidate cache line by set/way.

All other values are reserved.

If this field is set to a value other than 0b0000 then the L1 Harvard cache s/w field, bits[11:8], must be set to 0b0000.

L1HvdSW, bits [11:8]

Level 1 Harvard cache by Set/Way. Indicates the supported Level 1 cache line maintenance operations by set/way, for a Harvard cache implementation. Permitted values are:

- 0000 None supported. This is the required setting for ARMv7, because ARMv7 requires a hierarchical cache implementation.
- 0001 Supported Level 1 Harvard cache line maintenance operations by set/way are:
 - Clean data cache line by set/way.
 - Clean and invalidate data cache line by set/way.
- 0010 As for 0b0001, and adds:
 - Invalidate data cache line by set/way.
- 0011 As for 0b0010, and adds:
 - Invalidate instruction cache line by set/way.

All other values are reserved.

If this field is set to a value other than 0b0000 then the L1 unified cache s/w field, bits[15:12], must be set to 0b0000.

L1UniVA, bits [7:4]

Level 1 Unified cache by Virtual Address. Indicates the supported Level 1 cache line maintenance operations by VA, for a unified cache implementation. Permitted values are:

- 0000 None supported. This is the required setting for ARMv7, because ARMv7 requires a hierarchical cache implementation.
- 0001 Supported Level 1 unified cache line maintenance operations by VA are:
 - Clean cache line by VA.
 - Invalidate cache line by VA.
 - Clean and invalidate cache line by VA.
- 0010 As for 0b0001, and adds:
 - Invalidate branch predictor by VA, if branch predictor is implemented.

All other values are reserved.

If this field is set to a value other than 0b0000 then the L1 Harvard cache VA field, bits[3:0], must be set to 0b0000.

L1HvdVA, bits [3:0]

Level 1 Harvard cache by Virtual Address. Indicates the supported Level 1 cache line maintenance operations by VA, for a Harvard cache implementation. Permitted values are:

- 0000 None supported. This is the required setting for ARMv7, because ARMv7 requires a hierarchical cache implementation.
- 0001 Supported Level 1 Harvard cache line maintenance operations by VA are:
 - Clean data cache line by VA.
 - Invalidate data cache line by VA.
 - Clean and invalidate data cache line by VA.
 - Clean instruction cache line by VA.
- 0010 As for 0b0001, and adds:
 - Invalidate branch predictor by VA, if branch predictor is implemented.

All other values are reserved.

If this field is set to a value other than 0b0000 then the L1 unified cache VA field, bits[7:4], must be set to 0b0000.

Accessing the ID_MMFR1_EL1:

To access the ID_MMFR1_EL1:

MRS <Xt>, ID_MMFR1_EL1 ; Read ID_MMFR1_EL1 into Xt

Register access is encoded as follows:

op0	op1	CRn	CRm	op2
11	000	0000	0001	101

D8.2.55 ID_MMFR2_EL1, AArch32 Memory Model Feature Register 2

The ID_MMFR2_EL1 characteristics are:

Purpose

Provides information about the implemented memory model and memory management support in AArch32.

This register is part of the Identification registers functional group.

Usage constraints

This register is accessible as shown below:

EL0	EL1 (NS)	EL1 (S)	EL2	EL3 (SCR.NS=1)	EL3 (SCR.NS=0)
-	RO	RO	RO	RO	RO

Configurations

ID_MMFR2_EL1 is architecturally mapped to AArch32 register [ID_MMFR2](#).

In an AArch64-only implementation, this register is RES0.

Attributes

ID_MMFR2_EL1 is a 32-bit register.

The ID_MMFR2_EL1 bit assignments are:

31	28 27	24 23	20 19	16 15	12 11	8 7	4 3	0
HWAccFlg	WFIStall	MemBarr	UniTLB	HvdTLB	L1HvdRng	L1HvdBG	L1HvdFG	

HWAccFlg, bits [31:28]

Hardware Access Flag. Indicates support for a Hardware Access flag, as part of the VMSAv7 implementation. Permitted values are:

0000 Not supported.

0001 Support for VMSAv7 Access flag, updated in hardware.

All other values are reserved.

On an ARMv7-R implementation this field must be 0b0000.

WFIStall, bits [27:24]

Wait For Interrupt Stall. Indicates the support for Wait For Interrupt (WFI) stalling. Permitted values are:

0000 Not supported.

0001 Support for WFI stalling.

All other values are reserved.

MemBarr, bits [23:20]

Memory Barrier. Indicates the supported CP15 memory barrier operations:

0000 None supported.

0001 Supported CP15 Memory barrier operations are:

- Data Synchronization Barrier (DSB), which in previous versions of the ARM architecture was named Data Write Barrier (DWB).

- 0010 As for 0b0001, and adds:
- Instruction Synchronization Barrier (ISB), which in previous versions of the ARM architecture was called Prefetch Flush.
 - Data Memory Barrier (DMB).

All other values are reserved.

From ARMv7, ARM deprecates the use of these operations. ID_ISAR4.Barrier_instrs indicates the level of support for the preferred barrier instructions.

UniTLB, bits [19:16]

Unified TLB. Indicates the supported TLB maintenance operations, for a unified TLB implementation. Permitted values are:

- 0000 Not supported.
- 0001 Supported unified TLB maintenance operations are:
- Invalidate all entries in the TLB.
 - Invalidate TLB entry by VA.
- 0010 As for 0b0001, and adds:
- Invalidate TLB entries by ASID match.
- 0011 As for 0b0010, and adds:
- Invalidate instruction TLB and data TLB entries by VA All ASID. This is a shared unified TLB operation.
- 0100 As for 0b0011, and adds:
- Invalidate Hyp mode unified TLB entry by VA.
 - Invalidate entire Non-secure EL1&0 unified TLB.
 - Invalidate entire Hyp mode unified TLB.
- 0101 As for 0b0100, and adds the following operations: [TLBIMVALIS](#), [TLBIMVAALIS](#), [TLBIMVALHIS](#), [TLBIMVAL](#), [TLBIMVAAL](#), [TLBIMVALH](#).
- 0110 As for 0b0101, and adds the following operations: [TLBIIPAS2IS](#), [TLBIIPAS2LIS](#), [TLBIIPAS2](#), [TLBIIPAS2L](#).

All other values are reserved.

If this field is set to a value other than 0b0000 then the Harvard TLB field, bits[15:12], must be set to 0b0000.

HvdTLB, bits [15:12]

Harvard TLB. Indicates the supported TLB maintenance operations, for a Harvard TLB implementation. Permitted values are:

- 0000 Not supported.
- 0001 Supported Harvard TLB maintenance operations are:
- Invalidate all entries in the ITLB and the DTLB. This is a shared unified TLB operation.
 - Invalidate all ITLB entries.
 - Invalidate all DTLB entries.
 - Invalidate ITLB entry by VA.
 - Invalidate DTLB entry by VA.
- 0010 As for 0b0001, and adds:
- Invalidate ITLB and DTLB entries by ASID match. This is a shared unified TLB operation.
 - Invalidate ITLB entries by ASID match.
 - Invalidate DTLB entries by ASID match.

All other values are reserved.

If this field is set to a value other than 0b0000 then the Unified TLB field, bits[19:16], must be set to 0b0000.

L1HvdRng, bits [11:8]

Level 1 Harvard cache Range. Indicates the supported Level 1 cache maintenance range operations, for a Harvard cache implementation. Permitted values are:

0000 Not supported.

0001 Supported Level 1 Harvard cache maintenance range operations are:

- Invalidate data cache range by VA.
- Invalidate instruction cache range by VA.
- Clean data cache range by VA.
- Clean and invalidate data cache range by VA.

All other values are reserved.

L1HvdBG, bits [7:4]

Level 1 Harvard cache Background fetch. Indicates the supported Level 1 cache background fetch operations, for a Harvard cache implementation. When supported, background fetch operations are non-blocking operations. Permitted values are:

0000 Not supported.

0001 Supported Level 1 Harvard cache background fetch operations are:

- Fetch instruction cache range by VA.
- Fetch data cache range by VA.

All other values are reserved.

L1HvdFG, bits [3:0]

Level 1 Harvard cache Foreground fetch. Indicates the supported Level 1 cache foreground fetch operations, for a Harvard cache implementation. When supported, foreground fetch operations are blocking operations. Permitted values are:

0000 Not supported.

0001 Supported Level 1 Harvard cache foreground fetch operations are:

- Fetch instruction cache range by VA.
- Fetch data cache range by VA.

All other values are reserved.

Accessing the ID_MMFR2_EL1:

To access the ID_MMFR2_EL1:

MRS <Xt>, ID_MMFR2_EL1 ; Read ID_MMFR2_EL1 into Xt

Register access is encoded as follows:

op0	op1	CRn	CRm	op2
11	000	0000	0001	110

D8.2.56 ID_MMFR3_EL1, AArch32 Memory Model Feature Register 3

The ID_MMFR3_EL1 characteristics are:

Purpose

Provides information about the implemented memory model and memory management support in AArch32.

This register is part of the Identification registers functional group.

Usage constraints

This register is accessible as shown below:

EL0	EL1 (NS)	EL1 (S)	EL2	EL3 (SCR.NS=1)	EL3 (SCR.NS=0)
-	RO	RO	RO	RO	RO

Configurations

ID_MMFR3_EL1 is architecturally mapped to AArch32 register [ID_MMFR3](#).

In an AArch64-only implementation, this register is RES0.

Attributes

ID_MMFR3_EL1 is a 32-bit register.

The ID_MMFR3_EL1 bit assignments are:

31	28 27	24 23	20 19	16 15	12 11	8 7	4 3	0
Supersec	CMemSz	CohWalk	RES0	MaintBcst	BPMaint	CMaintSW	CMaintVA	

Supersec, bits [31:28]

Supersections. On a VMSA implementation, indicates whether Supersections are supported.

Permitted values are:

0000 Supersections supported.

1111 Supersections not supported.

All other values are reserved.

The sense of this identification is reversed from the normal usage in the CPUID mechanism, with the value of zero indicating that the feature is supported.

CMemSz, bits [27:24]

Cached Memory Size. Indicates the physical memory size supported by the processor caches.

Permitted values are:

0000 4GBbyte, corresponding to a 32-bit physical address range.

0001 64GBbyte, corresponding to a 36-bit physical address range.

0010 1TBbyte or more, corresponding to a 40-bit or larger physical address range.

All other values are reserved.

CohWalk, bits [23:20]

Coherent Walk. Indicates whether Translation table updates require a clean to the point of unification. Permitted values are:

0000 Updates to the translation tables require a clean to the point of unification to ensure visibility by subsequent translation table walks.

0001 Updates to the translation tables do not require a clean to the point of unification to ensure visibility by subsequent translation table walks.

All other values are reserved.

Bits [19:16]

Reserved, RES0.

MaintBest, bits [15:12]

Maintenance Broadcast. Indicates whether Cache, TLB, and branch predictor operations are broadcast. Permitted values are:

0000 Cache, TLB, and branch predictor operations only affect local structures.

0001 Cache and branch predictor operations affect structures according to shareability and defined behavior of instructions. TLB operations only affect local structures.

0010 Cache, TLB, and branch predictor operations affect structures according to shareability and defined behavior of instructions.

All other values are reserved.

BPMaint, bits [11:8]

Branch Predictor Maintenance. Indicates the supported branch predictor maintenance operations in an implementation with hierarchical cache maintenance operations. Permitted values are:

0000 None supported.

0001 Supported branch predictor maintenance operations are:

- Invalidate all branch predictors.

0010 As for 0b0001, and adds:

- Invalidate branch predictors by VA.

All other values are reserved.

CMaintSW, bits [7:4]

Cache Maintenance by Set/Way. Indicates the supported cache maintenance operations by set/way, in an implementation with hierarchical caches. Permitted values are:

0000 None supported.

0001 Supported hierarchical cache maintenance operations by set/way are:

- Invalidate data cache by set/way.
- Clean data cache by set/way.
- Clean and invalidate data cache by set/way.

All other values are reserved.

In a unified cache implementation, the data cache operations apply to the unified caches.

CMaintVA, bits [3:0]

Cache Maintenance by Virtual Address. Indicates the supported cache maintenance operations by VA, in an implementation with hierarchical caches. Permitted values are:

0000 None supported.

0001 Supported hierarchical cache maintenance operations by VA are:

- Invalidate data cache by VA.
- Clean data cache by VA.
- Clean and invalidate data cache by VA.
- Invalidate instruction cache by VA.
- Invalidate all instruction cache entries.

All other values are reserved.

In a unified cache implementation, the data cache operations apply to the unified caches, and the instruction cache operations are not implemented.

Accessing the ID_MMFR3_EL1:

To access the ID_MMFR3_EL1:

MRS <Xt>, ID_MMFR3_EL1 ; Read ID_MMFR3_EL1 into Xt

Register access is encoded as follows:

op0	op1	CRn	CRm	op2
11	000	0000	0001	111

D8.2.57 ID_PFR0_EL1, AArch32 Processor Feature Register 0

The ID_PFR0_EL1 characteristics are:

Purpose

Gives top-level information about the instruction sets supported by the processor in AArch32.
This register is part of the Identification registers functional group.

Usage constraints

This register is accessible as shown below:

EL0	EL1 (NS)	EL1 (S)	EL2	EL3 (SCR.NS=1)	EL3 (SCR.NS=0)
-	RO	RO	RO	RO	RO

Configurations

ID_PFR0_EL1 is architecturally mapped to AArch32 register [ID_PFR0](#).

In an AArch64-only implementation, this register is RES0.

Attributes

ID_PFR0_EL1 is a 32-bit register.

The ID_PFR0_EL1 bit assignments are:

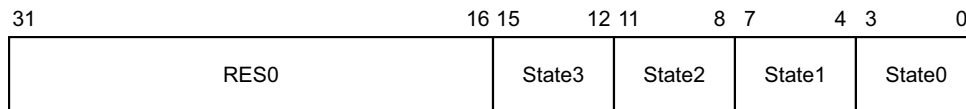

Bits [31:16]

Reserved, RES0.

State3, bits [15:12]

T32EE instruction set support. Permitted values are:

- 0000 Not implemented.
- 0001 T32EE instruction set implemented.

All other values are reserved.

The value of 0b0001 is only permitted when State1 == 0b0011.

State2, bits [11:8]

Jazelle extension support. Permitted values are:

- 0000 Not implemented.
- 0001 Jazelle extension implemented, without clearing of [JOSCR.CV](#) on exception entry.
- 0010 Jazelle extension implemented, with clearing of [JOSCR.CV](#) on exception entry.

All other values are reserved.

State1, bits [7:4]

T32 instruction set support. Permitted values are:

- 0000 T32 instruction set not implemented.
- 0001 T32 encodings before the introduction of Thumb-2 technology implemented:
 - All instructions are 16-bit.
 - A BL or BLX is a pair of 16-bit instructions.

- 32-bit instructions other than BL and BLX cannot be encoded.

0011 T32 encodings after the introduction of Thumb-2 technology implemented, for all 16-bit and 32-bit T32 basic instructions.

All other values are reserved.

State0, bits [3:0]

A32 instruction set support. Permitted values are:

0000 A32 instruction set not implemented.

0001 A32 instruction set implemented.

All other values are reserved.

Accessing the ID_PFR0_EL1:

To access the ID_PFR0_EL1:

MRS <Xt>, ID_PFR0_EL1 ; Read ID_PFR0_EL1 into Xt

Register access is encoded as follows:

op0	op1	CRn	CRm	op2
11	000	0000	0001	000

D8.2.58 ID_PFR1_EL1, AArch32 Processor Feature Register 1

The ID_PFR1_EL1 characteristics are:

Purpose

Gives information about the programmers' model and extensions support in AArch32.
This register is part of the Identification registers functional group.

Usage constraints

This register is accessible as shown below:

ELO	EL1 (NS)	EL1 (S)	EL2	EL3 (SCR.NS=1)	EL3 (SCR.NS=0)
-	RO	RO	RO	RO	RO

Configurations

ID_PFR1_EL1 is architecturally mapped to AArch32 register [ID_PFR1](#).
In an AArch64-only implementation, this register is RES0.

Attributes

ID_PFR1_EL1 is a 32-bit register.

The ID_PFR1_EL1 bit assignments are:

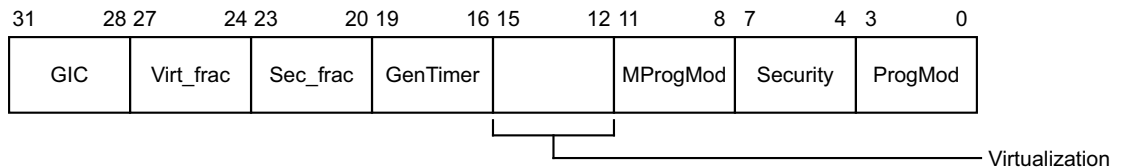

GIC, bits [31:28]

GIC CP15 interface. Permitted values are:

0000 No GIC CP15 registers are supported.

0001 GICv3 CP15 registers are supported.

All other values are reserved.

Virt_frac, bits [27:24]

Virtualization fractional field. When the Virtualization field is 0b0000, determines the support for features from the ARMv7 Virtualization Extensions. Permitted values are:

0000 No features from the ARMv7 Virtualization Extensions are implemented.

0001 The [SCR.SIF](#) bit is implemented. The modifications to the [SCR.AW](#) and [SCR.FW](#) bits are part of the control of whether the CPSR.A and CPSR.F bits mask the corresponding aborts. The MSR (Banked register) and MRS (Banked register) instructions are implemented.

This value is permitted only when ID_PFR1.Security is not 0b0000.

All other values are reserved.

This field is only valid when ID_PFR1_EL1[15:12] == 0, otherwise it holds the value 0b0000.

Sec_frac, bits [23:20]

Security fractional field. When the Security field is 0b0000, determines the support for features from the ARMv7 Security Extensions. Permitted values are:

0000 No features from the ARMv7 Security Extensions are implemented.

0001 The implementation includes the VBAR, and the TCR.PD0 and TCR.PD1 bits.
0010 As for 0b0001, plus the ability to access Secure or Non-secure physical memory is supported.
All other values are reserved.
This field is only valid when ID_PFR1_EL1[7:4] == 0, otherwise it holds the value 0b0000.

GenTimer, bits [19:16]

Generic Timer Extension support. Permitted values are:
0000 Not implemented.
0001 Generic Timer Extension implemented.
All other values are reserved.

Virtualization, bits [15:12]

Virtualization support. Permitted values are:
0000 EL2 not implemented.
0001 EL2 implemented.
All other values are reserved.
A value of 0b0001 implies implementation of the HVC, ERET, MRS (banked register), and MSR (banked register) instructions. The ID_ISARs do not identify whether these instructions are implemented.

MProgMod, bits [11:8]

M profile programmers' model support. Permitted values are:
0000 Not supported.
0010 Support for two-stack programmers' model.
All other values are reserved.

Security, bits [7:4]

Security support. Permitted values are:
0000 EL3 not implemented.
0001 EL3 implemented.
This includes support for Monitor mode and the SMC instruction.
0010 As for 0b0001, and adds the ability to set the NSACR.RFR bit. Not permitted in v8-A as the NSACR.RFR bit is RES0.
All other values are reserved.

ProgMod, bits [3:0]

Support for the standard programmers' model for ARMv4 and later. Model must support User, FIQ, IRQ, Supervisor, Abort, Undefined, and System modes. Permitted values are:
0000 Not supported.
0001 Supported.
All other values are reserved.

Accessing the ID_PFR1_EL1:

To access the ID_PFR1_EL1:
MRS <Xt>, ID_PFR1_EL1 ; Read ID_PFR1_EL1 into Xt

Register access is encoded as follows:

op0	op1	CRn	CRm	op2
11	000	0000	0001	001

D8.2.59 IFSR32_EL2, Instruction Fault Status Register (EL2)

The IFSR32_EL2 characteristics are:

Purpose

Allows access to the AArch32 [IFSR](#) register from AArch64 state only. Its value has no effect on execution in AArch64 state.

This register is part of the Exception and fault handling registers functional group.

Usage constraints

This register is accessible as shown below:

EL0	EL1 (NS)	EL1 (S)	EL2	EL3 (SCR.NS=1)	EL3 (SCR.NS=0)
-	-	-	RW	RW	RW

Configurations

IFSR32_EL2 is architecturally mapped to AArch32 register [IFSR](#) (NS).

Attributes

IFSR32_EL2 is a 32-bit register.

The IFSR32_EL2 bit assignments are:

When TTBCR.EAE==0:

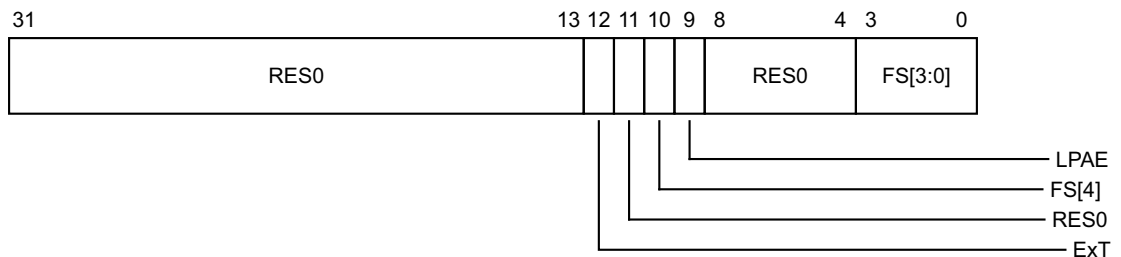

Bits [31:13]

Reserved, RES0.

ExT, bit [12]

External abort type. This bit can be used to provide an IMPLEMENTATION DEFINED classification of external aborts.

For aborts other than external aborts this bit always returns 0.

Bit [11]

Reserved, RES0.

FS[4], bit [10]

See below for description of the FS field.

LPAE, bit [9]

On taking a Data Abort exception, this bit is set as follows:

- 0 Using the Short-descriptor translation table formats.
- 1 Using the Long-descriptor translation table formats.

Hardware does not interpret this bit to determine the behavior of the memory system, and therefore software can set this bit to 0 or 1 without affecting operation.

Bits [8:4]

Reserved, RES0.

FS[3:0], bits [3:0]

Fault status bits. Possible values of this field are:

- 0010 Debug event
- 0011 Access flag fault, first level
- 0101 Translation fault, first level
- 0110 Access flag fault, second level
- 0111 Translation fault, second level
- 1000 Synchronous external abort
- 1001 Domain fault, first level
- 1011 Domain fault, second level
- 1100 Synchronous external abort on translation table walk, first level
- 1101 Permission fault, first level
- 1110 Synchronous external abort on translation table walk, second level
- 1111 Permission fault, second level
- 10000 TLB conflict abort
- 10100 IMPLEMENTATION DEFINED fault (Lockdown fault)
- 11001 Synchronous parity error on memory access
- 11100 Synchronous parity error on translation table walk, first level
- 11110 Synchronous parity error on translation table walk, second level

All other values are reserved.

When TTBCR.EAE==1:

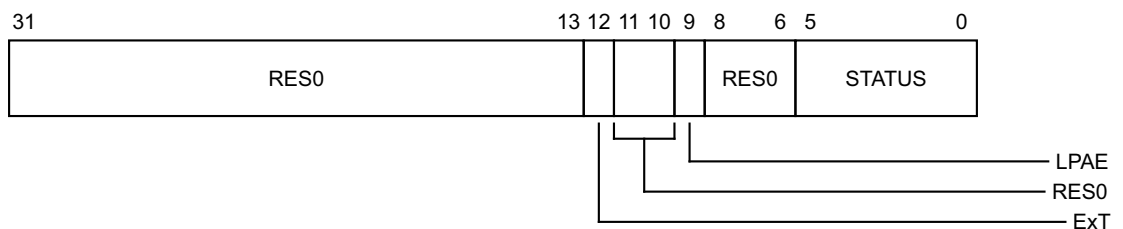

Bits [31:13]

Reserved, RES0.

ExT, bit [12]

External abort type. This bit can be used to provide an IMPLEMENTATION DEFINED classification of external aborts.

For aborts other than external aborts this bit always returns 0.

Bits [11:10]

Reserved, RES0.

LPAE, bit [9]

On taking a Data Abort exception, this bit is set as follows:

- 0 Using the Short-descriptor translation table formats.
- 1 Using the Long-descriptor translation table formats.

Hardware does not interpret this bit to determine the behavior of the memory system, and therefore software can set this bit to 0 or 1 without affecting operation.

Bits [8:6]

Reserved, RES0.

STATUS, bits [5:0]

Fault status bits. All encodings not shown below are reserved:

000000	Address size fault in TTBR0 or TTBR1
000101	Translation fault, first level
000110	Translation fault, second level
000111	Translation fault, third level
001001	Access flag fault, first level
001010	Access flag fault, second level
001011	Access flag fault, third level
001101	Permission fault, first level
001110	Permission fault, second level
001111	Permission fault, third level
010000	Synchronous external abort
010101	Synchronous external abort on translation table walk, first level
010110	Synchronous external abort on translation table walk, second level
010111	Synchronous external abort on translation table walk, third level
011000	Synchronous parity error on memory access
011101	Synchronous parity error on memory access on translation table walk, first level
011110	Synchronous parity error on memory access on translation table walk, second level
011111	Synchronous parity error on memory access on translation table walk, third level
100001	Alignment fault
100010	Debug event
110000	TLB conflict abort
110100	IMPLEMENTATION DEFINED fault (Lockdown fault)

All other values are reserved.

The lookup level associated with a fault is:

- For a fault generated on a translation table walk, the lookup level of the walk being performed.
- For a Translation fault, the lookup level of the translation table that gave the fault. If a fault occurs because an MMU is disabled, or because the input address is outside the range specified by the appropriate base address register or registers, the fault is reported as a First level fault.
- For an Access flag fault, the lookup level of the translation table that gave the fault.
- For a Permission fault, including a Permission fault caused by hierarchical permissions, the lookup level of the final level of translation table accessed for the translation. That is, the lookup level of the translation table that returned a Block or Page descriptor.

Accessing the IFSR32_EL2:

To access the IFSR32_EL2:

MRS <Xt>, IFSR32_EL2 ; Read IFSR32_EL2 into Xt
MSR IFSR32_EL2, <Xt> ; Write Xt to IFSR32_EL2

Register access is encoded as follows:

op0	op1	CRn	CRm	op2
11	100	0101	0000	001

D8.2.60 ISR_EL1, Interrupt Status Register

The ISR_EL1 characteristics are:

Purpose

Shows whether an IRQ, FIQ, or SError interrupt is pending. If EL2 is implemented, an indicated pending interrupt might be a physical interrupt or a virtual interrupt.

This register is part of the Exception and fault handling registers functional group.

Usage constraints

This register is accessible as shown below:

EL0	EL1 (NS)	EL1 (S)	EL2	EL3 (SCR.NS=1)	EL3 (SCR.NS=0)
-	RO	RO	RO	RO	RO

Configurations

ISR_EL1 is architecturally mapped to AArch32 register [ISR](#).

Attributes

ISR_EL1 is a 32-bit register.

The ISR_EL1 bit assignments are:



Bits [31:9]

Reserved, RES0.

A, bit [8]

SError pending bit:

0 No pending SError.

1 An SError interrupt is pending.

I, bit [7]

IRQ pending bit. Indicates whether an IRQ interrupt is pending:

0 No pending IRQ.

1 An IRQ interrupt is pending.

F, bit [6]

FIQ pending bit. Indicates whether an FIQ interrupt is pending.

0 No pending FIQ.

1 An FIQ interrupt is pending.

Bits [5:0]

Reserved, RES0.

Accessing the ISR_EL1:

To access the ISR_EL1:

MRS <Xt>, ISR_EL1 ; Read ISR_EL1 into Xt

Register access is encoded as follows:

op0	op1	CRn	CRm	op2
11	000	1100	0001	000

D8.2.61 MAIR_EL1, Memory Attribute Indirection Register (EL1)

The MAIR_EL1 characteristics are:

Purpose

Provides the memory attribute encodings corresponding to the possible AttrIdx values in a Long-descriptor format translation table entry for stage 1 translations at EL1.

This register is part of the Virtual memory control registers functional group.

Usage constraints

This register is accessible as shown below:

EL0	EL1 (NS)	EL1 (S)	EL2	EL3 (SCR.NS=1)	EL3 (SCR.NS=0)
-	RW	RW	RW	RW	RW

MAIR_EL1 is permitted to be cached in a TLB.

Configurations

MAIR_EL1[31:0] is architecturally mapped to AArch32 register [PRRR](#) (NS) when TTBCR.EAE==0.

MAIR_EL1[31:0] is architecturally mapped to AArch32 register [MAIR0](#) (NS) when TTBCR.EAE==1.

MAIR_EL1[63:32] is architecturally mapped to AArch32 register [NMRR](#) (NS) when TTBCR.EAE==0.

MAIR_EL1[63:32] is architecturally mapped to AArch32 register [MAIR1](#) (NS) when TTBCR.EAE==1.

Attributes

MAIR_EL1 is a 64-bit register.

The MAIR_EL1 bit assignments are:

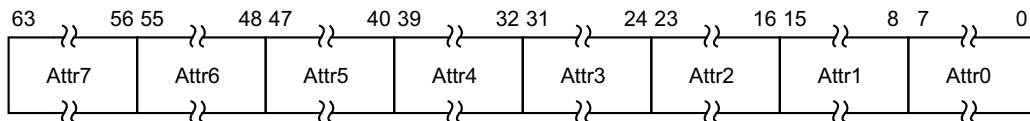

Attr<n>, bits [8n+7:8n], for n = 0 to 7

The memory attribute encoding for an AttrIdx[2:0] entry in a Long descriptor format translation table entry, where AttrIdx[2:0] gives the value of <n> in Attr<n>.

Bits [7:4] are encoded as follows:

Attr<n>[7:4]	Meaning
0000	Device memory. See encoding of Attr<n>[3:0] for the type of Device memory.
00RW, RW not 00	Normal Memory, Outer Write-through transient
0100	Normal Memory, Outer Non-Cacheable
01RW, RW not 00	Normal Memory, Outer Write-back transient
10RW	Normal Memory, Outer Write-through non-transient
11RW	Normal Memory, Outer Write-back non-transient

R = Outer Read Allocate Policy, W = Outer Write Allocate Policy.

The meaning of bits [3:0] depends on the value of bits [7:4]:

Attr<n>[3:0]	Meaning when Attr<n>[7:4] is 0000	Meaning when Attr<n>[7:4] is not 0000
0000	Device-nGnRnE memory	UNPREDICTABLE
00RW, RW not 00	UNPREDICTABLE	Normal Memory, Inner Write-through transient
0100	Device-nGnRE memory	Normal memory, Inner Non-Cacheable
01RW, RW not 00	UNPREDICTABLE	Normal Memory, Inner Write-back transient
1000	Device-nGRE memory	Normal Memory, Inner Write-through non-transient (RW=00)
10RW, RW not 00	UNPREDICTABLE	Normal Memory, Inner Write-through non-transient
1100	Device-GRE memory	Normal Memory, Inner Write-back non-transient (RW=00)
11RW, RW not 00	UNPREDICTABLE	Normal Memory, Inner Write-back non-transient

R = Inner Read Allocate Policy, W = Inner Write Allocate Policy.

ARMv7's Strongly-ordered and Device memory types have been renamed to Device-nGnRnE and Device-nGnRE in ARMv8.

The R and W bits in some Attr<n> fields have the following meanings:

R or W	Meaning
0	Do not allocate
1	Allocate

Accessing the MAIR_EL1:

To access the MAIR_EL1:

MRS <Xt>, MAIR_EL1 ; Read MAIR_EL1 into Xt
MSR MAIR_EL1, <Xt> ; Write Xt to MAIR_EL1

Register access is encoded as follows:

op0	op1	CRn	CRm	op2
11	000	1010	0010	000

D8.2.62 MAIR_EL2, Memory Attribute Indirection Register (EL2)

The MAIR_EL2 characteristics are:

Purpose

Provides the memory attribute encodings corresponding to the possible AttrIdx values in a Long-descriptor format translation table entry for stage 1 translations at EL2.

This register is part of:

- the Virtualization registers functional group
- the Virtual memory control registers functional group.

Usage constraints

This register is accessible as shown below:

ELO	EL1 (NS)	EL1 (S)	EL2	EL3 (SCR.NS=1)	EL3 (SCR.NS=0)
-	-	-	RW	RW	RW

MAIR_EL2 is permitted to be cached in a TLB.

Configurations

MAIR_EL2[31:0] is architecturally mapped to AArch32 register [HMAIR0](#).

MAIR_EL2[63:32] is architecturally mapped to AArch32 register [HMAIR1](#).

If EL2 is not implemented, this register is RES0 from EL3.

Attributes

MAIR_EL2 is a 64-bit register.

The MAIR_EL2 bit assignments are:

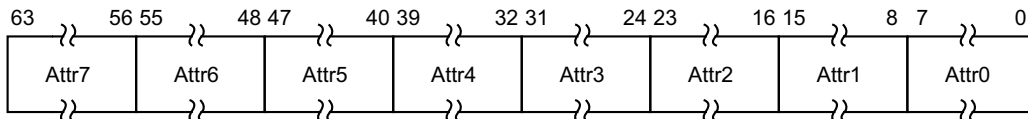

Attr<n>, bits [8n+7:8n], for n = 0 to 7

The memory attribute encoding for an AttrIdx[2:0] entry in a Long descriptor format translation table entry, where AttrIdx[2:0] gives the value of <n> in Attr<n>.

Bits [7:4] are encoded as follows:

Attr<n>[7:4]	Meaning
0000	Device memory. See encoding of Attr<n>[3:0] for the type of Device memory.
00RW, RW not 00	Normal Memory, Outer Write-through transient
0100	Normal Memory, Outer Non-Cacheable
01RW, RW not 00	Normal Memory, Outer Write-back transient
10RW	Normal Memory, Outer Write-through non-transient
11RW	Normal Memory, Outer Write-back non-transient

R = Outer Read Allocate Policy, W = Outer Write Allocate Policy.

The meaning of bits [3:0] depends on the value of bits [7:4]:

Attr<n>[3:0]	Meaning when Attr<n>[7:4] is 0000	Meaning when Attr<n>[7:4] is not 0000
0000	Device-nGnRnE memory	UNPREDICTABLE
00RW, RW not 00	UNPREDICTABLE	Normal Memory, Inner Write-through transient
0100	Device-nGnRE memory	Normal memory, Inner Non-Cacheable
01RW, RW not 00	UNPREDICTABLE	Normal Memory, Inner Write-back transient
1000	Device-nGRE memory	Normal Memory, Inner Write-through non-transient (RW=00)
10RW, RW not 00	UNPREDICTABLE	Normal Memory, Inner Write-through non-transient
1100	Device-GRE memory	Normal Memory, Inner Write-back non-transient (RW=00)
11RW, RW not 00	UNPREDICTABLE	Normal Memory, Inner Write-back non-transient

R = Inner Read Allocate Policy, W = Inner Write Allocate Policy.

ARMv7's Strongly-ordered and Device memory types have been renamed to Device-nGnRnE and Device-nGnRE in ARMv8.

The R and W bits in some Attr<n> fields have the following meanings:

R or W	Meaning
0	Do not allocate
1	Allocate

Accessing the MAIR_EL2:

To access the MAIR_EL2:

MRS <Xt>, MAIR_EL2 ; Read MAIR_EL2 into Xt

MSR MAIR_EL2, <Xt> ; Write Xt to MAIR_EL2

Register access is encoded as follows:

op0	op1	CRn	CRm	op2
11	100	1010	0010	000

D8.2.63 MAIR_EL3, Memory Attribute Indirection Register (EL3)

The MAIR_EL3 characteristics are:

Purpose

Provides the memory attribute encodings corresponding to the possible AttrIdx values in a Long-descriptor format translation table entry for stage 1 translations at EL3.

This register is part of the Virtual memory control registers functional group.

Usage constraints

This register is accessible as shown below:

EL0	EL1 (NS)	EL1 (S)	EL2	EL3 (SCR.NS=1)	EL3 (SCR.NS=0)
-	-	-	-	RW	RW

MAIR_EL3 is permitted to be cached in a TLB.

Configurations

MAIR_EL3[31:0] can be mapped to AArch32 register [PRRR](#) (S) when TTBCR.EAE==0, but this is not architecturally mandated.

MAIR_EL3[31:0] can be mapped to AArch32 register [MAIRO](#) (S) when TTBCR.EAE==1, but this is not architecturally mandated.

MAIR_EL3[63:32] can be mapped to AArch32 register [NMRR](#) (S) when TTBCR.EAE==0, but this is not architecturally mandated.

MAIR_EL3[63:32] can be mapped to AArch32 register [MAIR1](#) (S) when TTBCR.EAE==1, but this is not architecturally mandated.

Attributes

MAIR_EL3 is a 64-bit register.

The MAIR_EL3 bit assignments are:

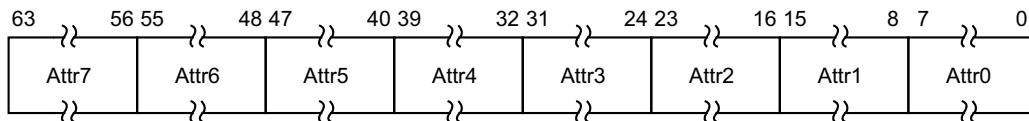

Attr<n>, bits [8n+7:8n], for n = 0 to 7

The memory attribute encoding for an AttrIdx[2:0] entry in a Long descriptor format translation table entry, where AttrIdx[2:0] gives the value of <n> in Attr<n>.

Bits [7:4] are encoded as follows:

Attr<n>[7:4]	Meaning
0000	Device memory. See encoding of Attr<n>[3:0] for the type of Device memory.
00RW, RW not 00	Normal Memory, Outer Write-through transient
0100	Normal Memory, Outer Non-Cacheable
01RW, RW not 00	Normal Memory, Outer Write-back transient
10RW	Normal Memory, Outer Write-through non-transient
11RW	Normal Memory, Outer Write-back non-transient

R = Outer Read Allocate Policy, W = Outer Write Allocate Policy.

The meaning of bits [3:0] depends on the value of bits [7:4]:

Attr<n>[3:0]	Meaning when Attr<n>[7:4] is 0000	Meaning when Attr<n>[7:4] is not 0000
0000	Device-nGnRnE memory	UNPREDICTABLE
00RW, RW not 00	UNPREDICTABLE	Normal Memory, Inner Write-through transient
0100	Device-nGnRE memory	Normal memory, Inner Non-Cacheable
01RW, RW not 00	UNPREDICTABLE	Normal Memory, Inner Write-back transient
1000	Device-nGRE memory	Normal Memory, Inner Write-through non-transient (RW=00)
10RW, RW not 00	UNPREDICTABLE	Normal Memory, Inner Write-through non-transient
1100	Device-GRE memory	Normal Memory, Inner Write-back non-transient (RW=00)
11RW, RW not 00	UNPREDICTABLE	Normal Memory, Inner Write-back non-transient

R = Inner Read Allocate Policy, W = Inner Write Allocate Policy.

ARMv7's Strongly-ordered and Device memory types have been renamed to Device-nGnRnE and Device-nGnRE in ARMv8.

The R and W bits in some Attr<n> fields have the following meanings:

R or W	Meaning
0	Do not allocate
1	Allocate

Accessing the MAIR_EL3:

To access the MAIR_EL3:

MRS <Xt>, MAIR_EL3 ; Read MAIR_EL3 into Xt
MSR MAIR_EL3, <Xt> ; Write Xt to MAIR_EL3

Register access is encoded as follows:

op0	op1	CRn	CRm	op2
11	110	1010	0010	000

D8.2.64 MIDR_EL1, Main ID Register

The MIDR_EL1 characteristics are:

Purpose

Provides identification information for the processor, including an implementer code for the device and a device ID number.

This register is part of the Identification registers functional group.

Usage constraints

This register is accessible as shown below:

EL0	EL1 (NS)	EL1 (S)	EL2	EL3 (SCR.NS=1)	EL3 (SCR.NS=0)
-	RO	RO	RO	RO	RO

Configurations

MIDR_EL1 is architecturally mapped to AArch32 register [MIDR](#).

MIDR_EL1 is architecturally mapped to external register [MIDR_EL1](#).

Attributes

MIDR_EL1 is a 32-bit register.

The MIDR_EL1 bit assignments are:

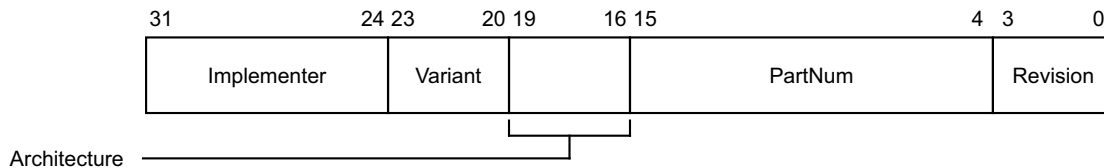

Implementer, bits [31:24]

The Implementer code. This field must hold an implementer code that has been assigned by ARM. Assigned codes include the following:

Hex representation	ASCII representation	Implementer
0x41	A	ARM Limited
0x42	B	Broadcom Corporation
0x43	C	Cavium Inc.
0x44	D	Digital Equipment Corporation
0x49	I	Infineon Technologies AG
0x4D	M	Motorola or Freescale Semiconductor Inc.
0x4E	N	NVIDIA Corporation
0x50	P	Applied Micro Circuits Corporation

Hex representation	ASCII representation	Implementer
0x51	Q	Qualcomm Inc.
0x56	V	Marvell International Ltd.
0x69	i	Intel Corporation

ARM can assign codes that are not published in this manual. All values not assigned by ARM are reserved and must not be used.

Variant, bits [23:20]

An IMPLEMENTATION DEFINED variant number. Typically, this field is used to distinguish between different product variants, or major revisions of a product.

Architecture, bits [19:16]

The permitted values of this field are:

0001	ARMv4
0010	ARMv4T
0011	ARMv5 (obsolete)
0100	ARMv5T
0101	ARMv5TE
0110	ARMv5TEJ
0111	ARMv6
1111	Defined by CPUID scheme

All other values are reserved.

PartNum, bits [15:4]

An IMPLEMENTATION DEFINED primary part number for the device.

On processors implemented by ARM, if the top four bits of the primary part number are 0x0 or 0x7, the variant and architecture are encoded differently.

Revision, bits [3:0]

An IMPLEMENTATION DEFINED revision number for the device.

Accessing the MIDR_EL1:

To access the MIDR_EL1:

MRS <Xt>, MIDR_EL1 ; Read MIDR_EL1 into Xt

Register access is encoded as follows:

op0	op1	CRn	CRm	op2
11	000	0000	0000	000

D8.2.65 MPIDR_EL1, Multiprocessor Affinity Register

The MPIDR_EL1 characteristics are:

Purpose

In a multiprocessor system, provides an additional processor identification mechanism for scheduling purposes, and indicates whether the implementation includes the Multiprocessing Extensions.

This register is part of the Identification registers functional group.

Usage constraints

This register is accessible as shown below:

EL0	EL1 (NS)	EL1 (S)	EL2	EL3 (SCR.NS=1)	EL3 (SCR.NS=0)
-	RO	RO	RO	RO	RO

Configurations

MPIDR_EL1 is architecturally mapped to AArch32 register [MPIDR](#).

Attributes

MPIDR_EL1 is a 64-bit register.

The MPIDR_EL1 bit assignments are:

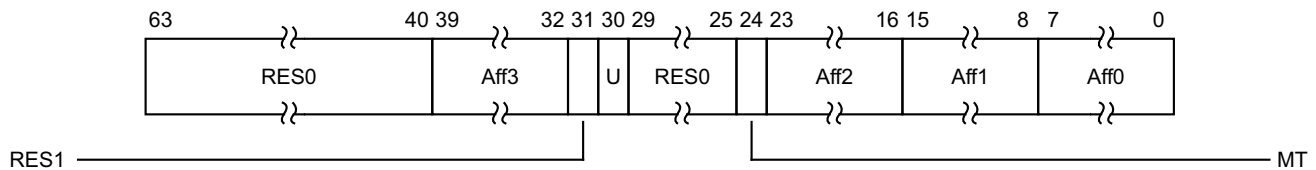

Bits [63:40]

Reserved, RES0.

Aff3, bits [39:32]

Affinity level 3. Highest level affinity field.

Bit [31]

Reserved, RES1.

U, bit [30]

Indicates a Uniprocessor system, as distinct from processor 0 in a multiprocessor system. The possible values of this bit are:

- 0 Processor is part of a multiprocessor system.
- 1 Processor is part of a uniprocessor system.

Bits [29:25]

Reserved, RES0.

MT, bit [24]

Indicates whether the lowest level of affinity consists of logical processors that are implemented using a multi-threading type approach. The possible values of this bit are:

- 0 Performance of processors at the lowest affinity level is largely independent.
- 1 Performance of processors at the lowest affinity level is very interdependent.

Aff2, bits [23:16]

Affinity level 2. Second highest level affinity field.

Aff1, bits [15:8]

Affinity level 1. Third highest level affinity field.

Aff0, bits [7:0]

Affinity level 0. Lowest level affinity field.

Accessing the MPIDR_EL1:

To access the MPIDR_EL1:

MRS <Xt>, MPIDR_EL1 ; Read MPIDR_EL1 into Xt

Register access is encoded as follows:

op0	op1	CRn	CRm	op2
11	000	0000	0000	101

D8.2.66 MVFR0_EL1, Media and VFP Feature Register 0

The MVFR0_EL1 characteristics are:

Purpose

Describes the features provided by the Advanced SIMD and Floating-point extensions.

This register is part of:

- the Floating-point registers functional group
- the Identification registers functional group.

Usage constraints

This register is accessible as shown below:

EL0	EL1 (NS)	EL1 (S)	EL2	EL3 (SCR.NS=1)	EL3 (SCR.NS=0)
-	RO	RO	RO	RO	RO

Configurations

MVFR0_EL1 is architecturally mapped to AArch32 register [MVFR0](#).

Attributes

MVFR0_EL1 is a 32-bit register.

The MVFR0_EL1 bit assignments are:

31	28 27	24 23	20 19	16 15	12 11	8 7	4 3	0
FPRound	FPShVec	FPSqrt	FPDivide	FPTrap	FPDP	FPSP	SIMDReg	

FPRound, bits [31:28]

Floating-Point Rounding modes. Indicates the rounding modes supported by the VFP floating-point hardware. Permitted values are:

0000 Only Round to Nearest mode supported, except that Round towards Zero mode is supported for VCVT instructions that always use that rounding mode regardless of the [FPSCR](#) setting.

0001 All rounding modes supported.

All other values are reserved.

FPShVec, bits [27:24]

Short Vectors. Indicates the hardware support for VFP short vectors. Permitted values are:

0000 Not supported.

0001 Short vector operation supported.

All other values are reserved.

FPSqrt, bits [23:20]

Square Root. Indicates the hardware support for VFP square root operations. Permitted values are:

0000 Not supported in hardware.

0001 Supported.

All other values are reserved.

The VSQRT.F32 instruction also requires the single-precision VFP attribute, and the VSQRT.F64 instruction also requires the double-precision VFP attribute.

FPDivide, bits [19:16]

Indicates the hardware support for VFP divide operations. Permitted values are:

0000 Not supported in hardware.

0001 Supported.

All other values are reserved.

The VDIV.F32 instruction also requires the single-precision VFP attribute, and the VDIV.F64 instruction also requires the double-precision VFP attribute.

FPTrap, bits [15:12]

Floating Point Exception Trapping. Indicates whether the VFP hardware implementation supports exception trapping. Permitted values are:

0000 Not supported. This is the value for VFPv3 and VFPv4.

0001 Supported by the hardware. This is the value for VFPv3U, VFP4U, and for VFPv2. When exception trapping is supported, support code is needed to handle the trapped exceptions.

All other values are reserved.

A value of 0b0001 does not indicate that trapped exception handling is available. Because trapped exception handling requires support code, only the support code can provide this information.

FPDP, bits [11:8]

Double Precision. Indicates the hardware support for VFP double-precision operations. Permitted values are:

0000 Not supported in hardware.

0001 Supported, VFPv2.

0010 Supported, VFPv3 or VFPv4. VFPv3 adds an instruction to load a double-precision floating-point constant, and conversions between double-precision and fixed-point values.

All other values are reserved.

A value of 0b0001 or 0b0010 indicates support for all VFP double-precision instructions in the supported version of VFP, except that, in addition to this field being nonzero:

- VSQRT.F64 is only available if the Square root field is 0b0001.
- VDIV.F64 is only available if the Divide field is 0b0001.
- Conversion between double-precision and single-precision is only available if the single-precision field is nonzero.

FPSP, bits [7:4]

Single Precision. Indicates the hardware support for VFP single-precision operations. Permitted values are:

0000 Not supported in hardware.

0001 Supported, VFPv2.

0010 Supported, VFPv3 or VFPv4. VFPv3 adds an instruction to load a single-precision floating-point constant, and conversions between single-precision and fixed-point values.

All other values are reserved.

A value of 0b0001 or 0b0010 indicates support for all VFP single-precision instructions in the supported version of VFP, except that, in addition to this field being nonzero:

- VSQRT.F32 is only available if the Square root field is 0b0001.
- VDIV.F32 is only available if the Divide field is 0b0001.
- Conversion between double-precision and single-precision is only available if the double-precision field is nonzero.

SIMDReg, bits [3:0]

Advanced SIMD registers. Indicates support for the Advanced SIMD register bank. Permitted values are:

- 0000 Not supported.
- 0001 Supported, 16 x 64-bit registers.
- 0010 Supported, 32 x 64-bit registers.

All other values are reserved.

If this field is nonzero:

- All VFP LDC, STC, MCR, and MRC instructions are supported.
- If the CPUID registers show that the MCRR and MRRC instructions are supported then the corresponding VFP instructions are supported.

Accessing the MVFR0_EL1:

To access the MVFR0_EL1:

MRS <Xt>, MVFR0_EL1 ; Read MVFR0_EL1 into Xt

Register access is encoded as follows:

op0	op1	CRn	CRm	op2
11	000	0000	0011	000

D8.2.67 MVFR1_EL1, Media and VFP Feature Register 1

The MVFR1_EL1 characteristics are:

Purpose

Describes the features provided by the Advanced SIMD and Floating-point extensions.

This register is part of:

- the Floating-point registers functional group
- the Identification registers functional group.

Usage constraints

This register is accessible as shown below:

EL0	EL1 (NS)	EL1 (S)	EL2	EL3 (SCR.NS=1)	EL3 (SCR.NS=0)
-	RO	RO	RO	RO	RO

Configurations

MVFR1_EL1 is architecturally mapped to AArch32 register [MVFR1](#).

Attributes

MVFR1_EL1 is a 32-bit register.

The MVFR1_EL1 bit assignments are:

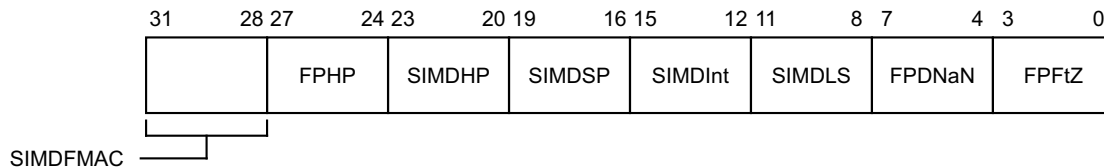

SIMDFMAC, bits [31:28]

Advanced SIMD Fused Multiply-Accumulate. Indicates whether any implemented VFP or Advanced SIMD extension implements the fused multiply accumulate instructions. Permitted values are:

0000 Not implemented.

0001 Implemented.

All other values are reserved.

If an implementation includes both the VFP extension and the Advanced SIMD extension, both extensions must provide the same level of support for these instructions.

FPHP, bits [27:24]

Floating Point Half Precision. Indicates whether the VFP extension implements half-precision floating-point conversion instructions. Permitted values are:

0000 Not implemented.

0001 Instructions to convert between half-precision and single-precision implemented.

0010 As for 0b0001, and also instructions to convert between half-precision and double-precision implemented.

All other values are reserved.

SIMDHP, bits [23:20]

Advanced SIMD Half Precision. Indicates whether the Advanced SIMD extension implements half-precision floating-point conversion instructions. Permitted values are:

- 0000 Not implemented.
 - 0001 Implemented. This value is permitted only if the AdvSIMD SPFP field is 0b0001.
- All other values are reserved.

SIMDSP, bits [19:16]

Advanced SIMD Single Precision. Indicates whether the Advanced SIMD extension implements single-precision floating-point instructions. Permitted values are:

- 0000 Not implemented.
 - 0001 Implemented. This value is permitted only if the AdvSIMD integer field is 0b0001.
- All other values are reserved.

SIMDInt, bits [15:12]

Advanced SIMD Integer. Indicates whether the Advanced SIMD extension implements integer instructions. Permitted values are:

- 0000 Not implemented.
 - 0001 Implemented.
- All other values are reserved.

SIMDLS, bits [11:8]

Advanced SIMD Load/Store. Indicates whether the Advanced SIMD extension implements load/store instructions. Permitted values are:

- 0000 Not implemented.
 - 0001 Implemented.
- All other values are reserved.

FPDNaN, bits [7:4]

Default NaN mode. Indicates whether the VFP hardware implementation supports only the Default NaN mode. Permitted values are:

- 0000 Hardware supports only the Default NaN mode. If a VFP subarchitecture is implemented its support code might include support for propagation of NaN values.
 - 0001 Hardware supports propagation of NaN values.
- All other values are reserved.

FPFtZ, bits [3:0]

Flush to Zero mode. Indicates whether the VFP hardware implementation supports only the Flush-to-Zero mode of operation. Permitted values are:

- 0000 Hardware supports only the Flush-to-Zero mode of operation. If a VFP subarchitecture is implemented its support code might include support for full denormalized number arithmetic.
 - 0001 Hardware supports full denormalized number arithmetic.
- All other values are reserved.

Accessing the MVFR1_EL1:

To access the MVFR1_EL1:

MRS <Xt>, MVFR1_EL1 ; Read MVFR1_EL1 into Xt

Register access is encoded as follows:

op0	op1	CRn	CRm	op2
11	000	0000	0011	001

D8.2.68 MVFR2_EL1, Media and VFP Feature Register 2

The MVFR2_EL1 characteristics are:

Purpose

Describes the features provided by the Advanced SIMD and Floating-point extensions.

This register is part of:

- the Floating-point registers functional group
- the Identification registers functional group.

Usage constraints

This register is accessible as shown below:

EL0	EL1 (NS)	EL1 (S)	EL2	EL3 (SCR.NS=1)	EL3 (SCR.NS=0)
-	RO	RO	RO	RO	RO

Configurations

MVFR2_EL1 is architecturally mapped to AArch32 register [MVFR2](#).

Attributes

MVFR2_EL1 is a 32-bit register.

The MVFR2_EL1 bit assignments are:

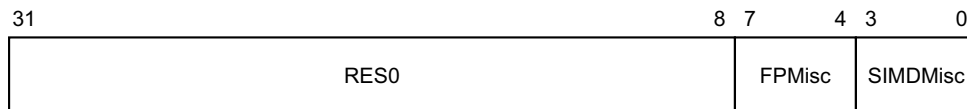

Bits [31:8]

Reserved, RES0.

FPMisc, bits [7:4]

Indicates support for miscellaneous VFP features.

0000 No support for miscellaneous features.

0001 Support for Floating-point selection.

0010 As 0b0001, and Floating-point Conversion to Integer with Directed Rounding modes.

0011 As 0b0010, and Floating-point Round to Integral Floating-point.

0100 As 0b0011, and Floating-point MaxNum and MinNum.

All other values are reserved.

SIMDMisc, bits [3:0]

Indicates support for miscellaneous Advanced SIMD features.

0000 No support for miscellaneous features.

0001 Floating-point Conversion to Integer with Directed Rounding modes.

0010 As 0b0001, and Floating-point Round to Integral Floating-point.

0011 As 0b0010, and Floating-point MaxNum and MinNum.

All other values are reserved.

Accessing the MVFR2_EL1:

To access the MVFR2_EL1:

MRS <Xt>, MVFR2_EL1 ; Read MVFR2_EL1 into Xt

Register access is encoded as follows:

op0	op1	CRn	CRm	op2
11	000	0000	0011	010

D8.2.69 PAR_EL1, Physical Address Register

The PAR_EL1 characteristics are:

Purpose

Receives the PA from any address translation operation.

This register is part of the Address translation operations functional group.

Usage constraints

This register is accessible as shown below:

EL0	EL1 (NS)	EL1 (S)	EL2	EL3 (SCR.NS=1)	EL3 (SCR.NS=0)
-	RW	RW	RW	RW	RW

Configurations

PAR_EL1 is architecturally mapped to AArch32 register [PAR](#) (NS).

Attributes

PAR_EL1 is a 64-bit register.

The PAR_EL1 bit assignments are:

For all register layouts:

F, bit [0]

Indicates whether the conversion completed successfully.

0 VA to PA conversion completed successfully.

1 VA to PA conversion aborted.

When PAR_EL1.F==0:

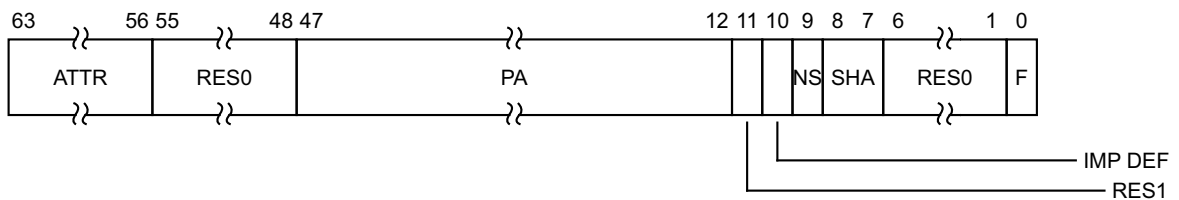

ATTR, bits [63:56]

Memory attributes for the returned PA, as indicated by the translation table entry. This field uses the same encoding as the Attr<7:0> fields in [MAIR_EL1](#), [MAIR_EL2](#), and [MAIR_EL3](#).

Bits [55:48]

Reserved, RES0.

PA, bits [47:12]

Physical Address. The physical address corresponding to the supplied virtual address. This field returns address bits[47:12].

Bit [11]

Reserved, RES1.

NS, bit [9]

Non-secure. The NS attribute for a translation table entry read from Secure state.
This bit is UNKNOWN for a translation table entry read from Non-secure state.

SHA, bits [8:7]

Shareability attribute, from the translation table entry for the returned PA. Permitted values are:

- 00 Non-shareable.
- 10 Outer Shareable.
- 11 Inner Shareable.

The value 0b01 is reserved.

Note: this takes the value 0b10 for:

- Any type of Device memory.
- Normal memory with both Inner Non-cacheable and Outer Non-cacheable attributes.

Bits [6:1]

Reserved, RES0.

F, bit [0]

Indicates whether the conversion completed successfully.

- 0 VA to PA conversion completed successfully.

When PAR_EL1.F==1:

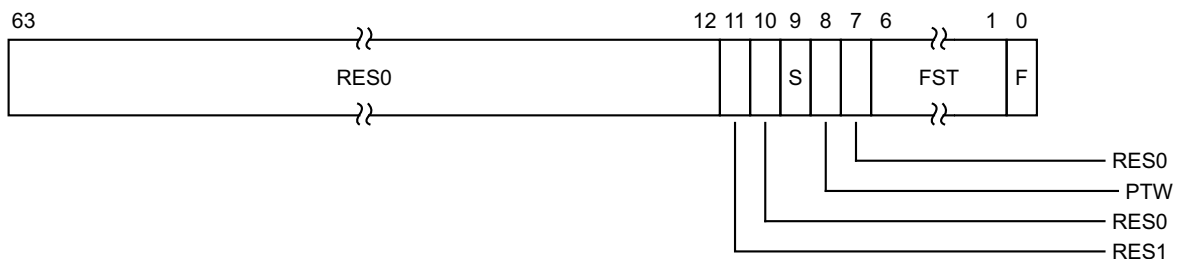

Bits [63:12]

Reserved, RES0.

Bit [11]

Reserved, RES1.

Bit [10]

Reserved, RES0.

S, bit [9]

Indicates the translation stage at which the translation aborted:

- 0 Translation aborted because of a fault in the stage 1 translation.
- 1 Translation aborted because of a fault in the stage 2 translation.

PTW, bit [8]

If this bit is set to 1, it indicates the translation aborted because of a stage 2 fault during a stage 1 translation table walk.

Bit [7]

Reserved, RES0.

FST, bits [6:1]

Fault status code, as shown in the Data Abort ESR encoding.

F, bit [0]

Indicates whether the conversion completed successfully.

1 VA to PA conversion aborted.

Accessing the PAR_EL1:

To access the PAR_EL1:

MRS <Xt>, PAR_EL1 ; Read PAR_EL1 into Xt

MSR PAR_EL1, <Xt> ; Write Xt to PAR_EL1

Register access is encoded as follows:

op0	op1	CRn	CRm	op2
11	000	0111	0100	000

D8.2.70 REVIDR_EL1, Revision ID Register

The REVIDR_EL1 characteristics are:

Purpose

Provides implementation-specific minor revision information that can only be interpreted in conjunction with the Main ID Register.

This register is part of the Identification registers functional group.

Usage constraints

This register is accessible as shown below:

EL0	EL1 (NS)	EL1 (S)	EL2	EL3 (SCR.NS=1)	EL3 (SCR.NS=0)
-	RO	RO	RO	RO	RO

Configurations

REVIDR_EL1 is architecturally mapped to AArch32 register [REVIDR](#).

Attributes

REVIDR_EL1 is a 32-bit register.

The REVIDR_EL1 bit assignments are:



Accessing the REVIDR_EL1:

To access the REVIDR_EL1:

MRS <Xt>, REVIDR_EL1 ; Read REVIDR_EL1 into Xt

Register access is encoded as follows:

op0	op1	CRn	CRm	op2
11	000	0000	0000	110

D8.2.71 RMR_EL1, Reset Management Register (if EL2 and EL3 not implemented)

The RMR_EL1 characteristics are:

Purpose

If EL1 is the highest exception level implemented, and is capable of using both AArch32 and AArch64, controls the execution state that the processor boots into and allows request of a Warm reset.

This register is part of the Reset management registers functional group.

Usage constraints

This register is accessible as shown below:

EL0	EL1
-	RW

Configurations

RMR_EL1 is architecturally mapped to AArch32 register [RMR \(at EL1\)](#).

Only implemented if the highest exception level implemented is EL1 and supports AArch32 and AArch64.

If EL1 is not the highest one implemented, then this register is not implemented and its encoding is UNDEFINED.

Attributes

RMR_EL1 is a 32-bit register.

The RMR_EL1 bit assignments are:

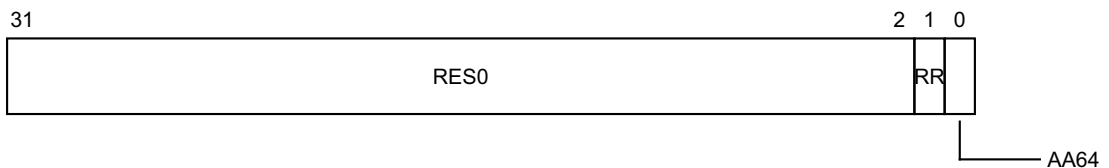

Bits [31:2]

Reserved, RES0.

RR, bit [1]

When set to 1 this bit requests a Warm reset. The bit is strictly a request.

On Warm reset, the field resets to 0.

AA64, bit [0]

Determines which execution state the processor boots into after a Warm reset:

- 0 AArch32.
- 1 AArch64.

The reset vector address on reset takes a choice between two IMP DEF values, depending on the value in the AA64 bit. This ensures that even with reprogramming of the AA64 bit, it is not possible to change the reset vector to go to a different location.

On Cold reset, the field resets to 1.

Accessing the RMR_EL1:

To access the RMR_EL1:

MRS <Xt>, RMR_EL1 ; Read RMR_EL1 into Xt
MSR RMR_EL1, <Xt> ; Write Xt to RMR_EL1

Register access is encoded as follows:

op0	op1	CRn	CRm	op2
11	000	1100	0000	010

D8.2.72 RMR_EL2, Reset Management Register (if EL3 not implemented)

The RMR_EL2 characteristics are:

Purpose

If EL2 is the highest exception level implemented, and is capable of using both AArch32 and AArch64, controls the execution state that the processor boots into and allows request of a Warm reset.

This register is part of:

- the Virtualization registers functional group
- the Reset management registers functional group.

Usage constraints

This register is accessible as shown below:

EL0	EL1	EL2
-	-	RW

Configurations

RMR_EL2 is architecturally mapped to AArch32 register [HRMR](#).

Only implemented if the highest exception level implemented is EL2 and supports AArch32 and AArch64.

If EL2 is not the highest one implemented, then this register is not implemented and its encoding is UNDEFINED.

Attributes

RMR_EL2 is a 32-bit register.

The RMR_EL2 bit assignments are:

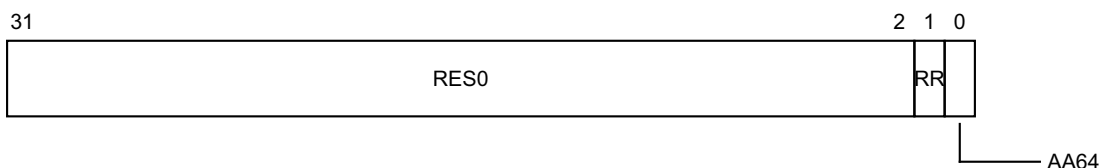

Bits [31:2]

Reserved, RES0.

RR, bit [1]

When set to 1 this bit requests a Warm reset. The bit is strictly a request.

On Warm reset, the field resets to 0.

AA64, bit [0]

Determines which execution state the processor boots into after a Warm reset:

- 0 AArch32.
- 1 AArch64.

The reset vector address on reset takes a choice between two IMP DEF values, depending on the value in the AA64 bit. This ensures that even with reprogramming of the AA64 bit, it is not possible to change the reset vector to go to a different location.

On Cold reset, the field resets to 1.

Accessing the RMR_EL2:

To access the RMR_EL2:

MRS <Xt>, RMR_EL2 ; Read RMR_EL2 into Xt
MSR RMR_EL2, <Xt> ; Write Xt to RMR_EL2

Register access is encoded as follows:

op0	op1	CRn	CRm	op2
11	100	1100	0000	010

D8.2.73 RMR_EL3, Reset Management Register (if EL3 implemented)

The RMR_EL3 characteristics are:

Purpose

If EL3 is the highest exception level implemented, and is capable of using both AArch32 and AArch64, controls the execution state that the processor boots into and allows request of a Warm reset.

This register is part of the Reset management registers functional group.

Usage constraints

This register is accessible as shown below:

EL0	EL1 (NS)	EL1 (S)	EL2	EL3 (SCR.NS=1)	EL3 (SCR.NS=0)
-	-	-	-	RW	RW

Configurations

RMR_EL3 is architecturally mapped to AArch32 register [RMR \(at EL3\)](#).

Only implemented if the highest exception level implemented is EL3 and supports AArch32 and AArch64.

If EL3 is not the highest one implemented, then this register is not implemented and its encoding is UNDEFINED.

Attributes

RMR_EL3 is a 32-bit register.

The RMR_EL3 bit assignments are:

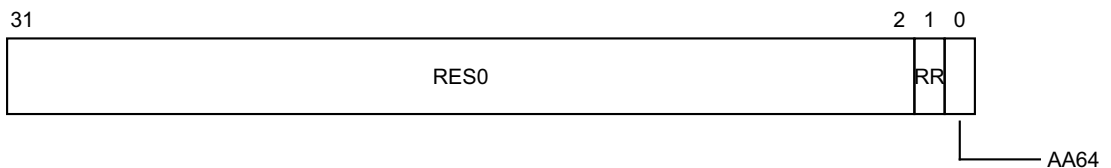

Bits [31:2]

Reserved, RES0.

RR, bit [1]

When set to 1 this bit requests a Warm reset. The bit is strictly a request.

On Warm reset, the field resets to 0.

AA64, bit [0]

Determines which execution state the processor boots into after a Warm reset:

- 0 AArch32.
- 1 AArch64.

The reset vector address on reset takes a choice between two IMP DEF values, depending on the value in the AA64 bit. This ensures that even with reprogramming of the AA64 bit, it is not possible to change the reset vector to go to a different location.

On Cold reset, the field resets to 1.

Accessing the RMR_EL3:

To access the RMR_EL3:

MRS <Xt>, RMR_EL3 ; Read RMR_EL3 into Xt
MSR RMR_EL3, <Xt> ; Write Xt to RMR_EL3

Register access is encoded as follows:

op0	op1	CRn	CRm	op2
11	110	1100	0000	010

D8.2.74 RVBAR_EL1, Reset Vector Base Address Register (if EL2 and EL3 not implemented)

The RVBAR_EL1 characteristics are:

Purpose

If EL1 is the highest exception level implemented, contains the IMPLEMENTATION DEFINED address that execution starts from after reset when executing in AArch64 state.

This register is part of the Reset management registers functional group.

Usage constraints

This register is accessible as shown below:

EL0	EL1
-	RO

Configurations

Only implemented if the highest exception level implemented is EL1.

Attributes

RVBAR_EL1 is a 64-bit register.

The RVBAR_EL1 bit assignments are:

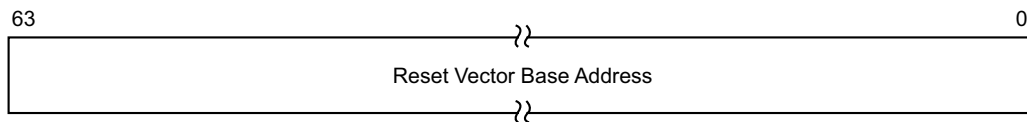

Bits [63:0]

Reset Vector Base Address. If this exception level is the highest one implemented, this field contains the IMPLEMENTATION DEFINED address that execution starts from after reset when executing in 64-bit state. Bits[1:0] of this register are 00, as this address must be aligned, and the address must be within the physical address size supported by the processor.

If this exception level is not the highest one implemented, then this register is not implemented and its encoding is UNDEFINED.

Accessing the RVBAR_EL1:

To access the RVBAR_EL1:

MRS <Xt>, RVBAR_EL1 ; Read RVBAR_EL1 into Xt

Register access is encoded as follows:

op0	op1	CRn	CRm	op2
11	000	1100	0000	001

D8.2.75 RVBAR_EL2, Reset Vector Base Address Register (if EL3 not implemented)

The RVBAR_EL2 characteristics are:

Purpose

If EL2 is the highest exception level implemented, contains the IMPLEMENTATION DEFINED address that execution starts from after reset when executing in AArch64 state.

This register is part of the Reset management registers functional group.

Usage constraints

This register is accessible as shown below:

EL0	EL1	EL2
-	-	RO

Configurations

Only implemented if the highest exception level implemented is EL2.

Attributes

RVBAR_EL2 is a 64-bit register.

The RVBAR_EL2 bit assignments are:

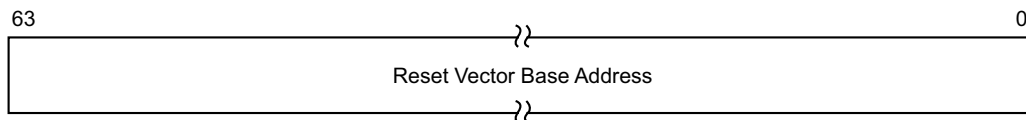

Bits [63:0]

Reset Vector Base Address. If this exception level is the highest one implemented, this field contains the IMPLEMENTATION DEFINED address that execution starts from after reset when executing in 64-bit state. Bits[1:0] of this register are 00, as this address must be aligned, and the address must be within the physical address size supported by the processor.

If this exception level is not the highest one implemented, then this register is not implemented and its encoding is UNDEFINED.

Accessing the RVBAR_EL2:

To access the RVBAR_EL2:

MRS <Xt>, RVBAR_EL2 ; Read RVBAR_EL2 into Xt

Register access is encoded as follows:

op0	op1	CRn	CRm	op2
11	100	1100	0000	001

D8.2.76 RVBAR_EL3, Reset Vector Base Address Register (if EL3 implemented)

The RVBAR_EL3 characteristics are:

Purpose

If EL3 is the highest exception level implemented, contains the IMPLEMENTATION DEFINED address that execution starts from after reset when executing in AArch64 state.

This register is part of the Reset management registers functional group.

Usage constraints

This register is accessible as shown below:

EL0	EL1 (NS)	EL1 (S)	EL2	EL3 (SCR.NS=1)	EL3 (SCR.NS=0)
-	-	-	-	RO	RO

Configurations

Only implemented if the highest exception level implemented is EL3.

Attributes

RVBAR_EL3 is a 64-bit register.

The RVBAR_EL3 bit assignments are:

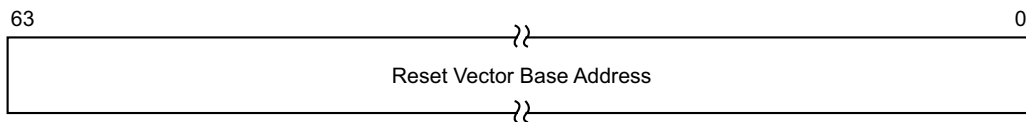

Bits [63:0]

Reset Vector Base Address. If this exception level is the highest one implemented, this field contains the IMPLEMENTATION DEFINED address that execution starts from after reset when executing in 64-bit state. Bits[1:0] of this register are 00, as this address must be aligned, and the address must be within the physical address size supported by the processor.

If this exception level is not the highest one implemented, then this register is not implemented and its encoding is UNDEFINED.

Accessing the RVBAR_EL3:

To access the RVBAR_EL3:

MRS <Xt>, RVBAR_EL3 ; Read RVBAR_EL3 into Xt

Register access is encoded as follows:

op0	op1	CRn	CRm	op2
11	110	1100	0000	001

D8.2.77 S3_<op1>_<Cn>_<Cm>_<op2>, IMPLEMENTATION DEFINED registers

The S3_<op1>_<Cn>_<Cm>_<op2> characteristics are:

Purpose

This area of the instruction set space is reserved for IMPLEMENTATION DEFINED registers.
This register is part of the IMPLEMENTATION DEFINED functional group.

Usage constraints

This register is accessible as shown below:

EL0	EL1 (NS)	EL1 (S)	EL2	EL3 (SCR.NS=1)	EL3 (SCR.NS=0)
IMP DEF	IMP DEF	IMP DEF	IMP DEF	IMP DEF	IMP DEF

The numbers in these register names are encoded in decimal without leading zeroes, and the Cn and Cm fields require a literal C before the number. For example, S3_4_C11_C9_7.

Configurations

There are no configuration notes.

Attributes

S3_<op1>_<Cn>_<Cm>_<op2> is a 32-bit register.

The S3_<op1>_<Cn>_<Cm>_<op2> bit assignments are:



Accessing the S3_<op1>_<Cn>_<Cm>_<op2>:

To access the S3_<op1>_<Cn>_<Cm>_<op2>:

MRS <Xt>, S3_<op1>_<Cn>_<Cm>_<op2> ; Read S3_<op1>_<Cn>_<Cm>_<op2> into Xt
MSR S3_<op1>_<Cn>_<Cm>_<op2>, <Xt> ; Write Xt to S3_<op1>_<Cn>_<Cm>_<op2>

Register access is encoded as follows:

op0	op1	CRn	CRm	op2
11	xxx	1x11	xxxx	xxx

D8.2.78 SCR_EL3, Secure Configuration Register

The SCR_EL3 characteristics are:

Purpose

Defines the configuration of the current security state. It specifies:

- The security state of EL0 and EL1, either Secure or Non-secure.
- The register width at lower exception levels.
- Whether IRQ, FIQ, and External Abort interrupts are taken to EL3.

This register is part of the Security registers functional group.

Usage constraints

This register is accessible as shown below:

EL0	EL1 (NS)	EL1 (S)	EL2	EL3 (SCR.NS=1)	EL3 (SCR.NS=0)
-	-	-	-	RW	RW

Configurations

SCR_EL3 can be mapped to AArch32 register [SCR](#), but this is not architecturally mandated.

Attributes

SCR_EL3 is a 32-bit register.

The SCR_EL3 bit assignments are:

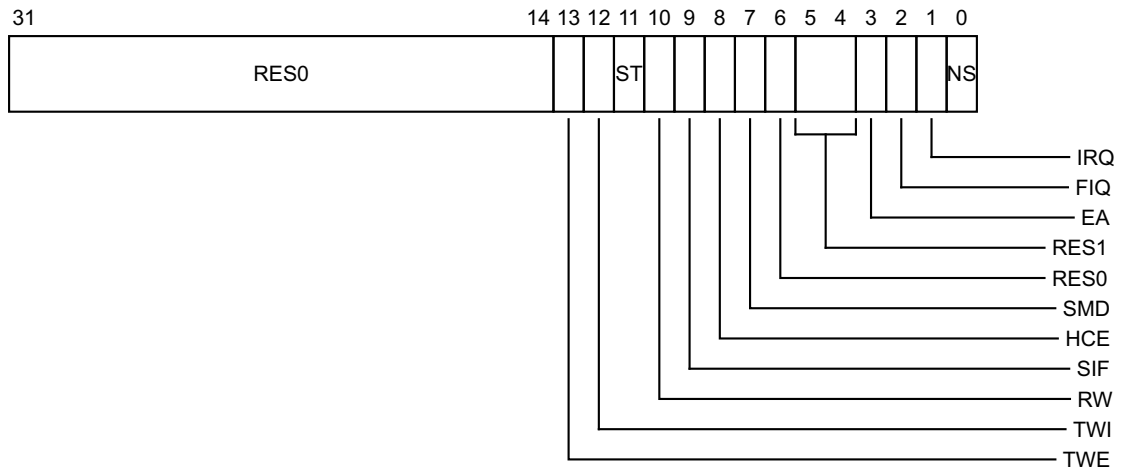

Bits [31:14]

Reserved, RES0.

TWE, bit [13]

Trap WFE. The possible values of this bit are:

- 0 WFE instructions not trapped.
- 1 WFE instructions executed in AArch32 or AArch64 at EL2, EL1, or EL0 are trapped to EL3 if the instruction would otherwise cause suspension of execution, i.e. if there is not a pending WFI wakeup event and the instruction does not cause another exception.

TWI, bit [12]

Trap WFI. The possible values of this bit are:

- 0 WFI instructions not trapped.
- 1 WFI instructions executed in AArch32 or AArch64 at EL2, EL1, or EL0 are trapped to EL3 if the instruction would otherwise cause suspension of execution.

ST, bit [11]

Enables Secure EL1 access to the [CNTPS_TVAL_EL1](#), [CNTPS_CTL_EL1](#), and [CNTPS_CVAL_EL1](#) registers. The possible values of this bit are:

- 0 These registers are only accessible in EL3.
- 1 These registers are accessible in EL3 and also in EL1 when `SCR_EL3.NS==0`.

If this bit is 0 and there is a Secure EL1 access to one of the CNTPS registers:

- An exception is taken to EL3.
- The exception class for this exception, as returned in `ESR_EL3.EC`, is 0x18.

RW, bit [10]

Register width control for lower exception levels.

- 0 Lower levels are all AArch32.
- 1 The next lower level is AArch64.
If EL2 is present:
 - EL2 is AArch64.
 - EL2 controls EL1 and EL0 behaviors.If EL2 is not present:
 - EL1 is AArch64.
 - EL0 is determined by the Register Width described in the current process state when executing at EL0.

This bit is permitted to be cached in a TLB.

SIF, bit [9]

Secure instruction fetch. When the processor is in Secure state, this bit disables instruction fetch from Non-secure memory. The possible values for this bit are:

- 0 Secure state instruction fetches from Non-secure memory are permitted.
- 1 Secure state instruction fetches from Non-secure memory are not permitted.

This bit is permitted to be cached in a TLB.

HCE, bit [8]

Hypervisor Call enable. This bit enables use of the HVC instruction from Non-secure EL1 modes. The possible values of this bit are:

- 0 HVC instruction is UNDEFINED in Non-secure EL1 modes, and either UNDEFINED or a NOP in Hyp mode, depending on the implementation.
- 1 HVC instruction is enabled in Non-secure EL1 modes, and performs a Hypervisor Call.

If EL3 is implemented but EL2 is not implemented, this bit is RES0.

SMD, bit [7]

SMC Disable.

- 0 SMC is enabled at EL1, EL2, or EL3.
- 1 SMC is UNDEFINED at all exception levels. At EL1 in the Non-secure state, the [HCR_EL2.TSC](#) bit has priority over this control.

Bit [6]

Reserved, RES0.

Bits [5:4]

Reserved, RES1.

EA, bit [3]

External Abort and SError Interrupt Routing.

- 0 External Aborts and SError Interrupts while executing at exception levels other than EL3 are not taken in EL3.
- 1 External Aborts and SError Interrupts while executing at all exception levels are taken in EL3.

FIQ, bit [2]

Physical FIQ Routing.

- 0 Physical FIQ while executing at exception levels other than EL3 are not taken in EL3.
- 1 Physical FIQ while executing at all exception levels are taken in EL3.

IRQ, bit [1]

Physical IRQ Routing.

- 0 Physical IRQ while executing at exception levels other than EL3 are not taken in EL3.
- 1 Physical IRQ while executing at all exception levels are taken in EL3.

NS, bit [0]

Non-secure bit.

- 0 Indicates that EL0 and EL1 are in Secure state, and so memory accesses from those exception levels can access Secure memory.
- 1 Indicates that EL0 and EL1 are in Non-secure state, and so memory accesses from those exception levels cannot access Secure memory.

Accessing the SCR_EL3:

To access the SCR_EL3:

MRS <Xt>, SCR_EL3 ; Read SCR_EL3 into Xt
MSR SCR_EL3, <Xt> ; Write Xt to SCR_EL3

Register access is encoded as follows:

op0	op1	CRn	CRm	op2
11	110	0001	0001	000

D8.2.79 SCTLR_EL1, System Control Register (EL1)

The SCTLR_EL1 characteristics are:

Purpose

Provides top level control of the system, including its memory system, at EL1.
This register is part of the Other system control registers functional group.

Usage constraints

This register is accessible as shown below:

EL0	EL1 (NS)	EL1 (S)	EL2	EL3 (SCR.NS=1)	EL3 (SCR.NS=0)
-	RW	RW	RW	RW	RW

Configurations

SCTLR_EL1 is architecturally mapped to AArch32 register [SCTLR](#) (NS).

Attributes

SCTLR_EL1 is a 32-bit register.

The SCTLR_EL1 bit assignments are:

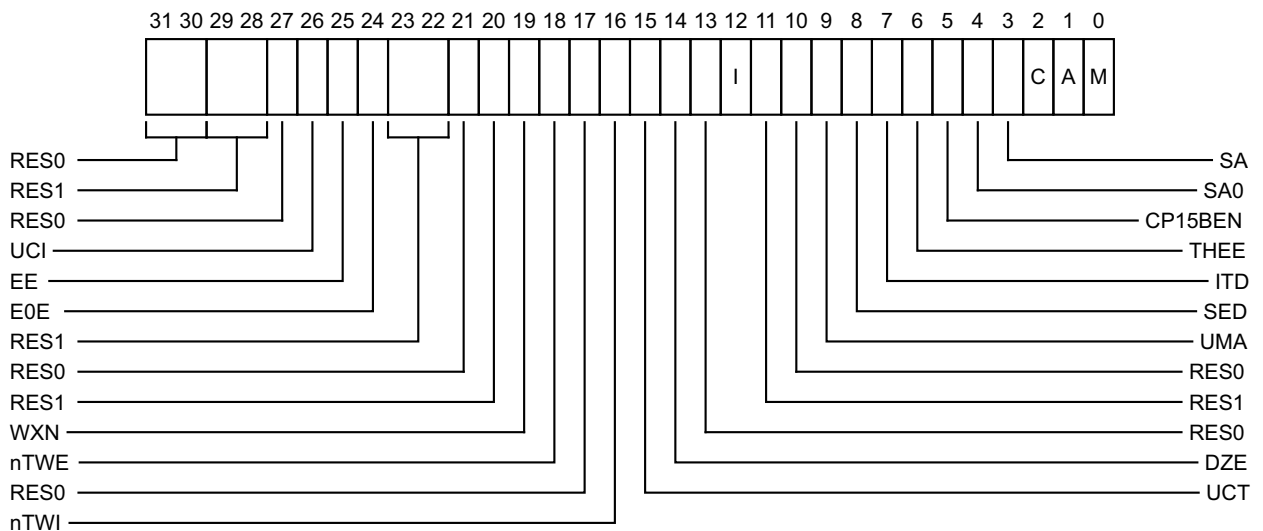

Bits [31:30]

Reserved, RES0.

Bits [29:28]

Reserved, RES1.

Bit [27]

Reserved, RES0.

UCI, bit [26]

When set, enables EL0 access in AArch64 for [DC CVAU](#), [DC CIVAC](#), [DC CVAC](#), and [IC IVAU](#) instructions.

Reset value is architecturally UNKNOWN.

EE, bit [25]

Exception Endianness. This bit controls the endianness for:

- Explicit data accesses at EL1.
- Stage 1 translation table walks at EL1 and EL0.

The possible values of this bit are:

- 0 Little-endian.
- 1 Big-endian.

If an implementation does not provide Big-endian support, this bit is RES0. If it does not provide Little-endian support, this bit is RES1.

The EE bit is permitted to be cached in a TLB.

If this register is at the highest exception level implemented, field resets to an IMPLEMENTATION DEFINED value. Otherwise, its reset value is UNKNOWN.

E0E, bit [24]

Endianness of explicit data accesses at EL0. The possible values of this bit are:

- 0 Explicit data accesses at EL0 are little-endian.
- 1 Explicit data accesses at EL0 are big-endian.

If an implementation only supports Little-endian accesses at EL0 then this bit is RES0.

If an implementation only supports Big-endian accesses at EL0 then this bit is RES1.

This bit has no effect on the endianness of LDTR* and STTR* instructions executed at EL1.

Reset value is architecturally UNKNOWN.

Bits [23:22]

Reserved, RES1.

Bit [21]

Reserved, RES0.

Bit [20]

Reserved, RES1.

WXN, bit [19]

Write permission implies XN (Execute Never). This bit can be used to require all memory regions with write permission to be treated as XN. The possible values of this bit are:

- 0 Regions with write permission are not forced to XN.
- 1 Regions with write permission are forced to XN.

The WXN bit is permitted to be cached in a TLB.

Reset value is architecturally UNKNOWN.

nTWE, bit [18]

Not trap WFE. Possible values of this bit are:

- 0 If a WFE instruction executed at EL0 would cause execution to be suspended, such as if the event register is not set and there is not a pending WFE wakeup event, it is taken as an exception to EL1 using the 0x1 ESR code.
- 1 WFE instructions are executed as normal.

Conditional WFE instructions that fail their condition do not cause an exception if this bit is 0.

Reset value is architecturally UNKNOWN.

Bit [17]

Reserved, RES0.

nTWI, bit [16]

Not trap WFI. Possible values of this bit are:

- 0 If a WFI instruction executed at EL0 would cause execution to be suspended, such as if there is not a pending WFI wakeup event, it is taken as an exception to EL1 using the 0x1 ESR code.
- 1 WFI instructions are executed as normal.

Conditional WFI instructions that fail their condition do not cause an exception if this bit is 0.

Reset value is architecturally UNKNOWN.

UCT, bit [15]

When set, enables EL0 access in AArch64 to the [CTR_EL0](#) register.

Reset value is architecturally UNKNOWN.

DZE, bit [14]

Access to [DC ZVA](#) instruction at EL0. The possible values of this bit are:

- 0 Execution of the [DC ZVA](#) instruction is prohibited at EL0, and it is treated as UNDEFINED at EL0.
- 1 Execution of the [DC ZVA](#) instruction is allowed at EL0.

Reset value is architecturally UNKNOWN.

Bit [13]

Reserved, RES0.

I, bit [12]

Instruction cache enable. This is an enable bit for instruction caches at EL0 and EL1:

- 0 Instruction caches disabled at EL0 and EL1. If [SCTLR_EL1.M](#) is set to 0, instruction accesses from stage 1 of the EL1&0 translation regime are to Normal memory, Outer Shareable, Inner Non-cacheable, Outer Non-cacheable.
- 1 Instruction caches enabled at EL0 and EL1. If [SCTLR_EL1.M](#) is set to 0, instruction accesses from stage 1 of the EL1&0 translation regime are to Normal memory, Outer Shareable, Inner Write-Through, Outer Write-Through.

When this bit is 0, all EL1 and EL0 Normal memory instruction accesses are Non-cacheable.

If the [HCR_EL2.DC](#) bit is set to 1, then the Non-secure stage 1 EL1&0 translation regime is Cacheable regardless of the value of this bit.

If this register is at the highest exception level implemented, field resets to 0. Otherwise, its reset value is UNKNOWN.

Bit [11]

Reserved, RES1.

Bit [10]

Reserved, RES0.

UMA, bit [9]

User Mask Access. Controls access to interrupt masks from EL0, when EL0 is using AArch64. The possible values of this bit are:

- 0 Disable access to the interrupt masks from EL0.
- 1 Enable access to the interrupt masks from EL0.

Reset value is architecturally UNKNOWN.

SED, bit [8]

SETEND Disable. The possible values of this bit are:

- 0 The SETEND instruction is available.
- 1 The SETEND instruction is UNALLOCATED.

If an implementation does not support mixed endian operation, this bit is RES1.

Reset value is architecturally UNKNOWN.

ITD, bit [7]

IT Disable. The possible values of this bit are:

- 0 The IT instruction functionality is available.
- 1 It is IMPLEMENTATION DEFINED whether the IT instruction is treated as either:
 - A 16-bit instruction, which can only be followed by another 16-bit instruction.
 - The first half of a 32-bit instruction.

An implementation might vary dynamically as to whether IT is treated as a 16-bit instruction or the first half of a 32-bit instruction.

All encodings of the IT instruction with hw1[3:0]!=1000 are UNDEFINED and treated as unallocated.

All encodings of the subsequent instruction with the following values for hw1 are UNDEFINED (and treated as unallocated):

11xxxxxxxxxxxx

All 32-bit instructions, B(2), B(1), Undefined, SVC, Load/Store multiple

1x11xxxxxxxxxxxx

Miscellaneous 16-bit instructions

1x100xxxxxxxxxxx

ADD Rd, PC, #imm

01001xxxxxxxxxxx

LDR Rd, [PC, #imm]

0100x1xxx1111xxx

ADD(4),CMP(3), MOV, BX pc, BLX pc

010001xx1xxxx111

ADD(4),CMP(3), MOV (Note: this pattern also covers UNPREDICTABLE cases with BLX Rn)

Contrary to the standard treatment of conditional UNDEFINED instructions in the ARM architecture, in this case these instructions are always treated as UNDEFINED, regardless of whether the instruction would pass or fail its condition codes as a result of being in an IT block.

Reset value is architecturally UNKNOWN.

THEE, bit [6]

T32EE enable. The possible values of this bit are:

- 0 T32EE is disabled.
- 1 T32EE is enabled.

If T32EE is not implemented, this bit is RES0.

Reset value is architecturally UNKNOWN.

CP15BEN, bit [5]

CP15 barrier enable. If implemented, this is an enable bit for the AArch32 CP15 DMB, DSB, and ISB barrier operations:

- 0 AArch32 CP15 barrier operations disabled. Their encodings are UNDEFINED.

1 AArch32 CP15 barrier operations enabled.

If an implementation does not support the CP15 barrier operations, this bit is RES0.

Reset value is architecturally UNKNOWN.

SA0, bit [4]

Stack Alignment Check Enable for EL0. When set, use of the stack pointer as the base address in a load/store instruction at EL0 must be aligned to a 16-byte boundary, or a Stack Alignment Fault exception will be raised.

Reset value is architecturally UNKNOWN.

SA, bit [3]

Stack Alignment Check Enable. When set, use of the stack pointer as the base address in a load/store instruction at this register's exception level must be aligned to a 16-byte boundary, or a Stack Alignment Fault exception will be raised.

Reset value is architecturally UNKNOWN.

C, bit [2]

Cache enable. This is an enable bit for data and unified caches at EL0 and EL1:

0 Data and unified caches disabled.

1 Data and unified caches enabled.

When this bit is 0, all EL0 and EL1 Normal memory data accesses and all accesses to the EL1&0 stage 1 translation tables are Non-cacheable.

If the HCR_EL2.DC bit is set to 1, then the Non-secure stage 1 EL1&0 translation regime is Cacheable regardless of the value of the SCTLR_EL1.C bit.

If this register is at the highest exception level implemented, field resets to 0. Otherwise, its reset value is UNKNOWN.

A, bit [1]

Alignment check enable. This is the enable bit for Alignment fault checking:

0 Alignment fault checking disabled.

Instructions that load or store one or more registers, other than load/store exclusive and load-acquire/store-release, do not check that the address being accessed is aligned to the size of the data element(s) being accessed.

1 Alignment fault checking enabled.

All instructions that load or store one or more registers have an alignment check that the address being accessed is aligned to the size of the data element(s) being accessed. If this check fails it causes an Alignment fault, which is taken as a Data Abort exception.

Load/store exclusive and load-acquire/store-release instructions have an alignment check regardless of the value of the A bit.

Reset value is architecturally UNKNOWN.

M, bit [0]

MMU enable for EL1 and EL0 stage 1 address translation. Possible values of this bit are:

0 EL1 and EL0 stage 1 address translation disabled.

1 EL1 and EL0 stage 1 address translation enabled.

If this register is at the highest exception level implemented, field resets to 0. Otherwise, its reset value is UNKNOWN.

Accessing the SCTLR_EL1:

To access the SCTLR_EL1:

MRS <Xt>, SCTLR_EL1 ; Read SCTLR_EL1 into Xt

MSR SCTLR_EL1, <Xt> ; Write Xt to SCTLR_EL1

Register access is encoded as follows:

op0	op1	CRn	CRm	op2
11	000	0001	0000	000

D8.2.80 SCTLR_EL2, System Control Register (EL2)

The SCTLR_EL2 characteristics are:

Purpose

Provides top level control of the system, including its memory system, at EL2.

This register is part of:

- the Virtualization registers functional group
- the Other system control registers functional group.

Usage constraints

This register is accessible as shown below:

EL0	EL1 (NS)	EL1 (S)	EL2	EL3 (SCR.NS=1)	EL3 (SCR.NS=0)
-	-	-	RW	RW	RW

Configurations

SCTLR_EL2 is architecturally mapped to AArch32 register [HSCTLR](#).

If EL2 is not implemented, this register is RES0 from EL3.

Attributes

SCTLR_EL2 is a 32-bit register.

The SCTLR_EL2 bit assignments are:

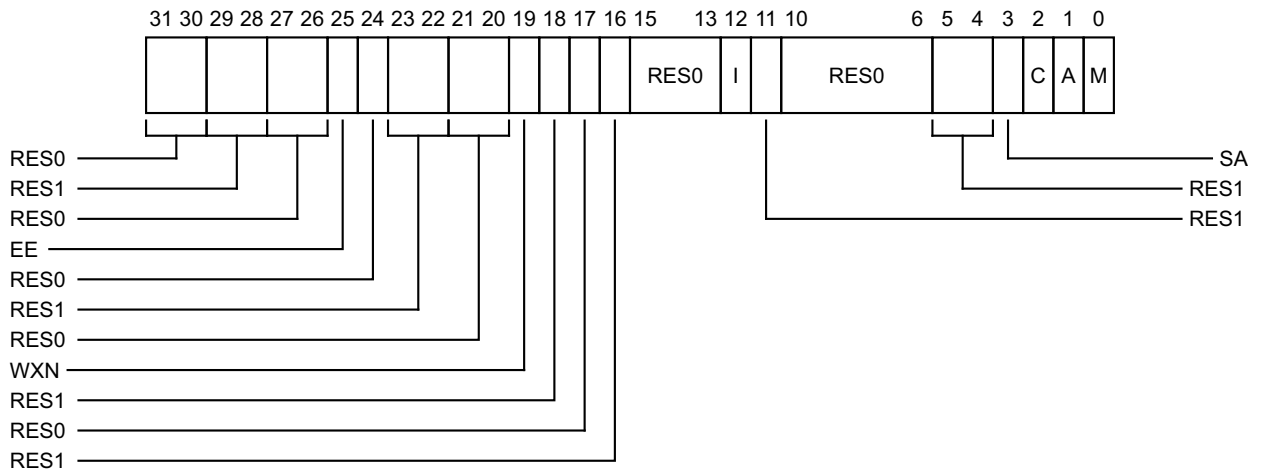

Bits [31:30]

Reserved, RES0.

Bits [29:28]

Reserved, RES1.

Bits [27:26]

Reserved, RES0.

EE, bit [25]

Exception Endianness. This bit controls the endianness for:

- Explicit data accesses at EL2.

- Stage 1 translation table walks at EL2.
- Stage 2 translation table walks at EL1 and EL0.

The possible values of this bit are:

- 0 Little-endian.
- 1 Big-endian.

If an implementation does not provide Big-endian support, this bit is RES0. If it does not provide Little-endian support, this bit is RES1.

The EE bit is permitted to be cached in a TLB.

If this register is at the highest exception level implemented, field resets to an IMPLEMENTATION DEFINED value. Otherwise, its reset value is UNKNOWN.

Bit [24]

Reserved, RES0.

Bits [23:22]

Reserved, RES1.

Bits [21:20]

Reserved, RES0.

WXN, bit [19]

Write permission implies XN (Execute Never). This bit can be used to require all memory regions with write permission to be treated as XN. The possible values of this bit are:

- 0 Regions with write permission are not forced to XN.
- 1 Regions with write permission are forced to XN.

The WXN bit is permitted to be cached in a TLB.

Reset value is architecturally UNKNOWN.

Bit [18]

Reserved, RES1.

Bit [17]

Reserved, RES0.

Bit [16]

Reserved, RES1.

Bits [15:13]

Reserved, RES0.

I, bit [12]

Instruction cache enable. This is an enable bit for instruction caches at EL2:

- 0 Instruction caches disabled at EL2. If SCTLR_EL2.M is set to 0, instruction accesses from stage 1 of the EL2 translation regime are to Normal memory, Outer Shareable, Inner Non-cacheable, Outer Non-cacheable.
- 1 Instruction caches enabled at EL2. If SCTLR_EL2.M is set to 0, instruction accesses from stage 1 of the EL2 translation regime are to Normal memory, Outer Shareable, Inner Write-Through, Outer Write-Through.

When this bit is 0, all EL2 Normal memory instruction accesses are Non-cacheable. This bit has no effect on the EL1&0 or EL3 translation regimes.

If this register is at the highest exception level implemented, field resets to 0. Otherwise, its reset value is UNKNOWN.

Bit [11]

Reserved, RES1.

Bits [10:6]

Reserved, RES0.

Bits [5:4]

Reserved, RES1.

SA, bit [3]

Stack Alignment Check Enable. When set, use of the stack pointer as the base address in a load/store instruction at this register's exception level must be aligned to a 16-byte boundary, or a Stack Alignment Fault exception will be raised.

Reset value is architecturally UNKNOWN.

C, bit [2]

Cache enable. This is an enable bit for data and unified caches at EL2:

0 Data and unified caches disabled at EL2.

1 Data and unified caches enabled at EL2.

When this bit is 0, all EL2 Normal memory data accesses and all accesses to the EL2 translation tables are Non-cacheable. This bit has no effect on the EL1&0 or EL3 translation regimes.

If this register is at the highest exception level implemented, field resets to 0. Otherwise, its reset value is UNKNOWN.

A, bit [1]

Alignment check enable. This is the enable bit for Alignment fault checking:

0 Alignment fault checking disabled.

Instructions that load or store one or more registers, other than load/store exclusive and load-acquire/store-release, do not check that the address being accessed is aligned to the size of the data element(s) being accessed.

1 Alignment fault checking enabled.

All instructions that load or store one or more registers have an alignment check that the address being accessed is aligned to the size of the data element(s) being accessed. If this check fails it causes an Alignment fault, which is taken as a Data Abort exception.

Load/store exclusive and load-acquire/store-release instructions have an alignment check regardless of the value of the A bit.

Reset value is architecturally UNKNOWN.

M, bit [0]

MMU enable for EL2 stage 1 address translation. Possible values of this bit are:

0 EL2 stage 1 address translation disabled.

1 EL2 stage 1 address translation enabled.

If this register is at the highest exception level implemented, field resets to 0. Otherwise, its reset value is UNKNOWN.

Accessing the SCTLR_EL2:

To access the SCTLR_EL2:

MRS <Xt>, SCTLR_EL2 ; Read SCTLR_EL2 into Xt

MSR SCTLR_EL2, <Xt> ; Write Xt to SCTLR_EL2

Register access is encoded as follows:

op0	op1	CRn	CRm	op2
11	100	0001	0000	000

D8.2.81 SCTLR_EL3, System Control Register (EL3)

The SCTLR_EL3 characteristics are:

Purpose

Provides top level control of the system, including its memory system, at EL3.
This register is part of the Other system control registers functional group.

Usage constraints

This register is accessible as shown below:

EL0	EL1 (NS)	EL1 (S)	EL2	EL3 (SCR.NS=1)	EL3 (SCR.NS=0)
-	-	-	-	RW	RW

Configurations

SCTLR_EL3 can be mapped to AArch32 register [SCTLR](#) (S), but this is not architecturally mandated.

Attributes

SCTLR_EL3 is a 32-bit register.

The SCTLR_EL3 bit assignments are:

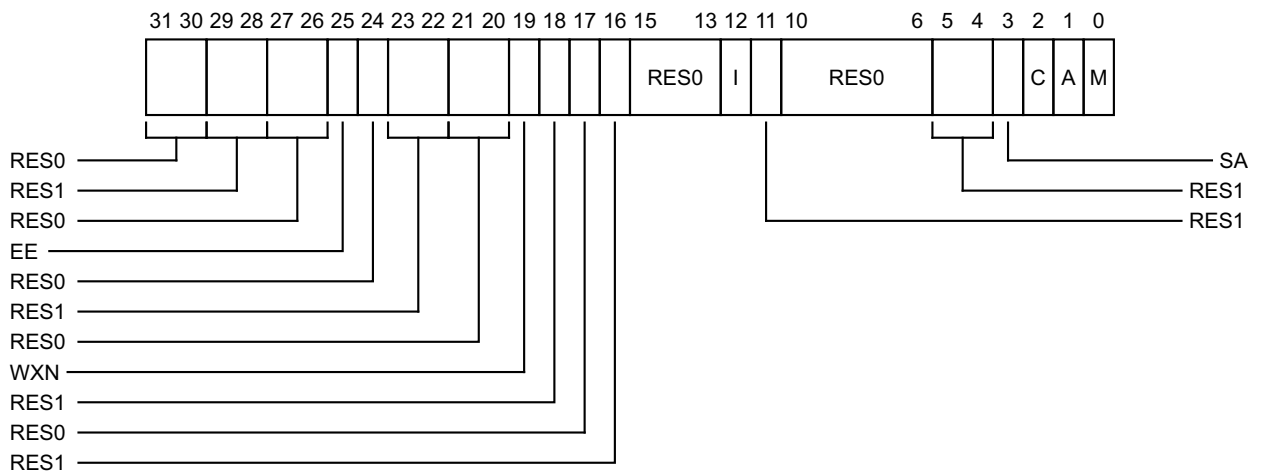

Bits [31:30]

Reserved, RES0.

Bits [29:28]

Reserved, RES1.

Bits [27:26]

Reserved, RES0.

EE, bit [25]

Exception Endianness. This bit controls the endianness for:

- Explicit data accesses at EL3.
- Stage 1 translation table walks at EL3.

The possible values of this bit are:

- 0 Little-endian.
- 1 Big-endian.

If an implementation does not provide Big-endian support, this bit is RES0. If it does not provide Little-endian support, this bit is RES1.

The EE bit is permitted to be cached in a TLB.

If this register is at the highest exception level implemented, field resets to an IMPLEMENTATION DEFINED value. Otherwise, its reset value is UNKNOWN.

Bit [24]

Reserved, RES0.

Bits [23:22]

Reserved, RES1.

Bits [21:20]

Reserved, RES0.

WXN, bit [19]

Write permission implies XN (Execute Never). This bit can be used to require all memory regions with write permission to be treated as XN. The possible values of this bit are:

- 0 Regions with write permission are not forced to XN.
- 1 Regions with write permission are forced to XN.

The WXN bit is permitted to be cached in a TLB.

Reset value is architecturally UNKNOWN.

Bit [18]

Reserved, RES1.

Bit [17]

Reserved, RES0.

Bit [16]

Reserved, RES1.

Bits [15:13]

Reserved, RES0.

I, bit [12]

Instruction cache enable. This is an enable bit for instruction caches at EL3:

- 0 Instruction caches disabled at EL3. If SCTLR_EL3.M is set to 0, instruction accesses from stage 1 of the EL3 translation regime are to Normal memory, Outer Shareable, Inner Non-cacheable, Outer Non-cacheable.
- 1 Instruction caches enabled at EL3. If SCTLR_EL3.M is set to 0, instruction accesses from stage 1 of the EL3 translation regime are to Normal memory, Outer Shareable, Inner Write-Through, Outer Write-Through.

When this bit is 0, all EL3 Normal memory instruction accesses are Non-cacheable. This bit has no effect on the EL1&0 or EL2 translation regimes.

If this register is at the highest exception level implemented, field resets to 0. Otherwise, its reset value is UNKNOWN.

Bit [11]

Reserved, RES1.

Bits [10:6]

Reserved, RES0.

Bits [5:4]

Reserved, RES1.

SA, bit [3]

Stack Alignment Check Enable. When set, use of the stack pointer as the base address in a load/store instruction at this register's exception level must be aligned to a 16-byte boundary, or a Stack Alignment Fault exception will be raised.

Reset value is architecturally UNKNOWN.

C, bit [2]

Cache enable. This is an enable bit for data and unified caches at EL3:

0 Data and unified caches disabled at EL3.

1 Data and unified caches enabled at EL3.

When this bit is 0, all EL3 Normal memory data accesses and all accesses to the EL3 translation tables are Non-cacheable. This bit has no effect on the EL1&0 or EL2 translation regimes.

If this register is at the highest exception level implemented, field resets to 0. Otherwise, its reset value is UNKNOWN.

A, bit [1]

Alignment check enable. This is the enable bit for Alignment fault checking:

0 Alignment fault checking disabled.

Instructions that load or store one or more registers, other than load/store exclusive and load-acquire/store-release, do not check that the address being accessed is aligned to the size of the data element(s) being accessed.

1 Alignment fault checking enabled.

All instructions that load or store one or more registers have an alignment check that the address being accessed is aligned to the size of the data element(s) being accessed. If this check fails it causes an Alignment fault, which is taken as a Data Abort exception.

Load/store exclusive and load-acquire/store-release instructions have an alignment check regardless of the value of the A bit.

Reset value is architecturally UNKNOWN.

M, bit [0]

MMU enable for EL3 stage 1 address translation. Possible values of this bit are:

0 EL3 stage 1 address translation disabled.

1 EL3 stage 1 address translation enabled.

If this register is at the highest exception level implemented, field resets to 0. Otherwise, its reset value is UNKNOWN.

Accessing the SCTLR_EL3:

To access the SCTLR_EL3:

MRS <Xt>, SCTLR_EL3 ; Read SCTLR_EL3 into Xt

MSR SCTLR_EL3, <Xt> ; Write Xt to SCTLR_EL3

Register access is encoded as follows:

op0	op1	CRn	CRm	op2
11	110	0001	0000	000

D8.2.82 TCR_EL1, Translation Control Register (EL1)

The TCR_EL1 characteristics are:

Purpose

Determines which of the Translation Table Base Registers defined the base address for a translation table walk required for the stage 1 translation of a memory access from EL0 or EL1. Also controls the translation table format and holds cacheability and shareability information.

This register is part of the Virtual memory control registers functional group.

Usage constraints

This register is accessible as shown below:

EL0	EL1 (NS)	EL1 (S)	EL2	EL3 (SCR.NS=1)	EL3 (SCR.NS=0)
-	RW	RW	RW	RW	RW

Any of the bits in TCR_EL1 are permitted to be cached in a TLB.

Configurations

TCR_EL1[31:0] is architecturally mapped to AArch32 register [TTBCR](#) (NS).

Attributes

TCR_EL1 is a 64-bit register.

The TCR_EL1 bit assignments are:

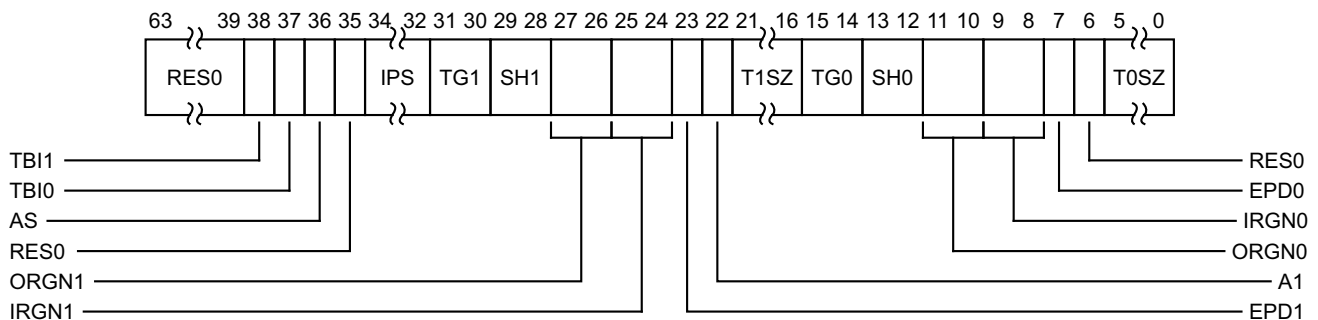

Bits [63:39]

Reserved, RES0.

TBI1, bit [38]

Top Byte ignored - indicates whether the top byte of an address is used for address match for the [TTBR1_EL1](#) region, or ignored and used for tagged addresses.

0 Top Byte used in the address calculation.

1 Top Byte ignored in the address calculation.

This affects addresses generated in EL0 and EL1 using AArch64 where the address would be translated by tables pointed to by [TTBR1_EL1](#). It has an effect whether the EL1&0 translation regime is enabled or not.

Additionally, this affects changes to the program counter, when TBI1 is 1 and bit [55] of the target address is 1, caused by:

- A branch or procedure return within EL0 or EL1.
- An exception taken to EL1.

- An exception return to EL0 or EL1.

In these cases bits [63:56] of the address are also set to 1 before it is stored in the PC.

TBIO, bit [37]

Top Byte ignored - indicates whether the top byte of an address is used for address match for the [TTBR0_EL1](#) region, or ignored and used for tagged addresses.

- 0 Top Byte used in the address calculation.
- 1 Top Byte ignored in the address calculation.

This affects addresses generated in EL0 and EL1 using AArch64 where the address would be translated by tables pointed to by [TTBR0_EL1](#). It has an effect whether the EL1&0 translation regime is enabled or not.

Additionally, this affects changes to the program counter, when TBIO is 1 and bit [55] of the target address is 0, caused by:

- A branch or procedure return within EL0 or EL1.
- An exception taken to EL1.
- An exception return to EL0 or EL1.

In these cases bits [63:56] of the address are also set to 0 before it is stored in the PC.

AS, bit [36]

ASID Size.

- 0 8 bit - the upper 8 bits of [TTBR0_EL1](#) and [TTBR1_EL1](#) are ignored by hardware for every purpose except reading back the register, and are treated as if they are all zeros for when used for allocation and matching entries in the TLB.
- 1 16 bit - the upper 16 bits of [TTBR0_EL1](#) and [TTBR1_EL1](#) are used for allocation and matching in the TLB.

If the implementation has only 8 bits of ASID, this field is RES0.

Bit [35]

Reserved, RES0.

IPS, bits [34:32]

Intermediate Physical Address Size.

- 000 32 bits, 4 GB.
- 001 36 bits, 64 GB.
- 010 40 bits, 1 TB.
- 011 42 bits, 4 TB.
- 100 44 bits, 16 TB.
- 101 48 bits, 256 TB.

Other values are reserved.

The reserved values behave in the same way as the 101 encoding, but software must not rely on this property as the behavior of the RESERVED values might change in a future revision of the architecture.

TG1, bits [31:30]

[TTBR1_EL1](#) Granule size.

- 01 16KByte
- 10 4KByte
- 11 64KByte

Other values are reserved.

If the value is programmed to either a reserved value, or a size that has not been implemented, then the hardware will treat the field as if it has been programmed to an IMPLEMENTATION DEFINED choice of the sizes that has been implemented for all purposes other than the value read back from this register.

It is IMPLEMENTATION DEFINED whether the value read back is the value programmed or the value that corresponds to the size chosen.

SH1, bits [29:28]

Shareability attribute for memory associated with translation table walks using [TTBR1_EL1](#).

- 00 Non-shareable
- 10 Outer Shareable
- 11 Inner Shareable

Other values are reserved.

ORGN1, bits [27:26]

Outer cacheability attribute for memory associated with translation table walks using [TTBR1_EL1](#).

- 00 Normal memory, Outer Non-cacheable
- 01 Normal memory, Outer Write-Back Write-Allocate Cacheable
- 10 Normal memory, Outer Write-Through Cacheable
- 11 Normal memory, Outer Write-Back no Write-Allocate Cacheable

IRGN1, bits [25:24]

Inner cacheability attribute for memory associated with translation table walks using [TTBR1_EL1](#).

- 00 Normal memory, Inner Non-cacheable
- 01 Normal memory, Inner Write-Back Write-Allocate Cacheable
- 10 Normal memory, Inner Write-Through Cacheable
- 11 Normal memory, Inner Write-Back no Write-Allocate Cacheable

EPD1, bit [23]

Translation table walk disable for translations using [TTBR1_EL1](#). This bit controls whether a translation table walk is performed on a TLB miss, for an address that is translated using [TTBR1_EL1](#). The encoding of this bit is:

- 0 Perform translation table walks using [TTBR1_EL1](#).
- 1 A TLB miss on an address that is translated using [TTBR1_EL1](#) generates a Translation fault. No translation table walk is performed.

A1, bit [22]

Selects whether [TTBR0_EL1](#) or [TTBR1_EL1](#) defines the ASID. The encoding of this bit is:

- 0 [TTBR0_EL1](#).ASID defines the ASID.
- 1 [TTBR1_EL1](#).ASID defines the ASID.

T1SZ, bits [21:16]

The size offset of the memory region addressed by [TTBR1_EL1](#). The region size is $2^{64-T1SZ}$ bytes.

The maximum and minimum possible values for T1SZ depend on the level of translation table and the memory translation granule size, as described in the AArch64 Virtual Memory System Architecture chapter.

TG0, bits [15:14]

Granule size for the corresponding translation table base address register.

- 00 4KByte
- 01 64KByte

10 16KByte

Other values are reserved.

If the value is programmed to either a reserved value, or a size that has not been implemented, then the hardware will treat the field as if it has been programmed to an IMPLEMENTATION DEFINED choice of the sizes that has been implemented for all purposes other than the value read back from this register.

It is IMPLEMENTATION DEFINED whether the value read back is the value programmed or the value that corresponds to the size chosen.

SH0, bits [13:12]

Shareability attribute for memory associated with translation table walks using [TTBR0_EL1](#).

00 Non-shareable
10 Outer Shareable
11 Inner Shareable

Other values are reserved.

ORGN0, bits [11:10]

Outer cacheability attribute for memory associated with translation table walks using [TTBR0_EL1](#).

00 Normal memory, Outer Non-cacheable
01 Normal memory, Outer Write-Back Write-Allocate Cacheable
10 Normal memory, Outer Write-Through Cacheable
11 Normal memory, Outer Write-Back no Write-Allocate Cacheable

IRGN0, bits [9:8]

Inner cacheability attribute for memory associated with translation table walks using [TTBR0_EL1](#).

00 Normal memory, Inner Non-cacheable
01 Normal memory, Inner Write-Back Write-Allocate Cacheable
10 Normal memory, Inner Write-Through Cacheable
11 Normal memory, Inner Write-Back no Write-Allocate Cacheable

EPD0, bit [7]

Translation table walk disable for translations using [TTBR0](#). This bit controls whether a translation table walk is performed on a TLB miss, for an address that is translated using [TTBR0](#). The encoding of this bit is:

0 Perform translation table walks using [TTBR0](#).
1 A TLB miss on an address that is translated using [TTBR0](#) generates a Translation fault. No translation table walk is performed.

Bit [6]

Reserved, RES0.

T0SZ, bits [5:0]

The size offset of the memory region addressed by [TTBR0_EL1](#). The region size is $2^{64-T0SZ}$ bytes.

The maximum and minimum possible values for T0SZ depend on the level of translation table and the memory translation granule size, as described in the AArch64 Virtual Memory System Architecture chapter.

Accessing the TCR_EL1:

To access the TCR_EL1:

MRS <Xt>, TCR_EL1 ; Read TCR_EL1 into Xt
MSR TCR_EL1, <Xt> ; Write Xt to TCR_EL1

Register access is encoded as follows:

op0	op1	CRn	CRm	op2
11	000	0010	0000	010

D8.2.83 TCR_EL2, Translation Control Register (EL2)

The TCR_EL2 characteristics are:

Purpose

Controls translation table walks required for the stage 1 translation of memory accesses from EL2, and holds cacheability and shareability information for the accesses.

This register is part of:

- the Virtualization registers functional group
- the Virtual memory control registers functional group.

Usage constraints

This register is accessible as shown below:

EL0	EL1 (NS)	EL1 (S)	EL2	EL3 (SCR.NS=1)	EL3 (SCR.NS=0)
-	-	-	RW	RW	RW

Any of the bits in TCR_EL2 are permitted to be cached in a TLB.

Configurations

TCR_EL2 is architecturally mapped to AArch32 register [HTCR](#).

If EL2 is not implemented, this register is RES0 from EL3.

Attributes

TCR_EL2 is a 32-bit register.

The TCR_EL2 bit assignments are:

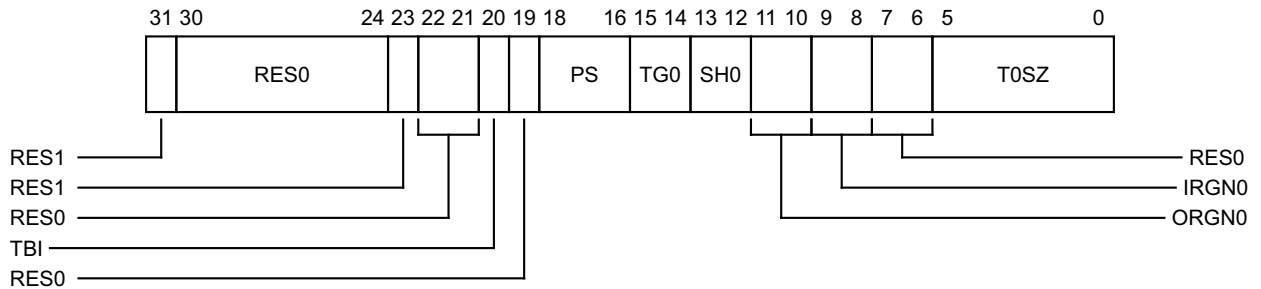

Bit [31]

Reserved, RES1.

Bits [30:24]

Reserved, RES0.

Bit [23]

Reserved, RES1.

Bits [22:21]

Reserved, RES0.

TBI, bit [20]

Top Byte ignored - indicates whether the top byte of an address is used for address match for the [TTBR0_EL2](#) region, or ignored and used for tagged addresses.

0 Top Byte used in the address calculation.

1 Top Byte ignored in the address calculation.

This affects addresses generated in EL2 using AArch64 where the address would be translated by tables pointed to by [TTBR0_EL2](#). It has an effect whether the EL2 translation regime is enabled or not.

Additionally, this affects changes to the program counter, when TBI is 1, caused by:

- A branch or procedure return within EL2.
- An exception taken to EL2.
- An exception return to EL2.

In these cases bits [63:56] of the address are set to 0 before it is stored in the PC.

Bit [19]

Reserved, RES0.

PS, bits [18:16]

Physical Address Size.

000 32 bits, 4 GB.

001 36 bits, 64 GB.

010 40 bits, 1 TB.

011 42 bits, 4 TB.

100 44 bits, 16 TB.

101 48 bits, 256 TB.

Other values are reserved.

The reserved values behave in the same way as the 101 encoding, but software must not rely on this property as the behavior of the RESERVED values might change in a future revision of the architecture.

TG0, bits [15:14]

Granule size for the corresponding translation table base address register.

00 4KByte

01 64KByte

10 16KByte

Other values are reserved.

If the value is programmed to either a reserved value, or a size that has not been implemented, then the hardware will treat the field as if it has been programmed to an IMPLEMENTATION DEFINED choice of the sizes that has been implemented for all purposes other than the value read back from this register.

It is IMPLEMENTATION DEFINED whether the value read back is the value programmed or the value that corresponds to the size chosen.

SH0, bits [13:12]

Shareability attribute for memory associated with translation table walks using [TTBR0_EL2](#).

00 Non-shareable

10 Outer Shareable

11 Inner Shareable

Other values are reserved.

ORGN0, bits [11:10]

Outer cacheability attribute for memory associated with translation table walks using [TTBR0_EL2](#).

- 00 Normal memory, Outer Non-cacheable
- 01 Normal memory, Outer Write-Back Write-Allocate Cacheable
- 10 Normal memory, Outer Write-Through Cacheable
- 11 Normal memory, Outer Write-Back no Write-Allocate Cacheable

IRGN0, bits [9:8]

Inner cacheability attribute for memory associated with translation table walks using [TTBR0_EL2](#).

- 00 Normal memory, Inner Non-cacheable
- 01 Normal memory, Inner Write-Back Write-Allocate Cacheable
- 10 Normal memory, Inner Write-Through Cacheable
- 11 Normal memory, Inner Write-Back no Write-Allocate Cacheable

Bits [7:6]

Reserved, RES0.

T0SZ, bits [5:0]

The size offset of the memory region addressed by [TTBR0_EL2](#). The region size is $2^{64-T0SZ}$ bytes.

The maximum and minimum possible values for T0SZ depend on the level of translation table and the memory translation granule size, as described in the AArch64 Virtual Memory System Architecture chapter.

Accessing the TCR_EL2:

To access the TCR_EL2:

MRS <Xt>, TCR_EL2 ; Read TCR_EL2 into Xt
MSR TCR_EL2, <Xt> ; Write Xt to TCR_EL2

Register access is encoded as follows:

op0	op1	CRn	CRm	op2
11	100	0010	0000	010

D8.2.84 TCR_EL3, Translation Control Register (EL3)

The TCR_EL3 characteristics are:

Purpose

Controls translation table walks required for the stage 1 translation of memory accesses from EL3, and holds cacheability and shareability information for the accesses.

This register is part of the Virtual memory control registers functional group.

Usage constraints

This register is accessible as shown below:

EL0	EL1 (NS)	EL1 (S)	EL2	EL3 (SCR.NS=1)	EL3 (SCR.NS=0)
-	-	-	-	RW	RW

Any of the bits in TCR_EL3 are permitted to be cached in a TLB.

Configurations

TCR_EL3[31:0] can be mapped to AArch32 register [TTBCR](#) (S), but this is not architecturally mandated.

Attributes

TCR_EL3 is a 32-bit register.

The TCR_EL3 bit assignments are:

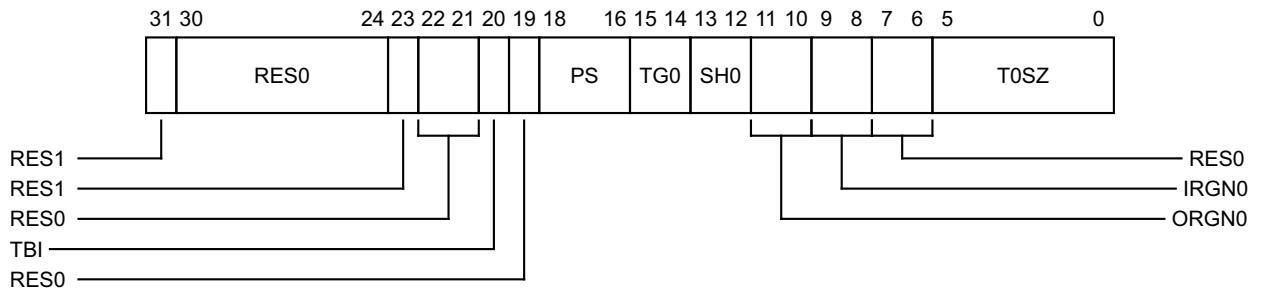

Bit [31]

Reserved, RES1.

Bits [30:24]

Reserved, RES0.

Bit [23]

Reserved, RES1.

Bits [22:21]

Reserved, RES0.

TBI, bit [20]

Top Byte ignored - indicates whether the top byte of an address is used for address match for the [TTBR0_EL3](#) region, or ignored and used for tagged addresses.

0 Top Byte used in the address calculation.

1 Top Byte ignored in the address calculation.

This affects addresses generated in EL3 using AArch64 where the address would be translated by tables pointed to by [TTBR0_EL3](#). It has an effect whether the EL3 translation regime is enabled or not.

Additionally, this affects changes to the program counter, when TBI is 1, caused by:

- A branch or procedure return within EL3.
- A exception taken to EL3.
- An exception return to EL3.

In these cases bits [63:56] of the address are set to 0 before it is stored in the PC.

Bit [19]

Reserved, RES0.

PS, bits [18:16]

Physical Address Size.

000	32 bits, 4 GB.
001	36 bits, 64 GB.
010	40 bits, 1 TB.
011	42 bits, 4 TB.
100	44 bits, 16 TB.
101	48 bits, 256 TB.

Other values are reserved.

The reserved values behave in the same way as the 101 encoding, but software must not rely on this property as the behavior of the RESERVED values might change in a future revision of the architecture.

TG0, bits [15:14]

Granule size for the corresponding translation table base address register.

00	4KByte
01	64KByte
10	16KByte

Other values are reserved.

If the value is programmed to either a reserved value, or a size that has not been implemented, then the hardware will treat the field as if it has been programmed to an IMPLEMENTATION DEFINED choice of the sizes that has been implemented for all purposes other than the value read back from this register.

It is IMPLEMENTATION DEFINED whether the value read back is the value programmed or the value that corresponds to the size chosen.

SH0, bits [13:12]

Shareability attribute for memory associated with translation table walks using [TTBR0_EL3](#).

00	Non-shareable
10	Outer Shareable
11	Inner Shareable

Other values are reserved.

ORGN0, bits [11:10]

Outer cacheability attribute for memory associated with translation table walks using [TTBR0_EL3](#).

00	Normal memory, Outer Non-cacheable
01	Normal memory, Outer Write-Back Write-Allocate Cacheable
10	Normal memory, Outer Write-Through Cacheable

11 Normal memory, Outer Write-Back no Write-Allocate Cacheable

IRGN0, bits [9:8]

Inner cacheability attribute for memory associated with translation table walks using [TTBR0_EL3](#).

- 00 Normal memory, Inner Non-cacheable
- 01 Normal memory, Inner Write-Back Write-Allocate Cacheable
- 10 Normal memory, Inner Write-Through Cacheable
- 11 Normal memory, Inner Write-Back no Write-Allocate Cacheable

Bits [7:6]

Reserved, RES0.

T0SZ, bits [5:0]

The size offset of the memory region addressed by [TTBR0_EL3](#). The region size is $2^{64-T0SZ}$ bytes. The maximum and minimum possible values for T0SZ depend on the level of translation table and the memory translation granule size, as described in the AArch64 Virtual Memory System Architecture chapter.

Accessing the TCR_EL3:

To access the TCR_EL3:

MRS <Xt>, TCR_EL3 ; Read TCR_EL3 into Xt
MSR TCR_EL3, <Xt> ; Write Xt to TCR_EL3

Register access is encoded as follows:

op0	op1	CRn	CRm	op2
11	110	0010	0000	010

D8.2.85 TEECR32_EL1, T32EE Configuration Register

The TEECR32_EL1 characteristics are:

Purpose

Allows access to the AArch32 register [TEECR](#) from AArch64 state only. Its value has no effect on execution in AArch64 state.

This register is part of the Legacy feature registers functional group.

Usage constraints

This register is accessible as shown below:

ELO	EL1 (NS)	EL1 (S)	EL2	EL3 (SCR.NS=1)	EL3 (SCR.NS=0)
-	RW	RW	RW	RW	RW

Configurations

TEECR32_EL1 is architecturally mapped to AArch32 register [TEECR](#).

This register is optional in ARMv8. It is UNDEFINED at all exception levels when T32EE is not implemented, and UNDEFINED at EL1 when [SCTLR_EL1](#).THEE is 0.

Attributes

TEECR32_EL1 is a 32-bit register.

The TEECR32_EL1 bit assignments are:

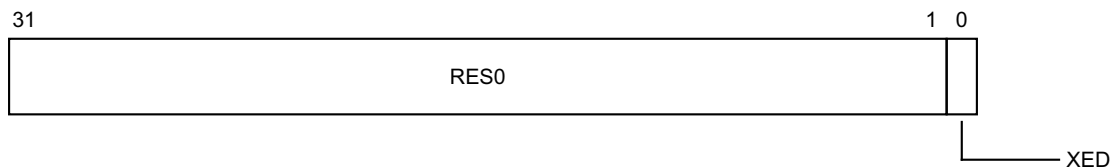

Bits [31:1]

Reserved, RES0.

XED, bit [0]

Execution Environment Disable bit. Control unprivileged access to [TEEHBR](#):

0 Unprivileged access permitted.

1 Unprivileged access disabled.

The effects of a write to this register on T32EE configuration are only guaranteed to be visible to subsequent instructions after the execution of a context synchronization operation. However, a read of this register always returns the value most recently written to the register.

Accessing the TEECR32_EL1:

To access the TEECR32_EL1:

MRS <Xt>, TEECR32_EL1 ; Read TEECR32_EL1 into Xt
MSR TEECR32_EL1, <Xt> ; Write Xt to TEECR32_EL1

Register access is encoded as follows:

op0	op1	CRn	CRm	op2
10	010	0000	0000	000

D8.2.86 TEEHBR32_EL1, T32EE Handler Base Register

The TEEHBR32_EL1 characteristics are:

Purpose

Allows access to the AArch32 register [TEEHBR](#) from AArch64 state only. Its value has no effect on execution in AArch64 state.

This register is part of the Legacy feature registers functional group.

Usage constraints

This register is accessible as shown below:

ELO	EL1 (NS)	EL1 (S)	EL2	EL3 (SCR.NS=1)	EL3 (SCR.NS=0)
-	RW	RW	RW	RW	RW

Configurations

TEEHBR32_EL1 is architecturally mapped to AArch32 register [TEEHBR](#).

This register is optional in ARMv8, and is UNDEFINED when not implemented, or when disabled by [SCTLR_EL1.THEE](#).

Attributes

TEEHBR32_EL1 is a 32-bit register.

The TEEHBR32_EL1 bit assignments are:

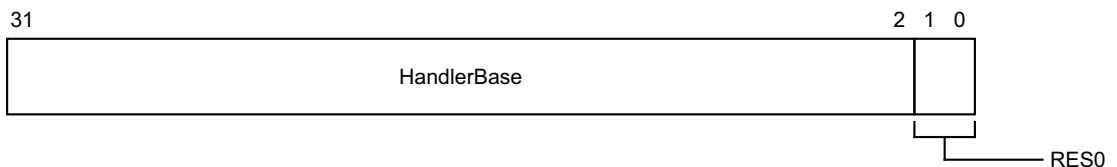

HandlerBase, bits [31:2]

The address of the T32EE Handler_00 implementation. This is the address of the first of the T32EE handlers.

Bits [1:0]

Reserved, RES0.

Accessing the TEEHBR32_EL1:

To access the TEEHBR32_EL1:

MRS <Xt>, TEEHBR32_EL1 ; Read TEEHBR32_EL1 into Xt
MSR TEEHBR32_EL1, <Xt> ; Write Xt to TEEHBR32_EL1

Register access is encoded as follows:

op0	op1	CRn	CRm	op2
10	010	0001	0000	000

D8.2.87 TPIDR_EL0, Thread Pointer / ID Register (EL0)

The TPIDR_EL0 characteristics are:

Purpose

Provides a location where software executing at EL0 can store thread identifying information, for OS management purposes.

This register is part of the Thread and process ID registers functional group.

Usage constraints

This register is accessible as shown below:

EL0	EL1 (NS)	EL1 (S)	EL2	EL3 (SCR.NS=1)	EL3 (SCR.NS=0)
RW	RW	RW	RW	RW	RW

Configurations

TPIDR_EL0[31:0] is architecturally mapped to AArch32 register [TPIDRURW](#) (NS).

Attributes

TPIDR_EL0 is a 64-bit register.

The TPIDR_EL0 bit assignments are:

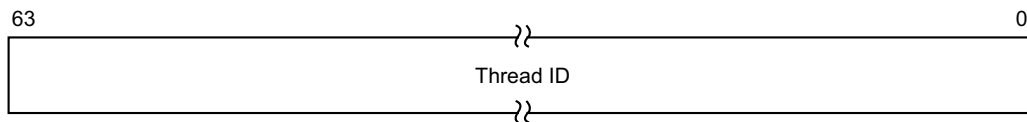

Bits [63:0]

Thread ID. Thread identifying information stored by software running at this exception level.

Accessing the TPIDR_EL0:

To access the TPIDR_EL0:

MRS <Xt>, TPIDR_EL0 ; Read TPIDR_EL0 into Xt
MSR TPIDR_EL0, <Xt> ; Write Xt to TPIDR_EL0

Register access is encoded as follows:

op0	op1	CRn	CRm	op2
11	011	1101	0000	010

D8.2.88 TPIDR_EL1, Thread Pointer / ID Register (EL1)

The TPIDR_EL1 characteristics are:

Purpose

Provides a location where software executing at EL1 can store thread identifying information, for OS management purposes.

This register is part of the Thread and process ID registers functional group.

Usage constraints

This register is accessible as shown below:

EL0	EL1 (NS)	EL1 (S)	EL2	EL3 (SCR.NS=1)	EL3 (SCR.NS=0)
-	RW	RW	RW	RW	RW

Configurations

TPIDR_EL1[31:0] is architecturally mapped to AArch32 register [TPIDRPRW](#) (NS).

Attributes

TPIDR_EL1 is a 64-bit register.

The TPIDR_EL1 bit assignments are:

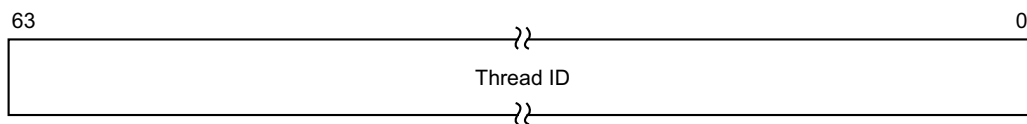

Bits [63:0]

Thread ID. Thread identifying information stored by software running at this exception level.

Accessing the TPIDR_EL1:

To access the TPIDR_EL1:

MRS <Xt>, TPIDR_EL1 ; Read TPIDR_EL1 into Xt
MSR TPIDR_EL1, <Xt> ; Write Xt to TPIDR_EL1

Register access is encoded as follows:

op0	op1	CRn	CRm	op2
11	000	1101	0000	100

D8.2.89 TPIDR_EL2, Thread Pointer / ID Register (EL2)

The TPIDR_EL2 characteristics are:

Purpose

Provides a location where software executing at EL2 can store thread identifying information, for OS management purposes.

This register is part of:

- the Virtualization registers functional group
- the Thread and process ID registers functional group.

Usage constraints

This register is accessible as shown below:

ELO	EL1 (NS)	EL1 (S)	EL2	EL3 (SCR.NS=1)	EL3 (SCR.NS=0)
-	-	-	RW	RW	RW

Configurations

TPIDR_EL2[31:0] is architecturally mapped to AArch32 register [HTPIDR](#).

If EL2 is not implemented, this register is RES0 from EL3.

Attributes

TPIDR_EL2 is a 64-bit register.

The TPIDR_EL2 bit assignments are:

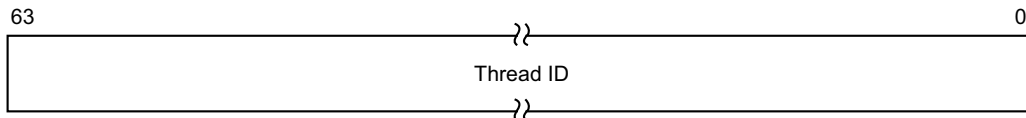

Bits [63:0]

Thread ID. Thread identifying information stored by software running at this exception level.

Accessing the TPIDR_EL2:

To access the TPIDR_EL2:

MRS <Xt>, TPIDR_EL2 ; Read TPIDR_EL2 into Xt
MSR TPIDR_EL2, <Xt> ; Write Xt to TPIDR_EL2

Register access is encoded as follows:

op0	op1	CRn	CRm	op2
11	100	1101	0000	010

D8.2.90 TPIDR_EL3, Thread Pointer / ID Register (EL3)

The TPIDR_EL3 characteristics are:

Purpose

Provides a location where software executing at EL3 can store thread identifying information, for OS management purposes.

This register is part of the Thread and process ID registers functional group.

Usage constraints

This register is accessible as shown below:

EL0	EL1 (NS)	EL1 (S)	EL2	EL3 (SCR.NS=1)	EL3 (SCR.NS=0)
-	-	-	-	RW	RW

Configurations

There are no configuration notes.

Attributes

TPIDR_EL3 is a 64-bit register.

The TPIDR_EL3 bit assignments are:

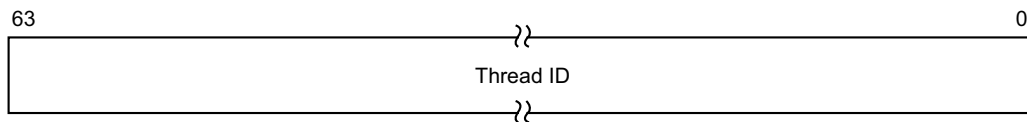

Bits [63:0]

Thread ID. Thread identifying information stored by software running at this exception level.

Accessing the TPIDR_EL3:

To access the TPIDR_EL3:

MRS <Xt>, TPIDR_EL3 ; Read TPIDR_EL3 into Xt
MSR TPIDR_EL3, <Xt> ; Write Xt to TPIDR_EL3

Register access is encoded as follows:

op0	op1	CRn	CRm	op2
11	110	1101	0000	010

D8.2.91 TPIDRRO_EL0, Thread Pointer / ID Register, Read-Only (EL0)

The TPIDRRO_EL0 characteristics are:

Purpose

Provides a location where software executing at EL1 or higher can store thread identifying information that is visible to software executing at EL0, for OS management purposes.

This register is part of the Thread and process ID registers functional group.

Usage constraints

This register is accessible as shown below:

EL0	EL1 (NS)	EL1 (S)	EL2	EL3 (SCR.NS=1)	EL3 (SCR.NS=0)
RO	RW	RW	RW	RW	RW

Configurations

TPIDRRO_EL0[31:0] is architecturally mapped to AArch32 register [TPIDRURO](#) (NS).

Attributes

TPIDRRO_EL0 is a 64-bit register.

The TPIDRRO_EL0 bit assignments are:

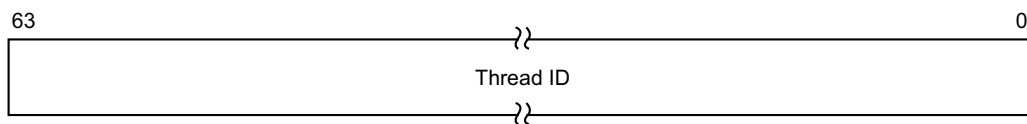

Bits [63:0]

Thread ID. Thread identifying information stored by software running at this exception level.

Accessing the TPIDRRO_EL0:

To access the TPIDRRO_EL0:

MRS <Xt>, TPIDRRO_EL0 ; Read TPIDRRO_EL0 into Xt
MSR TPIDRRO_EL0, <Xt> ; Write Xt to TPIDRRO_EL0

Register access is encoded as follows:

op0	op1	CRn	CRm	op2
11	011	1101	0000	011

D8.2.92 TTBR0_EL1, Translation Table Base Register 0 (EL1)

The TTBR0_EL1 characteristics are:

Purpose

Holds the base address of translation table 0, and information about the memory it occupies. This is one of the translation tables for the stage 1 translation of memory accesses at EL0 and EL1.

This register is part of the Virtual memory control registers functional group.

Usage constraints

This register is accessible as shown below:

EL0	EL1 (NS)	EL1 (S)	EL2	EL3 (SCR.NS=1)	EL3 (SCR.NS=0)
-	RW	RW	RW	RW	RW

Any of the fields in this register are permitted to be cached in a TLB.

Configurations

TTBR0_EL1 is architecturally mapped to AArch32 register [TTBR0](#) (NS).

Attributes

TTBR0_EL1 is a 64-bit register.

The TTBR0_EL1 bit assignments are:

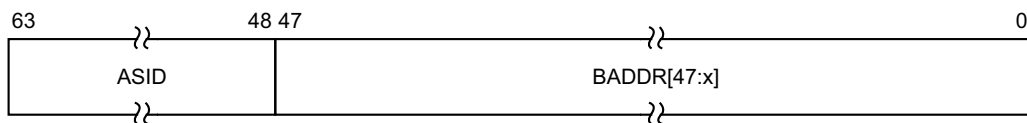

ASID, bits [63:48]

An ASID for the translation table base address. The [TCR_EL1.A1](#) field selects either TTBR0_EL1.ASID or TTBR1_EL1.ASID.

If the implementation has only 8 bits of ASID, then the upper 8 bits of this field are RES0.

BADDR[47:x], bits [47:0]

Translation table base address, bits[47:x]. Bits [x-1:0] are RES0.

x is based on the value of [TCR_EL1.TOSZ](#), the stage of translation, and the memory translation granule size.

The AArch64 Virtual Memory System Architecture chapter describes how x is calculated.

The value of x determines the required alignment of the translation table, which must be aligned to 2^x bytes.

If bits [x-1:0] are not all zero, this is a misaligned Translation Table Base Address. Its effects are CONSTRAINED UNPREDICTABLE, and can be one of the following:

- Bits [x-1:0] are treated as if all the bits are zero. The value read back from those bits might be the value written or might be zero.
- The calculation of an address for a translation table walk using this register can be corrupted in those bits that are non-zero.

Accessing the TTBR0_EL1:

To access the TTBR0_EL1:

MRS <Xt>, TTBR0_EL1 ; Read TTBR0_EL1 into Xt
MSR TTBR0_EL1, <Xt> ; Write Xt to TTBR0_EL1

Register access is encoded as follows:

op0	op1	CRn	CRm	op2
11	000	0010	0000	000

D8.2.93 TTBR0_EL2, Translation Table Base Register 0 (EL2)

The TTBR0_EL2 characteristics are:

Purpose

Holds the base address of the translation table for the stage 1 translation of memory accesses from EL2.

This register is part of:

- the Virtualization registers functional group
- the Virtual memory control registers functional group.

Usage constraints

This register is accessible as shown below:

EL0	EL1 (NS)	EL1 (S)	EL2	EL3 (SCR.NS=1)	EL3 (SCR.NS=0)
-	-	-	RW	RW	RW

Any of the fields in this register are permitted to be cached in a TLB.

Configurations

TTBR0_EL2 is architecturally mapped to AArch32 register [HTTBR](#).

If EL2 is not implemented, this register is RES0 from EL3.

Attributes

TTBR0_EL2 is a 64-bit register.

The TTBR0_EL2 bit assignments are:

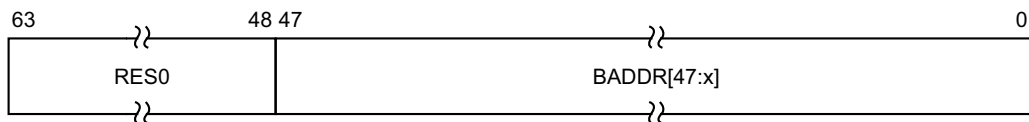

Bits [63:48]

Reserved, RES0.

BADDR[47:x], bits [47:0]

Translation table base address, bits[47:x]. Bits [x-1:0] are RES0.

x is based on the value of [TCR_EL2.T0SZ](#), the stage of translation, and the memory translation granule size.

The AArch64 Virtual Memory System Architecture chapter describes how x is calculated.

The value of x determines the required alignment of the translation table, which must be aligned to 2^x bytes.

If bits [x-1:0] are not all zero, this is a misaligned Translation Table Base Address. Its effects are CONstrained UNPREDICTABLE, and can be one of the following:

- Bits [x-1:0] are treated as if all the bits are zero. The value read back from those bits might be the value written or might be zero.
- The calculation of an address for a translation table walk using this register can be corrupted in those bits that are non-zero.

Accessing the TTBR0_EL2:

To access the TTBR0_EL2:

MRS <Xt>, TTBR0_EL2 ; Read TTBR0_EL2 into Xt
MSR TTBR0_EL2, <Xt> ; Write Xt to TTBR0_EL2

Register access is encoded as follows:

op0	op1	CRn	CRm	op2
11	100	0010	0000	000

D8.2.94 TTBR0_EL3, Translation Table Base Register 0 (EL3)

The TTBR0_EL3 characteristics are:

Purpose

Holds the base address of the translation table for the stage 1 translation of memory accesses from EL3.

This register is part of the Virtual memory control registers functional group.

Usage constraints

This register is accessible as shown below:

EL0	EL1 (NS)	EL1 (S)	EL2	EL3 (SCR.NS=1)	EL3 (SCR.NS=0)
-	-	-	-	RW	RW

Any of the fields in this register are permitted to be cached in a TLB.

Configurations

TTBR0_EL3 can be mapped to AArch32 register [TTBR0](#) (S), but this is not architecturally mandated.

Attributes

TTBR0_EL3 is a 64-bit register.

The TTBR0_EL3 bit assignments are:

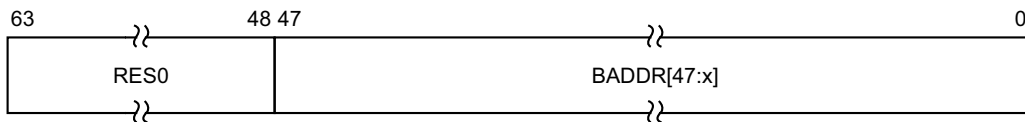

Bits [63:48]

Reserved, RES0.

BADDR[47:x], bits [47:0]

Translation table base address, bits[47:x]. Bits [x-1:0] are RES0.

x is based on the value of [TCR_EL3.TOSZ](#), the stage of translation, and the memory translation granule size.

The AArch64 Virtual Memory System Architecture chapter describes how x is calculated.

The value of x determines the required alignment of the translation table, which must be aligned to 2^x bytes.

If bits [x-1:0] are not all zero, this is a misaligned Translation Table Base Address. Its effects are CONstrained UNpredictable, and can be one of the following:

- Bits [x-1:0] are treated as if all the bits are zero. The value read back from those bits might be the value written or might be zero.
- The calculation of an address for a translation table walk using this register can be corrupted in those bits that are non-zero.

Accessing the TTBR0_EL3:

To access the TTBR0_EL3:

MRS <Xt>, TTBR0_EL3 ; Read TTBR0_EL3 into Xt
MSR TTBR0_EL3, <Xt> ; Write Xt to TTBR0_EL3

Register access is encoded as follows:

op0	op1	CRn	CRm	op2
11	110	0010	0000	000

D8.2.95 TTBR1_EL1, Translation Table Base Register 1

The TTBR1_EL1 characteristics are:

Purpose

Holds the base address of translation table 1, and information about the memory it occupies. This is one of the translation tables for the stage 1 translation of memory accesses at EL0 and EL1.

This register is part of the Virtual memory control registers functional group.

Usage constraints

This register is accessible as shown below:

EL0	EL1 (NS)	EL1 (S)	EL2	EL3 (SCR.NS=1)	EL3 (SCR.NS=0)
-	RW	RW	RW	RW	RW

Any of the fields in this register are permitted to be cached in a TLB.

Configurations

TTBR1_EL1 is architecturally mapped to AArch32 register [TTBR1](#) (NS).

Attributes

TTBR1_EL1 is a 64-bit register.

The TTBR1_EL1 bit assignments are:

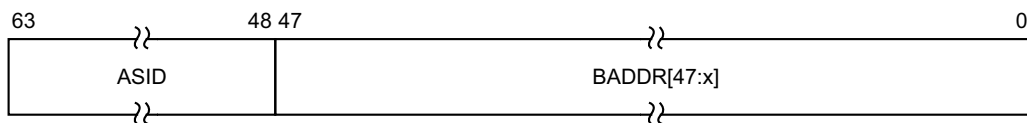

ASID, bits [63:48]

An ASID for the translation table base address. The [TCR_EL1.A1](#) field selects either TTBR0_EL1.ASID or TTBR1_EL1.ASID.

If the implementation has only 8 bits of ASID, then the upper 8 bits of this field are RES0.

BADDR[47:x], bits [47:0]

Translation table base address, bits[47:x]. Bits [x-1:0] are RES0.

x is based on the value of [TCR_EL1.TOSZ](#), the stage of translation, and the memory translation granule size.

The AArch64 Virtual Memory System Architecture chapter describes how x is calculated.

The value of x determines the required alignment of the translation table, which must be aligned to 2^x bytes.

If bits [x-1:0] are not all zero, this is a misaligned Translation Table Base Address. Its effects are CONSTRAINED UNPREDICTABLE, and can be one of the following:

- Bits [x-1:0] are treated as if all the bits are zero. The value read back from those bits might be the value written or might be zero.
- The calculation of an address for a translation table walk using this register can be corrupted in those bits that are non-zero.

Accessing the TTBR1_EL1:

To access the TTBR1_EL1:

MRS <Xt>, TTBR1_EL1 ; Read TTBR1_EL1 into Xt
MSR TTBR1_EL1, <Xt> ; Write Xt to TTBR1_EL1

Register access is encoded as follows:

op0	op1	CRn	CRm	op2
11	000	0010	0000	001

D8.2.96 VBAR_EL1, Vector Base Address Register (EL1)

The VBAR_EL1 characteristics are:

Purpose

Holds the exception base address for any exception that is taken to EL1.

This register is part of the Exception and fault handling registers functional group.

Usage constraints

This register is accessible as shown below:

EL0	EL1 (NS)	EL1 (S)	EL2	EL3 (SCR.NS=1)	EL3 (SCR.NS=0)
-	RW	RW	RW	RW	RW

Configurations

VBAR_EL1[31:0] is architecturally mapped to AArch32 register [VBAR](#) (NS).

Attributes

VBAR_EL1 is a 64-bit register.

The VBAR_EL1 bit assignments are:

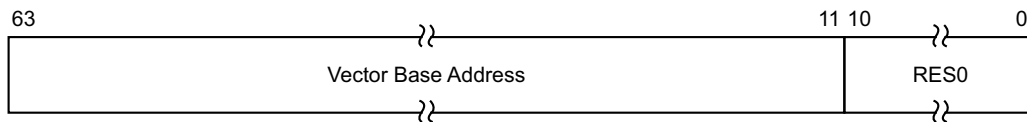

Bits [63:11]

Vector Base Address. Base address of the exception vectors for exceptions taken in EL1.

If tagged addresses are being used, bits [55:48] of VBAR_EL1 must be the same or else the use of the vector address will result in a recursive exception.

If tagged addresses are not being used, bits [63:48] of VBAR_EL1 must be the same or else the use of the vector address will result in a recursive exception.

Bits [10:0]

Reserved, RES0.

Accessing the VBAR_EL1:

To access the VBAR_EL1:

MRS <Xt>, VBAR_EL1 ; Read VBAR_EL1 into Xt
MSR VBAR_EL1, <Xt> ; Write Xt to VBAR_EL1

Register access is encoded as follows:

op0	op1	CRn	CRm	op2
11	000	1100	0000	000

D8.2.97 VBAR_EL2, Vector Base Address Register (EL2)

The VBAR_EL2 characteristics are:

Purpose

Holds the exception base address for any exception that is taken to EL2.

This register is part of:

- the Virtualization registers functional group
- the Exception and fault handling registers functional group.

Usage constraints

This register is accessible as shown below:

EL0	EL1 (NS)	EL1 (S)	EL2	EL3 (SCR.NS=1)	EL3 (SCR.NS=0)
-	-	-	RW	RW	RW

Configurations

VBAR_EL2[31:0] is architecturally mapped to AArch32 register [HVBAR](#).

If EL2 is not implemented, this register is RES0 from EL3.

Attributes

VBAR_EL2 is a 64-bit register.

The VBAR_EL2 bit assignments are:

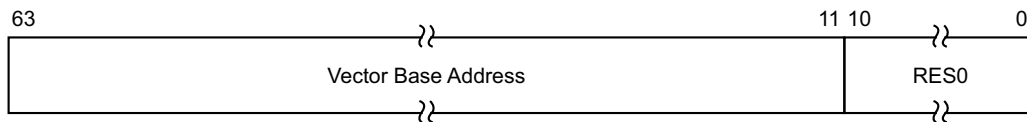

Bits [63:11]

Vector Base Address. Base address of the exception vectors for exceptions taken in EL2.

If tagged addresses are being used, bits [55:48] of VBAR_EL2 must be 0 or else the use of the vector address will result in a recursive exception.

If tagged addresses are not being used, bits [63:48] of VBAR_EL2 must be 0 or else the use of the vector address will result in a recursive exception.

Bits [10:0]

Reserved, RES0.

Accessing the VBAR_EL2:

To access the VBAR_EL2:

MRS <Xt>, VBAR_EL2 ; Read VBAR_EL2 into Xt

MSR VBAR_EL2, <Xt> ; Write Xt to VBAR_EL2

Register access is encoded as follows:

op0	op1	CRn	CRm	op2
11	100	1100	0000	000

D8.2.98 VBAR_EL3, Vector Base Address Register (EL3)

The VBAR_EL3 characteristics are:

Purpose

Holds the exception base address for any exception that is taken to EL3.

This register is part of:

- the Exception and fault handling registers functional group
- the Security registers functional group.

Usage constraints

This register is accessible as shown below:

EL0	EL1 (NS)	EL1 (S)	EL2	EL3 (SCR.NS=1)	EL3 (SCR.NS=0)
-	-	-	-	RW	RW

Configurations

VBAR_EL3[31:0] can be mapped to AArch32 register [VBAR](#) (S), but this is not architecturally mandated.

Attributes

VBAR_EL3 is a 64-bit register.

The VBAR_EL3 bit assignments are:

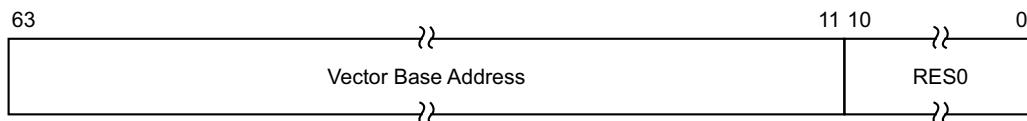

Bits [63:11]

Vector Base Address. Base address of the exception vectors for exceptions taken in EL3.

If tagged addresses are being used, bits [55:48] of VBAR_EL3 must be 0 or else the use of the vector address will result in a recursive exception.

If tagged addresses are not being used, bits [63:48] of VBAR_EL3 must be 0 or else the use of the vector address will result in a recursive exception.

Bits [10:0]

Reserved, RES0.

Accessing the VBAR_EL3:

To access the VBAR_EL3:

MRS <Xt>, VBAR_EL3 ; Read VBAR_EL3 into Xt
MSR VBAR_EL3, <Xt> ; Write Xt to VBAR_EL3

Register access is encoded as follows:

op0	op1	CRn	CRm	op2
11	110	1100	0000	000

D8.2.99 VMPIDR_EL2, Virtualization Multiprocessor ID Register

The VMPIDR_EL2 characteristics are:

Purpose

Holds the value of the Virtualization Multiprocessor ID. This is the value returned by Non-secure EL1 reads of [MPIDR_EL1](#).

This register is part of:

- the Identification registers functional group
- the Virtualization registers functional group.

Usage constraints

This register is accessible as shown below:

EL0	EL1 (NS)	EL1 (S)	EL2	EL3 (SCR.NS=1)	EL3 (SCR.NS=0)
-	-	-	RW	RW	RW

Configurations

VMPIDR_EL2[31:0] is architecturally mapped to AArch32 register [VMPIDR](#).

If EL2 is not implemented, this register is RES0 from EL3.

Attributes

VMPIDR_EL2 is a 64-bit register.

The VMPIDR_EL2 bit assignments are:

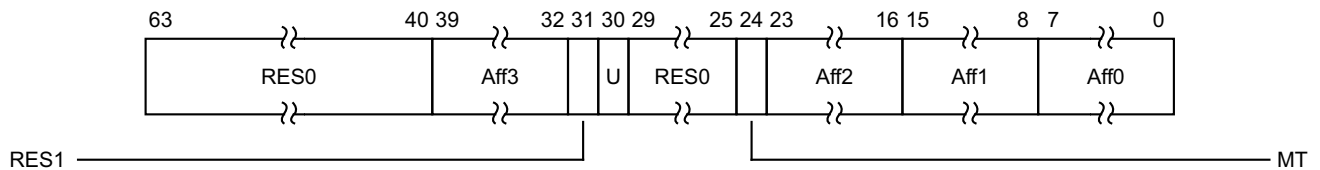

Bits [63:40]

Reserved, RES0.

Aff3, bits [39:32]

Affinity level 3. Highest level affinity field.

Bit [31]

Reserved, RES1.

U, bit [30]

Indicates a Uniprocessor system, as distinct from processor 0 in a multiprocessor system. The possible values of this bit are:

- 0 Processor is part of a multiprocessor system.
- 1 Processor is part of a uniprocessor system.

Bits [29:25]

Reserved, RES0.

MT, bit [24]

Indicates whether the lowest level of affinity consists of logical processors that are implemented using a multi-threading type approach. The possible values of this bit are:

- 0 Performance of processors at the lowest affinity level is largely independent.
- 1 Performance of processors at the lowest affinity level is very interdependent.

Aff2, bits [23:16]

Affinity level 2. Second highest level affinity field.

Aff1, bits [15:8]

Affinity level 1. Third highest level affinity field.

Aff0, bits [7:0]

Affinity level 0. Lowest level affinity field.

Accessing the VMPIDR_EL2:

To access the VMPIDR_EL2:

MRS <Xt>, VMPIDR_EL2 ; Read VMPIDR_EL2 into Xt
MSR VMPIDR_EL2, <Xt> ; Write Xt to VMPIDR_EL2

Register access is encoded as follows:

op0	op1	CRn	CRm	op2
11	100	0000	0000	101

D8.2.100 VPIDR_EL2, Virtualization Processor ID Register

The VPIDR_EL2 characteristics are:

Purpose

Holds the value of the Virtualization Processor ID. This is the value returned by Non-secure EL1 reads of [MIDR_EL1](#).

This register is part of:

- the Virtualization registers functional group
- the Identification registers functional group.

Usage constraints

This register is accessible as shown below:

EL0	EL1 (NS)	EL1 (S)	EL2	EL3 (SCR.NS=1)	EL3 (SCR.NS=0)
-	-	-	RW	RW	RW

Configurations

VPIDR_EL2 is architecturally mapped to AArch32 register [VPIDR](#).

If EL2 is not implemented, this register is RES0 from EL3.

Attributes

VPIDR_EL2 is a 32-bit register.

The VPIDR_EL2 bit assignments are:

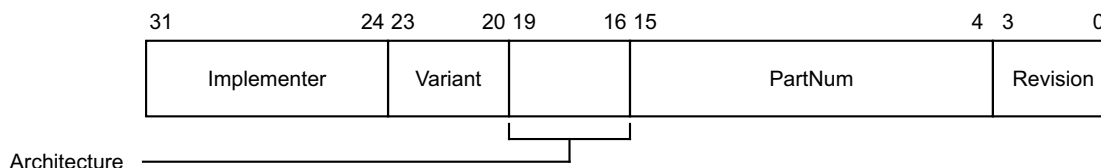

Implementer, bits [31:24]

The Implementer code. This field must hold an implementer code that has been assigned by ARM. Assigned codes include the following:

Hex representation	ASCII representation	Implementer
0x41	A	ARM Limited
0x42	B	Broadcom Corporation
0x43	C	Cavium Inc.
0x44	D	Digital Equipment Corporation
0x49	I	Infineon Technologies AG
0x4D	M	Motorola or Freescale Semiconductor Inc.
0x4E	N	NVIDIA Corporation
0x50	P	Applied Micro Circuits Corporation

Hex representation	ASCII representation	Implementer
0x51	Q	Qualcomm Inc.
0x56	V	Marvell International Ltd.
0x69	i	Intel Corporation

ARM can assign codes that are not published in this manual. All values not assigned by ARM are reserved and must not be used.

Variant, bits [23:20]

An IMPLEMENTATION DEFINED variant number. Typically, this field is used to distinguish between different product variants, or major revisions of a product.

Architecture, bits [19:16]

The permitted values of this field are:

0001	ARMv4
0010	ARMv4T
0011	ARMv5 (obsolete)
0100	ARMv5T
0101	ARMv5TE
0110	ARMv5TEJ
0111	ARMv6
1111	Defined by CPUID scheme

All other values are reserved.

PartNum, bits [15:4]

An IMPLEMENTATION DEFINED primary part number for the device.

On processors implemented by ARM, if the top four bits of the primary part number are 0x0 or 0x7, the variant and architecture are encoded differently.

Revision, bits [3:0]

An IMPLEMENTATION DEFINED revision number for the device.

Accessing the VPIDR_EL2:

To access the VPIDR_EL2:

MRS <Xt>, VPIDR_EL2 ; Read VPIDR_EL2 into Xt
MSR VPIDR_EL2, <Xt> ; Write Xt to VPIDR_EL2

Register access is encoded as follows:

op0	op1	CRn	CRm	op2
11	100	0000	0000	000

D8.2.101 VTCR_EL2, Virtualization Translation Control Register

The VTCR_EL2 characteristics are:

Purpose

Controls the translation table walks required for the stage 2 translation of memory accesses from Non-secure EL0 and EL1, and holds cacheability and shareability information for the accesses.

This register is part of:

- the Virtualization registers functional group
- the Virtual memory control registers functional group.

Usage constraints

This register is accessible as shown below:

EL0	EL1 (NS)	EL1 (S)	EL2	EL3 (SCR.NS=1)	EL3 (SCR.NS=0)
-	-	-	RW	RW	RW

Any of the bits in VTCR_EL2 are permitted to be cached in a TLB.

Configurations

VTCR_EL2 is architecturally mapped to AArch32 register [VTCR](#).

If EL2 is not implemented, this register is RES0 from EL3.

Attributes

VTCR_EL2 is a 32-bit register.

The VTCR_EL2 bit assignments are:

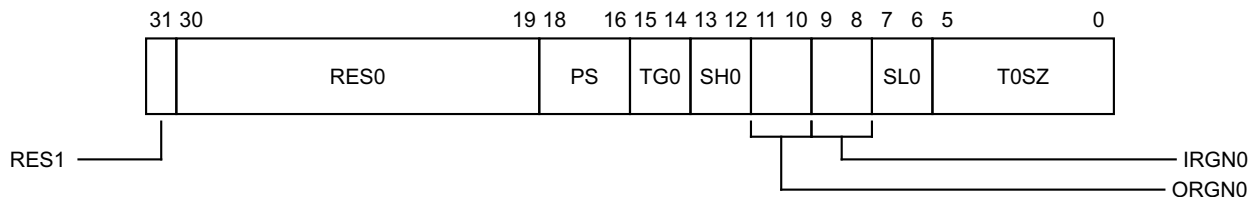

Bit [31]

Reserved, RES1.

Bits [30:19]

Reserved, RES0.

PS, bits [18:16]

Physical Address Size.

000	32 bits, 4 GB.
001	36 bits, 64 GB.
010	40 bits, 1 TB.
011	42 bits, 4 TB.
100	44 bits, 16 TB.
101	48 bits, 256 TB.

Other values are reserved.

The reserved values behave in the same way as the 101 encoding, but software must not rely on this property as the behavior of the RESERVED values might change in a future revision of the architecture.

TG0, bits [15:14]

Granule size for the corresponding translation table base address register.

00	4KByte
01	64KByte
10	16KByte

Other values are reserved.

If the value is programmed to either a reserved value, or a size that has not been implemented, then the hardware will treat the field as if it has been programmed to an IMPLEMENTATION DEFINED choice of the sizes that has been implemented for all purposes other than the value read back from this register.

It is IMPLEMENTATION DEFINED whether the value read back is the value programmed or the value that corresponds to the size chosen.

SH0, bits [13:12]

Shareability attribute for memory associated with translation table walks using [VTTBR_EL2](#).

00	Non-shareable
10	Outer Shareable
11	Inner Shareable

Other values are reserved.

ORGN0, bits [11:10]

Outer cacheability attribute for memory associated with translation table walks using [VTTBR_EL2](#).

00	Normal memory, Outer Non-cacheable
01	Normal memory, Outer Write-Back Write-Allocate Cacheable
10	Normal memory, Outer Write-Through Cacheable
11	Normal memory, Outer Write-Back no Write-Allocate Cacheable

IRGN0, bits [9:8]

Inner cacheability attribute for memory associated with translation table walks using [VTTBR_EL2](#).

00	Normal memory, Inner Non-cacheable
01	Normal memory, Inner Write-Back Write-Allocate Cacheable
10	Normal memory, Inner Write-Through Cacheable
11	Normal memory, Inner Write-Back no Write-Allocate Cacheable

SL0, bits [7:6]

Starting level of the [VTCR_EL2](#) addressed region. The meaning of this field depends on the value of [VTCR_EL2.TG0](#) (the granule size).

00	If TG0 is 0b00 (4KB granule), start at level 2. If TG0 is 0b10 (16KB granule) or 0b01 (64KB granule), start at level 3.
01	If TG0 is 0b00 (4KB granule), start at level 1. If TG0 is 0b10 (16KB granule) or 0b01 (64KB granule), start at level 2.
10	If TG0 is 0b00 (4KB granule), start at level 0. If TG0 is 0b10 (16KB granule) or 0b01 (64KB granule), start at level 1.

Other values are reserved.

T0SZ, bits [5:0]

The size offset of the memory region addressed by [VTTBR_EL2](#). The region size is $2^{64-T0SZ}$ bytes.

The maximum and minimum possible values for TOSZ depend on the level of translation table and the memory translation granule size, as described in the AArch64 Virtual Memory System Architecture chapter.

Accessing the VTCR_EL2:

To access the VTCR_EL2:

MRS <Xt>, VTCR_EL2 ; Read VTCR_EL2 into Xt
MSR VTCR_EL2, <Xt> ; Write Xt to VTCR_EL2

Register access is encoded as follows:

op0	op1	CRn	CRm	op2
11	100	0010	0001	010

D8.2.102 VTTBR_EL2, Virtualization Translation Table Base Register

The VTTBR_EL2 characteristics are:

Purpose

Holds the base address of the translation table for the stage 2 translation of memory accesses from Non-secure EL0 and EL1.

This register is part of:

- the Virtualization registers functional group
- the Virtual memory control registers functional group.

Usage constraints

This register is accessible as shown below:

EL0	EL1 (NS)	EL1 (S)	EL2	EL3 (SCR.NS=1)	EL3 (SCR.NS=0)
-	-	-	RW	RW	RW

Any of the fields in this register are permitted to be cached in a TLB.

Configurations

VTTBR_EL2 is architecturally mapped to AArch32 register [VTTBR](#).

If EL2 is not implemented, this register is RES0 from EL3.

Attributes

VTTBR_EL2 is a 64-bit register.

The VTTBR_EL2 bit assignments are:

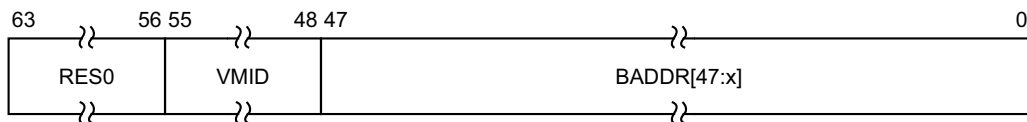

Bits [63:56]

Reserved, RES0.

VMID, bits [55:48]

The VMID for the translation table.

BADDR[47:x], bits [47:0]

Translation table base address, bits[47:x]. Bits [x-1:0] are RES0.

x is based on the value of [VTCR_EL2.TOSZ](#), the stage of translation, and the memory translation granule size.

The AArch64 Virtual Memory System Architecture chapter describes how x is calculated.

The value of x determines the required alignment of the translation table, which must be aligned to 2^x bytes.

If bits [x-1:0] are not all zero, this is a misaligned Translation Table Base Address. Its effects are CONstrained UNPREDICTABLE, and can be one of the following:

- Bits [x-1:0] are treated as if all the bits are zero. The value read back from those bits might be the value written or might be zero.
- The calculation of an address for a translation table walk using this register can be corrupted in those bits that are non-zero.

Accessing the VTTBR_EL2:

To access the VTTBR_EL2:

MRS <Xt>, VTTBR_EL2 ; Read VTTBR_EL2 into Xt
MSR VTTBR_EL2, <Xt> ; Write Xt to VTTBR_EL2

Register access is encoded as follows:

op0	op1	CRn	CRm	op2
11	100	0010	0001	000

D8.3 Debug registers

This section lists the Debug registers in AArch64 state.

D8.3.1 DBGAUTHSTATUS_EL1, Debug Authentication Status register

The DBGAUTHSTATUS_EL1 characteristics are:

Purpose

Provides information about the state of the IMPLEMENTATION DEFINED authentication interface for debug.

This register is part of the Debug registers functional group.

Usage constraints

This register is accessible as shown below:

ELO	EL1 (NS)	EL1 (S)	EL2	EL3 (SCR.NS=1)	EL3 (SCR.NS=0)
-	RO	RO	RO	RO	RO

Configurations

DBGAUTHSTATUS_EL1 is architecturally mapped to AArch32 register [DBGAUTHSTATUS](#).

DBGAUTHSTATUS_EL1 is architecturally mapped to external register [DBGAUTHSTATUS_EL1](#).

Attributes

DBGAUTHSTATUS_EL1 is a 32-bit register.

The DBGAUTHSTATUS_EL1 bit assignments are:

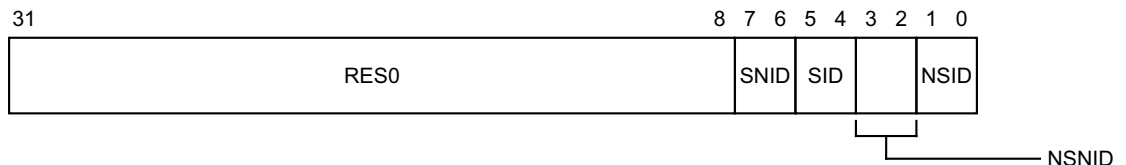

Bits [31:8]

Reserved, RES0.

SNID, bits [7:6]

Secure non-invasive debug. Possible values of this field are:

- 00 Not implemented. EL3 is not implemented and the processor is Non-secure.
- 10 Implemented and disabled. ExternalSecureNoninvasiveDebugEnabled() == FALSE.
- 11 Implemented and enabled. ExternalSecureNoninvasiveDebugEnabled() == TRUE.

Other values are reserved.

SID, bits [5:4]

Secure invasive debug. Possible values of this field are:

- 00 Not implemented. EL3 is not implemented and the processor is Non-secure.
- 10 Implemented and disabled. ExternalSecureInvasiveDebugEnabled() == FALSE.
- 11 Implemented and enabled. ExternalSecureInvasiveDebugEnabled() == TRUE.

Other values are reserved.

NSNID, bits [3:2]

Non-secure non-invasive debug. Possible values of this field are:

- 00 Not implemented. EL3 is not implemented and the processor is Secure.
- 10 Implemented and disabled. ExternalNoninvasiveDebugEnabled() == FALSE.
- 11 Implemented and enabled. ExternalNoninvasiveDebugEnabled() == TRUE.

Other values are reserved.

NSID, bits [1:0]

Non-secure invasive debug. Possible values of this field are:

- 00 Not implemented. EL3 is not implemented and the processor is Secure.
- 10 Implemented and disabled. ExternalInvasiveDebugEnabled() == FALSE.
- 11 Implemented and enabled. ExternalInvasiveDebugEnabled() == TRUE.

Other values are reserved.

Accessing the DBGAUTHSTATUS_EL1:

To access the DBGAUTHSTATUS_EL1:

MRS <Xt>, DBGAUTHSTATUS_EL1 ; Read DBGAUTHSTATUS_EL1 into Xt

Register access is encoded as follows:

op0	op1	CRn	CRm	op2
10	000	0111	1110	110

D8.3.2 DBGBCR<n>_EL1, Debug Breakpoint Control Registers, n = 0 - 15

The DBGBCR<n>_EL1 characteristics are:

Purpose

Holds control information for a breakpoint. Forms breakpoint n together with value register [DBGBVR<n>_EL1](#), where n is 0 to 15.

This register is part of the Debug registers functional group.

Usage constraints

This register is accessible as shown below:

ELO	EL1 (NS)	EL1 (S)	EL2	EL3 (SCR.NS=1)	EL3 (SCR.NS=0)
-	RW	RW	RW	RW	RW

When the E field is zero, all the other fields in the register are ignored.

Configurations

DBGBCR<n>_EL1 is architecturally mapped to AArch32 register [DBGBCR<n>](#).

DBGBCR<n>_EL1 is architecturally mapped to external register [DBGBCR<n>_EL1](#).

Attributes

DBGBCR<n>_EL1 is a 32-bit register.

The DBGBCR<n>_EL1 bit assignments are:

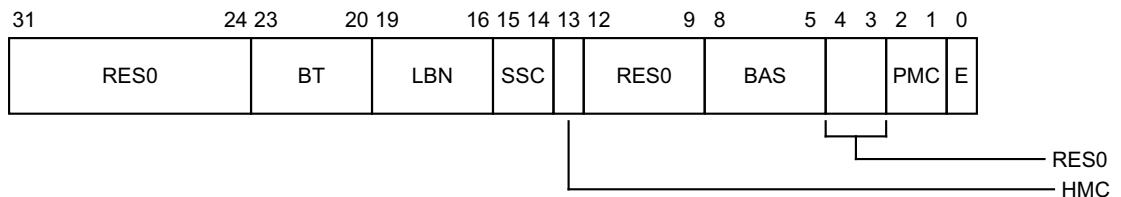

Bits [31:24]

Reserved, RES0.

BT, bits [23:20]

Breakpoint Type. Possible values are:

0000	Unlinked address match.
0001	Linked address match.
0010	Unlinked context ID match.
0011	Linked context ID match
0100	Unlinked address mismatch.
0101	Linked address mismatch.
1000	Unlinked VMID match.
1001	Linked VMID match.
1010	Unlinked VMID and context ID match.
1011	Linked VMID and context ID match.

The field breaks down as follows:

- BT[3:1]: Base type.
 - 000 Match address. `DBGVVR<n>_EL1` is the address of an instruction.
 - 010 Mismatch address. Behaves as type `0b000` if in an AArch64 translation, or if halting debug-mode is enabled and halting is allowed. Otherwise, `DBGVVR<n>_EL1` is the address of an instruction to be stepped.
 - 001 Match context ID. `DBGVVR<n>_EL1[31:0]` is a context ID.
 - 100 Match VMID. `DBGVVR<n>_EL1[39:32]` is a VMID.
 - 101 Match VMID and context ID. `DBGVVR<n>_EL1[31:0]` is a context ID, and `DBGVVR<n>_EL1[39:32]` is a VMID.
- BT[0]: Enable linking.

If the breakpoint is not context-aware, BT[3] and BT[1] are RES0. If EL2 is not implemented, BT[3] is RES0. If EL1 using AArch32 is not implemented, BT[2] is RES0.

The values `011x` and `11xx` are reserved, but must behave as if the breakpoint is disabled. Software must not rely on this property as the behavior of reserved values might change in a future revision of the architecture.

On Cold reset, the field reset value is architecturally UNKNOWN.

LBN, bits [19:16]

Linked breakpoint number. For Linked address matching breakpoints, this specifies the index of the Context-matching breakpoint linked to.

On Cold reset, the field reset value is architecturally UNKNOWN.

SSC, bits [15:14]

Security state control. Determines the security states under which a breakpoint debug event for breakpoint *n* is generated. This field must be interpreted along with the HMC and PMC fields.

On Cold reset, the field reset value is architecturally UNKNOWN.

HMC, bit [13]

Higher mode control. Determines the debug perspective for deciding when a breakpoint debug event for breakpoint *n* is generated. This field must be interpreted along with the SSC and PMC fields.

On Cold reset, the field reset value is architecturally UNKNOWN.

Bits [12:9]

Reserved, RES0.

BAS, bits [8:5]

Byte address select. Defines which half-words an address-matching breakpoint matches, regardless of the instruction set and execution state. In an AArch64-only implementation, this field is reserved, RES1. Otherwise:

- BAS[2] and BAS[0] are read/write.
- BAS[3] and BAS[1] are read-only copies of BAS[2] and BAS[0] respectively.

The values `0b0011` and `0b1100` are only supported if AArch32 is supported at any exception level.

The permitted values depend on the breakpoint type.

For Address match breakpoints in either AArch32 or AArch64 state:

BAS	Match instruction at	Constraint for debuggers
0b0011	DBGBVR<n>_EL1	Use for T32 and T32EE instructions.
0b1100	DBGBVR<n>_EL1+2	Use for T32 and T32EE instructions.
0b1111	DBGBVR<n>_EL1	Use for A64 and A32 instructions.

0b0000 is reserved and must behave as if the breakpoint is disabled or map to a permitted value.

For Address mismatch breakpoints in an AArch32 stage 1 translation regime:

BAS	Step instruction at	Constraint for debuggers
0b0000	-	Use for a match anywhere breakpoint.
0b0011	DBGBVR<n>_EL1	Use for stepping T32 and T32EE instructions.
0b1100	DBGBVR<n>_EL1+2	Use for stepping T32 and T32EE instructions.
0b1111	DBGBVR<n>_EL1	Use for stepping A32 instructions.

For Context matching breakpoints, this field is RES1 and ignored.

On Cold reset, the field reset value is architecturally UNKNOWN.

Bits [4:3]

Reserved, RES0.

PMC, bits [2:1]

Privilege mode control. Determines the exception level or levels at which a breakpoint debug event for breakpoint n is generated. This field must be interpreted along with the SSC and HMC fields.

On Cold reset, the field reset value is architecturally UNKNOWN.

E, bit [0]

Enable breakpoint [DBGBVR<n>_EL1](#). Possible values are:

- 0 Breakpoint disabled.
- 1 Breakpoint enabled.

On Cold reset, the field reset value is architecturally UNKNOWN.

Accessing the [DBGBCR<n>_EL1](#):

To access the [DBGBCR<n>_EL1](#):

MRS <Xt>, [DBGBCR<n>_EL1](#) ; Read [DBGBCR<n>_EL1](#) into Xt, where n is in the range 0 to 15
MSR [DBGBCR<n>_EL1](#), <Xt> ; Write Xt to [DBGBCR<n>_EL1](#), where n is in the range 0 to 15

Register access is encoded as follows:

op0	op1	CRn	CRm	op2
10	000	0000	n<3:0>	101

D8.3.3 DBGBVR<n>_EL1, Debug Breakpoint Value Registers, n = 0 - 15

The DBGBVR<n>_EL1 characteristics are:

Purpose

Holds a virtual address, or a VMID and/or a context ID, for use in breakpoint matching. Forms breakpoint n together with control register [DBGBCR<n>_EL1](#), where n is 0 to 15.

This register is part of the Debug registers functional group.

Usage constraints

This register is accessible as shown below:

EL0	EL1 (NS)	EL1 (S)	EL2	EL3 (SCR.NS=1)	EL3 (SCR.NS=0)
-	RW	RW	RW	RW	RW

Configurations

DBGBVR<n>_EL1[31:0] is architecturally mapped to AArch32 register [DBGBVR<n>](#).

DBGBVR<n>_EL1[63:32] is architecturally mapped to AArch32 register [DBGXVR<n>](#).

DBGBVR<n>_EL1 is architecturally mapped to external register [DBGBVR<n>_EL1](#).

Attributes

DBGBVR<n>_EL1 is a 64-bit register.

The DBGBVR<n>_EL1 bit assignments are:

When [DBGBCR<n>_EL1.BT==0b0x0x](#):

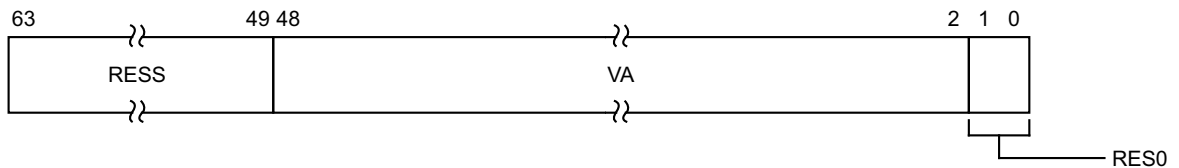

RESS, bits [63:49]

Reserved, Sign extended. Hardwired to the value of the sign bit, bit [48]. Hardware and software must treat this field as RES0 if bit[48] is 0, and as RES1 if bit[48] is 1.

VA, bits [48:2]

Bits[48:2] of the address value for comparison.

On Cold reset, the field reset value is architecturally UNKNOWN.

Bits [1:0]

Reserved, RES0.

When [DBGBCR<n>_EL1.BT==0b0x1x](#):

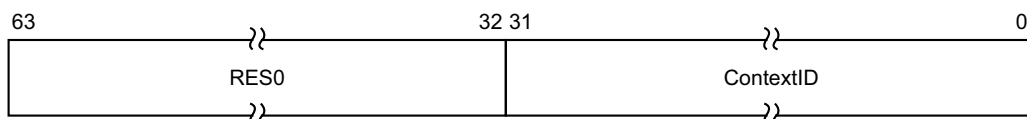

Bits [63:32]

Reserved, RES0.

ContextID, bits [31:0]

Context ID value for comparison.

On Cold reset, the field reset value is architecturally UNKNOWN.

When DBGBCR<n>_EL1.BT==0b1x0x and EL2 implemented:

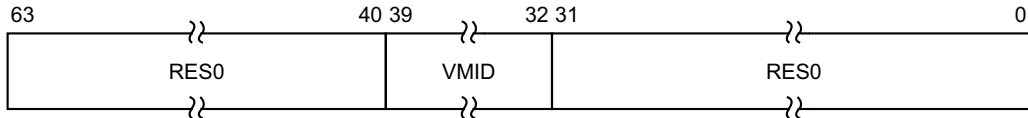

Bits [63:40]

Reserved, RES0.

VMID, bits [39:32]

VMID value for comparison.

On Cold reset, the field reset value is architecturally UNKNOWN.

Bits [31:0]

Reserved, RES0.

When DBGBCR<n>_EL1.BT==0x1x1x and EL2 implemented:

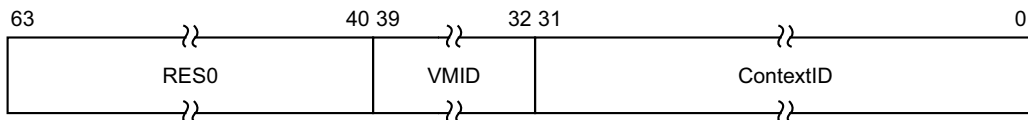

Bits [63:40]

Reserved, RES0.

VMID, bits [39:32]

VMID value for comparison.

On Cold reset, the field reset value is architecturally UNKNOWN.

ContextID, bits [31:0]

Context ID value for comparison.

On Cold reset, the field reset value is architecturally UNKNOWN.

Accessing the DBGBVR<n>_EL1:

To access the DBGBVR<n>_EL1:

MRS <Xt>, DBGBVR<n>_EL1 ; Read DBGBVR<n>_EL1 into Xt, where n is in the range 0 to 15
MSR DBGBVR<n>_EL1, <Xt> ; Write Xt to DBGBVR<n>_EL1, where n is in the range 0 to 15

Register access is encoded as follows:

op0	op1	CRn	CRm	op2
10	000	0000	n<3:0>	100

D8.3.4 DBGCLAIMCLR_EL1, Debug Claim Tag Clear register

The DBGCLAIMCLR_EL1 characteristics are:

Purpose

Used by software to read the values of the CLAIM bits, and to clear these bits to 0.
This register is part of the Debug registers functional group.

Usage constraints

This register is accessible as shown below:

EL0	EL1 (NS)	EL1 (S)	EL2	EL3 (SCR.NS=1)	EL3 (SCR.NS=0)
-	RW	RW	RW	RW	RW

Configurations

DBGCLAIMCLR_EL1 is architecturally mapped to AArch32 register [DBGCLAIMCLR](#).
DBGCLAIMCLR_EL1 is architecturally mapped to external register [DBGCLAIMCLR_EL1](#).

Attributes

DBGCLAIMCLR_EL1 is a 32-bit register.

The DBGCLAIMCLR_EL1 bit assignments are:

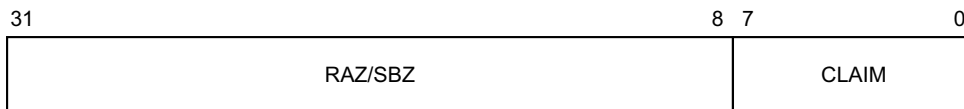

Bits [31:8]

Reserved, RAZ/SBZ. Software can rely on these bits reading as zero, and must use a should-be-zero policy on writes. Implementations must ignore writes.

CLAIM, bits [7:0]

Claim clear bits. Reading this field returns the current value of the CLAIM bits.
Writing a 1 to one of these bits clears the corresponding CLAIM bit to 0. This is an indirect write to the CLAIM bits.
A single write operation can clear multiple bits to 0. Writing 0 to one of these bits has no effect.
On Cold reset, the field resets to 0.

Accessing the DBGCLAIMCLR_EL1:

To access the DBGCLAIMCLR_EL1:

MRS <Xt>, DBGCLAIMCLR_EL1 ; Read DBGCLAIMCLR_EL1 into Xt
MSR DBGCLAIMCLR_EL1, <Xt> ; Write Xt to DBGCLAIMCLR_EL1

Register access is encoded as follows:

op0	op1	CRn	CRm	op2
10	000	0111	1001	110

D8.3.5 DBGCLAIMSET_EL1, Debug Claim Tag Set register

The DBGCLAIMSET_EL1 characteristics are:

Purpose

Used by software to set CLAIM bits to 1.

This register is part of the Debug registers functional group.

Usage constraints

This register is accessible as shown below:

EL0	EL1 (NS)	EL1 (S)	EL2	EL3 (SCR.NS=1)	EL3 (SCR.NS=0)
-	RW	RW	RW	RW	RW

Configurations

DBGCLAIMSET_EL1 is architecturally mapped to AArch32 register [DBGCLAIMSET](#).

DBGCLAIMSET_EL1 is architecturally mapped to external register [DBGCLAIMSET_EL1](#).

Attributes

DBGCLAIMSET_EL1 is a 32-bit register.

The DBGCLAIMSET_EL1 bit assignments are:

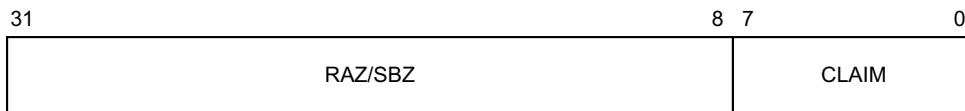

Bits [31:8]

Reserved, RAZ/SBZ. Software can rely on these bits reading as zero, and must use a should-be-zero policy on writes. Implementations must ignore writes.

CLAIM, bits [7:0]

Claim set bits. RAO.

Writing a 1 to one of these bits sets the corresponding CLAIM bit to 1. This is an indirect write to the CLAIM bits.

A single write operation can set multiple bits to 1. Writing 0 to one of these bits has no effect.

On Cold reset, the field resets to 0.

Accessing the DBGCLAIMSET_EL1:

To access the DBGCLAIMSET_EL1:

MRS <Xt>, DBGCLAIMSET_EL1 ; Read DBGCLAIMSET_EL1 into Xt
MSR DBGCLAIMSET_EL1, <Xt> ; Write Xt to DBGCLAIMSET_EL1

Register access is encoded as follows:

op0	op1	CRn	CRm	op2
10	000	0111	1000	110

D8.3.6 DBGDTR_EL0, Debug Data Transfer Register, half-duplex

The DBGDTR_EL0 characteristics are:

Purpose

Transfers 64 bits of data between the processor and an external host. Can transfer both ways using only a single register.

This register is part of the Debug registers functional group.

Usage constraints

This register is accessible as shown below:

EL0	EL1 (NS)	EL1 (S)	EL2	EL3 (SCR.NS=1)	EL3 (SCR.NS=0)
Config-RW	RW	RW	RW	RW	RW

This register can be accessed at EL0 when `MDSR_EL1.TDCC` is set to 0. When it is set to 1, EL0 access to this register is trapped to EL1.

If `EDSCR.ITE == 0` when the processor exits Debug state on receiving a Restart request trigger event, the behavior of any operation issued by a DTR access in memory access mode that has not completed execution is **CONSTRAINED UNPREDICTABLE**, and must do one of the following:

- It must complete execution in Debug state before the processor executes the restart sequence.
- It must complete execution in Non-debug state before the processor executes the restart sequence.
- It must be abandoned. This means that the instruction does not execute. Any registers or memory accessed by the instruction are left in an UNKNOWN state.

Configurations

There are no configuration notes.

Attributes

DBGDTR_EL0 is a 64-bit register.

The DBGDTR_EL0 bit assignments are:

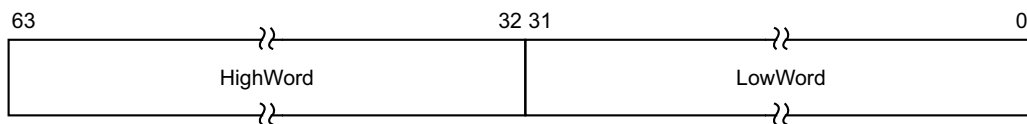

HighWord, bits [63:32]

Writes to this register set `DTRRX` to the value in this field. Reads from this register return the value of `DTRTX`.

LowWord, bits [31:0]

Writes to this register set `DTRTX` to the value in this field. Reads from this register return the value of `DTRRX`.

Accessing the DBGDTR_EL0:

To access the DBGDTR_EL0:

MRS <Xt>, DBGDTR_EL0 ; Read DBGDTR_EL0 into Xt
MSR DBGDTR_EL0, <Xt> ; Write Xt to DBGDTR_EL0

Register access is encoded as follows:

op0	op1	CRn	CRm	op2
10	011	0000	0100	000

D8.3.7 DBGDTRRX_EL0, Debug Data Transfer Register, Receive

The DBGDTRRX_EL0 characteristics are:

Purpose

Transfers 32 bits of data from an external host to the processor.
This register is part of the Debug registers functional group.

Usage constraints

This register is accessible as shown below:

EL0	EL1 (NS)	EL1 (S)	EL2	EL3 (SCR.NS=1)	EL3 (SCR.NS=0)
Config-RO	RO	RO	RO	RO	RO

This register can be read at EL0 when [MDSCR_EL1.TDCC](#) is set to 0. When it is set to 1, EL0 access to this register is trapped to EL1.

If [EDSCR.ITE](#) == 0 when the processor exits Debug state on receiving a Restart request trigger event, the behavior of any operation issued by a DTR access in memory access mode that has not completed execution is CONstrained UNPREDICTABLE, and must do one of the following:

- It must complete execution in Debug state before the processor executes the restart sequence.
- It must complete execution in Non-debug state before the processor executes the restart sequence.
- It must be abandoned. This means that the instruction does not execute. Any registers or memory accessed by the instruction are left in an UNKNOWN state.

Configurations

DBGDTRRX_EL0 is architecturally mapped to AArch32 register [DBGDTRRXint](#).

DBGDTRRX_EL0 is architecturally mapped to external register [DBGDTRRX_EL0](#).

Attributes

DBGDTRRX_EL0 is a 32-bit register.

The DBGDTRRX_EL0 bit assignments are:

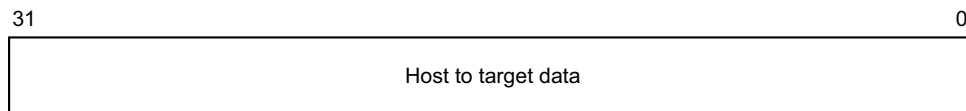

Bits [31:0]

Host to target data. One word of data for transfer from the debug host to the debug target.

For the full behavior of the Debug Communications Channel, see section 9 (The Debug Communications Channel and Instruction Transfer Register) in document PRD03-PRDC-010486.

On Cold reset, the field reset value is architecturally UNKNOWN.

Accessing the DBGDTRRX_EL0:

To access the DBGDTRRX_EL0:

MRS <Xt>, DBGDTRRX_EL0 ; Read DBGDTRRX_EL0 into Xt

Register access is encoded as follows:

op0	op1	CRn	CRm	op2
10	011	0000	0101	000

D8.3.8 DBGDTRTX_EL0, Debug Data Transfer Register, Transmit

The DBGDTRTX_EL0 characteristics are:

Purpose

Transfers 32 bits of data from the processor to an external host.
This register is part of the Debug registers functional group.

Usage constraints

This register is accessible as shown below:

EL0	EL1 (NS)	EL1 (S)	EL2	EL3 (SCR.NS=1)	EL3 (SCR.NS=0)
Config-WO	WO	WO	WO	WO	WO

This register can be written at EL0 when [MDSR_EL1.TDCC](#) is set to 0. When it is set to 1, EL0 access to this register is trapped to EL1.

If [EDSCR.ITE](#) == 0 when the processor exits Debug state on receiving a Restart request trigger event, the behavior of any operation issued by a DTR access in memory access mode that has not completed execution is **CONSTRAINED UNPREDICTABLE**, and must do one of the following:

- It must complete execution in Debug state before the processor executes the restart sequence.
- It must complete execution in Non-debug state before the processor executes the restart sequence.
- It must be abandoned. This means that the instruction does not execute. Any registers or memory accessed by the instruction are left in an UNKNOWN state.

Configurations

DBGDTRTX_EL0 is architecturally mapped to AArch32 register [DBGDTRTXint](#).

DBGDTRTX_EL0 is architecturally mapped to external register [DBGDTRTX_EL0](#).

Attributes

DBGDTRTX_EL0 is a 32-bit register.

The DBGDTRTX_EL0 bit assignments are:

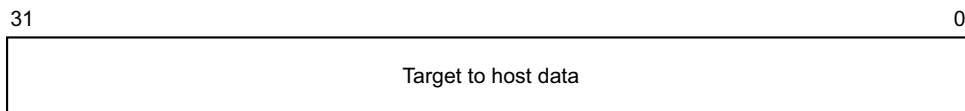

Bits [31:0]

Target to host data. One word of data for transfer from the debug target to the debug host.

For the full behavior of the Debug Communications Channel, see section 9 (The Debug Communications Channel and Instruction Transfer Register) in document PRD03-PRDC-010486.

On Cold reset, the field reset value is architecturally UNKNOWN.

Accessing the DBGDTRTX_EL0:

To access the DBGDTRTX_EL0:

MSR DBGDTRTX_EL0, <Xt> ; Write Xt to DBGDTRTX_EL0

Register access is encoded as follows:

op0	op1	CRn	CRm	op2
10	011	0000	0101	000

D8.3.9 DBGPRCR_EL1, Debug Power Control Register

The DBGPRCR_EL1 characteristics are:

Purpose

Controls behavior of processor on power-down request.
This register is part of the Debug registers functional group.

Usage constraints

This register is accessible as shown below:

EL0	EL1 (NS)	EL1 (S)	EL2	EL3 (SCR.NS=1)	EL3 (SCR.NS=0)
-	RW	RW	RW	RW	RW

Configurations

DBGPRCR_EL1 is architecturally mapped to AArch32 register [DBGPRCR](#).

Bit [0] of this register is mapped to [EDPRCR.CORENPDRQ](#), bit [0] of the external view of this register. The other bits in these registers are not mapped to each other.

Attributes

DBGPRCR_EL1 is a 32-bit register.

The DBGPRCR_EL1 bit assignments are:

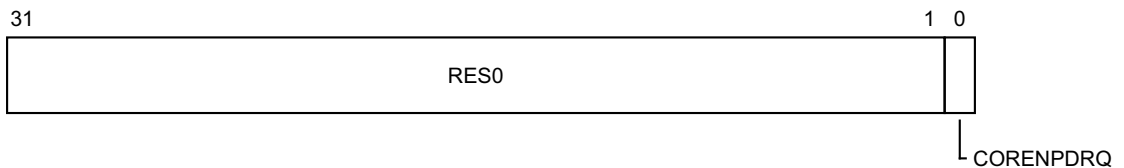

Bits [31:1]

Reserved, RES0.

CORENPDRQ, bit [0]

Core no powerdown request. Requests emulation of powerdown. Possible values of this bit are:

- 0 On a powerdown request, the system powers down the Core power domain.
- 1 On a powerdown request, the system emulates powerdown of the Core power domain. In this emulation mode the Core power domain is not actually powered down.

On Cold reset, the field resets to the value of [EDPRCR.COREPURQ](#).

Accessing the DBGPRCR_EL1:

To access the DBGPRCR_EL1:

MRS <Xt>, DBGPRCR_EL1 ; Read DBGPRCR_EL1 into Xt
MSR DBGPRCR_EL1, <Xt> ; Write Xt to DBGPRCR_EL1

Register access is encoded as follows:

op0	op1	CRn	CRm	op2
10	000	0001	0100	100

D8.3.10 DBGVCR32_EL2, Debug Vector Catch Register

The DBGVCR32_EL2 characteristics are:

Purpose

Allows access to the AArch32 register [DBGVCR](#) from AArch64 state only. Its value has no effect on execution in AArch64 state.

This register is part of the Debug registers functional group.

Usage constraints

This register is accessible as shown below:

EL0	EL1 (NS)	EL1 (S)	EL2	EL3 (SCR.NS=1)	EL3 (SCR.NS=0)
-	-	-	RW	RW	RW

Configurations

DBGVCR32_EL2 is architecturally mapped to AArch32 register [DBGVCR](#).

Attributes

DBGVCR32_EL2 is a 32-bit register.

The DBGVCR32_EL2 bit assignments are:

When EL3 implemented and using AArch64:

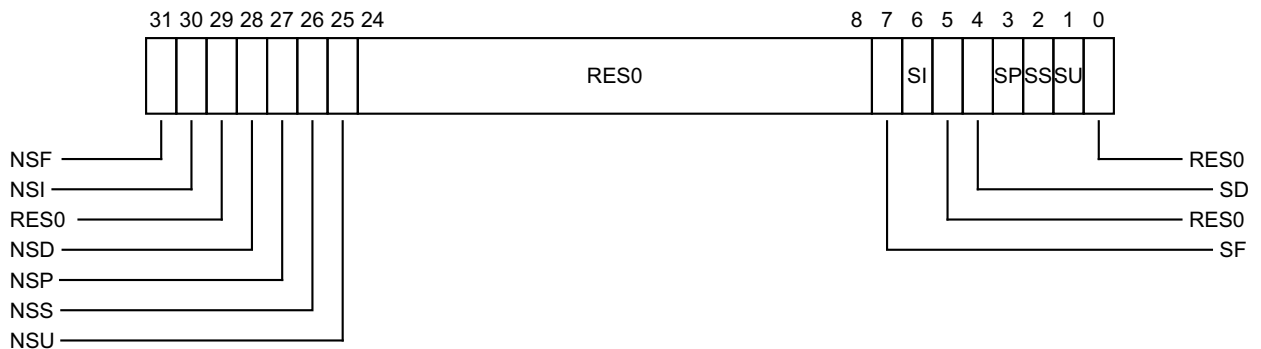

NSF, bit [31]

FIQ vector catch enable in Non-secure state.

The exception vector offset is 0x1C.

On Warm reset, the field reset value is architecturally UNKNOWN.

NSI, bit [30]

IRQ vector catch enable in Non-secure state.

The exception vector offset is 0x18.

On Warm reset, the field reset value is architecturally UNKNOWN.

Bit [29]

Reserved, RES0.

NSD, bit [28]

Data Abort vector catch enable in Non-secure state.

The exception vector offset is $0x10$.

On Warm reset, the field reset value is architecturally UNKNOWN.

NSP, bit [27]

Prefetch Abort vector catch enable in Non-secure state.

The exception vector offset is $0x0C$.

On Warm reset, the field reset value is architecturally UNKNOWN.

NSS, bit [26]

Supervisor Call (SVC) vector catch enable in Non-secure state.

The exception vector offset is $0x08$.

On Warm reset, the field reset value is architecturally UNKNOWN.

NSU, bit [25]

Undefined Instruction vector catch enable in Non-secure state.

The exception vector offset is $0x04$.

On Warm reset, the field reset value is architecturally UNKNOWN.

Bits [24:8]

Reserved, RES0.

SF, bit [7]

FIQ vector catch enable in Secure state.

The exception vector offset is $0x1C$.

On Warm reset, the field reset value is architecturally UNKNOWN.

SI, bit [6]

IRQ vector catch enable in Secure state.

The exception vector offset is $0x18$.

On Warm reset, the field reset value is architecturally UNKNOWN.

Bit [5]

Reserved, RES0.

SD, bit [4]

Data Abort vector catch enable in Secure state.

The exception vector offset is $0x10$.

On Warm reset, the field reset value is architecturally UNKNOWN.

SP, bit [3]

Prefetch Abort vector catch enable in Secure state.

The exception vector offset is $0x0C$.

On Warm reset, the field reset value is architecturally UNKNOWN.

SS, bit [2]

Supervisor Call (SVC) vector catch enable in Secure state.

The exception vector offset is $0x08$.

On Warm reset, the field reset value is architecturally UNKNOWN.

SU, bit [1]

Undefined Instruction vector catch enable in Secure state.

The exception vector offset is $0x04$.

On Warm reset, the field reset value is architecturally UNKNOWN.

Bit [0]

Reserved, RES0.

When EL3 not implemented:

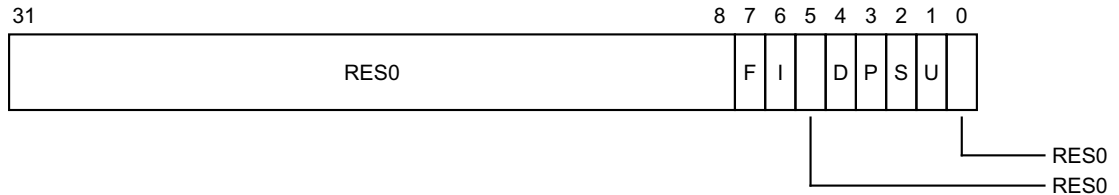

Bits [31:8]

Reserved, RES0.

F, bit [7]

FIQ vector catch enable.

The exception vector offset is $0x1C$.

On Warm reset, the field reset value is architecturally UNKNOWN.

I, bit [6]

IRQ vector catch enable.

The exception vector offset is $0x18$.

On Warm reset, the field reset value is architecturally UNKNOWN.

Bit [5]

Reserved, RES0.

D, bit [4]

Data Abort vector catch enable.

The exception vector offset is $0x10$.

On Warm reset, the field reset value is architecturally UNKNOWN.

P, bit [3]

Prefetch Abort vector catch enable.

The exception vector offset $0x0C$.

On Warm reset, the field reset value is architecturally UNKNOWN.

S, bit [2]

Supervisor Call (SVC) vector catch enable.

The exception vector offset is $0x08$.

On Warm reset, the field reset value is architecturally UNKNOWN.

U, bit [1]

Undefined Instruction vector catch enable.

The exception vector offset is $0x04$.

On Warm reset, the field reset value is architecturally UNKNOWN.

Bit [0]

Reserved, RES0.

Accessing the DBGVCR32_EL2:

To access the DBGVCR32_EL2:

MRS <Xt>, DBGVCR32_EL2 ; Read DBGVCR32_EL2 into Xt
MSR DBGVCR32_EL2, <Xt> ; Write Xt to DBGVCR32_EL2

Register access is encoded as follows:

op0	op1	CRn	CRm	op2
10	100	0000	0111	000

D8.3.11 DBGWCR<n>_EL1, Debug Watchpoint Control Registers, n = 0 - 15

The DBGWCR<n>_EL1 characteristics are:

Purpose

Holds control information for a watchpoint. Forms watchpoint n together with value register [DBGWVR<n>_EL1](#), where n is 0 to 15.

This register is part of the Debug registers functional group.

Usage constraints

This register is accessible as shown below:

ELO	EL1 (NS)	EL1 (S)	EL2	EL3 (SCR.NS=1)	EL3 (SCR.NS=0)
-	RW	RW	RW	RW	RW

When the E field is zero, all the other fields in the register are ignored.

Configurations

DBGWCR<n>_EL1 is architecturally mapped to AArch32 register [DBGWCR<n>](#).

DBGWCR<n>_EL1 is architecturally mapped to external register [DBGWCR<n>_EL1](#).

Attributes

DBGWCR<n>_EL1 is a 32-bit register.

The DBGWCR<n>_EL1 bit assignments are:

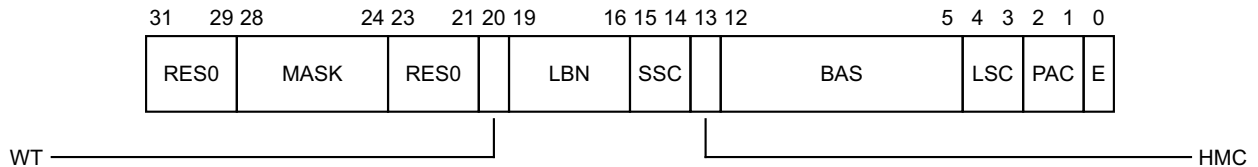

Bits [31:29]

Reserved, RES0.

MASK, bits [28:24]

Address mask. Only objects up to 2GB can be watched using a single mask.

00000 No mask.

00001 Reserved.

00010 Reserved.

Other values mask the corresponding number of address bits, from 0b00011 masking 3 address bits (0x00000007 mask for address) to 0b11111 masking 31 address bits (0x7FFFFFFF mask for address).

On Cold reset, the field reset value is architecturally UNKNOWN.

Bits [23:21]

Reserved, RES0.

WT, bit [20]

Watchpoint type. Possible values are:

0 Unlinked data address match.

1 Linked data address match.

On Cold reset, the field reset value is architecturally UNKNOWN.

LBN, bits [19:16]

Linked breakpoint number. For Linked data address watchpoints, this specifies the index of the Context-matching breakpoint linked to.

On Cold reset, the field reset value is architecturally UNKNOWN.

SSC, bits [15:14]

Security state control. Determines the security states under which a watchpoint debug event for watchpoint *n* is generated. This field must be interpreted along with the HMC and PAC fields.

On Cold reset, the field reset value is architecturally UNKNOWN.

HMC, bit [13]

Higher mode control. Determines the debug perspective for deciding when a watchpoint debug event for watchpoint *n* is generated. This field must be interpreted along with the SSC and PAC fields.

On Cold reset, the field reset value is architecturally UNKNOWN.

BAS, bits [12:5]

Byte address select. Each bit of this field selects whether a byte from within the word or double-word addressed by `DBGWVR<n>_EL1` is being watched.

BAS	Description
xxxxxxx1	Match byte at <code>DBGWVR<n>_EL1</code>
xxxxxx1x	Match byte at <code>DBGWVR<n>_EL1+1</code>
xxxxx1xx	Match byte at <code>DBGWVR<n>_EL1+2</code>
xxx1xxx	Match byte at <code>DBGWVR<n>_EL1+3</code>

In cases where `DBGWVR<n>_EL1` addresses a double-word:

BAS	Description, if <code>DBGWVR<n>_EL1[2] == 0</code>
xxx1xxxx	Match byte at <code>DBGWVR<n>_EL1+4</code>
xx1xxxxx	Match byte at <code>DBGWVR<n>_EL1+5</code>
x1xxxxxx	Match byte at <code>DBGWVR<n>_EL1+6</code>
1xxxxxxx	Match byte at <code>DBGWVR<n>_EL1+7</code>

If `DBGWVR<n>_EL1[2] == 1`, only `BAS[3:0]` is used. ARM deprecates setting `DBGWVR<n>_EL1 == 1`.

The valid values for BAS are `0b0000000`, or a binary number all of whose set bits are contiguous. All other values are reserved and must not be used by software.

If BAS is zero, no bytes are watched by this watchpoint.

Ignored if E is 0.

On Cold reset, the field reset value is architecturally UNKNOWN.

LSC, bits [4:3]

Load/store control. This field enables watchpoint matching on the type of access being made. Possible values of this field are:

01 Match instructions that load from a watchpointed address.

- 10 Match instructions that store to a watchpointed address.
- 11 Match instructions that load from or store to a watchpointed address.

All other values are reserved, but must behave as if the watchpoint is disabled. Software must not rely on this property as the behavior of reserved values might change in a future revision of the architecture.

Ignored if E is 0.

On Cold reset, the field reset value is architecturally UNKNOWN.

PAC, bits [2:1]

Privilege of access control. Determines the exception level or levels at which a watchpoint debug event for watchpoint n is generated. This field must be interpreted along with the SSC and HMC fields.

On Cold reset, the field reset value is architecturally UNKNOWN.

E, bit [0]

Enable watchpoint n. Possible values are:

- 0 Watchpoint disabled.
- 1 Watchpoint enabled.

On Cold reset, the field reset value is architecturally UNKNOWN.

Accessing the DBGWCR<n>_EL1:

To access the DBGWCR<n>_EL1:

MRS <Xt>, DBGWCR<n>_EL1 ; Read DBGWCR<n>_EL1 into Xt, where n is in the range 0 to 15
MSR DBGWCR<n>_EL1, <Xt> ; Write Xt to DBGWCR<n>_EL1, where n is in the range 0 to 15

Register access is encoded as follows:

op0	op1	CRn	CRm	op2
10	000	0000	n<3:0>	111

D8.3.12 DBGWVR<n>_EL1, Debug Watchpoint Value Registers, n = 0 - 15

The DBGWVR<n>_EL1 characteristics are:

Purpose

Holds a data address value for use in watchpoint matching. Forms watchpoint n together with control register [DBGWCR<n>_EL1](#), where n is 0 to 15.

This register is part of the Debug registers functional group.

Usage constraints

This register is accessible as shown below:

EL0	EL1 (NS)	EL1 (S)	EL2	EL3 (SCR.NS=1)	EL3 (SCR.NS=0)
-	RW	RW	RW	RW	RW

Configurations

DBGWVR<n>_EL1[31:0] is architecturally mapped to AArch32 register [DBGWVR<n>](#).

DBGWVR<n>_EL1 is architecturally mapped to external register [DBGWVR<n>_EL1](#).

Attributes

DBGWVR<n>_EL1 is a 64-bit register.

The DBGWVR<n>_EL1 bit assignments are:

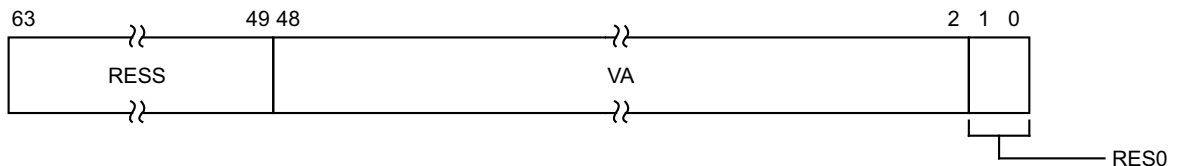

RESS, bits [63:49]

Reserved, Sign extended. Hardwired to the value of the sign bit, bit [48]. Hardware and software must treat this field as RES0 if bit[48] is 0, and as RES1 if bit[48] is 1.

VA, bits [48:2]

Bits[48:2] of the address value for comparison.

ARM deprecates setting [DBGWVR<n>_EL1\[2\] == 1](#).

On Cold reset, the field reset value is architecturally UNKNOWN.

Bits [1:0]

Reserved, RES0.

Accessing the DBGWVR<n>_EL1:

To access the [DBGWVR<n>_EL1](#):

MRS <Xt>, [DBGWVR<n>_EL1](#) ; Read [DBGWVR<n>_EL1](#) into Xt, where n is in the range 0 to 15
MSR [DBGWVR<n>_EL1](#), <Xt> ; Write Xt to [DBGWVR<n>_EL1](#), where n is in the range 0 to 15

Register access is encoded as follows:

op0	op1	CRn	CRm	op2
10	000	0000	n<3:0>	110

D8.3.13 DLR_EL0, Debug Link Register

The DLR_EL0 characteristics are:

Purpose

In Debug state, holds the address to restart from.

This register is part of:

- the Debug registers functional group
- the Special purpose registers functional group.

Usage constraints

This register is accessible as shown below:

EL0	EL1 (NS)	EL1 (S)	EL2	EL3 (SCR.NS=1)	EL3 (SCR.NS=0)
RW	RW	RW	RW	RW	RW

Access to this register is from Debug state only. During normal execution this register is UNALLOCATED.

Configurations

DLR_EL0[31:0] is architecturally mapped to AArch32 register [DLR](#).

Attributes

DLR_EL0 is a 64-bit register.

The DLR_EL0 bit assignments are:

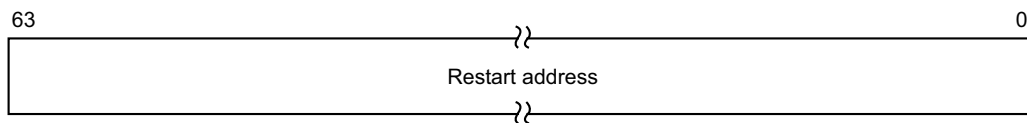

Bits [63:0]

Restart address.

Accessing the DLR_EL0:

To access the DLR_EL0:

MRS <Xt>, DLR_EL0 ; Read DLR_EL0 into Xt
MSR DLR_EL0, <Xt> ; Write Xt to DLR_EL0

Register access is encoded as follows:

op0	op1	CRn	CRm	op2
11	011	0100	0101	001

D8.3.14 DSPSR_EL0, Debug Saved Program Status Register

The DSPSR_EL0 characteristics are:

Purpose

Holds the saved processor state on entry to Debug state.

This register is part of:

- the Debug registers functional group
- the Special purpose registers functional group.

Usage constraints

This register is accessible as shown below:

EL0	EL1 (NS)	EL1 (S)	EL2	EL3 (SCR.NS=1)	EL3 (SCR.NS=0)
RW	RW	RW	RW	RW	RW

Access to this register is from Debug state only. During normal execution this register is UNALLOCATED.

Configurations

DSPSR_EL0 is architecturally mapped to AArch32 register [DSPSR](#).

Attributes

DSPSR_EL0 is a 32-bit register.

The DSPSR_EL0 bit assignments are:

When entering Debug state from AArch32:

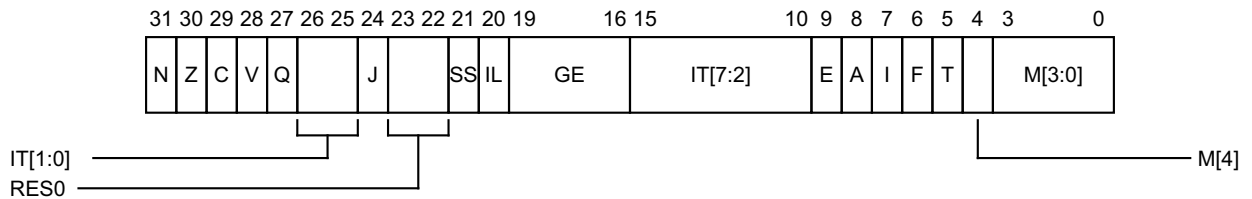

N, bit [31]

Set to the value of [CPSR.N](#) on entering Debug state, and copied to [CPSR.N](#) on exiting Debug state.

Z, bit [30]

Set to the value of [CPSR.Z](#) on entering Debug state, and copied to [CPSR.Z](#) on exiting Debug state.

C, bit [29]

Set to the value of [CPSR.C](#) on entering Debug state, and copied to [CPSR.C](#) on exiting Debug state.

V, bit [28]

Set to the value of [CPSR.V](#) on entering Debug state, and copied to [CPSR.V](#) on exiting Debug state.

Q, bit [27]

Cumulative saturation bit. Set to 1 to indicate that overflow or saturation occurred in some instructions.

IT[1:0], bits [26:25]

If-Then execution state bits for the T32 IT (If-Then) instruction. See IT[7:2] for explanation of this field.

J, bit [24]

Jazelle bit. Along with the T bit, determines the AArch32 instruction set state that the Debug state entry was taken from. Possible values of this bit are:

- | | |
|---|---|
| 0 | Processor in A32 state if T is 0, or T32 state if T is 1. |
| 1 | Processor in an invalid state (Jazelle state before ARMv8) if T is 0, or T32EE state if T is 1. |

Since the Jazelle state is obsolete in ARMv8, J==1 and T==0 is an invalid combination, and attempting to exit Debug state with those values is an illegal exception return.

If T32EE is not implemented, this bit is RES0, so the possible values of the T bit signify either A32 or T32 state.

Bits [23:22]

Reserved, RES0.

SS, bit [21]

Software step. Indicates whether software step was enabled when Debug state was entered.

IL, bit [20]

Illegal Execution State bit. Shows the value of PSTATE.IL immediately before Debug state was entered.

GE, bits [19:16]

Greater than or Equal flags, for parallel addition and subtraction.

IT[7:2], bits [15:10]

If-Then execution state bits for the T32 IT (If-Then) instruction. This field must be interpreted in two parts.

- IT[7:5] holds the base condition for the IT block. The base condition is the top 3 bits of the condition code specified by the first condition field of the IT instruction.
- IT[4:0] encodes the size of the IT block, which is the number of instructions that are to be conditionally executed, by the position of the least significant 1 in this field. It also encodes the value of the least significant bit of the condition code for each instruction in the block.

The IT field is 0b00000000 when no IT block is active.

E, bit [9]

Endianness execution state bit. Controls the load and store endianness for data accesses:

- | | |
|---|-------------------------|
| 0 | Little-endian operation |
| 1 | Big-endian operation. |

Instruction fetches ignore this bit.

When the reset value of the SCTL.R.EE bit is defined by a configuration input signal, that value also applies to the CPSR.E bit on reset, and therefore applies to software execution from reset.

If an implementation does not provide Big-endian support, this bit is RES0. If it does not provide Little-endian support, this bit is RES1.

If an implementation provides Big-endian support but only at EL0, this bit is RES0 for an exception return to any exception level other than EL0.

Likewise, if it provides Little-endian support only at EL0, this bit is RES1 for an exception return to any exception level other than EL0.

A, bit [8]

Asynchronous data abort mask bit. The possible values of this bit are:

- 0 Exception not masked.
- 1 Exception masked.

I, bit [7]

IRQ mask bit. The possible values of this bit are:

- 0 Exception not masked.
- 1 Exception masked.

F, bit [6]

FIQ mask bit. The possible values of this bit are:

- 0 Exception not masked.
- 1 Exception masked.

T, bit [5]

Thumb execution state bit. Along with the J bit, determines the AArch32 instruction set state that the Debug state entry was taken from. Possible values of this bit are:

- 0 Processor in A32 state if J is 0, or an invalid state (Jazelle state before ARMv8) if J is 1.
- 1 Processor in T32 state if J is 0, or T32EE state if J is 1.

Since the Jazelle state is obsolete in ARMv8, J==1 and T==0 is an invalid combination, and attempting to exit Debug state with those values is an illegal exception return.

If T32EE is not implemented, the J bit is RES0, so the possible values of this bit signify either A32 or T32 state.

M[4], bit [4]

Register width that the exception was taken from. Possible values of this bit are:

- 1 Exception taken from AArch32.

M[3:0], bits [3:0]

Mode that an exception was taken from. For exceptions taken from AArch32, the possible values are:

M[3:0]	Mode
0b0000	User
0b0001	FIQ
0b0010	IRQ
0b0011	Supervisor
0b0110	Monitor
0b0111	Abort
0b1010	Hyp
0b1011	Undefined
0b1111	System

Other values are reserved.

When entering Debug state from AArch64:

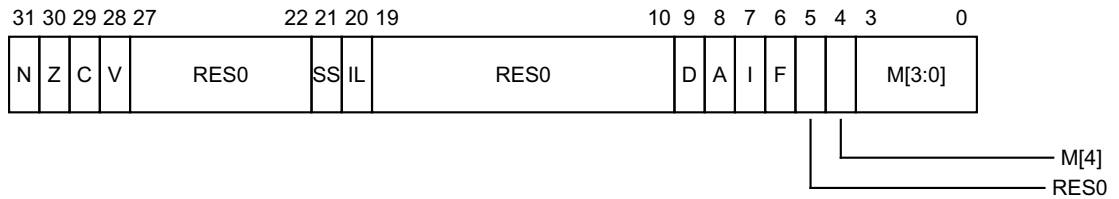

N, bit [31]

Set to the value of the N condition flag on entering Debug state, and copied to the N condition flag on exiting Debug state.

Z, bit [30]

Set to the value of the Z condition flag on entering Debug state, and copied to the Z condition flag on exiting Debug state.

C, bit [29]

Set to the value of the C condition flag on entering Debug state, and copied to the C condition flag on exiting Debug state.

V, bit [28]

Set to the value of the V condition flag on entering Debug state, and copied to the V condition flag on exiting Debug state.

Bits [27:22]

Reserved, RES0.

SS, bit [21]

Software step. Indicates whether software step was enabled when Debug state was entered.

IL, bit [20]

Illegal Execution State bit. Shows the value of PSTATE.IL immediately before Debug state was entered.

Bits [19:10]

Reserved, RES0.

D, bit [9]

Process state D mask. The possible values of this bit are:

- 0 Debug exceptions from Watchpoint, Breakpoint, and Software step debug events targeted at the current exception level are not masked.
- 1 Debug exceptions from Watchpoint, Breakpoint, and Software step debug events targeted at the current exception level are masked.

When the target exception level of the debug exception is not than the current exception level, the exception is not masked by this bit.

A, bit [8]

SError (System Error) mask bit. The possible values of this bit are:

- 0 Exception not masked.
- 1 Exception masked.

I, bit [7]

IRQ mask bit. The possible values of this bit are:

- 0 Exception not masked.
- 1 Exception masked.

F, bit [6]

FIQ mask bit. The possible values of this bit are:

- 0 Exception not masked.
- 1 Exception masked.

Bit [5]

Reserved, RES0.

M[4], bit [4]

Register width that the exception was taken from. Possible values of this bit are:

- 0 Exception taken from AArch64.

M[3:0], bits [3:0]

Mode that an exception was taken from. For exceptions taken from AArch64, the possible values are:

M[3:0]	Mode
0b0000	EL0t
0b0100	EL1t
0b0101	EL1h
0b1000	EL2t
0b1001	EL2h
0b1100	EL3t
0b1101	EL3h

Other values are reserved.

For exceptions from AArch64:

- M[3:2] holds the Exception Level.
- M[1] is unused, and returning to an exception level that is using AArch64 with this bit set is treated as an illegal exception return.
- M[0] is used to select the SP:
 - 0 means the SP is always SP0.
 - 1 means the exception SP is determined by the EL.

Accessing the DSPSR_EL0:

To access the DSPSR_EL0:

MRS <Xt>, DSPSR_EL0 ; Read DSPSR_EL0 into Xt
MSR DSPSR_EL0, <Xt> ; Write Xt to DSPSR_EL0

Register access is encoded as follows:

op0	op1	CRn	CRm	op2
11	011	0100	0101	000

D8.3.15 MDCCINT_EL1, Monitor DCC Interrupt Enable Register

The MDCCINT_EL1 characteristics are:

Purpose

Enables interrupt requests to be signaled based on the DCC status flags.
This register is part of the Debug registers functional group.

Usage constraints

This register is accessible as shown below:

EL0	EL1 (NS)	EL1 (S)	EL2	EL3 (SCR.NS=1)	EL3 (SCR.NS=0)
-	RW	RW	RW	RW	RW

Configurations

MDCCINT_EL1 is architecturally mapped to AArch32 register [DBGDCCINT](#).

Attributes

MDCCINT_EL1 is a 32-bit register.

The MDCCINT_EL1 bit assignments are:

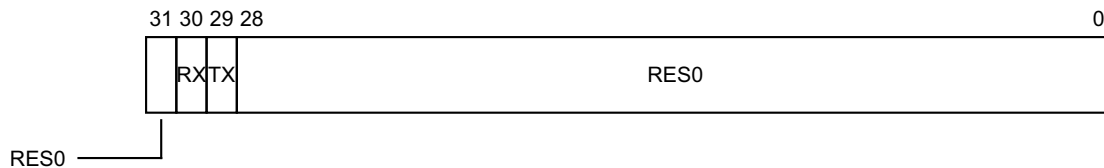

Bit [31]

Reserved, RES0.

RX, bit [30]

DCC interrupt request enable control for DTRRX. Enables a common COMMIRQ interrupt request to be signaled based on the DCC status flags.

0 No interrupt request generated by DTRRX.

1 Interrupt request will be generated on RXfull == 1.

If legacy COMMRX and COMMTX signals are implemented, then these are not affected by the value of this bit.

On Warm reset, the field resets to 0.

TX, bit [29]

DCC interrupt request enable control for DTRTX. Enables a common COMMIRQ interrupt request to be signaled based on the DCC status flags.

0 No interrupt request generated by DTRTX.

1 Interrupt request will be generated on TXfull == 0.

If legacy COMMRX and COMMTX signals are implemented, then these are not affected by the value of this bit.

On Warm reset, the field resets to 0.

Bits [28:0]

Reserved, RES0.

Accessing the MDCCINT_EL1:

To access the MDCCINT_EL1:

MRS <Xt>, MDCCINT_EL1 ; Read MDCCINT_EL1 into Xt
MSR MDCCINT_EL1, <Xt> ; Write Xt to MDCCINT_EL1

Register access is encoded as follows:

op0	op1	CRn	CRm	op2
10	000	0000	0010	000

D8.3.16 MDCCSR_EL0, Monitor DCC Status Register

The MDCCSR_EL0 characteristics are:

Purpose

Main control register for the debug implementation, containing flow-control flags for the DCC. This is an internal, read-only view.

This register is part of the Debug registers functional group.

Usage constraints

This register is accessible as shown below:

EL0	EL1 (NS)	EL1 (S)	EL2	EL3 (SCR.NS=1)	EL3 (SCR.NS=0)
Config-RO	RO	RO	RO	RO	RO

This register can be read at EL0 when [MDSCR_EL1.TDCC](#) is set to 0. When it is set to 1, EL0 access to this register is trapped to EL1.

Configurations

MDCCSR_EL0 is architecturally mapped to AArch32 register [DBGDSCRint](#).

Attributes

MDCCSR_EL0 is a 32-bit register.

The MDCCSR_EL0 bit assignments are:

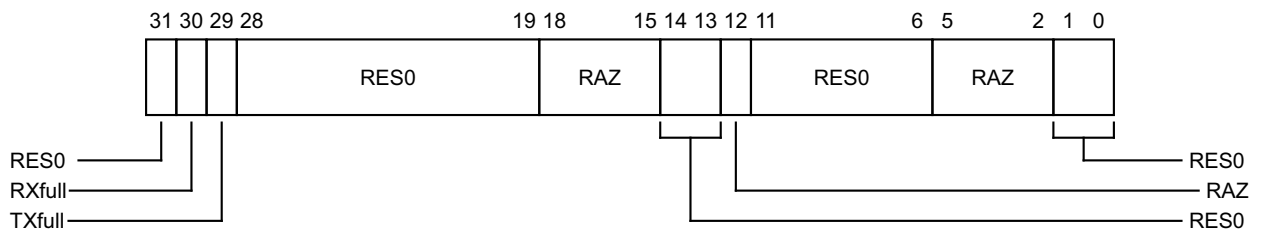

Bit [31]

Reserved, RES0.

RXfull, bit [30]

DTRRX full. Read-only view of the equivalent bit in the [EDSCR](#).

TXfull, bit [29]

DTRTX full. Read-only view of the equivalent bit in the [EDSCR](#).

Bits [28:19]

Reserved, RES0.

Bits [18:15]

Reserved, RAZ. Hardware must implement this field as RAZ. Software must not rely on this field being RAZ.

Bits [14:13]

Reserved, RES0.

Bit [12]

Reserved, RAZ. Hardware must implement this field as RAZ. Software must not rely on this field being RAZ.

Bits [11:6]

Reserved, RES0.

Bits [5:2]

Reserved, RAZ. Hardware must implement this field as RAZ. Software must not rely on this field being RAZ.

Bits [1:0]

Reserved, RES0.

Accessing the MDCCSR_EL0:

To access the MDCCSR_EL0:

MRS <Xt>, MDCCSR_EL0 ; Read MDCCSR_EL0 into Xt

Register access is encoded as follows:

op0	op1	CRn	CRm	op2
10	011	0000	0001	000

D8.3.17 MDCR_EL2, Monitor Debug Configuration Register (EL2)

The MDCR_EL2 characteristics are:

Purpose

Provides configuration options for the Virtualization extensions to self-hosted debug and the Performance Monitors extension.

This register is part of:

- the Debug registers functional group
- the Virtualization registers functional group.

Usage constraints

This register is accessible as shown below:

EL0	EL1 (NS)	EL1 (S)	EL2	EL3 (SCR.NS=1)	EL3 (SCR.NS=0)
-	-	-	RW	RW	RW

Configurations

MDCR_EL2 is architecturally mapped to AArch32 register [HDCR](#).

If EL2 is not implemented, this register is RES0 from EL3.

Attributes

MDCR_EL2 is a 32-bit register.

The MDCR_EL2 bit assignments are:

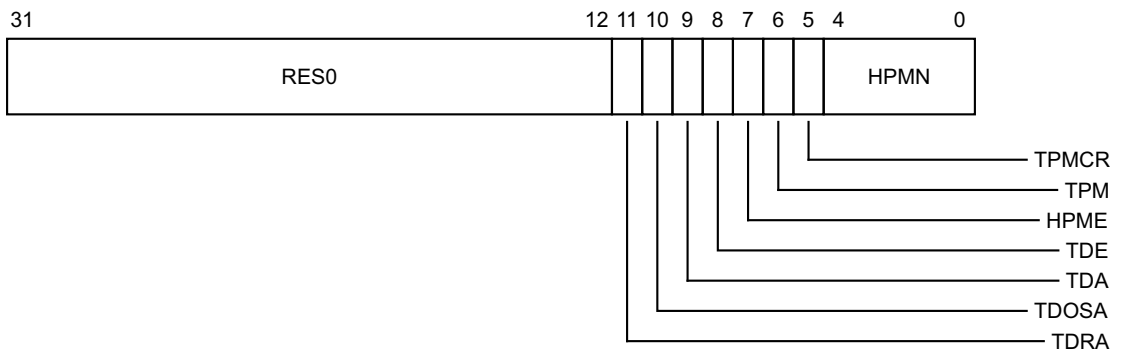

Bits [31:12]

Reserved, RES0.

TDRA, bit [11]

Trap debug ROM address register access. The possible values of this bit are:

- 0 Has no effect on accesses to debug ROM address registers from EL1 and EL0.
- 1 Trap valid EL1 and EL0 access to debug ROM address registers to EL2.

When this bit is set to 1, any access to the following registers from EL1 or EL0 is trapped to EL2:

AArch32: [DBGDRAR](#), [DBGDSAR](#).

AArch64: [MDRAR_EL1](#).

If [HCR_EL2.TGE](#) == 1 or [MDCR_EL2.TDE](#) == 1, then this bit is ignored and treated as though it is 1 other than for the value read back from MDCR_EL2.

On Warm reset, the field reset value is architecturally UNKNOWN.

TDOSA, bit [10]

Trap debug OS-related register access. The possible values of this bit are:

- 0 Has no effect on accesses to OS-related debug registers.
- 1 Trap valid accesses to OS-related debug registers to EL2.

When this bit is set to 1, any access to the following registers from EL1 or EL0 is trapped to EL2:

AArch32: [DBGOSLAR](#), [DBGOSLSR](#), [DBGOSDLR](#), [DBGPRCR](#).

AArch64: [OSLAR_EL1](#), [OSLSR_EL1](#), [OSDLR_EL1](#), [DBGPRCR_EL1](#).

If [HCR_EL2.TGE](#) == 1 or [MDCR_EL2.TDE](#) == 1, then this bit is ignored and treated as though it is 1 other than for the value read back from [MDCR_EL2](#).

On Warm reset, the field reset value is architecturally UNKNOWN.

TDA, bit [9]

Trap debug access. The possible values of this bit are:

- 0 Has no effect on accesses to Debug registers.
- 1 Trap valid Non-secure accesses to Debug registers to EL2.

When this bit is set to 1, any valid Non-secure access to the debug registers from EL1 or EL0, other than the registers trapped by the TDRA and TDOSA bits, is trapped to EL2.

If [HCR_EL2.TGE](#) == 1 or [MDCR_EL2.TDE](#) == 1, then this bit is ignored and treated as though it is 1 other than for the value read back from [MDCR_EL2](#).

On Warm reset, the field reset value is architecturally UNKNOWN.

TDE, bit [8]

Route Software debug exceptions from Non-secure EL1 and EL0 to EL2. Also enables traps on all debug register accesses to EL2.

If [HCR_EL2.TGE](#) == 1, then this bit is ignored and treated as though it is 1 other than for the value read back from [MDCR_EL2](#).

On Warm reset, the field reset value is architecturally UNKNOWN.

HPME, bit [7]

Hypervisor Performance Monitors Enable. The possible values of this bit are:

- 0 EL2 Performance Monitors disabled.
- 1 EL2 Performance Monitors enabled.

When this bit is set to 1, the Performance Monitors counters that are reserved for use from EL2 or Secure state are enabled. For more information see the description of the HPMN field.

If the Performance Monitors extension is not implemented, this field is RES0.

On Warm reset, the field reset value is architecturally UNKNOWN.

TPM, bit [6]

Trap Performance Monitors accesses. The possible values of this bit are:

- 0 Has no effect on Performance Monitors accesses.
- 1 Trap Non-secure EL0 and EL1 accesses to Performance Monitors registers that are not UNALLOCATED to EL2.

If the Performance Monitors extension is not implemented, this field is RES0.

On Warm reset, the field reset value is architecturally UNKNOWN.

TPMCR, bit [5]

Trap [PMCR_EL0](#) accesses. The possible values of this bit are:

- 0 Has no effect on [PMCR_EL0](#) accesses.
- 1 Trap Non-secure EL0 and EL1 accesses to [PMCR_EL0](#) to EL2.

If the Performance Monitors extension is not implemented, this field is RES0.

On Warm reset, the field reset value is architecturally UNKNOWN.

HPMN, bits [4:0]

Defines the number of Performance Monitors counters that are accessible from Non-secure EL0 and EL1 modes.

If the Performance Monitors extension is not implemented, this field is RES0.

In Non-secure state, HPMN divides the Performance Monitors counters as follows. For counter *n* in Non-secure state:

- If *n* is in the range $0 \leq n < \text{HPMN}$, the counter is accessible from EL1 and EL2, and from EL0 if permitted by `PMUSERENR_EL0.PMCR_EL0.E` enables the operation of counters in this range.
- If *n* is in the range $\text{HPMN} \leq n < \text{PMCR_EL0.N}$, the counter is accessible only from EL2. `MDCR_EL2.HPME` enables the operation of counters in this range.

If this field is set to 0, or to a value larger than `PMCR_EL0.N`, then the behavior in Non-secure EL0 and EL1 is CONSTRAINED UNPREDICTABLE, and one of the following must happen:

- The number of counters accessible is an UNKNOWN non-zero value less than `PMCR_EL0.N`.
- There is no access to any counters.

For reads of `MDCR_EL2.HPMN` by EL2 or higher, if this field is set to 0 or to a value larger than `PMCR_EL0.N`, the processor must return a CONSTRAINED UNPREDICTABLE value being one of:

- `PMCR_EL0.N`.
- The value that was written to `MDCR_EL2.HPMN`.
- (The value that was written to `MDCR_EL2.HPMN`) modulo 2^h , where *h* is the smallest number of bits required for a value in the range 0 to `PMCR_EL0.N`.

On Warm reset, the field resets to the value of `PMCR_EL0.N`.

Accessing the MDCR_EL2:

To access the `MDCR_EL2`:

MRS <Xt>, MDCR_EL2 ; Read MDCR_EL2 into Xt
MSR MDCR_EL2, <Xt> ; Write Xt to MDCR_EL2

Register access is encoded as follows:

op0	op1	CRn	CRm	op2
11	100	0001	0001	001

D8.3.18 MDCR_EL3, Monitor Debug Configuration Register (EL3)

The MDCR_EL3 characteristics are:

Purpose

Provides configuration options for the Security extensions to self-hosted debug.

This register is part of:

- the Debug registers functional group
- the Security registers functional group.

Usage constraints

This register is accessible as shown below:

EL0	EL1 (NS)	EL1 (S)	EL2	EL3 (SCR.NS=1)	EL3 (SCR.NS=0)
-	-	-	-	RW	RW

Configurations

MDCR_EL3 can be mapped to AArch32 register [SDCR](#), but this is not architecturally mandated.

Attributes

MDCR_EL3 is a 32-bit register.

The MDCR_EL3 bit assignments are:

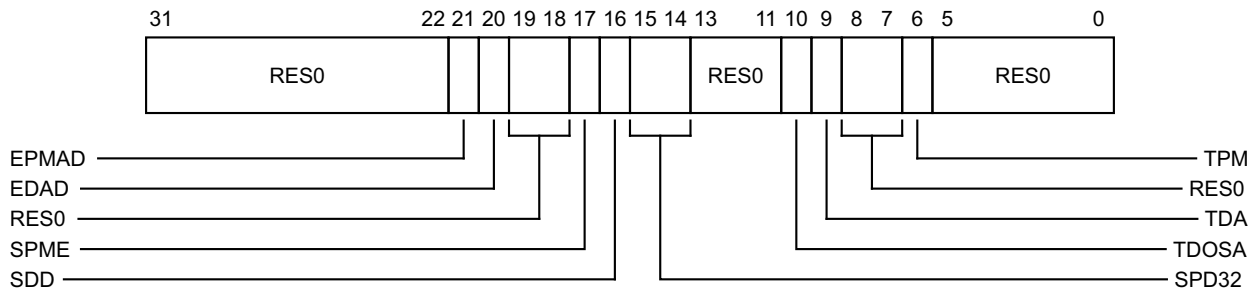

Bits [31:22]

Reserved, RES0.

EPMAD, bit [21]

External debugger access to Performance Monitors registers disabled. This disables access to these registers by an external debugger:

- 0 Access to Performance Monitors registers from external debugger is permitted.
- 1 Access to Performance Monitors registers from external debugger is disabled, unless overridden by authentication interface.

On Warm reset, the field resets to 0.

EDAD, bit [20]

External debugger access to breakpoint and watchpoint registers disabled. This disables access to these registers by an external debugger:

- 0 Access to breakpoint and watchpoint registers from external debugger is permitted.
- 1 Access to breakpoint and watchpoint registers from external debugger is disabled, unless overridden by authentication interface.

On Warm reset, the field resets to 0.

Bits [19:18]

Reserved, RES0.

SPME, bit [17]

Secure performance monitors enable. This allows event counting in Secure state:

- 0 Event counting prohibited in Secure state, unless overridden by the authentication interface.
- 1 Event counting allowed in Secure state.

On Warm reset, the field resets to 0.

SDD, bit [16]

AArch64 secure self-hosted invasive debug disable. Disables Software debug exceptions in Secure state, other than Software breakpoint instruction.

- 0 Taking Software debug events as debug exceptions is permitted from Secure EL0 and EL1, if enabled by the relevant [MDSCR_EL1](#) and [PSTATE.D](#) flags.
- 1 Software debug events, other than software breakpoint instruction debug events, are disabled from all exception levels in Secure state.

SDD only applies when both of the following are true:

- The processor is executing in Secure state.
- Secure EL1 is using AArch64.

On Warm reset, the field reset value is architecturally UNKNOWN.

SPD32, bits [15:14]

AArch32 secure self-hosted privileged invasive debug. Enables or disables debug exceptions from Secure state if Secure EL1 is using AArch32, other than Software breakpoint instructions. Valid values for this field are:

- 00 Legacy mode. Debug exceptions from Secure EL1 are enabled by the authentication interface.
- 10 Secure privileged debug disabled. Debug exceptions from Secure EL1 are disabled.
- 11 Secure privileged debug enabled. Debug exceptions from Secure EL1 are enabled.

Other values are reserved.

If Secure EL1 is using AArch32 then:

- If debug exceptions from Secure EL1 are enabled, then debug exceptions from Secure EL0 are also enabled.
- Otherwise, debug exceptions from Secure EL0 are enabled only if [SDER32_EL3.SUIDEN](#) == 1.

Ignored if Secure EL1 is using AArch64 and in Non-secure state. Debug exceptions from Software breakpoint instruction debug events are always enabled.

On Warm reset, the field reset value is architecturally UNKNOWN.

Bits [13:11]

Reserved, RES0.

TDOSA, bit [10]

Trap debug OS-related register access. The possible values of this bit are:

- 0 Has no effect on accesses to OS-related debug registers.
- 1 Trap valid accesses to OS-related debug registers to EL3.

When this bit is set to 1, any access to the following registers from EL2 or below is trapped to EL3:

AArch32: [DBGOSLAR](#), [DBGOSLSR](#), [DBGOSDLR](#), [DBGPRCR](#).

AArch64: [OSLAR_EL1](#), [OSLSR_EL1](#), [OSDLR_EL1](#), [DBGPRCR_EL1](#).

On Warm reset, the field reset value is architecturally UNKNOWN.

TDA, bit [9]

Trap debug access. The possible values of this bit are:

- 0 Has no effect on accesses to Debug registers.
- 1 Trap valid Non-secure accesses to Debug registers to EL3.

When this bit is set to 1, any valid Non-secure access to the debug registers from EL2 or below, other than the registers trapped by the TDRA and TDOSA bits, is trapped to EL3.

On Warm reset, the field reset value is architecturally UNKNOWN.

Bits [8:7]

Reserved, RES0.

TPM, bit [6]

Trap Performance Monitors accesses. The possible values of this bit are:

- 0 Has no effect on Performance Monitors accesses.
- 1 Trap Non-secure EL0, EL1 and EL2 accesses to Performance Monitors registers that are not UNALLOCATED, or trapped to a lower exception level, to EL3.

If the Performance Monitors extension is not implemented, this field is RES0.

On Warm reset, the field reset value is architecturally UNKNOWN.

Bits [5:0]

Reserved, RES0.

Accessing the MDCR_EL3:

To access the MDCR_EL3:

MRS <Xt>, MDCR_EL3 ; Read MDCR_EL3 into Xt
MSR MDCR_EL3, <Xt> ; Write Xt to MDCR_EL3

Register access is encoded as follows:

op0	op1	CRn	CRm	op2
11	110	0001	0011	001

D8.3.19 MDRAR_EL1, Monitor Debug ROM Address Register

The MDRAR_EL1 characteristics are:

Purpose

Defines the base physical address of a 4KB-aligned memory-mapped debug component, usually a ROM table that locates and describes the memory-mapped debug components in the system.

This register is part of the Debug registers functional group.

Usage constraints

This register is accessible as shown below:

EL0	EL1 (NS)	EL1 (S)	EL2	EL3 (SCR.NS=1)	EL3 (SCR.NS=0)
-	RO	RO	RO	RO	RO

Configurations

MDRAR_EL1 is architecturally mapped to AArch32 register [DBGDRAR](#).

Attributes

MDRAR_EL1 is a 64-bit register.

The MDRAR_EL1 bit assignments are:

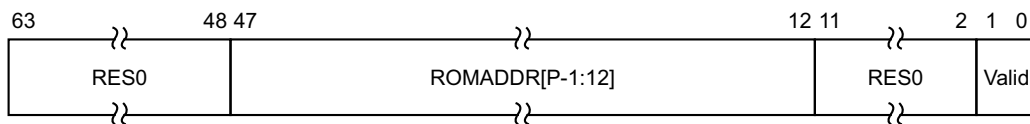

Bits [63:48]

Reserved, RES0.

ROMADDR[P-1:12], bits [47:12]

Bits[P-1:12] of the ROM table physical address, where P is the physical address size in bits (up to 48 bits) as stored in [ID_AA64MMFR0_EL1](#). If P is less than 48, bits[47:P] of this register are RES0.

Bits [11:0] of the ROM table physical address are zero.

If EL3 is implemented, ROMADDR is an address in Non-secure memory. Whether the ROM table is also accessible in Secure memory is IMPLEMENTATION DEFINED.

Bits [11:2]

Reserved, RES0.

Valid, bits [1:0]

This field indicates whether the ROM Table address is valid. The permitted values of this field are:

00 ROM Table address is not valid

11 ROM Table address is valid.

Other values are reserved.

Accessing the MDRAR_EL1:

To access the MDRAR_EL1:

MRS <Xt>, MDRAR_EL1 ; Read MDRAR_EL1 into Xt

Register access is encoded as follows:

op0	op1	CRn	CRm	op2
10	000	0001	0000	000

D8.3.20 MDSCR_EL1, Monitor Debug System Control Register

The MDSCR_EL1 characteristics are:

Purpose

Main control register for the debug implementation.
This register is part of the Debug registers functional group.

Usage constraints

This register is accessible as shown below:

EL0	EL1 (NS)	EL1 (S)	EL2	EL3 (SCR.NS=1)	EL3 (SCR.NS=0)
-	RW	RW	RW	RW	RW

Configurations

MDSCR_EL1 is architecturally mapped to AArch32 register [DBGDSCRExt](#).

Attributes

MDSCR_EL1 is a 32-bit register.

The MDSCR_EL1 bit assignments are:

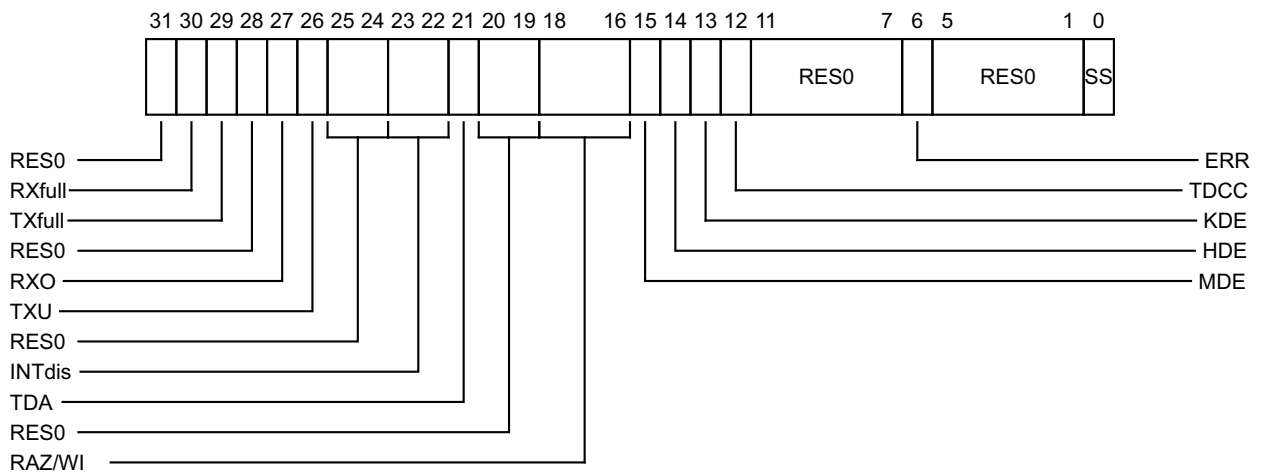

Bit [31]

Reserved, RES0.

RXfull, bit [30]

Used for save/restore of [EDSCR.RXfull](#).

When [OSLSR_EL1.OSLK](#) == 0 (the OS lock is unlocked), this bit is RO, and software must treat it as UNK/SBZP.

When [OSLSR_EL1.OSLK](#) == 1 (the OS lock is locked), this bit is RW.

TXfull, bit [29]

Used for save/restore of [EDSCR.TXfull](#).

When [OSLSR_EL1.OSLK](#) == 0 (the OS lock is unlocked), this bit is RO, and software must treat it as UNK/SBZP.

When [OSLSR_EL1.OSLK](#) == 1 (the OS lock is locked), this bit is RW.

Bit [28]

Reserved, RES0.

RXO, bit [27]

Used for save/restore of [EDSCR.RXO](#).

When [OSLSR_EL1.OSLK](#) == 0 (the OS lock is unlocked), this bit is RO. Software must treat it as UNKNOWN and use an SBZP policy for writes.

When [OSLSR_EL1.OSLK](#) == 1 (the OS lock is locked), this bit is RW.

TXU, bit [26]

Used for save/restore of [EDSCR.TXU](#).

When [OSLSR_EL1.OSLK](#) == 0 (the OS lock is unlocked), this bit is RO. Software must treat it as UNKNOWN and use an SBZP policy for writes.

When [OSLSR_EL1.OSLK](#) == 1 (the OS lock is locked), this bit is RW.

Bits [25:24]

Reserved, RES0.

INTdis, bits [23:22]

Used for save/restore of [EDSCR.INTdis](#).

When [OSLSR_EL1.OSLK](#) == 0 (the OS lock is unlocked), this field is RO. Software must treat it as UNKNOWN and use an SBZP policy for writes.

When [OSLSR_EL1.OSLK](#) == 1 (the OS lock is locked), this field is RW.

TDA, bit [21]

Used for save/restore of [EDSCR.TDA](#).

When [OSLSR_EL1.OSLK](#) == 0 (the OS lock is unlocked), this bit is RO. Software must treat it as UNKNOWN and use an SBZP policy for writes.

When [OSLSR_EL1.OSLK](#) == 1 (the OS lock is locked), this bit is RW.

Bits [20:19]

Reserved, RES0.

Bits [18:16]

Reserved, RAZ/WI. Hardware must implement this as RAZ/WI. Software must not rely on this property as the behavior of reserved values might change in a future revision of the architecture.

MDE, bit [15]

Monitor debug events. Enable Breakpoint, Watchpoint, and Vector catch debug exceptions.

0 Breakpoint, Watchpoint, and Vector catch debug exceptions disabled.

1 Breakpoint, Watchpoint, and Vector catch debug exceptions enabled.

On Warm reset, the field reset value is architecturally UNKNOWN.

HDE, bit [14]

Used for save/restore of [EDSCR.HDE](#).

When [OSLSR_EL1.OSLK](#) == 0 (the OS lock is unlocked), this bit is RO. Software must treat it as UNKNOWN and use an SBZP policy for writes.

When [OSLSR_EL1.OSLK](#) == 1 (the OS lock is locked), this bit is RW.

KDE, bit [13]

Local (kernel) debug enable. If EL_D is using AArch64, enable Software debug events within EL_D. Permitted values are:

- 0 Software debug events, other than Software breakpoint instructions, disabled within EL_D.
- 1 Software debug events enabled within EL_D.

RES0 if EL_D is using AArch32.

On Warm reset, the field reset value is architecturally UNKNOWN.

TDCC, bit [12]

Trap Debug Communications Channel access. When set, any EL0 access to the following registers is trapped to EL1:

AArch32: [DBGDIDR](#), [DBGDRAR](#), [DBGDSAR](#), [DBGDSCRint](#), [DBGDTRTXint](#), [DBGDTRRXint](#).

AArch64: [MDCCSR_EL0](#), [DBGDTR_EL0](#), [DBGDTRTX_EL0](#), [DBGDTRRX_EL0](#).

On Warm reset, the field reset value is architecturally UNKNOWN.

Bits [11:7]

Reserved, RES0.

ERR, bit [6]

Used for save/restore of [EDSCR.ERR](#).

When [OSLSR_EL1.OSLK](#) == 0 (the OS lock is unlocked), this bit is RO. Software must treat it as UNKNOWN and use an SBZP policy for writes.

When [OSLSR_EL1.OSLK](#) == 1 (the OS lock is locked), this bit is RW.

Bits [5:1]

Reserved, RES0.

SS, bit [0]

Software step control bit. If EL_D is using AArch64, enable Software step. Permitted values are:

- 0 Software step disabled
- 1 Software step enabled.

RES0 if EL_D is using AArch32.

On Warm reset, the field reset value is architecturally UNKNOWN.

Accessing the MDSCR_EL1:

To access the MDSCR_EL1:

MRS <Xt>, MDSCR_EL1 ; Read MDSCR_EL1 into Xt
MSR MDSCR_EL1, <Xt> ; Write Xt to MDSCR_EL1

Register access is encoded as follows:

op0	op1	CRn	CRm	op2
10	000	0000	0010	010

D8.3.21 OSDLR_EL1, OS Double Lock Register

The OSDLR_EL1 characteristics are:

Purpose

Used to control the OS Double Lock.

This register is part of the Debug registers functional group.

Usage constraints

This register is accessible as shown below:

EL0	EL1 (NS)	EL1 (S)	EL2	EL3 (SCR.NS=1)	EL3 (SCR.NS=0)
-	RW	RW	RW	RW	RW

Configurations

OSDLR_EL1 is architecturally mapped to AArch32 register [DBGOSDLR](#).

Attributes

OSDLR_EL1 is a 32-bit register.

The OSDLR_EL1 bit assignments are:

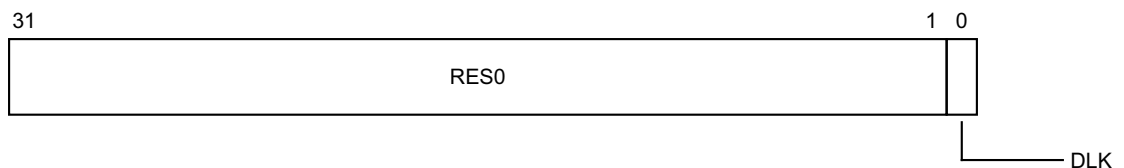

Bits [31:1]

Reserved, RES0.

DLK, bit [0]

OS Double Lock control bit. Possible values are:

0 OS Double Lock unlocked.

1 OS Double Lock locked, if [DBGPRCR_EL1](#).CORENPDRQ (Core no power-down request) bit is set to 0 and the processor is in Non-debug state.

On Warm reset, the field resets to 0.

Accessing the OSDLR_EL1:

To access the OSDLR_EL1:

MRS <Xt>, OSDLR_EL1 ; Read OSDLR_EL1 into Xt

MSR OSDLR_EL1, <Xt> ; Write Xt to OSDLR_EL1

Register access is encoded as follows:

op0	op1	CRn	CRm	op2
10	000	0001	0011	100

D8.3.22 OSDTRRX_EL1, OS Lock Data Transfer Register, Receive

The OSDTRRX_EL1 characteristics are:

Purpose

Transfers data from an external host to the ARM processor. Part of the software save/restore mechanism for external debug. Can be used to access [DBGDTRRX_EL0](#).

This register is part of the Debug registers functional group.

Usage constraints

This register is accessible as shown below:

EL0	EL1 (NS)	EL1 (S)	EL2	EL3 (SCR.NS=1)	EL3 (SCR.NS=0)
-	RW	RW	RW	RW	RW

Configurations

OSDTRRX_EL1 is architecturally mapped to AArch32 register [DBGDTRRXExt](#).

Attributes

OSDTRRX_EL1 is a 32-bit register.

The OSDTRRX_EL1 bit assignments are:

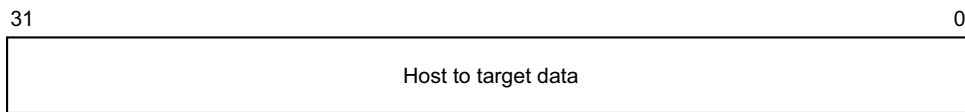

Bits [31:0]

Host to target data. One word of data for transfer from the debug host to the debug target.

For the full behavior of the Debug Communications Channel, see section 9 (The Debug Communications Channel and Instruction Transfer Register) in document PRD03-PRDC-010486.

Accessing the OSDTRRX_EL1:

To access the OSDTRRX_EL1:

MRS <Xt>, OSDTRRX_EL1 ; Read OSDTRRX_EL1 into Xt
MSR OSDTRRX_EL1, <Xt> ; Write Xt to OSDTRRX_EL1

Register access is encoded as follows:

op0	op1	CRn	CRm	op2
10	000	0000	0000	010

D8.3.23 OSDTRTX_EL1, OS Lock Data Transfer Register, Transmit

The OSDTRTX_EL1 characteristics are:

Purpose

Transfers data from the ARM processor to an external host. Part of the software save/restore mechanism for external debug. Can be used to access [DBGDTRTX_EL0](#).

This register is part of the Debug registers functional group.

Usage constraints

This register is accessible as shown below:

EL0	EL1 (NS)	EL1 (S)	EL2	EL3 (SCR.NS=1)	EL3 (SCR.NS=0)
-	RW	RW	RW	RW	RW

Configurations

OSDTRTX_EL1 is architecturally mapped to AArch32 register [DBGDTRTXext](#).

Attributes

OSDTRTX_EL1 is a 32-bit register.

The OSDTRTX_EL1 bit assignments are:

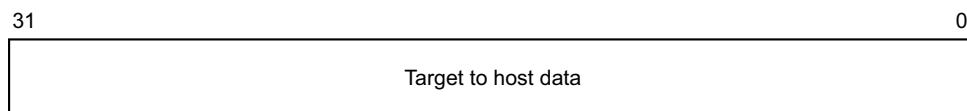

Bits [31:0]

Target to host data. One word of data for transfer from the debug target to the debug host.

For the full behavior of the Debug Communications Channel, see section 9 (The Debug Communications Channel and Instruction Transfer Register) in document PRD03-PRDC-010486.

Accessing the OSDTRTX_EL1:

To access the OSDTRTX_EL1:

MRS <Xt>, OSDTRTX_EL1 ; Read OSDTRTX_EL1 into Xt
MSR OSDTRTX_EL1, <Xt> ; Write Xt to OSDTRTX_EL1

Register access is encoded as follows:

op0	op1	CRn	CRm	op2
10	000	0000	0011	010

D8.3.24 OSECCR_EL1, OS Lock Exception Catch Control Register

The OSECCR_EL1 characteristics are:

Purpose

Provides a mechanism for an operating system to access the contents of [EDECCECR](#) that are otherwise invisible to software, so it can save/restore the contents of [EDECCECR](#) over powerdown on behalf of the external debugger.

This register is part of the Debug registers functional group.

Usage constraints

This register is accessible as shown below:

EL0	EL1 (NS)	EL1 (S)	EL2	EL3 (SCR.NS=1)	EL3 (SCR.NS=0)
-	RW	RW	RW	RW	RW

Configurations

OSECCR_EL1 is architecturally mapped to AArch32 register [DBGOSECCR](#).

OSECCR_EL1 is architecturally mapped to external register [EDECCECR](#).

Attributes

OSECCR_EL1 is a 32-bit register.

The OSECCR_EL1 bit assignments are:

When OLSR.OSLK==1:

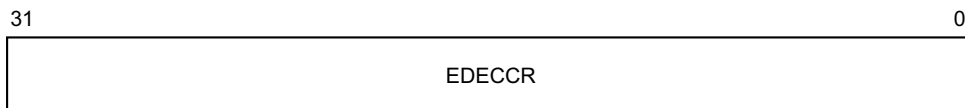

EDECCECR, bits [31:0]

Used for save/restore to [EDECCECR](#) over powerdown.

Accessing the OSECCR_EL1:

To access the OSECCR_EL1:

MRS <Xt>, OSECCR_EL1 ; Read OSECCR_EL1 into Xt

MSR OSECCR_EL1, <Xt> ; Write Xt to OSECCR_EL1

Register access is encoded as follows:

op0	op1	CRn	CRm	op2
10	000	0000	0110	010

D8.3.25 OSLAR_EL1, OS Lock Access Register

The OSLAR_EL1 characteristics are:

Purpose

Used to lock or unlock the OS lock.

This register is part of the Debug registers functional group.

Usage constraints

This register is accessible as shown below:

EL0	EL1 (NS)	EL1 (S)	EL2	EL3 (SCR.NS=1)	EL3 (SCR.NS=0)
-	WO	WO	WO	WO	WO

Configurations

OSLAR_EL1 is architecturally mapped to AArch32 register [DBGOSLAR](#).

OSLAR_EL1 is architecturally mapped to external register [OSLAR_EL1](#).

Attributes

OSLAR_EL1 is a 32-bit register.

The OSLAR_EL1 bit assignments are:

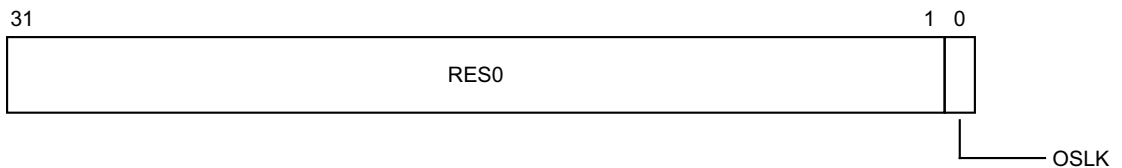

Bits [31:1]

Reserved, RES0.

OSLK, bit [0]

On writes to OSLAR_EL1, bit[0] is copied to the OS lock.

Use [OSLSR_EL1.OSLK](#) to check the current status of the lock.

Accessing the OSLAR_EL1:

To access the OSLAR_EL1:

MSR OSLAR_EL1, <Xt> ; Write Xt to OSLAR_EL1

Register access is encoded as follows:

op0	op1	CRn	CRm	op2
10	000	0001	0000	100

D8.3.26 OSLSR_EL1, OS Lock Status Register

The OSLSR_EL1 characteristics are:

Purpose

Provides the status of the OS lock.

This register is part of the Debug registers functional group.

Usage constraints

This register is accessible as shown below:

ELO	EL1 (NS)	EL1 (S)	EL2	EL3 (SCR.NS=1)	EL3 (SCR.NS=0)
-	RO	RO	RO	RO	RO

Configurations

OSLSR_EL1 is architecturally mapped to AArch32 register [DBGOSLSR](#).

Attributes

OSLSR_EL1 is a 32-bit register.

The OSLSR_EL1 bit assignments are:

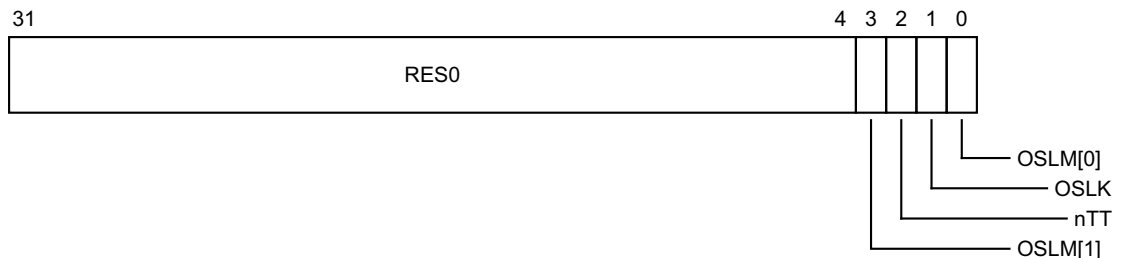

Bits [31:4]

Reserved, RES0.

OSLM[1], bit [3]

See below for description of the OSLM field.

nTT, bit [2]

Not 32-bit access. This bit is always RAZ. It indicates that a 32-bit access is needed to write the key to the OS Lock Access Register.

OSLK, bit [1]

OS Lock Status. The possible values are:

- 0 OS lock unlocked.
- 1 OS lock locked.

The OS Lock is locked and unlocked by writing to the OS Lock Access Register.

On Cold reset, the field resets to 1.

OSLM[0], bit [0]

OS lock model implemented. Identifies the form of OS save and restore mechanism implemented. In v8-A these bits are as follows:

- 10 OS lock implemented. DBGOSRR not implemented.

All other values are reserved.

Accessing the OSLSR_EL1:

To access the OSLSR_EL1:

MRS <Xt>, OSLSR_EL1 ; Read OSLSR_EL1 into Xt

Register access is encoded as follows:

op0	op1	CRn	CRm	op2
10	000	0001	0001	100

D8.3.27 SDER32_EL3, AArch32 Secure Debug Enable Register

The SDER32_EL3 characteristics are:

Purpose

Allows access to the AArch32 register **SDER** from AArch64 state only. Its value has no effect on execution in AArch64 state.

This register is part of:

- the Debug registers functional group
- the Security registers functional group.

Usage constraints

This register is accessible as shown below:

EL0	EL1 (NS)	EL1 (S)	EL2	EL3 (SCR.NS=1)	EL3 (SCR.NS=0)
-	-	-	-	RW	RW

Configurations

SDER32_EL3 is architecturally mapped to AArch32 register **SDER**.

If EL1 does not support AArch32, SDER32_EL3 is not implemented.

Attributes

SDER32_EL3 is a 32-bit register.

The SDER32_EL3 bit assignments are:

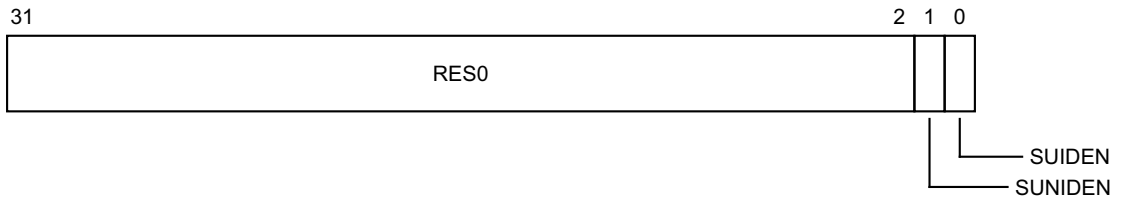

Bits [31:2]

Reserved, RES0.

SUNIDEN, bit [1]

Secure User Non-Invasive Debug Enable:

- 0 Non-invasive debug not permitted in Secure EL0 mode.
- 1 Non-invasive debug permitted in Secure EL0 mode.

SUIDEN, bit [0]

Secure User Invasive Debug Enable:

- 0 Invasive debug not permitted in Secure EL0 mode.
- 1 Invasive debug permitted in Secure EL0 mode.

Accessing the SDER32_EL3:

To access the SDER32_EL3:

MRS <Xt>, SDER32_EL3 ; Read SDER32_EL3 into Xt
MSR SDER32_EL3, <Xt> ; Write Xt to SDER32_EL3

Register access is encoded as follows:

op0	op1	CRn	CRm	op2
11	110	0001	0001	001

D8.4 Performance Monitors registers

This section lists the Performance Monitoring registers in AArch64 state.

D8.4.1 PMCCFILTR_EL0, Performance Monitors Cycle Count Filter Register

The PMCCFILTR_EL0 characteristics are:

Purpose

Determines the modes in which the Cycle Counter, [PMCCNTR_EL0](#), increments.

This register is part of the Performance Monitors registers functional group.

Usage constraints

This register is accessible as shown below:

EL0	EL1 (NS)	EL1 (S)	EL2	EL3 (SCR.NS=1)	EL3 (SCR.NS=0)
Config-RW	RW	RW	RW	RW	RW

This register is accessible at EL0 when [PMUSERENR_EL0.EN](#) is set to 1.

PMCCFILTR_EL0 can also be accessed by using [PMXEVTYPYPER_EL0](#) with [PMSELR_EL0.SEL](#) set to 0b11111.

Configurations

PMCCFILTR_EL0 is architecturally mapped to AArch32 register [PMCCFILTR](#).

PMCCFILTR_EL0 is architecturally mapped to external register [PMCCFILTR_EL0](#).

Attributes

PMCCFILTR_EL0 is a 32-bit register.

The PMCCFILTR_EL0 bit assignments are:

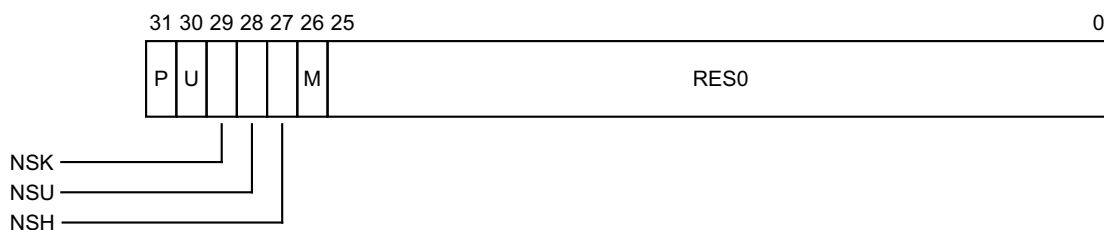

P, bit [31]

EL1 modes filtering bit. Controls counting in EL1. If EL3 is implemented, then counting in Non-secure EL1 is further controlled by the NSK bit. The possible values of this bit are:

- 0 Count cycles in EL1.
- 1 Do not count cycles in EL1.

On Warm reset, the field reset value is architecturally UNKNOWN.

U, bit [30]

EL0 filtering bit. Controls counting in EL0. If EL3 is implemented, then counting in Non-secure EL0 is further controlled by the NSU bit. The possible values of this bit are:

- 0 Count cycles in EL0.
- 1 Do not count cycles in EL0.

On Warm reset, the field reset value is architecturally UNKNOWN.

NSK, bit [29]

Non-secure kernel modes filtering bit. Controls counting in Non-secure EL1. If EL3 is not implemented, this bit is RES0.

If the value of this bit is equal to the value of P, cycles in Non-secure EL1 are counted.

Otherwise, cycles in Non-secure EL1 are not counted.

On Warm reset, the field reset value is architecturally UNKNOWN.

NSU, bit [28]

Non-secure user modes filtering bit. Controls counting in Non-secure EL0. If EL3 is not implemented, this bit is RES0.

If the value of this bit is equal to the value of U, cycles in Non-secure EL0 are counted.

Otherwise, cycles in Non-secure EL0 are not counted.

On Warm reset, the field reset value is architecturally UNKNOWN.

NSH, bit [27]

Non-secure Hyp modes filtering bit. Controls counting in Non-secure EL2. If EL2 is not implemented, this bit is RES0.

0 Do not count cycles in EL2.

1 Count cycles in EL2.

On Warm reset, the field reset value is architecturally UNKNOWN.

M, bit [26]

Secure EL3 filtering bit. Most applications can ignore this bit and set the value to zero. If EL3 is not implemented, this bit is RES0.

If the value of this bit is equal to the value of P, cycles in Secure EL3 are counted.

Otherwise, cycles in Secure EL3 are not counted.

On Warm reset, the field reset value is architecturally UNKNOWN.

Bits [25:0]

Reserved, RES0.

Accessing the PMCCFILTR_EL0:

To access the PMCCFILTR_EL0:

MRS <Xt>, PMCCFILTR_EL0 ; Read PMCCFILTR_EL0 into Xt

MSR PMCCFILTR_EL0, <Xt> ; Write Xt to PMCCFILTR_EL0

Register access is encoded as follows:

op0	op1	CRn	CRm	op2
11	011	1110	1111	111

D8.4.2 PMCCNTR_EL0, Performance Monitors Cycle Count Register

The PMCCNTR_EL0 characteristics are:

Purpose

Holds the value of the processor Cycle Counter, CCNT, that counts processor clock cycles.
This register is part of the Performance Monitors registers functional group.

Usage constraints

This register is accessible as shown below:

EL0	EL1 (NS)	EL1 (S)	EL2	EL3 (SCR.NS=1)	EL3 (SCR.NS=0)
Config-RW	RW	RW	RW	RW	RW

This register is accessible at EL0 when [PMUSERENR_EL0.EN](#) or [PMUSERENR_EL0.CR](#) is set to 1.

Configurations

PMCCNTR_EL0 is architecturally mapped to AArch32 register [PMCCNTR](#) when accessing as a 64-bit register.

PMCCNTR_EL0 is architecturally mapped to external register [PMCCNTR_EL0](#).

PMCCNTR_EL0[31:0] is architecturally mapped to AArch32 register [PMCCNTR](#).

All counters are subject to any changes in clock frequency, including clock stopping caused by the WFI and WFE instructions. This means that it is **CONSTRAINED UNPREDICTABLE** whether or not PMCCNTR_EL0 continues to increment when clocks are stopped by WFI and WFE instructions.

Attributes

PMCCNTR_EL0 is a 64-bit register.

The PMCCNTR_EL0 bit assignments are:

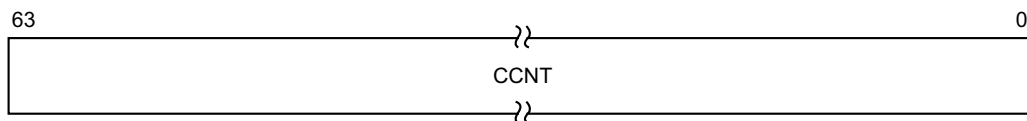

CCNT, bits [63:0]

Cycle count. Depending on the values of [PMCR_EL0](#).{LC,D}, this field increments in one of the following ways:

- Every processor clock cycle.
- Every 64th processor clock cycle.

This field can be reset to zero by writing 1 to [PMCR_EL0.C](#).

On Warm reset, the field reset value is architecturally UNKNOWN.

Accessing the PMCCNTR_EL0:

To access the PMCCNTR_EL0:

MRS <Xt>, PMCCNTR_EL0 ; Read PMCCNTR_EL0 into Xt
MSR PMCCNTR_EL0, <Xt> ; Write Xt to PMCCNTR_EL0

Register access is encoded as follows:

op0	op1	CRn	CRm	op2
11	011	1001	1101	000

D8.4.3 PMCEID0_EL0, Performance Monitors Common Event Identification register 0

The PMCEID0_EL0 characteristics are:

Purpose

Defines which common architectural and common microarchitectural feature events are implemented. If a particular bit is set to 1, then the event for that bit is implemented.

This register is part of the Performance Monitors registers functional group.

Usage constraints

This register is accessible as shown below:

EL0	EL1 (NS)	EL1 (S)	EL2	EL3 (SCR.NS=1)	EL3 (SCR.NS=0)
Config-RO	RO	RO	RO	RO	RO

This register is accessible at EL0 when [PMUSERENR_EL0.EN](#) is set to 1.

Configurations

PMCEID0_EL0 is architecturally mapped to AArch32 register [PMCEID0](#).

PMCEID0_EL0 is architecturally mapped to external register [PMCEID0_EL0](#).

Attributes

PMCEID0_EL0 is a 32-bit register.

The PMCEID0_EL0 bit assignments are:

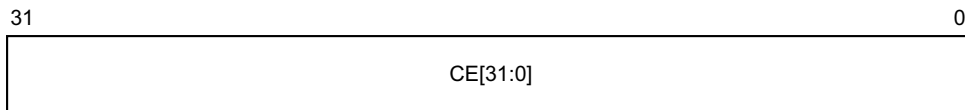

CE[31:0], bits [31:0]

Common architectural and microarchitectural feature events that can be counted by the PMU event counters.

For each bit described in the following table, the event is implemented if the bit is set to 1, or not implemented if the bit is set to 0.

Bit	Event number	Event mnemonic
31	0x01F	L1D_CACHE_ALLOCATE
30	0x01E	CHAIN
29	0x01D	BUS_CYCLES
28	0x01C	TTBR_WRITE_RETIRED
27	0x01B	INST_SPEC
26	0x01A	MEMORY_ERROR
25	0x019	BUS_ACCESS
24	0x018	L2D_CACHE_WB

Bit	Event number	Event mnemonic
23	0x017	L2D_CACHE_REFILL
22	0x016	L2D_CACHE
21	0x015	L1D_CACHE_WB
20	0x014	L1I_CACHE
19	0x013	MEM_ACCESS
18	0x012	BR_PRED
17	0x011	CPU_CYCLES
16	0x010	BR_MIS_PRED
15	0x00F	UNALIGNED_LDST_RETIRED
14	0x00E	BR_RETURN_RETIRED
13	0x00D	BR_IMMED_RETIRED
12	0x00C	PC_WRITE_RETIRED
11	0x00B	CID_WRITE_RETIRED
10	0x00A	EXC_RETURN
9	0x009	EXC_TAKEN
8	0x008	INST_RETIRED
7	0x007	ST_RETIRED
6	0x006	LD_RETIRED
5	0x005	L1D_TLB_REFILL
4	0x004	L1D_CACHE
3	0x003	L1D_CACHE_REFILL
2	0x002	L1I_TLB_REFILL
1	0x001	L1I_CACHE_REFILL
0	0x000	SW_INCR

Accessing the PMCEID0_EL0:

To access the PMCEID0_EL0:

MRS <Xt>, PMCEID0_EL0 ; Read PMCEID0_EL0 into Xt

Register access is encoded as follows:

op0	op1	CRn	CRm	op2
11	011	1001	1100	110

D8.4.4 PMCEID1_EL0, Performance Monitors Common Event Identification register 1

The PMCEID1_EL0 characteristics are:

Purpose

Reserved for future indication of which common architectural and common microarchitectural feature events are implemented.

This register is part of the Performance Monitors registers functional group.

Usage constraints

This register is accessible as shown below:

EL0	EL1 (NS)	EL1 (S)	EL2	EL3 (SCR.NS=1)	EL3 (SCR.NS=0)
Config-RO	RO	RO	RO	RO	RO

This register is accessible at EL0 when [PMUSERENR_EL0.EN](#) is set to 1.

Configurations

PMCEID1_EL0 is architecturally mapped to AArch32 register [PMCEID1](#).

PMCEID1_EL0 is architecturally mapped to external register [PMCEID1_EL0](#).

Attributes

PMCEID1_EL0 is a 32-bit register.

The PMCEID1_EL0 bit assignments are:

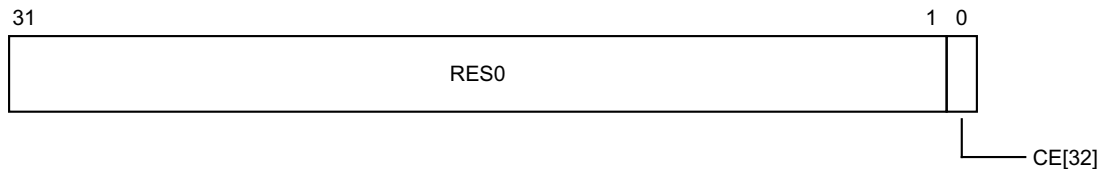

Bits [31:1]

Reserved, RES0.

CE[32], bit [0]

Common architectural and microarchitectural feature events that can be counted by the PMU event counters.

For the bit described in the following table, the event is implemented if the bit is set to 1, or not implemented if the bit is set to 0.

Bit	Event number	Event mnemonic
0	0x020	L2D_CACHE_ALLOCATE

Accessing the PMCEID1_EL0:

To access the PMCEID1_EL0:

MRS <Xt>, PMCEID1_EL0 ; Read PMCEID1_EL0 into Xt

Register access is encoded as follows:

op0	op1	CRn	CRm	op2
11	011	1001	1100	111

D8.4.5 PMCNTENCLR_EL0, Performance Monitors Count Enable Clear register

The PMCNTENCLR_EL0 characteristics are:

Purpose

Disables the Cycle Count Register, [PMCCNTR_EL0](#), and any implemented event counters [PMEVCNTR<x>](#). Reading this register shows which counters are enabled.

This register is part of the Performance Monitors registers functional group.

Usage constraints

This register is accessible as shown below:

EL0	EL1 (NS)	EL1 (S)	EL2	EL3 (SCR.NS=1)	EL3 (SCR.NS=0)
Config-RW	RW	RW	RW	RW	RW

This register is accessible at EL0 when [PMUSERENR_EL0.EN](#) is set to 1.

Configurations

PMCNTENCLR_EL0 is architecturally mapped to AArch32 register [PMCNTENCLR](#).

PMCNTENCLR_EL0 is architecturally mapped to external register [PMCNTENCLR_EL0](#).

Attributes

PMCNTENCLR_EL0 is a 32-bit register.

The PMCNTENCLR_EL0 bit assignments are:

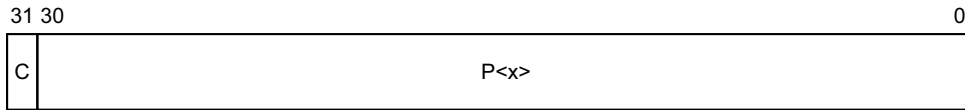

C, bit [31]

[PMCCNTR_EL0](#) disable bit. Disables the cycle counter register. Possible values are:

- 0 When read, means the cycle counter is disabled. When written, has no effect.
- 1 When read, means the cycle counter is enabled. When written, disables the cycle counter.

On Warm reset, the field reset value is architecturally UNKNOWN.

P<x>, bit [x] for x = 0 to (N - 1)

Event counter disable bit for [PMEVCNTR<x>](#).

When EL2 is implemented, in Non-secure EL1 and EL0, N is the value in [MDCR_EL2.HPMN](#). Otherwise, N is the value in [PMCR_EL0.N](#).

Bits [30:N] are RAZ/WI.

Possible values of each bit are:

- 0 When read, means that [PMEVCNTR<x>](#) is disabled. When written, has no effect.
- 1 When read, means that [PMEVCNTR<x>](#) is enabled. When written, disables [PMEVCNTR<x>](#).

On Warm reset, the field reset value is architecturally UNKNOWN.

Accessing the PMCNTENCLR_EL0:

To access the PMCNTENCLR_EL0:

MRS <Xt>, PMCNTENCLR_EL0 ; Read PMCNTENCLR_EL0 into Xt
MSR PMCNTENCLR_EL0, <Xt> ; Write Xt to PMCNTENCLR_EL0

Register access is encoded as follows:

op0	op1	CRn	CRm	op2
11	011	1001	1100	010

D8.4.6 PMCNTENSET_EL0, Performance Monitors Count Enable Set register

The PMCNTENSET_EL0 characteristics are:

Purpose

Enables the Cycle Count Register, [PMCCNTR_EL0](#), and any implemented event counters [PMEVCNTR<x>](#). Reading this register shows which counters are enabled.

This register is part of the Performance Monitors registers functional group.

Usage constraints

This register is accessible as shown below:

EL0	EL1 (NS)	EL1 (S)	EL2	EL3 (SCR.NS=1)	EL3 (SCR.NS=0)
Config-RW	RW	RW	RW	RW	RW

This register is accessible at EL0 when [PMUSERENR_EL0.EN](#) is set to 1.

Configurations

PMCNTENSET_EL0 is architecturally mapped to AArch32 register [PMCNTENSET](#).

PMCNTENSET_EL0 is architecturally mapped to external register [PMCNTENSET_EL0](#).

Attributes

PMCNTENSET_EL0 is a 32-bit register.

The PMCNTENSET_EL0 bit assignments are:

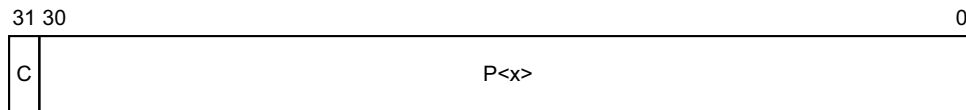

C, bit [31]

[PMCCNTR_EL0](#) enable bit. Enables the cycle counter register. Possible values are:

0 When read, means the cycle counter is disabled. When written, has no effect.

1 When read, means the cycle counter is enabled. When written, enables the cycle counter.

On Warm reset, the field reset value is architecturally UNKNOWN.

P<x>, bit [x] for x = 0 to (N - 1)

Event counter enable bit for [PMEVCNTR<x>](#).

When EL2 is implemented, in Non-secure EL1 and EL0, N is the value in [MDCR_EL2.HPMN](#). Otherwise, N is the value in [PMCR_EL0.N](#).

Bits [30:N] are RAZ/WI.

Possible values of each bit are:

0 When read, means that [PMEVCNTR<x>](#) is disabled. When written, has no effect.

1 When read, means that [PMEVCNTR<x>](#) event counter is enabled. When written, enables [PMEVCNTR<x>](#).

On Warm reset, the field reset value is architecturally UNKNOWN.

Accessing the PMCNTENSET_EL0:

To access the PMCNTENSET_EL0:

MRS <Xt>, PMCNSET_EL0 ; Read PMCNSET_EL0 into Xt
MSR PMCNSET_EL0, <Xt> ; Write Xt to PMCNSET_EL0

Register access is encoded as follows:

op0	op1	CRn	CRm	op2
11	011	1001	1100	001

D8.4.7 PMCR_EL0, Performance Monitors Control Register

The PMCR_EL0 characteristics are:

Purpose

Provides details of the Performance Monitors implementation, including the number of counters implemented, and configures and controls the counters.

This register is part of the Performance Monitors registers functional group.

Usage constraints

This register is accessible as shown below:

EL0	EL1 (NS)	EL1 (S)	EL2	EL3 (SCR.NS=1)	EL3 (SCR.NS=0)
Config-RW	RW	RW	RW	RW	RW

This register is accessible at EL0 when [PMUSERENR_EL0.EN](#) is set to 1.

Configurations

PMCR_EL0 is architecturally mapped to AArch32 register [PMCR](#).

PMCR_EL0 is architecturally mapped to external register [PMCR_EL0](#).

Attributes

PMCR_EL0 is a 32-bit register.

The PMCR_EL0 bit assignments are:

31	24 23	16 15	11 10	7 6 5 4 3 2 1 0
IMP	IDCODE	N	RES0	L C D P E X D C P E

IMP, bits [31:24]

Implementer code. This field is RO with an IMPLEMENTATION DEFINED value.

The implementer codes are allocated by ARM. Values have the same interpretation as bits [31:24] of the [MIDR](#).

IDCODE, bits [23:16]

Identification code. This field is RO with an IMPLEMENTATION DEFINED value.

Each implementer must maintain a list of identification codes that is specific to the implementer. A specific implementation is identified by the combination of the implementer code and the identification code.

N, bits [15:11]

Number of event counters. This field is RO with an IMPLEMENTATION DEFINED value that indicates the number of counters implemented.

The value of this field is the number of counters implemented, from `0b00000` for no counters to `0b11111` for 31 counters.

An implementation can implement only the Cycle Count Register, [PMCCNTR_EL0](#). This is indicated by a value of `0b00000` for the N field.

Bits [10:7]

Reserved, RES0.

LC, bit [6]

Long cycle counter enable. Determines which [PMCCNTR_ELO](#) bit generates an overflow recorded by [PMOVSRR\[31\]](#).

- 0 Cycle counter overflow on increment that changes [PMCCNTR_ELO\[31\]](#) from 1 to 0.
- 1 Cycle counter overflow on increment that changes [PMCCNTR_ELO\[63\]](#) from 1 to 0.

ARM deprecates use of `PMCR_ELO.LC = 0`.

On Warm reset, the field reset value is architecturally UNKNOWN.

DP, bit [5]

Disable cycle counter when event counting is prohibited. The possible values of this bit are:

- 0 [PMCCNTR_ELO](#), if enabled, counts when event counting is prohibited.
- 1 [PMCCNTR_ELO](#) does not count when event counting is prohibited.

Event counting is prohibited when `ProfilingProhibited(IsSecure(),PSTATE.EL) == TRUE`.

This bit is RW.

On Warm reset, the field reset value is architecturally UNKNOWN.

X, bit [4]

Enable export of events in an IMPLEMENTATION DEFINED event stream. The possible values of this bit are:

- 0 Do not export events.
- 1 Export events where not prohibited.

This bit is used to permit events to be exported to another debug device, such as an OPTIONAL trace extension, over an event bus. If the implementation does not include such an event bus, this bit is RAZ/WI.

This bit does not affect the generation of Performance Monitors overflow interrupt requests or signaling to a cross-trigger interface (CTI) that can be implemented as signals exported from the processor.

If the implementation does not include an exported event stream, this bit is RAZ/WI. Otherwise this bit is RW.

On Warm reset, the field reset value is architecturally UNKNOWN.

D, bit [3]

Clock divider. The possible values of this bit are:

- 0 When enabled, [PMCCNTR_ELO](#) counts every clock cycle.
- 1 When enabled, [PMCCNTR_ELO](#) counts once every 64 clock cycles.

This bit is RW.

If `PMCR_ELO.LC == 1`, this bit is ignored and the cycle counter counts every clock cycle.

ARM deprecates use of `PMCR.D = 1`.

On Warm reset, the field reset value is architecturally UNKNOWN.

C, bit [2]

Cycle counter reset. This bit is WO. The effects of writing to this bit are:

- 0 No action.
- 1 Reset [PMCCNTR_ELO](#) to zero.

This bit is always RAZ.

Resetting [PMCCNTR_ELO](#) does not clear the [PMCCNTR_ELO](#) overflow bit to 0.

On Warm reset, the field reset value is architecturally UNKNOWN.

P, bit [1]

Event counter reset. This bit is WO. The effects of writing to this bit are:

- 0 No action.
- 1 Reset all event counters accessible in the current EL, not including [PMCCNTR_EL0](#), to zero.

This bit is always RAZ.

In Non-secure EL0 and EL1, if EL2 is implemented, a write of 1 to this bit does not reset event counters that [MDCR_EL2.HPMN](#) reserves for EL2 use.

In EL2 and EL3, a write of 1 to this bit resets all the event counters.

Resetting the event counters does not clear any overflow bits to 0.

On Warm reset, the field reset value is architecturally UNKNOWN.

E, bit [0]

Enable. The possible values of this bit are:

- 0 All counters, including [PMCCNTR_EL0](#), are disabled.
- 1 All counters are enabled by [PMCNTENSET_EL0](#).

This bit is RW.

In Non-secure EL0 and EL1, if EL2 is implemented, this bit does not affect the operation of event counters that [MDCR_EL2.HPMN](#) reserves for EL2 use.

On Warm reset, the field resets to 0.

Accessing the PMCR_EL0:

To access the PMCR_EL0:

MRS <Xt>, PMCR_EL0 ; Read PMCR_EL0 into Xt
MSR PMCR_EL0, <Xt> ; Write Xt to PMCR_EL0

Register access is encoded as follows:

op0	op1	CRn	CRm	op2
11	011	1001	1100	000

D8.4.8 PMEVCNTR<n>_EL0, Performance Monitors Event Count Registers, n = 0 - 30

The PMEVCNTR<n>_EL0 characteristics are:

Purpose

Holds event counter n, which counts events, where n is 0 to 30.

This register is part of the Performance Monitors registers functional group.

Usage constraints

This register is accessible as shown below:

EL0	EL1 (NS)	EL1 (S)	EL2	EL3 (SCR.NS=1)	EL3 (SCR.NS=0)
Config-RW	RW	RW	RW	RW	RW

This register can be read at EL0 when [PMUSERENR_EL0.EN](#) or [PMUSERENR_EL0.ER](#) is set to 1, and can be written at EL0 when [PMUSERENR_EL0.ER](#) is set to 1.

PMEVCNTR<n>_EL0 can also be accessed by using [PMXVCNTR_EL0](#) with [PMSELR_EL0.SEL](#) set to n.

If <n> is greater than the number of counters available in the current Exception level and state, reads and writes of PMEVCNTR<n>_EL0 are CONstrained UNPREDICTABLE, and must behave as one of the following:

- UNALLOCATED.
- RAZ/WI.
- No-op.

Configurations

PMEVCNTR<n>_EL0 is architecturally mapped to AArch32 register [PMEVCNTR<n>](#).

PMEVCNTR<n>_EL0 is architecturally mapped to external register [PMEVCNTR<n>_EL0](#).

Attributes

PMEVCNTR<n>_EL0 is a 32-bit register.

The PMEVCNTR<n>_EL0 bit assignments are:

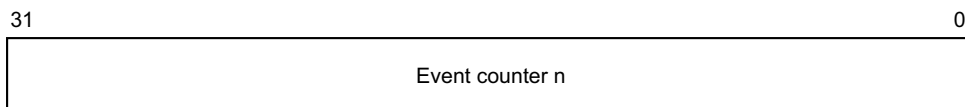

Bits [31:0]

Event counter n. Value of event counter n, where n is the number of this register and is a number from 0 to 30.

On Warm reset, the field reset value is architecturally UNKNOWN.

Accessing the PMEVCNTR<n>_EL0:

To access the PMEVCNTR<n>_EL0:

MRS <Xt>, PMEVCNTR<n>_EL0 ; Read PMEVCNTR<n>_EL0 into Xt, where n is in the range 0 to 30
MSR PMEVCNTR<n>_EL0, <Xt> ; Write Xt to PMEVCNTR<n>_EL0, where n is in the range 0 to 30

Register access is encoded as follows:

op0	op1	CRn	CRm	op2
11	011	1110	10:n<4:3>	n<2:0>

D8.4.9 PMEVTYPER<n>_EL0, Performance Monitors Event Type Registers, n = 0 - 30

The PMEVTYPER<n>_EL0 characteristics are:

Purpose

Configures event counter n, where n is 0 to 30.

This register is part of the Performance Monitors registers functional group.

Usage constraints

This register is accessible as shown below:

EL0	EL1 (NS)	EL1 (S)	EL2	EL3 (SCR.NS=1)	EL3 (SCR.NS=0)
Config-RW	RW	RW	RW	RW	RW

This register is accessible at EL0 when [PMUSERENR_EL0.EN](#) is set to 1.

PMEVTYPER<n>_EL0 can also be accessed by using [PMXEVTYPER_EL0](#) with [PMSELR_EL0.SEL](#) set to n.

If <n> is greater than the number of counters available in the current Exception level and state, reads and writes of PMEVTYPER<n>_EL0 are CONstrained UNPREDICTABLE, and must behave as one of the following:

- UNALLOCATED.
- RAZ/WI.
- No-op.

Configurations

PMEVTYPER<n>_EL0 is architecturally mapped to AArch32 register [PMEVTYPER<n>](#).

PMEVTYPER<n>_EL0 is architecturally mapped to external register [PMEVTYPER<n>_EL0](#).

Attributes

PMEVTYPER<n>_EL0 is a 32-bit register.

The PMEVTYPER<n>_EL0 bit assignments are:

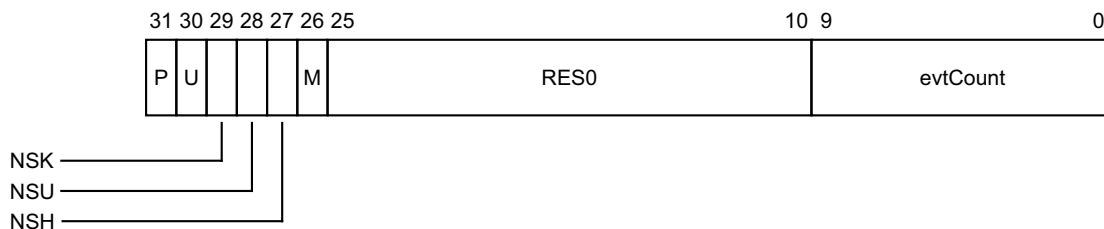

P, bit [31]

EL1 modes filtering bit. Controls counting in EL1. If EL3 is implemented, then counting in Non-secure EL1 is further controlled by the NSK bit. The possible values of this bit are:

- 0 Count events in EL1.
- 1 Do not count events in EL1.

On Warm reset, the field reset value is architecturally UNKNOWN.

U, bit [30]

EL0 filtering bit. Controls counting in EL0. If EL3 is implemented, then counting in Non-secure EL0 is further controlled by the NSU bit. The possible values of this bit are:

- 0 Count events in EL0.
- 1 Do not count events in EL0.

On Warm reset, the field reset value is architecturally UNKNOWN.

NSK, bit [29]

Non-secure kernel modes filtering bit. Controls counting in Non-secure EL1. If EL3 is not implemented, this bit is RES0.

If the value of this bit is equal to the value of P, events in Non-secure EL1 are counted.

Otherwise, events in Non-secure EL1 are not counted.

On Warm reset, the field reset value is architecturally UNKNOWN.

NSU, bit [28]

Non-secure user modes filtering bit. Controls counting in Non-secure EL0. If EL3 is not implemented, this bit is RES0.

If the value of this bit is equal to the value of U, events in Non-secure EL0 are counted.

Otherwise, events in Non-secure EL0 are not counted.

On Warm reset, the field reset value is architecturally UNKNOWN.

NSH, bit [27]

Non-secure Hyp modes filtering bit. Controls counting in Non-secure EL2. If EL2 is not implemented, this bit is RES0.

0 Do not count events in EL2.

1 Count events in EL2.

On Warm reset, the field reset value is architecturally UNKNOWN.

M, bit [26]

Secure EL3 filtering bit. Most applications can ignore this bit and set the value to zero. If EL3 is not implemented, this bit is RES0.

If the value of this bit is equal to the value of P, events in Secure EL3 are counted.

Otherwise, events in Secure EL3 are not counted.

On Warm reset, the field reset value is architecturally UNKNOWN.

Bits [25:10]

Reserved, RES0.

evtCount, bits [9:0]

Event to count. The event number of the event that is counted by event counter [PMEVCNTR<n>_EL0](#).

Software must program this field with an event defined by the processor or a common event defined by the architecture.

If evtCount is programmed to an event that is reserved or not implemented, the behavior depends on the event type.

For common architectural and microarchitectural events:

- No events are counted.
- The value read back on evtCount is the value written.

For IMPLEMENTATION DEFINED events:

- It is UNPREDICTABLE what event, if any, is counted. UNPREDICTABLE in this case means the event must not expose privileged information.

- The value read back on evtCount is an UNKNOWN value with the same effect.

ARM recommends that the behavior across a family of implementations is defined such that if a given implementation does not include an event from a set of common IMPLEMENTATION DEFINED events, then no event is counted and the value read back on evtCount is the value written.

On Warm reset, the field reset value is architecturally UNKNOWN.

Accessing the PMEVTYPER<n>_EL0:

To access the PMEVTYPER<n>_EL0:

MRS <Xt>, PMEVTYPER<n>_EL0 ; Read PMEVTYPER<n>_EL0 into Xt, where n is in the range 0 to 30
MSR PMEVTYPER<n>_EL0, <Xt> ; Write Xt to PMEVTYPER<n>_EL0, where n is in the range 0 to 30

Register access is encoded as follows:

op0	op1	CRn	CRm	op2
11	011	1110	11:n<4:3>	n<2:0>

D8.4.10 PMINTENCLR_EL1, Performance Monitors Interrupt Enable Clear register

The PMINTENCLR_EL1 characteristics are:

Purpose

Disables the generation of interrupt requests on overflows from the Cycle Count Register, [PMCCNTR_ELO](#), and the event counters [PMEVCNTR<n>_ELO](#). Reading the register shows which overflow interrupt requests are enabled.

This register is part of the Performance Monitors registers functional group.

Usage constraints

This register is accessible as shown below:

EL0	EL1 (NS)	EL1 (S)	EL2	EL3 (SCR.NS=1)	EL3 (SCR.NS=0)
-	RW	RW	RW	RW	RW

Configurations

PMINTENCLR_EL1 is architecturally mapped to AArch32 register [PMINTENCLR](#).

PMINTENCLR_EL1 is architecturally mapped to external register [PMINTENCLR_EL1](#).

Attributes

PMINTENCLR_EL1 is a 32-bit register.

The PMINTENCLR_EL1 bit assignments are:

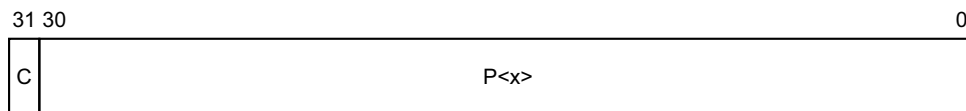

C, bit [31]

[PMCCNTR_ELO](#) overflow interrupt request disable bit. Possible values are:

- 0 When read, means the cycle counter overflow interrupt request is disabled. When written, has no effect.
- 1 When read, means the cycle counter overflow interrupt request is enabled. When written, disables the cycle count overflow interrupt request.

On Warm reset, the field reset value is architecturally UNKNOWN.

P<x>, bit [x] for x = 0 to (N - 1)

Event counter overflow interrupt request disable bit for [PMEVCNTR<x>_ELO](#).

When EL2 is implemented, in Non-secure EL1 and EL0, N is the value in [MDCR_EL2.HPMN](#). Otherwise, N is the value in [PMCR_ELO.N](#).

Bits [30:N] are RAZ/WI.

Possible values are:

- 0 When read, means that the [PMEVCNTR<x>_ELO](#) event counter interrupt request is disabled. When written, has no effect.
- 1 When read, means that the [PMEVCNTR<x>_ELO](#) event counter interrupt request is enabled. When written, disables the [PMEVCNTR<x>_ELO](#) interrupt request.

On Warm reset, the field reset value is architecturally UNKNOWN.

Accessing the PMINTENCLR_EL1:

To access the PMINTENCLR_EL1:

MRS <Xt>, PMINTENCLR_EL1 ; Read PMINTENCLR_EL1 into Xt
MSR PMINTENCLR_EL1, <Xt> ; Write Xt to PMINTENCLR_EL1

Register access is encoded as follows:

op0	op1	CRn	CRm	op2
11	000	1001	1110	010

D8.4.11 PMINTENSET_EL1, Performance Monitors Interrupt Enable Set register

The PMINTENSET_EL1 characteristics are:

Purpose

Enables the generation of interrupt requests on overflows from the Cycle Count Register, [PMCCNTR_ELO](#), and the event counters [PMEVCNTR<n>_ELO](#). Reading the register shows which overflow interrupt requests are enabled.

This register is part of the Performance Monitors registers functional group.

Usage constraints

This register is accessible as shown below:

EL0	EL1 (NS)	EL1 (S)	EL2	EL3 (SCR.NS=1)	EL3 (SCR.NS=0)
-	RW	RW	RW	RW	RW

Configurations

PMINTENSET_EL1 is architecturally mapped to AArch32 register [PMINTENSET](#).

PMINTENSET_EL1 is architecturally mapped to external register [PMINTENSET_EL1](#).

Attributes

PMINTENSET_EL1 is a 32-bit register.

The PMINTENSET_EL1 bit assignments are:

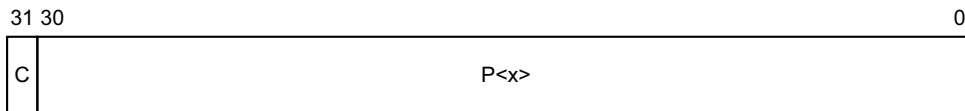

C, bit [31]

[PMCCNTR_ELO](#) overflow interrupt request enable bit. Possible values are:

- 0 When read, means the cycle counter overflow interrupt request is disabled. When written, has no effect.
- 1 When read, means the cycle counter overflow interrupt request is enabled. When written, enables the cycle count overflow interrupt request.

On Warm reset, the field reset value is architecturally UNKNOWN.

P<x>, bit [x] for x = 0 to (N - 1)

Event counter overflow interrupt request enable bit for [PMEVCNTR<x>_ELO](#).

When EL2 is implemented, in Non-secure EL1 and EL0, N is the value in [MDCR_EL2.HPMN](#). Otherwise, N is the value in [PMCR_ELO.N](#).

Bits [30:N] are RAZ/WI.

Possible values are:

- 0 When read, means that the [PMEVCNTR<x>_ELO](#) event counter interrupt request is disabled. When written, has no effect.
- 1 When read, means that the [PMEVCNTR<x>_ELO](#) event counter interrupt request is enabled. When written, enables the [PMEVCNTR<x>_ELO](#) interrupt request.

On Warm reset, the field reset value is architecturally UNKNOWN.

Accessing the PMINTENSET_EL1:

To access the PMINTENSET_EL1:

MRS <Xt>, PMINTENSET_EL1 ; Read PMINTENSET_EL1 into Xt
MSR PMINTENSET_EL1, <Xt> ; Write Xt to PMINTENSET_EL1

Register access is encoded as follows:

op0	op1	CRn	CRm	op2
11	000	1001	1110	001

D8.4.12 PMOVSLR_EL0, Performance Monitors Overflow Flag Status Clear Register

The PMOVSLR_EL0 characteristics are:

Purpose

Contains the state of the overflow bit for the Cycle Count Register, [PMCCNTR_EL0](#), and each of the implemented event counters [PMEVCNTR<x>](#). Writing to this register clears these bits.

This register is part of the Performance Monitors registers functional group.

Usage constraints

This register is accessible as shown below:

EL0	EL1 (NS)	EL1 (S)	EL2	EL3 (SCR.NS=1)	EL3 (SCR.NS=0)
Config-RW	RW	RW	RW	RW	RW

This register is accessible at EL0 when [PMUSERENR_EL0.EN](#) is set to 1.

Configurations

PMOVSLR_EL0 is architecturally mapped to AArch32 register [PMOVSRR](#).

PMOVSLR_EL0 is architecturally mapped to external register [PMOVSLR_EL0](#).

Attributes

PMOVSLR_EL0 is a 32-bit register.

The PMOVSLR_EL0 bit assignments are:

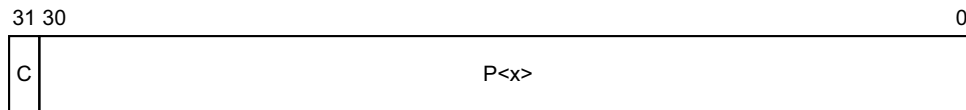

C, bit [31]

[PMCCNTR_EL0](#) overflow bit. Possible values are:

- 0 When read, means the cycle counter has not overflowed. When written, has no effect.
- 1 When read, means the cycle counter has overflowed. When written, clears the overflow bit to 0.

[PMCR_EL0.LC](#) is used to control from which bit of [PMCCNTR_EL0](#) (bit 31 or bit 63) an overflow is detected.

On Warm reset, the field reset value is architecturally UNKNOWN.

P<x>, bit [x] for x = 0 to (N - 1)

Event counter overflow clear bit for [PMEVCNTR<x>](#).

When EL2 is implemented, in Non-secure EL1 and EL0, N is the value in [MDCR_EL2.HPMN](#). Otherwise, N is the value in [PMCR_EL0.N](#).

Bits [30:N] are RAZ/WI.

Possible values of each bit are:

- 0 When read, means that [PMEVCNTR<x>](#) has not overflowed. When written, has no effect.
- 1 When read, means that [PMEVCNTR<x>](#) has overflowed. When written, clears the [PMEVCNTR<x>](#) overflow bit to 0.

On Warm reset, the field reset value is architecturally UNKNOWN.

Accessing the PMOVSLR_EL0:

To access the PMOVSLR_EL0:

MRS <Xt>, PMOVSLR_EL0 ; Read PMOVSLR_EL0 into Xt
MSR PMOVSLR_EL0, <Xt> ; Write Xt to PMOVSLR_EL0

Register access is encoded as follows:

op0	op1	CRn	CRm	op2
11	011	1001	1100	011

D8.4.13 PMOVSSET_EL0, Performance Monitors Overflow Flag Status Set register

The PMOVSSET_EL0 characteristics are:

Purpose

Sets the state of the overflow bit for the Cycle Count Register, [PMCCNTR_EL0](#), and each of the implemented event counters [PMEVCNTR<x>](#).

This register is part of the Performance Monitors registers functional group.

Usage constraints

This register is accessible as shown below:

EL0	EL1 (NS)	EL1 (S)	EL2	EL3 (SCR.NS=1)	EL3 (SCR.NS=0)
Config-RW	RW	RW	RW	RW	RW

This register is accessible at EL0 when [PMUSERENR_EL0.EN](#) is set to 1.

Configurations

PMOVSSET_EL0 is architecturally mapped to AArch32 register [PMOVSSET](#).

PMOVSSET_EL0 is architecturally mapped to external register [PMOVSSET_EL0](#).

Attributes

PMOVSSET_EL0 is a 32-bit register.

The PMOVSSET_EL0 bit assignments are:

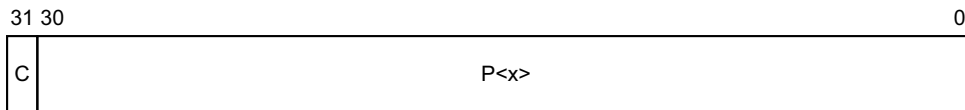

C, bit [31]

[PMCCNTR_EL0](#) overflow bit. Possible values are:

- 0 When read, means the cycle counter has not overflowed. When written, has no effect.
- 1 When read, means the cycle counter has overflowed. When written, sets the overflow bit to 1.

On Warm reset, the field reset value is architecturally UNKNOWN.

P<x>, bit [x] for x = 0 to (N - 1)

Event counter overflow set bit for [PMEVCNTR<x>](#).

When EL2 is implemented, in Non-secure EL1 and EL0, N is the value in [MDCR_EL2.HPMN](#). Otherwise, N is the value in [PMCR_EL0.N](#).

Bits [30:N] are RAZ/WI.

Possible values are:

- 0 When read, means that [PMEVCNTR<x>](#) has not overflowed. When written, has no effect.
- 1 When read, means that [PMEVCNTR<x>](#) has overflowed. When written, sets the [PMEVCNTR<x>](#) overflow bit to 1.

On Warm reset, the field reset value is architecturally UNKNOWN.

Accessing the PMOVSSET_EL0:

To access the PMOVSSET_EL0:

MRS <Xt>, PMOVSSET_EL0 ; Read PMOVSSET_EL0 into Xt
MSR PMOVSSET_EL0, <Xt> ; Write Xt to PMOVSSET_EL0

Register access is encoded as follows:

op0	op1	CRn	CRm	op2
11	011	1001	1110	011

D8.4.14 PMSELR_EL0, Performance Monitors Event Counter Selection Register

The PMSELR_EL0 characteristics are:

Purpose

Selects the current event counter `PMEVCNTR<x>` or the cycle counter, `CCNT`.
This register is part of the Performance Monitors registers functional group.

Usage constraints

This register is accessible as shown below:

EL0	EL1 (NS)	EL1 (S)	EL2	EL3 (SCR.NS=1)	EL3 (SCR.NS=0)
Config-RW	RW	RW	RW	RW	RW

This register is accessible at EL0 when `PMUSERENR_EL0.EN` or `PMUSERENR_EL0.ER` is set to 1.

Configurations

PMSELR_EL0 is architecturally mapped to AArch32 register `PMSELR`.

Attributes

PMSELR_EL0 is a 32-bit register.

The PMSELR_EL0 bit assignments are:

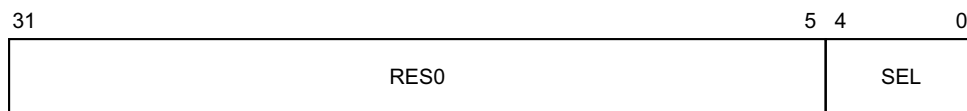

Bits [31:5]

Reserved, RES0.

SEL, bits [4:0]

Selects event counter, `PMEVCNTR<x>`, where `x` is the value held in this field. This value identifies which event counter is accessed when a subsequent access to `PMXEVTYPYPER_EL0` or `PMXEVCNTR_EL0` occurs.

This field can take any value from 0 (`0b00000`) to `(PMCR.N)-1`, or 31 (`0b11111`).

When `PMSELR_EL0.SEL` is `0b11111` it selects the cycle counter and:

- A read of the `PMXEVTYPYPER_EL0` returns the value of `PMCCFILTR_EL0`.
- A write of the `PMXEVTYPYPER_EL0` writes to `PMCCFILTR_EL0`.
- A read or write of `PMXEVCNTR_EL0` has CONstrained UNPREDICTABLE effects, that can be one of the following:
 - Access to `PMXEVCNTR_EL0` is UNDEFINED.
 - Access to `PMXEVCNTR_EL0` behaves as a NOP.
 - Access to `PMXEVCNTR_EL0` behaves as if the register is RAZ/WI.
 - Access to `PMXEVCNTR_EL0` behaves as if the `PMSELR_EL0.SEL` field contains an UNKNOWN value.

If this field is set to a value greater than or equal to the number of implemented counters, but not equal to 31, the results of access to `PMXEVTYPYPER_EL0` or `PMXEVCNTR_EL0` are CONstrained UNPREDICTABLE, and can be one of the following:

- Access to `PMXEVTYPYPER_EL0` or `PMXEVCNTR_EL0` is UNDEFINED.

- Access to [PMXEVTYPYPER_ELO](#) or [PMXEVCNTR_ELO](#) behaves as a NOP.
- Access to [PMXEVTYPYPER_ELO](#) or [PMXEVCNTR_ELO](#) behaves as if the register is RAZ/WI.
- Access to [PMXEVTYPYPER_ELO](#) or [PMXEVCNTR_ELO](#) behaves as if the PMSELR_ELO.SEL field contains an UNKNOWN value.
- Access to [PMXEVTYPYPER_ELO](#) or [PMXEVCNTR_ELO](#) behaves as if the PMSELR_ELO.SEL field contains 0b11111.

On Warm reset, the field reset value is architecturally UNKNOWN.

Accessing the PMSELR_ELO:

To access the PMSELR_ELO:

MRS <Xt>, PMSELR_ELO ; Read PMSELR_ELO into Xt
MSR PMSELR_ELO, <Xt> ; Write Xt to PMSELR_ELO

Register access is encoded as follows:

op0	op1	CRn	CRm	op2
11	011	1001	1100	101

D8.4.15 PMSWINC_EL0, Performance Monitors Software Increment register

The PMSWINC_EL0 characteristics are:

Purpose

Increments a counter that is configured to count the Software increment event, event 0x00.
This register is part of the Performance Monitors registers functional group.

Usage constraints

This register is accessible as shown below:

EL0	EL1 (NS)	EL1 (S)	EL2	EL3 (SCR.NS=1)	EL3 (SCR.NS=0)
Config-WO	WO	WO	WO	WO	WO

This register is accessible at EL0 when [PMUSERENR_EL0.EN](#) or [PMUSERENR_EL0.SW](#) is set to 1.

Configurations

PMSWINC_EL0 is architecturally mapped to AArch32 register [PMSWINC](#).
PMSWINC_EL0 is architecturally mapped to external register [PMSWINC_EL0](#).

Attributes

PMSWINC_EL0 is a 32-bit register.

The PMSWINC_EL0 bit assignments are:

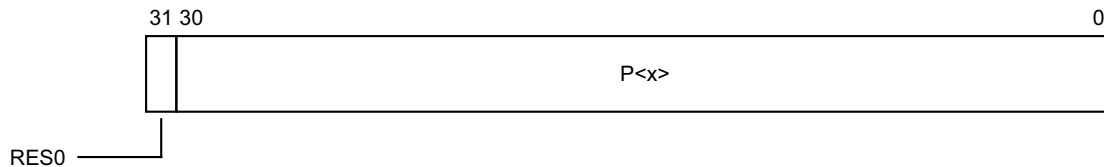

Bit [31]

Reserved, RES0.

P<x>, bit [x] for x = 0 to (N - 1)

Event counter software increment bit for [PMEVCNTR<x>](#).

When EL2 is implemented, in Non-secure EL1 and EL0, N is the value in [MDCR_EL2.HPMN](#).
Otherwise, N is the value in [PMCR.N](#).

Bits [30:N] are RAZ/WI.

The effects of writing to this bit are:

- 0 No action. The write to this bit is ignored.
- 1 If [PMEVCNTR<x>](#) is enabled and configured to count the software increment event, increments [PMEVCNTR<x>](#) by 1. If [PMEVCNTR<x>](#) is disabled, or not configured to count the software increment event, the write to this bit is ignored.

Accessing the PMSWINC_EL0:

To access the PMSWINC_EL0:

MSR PMSWINC_EL0, <Xt> ; Write Xt to PMSWINC_EL0

Register access is encoded as follows:

op0	op1	CRn	CRm	op2
11	011	1001	1100	100

D8.4.16 PMUSERENR_EL0, Performance Monitors User Enable Register

The PMUSERENR_EL0 characteristics are:

Purpose

Enables or disables EL0 access to the Performance Monitors.

This register is part of the Performance Monitors registers functional group.

Usage constraints

This register is accessible as shown below:

EL0	EL1 (NS)	EL1 (S)	EL2	EL3 (SCR.NS=1)	EL3 (SCR.NS=0)
RO	RW	RW	RW	RW	RW

Configurations

PMUSERENR_EL0 is architecturally mapped to AArch32 register [PMUSERENR](#).

Attributes

PMUSERENR_EL0 is a 32-bit register.

The PMUSERENR_EL0 bit assignments are:

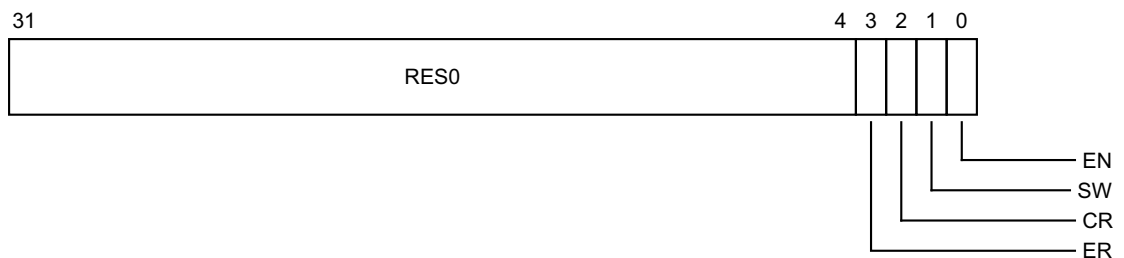

Bits [31:4]

Reserved, RES0.

ER, bit [3]

Event counter read enable. The possible values of this bit are:

- 0 ELO read access to [PMXVCNTR_EL0](#) / [PMEVCNTR<n>_EL0](#) and read/write access to [PMSELR_EL0](#) disabled if PMUSERENR_EL0.EN is also 0.
- 1 ELO read access to [PMXVCNTR_EL0](#) / [PMEVCNTR<n>_EL0](#) and read/write access to [PMSELR_EL0](#) enabled.

On Warm reset, the field reset value is architecturally UNKNOWN.

CR, bit [2]

Cycle counter read enable. The possible values of this bit are:

- 0 ELO read access to [PMCCNTR_EL0](#) disabled if PMUSERENR_EL0.EN is also 0.
- 1 ELO read access to [PMCCNTR_EL0](#) enabled.

On Warm reset, the field reset value is architecturally UNKNOWN.

SW, bit [1]

Software Increment write enable. The possible values of this bit are:

- 0 ELO write access to [PMSWINC_EL0](#) disabled if PMUSERENR_EL0.EN is also 0.

1 ELO write access to [PMSWINC_ELO](#) enabled.

On Warm reset, the field reset value is architecturally UNKNOWN.

EN, bit [0]

ELO access enable bit. The possible values of this bit are:

0 ELO access to the Performance Monitors disabled.

1 ELO access to the Performance Monitors enabled. Can access all PMU registers at ELO, except for writes to [PMUSERENR_ELO](#) and reads/writes of [PMINTENSET_EL1](#) and [PMINTENCLR_EL1](#).

On Warm reset, the field reset value is architecturally UNKNOWN.

Accessing the PMUSERENR_EL0:

To access the PMUSERENR_EL0:

MRS <Xt>, PMUSERENR_EL0 ; Read PMUSERENR_EL0 into Xt
MSR PMUSERENR_EL0, <Xt> ; Write Xt to PMUSERENR_EL0

Register access is encoded as follows:

op0	op1	CRn	CRm	op2
11	011	1001	1110	000

D8.4.17 PMXEVNTR_EL0, Performance Monitors Selected Event Count Register

The PMXEVNTR_EL0 characteristics are:

Purpose

Reads or writes the value of the selected event counter, PMXEVNTR<x>_EL0. PMSELR_EL0.SEL determines which event counter is selected.

This register is part of the Performance Monitors registers functional group.

Usage constraints

This register is accessible as shown below:

EL0	EL1 (NS)	EL1 (S)	EL2	EL3 (SCR.NS=1)	EL3 (SCR.NS=0)
Config-RW	RW	RW	RW	RW	RW

This register can be read at EL0 when PMUSERENR_EL0.EN or PMUSERENR_EL0.ER is set to 1, and can be written at EL0 when PMUSERENR_EL0.ER is set to 1.

Configurations

PMXEVNTR_EL0 is architecturally mapped to AArch32 register PMXEVNTR.

Attributes

PMXEVNTR_EL0 is a 32-bit register.

The PMXEVNTR_EL0 bit assignments are:



PMXEVNTR<x>, bits [31:0]

Value of the selected event counter, PMXEVNTR<x>_EL0, where x is the value stored in PMSELR_EL0.SEL.

Accessing the PMXEVNTR_EL0:

To access the PMXEVNTR_EL0:

MRS <Xt>, PMXEVNTR_EL0 ; Read PMXEVNTR_EL0 into Xt
MSR PMXEVNTR_EL0, <Xt> ; Write Xt to PMXEVNTR_EL0

Register access is encoded as follows:

op0	op1	CRn	CRm	op2
11	011	1001	1101	010

D8.4.18 PMXEVTYPER_EL0, Performance Monitors Selected Event Type Register

The PMXEVTYPER_EL0 characteristics are:

Purpose

When [PMSELR_EL0.SEL](#) selects an event counter, this accesses a [PMEVTYPER<n>_EL0](#) register. When [PMSELR_EL0.SEL](#) selects the cycle counter, this accesses [PMCCFILTR_EL0](#).

This register is part of the Performance Monitors registers functional group.

Usage constraints

This register is accessible as shown below:

EL0	EL1 (NS)	EL1 (S)	EL2	EL3 (SCR.NS=1)	EL3 (SCR.NS=0)
Config-RW	RW	RW	RW	RW	RW

This register is accessible at EL0 when [PMUSERENR_EL0.EN](#) is set to 1.

Configurations

PMXEVTYPER_EL0 is architecturally mapped to AArch32 register [PMXEVTYPER](#).

Attributes

PMXEVTYPER_EL0 is a 32-bit register.

The PMXEVTYPER_EL0 bit assignments are:

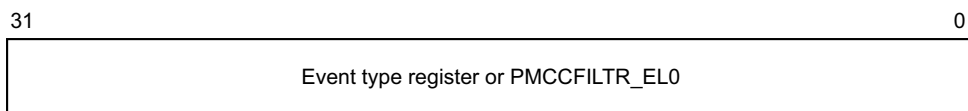

Bits [31:0]

Event type register or [PMCCFILTR_EL0](#).

When [PMSELR_EL0.SEL](#) == 31, this register accesses [PMCCFILTR_EL0](#).

Otherwise, this register accesses [PMEVTYPER<n>_EL0](#) where n is the value in [PMSELR_EL0.SEL](#).

Accessing the PMXEVTYPER_EL0:

To access the PMXEVTYPER_EL0:

MRS <Xt>, PMXEVTYPER_EL0 ; Read PMXEVTYPER_EL0 into Xt
MSR PMXEVTYPER_EL0, <Xt> ; Write Xt to PMXEVTYPER_EL0

Register access is encoded as follows:

op0	op1	CRn	CRm	op2
11	011	1001	1101	001

D8.5 Generic Timer registers

This section lists the Generic Timer registers in AArch64 state.

D8.5.1 CNTFRQ_EL0, Counter-timer Frequency register

The CNTFRQ_EL0 characteristics are:

Purpose

Holds the clock frequency of the system counter.

This register is part of the Generic Timer registers functional group.

Usage constraints

This register is accessible as shown below:

EL0	EL1 (NS)	EL1 (S)	EL2	EL3 (SCR.NS=1)	EL3 (SCR.NS=0)
Config-RO	RO	RO	RO	RW	RW

Can only be written at the highest exception level implemented. For example, if EL3 is the highest implemented exception level, CNTFRQ_EL0 can only be written at EL3.

This register is accessible and read-only at EL0 when [CNTKCTL_EL1.EL0PCTEN](#) or [CNTKCTL_EL1.EL0VCTEN](#) is set to 1.

Configurations

CNTFRQ_EL0 is architecturally mapped to AArch32 register [CNTFRQ](#).

CNTFRQ_EL0 is architecturally mapped to external register [CNTFRQ](#).

Attributes

CNTFRQ_EL0 is a 32-bit register.

The CNTFRQ_EL0 bit assignments are:

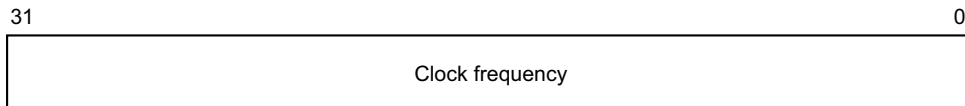

Bits [31:0]

Clock frequency. Indicates the system counter clock frequency, in Hz.

Accessing the CNTFRQ_EL0:

To access the CNTFRQ_EL0:

MRS <Xt>, CNTFRQ_EL0 ; Read CNTFRQ_EL0 into Xt
MSR CNTFRQ_EL0, <Xt> ; Write Xt to CNTFRQ_EL0

Register access is encoded as follows:

op0	op1	CRn	CRm	op2
11	011	1110	0000	000

D8.5.2 CNTHCTL_EL2, Counter-timer Hypervisor Control register

The CNTHCTL_EL2 characteristics are:

Purpose

Controls the generation of an event stream from the physical counter, and access from Non-secure EL1 to the physical counter and the Non-secure EL1 physical timer.

This register is part of:

- the Generic Timer registers functional group
- the Virtualization registers functional group.

Usage constraints

This register is accessible as shown below:

EL0	EL1 (NS)	EL1 (S)	EL2	EL3 (SCR.NS=1)	EL3 (SCR.NS=0)
-	-	-	RW	RW	RW

Configurations

CNTHCTL_EL2 is architecturally mapped to AArch32 register [CNTHCTL](#).

If EL2 is not implemented, this register is RES0 from EL3.

Attributes

CNTHCTL_EL2 is a 32-bit register.

The CNTHCTL_EL2 bit assignments are:

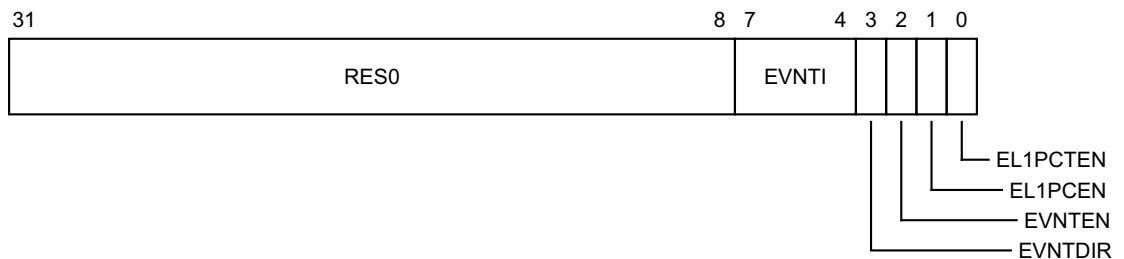

Bits [31:8]

Reserved, RES0.

EVNTI, bits [7:4]

Selects which bit (0 to 15) of the corresponding counter register ([CNTPCT_EL0](#) or [CNTVCT_EL0](#)) is the trigger for the event stream generated from that counter, when that stream is enabled.

Reset value is architecturally UNKNOWN.

EVNTDIR, bit [3]

Controls which transition of the counter register ([CNTPCT_EL0](#) or [CNTVCT_EL0](#)) trigger bit, defined by EVNTI, generates an event when the event stream is enabled:

- 0 A 0 to 1 transition of the trigger bit triggers an event.
- 1 A 1 to 0 transition of the trigger bit triggers an event.

Reset value is architecturally UNKNOWN.

EVNTEN, bit [2]

Enables the generation of an event stream from the corresponding counter:

- 0 Disables the event stream.
- 1 Enables the event stream.

Resets to 0.

EL1PCEN, bit [1]

Controls whether the physical timer registers are accessible from Non-secure EL1 and EL0 modes:

- 0 The [CNTP_CVAL_ELO](#), [CNTP_TVAL_ELO](#), and [CNTP_CTL_ELO](#) registers are not accessible from Non-secure EL1 and EL0 modes.
- 1 The [CNTP_CVAL_ELO](#), [CNTP_TVAL_ELO](#), and [CNTP_CTL_ELO](#) registers are accessible from Non-secure EL1 and EL0 modes.

If EL3 is implemented and EL2 is not implemented, this bit is treated as if it is 1 for all purposes other than reading the register.

Reset value is architecturally UNKNOWN.

EL1PCTEN, bit [0]

Controls whether the physical counter, [CNTPCT_ELO](#), is accessible from Non-secure EL1 and EL0 modes:

- 0 The [CNTPCT_ELO](#) register is not accessible from Non-secure EL1 and EL0 modes.
- 1 The [CNTPCT_ELO](#) register is accessible from Non-secure EL1 and EL0 modes.

If EL3 is implemented and EL2 is not implemented, this bit is treated as if it is 1 for all purposes other than reading the register.

Reset value is architecturally UNKNOWN.

Accessing the CNTHCTL_EL2:

To access the CNTHCTL_EL2:

MRS <Xt>, CNTHCTL_EL2 ; Read CNTHCTL_EL2 into Xt
MSR CNTHCTL_EL2, <Xt> ; Write Xt to CNTHCTL_EL2

Register access is encoded as follows:

op0	op1	CRn	CRm	op2
11	100	1110	0001	000

D8.5.3 CNTHP_CTL_EL2, Counter-timer Hypervisor Physical Timer Control register

The CNTHP_CTL_EL2 characteristics are:

Purpose

Control register for the EL2 physical timer.

This register is part of:

- the Generic Timer registers functional group
- the Virtualization registers functional group.

Usage constraints

This register is accessible as shown below:

EL0	EL1 (NS)	EL1 (S)	EL2	EL3 (SCR.NS=1)	EL3 (SCR.NS=0)
-	-	-	RW	RW	RW

Configurations

CNTHP_CTL_EL2 is architecturally mapped to AArch32 register [CNTHP_CTL](#).

If EL2 is not implemented, this register is RES0 from EL3.

Attributes

CNTHP_CTL_EL2 is a 32-bit register.

The CNTHP_CTL_EL2 bit assignments are:

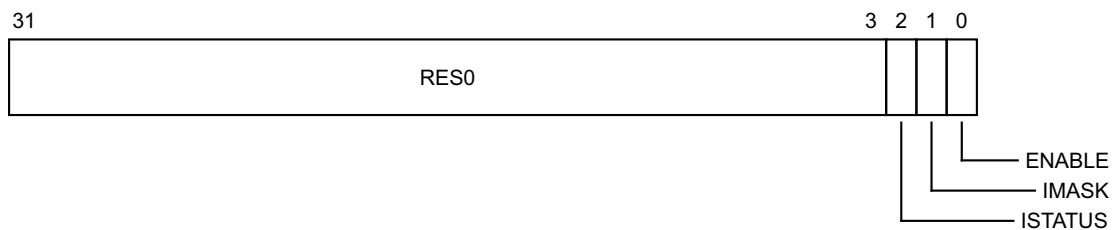

Bits [31:3]

Reserved, RES0.

ISTATUS, bit [2]

The status of the timer interrupt. This bit is read-only. Permitted values are:

- 0 Interrupt not asserted.
- 1 Interrupt asserted.

A register write that sets IMASK to 1 latches this bit to reflect the status of the interrupt immediately before that write.

Reset value is architecturally UNKNOWN.

IMASK, bit [1]

Timer interrupt mask bit. Permitted values are:

- 0 Timer interrupt is not masked.
- 1 Timer interrupt is masked.

Reset value is architecturally UNKNOWN.

ENABLE, bit [0]

Enables the timer. Permitted values are:

0 Timer disabled.

1 Timer enabled.

Disabling the timer masks the timer interrupt, but the timer value continues to count down.

Resets to 0.

Accessing the CNTHP_CTL_EL2:

To access the CNTHP_CTL_EL2:

MRS <Xt>, CNTHP_CTL_EL2 ; Read CNTHP_CTL_EL2 into Xt
MSR CNTHP_CTL_EL2, <Xt> ; Write Xt to CNTHP_CTL_EL2

Register access is encoded as follows:

op0	op1	CRn	CRm	op2
11	100	1110	0010	001

D8.5.4 CNTHP_CVAL_EL2, Counter-timer Hypervisor Physical Timer CompareValue register

The CNTHP_CVAL_EL2 characteristics are:

Purpose

Holds the compare value for the EL2 physical timer.

This register is part of:

- the Generic Timer registers functional group
- the Virtualization registers functional group.

Usage constraints

This register is accessible as shown below:

EL0	EL1 (NS)	EL1 (S)	EL2	EL3 (SCR.NS=1)	EL3 (SCR.NS=0)
-	-	-	RW	RW	RW

Configurations

CNTHP_CVAL_EL2 is architecturally mapped to AArch32 register [CNTHP_CVAL](#).

If EL2 is not implemented, this register is RES0 from EL3.

Attributes

CNTHP_CVAL_EL2 is a 64-bit register.

The CNTHP_CVAL_EL2 bit assignments are:

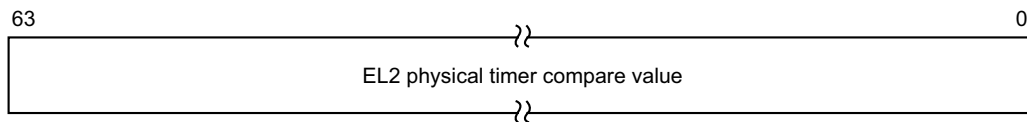

Bits [63:0]

EL2 physical timer compare value.

Accessing the CNTHP_CVAL_EL2:

To access the CNTHP_CVAL_EL2:

MRS <Xt>, CNTHP_CVAL_EL2 ; Read CNTHP_CVAL_EL2 into Xt

MSR CNTHP_CVAL_EL2, <Xt> ; Write Xt to CNTHP_CVAL_EL2

Register access is encoded as follows:

op0	op1	CRn	CRm	op2
11	100	1110	0010	010

D8.5.5 CNTHP_TVAL_EL2, Counter-timer Hypervisor Physical Timer TimerValue register

The CNTHP_TVAL_EL2 characteristics are:

Purpose

Holds the timer value for the EL2 physical timer.

This register is part of:

- the Generic Timer registers functional group
- the Virtualization registers functional group.

Usage constraints

This register is accessible as shown below:

EL0	EL1 (NS)	EL1 (S)	EL2	EL3 (SCR.NS=1)	EL3 (SCR.NS=0)
-	-	-	RW	RW	RW

Configurations

CNTHP_TVAL_EL2 is architecturally mapped to AArch32 register [CNTHP_TVAL](#).

If EL2 is not implemented, this register is RES0 from EL3.

Attributes

CNTHP_TVAL_EL2 is a 32-bit register.

The CNTHP_TVAL_EL2 bit assignments are:

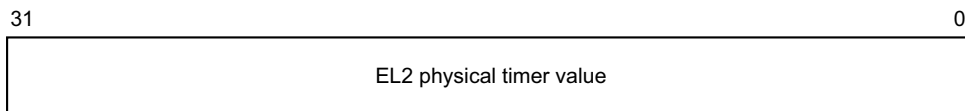

Bits [31:0]

EL2 physical timer value.

Accessing the CNTHP_TVAL_EL2:

To access the CNTHP_TVAL_EL2:

MRS <Xt>, CNTHP_TVAL_EL2 ; Read CNTHP_TVAL_EL2 into Xt
MSR CNTHP_TVAL_EL2, <Xt> ; Write Xt to CNTHP_TVAL_EL2

Register access is encoded as follows:

op0	op1	CRn	CRm	op2
11	100	1110	0010	000

D8.5.6 CNTKCTL_EL1, Counter-timer Kernel Control register

The CNTKCTL_EL1 characteristics are:

Purpose

Controls the generation of an event stream from the virtual counter, and access from EL0 to the physical counter, virtual counter, EL1 physical timers, and the virtual timer.

This register is part of the Generic Timer registers functional group.

Usage constraints

This register is accessible as shown below:

EL0	EL1 (NS)	EL1 (S)	EL2	EL3 (SCR.NS=1)	EL3 (SCR.NS=0)
-	RW	RW	RW	RW	RW

Configurations

CNTKCTL_EL1 is architecturally mapped to AArch32 register [CNTKCTL](#).

Attributes

CNTKCTL_EL1 is a 32-bit register.

The CNTKCTL_EL1 bit assignments are:

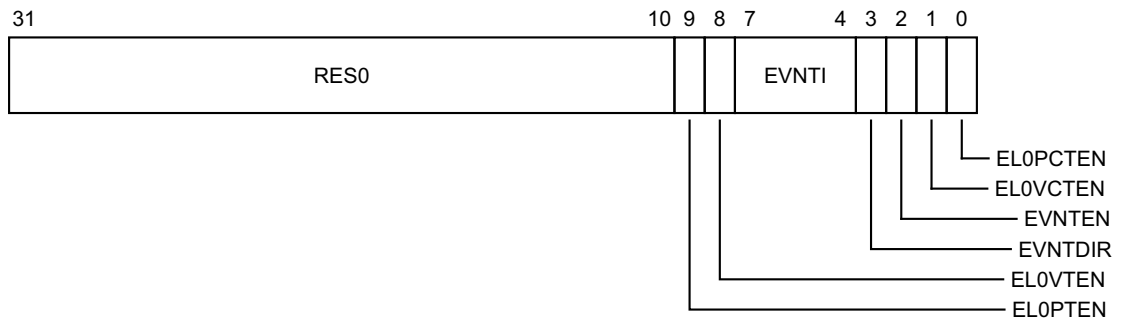

Bits [31:10]

Reserved, RES0.

ELOPTEN, bit [9]

Controls whether the physical timer registers are accessible from EL0 modes:

- 0 The [CNTP_CVAL_EL0](#), [CNTP_CTL_EL0](#), and [CNTP_TVAL_EL0](#) registers are not accessible from EL0.
- 1 The [CNTP_CVAL_EL0](#), [CNTP_CTL_EL0](#), and [CNTP_TVAL_EL0](#) registers are accessible from EL0.

Reset value is architecturally UNKNOWN.

ELOVTEN, bit [8]

Controls whether the virtual timer registers are accessible from EL0 modes:

- 0 The [CNTV_CVAL_EL0](#), [CNTV_CTL_EL0](#), and [CNTV_TVAL_EL0](#) registers are not accessible from EL0.
- 1 The [CNTV_CVAL_EL0](#), [CNTV_CTL_EL0](#), and [CNTV_TVAL_EL0](#) registers are accessible from EL0.

Reset value is architecturally UNKNOWN.

EVNTI, bits [7:4]

Selects which bit (0 to 15) of the corresponding counter register ([CNTPCT_ELO](#) or [CNTVCT_ELO](#)) is the trigger for the event stream generated from that counter, when that stream is enabled.

Reset value is architecturally UNKNOWN.

EVNTDIR, bit [3]

Controls which transition of the counter register ([CNTPCT_ELO](#) or [CNTVCT_ELO](#)) trigger bit, defined by EVNTI, generates an event when the event stream is enabled:

0 A 0 to 1 transition of the trigger bit triggers an event.

1 A 1 to 0 transition of the trigger bit triggers an event.

Reset value is architecturally UNKNOWN.

EVNTEN, bit [2]

Enables the generation of an event stream from the corresponding counter:

0 Disables the event stream.

1 Enables the event stream.

Resets to 0.

EL0VCTEN, bit [1]

Controls whether the virtual counter, [CNTVCT_ELO](#), and the frequency register [CNTFRQ_ELO](#), are accessible from EL0 modes:

0 [CNTVCT_ELO](#) is not accessible from EL0. If [EL0PCTEN](#) is set to 0, [CNTFRQ_ELO](#) is not accessible from EL0.

1 [CNTVCT_ELO](#) and [CNTFRQ_ELO](#) are accessible from EL0.

Reset value is architecturally UNKNOWN.

EL0PCTEN, bit [0]

Controls whether the physical counter, [CNTPCT_ELO](#), and the frequency register [CNTFRQ_ELO](#), are accessible from EL0 modes:

0 [CNTPCT_ELO](#) is not accessible from EL0 modes. If [EL0VCTEN](#) is set to 0, [CNTFRQ_ELO](#) is not accessible from EL0.

1 [CNTPCT_ELO](#) and [CNTFRQ_ELO](#) are accessible from EL0.

Reset value is architecturally UNKNOWN.

Accessing the CNTKCTL_EL1:

To access the CNTKCTL_EL1:

MRS <Xt>, CNTKCTL_EL1 ; Read CNTKCTL_EL1 into Xt

MSR CNTKCTL_EL1, <Xt> ; Write Xt to CNTKCTL_EL1

Register access is encoded as follows:

op0	op1	CRn	CRm	op2
11	000	1110	0001	000

D8.5.7 CNTP_CTL_EL0, Counter-timer Physical Timer Control register

The CNTP_CTL_EL0 characteristics are:

Purpose

Control register for the EL1 physical timer.

This register is part of the Generic Timer registers functional group.

Usage constraints

This register is accessible as shown below:

EL0	EL1 (NS)	EL1 (S)	EL2	EL3 (SCR.NS=1)	EL3 (SCR.NS=0)
Config-RW	Config-RW	RW	RW	RW	RW

This register is accessible at EL0 when [CNTKCTL_EL1.EL0PTEN](#) is set to 1.

If EL2 is implemented, this register is accessible at Non-secure EL1 and EL0 when [CNTHCTL_EL2.EL1PCEN](#) is set to 1.

Configurations

CNTP_CTL_EL0 is architecturally mapped to AArch32 register [CNTP_CTL](#) (NS).

CNTP_CTL_EL0 is architecturally mapped to external register [CNTP_CTL](#).

Attributes

CNTP_CTL_EL0 is a 32-bit register.

The CNTP_CTL_EL0 bit assignments are:

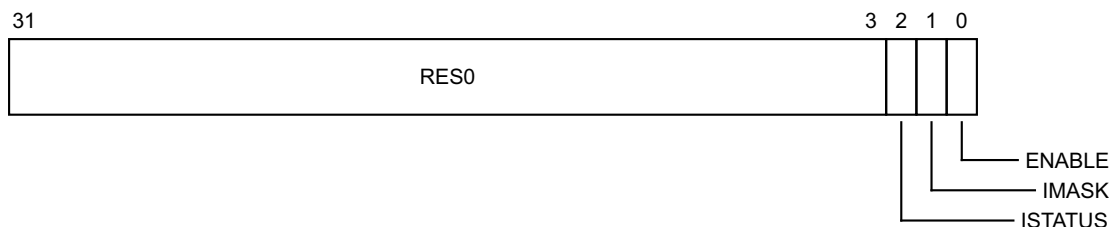

Bits [31:3]

Reserved, RES0.

ISTATUS, bit [2]

The status of the timer interrupt. This bit is read-only. Permitted values are:

- 0 Interrupt not asserted.
- 1 Interrupt asserted.

A register write that sets IMASK to 1 latches this bit to reflect the status of the interrupt immediately before that write.

Reset value is architecturally UNKNOWN.

IMASK, bit [1]

Timer interrupt mask bit. Permitted values are:

- 0 Timer interrupt is not masked.
- 1 Timer interrupt is masked.

Reset value is architecturally UNKNOWN.

ENABLE, bit [0]

Enables the timer. Permitted values are:

0 Timer disabled.

1 Timer enabled.

Disabling the timer masks the timer interrupt, but the timer value continues to count down.

Resets to 0.

Accessing the CNTP_CTL_ELO:

To access the CNTP_CTL_ELO:

MRS <Xt>, CNTP_CTL_ELO ; Read CNTP_CTL_ELO into Xt
MSR CNTP_CTL_ELO, <Xt> ; Write Xt to CNTP_CTL_ELO

Register access is encoded as follows:

op0	op1	CRn	CRm	op2
11	011	1110	0010	001

D8.5.8 CNTP_CVAL_EL0, Counter-timer Physical Timer CompareValue register

The CNTP_CVAL_EL0 characteristics are:

Purpose

Holds the compare value for the EL1 physical timer.

This register is part of the Generic Timer registers functional group.

Usage constraints

This register is accessible as shown below:

EL0	EL1 (NS)	EL1 (S)	EL2	EL3 (SCR.NS=1)	EL3 (SCR.NS=0)
Config-RW	Config-RW	RW	RW	RW	RW

This register is accessible at EL0 when [CNTKCTL_EL1.EL0PTEN](#) is set to 1.

If EL2 is implemented, this register is accessible at Non-secure EL1 and EL0 when [CNTHCTL_EL2.EL1PCEN](#) is set to 1.

Configurations

CNTP_CVAL_EL0 is architecturally mapped to AArch32 register [CNTP_CVAL](#) (NS).

CNTP_CVAL_EL0 is architecturally mapped to external register [CNTP_CVAL](#).

Attributes

CNTP_CVAL_EL0 is a 64-bit register.

The CNTP_CVAL_EL0 bit assignments are:

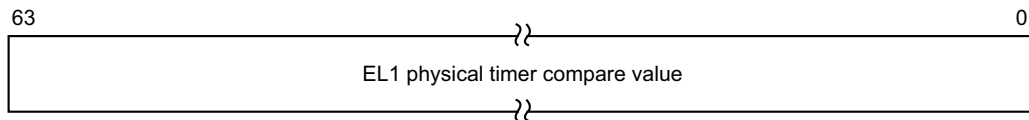

Bits [63:0]

EL1 physical timer compare value.

Accessing the CNTP_CVAL_EL0:

To access the CNTP_CVAL_EL0:

MRS <Xt>, CNTP_CVAL_EL0 ; Read CNTP_CVAL_EL0 into Xt
MSR CNTP_CVAL_EL0, <Xt> ; Write Xt to CNTP_CVAL_EL0

Register access is encoded as follows:

op0	op1	CRn	CRm	op2
11	011	1110	0010	010

D8.5.9 CNTP_TVAL_EL0, Counter-timer Physical Timer TimerValue register

The CNTP_TVAL_EL0 characteristics are:

Purpose

Holds the timer value for the EL1 physical timer.

This register is part of the Generic Timer registers functional group.

Usage constraints

This register is accessible as shown below:

EL0	EL1 (NS)	EL1 (S)	EL2	EL3 (SCR.NS=1)	EL3 (SCR.NS=0)
Config-RW	Config-RW	RW	RW	RW	RW

This register is accessible at EL0 when [CNTKCTL_EL1.EL0PTEN](#) is set to 1.

If EL2 is implemented, this register is accessible at Non-secure EL1 and EL0 when [CNTHCTL_EL2.EL1PCEN](#) is set to 1.

Configurations

CNTP_TVAL_EL0 is architecturally mapped to AArch32 register [CNTP_TVAL](#) (NS).

CNTP_TVAL_EL0 is architecturally mapped to external register [CNTP_TVAL](#).

Attributes

CNTP_TVAL_EL0 is a 32-bit register.

The CNTP_TVAL_EL0 bit assignments are:

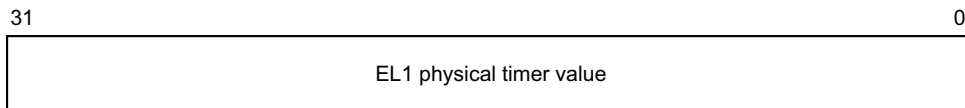

Bits [31:0]

EL1 physical timer value.

Accessing the CNTP_TVAL_EL0:

To access the CNTP_TVAL_EL0:

MRS <Xt>, CNTP_TVAL_EL0 ; Read CNTP_TVAL_EL0 into Xt
MSR CNTP_TVAL_EL0, <Xt> ; Write Xt to CNTP_TVAL_EL0

Register access is encoded as follows:

op0	op1	CRn	CRm	op2
11	011	1110	0010	000

D8.5.10 CNTPCT_EL0, Counter-timer Physical Count register

The CNTPCT_EL0 characteristics are:

Purpose

Holds the 64-bit physical count value.

This register is part of the Generic Timer registers functional group.

Usage constraints

This register is accessible as shown below:

EL0	EL1 (NS)	EL1 (S)	EL2	EL3 (SCR.NS=1)	EL3 (SCR.NS=0)
Config-RO	Config-RO	RO	RO	RO	RO

This register is accessible at EL0 when [CNTKCTL_EL1.EL0PCTEN](#) is set to 1.

If EL2 is implemented, this register is accessible at Non-secure EL1 and EL0 when [CNTHCTL_EL2.EL1PCTEN](#) is set to 1.

Configurations

CNTPCT_EL0 is architecturally mapped to AArch32 register [CNTPCT](#).

CNTPCT_EL0 is architecturally mapped to external register [CNTPCT](#).

Attributes

CNTPCT_EL0 is a 64-bit register.

The CNTPCT_EL0 bit assignments are:

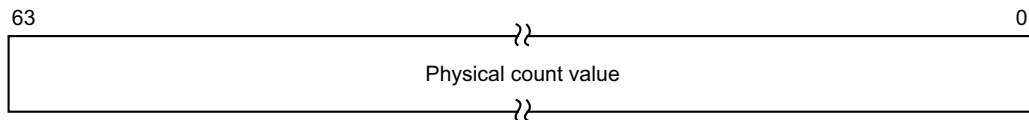

Bits [63:0]

Physical count value.

Accessing the CNTPCT_EL0:

To access the CNTPCT_EL0:

MRS <Xt>, CNTPCT_EL0 ; Read CNTPCT_EL0 into Xt

Register access is encoded as follows:

op0	op1	CRn	CRm	op2
11	011	1110	0000	001

D8.5.11 CNTPS_CTL_EL1, Counter-timer Physical Secure Timer Control register

The CNTPS_CTL_EL1 characteristics are:

Purpose

Control register for the secure physical timer, usually accessible at EL3 but configurably accessible at EL1 in Secure state.

This register is part of the Generic Timer registers functional group.

Usage constraints

This register is accessible as shown below:

EL0	EL1 (NS)	EL1 (S)	EL2	EL3 (SCR.NS=1)	EL3 (SCR.NS=0)
-	-	Config-RW	-	RW	RW

This register is accessible at Secure EL1 when [SCR_EL3.ST](#) is set to 1.

Configurations

There are no configuration notes.

Attributes

CNTPS_CTL_EL1 is a 32-bit register.

The CNTPS_CTL_EL1 bit assignments are:

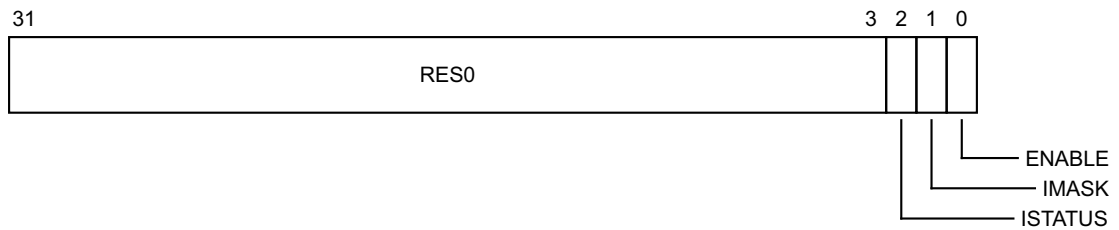

Bits [31:3]

Reserved, RES0.

ISTATUS, bit [2]

The status of the timer interrupt. This bit is read-only. Permitted values are:

- 0 Interrupt not asserted.
- 1 Interrupt asserted.

A register write that sets IMASK to 1 latches this bit to reflect the status of the interrupt immediately before that write.

Reset value is architecturally UNKNOWN.

IMASK, bit [1]

Timer interrupt mask bit. Permitted values are:

- 0 Timer interrupt is not masked.
- 1 Timer interrupt is masked.

Reset value is architecturally UNKNOWN.

ENABLE, bit [0]

Enables the timer. Permitted values are:

0 Timer disabled.

1 Timer enabled.

Disabling the timer masks the timer interrupt, but the timer value continues to count down.

Resets to 0.

Accessing the CNTPS_CTL_EL1:

To access the CNTPS_CTL_EL1:

MRS <Xt>, CNTPS_CTL_EL1 ; Read CNTPS_CTL_EL1 into Xt

MSR CNTPS_CTL_EL1, <Xt> ; Write Xt to CNTPS_CTL_EL1

Register access is encoded as follows:

op0	op1	CRn	CRm	op2
11	111	1110	0010	001

D8.5.12 CNTPS_CVAL_EL1, Counter-timer Physical Secure Timer CompareValue register

The CNTPS_CVAL_EL1 characteristics are:

Purpose

Holds the compare value for the secure physical timer, usually accessible at EL3 but configurably accessible at EL1 in Secure state.

This register is part of the Generic Timer registers functional group.

Usage constraints

This register is accessible as shown below:

EL0	EL1 (NS)	EL1 (S)	EL2	EL3 (SCR.NS=1)	EL3 (SCR.NS=0)
-	-	Config-RW	-	RW	RW

This register is accessible at Secure EL1 when [SCR_EL3.ST](#) is set to 1.

Configurations

There are no configuration notes.

Attributes

CNTPS_CVAL_EL1 is a 64-bit register.

The CNTPS_CVAL_EL1 bit assignments are:

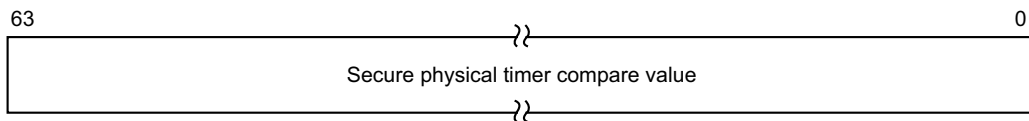

Bits [63:0]

Secure physical timer compare value.

Accessing the CNTPS_CVAL_EL1:

To access the CNTPS_CVAL_EL1:

MRS <Xt>, CNTPS_CVAL_EL1 ; Read CNTPS_CVAL_EL1 into Xt
MSR CNTPS_CVAL_EL1, <Xt> ; Write Xt to CNTPS_CVAL_EL1

Register access is encoded as follows:

op0	op1	CRn	CRm	op2
11	111	1110	0010	010

D8.5.13 CNTPS_TVAL_EL1, Counter-timer Physical Secure Timer TimerValue register

The CNTPS_TVAL_EL1 characteristics are:

Purpose

Holds the timer value for the secure physical timer, usually accessible at EL3 but configurably accessible at EL1 in Secure state.

This register is part of the Generic Timer registers functional group.

Usage constraints

This register is accessible as shown below:

EL0	EL1 (NS)	EL1 (S)	EL2	EL3 (SCR.NS=1)	EL3 (SCR.NS=0)
-	-	Config-RW	-	RW	RW

This register is accessible at Secure EL1 when [SCR_EL3.ST](#) is set to 1.

Configurations

There are no configuration notes.

Attributes

CNTPS_TVAL_EL1 is a 32-bit register.

The CNTPS_TVAL_EL1 bit assignments are:

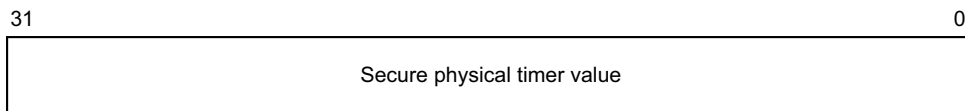

Bits [31:0]

Secure physical timer value.

Accessing the CNTPS_TVAL_EL1:

To access the CNTPS_TVAL_EL1:

MRS <Xt>, CNTPS_TVAL_EL1 ; Read CNTPS_TVAL_EL1 into Xt
MSR CNTPS_TVAL_EL1, <Xt> ; Write Xt to CNTPS_TVAL_EL1

Register access is encoded as follows:

op0	op1	CRn	CRm	op2
11	111	1110	0010	000

D8.5.14 CNTV_CTL_EL0, Counter-timer Virtual Timer Control register

The CNTV_CTL_EL0 characteristics are:

Purpose

Control register for the virtual timer.

This register is part of the Generic Timer registers functional group.

Usage constraints

This register is accessible as shown below:

EL0	EL1 (NS)	EL1 (S)	EL2	EL3 (SCR.NS=1)	EL3 (SCR.NS=0)
Config-RW	RW	RW	RW	RW	RW

This register is accessible at EL0 when `CNTKCTL_EL1.EL0VTEN` is set to 1.

Configurations

CNTV_CTL_EL0 is architecturally mapped to AArch32 register `CNTV_CTL`.

CNTV_CTL_EL0 is architecturally mapped to external register `CNTV_CTL`.

Attributes

CNTV_CTL_EL0 is a 32-bit register.

The CNTV_CTL_EL0 bit assignments are:

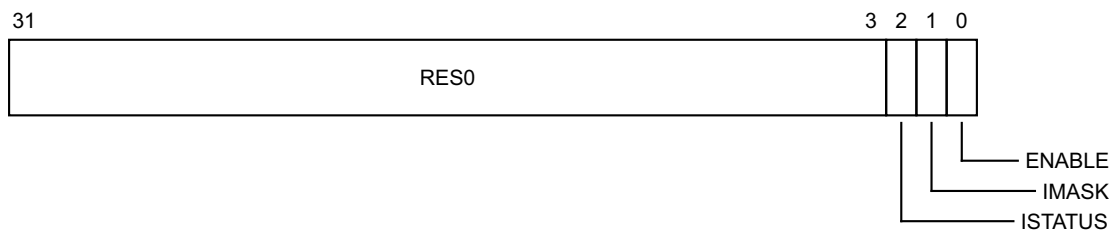

Bits [31:3]

Reserved, RES0.

ISTATUS, bit [2]

The status of the timer interrupt. This bit is read-only. Permitted values are:

0 Interrupt not asserted.

1 Interrupt asserted.

A register write that sets IMASK to 1 latches this bit to reflect the status of the interrupt immediately before that write.

Reset value is architecturally UNKNOWN.

IMASK, bit [1]

Timer interrupt mask bit. Permitted values are:

0 Timer interrupt is not masked.

1 Timer interrupt is masked.

Reset value is architecturally UNKNOWN.

ENABLE, bit [0]

Enables the timer. Permitted values are:

0 Timer disabled.

1 Timer enabled.

Disabling the timer masks the timer interrupt, but the timer value continues to count down.

Resets to 0.

Accessing the CNTV_CTL_EL0:

To access the CNTV_CTL_EL0:

MRS <Xt>, CNTV_CTL_EL0 ; Read CNTV_CTL_EL0 into Xt

MSR CNTV_CTL_EL0, <Xt> ; Write Xt to CNTV_CTL_EL0

Register access is encoded as follows:

op0	op1	CRn	CRm	op2
11	011	1110	0011	001

D8.5.15 CNTV_CVAL_EL0, Counter-timer Virtual Timer CompareValue register

The CNTV_CVAL_EL0 characteristics are:

Purpose

Holds the compare value for the virtual timer.

This register is part of the Generic Timer registers functional group.

Usage constraints

This register is accessible as shown below:

EL0	EL1 (NS)	EL1 (S)	EL2	EL3 (SCR.NS=1)	EL3 (SCR.NS=0)
Config-RW	RW	RW	RW	RW	RW

This register is accessible at EL0 when CNTKCTL_EL1.EL0VTEN is set to 1.

Configurations

CNTV_CVAL_EL0 is architecturally mapped to AArch32 register CNTV_CVAL.

CNTV_CVAL_EL0 is architecturally mapped to external register CNTV_CVAL.

Attributes

CNTV_CVAL_EL0 is a 64-bit register.

The CNTV_CVAL_EL0 bit assignments are:

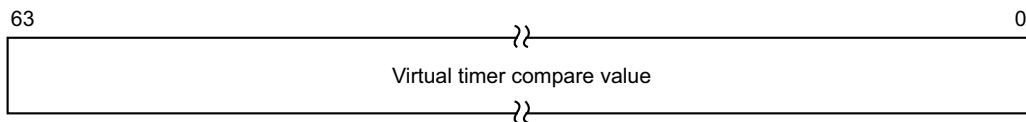

Bits [63:0]

Virtual timer compare value.

Accessing the CNTV_CVAL_EL0:

To access the CNTV_CVAL_EL0:

MRS <Xt>, CNTV_CVAL_EL0 ; Read CNTV_CVAL_EL0 into Xt

MSR CNTV_CVAL_EL0, <Xt> ; Write Xt to CNTV_CVAL_EL0

Register access is encoded as follows:

op0	op1	CRn	CRm	op2
11	011	1110	0011	010

D8.5.16 CNTV_TVAL_EL0, Counter-timer Virtual Timer TimerValue register

The CNTV_TVAL_EL0 characteristics are:

Purpose

Holds the timer value for the virtual timer.

This register is part of the Generic Timer registers functional group.

Usage constraints

This register is accessible as shown below:

EL0	EL1 (NS)	EL1 (S)	EL2	EL3 (SCR.NS=1)	EL3 (SCR.NS=0)
Config-RW	RW	RW	RW	RW	RW

This register is accessible at EL0 when [CNTKCTL_EL1.EL0VTEN](#) is set to 1.

Configurations

CNTV_TVAL_EL0 is architecturally mapped to AArch32 register [CNTV_TVAL](#).

CNTV_TVAL_EL0 is architecturally mapped to external register [CNTV_TVAL](#).

Attributes

CNTV_TVAL_EL0 is a 32-bit register.

The CNTV_TVAL_EL0 bit assignments are:

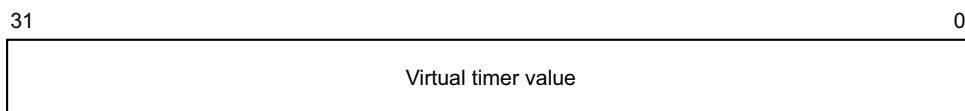

Bits [31:0]

Virtual timer value.

Accessing the CNTV_TVAL_EL0:

To access the CNTV_TVAL_EL0:

MRS <Xt>, CNTV_TVAL_EL0 ; Read CNTV_TVAL_EL0 into Xt

MSR CNTV_TVAL_EL0, <Xt> ; Write Xt to CNTV_TVAL_EL0

Register access is encoded as follows:

op0	op1	CRn	CRm	op2
11	011	1110	0011	000

D8.5.17 CNTVCT_EL0, Counter-timer Virtual Count register

The CNTVCT_EL0 characteristics are:

Purpose

Holds the 64-bit virtual count value.

This register is part of the Generic Timer registers functional group.

Usage constraints

This register is accessible as shown below:

EL0	EL1 (NS)	EL1 (S)	EL2	EL3 (SCR.NS=1)	EL3 (SCR.NS=0)
Config-RO	RO	RO	RO	RO	RO

This register is accessible at EL0 when [CNTKCTL_EL1.EL0VCTEN](#) is set to 1.

Configurations

CNTVCT_EL0 is architecturally mapped to AArch32 register [CNTVCT](#).

CNTVCT_EL0 is architecturally mapped to external register [CNTVCT](#).

Attributes

CNTVCT_EL0 is a 64-bit register.

The CNTVCT_EL0 bit assignments are:

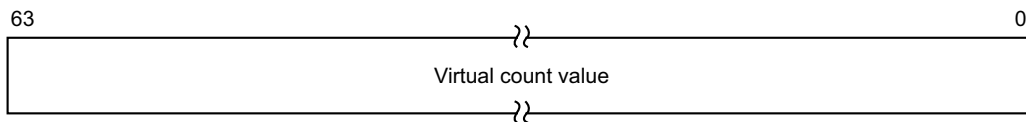

Bits [63:0]

Virtual count value.

Accessing the CNTVCT_EL0:

To access the CNTVCT_EL0:

MRS <Xt>, CNTVCT_EL0 ; Read CNTVCT_EL0 into Xt

Register access is encoded as follows:

op0	op1	CRn	CRm	op2
11	011	1110	0000	010

D8.5.18 CNTVOFF_EL2, Counter-timer Virtual Offset register

The CNTVOFF_EL2 characteristics are:

Purpose

Holds the 64-bit virtual offset.

This register is part of:

- the Generic Timer registers functional group
- the Virtualization registers functional group.

Usage constraints

This register is accessible as shown below:

EL0	EL1 (NS)	EL1 (S)	EL2	EL3 (SCR.NS=1)	EL3 (SCR.NS=0)
-	-	-	RW	RW	RW

Configurations

CNTVOFF_EL2 is architecturally mapped to AArch32 register [CNTVOFF](#).

CNTVOFF_EL2 is architecturally mapped to external register [CNTVOFF](#).

CNTVOFF_EL2 is architecturally mapped to external register [CNTVOFF<n>](#).

If EL2 is not implemented, this register is RES0 from EL3.

Attributes

CNTVOFF_EL2 is a 64-bit register.

The CNTVOFF_EL2 bit assignments are:

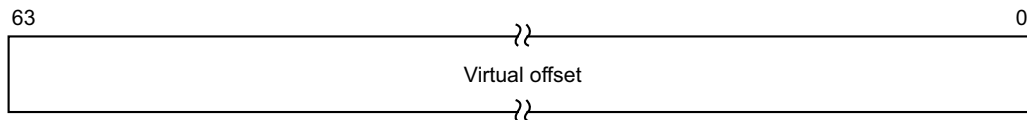

Bits [63:0]

Virtual offset.

Accessing the CNTVOFF_EL2:

To access the CNTVOFF_EL2:

MRS <Xt>, CNTVOFF_EL2 ; Read CNTVOFF_EL2 into Xt

MSR CNTVOFF_EL2, <Xt> ; Write Xt to CNTVOFF_EL2

Register access is encoded as follows:

op0	op1	CRn	CRm	op2
11	100	1110	0000	011

D8.6 Generic Interrupt Controller CPU interface registers

This section lists the GIC CPU interface registers in AArch64 state.

D8.6.1 ICC_AP0R0_EL1, Interrupt Controller Active Priorities Register (0,0)

The ICC_AP0R0_EL1 characteristics are:

Purpose

Provides information about the active priorities for the current interrupt regime.

This register is part of the GIC registers functional group.

Usage constraints

This register is accessible as shown below:

EL0	EL1 (NS)	EL1 (S)	EL2	EL3 (SCR.NS=1)	EL3 (SCR.NS=0)
-	RW	RW	RW	RW	RW

In implementations supporting fewer than 8 bits of priority, some of these registers correspond to unimplemented priority levels. Access to such registers will generate an Undefined exception.

Configurations

ICC_AP0R0_EL1 is architecturally mapped to AArch32 register [ICC_AP0R0](#).

Attributes

ICC_AP0R0_EL1 is a 32-bit register.

The ICC_AP0R0_EL1 bit assignments are:

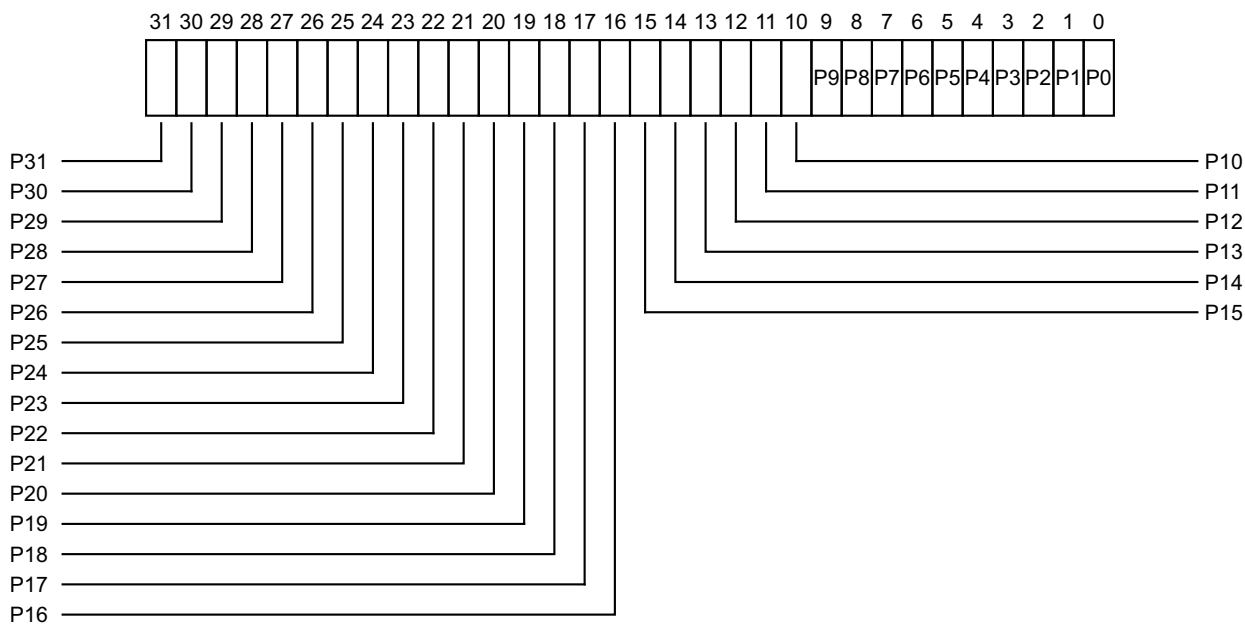

P<n>, bit [n], for n = 0 to 31

Provides information about priority M, according to the following relationship:

Bit P<n> corresponds to priority (M divided by 2^U) minus 1, where U is the number of unimplemented bits of priority and is equal to (7 - ICC_CTLR_EL1.PRIbits).

For example, in a system with ICC_CTLR_EL1.PRIbits == 0b100:

- There are 5 bits of implemented priority.
- This means there are 3 bits of unimplemented priority, which are always at the least significant end (bits [2:0] are RES0).
- Valid priorities are 8, 16, 24, 32, and so on. Dividing these by 2^3 gives 1, 2, 3, 4, and so on.
- Subtracting 1 from each gives bits 0, 1, 2, 3, and so on that provide information about those priorities.

Accesses to these registers from an interrupt regime give a view of the active priorities that is appropriate for that interrupt regime, to allow save and restore of the appropriate state.

Interrupt regime and the number of security states supported by the Distributor affect the view as follows. Unless otherwise stated, when a bit is successfully set to one, this clears any other active priorities corresponding to that bit.

Exception level	AP0Rn access
(Secure) EL3	Permitted. Accesses Group 0 Secure active priorities.
Secure EL1	Permitted. Accesses Group 0 Secure active priorities.
Non-secure EL1 access for a Virtual interrupt	ICH_AP0Rn_EL2
Non-secure EL1 or EL2 when GIC Distributor supports two Security states	Permitted. Accesses Group 0 Secure active priorities.
Non-secure EL1 or EL2 when GIC Distributor supports one Security state	Permitted. Accesses Group 0 active priorities.

A Virtual interrupt in this case means that the interrupt group associated with the register has been virtualized.

Accessing the ICC_AP0R0_EL1:

To access the ICC_AP0R0_EL1:

MRS <Xt>, ICC_AP0R0_EL1 ; Read ICC_AP0R0_EL1 into Xt
MSR ICC_AP0R0_EL1, <Xt> ; Write Xt to ICC_AP0R0_EL1

Register access is encoded as follows:

op0	op1	CRn	CRm	op2
11	000	1100	1000	100

D8.6.2 ICC_AP0R1_EL1, Interrupt Controller Active Priorities Register (0,1)

The ICC_AP0R1_EL1 characteristics are:

Purpose

Provides information about the active priorities for the current interrupt regime.
This register is part of the GIC registers functional group.

Usage constraints

This register is accessible as shown below:

EL0	EL1 (NS)	EL1 (S)	EL2	EL3 (SCR.NS=1)	EL3 (SCR.NS=0)
-	RW	RW	RW	RW	RW

In implementations supporting fewer than 8 bits of priority, some of these registers correspond to unimplemented priority levels. Access to such registers will generate an Undefined exception.

Configurations

ICC_AP0R1_EL1 is architecturally mapped to AArch32 register [ICC_AP0R1](#).

Attributes

ICC_AP0R1_EL1 is a 32-bit register.

The ICC_AP0R1_EL1 bit assignments are:

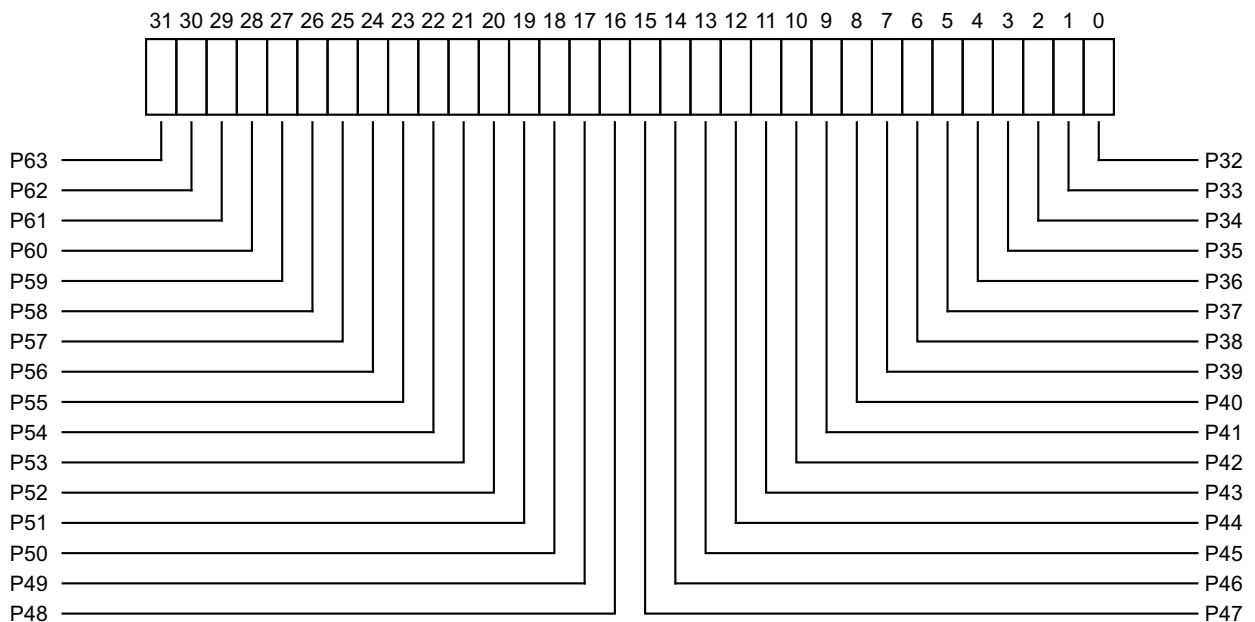

P<n>, bit [(n-32)], for n = 32 to 63

Provides information about priority M, according to the following relationship:

Bit P<n> corresponds to priority (M divided by 2^U) minus 1, where U is the number of unimplemented bits of priority and is equal to (7 - ICC_CTLR_EL1.PRIbits).

For example, in a system with ICC_CTLR_EL1.PRIbits == 0b100:

- There are 5 bits of implemented priority.

- This means there are 3 bits of unimplemented priority, which are always at the least significant end (bits [2:0] are RES0).
- Valid priorities are 8, 16, 24, 32, and so on. Dividing these by 2^3 gives 1, 2, 3, 4, and so on.
- Subtracting 1 from each gives bits 0, 1, 2, 3, and so on that provide information about those priorities.

Accesses to these registers from an interrupt regime give a view of the active priorities that is appropriate for that interrupt regime, to allow save and restore of the appropriate state.

Interrupt regime and the number of security states supported by the Distributor affect the view as follows. Unless otherwise stated, when a bit is successfully set to one, this clears any other active priorities corresponding to that bit.

Exception level	AP0Rn access
(Secure) EL3	Permitted. Accesses Group 0 Secure active priorities.
Secure EL1	Permitted. Accesses Group 0 Secure active priorities.
Non-secure EL1 access for a Virtual interrupt	ICH_AP0Rn_EL2
Non-secure EL1 or EL2 when GIC Distributor supports two Security states	Permitted. Accesses Group 0 Secure active priorities.
Non-secure EL1 or EL2 when GIC Distributor supports one Security state	Permitted. Accesses Group 0 active priorities.

A Virtual interrupt in this case means that the interrupt group associated with the register has been virtualized.

Accessing the ICC_AP0R1_EL1:

To access the ICC_AP0R1_EL1:

MRS <Xt>, ICC_AP0R1_EL1 ; Read ICC_AP0R1_EL1 into Xt
MSR ICC_AP0R1_EL1, <Xt> ; Write Xt to ICC_AP0R1_EL1

Register access is encoded as follows:

op0	op1	CRn	CRm	op2
11	000	1100	1000	101

D8.6.3 ICC_AP0R2_EL1, Interrupt Controller Active Priorities Register (0,2)

The ICC_AP0R2_EL1 characteristics are:

Purpose

Provides information about the active priorities for the current interrupt regime.
This register is part of the GIC registers functional group.

Usage constraints

This register is accessible as shown below:

EL0	EL1 (NS)	EL1 (S)	EL2	EL3 (SCR.NS=1)	EL3 (SCR.NS=0)
-	RW	RW	RW	RW	RW

In implementations supporting fewer than 8 bits of priority, some of these registers correspond to unimplemented priority levels. Access to such registers will generate an Undefined exception.

Configurations

ICC_AP0R2_EL1 is architecturally mapped to AArch32 register [ICC_AP0R2](#).

Attributes

ICC_AP0R2_EL1 is a 32-bit register.

The ICC_AP0R2_EL1 bit assignments are:

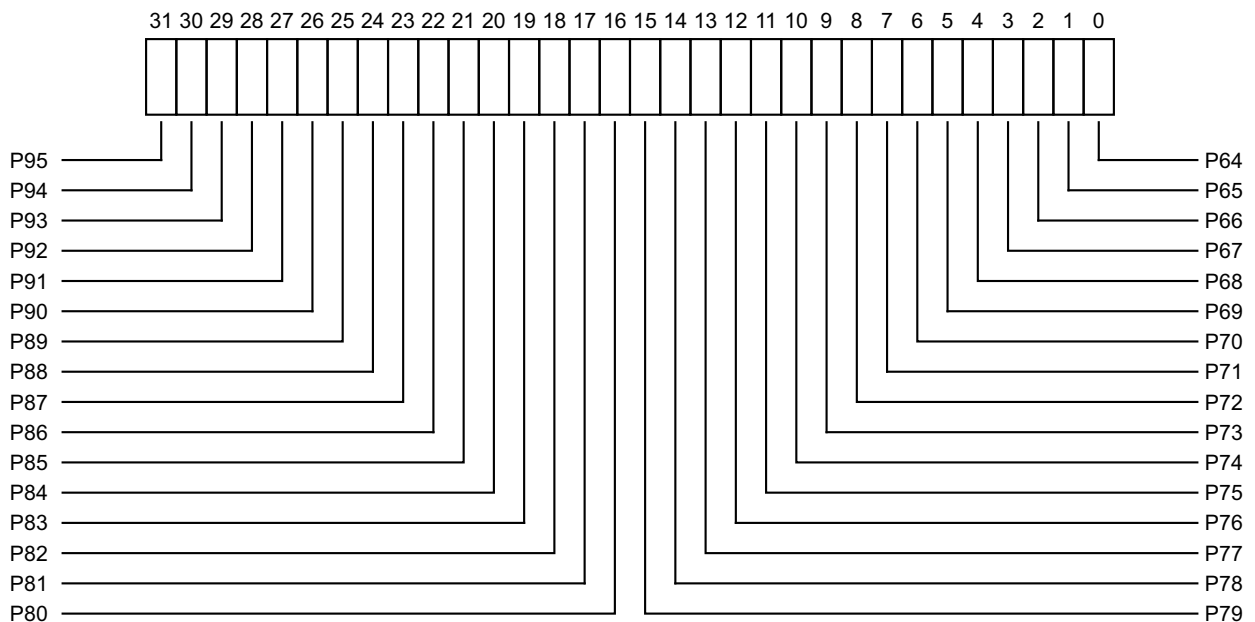

P<n>, bit [(n-64)], for n = 64 to 95

Provides information about priority M, according to the following relationship:

Bit P<n> corresponds to priority (M divided by 2^U) minus 1, where U is the number of unimplemented bits of priority and is equal to (7 - ICC_CTLR_EL1.PRIbits).

For example, in a system with ICC_CTLR_EL1.PRIbits == 0b100:

- There are 5 bits of implemented priority.

- This means there are 3 bits of unimplemented priority, which are always at the least significant end (bits [2:0] are RES0).
- Valid priorities are 8, 16, 24, 32, and so on. Dividing these by 2^3 gives 1, 2, 3, 4, and so on.
- Subtracting 1 from each gives bits 0, 1, 2, 3, and so on that provide information about those priorities.

Accesses to these registers from an interrupt regime give a view of the active priorities that is appropriate for that interrupt regime, to allow save and restore of the appropriate state.

Interrupt regime and the number of security states supported by the Distributor affect the view as follows. Unless otherwise stated, when a bit is successfully set to one, this clears any other active priorities corresponding to that bit.

Exception level	AP0Rn access
(Secure) EL3	Permitted. Accesses Group 0 Secure active priorities.
Secure EL1	Permitted. Accesses Group 0 Secure active priorities.
Non-secure EL1 access for a Virtual interrupt	ICH_AP0Rn_EL2
Non-secure EL1 or EL2 when GIC Distributor supports two Security states	Permitted. Accesses Group 0 Secure active priorities.
Non-secure EL1 or EL2 when GIC Distributor supports one Security state	Permitted. Accesses Group 0 active priorities.

A Virtual interrupt in this case means that the interrupt group associated with the register has been virtualized.

Accessing the ICC_AP0R2_EL1:

To access the ICC_AP0R2_EL1:

MRS <Xt>, ICC_AP0R2_EL1 ; Read ICC_AP0R2_EL1 into Xt
MSR ICC_AP0R2_EL1, <Xt> ; Write Xt to ICC_AP0R2_EL1

Register access is encoded as follows:

op0	op1	CRn	CRm	op2
11	000	1100	1000	110

D8.6.4 ICC_AP0R3_EL1, Interrupt Controller Active Priorities Register (0,3)

The ICC_AP0R3_EL1 characteristics are:

Purpose

Provides information about the active priorities for the current interrupt regime.
This register is part of the GIC registers functional group.

Usage constraints

This register is accessible as shown below:

EL0	EL1 (NS)	EL1 (S)	EL2	EL3 (SCR.NS=1)	EL3 (SCR.NS=0)
-	RW	RW	RW	RW	RW

In implementations supporting fewer than 8 bits of priority, some of these registers correspond to unimplemented priority levels. Access to such registers will generate an Undefined exception.

Configurations

ICC_AP0R3_EL1 is architecturally mapped to AArch32 register [ICC_AP0R3](#).

Attributes

ICC_AP0R3_EL1 is a 32-bit register.

The ICC_AP0R3_EL1 bit assignments are:

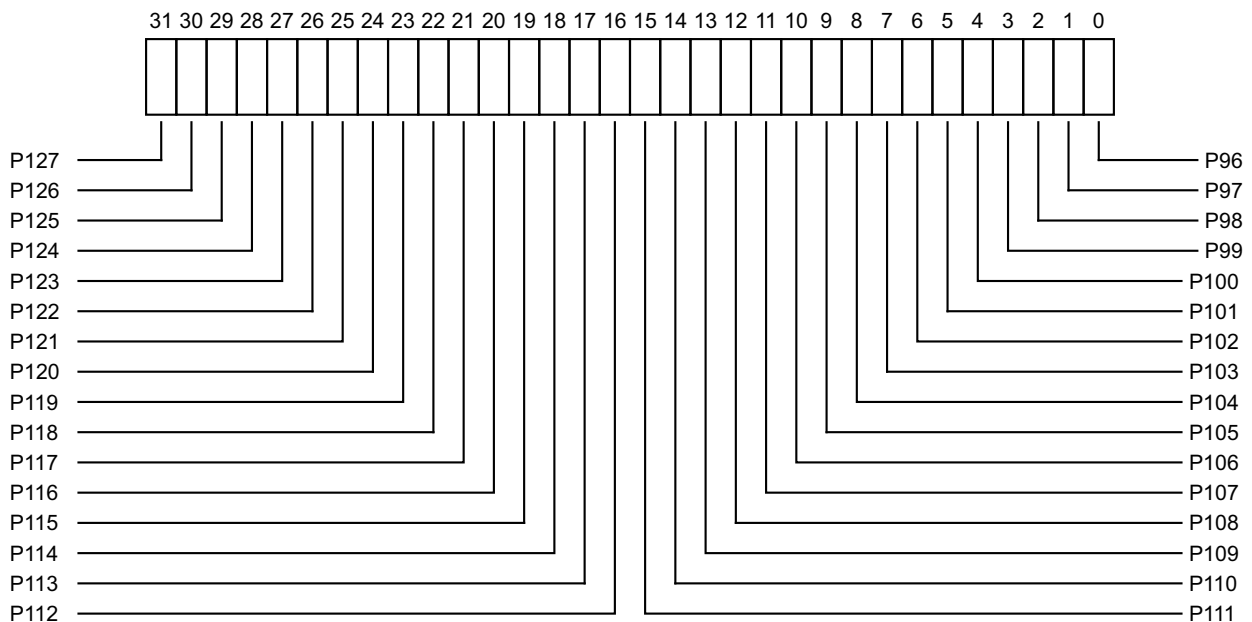

P<n>, bit [(n-96)], for n = 96 to 127

Provides information about priority M, according to the following relationship:

Bit P<n> corresponds to priority (M divided by 2^U) minus 1, where U is the number of unimplemented bits of priority and is equal to (7 - ICC_CTLR_EL1.PRIbits).

For example, in a system with ICC_CTLR_EL1.PRIbits == 0b100:

- There are 5 bits of implemented priority.

- This means there are 3 bits of unimplemented priority, which are always at the least significant end (bits [2:0] are RES0).
- Valid priorities are 8, 16, 24, 32, and so on. Dividing these by 2^3 gives 1, 2, 3, 4, and so on.
- Subtracting 1 from each gives bits 0, 1, 2, 3, and so on that provide information about those priorities.

Accesses to these registers from an interrupt regime give a view of the active priorities that is appropriate for that interrupt regime, to allow save and restore of the appropriate state.

Interrupt regime and the number of security states supported by the Distributor affect the view as follows. Unless otherwise stated, when a bit is successfully set to one, this clears any other active priorities corresponding to that bit.

Exception level	AP0Rn access
(Secure) EL3	Permitted. Accesses Group 0 Secure active priorities.
Secure EL1	Permitted. Accesses Group 0 Secure active priorities.
Non-secure EL1 access for a Virtual interrupt	ICH_AP0Rn_EL2
Non-secure EL1 or EL2 when GIC Distributor supports two Security states	Permitted. Accesses Group 0 Secure active priorities.
Non-secure EL1 or EL2 when GIC Distributor supports one Security state	Permitted. Accesses Group 0 active priorities.

A Virtual interrupt in this case means that the interrupt group associated with the register has been virtualized.

Accessing the ICC_AP0R3_EL1:

To access the ICC_AP0R3_EL1:

MRS <Xt>, ICC_AP0R3_EL1 ; Read ICC_AP0R3_EL1 into Xt
MSR ICC_AP0R3_EL1, <Xt> ; Write Xt to ICC_AP0R3_EL1

Register access is encoded as follows:

op0	op1	CRn	CRm	op2
11	000	1100	1000	111

D8.6.5 ICC_AP1R0_EL1, Interrupt Controller Active Priorities Register (1,0)

The ICC_AP1R0_EL1 characteristics are:

Purpose

Provides information about the active priorities for the current interrupt regime.
This register is part of the GIC registers functional group.

Usage constraints

This register is accessible as shown below:

EL0	EL1 (NS)	EL1 (S)	EL2	EL3 (SCR.NS=1)	EL3 (SCR.NS=0)
-	RW	RW	RW	RW	RW

In implementations supporting fewer than 8 bits of priority, some of these registers correspond to unimplemented priority levels. Access to such registers will generate an Undefined exception.

Configurations

ICC_AP1R0_EL1 is architecturally mapped to AArch32 register [ICC_AP1R0](#).

Attributes

ICC_AP1R0_EL1 is a 32-bit register.

The ICC_AP1R0_EL1 bit assignments are:

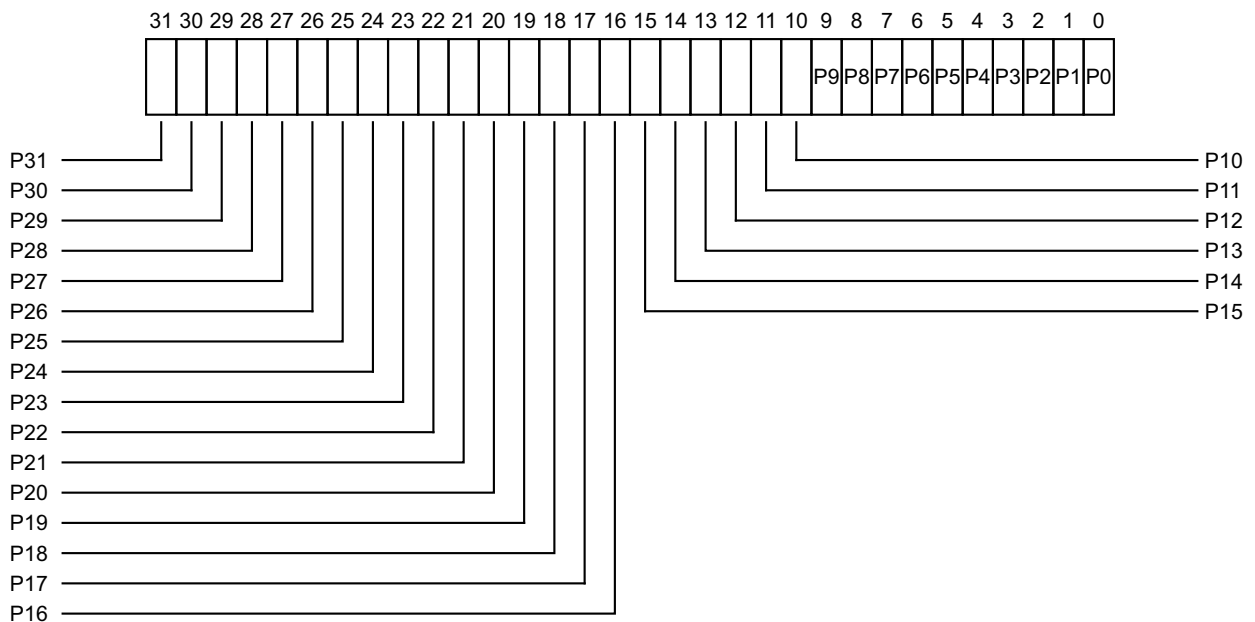

P<n>, bit [n], for n = 0 to 31

Provides information about priority M, according to the following relationship:

Bit P<n> corresponds to priority (M divided by 2^U) minus 1, where U is the number of unimplemented bits of priority and is equal to (7 - ICC_CTLR_EL1.PRIbits).

For example, in a system with ICC_CTLR_EL1.PRIbits == 0b100:

- There are 5 bits of implemented priority.

- This means there are 3 bits of unimplemented priority, which are always at the least significant end (bits [2:0] are RES0).
- Valid priorities are 8, 16, 24, 32, and so on. Dividing these by 2^3 gives 1, 2, 3, 4, and so on.
- Subtracting 1 from each gives bits 0, 1, 2, 3, and so on that provide information about those priorities.

Accesses to these registers from an interrupt regime give a view of the active priorities that is appropriate for that interrupt regime, to allow save and restore of the appropriate state.

Interrupt regime and the number of security states supported by the Distributor affect the view as follows. Unless otherwise stated, when a bit is successfully set to one, this clears any other active priorities corresponding to that bit.

Current exception level and security state	AP1Rn access
(Secure) EL3	Permitted. When SCR_EL3.NS is 0, accesses Group 1 Secure active priorities. When SCR_EL3.NS is 1, accesses Group 1 Non-secure active priorities (unshifted). When a bit is written, the bit is only updated if the corresponding Group 0 and Group 1 Secure active priority is zero.
Secure EL1	Permitted. Accesses Group 1 Secure active priorities (unshifted). When a bit is written, the bit is only updated if the corresponding Group 0 Secure active priority is zero.
Non-secure EL1 access for a Virtual interrupt	ICH_AP1Rn_EL2
Non-secure EL1 or EL2 when GIC Distributor supports two Security states	Permitted. Accesses Group 1 Non-secure active priorities (shifted). When a bit is written, the bit is only updated if the corresponding Group 0 and Group 1 Secure active priority is zero.
Non-secure EL1 or EL2 when GIC Distributor supports one Security state	Permitted. Accesses Group 1 Non-secure active priorities (unshifted). When a bit is written, the bit is only updated if the Group 0 active priority is zero.

A Virtual interrupt in this case means that the interrupt group associated with the register has been virtualized.

Accessing the ICC_AP1R0_EL1:

To access the ICC_AP1R0_EL1:

MRS <Xt>, ICC_AP1R0_EL1 ; Read ICC_AP1R0_EL1 into Xt
MSR ICC_AP1R0_EL1, <Xt> ; Write Xt to ICC_AP1R0_EL1

Register access is encoded as follows:

op0	op1	CRn	CRm	op2
11	000	1100	1001	000

D8.6.6 ICC_AP1R1_EL1, Interrupt Controller Active Priorities Register (1,1)

The ICC_AP1R1_EL1 characteristics are:

Purpose

Provides information about the active priorities for the current interrupt regime.
This register is part of the GIC registers functional group.

Usage constraints

This register is accessible as shown below:

EL0	EL1 (NS)	EL1 (S)	EL2	EL3 (SCR.NS=1)	EL3 (SCR.NS=0)
-	RW	RW	RW	RW	RW

In implementations supporting fewer than 8 bits of priority, some of these registers correspond to unimplemented priority levels. Access to such registers will generate an Undefined exception.

Configurations

ICC_AP1R1_EL1 is architecturally mapped to AArch32 register [ICC_AP1R1](#).

Attributes

ICC_AP1R1_EL1 is a 32-bit register.

The ICC_AP1R1_EL1 bit assignments are:

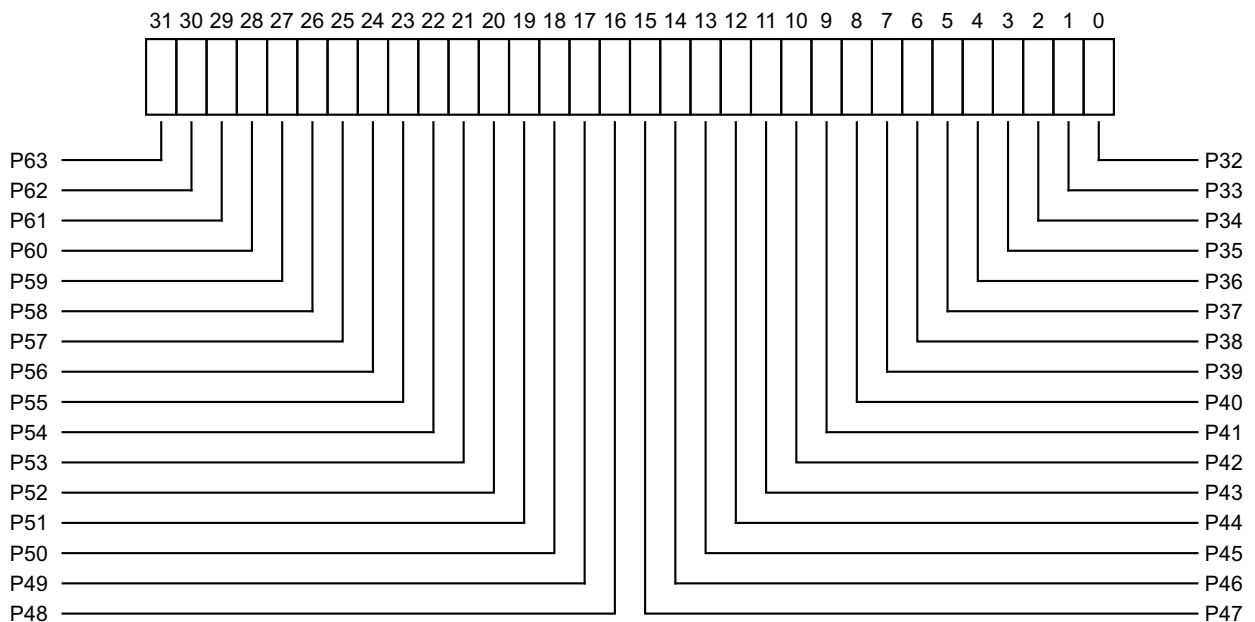

P<n>, bit [(n-32)], for n = 32 to 63

Provides information about priority M, according to the following relationship:

Bit P<n> corresponds to priority (M divided by 2^U) minus 1, where U is the number of unimplemented bits of priority and is equal to (7 - ICC_CTLR_EL1.PRIbits).

For example, in a system with ICC_CTLR_EL1.PRIbits == 0b100:

- There are 5 bits of implemented priority.

- This means there are 3 bits of unimplemented priority, which are always at the least significant end (bits [2:0] are RES0).
- Valid priorities are 8, 16, 24, 32, and so on. Dividing these by 2^3 gives 1, 2, 3, 4, and so on.
- Subtracting 1 from each gives bits 0, 1, 2, 3, and so on that provide information about those priorities.

Accesses to these registers from an interrupt regime give a view of the active priorities that is appropriate for that interrupt regime, to allow save and restore of the appropriate state.

Interrupt regime and the number of security states supported by the Distributor affect the view as follows. Unless otherwise stated, when a bit is successfully set to one, this clears any other active priorities corresponding to that bit.

Current exception level and security state	AP1Rn access
(Secure) EL3	Permitted. When SCR_EL3.NS is 0, accesses Group 1 Secure active priorities. When SCR_EL3.NS is 1, accesses Group 1 Non-secure active priorities (unshifted). When a bit is written, the bit is only updated if the corresponding Group 0 and Group 1 Secure active priority is zero.
Secure EL1	Permitted. Accesses Group 1 Secure active priorities (unshifted). When a bit is written, the bit is only updated if the corresponding Group 0 Secure active priority is zero.
Non-secure EL1 access for a Virtual interrupt	ICH_AP1Rn_EL2
Non-secure EL1 or EL2 when GIC Distributor supports two Security states	Permitted. Accesses Group 1 Non-secure active priorities (shifted). When a bit is written, the bit is only updated if the corresponding Group 0 and Group 1 Secure active priority is zero.
Non-secure EL1 or EL2 when GIC Distributor supports one Security state	Permitted. Accesses Group 1 Non-secure active priorities (unshifted). When a bit is written, the bit is only updated if the Group 0 active priority is zero.

A Virtual interrupt in this case means that the interrupt group associated with the register has been virtualized.

Accessing the ICC_AP1R1_EL1:

To access the ICC_AP1R1_EL1:

MRS <Xt>, ICC_AP1R1_EL1 ; Read ICC_AP1R1_EL1 into Xt
MSR ICC_AP1R1_EL1, <Xt> ; Write Xt to ICC_AP1R1_EL1

Register access is encoded as follows:

op0	op1	CRn	CRm	op2
11	000	1100	1001	001

D8.6.7 ICC_AP1R2_EL1, Interrupt Controller Active Priorities Register (1,2)

The ICC_AP1R2_EL1 characteristics are:

Purpose

Provides information about the active priorities for the current interrupt regime.
This register is part of the GIC registers functional group.

Usage constraints

This register is accessible as shown below:

EL0	EL1 (NS)	EL1 (S)	EL2	EL3 (SCR.NS=1)	EL3 (SCR.NS=0)
-	RW	RW	RW	RW	RW

In implementations supporting fewer than 8 bits of priority, some of these registers correspond to unimplemented priority levels. Access to such registers will generate an Undefined exception.

Configurations

ICC_AP1R2_EL1 is architecturally mapped to AArch32 register [ICC_AP1R2](#).

Attributes

ICC_AP1R2_EL1 is a 32-bit register.

The ICC_AP1R2_EL1 bit assignments are:

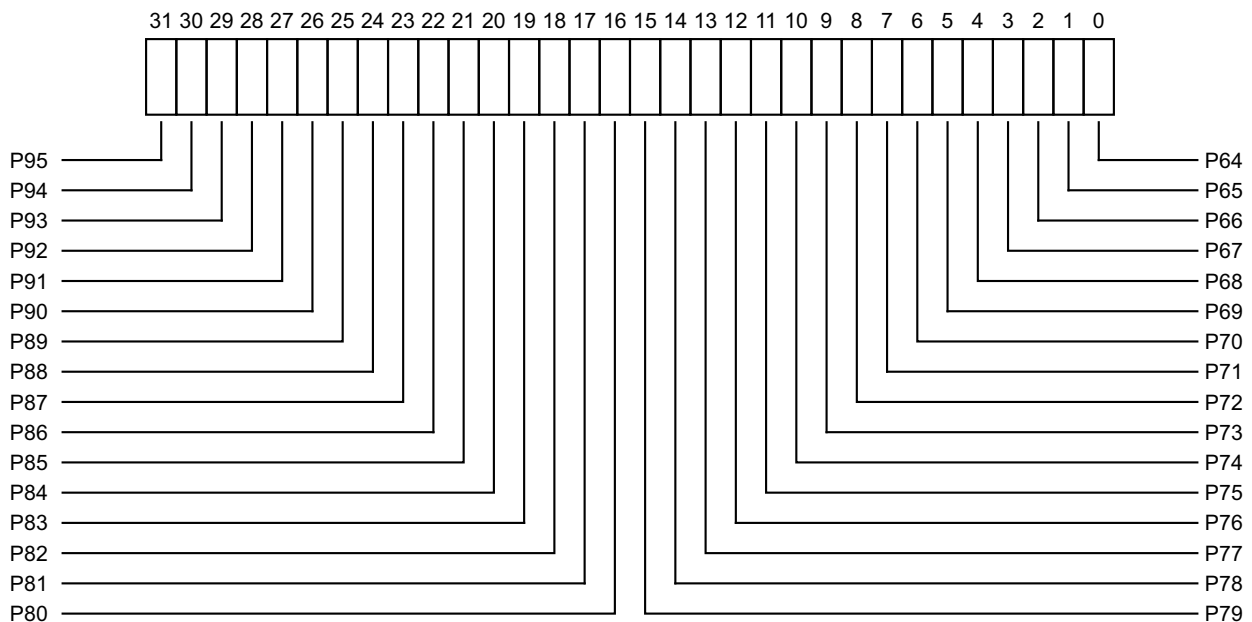

P<n>, bit [(n-64)], for n = 64 to 95

Provides information about priority M, according to the following relationship:

Bit P<n> corresponds to priority (M divided by 2^U) minus 1, where U is the number of unimplemented bits of priority and is equal to (7 - ICC_CTLR_EL1.PRIbits).

For example, in a system with ICC_CTLR_EL1.PRIbits == 0b100:

- There are 5 bits of implemented priority.

- This means there are 3 bits of unimplemented priority, which are always at the least significant end (bits [2:0] are RES0).
- Valid priorities are 8, 16, 24, 32, and so on. Dividing these by 2^3 gives 1, 2, 3, 4, and so on.
- Subtracting 1 from each gives bits 0, 1, 2, 3, and so on that provide information about those priorities.

Accesses to these registers from an interrupt regime give a view of the active priorities that is appropriate for that interrupt regime, to allow save and restore of the appropriate state.

Interrupt regime and the number of security states supported by the Distributor affect the view as follows. Unless otherwise stated, when a bit is successfully set to one, this clears any other active priorities corresponding to that bit.

Current exception level and security state	AP1Rn access
(Secure) EL3	Permitted. When SCR_EL3.NS is 0, accesses Group 1 Secure active priorities. When SCR_EL3.NS is 1, accesses Group 1 Non-secure active priorities (unshifted). When a bit is written, the bit is only updated if the corresponding Group 0 and Group 1 Secure active priority is zero.
Secure EL1	Permitted. Accesses Group 1 Secure active priorities (unshifted). When a bit is written, the bit is only updated if the corresponding Group 0 Secure active priority is zero.
Non-secure EL1 access for a Virtual interrupt	ICH_AP1Rn_EL2
Non-secure EL1 or EL2 when GIC Distributor supports two Security states	Permitted. Accesses Group 1 Non-secure active priorities (shifted). When a bit is written, the bit is only updated if the corresponding Group 0 and Group 1 Secure active priority is zero.
Non-secure EL1 or EL2 when GIC Distributor supports one Security state	Permitted. Accesses Group 1 Non-secure active priorities (unshifted). When a bit is written, the bit is only updated if the Group 0 active priority is zero.

A Virtual interrupt in this case means that the interrupt group associated with the register has been virtualized.

Accessing the ICC_AP1R2_EL1:

To access the ICC_AP1R2_EL1:

MRS <Xt>, ICC_AP1R2_EL1 ; Read ICC_AP1R2_EL1 into Xt
MSR ICC_AP1R2_EL1, <Xt> ; Write Xt to ICC_AP1R2_EL1

Register access is encoded as follows:

op0	op1	CRn	CRm	op2
11	000	1100	1001	010

D8.6.8 ICC_AP1R3_EL1, Interrupt Controller Active Priorities Register (1,3)

The ICC_AP1R3_EL1 characteristics are:

Purpose

Provides information about the active priorities for the current interrupt regime.
This register is part of the GIC registers functional group.

Usage constraints

This register is accessible as shown below:

EL0	EL1 (NS)	EL1 (S)	EL2	EL3 (SCR.NS=1)	EL3 (SCR.NS=0)
-	RW	RW	RW	RW	RW

In implementations supporting fewer than 8 bits of priority, some of these registers correspond to unimplemented priority levels. Access to such registers will generate an Undefined exception.

Configurations

ICC_AP1R3_EL1 is architecturally mapped to AArch32 register [ICC_AP1R3](#).

Attributes

ICC_AP1R3_EL1 is a 32-bit register.

The ICC_AP1R3_EL1 bit assignments are:

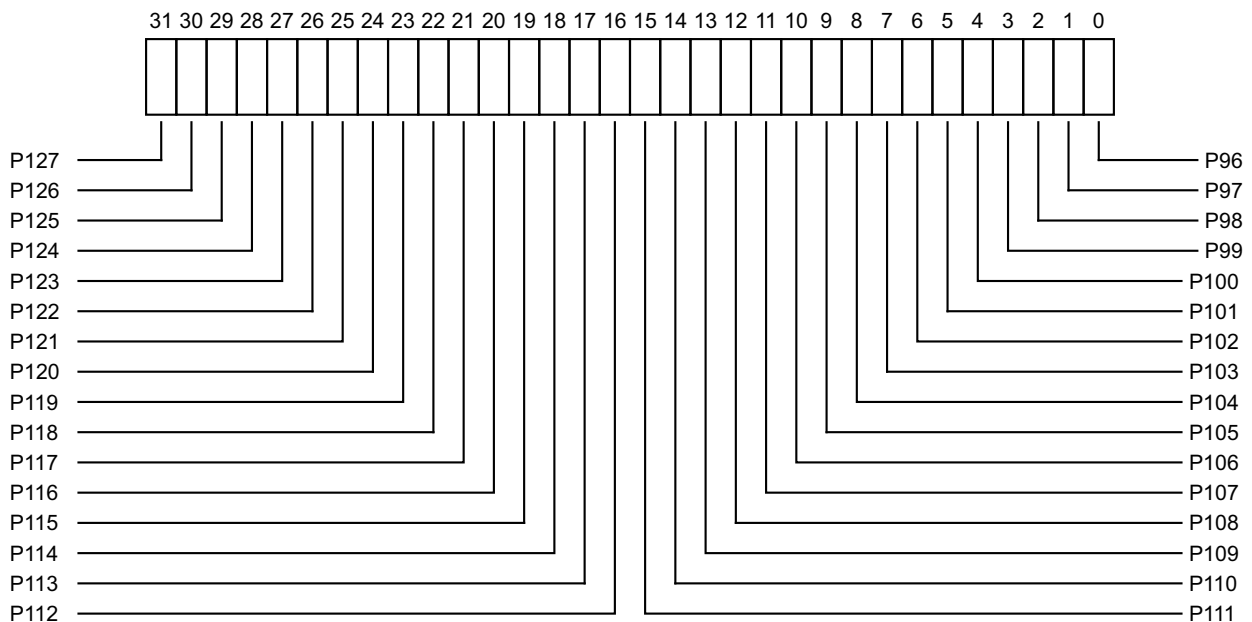

P<n>, bit [(n-96)], for n = 96 to 127

Provides information about priority M, according to the following relationship:

Bit P<n> corresponds to priority (M divided by 2^U) minus 1, where U is the number of unimplemented bits of priority and is equal to (7 - ICC_CTLR_EL1.PRIbits).

For example, in a system with ICC_CTLR_EL1.PRIbits == 0b100:

- There are 5 bits of implemented priority.

- This means there are 3 bits of unimplemented priority, which are always at the least significant end (bits [2:0] are RES0).
- Valid priorities are 8, 16, 24, 32, and so on. Dividing these by 2^3 gives 1, 2, 3, 4, and so on.
- Subtracting 1 from each gives bits 0, 1, 2, 3, and so on that provide information about those priorities.

Accesses to these registers from an interrupt regime give a view of the active priorities that is appropriate for that interrupt regime, to allow save and restore of the appropriate state.

Interrupt regime and the number of security states supported by the Distributor affect the view as follows. Unless otherwise stated, when a bit is successfully set to one, this clears any other active priorities corresponding to that bit.

Current exception level and security state	AP1Rn access
(Secure) EL3	Permitted. When SCR_EL3.NS is 0, accesses Group 1 Secure active priorities. When SCR_EL3.NS is 1, accesses Group 1 Non-secure active priorities (unshifted). When a bit is written, the bit is only updated if the corresponding Group 0 and Group 1 Secure active priority is zero.
Secure EL1	Permitted. Accesses Group 1 Secure active priorities (unshifted). When a bit is written, the bit is only updated if the corresponding Group 0 Secure active priority is zero.
Non-secure EL1 access for a Virtual interrupt	ICH_AP1Rn_EL2
Non-secure EL1 or EL2 when GIC Distributor supports two Security states	Permitted. Accesses Group 1 Non-secure active priorities (shifted). When a bit is written, the bit is only updated if the corresponding Group 0 and Group 1 Secure active priority is zero.
Non-secure EL1 or EL2 when GIC Distributor supports one Security state	Permitted. Accesses Group 1 Non-secure active priorities (unshifted). When a bit is written, the bit is only updated if the Group 0 active priority is zero.

A Virtual interrupt in this case means that the interrupt group associated with the register has been virtualized.

Accessing the ICC_AP1R3_EL1:

To access the ICC_AP1R3_EL1:

MRS <Xt>, ICC_AP1R3_EL1 ; Read ICC_AP1R3_EL1 into Xt
MSR ICC_AP1R3_EL1, <Xt> ; Write Xt to ICC_AP1R3_EL1

Register access is encoded as follows:

op0	op1	CRn	CRm	op2
11	000	1100	1001	011

D8.6.9 ICC_ASGI1R_EL1, Interrupt Controller Alias Software Generated Interrupt group 1 Register

The ICC_ASGI1R_EL1 characteristics are:

Purpose

Provides software the ability to generate group 1 SGIs for the other security state.
This register is part of the GIC registers functional group.

Usage constraints

This register is accessible as shown below:

When accessed as ICC_ASGI1R_EL1(S):

EL1 (NS)	EL1 (S)	EL2	EL3 (SCR.NS=1)	EL3 (SCR.NS=0)
-	WO	-	-	WO

When accessed as ICC_ASGI1R_EL1(NS):

EL1 (NS)	EL1 (S)	EL2	EL3 (SCR.NS=1)	EL3 (SCR.NS=0)
WO	-	WO	WO	-

Configurations

ICC_ASGI1R_EL1(S) is architecturally mapped to AArch32 register [ICC_ASGI1R \(S\)](#).

ICC_ASGI1R_EL1(NS) is architecturally mapped to AArch32 register [ICC_ASGI1R \(NS\)](#).

There are separate Secure and Non-secure instances of this register.

Attributes

ICC_ASGI1R_EL1 is a 64-bit register.

The ICC_ASGI1R_EL1 bit assignments are:

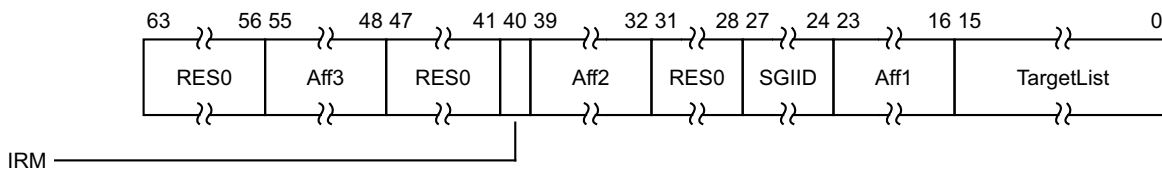

Bits [63:56]

Reserved, RES0.

Aff3, bits [55:48]

The affinity 3 value of the affinity path of the cluster for which SGI interrupts will be generated.

Bits [47:41]

Reserved, RES0.

IRM, bit [40]

Interrupt Routing Mode. Determines how the generated interrupts should be distributed to processors. Possible values are:

- 0 Interrupts routed to the processors specified by a.b.c.{target list}. In this routing, a, b, and c are the values of fields Aff3, Aff2, and Aff1 respectively.

1 Interrupts routed to all processors in the system, excluding "self".

Aff2, bits [39:32]

The affinity 2 value of the affinity path of the cluster for which SGI interrupts will be generated.

Bits [31:28]

Reserved, RES0.

SGIID, bits [27:24]

SGI Interrupt ID.

Aff1, bits [23:16]

The affinity 1 value of the affinity path of the cluster for which SGI interrupts will be generated.

TargetList, bits [15:0]

Target List. The set of processors for which SGI interrupts will be generated. Each bit corresponds to the processor within a cluster with an Affinity 0 value equal to the bit number.

If a bit is 1 and the bit does not correspond to a valid target processor, the bit must be ignored by the Distributor. In such cases, a Distributor may optionally generate an SGI.

This restricts distribution of SGIs to the first 16 processors of an affinity 1 cluster.

Accessing the ICC_ASGI1R_EL1:

To access the ICC_ASGI1R_EL1:

MSR ICC_ASGI1R_EL1, <Xt> ; Write Xt to ICC_ASGI1R_EL1

Register access is encoded as follows:

op0	op1	CRn	CRm	op2
11	000	1100	1011	110

D8.6.10 ICC_BPR0_EL1, Interrupt Controller Binary Point Register 0

The ICC_BPR0_EL1 characteristics are:

Purpose

Defines the point at which the priority value fields split into two parts, the group priority field and the subpriority field. The group priority field is used to determine interrupt preemption.

This register is part of the GIC registers functional group.

Usage constraints

This register is accessible as shown below:

When accessed as ICC_BPR0_EL1(S):

EL1 (NS)	EL1 (S)	EL2	EL3 (SCR.NS=1)	EL3 (SCR.NS=0)
-	RW	-	-	RW

When accessed as ICC_BPR0_EL1(NS):

EL1 (NS)	EL1 (S)	EL2	EL3 (SCR.NS=1)	EL3 (SCR.NS=0)
RW	-	RW	RW	-

In Secure state, this register is the binary point register for Group 0 interrupts. In Non-secure state, this is the BPR for Group 1 interrupts.

The minimum binary point value is IMPLEMENTATION DEFINED in the range:

- 0-3 if the implementation supports one security state, and for the Secure copy of the register if the implementation supports two security states.
- 1-4 for the Non-secure copy of the register.

An attempt to program the binary point field to a value less than the minimum value sets the field to the minimum value. On a reset, the binary point field is set to the minimum supported value.

Configurations

ICC_BPR0_EL1(S) is architecturally mapped to AArch32 register [ICC_BPR0](#) (S).

ICC_BPR0_EL1(NS) is architecturally mapped to AArch32 register [ICC_BPR0](#) (NS).

There are separate Secure and Non-secure instances of this register.

Attributes

ICC_BPR0_EL1 is a 32-bit register.

The ICC_BPR0_EL1 bit assignments are:

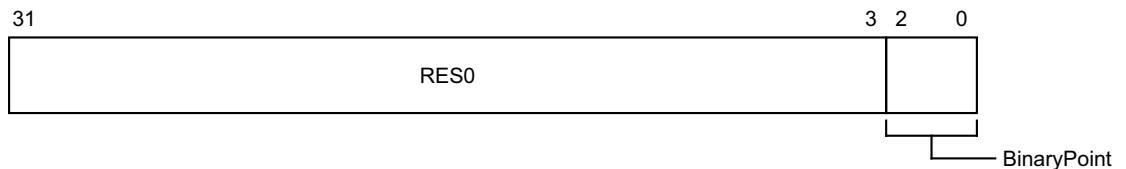

Bits [31:3]

Reserved, RES0.

BinaryPoint, bits [2:0]

The value of this field controls how the 8-bit interrupt priority field is split into a group priority field, used to determine interrupt preemption, and a subpriority field. This is done as follows:

Binary point value	Group priority field	Subpriority field	Field with binary point
0	[7:1]	[0]	ggggggg.s
1	[7:2]	[1:0]	ggggg.ss
2	[7:3]	[2:0]	ggggg.sss
3	[7:4]	[3:0]	gggg.ssss
4	[7:5]	[4:0]	ggg.sssss
5	[7:6]	[5:0]	gg.ssssss
6	[7]	[6:0]	g.ssssss
7	No preemption	[7:0]	.sssssss

Accessing the ICC_BPR0_EL1:

To access the ICC_BPR0_EL1:

MRS <Xt>, ICC_BPR0_EL1 ; Read ICC_BPR0_EL1 into Xt
MSR ICC_BPR0_EL1, <Xt> ; Write Xt to ICC_BPR0_EL1

Register access is encoded as follows:

op0	op1	CRn	CRm	op2
11	000	1100	1000	011

D8.6.11 ICC_BPR1_EL1, Interrupt Controller Binary Point Register 1

The ICC_BPR1_EL1 characteristics are:

Purpose

Defines the point at which the priority value fields split into two parts, the group priority field and the subpriority field. The group priority field is used to determine Group 1 interrupt preemption.

This register is part of the GIC registers functional group.

Usage constraints

This register is accessible as shown below:

EL0	EL1 (NS)	EL1 (S)	EL2	EL3 (SCR.NS=1)	EL3 (SCR.NS=0)
-	RW	RW	RW	RW	RW

This register is an alias of the Non-secure view of [ICC_BPR0_EL1](#), and a Secure access to this register is identical to a Non-secure access to [ICC_BPR0_EL1](#).

The minimum binary point value is IMPLEMENTATION DEFINED in the range 1-4.

An attempt to program the binary point field to a value less than the minimum value sets the field to the minimum value. On a reset, the binary point field is set to the minimum supported value.

Configurations

ICC_BPR1_EL1 is architecturally mapped to AArch32 register [ICC_BPR1](#).

Attributes

ICC_BPR1_EL1 is a 32-bit register.

The ICC_BPR1_EL1 bit assignments are:

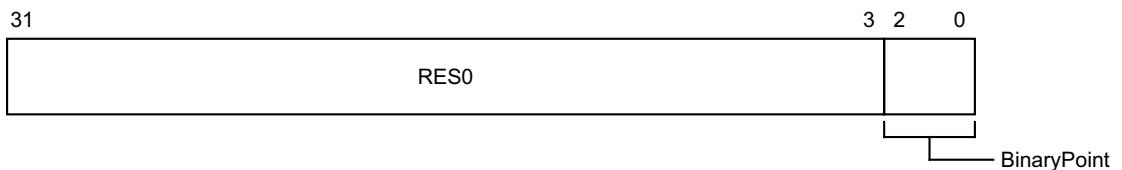

Bits [31:3]

Reserved, RES0.

BinaryPoint, bits [2:0]

The value of this field controls how the 8-bit interrupt priority field is split into a group priority field, used to determine interrupt preemption, and a subpriority field. This is done as follows:

Binary point value	Group priority field	Subpriority field	Field with binary point
0	[7:1]	[0]	ggggggg.s
1	[7:2]	[1:0]	gggggg.ss
2	[7:3]	[2:0]	ggggg.sss
3	[7:4]	[3:0]	gggg.ssss
4	[7:5]	[4:0]	ggg.sssss

Binary point value	Group priority field	Subpriority field	Field with binary point
5	[7:6]	[5:0]	gg.ssssss
6	[7]	[6:0]	g.sssssss
7	No preemption	[7:0]	.ssssssss

Accessing the ICC_BPR1_EL1:

To access the ICC_BPR1_EL1:

MRS <Xt>, ICC_BPR1_EL1 ; Read ICC_BPR1_EL1 into Xt
MSR ICC_BPR1_EL1, <Xt> ; Write Xt to ICC_BPR1_EL1

Register access is encoded as follows:

op0	op1	CRn	CRm	op2
11	000	1100	1100	011

D8.6.12 ICC_CTLR_EL1, Interrupt Controller Control Register (EL1)

The ICC_CTLR_EL1 characteristics are:

Purpose

Controls aspects of the behavior of the GIC CPU interface and provides information about the features implemented.

This register is part of the GIC registers functional group.

Usage constraints

This register is accessible as shown below:

When accessed as ICC_CTLR_EL1(S):

EL1 (NS)	EL1 (S)	EL2	EL3 (SCR.NS=1)	EL3 (SCR.NS=0)
-	RW	-	-	RW

When accessed as ICC_CTLR_EL1(NS):

EL1 (NS)	EL1 (S)	EL2	EL3 (SCR.NS=1)	EL3 (SCR.NS=0)
RW	-	RW	RW	-

Configurations

ICC_CTLR_EL1(S) is architecturally mapped to AArch32 register [ICC_CTLR \(S\)](#).

ICC_CTLR_EL1(NS) is architecturally mapped to AArch32 register [ICC_CTLR \(NS\)](#).

There are separate Secure and Non-secure instances of this register.

Attributes

ICC_CTLR_EL1 is a 32-bit register.

The ICC_CTLR_EL1 bit assignments are:

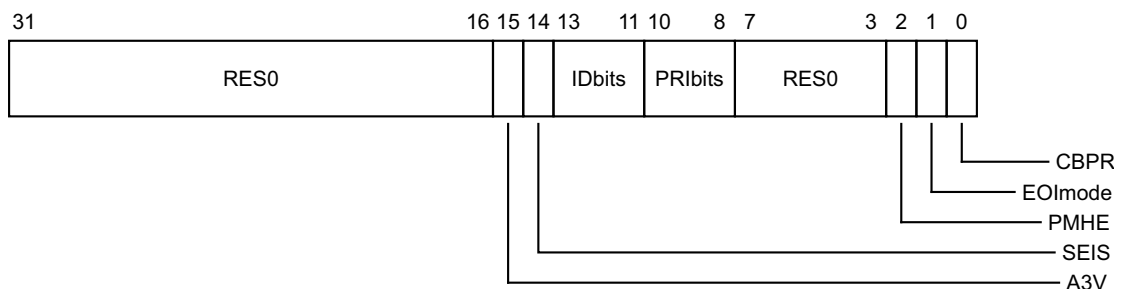

Bits [31:16]

Reserved, RES0.

A3V, bit [15]

Affinity 3 Valid. Read-only. Possible values are:

- 0 The CPU interface logic only supports zero values of Affinity 3 in SGI generation system registers.
- 1 The CPU interface logic supports non-zero values of Affinity 3 in SGI generation system registers.

Virtual accesses return the value from ICH_VTR_EL2.A3V.

SEIS, bit [14]

SEI Support. Read-only. Indicates whether the CPU interface supports local generation of SEIs:

- 0 The CPU interface logic does not support local generation of SEIs by the CPU interface.
- 1 The CPU interface logic supports local generation of SEIs by the CPU interface.

Virtual accesses return the value from ICH_VTR_EL2.SEIS.

IDbits, bits [13:11]

The number of physical interrupt identifier bits supported:

- 000 16 bits.
- 001 24 bits.

All other values are reserved.

Virtual accesses return the value from ICH_VTR_EL2.IDbits.

Reset value is architecturally UNKNOWN.

PRIbits, bits [10:8]

The number of priority bits implemented, minus one. Read-only.

Virtual accesses return the value from ICH_VTR_EL2.PRIbits.

Bits [7:3]

Reserved, RES0.

PMHE, bit [2]

Priority Mask Hint Enable.

If EL3 is present and GICD_CTLR.DS == 0, this bit is a read-only alias of ICC_CTLR_EL3.PMHE.

If EL3 is present and GICD_CTLR.DS == 1, this bit is writeable at EL1 and EL2.

Resets to 0.

EOImode, bit [1]

Alias of ICC_CTLR_EL3.EOImode_EL1{S,NS} as appropriate to the current security state.

Virtual accesses modify ICH_VMCR_EL2.VEOIM.

Reset value is architecturally UNKNOWN.

CBPR, bit [0]

Common Binary Point Register.

If EL3 is present and GICD_CTLR.DS == 0, this bit is a read-only alias of ICC_CTLR_EL3.CBPR_EL1{S,NS} as appropriate.

If EL3 is not present, this field resets to zero.

If EL3 is present and GICD_CTLR.DS == 1, this bit is writeable at EL1 and EL2.

Virtual accesses modify ICH_VMCR_EL2.VCBPR. An access is virtual when accessed at non-secure EL1 and either of FIQ or IRQ has been virtualized. That is, when (SCR_EL3.NS == '1' && (HCR_EL2.FMO == '1' || HCR_EL2.IMO == '1')).

Accessing the ICC_CTLR_EL1:

To access the ICC_CTLR_EL1:

```
MRS <Xt>, ICC_CTLR_EL1 ; Read ICC_CTLR_EL1 into Xt
MSR ICC_CTLR_EL1, <Xt> ; Write Xt to ICC_CTLR_EL1
```

Register access is encoded as follows:

op0	op1	CRn	CRm	op2
11	000	1100	1100	100

D8.6.13 ICC_CTLR_EL3, Interrupt Controller Control Register (EL3)

The ICC_CTLR_EL3 characteristics are:

Purpose

Controls aspects of the behavior of the GIC CPU interface and provides information about the features implemented.

This register is part of:

- the GIC registers functional group
- the Security registers functional group.

Usage constraints

This register is accessible as shown below:

EL0	EL1 (NS)	EL1 (S)	EL2	EL3 (SCR.NS=1)	EL3 (SCR.NS=0)
-	-	-	-	RW	RW

Configurations

ICC_CTLR_EL3 is architecturally mapped to AArch32 register [ICC_MCTLR](#).

Attributes

ICC_CTLR_EL3 is a 32-bit register.

The ICC_CTLR_EL3 bit assignments are:

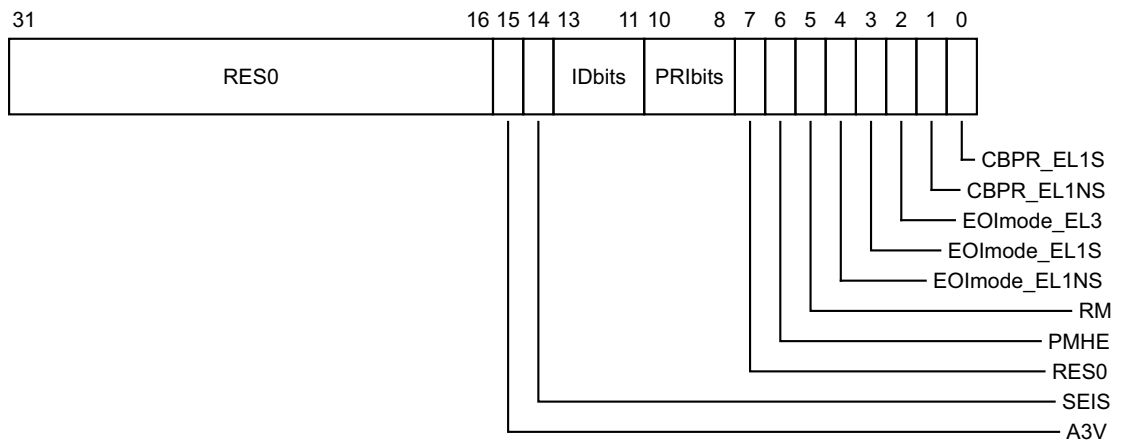

Bits [31:16]

Reserved, RES0.

A3V, bit [15]

Affinity 3 Valid. Read-only. Possible values are:

- 0 The CPU interface logic only supports zero values of Affinity 3 in SGI generation system registers.
- 1 The CPU interface logic supports non-zero values of Affinity 3 in SGI generation system registers.

Virtual accesses return the value from ICH_VTR_EL2.A3V.

SEIS, bit [14]

SEI Support. Read-only. Indicates whether the CPU interface supports generation of SEIs:

- 0 The CPU interface logic does not support generation of SEIs.
- 1 The CPU interface logic supports generation of SEIs.

Virtual accesses return the value from ICH_VTR_EL2.SEIS.

IDbits, bits [13:11]

The number of physical interrupt identifier bits supported:

- 000 16 bits.
- 001 24 bits.

All other values are reserved.

Reset value is architecturally UNKNOWN.

PRBits, bits [10:8]

The number of priority bits implemented, minus one. Read-only.

Bit [7]

Reserved, RES0.

PMHE, bit [6]

Priority Mask Hint Enable.

When set, enables use of the PMR as a hint for interrupt distribution.

Resets to 0.

RM, bit [5]

Routing Modifier. This bit is used to modify the behavior of [ICC_IAR0_EL1](#) and [ICC_IAR1_EL1](#) such that systems with legacy secure software may be supported correctly.

- 0 Reading [ICC_IAR0_EL1](#) and [ICC_IAR1_EL1](#) at EL3 acknowledges interrupts normally.
- 1 Reading [ICC_IAR0_EL1](#) and [ICC_IAR1_EL1](#) at EL3 returns special values:
 - Reading [ICC_IAR0_EL1](#) at EL3 returns ID 1020, indicating the interrupt should be handled at Secure EL1.
 - Reading [ICC_IAR1_EL1](#) at EL3 returns ID 1021, indicating the interrupt should be handled at Non-secure EL1 or EL2.

Reset value is architecturally UNKNOWN.

EOImode_EL1NS, bit [4]

EOI mode for interrupts handled at non-secure EL1 and EL2.

Reset value is architecturally UNKNOWN.

EOImode_EL1S, bit [3]

EOI mode for interrupts handled at secure EL1.

Reset value is architecturally UNKNOWN.

EOImode_EL3, bit [2]

EOI mode for interrupts handled at EL3.

Reset value is architecturally UNKNOWN.

CBPR_EL1NS, bit [1]

When set, non-secure accesses to GICC_BPR and [ICC_BPR1_EL1](#) access the state of [ICC_BPR0_EL1](#). [ICC_BPR0_EL1](#) is used to determine the preemption group for Non-secure Group 1 interrupts.

Reset value is architecturally UNKNOWN.

CBPR_EL1S, bit [0]

When set, secure EL1 accesses to [ICC_BPR1_EL1](#) access the state of [ICC_BPR0_EL1](#).
[ICC_BPR0_EL1](#) is used to determine the preemption group for Secure Group 1 interrupts.

Reset value is architecturally UNKNOWN.

Accessing the ICC_CTLR_EL3:

To access the ICC_CTLR_EL3:

MRS <Xt>, ICC_CTLR_EL3 ; Read ICC_CTLR_EL3 into Xt
MSR ICC_CTLR_EL3, <Xt> ; Write Xt to ICC_CTLR_EL3

Register access is encoded as follows:

op0	op1	CRn	CRm	op2
11	110	1100	1100	100

D8.6.14 ICC_DIR_EL1, Interrupt Controller Deactivate Interrupt Register

The ICC_DIR_EL1 characteristics are:

Purpose

When interrupt priority drop is separated from interrupt deactivation, a write to this register deactivates the specified interrupt.

This register is part of the GIC registers functional group.

Usage constraints

This register is accessible as shown below:

EL0	EL1 (NS)	EL1 (S)	EL2	EL3 (SCR.NS=1)	EL3 (SCR.NS=0)
-	WO	WO	WO	WO	WO

Configurations

ICC_DIR_EL1 is architecturally mapped to AArch32 register [ICC_DIR](#).

Attributes

ICC_DIR_EL1 is a 32-bit register.

The ICC_DIR_EL1 bit assignments are:

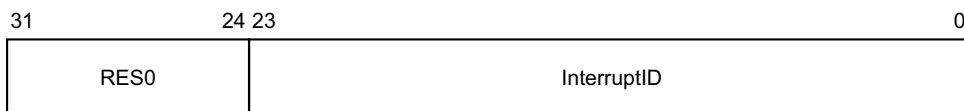

Bits [31:24]

Reserved, RES0.

InterruptID, bits [23:0]

The interrupt ID.

This field has either 16 or 24 bits implemented. The number of implemented bits can be found in [ICC_CTLR_EL1.IDbits](#) and [ICC_CTLR_EL3.IDbits](#). If only 16 bits are implemented, bits [23:16] of this register are RES0.

Accessing the ICC_DIR_EL1:

To access the ICC_DIR_EL1:

MSR ICC_DIR_EL1, <Xt> ; Write Xt to ICC_DIR_EL1

Register access is encoded as follows:

op0	op1	CRn	CRm	op2
11	000	1100	1011	001

D8.6.15 ICC_EOIR0_EL1, Interrupt Controller End Of Interrupt Register 0

The ICC_EOIR0_EL1 characteristics are:

Purpose

A processor writes to this register to inform the CPU interface that it has completed the processing of the specified interrupt.

This register is part of the GIC registers functional group.

Usage constraints

This register is accessible as shown below:

When accessed as ICC_EOIR0_EL1(S):

EL1 (NS)	EL1 (S)	EL2	EL3 (SCR.NS=1)	EL3 (SCR.NS=0)
-	WO	-	-	WO

When accessed as ICC_EOIR0_EL1(NS):

EL1 (NS)	EL1 (S)	EL2	EL3 (SCR.NS=1)	EL3 (SCR.NS=0)
WO	-	WO	WO	-

A write to this register must correspond to the most recent valid read from an Interrupt Acknowledge Register. A valid read is a read that returns a valid interrupt ID, that is not a spurious interrupt ID.

Configurations

ICC_EOIR0_EL1(S) is architecturally mapped to AArch32 register [ICC_EOIR0 \(S\)](#).

ICC_EOIR0_EL1(NS) is architecturally mapped to AArch32 register [ICC_EOIR0 \(NS\)](#).

There are separate Secure and Non-secure instances of this register.

In Secure state, this register is the end of interrupt register for Group 0 interrupts. In Non-secure state, this is the EOIR for Group 1 interrupts.

Attributes

ICC_EOIR0_EL1 is a 32-bit register.

The ICC_EOIR0_EL1 bit assignments are:

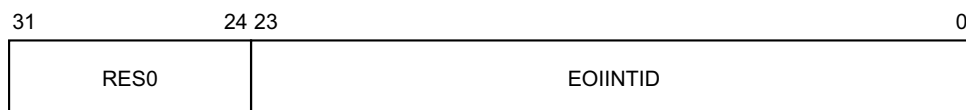

Bits [31:24]

Reserved, RES0.

EOINTID, bits [23:0]

The InterruptID value from the corresponding GICC_IAR access.

This field has either 16 or 24 bits implemented. The number of implemented bits can be found in [ICC_CTLR_EL1.IDbits](#) and [ICC_CTLR_EL3.IDbits](#). If only 16 bits are implemented, bits [23:16] of this register are RES0.

Accessing the ICC_EOIR0_EL1:

To access the ICC_EOIR0_EL1:

MSR ICC_EOIR0_EL1, <Xt> ; Write Xt to ICC_EOIR0_EL1

Register access is encoded as follows:

op0	op1	CRn	CRm	op2
11	000	1100	1000	001

D8.6.16 ICC_EOIR1_EL1, Interrupt Controller End Of Interrupt Register 1

The ICC_EOIR1_EL1 characteristics are:

Purpose

A processor writes to this register to inform the CPU interface that it has completed the processing of the specified Group 1 interrupt.

This register is part of the GIC registers functional group.

Usage constraints

This register is accessible as shown below:

EL0	EL1 (NS)	EL1 (S)	EL2	EL3 (SCR.NS=1)	EL3 (SCR.NS=0)
-	WO	WO	WO	WO	WO

A write to this register must correspond to the most recent valid read from an Interrupt Acknowledge Register. A valid read is a read that returns a valid interrupt ID, that is not a spurious interrupt ID.

Configurations

ICC_EOIR1_EL1 is architecturally mapped to AArch32 register [ICC_EOIR1](#).

This register is an alias of the Non-secure view of [ICC_EOIR0_EL1](#), and a Secure access to this register is identical to a Non-secure access to [ICC_EOIR0_EL1](#).

Attributes

ICC_EOIR1_EL1 is a 32-bit register.

The ICC_EOIR1_EL1 bit assignments are:

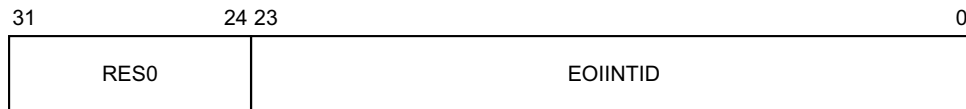

Bits [31:24]

Reserved, RES0.

EOIINTID, bits [23:0]

The InterruptID value from the corresponding GICC_IAR access.

This field has either 16 or 24 bits implemented. The number of implemented bits can be found in [ICC_CTLR_EL1.IDbits](#) and [ICC_CTLR_EL3.IDbits](#). If only 16 bits are implemented, bits [23:16] of this register are RES0.

Accessing the ICC_EOIR1_EL1:

To access the ICC_EOIR1_EL1:

MSR ICC_EOIR1_EL1, <Xt> ; Write Xt to ICC_EOIR1_EL1

Register access is encoded as follows:

op0	op1	CRn	CRm	op2
11	000	1100	1100	001

D8.6.17 ICC_HPPIR0_EL1, Interrupt Controller Highest Priority Pending Interrupt Register 0

The ICC_HPPIR0_EL1 characteristics are:

Purpose

Indicates the Interrupt ID, and processor ID if appropriate, of the highest priority pending interrupt on the CPU interface.

This register is part of the GIC registers functional group.

Usage constraints

This register is accessible as shown below:

When accessed as ICC_HPPIR0_EL1(S):

EL1 (NS)	EL1 (S)	EL2	EL3 (SCR.NS=1)	EL3 (SCR.NS=0)
-	RO	-	-	RO

When accessed as ICC_HPPIR0_EL1(NS):

EL1 (NS)	EL1 (S)	EL2	EL3 (SCR.NS=1)	EL3 (SCR.NS=0)
RO	-	RO	RO	-

Configurations

ICC_HPPIR0_EL1(S) is architecturally mapped to AArch32 register [ICC_HPPIR0 \(S\)](#).

ICC_HPPIR0_EL1(NS) is architecturally mapped to AArch32 register [ICC_HPPIR0 \(NS\)](#).

There are separate Secure and Non-secure instances of this register.

In Secure state, this register is the highest priority pending interrupt register for Group 0 interrupts.

In Non-secure state, this is the HPPIR for Group 1 interrupts.

Attributes

ICC_HPPIR0_EL1 is a 32-bit register.

The ICC_HPPIR0_EL1 bit assignments are:

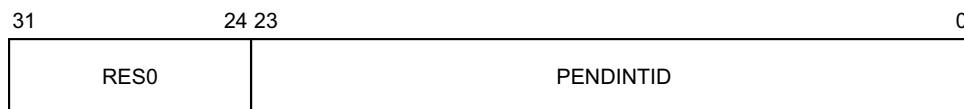

Bits [31:24]

Reserved, RES0.

PENDINTID, bits [23:0]

The interrupt ID of the highest priority pending interrupt.

This field has either 16 or 24 bits implemented. The number of implemented bits can be found in [ICC_CTLR_EL1.IDbits](#) and [ICC_CTLR_EL3.IDbits](#). If only 16 bits are implemented, bits [23:16] of this register are RES0.

Accessing the ICC_HPPIR0_EL1:

To access the ICC_HPPIR0_EL1:

MRS <Xt>, ICC_HPPIR0_EL1 ; Read ICC_HPPIR0_EL1 into Xt

Register access is encoded as follows:

op0	op1	CRn	CRm	op2
11	000	1100	1000	010

D8.6.18 ICC_HPPIR1_EL1, Interrupt Controller Highest Priority Pending Interrupt Register 1

The ICC_HPPIR1_EL1 characteristics are:

Purpose

If the highest priority pending interrupt on the CPU interface is a Group 1 interrupt, returns the interrupt ID of that interrupt. Otherwise, returns a spurious interrupt ID of 1023.

This register is part of the GIC registers functional group.

Usage constraints

This register is accessible as shown below:

EL0	EL1 (NS)	EL1 (S)	EL2	EL3 (SCR.NS=1)	EL3 (SCR.NS=0)
-	RO	RO	RO	RO	RO

Configurations

ICC_HPPIR1_EL1 is architecturally mapped to AArch32 register [ICC_HPPIR1](#).

This register is an alias of the Non-secure view of [ICC_HPPIR0_EL1](#), and a Secure access to this register is identical to a Non-secure access to [ICC_HPPIR0_EL1](#).

Attributes

ICC_HPPIR1_EL1 is a 32-bit register.

The ICC_HPPIR1_EL1 bit assignments are:

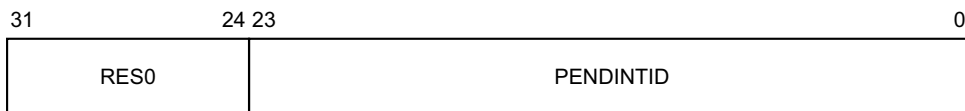

Bits [31:24]

Reserved, RES0.

PENDINTID, bits [23:0]

The interrupt ID of the highest priority pending interrupt.

This field has either 16 or 24 bits implemented. The number of implemented bits can be found in [ICC_CTLR_EL1.IDbits](#) and [ICC_CTLR_EL3.IDbits](#). If only 16 bits are implemented, bits [23:16] of this register are RES0.

Accessing the ICC_HPPIR1_EL1:

To access the ICC_HPPIR1_EL1:

MRS <Xt>, ICC_HPPIR1_EL1 ; Read ICC_HPPIR1_EL1 into Xt

Register access is encoded as follows:

op0	op1	CRn	CRm	op2
11	000	1100	1100	010

D8.6.19 ICC_IAR0_EL1, Interrupt Controller Interrupt Acknowledge Register 0

The ICC_IAR0_EL1 characteristics are:

Purpose

The processor reads this register to obtain the interrupt ID of the signaled interrupt. This read acts as an acknowledge for the interrupt.

This register is part of the GIC registers functional group.

Usage constraints

This register is accessible as shown below:

When accessed as ICC_IAR0_EL1(S):

EL1 (NS)	EL1 (S)	EL2	EL3 (SCR.NS=1)	EL3 (SCR.NS=0)
-	RO	-	-	RO

When accessed as ICC_IAR0_EL1(NS):

EL1 (NS)	EL1 (S)	EL2	EL3 (SCR.NS=1)	EL3 (SCR.NS=0)
RO	-	RO	RO	-

Configurations

ICC_IAR0_EL1(S) is architecturally mapped to AArch32 register [ICC_IAR0 \(S\)](#).

ICC_IAR0_EL1(NS) is architecturally mapped to AArch32 register [ICC_IAR0 \(NS\)](#).

There are separate Secure and Non-secure instances of this register.

In Secure state, this register is the interrupt acknowledge register for Group 0 interrupts. In Non-secure state, this is the IAR for Group 1 interrupts.

Attributes

ICC_IAR0_EL1 is a 32-bit register.

The ICC_IAR0_EL1 bit assignments are:

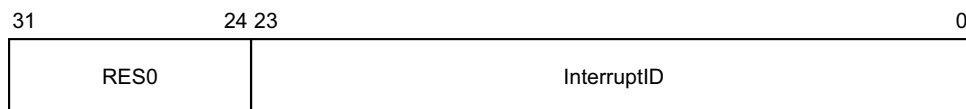

Bits [31:24]

Reserved, RES0.

InterruptID, bits [23:0]

The ID of the signaled interrupt. IDs 1020 to 1023 are reserved and convey additional information such as spurious interrupts.

This field has either 16 or 24 bits implemented. The number of implemented bits can be found in [ICC_CTLR_EL1.IDbits](#) and [ICC_CTLR_EL3.IDbits](#). If only 16 bits are implemented, bits [23:16] of this register are RES0.

Accessing the ICC_IAR0_EL1:

To access the ICC_IAR0_EL1:

MRS <Xt>, ICC_IAR0_EL1 ; Read ICC_IAR0_EL1 into Xt

Register access is encoded as follows:

op0	op1	CRn	CRm	op2
11	000	1100	1000	000

D8.6.20 ICC_IAR1_EL1, Interrupt Controller Interrupt Acknowledge Register 1

The ICC_IAR1_EL1 characteristics are:

Purpose

The processor reads this register to obtain the interrupt ID of the signaled Group 1 interrupt. This read acts as an acknowledge for the interrupt.

This register is part of the GIC registers functional group.

Usage constraints

This register is accessible as shown below:

EL0	EL1 (NS)	EL1 (S)	EL2	EL3 (SCR.NS=1)	EL3 (SCR.NS=0)
-	RO	RO	RO	RO	RO

Configurations

ICC_IAR1_EL1 is architecturally mapped to AArch32 register [ICC_IAR1](#).

This register is an alias of the Non-secure view of [ICC_IAR0_EL1](#), and a Secure access to this register is identical to a Non-secure access to [ICC_IAR0_EL1](#).

Attributes

ICC_IAR1_EL1 is a 32-bit register.

The ICC_IAR1_EL1 bit assignments are:

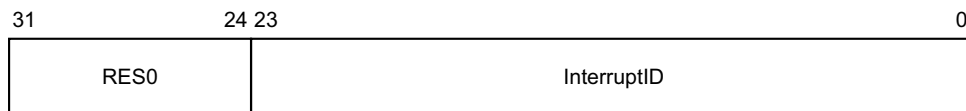

Bits [31:24]

Reserved, RES0.

InterruptID, bits [23:0]

The ID of the signaled interrupt. IDs 1020 to 1023 are reserved and convey additional information such as spurious interrupts.

This field has either 16 or 24 bits implemented. The number of implemented bits can be found in [ICC_CTLR_EL1.IDbits](#) and [ICC_CTLR_EL3.IDbits](#). If only 16 bits are implemented, bits [23:16] of this register are RES0.

Accessing the ICC_IAR1_EL1:

To access the ICC_IAR1_EL1:

MRS <Xt>, ICC_IAR1_EL1 ; Read ICC_IAR1_EL1 into Xt

Register access is encoded as follows:

op0	op1	CRn	CRm	op2
11	000	1100	1100	000

D8.6.21 ICC_IGRPEN0_EL1, Interrupt Controller Interrupt Group 0 Enable register

The ICC_IGRPEN0_EL1 characteristics are:

Purpose

Controls whether Group 0 interrupts are enabled or not.
This register is part of the GIC registers functional group.

Usage constraints

This register is accessible as shown below:
When accessed as ICC_IGRPEN0_EL1(S):

EL1 (NS)	EL1 (S)	EL2	EL3 (SCR.NS=1)	EL3 (SCR.NS=0)
-	RW	-	-	RW

When accessed as ICC_IGRPEN0_EL1(NS):

EL1 (NS)	EL1 (S)	EL2	EL3 (SCR.NS=1)	EL3 (SCR.NS=0)
RW	-	RW	RW	-

The lowest exception level at which this register may be accessed is governed by the exception level to which FIQ is routed. This routing depends on SCR_EL3.FIQ, SCR_EL3.NS and HCR_EL2.FMO.

If an interrupt is pending within the CPU interface when Enable becomes 0, the interrupt must be released to allow the Distributor to forward the interrupt to a different processor.

Configurations

ICC_IGRPEN0_EL1(S) is architecturally mapped to AArch32 register [ICC_IGRPEN0 \(S\)](#).
ICC_IGRPEN0_EL1(NS) is architecturally mapped to AArch32 register [ICC_IGRPEN0 \(NS\)](#).
There are separate Secure and Non-secure instances of this register.

Attributes

ICC_IGRPEN0_EL1 is a 32-bit register.

The ICC_IGRPEN0_EL1 bit assignments are:

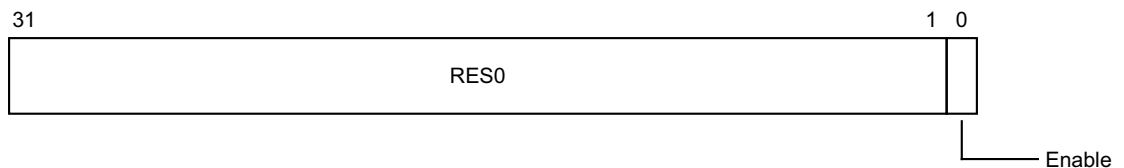

Bits [31:1]

Reserved, RES0.

Enable, bit [0]

Enables Group 0 interrupts.
0 Group 0 interrupts are disabled.
1 Group 0 interrupts are enabled.
Virtual accesses to this register update ICH_VMCR_EL2.VENG0.

Resets to 0.

Accessing the ICC_IGRPEN0_EL1:

To access the ICC_IGRPEN0_EL1:

MRS <Xt>, ICC_IGRPEN0_EL1 ; Read ICC_IGRPEN0_EL1 into Xt
MSR ICC_IGRPEN0_EL1, <Xt> ; Write Xt to ICC_IGRPEN0_EL1

Register access is encoded as follows:

op0	op1	CRn	CRm	op2
11	000	1100	1100	110

D8.6.22 ICC_IGRPEN1_EL1, Interrupt Controller Interrupt Group 1 Enable register

The ICC_IGRPEN1_EL1 characteristics are:

Purpose

Controls whether Group 1 interrupts are enabled for the current security state.
This register is part of the GIC registers functional group.

Usage constraints

This register is accessible as shown below:

EL0	EL1 (NS)	EL1 (S)	EL2	EL3 (SCR.NS=1)	EL3 (SCR.NS=0)
-	RW	RW	RW	RW	RW

The lowest exception level at which this register may be accessed is governed by the exception level to which FIQ is routed. This routing depends on SCR_EL3.FIQ, SCR_EL3.NS and HCR_EL2.FMO.

If an interrupt is pending within the CPU interface when Enable becomes 0, the interrupt must be released to allow the Distributor to forward the interrupt to a different processor.

Configurations

ICC_IGRPEN1_EL1 is architecturally mapped to AArch32 register [ICC_IGRPEN1](#).

Attributes

ICC_IGRPEN1_EL1 is a 32-bit register.

The ICC_IGRPEN1_EL1 bit assignments are:

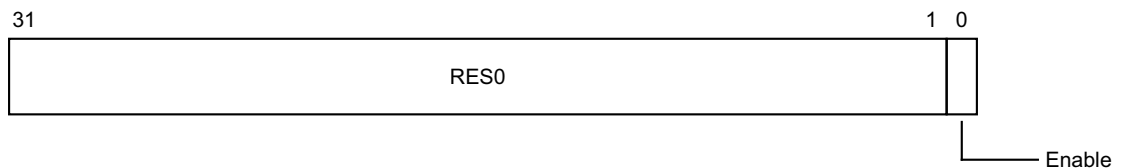

Bits [31:1]

Reserved, RES0.

Enable, bit [0]

Enables Group 1 interrupts for the current security state.

0 Group 1 interrupts are disabled for the current security state.

1 Group 1 interrupts are enabled for the current security state.

Virtual accesses to this register update ICH_VMCR_EL2.VENG1.

When this register is accessed at EL3, the copy of this register appropriate to the current setting of SCR_EL3.NS is accessed.

Resets to 0.

Accessing the ICC_IGRPEN1_EL1:

To access the ICC_IGRPEN1_EL1:

MRS <Xt>, ICC_IGRPEN1_EL1 ; Read ICC_IGRPEN1_EL1 into Xt
MSR ICC_IGRPEN1_EL1, <Xt> ; Write Xt to ICC_IGRPEN1_EL1

Register access is encoded as follows:

op0	op1	CRn	CRm	op2
11	000	1100	1100	111

D8.6.23 ICC_IGRPEN1_EL3, Interrupt Controller Interrupt Group 1 Enable register (EL3)

The ICC_IGRPEN1_EL3 characteristics are:

Purpose

Controls whether Group 1 interrupts are enabled or not.
This register is part of the GIC registers functional group.

Usage constraints

This register is accessible as shown below:

EL0	EL1 (NS)	EL1 (S)	EL2	EL3 (SCR.NS=1)	EL3 (SCR.NS=0)
-	-	-	-	RW	RW

If an interrupt is pending within the CPU interface when an Enable bit becomes 0, the interrupt must be released to allow the Distributor to forward the interrupt to a different processor.

Configurations

ICC_IGRPEN1_EL3 is architecturally mapped to AArch32 register [ICC_MGRPEN1](#).

Attributes

ICC_IGRPEN1_EL3 is a 32-bit register.

The ICC_IGRPEN1_EL3 bit assignments are:

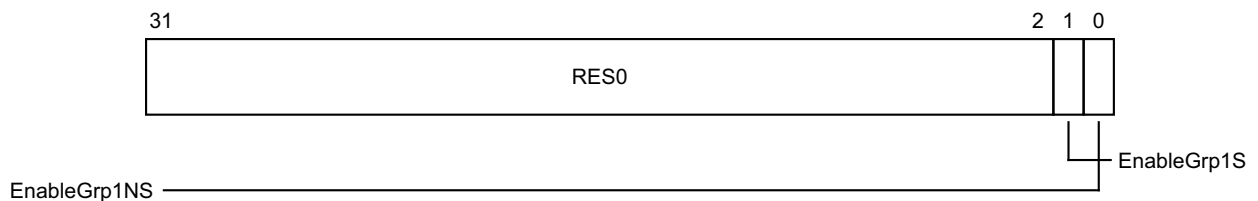

Bits [31:2]

Reserved, RES0.

EnableGrp1S, bit [1]

Enables Group 1 interrupts for the Secure state.

0 Group 1 interrupts are disabled for the Secure state.

1 Group 1 interrupts are enabled for the Secure state.

Resets to 0.

EnableGrp1NS, bit [0]

Enables Group 1 interrupts for the Non-secure state.

0 Group 1 interrupts are disabled for the Non-secure state.

1 Group 1 interrupts are enabled for the Non-secure state.

Resets to 0.

Accessing the ICC_IGRPEN1_EL3:

To access the ICC_IGRPEN1_EL3:

MRS <Xt>, ICC_IGRPEN1_EL3 ; Read ICC_IGRPEN1_EL3 into Xt

MSR ICC_IGRPEN1_EL3, <Xt> ; Write Xt to ICC_IGRPEN1_EL3

Register access is encoded as follows:

op0	op1	CRn	CRm	op2
11	110	1100	1100	111

D8.6.24 ICC_PMR_EL1, Interrupt Controller Interrupt Priority Mask Register

The ICC_PMR_EL1 characteristics are:

Purpose

Provides an interrupt priority filter. Only interrupts with higher priority than the value in this register are signaled to the processor.

This register is part of the GIC registers functional group.

Usage constraints

This register is accessible as shown below:

EL0	EL1 (NS)	EL1 (S)	EL2	EL3 (SCR.NS=1)	EL3 (SCR.NS=0)
-	RW	RW	RW	RW	RW

Configurations

ICC_PMR_EL1 is architecturally mapped to AArch32 register [ICC_PMR](#).

Attributes

ICC_PMR_EL1 is a 32-bit register.

The ICC_PMR_EL1 bit assignments are:

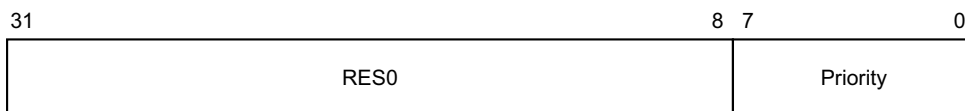

Bits [31:8]

Reserved, RES0.

Priority, bits [7:0]

The priority mask level for the CPU interface. If the priority of an interrupt is higher than the value indicated by this field, the interface signals the interrupt to the processor.

If the GIC supports fewer than 256 priority levels then some bits are RAZ/WI, as follows:

128 supported levels Bit [0] = 0.

64 supported levels Bits [1:0] = 0b00.

32 supported levels Bits [2:0] = 0b000.

16 supported levels Bits [3:0] = 0b0000.

The possible priority field values are as follows:

Implemented priority bits	Possible priority field values	Number of priority levels
[7:0]	0x00-0xFF (0-255), all values	256
[7:1]	0x00-0xFE (0-254), even values only	128

Implemented priority bits	Possible priority field values	Number of priority levels
[7:2]	0x00-0xFC (0-252), in steps of 4	64
[7:3]	0x00-0xF8 (0-248), in steps of 8	32
[7:4]	0x00-0xF0 (0-240), in steps of 16	16

Accessing the ICC_PMR_EL1:

To access the ICC_PMR_EL1:

MRS <Xt>, ICC_PMR_EL1 ; Read ICC_PMR_EL1 into Xt
MSR ICC_PMR_EL1, <Xt> ; Write Xt to ICC_PMR_EL1

Register access is encoded as follows:

op0	op1	CRn	CRm	op2
11	000	0100	0110	000

D8.6.25 ICC_RPR_EL1, Interrupt Controller Running Priority Register

The ICC_RPR_EL1 characteristics are:

Purpose

Indicates the Running priority of the CPU interface.
This register is part of the GIC registers functional group.

Usage constraints

This register is accessible as shown below:

EL0	EL1 (NS)	EL1 (S)	EL2	EL3 (SCR.NS=1)	EL3 (SCR.NS=0)
-	RO	RO	RO	RO	RO

If there is no active interrupt on the CPU interface, the value returned is the Idle priority.
Software cannot determine the number of implemented priority bits from a read of this register.

Configurations

ICC_RPR_EL1 is architecturally mapped to AArch32 register [ICC_RPR](#).

Attributes

ICC_RPR_EL1 is a 32-bit register.

The ICC_RPR_EL1 bit assignments are:

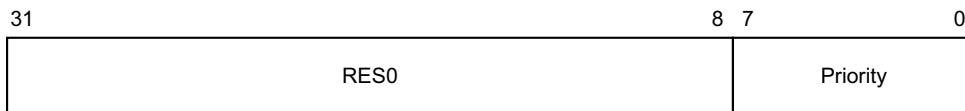

Bits [31:8]

Reserved, RES0.

Priority, bits [7:0]

The current running priority on the CPU interface. This is the priority of the current active interrupt.

Accessing the ICC_RPR_EL1:

To access the ICC_RPR_EL1:

MRS <Xt>, ICC_RPR_EL1 ; Read ICC_RPR_EL1 into Xt

Register access is encoded as follows:

op0	op1	CRn	CRm	op2
11	000	1100	1011	011

D8.6.26 ICC_SEIEN_EL1, Interrupt Controller System Error Interrupt Enable register

The ICC_SEIEN_EL1 characteristics are:

Purpose

Controls whether System Error Interrupts generated by bus message are enabled.
This register is part of the GIC registers functional group.

Usage constraints

This register is accessible as shown below:

ELO	EL1 (NS)	EL1 (S)	EL2	EL3 (SCR.NS=1)	EL3 (SCR.NS=0)
-	RW	RW	RW	RW	RW

The lowest exception level at which this register may be accessed is governed by the exception level to which SError is routed. This routing depends on SCR_EL3.EA, SCR_EL3.NS and HCR_EL2.AMO.

Internally generated SEIs and pin-generated SEIs might still be generated.

Configurations

ICC_SEIEN_EL1 is architecturally mapped to AArch32 register [ICC_SEIEN](#).

Attributes

ICC_SEIEN_EL1 is a 32-bit register.

The ICC_SEIEN_EL1 bit assignments are:



Accessing the ICC_SEIEN_EL1:

To access the ICC_SEIEN_EL1:

MRS <Xt>, ICC_SEIEN_EL1 ; Read ICC_SEIEN_EL1 into Xt
MSR ICC_SEIEN_EL1, <Xt> ; Write Xt to ICC_SEIEN_EL1

Register access is encoded as follows:

op0	op1	CRn	CRm	op2
11	000	1100	1101	000

D8.6.27 ICC_SGIOR_EL1, Interrupt Controller Software Generated Interrupt group 0 Register

The ICC_SGIOR_EL1 characteristics are:

Purpose

Provides software the ability to generate secure group 0 SGIs, including from the Non-secure state when permitted by GICR_NSACR.

This register is part of the GIC registers functional group.

Usage constraints

This register is accessible as shown below:

EL0	EL1 (NS)	EL1 (S)	EL2	EL3 (SCR.NS=1)	EL3 (SCR.NS=0)
-	WO	WO	WO	WO	WO

Configurations

ICC_SGIOR_EL1 is architecturally mapped to AArch32 register [ICC_SGIOR](#).

Attributes

ICC_SGIOR_EL1 is a 64-bit register.

The ICC_SGIOR_EL1 bit assignments are:

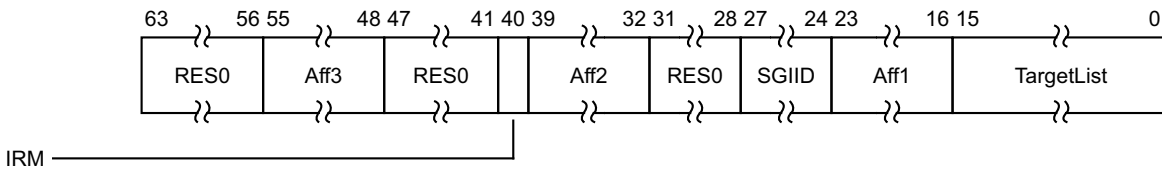

Bits [63:56]

Reserved, RES0.

Aff3, bits [55:48]

The affinity 3 value of the affinity path of the cluster for which SGI interrupts will be generated.

Bits [47:41]

Reserved, RES0.

IRM, bit [40]

Interrupt Routing Mode. Determines how the generated interrupts should be distributed to processors. Possible values are:

- 0 Interrupts routed to the processors specified by a.b.c.{target list}. In this routing, a, b, and c are the values of fields Aff3, Aff2, and Aff1 respectively.
- 1 Interrupts routed to all processors in the system, excluding "self".

Aff2, bits [39:32]

The affinity 2 value of the affinity path of the cluster for which SGI interrupts will be generated.

Bits [31:28]

Reserved, RES0.

SGIID, bits [27:24]

SGI Interrupt ID.

Aff1, bits [23:16]

The affinity 1 value of the affinity path of the cluster for which SGI interrupts will be generated.

TargetList, bits [15:0]

Target List. The set of processors for which SGI interrupts will be generated. Each bit corresponds to the processor within a cluster with an Affinity 0 value equal to the bit number.

If a bit is 1 and the bit does not correspond to a valid target processor, the bit must be ignored by the Distributor. In such cases, a Distributor may optionally generate an SGI.

This restricts distribution of SGIs to the first 16 processors of an affinity 1 cluster.

Accessing the ICC_SGI0R_EL1:

To access the ICC_SGI0R_EL1:

MSR ICC_SGI0R_EL1, <Xt> ; Write Xt to ICC_SGI0R_EL1

Register access is encoded as follows:

op0	op1	CRn	CRm	op2
11	000	1100	1011	111

D8.6.28 ICC_SGI1R_EL1, Interrupt Controller Software Generated Interrupt group 1 Register

The ICC_SGI1R_EL1 characteristics are:

Purpose

Provides software the ability to generate group 1 SGIs for the current security state.
This register is part of the GIC registers functional group.

Usage constraints

This register is accessible as shown below:

When accessed as ICC_SGI1R_EL1(S):

EL1 (NS)	EL1 (S)	EL2	EL3 (SCR.NS=1)	EL3 (SCR.NS=0)
-	WO	-	-	WO

When accessed as ICC_SGI1R_EL1(NS):

EL1 (NS)	EL1 (S)	EL2	EL3 (SCR.NS=1)	EL3 (SCR.NS=0)
WO	-	WO	WO	-

Configurations

ICC_SGI1R_EL1(S) is architecturally mapped to AArch32 register [ICC_SGI1R \(S\)](#).

ICC_SGI1R_EL1(NS) is architecturally mapped to AArch32 register [ICC_SGI1R \(NS\)](#).

There are separate Secure and Non-secure instances of this register.

Attributes

ICC_SGI1R_EL1 is a 64-bit register.

The ICC_SGI1R_EL1 bit assignments are:

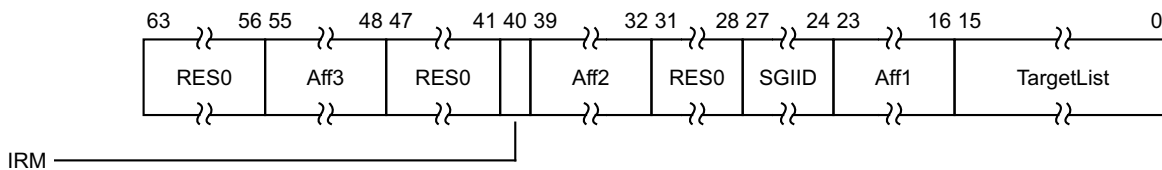

Bits [63:56]

Reserved, RES0.

Aff3, bits [55:48]

The affinity 3 value of the affinity path of the cluster for which SGI interrupts will be generated.

Bits [47:41]

Reserved, RES0.

IRM, bit [40]

Interrupt Routing Mode. Determines how the generated interrupts should be distributed to processors. Possible values are:

- 0 Interrupts routed to the processors specified by a.b.c.{target list}. In this routing, a, b, and c are the values of fields Aff3, Aff2, and Aff1 respectively.

1 Interrupts routed to all processors in the system, excluding "self".

Aff2, bits [39:32]

The affinity 2 value of the affinity path of the cluster for which SGI interrupts will be generated.

Bits [31:28]

Reserved, RES0.

SGIID, bits [27:24]

SGI Interrupt ID.

Aff1, bits [23:16]

The affinity 1 value of the affinity path of the cluster for which SGI interrupts will be generated.

TargetList, bits [15:0]

Target List. The set of processors for which SGI interrupts will be generated. Each bit corresponds to the processor within a cluster with an Affinity 0 value equal to the bit number.

If a bit is 1 and the bit does not correspond to a valid target processor, the bit must be ignored by the Distributor. In such cases, a Distributor may optionally generate an SGI.

This restricts distribution of SGIs to the first 16 processors of an affinity 1 cluster.

Accessing the ICC_SGI1R_EL1:

To access the ICC_SGI1R_EL1:

MSR ICC_SGI1R_EL1, <Xt> ; Write Xt to ICC_SGI1R_EL1

Register access is encoded as follows:

op0	op1	CRn	CRm	op2
11	000	1100	1011	101

D8.6.29 ICC_SRE_EL1, Interrupt Controller System Register Enable register (EL1)

The ICC_SRE_EL1 characteristics are:

Purpose

Controls whether the system register interface or the memory mapped interface to the GIC CPU interface is used for EL0 and EL1.

This register is part of the GIC registers functional group.

Usage constraints

This register is accessible as shown below:

When accessed as ICC_SRE_EL1(S):

EL1 (NS)	EL1 (S)	EL2	EL3 (SCR.NS=1)	EL3 (SCR.NS=0)
-	RW	-	-	RW

When accessed as ICC_SRE_EL1(NS):

EL1 (NS)	EL1 (S)	EL2	EL3 (SCR.NS=1)	EL3 (SCR.NS=0)
RW	-	RW	RW	-

Configurations

ICC_SRE_EL1(S) is architecturally mapped to AArch32 register [ICC_SRE \(S\)](#).

ICC_SRE_EL1(NS) is architecturally mapped to AArch32 register [ICC_SRE \(NS\)](#).

There are separate Secure and Non-secure instances of this register.

Attributes

ICC_SRE_EL1 is a 32-bit register.

The ICC_SRE_EL1 bit assignments are:

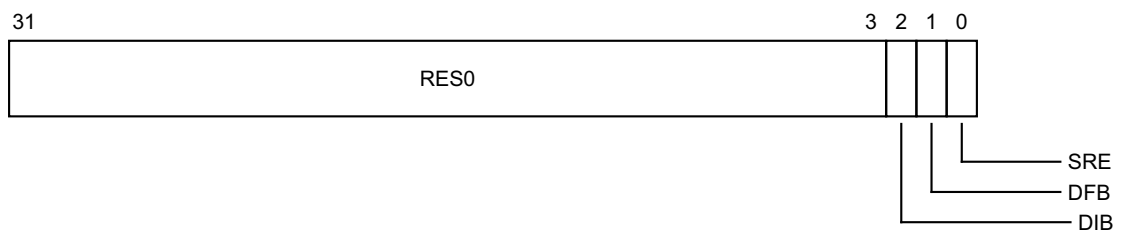

Bits [31:3]

Reserved, RES0.

DIB, bit [2]

Disable IRQ bypass.

If EL3 is present, this field is a read-only alias of ICC_SRE_EL3.DIB.

If EL3 is not present and EL2 is present, this field is a read-only alias of ICC_SRE_EL2.DIB.

Resets to 0.

DFB, bit [1]

Disable FIQ bypass.

If EL3 is present, this field is a read-only alias of ICC_SRE_EL3.DFB.

If EL3 is not present and EL2 is present, this field is a read-only alias of ICC_SRE_EL2.DFB.

Resets to 0.

SRE, bit [0]

System Register Enable.

0 The memory mapped interface must be used. Access at EL1 to any ICC_* system register other than ICC_SRE_EL1 results in an Undefined exception.

1 The system register interface for the current security state is enabled.

Virtual accesses modify ICH_VMCR_EL2.VSRE.

Resets to 0.

Accessing the ICC_SRE_EL1:

To access the ICC_SRE_EL1:

MRS <Xt>, ICC_SRE_EL1 ; Read ICC_SRE_EL1 into Xt
MSR ICC_SRE_EL1, <Xt> ; Write Xt to ICC_SRE_EL1

Register access is encoded as follows:

op0	op1	CRn	CRm	op2
11	000	1100	1100	101

D8.6.30 ICC_SRE_EL2, Interrupt Controller System Register Enable register (EL2)

The ICC_SRE_EL2 characteristics are:

Purpose

Controls whether the system register interface or the memory mapped interface to the GIC CPU interface is used for EL2.

This register is part of:

- the GIC registers functional group
- the Virtualization registers functional group.

Usage constraints

This register is accessible as shown below:

EL0	EL1 (NS)	EL1 (S)	EL2	EL3 (SCR.NS=1)	EL3 (SCR.NS=0)
-	-	-	RW	RW	-

If EL3 is present and ICC_SRE_EL3.Enable is 0, EL2 accesses to this register will trap to EL3.

Configurations

ICC_SRE_EL2 is architecturally mapped to AArch32 register [ICC_HSRE](#).

Attributes

ICC_SRE_EL2 is a 32-bit register.

The ICC_SRE_EL2 bit assignments are:

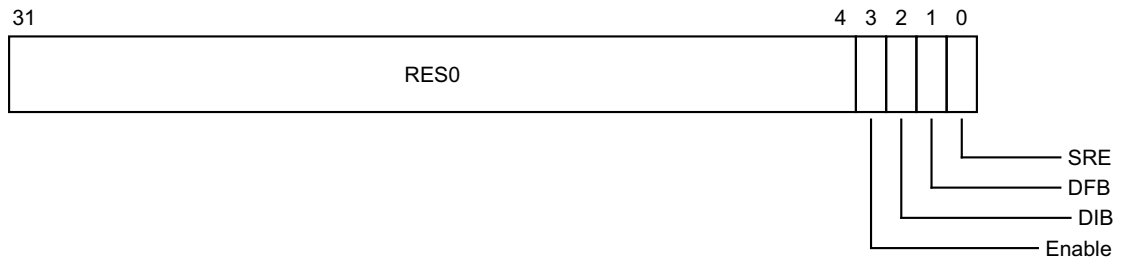

Bits [31:4]

Reserved, RES0.

Enable, bit [3]

Enable. Enables lower exception level access to ICC_SRE_EL1.

- 0 Non-secure EL1 accesses to ICC_SRE_EL1 trap to EL2.
- 1 Non-secure EL1 accesses to ICC_SRE_EL1 are permitted if EL3 is not present or ICC_SRE_EL3.Enable is 1, otherwise Non-secure EL1 accesses to ICC_SRE_EL1 trap to EL3.

Resets to 0.

DIB, bit [2]

Disable IRQ bypass.

If EL3 is present and GICD_CTLR.DS is 0, this field is a read-only alias of ICC_SRE_EL3.DIB.

Resets to 0.

DFB, bit [1]

Disable FIQ bypass.

If EL3 is present and GICD_CTLR.DS is 0, this field is a read-only alias of ICC_SRE_EL3.DFB.

Resets to 0.

Accessing the ICC_SRE_EL2:

To access the ICC_SRE_EL2:

MRS <Xt>, ICC_SRE_EL2 ; Read ICC_SRE_EL2 into Xt

MSR ICC_SRE_EL2, <Xt> ; Write Xt to ICC_SRE_EL2

Register access is encoded as follows:

op0	op1	CRn	CRm	op2
11	100	1100	1001	101

D8.6.31 ICC_SRE_EL3, Interrupt Controller System Register Enable register (EL3)

The ICC_SRE_EL3 characteristics are:

Purpose

Controls whether the system register interface or the memory mapped interface to the GIC CPU interface is used for EL2.

This register is part of:

- the GIC registers functional group
- the Security registers functional group.

Usage constraints

This register is accessible as shown below:

EL0	EL1 (NS)	EL1 (S)	EL2	EL3 (SCR.NS=1)	EL3 (SCR.NS=0)
-	-	-	-	RW	RW

Configurations

ICC_SRE_EL3 is architecturally mapped to AArch32 register [ICC_MSRE](#).

Attributes

ICC_SRE_EL3 is a 32-bit register.

The ICC_SRE_EL3 bit assignments are:

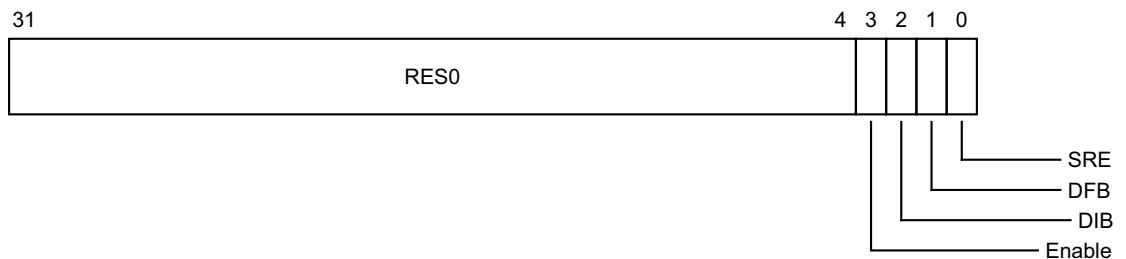

Bits [31:4]

Reserved, RES0.

Enable, bit [3]

Enable. Enables lower exception level access to ICC_SRE_EL1 and ICC_SRE_EL2.

0 EL1 and EL2 accesses to ICC_SRE_EL1 or ICC_SRE_EL2 trap to EL3.

1 EL2 accesses to ICC_SRE_EL2 are permitted. If the Enable bit of ICC_SRE_EL2 is 1, then EL1 accesses to ICC_SRE_EL1 are also permitted.

Resets to 0.

DIB, bit [2]

Disable IRQ bypass.

Resets to 0.

DFB, bit [1]

Disable FIQ bypass.

Resets to 0.

SRE, bit [0]

System Register Enable.

- 0 The memory mapped interface must be used. Access at EL3 to any ICH_* system register, or any EL1, EL2, or EL3 ICC_* register other than ICC_SRE_EL1, ICC_SRE_EL2, or ICC_SRE_EL3, results in an Undefined exception.
- 1 The system register interface to the ICH_* registers and the EL1, EL2, and EL3 ICC_* registers is enabled for EL3.

Resets to 0.

Accessing the ICC_SRE_EL3:

To access the ICC_SRE_EL3:

MRS <Xt>, ICC_SRE_EL3 ; Read ICC_SRE_EL3 into Xt
MSR ICC_SRE_EL3, <Xt> ; Write Xt to ICC_SRE_EL3

Register access is encoded as follows:

op0	op1	CRn	CRm	op2
11	110	1100	1100	101

D8.6.32 ICH_AP0R0_EL2, Interrupt Controller Hyp Active Priorities Register (0,0)

The ICH_AP0R0_EL2 characteristics are:

Purpose

Provides information about the active priorities for the current EL2 interrupt regime.

This register is part of:

- the GIC registers functional group
- the Virtualization registers functional group.

Usage constraints

This register is accessible as shown below:

EL0	EL1 (NS)	EL1 (S)	EL2	EL3 (SCR.NS=1)	EL3 (SCR.NS=0)
-	-	-	RW	RW	RW

In implementations supporting fewer than 8 bits of priority, some of these registers correspond to unimplemented priority levels. Access to such registers will generate an Undefined exception.

Configurations

ICH_AP0R0_EL2 is architecturally mapped to AArch32 register [ICH_AP0R0](#).

Attributes

ICH_AP0R0_EL2 is a 32-bit register.

The ICH_AP0R0_EL2 bit assignments are:

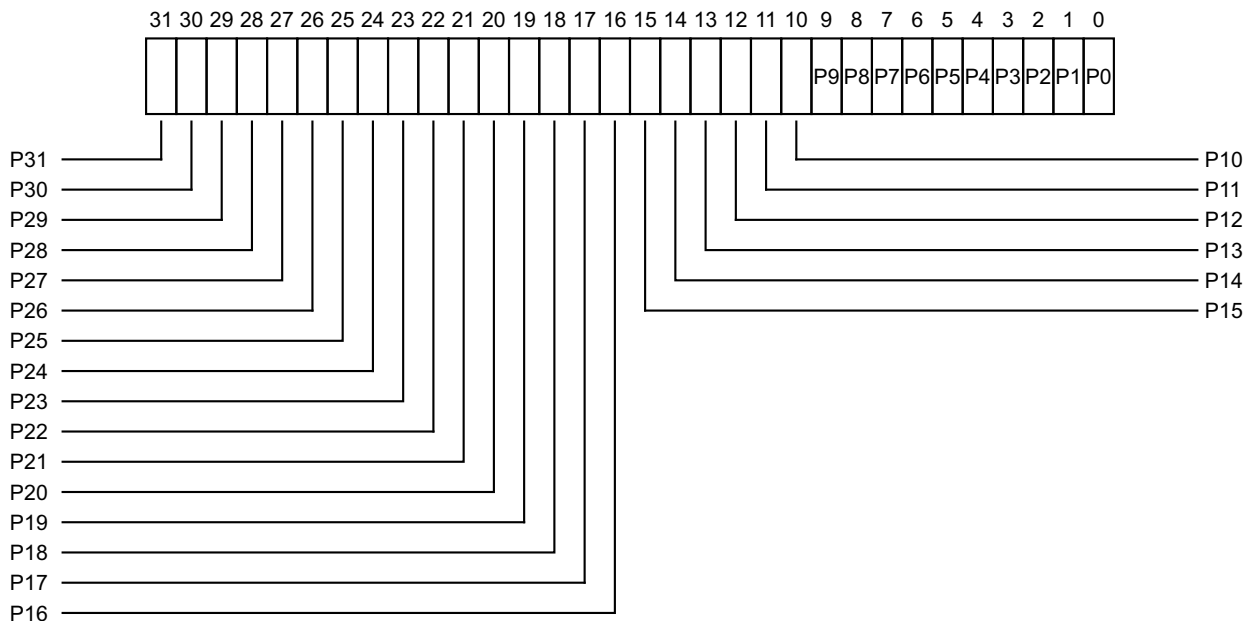

P<n>, bit [n], for n = 0 to 31

Provides information about priority M, according to the following relationship:

Bit P<n> corresponds to priority (M divided by 2^U) minus 1, where U is the number of unimplemented bits of priority and is equal to (7 - ICC_CTLR_EL1.PRIbits).

For example, in a system with `ICC_CTLR_EL1.PRIbits == 0b100`:

- There are 5 bits of implemented priority.
- This means there are 3 bits of unimplemented priority, which are always at the least significant end (bits [2:0] are RES0).
- Valid priorities are 8, 16, 24, 32, and so on. Dividing these by 2^3 gives 1, 2, 3, 4, and so on.
- Subtracting 1 from each gives bits 0, 1, 2, 3, and so on that provide information about those priorities.

Accesses to these registers from an interrupt regime give a view of the active priorities that is appropriate for that interrupt regime, to allow save and restore of the appropriate state.

Interrupt regime and the number of security states supported by the Distributor affect the view as follows. Unless otherwise stated, when a bit is successfully set to one, this clears any other active priorities corresponding to that bit.

Exception level	AP0Rn access
(Secure) EL3	Permitted. Accesses Group 0 Secure active priorities.
Secure EL1	Permitted. Accesses Group 0 Secure active priorities.
Non-secure EL1 access for a Virtual interrupt	ICH_AP0Rn_EL2
Non-secure EL1 or EL2 when GIC Distributor supports two Security states	Permitted. Accesses Group 0 Secure active priorities.
Non-secure EL1 or EL2 when GIC Distributor supports one Security state	Permitted. Accesses Group 0 active priorities.

A Virtual interrupt in this case means that the interrupt group associated with the register has been virtualized.

Accessing the ICH_AP0R0_EL2:

To access the ICH_AP0R0_EL2:

MRS <Xt>, ICH_AP0R0_EL2 ; Read ICH_AP0R0_EL2 into Xt
MSR ICH_AP0R0_EL2, <Xt> ; Write Xt to ICH_AP0R0_EL2

Register access is encoded as follows:

op0	op1	CRn	CRm	op2
11	100	1100	1000	000

D8.6.33 ICH_AP0R1_EL2, Interrupt Controller Hyp Active Priorities Register (0,1)

The ICH_AP0R1_EL2 characteristics are:

Purpose

Provides information about the active priorities for the current EL2 interrupt regime.

This register is part of:

- the GIC registers functional group
- the Virtualization registers functional group.

Usage constraints

This register is accessible as shown below:

EL0	EL1 (NS)	EL1 (S)	EL2	EL3 (SCR.NS=1)	EL3 (SCR.NS=0)
-	-	-	RW	RW	RW

In implementations supporting fewer than 8 bits of priority, some of these registers correspond to unimplemented priority levels. Access to such registers will generate an Undefined exception.

Configurations

ICH_AP0R1_EL2 is architecturally mapped to AArch32 register [ICH_AP0R1](#).

Attributes

ICH_AP0R1_EL2 is a 32-bit register.

The ICH_AP0R1_EL2 bit assignments are:

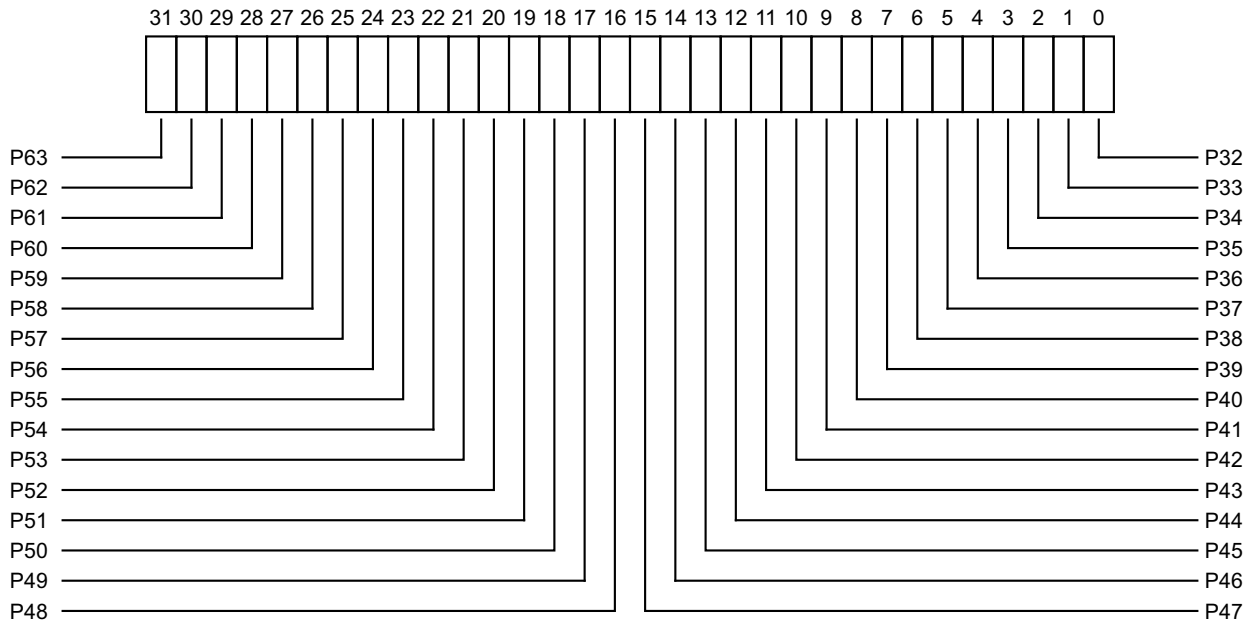

P<n>, bit [(n-32)], for n = 32 to 63

Provides information about priority M, according to the following relationship:

Bit P<n> corresponds to priority (M divided by 2^U) minus 1, where U is the number of unimplemented bits of priority and is equal to (7 - ICC_CTLR_EL1.PRIbits).

For example, in a system with `ICC_CTLR_EL1.PRIbits == 0b100`:

- There are 5 bits of implemented priority.
- This means there are 3 bits of unimplemented priority, which are always at the least significant end (bits [2:0] are RES0).
- Valid priorities are 8, 16, 24, 32, and so on. Dividing these by 2^3 gives 1, 2, 3, 4, and so on.
- Subtracting 1 from each gives bits 0, 1, 2, 3, and so on that provide information about those priorities.

Accesses to these registers from an interrupt regime give a view of the active priorities that is appropriate for that interrupt regime, to allow save and restore of the appropriate state.

Interrupt regime and the number of security states supported by the Distributor affect the view as follows. Unless otherwise stated, when a bit is successfully set to one, this clears any other active priorities corresponding to that bit.

Exception level	AP0Rn access
(Secure) EL3	Permitted. Accesses Group 0 Secure active priorities.
Secure EL1	Permitted. Accesses Group 0 Secure active priorities.
Non-secure EL1 access for a Virtual interrupt	ICH_AP0Rn_EL2
Non-secure EL1 or EL2 when GIC Distributor supports two Security states	Permitted. Accesses Group 0 Secure active priorities.
Non-secure EL1 or EL2 when GIC Distributor supports one Security state	Permitted. Accesses Group 0 active priorities.

A Virtual interrupt in this case means that the interrupt group associated with the register has been virtualized.

Accessing the ICH_AP0R1_EL2:

To access the ICH_AP0R1_EL2:

MRS <Xt>, ICH_AP0R1_EL2 ; Read ICH_AP0R1_EL2 into Xt
MSR ICH_AP0R1_EL2, <Xt> ; Write Xt to ICH_AP0R1_EL2

Register access is encoded as follows:

op0	op1	CRn	CRm	op2
11	100	1100	1000	001

D8.6.34 ICH_AP0R2_EL2, Interrupt Controller Hyp Active Priorities Register (0,2)

The ICH_AP0R2_EL2 characteristics are:

Purpose

Provides information about the active priorities for the current EL2 interrupt regime.

This register is part of:

- the GIC registers functional group
- the Virtualization registers functional group.

Usage constraints

This register is accessible as shown below:

EL0	EL1 (NS)	EL1 (S)	EL2	EL3 (SCR.NS=1)	EL3 (SCR.NS=0)
-	-	-	RW	RW	RW

In implementations supporting fewer than 8 bits of priority, some of these registers correspond to unimplemented priority levels. Access to such registers will generate an Undefined exception.

Configurations

ICH_AP0R2_EL2 is architecturally mapped to AArch32 register [ICH_AP0R2](#).

Attributes

ICH_AP0R2_EL2 is a 32-bit register.

The ICH_AP0R2_EL2 bit assignments are:

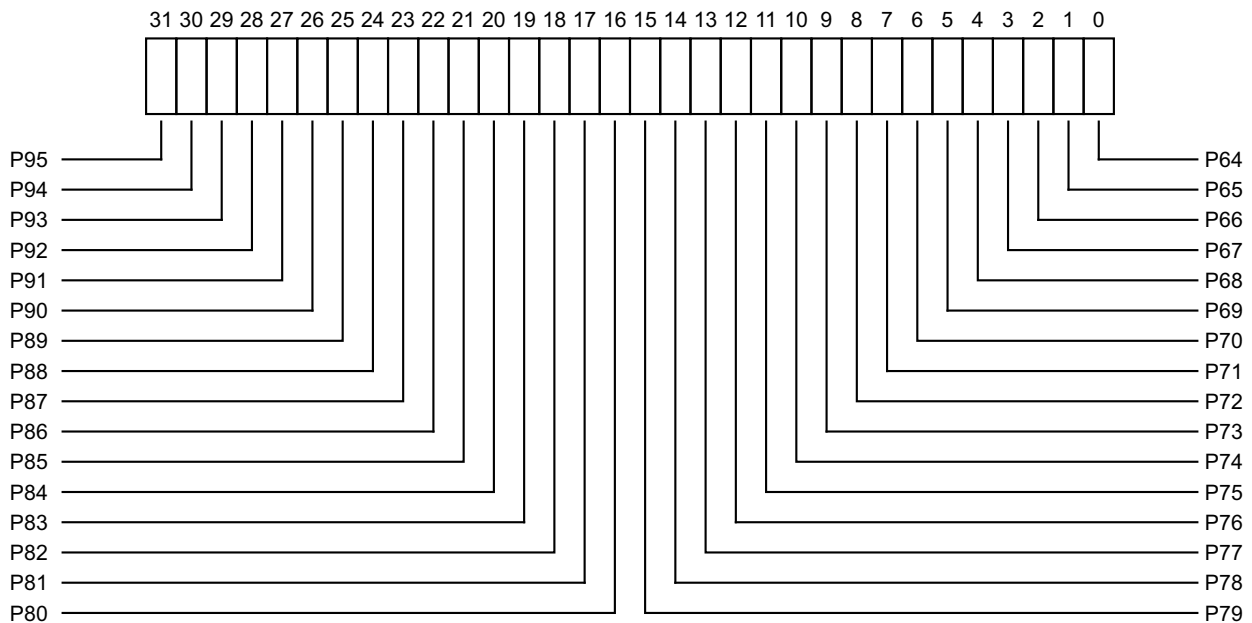

P<n>, bit [(n-64)], for n = 64 to 95

Provides information about priority M, according to the following relationship:

Bit P<n> corresponds to priority $(M \text{ divided by } 2^U) \text{ minus } 1$, where U is the number of unimplemented bits of priority and is equal to $(7 - \text{ICC_CTLR_EL1.PRIbits})$.

For example, in a system with `ICC_CTLR_EL1.PRIbits == 0b100`:

- There are 5 bits of implemented priority.
- This means there are 3 bits of unimplemented priority, which are always at the least significant end (bits [2:0] are RES0).
- Valid priorities are 8, 16, 24, 32, and so on. Dividing these by 2^3 gives 1, 2, 3, 4, and so on.
- Subtracting 1 from each gives bits 0, 1, 2, 3, and so on that provide information about those priorities.

Accesses to these registers from an interrupt regime give a view of the active priorities that is appropriate for that interrupt regime, to allow save and restore of the appropriate state.

Interrupt regime and the number of security states supported by the Distributor affect the view as follows. Unless otherwise stated, when a bit is successfully set to one, this clears any other active priorities corresponding to that bit.

Exception level	AP0Rn access
(Secure) EL3	Permitted. Accesses Group 0 Secure active priorities.
Secure EL1	Permitted. Accesses Group 0 Secure active priorities.
Non-secure EL1 access for a Virtual interrupt	ICH_AP0Rn_EL2
Non-secure EL1 or EL2 when GIC Distributor supports two Security states	Permitted. Accesses Group 0 Secure active priorities.
Non-secure EL1 or EL2 when GIC Distributor supports one Security state	Permitted. Accesses Group 0 active priorities.

A Virtual interrupt in this case means that the interrupt group associated with the register has been virtualized.

Accessing the ICH_AP0R2_EL2:

To access the ICH_AP0R2_EL2:

MRS <Xt>, ICH_AP0R2_EL2 ; Read ICH_AP0R2_EL2 into Xt
MSR ICH_AP0R2_EL2, <Xt> ; Write Xt to ICH_AP0R2_EL2

Register access is encoded as follows:

op0	op1	CRn	CRm	op2
11	100	1100	1000	010

D8.6.35 ICH_AP0R3_EL2, Interrupt Controller Hyp Active Priorities Register (0,3)

The ICH_AP0R3_EL2 characteristics are:

Purpose

Provides information about the active priorities for the current EL2 interrupt regime.

This register is part of:

- the GIC registers functional group
- the Virtualization registers functional group.

Usage constraints

This register is accessible as shown below:

EL0	EL1 (NS)	EL1 (S)	EL2	EL3 (SCR.NS=1)	EL3 (SCR.NS=0)
-	-	-	RW	RW	RW

In implementations supporting fewer than 8 bits of priority, some of these registers correspond to unimplemented priority levels. Access to such registers will generate an Undefined exception.

Configurations

ICH_AP0R3_EL2 is architecturally mapped to AArch32 register [ICH_AP0R3](#).

Attributes

ICH_AP0R3_EL2 is a 32-bit register.

The ICH_AP0R3_EL2 bit assignments are:

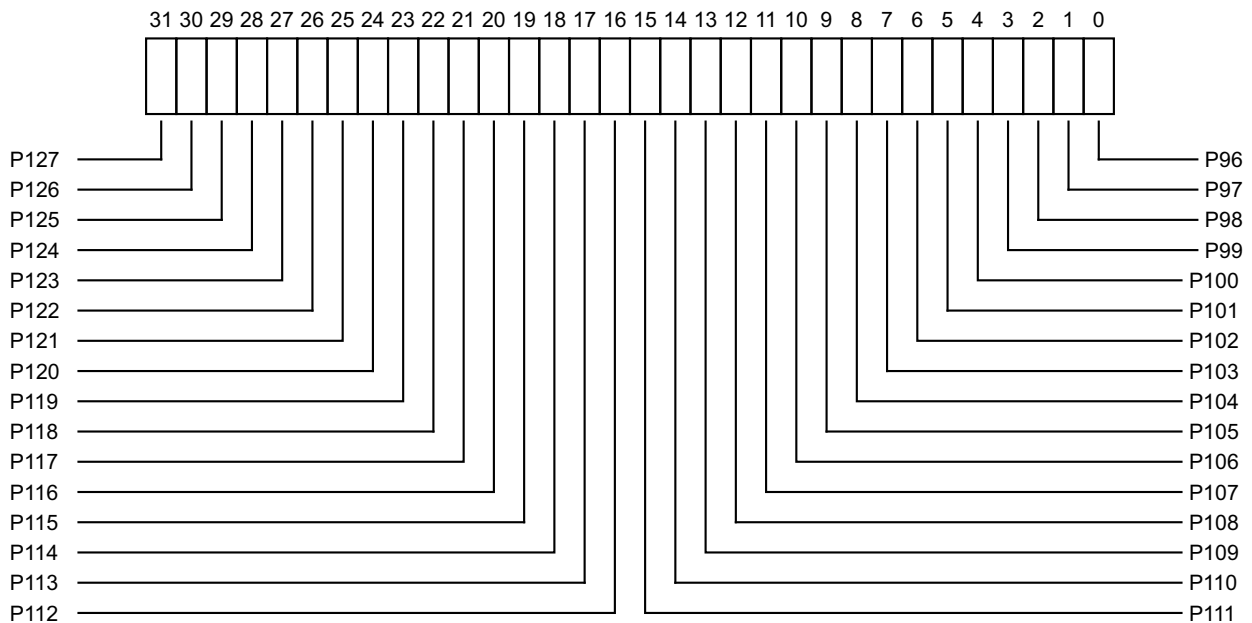

P<n>, bit [(n-96)], for n = 96 to 127

Provides information about priority M, according to the following relationship:

Bit P<n> corresponds to priority $(M \text{ divided by } 2^U) \text{ minus } 1$, where U is the number of unimplemented bits of priority and is equal to $(7 - \text{ICC_CTLR_EL1.PRIbits})$.

For example, in a system with `ICC_CTLR_EL1.PRIbits == 0b100`:

- There are 5 bits of implemented priority.
- This means there are 3 bits of unimplemented priority, which are always at the least significant end (bits [2:0] are RES0).
- Valid priorities are 8, 16, 24, 32, and so on. Dividing these by 2^3 gives 1, 2, 3, 4, and so on.
- Subtracting 1 from each gives bits 0, 1, 2, 3, and so on that provide information about those priorities.

Accesses to these registers from an interrupt regime give a view of the active priorities that is appropriate for that interrupt regime, to allow save and restore of the appropriate state.

Interrupt regime and the number of security states supported by the Distributor affect the view as follows. Unless otherwise stated, when a bit is successfully set to one, this clears any other active priorities corresponding to that bit.

Exception level	AP0Rn access
(Secure) EL3	Permitted. Accesses Group 0 Secure active priorities.
Secure EL1	Permitted. Accesses Group 0 Secure active priorities.
Non-secure EL1 access for a Virtual interrupt	ICH_AP0Rn_EL2
Non-secure EL1 or EL2 when GIC Distributor supports two Security states	Permitted. Accesses Group 0 Secure active priorities.
Non-secure EL1 or EL2 when GIC Distributor supports one Security state	Permitted. Accesses Group 0 active priorities.

A Virtual interrupt in this case means that the interrupt group associated with the register has been virtualized.

Accessing the ICH_AP0R3_EL2:

To access the ICH_AP0R3_EL2:

MRS <Xt>, ICH_AP0R3_EL2 ; Read ICH_AP0R3_EL2 into Xt
MSR ICH_AP0R3_EL2, <Xt> ; Write Xt to ICH_AP0R3_EL2

Register access is encoded as follows:

op0	op1	CRn	CRm	op2
11	100	1100	1000	011

D8.6.36 ICH_AP1R0_EL2, Interrupt Controller Hyp Active Priorities Register (1,0)

The ICH_AP1R0_EL2 characteristics are:

Purpose

Provides information about the active priorities for the current EL2 interrupt regime.

This register is part of:

- the GIC registers functional group
- the Virtualization registers functional group.

Usage constraints

This register is accessible as shown below:

EL0	EL1 (NS)	EL1 (S)	EL2	EL3 (SCR.NS=1)	EL3 (SCR.NS=0)
-	-	-	RW	RW	RW

In implementations supporting fewer than 8 bits of priority, some of these registers correspond to unimplemented priority levels. Access to such registers will generate an Undefined exception.

Configurations

ICH_AP1R0_EL2 is architecturally mapped to AArch32 register [ICH_AP1R0](#).

Attributes

ICH_AP1R0_EL2 is a 32-bit register.

The ICH_AP1R0_EL2 bit assignments are:

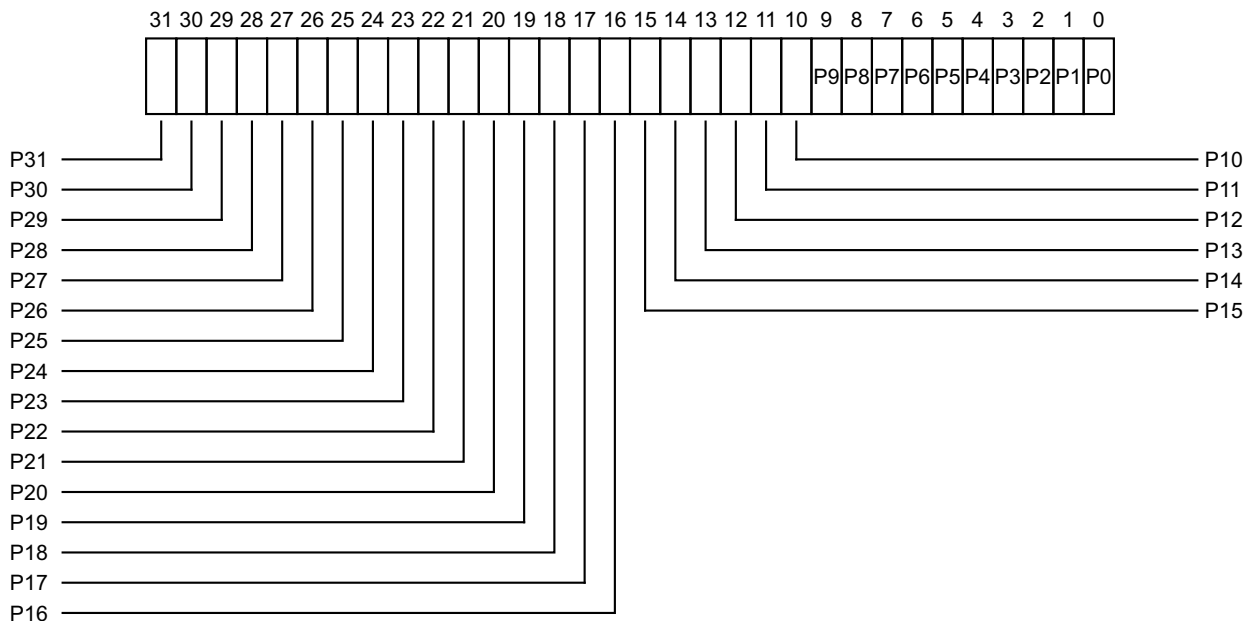

P<n>, bit [n], for n = 0 to 31

Provides information about priority M, according to the following relationship:

Bit P<n> corresponds to priority (M divided by 2^U) minus 1, where U is the number of unimplemented bits of priority and is equal to (7 - ICC_CTLR_EL1.PRIbits).

For example, in a system with `ICC_CTLR_EL1.PRIBits == 0b100`:

- There are 5 bits of implemented priority.
- This means there are 3 bits of unimplemented priority, which are always at the least significant end (bits [2:0] are RES0).
- Valid priorities are 8, 16, 24, 32, and so on. Dividing these by 2^3 gives 1, 2, 3, 4, and so on.
- Subtracting 1 from each gives bits 0, 1, 2, 3, and so on that provide information about those priorities.

Accesses to these registers from an interrupt regime give a view of the active priorities that is appropriate for that interrupt regime, to allow save and restore of the appropriate state.

Interrupt regime and the number of security states supported by the Distributor affect the view as follows. Unless otherwise stated, when a bit is successfully set to one, this clears any other active priorities corresponding to that bit.

Current exception level and security state	AP1Rn access
(Secure) EL3	Permitted. When <code>SCR_EL3.NS</code> is 0, accesses Group 1 Secure active priorities. When <code>SCR_EL3.NS</code> is 1, accesses Group 1 Non-secure active priorities (unshifted). When a bit is written, the bit is only updated if the corresponding Group 0 and Group 1 Secure active priority is zero.
Secure EL1	Permitted. Accesses Group 1 Secure active priorities (unshifted). When a bit is written, the bit is only updated if the corresponding Group 0 Secure active priority is zero.
Non-secure EL1 access for a Virtual interrupt	<code>ICH_AP1Rn_EL2</code>
Non-secure EL1 or EL2 when GIC Distributor supports two Security states	Permitted. Accesses Group 1 Non-secure active priorities (shifted). When a bit is written, the bit is only updated if the corresponding Group 0 and Group 1 Secure active priority is zero.
Non-secure EL1 or EL2 when GIC Distributor supports one Security state	Permitted. Accesses Group 1 Non-secure active priorities (unshifted). When a bit is written, the bit is only updated if the Group 0 active priority is zero.

A Virtual interrupt in this case means that the interrupt group associated with the register has been virtualized.

Accessing the `ICH_AP1R0_EL2`:

To access the `ICH_AP1R0_EL2`:

MRS <Xt>, `ICH_AP1R0_EL2` ; Read `ICH_AP1R0_EL2` into Xt
MSR `ICH_AP1R0_EL2`, <Xt> ; Write Xt to `ICH_AP1R0_EL2`

Register access is encoded as follows:

op0	op1	CRn	CRm	op2
11	100	1100	1001	000

D8.6.37 ICH_AP1R1_EL2, Interrupt Controller Hyp Active Priorities Register (1,1)

The ICH_AP1R1_EL2 characteristics are:

Purpose

Provides information about the active priorities for the current EL2 interrupt regime.

This register is part of:

- the GIC registers functional group
- the Virtualization registers functional group.

Usage constraints

This register is accessible as shown below:

EL0	EL1 (NS)	EL1 (S)	EL2	EL3 (SCR.NS=1)	EL3 (SCR.NS=0)
-	-	-	RW	RW	RW

In implementations supporting fewer than 8 bits of priority, some of these registers correspond to unimplemented priority levels. Access to such registers will generate an Undefined exception.

Configurations

ICH_AP1R1_EL2 is architecturally mapped to AArch32 register [ICH_AP1R1](#).

Attributes

ICH_AP1R1_EL2 is a 32-bit register.

The ICH_AP1R1_EL2 bit assignments are:

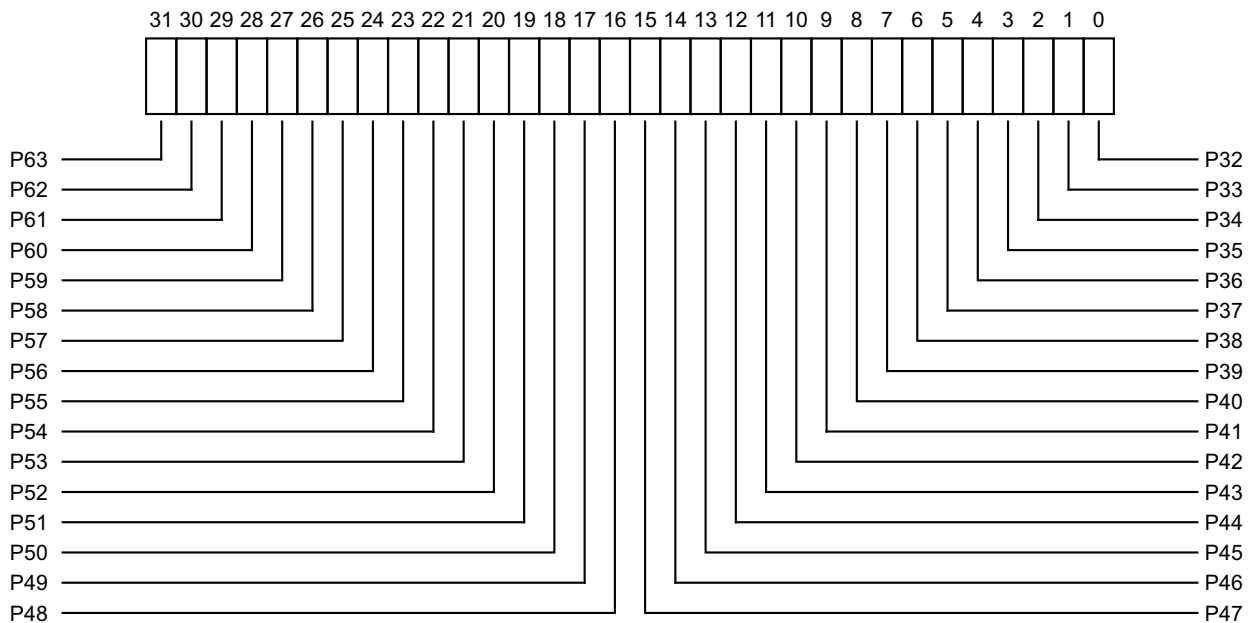

P<n>, bit [(n-32)], for n = 32 to 63

Provides information about priority M, according to the following relationship:

Bit P<n> corresponds to priority (M divided by 2^U) minus 1, where U is the number of unimplemented bits of priority and is equal to (7 - ICC_CTLR_EL1.PRIbits).

For example, in a system with ICC_CTLR_EL1.PRIbits == 0b100:

- There are 5 bits of implemented priority.
- This means there are 3 bits of unimplemented priority, which are always at the least significant end (bits [2:0] are RES0).
- Valid priorities are 8, 16, 24, 32, and so on. Dividing these by 2^3 gives 1, 2, 3, 4, and so on.
- Subtracting 1 from each gives bits 0, 1, 2, 3, and so on that provide information about those priorities.

Accesses to these registers from an interrupt regime give a view of the active priorities that is appropriate for that interrupt regime, to allow save and restore of the appropriate state.

Interrupt regime and the number of security states supported by the Distributor affect the view as follows. Unless otherwise stated, when a bit is successfully set to one, this clears any other active priorities corresponding to that bit.

Current exception level and security state	AP1Rn access
(Secure) EL3	Permitted. When SCR_EL3.NS is 0, accesses Group 1 Secure active priorities. When SCR_EL3.NS is 1, accesses Group 1 Non-secure active priorities (unshifted). When a bit is written, the bit is only updated if the corresponding Group 0 and Group 1 Secure active priority is zero.
Secure EL1	Permitted. Accesses Group 1 Secure active priorities (unshifted). When a bit is written, the bit is only updated if the corresponding Group 0 Secure active priority is zero.
Non-secure EL1 access for a Virtual interrupt	ICH_AP1Rn_EL2
Non-secure EL1 or EL2 when GIC Distributor supports two Security states	Permitted. Accesses Group 1 Non-secure active priorities (shifted). When a bit is written, the bit is only updated if the corresponding Group 0 and Group 1 Secure active priority is zero.
Non-secure EL1 or EL2 when GIC Distributor supports one Security state	Permitted. Accesses Group 1 Non-secure active priorities (unshifted). When a bit is written, the bit is only updated if the Group 0 active priority is zero.

A Virtual interrupt in this case means that the interrupt group associated with the register has been virtualized.

Accessing the ICH_AP1R1_EL2:

To access the ICH_AP1R1_EL2:

MRS <Xt>, ICH_AP1R1_EL2 ; Read ICH_AP1R1_EL2 into Xt
MSR ICH_AP1R1_EL2, <Xt> ; Write Xt to ICH_AP1R1_EL2

Register access is encoded as follows:

op0	op1	CRn	CRm	op2
11	100	1100	1001	001

D8.6.38 ICH_AP1R2_EL2, Interrupt Controller Hyp Active Priorities Register (1,2)

The ICH_AP1R2_EL2 characteristics are:

Purpose

Provides information about the active priorities for the current EL2 interrupt regime.

This register is part of:

- the GIC registers functional group
- the Virtualization registers functional group.

Usage constraints

This register is accessible as shown below:

EL0	EL1 (NS)	EL1 (S)	EL2	EL3 (SCR.NS=1)	EL3 (SCR.NS=0)
-	-	-	RW	RW	RW

In implementations supporting fewer than 8 bits of priority, some of these registers correspond to unimplemented priority levels. Access to such registers will generate an Undefined exception.

Configurations

ICH_AP1R2_EL2 is architecturally mapped to AArch32 register [ICH_AP1R2](#).

Attributes

ICH_AP1R2_EL2 is a 32-bit register.

The ICH_AP1R2_EL2 bit assignments are:

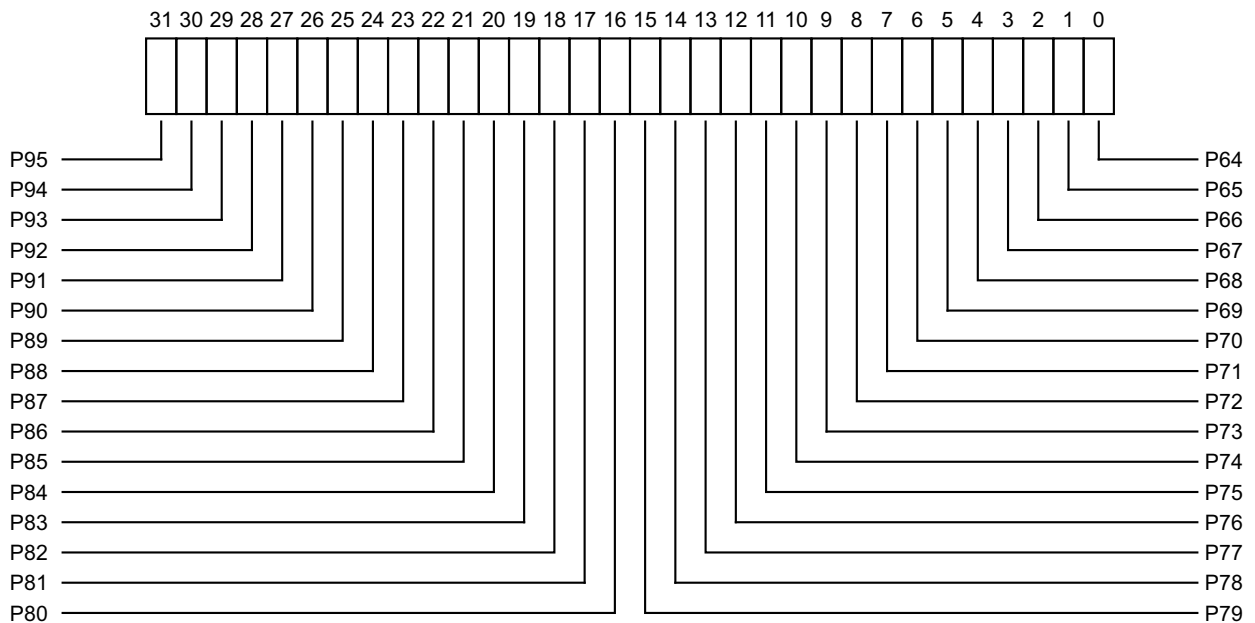

P<n>, bit [(n-64)], for n = 64 to 95

Provides information about priority M, according to the following relationship:

Bit P<n> corresponds to priority (M divided by 2^U) minus 1, where U is the number of unimplemented bits of priority and is equal to (7 - ICC_CTLR_EL1.PRIbits).

For example, in a system with `ICC_CTLR_EL1.PRIbits == 0b100`:

- There are 5 bits of implemented priority.
- This means there are 3 bits of unimplemented priority, which are always at the least significant end (bits [2:0] are RES0).
- Valid priorities are 8, 16, 24, 32, and so on. Dividing these by 2^3 gives 1, 2, 3, 4, and so on.
- Subtracting 1 from each gives bits 0, 1, 2, 3, and so on that provide information about those priorities.

Accesses to these registers from an interrupt regime give a view of the active priorities that is appropriate for that interrupt regime, to allow save and restore of the appropriate state.

Interrupt regime and the number of security states supported by the Distributor affect the view as follows. Unless otherwise stated, when a bit is successfully set to one, this clears any other active priorities corresponding to that bit.

Current exception level and security state	AP1Rn access
(Secure) EL3	Permitted. When <code>SCR_EL3.NS</code> is 0, accesses Group 1 Secure active priorities. When <code>SCR_EL3.NS</code> is 1, accesses Group 1 Non-secure active priorities (unshifted). When a bit is written, the bit is only updated if the corresponding Group 0 and Group 1 Secure active priority is zero.
Secure EL1	Permitted. Accesses Group 1 Secure active priorities (unshifted). When a bit is written, the bit is only updated if the corresponding Group 0 Secure active priority is zero.
Non-secure EL1 access for a Virtual interrupt	<code>ICH_AP1Rn_EL2</code>
Non-secure EL1 or EL2 when GIC Distributor supports two Security states	Permitted. Accesses Group 1 Non-secure active priorities (shifted). When a bit is written, the bit is only updated if the corresponding Group 0 and Group 1 Secure active priority is zero.
Non-secure EL1 or EL2 when GIC Distributor supports one Security state	Permitted. Accesses Group 1 Non-secure active priorities (unshifted). When a bit is written, the bit is only updated if the Group 0 active priority is zero.

A Virtual interrupt in this case means that the interrupt group associated with the register has been virtualized.

Accessing the `ICH_AP1R2_EL2`:

To access the `ICH_AP1R2_EL2`:

MRS <Xt>, `ICH_AP1R2_EL2` ; Read `ICH_AP1R2_EL2` into Xt
MSR `ICH_AP1R2_EL2`, <Xt> ; Write Xt to `ICH_AP1R2_EL2`

Register access is encoded as follows:

op0	op1	CRn	CRm	op2
11	100	1100	1001	010

D8.6.39 ICH_AP1R3_EL2, Interrupt Controller Hyp Active Priorities Register (1,3)

The ICH_AP1R3_EL2 characteristics are:

Purpose

Provides information about the active priorities for the current EL2 interrupt regime.

This register is part of:

- the GIC registers functional group
- the Virtualization registers functional group.

Usage constraints

This register is accessible as shown below:

EL0	EL1 (NS)	EL1 (S)	EL2	EL3 (SCR.NS=1)	EL3 (SCR.NS=0)
-	-	-	RW	RW	RW

In implementations supporting fewer than 8 bits of priority, some of these registers correspond to unimplemented priority levels. Access to such registers will generate an Undefined exception.

Configurations

ICH_AP1R3_EL2 is architecturally mapped to AArch32 register [ICH_AP1R3](#).

Attributes

ICH_AP1R3_EL2 is a 32-bit register.

The ICH_AP1R3_EL2 bit assignments are:

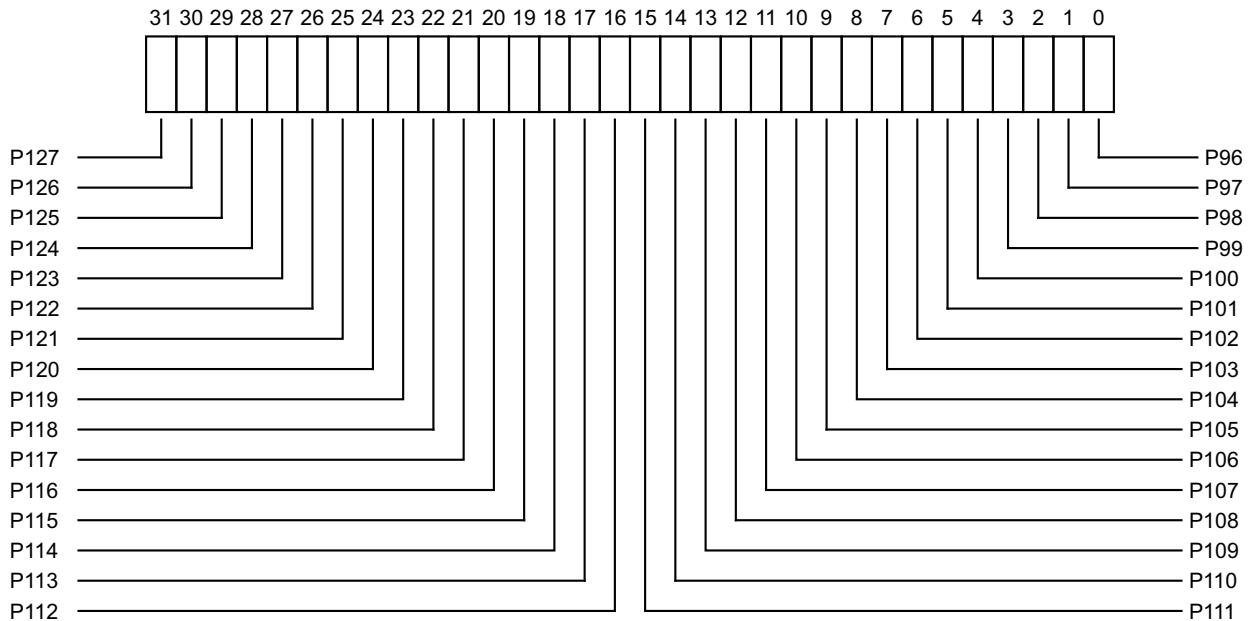

P<n>, bit [(n-96)], for n = 96 to 127

Provides information about priority M, according to the following relationship:

Bit P<n> corresponds to priority (M divided by 2^U) minus 1, where U is the number of unimplemented bits of priority and is equal to (7 - ICC_CTLR_EL1.PRIbits).

For example, in a system with `ICC_CTLR_EL1.PRIbits == 0b100`:

- There are 5 bits of implemented priority.
- This means there are 3 bits of unimplemented priority, which are always at the least significant end (bits [2:0] are RES0).
- Valid priorities are 8, 16, 24, 32, and so on. Dividing these by 2^3 gives 1, 2, 3, 4, and so on.
- Subtracting 1 from each gives bits 0, 1, 2, 3, and so on that provide information about those priorities.

Accesses to these registers from an interrupt regime give a view of the active priorities that is appropriate for that interrupt regime, to allow save and restore of the appropriate state.

Interrupt regime and the number of security states supported by the Distributor affect the view as follows. Unless otherwise stated, when a bit is successfully set to one, this clears any other active priorities corresponding to that bit.

Current exception level and security state	AP1Rn access
(Secure) EL3	Permitted. When <code>SCR_EL3.NS</code> is 0, accesses Group 1 Secure active priorities. When <code>SCR_EL3.NS</code> is 1, accesses Group 1 Non-secure active priorities (unshifted). When a bit is written, the bit is only updated if the corresponding Group 0 and Group 1 Secure active priority is zero.
Secure EL1	Permitted. Accesses Group 1 Secure active priorities (unshifted). When a bit is written, the bit is only updated if the corresponding Group 0 Secure active priority is zero.
Non-secure EL1 access for a Virtual interrupt	<code>ICH_AP1Rn_EL2</code>
Non-secure EL1 or EL2 when GIC Distributor supports two Security states	Permitted. Accesses Group 1 Non-secure active priorities (shifted). When a bit is written, the bit is only updated if the corresponding Group 0 and Group 1 Secure active priority is zero.
Non-secure EL1 or EL2 when GIC Distributor supports one Security state	Permitted. Accesses Group 1 Non-secure active priorities (unshifted). When a bit is written, the bit is only updated if the Group 0 active priority is zero.

A Virtual interrupt in this case means that the interrupt group associated with the register has been virtualized.

Accessing the `ICH_AP1R3_EL2`:

To access the `ICH_AP1R3_EL2`:

MRS <Xt>, `ICH_AP1R3_EL2` ; Read `ICH_AP1R3_EL2` into Xt
MSR `ICH_AP1R3_EL2`, <Xt> ; Write Xt to `ICH_AP1R3_EL2`

Register access is encoded as follows:

op0	op1	CRn	CRm	op2
11	100	1100	1001	011

D8.6.40 ICH_EISR_EL2, Interrupt Controller End of Interrupt Status Register

The ICH_EISR_EL2 characteristics are:

Purpose

When a maintenance interrupt is received, this register helps determine which List registers have outstanding EOI interrupts that require servicing.

This register is part of:

- the GIC registers functional group
- the Virtualization registers functional group.

Usage constraints

This register is accessible as shown below:

EL0	EL1 (NS)	EL1 (S)	EL2	EL3 (SCR.NS=1)	EL3 (SCR.NS=0)
-	-	-	RO	RO	RO

Configurations

ICH_EISR_EL2 is architecturally mapped to AArch32 register [ICH_EISR](#).

Attributes

ICH_EISR_EL2 is a 32-bit register.

The ICH_EISR_EL2 bit assignments are:

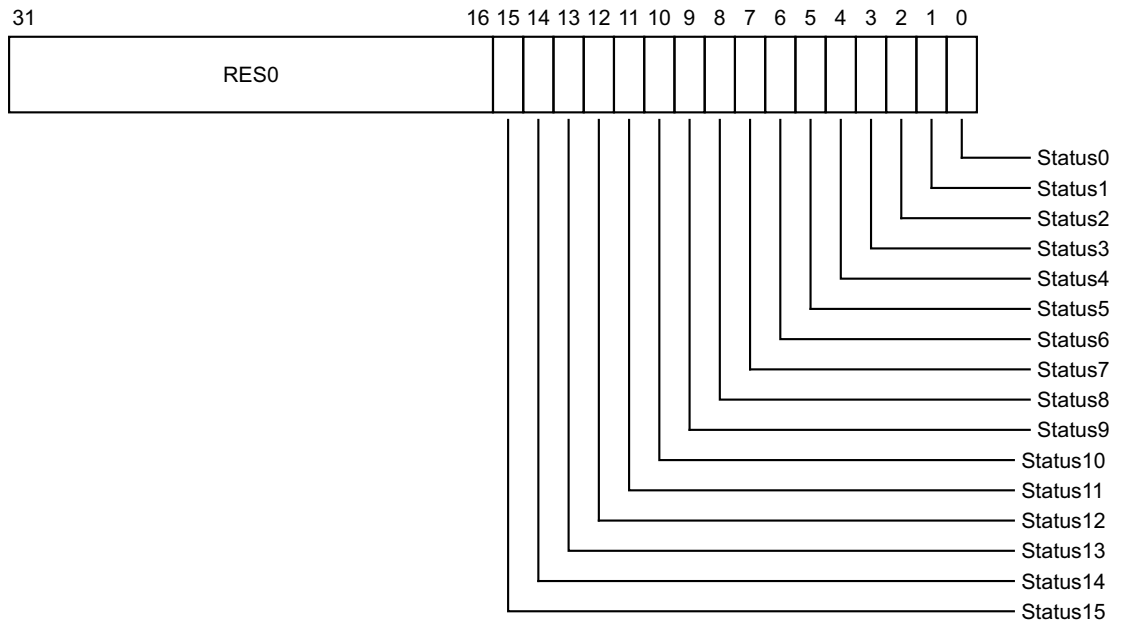

Bits [31:16]

Reserved, RES0.

Status<n>, bit [n], for n = 0 to 15

EOI status bit for List register <n>:

- 0 List register <n>, ICH_LR<n>_EL2, does not have an EOI.
- 1 List register <n>, ICH_LR<n>_EL2, has an EOI.

For any ICH_LR<n>_EL2, the corresponding status bit is set to 1 if ICH_LR<n>_EL2.State is 0b00 and ICH_LR<n>_EL2.HW is 0 and ICH_LR<n>_EL2.EOI is 1.

Accessing the ICH_EISR_EL2:

To access the ICH_EISR_EL2:

MRS <Xt>, ICH_EISR_EL2 ; Read ICH_EISR_EL2 into Xt

Register access is encoded as follows:

op0	op1	CRn	CRm	op2
11	100	1100	1011	011

D8.6.41 ICH_ELSR_EL2, Interrupt Controller Empty List Register Status Register

The ICH_ELSR_EL2 characteristics are:

Purpose

This register can be used to locate a usable List register when the hypervisor is delivering an interrupt to a Guest OS.

This register is part of:

- the GIC registers functional group
- the Virtualization registers functional group.

Usage constraints

This register is accessible as shown below:

ELO	EL1 (NS)	EL1 (S)	EL2	EL3 (SCR.NS=1)	EL3 (SCR.NS=0)
-	-	-	RO	RO	RO

Configurations

ICH_ELSR_EL2 is architecturally mapped to AArch32 register [ICH_ELSR](#).

Attributes

ICH_ELSR_EL2 is a 32-bit register.

The ICH_ELSR_EL2 bit assignments are:

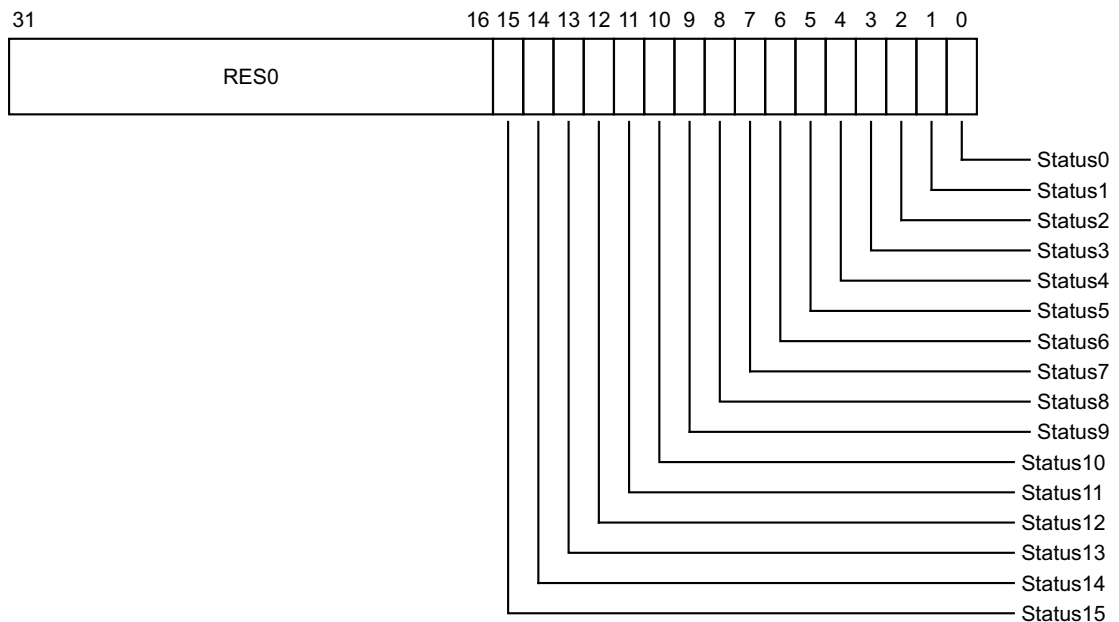

Bits [31:16]

Reserved, RES0.

Status<n>, bit [n], for n = 0 to 15

Status bit for List register <n>, ICH_LR<n>_EL2:

- 0 List register ICH_LR<n>_EL2, if implemented, contains a valid interrupt. Using this List register can result in overwriting a valid interrupt.

- 1 List register ICH_LR<n>_EL2 does not contain a valid interrupt. The List register is empty and can be used without overwriting a valid interrupt or losing an EOI maintenance interrupt.

For any ICH_LR<n>_EL2, the corresponding status bit is set to 1 if ICH_LR<n>_EL2.State is 0b00 and either ICH_LR<n>_EL2.HW is 1 or ICH_LR<n>_EL2.EOI is 0.

Accessing the ICH_ELSR_EL2:

To access the ICH_ELSR_EL2:

MRS <Xt>, ICH_ELSR_EL2 ; Read ICH_ELSR_EL2 into Xt

Register access is encoded as follows:

op0	op1	CRn	CRm	op2
11	100	1100	1011	101

D8.6.42 ICH_HCR_EL2, Interrupt Controller Hyp Control Register

The ICH_HCR_EL2 characteristics are:

Purpose

Controls the environment for guest operating systems.

This register is part of:

- the GIC registers functional group
- the Virtualization registers functional group.

Usage constraints

This register is accessible as shown below:

EL0	EL1 (NS)	EL1 (S)	EL2	EL3 (SCR.NS=1)	EL3 (SCR.NS=0)
-	-	-	RW	RW	RW

Configurations

ICH_HCR_EL2 is architecturally mapped to AArch32 register [ICH_HCR](#).

Attributes

ICH_HCR_EL2 is a 32-bit register.

The ICH_HCR_EL2 bit assignments are:

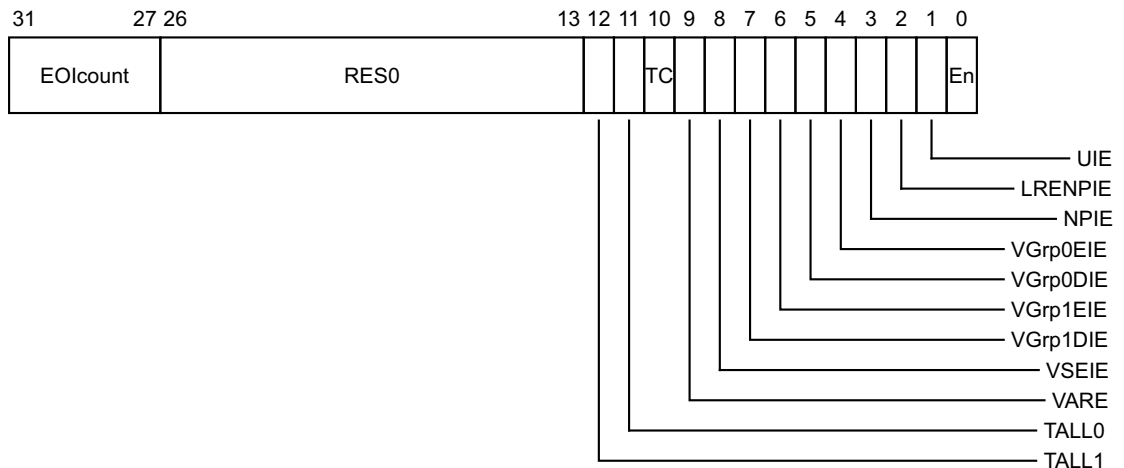

EOIcount, bits [31:27]

Counts the number of EOIs received that do not have a corresponding entry in the List registers. The virtual CPU interface increments this field automatically when a matching EOI is received.

EOIs that do not clear a bit in one of the Active Priorities registers ICH_APmRn_EL2 do not cause an increment.

Although not possible under correct operation, if an EOI occurs when the value of this field is 31, this field wraps to 0.

The maintenance interrupt is asserted whenever this field is non-zero and the LRENPIE bit is set to 1.

Bits [26:13]

Reserved, RES0.

TALL1, bit [12]

Trap all Non-secure EL1 accesses to ICC_* system registers for group 1 interrupts to EL2.

- 0 Non-Secure EL1 accesses to ICC_* registers for group 1 interrupts proceed as normal.
- 1 Any Non-secure EL1 accesses to ICC_* registers for group 1 interrupts trap to EL2.

TALL0, bit [11]

Trap all Non-secure EL1 accesses to ICC_* system registers for group 0 interrupts to EL2.

- 0 Non-Secure EL1 accesses to ICC_* registers for group 0 interrupts proceed as normal.
- 1 Any Non-secure EL1 accesses to ICC_* registers for group 0 interrupts trap to EL2.

TC, bit [10]

Trap all Non-secure EL1 accesses to system registers that are common to group 0 and group 1 to EL2.

- 0 Non-secure EL1 accesses to common registers proceed as normal.
- 1 Any Non-secure EL1 accesses to common registers trap to EL2.

This affects [ICC_DIR_EL1](#), [ICC_PMR_EL1](#), and [ICC_RPR_EL1](#).

VARE, bit [9]

Virtual ARE.

- 0 The guest operating system does not use affinity routing and expects a Source CPU ID for SGIs.
- 1 The guest operating system uses affinity routing.

When VARE is 0, the guest operating system does not support LPIs and software must ensure that no LPIs are presented to the guest either using the List registers or from the Distributor.

VSEIE, bit [8]

Virtual SEI Enable. Enables the signaling of a maintenance interrupt when performing a virtual access to a system register and a condition that would result in an (optional) SEI for a physical access is detected.

- 0 VSEIE maintenance interrupt is disabled.
- 1 VSEIE maintenance interrupt is enabled.

VGrp1DIE, bit [7]

VM Disable Group 1 Interrupt Enable. Enables the signaling of a maintenance interrupt while signaling of Group 1 interrupts from the virtual CPU interface to the connected virtual machine is disabled:

- 0 Maintenance interrupt disabled.
- 1 Maintenance interrupt signaled while GICV_CTLR.EnableGrp1 is set to 0.

VGrp1EIE, bit [6]

VM Enable Group 1 Interrupt Enable. Enables the signaling of a maintenance interrupt while signaling of Group 1 interrupts from the virtual CPU interface to the connected virtual machine is enabled:

- 0 Maintenance interrupt disabled.
- 1 Maintenance interrupt signaled while GICV_CTLR.EnableGrp1 is set to 1.

VGrp0DIE, bit [5]

VM Disable Group 0 Interrupt Enable. Enables the signaling of a maintenance interrupt while signaling of Group 0 interrupts from the virtual CPU interface to the connected virtual machine is disabled:

- 0 Maintenance interrupt disabled.
- 1 Maintenance interrupt signaled while GICV_CTLR.EnableGrp0 is set to 0.

VGrp0EIE, bit [4]

VM Enable Group 0 Interrupt Enable. Enables the signaling of a maintenance interrupt while signaling of Group 0 interrupts from the virtual CPU interface to the connected virtual machine is enabled:

- 0 Maintenance interrupt disabled.
- 1 Maintenance interrupt signaled while GICV_CTLR.EnableGrp0 is set to 1.

NPIE, bit [3]

No Pending Interrupt Enable. Enables the signaling of a maintenance interrupt while no pending interrupts are present in the List registers:

- 0 Maintenance interrupt disabled.
- 1 Maintenance interrupt signaled while the List registers contain no interrupts in the pending state.

LRENPIE, bit [2]

List Register Entry Not Present Interrupt Enable. Enables the signaling of a maintenance interrupt while the virtual CPU interface does not have a corresponding valid List register entry for an EOI request:

- 0 Maintenance interrupt disabled.
- 1 A maintenance interrupt is asserted while the EOICount field is not 0.

UIE, bit [1]

Underflow Interrupt Enable. Enables the signaling of a maintenance interrupt when the List registers are empty, or hold only one valid entry:

- 0 Maintenance interrupt disabled.
- 1 A maintenance interrupt is asserted if none, or only one, of the List register entries is marked as a valid interrupt.

En, bit [0]

Enable. Global enable bit for the virtual CPU interface:

- 0 Virtual CPU interface operation disabled.
- 1 Virtual CPU interface operation enabled.

When this field is set to 0:

- The virtual CPU interface does not signal any maintenance interrupts.
- The virtual CPU interface does not signal any virtual interrupts.
- A read of GICV_IAR or GICV_AIAR returns a spurious interrupt ID.

Accessing the ICH_HCR_EL2:

To access the ICH_HCR_EL2:

MRS <Xt>, ICH_HCR_EL2 ; Read ICH_HCR_EL2 into Xt
MSR ICH_HCR_EL2, <Xt> ; Write Xt to ICH_HCR_EL2

Register access is encoded as follows:

op0	op1	CRn	CRm	op2
11	100	1100	1011	000

D8.6.43 ICH_LR<n>_EL2, Interrupt Controller List Registers, n = 0 - 15

The ICH_LR<n>_EL2 characteristics are:

Purpose

Provides interrupt context information for the virtual CPU interface.

This register is part of:

- the GIC registers functional group
- the Virtualization registers functional group.

Usage constraints

This register is accessible as shown below:

EL0	EL1 (NS)	EL1 (S)	EL2	EL3 (SCR.NS=1)	EL3 (SCR.NS=0)
-	-	-	RW	RW	RW

Configurations

ICH_LR<n>_EL2[31:0] is architecturally mapped to AArch32 register ICH_LR<n>.

ICH_LR<n>_EL2[63:32] is architecturally mapped to AArch32 register ICH_LRC<n>.

Attributes

ICH_LR<n>_EL2 is a 64-bit register.

The ICH_LR<n>_EL2 bit assignments are:

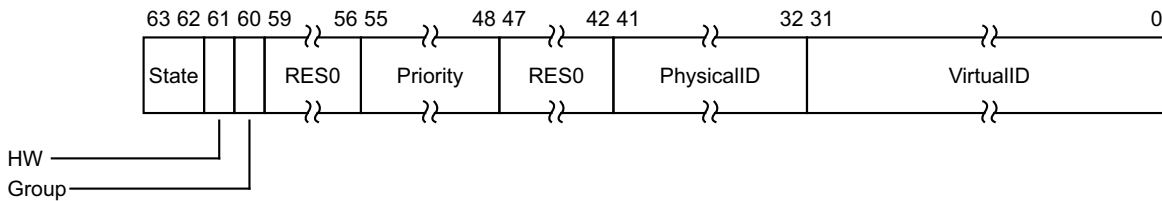

State, bits [63:62]

The state of the interrupt:

- 00 Invalid
- 01 Pending
- 10 Active
- 11 Pending and active.

The GIC updates these state bits as virtual interrupts proceed through the interrupt life cycle. Entries in the invalid state are ignored, except for the purpose of generating virtual maintenance interrupts.

For hardware interrupts, the pending and active state is held in the physical Distributor rather than the virtual CPU interface. A hypervisor must only use the pending and active state for software originated interrupts, which are typically associated with virtual devices, or SGIs.

HW, bit [61]

Indicates whether this virtual interrupt is a hardware interrupt, meaning that it corresponds to a physical interrupt. Deactivation of the virtual interrupt also causes the deactivation of the physical interrupt with the ID that the PhysicalID field indicates.

- 0 The interrupt is triggered entirely in software. No notification is sent to the Distributor when the virtual interrupt is deactivated.

- 1 The interrupt is a hardware interrupt. A deactivate interrupt request is sent to the Distributor when the virtual interrupt is deactivated, using the PhysicalID field from this register to indicate the physical interrupt ID.
If GICV_CTLR.EOImode is 0, this request corresponds to a write to the GICV_EOIR or GICV_AEOIR, otherwise it corresponds to a write to the GICV_DIR.

Bits [59:56]

Reserved, RES0.

Priority, bits [55:48]

The priority of this interrupt.

It is IMPLEMENTATION DEFINED how many bits of priority are implemented, though at least five bits must be implemented. Unimplemented bits are RES0 and start from bit [48] up to bit [50]. The number of implemented bits can be discovered from ICH_VTR_EL2.PRIBits, and determines how many GICH_APR<n> registers exist.

Bits [47:42]

Reserved, RES0.

PhysicalID, bits [41:32]

Physical ID, for hardware interrupts.

When HW is 0 (i.e. there is no corresponding physical interrupt), some of these bits have a special meaning:

Bit [39] EOI. When this bit is 1, a maintenance interrupt is asserted to signal EOI when the interrupt state is invalid, which typically occurs when the interrupt is deactivated.

Bits [38:32]Reserved, RES0.

It is IMPLEMENTATION DEFINED how many bits are implemented, though at least 16 bits must be implemented. Unimplemented bits are RES0. The number of implemented bits can be discovered from ICH_VTR_EL2.IDbits.

VirtualID, bits [31:0]

Virtual ID of the interrupt.

When VARE is zero, software must ensure the correct Source CPU ID is provided in bits [12:10].

Software must ensure there is only a single valid entry for a given VirtualID.

It is IMPLEMENTATION DEFINED how many bits are implemented, though at least 16 bits must be implemented. Unimplemented bits are RES0. The number of implemented bits can be discovered from ICH_VTR_EL2.IDbits.

Accessing the ICH_LR<n>_EL2:

To access the ICH_LR<n>_EL2:

MRS <Xt>, ICH_LR<n>_EL2 ; Read ICH_LR<n>_EL2 into Xt, where n is in the range 0 to 15
MSR ICH_LR<n>_EL2, <Xt> ; Write Xt to ICH_LR<n>_EL2, where n is in the range 0 to 15

Register access is encoded as follows:

op0	op1	CRn	CRm	op2
11	100	1100	110:n<3:3>	n<2:0>

D8.6.44 ICH_MISR_EL2, Interrupt Controller Maintenance Interrupt State Register

The ICH_MISR_EL2 characteristics are:

Purpose

Indicates which maintenance interrupts are asserted.

This register is part of:

- the GIC registers functional group
- the Virtualization registers functional group.

Usage constraints

This register is accessible as shown below:

ELO	EL1 (NS)	EL1 (S)	EL2	EL3 (SCR.NS=1)	EL3 (SCR.NS=0)
-	-	-	RO	RO	RO

Configurations

ICH_MISR_EL2 is architecturally mapped to AArch32 register [ICH_MISR](#).

Attributes

ICH_MISR_EL2 is a 32-bit register.

The ICH_MISR_EL2 bit assignments are:

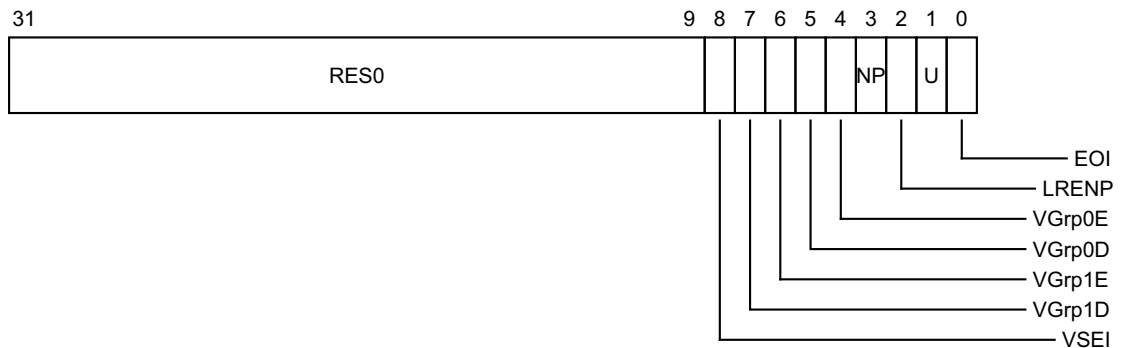

Bits [31:9]

Reserved, RES0.

VSEI, bit [8]

Virtual SEI. Set to 1 when a condition that would result in generation of an SEI is detected during a virtual access to an ICC_* system register.

VGrp1D, bit [7]

Disabled Group 1 maintenance interrupt.

Asserted whenever ICH_HCR_EL2.VGrp1DIE is 1 and ICH_VMCR_EL2.VMGrp1En is 0.

VGrp1E, bit [6]

Enabled Group 1 maintenance interrupt.

Asserted whenever ICH_HCR_EL2.VGrp1EIE is 1 and ICH_VMCR_EL2.VMGrp1En is 1.

VGrp0D, bit [5]

Disabled Group 0 maintenance interrupt.

Asserted whenever ICH_HCR_EL2.VGrp0DIE is 1 and ICH_VMCR_EL2.VMGrp0En is 0.

VGrp0E, bit [4]

Enabled Group 0 maintenance interrupt.

Asserted whenever ICH_HCR_EL2.VGrp0EIE is 1 and ICH_VMCR_EL2.VMGrp0En is 1.

NP, bit [3]

No Pending maintenance interrupt.

Asserted whenever ICH_HCR_EL2.NPIE is 1 and no List register is in pending state.

LRENP, bit [2]

List Register Entry Not Present maintenance interrupt.

Asserted whenever ICH_HCR_EL2.LRENPIE is 1 and ICH_HCR_EL2.EOIcount is non-zero.

U, bit [1]

Underflow maintenance interrupt.

Asserted whenever ICH_HCR_EL2.UIE is 1 and if none, or only one, of the List register entries are marked as a valid interrupt, that is, if the corresponding ICH_LR<n>_EL2.State bits do not equal 0x0.

EOI, bit [0]

EOI maintenance interrupt.

Asserted whenever at least one List register is asserting an EOI interrupt. That is, when at least one bit in ICH_EISR0_EL1 or ICH_EISR1_EL1 is 1.

Accessing the ICH_MISR_EL2:

To access the ICH_MISR_EL2:

MRS <Xt>, ICH_MISR_EL2 ; Read ICH_MISR_EL2 into Xt

Register access is encoded as follows:

op0	op1	CRn	CRm	op2
11	100	1100	1011	010

D8.6.45 ICH_VMCR_EL2, Interrupt Controller Virtual Machine Control Register

The ICH_VMCR_EL2 characteristics are:

Purpose

Enables the hypervisor to save and restore the virtual machine view of the GIC state.

This register is part of:

- the GIC registers functional group
- the Virtualization registers functional group.

Usage constraints

This register is accessible as shown below:

EL0	EL1 (NS)	EL1 (S)	EL2	EL3 (SCR.NS=1)	EL3 (SCR.NS=0)
-	-	-	RW	RW	RW

When EL2 is using system register access, EL1 using either system register or memory-mapped access must be supported.

Configurations

ICH_VMCR_EL2 is architecturally mapped to AArch32 register [ICH_VMCR](#).

Attributes

ICH_VMCR_EL2 is a 32-bit register.

The ICH_VMCR_EL2 bit assignments are:

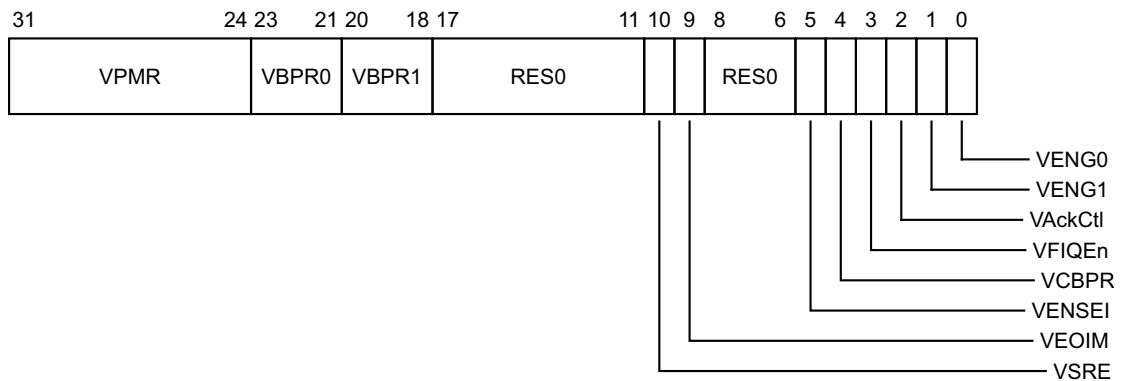

VPMR, bits [31:24]

Virtual Priority Mask.

Visible to the guest OS as ICC_PMR_EL1 / GICV_PMR.

VBPR0, bits [23:21]

Virtual BPR0.

Visible to the guest OS as ICC_BPR0_EL1 / GICV_BPR.

VBPR1, bits [20:18]

Virtual BPR1.

Visible to the guest OS as ICC_BPR1_EL1 / GICV_ABPR.

Bits [17:11]

Reserved, RES0.

VSRE, bit [10]

Virtual SRE.

Visible to the guest OS as ICC_SRE_EL1.SRE.

If EL2 is not configured to use system registers, this bit is treated as if it is 0.

VEOIM, bit [9]

Virtual EOImode.

Visible to the guest OS as ICC_CTLR_EL1.EOImode / GICV_CTLR.EOImode.

Bits [8:6]

Reserved, RES0.

VENSEL, bit [5]

This bit is IMP DEF.

If an implementation does not have functionality associated with this bit, ARM recommends that the bit is RES0.

VCBPR, bit [4]

Virtual CBPR.

Visible to the guest OS as ICC_CTLR_EL1.CBPR / GICV_CTLR.CBPR.

VFIQEn, bit [3]

Virtual FIQ enable.

Visible to the guest OS as GICV_CTLR.FIQEn.

VAckCtl, bit [2]

Virtual AckCtl.

Visible to the guest OS as GICV_CTLR.AckCtl.

VENG1, bit [1]

Virtual group 1 interrupt enable.

Visible to the guest OS as ICC_IGRPEN1_EL1.Enable / GICV_CTLR.EnableGrp1.

VENG0, bit [0]

Virtual group 0 interrupt enable.

Visible to the guest OS as ICC_IGRPEN0_EL1.Enable / GICV_CTLR.EnableGrp0.

Accessing the ICH_VMCR_EL2:

To access the ICH_VMCR_EL2:

MRS <Xt>, ICH_VMCR_EL2 ; Read ICH_VMCR_EL2 into Xt
MSR ICH_VMCR_EL2, <Xt> ; Write Xt to ICH_VMCR_EL2

Register access is encoded as follows:

op0	op1	CRn	CRm	op2
11	100	1100	1011	111

D8.6.46 ICH_VSEIR_EL2, Interrupt Controller Virtual System Error Interrupt Register

The ICH_VSEIR_EL2 characteristics are:

Purpose

Allows the hypervisor to inject a virtual SEI.

This register is part of:

- the GIC registers functional group
- the Virtualization registers functional group.

Usage constraints

This register is accessible as shown below:

EL0	EL1 (NS)	EL1 (S)	EL2	EL3 (SCR.NS=1)	EL3 (SCR.NS=0)
-	-	-	RW	RW	RW

Configurations

ICH_VSEIR_EL2 is architecturally mapped to AArch32 register [ICH_VSEIR](#).

Attributes

ICH_VSEIR_EL2 is a 32-bit register.

The ICH_VSEIR_EL2 bit assignments are:



Accessing the ICH_VSEIR_EL2:

To access the ICH_VSEIR_EL2:

MRS <Xt>, ICH_VSEIR_EL2 ; Read ICH_VSEIR_EL2 into Xt

MSR ICH_VSEIR_EL2, <Xt> ; Write Xt to ICH_VSEIR_EL2

Register access is encoded as follows:

op0	op1	CRn	CRm	op2
11	100	1100	1001	100

D8.6.47 ICH_VTR_EL2, Interrupt Controller VGIC Type Register

The ICH_VTR_EL2 characteristics are:

Purpose

Describes the number of implemented virtual priority bits and List registers.

This register is part of:

- the GIC registers functional group
- the Virtualization registers functional group.

Usage constraints

This register is accessible as shown below:

EL0	EL1 (NS)	EL1 (S)	EL2	EL3 (SCR.NS=1)	EL3 (SCR.NS=0)
-	-	-	RO	RO	RO

Configurations

ICH_VTR_EL2 is architecturally mapped to AArch32 register [ICH_VTR](#).

Attributes

ICH_VTR_EL2 is a 32-bit register.

The ICH_VTR_EL2 bit assignments are:

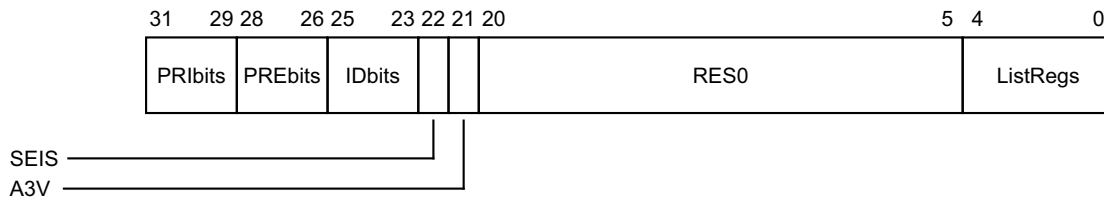

PRBits, bits [31:29]

The number of virtual priority bits implemented, minus one.

PREbits, bits [28:26]

The number of virtual preemption bits implemented, minus one.

IDbits, bits [25:23]

The number of virtual interrupt identifier bits supported:

000 16 bits.

001 24 bits.

All other values are reserved.

SEIS, bit [22]

SEI Support. Indicates whether the virtual CPU interface supports generation of SEIs:

0 The virtual CPU interface logic does not support generation of SEIs.

1 The virtual CPU interface logic supports generation of SEIs.

Virtual system errors may still be generated by writing to ICH_VSEIR_EL2 regardless of the value of this field.

A3V, bit [21]

Affinity 3 Valid. Possible values are:

- 0 The virtual CPU interface logic only supports zero values of Affinity 3 in SGI generation system registers.
- 1 The virtual CPU interface logic supports non-zero values of Affinity 3 in SGI generation system registers.

Bits [20:5]

Reserved, RES0.

ListRegs, bits [4:0]

The number of implemented List registers, minus one. For example, a value of 0b01111 indicates that the maximum of 16 List registers are implemented.

Accessing the ICH_VTR_EL2:

To access the ICH_VTR_EL2:

MRS <Xt>, ICH_VTR_EL2 ; Read ICH_VTR_EL2 into Xt

Register access is encoded as follows:

op0	op1	CRn	CRm	op2
11	100	1100	1011	001

Part E

The AArch32 Application Level Architecture

Chapter E1

The AArch32 Application Level Programmers' Model

This chapter gives an Application level description of the programmers' model for software executing in AArch32 state. This means it describes execution in EL0 when EL0 is using AArch32. It contains the following sections:

- *About the Application level programmers' model* on page E1-2288.
- *Additional information about the programmers' model in AArch32 state* on page E1-2289.
- *Advanced SIMD and floating-point instructions* on page E1-2303.
- *Coprocessor support* on page E1-2331.
- *Exceptions and debug events* on page E1-2332.

E1.1 About the Application level programmers' model

This chapter contains the programmers' model information required for the development of applications that will execute in AArch32 state.

The information in this chapter is distinct from the system information required to service and support application execution under an operating system, or higher level of system software. However, some knowledge of that system information is needed to put the Application level programmers' model into context.

Depending on the implementation, the architecture supports multiple levels of execution privilege. These privilege levels are indicated by different *Exception levels* that number upwards from EL0, where EL0 corresponds to the lowest privilege level and is often described as *unprivileged*. The Application level programmers' model is the programmers' model for software executing at EL0. For more information see [ARMv8 architectural concepts on page A1-33](#).

System software determines the Exception level, and therefore the level of privilege, at which application software runs. When an operating system supports execution at both EL1 and EL0, an application usually runs unprivileged. This:

- Means the operating system can allocate system resources to an application in a unique or shared manner.
- Provides a degree of protection from other processes, and so helps protect the operating system from malfunctioning software.

This chapter indicates where some System level understanding is helpful, and if appropriate it gives a reference to the System level description.

When included in an implementation:

- EL3 provides two Security states, Secure and Non-secure. Secure state provides additional hardware features that support the development of secure applications.
- EL2 provides virtualization of operation in Non-secure state.

However, application level software is generally unaware of its Security state, and of any virtualization. For more information, see [The ARMv8-A security model on page G1-3407](#) and [The effect of implementing EL2 on the Exception model on page G1-3410](#).

———— **Note** —————

- When an implementation includes EL3, application and operating system software normally executes in Non-secure state.
- EL2, that provides the virtualization features, is implemented only in Non-secure state.
- Older documentation, describing implementations or architecture versions that support only two privilege levels, often refers to execution at EL1 as *privileged* execution.
- In this manual, the terms *CONSTRAINED UNPREDICTABLE, IMPLEMENTATION DEFINED, OPTIONAL, RES0, RES1, SUBARCHITECTURE DEFINED, UNDEFINED, UNKNOWN, and UNPREDICTABLE* have special meanings, as defined in the [Glossary](#). In body text, these terms are shown in small caps, for example IMPLEMENTATION DEFINED.

E1.2 Additional information about the programmers' model in AArch32 state

The following sections give more information about the Application level programmer's model in AArch32 state:

- [Instruction sets, arithmetic operations, and register files.](#)
- [Core data types and arithmetic in AArch32 state.](#)
- [The general-purpose registers, and the PC, in AArch32 state on page E1-2294.](#)
- [The Application Program Status Register \(APSR\) on page E1-2297.](#)
- [Execution state registers on page E1-2298.](#)

E1.2.1 Instruction sets, arithmetic operations, and register files

The A32 and T32 instruction sets both provide a wide range of integer arithmetic and logical operations, that operate on a register file of sixteen 32-bit registers, that comprise the AArch32 general-purpose registers and the PC. As described in [The general-purpose registers, and the PC, in AArch32 state on page E1-2294](#), these registers include the special registers SP and LR. [Core data types and arithmetic in AArch32 state](#) gives more information about these operations.

In addition, an implementation that implements the T32 and A32 instruction sets includes both:

- Scalar floating-point instructions.
- The Advanced SIMD vector instructions.

Floating-point and vector instructions operate on a separate common register file, described in [The Advanced SIMD and floating-point register file on page E1-2303](#). [Advanced SIMD and floating-point instructions on page E1-2303](#) gives more information about these instructions.

E1.2.2 Core data types and arithmetic in AArch32 state

When executing in AArch32 state, a PE supports the following data types in memory:

Byte	8 bits
Halfword	16 bits
Word	32 bits
Doubleword	64 bits.

PE registers are 32 bits in size. The instruction sets provide instructions that use the following data types for data held in registers:

- 32-bit pointers.
- Unsigned or signed 32-bit integers.
- Unsigned 16-bit or 8-bit integers, held in zero-extended form.
- Signed 16-bit or 8-bit integers, held in sign-extended form.
- Two 16-bit integers packed into a register.
- Four 8-bit integers packed into a register.
- Unsigned or signed 64-bit integers held in two registers.

Load and store operations can transfer bytes, halfwords, or words to and from memory. Loads of bytes or halfwords zero-extend or sign-extend the data as it is loaded, as specified in the appropriate load instruction.

The instruction sets include load and store operations that transfer two or more words to and from memory. Software can load and store doublewords using these instructions.

———— **Note** ————

For information about the atomicity of memory accesses see [Atomicity in the ARM architecture on page E2-2346](#).

When any of the data types is described as *unsigned*, the N-bit data value represents a non-negative integer in the range 0 to 2^N-1 , using normal binary format.

When any of these types is described as *signed*, the N-bit data value represents an integer in the range $-2^{(N-1)}$ to $+2^{(N-1)}-1$, using two's complement format.

The instructions that operate on packed halfwords or bytes include some multiply instructions that use only one of two halfwords, and SIMD instructions that perform parallel addition or subtraction on all of the halfwords or bytes.

Direct instruction support for 64-bit integers is limited, and most 64-bit operations require sequences of two or more instructions to synthesize them.

Integer arithmetic

The instruction set provides a wide range of operations on the values in registers, including bitwise logical operations, shifts, additions, subtractions, multiplications, and divisions. The pseudocode described in [Appendix H ARM Pseudocode Definition](#) defines these operations, usually in one of three ways:

- By direct use of the pseudocode operators and built-in functions defined in [Operators and built-in functions on page AppxH-5069](#).
- By use of pseudocode helper functions defined in the main text. See [Appendix I Pseudocode Index](#).
- By a sequence of the form:
 1. Use of the SInt(), UInt(), and Int() built-in functions defined in [Converting bitstrings to integers on page AppxH-5071](#) to convert the bitstring contents of the instruction operands to the unbounded integers that they represent as two's complement or unsigned integers.
 2. Use of mathematical operators, built-in functions and helper functions on those unbounded integers to calculate other such integers.
 3. Use of either the bitstring extraction operator defined in [Bitstring extraction on page AppxH-5070](#) or of the saturation helper functions described in [Pseudocode details of saturation on page E1-2293](#) to convert an unbounded integer result into a bitstring result that can be written to a register.

Shift and rotate operations

The following types of shift and rotate operations are used in instructions:

Logical Shift Left

(LSL) moves each bit of a bitstring left by a specified number of bits. Zeros are shifted in at the right end of the bitstring. Bits that are shifted off the left end of the bitstring are discarded, except that the last such bit can be produced as a carry output.

Logical Shift Right

(LSR) moves each bit of a bitstring right by a specified number of bits. Zeros are shifted in at the left end of the bitstring. Bits that are shifted off the right end of the bitstring are discarded, except that the last such bit can be produced as a carry output.

Arithmetic Shift Right

(ASR) moves each bit of a bitstring right by a specified number of bits. Copies of the leftmost bit are shifted in at the left end of the bitstring. Bits that are shifted off the right end of the bitstring are discarded, except that the last such bit can be produced as a carry output.

Rotate Right (ROR) moves each bit of a bitstring right by a specified number of bits. Each bit that is shifted off the right end of the bitstring is re-introduced at the left end. The last bit shifted off the right end of the bitstring can be produced as a carry output.

Rotate Right with Extend

(RRX) moves each bit of a bitstring right by one bit. A carry input is shifted in at the left end of the bitstring. The bit shifted off the right end of the bitstring can be produced as a carry output.

Pseudocode details of shift and rotate operations

These shift and rotate operations are supported in pseudocode by the following functions:

```
// LSL_C()  
// =====
```



```
(bits(N), bit) LSL_C(bits(N) x, integer shift)
    assert shift > 0;
    extended_x = x : Zeros(shift);
    result = extended_x<N-1:0>;
    carry_out = extended_x<N>;
    return (result, carry_out);
```

```
// LSL()
// =====
```

```
bits(N) LSL(bits(N) x, integer shift)
    assert shift >= 0;
    if shift == 0 then
        result = x;
    else
        (result, -) = LSL_C(x, shift);
    return result;
```

```
// LSR_C()
// =====
```

```
(bits(N), bit) LSR_C(bits(N) x, integer shift)
    assert shift > 0;
    extended_x = ZeroExtend(x, shift+N);
    result = extended_x<shift+N-1:shift>;
    carry_out = extended_x<shift-1>;
    return (result, carry_out);
```

```
// LSR()
// =====
```

```
bits(N) LSR(bits(N) x, integer shift)
    assert shift >= 0;
    if shift == 0 then
        result = x;
    else
        (result, -) = LSR_C(x, shift);
    return result;
```

```
// ASR_C()
// =====
```

```
(bits(N), bit) ASR_C(bits(N) x, integer shift)
    assert shift > 0;
    extended_x = SignExtend(x, shift+N);
    result = extended_x<shift+N-1:shift>;
    carry_out = extended_x<shift-1>;
    return (result, carry_out);
```

```
// ASR()
// =====
```

```
bits(N) ASR(bits(N) x, integer shift)
    assert shift >= 0;
    if shift == 0 then
        result = x;
    else
        (result, -) = ASR_C(x, shift);
    return result;
```

```
// ROR_C()
// =====
```

```
(bits(N), bit) ROR_C(bits(N) x, integer shift)
    assert shift != 0;
    m = shift MOD N;
    result = LSR(x,m) OR LSL(x,N-m);
    carry_out = result<N-1>;
    return (result, carry_out);

// ROR()
// =====

bits(N) ROR(bits(N) x, integer shift)
    assert shift >= 0;
    if shift == 0 then
        result = x;
    else
        (result, -) = ROR_C(x, shift);
    return result;

// RRX_C()
// =====

(bits(N), bit) RRX_C(bits(N) x, bit carry_in)
    result = carry_in : x<N-1:1>;
    carry_out = x<0>;
    return (result, carry_out);

// RRX()
// =====

bits(N) RRX(bits(N) x, bit carry_in)
    (result, -) = RRX_C(x, carry_in);
    return result;
```

Pseudocode details of addition and subtraction

In pseudocode, addition and subtraction can be performed on any combination of unbounded integers and bitstrings, provided that if they are performed on two bitstrings, the bitstrings must be identical in length. The result is another unbounded integer if both operands are unbounded integers, and a bitstring of the same length as the bitstring operand or operands otherwise. For the definition of these operations, see [Addition and subtraction on page AppxH-5072](#).

The main addition and subtraction instructions can produce status information about both unsigned carry and signed overflow conditions. When necessary, multi-word additions and subtractions can be synthesized from this status information. In pseudocode the `AddWithCarry()` function provides an addition with a carry input and a set of output condition flags including carry output and overflow:

```
// AddWithCarry()
// =====
// Integer addition with carry input, returning result and NZCV flags

(bits(N), bits(4)) AddWithCarry(bits(N) x, bits(N) y, bit carry_in)
    integer unsigned_sum = UInt(x) + UInt(y) + UInt(carry_in);
    integer signed_sum = SInt(x) + SInt(y) + UInt(carry_in);
    bits(N) result = unsigned_sum<N-1:0>; // same value as signed_sum<N-1:0>
    bit n = result<N-1>;
    bit z = if IsZero(result) then '1' else '0';
    bit c = if UInt(result) == unsigned_sum then '0' else '1';
    bit v = if SInt(result) == signed_sum then '0' else '1';
    return (result, n:z:c:v);
```

An important property of the `AddWithCarry()` function is that if:

```
(result, nzcvc) = AddWithCarry(x, NOT(y), carry_in)
```

Then:

- If `carry_in == '1'`, then `result == x-y` with:
 - `nzcvc<0> == '1'` if signed overflow occurred during the subtraction.
 - `nzcvc<1> == '1'` if unsigned borrow did not occur during the subtraction, that is, if $x \geq y$.
- If `carry_in == '0'`, then `result == x-y-1` with:
 - `nzcvc<0> == '1'` if signed overflow occurred during the subtraction.
 - `nzcvc<1> == '1'` if unsigned borrow did not occur during the subtraction, that is, if $x \geq y$.

Taken together, this means that the `carry_in` and `nzcvc<1>` output in `AddWithCarry()` calls can act as NOT borrow flags for subtractions as well as carry flags for additions.

Pseudocode details of saturation

Some instructions perform *saturation arithmetic*, that is, if the result of the arithmetic overflows the destination signed or unsigned N-bit integer range, the result produced is the largest or smallest value in that range, rather than wrapping around modulo 2^N . This is supported in pseudocode by:

- The `SignedSatQ()` and `UnsignedSatQ()` functions when an operation requires, in addition to the saturated result, a Boolean argument that indicates whether saturation occurred.
- The `SignedSat()` and `UnsignedSat()` functions when only the saturated result is required.

```
// SignedSatQ()
// =====

(bits(N), boolean) SignedSatQ(integer i, integer N)
    if i > 2^(N-1) - 1 then
        result = 2^(N-1) - 1; saturated = TRUE;
    elsif i < -(2^(N-1)) then
        result = -(2^(N-1)); saturated = TRUE;
    else
        result = i; saturated = FALSE;
    return (result<N-1:0>, saturated);

// UnsignedSatQ()
// =====

(bits(N), boolean) UnsignedSatQ(integer i, integer N)
    if i > 2^N - 1 then
        result = 2^N - 1; saturated = TRUE;
    elsif i < 0 then
        result = 0; saturated = TRUE;
    else
        result = i; saturated = FALSE;
    return (result<N-1:0>, saturated);

// SignedSat()
// =====

bits(N) SignedSat(integer i, integer N)
    (result, -) = SignedSatQ(i, N);
    return result;

// UnsignedSat()
// =====

bits(N) UnsignedSat(integer i, integer N)
    (result, -) = UnsignedSatQ(i, N);
    return result;
```

SatQ(i, N, unsigned) returns either UnsignedSatQ(i, N) or SignedSatQ(i, N) depending on the value of its third argument, and Sat(i, N, unsigned) returns either UnsignedSat(i, N) or SignedSat(i, N) depending on the value of its third argument:

```
// SatQ()
// =====

(bits(N), boolean) SatQ(integer i, integer N, boolean unsigned)
    (result, sat) = if unsigned then UnsignedSatQ(i, N) else SignedSatQ(i, N);
    return (result, sat);

// Sat()
// =====

(bits(N) Sat(integer i, integer N, boolean unsigned)
    result = if unsigned then UnsignedSat(i, N) else SignedSat(i, N);
    return result;
```

E1.2.3 The general-purpose registers, and the PC, in AArch32 state

In the AArch32 Application level view, a PE has:

- Fifteen general-purpose 32-bit registers, R0 to R14, of which R13 and R14 have alternative names reflecting how they are, or can be, used:
 - R13 is usually identified as SP.
 - R14 is usually identified as LR.
- The PC (*program counter*), that can be described as R15.

The specialized uses of the SP (R13), LR (R14), and PC (R15) are:

SP, the stack pointer

The PE uses SP as a pointer to the active stack.

In the T32 instruction set, some instructions cannot access SP, and for most T32 instructions ARM deprecates using SP as a general-purpose register. The only T32 instructions for which the use of SP is not deprecated are those designed to use SP as a stack pointer.

The A32 instruction set provides more general access to the SP, and it can be used as a general-purpose register. However, ARM deprecates the use of SP for any purpose other than as a stack pointer.

————— Note —————

- Using SP for any purpose other than as a stack pointer is likely to break the requirements of operating systems, debuggers, and other software systems, causing them to malfunction.
- Before ARMv8, for most T32 instructions, using SP as a general-purpose register was UNPREDICTABLE. In ARMv8, most of these uses of SP behave predictably, but are deprecated by ARM. The instruction descriptions give more information.

Software can refer to SP as R13.

LR, the link register

The link register is a special register that can hold return link information. Some cases described in this manual require this use of the LR. When software does not require the LR for linking, it can use it for other purposes. Software can refer to LR as R14.

PC, the program counter

- When executing an A32 instruction, PC reads as the address of the current instruction plus 8.
- When executing a T32 instruction, PC reads as the address of the current instruction plus 4.
- Writing an address to PC causes a branch to that address.

Most T32 instructions cannot access PC.

The A32 instruction set provides more general access to the PC, and many A32 instructions can use the PC as a general-purpose register. However, ARM deprecates the use of PC for any purpose other than as the program counter. See [Writing to the PC](#) for more information.

Software can refer to PC as R15.

See [AArch32 general-purpose registers, and the PC](#) on page G1-3418 for the system level view of these registers.

Note

In general, ARM strongly recommends using the names SP, LR and PC instead of R13, R14 and R15. However, sometimes it is simpler to use the R13-R15 names when referring to a group of registers. For example, it is simpler to refer to *registers R8 to R15*, rather than to *registers R8 to R12, the SP, LR and PC*. These two descriptions of the group of registers have exactly the same meaning.

Writing to the PC

In the A32 and T32 instruction sets, many data-processing instructions can write to the PC. Writes to the PC are handled as follows:

- In T32 state, the following 16-bit T32 instruction encodings branch to the value written to the PC:
 - Encoding T2 of [ADD \(register, T32\)](#) on page F7-2544.
 - Encoding T1 of [MOV \(register, T32\)](#) on page F7-2710.The value written to the PC is forced to be halfword-aligned by ignoring its least significant bit, treating that bit as being 0.
- The B, BL, CBNZ, CBZ, CHKA, HB, HBL, HBLP, HBP, TBB, and TBH instructions remain in the same instruction set state and branch to the value written to the PC.
The definition of each of these instructions ensures that the value written to the PC is correctly aligned for the current instruction set state.
- The BLX (immediate) instruction switches between A32 and T32 states and branches to the value written to the PC. Its definition ensures that the value written to the PC is correctly aligned for the new instruction set state.
- The following instructions write a value to the PC, treating that value as an interworking address to branch to, with low-order bits that determine the new instruction set state:
 - BLX (register), BX, and BXJ.
 - LDR instructions with <Rt> equal to the PC.
 - POP and all forms of LDM except LDM (exception return), when the register list includes the PC.
 - In A32 state only, ADC, ADD, ADR, AND, ASR (immediate), BIC, EOR, LSL (immediate), LSR (immediate), MOV, MVN, ORR, ROR (immediate), RRX, RSB, RSC, SBC, and SUB instructions with <Rd> equal to the PC and without flag-setting specified.

For details of how an interworking address specifies the new instruction set state and instruction address, see [Pseudocode details of operations on the AArch32 general-purpose registers and the PC](#) on page E1-2296.

Note

The register-shifted register instructions, that are available only in the A32 instruction set and are summarized in [Data-processing \(register-shifted register\)](#) on page F4-2470, are UNPREDICTABLE if they attempt to write to the PC.

- Some instructions are treated as exception return instructions, and write both the PC and the CPSR. For more information, including which instructions are exception return instructions, see [Exception return to an Exception level using AArch32](#) on page G1-3454.
- Some instructions cause an exception, and the exception handler address is written to the PC as part of the exception entry.

Pseudocode details of operations on the AArch32 general-purpose registers and the PC

In pseudocode, the uses of the R[] function are:

- Reading or writing R0-R12, SP, and LR, using n = 0-12, 13, and 14 respectively.
- Reading the PC, using n = 15.

This function has prototypes:

```
array bits(64) _R[0..30];
```

[Pseudocode details of general-purpose register and PC operations on page G1-3419](#) explains the full operation of this function.

Descriptions of A32 store instructions that store the PC value use the PCStoreValue() pseudocode function to specify the PC value stored by the instruction:

```
// PCStoreValue()
// =====

bits(32) PCStoreValue()
    // This function returns the PC value. On architecture versions before ARMv7, it
    // is permitted to instead return PC+4, provided it does so consistently. It is
    // used only to describe ARM instructions, so it returns the address of the current
    // instruction plus 8 (normally) or 12 (when the alternative is permitted).
    return PC;
```

Writing an address to the PC causes either a simple branch to that address or an *interworking* branch that also selects the instruction set to execute after the branch. A simple branch is performed by the BranchWritePC() function:

```
// BranchWritePC()
// =====

BranchWritePC(bits(32) address)
    if CurrentInstrSet() == InstrSet_A32 then
        address<1:0> = '00';
    else
        address<0> = '0';
    BranchTo(address, BranchType_UNKNOWN);
```

An interworking branch is performed by the BXWritePC() function:

```
// BXWritePC()
// =====

BXWritePC(bits(32) address)
    if CurrentInstrSet() == InstrSet_T32EE then
        if address<0> == '1' then
            // Remaining in T32EE state
            address<0> = '0';
        else
            // For branches to an unaligned PC counter in T32EE state, the processor takes the
            // branch and does one of:
            // * take the branch and remain in T32EE state
            // * take the branch and enter A32 state
            // * take the branch and set PSTATE.IL to 1, meaning the target generates an Illegal
            // Execution State exception.
            UNPREDICTABLE;
    else // T32 or A32 state
        if address<0> == '1' then
            SelectInstrSet(InstrSet_T32);
            address<0> = '0';
        else
            SelectInstrSet(InstrSet_A32);
            // For branches to an unaligned PC counter in A32 state, the processor takes the branch
            // and does one of:
            // * Forces the address to be aligned
```

```
// * Leaves the PC unaligned, meaning the target generates a PC Alignment fault.
if address<1> == '1' && ConstrainUnpredictableBool() then
    address<1> = '0';
BranchTo(address, BranchType_UNKNOWN);
```

The LoadWritePC() and ALUWritePC() functions are used for two cases where the behavior was systematically modified between architecture versions:

```
// LoadWritePC()
// =====

LoadWritePC(bits(32) address)
    BXWritePC(address);

// ALUWritePC()
// =====

ALUWritePC(bits(32) address)
    if CurrentInstrSet() == InstrSet_A32 then
        BXWritePC(address);
    else
        BranchWritePC(address);
```

———— **Note** ————

The behavior of the PC writes performed by the ALUWritePC() function is different in Debug state, where there are more UNPREDICTABLE cases. The pseudocode in this section only handles the non-debug cases.

E1.2.4 The Application Program Status Register (APSR)

Program status is reported in the 32-bit *Application Program Status Register* (APSR). The APSR bit assignments are:

31	30	29	28	27	26	24	23	20	19	16	15					0
N	Z	C	V	Q	RAZ/ SBZP	Reserved, UNK/SBZP		GE[3:0]		Reserved, UNK/SBZP						

The APSR bit categories are:

- Reserved bits, that are allocated to system features, or are available for future expansion. Unprivileged execution ignores writes to fields that are accessible only at EL1 or higher. However, application level software that writes to the APSR must treat reserved bits as *Do-Not-Modify* (DNM) bits. For more information about the reserved bits, see [Format of the CPSR and SPSRs on page G1-3423](#).
- Bits that can be set by many instructions:
 - The Condition flags:
 - N, bit[31]** Negative condition flag. Set to bit[31] of the result of the instruction. If the result is regarded as a two's complement signed integer, then the PE sets N to 1 if the result is negative, and sets N to 0 if it is positive or zero.
 - Z, bit[30]** Zero condition flag. Set to 1 if the result of the instruction is zero, and to 0 otherwise. A result of zero often indicates an equal result from a comparison.
 - C, bit[29]** Carry condition flag. Set to 1 if the instruction results in a carry condition, for example an unsigned overflow on an addition.
 - V, bit[28]** Overflow condition flag. Set to 1 if the instruction results in an overflow condition, for example a signed overflow on an addition.
 - The Overflow or saturation flag:
 - Q, bit[27]** Set to 1 to indicate overflow or saturation occurred in some instructions, normally related to *digital signal processing* (DSP). For more information, see [Pseudocode details of saturation on page E1-2293](#).

- The Greater than or Equal flags:

GE[3:0], bits[19:16]

The instructions described in [Parallel addition and subtraction instructions on page F1-2389](#) update these flags to indicate the results from individual bytes or halfwords of the operation. These flags can control a later SEL instruction. For more information, see [SEL on page F7-2802](#).

- Bits[26:24] are RAZ/SBZP. Therefore, software can use MSR instructions that write the top byte of the APSR without using a read, modify, write sequence. If it does this, it must write zeros to bits[26:24].

Instructions can test the N, Z, C, and V condition flags, combining these with the *condition code* for the instruction to determine whether the instruction must be executed. In this way, execution of the instruction is conditional on the result of a previous operation. For more information about conditional execution see [Conditional execution on page F2-2416](#).

In AArch32 state, the APSR is the same register as the CPSR, but the APSR must be used only to access the N, Z, C, V, Q, and GE[3:0] bits. For more information, see [Program Status Registers \(PSRs\) on page G1-3422](#).

E1.2.5 Execution state registers

The execution state registers modify the execution of instructions. They control:

- Whether instructions are interpreted as T32 instructions or A32 instructions. For more information, see [Instruction set state register, ISETSTATE](#).
- In T32 state, the condition codes that apply to the next one to four instructions. For more information, see [IT block state register, ITSTATE on page E1-2300](#).
- Whether data is interpreted as big-endian or little-endian. For more information, see [Endianness mapping register, ENDIANSTATE on page E1-2302](#).

In AArch32 state, the execution state registers are part of the Current Program Status Register. For more information, see [Program Status Registers \(PSRs\) on page G1-3422](#).

There is no direct access to the execution state registers from application level instructions, but they can be changed by side-effects of application level instructions.

Instruction set state register, ISETSTATE

The instruction set state register, ISETSTATE, format is:



The J bit and the T bit determine the current *instruction set state* for the PE, as [Table E1-1](#) shows.

Table E1-1 J and T bit encoding in ISETSTATE

J	T	Instruction set state
0	0	A32
0	1	T32
1	0	Reserved, Jazelle state before ARMv8
1	1	Reserved, T32EE state ^a before ARMv8

a. In ARMv8, support for T32EE state is OPTIONAL and deprecated.

A32 state The PE executes the A32 instruction set summarized in [Chapter F4 A32 Base Instruction Set Encoding](#) and [Chapter F5 T32 and A32 Instruction Sets Advanced SIMD and floating-point Encodings](#).

T32 state The PE executes the T32 instruction set summarized in [Chapter F3 T32 Base Instruction Set Encoding](#) and [Chapter F5 T32 and A32 Instruction Sets Advanced SIMD and floating-point Encodings](#).

Reserved, Jazelle state before ARMv8

Before ARMv8, an implementation could include Jazelle state, that provided hardware execution of Java bytecodes. In ARMv8, Java bytecodes must be executed by a software implementation of a *Java Virtual Machine* (JVM). This means that, in AArch32 state:

- The implementation includes a Trivial Jazelle implementation, see [Trivial implementation of the Jazelle extension on page G1-3429](#).
- Setting {J, T} to {1, 0} selects an unimplemented Instruction set state, see [Unimplemented instruction sets on page G1-3429](#).

Reserved, T32EE state before ARMv8

The T32EE instruction set is a variation of the T32 instruction set specifically targeted for use with dynamic compilation techniques associated. In ARMv8, support for the T32EE instruction set and the corresponding Instruction set state is OPTIONAL and deprecated, and this manual generally describes an implementation that does not include support for T32EE. In this case, setting {J, T} to {1, 1} selects an unimplemented Instruction set state, see [Unimplemented instruction sets on page G1-3429](#).

Pseudocode details of ISETSTATE operations

The following pseudocode functions return the current instruction set and select a new instruction set:

enumeration InstrSet {InstrSet_A64, InstrSet_A32, InstrSet_T32, InstrSet_T32EE};

```
// CurrentInstrSet()
// =====

InstrSet CurrentInstrSet()
{
    if UsingAArch32() then
        case PSTATE.<J,T> of
            when '00' result = InstrSet_A32;
            when '01' result = InstrSet_T32;
            when '10' Unreachable(); // Non-trivial implementation of Jazelle not permitted
            when '11' result = InstrSet_T32EE;
        else
            return InstrSet_A64;
    return result;
}
```

```
// SelectInstrSet()
// =====

SelectInstrSet(InstrSet iset)
    assert CurrentInstrSet() != InstrSet_A64;
    case iset of
        when InstrSet_A32
            assert CurrentInstrSet() != InstrSet_T32EE;
            ISETSTATE = '00';
        when InstrSet_T32
            ISETSTATE = '01';
        when InstrSet_T32EE
            assert CurrentInstrSet() != InstrSet_A32;
            ISETSTATE = '11';
        otherwise
            Unreachable();
    return;
```

IT block state register, ITSTATE

The IT block state register, ITSTATE, format is:

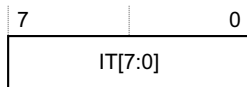

This field holds the If-Then execution state bits for the T32 IT instruction, that applies to the *IT block* of one to four instructions that immediately follow the IT instruction. See [IT on page F7-2610](#) for a description of the IT instruction and the associated IT block.

ITSTATE divides into two subfields:

IT[7:5] Holds the *base condition* for the current IT block. The base condition is the top 3 bits of the condition code specified by the `<firstcond>` field of the IT instruction.

This subfield is `0b000` when no IT block is active.

IT[4:0] Encodes:

- The size of the IT block. This is the number of instructions that are to be conditionally executed. The size of the block is implied by the position of the least significant 1 in this field, as shown in [Table E1-2 on page E1-2301](#).
- The value of the least significant bit of the condition code for each instruction in the block.

———— Note ————

Changing the value of the least significant bit of a condition code from 0 to 1 has the effect of inverting the condition code.

This subfield is `0b00000` when no IT block is active.

When an IT instruction is executed, these bits are set according to the `<firstcond>` condition code in the instruction, and the *Then* and *Else* (T and E) parameters in the instruction. For more information, see [IT on page F7-2610](#).

When permitted, an instruction in an IT block is conditional, see [Conditional instructions on page F1-2380](#) and [Conditional execution on page F2-2416](#). The condition code used is the current value of IT[7:4]. When an instruction in an IT block completes its execution normally, ITSTATE advances to the next line of [Table E1-2 on page E1-2301](#). A few instructions, for example BKPT, cannot be conditional and therefore are always executed, ignoring the current ITSTATE.

For details of what happens if an instruction in an IT block takes an exception, see [Overview of exception entry on page G1-3436](#).

An instruction that might complete its normal execution by branching is only permitted in an IT block as the last instruction in the block. This means that normal execution of the instruction always results in ITSTATE advancing to normal execution.

Table E1-2 Effect of IT execution state bits

	IT bits ^a					Note
	[7:5]	[4]	[3]	[2]	[1]	
cond_base	P1	P2	P3	P4	1	Entry point for 4-instruction IT block
cond_base	P1	P2	P3	1	0	Entry point for 3-instruction IT block
cond_base	P1	P2	1	0	0	Entry point for 2-instruction IT block
cond_base	P1	1	0	0	0	Entry point for 1-instruction IT block
000	0	0	0	0	0	Normal execution, not in an IT block

a. Combinations of the IT bits not shown in this table are reserved.

On a branch or an exception return, if ITSTATE is set to a value that is not consistent with the instruction stream being branched to or returned to, then instruction execution is UNPREDICTABLE.

ITSTATE affects instruction execution only in T32 state. In A32 state, ITSTATE must be '00000000', otherwise the behavior is UNPREDICTABLE.

Pseudocode details of ITSTATE operations

ITSTATE advances after normal execution of an IT block instruction. This is described by the ITAdvance() pseudocode function:

```
// AArch32.ITAdvance()
// =====

AArch32.ITAdvance()
    if PSTATE.IT<2:0> == '000' then
        PSTATE.IT = '00000000';
    else
        PSTATE.IT<4:0> = LSL(PSTATE.IT<4:0>, 1);
    return;
```

The following functions test whether the current instruction is in an IT block, and whether it is the last instruction of an IT block:

```
// InITBlock()
// =====

boolean InITBlock()
    if CurrentInstrSet() IN {InstrSet_T32, InstrSet_T32EE} then
        return ITSTATE.IT<3:0> != '0000';
    else
        return FALSE;

// LastInITBlock()
// =====

boolean LastInITBlock()
    return (ITSTATE.IT<3:0> == '1000');
```

Endianness mapping register, ENDIANSTATE

ARMv8 supports configuration between little-endian and big-endian interpretations of data memory, as [Table E1-3](#) shows. The endianness is controlled by ENDIANSTATE.

Table E1-3 ENDIANSTATE encoding of endianness

ENDIANSTATE	Endian mapping
0	Little-endian
1	Big-endian

The A32 and T32 instruction sets both include an instruction to manipulate ENDIANSTATE:

SETEND BE Sets ENDIANSTATE to 1, for big-endian operation.

SETEND LE Sets ENDIANSTATE to 0, for little-endian operation.

The SETEND instruction is unconditional. For more information, see [SETEND on page F7-2803](#).

Pseudocode details of ENDIANSTATE operations

The BigEndian() pseudocode function tests whether big-endian memory accesses are currently selected.

```
// BigEndian()
// =====

boolean BigEndian()
    boolean bigend;
    if UsingAArch32() then
        bigend = (PSTATE.E != '0');
    elseif PSTATE.EL == EL0 then
        bigend = (SCTLR_EL1.E0E != '0');
    else
        bigend = (SCTLR[.EE != '0');
    return bigend;
```

E1.2.6 Jazelle support

ARMv8 requires AArch32 state to include a trivial implementation of the Jazelle extension, as described in [Trivial implementation of the Jazelle extension on page G1-3429](#). For execution at EL0, this means:

- The JIDR is RO and RAZ.
- A BXJ instruction behaves as a BX instruction, see [BXJ on page F7-2580](#).

E1.3 Advanced SIMD and floating-point instructions

In general, ARMv8 requires implementation of Advanced SIMD and floating-point instructions in the T32 and A32 instruction sets, but see [Implications of not including Advanced SIMD and floating-point support on page E1-2310](#).

The Advanced SIMD instructions perform packed *Single Instruction Multiple Data* (SIMD) operations, either integer or single-precision floating-point. The floating-point instructions perform single-precision or double-precision scalar floating-point operations.

These instructions permit *floating-point exceptions*, such as overflow or division by zero, to be handled without trapping. When handled in this way, a floating-point exception causes a cumulative status register bit to be set to 1 and a default result to be produced by the operation.

ARMv8 also optionally supports the trapping of floating-point exceptions, see [Trapping of floating-point exception on page E1-2306](#).

For more information about floating-point exceptions see [Floating-point exceptions on page E1-2307](#).

The floating-point and Advanced SIMD instructions also provide conversion functions in both directions between half-precision floating-point and single-precision floating-point.

For system level information about the Advanced SIMD and Floating-point implementation see [Advanced SIMD and floating-point support on page G1-3494](#).

Some Advanced SIMD instructions support polynomial arithmetic over {0, 1}, as described in [Polynomial arithmetic over {0, 1} on page A1-45](#).

E1.3.1 Floating-point standards, and terminology

[Floating-point standards, and terminology on page A1-48](#) describes the ARMv8 alignment with the IEEE 754 standard, and the floating-point terminology used throughout this manual.

E1.3.2 The Advanced SIMD and floating-point register file

The Advanced SIMD and floating-point instructions use the same register file, that comprises 32 registers. This is distinct from the register file that holds the general-purpose registers and the PC.

The Advanced SIMD and floating-point views of the register file are different. The following sections describe these different views. [Figure E1-1 on page E1-2304](#) shows the views of the register file, and the way the word, doubleword, and quadword registers overlap.

Advanced SIMD views of the register file

Advanced SIMD can view this register set as:

- Sixteen 128-bit quadword registers, Q0-Q15.
- Thirty-two 64-bit doubleword registers, D0-D31.

These views can be used simultaneously. For example, a program might hold 64-bit vectors in D0 and D1 and a 128-bit vector in Q1.

Floating-point views of the register file

The extension register file consists of thirty-two doubleword registers, that can be viewed as:

- Thirty-two 64-bit doubleword registers, D0-D31. This view is also available to Advanced SIMD instructions.
- Thirty-two 32-bit single word registers, S0-S31. Only half of the set is accessible in this view.

The two views can be used simultaneously.

Advanced SIMD and Floating-point register mapping

Figure E1-1 shows the different views of Advanced SIMD and floating-point register file, and the relationship between them.

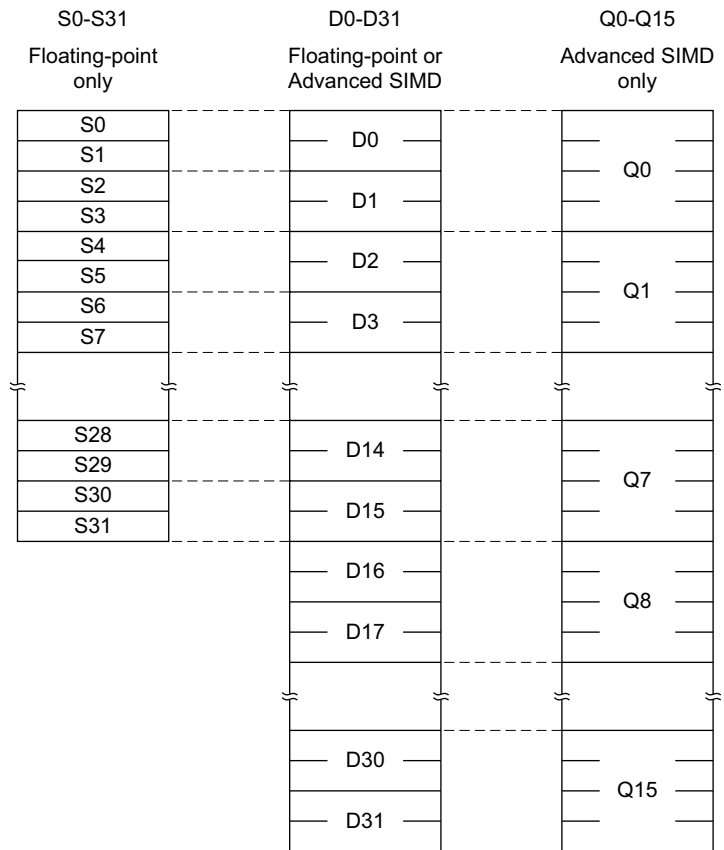

Figure E1-1 Advanced SIMD and floating-point register file, AArch32 operation

The mapping between the registers is as follows:

- $S\langle 2n \rangle$ maps to the least significant half of $D\langle n \rangle$.
- $S\langle 2n+1 \rangle$ maps to the most significant half of $D\langle n \rangle$.
- $D\langle 2n \rangle$ maps to the least significant half of $Q\langle n \rangle$.
- $D\langle 2n+1 \rangle$ maps to the most significant half of $Q\langle n \rangle$.

For example, software can access the least significant half of the elements of a vector in Q6 by referring to D12, and the most significant half of the elements by referring to D13.

Pseudocode details of the Advanced SIMD and Floating-point register file

The pseudocode function `boolean VFPSmallRegisterBank()`; always returns `FALSE` in an ARMv8 implementation.

```
array bits(128) _V[0..31];
```

———— **Note** ————

AArch32 only uses the first 16 of the registers, V0 - V15.

The following functions provide the S0-S31, D0-D31, and Q0-Q15 views of the registers:

```
array bits(64) _Dclone[0..31];
```

```
// S[] - non-assignment form
// =====

bits(32) S[integer n]
    assert n >= 0 && n <= 31;
    base = (n MOD 4) * 32;
    return _V[n DIV 4]<base+31:base>;

// S[] - assignment form
// =====

S[integer n] = bits(32) value
    assert n >= 0 && n <= 31;
    base = (n MOD 4) * 32;
    _V[n DIV 4]<base+31:base> = value;
    return;

// D[] - non-assignment form
// =====

bits(64) D[integer n]
    assert n >= 0 && n <= 31;
    base = (n MOD 2) * 64;
    return _V[n DIV 2]<base+63:base>;

// D[] - assignment form
// =====

D[integer n] = bits(64) value
    assert n >= 0 && n <= 31;
    base = (n MOD 2) * 64;
    _V[n DIV 2]<base+63:base> = value;
    return;
```

The `Din[]` function returns a Doubleword register from the `_Dclone[]` copy of the Advanced SIMD and Floating-point register bank, and the `Qin[]` function returns a Quadword register from that register bank.

———— **Note** ————

The `CheckAdvancedSIMDEnabled()` function copies the `D[]` register bank to `_Dclone[]`, see [Pseudocode details of enabling the Advanced SIMD and Floating-point Extensions on page G1-3499](#).

```
// Din[] - non-assignment form
// =====

bits(64) Din[integer n]
    assert n >= 0 && n <= 31;
    if n >= 16 && VFPSmallRegisterBank() then UNDEFINED;
    return _Dclone[n];

// Qin[] - non-assignment form
// =====

bits(128) Qin[integer n]
    assert n >= 0 && n <= 15;
    return Din[2*n+1]:Din[2*n];
```

E1.3.3 Data types supported by the Advanced SIMD implementation

Advanced SIMD instructions can operate on integer and floating-point data, and the implementation defines a set of data types that support the required data formats. [Vector formats in AArch32 state on page A1-38](#) describes these formats.

Advanced SIMD vectors

In an implementation that includes the Advanced SIMD Extension, a register can hold one or more packed elements, all of the same size and type. The combination of a register and a data type describes a vector of elements. The vector is considered to be an array of elements of the data type specified in the instruction. The number of elements in the vector is implied by the size of the data elements and the size of the register.

Vector indices are in the range 0 to (number of elements – 1). An index of 0 refers to the least significant end of the vector. In [Vector formats in AArch32 state on page A1-38](#), [Figure A1-3 on page A1-40](#) shows the Advanced SIMD vector formats.

Pseudocode details of Advanced SIMD vectors

The pseudocode function Elem[] accesses the element of a specified index and size in a vector:

```
// Elem[] - non-assignment form
// =====

bits(size) Elem[bits(N) vector, integer e, integer size]
    assert e >= 0 && (e+1)*size <= N;
    return vector<e*size+size-1 : e*size>;

// Elem[] - non-assignment form
// =====

bits(size) Elem[bits(N) vector, integer e]
    return Elem[vector, e, size];

// Elem[] - assignment form
// =====

Elem[bits(N) &vector, integer e, integer size] = bits(size) value
    assert e >= 0 && (e+1)*size <= N;
    vector<(e+1)*size-1:e*size> = value;
    return;

// Elem[] - assignment form
// =====

Elem[bits(N) &vector, integer e] = bits(size) value
    Elem[vector, e, size] = value;
    return;
```

E1.3.4 Advanced SIMD and Floating-point system registers

The Advanced SIMD and floating-point instructions have a shared register space for system registers. Only one register in this space is accessible at the Application level, see [FPSCR, Floating-Point Status and Control Register on page G4-3845](#).

Writes to the FPSCR can have side-effects on various aspects of PE operation. All of these side-effects are synchronous to the FPSCR write. This means they are guaranteed not to be visible to earlier instructions in the execution stream, and they are guaranteed to be visible to later instructions in the execution stream.

See [Advanced SIMD and floating-point system registers on page G1-3500](#) for the system level view of the registers.

E1.3.5 Trapping of floating-point exception

It is IMPLEMENTATION DEFINED whether the floating-point implementation supports the trapping of floating-point exceptions:

- If it does, the FPSCR.{IDE, IXE, UFE, OFE, DZE, IOE} bits enable the exception traps.
- Otherwise, the FPSCR trap bits are RES0.

Trapped exception handling never causes the corresponding cumulative exception bit of the **FPSCR** to be set to 1. If this behavior is desired, the trap handler routine must use a read, modify, write sequence on the **FPSCR** to set the cumulative exception bit.

E1.3.6 Floating-point data types and arithmetic

The T32 and A32 floating-point instructions support single-precision (32-bit) and double-precision (64-bit) data types and arithmetic as defined by the IEEE 754 floating-point standard. They also support the half-precision (16-bit) floating-point data type for data storage only, by supporting conversions between single-precision and half-precision data types.

ARM standard floating-point arithmetic means IEEE 754 floating-point arithmetic with the restrictions described in *Floating-point and Advanced SIMD support* on page A1-46, including supporting only the input and output values described in *ARM standard floating-point input and output values* on page A1-48.

The AArch32 Advanced SIMD instructions support only single-precision ARM standard floating-point arithmetic.

———— Note ————

The floating-point instructions require *support code* to be installed in the system if trapped floating-point exception handling is required. See *Floating-point exception traps, serialization, and floating-point exception barriers* on page G1-3501.

The following sections describe the Advanced SIMD and floating-point formats:

- *Half-precision floating-point formats* on page A1-40.
- *Single-precision floating-point format* on page A1-42.
- *Double-precision floating-point format* on page A1-43.

The following sections describe features of Advanced SIMD and floating-point processing:

- *Flush-to-zero* on page A1-49.
- *NaN handling and the Default NaN* on page A1-50.

E1.3.7 Floating-point exceptions

ARM Advanced SIMD and floating-point instructions record the following floating-point exceptions in the **FPSCR** cumulative bits:

FPSCR.IOC Invalid Operation. The bit is set to 1 if the result of an operation has no mathematical value or cannot be represented. Cases include, for example:

- $(\text{infinity}) \times 0$.
- $(+\text{infinity}) + (-\text{infinity})$.

These tests are made after flush-to-zero processing. For example, if flush-to-zero mode is selected, multiplying a denormalized number and an infinity is treated as $(0 \times \text{infinity})$, and causes an Invalid Operation floating-point exception.

IOC is also set on any floating-point operation with one or more signaling NaNs as operands, except for negation and absolute value, as described in *Floating-point negation and absolute value* on page E1-2312.

FPSCR.DZC Division by Zero. The bit is set to 1 if a divide operation has a zero divisor and a dividend that is not zero, an infinity or a NaN. These tests are made after flush-to-zero processing, so if flush-to-zero processing is selected, a denormalized dividend is treated as zero and prevents Division by Zero from occurring, and a denormalized divisor is treated as zero and causes Division by Zero to occur if the dividend is a normalized number.

For the reciprocal and reciprocal square root estimate functions the dividend is assumed to be +1.0. This means that a zero or denormalized operand to these functions sets the DZC bit.

FPSCR.OFC Overflow. The bit is set to 1 if the absolute value of the result of an operation, produced after rounding, is greater than the maximum positive normalized number for the destination precision.

FPSCR.UFC Underflow. The bit is set to 1 if the absolute value of the result of an operation, produced before rounding, is less than the minimum positive normalized number for the destination precision, and the rounded result is inexact.

The criteria for the Underflow exception to occur are different in Flush-to-zero mode. For details, see *Flush-to-zero* on page A1-49.

FPSCR.IXC Inexact. The bit is set to 1 if the result of an operation is not equivalent to the value that would be produced if the operation were performed with unbounded precision and exponent range.

The criteria for the Inexact exception to occur are different in Flush-to-zero mode. For details, see *Flush-to-zero* on page A1-49.

FPSCR.IDC Input Denormal. The bit is set to 1 if a denormalized input operand is replaced in the computation by a zero, as described in *Flush-to-zero* on page A1-49.

For Advanced SIMD instructions, and for floating-point instructions when floating-point exception trapping is not supported, these are non-trapping exceptions and the data-processing instructions do not generate any trapped exceptions.

For floating-point instructions when floating-point exception trapping is supported:

- These exceptions can be trapped, by setting trap enable bits in the **FPSCR**, see *Trapping of floating-point exception* on page E1-2306. The way in which trapped floating-point exceptions are delivered to user software is IMPLEMENTATION DEFINED.
- The definition of the Underflow exception is different in the trapped and cumulative exception cases. In the trapped case the definition is:
 - The trapped Underflow exception occurs if the absolute value of the result of an operation, produced before rounding, is less than the minimum positive normalized number for the destination precision, regardless of whether the rounded result is inexact.
- As with cumulative exceptions, higher priority trapped exceptions can prevent lower priority exceptions from occurring, as described in *Combinations of exceptions* on page E1-2309.
- For Invalid Operation exceptions, for details of which quiet NaN is produced as the default result see *NaN handling and the Default NaN* on page A1-50.
- For Overflow exceptions, the sign bit of the default result is determined normally for the overflowing operation.
- For Division by Zero exceptions, the sign bit of the default result is determined normally for a division. This means it is the exclusive OR of the sign bits of the two operands.

Table E1-4 shows the results of untrapped floating-point exceptions:

In Table E1-4:

MaxNorm The maximum normalized number of the destination precision.
RM Round towards Minus Infinity mode, as defined in the IEEE 754 standard.
RN Round to Nearest mode, as defined in the IEEE 754 standard.
RP Round towards Plus Infinity mode, as defined in the IEEE 754 standard.
RZ Round towards Zero mode, as defined in the IEEE 754 standard.

Table E1-4 Results of untrapped floating-point exceptions

Exception type	Default result for positive sign	Default result for negative sign
IOC, Invalid Operation	Quiet NaN	Quiet NaN
DZC, Division by Zero	+infinity	-infinity
OFC, Overflow	RN, RP: +infinity RM, RZ: +MaxNorm	RN, RM: -infinity RP, RZ: -MaxNorm

Table E1-4 Results of untrapped floating-point exceptions (continued)

Exception type	Default result for positive sign	Default result for negative sign
UFC, Underflow	Normal rounded result	Normal rounded result
IXC, Inexact	Normal rounded result	Normal rounded result
IDC, Input Denormal	Normal rounded result	Normal rounded result

Combinations of exceptions

The following pseudocode functions perform *floating-point operations*:

```

FixedToFP()
FPAdd()
FPCompare()
FPCompareEQ()
FPCompareGE()
FPCompareGT()
FPDiv()
FPDoubleToSingle()
FPHalfToSingle()
FPMax()
FPMin()
FPMul()
FPMulAdd()
FPrecipEstimate()
FPrecipStep()
FPRsqrtEstimate()
FPRsqrtStep()
FPSingleToDouble()
FPSingleToHalf()
FPSqrt()
FPSub()
FPToFixed()

```

All of these operations can generate floating-point exceptions.

Note

FPAbs() and FPNeg() are not classified as *floating-point operations* because:

- They cannot generate floating-point exceptions.
- The floating-point operation behavior described in the following sections does not apply to them:
 - [Flush-to-zero on page A1-49](#).
 - [NaN handling and the Default NaN on page A1-50](#).

More than one exception can occur on the same operation. The only combinations of exceptions that can occur are:

- Overflow with Inexact.
- Underflow with Inexact.
- Input Denormal with other exceptions.

When none of the exceptions caused by an operation are trapped, any exception that occurs causes the associated cumulative bit in the **FPSCR** to be set.

When one or more exceptions caused by an operation are trapped, the behavior of the instruction depends on the priority of the exceptions. The Inexact exception is treated as lowest priority, and Input Denormal as highest priority:

- If the higher priority exception is trapped, its trap handler is called. It is IMPLEMENTATION DEFINED whether the parameters to the trap handler include information about the lower priority exception. Apart from this, the lower priority exception is ignored in this case.

- If the higher priority exception is untrapped, its cumulative bit is set to 1 and its default result is evaluated. Then the lower priority exception is handled normally, using this default result.

Some floating-point instructions specify more than one floating-point operation, as indicated by the pseudocode descriptions of the instruction. In such cases, an exception on one operation is treated as higher priority than an exception on another operation if the occurrence of the second exception depends on the result of the first operation. Otherwise, it is UNPREDICTABLE which exception is treated as higher priority.

For example, a VMLA.F32 instruction specifies a floating-point multiplication followed by a floating-point addition. The addition can generate Overflow, Underflow and Inexact exceptions, all of which depend on both operands to the addition and so are treated as lower priority than any exception on the multiplication. The same applies to Invalid Operation exceptions on the addition caused by adding opposite-signed infinities. The addition can also generate an Input Denormal exception, caused by the addend being a denormalized number while in Flush-to-zero mode. It is UNPREDICTABLE which of an Input Denormal exception on the addition and an exception on the multiplication is treated as higher priority, because the occurrence of the Input Denormal exception does not depend on the result of the multiplication. The same applies to an Invalid Operation exception on the addition caused by the addend being a signaling NaN.

Note

- The VFMA instruction performs a vector addition and a vector multiplication as a single operation. The VFMS instruction performs a vector subtraction and a vector multiplication as a single operation.
- Like other details of Floating-point instruction execution, these rules about exception handling apply to the overall results produced by an instruction when the system uses a combination of hardware and support code to implement it. See *Floating-point exception traps, serialization, and floating-point exception barriers* on page G1-3501 for more information.

E1.3.8 Implications of not including Advanced SIMD and floating-point support

In general, ARMv8 requires the inclusion of the Advanced SIMD and floating-point instructions in all instruction sets. Exceptionally, for implementation targeting specialized markets, ARM might produce or license an ARMv8-A implementation that does not provide any support for Advanced SIMD and floating-point instructions. In such an implementation, in AArch32 state:

- Each of the CPACR.{cp10, cp11} fields is RES0.
- The CPACR.ASEDIS bit is RES1.
- Each of the HCPTR.{TASE, TCP10, TCP11} fields is RES1.
- Each of the NSACR.{NSASEDIS, cp10, cp11} fields is RES0.
- The FPEXC register is UNDEFINED.

E1.3.9 Pseudocode details of floating-point operations

The following subsections contain pseudocode definitions of the floating-point functionality supported by the ARMv8 architecture:

- *Generation of specific floating-point values* on page E1-2311.
- *Floating-point negation and absolute value* on page E1-2312.
- *Floating-point value unpacking* on page E1-2312.
- *Floating-point exception and NaN handling* on page E1-2313.
- *Floating-point rounding* on page E1-2315.
- *Selection of ARM standard floating-point arithmetic* on page E1-2317.
- *Floating-point comparisons* on page E1-2317.
- *Floating-point maximum and minimum* on page E1-2318.
- *Floating-point addition and subtraction* on page E1-2319.
- *Floating-point multiplication and division* on page E1-2320.
- *Floating-point fused multiply-add* on page E1-2321.
- *Floating-point reciprocal estimate and step* on page E1-2322.
- *Floating-point square root* on page E1-2324.

- [Floating-point reciprocal square root estimate and step on page E1-2325.](#)
- [Floating-point conversions on page E1-2328.](#)

Generation of specific floating-point values

The following pseudocode functions generate specific floating-point values. The sign argument is '0' for the positive version and '1' for the negative version.

```
// FPInfinity()
// =====

bits(N) FPInfinity(bit sign)
  assert N IN {16,32,64};
  constant integer E = (if N == 16 then 5 elsif N == 32 then 8 else 11);
  constant integer F = N - E - 1;
  exp = Ones(E);
  frac = Zeros(F);
  return sign : exp : frac;

// FPMaxNormal()
// =====

bits(N) FPMaxNormal(bit sign)
  assert N IN {16,32,64};
  constant integer E = (if N == 16 then 5 elsif N == 32 then 8 else 11);
  constant integer F = N - E - 1;
  exp = Ones(E-1):'0';
  frac = Ones(F);
  return sign : exp : frac;

// FPZero()
// =====

bits(N) FPZero(bit sign)
  assert N IN {16,32,64};
  constant integer E = (if N == 16 then 5 elsif N == 32 then 8 else 11);
  constant integer F = N - E - 1;
  exp = Zeros(E);
  frac = Zeros(F);
  return sign : exp : frac;

// FPTwo()
// =====

bits(N) FPTwo(bit sign)
  assert N IN {32,64};
  constant integer E = (if N == 32 then 8 else 11);
  constant integer F = N - E - 1;
  exp = '1':Zeros(E-1);
  frac = Zeros(F);
  return sign : exp : frac;

// FPThree()
// =====

bits(N) FPThree(bit sign)
  assert N IN {32,64};
  constant integer E = (if N == 32 then 8 else 11);
  constant integer F = N - E - 1;
  exp = '1':Zeros(E-1);
  frac = '1':Zeros(F-1);
  return sign : exp : frac;

// FPDefaultNaN()
// =====
```

```
bits(N) FPDefaultNaN()  
    assert N IN {16,32,64};  
    constant integer E = (if N == 16 then 5 elsif N == 32 then 8 else 11);  
    constant integer F = N - E - 1;  
    sign = '0';  
    exp = Ones(E);  
    frac = '1':Zeros(F-1);  
    return sign : exp : frac;
```

Floating-point negation and absolute value

The floating-point negation and absolute value operations only affect the sign bit. They do not treat NaN operands specially, nor denormalized number operands when flush-to-zero is selected.

```
// FPNeg()  
// =====  
  
bits(N) FPNeg(bits(N) op)  
    assert N IN {32,64};  
    return NOT(op<N-1>) : op<N-2:0>;  
  
// FPAbs()  
// =====  
  
bits(N) FPAbs(bits(N) op)  
    assert N IN {32,64};  
    return '0' : op<N-2:0>;
```

Floating-point value unpacking

The FPUnpack() function determines the type and numerical value of a floating-point number. It also does flush-to-zero processing on input operands.

```
enumeration FPType    {FPType_Nonzero, FPType_Zero, FPType_Infinity,  
                      FPType_QNaN, FPType_SNaN};  
  
// FPUnpack()  
// =====  
//  
// Unpack a floating-point number into its type, sign bit and the real number  
// that it represents. The real number result has the correct sign for numbers  
// and infinities, is very large in magnitude for infinities, and is 0.0 for  
// NaNs. (These values are chosen to simplify the description of comparisons  
// and conversions.)  
//  
// The 'fpcr' argument supplies FPCR control bits. Status information is  
// updated directly in the FPSR where appropriate.  
  
(FPType, bit, real) FPUnpack(bits(N) fpval, FPCRTYPE fpcr)  
    assert N IN {16,32,64};  
  
    if N == 16 then  
        sign = fpval<15>;  
        exp16 = fpval<14:10>;  
        frac16 = fpval<9:0>;  
        if IsZero(exp16) then  
            // Produce zero if value is zero  
            if IsZero(frac16) then  
                type = FPType_Zero; value = 0.0;  
            else  
                type = FPType_Nonzero; value = 2.0-14 * (UInt(frac16) * 2.0-10);  
        elsif IsOnes(exp16) && fpcr.AHP == '0' then // Infinity or NaN in IEEE format  
            if IsZero(frac16) then  
                type = FPType_Infinity; value = 2.01000000;  
            else
```

```

        type = if frac16<9> == '1' then FPType_QNaN else FPType_SNaN;
        value = 0.0;
    else
        type = FPType_Nonzero; value = 2.0^(UInt(exp16)-15) * (1.0 + UInt(frac16) * 2.0^-10);
elseif N == 32 then

    sign = fpval<31>;
    exp32 = fpval<30:23>;
    frac32 = fpval<22:0>;
    if IsZero(exp32) then
        // Produce zero if value is zero or flush-to-zero is selected.
        if IsZero(frac32) || fpcr.FZ == '1' then
            type = FPType_Zero; value = 0.0;
            if !IsZero(frac32) then // Denormalized input flushed to zero
                FPProcessException(FPExc_InputDenorm, fpcr);
        else
            type = FPType_Nonzero; value = 2.0^-126 * (UInt(frac32) * 2.0^-23);
    elseif IsOnes(exp32) then
        if IsZero(frac32) then
            type = FPType_Infinity; value = 2.0^1000000;
        else
            type = if frac32<22> == '1' then FPType_QNaN else FPType_SNaN;
            value = 0.0;
    else
        type = FPType_Nonzero; value = 2.0^(UInt(exp32)-127) * (1.0 + UInt(frac32) * 2.0^-23);

else // N == 64

    sign = fpval<63>;
    exp64 = fpval<62:52>;
    frac64 = fpval<51:0>;
    if IsZero(exp64) then
        // Produce zero if value is zero or flush-to-zero is selected.
        if IsZero(frac64) || fpcr.FZ == '1' then
            type = FPType_Zero; value = 0.0;
            if !IsZero(frac64) then // Denormalized input flushed to zero
                FPProcessException(FPExc_InputDenorm, fpcr);
        else
            type = FPType_Nonzero; value = 2.0^-1022 * (UInt(frac64) * 2.0^-52);
    elseif IsOnes(exp64) then
        if IsZero(frac64) then
            type = FPType_Infinity; value = 2.0^1000000;
        else
            type = if frac64<51> == '1' then FPType_QNaN else FPType_SNaN;
            value = 0.0;
    else
        type = FPType_Nonzero; value = 2.0^(UInt(exp64)-1023) * (1.0 + UInt(frac64) * 2.0^-52);

if sign == '1' then value = -value;
return (type, sign, value);

```

Floating-point exception and NaN handling

The `FPProcessException()` procedure checks whether a floating-point exception is trapped, and handles it accordingly:

```

enumeration FPExc    {FPExc_InvalidOp, FPExc_DivideByZero, FPExc_Overflow,
                    FPExc_Underflow, FPExc_Inexact, FPExc_InputDenorm};

```

```

// FPProcessException()
// =====
//
// The 'fpcr' argument supplies FPCR control bits. Status information is
// updated directly in the FPSR where appropriate.

```

```

FPProcessException(FPExc exception, FPCRType fpcr)

```

```

// Determine the cumulative exception bit number
case exception of
    when FPExc_InvalidOp      cumul = 0;
    when FPExc_DivideByZero   cumul = 1;
    when FPExc_Overflow       cumul = 2;
    when FPExc_Underflow      cumul = 3;
    when FPExc_Inexact        cumul = 4;
    when FPExc_InputDenorm    cumul = 7;
enable = cumul + 8;
if fpcr<enable> == '1' then
    // Trapping of the exception enabled.
    // It is IMPLEMENTATION DEFINED whether the enable bit may be set at all, and
    // if so then how exceptions may be accumulated before calling FPTrapException()
    IMPLEMENTATION_DEFINED "floating-point trap handling";
else if UsingAArch32() then
    // Set the cumulative exception bit
    FPSR<cumul> = '1';
else
    // Set the cumulative exception bit
    FPSR<cumul> = '1';
return;

```

The FPProcessNaN() function processes a NaN operand, producing the correct result value and generating an Invalid Operation exception if necessary:

```

// FPProcessNaN()
// =====

bits(N) FPProcessNaN(FPType type, bits(N) op, FPCRTYPE fpcr)
    assert N IN {32,64};
    assert type IN {FPType_QNaN, FPType_SNaN};

    topfrac = if N == 32 then 22 else 51;
    result = op;
    if type == FPType_SNaN then
        result<topfrac> = '1';
        FPProcessException(FPExc_InvalidOp, fpcr);
    if fpcr.DN == '1' then // DefaultNaN requested
        result = FPDefaultNaN();
    return result;

```

The FPProcessNaNs() function performs the standard NaN processing for a two-operand operation:

```

// FPProcessNaNs()
// =====
//
// The boolean part of the return value says whether a NaN has been found and
// processed. The bits(N) part is only relevant if it has and supplies the
// result of the operation.
//
// The 'fpcr' argument supplies FPCR control bits. Status information is
// updated directly in the FPSR where appropriate.

(boolean, bits(N)) FPProcessNaNs(FPType type1, FPType type2,
                                bits(N) op1, bits(N) op2,
                                FPCRTYPE fpcr)

    assert N IN {32,64};
    if type1 == FPType_SNaN then
        done = TRUE; result = FPProcessNaN(type1, op1, fpcr);
    elsif type2 == FPType_SNaN then
        done = TRUE; result = FPProcessNaN(type2, op2, fpcr);
    elsif type1 == FPType_QNaN then
        done = TRUE; result = FPProcessNaN(type1, op1, fpcr);
    elsif type2 == FPType_QNaN then
        done = TRUE; result = FPProcessNaN(type2, op2, fpcr);
    else
        done = FALSE; result = Zeros(); // 'Don't care' result
    return (done, result);

```

The FPPProcessNaNs3() function performs the standard NaN processing for a three-operand operation:

```
// FPPProcessNaNs3()
// =====
//
// The boolean part of the return value says whether a NaN has been found and
// processed. The bits(N) part is only relevant if it has and supplies the
// result of the operation.
//
// The 'fpcr' argument supplies FPCR control bits. Status information is
// updated directly in the FPSR where appropriate.

(boolean, bits(N)) FPPProcessNaNs3(FPType type1, FPType type2, FPType type3,
                                   bits(N) op1, bits(N) op2, bits(N) op3,
                                   FPCRTYPE fpcr)

    assert N IN {32,64};
    if type1 == FPType_SNaN then
        done = TRUE; result = FPPProcessNaN(type1, op1, fpcr);
    elsif type2 == FPType_SNaN then
        done = TRUE; result = FPPProcessNaN(type2, op2, fpcr);
    elsif type3 == FPType_SNaN then
        done = TRUE; result = FPPProcessNaN(type3, op3, fpcr);
    elsif type1 == FPType_QNaN then
        done = TRUE; result = FPPProcessNaN(type1, op1, fpcr);
    elsif type2 == FPType_QNaN then
        done = TRUE; result = FPPProcessNaN(type2, op2, fpcr);
    elsif type3 == FPType_QNaN then
        done = TRUE; result = FPPProcessNaN(type3, op3, fpcr);
    else
        done = FALSE; result = Zeros(); // 'Don't care' result
    return (done, result);
```

Floating-point rounding

The FPRound() function rounds and encodes a floating-point result value to a specified destination format. This includes processing Overflow, Underflow and Inexact floating-point exceptions and performing flush-to-zero processing on result values.

```
// FPRound()
// =====

// Convert a real number OP into an N-bit floating-point value using the
// supplied rounding mode RMODE.

bits(N) FPRound(real op, FPCRTYPE fpcr, FPRounding rounding)
    assert N IN {16,32,64};
    assert op != 0.0;
    assert rounding != FPRounding_TIEAWAY;
    bits(N) result;

    // Obtain format parameters - minimum exponent, numbers of exponent and fraction bits.
    if N == 16 then
        minimum_exp = -14; E = 5; F = 10;
    elsif N == 32 then
        minimum_exp = -126; E = 8; F = 23;
    else // N == 64
        minimum_exp = -1022; E = 11; F = 52;

    // Split value into sign, unrounded mantissa and exponent.
    if op < 0.0 then
        sign = '1'; mantissa = -op;
    else
        sign = '0'; mantissa = op;
    exponent = 0;
    while mantissa < 1.0 do
        mantissa = mantissa * 2.0; exponent = exponent + 1;
    while mantissa >= 2.0 do
```

```

    mantissa = mantissa / 2.0; exponent = exponent + 1;

// Deal with flush-to-zero.
if fpcr.FZ == '1' && N != 16 && exponent < minimum_exp then
    // Flush-to-zero never generates a trapped exception
    if UsingAArch32() then
        FPSCR.UFC = '1';
    else
        FPSR.UFC = '1';
    return FPZero(sign);

// Start creating the exponent value for the result. Start by biasing the actual exponent
// so that the minimum exponent becomes 1, lower values 0 (indicating possible underflow).
biased_exp = Max(exponent - minimum_exp + 1, 0);
if biased_exp == 0 then mantissa = mantissa / 2^(minimum_exp - exponent);

// Get the unrounded mantissa as an integer, and the "units in last place" rounding error.
int_mant = RoundDown(mantissa * 2^F); // < 2^F if biased_exp == 0, >= 2^F if not
error = mantissa * 2^F - int_mant;

// Underflow occurs if exponent is too small before rounding, and result is inexact or
// the Underflow exception is trapped.
if biased_exp == 0 && (error != 0.0 || fpcr.UFE == '1') then
    FPProcessException(FPExc_Underflow, fpcr);

// Round result according to rounding mode.
case rounding of
    when FPRounding_TIEEVEN
        round_up = (error > 0.5 || (error == 0.5 && int_mant<0> == '1'));
        overflow_to_inf = TRUE;
    when FPRounding_POSINF
        round_up = (error != 0.0 && sign == '0');
        overflow_to_inf = (sign == '0');
    when FPRounding_NEGINF
        round_up = (error != 0.0 && sign == '1');
        overflow_to_inf = (sign == '1');
    when FPRounding_ZERO, FPRounding_ODD
        round_up = FALSE;
        overflow_to_inf = FALSE;

if round_up then
    int_mant = int_mant + 1;
    if int_mant == 2^F then // Rounded up from denormalized to normalized
        biased_exp = 1;
    if int_mant == 2^(F+1) then // Rounded up to next exponent
        biased_exp = biased_exp + 1; int_mant = int_mant DIV 2;

// Handle rounding to odd aka Von Neumann rounding
if error != 0.0 && rounding == FPRounding_ODD then
    int_mant<0> = '1';

// Deal with overflow and generate result.
if N != 16 || fpcr.AHP == '0' then // Single, double or IEEE half precision
    if biased_exp >= 2^E - 1 then
        result = if overflow_to_inf then FPinfinity(sign) else FPMaxNormal(sign);
        FPProcessException(FPExc_Overflow, fpcr);
        error = 1.0; // Ensure that an Inexact exception occurs
    else
        result = sign : biased_exp<N-F-2:0> : int_mant<F-1:0>;
else // Alternative half precision
    if biased_exp >= 2^E then
        result = sign : Ones(N-1);
        FPProcessException(FPExc_InvalidOp, fpcr);
        error = 0.0; // Ensure that an Inexact exception does not occur
    else
        result = sign : biased_exp<N-F-2:0> : int_mant<F-1:0>;

// Deal with Inexact exception.

```

```

if error != 0.0 then
    FPProcessException(FPExc_Inexact, fpcr);

return result;

// FPRound()
// =====

bits(N) FPRound(real op, FPCRTYPE fpcr)
    return FPRound(op, fpcr, FPRoundingMode(fpcr));

```

Selection of ARM standard floating-point arithmetic

The StandardFPSCRValue() function returns the FPSCR value that selects ARM standard floating-point arithmetic. Most of the arithmetic functions have a Boolean fpcr_controlled argument that is TRUE for Floating-point operations and FALSE for Advanced SIMD operations, and that selects between using the real FPSCR value and this value.

```

// StandardFPSCRValue()
// =====

FPCRTYPE StandardFPSCRValue()
    return '00000' : FPSCR.AHP : '11000000000000000000000000000000';

```

Floating-point comparisons

The FPCompare() function compares two floating-point numbers, producing a {N, Z, C, V} condition flags result as shown in Table E1-5:

Table E1-5 Effect of a Floating-point comparison on the condition flags

Comparison result	N	Z	C	V
Equal	0	1	1	0
Less than	1	0	0	0
Greater than	0	0	1	0
Unordered	0	0	1	1

This result defines the operation of the VCMPI instruction in the Floating-point Extension. The VCMPI instruction writes these flag values in the FPSCR. After using a VMRS instruction to transfer them to the APSR, they can control conditional execution as shown in Table F2-1 on page F2-2416.

```

// FPCompare()
// =====

bits(4) FPCompare(bits(N) op1, bits(N) op2, boolean signal_nans, FPCRTYPE fpcr)
    assert N IN {32,64};
    (type1,sign1,value1) = FPUunpack(op1, fpcr);
    (type2,sign2,value2) = FPUunpack(op2, fpcr);
    if type1==FPTYPE_SNaN || type1==FPTYPE_QNaN || type2==FPTYPE_SNaN || type2==FPTYPE_QNaN then
        result = '0011';
        if type1==FPTYPE_SNaN || type2==FPTYPE_SNaN || signal_nans then
            FPProcessException(FPExc_InvalidOp, fpcr);
    else
        // All non-NaN cases can be evaluated on the values produced by FPUunpack()
        if value1 == value2 then
            result = '0110';
        elseif value1 < value2 then
            result = '1000';
        else // value1 > value2

```

```
        result = '0010';  
    return result;
```

The FPCompareEQ(), FPCompareGE() and FPCompareGT() functions describe the operation of Advanced SIMD instructions that perform floating-point comparisons.

```
// FPCompareEQ()  
// =====  
  
boolean FPCompareEQ(bits(N) op1, bits(N) op2, FPCRTYPE fpcr)  
    assert N IN {32,64};  
    (type1,sign1,value1) = FPUunpack(op1, fpcr);  
    (type2,sign2,value2) = FPUunpack(op2, fpcr);  
    if type1==FPTYPE_SNaN || type1==FPTYPE_QNaN || type2==FPTYPE_SNaN || type2==FPTYPE_QNaN then  
        result = FALSE;  
        if type1==FPTYPE_SNaN || type2==FPTYPE_SNaN then  
            FPPROCESSException(FPEXC_InvalidOp, fpcr);  
    else  
        // All non-NaN cases can be evaluated on the values produced by FPUunpack()  
        result = (value1 == value2);  
    return result;  
  
// FPCompareGE()  
// =====  
  
boolean FPCompareGE(bits(N) op1, bits(N) op2, FPCRTYPE fpcr)  
    assert N IN {32,64};  
    (type1,sign1,value1) = FPUunpack(op1, fpcr);  
    (type2,sign2,value2) = FPUunpack(op2, fpcr);  
    if type1==FPTYPE_SNaN || type1==FPTYPE_QNaN || type2==FPTYPE_SNaN || type2==FPTYPE_QNaN then  
        result = FALSE;  
        FPPROCESSException(FPEXC_InvalidOp, fpcr);  
    else  
        // All non-NaN cases can be evaluated on the values produced by FPUunpack()  
        result = (value1 >= value2);  
    return result;  
  
// FPCompareGT()  
// =====  
  
boolean FPCompareGT(bits(N) op1, bits(N) op2, FPCRTYPE fpcr)  
    assert N IN {32,64};  
    (type1,sign1,value1) = FPUunpack(op1, fpcr);  
    (type2,sign2,value2) = FPUunpack(op2, fpcr);  
    if type1==FPTYPE_SNaN || type1==FPTYPE_QNaN || type2==FPTYPE_SNaN || type2==FPTYPE_QNaN then  
        result = FALSE;  
        FPPROCESSException(FPEXC_InvalidOp, fpcr);  
    else  
        // All non-NaN cases can be evaluated on the values produced by FPUunpack()  
        result = (value1 > value2);  
    return result;
```

Floating-point maximum and minimum

```
// FPMax()  
// =====  
  
bits(N) FPMax(bits(N) op1, bits(N) op2, FPCRTYPE fpcr)  
    assert N IN {32,64};  
    (type1,sign1,value1) = FPUunpack(op1, fpcr);  
    (type2,sign2,value2) = FPUunpack(op2, fpcr);  
    (done,result) = FPPROCESSNaNs(type1, type2, op1, op2, fpcr);  
    if !done then  
        if value1 > value2 then  
            (type,sign,value) = (type1,sign1,value1);  
        else
```

```

        (type,sign,value) = (type2,sign2,value2);
    if type == FPType_Infinity then
        result = FPInfinity(sign);
    elsif type == FPType_Zero then
        sign = sign1 AND sign2; // Use most positive sign
        result = FPZero(sign);
    else
        result = FPRound(value, fpcr);
    return result;

// FPMin()
// =====

bits(N) FPMin(bits(N) op1, bits(N) op2, FPCRTType fpcr)
    assert N IN {32,64};
    (type1,sign1,value1) = FPUnpack(op1, fpcr);
    (type2,sign2,value2) = FPUnpack(op2, fpcr);
    (done,result) = FPProcessNaNs(type1, type2, op1, op2, fpcr);
    if !done then
        if value1 < value2 then
            (type,sign,value) = (type1,sign1,value1);
        else
            (type,sign,value) = (type2,sign2,value2);
        if type == FPType_Infinity then
            result = FPInfinity(sign);
        elsif type == FPType_Zero then
            sign = sign1 OR sign2; // Use most negative sign
            result = FPZero(sign);
        else
            result = FPRound(value, fpcr);
    return result;

```

Floating-point addition and subtraction

```

// FPAAdd()
// =====

bits(N) FPAAdd(bits(N) op1, bits(N) op2, FPCRTType fpcr)
    assert N IN {32,64};
    rounding = FPRoundingMode(fpcr);
    (type1,sign1,value1) = FPUnpack(op1, fpcr);
    (type2,sign2,value2) = FPUnpack(op2, fpcr);
    (done,result) = FPProcessNaNs(type1, type2, op1, op2, fpcr);
    if !done then
        inf1 = (type1 == FPType_Infinity);  inf2 = (type2 == FPType_Infinity);
        zero1 = (type1 == FPType_Zero);    zero2 = (type2 == FPType_Zero);
        if inf1 && inf2 && sign1 == NOT(sign2) then
            result = FPDefaultNaN();
            FPProcessException(FPExc_InvalidOp, fpcr);
        elsif (inf1 && sign1 == '0') || (inf2 && sign2 == '0') then
            result = FPInfinity('0');
        elsif (inf1 && sign1 == '1') || (inf2 && sign2 == '1') then
            result = FPInfinity('1');
        elsif zero1 && zero2 && sign1 == sign2 then
            result = FPZero(sign1);
        else
            result_value = value1 + value2;
            if result_value == 0.0 then // Sign of exact zero result depends on rounding mode
                result_sign = if rounding == FPRounding_NEGINF then '1' else '0';
                result = FPZero(result_sign);
            else
                result = FPRound(result_value, fpcr, rounding);
    return result;

// FPSub()
// =====

```

```
bits(N) FPSub(bits(N) op1, bits(N) op2, FPCRType fpcr)
assert N IN {32,64};
rounding = FPRoundingMode(fpcr);
(type1,sign1,value1) = FPUunpack(op1, fpcr);
(type2,sign2,value2) = FPUunpack(op2, fpcr);
(done,result) = FPProcessNaNs(type1, type2, op1, op2, fpcr);
if !done then
    inf1 = (type1 == FPType_Infinity);
    inf2 = (type2 == FPType_Infinity);
    zero1 = (type1 == FPType_Zero);
    zero2 = (type2 == FPType_Zero);
    if inf1 && inf2 && sign1 == sign2 then
        result = FPDefaultNaN();
        FPProcessException(FPExc_InvalidOp, fpcr);
    elsif (inf1 && sign1 == '0') || (inf2 && sign2 == '1') then
        result = FPIfinity('0');
    elsif (inf1 && sign1 == '1') || (inf2 && sign2 == '0') then
        result = FPIfinity('1');
    elsif zero1 && zero2 && sign1 == NOT(sign2) then
        result = FPZero(sign1);
    else
        result_value = value1 - value2;
        if result_value == 0.0 then // Sign of exact zero result depends on rounding mode
            result_sign = if rounding == FPRounding_NEGINF then '1' else '0';
            result = FPZero(result_sign);
        else
            result = FPRound(result_value, fpcr, rounding);
    return result;
```

Floating-point multiplication and division

```
// FPMul()
// =====
```

```
bits(N) FPMul(bits(N) op1, bits(N) op2, FPCRType fpcr)
assert N IN {32,64};
(type1,sign1,value1) = FPUunpack(op1, fpcr);
(type2,sign2,value2) = FPUunpack(op2, fpcr);
(done,result) = FPProcessNaNs(type1, type2, op1, op2, fpcr);
if !done then
    inf1 = (type1 == FPType_Infinity);
    inf2 = (type2 == FPType_Infinity);
    zero1 = (type1 == FPType_Zero);
    zero2 = (type2 == FPType_Zero);
    if (inf1 && zero2) || (zero1 && inf2) then
        result = FPDefaultNaN();
        FPProcessException(FPExc_InvalidOp, fpcr);
    elsif inf1 || inf2 then
        result = FPIfinity(sign1 EOR sign2);
    elsif zero1 || zero2 then
        result = FPZero(sign1 EOR sign2);
    else
        result = FPRound(value1*value2, fpcr);
    return result;
```

```
// FPDiv()
// =====
```

```
bits(N) FPDiv(bits(N) op1, bits(N) op2, FPCRType fpcr)
assert N IN {32,64};
(type1,sign1,value1) = FPUunpack(op1, fpcr);
(type2,sign2,value2) = FPUunpack(op2, fpcr);
(done,result) = FPProcessNaNs(type1, type2, op1, op2, fpcr);
if !done then
    inf1 = (type1 == FPType_Infinity);
    inf2 = (type2 == FPType_Infinity);
    zero1 = (type1 == FPType_Zero);
```

```

zero2 = (type2 == FPType_Zero);
if (inf1 && inf2) || (zero1 && zero2) then
    result = FPDefaultNaN();
    FPProcessException(FPExc_InvalidOp, fpcr);
elseif inf1 || zero2 then
    result = FPInfinity(sign1 EOR sign2);
    if !inf1 then FPProcessException(FPExc_DivideByZero, fpcr);
elseif zero1 || inf2 then
    result = FPZero(sign1 EOR sign2);
else
    result = FPRound(value1/value2, fpcr);
return result;

```

Floating-point fused multiply-add

```

// FPMu1Add()
// =====
//
// Calculates addend + op1*op2 with a single rounding.

bits(N) FPMu1Add(bits(N) addend, bits(N) op1, bits(N) op2, FPCRType fpcr)
    assert N IN {32,64};
    rounding = FPRoundingMode(fpcr);
    (typeA,signA,valueA) = FPUunpack(addend, fpcr);
    (type1,sign1,value1) = FPUunpack(op1, fpcr);
    (type2,sign2,value2) = FPUunpack(op2, fpcr);
    inf1 = (type1 == FPType_Infinity); zero1 = (type1 == FPType_Zero);
    inf2 = (type2 == FPType_Infinity); zero2 = (type2 == FPType_Zero);
    (done,result) = FPProcessNaNs3(typeA, type1, type2, addend, op1, op2, fpcr);

    if typeA == FPType_QNaN && ((inf1 && zero2) || (zero1 && inf2)) then
        result = FPDefaultNaN();
        FPProcessException(FPExc_InvalidOp, fpcr);

    if !done then
        infA = (typeA == FPType_Infinity); zeroA = (typeA == FPType_Zero);

        // Determine sign and type product will have if it does not cause an Invalid
        // Operation.
        signP = sign1 EOR sign2;
        infP = inf1 || inf2;
        zeroP = zero1 || zero2;

        // Non SNaN-generated Invalid Operation cases are multiplies of zero by infinity and
        // additions of opposite-signed infinities.
        if (inf1 && zero2) || (zero1 && inf2) || (infA && infP && signA != signP) then
            result = FPDefaultNaN();
            FPProcessException(FPExc_InvalidOp, fpcr);

        // Other cases involving infinities produce an infinity of the same sign.
        elseif (infA && signA == '0') || (infP && signP == '0') then
            result = FPInfinity('0');
        elseif (infA && signA == '1') || (infP && signP == '1') then
            result = FPInfinity('1');

        // Cases where the result is exactly zero and its sign is not determined by the
        // rounding mode are additions of same-signed zeros.
        elseif zeroA && zeroP && signA == signP then
            result = FPZero(signA);

        // Otherwise calculate numerical result and round it.
        else
            result_value = valueA + (value1 * value2);
            if result_value == 0.0 then // Sign of exact zero result depends on rounding mode
                result_sign = if rounding == FPRounding_NEGINF then '1' else '0';
                result = FPZero(result_sign);
            else

```

```
        result = FPRound(result_value, fpcr);  
  
    return result;
```

Floating-point reciprocal estimate and step

The Advanced SIMD implementation includes instructions that support Newton-Raphson calculation of the reciprocal of a number.

The VRECPE instruction produces the initial estimate of the reciprocal. It uses the following pseudocode functions:

```
// FPrecipEstimate()  
// =====  
  
bits(N) FPrecipEstimate(bits(N) operand, FPCRTYPE fpcr)  
    assert N IN {32, 64};  
    (type,sign,value) = FPUnpack(operand, fpcr);  
    if type == FPTYPE_SNaN || type == FPTYPE_QNaN then  
        result = FPPROCESSNaN(type, operand, fpcr);  
    elseif type == FPTYPE_Infinity then  
        result = FPZero(sign);  
    elseif type == FPTYPE_Zero then  
        result = FPInfinity(sign);  
        FPPROCESSException(FPEXC_DivideByZero, fpcr);  
    elseif (N == 32 && Abs(value) < 2.0-128)  
        || (N == 64 && Abs(value) < 2.0-1024) then  
        case FPRoundingMode(fpcr) of  
            when FPRounding_TIEEVEN  
                overflow_to_inf = TRUE;  
            when FPRounding_POSINF  
                overflow_to_inf = (sign == '0');  
            when FPRounding_NEGINF  
                overflow_to_inf = (sign == '1');  
            when FPRounding_ZERO  
                overflow_to_inf = FALSE;  
        result = if overflow_to_inf then FPInfinity(sign) else FPMaxNormal(sign);  
        FPPROCESSException(FPEXC_Overflow, fpcr);  
        FPPROCESSException(FPEXC_Inexact, fpcr);  
    elseif fpcr.FZ == '1'  
        && ((N == 32 && Abs(value) >= 2.0126)  
            || (N == 64 && Abs(value) >= 2.01022)) then  
        // Result flushed to zero of correct sign  
        result = FPZero(sign);  
        FPPROCESSException(FPEXC_Underflow, fpcr);  
    else  
        // Scale to a double-precision value in the range 0.5 <= x < 1.0, and  
        // calculate result exponent. Scaled value has copied sign bit,  
        // exponent = 1022 = double-precision biased version of -1,  
        // fraction = original fraction extended with zeros.  
  
        if N == 32 then  
            fraction = operand<22:0> : Zeros(29);  
            exp = UInt(operand<30:23>);  
        else // N == 64  
            fraction = operand<51:0>;  
            exp = UInt(operand<62:52>);  
  
        if exp == 0 then  
            if fraction<51> == 0 then  
                exp = -1;  
                fraction = fraction<49:0>:'00';  
            else  
                fraction = fraction<50:0>:'0';  
        scaled = '0' : '0111111110' : fraction<51:44> : Zeros(44);  
  
        if N == 32 then
```



```

        result_exp = 253 - exp;    // In range 253-254 = -1 to 253+1 = 254
    else // N == 64
        result_exp = 2045 - exp;   // In range 2045-2046 = -1 to 2045+1 = 2046

    // Call C function to get reciprocal estimate of scaled value.
    // Input is rounded down to a multiple of 1/512.
    estimate = recip_estimate(scaled);

    // Result is double-precision and a multiple of 1/256 in the range 1 to 511/256.
    // Convert to scaled single-precision result with copied sign bit and high-order
    // fraction bits, and exponent calculated above.

    fraction = estimate<51:0>;
    if result_exp == 0 then
        fraction = '1' : fraction<51:1>;
    elseif result_exp == -1 then
        fraction = '01' : fraction<51:2>;
        result_exp = 0;
    if N == 32 then
        result = sign : result_exp<N-25:0> : fraction<51:29>;
    else // N == 64
        result = sign : result_exp<N-54:0> : fraction<51:0>;

return result;

// UnsignedRecipEstimate()
// =====

bits(32) UnsignedRecipEstimate(bits(32) operand)

    if operand<31> == '0' then // Operands <= 0x7FFFFFFF produce 0xFFFFFFFF
        result = Ones(32);
    else
        // Generate double-precision value = operand * 2^(-32). This has zero sign bit, with:
        //   exponent = 1022 = double-precision representation of 2^(-1)
        //   fraction taken from operand, excluding its most significant bit.
        dp_operand = '0 0111111110' : operand<30:0> : Zeros(21);

        // Call C function to get reciprocal estimate of scaled value.
        estimate = recip_estimate(dp_operand);

        // Result is double-precision and a multiple of 1/256 in the range 1 to 511/256.
        // Multiply by 2^31 and convert to an unsigned integer - this just involves
        // concatenating the implicit units bit with the top 31 fraction bits.
        result = '1' : estimate<51:21>;

return result;

```

recip_estimate() is defined by the following C function:

```

double recip_estimate(double a)
{
    int q, s;
    double r;
    q = (int)(a * 512.0);    /* a in units of 1/512 rounded down */
    r = 1.0 / (((double)q + 0.5) / 512.0); /* reciprocal r */
    s = (int)(256.0 * r + 0.5); /* r in units of 1/256 rounded to nearest */
    return (double)s / 256.0;
}

```

Table E1-6 shows the results where input values are out of range.

Table E1-6 VRECPE results for out of range inputs

Number type	Input Vm[i]	Result Vd[i]
Integer	$\leq 0x7FFFFFFF$	0xFFFFFFFF
Floating-point	NaN	Default NaN
Floating-point	± 0 or denormalized number	\pm infinity ^a
Floating-point	\pm infinity	± 0
Floating-point	Absolute value $\geq 2^{126}$	± 0

a. FPSCR.DZC is set to 1

The Newton-Raphson iteration:

$$x_{n+1} = x_n(2 - dx_n)$$

converges to $(1/d)$ if x_0 is the result of VRECPE applied to d .

The VRECPS instruction performs a $(2 - op1 \times op2)$ calculation and can be used with a multiplication to perform a step of this iteration. The functionality of this instruction is defined by the following pseudocode function:

```
// FPrecipStep()
// =====
bits(32) FPrecipStep(bits(32) op1, bits(32) op2)
    FPCRType fpcr = StandardFPCRValue();
    (type1, sign1, value1) = FPUnpack(op1, fpcr);
    (type2, sign2, value2) = FPUnpack(op2, fpcr);
    (done, result) = FPProcessNaNs(type1, type2, op1, op2, fpcr);
    if !done then
        inf1 = (type1 == FPType_Infinity); inf2 = (type2 == FPType_Infinity);
        zero1 = (type1 == FPType_Zero); zero2 = (type2 == FPType_Zero);
        bits(32) product;
        if (inf1 && zero2) || (zero1 && inf2) then
            product = FPZero('0');
        else
            product = FPMul(op1, op2, fpcr);
            result = FPSub(FPTwo('0'), product, fpcr);
    return result;
```

Table E1-7 shows the results where input values are out of range.

Table E1-7 VRECPS results for out of range inputs

Input Vn[i]	Input Vm[i]	Result Vd[i]
Any NaN	-	Default NaN
-	Any NaN	Default NaN
± 0.0 or denormalized number	\pm infinity	2.0
\pm infinity	± 0.0 or denormalized number	2.0

Floating-point square root

```
// FPSqrt()
// =====
```

```

bits(N) FPSqrt(bits(N) op, FPCRTType fpcr)
    assert N IN {32,64};
    (type,sign,value) = FPUnpack(op, fpcr);
    if type == FPType_SNaN || type == FPType_QNaN then
        result = FPProcessNaN(type, op, fpcr);
    elsif type == FPType_Zero then
        result = FPZero(sign);
    elsif type == FPType_Infinity && sign == '0' then
        result = FPInfinity(sign);
    elsif sign == '1' then
        result = FPDefaultNaN();
        FPProcessException(FPExc_InvalidOp, fpcr);
    else
        result = FPRound(Sqrt(value), fpcr);
    return result;

```

Floating-point reciprocal square root estimate and step

The Advanced SIMD implementation includes instructions that support Newton-Raphson calculation of the reciprocal of the square root of a number.

The VRSQRTE instruction produces the initial estimate of the reciprocal of the square root. It uses the following pseudocode functions:

```

// FPRSqrtEstimate()
// =====

bits(N) FPRSqrtEstimate(bits(N) operand, FPCRTType fpcr)
    assert N IN {32, 64};
    (type,sign,value) = FPUnpack(operand, fpcr);
    if type == FPType_SNaN || type == FPType_QNaN then
        result = FPProcessNaN(type, operand, fpcr);
    elsif type == FPType_Zero then
        result = FPInfinity(sign);
        FPProcessException(FPExc_DivideByZero, fpcr);
    elsif sign == '1' then
        result = FPDefaultNaN();
        FPProcessException(FPExc_InvalidOp, fpcr);
    elsif type == FPType_Infinity then
        result = FPZero('0');
    else
        // Scale to a double-precision value in the range 0.25 <= x < 1.0, with the
        // evenness or oddness of the exponent unchanged, and calculate result exponent.
        // Scaled value has copied sign bit, exponent = 1022 or 1021 = double-precision
        // biased version of -1 or -2, fraction = original fraction extended with zeros.

        if N == 32 then
            fraction = operand<22:0> : Zeros(29);
            exp = UInt(operand<30:23>);
        else // N == 64
            fraction = operand<51:0>;
            exp = UInt(operand<62:52>);

        if exp == 0 then
            while fraction<51> == 0 do
                fraction = fraction<50:0> : '0';
                exp = exp - 1;
            fraction = fraction<50:0> : '0';

        if exp<0> == '0' then
            scaled = '0' : '0111111110' : fraction<51:44> : Zeros(44);
        else
            scaled = '0' : '0111111101' : fraction<51:44> : Zeros(44);

        if N == 32 then
            result_exp = (380 - exp) DIV 2;

```

```

else // N == 64
    result_exp = (3068 - exp) DIV 2;

// Call C function to get reciprocal estimate of scaled value.
estimate = recip_sqrt_estimate(scaled);

// Result is double-precision and a multiple of 1/256 in the range 1 to 511/256.
// Convert to scaled single-precision result with copied sign bit and high-order
// fraction bits, and exponent calculated above.

if N == 32 then
    result = '0' : result_exp<N-25:0> : estimate<51:29>;
else // N == 64
    result = '0' : result_exp<N-54:0> : estimate<51:0>;
return result;

// UnsignedRSqrtEstimate()
// =====

bits(32) UnsignedRSqrtEstimate(bits(32) operand)

if operand<31:30> == '00' then // Operands <= 0x3FFFFFFF produce 0xFFFFFFFF
    result = Ones(32);
else
    // Generate double-precision value = operand * 2^(-32). This has zero sign bit, with:
    //     exponent = 1022 or 1021 = double-precision representation of 2^(-1) or 2^(-2)
    //     fraction taken from operand, excluding its most significant one or two bits.
    if operand<31> == '1' then
        dp_operand = '0 0111111110' : operand<30:0> : Zeros(21);
    else // operand<31:30> == '01'
        dp_operand = '0 01111111101' : operand<29:0> : Zeros(22);

    // Call C function to get reciprocal estimate of scaled value.
    estimate = recip_sqrt_estimate(dp_operand);

    // Result is double-precision and a multiple of 1/256 in the range 1 to 511/256.
    // Multiply by 2^31 and convert to an unsigned integer - this just involves
    // concatenating the implicit units bit with the top 31 fraction bits.
    result = '1' : estimate<51:21>;

return result;

```

recip_sqrt_estimate() is defined by the following C function:

```

double recip_sqrt_estimate(double a)
{
    int q0, q1, s;
    double r;
    if (a < 0.5) /* range 0.25 <= a < 0.5 */
    {
        q0 = (int)(a * 512.0); /* a in units of 1/512 rounded down */
        r = 1.0 / sqrt(((double)q0 + 0.5) / 512.0); /* reciprocal root r */
    }
    else /* range 0.5 <= a < 1.0 */
    {
        q1 = (int)(a * 256.0); /* a in units of 1/256 rounded down */
        r = 1.0 / sqrt(((double)q1 + 0.5) / 256.0); /* reciprocal root r */
    }
    s = (int)(256.0 * r + 0.5); /* r in units of 1/256 rounded to nearest */
    return (double)s / 256.0;
}

```

Table E1-8 shows the results where input values are out of range.

Table E1-8 VRSQRTE results for out of range inputs

Number type	Input Vm[i]	Result Vd[i]
Integer	$\leq 0x3FFFFFFF$	0xFFFFFFFF
Floating-point	NaN, $-(\text{normalized number})$, $-\text{infinity}$	Default NaN
Floating-point	-0 or $-(\text{denormalized number})$	$-\text{infinity}^a$
Floating-point	$+0$ or $(\text{denormalized number})$	$+\text{infinity}^a$
Floating-point	$+\text{infinity}$	$+0$

a. `FPSCR.DZC` is set to 1.

The Newton-Raphson iteration:

$$x_{n+1} = x_n(3 - dx_n^2)/2$$

converges to $(1/\sqrt{d})$ if x_0 is the result of VRSQRTE applied to d .

The VRSQRTS instruction performs a $(3 - \text{op1} \times \text{op2})/2$ calculation and can be used with two multiplications to perform a step of this iteration. The `FPRSqrtStep()` pseudocode function defines the functionality of this instruction:

```
// FPRSqrtStep()
// =====

bits(32) FPRSqrtStep(bits(32) op1, bits(32) op2)
    FPCRType fpcr = StandardFPCRValue();
    (type1, sign1, value1) = FPUnpack(op1, fpcr);
    (type2, sign2, value2) = FPUnpack(op2, fpcr);
    (done, result) = FPProcessNaNs(type1, type2, op1, op2, fpcr);
    if !done then
        inf1 = (type1 == FPType_Infinity);  inf2 = (type2 == FPType_Infinity);
        zero1 = (type1 == FPType_Zero);     zero2 = (type2 == FPType_Zero);
        bits(32) product;
        if (inf1 && zero2) || (zero1 && inf2) then
            product = FPZero('0');
        else
            product = FPMul(op1, op2, fpcr);
            result = FPHalvedSub(FPThree('0'), product, fpcr);
    return result;
```

Table E1-9 shows the results where input values are out of range.

Table E1-9 VRSQRTS results for out of range inputs

Input Vn[i]	Input Vm[i]	Result Vd[i]
Any NaN	-	Default NaN
-	Any NaN	Default NaN
± 0.0 or denormalized number	$\pm \text{infinity}$	1.5
$\pm \text{infinity}$	± 0.0 or denormalized number	1.5

`FPRSqrtStep()` calls the `FPHalvedSub()` pseudocode function:

```
// FPHalvedSub()
// =====
```

```
bits(N) FPHalvedSub(bits(N) op1, bits(N) op2, FPCRType fpcr)
    assert N IN {32,64};
    rounding = FPRoundingMode(fpcr);
    (type1,sign1,value1) = FPUunpack(op1, fpcr);
    (type2,sign2,value2) = FPUunpack(op2, fpcr);
    (done,result) = FPProcessNaNs(type1, type2, op1, op2, fpcr);
    if !done then
        inf1 = (type1 == FPType_Infinity);  inf2 = (type2 == FPType_Infinity);
        zero1 = (type1 == FPType_Zero);     zero2 = (type2 == FPType_Zero);
        if inf1 && inf2 && sign1 == sign2 then
            result = FPDefaultNaN();
            FPProcessException(FPExc_InvalidOp, fpcr);
        elseif (inf1 && sign1 == '0') || (inf2 && sign2 == '1') then
            result = FPinfinity('0');
        elseif (inf1 && sign1 == '1') || (inf2 && sign2 == '0') then
            result = FPinfinity('1');
        elseif zero1 && zero2 && sign1 != sign2 then
            result = FPZero(sign1);
        else
            result_value = (value1 - value2) / 2.0;
            if result_value == 0.0 then // Sign of exact zero result depends on rounding mode
                result_sign = if rounding == FPRounding_NEGINF then '1' else '0';
                result = FPZero(result_sign);
            else
                result = FPRound(result_value, fpcr);
    return result;
```

Floating-point conversions

The following function performs conversions between half-precision, single-precision and double-precision floating-point numbers.

```
// FPConvert()
// =====

// Convert floating point OP with N-bit precision to M-bit precision,
// with rounding controlled by ROUNDING.

bits(M) FPConvert(bits(N) op, FPCRType fpcr, FPRounding rounding)
    assert M IN {16,32,64};
    assert N IN {16,32,64};
    bits(M) result;

    // Unpack floating-point operand optionally with flush-to-zero.
    (type,sign,value) = FPUunpack(op, fpcr);

    alt_hp = (M == 16) && (fpcr.AHP == '1');

    if type == FPType_SNaN || type == FPType_QNaN then
        if alt_hp then
            result = FPZero(sign);
        elseif fpcr.DN == '1' then
            result = FPDefaultNaN();
        else
            result = FPConvertNaN(op);
            if type == FPType_SNaN || alt_hp then
                FPProcessException(FPExc_InvalidOp, fpcr);
    elseif type == FPType_Infinity then
        if alt_hp then
            result = sign:Ones(M-1);
            FPProcessException(FPExc_InvalidOp, fpcr);
        else
            result = FPinfinity(sign);
    elseif type == FPType_Zero then
        result = FPZero(sign);
    else
```

```

        result = FPRound(value, fpcr, rounding);

    return result;

// FPConvert()
// =====

bits(M) FPConvert(bits(N) op, FPCRTYPE fpcr)
    return FPConvert(op, fpcr, FPRoundingMode(fpcr));

```

The following functions perform conversions between floating-point numbers and integers or fixed-point numbers:

```

// FPToFixed()
// =====

// Convert N-bit precision floating point OP to M-bit fixed point with
// FBITS fractional bits, controlled by UNSIGNED and ROUNDING.

bits(M) FPToFixed(bits(N) op, integer fbits, boolean unsigned, FPCRTYPE fpcr, FPRounding rounding)
    assert N IN {32,64};
    assert M IN {32,64};
    assert fbits >= 0;
    assert rounding != FPRounding_ODD;

    // Unpack using fpcr to determine if subnormals are flushed-to-zero
    (type,sign,value) = FPUnpack(op, fpcr);

    // If NaN, set cumulative flag or take exception
    if type == FPTYPE_SNaN || type == FPTYPE_QNaN then
        FPPROCESSException(FPEXC_InvalidOp, fpcr);

    // Scale by fractional bits and produce integer rounded towards minus-infinity
    value = value * 2^fbits;
    int_result = RoundDown(value);
    error = value - int_result;

    // Determine whether supplied rounding mode requires an increment
    case rounding of
        when FPRounding_TIEEVEN
            round_up = (error > 0.5 || (error == 0.5 && int_result<0> == '1'));
        when FPRounding_POSINF
            round_up = (error != 0.0);
        when FPRounding_NEGINF
            round_up = FALSE;
        when FPRounding_ZERO
            round_up = (error != 0.0 && int_result < 0);
        when FPRounding_TIEAWAY
            round_up = (error > 0.5 || (error == 0.5 && int_result >= 0));

    if round_up then int_result = int_result + 1;

    // Generate saturated result and exceptions
    (result, overflow) = SatQ(int_result, M, unsigned);
    if overflow then
        FPPROCESSException(FPEXC_InvalidOp, fpcr);
    elsif error != 0.0 then
        FPPROCESSException(FPEXC_Inexact, fpcr);

    return result;

// FixedToFP()
// =====

// Convert M-bit fixed point OP with FBITS fractional bits to
// N-bit precision floating point, controlled by UNSIGNED and ROUNDING.

bits(N) FixedToFP(bits(M) op, integer fbits, boolean unsigned, FPCRTYPE fpcr, FPRounding rounding)
    assert N IN {32,64};

```

```
assert M IN {32,64};
bits(N) result;
assert fbits >= 0;
assert rounding != FPRounding_ODD;

// Correct signed-ness
int_operand = Int(op, unsigned);

// Scale by fractional bits and generate a real value
real_operand = int_operand / 2^fbits;

if real_operand == 0.0 then
    result = FPZero('0');
else
    result = FPRound(real_operand, fpcr, rounding);

return result;
```

E1.4 Coprocessor support

AArch32 state provides a coprocessor interface, that comprises the coprocessor instructions summarized in [Coprocessor instructions on page F1-2397](#). These can provide access to sixteen coprocessors, described as CP0 to CP15. The following conceptual coprocessors are reserved by ARM for specific purposes, and from ARMv8 are the only supported coprocessors:

- Coprocessor 15 (CP15) provides system control functionality, by providing access to System registers. This includes architecture and feature identification, as well as control, status information and configuration support.

The following sections give a general description of CP15:

- [About the System registers for VMSAv8-32 on page G3-3691](#).
- [Organization of the CP15 registers in VMSAv8-32 on page G3-3716](#).
- [Functional grouping of VMSAv8-32 System registers on page G3-3735](#).

CP15 also provides performance monitor registers, see [Chapter D6 The Performance Monitors Extension](#).

- Coprocessor 14 (CP14) provides access to additional registers, that support:
 - Debug, see [Chapter H8 About the External Debug Registers](#).
 - The Jazelle identification registers, see [Jazelle support on page E1-2302](#).
 - T32EE registers when implemented.]
- Coprocessors 10 and 11 (CP10 and CP11) together support floating-point and Advanced SIMD vector operations, and the control and configuration of Advanced SIMD and floating-point operation.

Note

To enable use of the Advanced SIMD and floating-point instructions, software must enable access to both CP10 and CP11, see [Enabling Advanced SIMD and floating-point support on page G1-3494](#).

[UNPREDICTABLE and UNDEFINED behavior for CP14 and CP15 accesses on page G3-3693](#) gives information more information about permitted accesses to coprocessors CP14 and CP15.

Most CP14 and CP15 functions cannot be accessed by software executing at EL0. This manual clearly identifies those functions that can be accessed at EL0. However, software executing at EL1 can enable the unprivileged execution of all load, store, branch and data operation instructions associated with floating-point, Advanced SIMD and execution environment support.

E1.5 Exceptions and debug events

The ARM architecture uses the following terms to describe various types of exceptional condition:

Exceptions In the ARM architecture, an *exception* causes entry to EL1, EL2, or EL3. If the Exception level that is entered is using AArch32, it also causes entry to the PE mode in which the exception must be taken. A software handler for the exception is then executed.

———— **Note** —————

The term *floating-point exception* does not use this meaning of *exception*. This term is described later in this list.

Exceptions include:

- Reset.
- Interrupts.
- Memory system aborts.
- Undefined instructions.
- Supervisor calls (SVCs), Secure Monitor calls (SMCs), and hypervisor calls (HVCs).

Most details of exception handling are not visible to application level software, and are described in [Handling exceptions that are taken to an Exception level using AArch32 on page G1-3431](#). In an ARMv8 implementation that includes all the Exception levels, aspects that are visible to application level software are:

- The SVC instruction causes a Supervisor Call exception. This provides a mechanism for unprivileged software to make a call to the operating system, or other system component that is accessible only at EL1.
- The SMC instruction causes a Secure Monitor Call exception, but only if software execution is at EL1 or higher. Unprivileged software can only cause a Secure Monitor Call exception by methods defined by the operating system, or by another component of the software system that executes at EL1 or higher.
- The HVC instruction causes a Hypervisor Call exception, but only if software execution is at EL1 or higher. Unprivileged software can only cause a Hypervisor Call exception by methods defined by the hypervisor, or by another component of the software system that executes at EL1 or higher.
- The WFI (Wait for Interrupt) instruction provides a hint that nothing needs to be done until an interrupt or another WFI wake-up event occurs, see [Wait For Interrupt on page G1-3463](#). This means the hardware might enter a low-power state until the wake-up event occurs.
- The WFE (Wait for Event) instruction provides a hint that nothing needs to be done until either an SEV instruction generates an event, or another WFE wake-up event occurs, see [Wait For Event and Send Event on page G1-3460](#). This means the hardware might enter a low-power state until the wake-up event occurs.

Floating-point exceptions

These relate to exceptional conditions encountered during floating-point arithmetic, such as division by zero or overflow. For more information see:

- [Floating-point exceptions on page E1-2307](#).
- [FPSCR, Floating-Point Status and Control Register on page G4-3845](#).
- ANSI/IEEE Std. 754, *IEEE Standard for Binary Floating-Point Arithmetic*.

Debug events These are conditions that cause a debug system to take action. Most aspects of debug events are not visible to application level software, and are described in [Chapter D2 Debug Exceptions](#). Aspects that are visible to application level software include:

- The BKPT instruction causes a BKPT instruction debug event to occur, see [BKPT on page F7-2575](#).
- The DBG instruction provides a hint to the debug system.

Chapter E2

The AArch32 Application Level Memory Model

This chapter gives an application level description of the memory model for software executing in AArch32 state. This means it describes the memory model for execution in EL0 when EL0 is using AArch32 in the following sections:

- [Address space](#) on page E2-2334.
- [Memory type overview](#) on page E2-2336.
- [Caches and memory hierarchy](#) on page E2-2337.
- [Alignment support](#) on page E2-2341.
- [Endian support](#) on page E2-2343.
- [Atomicity in the ARM architecture](#) on page E2-2346.
- [Memory ordering](#) on page E2-2350.
- [Memory types and attributes](#) on page E2-2357.
- [Mismatched memory attributes](#) on page E2-2366.
- [Synchronization and semaphores](#) on page E2-2369

Note

In this chapter, system register names usually link to the description of the register in [Chapter G4 AArch32 System Register Descriptions](#), for example [SCTLR](#).

E2.1 Address space

Address calculations are performed using 32-bit registers. Supervisory software determines the valid address range.

Attempting to access an address that is not valid generates an MMU fault.

Address calculations are performed modulo 2^{32} .

The result of an address calculation is UNKNOWN if it overflows or underflows the 32-bit address range A[31:0].

Memory accesses use the MemA[], MemU[], and MemU_unpriv[] functions:

- The MemA[] function makes an aligned access of the required type.
- The MemU[] function makes an unaligned access of the required type
- The MemU_unpriv[] function makes an unaligned, unprivileged access of the required type.

```
// MemA[] - non-assignment form
// =====

bits(8*size) MemA[bits(32) address, integer size]
    acctype = AccType_ATOMIC;
    return MemU_with_type[address, size, acctype];

// MemA[] - assignment form
// =====

MemA[bits(32) address, integer size] = bits(8*size) value
    acctype = AccType_ATOMIC;
    MemU_with_type[address, size, acctype] = value;
    return;

// MemU[] - non-assignment form
// =====

bits(8*size) MemU[bits(32) address, integer size]
    acctype = AccType_NORMAL;
    return MemU_with_type[address, size, acctype];

// MemU[] - assignment form
// =====

MemU[bits(32) address, integer size] = bits(8*size) value
    acctype = AccType_NORMAL;
    MemU_with_type[address, size, acctype] = value;
    return;

// MemU_unpriv[] - non-assignment form
// =====

bits(8*size) MemU_unpriv[bits(32) address, integer size]
    acctype = AccType_UNPRIV;
    return MemU_with_type[address, size, acctype];

// MemU_unpriv[] - assignment form
// =====

MemU_unpriv[bits(32) address, integer size] = bits(8*size) value
    acctype = AccType_UNPRIV;
    MemU_with_type[address, size, acctype] = value;
    return;
```

The AccType enumeration defines the different access types:

```
enumeration AccType {AccType_NORMAL, AccType_VEC,          // Normal loads and stores
                    AccType_STREAM, AccType_VECSTREAM,    // Streaming loads and stores
                    AccType_ATOMIC,                       // Atomic loads and stores
                    AccType_ORDERED,                      // Load-Acquire and Store-Release
                    AccType_UNPRIV,                      // Load and store unprivileged
                    AccType_IFETCH,                      // Instruction fetch
                    AccType_PTW,                         // Page table walk
                    // Other operations
                    AccType_DC,                          // Data cache maintenance
                    AccType_IC,                          // Instruction cache maintenance
                    AccType_AT};                          // Address translation
```

Note

- [Chapter G2 The AArch32 System Level Memory Model](#) and [Chapter G3 The AArch32 Virtual Memory System Architecture](#) include descriptions of memory system features that are transparent to the application, including memory access, address translation, memory maintenance instructions, and alignment checking and the associated fault handling. These chapters also include pseudocode descriptions of these operations.
 - For information on the pseudocode that relates to memory accesses, see [Basic memory access on page G2-3550](#), [Unaligned memory access on page G2-3551](#), and [Aligned memory access on page G2-3550](#).
-

E2.2 Memory type overview

ARMv8 provides the following mutually-exclusive memory types:

- Normal** This is generally used for bulk memory operations, both read-write and read-only operations.
- Device** The ARM architecture forbids speculative reads of any type of Device memory. This means Device memory types are suitable attributes for read-sensitive locations.
- Locations of the memory map that are assigned to peripherals are usually assigned the Device memory attribute.
- Device memory has additional attributes that have the following effects:
- They prevent aggregation of reads and writes, maintaining the number and size of the specified memory accesses. See [Gathering](#) on page E2-2362.
 - They preserve the access order and synchronization requirements, both for accesses to a single peripheral and where there is a synchronization requirement on the observability of one or more memory write and read accesses. See [Reordering](#) on page E2-2363
 - They indicate whether a write can be acknowledged other than at the end point. See [Early Write Acknowledgement](#) on page E2-2364.
- For more information on Normal memory and Device memory, see [Memory types and attributes](#) on page E2-2357.

Note

Earlier versions of the ARM architecture defined a single Device memory type and a Strongly-Ordered memory type. A Note in [Device memory](#) on page E2-2360 describes how these memory types map onto the ARMv8 memory types.

E2.3 Caches and memory hierarchy

The implementation of a memory system depends heavily on the microarchitecture and therefore many details of the memory system are IMPLEMENTATION DEFINED. ARMv8 defines the application level interface to the memory system, including a hierarchical memory system with multiple levels of cache. This section describes an application level view of this system. It contains the subsections:

- [Introduction to caches.](#)
- [Memory hierarchy.](#)
- [Implication of caches for the application programmer on page E2-2339.](#)
- [Preloading caches on page E2-2340.](#)

E2.3.1 Introduction to caches

A cache is a block of high-speed memory that contains a number of entries, each consisting of:

- Main memory address information, commonly known as a *tag*.
- The associated data.

Caches increase the average speed of a memory access and take account of two principles of locality:

Spatial locality

An access to one location is likely to be followed by accesses to adjacent locations. Examples of this principle are:

- Sequential instruction execution.
- Accessing a data structure.

Temporal locality

An access to an area of memory is likely to be repeated in a short time period. An example of this principle is the execution of a software loop.

To minimize the quantity of control information stored, the spatial locality property groups several locations together under the same tag. This logical block is commonly known as a *cache line*. When data is loaded into a cache, access times for subsequent loads and stores are reduced, resulting in overall performance benefits. An access to information already in a cache is known as a *cache hit*, and other accesses are called *cache misses*.

Normally, caches are self-managing, with the updates occurring automatically. Whenever the PE accesses a cacheable memory location, the cache is checked. If the access is a cache hit, the access occurs in the cache. Otherwise, the access is made to memory. Typically, when making this access, a cache location is allocated and the cache line loaded from memory. ARMv8 permits different cache topologies and access policies, provided they comply with the memory coherency model described in this manual.

Caches introduce a number of potential problems, mainly because:

- Memory accesses can occur at times other than when the programmer would expect them.
- A data item can be held in multiple physical locations.

E2.3.2 Memory hierarchy

Typically memory close to a PE has very low latency, but is limited in size and expensive to implement. Further from the PE it is common to implement larger blocks of memory but these have increased latency. To optimize overall performance, an ARMv8 memory system can include multiple levels of cache in a hierarchical memory system that exploits this trade-off between size and latency. [Figure E2-1 on page E2-2338](#) shows an example of such a system in an ARMv8-A system that supports virtual addressing.

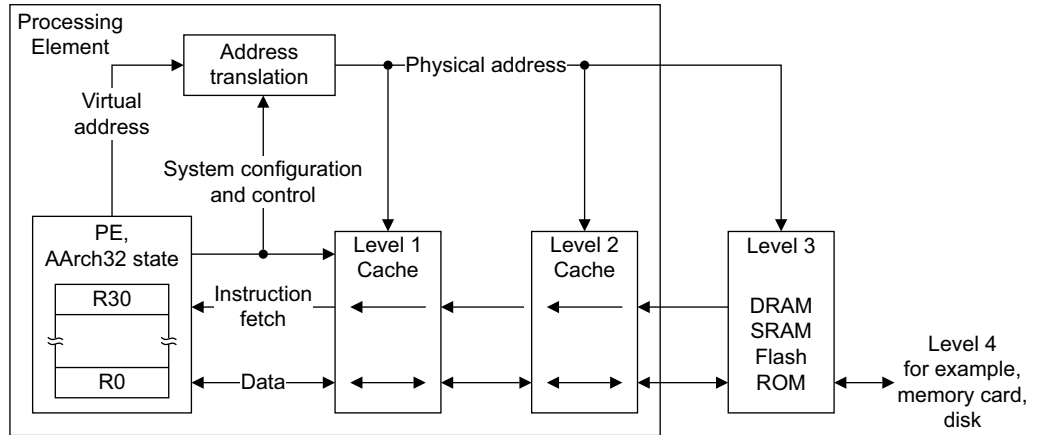

Figure E2-1 Multiple levels of cache in a memory hierarchy

Note

In this manual, in a hierarchical memory system, Level 1 refers to the level closest to the PE, as shown in [Figure E2-1](#).

Instructions and data can be held in separate caches or in a unified cache. A cache hierarchy can have one or more levels of separate instruction and data caches, with one or more unified caches located at the levels closest to the main memory. Memory coherency for cache topologies can be defined by two conceptual points:

Point of Unification (PoU)

The point at which the instruction cache, data cache, and translation table walks of a particular PE are guaranteed to see the same copy of a memory location. In many cases, the point of unification is the point in a uniprocessor memory system by which the instruction and data caches and the translation table walks have merged. The point of unification might coincide with the point of coherency.

Point of Coherency (PoC)

The point at which all agents that can access memory are guaranteed to see the same copy of a memory location. In many cases this is effectively the main system memory, although the architecture does not prohibit the implementation of caches beyond the PoC that have no effect on the coherency between memory system agents.

See also [The ARMv8 cache maintenance functionality on page G2-3529](#).

The cacheability and shareability memory attributes

Cacheability and shareability are two attributes that describe the memory hierarchy in a multiprocessing system:

Cacheability This term defines whether memory locations are allowed to be allocated into a cache or not. Cacheability can be defined independently for Inner and Outer cacheability locations.

Shareability This term defines whether memory locations are shareable between different agents in a system. Marking a memory location as shareable for a particular domain requires hardware to ensure that the location is coherent for all agents in that domain. Shareability can be defined independently for Inner and Outer shareability domains.

- For more information about cacheability and shareability see [Memory types and attributes on page E2-2357](#).

E2.3.3 Implication of caches for the application programmer

In normal operation, the caches are largely invisible to the application programmer. However they can become visible when there is a breakdown in the coherency of the caches. Such a breakdown can occur:

- When memory locations are updated by other agents in the system that do not use hardware management of coherency.
- When memory updates made from the application software must be made visible to other agents in the system, without the use of hardware management of coherency.

For example:

- In the absence of hardware management of coherency of DMA accesses, in a system with a DMA controller that reads memory locations that are held in the data cache of a PE, a breakdown of coherency occurs when the PE has written new data in the data cache, but the DMA controller reads the old data held in memory.
- In a Harvard cache implementation, where there are separate instruction and data caches, a breakdown of coherency occurs when new instruction data has been written into the data cache, but the instruction cache still contains the old instruction data.

Data coherency issues

Software can ensure the data coherency of caches in the following ways:

- By not using the caches in situations where coherency issues can arise. This can be achieved by:
 - Using Non-cacheable or, in some cases, Write-Through Cacheable memory.
 - Not enabling caches in the system.
- By using system calls to functions using cache maintenance instructions that execute at a higher Exception level.
- By using hardware coherency mechanisms to ensure the coherency of data accesses to memory for cacheable locations by observers within the different shareability domains, see [Non-shareable Normal memory on page E2-2359](#) and [Shareable, Inner Shareable, and Outer Shareable Normal memory on page E2-2358](#).

———— **Note** —————

The performance of these hardware coherency mechanisms is highly implementation-specific. In some implementations the mechanism suppresses the ability to cache shareable locations. In other implementations, cache coherency hardware can hold data in caches while managing coherency between observers within the shareability domains.

Synchronization and coherency issues between data and instruction accesses

How far ahead of the current point of execution instructions are fetched from is IMPLEMENTATION DEFINED. Such prefetching can be either a fixed or a dynamically varying number of instructions, and can follow any or all possible future execution paths. For all types of memory:

- The PE might have fetched the instructions from memory at any time since the last [Context synchronization operation](#) on that PE.
- Any instructions fetched in this way might be executed multiple times, if this is required by the execution of the program, without being re-fetched from memory.

The ARM architecture does not require the hardware to ensure coherency between instruction caches and memory, even for locations of shared memory. This means that for cacheable locations of memory, an instruction cache can hold instructions that were fetched from memory before any [Context synchronization operation](#).

If software requires coherency between instruction execution and memory, it must manage this coherency using the ISB and DSB memory barriers and cache maintenance instructions. These can only be accessed from an Exception level that is higher than EL0, and therefore require a system call, see [Exception-generating and exception-handling instructions on page F1-2396](#). The following code sequence can then be used:

```
; Coherency example for data and instruction accesses within the same Inner Shareable domain.  
; Enter this code with <Rt> containing a new 32-bit instruction,  
; to be held in non-cacheable space at a location pointed to by Rn.  
STR Rt, [Rn]  
DC CMVAU Rn      ; Clean data cache by MVA to point of unification (PoU)  
DSB              ; Ensure visibility of the data cleaned from cache  
IC IMVAU Rn     ; Invalidate instruction cache by MVA to PoU  
BPIMVAU Rn     ; Invalidate branch predictor by MVA to PoU  
DSB              ; Ensure completion of the invalidations  
ISB              ; Synchronize the fetched instruction stream
```

E2.3.4 Preloading caches

The ARM architecture provides the memory system hints PLD (Preload Data), PLDW (Preload Data With Intent To Write) and PLI (Preload Instruction) that software can use to communicate the expected use of memory locations to the hardware. The memory system can respond by taking actions that are expected to speed up the memory accesses if they occur. The effect of these memory system hints is IMPLEMENTATION DEFINED. Typically, implementations use this information to bring data or instruction locations into caches.

The Preload instructions are hints, and so implementations can treat them as NOPs without affecting the functional behavior of the device. The instructions cannot generate synchronous Data Abort exceptions, but the resulting memory system operations might, under exceptional circumstances, generate an asynchronous external abort, which is taken using an asynchronous Data Abort exception. For more information, see [Data Abort exception on page G1-3483](#).

A PLD or PLDW instruction is guaranteed not to cause any effects to the caches, or TLB, or memory, other than the effects that, for permission or other reasons, can be caused by the equivalent load from the same location with same context and at the same Exception level.

A PLD or PLDW instruction is guaranteed not to access Device memory.

A PLI instruction is guaranteed not to cause any effect to the caches, or TLB, or memory, other than the effect that, for permission or other reasons, can be caused by the fetch resulting from changing the PC to the location specified by the PLI instruction with the same context and at the same Exception level.

A PLI instruction must not perform any access that might be performed by a speculative instruction fetch by the PE. Therefore:

- A PLI instruction cannot access memory that has a Device attribute.
- If all associated MMUs are disabled, a PLI instruction cannot access any memory location that cannot be accessed by the instruction fetches.

PrefetchHint{} defines the prefetch hint types:

```
enumeration PrefetchHint {Prefetch_READ, Prefetch_WRITE, Prefetch_EXEC};
```

The Hint_Prefetch() function signals to the memory system that memory accesses of the type hint to or from the specified address are likely to occur in the near future. The memory system might take some action to speed-up the memory accesses when they do occur, such as preloading the specified address into one or more caches as indicated by the innermost cache level target and non-temporal hint stream.

```
Hint_Prefetch(bits(64) address, PrefetchHint hint, integer target, boolean stream);
```

For more information on PLD, PLI, and PLDW, see:

- [PLD, PLDW \(immediate\) on page F7-2746](#).
- [PLD \(literal\) on page F7-2748](#).
- [PLD, PLDW \(register\) on page F7-2750](#).
- [PLI \(immediate, literal\) on page F7-2752](#).
- [PLI \(register\) on page F7-2754](#).

E2.4 Alignment support

This section describes alignment support. It contains the following subsections:

- [Instruction alignment.](#)
- [Unaligned data access.](#)
- [Cases where unaligned accesses are UNPREDICTABLE.](#)
- [Unaligned data access restrictions on page E2-2342.](#)

E2.4.1 Instruction alignment

A32 instructions are word-aligned.

T32 instruction are halfword-aligned.

E2.4.2 Unaligned data access

An ARMv8 implementation must support unaligned data accesses by some load and store instructions, as [Table E2-1](#) shows. Software can set [SCTLR.A](#) or [HSCTLR.A](#) to control whether a misaligned access by one of these instructions causes an Alignment fault Data Abort exception.

Table E2-1 Alignment requirements of load/store instructions

Instructions	Alignment check	Result if check fails when:	
		SCTLR.A/HSCTLR.A is 0	SCTLR.A/HSCTLR.A is 1
LDRB, LDREXB, LDRBT, LDRSB, LDRSBT, STRB, STREXB, STRBT, TBB	None	-	-
LDRH, LDRHT, LDRSH, LDRSHT, STRH, STRHT, TBH	Halfword	Unaligned access	Alignment fault
LDREXH, STREXH	Halfword	Alignment fault	Alignment fault
LDR, LDRT, STR, STRT PUSH, encodings T3 and A2 only POP, encodings T3 and A2 only	Word	Unaligned access	Alignment fault
LDREX, STREX	Word	Alignment fault	Alignment fault
LDREXD, STREXD	Doubleword	Alignment fault	Alignment fault
All forms of LDM and STM, LDRD, RFE, SRS, STRD	Word	Alignment fault	Alignment fault
LDC, LDC2, STC, STC2	Word	Alignment fault	Alignment fault
VLDM, VLDR, VPOP, VPUSH, VSTM, VSTR	Word	Alignment fault	Alignment fault
VLD1, VLD2, VLD3, VLD4, VST1, VST2, VST3, VST4, all with standard alignment	Element size	Unaligned access	Alignment fault
VLD1, VLD2, VLD3, VLD4, VST1, VST2, VST3, VST4, all with :<align> specified ^a	As specified by :<align>	Alignment fault	Alignment fault

a. Previous versions of this document used @<align> to specify alignment. Both forms are supported, see [Chapter F8 T32 and A32 Advanced SIMD and floating-point Instruction Descriptions](#) for more information.

E2.4.3 Cases where unaligned accesses are UNPREDICTABLE

Any load instruction that is not faulted by the alignment restrictions shown in [Table E2-1](#) and that loads the PC has UNPREDICTABLE behavior if the address it loads from is not word-aligned. This overrules any permitted Load/Store behavior shown in [Table E2-1](#).

———— **Note** —————

- An unaligned access to Device memory generates an Alignment fault, see [Alignment faults on page G3-3654](#).
- [Device memory on page E2-2360](#) describes the Device memory attributes.

E2.4.4 Unaligned data access restrictions

The following points apply to unaligned data accesses in ARMv8:

- Accesses are not guaranteed to be single-copy atomic except at the byte access level, see [Atomicity in the ARM architecture on page E2-2346](#).
- Unaligned accesses typically takes a number of additional cycles to complete compared to a naturally-aligned access.
- An operation that performs an unaligned access can abort on any memory access that it makes, and can abort on more than one access. This means that an unaligned access that occurs across a page boundary can generate an abort on either side of the boundary.

E2.5 Endian support

General description of endianness in the ARM architecture describes the relationship between endianness and memory addressing in the ARM architecture.

The following subsections then describe the endianness schemes supported by the architecture:

- *Instruction endianness.*
- *Data endianness on page E2-2344.*

E2.5.1 General description of endianness in the ARM architecture

This section only describes memory addressing and the effects of endianness for data elements up to doubleword of 64 bits. However, this description can be extended to apply to larger data elements.

For an address A, [Figure E2-2](#) shows, for big-endian and little-endian memory systems, the relationship between:

- The doubleword at address A.
- The words at addresses A and A+4.
- The halfwords at addresses A, A+2, A+4, and A+6.
- The bytes at addresses A, A+1, A+2, A+3, A+4, A+5, A+6, and A+7.

The terms in [Figure E2-2](#) have the following definitions:

MSByte Most-significant byte.

LSByte Least-significant byte.

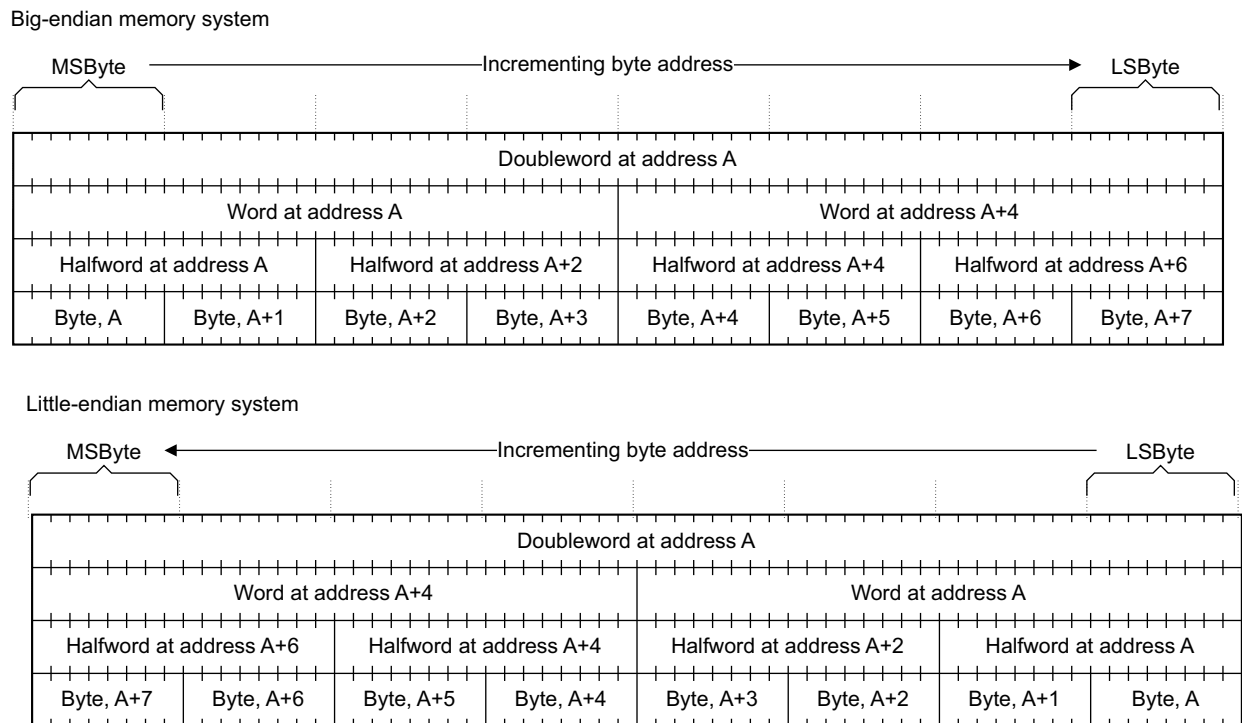

In this figure, *Byte, A+1* is an abbreviation for *Byte at address A+1*

Figure E2-2 Endianness relationships in AArch32

E2.5.2 Instruction endianness

In ARMv8-A, the mapping of instruction memory is always little-endian.

E2.5.3 Data endianness

The size of the data value that is loaded or stored is the size that is used for the purpose of endian conversion for floating-point, Advanced SIMD, and general-purpose register loads and stores.

Table E2-2 shows the element sizes of all the load/store instructions, for all instruction sets.

Table E2-2 Element size of load/store instructions

Instructions	Element size
LDRB, LDREXB, LDRBT, LDRSB, LDRSBT, STRB, STREXB, STRBT, TBB	Byte
LDRH, LDREXH, LDRHT, LDRSH, LDRSHT, STRH, STREXH, STRHT, TBH	Halfword
LDR, LDRT, LDREX, STR, STRT, STREX	Word
LDRD, LDREXD, STRD, STREXD	Word
All forms of LDM, PUSH, POP, RFE, SRS, all forms of STM,	Word
LDC, LDC2, STC, STC2	Word
Forms of VLDM, VLDR, VPOP, VPUSH, VSTM, VSTR that transfer 32-bit Si registers	Word
Forms of VLDM, VLDR, VPOP, VPUSH, VSTM, VSTR that transfer 64-bit Di registers	Doubleword
VLD1, VLD2, VLD3, VLD4, VST1, VST2, VST3, VST4	Element size of the Advanced SIMD access

CPSR.E determines the data endianness.

The data size used for endianness conversions:

- Is the size of the data value that is loaded or stored for SIMD and floating-point register and general-purpose register loads and stores.
- Is the size of the data element that is loaded or stored for SIMD element and data structure loads and stores. For more information see [Endianness in SIMD on page E2-2345](#).

Instructions to reverse bytes in a general-purpose register or Advanced SIMD register

An application or device driver might have to interface to memory-mapped peripheral registers or shared memory structures that are not the same endianness as the internal data structures. Similarly, the endianness of the operating system might not match that of the peripheral registers or shared memory. In these cases, the PE requires an efficient method to transform explicitly the endianness of the data.

Table E2-3 shows the instructions that provide this functionality A32, and T32 instruction sets:

Table E2-3 Byte reversal instructions

Function	T32 / A32 Instruction	Notes
Reverse bytes in whole register	REV	For use with general purpose registers.
Reverse bytes in 16-bit halfwords	REV16	For use with general purpose registers.
Reverse bytes in halfword and sign-extend	REVSH	For use with general purpose registers.
Reverse elements in doublewords, vector	VREV64	For use with SIMD and floating-point registers
Reverse elements in words, vector	VREV32	For use with SIMD and floating-point registers
Reverse elements in halfwords, vector	VREV16	For use with SIMD and floating-point registers

Endianness in SIMD

Advanced SIMD element Load/Store instructions transfer vectors of elements between memory and the Advanced SIMD register file. An instruction specifies both the length of the transfer and the size of the data elements being transferred. This information is used by the PE to load and store data correctly in both big-endian and little-endian systems.

Consider, for example, the A32 or T32 instruction:

```
VLD1.16 {D0}, [R1]
```

This loads a 64-bit register with four 16-bit values. The four elements appear in the register in array order, with the lowest indexed element fetched from the lowest address. The order of bytes in the elements depends on the endianness configuration, as shown in Figure E2-3. Therefore, the order of the elements in the registers is the same regardless of the endianness configuration.

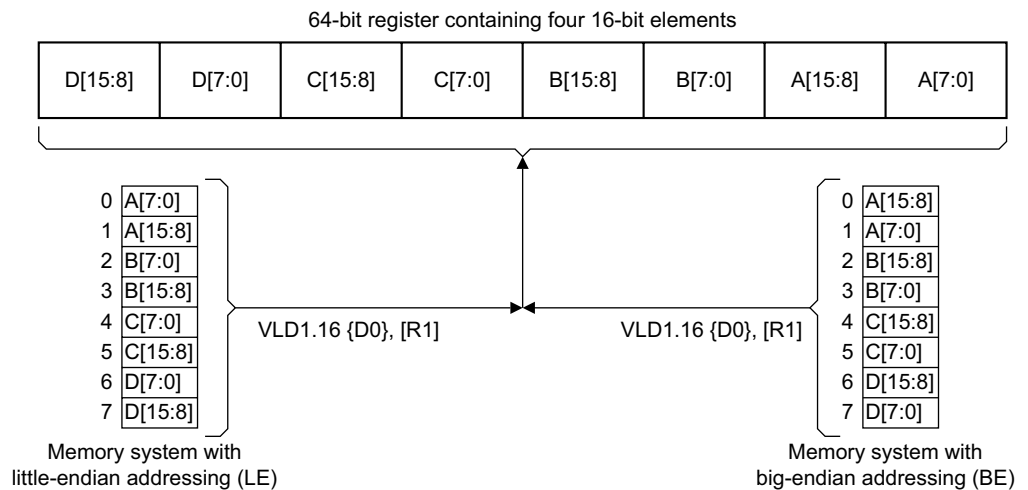

Figure E2-3 Advanced SIMD byte order example for AArch32

For information about the alignment of Advanced SIMD instructions see [Alignment support on page E2-2341](#).

The `BigEndian()` function determines the current endianness of the data:

```
boolean BigEndian();
```

The pseudocode function for `BigEndianReverse()` is as follows:

```
// BigEndianReverse()
// =====

bits(width) BigEndianReverse (bits(width) value)
    assert width IN {8, 16, 32, 64, 128};
    integer half = width DIV 2;
    if width == 8 then return value;
    return BigEndianReverse(value<half-1:0>) : BigEndianReverse(value<width-1:half>);
```

E2.6 Atomicity in the ARM architecture

Atomicity is a feature of memory accesses, described as *atomic* accesses. The ARM architecture description refers to two types of atomicity, defined in:

- [Single-copy atomicity](#).
- [Multi-copy atomicity on page E2-2347](#).

In the ARMv8 architecture, the atomicity requirements for memory accesses depends on the memory type, and whether the access is explicit or implicit. For more information, see:

- [Memory type overview on page E2-2336](#).
- [Requirements for single-copy atomicity](#).
- [Requirements for multi-copy atomicity on page E2-2348](#).

E2.6.1 Single-copy atomicity

A read or write operation is *single-copy atomic* if the following conditions are both true:

- After any number of write operations to a memory location, the value of the memory location is the value written by one of the write operations. It is impossible for part of the value of the memory location to come from one write operation and another part of the value to come from a different write operation.
- When a read operation and a write operation are made to the same memory location, the value obtained by the read operation is one of:
 - The value of the memory location before the write operation.
 - The value of the memory location after the write operation.

It is never the case that the value of the read operation is partly the value of the memory location before the write operation and partly the value of the memory location after the write operation.

E2.6.2 Requirements for single-copy atomicity

In AArch32 state, the single-copy atomic PE accesses are:

- All byte accesses.
- All halfword accesses to halfword-aligned locations.
- All word accesses to word-aligned locations.
- Memory accesses caused by LDREXD and STREXD instructions to doubleword-aligned locations.

LDM, LDC, LDC2, LDRD, STM, STC, STC2, STRD, PUSH, POP, RFE, SRS, VLDM, VLDR, VSTM, and VSTR instructions are executed as a sequence of word-aligned word accesses. Each 32-bit word access is guaranteed to be single-copy atomic. The architecture does not require subsequences of two or more word accesses from the sequence to be single-copy atomic.

LDRD and STRD accesses to 64-bit aligned locations are 64-bit single-copy atomic as seen by translation table walks and accesses to translation tables.

———— **Note** —————

This requirement has been added to avoid the need for complex measures to avoid atomicity issues when changing translation table entries, without creating a requirement that all locations in the memory system are 64-bit single-copy atomic. This addition means:

- The system designer must ensure that all writable memory locations that might be used to hold translations, such as bulk SDRAM, can be accessed with 64-bit single-copy atomicity.
- Software must ensure that translation tables are not held in memory locations that cannot meet this atomicity requirement, such as peripherals that are typically accessed using a narrow bus.

This requirement places no burden on read-only memory locations for which reads have no side effects, since it is impossible to detect the size of memory accesses to such locations.

Advanced SIMD element and structure loads and stores are executed as a sequence of accesses of the element or structure size. The architecture requires the element accesses to be single-copy atomic if and only if both:

- The element size is 32 bits, or smaller.
- The elements are naturally aligned.

Accesses to 64-bit elements or structures that are at least word-aligned are executed as a sequence of 32-bit accesses, each of which is single-copy atomic. The architecture does not require subsequences of two or more 32-bit accesses from the sequence to be single-copy atomic.

When a store that, by the rules given in this section, would be single-copy atomic is made to a memory location at a time when there is at least one store to the same memory location that has not completed and that would be single-copy atomic at a different size, then the architecture does not give any assurance of atomicity between accesses to the bytes of that location.

When an access is not single-copy atomic, it is executed as a sequence of smaller accesses, each of which is single-copy atomic, at least at the byte level.

———— **Note** —————

In this section, the terms *before the write operation* and *after the write operation* mean before or after the write operation has had its effect on the coherence order of the bytes of the memory location accessed by the write operation.

If, according to these rules, an instruction is executed as a sequence of accesses, a synchronous Data Abort exception can be taken during that sequence. This causes execution of the instruction to be abandoned.

If the synchronous Data Abort exception is returned from using the preferred return address, the instruction that generated the sequence of accesses is re-executed and so any access that was performed before the exception was taken is repeated.

———— **Note** —————

The exception behavior for these multiple access instructions means they are not suitable for use for writes to memory for the purpose of software synchronization.

For implicit accesses:

- Cache linefills and evictions have no effect on the single-copy atomicity of explicit transactions or instruction fetches.
- Instruction fetches are single-copy atomic:
 - At 32-bit granularity in A32 state.
 - At 16-bit granularity in T32 state.
- [Concurrent modification and execution of instructions on page E2-2348](#) describes additional constraints on the behavior of instruction fetches.
- Translation table walks are performed using accesses that are single-copy atomic:
 - At 32-bit granularity when using Short-descriptor format translation tables.
 - At 64-bit granularity when using Long-descriptor format translation tables.

E2.6.3 Multi-copy atomicity

In a multiprocessing system, writes to a memory location are *multi-copy atomic* if the following conditions are both true:

- All writes to the same location are *serialized*, meaning they are observed in the same order by all observers, although some observers might not observe all of the writes.
- A read of a location does not return the value of a write until all observers observe that write.

———— **Note** —————

Writes that are not coherent are not multi-copy atomic.

E2.6.4 Requirements for multi-copy atomicity

For Normal memory, writes are not required to be multi-copy atomic.

For Device memory with the non-Gathering attribute, writes that are single-copy atomic are also multi-copy atomic.

For Device memory with the Gathering attribute, writes are not required to be multi-copy atomic.

E2.6.5 Concurrent modification and execution of instructions

The ARMv8 architecture limits the set of instructions that can be executed by one thread of execution as they are being modified by another thread of execution without requiring explicit synchronization.

Concurrent modification and execution of instructions can lead to the resulting instruction performing any behavior that can be achieved by executing any sequence of instructions that can be executed from the same Exception level, except where the instruction before modification or the instruction after modification is a:

- B, BL, NOP, BKPT, SVC, HVC, or SMC A32 instruction
- B, BL, BLX, NOP, BKPT, or SVC 16-bit T32 instruction.

In addition, for the T32 instructions:

- The most-significant halfword of a 32-bit BL immediate instruction can be concurrently modified to the most significant halfword of another BL immediate instruction:
 - This means that the most significant bits of the immediate value can be modified.
- The most-significant halfword of a 32-bit BLX immediate instruction can be concurrently modified to the most significant halfword of another BLX immediate instruction:
 - This means that the most significant bits of the immediate value can be modified.
- The most-significant halfword of a 32-bit BL immediate or BLX immediate instruction can be concurrently modified to a T32 16-bit B, BL, BLX, BKPT, or SVC instruction. This modification also works in reverse.
- The least-significant halfword of a 32-bit BL immediate instruction can be concurrently modified to the least significant halfword of another BL instruction with a different immediate:
 - This means that the least significant bits of the immediate value can be modified.
- The least-significant halfword of a 32-bit BLX immediate instruction can be concurrently modified to the least significant halfword of another BLX immediate instruction with a different immediate:
 - This means that the least significant bits of the immediate value can be modified.
- The least-significant halfword of a 32-bit B immediate instruction with a condition field can be concurrently modified to the least significant halfword of another 32-bit B immediate instruction with a condition field with a different immediate:
 - This means that the least significant bits of the immediate value can be modified.
- The least-significant halfword of a 32-bit B immediate instruction without a condition field can be concurrently modified to the least significant halfword of another 32-bit B immediate instruction without a condition field:
 - This means that the least significant bits of the immediate value can be modified.

———— **Note** —————

In the T32 instruction set:

- The only encodings of BKPT and SVC are 16-bit.
 - The only encoding of BL is 32-bit.
-

For instructions listed in this section the architecture guarantees that after modification of the instruction, behavior is consistent with execution of either:

- The instruction originally fetched.
- A fetch of the modified instruction.

If one thread of execution changes a conditional branch instruction, such as B or BL, to another conditional instruction and the change affects both the condition field and the branch target, execution of the changed instruction by another thread of execution before the change is synchronized can lead to either:

- The old condition being associated with the new target address.
- The new condition being associated with the old target address.

For more information about the required synchronization operation, see [Synchronization and coherency issues between data and instruction accesses](#) on page E2-2339.

These possibilities apply regardless of whether the condition, either before or after the change to the branch instruction, is the always condition.

———— **Note** —————

For information about memory accesses caused by instruction fetches, see [Ordering requirements](#) on page E2-2351.

E2.7 Memory ordering

This section describes observation ordering. It contains the following subsections:

- [Observability and completion.](#)
- [Ordering requirements on page E2-2351.](#)
- [Memory barriers on page E2-2352.](#)

For information on endpoint ordering of memory accesses, see [Reordering on page E2-2363.](#)

In the ARMv8 memory model, the shareability memory attribute indicates whether hardware must ensure memory coherency.

The ARMv8 memory system architecture defines additional attributes and associated behaviors, defined in the system level section of this manual. See:

- [Chapter G2 The AArch32 System Level Memory Model.](#)
- [Chapter G3 The AArch32 Virtual Memory System Architecture.](#)

See also [Mismatched memory attributes on page E2-2366.](#)

E2.7.1 Observability and completion

An *observer* is a master in the system that is capable of observing memory accesses. For a PE, the following mechanisms must be treated as independent observers:

- The mechanism that performs reads or writes to memory.
- A mechanism that causes an instruction cache to be filled from memory or that fetches instructions to be executed directly from memory. These are treated as reads.
- A mechanism that performs translation table walks. These are treated as reads.

The set of observers that can observe a memory access is defined by the system.

In the definitions in this subsection, *subsequent* means whichever of the following is appropriate to the context:

- After the point in time where the location is observed by that observer.
- After the point in time where the location is globally observed.

For all memory:

- A write to a location in memory is said to be *observed* by an observer when:
 - A subsequent read of the location by the same observer returns the value written by the observed write, or written by a write to that location by any observer that is sequenced in the *Coherence order* of the location after the observed write.
 - A subsequent write of the location by the same observer is sequenced in the *Coherence order* of the location after the observed write.
- A write to a location in memory is said to be *globally observed* for a shareability domain or set of observers when:
 - A subsequent read of the location by any observer in that shareability domain returns the value written by the globally observed write, or written by a write to that location by any observer that is sequenced in the *Coherence order* of the location after the globally observed write.
 - A subsequent write of the location by any observer in that shareability domain is sequenced in the *Coherence order* of the location after the globally observed write.
- A read of a location in memory is said to be observed by an observer when a subsequent write to the location by the same observer has no effect on the value returned by the read.
- A read of a location in memory is said to be globally observed for a shareability domain when a subsequent write to the location by any observer in that shareability domain has no effect on the value returned by the read.

Additionally, for Device-nGnRnE memory:

- A read or write of a memory-mapped location in a peripheral that exhibits side-effects is said to be observed, and globally observed, only when the read or write:
 - Meets the general conditions listed.
 - Can begin to affect the state of the memory-mapped peripheral.
 - Can trigger all associated side-effects, whether they affect other peripheral devices, processors, or memory.

———— **Note** —————

This definition is consistent with the memory access having reached the peripheral.

For all memory, the completion rules are defined as:

- A read or write is complete for a shareability domain when all of the following are true:
 - The read or write is globally observed for that shareability domain.
 - Any translation table walks associated with the read or write are complete for that shareability domain.
- A translation table walk is complete for a shareability domain when the memory accesses associated with the translation table walk are globally observed for that shareability domain, and the TLB is updated.
- A cache or TLB maintenance instruction is complete for a shareability domain when the effects of the instruction are globally observed for that shareability domain, and any translation table walks that arise from the instruction are complete for that shareability domain.

The completion of any cache or TLB maintenance instruction includes its completion on all processors that are affected by both the instruction and the DSB operation that is required to guarantee visibility of the maintenance instruction.

Completion of side-effects of accesses to Device memory

The completion of a memory access to Device memory other than Device-nGnRnE is not guaranteed to be sufficient to determine that the side-effects of the memory access are visible to all observers. The mechanism that ensures the visibility of side-effects of a memory access is IMPLEMENTATION DEFINED.

E2.7.2 Ordering requirements

- ARMv8 defines restrictions for the permitted ordering of memory accesses. These restrictions depend on the memory locations that are being accessed. See [Memory types and attributes on page E2-2357](#).

The following additional restrictions apply to the order in which accesses to Normal memory are observed:

- Reads and writes can be observed in any order provided the following constraints are met:
 - If an address dependency exists between two reads or between a read and a write, then those memory accesses are observed in program order by all observers within the shareability domain of the memory address being accessed.
 - Writes that would not occur in a simple sequential execution of the program cannot be observed by other observers. This implies that where a control, address or data dependency exists between a read and a write, those memory accesses are observed in program order by all observers within the shareability domain of the memory addresses being accessed.
 - Ordering can be achieved by using a DMB or DSB barrier. For more information on DMB and DSB instructions, see [Memory barriers on page E2-2352](#).
- Reads and writes to the same location are coherent within the shareability domain of the memory address being accessed.
- Two reads of the same location by the same observer are observed in program order by all observers within the shareability domain of the memory address being accessed.

- Writes are not required to be multi-copy atomic. This means that in the absence of barriers, the observation of a store by one observer does not imply the observation of the store by another observer.
- Instructions that access multiple elements have no defined ordering requirements for the memory accesses relative to each other.

Memory accesses caused by instruction fetches are not required to be observed in program order, unless they are separated by an ISB or other context synchronization event.

Address dependencies and order

In the ARMv8 architecture, a register data dependency creates order between a load instruction and a subsequent memory transaction, that is between the data value returned from the load and the address used by the subsequent memory transaction.

A register data dependency exists between a first data value and a second data value exists when either:

- The register used to hold the first data value is used in the calculation of the second data value, and the calculation between the first data value and the second data value does not consist of either:
 - A conditional branch whose condition is determined by the first data value.
 - A conditional selection, move, or computation whose condition is determined by the first data value, where the input data values for the selection, move, or computation do not have a data dependency on the first data value.
- There is a register data dependency between the first data value and a third data value, and between the third data value and the second data value.

————— **Note** —————

A register data dependency can exist even if the value of the first data value is discarded as part of the calculation, as might be the case if it is ANDed with $0x0$ or if arithmetic using the first data value cancels out its contribution.

For example, each of the following code snippets exhibits order between the memory transactions:

1. LDR R1, [R2]
AND R1, R1, #0
LDR R4, [R3, R1]
2. LDR R1, [R2]
ADD R3, R3, R1
SUB R3, R3, R1
STR R4, [R3]

E2.7.3 Memory barriers

The ARM architecture is a weakly ordered memory architecture that supports out of order completion. *Memory barrier* is the general term applied to an instruction, or sequence of instructions, that forces synchronization events by a PE with respect to retiring Load/Store instructions. The memory barriers defined by the ARMv8 architecture provide a range of functionality, including:

- Ordering of Load/Store instructions.
- Completion of Load/Store instructions.
- Context synchronization.

The following subsections describe the ARMv8 memory barrier instructions:

- [Instruction Synchronization Barrier \(ISB\) on page E2-2353.](#)
- [Data Memory Barrier \(DMB\) on page E2-2353.](#)
- [Data Synchronization Barrier \(DSB\) on page E2-2354.](#)
- [Shareability and access limitations on the data barrier operations on page E2-2355.](#)
- [Load-Acquire, Store-Release on page E2-2355.](#)

Note

Depending on the required synchronization, a program might use memory barriers on their own, or it might use them in conjunction with cache maintenance and memory management instructions that in general are only available when software execution is at EL1 or higher.

The DMB and DSB memory barriers affect reads and writes to the memory system generated by Load/Store instructions and data or unified cache maintenance instructions being executed by the PE. Instruction fetches or accesses caused by a hardware translation table access are not explicit accesses.

AArch32 state also supports the legacy CP15 barrier operations [CP15DMB](#), [CP15DSB](#), and [CP15ISB](#). These operations are accessible from EL0. However, ARM deprecates any use of these operations, and strongly recommends that software uses the DMB, DSB, and ISB instructions described in this section instead. Supervisory software can disable use of the CP15 barrier operations, meaning the encodings for these operations are unallocated:

- If EL1 is using AArch32, by setting [SCTLR.CP15BEN](#) to 0.
- If EL1 is using AArch64, by setting [SCTLR_EL1.CP15BEN](#) to 0.

Instruction Synchronization Barrier (ISB)

An ISB instruction flushes the pipeline in the PE, so that all instructions that come after the ISB instruction in program order are fetched from the cache or memory only after the ISB instruction has completed. Using an ISB ensures that the effects of context-changing operations executed before the ISB are visible to the instructions fetched after the ISB instruction. Examples of context-changing operations that require the insertion of an ISB instruction to ensure the effects of the operation are visible to instructions fetched after the ISB instruction are:

- Completed cache and TLB maintenance instructions.
- Changes to system control registers.

Any context-changing operations appearing in program order after the ISB instruction only take effect after the ISB has been executed.

```
InstructionSynchronizationBarrier();
```

See also [Memory barriers on page G2-3556](#).

Data Memory Barrier (DMB)

The DMB instruction is a data memory barrier. The PE that executes the DMB instruction is referred to as the executing PE, PEE. The DMB instruction takes the *required shareability domain* and *required access types* as arguments:

```
DataMemoryBarrier(MBReqDomain domain, MBReqTypes types);
```

See [Shareability and access limitations on the data barrier operations on page E2-2355](#).

If the required shareability is *Full system* then the operation applies to all observers within the system.

A DMB creates two groups of memory accesses, Group A and Group B:

Group A Contains:

- All explicit memory accesses of the required access types from observers in the same required shareability domain as PEE that are observed by PEE before the DMB instruction. These accesses include any accesses of the required access types performed by PEE.
- All loads of required access types from an observer PEX in the same required shareability domain as PEE that have been observed by any given different observer, PEY, in the same required shareability domain as PEE before PEY has performed a memory access that is a member of Group A.

Group B Contains:

- All explicit memory accesses of the required access types by PEE that occur in program order after the DMB instruction.

- All explicit memory accesses of the required access types by any given observer PEx in the same required shareability domain as PEe that can only occur after a load by PEx has returned the result of a store that is a member of Group B.

Any observer with the same required shareability domain as PEe observes all members of Group A before it observes any member of Group B to the extent that those group members are required to be observed, as determined by the shareability and cacheability of the memory locations accessed by the group members.

If members of Group A and members of Group B access the same memory-mapped peripheral of arbitrary system-defined size, then members of Group A that are accessing Device or Normal Non-cacheable memory arrive at that peripheral before members of Group B that are accessing Device or Normal Non-cacheable memory. Where the members of Group A and Group B that must be ordered are from the same PE, a DMB NSH is sufficient for this guarantee.

———— **Note** —————

- A memory access might be in neither Group A nor Group B. The DMB does not affect the order of observation of such a memory access.
- The second part of the definition of Group A is recursive. Ultimately, membership of Group A derives from the observation by PEy of a load before PEy performs an access that is a member of Group A as a result of the first part of the definition of Group A.
- The second part of the definition of Group B is recursive. Ultimately, membership of Group B derives from the observation by any observer of an access by PEe that is a member of Group B as a result of the first part of the definition of Group B.

DMB only affects memory accesses and the operation of data cache and unified cache maintenance instructions, see [Cache maintenance instructions on page D4-1684](#). It has no effect on the ordering of any other instructions executing on the PE.

See also [Memory barriers on page D4-1705](#).

Data Synchronization Barrier (DSB)

The DSB instruction is a special memory barrier, that synchronizes the execution stream with memory accesses.

The DSB instruction takes the *required shareability domain* and *required access types* as arguments:

```
DataSynchronizationBarrier(MBReqDomain domain, MBReqTypes types);
```

See [Shareability and access limitations on the data barrier operations on page E2-2355](#).

If the required shareability is *Full system* then the operation applies to all observers within the system.

A DSB behaves as a DMB with the same arguments, and also has the additional properties defined in this section. The PE that executes the DSB instruction is referred to as the executing PE, PEe.

A DSB completes when all of the following apply:

- All explicit memory accesses that are observed by PEe before the DSB is executed and are of the required access types, and are from observers in the same required shareability domain as PEe, are complete for the set of observers in the required shareability domain.
- All cache maintenance instructions issued by PEe before the DSB are complete for the required shareability domain.
- If the required access types of the DSB is *reads and writes*, all TLB maintenance instructions issued by PEe before the DSB are complete for the required shareability domain.

In addition, no instruction that appears in program order after the DSB instruction can execute until the DSB completes.

See also [Memory barriers on page G2-3556](#).

Shareability and access limitations on the data barrier operations

The DMB and DSB instructions can each take an optional limitation argument that specifies:

- The shareability domain over which the instruction must operate. This is one of:
 - Full system.
 - Outer Shareable.
 - Inner Shareable.
 - Non-shareable.
- The accesses for which the instruction operates. This is one of:
 - Read and write accesses in Group A and Group B.
 - Write accesses only in Group A and Group B.
 - Read access only in Group A.

———— **Note** —————

This is occasionally referred to as a Load-Load/Store barrier.

- Read and write accesses in Group B.

———— **Note** —————

This is occasionally referred to as a Load-Load/Store barrier.

If no specifiers are used then each instruction operates for read and write accesses, over the full system. See the instruction descriptions for more information about these arguments.

———— **Note** —————

ISB also supports an optional limitation argument that can only contain one value that corresponds to full system operation.

Load-Acquire, Store-Release

ARMv8 provides a set of instructions with Acquire semantics for loads, and Release semantics for stores.

For all memory types, these instructions have the following ordering requirements:

- A Store-Release followed by a Load-Acquire is observed in program order by each observer within the shareability domain of the memory address being accessed by the Store-Release and the memory address being accessed by the Load-Acquire.
- A Load-Acquire is a read that must be observed by all observers in the shareability domain of the accessed memory location before any other read or write that both:
 - Is caused by an instruction that appears in program order after the Load-Acquire.
 - Accesses memory in the shareability domain accessed by the Load-Acquire.
- A Load-Acquire places no additional ordering constraints on any loads or stores appearing before the Load-Acquire.
- Store-Release is a write:
 - Where the reads and writes generated by loads and stores appearing in program order before the Store-Release are observed as required by the shareability domains of the memory addresses being accessed by those loads and stores by each observer within the shareability domain of the memory address being accessed by the Store-Release, before that observer observes the write generated by the Store-Release.
 - Where any writes that have been observed before the Store-Release by the processing element executing the Store-Release are observed as required by the shareability domains of the memory addresses being accessed by those loads and store by each observer within the shareability domain of the memory address being accessed by the Store-Release, before that observer observes the write generated by the Store-Release.

- The Store-Release places no additional ordering constraints on any loads or stores appearing after the Store-Release instruction.
- All Store-Release instructions must be multi-copy atomic when they are observed with Load-Acquire instructions.

Load-Acquire and Store-Release, other than LDAEXD and STLEXD, access only a single data element. This access is single-copy atomic. The address of the data object must be aligned to the size of the data element being accessed, otherwise the access generates an Alignment fault.

LDAEXD and STLEXD access two data elements. The address supplied to the instructions must be doubleword aligned, otherwise the access generates an Alignment fault.

A Store-Release Exclusive instruction only has the release semantics if the store is successful.

Note

- Each Load-Acquire Exclusive and Store-Release Exclusive instruction is essentially a variant of the equivalent Load-Exclusive or Store-Exclusive instruction. All usage restrictions and single-copy atomicity properties that apply to the Load-Exclusive or Store-Exclusive instructions also apply to the Load-Acquire Exclusive or Store-Release Exclusive instructions.
 - The Load-Acquire/Store-Release instructions can remove the requirement to use the explicit DMB memory barrier instruction.
-

E2.8 Memory types and attributes

In ARMv8 the ordering of accesses for locations of memory, referred to as the memory order model, is defined by the memory attributes. The following sections describe this model:

- [Normal memory](#).
- [Device memory on page E2-2360](#).

E2.8.1 Normal memory

The Normal memory type attribute applies to most memory in a system. It indicates that the hardware might perform speculative data read accesses to these locations.

The Normal memory type has the following properties:

- A write to a memory location with the Normal attribute completes in finite time. This means that it is globally observed for the shareability domain of the memory location in finite time. For a Non-cacheable location, the location is observed by all observers in finite time.
- A completed write to a memory location with the Normal attribute is globally observed for the shareability domain of the memory location in finite time without the need for explicit cache maintenance instructions or barriers. For a Non-cacheable location, the completed write is globally observed for all observers in finite time without the need for explicit cache maintenance instructions or barriers.
- Writes to a memory location with the Normal memory attribute that are Non-cacheable must reach the endpoint for that location in the memory system in finite time.
- Unaligned memory accesses can access Normal memory if the system is configured to generate such accesses.
- There is no requirement for the memory system beyond the PE to be able to identify the elements accessed by multi-register Load/Store instructions. See [Multi-register loads and stores that access Normal memory on page E2-2360](#).

Note

- The Normal memory attribute is appropriate for locations of memory that are idempotent, meaning that they exhibit all of the following properties:
 - Read accesses can be repeated with no side-effects.
 - Repeated read accesses return the last value written to the resource being read.
 - Read accesses can fetch additional memory locations with no side-effects.
 - Write accesses can be repeated with no side-effects if the contents of the location accessed are unchanged between the repeated writes or as the result of an exception, as described in this section.
 - Unaligned accesses can be supported.
 - Accesses can be merged before accessing the target memory system.
- An instruction that generates a sequence of accesses as described in [Atomicity in the ARM architecture on page E2-2346](#) might be abandoned as a result of an exception being taken during the sequence of accesses. On return from the exception the instruction is restarted, and therefore one or more of the memory locations might be accessed multiple times. This can result in repeated write accesses to a location that has been changed between the write accesses.

The following sections describe the other attributes for Normal memory:

- [Shareable Normal memory on page E2-2358](#).
- [Non-shareable Normal memory on page E2-2359](#).

See also:

- [Atomicity in the ARM architecture on page E2-2346.](#)
- [Memory barriers on page E2-2352.](#) For accesses to Normal memory, a DMB instruction is required to ensure the required ordering.
- [Concurrent modification and execution of instructions on page E2-2348.](#)

Shareable Normal memory

A Normal memory location has a Shareability attribute that is:

- Defined independently for the Inner Shareable and Outer Shareable shareability domains.
- Defined, for each shareability domain, as being either Shareable or Non-shareable.

The shareability attributes define the data coherency requirements of the location, that hardware must enforce. They do not affect the coherency requirements of instruction fetches, see [Synchronization and coherency issues between data and instruction accesses on page E2-2339.](#)

Note

- System designers can use the shareability attribute to specify the locations in Normal memory for which coherency must be maintained. However, software developers must not assume that specifying a memory location as Non-shareable permits software to make assumptions about the incoherency of the location between different PEs in a shared memory system. Such assumptions are not portable between different multiprocessing implementations that might use the shareability attribute. Any multiprocessing implementation might implement caches that are shared, inherently, between different processing elements.
- This architecture assumes that all PEs that use the same operating system or hypervisor are in the same Inner Shareable shareability domain.

Shareable, Inner Shareable, and Outer Shareable Normal memory

The ARM architecture abstracts the system as a series of Inner and Outer Shareability domains.

Each Inner Shareability domain contains a set of observers that are data coherent for each member of that set for data accesses with the Inner Shareable attribute made by any member of that set.

Each Outer Shareability domain contains a set of observers that are data coherent for each member of that set for data accesses with the Outer Shareable attribute made by any member of that set.

The following properties also hold:

- Each observer is only a member of a single Inner Shareability domain.
- Each observer is only a member of a single Outer Shareability domain.
- All observers in an Inner Shareability domain are always members of the same Outer Shareability domain. This means that an Inner Shareability domain is a subset of an Outer Shareability domain, although it is not required to be a proper subset.

Note

- Because all data accesses to Non-cacheable locations are data coherent to all observers, Non-cacheable locations are always treated as Outer Shareable.
 - The Inner Shareable domain is expected to be the set of PEs controlled by a single hypervisor or operating system.
-

The details of the use of the shareability attributes are system-specific. [Example E2-1](#) shows how they might be used.

Example E2-1 Use of shareability attributes

In an implementation, a particular subsystem with two clusters of PEs has the requirement that:

- In each cluster, the data caches or unified caches of the PEs in the cluster are transparent for all data accesses to memory locations with the Inner Shareable attribute.
- However, between the two clusters, the caches:
 - Are not required to be coherent for data accesses that have only the Inner Shareable attribute.
 - Are coherent for data accesses that have the Outer Shareable attribute.

In this system, each cluster is in a different shareability domain for the Inner Shareable attribute, but all components of the subsystem are in the same shareability domain for the Outer Shareable attribute.

A system might implement two such subsystems. If the data caches or unified caches of one subsystem are not transparent to the accesses from the other subsystem, this system has two Outer Shareable shareability domains.

Having two levels of shareability means system designers can reduce the performance and power overhead for shared memory locations that do not need to be part of the Outer Shareable shareability domain.

For Shareable Normal memory, the Load-Exclusive and Store-Exclusive synchronization primitives take account of the possibility of accesses by more than one observer in the same Shareability domain.

Non-shareable Normal memory

For Normal memory locations, the Non-shareable attribute identifies Normal memory that is likely to be accessed only by a single PE.

A location in Normal memory with the Non-shareable attribute does not require the hardware to make data accesses by different observers coherent, unless the memory is Non-cacheable. For a Non-shareable location, if other observers share the memory system, software must use cache maintenance instructions, if the presence of caches might lead to coherency issues when communicating between the observers. This cache maintenance requirement is in addition to the barrier operations that are required to ensure memory ordering.

For Non-shareable Normal memory, it is IMPLEMENTATION DEFINED whether the Load-Exclusive and Store-Exclusive synchronization primitives take account of the possibility of accesses by more than one observer.

Concurrent modification and execution of instructions

The ARMv8 architecture limits the set of instructions that can be executed by one thread of execution as they are being modified by another thread of execution without requiring explicit synchronization.

Except where the instruction before modification or the instruction after modification is explicitly identified in this section, concurrent modification and execution of instructions can lead to the resulting instruction performing any behavior that can be achieved by executing any sequence of instructions that can be executed from the same Exception level.

For the instructions explicitly identified in this section, the architecture guarantees that, after modification of the instruction, behavior is consistent with execution of either:

- The instruction originally fetched.
- A fetch of the modified instruction.

The instructions to which this applies are the B, BL, NOP, BKPT, SVC, HVC, and SMC instructions.

For all other instructions, to avoid UNPREDICTABLE behavior, instruction modifications must be explicitly synchronized before they are executed. The required synchronization is as follows:

1. To ensure that the modified instructions are observable, the thread of execution that is modifying the instructions must issue the following sequence of instructions and operations:

```
; Coherency example for self-modifying code
; Enter this code with <Rt> containing a new 32-bit instruction,
; to be held in non-cacheable space at a location pointed to by Rn. Use STRH in the first
; line instead of STR for a 16-bit instruction.
STR <Rt>, [Rn]
DSB                               ; Ensure visibility of the data stored
IC IMVAU, Rn                      ; Invalidate instruction cache by VA to PoU
DSB                               ; Ensure completion of the invalidations
```

2. Once the modified instructions are observable, the thread of execution that is executing the modified instructions must issue the following instruction to ensure execution of the modified instructions:

```
ISB                               ; Synchronize fetched instruction stream
```

For both instruction sets, if one thread of execution changes a conditional branch instruction to another conditional branch instruction, and the change affects both the condition field and the branch target, execution of the changed instruction by another thread of execution before the change is synchronized can lead to either:

- The old condition being associated with the new target address.
- The new condition being associated with the old target address.

These possibilities apply regardless of whether the condition, either before or after the change to the branch instruction, is the always condition.

Multi-register loads and stores that access Normal memory

For all instructions that load or store more than one general-purpose register from an Exception level there is no requirement for the memory system beyond the PE to be able to identify the size of the elements accessed by these load or store instructions.

For all instructions that load or store more than one general-purpose register from an Exception level the order in which the registers are accessed is not defined by the architecture.

For all instructions that load or store one or more SIMD and floating-point register from an Exception level there is no requirement for the memory system beyond the PE to be able to identify the size of the element accessed by these load or store instructions.

E2.8.2 Device memory

The Device memory type attributes define memory locations where an access to the location can cause side-effects, or where the value returned for a load can vary depending on the number of loads performed. Typically, the Device memory attributes are used for memory-mapped peripherals and similar locations.

The attributes for ARMv8 Device memory are:

Gathering Identified as G or nG, see [Gathering on page E2-2362](#).

Reordering Identified as R or nR, see [Reordering on page E2-2363](#).

Early Write Acknowledgement hint

Identified as E or nE, see [Early Write Acknowledgement on page E2-2364](#).

The ARMv8 Device memory types are:

Device-nGnRnE Device non-Gathering, non-Reordering, No Early write acknowledgement.
Equivalent to the Strongly-ordered memory type in earlier versions of the architecture.

Device-nGnRE	Device non-Gathering, non-Reordering, Early Write Acknowledgement. Equivalent to the Device memory type in earlier versions of the architecture.
Device-nGRE	Device non-Gathering, Reordering, Early Write Acknowledgement. ARMv8 adds this memory type to the translation table formats found in earlier versions of the architecture. The use of barriers is required to order accesses to Device-nGRE memory. The Device-nGRE memory type is introduced into the AArch32 translation table formats when the PE is using the Long Descriptor Translation Table format.
Device-GRE	Device Gathering, Reordering, Early Write Acknowledgement. ARMv8 adds this memory type to the translation table formats found in earlier versions of the architecture. Device-GRE memory has the fewest constraints. It behaves similar to Normal memory, with the restriction that speculative accesses to Device-GRE memory is forbidden. The Device-GRE memory type is introduced into the AArch32 translation table formats when the PE is using the Long Descriptor Translation Table format.

Collectively these are referred to as *any Device memory type*. Going down the list, the memory types are described as getting *weaker*; conversely the going up the list the memory types are described as getting *stronger*.

———— **Note** —————

- As the list of types shows, these additional attributes are hierarchical. For example, a memory location that permits Gathering must also permit Reordering and Early Write Acknowledgement.
- The architecture does not require an implementation to distinguish between each of these memory types and ARM recognizes that not all implementations will do so. The subsection that describes each of the attributes, describes the implementation rules for the attribute.
- Earlier versions of the ARM architecture defined the following memory types:
 - Strongly-ordered memory. This is the equivalent of the Device-nGnRnE memory type.
 - Device memory. This is the equivalent of the Device-nGnRE memory type.

All of these memory types have the following properties:

- Speculative data accesses are not permitted to any memory location with any Device memory attribute. This means that each memory access to any Device memory type must be one that would be generated by a simple sequential execution of the program.
An exception to this applies:
 - Reads generated by the SIMD and floating-point instructions can access bytes that are not explicitly accessed by the instruction if the bytes accessed are in a 16-byte window, aligned to 16-bytes, that contains at least one byte that is explicitly accessed by the instruction.

———— **Note** —————

- An instruction that generates a sequence of accesses as described in [Atomicity in the ARM architecture on page E2-2346](#) might be abandoned as a result of an exception being taken during the sequence of accesses. On return from the exception the instruction is restarted, and therefore one or more of the memory locations might be accessed multiple times. This can result in repeated accesses to a location where the program only defines a single access. For this reason, ARM strongly recommends that no accesses to Device memory are performed from a single instruction that spans the boundary of a translation granule or which in some other way could lead to some of the accesses being aborted.
 - Write speculation that is visible to other observers is prohibited for all memory types.
- A write to a memory location with any Device memory attribute completes in finite time. This means that it is globally observed for all observers in the system in finite time.

- If a location with any Device memory attribute changes without an explicit write by an observer, this change must also be globally observed for all observers in the system in finite time. Such a change might occur in a peripheral location that holds status information.
- A completed write to a memory location with any Device memory attribute is globally observed for all observers in finite time without the need for explicit maintenance.
- Data accesses to memory locations are coherent for all observers in the system, and correspondingly are treated as being Outer Shareable.
- A memory location with any Device memory attribute cannot be allocated into a cache.
- Writes to a memory location with any Device memory attribute must reach the endpoint for that address in the memory system in finite time. Typically, the endpoint is a peripheral or some physical memory.
- All accesses to memory with any Device memory attribute must be aligned. Any unaligned access generates an Alignment fault at the first stage of translation that defined the location as being Device.

———— **Note** ————

In the Non-secure EL1 translation regime in systems where `HCR.TGE == 1` and `HCR.DC == 0`, any Alignment fault that results from the fact that all locations are treated as Device is a fault at the first stage of translation. This causes the value of `HSR.ISS.[24]` to be 0.

- Hardware does not prevent speculative instruction fetches from a memory location with any of the Device memory attributes unless the memory location is also marked as Execute-never for all Exception levels.

———— **Note** ————

This means that to prevent speculative instruction fetches from memory locations with Device memory attributes, any location that is assigned any Device memory type must also be marked as Execute-never for all Exception levels. Failure to mark a memory location with any Device memory attribute as Execute-never for all Exception levels is a programming error.

For instruction fetches, if branches cause the program counter to point to an area of memory with the Device attribute which is not marked as Execute-never for the current Exception level, an implementation can either:

- Treat the instruction fetch as if it were to a memory location with the Normal Non-cacheable attribute.
- Take a Permission fault.

Gathering

In the Device memory attribute:

- G** Indicates that the location has the Gathering attribute.
- nG** Indicates that the location does not have the Gathering attribute, meaning it is non-Gathering.

The Gathering attribute determines whether it is permissible for either:

- Multiple memory accesses of the same type, read or write, to the same memory location to be merged into a single transaction.
- Multiple memory accesses of the same type, read or write, to different memory locations to be merged into a single memory transaction on an interconnect.

For memory types with the Gathering attribute, either of these behaviors is permitted, provided that the ordering and coherency rules of the memory location are followed.

For memory types with the non-Gathering attribute, neither of these behaviors is permitted. As a result:

- The number of memory accesses that are made corresponds to the number that would be generated by a simple sequential execution of the program.

- All access occur at their programmed size, except that there is no requirement for the memory system beyond the PE to be able to identify the elements accessed by multi-register Load/Store instructions. See [Multi-register loads and stores that access Device memory on page E2-2364](#).

Gathering between memory accesses separated by a memory barrier that affects those memory accesses is not permitted. This applies if one memory access is in Group A and one memory access is in Group B. That is, gathering is not permitted between a memory access in Group A and a memory access in Group B if the two accesses are separated by a barrier that affects at least one of the accesses.

Gathering between two memory accesses generated by a Load-Acquire/Store-Release is not permitted.

A read from a memory location with the non-Gathering attribute cannot come from a cache or a buffer, but must come from the endpoint for that address in the memory system. Typically this is a peripheral or physical memory.

Note

- A read from a memory location with the Gathering attribute can come from intermediate buffering of a previous write, provided that:
 - The accesses are not separated by a DMB or DSB barrier that affects both of the accesses, for example if one access is in Group A and the other is in Group B.
 - The accesses are not separated by other ordering constructions that require that the accesses are in order. Such a construction might be a combination of Load-Acquire and Store-Release.
 - The accesses are not generated by a Store-Release instruction.
- The ARM architecture only defines programmer visible behavior. Therefore, gathering can be performed if a programmer cannot tell whether gathering has occurred.

An implementation is permitted to perform an access with the Gathering attribute in a manner consistent with the requirements specified by the Non-gathering attribute.

An implementation is not permitted to perform an access with the Non-gathering attribute in a manner consistent with the relaxations allowed by the Gathering attribute.

Reordering

In the Device memory attribute:

- R** Indicates that the location has the Reordering attribute.
nR Indicates that the location does not have the Reordering attribute, meaning it is non-Reordering.

For all memory types with the non-Reordering attribute, the order of memory accesses arriving at a single peripheral of IMPLEMENTATION DEFINED size, as defined by the peripheral, must be the same order that occurs in a simple sequential execution of the program. That is, the accesses appear in program order. This ordering applies to all accesses using any of the memory types with the non-Reordering attribute. As a result, if there is a mixture of Device-nGnRE and Device-nGnRnE accesses to the same peripheral, these occur in program order. If the memory accesses are not to a peripheral, then this attribute imposes no restrictions.

Note

- The IMPLEMENTATION DEFINED size of the single peripheral is the same as applies for the ordering guarantee provided by the DMB instruction.
- The ARM architecture only defines programmer visible behavior. Therefore, reordering can be performed if a programmer cannot tell whether reordering has occurred.

An implementation is permitted to perform an access with the Reordering attribute in a manner consistent with the requirements specified by the non-Reordering attribute.

An additional relaxation is that an implementation is not permitted to perform an access with the non-Reordering attribute in a manner consistent with the relaxations allowed by the Reordering attribute.

The non-Reordering attribute does not require any additional ordering, other than that which applies to Normal memory, between:

- Accesses with the non-Reordering attribute and accesses with the Reordering attribute.
- Accesses with the non-Reordering attribute and accesses to Normal memory.
- Accesses with the non-Reordering attribute and accesses to different peripherals of IMPLEMENTATION DEFINED size.

Early Write Acknowledgement

In the Device memory attribute:

- E** Indicates that the location has the Early Write Acknowledgement attribute.
nE Indicates that the location has the No Early Write Acknowledgement attribute.

Early Write Acknowledgement is a hint to the platform memory system. Assigning the No Early Write Acknowledgement attribute to a Device memory location recommends that only the endpoint of the write access returns a write acknowledgement of the access, and that no earlier point in the memory system returns a write acknowledge. This means that a DSB barrier, executed by the PE that performed the write to the No Early Write Acknowledgement location, completes only after the write has reached its endpoint in the memory system. Typically, this endpoint is a peripheral or physical memory.

When the Early Write Acknowledgement attribute is assigned to a Device memory location, there is no such recommendation for the handling of accesses to that location.

————— **Note** —————

- The Early Write Acknowledgement hint has no effect on the ordering rules. The purpose of signalling no Early Write Acknowledgement is to signal to the interconnect that the peripheral requires the ability to signal the acknowledgement. The No Write Acknowledgement signal also provides an additional semantic that can be interpreted by the driver that is accessing the peripheral.
- This attribute is treated as a hint, as the exact nature of the interconnects attached to a PE is outside the scope of the ARM architecture definition, and not all interconnects provide a mechanism to ensure that a write has reached the physical endpoint of the memory system.
- ARM recommends that writes with the No Early Write Acknowledgement hint are used for PCIe configuration writes. However, the mechanisms by which PCIe configuration writes are identified are IMPLEMENTATION DEFINED.
- ARM strongly recommends that the Early Write Acknowledgement hint is not ignored by a PE, but is made available for use by the system.

Because the No Early Write Acknowledgement attribute is a hint:

- An implementation is permitted to perform an access with the Early Write Acknowledgement attribute in a manner consistent with the requirements specified by the No Early Write Acknowledgement attribute.
- An implementation is permitted to perform an access with the No Early Write Acknowledgement attribute in a manner consistent with the relaxations allowed by the Early Write Acknowledgement attribute.

Multi-register loads and stores that access Device memory

For all instructions that load or store more than one general-purpose register from an Exception level there is no requirement for the memory system beyond the PE to be able to identify the size of the elements accessed by these load or store instructions.

For an LDRD, STRD, LDM instruction with a register list that includes the PC, or an STM instruction with a register list that includes the PC, the order in which the registers are accessed is not defined by the architecture, even for accesses to any type of Device memory.

For an LDM and STM instruction with a register list that doesn't include the PC, both registers are accessed in ascending address order.

For all instructions that load or store one or more floating-point and SIMD register from an Exception level there is no requirement for the memory system beyond the PE to be able to identify the size of the element accessed by these load or store instructions, even for access to any type of Device memory.

E2.9 Mismatched memory attributes

In the ARMv8 architecture mismatched memory attributes are controlled by privileged software. For more information, see [Chapter G3 The AArch32 Virtual Memory System Architecture](#).

Physical memory locations are accessed with *mismatched attributes* if all accesses to the location do not use a common definition of all of the following attributes of that location:

- Memory type, Device or Normal.
- Shareability.
- Cacheability, for the same level of the inner or outer cache, but excluding any cache allocation hints.

Collectively these are referred to as memory attributes.

———— **Note** ————

The terms *location* and *memory location* refer to any byte within the current coherency granule and are used interchangeably.

The following rules apply when a physical memory location is accessed with mismatched attributes:

1. When a memory location is accessed with mismatched attributes the only software visible effects are one or more of the following:
 - Uniprocessor semantics for reads and writes to that memory location might be lost. This means:
 - A read of the memory location by one agent might not return the value most recently written to that memory location by the same agent.
 - Multiple writes to the memory location by one agent with different memory attributes might not be ordered in program order.
 - There might be a loss of coherency when multiple agents attempt to access a memory location.
 - There might be a loss of properties derived from the memory type, as described in later bullets in this section.
 - If all Load-Exclusive/Store-Exclusive instructions executed across all threads to access a given memory location do not use consistent memory attributes, the exclusive monitor state becomes UNKNOWN.
 - Bytes written without the Write-Back cacheable attribute within the same Write-Back granule as bytes written with the Write-Back cacheable attribute might have their values reverted to the old values as a result of cache Write-Back.
2. The loss of properties associated with mismatched memory type attributes refers only to the following properties of Device memory that are additional to the properties of Normal memory:
 - Prohibition of speculative read accesses.
 - Prohibition on Gathering.
 - Prohibition on Re-ordering.
 - The Write Acknowledgement guarantee with respect to the endpoint of the access.

If the only memory type mismatch associated with a memory location across all users of the memory location is between different types of Device memory, then all accesses might take the properties of the weakest Device memory type.
3. If all aliases of a memory location that permit write access to the location assign the same shareability and cacheability attributes to that location, and all these aliases use a definition of the shareability attribute that includes all the threads of execution that can access the location, then any agent that reads the memory location using these shareability and cacheability attributes accesses it coherently, to the extent required by that common definition of the memory attributes.
4. The possible loss of software-visible effects caused by mismatched attributes for a memory location are defined more precisely if all of the mismatched attributes define the memory location as one of:
 - Any Device memory type.
 - Normal Inner Non-cacheable, Outer Non-cacheable memory.

In these cases, the only permitted software-visible effects of the mismatched attributes are one or more of the following:

- Possible loss of properties described in point 2 on [page E2-2366](#), derived from the memory type when multiple agents attempt to access the memory location.
 - Possible reordering of memory transactions to the memory location with different memory attributes, potentially leading to a loss of coherency or uniprocessor semantics. Any possible loss of coherency or uniprocessor semantics can be avoided by inserting DMB barrier instructions between accesses to the same memory location that might use different attributes.
5. If the mismatched attributes for a memory location all assign the same shareability attribute to the location, any loss of uniprocessor semantics or coherency within a shareability domain can be avoided by use of software cache management. To do so, software must use the techniques that are required for the software management of the coherency of cacheable locations between agents in different shareability domains. This means:
- Before writing to a location not using the Write-Back attribute, software must invalidate, or clean, a location from the caches if any agent might have written to the location with the Write-Back attribute. This avoids the possibility of overwriting the location with stale data.
 - After writing to a location with the Write-Back attribute, software must clean the location from the caches, to make the write visible to external memory.
 - Before reading the location with a cacheable attribute, software must invalidate the location from the caches, to ensure that any value held in the caches reflects the last value made visible in external memory.

Note

Cache maintenance instructions can only be accessed from an Exception level that is higher than EL0, and therefore require a system call. For information on system calls, see [Exception-generating and exception-handling instructions on page F1-2396](#). For information on cache maintenance instructions, see [Cache support on page G2-3524](#).

In all cases:

- Location refers to any byte within the current coherency granule.
- A clean and invalidate instruction can be used instead of a clean instruction, or instead of an invalidate instruction.
- In the sequences outlined in this section, all cache maintenance instructions and memory transactions must be completed, or ordered by the use of barrier operations, if they are not naturally ordered by the use of a common address, see [Ordering of cache and branch predictor maintenance instructions on page G2-3539](#).

Note

With software management of coherency, race conditions can cause loss of data. A race condition occurs when different agents write simultaneously to bytes that are in the same location, and the invalidate, write, clean sequence of one agent overlaps with the equivalent sequence of another agent. A race condition also occurs if the first operation of either sequence is a clean, rather than an invalidate.

6. If the mismatched attributes for a location mean that multiple cacheable accesses to the location might be made with different shareability attributes, then coherency is guaranteed only if processing elements that accesses the location with a cacheable attribute performs a clean and invalidate of the location before and after accessing that location.

Note

The Note in rule 5 on [page E2-2367](#) about possible race conditions also applies to this rule.

In addition, if multiple agents attempt to use Load-Exclusive or Store-Exclusive instructions to access a location, and the accesses from the different agents have different memory attributes associated with the location, the exclusive monitor state becomes UNKNOWN.

ARM strongly recommends that software does not use mismatched attributes for aliases of the same location. An implementation might not optimize the performance of a system that uses mismatched aliases.

E2.10 Synchronization and semaphores

ARMv8 provides non-blocking synchronization of shared memory, using *synchronization primitives*. The information in this section about memory accesses by synchronization primitives applies to accesses to both Normal and Device memory.

———— **Note** ————

Use of the ARMv8 synchronization primitives scales for multiprocessing system designs.

Table E2-4 shows the synchronization primitives and the associated CLREX instruction.

Table E2-4 Synchronization primitives and associated instruction

Function	A32/T32 Instruction
Load-Exclusive	
Byte	LDREXB, LDRAEXB
Halfword	LDREXH, LDRAEXH
Word	LDREX, LDRAEX
Doubleword	LDREXD, LDRAEXD
Store-Exclusive	
Byte	STREXB, STRLEXB
Halfword	STREXH, STRLEXH
Word	STREX, STRLEX
Doubleword	STREXD, STRLEXD
Clear-Exclusive	CLREX

The model for the use of a Load-Exclusive/Store-Exclusive instruction pair accessing a non-aborting memory address x is:

- The Load-Exclusive instruction reads a value from memory address x .
- The corresponding Store-Exclusive instruction succeeds in writing back to memory address x only if no other observer, process, or thread has performed a more recent store to address x . The Store-Exclusive instruction returns a status bit that indicates whether the memory write succeeded.

A Load-Exclusive instruction marks a small block of memory for exclusive access. The size of the marked block is IMPLEMENTATION DEFINED, see [Marking and the size of the marked memory block on page E2-2374](#). A Store-Exclusive instruction to any address in the marked block clears the marking.

———— **Note** ————

In this section, the term PE includes any observer that can generate a Load-Exclusive or a Store-Exclusive instruction.

E2.10.1 Exclusive access instructions and Non-shareable memory locations

For memory locations that do not have the *Shareable* attribute, the exclusive access instructions rely on a *local monitor* that marks any address from which the PE executes a Load-Exclusive instruction. Any non-aborted attempt by the same PE to use a Store-Exclusive instruction to modify any address is guaranteed to clear the marking.

A Load-Exclusive instruction performs a load from memory, and:

- The executing PE marks the physical memory address for exclusive access.
- The local monitor of the executing PE transitions to the Exclusive Access state.

A Store-Exclusive instruction performs a conditional store to memory that depends on the state of the local monitor:

If the local monitor is in the Exclusive Access state

- If the address of the Store-Exclusive instruction is the same as the address that has been marked in the monitor by an earlier Load-Exclusive instruction, then the store occurs. Otherwise, it is IMPLEMENTATION DEFINED whether the store occurs.
- A status value is returned to a register:
 - If the store took place the status value is 0.
 - Otherwise, the status value is 1.
- The local monitor of the executing PE transitions to the Open Access state.

If the local monitor is in the Open Access state

- No store takes place.
- A status value of 1 is returned to a register.
- The local monitor remains in the Open Access state.

The Store-Exclusive instruction defines the register to which the status value is returned.

When a PE writes using any instruction other than a Store-Exclusive instruction:

- If the write is to a physical address that is not tagged by its local monitor it is IMPLEMENTATION DEFINED whether the write affects the state of the local monitor.
- If the write is to a physical address that is tagged by its local monitor it is IMPLEMENTATION DEFINED whether the write affects the state of the local monitor.

It is IMPLEMENTATION DEFINED whether a store to a marked physical address causes a mark in the local monitor to be cleared if that store is by an observer other than the one that caused the physical address to be marked.

Figure E2-4 shows the state machine for the local monitor and the effect of each of the operations shown in the figure.

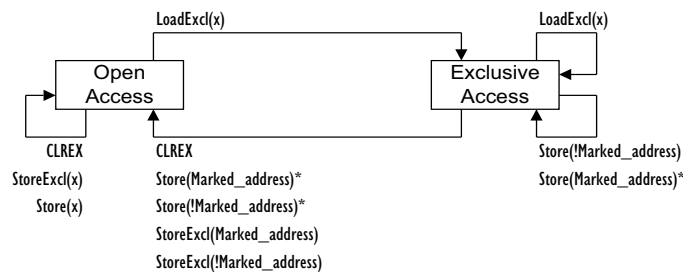

Operations marked * are possible alternative IMPLEMENTATION DEFINED options.

In the diagram: LoadExcl represents any Load-Exclusive instruction
 StoreExcl represents any Store-Exclusive instruction
 Store represents any other store instruction.

Any LoadExcl operation updates the marked address to the most significant bits of the address x used for the operation.

Figure E2-4 Local monitor state machine diagram

For more information about marking see [Marking and the size of the marked memory block](#) on page E2-2374.

Note

For the local monitor state machine, as shown in [Figure E2-4 on page E2-2370](#):

- The IMPLEMENTATION DEFINED options for the local monitor are consistent with the local monitor being constructed so that it does not hold any physical address, but instead treats any access as matching the address of the previous Load-Exclusive instruction.
- A local monitor implementation can be unaware of Load-Exclusive and Store-Exclusive instructions from other PEs.
- The architecture does not require a load instruction, by another PE, that is not a Load-Exclusive instruction, to have any effect on the local monitor.
- It is IMPLEMENTATION DEFINED whether the transition from Exclusive Access to Open Access state occurs when the Store or StoreExcl is from another observer.

Changes to the local monitor state resulting from speculative execution

The architecture permits a local monitor to transition to the Open Access state as a result of speculation, or from some other cause. This is in addition to the transitions to Open Access state caused by the architectural execution of an operation shown in [Figure E2-4 on page E2-2370](#).

An implementation must ensure that:

- The local monitor cannot be seen to transition to the Exclusive Access state except as a result of the architectural execution of one of the operations shown in [Figure E2-4 on page E2-2370](#).
- Any transition of the local monitor to the Open Access state not caused by the architectural execution of an operation shown in [Figure E2-4 on page E2-2370](#) must not indefinitely delay forward progress of execution.

E2.10.2 Exclusive access instructions and Shareable memory locations

For memory locations that have the *Shareable* attribute, exclusive access instructions rely on:

- A *local monitor* for each PE in the system, that marks any address from which the PE executes a Load-Exclusive. The local monitor operates as described in [Exclusive access instructions and Non-shareable memory locations on page E2-2369](#), except that for Shareable memory any Store-Exclusive is then subject to checking by the global monitor if it is described in that section as doing at least one of the following:
 - Updating memory.
 - Returning a status value of 0.

The local monitor can ignore accesses from other PEs in the system.

- A *global monitor* that marks a physical address as exclusive access for a particular PE. This marking is used later to determine whether a Store-Exclusive to that address that has not been failed by the local monitor can occur. Any successful write to the marked block by any other observer in the shareability domain of the memory location is guaranteed to clear the marking. For each PE in the system, the global monitor:
 - Can hold one marked block.
 - Maintains a state machine for each marked block it can hold.

Note

For each PE, the architecture only requires global monitor support for a single marked address. Any situation that might benefit from the use of multiple marked addresses on a single PE is UNPREDICTABLE, see [Load-Exclusive and Store-Exclusive instruction usage restrictions on page E2-2375](#).

Note

The global monitor can either reside in a block that is part of the hardware on which the PE executes or exist as a secondary monitor at the memory interfaces. The IMPLEMENTATION DEFINED aspects of the monitors mean that the global monitor and local monitor can be combined into a single unit, provided that the unit performs the global monitor and local monitor functions defined in this manual.

For Shareable locations of memory, in some implementations and for some memory types, the properties of the global monitor require functionality outside the PE. Some system implementations might not implement this functionality for all locations of memory. In particular, this can apply to:

- Any type of memory in the system implementation that does not support hardware cache coherency.
- Non-cacheable memory, or memory treated as Non-cacheable, in an implementation that does support hardware cache coherency.

In such a system, it is defined by the system:

- Whether the global monitor is implemented.
- If the global monitor is implemented, which address ranges or memory types it monitors.

Note

To support the use of the Load-Exclusive/Store-Exclusive mechanism when address translation is disabled, a system might define at least one location of memory, of at least the size of the translation granule, in the system memory map to support the global monitor for all PEs within a common Inner Shareable domain. However, this is not an architectural requirement. Therefore, architecturally-compliant software that requires mutual exclusion must not rely on using the Load-Exclusive/Store-Exclusive mechanism, and must instead use a software algorithm such as Lamport's Bakery algorithm to achieve mutual exclusion.

If the global monitor is not implemented for an address range or memory type, then performing a Load-Exclusive/Store-Exclusive instruction to such a location has one or more of the following effects:

- The instruction generates an external abort.
- The instruction generates an IMPLEMENTATION DEFINED MMU fault. This is reported using the Fault Status code of:
 - **DFSR.STATUS** = 0b110101 when using the Long-descriptor translation table format. The fault can also be reported in the **HSR.ISS[5:0]** field for exceptions to Hyp mode.
 - **DFSR.FS** = 0b10101 when using the Short-descriptor translation table format.
- The instruction is treated as a NOP.
- The Load-Exclusive instruction is treated as if it were accessing a Non-shareable location, but the state of the local monitor becomes UNKNOWN.
- The Store-Exclusive instruction is treated as if it were accessing a Non-shareable location, but the state of the local monitor becomes UNKNOWN.
- The value held in the result register of the Store-Exclusive instruction becomes UNKNOWN.

In addition, for write transactions generated by non-PE observers that do not implement exclusive accesses or other atomic access mechanisms, the effect that writes have on the global and local monitors used by an ARM PE is IMPLEMENTATION DEFINED. The writes might not clear the global monitors of other PEs for:

- Some address ranges.
- Some memory types.

Operation of the global monitor

A Load-Exclusive instruction from Shareable memory performs a load from memory, and causes the physical address of the access to be marked as exclusive access for the requesting PE. This access also causes the exclusive access mark to be removed from any other physical address that has been marked by the requesting PE.

Note

The global monitor only supports a single outstanding exclusive access to Shareable memory for each PE.

A Load-Exclusive instruction by one PE has no effect on the global monitor state for any other PE.

A Store-Exclusive instruction performs a conditional store to memory:

- The store is guaranteed to succeed only if the physical address accessed is marked as exclusive access for the requesting PE and both the local monitor and the global monitor state machines for the requesting PE are in the Exclusive Access state. In this case:
 - A status value of 0 is returned to a register to acknowledge the successful store.
 - The final state of the global monitor state machine for the requesting PE is IMPLEMENTATION DEFINED.
 - If the address accessed is marked for exclusive access in the global monitor state machine for any other PE then that state machine transitions to Open Access state.
- If no address is marked as exclusive access for the requesting PE, the store does not succeed:
 - A status value of 1 is returned to a register to indicate that the store failed.
 - The global monitor is not affected and remains in Open Access state for the requesting PE.
- If a different physical address is marked as exclusive access for the requesting PE, it is IMPLEMENTATION DEFINED whether the store succeeds or not:
 - If the store succeeds a status value of 0 is returned to a register, otherwise a value of 1 is returned.
 - If the global monitor state machine for the PE was in the Exclusive Access state before the Store-Exclusive instruction it is IMPLEMENTATION DEFINED whether that state machine transitions to the Open Access state.

The Store-Exclusive instruction defines the register to which the status value is returned.

In a shared memory system, the global monitor implements a separate state machine for each PE in the system. The state machine for accesses to Shareable memory by PE(n) can respond to all the Shareable memory accesses visible to it. This means it responds to:

- Accesses generated by PE(n).
- Accesses generated by the other observers in the shareability domain of the memory location. These accesses are identified as (!n).

In a shared memory system, the global monitor implements a separate state machine for each observer that can generate a Load-Exclusive or a Store-Exclusive instruction in the system.

Clear global monitor event

Whenever the global monitor state for a PE changes from Exclusive access to Open access, an event is generated and held in the Event register for that PE. This register is used by the Wait for Event mechanism, see [Wait For Event and Send Event](#) on page G1-3460.

Figure E2-5 on page E2-2374 shows the state machine for PE(n) in a global monitor.

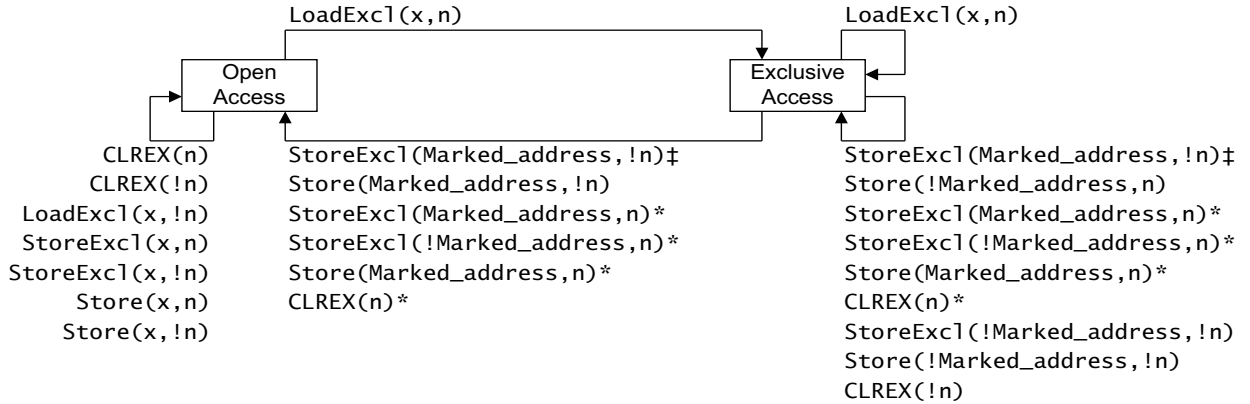

‡StoreExc1(Marked_address, !n) clears the monitor only if the StoreExc1 updates memory

Operations marked * are possible alternative IMPLEMENTATION DEFINED options.

In the diagram: LoadExc1 represents any Load-Exclusive instruction

StoreExc1 represents any Store-Exclusive instruction

Store represents any other store instruction.

Any LoadExc1 operation updates the marked address to the most significant bits of the address x used for the operation.

Figure E2-5 Global monitor state machine diagram for PE(n) in a multiprocessor system

For more information about marking see [Marking and the size of the marked memory block](#).

Note

For the global monitor state machine, as shown in [Figure E2-5](#):

- The architecture does not require a load instruction by another PE, that is not a Load-Exclusive instruction, to have any effect on the global monitor.
- Whether a Store-Exclusive instruction successfully updates memory or not depends on whether the address accessed matches the marked Shareable memory address for the PE issuing the Store-Exclusive instruction, and whether the local and global monitors are in the exclusive state. For this reason, [Figure E2-5](#) only shows how the operations by (!n) cause state transitions of the state machine for PE(n).
- A Load-Exclusive instruction can only update the marked Shareable memory address for the PE issuing the Load-Exclusive instruction.
- When the global monitor is in the Exclusive Access state, it is IMPLEMENTATION DEFINED whether a CLREX instruction causes the global monitor to transition from Exclusive Access to Open Access state.
- It is IMPLEMENTATION DEFINED:
 - Whether a modification to a Non-shareable memory location can cause a global monitor to transition from Exclusive Access to Open Access state.
 - Whether a Load-Exclusive instruction to a Non-shareable memory location can cause a global monitor to transition from Open Access to Exclusive Access state.

E2.10.3 Marking and the size of the marked memory block

When a Load-Exclusive instruction is executed, the resulting marked block ignores the least significant bits of the 64-bit memory address.

When a Load-Exclusive instruction is executed, a marked block of size 2^a is created by ignoring the least significant bits of the memory address. A marked address is any address within this marked block. For example, in an implementation where a is 4, a successful LDREXB of address 0x341B4 gives defines a marked block using bits[47:4] of the address. This means that the four words of memory from 0x341B0 to 0x341BF are marked for exclusive access.

The size of the marked memory block is called the *Exclusives Reservation Granule*. The Exclusives Reservation Granule is IMPLEMENTATION DEFINED in the range 2 - 512 words:

- 3 words in an implementation where a is 4.
- 512 words in an implementation where a is 11.

In some implementations the CTR identifies the Exclusives Reservation Granule, see [CTR](#). Otherwise, software must assume that the maximum Exclusives Reservation Granule, 512 words, is implemented.

E2.10.4 Context switch support

An exception return clears the local monitor. As a result, performing a CLREX instruction as part of a context switch is not required in most situations.

———— **Note** —————

Context switching is not an application level operation. However, this information is included here to complete the description of the exclusive operations.

—————

E2.10.5 Load-Exclusive and Store-Exclusive instruction usage restrictions

The Load-Exclusive and Store-Exclusive instructions are intended to work together as a pair, for example a LDREX/STREX pair or a LDREXB/STREXB pair. To support different implementations of these functions, software must follow the notes and restrictions given in this subsection.

The following notes describe use of a Load-Exclusive/ Store-Exclusive pair, LoadExc1/StoreExc1, to indicate the use of any of the Load-Exclusive/Store-Exclusive instruction pairs shown in [Table E2-4 on page E2-2369](#):

- The exclusives support a single outstanding exclusive access for each software thread that is executed. The architecture makes use of this by not requiring an address or size check as part of the IsExclusiveLocal() function. If the target virtual address of a StoreExc1 is different from the virtual address of the preceding LoadExc1 instruction in the same thread of execution, behavior can be UNPREDICTABLE. As a result, a LoadExc1/StoreExc1 pair can only be relied upon to eventually succeed if the LoadExc1 and the StoreExc1 are executed with the same address.
- If two StoreExc1 instructions are executed without an intervening LoadExc1 instruction the second StoreExc1 instruction returns a status value of 1. This means that:
 - ARM recommends that, in a given thread of execution, every StoreExc1 instruction has a preceding LoadExc1 instruction associated with it.

It is not necessary for every LoadExc1 instruction to have a subsequent StoreExc1 instruction.

- An implementation of the Load-Exclusive and Store-Exclusive instructions can require that, in any thread of execution, the transaction size of a Store-Exclusive instruction is the same as the transaction size of the preceding Load-Exclusive instruction executed in that thread. If the transaction size of a Store-Exclusive instruction is different from the preceding Load-Exclusive instruction in the same thread of execution, behavior can be UNPREDICTABLE. As a result, software can rely on an LoadExc1/StoreExc1 pair to eventually succeed only if they have the same size.
- An implementation might clear an exclusive monitor between the LoadExc1 instruction and the StoreExc1, instruction without any application-related cause. For example, this might happen because of cache evictions. Software must, in any single thread of execution, avoid having any explicit memory accesses or cache maintenance instructions between the LoadExc1 instruction and the associated StoreExc1 instruction.

- Implementations can benefit from keeping the LoadExcl and StoreExcl operations close together in a single thread of execution. This minimizes the likelihood of the exclusive monitor state being cleared between the LoadExcl instruction and the StoreExcl instruction. Therefore, for best performance, ARM strongly recommends a limit of 128 bytes between LoadExcl and StoreExcl instructions in a single thread of execution.
- The architecture sets an upper limit of 2048 bytes on the exclusive reservation granule that can be marked as exclusive. For performance reasons, ARM recommends that objects that are accessed by exclusive accesses are separated by the size of the exclusive reservations granule. This is a performance guideline rather than a functional requirement.
- After taking a Data Abort exception, the state of the exclusive monitors is UNKNOWN.
- If the memory attributes for the memory being accessed by a LoadExcl/StoreExcl pair are changed between the LoadExcl instruction and the StoreExcl instruction, behavior is UNPREDICTABLE.
- The effect of a cache invalidation instruction on a local or global exclusive monitor that is in the Exclusive Access state is UNPREDICTABLE. The instruction might clear the monitor, or it might leave it in the Exclusive Access state. For address-based invalidation this also applies to the monitors of other PEs in the same shareability domain as the PE executing the cache invalidation instruction, as determined by the shareability domain of the address being invalidated.

———— **Note** —————

ARM strongly recommends that implementations ensure that the use of such maintenance instructions by a PE in the Non-secure state cannot cause a denial of service on a PE in the Secure state.

———— **Note** —————

In the event of repeatedly-contending Load-Exclusive/Store-Exclusive instruction sequences from multiple PEs, an implementation must ensure that forward progress is made by at least one PE.

E2.10.6 Use of WFE and SEV instructions by spin-locks

ARMv8 provides Wait For Event, Send Event, and Send Event Local instructions, WFE, SEV, SEVL, that can assist with reducing power consumption and bus contention caused by PEs repeatedly attempting to obtain a spin-lock. These instructions can be used at the application level, but a complete understanding of what they do depends on a system level understanding of exceptions. They are described in [Wait For Event and Send Event on page G1-3460](#). However, in ARMv8, when the global monitor for a PE changes from Exclusive Access state to Open Access state, an event is generated.

———— **Note** —————

This is equivalent to issuing an SEV instruction on the PE for which the monitor state has changed. It removes the need for spinlock code to include an SEV instruction after clearing a spinlock.

Part F

The AArch32 Instruction Sets

Chapter F1

The AArch32 Instruction Sets Overview

This chapter describes the T32 and A32 instruction sets. It contains the following sections:

- *Unified Assembler Language* on page F1-2380.
- *Branch instructions* on page F1-2382.
- *Data-processing instructions* on page F1-2383.
- *Status register access instructions* on page F1-2391.
- *Load/store instructions* on page F1-2392.
- *Load/store multiple instructions* on page F1-2394.
- *Miscellaneous instructions* on page F1-2395.
- *Exception-generating and exception-handling instructions* on page F1-2396.
- *Coprocessor instructions* on page F1-2397.
- *Advanced SIMD and floating-point load/store instructions* on page F1-2398.
- *Advanced SIMD and floating-point register transfer instructions* on page F1-2400.
- *Advanced SIMD data-processing instructions* on page F1-2401.
- *Floating-point data-processing instructions* on page F1-2408.

F1.1 Unified Assembler Language

This document uses the ARM *Unified Assembler Language* (UAL). This assembly language syntax provides a canonical form for all T32 and A32 instructions.

UAL describes the syntax for the mnemonic and the operands of each instruction. In addition, it assumes that instructions and data items can be given labels. It does not specify the syntax to be used for labels, nor what assembler directives and options are available. See your assembler documentation for these details.

Most earlier ARM assembly language mnemonics are still supported as synonyms, as described in the instruction details.

———— **Note** —————

Most earlier T32 assembly language mnemonics are *not* supported.

UAL includes *instruction selection* rules that specify which instruction encoding is selected when more than one can provide the required functionality. For example, both 16-bit and 32-bit encodings exist for an ADD R0, R1, R2 instruction. The most common instruction selection rule is that when both a 16-bit encoding and a 32-bit encoding are available, the 16-bit encoding is selected, to optimize code density.

Syntax options exist to override the normal instruction selection rules and ensure that a particular encoding is selected. These are useful when disassembling code, to ensure that subsequent assembly produces the original code, and in some other situations.

F1.1.1 Conditional instructions

For maximum portability of UAL assembly language between the T32 and A32 instruction sets, ARM recommends that:

- IT instructions are written before conditional instructions in the correct way for the T32 instruction set.
- When assembling to the A32 instruction set, assemblers check that any IT instructions are correct, but do not generate any code for them.

Although other T32 instructions are unconditional, all instructions that are made conditional by an IT instruction must be written with a condition. These conditions must match the conditions imposed by the IT instruction. For example, an ITTEE EQ instruction imposes the EQ condition on the first two following instructions, and the NE condition on the next two. Those four instructions must be written with EQ, EQ, NE and NE conditions respectively.

Some instructions cannot be made conditional by an IT instruction. Some instructions can be conditional if they are the last instruction in the IT block, but not otherwise.

The branch instruction encodings that include a condition code field cannot be made conditional by an IT instruction. If the assembler syntax indicates a conditional branch that correctly matches a preceding IT instruction, it is assembled using a branch instruction encoding that does not include a condition code field.

F1.1.2 Use of labels in UAL instruction syntax

The UAL syntax for some instructions includes the label of an instruction or a literal data item that is at a fixed offset from the instruction being specified. The assembler must:

1. Calculate the PC or `Align(PC, 4)` value of the instruction. The PC value of an instruction is its address plus 4 for a T32 instruction, or plus 8 for an A32 instruction. The `Align(PC, 4)` value of an instruction is its PC value ANDed with `0xFFFFF0` to force it to be word-aligned. There is no difference between the PC and `Align(PC, 4)` values for an A32 instruction, but there can be for a T32 instruction.
2. Calculate the offset from the PC or `Align(PC, 4)` value of the instruction to the address of the labelled instruction or literal data item.
3. Assemble a *PC-relative* encoding of the instruction, that is, one that reads its PC or `Align(PC, 4)` value and adds the calculated offset to form the required address.

———— **Note** ————

For instructions that can encode a subtraction operation, if the instruction cannot encode the calculated offset but can encode minus the calculated offset, the instruction encoding specifies a subtraction of minus the calculated offset.

The syntax of the following instructions includes a label:

- B, BL, and BLX (immediate). The assembler syntax for these instructions always specifies the label of the instruction that they branch to. Their encodings specify a sign-extended immediate offset that is added to the PC value of the instruction to form the target address of the branch.
- CBNZ and CBZ. The assembler syntax for these instructions always specifies the label of the instruction that they branch to. Their encodings specify a zero-extended immediate offset that is added to the PC value of the instruction to form the target address of the branch. They do not support backward branches.
- LDC, LDC2, LDR, LDRB, LDRD, LDRH, LDRSB, LDRSH, PLD, PLDW, PLI, and VLDR. The normal assembler syntax of these load instructions can specify the label of a literal data item that is to be loaded. The encodings of these instructions specify a zero-extended immediate offset that is either added to or subtracted from the `Align(PC, 4)` value of the instruction to form the address of the data item. A few such encodings perform a fixed addition or a fixed subtraction and must only be used when that operation is required, but most contain a bit that specifies whether the offset is to be added or subtracted.

When the assembler calculates an offset of 0 for the normal syntax of these instructions, it must assemble an encoding that adds 0 to the `Align(PC, 4)` value of the instruction. Encodings that subtract 0 from the `Align(PC, 4)` value cannot be specified by the normal syntax.

There is an alternative syntax for these instructions that specifies the addition or subtraction and the immediate offset explicitly. In this syntax, the label is replaced by `[PC, #+/-<imm>]`, where:

- +/- Is + or omitted to specify that the immediate offset is to be added to the `Align(PC, 4)` value, or - if it is to be subtracted.
- <imm> Is the immediate offset.

This alternative syntax makes it possible to assemble the encodings that subtract 0 from the `Align(PC, 4)` value, and to disassemble them to a syntax that can be re-assembled correctly.

- ADR. The normal assembler syntax for this instruction can specify the label of an instruction or literal data item whose address is to be calculated. Its encoding specifies a zero-extended immediate offset that is either added to or subtracted from the `Align(PC, 4)` value of the instruction to form the address of the data item, and some opcode bits that determine whether it is an addition or subtraction.

When the assembler calculates an offset of 0 for the normal syntax of this instruction, it must assemble the encoding that adds 0 to the `Align(PC, 4)` value of the instruction. The encoding that subtracts 0 from the `Align(PC, 4)` value cannot be specified by the normal syntax.

There is an alternative syntax for this instruction that specifies the addition or subtraction and the immediate value explicitly, by writing them as additions `ADD <Rd>, PC, #<imm>` or subtractions `SUB <Rd>, PC, #<imm>`. This alternative syntax makes it possible to assemble the encoding that subtracts 0 from the `Align(PC, 4)` value, and to disassemble it to a syntax that can be re-assembled correctly.

———— **Note** ————

ARM recommends that where possible, software avoids using:

- The alternative syntax for the ADR, LDC, LDC2, LDR, LDRB, LDRD, LDRH, LDRSB, LDRSH, PLD, PLI, PLDW, and VLDR instructions.
- The encodings of these instructions that subtract 0 from the `Align(PC, 4)` value.

F1.2 Branch instructions

Table F1-1 summarizes the branch instructions in the T32 and A32 instruction sets. In addition to providing for changes in the flow of execution, some branch instructions can change instruction set.

Table F1-1 Branch instructions

Instruction	See	Range, T32	Range, A32
Branch to target address	B on page F7-2566	±16MB	±32MB
Compare and Branch on Nonzero, Compare and Branch on Zero	CBNZ, CBZ on page F7-2581	0-126 bytes	a
Call a subroutine	BL, BLX (immediate) on page F7-2576	±16MB	±32MB
Call a subroutine, change instruction set ^b	BL, BLX (immediate) on page F7-2576	±16MB	±32MB
Call a subroutine, optionally change instruction set	BLX (register) on page F7-2578	Any	Any
Branch to target address, change instruction set	BX on page F7-2579	Any	Any
Change to Jazelle state	BXJ on page F7-2580	-	-
Table Branch (byte offsets)	TBB, TBH on page F7-2940	0-510 bytes	a
Table Branch (halfword offsets)		0-131070 bytes	

a. These instructions do not exist in the A32 instruction set.

b. The range is determined by the instruction set of the BLX instruction, not of the instruction it branches to.

Branches to loaded and calculated addresses can be performed by LDR, LDM and data-processing instructions. For details see [Load/store instructions on page F1-2392](#), [Load/store multiple instructions on page F1-2394](#), [Standard data-processing instructions on page F1-2383](#), and [Shift instructions on page F1-2385](#).

In addition to the branch instructions shown in Table F1-1:

- In the A32 instruction set, a data-processing instruction that targets the PC behaves as a branch instruction. For more information, see [Data-processing instructions on page F1-2383](#).
- In the T32 and A32 instruction sets, a load instruction that targets the PC behaves as a branch instruction. For more information, see [Load/store instructions on page F1-2392](#).

F1.3 Data-processing instructions

Core data-processing instructions belong to one of the following groups:

- [Standard data-processing instructions](#).
 These instructions perform basic data-processing operations, and share a common format with some variations.
- [Shift instructions on page F1-2385](#).
- [Multiply instructions on page F1-2385](#).
- [Saturating instructions on page F1-2387](#).
- [Saturating addition and subtraction instructions on page F1-2387](#).
- [Packing and unpacking instructions on page F1-2388](#).
- [Parallel addition and subtraction instructions on page F1-2389](#).
- [Divide instructions on page F1-2390](#).
- [Miscellaneous data-processing instructions on page F1-2390](#).

For extension data-processing instructions, see [Advanced SIMD data-processing instructions on page F1-2401](#) and [Floating-point data-processing instructions on page F1-2408](#).

F1.3.1 Standard data-processing instructions

These instructions generally have a destination register Rd, a first operand register Rn, and a second operand. The second operand can be another register Rm, or an immediate constant.

If the second operand is an immediate constant, it can be:

- Encoded directly in the instruction.
- A *modified immediate constant* that uses 12 bits of the instruction to encode a range of constants. T32 and A32 instructions have slightly different ranges of modified immediate constants. For more information, see [Modified immediate constants in T32 instructions on page F3-2444](#) and [Modified immediate constants in A32 instructions on page F4-2472](#).

If the second operand is another register, it can optionally be shifted in any of the following ways:

LSL	Logical Shift Left by 1-31 bits.
LSR	Logical Shift Right by 1-32 bits.
ASR	Arithmetic Shift Right by 1-32 bits.
ROR	Rotate Right by 1-31 bits.
RRX	Rotate Right with Extend. For details see Shift and rotate operations on page E1-2290 .

In T32 code, the amount to shift by is always a constant encoded in the instruction. In A32 code, the amount to shift by is either a constant encoded in the instruction, or the value of a register, Rs.

For instructions other than CMN, CMP, TEQ, and TST, the result of the data-processing operation is placed in the destination register. In the A32 instruction set, the destination register can be the PC, causing the result to be treated as a branch address. In the T32 instruction set, this is only permitted for some 16-bit forms of the ADD and MOV instructions.

These instructions can optionally set the condition flags, according to the result of the operation. If they do not set the flags, existing flag settings from a previous instruction are preserved.

[Table F1-2 on page F1-2384](#) summarizes the main data-processing instructions in the T32 and A32 instruction sets. Generally, each of these instructions is described in three sections in [Chapter F2 About the T32 and A32 Instruction Descriptions](#), one section for each of the following:

- INSTRUCTION (immediate) where the second operand is a modified immediate constant.
- INSTRUCTION (register) where the second operand is a register, or a register shifted by a constant.
- INSTRUCTION (register-shifted register) where the second operand is a register shifted by a value obtained from another register. These are only available in the A32 instruction set.

Table F1-2 Standard data-processing instructions

Instruction	Mnemonic	Notes
Add with Carry	ADC	-
Add	ADD	T32 instruction set permits use of a modified immediate constant or a zero-extended 12-bit immediate constant.
Form PC-relative Address	ADR	First operand is the PC. Second operand is an immediate constant. T32 instruction set uses a zero-extended 12-bit immediate constant. Operation is an addition or a subtraction.
Bitwise AND	AND	-
Bitwise Bit Clear	BIC	-
Compare Negative	CMN	Sets flags. Like ADD but with no destination register.
Compare	CMP	Sets flags. Like SUB but with no destination register.
Bitwise Exclusive OR	EOR	-
Copy operand to destination	MOV	Has only one operand, with the same options as the second operand in most of these instructions. If the operand is a shifted register, the instruction is an LSL, LSR, ASR, or ROR instruction instead. For details see Shift instructions on page F1-2385 . The T32 and A32 instruction sets permit use of a modified immediate constant or a zero-extended 16-bit immediate constant.
Bitwise NOT	MVN	Has only one operand, with the same options as the second operand in most of these instructions.
Bitwise OR NOT	ORN	Not available in the A32 instruction set.
Bitwise OR	ORR	-
Reverse Subtract	RSB	Subtracts first operand from second operand. This permits subtraction from constants and shifted registers.
Reverse Subtract with Carry	RSC	Not available in the T32 instruction set.
Subtract with Carry	SBC	-
Subtract	SUB	T32 instruction set permits use of a modified immediate constant or a zero-extended 12-bit immediate constant.
Test Equivalence	TEQ	Sets flags. Like EOR but with no destination register.
Test	TST	Sets flags. Like AND but with no destination register.

F1.3.2 Shift instructions

Table F1-3 lists the shift instructions in the T32 and A32 instruction sets.

Table F1-3 Shift instructions

Instruction	See
Arithmetic Shift Right	<i>ASR (immediate)</i> on page F7-2562
Arithmetic Shift Right	<i>ASR (register)</i> on page F7-2564
Logical Shift Left	<i>LSL (immediate)</i> on page F7-2692
Logical Shift Left	<i>LSL (register)</i> on page F7-2694
Logical Shift Right	<i>LSR (immediate)</i> on page F7-2696
Logical Shift Right	<i>LSR (register)</i> on page F7-2698
Rotate Right	<i>ROR (immediate)</i> on page F7-2776
Rotate Right	<i>ROR (register)</i> on page F7-2778
Rotate Right with Extend	<i>RRX</i> on page F7-2780

In the A32 instruction set only, the destination register of these instructions can be the PC, causing the result to be treated as an address to branch to.

F1.3.3 Multiply instructions

These instructions can operate on signed or unsigned quantities. In some types of operation, the results are the same whether the operands are signed or unsigned.

- [Table F1-4](#) summarizes the multiply instructions where there is no distinction between signed and unsigned quantities.
The least significant 32 bits of the result are used. More significant bits are discarded.
- [Table F1-5 on page F1-2386](#) summarizes the signed multiply instructions.
- [Table F1-6 on page F1-2386](#) summarizes the unsigned multiply instructions.

Table F1-4 General multiply instructions

Instruction	See	Operation (number of bits)
Multiply Accumulate	<i>MLA</i> on page F7-2704	$32 = 32 + 32 \times 32$
Multiply and Subtract	<i>MLS</i> on page F7-2706	$32 = 32 - 32 \times 32$
Multiply	<i>MUL</i> on page F7-2726	$32 = 32 \times 32$

Table F1-5 Signed multiply instructions

Instruction	See	Operation (number of bits)
Signed Multiply Accumulate (halfwords)	SMLABB , SMLABT , SMLATB , SMLATT on page F7-2812	$32 = 32 + 16 \times 16$
Signed Multiply Accumulate Dual	SMLAD on page F7-2814	$32 = 32 + 16 \times 16 + 16 \times 16$
Signed Multiply Accumulate Long	SMLAL on page F7-2816	$64 = 64 + 32 \times 32$
Signed Multiply Accumulate Long (halfwords)	SMLALBB , SMLALBT , SMLALTB , SMLALTT on page F7-2818	$64 = 64 + 16 \times 16$
Signed Multiply Accumulate Long Dual	SMLALD on page F7-2820	$64 = 64 + 16 \times 16 + 16 \times 16$
Signed Multiply Accumulate (word by halfword)	SMLAWB , SMLAWT on page F7-2822	$32 = 32 + 32 \times 16^a$
Signed Multiply Subtract Dual	SMLSD on page F7-2824	$32 = 32 + 16 \times 16 - 16 \times 16$
Signed Multiply Subtract Long Dual	SMLS LD on page F7-2826	$64 = 64 + 16 \times 16 - 16 \times 16$
Signed Most Significant Word Multiply Accumulate	SMMLA on page F7-2828	$32 = 32 + 32 \times 32^b$
Signed Most Significant Word Multiply Subtract	SMMLS on page F7-2830	$32 = 32 - 32 \times 32^b$
Signed Most Significant Word Multiply	SMMUL on page F7-2832	$32 = 32 \times 32^b$
Signed Dual Multiply Add	SMUAD on page F7-2834	$32 = 16 \times 16 + 16 \times 16$
Signed Multiply (halfwords)	SMULBB , SMULBT , SMULTB , SMULTT on page F7-2836	$32 = 16 \times 16$
Signed Multiply Long	SMULL on page F7-2838	$64 = 32 \times 32$
Signed Multiply (word by halfword)	SMULWB , SMULWT on page F7-2840	$32 = 32 \times 16^a$
Signed Dual Multiply Subtract	SMUSD on page F7-2842	$32 = 16 \times 16 - 16 \times 16$

a. The most significant 32 bits of the 48-bit product are used. Less significant bits are discarded.

b. The most significant 32 bits of the 64-bit product are used. Less significant bits are discarded.

Table F1-6 Unsigned multiply instructions

Instruction	See	Operation (number of bits)
Unsigned Multiply Accumulate Accumulate Long	UMAAL on page F7-2978	$64 = 32 + 32 + 32 \times 32$
Unsigned Multiply Accumulate Long	UMLAL on page F7-2980	$64 = 64 + 32 \times 32$
Unsigned Multiply Long	UMULL on page F7-2982	$64 = 32 \times 32$

F1.3.4 Saturating instructions

Table F1-7 lists the saturating instructions in the T32 and A32 instruction sets. For more information, see [Pseudocode details of saturation on page E1-2293](#).

Table F1-7 Saturating instructions

Instruction	See	Operation
Signed Saturate	SSAT on page F7-2844	Saturates optionally shifted 32-bit value to selected range
Signed Saturate 16	SSAT16 on page F7-2846	Saturates two 16-bit values to selected range
Unsigned Saturate	USAT on page F7-3000	Saturates optionally shifted 32-bit value to selected range
Unsigned Saturate 16	USAT16 on page F7-3002	Saturates two 16-bit values to selected range

F1.3.5 Saturating addition and subtraction instructions

Table F1-8 lists the saturating addition and subtraction instructions in the T32 and A32 instruction sets. For more information, see [Pseudocode details of saturation on page E1-2293](#).

Table F1-8 Saturating addition and subtraction instructions

Instruction	See	Operation
Saturating Add	QADD on page F7-2762	Add, saturating result to the 32-bit signed integer range
Saturating Subtract	QSUB on page F7-2769	Subtract, saturating result to the 32-bit signed integer range
Saturating Double and Add	QDADD on page F7-2766	Doubles one value and adds a second value, saturating the doubling and the addition to the 32-bit signed integer range
Saturating Double and Subtract	QDSUB on page F7-2767	Doubles one value and subtracts the result from a second value, saturating the doubling and the subtraction to the 32-bit signed integer range

F1.3.6 Packing and unpacking instructions

Table F1-9 lists the packing and unpacking instructions in the T32 and A32 instruction sets. These are all available from ARMv6T2 in the T32 instruction set, and from ARMv6 onwards in the A32 instruction set.

Table F1-9 Packing and unpacking instructions

Instruction	See	Operation
Pack Halfword	PKH on page F7-2744	Combine halfwords
Signed Extend and Add Byte	SXTAB on page F7-2928	Extend 8 bits to 32 and add
Signed Extend and Add Byte 16	SXTAB16 on page F7-2930	Dual extend 8 bits to 16 and add
Signed Extend and Add Halfword	SXTAH on page F7-2932	Extend 16 bits to 32 and add
Signed Extend Byte	SXTB on page F7-2934	Extend 8 bits to 32
Signed Extend Byte 16	SXTB16 on page F7-2936	Dual extend 8 bits to 16
Signed Extend Halfword	SXTH on page F7-2938	Extend 16 bits to 32
Unsigned Extend and Add Byte	UXTAB on page F7-3010	Extend 8 bits to 32 and add
Unsigned Extend and Add Byte 16	UXTAB16 on page F7-3012	Dual extend 8 bits to 16 and add
Unsigned Extend and Add Halfword	UXTAH on page F7-3014	Extend 16 bits to 32 and add
Unsigned Extend Byte	UXTB on page F7-3016	Extend 8 bits to 32
Unsigned Extend Byte 16	UXTB16 on page F7-3018	Dual extend 8 bits to 16
Unsigned Extend Halfword	UXTH on page F7-3020	Extend 16 bits to 32

F1.3.7 Parallel addition and subtraction instructions

These instructions perform additions and subtractions on the values of two registers and write the result to a destination register, treating the register values as sets of two halfwords or four bytes. That is, they perform SIMD additions or subtractions on the registers. They are available in ARMv6 and above.

These instructions consist of a prefix followed by a main instruction mnemonic. The prefixes are as follows:

S	Signed arithmetic modulo 2^8 or 2^{16} .
Q	Signed saturating arithmetic.
SH	Signed arithmetic, halving the results.
U	Unsigned arithmetic modulo 2^8 or 2^{16} .
UQ	Unsigned saturating arithmetic.
UH	Unsigned arithmetic, halving the results.

The main instruction mnemonics are as follows:

ADD16	Adds the top halfwords of two operands to form the top halfword of the result, and the bottom halfwords of the same two operands to form the bottom halfword of the result.
ASX	Exchanges halfwords of the second operand, and then adds top halfwords and subtracts bottom halfwords.
SAX	Exchanges halfwords of the second operand, and then subtracts top halfwords and adds bottom halfwords.
SUB16	Subtracts each halfword of the second operand from the corresponding halfword of the first operand to form the corresponding halfword of the result.
ADD8	Adds each byte of the second operand to the corresponding byte of the first operand to form the corresponding byte of the result.
SUB8	Subtracts each byte of the second operand from the corresponding byte of the first operand to form the corresponding byte of the result.

The instruction set permits all 36 combinations of prefix and main instruction operand, as [Table F1-10](#) shows.

See also [Advanced SIMD parallel addition and subtraction on page F1-2402](#).

Table F1-10 Parallel addition and subtraction instructions

Main instruction	Signed	Saturating	Signed halving	Unsigned	Unsigned saturating	Unsigned halving
ADD16, add, two halfwords	SADD16	QADD16	SHADD16	UADD16	UQADD16	UHADD16
ASX, add and subtract with exchange	SASX	QASX	SHASX	UASX	UQASX	UHASX
SAX, subtract and add with exchange	SSAX	QSAX	SHSAX	USAX	UQSAX	UHSAX
SUB16, subtract, two halfwords	SSUB16	QSUB16	SHSUB16	USUB16	UQSUB16	UHSUB16
ADD8, add, four bytes	SADD8	QADD8	SHADD8	UADD8	UQADD8	UHADD8
SUB8, subtract, four C.bytes	SSUB8	QSUB8	SHSUB8	USUB8	UQSUB8	UHSUB8

F1.3.8 Divide instructions

In ARMv8, signed and unsigned integer divide instructions are included in both the T32 instruction set and the A32 instruction set. For more information about their implementation in previous versions of the ARM architecture see the *ARM® Architecture Reference Manual, ARMv7-A and ARMv7-R edition*.

For descriptions of the instructions see:

- [SDIV on page F7-2800](#).
- [UDIV on page F7-2964](#).

For the SDIV and UDIV instructions, divide-by-zero always returns a zero result.

The `ID_ISAR0.Divide_instrs` field indicates the level of support for these instructions. The field value of `0b0010` indicates they are implemented in both the T32 and A32 instruction sets.

F1.3.9 Miscellaneous data-processing instructions

[Table F1-11](#) lists the miscellaneous data-processing instructions in the T32 and A32 instruction sets. Immediate values in these instructions are simple binary numbers.

Table F1-11 Miscellaneous data-processing instructions

Instruction	See	Notes
Bit Field Clear	BFC on page F7-2568	-
Bit Field Insert	BFI on page F7-2569	-
Count Leading Zeros	CLZ on page F7-2585	-
Move Top	MOVT on page F7-2714	Moves 16-bit immediate value to top halfword. Bottom halfword unchanged.
Reverse Bits	RBIT on page F7-2772	-
Byte-Reverse Word	REV on page F7-2773	-
Byte-Reverse Packed Halfword	REV16 on page F7-2774	-
Byte-Reverse Signed Halfword	REVSH on page F7-2775	-
Signed Bit Field Extract	SBFX on page F7-2798	-
Select Bytes using GE flags	SEL on page F7-2802	-
Unsigned Bit Field Extract	UBFX on page F7-2960	-
Unsigned Sum of Absolute Differences	USAD8 on page F7-2996	-
Unsigned Sum of Absolute Differences and Accumulate	USADA8 on page F7-2998	-

F1.4 Status register access instructions

The MRS and MSR instructions move the contents of the *Application Program Status Register* (APSR) to or from a general-purpose register, see:

- [MRS on page F7-2720](#).
- [MSR \(immediate\) on page F7-2722](#).
- [MSR \(register\) on page F7-2724](#).

[The Application Program Status Register \(APSR\) on page E1-2297](#) described the APSR.

The condition flags in the APSR are normally set by executing data-processing instructions, and normally control the execution of conditional instructions. However, software can set the condition flags explicitly using the MSR instruction, and can read the current state of the condition flags explicitly using the MRS instruction.

At system level, software can also:

- Use these instructions to access the [SPSR](#) of the current mode.
- Use the CPS instruction to change the [CPSR.M](#) field and the [CPSR.{A, I, F}](#) interrupt mask bits.

For details of the system level use of status register access instructions CPS, MRS, and MSR, see:

- [CPS \(T32\) on page F7-3034](#).
- [CPS \(A32\) on page F7-3036](#).
- [MRS on page F7-3046](#).
- [MSR \(immediate\) on page F7-3052](#).
- [MSR \(register\) on page F7-3054](#).

F1.4.1 Banked register access instructions

In all privileged modes, the MRS (Banked register) and MSR (Banked register) instructions move the contents of a Banked general-purpose register, the [SPSR](#), or the [ELR_hyp](#), to or from a general-purpose register. For instruction descriptions see:

- [MRS \(Banked register\) on page F7-3048](#).
- [MSR \(Banked register\) on page F7-3050](#).

———— **Note** —————

These are system level instructions.

F1.5 Load/store instructions

Table F1-12 summarizes the general-purpose register load/store instructions in the T32 and A32 instruction sets. Some of these instructions can also operate on the PC. See also:

- [Load/store multiple instructions on page F1-2394.](#)
- [Advanced SIMD and floating-point load/store instructions on page F1-2398.](#)

Load/store instructions have several options for addressing memory. For more information, see [Addressing modes on page F1-2393.](#)

Table F1-12 Load/store instructions

Data type	Load	Store	Load unprivileged	Store unprivileged	Load-Exclusive	Store-Exclusive
32-bit word	LDR	STR	LDRT	STRT	LDREX	STREX
16-bit halfword	-	STRH	-	STRHT	-	STREXH
16-bit unsigned halfword	LDRH	-	LDRHT	-	LDREXH	-
16-bit signed halfword	LDRSH	-	LDRSHT	-	-	-
8-bit byte	-	STRB	-	STRBT	-	STREXB
8-bit unsigned byte	LDRB	-	LDRBT	-	LDREXB	-
8-bit signed byte	LDRSB	-	LDRSBT	-	-	-
Two 32-bit words	LDRD	STRD	-	-	-	-
64-bit doubleword	-	-	-	-	LDREXD	STREXD

F1.5.1 Loads to the PC

The LDR instruction can load a value into the PC. The value loaded is treated as an interworking address, as described by the `LoadWritePC()` pseudocode function in [Pseudocode details of operations on the AArch32 general-purpose registers and the PC on page E1-2296.](#)

F1.5.2 Halfword and byte loads and stores

Halfword and byte stores store the least significant halfword or byte from the register, to 16 or 8 bits of memory respectively. There is no distinction between signed and unsigned stores.

Halfword and byte loads load 16 or 8 bits from memory into the least significant halfword or byte of a register. Unsigned loads zero-extend the loaded value to 32 bits, and signed loads sign-extend the value to 32 bits.

F1.5.3 Load unprivileged and Store unprivileged

When executing at EL0, a Load unprivileged or Store unprivileged instruction operates in exactly the same way as the corresponding ordinary load or store instruction. For example, an LDRT instruction executes in exactly the same way as the equivalent LDR instruction. When executed at EL1, Load unprivileged and Store unprivileged instructions behave as they would if they were executed at EL0. For example, an LDRT instruction executes in exactly the way that the equivalent LDR instruction would execute at EL0. In particular, the instructions make unprivileged memory accesses.

The Load unprivileged and Store unprivileged instructions are UNPREDICTABLE if executed at EL2.

For more information, see [Access permissions on page G3-3609.](#)

F1.5.4 Exclusive loads and stores

Exclusive loads and stores provide shared memory synchronization. For more information, see [Synchronization and semaphores](#) on page E2-2369.

F1.5.5 Addressing modes

The address for a load or store is formed from two parts: a value from a base register, and an offset.

The base register can be any one of the general-purpose registers R0-R12, SP, or LR.

For loads, the base register can be the PC. This permits PC-relative addressing for position-independent code. Instructions marked (literal) in their title in [Chapter F2 About the T32 and A32 Instruction Descriptions](#) are PC-relative loads.

The offset takes one of three formats:

- | | |
|------------------------|--|
| Immediate | The offset is an unsigned number that can be added to or subtracted from the base register value. Immediate offset addressing is useful for accessing data elements that are a fixed distance from the start of the data object, such as structure fields, stack offsets and input/output registers. |
| Register | The offset is a value from a general-purpose register. The value can be added to, or subtracted from, the base register value. Register offsets are useful for accessing arrays or blocks of data. |
| Scaled register | The offset is a general-purpose register, shifted by an immediate value, then added to or subtracted from the base register. This means an array index can be scaled by the size of each array element. |

The offset and base register can be used in three different ways to form the memory address. The addressing modes are described as follows:

- | | |
|---------------------|--|
| Offset | The offset is added to or subtracted from the base register to form the memory address. |
| Pre-indexed | The offset is added to or subtracted from the base register to form the memory address. The base register is then updated with this new address, to permit automatic indexing through an array or memory block. |
| Post-indexed | The value of the base register alone is used as the memory address. The offset is then added to or subtracted from the base register. The result is stored back in the base register, to permit automatic indexing through an array or memory block. |

Note

Not every variant is available for every instruction, and the range of permitted immediate values and the options for scaled registers vary from instruction to instruction. See [Chapter F2 About the T32 and A32 Instruction Descriptions](#) for full details for each instruction.

F1.6 Load/store multiple instructions

Load Multiple instructions load from memory a subset, or possibly all, of the general-purpose registers and the PC.

Store Multiple instructions store to memory a subset, or possibly all, of the general-purpose registers.

The memory locations are consecutive word-aligned words. The addresses used are obtained from a base register, and can be either above or below the value in the base register. The base register can optionally be updated by the total size of the data transferred.

Table F1-13 summarizes the load/store multiple instructions in the T32 and A32 instruction sets.

Table F1-13 Load/store multiple instructions

Instruction	See
Load Multiple, Increment After or Full Descending	<i>LDM/LDMIA/LDMFD (T32)</i> on page F7-2624 <i>LDM/LDMIA/LDMFD (A32)</i> on page F7-2626
Load Multiple, Decrement After or Full Ascending ^a	<i>LDMDA/LDMFA</i> on page F7-2628
Load Multiple, Decrement Before or Empty Ascending	<i>LDMDB/LDMEA</i> on page F7-2630
Load Multiple, Increment Before or Empty Descending ^a	<i>LDMIB/LDMED</i> on page F7-2632
Pop multiple registers off the stack ^b	<i>POP (T32)</i> on page F7-2756 <i>POP (A32)</i> on page F7-2758
Push multiple registers onto the stack ^c	<i>PUSH</i> on page F7-2760
Store Multiple, Increment After or Empty Ascending	<i>STM (STMIA, STMFA)</i> on page F7-2870
Store Multiple, Decrement After or Empty Descending ^a	<i>STMDA (STMED)</i> on page F7-2872
Store Multiple, Decrement Before or Full Descending	<i>STMDB (STMFD)</i> on page F7-2874
Store Multiple, Increment Before or Full Ascending ^a	<i>STMIB (STMFA)</i> on page F7-2876

a. Not available in the T32 instruction set.

b. This instruction is equivalent to an LDM instruction with the SP as base register, and base register updating.

c. This instruction is equivalent to an STMDB instruction with the SP as base register, and base register updating.

When executing at EL1, variants of the LDM and STM instructions load and store User mode registers. Another system level variant of the LDM instruction performs an exception return.

F1.6.1 Loads to the PC

The LDM, LDMDA, LDMDB, LDMIB, and POP instructions can load a value into the PC. The value loaded is treated as an interworking address, as described by the LoadWritePC() pseudocode function in *Pseudocode details of operations on the AArch32 general-purpose registers and the PC* on page E1-2296.

F1.7 Miscellaneous instructions

Table F1-14 summarizes the miscellaneous instructions in the T32 and A32 instruction sets.

Table F1-14 Miscellaneous instructions

Instruction	See
Clear-Exclusive	<i>CLREX</i> on page F7-2584
Debug Hint	<i>DBG</i> on page F7-2596
Data Memory Barrier	<i>DMB</i> on page F7-2598
Data Synchronization Barrier	<i>DSB</i> on page F7-2600
Instruction Synchronization Barrier	<i>ISB</i> on page F7-2609
If-Then	<i>IT</i> on page F7-2610
No Operation	<i>NOP</i> on page F7-2734
Preload Data	<i>PLD, PLDW (immediate)</i> on page F7-2746 <i>PLD (literal)</i> on page F7-2748 <i>PLD, PLDW (register)</i> on page F7-2750
Preload Instruction	<i>PLI (immediate, literal)</i> on page F7-2752 <i>PLI (register)</i> on page F7-2754
Set Endianness	<i>SETEND</i> on page F7-2803
Send Event	<i>SEV</i> on page F7-2804
Wait For Event	<i>WFE</i> on page F7-3022
Wait For Interrupt	<i>WFI</i> on page F7-3024
Yield	<i>YIELD</i> on page F7-3026

F1.7.1 The Yield instruction

In a *Symmetric Multi-Threading* (SMT) design, a thread can use the YIELD instruction to give a hint to the PE that it is running on. The YIELD hint indicates that whatever the thread is currently doing is of low importance, and so could yield. For example, the thread might be sitting in a spin-lock. A similar use might be in modifying the arbitration priority of the snoop bus in a multiprocessor (MP) system. Defining such an instruction permits binary compatibility between SMT and SMP systems.

AArch32 state defines a YIELD instruction as a specific NOP (No Operation) hint instruction.

The YIELD instruction has no effect in a single-threaded system, but developers of such systems can use the instruction to flag its intended use on migration to a multiprocessor or multithreading system. Operating systems can use YIELD in places where a yield hint is wanted, knowing that it will be treated as a NOP if there is no implementation benefit.

F1.8 Exception-generating and exception-handling instructions

The following instructions are intended specifically to cause a synchronous exception to occur:

- The SVC instruction generates a Supervisor Call exception. For more information, see [Supervisor Call \(SVC\) exception on page G1-3479](#).
- The Breakpoint instruction BKPT provides software breakpoints. For more information, see [About Debug state on page H2-4328](#).
- In an implementation that includes EL3, when executing at EL1 or higher, the SMC instruction generates a Secure Monitor Call exception. For more information, see [Secure Monitor Call \(SMC\) exception on page G1-3480](#).
- In an implementation that includes EL2, in software executing in a Non-secure EL1 mode, the HVC instruction generates a Hypervisor Call exception. For more information, see [Hypervisor Call \(HVC\) exception on page G1-3481](#).

For an exception taken to a EL1 mode:

- The system level variants of the SUBS and LDM instructions perform a return from an exception.

———— **Note** ————

The variants of SUBS include MOV_S. See the references to SUBS PC, LR in [Table F1-15](#) for more information.

- From ARMv6, the SRS instruction can be used near the start of the handler, to store return information. The RFE instruction can then perform a return from the exception using the stored return information.

In an implementation that includes EL2, the ERET instruction performs a return from an exception taken to Hyp mode.

For more information, see [Exception return to an Exception level using AArch32 on page G1-3454](#).

[Table F1-15](#) summarizes the instructions, in the T32 and A32 instruction sets, for generating or handling an exception. Except for BKPT and SVC, these are system level instructions.

Table F1-15 Exception-generating and exception-handling instructions

Instruction	See
Supervisor Call	SVC (previously SWI) on page F7-2926
Breakpoint	BKPT on page F7-2575
Secure Monitor Call	SMC (previously SMI) on page F7-3058
Return From Exception	RFE on page F7-3056
Subtract (exception return)	SUBS PC, LR and related instructions (T32) on page F7-3066 SUBS PC, LR and related instructions (A32) on page F7-3068
Hypervisor Call	HVC on page F7-3040
Exception Return	ERET on page F7-3038
Load Multiple (exception return)	LDM (exception return) on page F7-3042
Store Return State	SRS (T32) on page F7-3060 SRS (A32) on page F7-3062

F1.9 Coprocessor instructions

There are three types of instruction for communicating with conceptual coprocessors. These permit the PE to:

- Initiate a coprocessor data-processing operation. For details see [CDP, CDP2 on page F7-2582](#).
- Transfer general-purpose registers to and from coprocessor registers. For details, see:
 - [MCR, MCR2 on page F7-2700](#).
 - [MCRR, MCRR2 on page F7-2702](#).
 - [MRC, MRC2 on page F7-2716](#).
 - [MRRC, MRRC2 on page F7-2718](#).
- Load or store the values of coprocessor registers. For details, see:
 - [LDC, LDC2 \(immediate\) on page F7-2620](#).
 - [LDC, LDC2 \(literal\) on page F7-2622](#).
 - [STC, STC2 on page F7-2854](#).

The instruction set supports up to 16 coprocessors, CP0 to CP15, with a 4-bit field in each coprocessor instruction to identify the coprocessor number.

In ARMv8 the only supported coprocessors are CP10, CP11, CP14, and CP15, and these are supported only in AArch32 state.

———— **Note** —————

Multiple coprocessors can be used together to provide a larger block of coprocessor instructions. CP10 and CP11 are used in this way.

CP10 and CP11 are used, together, for floating-point and some Advanced SIMD functionality. There are different instructions for accessing these coprocessors, of similar types to the instructions for the other coprocessors, that is, to:

- Initiate a coprocessor data-processing operation, see [Floating-point data-processing instructions on page F1-2408](#).
- Transfer general-purpose registers to and from coprocessor registers, see [Advanced SIMD and floating-point register transfer instructions on page F1-2400](#).
- Load or store the values of coprocessor registers, see [Advanced SIMD and floating-point load/store instructions on page F1-2398](#).

Coprocessor instructions are part of the instruction stream executed by the PE. Any coprocessor instruction that cannot be executed by the implemented conceptual coprocessors causes an Undefined Instruction exception. This means that, in ARMv8 AArch32 state, all coprocessor access instruction encodings for coprocessors other than CP10, CP11, CP14, and CP15 are UNALLOCATED.

F1.10 Advanced SIMD and floating-point load/store instructions

Table F1-16 summarizes the extension register load/store instructions in the Advanced SIMD and floating-point instruction sets.

Advanced SIMD also provides instructions for loading and storing multiple elements, or structures of elements, see *Element and structure load/store instructions*.

Table F1-16 Extension register load/store instructions

Instruction	See	Operation
Vector Load Multiple	VLDM on page F8-3198	Load 1-16 consecutive 64-bit registers, Advanced SIMD and floating-point. Load 1-16 consecutive 32-bit registers, floating-point only.
Vector Load Register	VLDR on page F8-3200	Load one 64-bit register, Advanced SIMD and floating-point. Load one 32-bit register, floating-point only.
Vector Store Multiple	VSTM on page F8-3372	Store 1-16 consecutive 64-bit registers, Advanced SIMD and floating-point. Store 1-16 consecutive 32-bit registers, floating-point only.
Vector Store Register	VSTR on page F8-3374	Store one 64-bit register, Advanced SIMD and floating-point. Store one 32-bit register, floating-point only.

F1.10.1 Element and structure load/store instructions

Table F1-17 shows the element and structure load/store instructions available in the Advanced SIMD instruction set. Loading and storing structures of more than one element automatically de-interleaves or interleaves the elements, see [Figure F1-1 on page F1-2399](#) for an example of de-interleaving. Interleaving is the inverse process.

Table F1-17 Element and structure load/store instructions

Instruction	See
Load single element	
Multiple elements	VLD1 (multiple single elements) on page F8-3174
To one lane	VLD1 (single element to one lane) on page F8-3176
To all lanes	VLD1 (single element to all lanes) on page F8-3178
Load 2-element structure	
Multiple structures	VLD2 (multiple 2-element structures) on page F8-3180
To one lane	VLD2 (single 2-element structure to one lane) on page F8-3182
To all lanes	VLD2 (single 2-element structure to all lanes) on page F8-3184
Load 3-element structure	
Multiple structures	VLD3 (multiple 3-element structures) on page F8-3186
To one lane	VLD3 (single 3-element structure to one lane) on page F8-3188
To all lanes	VLD3 (single 3-element structure to all lanes) on page F8-3190

Table F1-17 Element and structure load/store instructions (continued)

Instruction	See
Load 4-element structure	
Multiple structures	<i>VLD4 (multiple 4-element structures)</i> on page F8-3192
To one lane	<i>VLD4 (single 4-element structure to one lane)</i> on page F8-3194
To all lanes	<i>VLD4 (single 4-element structure to all lanes)</i> on page F8-3196
Store single element	
Multiple elements	<i>VST1 (multiple single elements)</i> on page F8-3356
From one lane	<i>VST1 (single element from one lane)</i> on page F8-3358
Store 2-element structure	
Multiple structures	<i>VST2 (multiple 2-element structures)</i> on page F8-3360
From one lane	<i>VST2 (single 2-element structure from one lane)</i> on page F8-3362
Store 3-element structure	
Multiple structures	<i>VST3 (multiple 3-element structures)</i> on page F8-3364
From one lane	<i>VST3 (single 3-element structure from one lane)</i> on page F8-3366
Store 4-element structure	
Multiple structures	<i>VST4 (multiple 4-element structures)</i> on page F8-3368
From one lane	<i>VST4 (single 4-element structure from one lane)</i> on page F8-3370

Figure F1-1 shows the de-interleaving of a VLD3.16 (multiple 3-element structures) instruction:

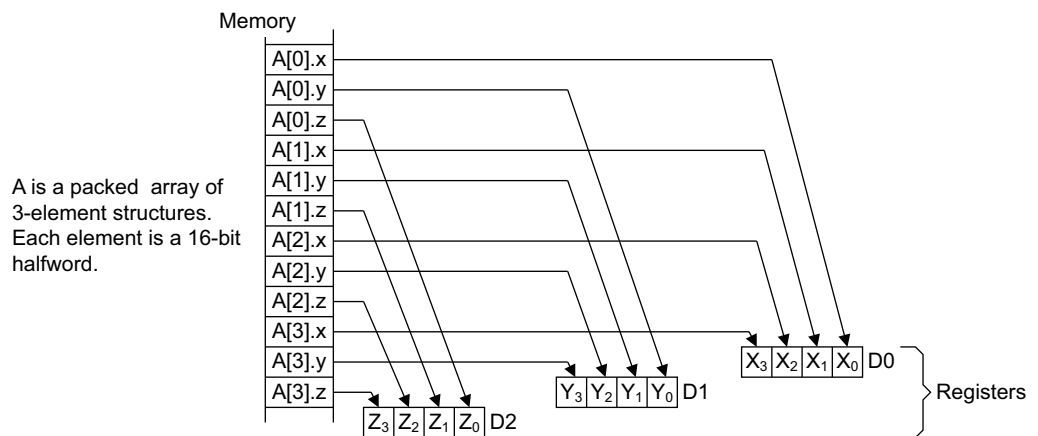

Figure F1-1 De-interleaving an array of 3-element structures

Figure F1-1 shows the VLD3.16 instruction operating to three 64-bit registers that comprise four 16-bit elements:

- Different instructions in this group would produce similar figures, but operate on different numbers of registers. For example, VLD4 and VST4 instructions operate on four registers.
- Different element sizes would produce similar figures but with 8-bit or 32-bit elements.
- These instructions operate only on doubleword (64-bit) registers.

F1.11 Advanced SIMD and floating-point register transfer instructions

Table F1-18 summarizes the extension register transfer instructions in the Advanced SIMD and floating-point instruction sets. These instructions transfer data from general-purpose registers to extension registers, or from extension registers to general-purpose registers.

Advanced SIMD vectors, and single-precision and double-precision floating-point registers, are all views of the same extension register set. For details see *The Advanced SIMD and floating-point register file* on page E1-2303.

Table F1-18 Extension register transfer instructions

Instruction	See
Copy element from general-purpose register to every element of Advanced SIMD vector	<i>VDUP (general-purpose register)</i> on page F8-3162
Copy byte, halfword, or word from general-purpose register to extension register	<i>VMOV (general-purpose register to scalar)</i> on page F8-3218
Copy byte, halfword, or word from extension register to general-purpose register	<i>VMOV (scalar to general-purpose register)</i> on page F8-3220
Copy from single-precision floating-point register to general-purpose register, or from general-purpose register to single-precision floating-point register	<i>VMOV (between general-purpose register and single-precision register)</i> on page F8-3222
Copy two words from general-purpose registers to consecutive single-precision floating-point registers, or from consecutive single-precision floating-point registers to general-purpose registers	<i>VMOV (between two general-purpose registers and two single-precision registers)</i> on page F8-3224
Copy two words from general-purpose registers to doubleword extension register, or from doubleword extension register to general-purpose registers	<i>VMOV (between two general-purpose registers and a doubleword extension register)</i> on page F8-3226
Copy from Advanced SIMD and floating-point System Register to general-purpose register	<i>VMRS</i> on page F8-3232 <i>VMRS</i> on page F7-3070 (system level view)
Copy from general-purpose register to Advanced SIMD and floating-point System Register	<i>VMSR</i> on page F8-3234 <i>VMSR</i> on page F7-3072 (system level view)

F1.12 Advanced SIMD data-processing instructions

Advanced SIMD data-processing instructions process registers containing vectors of elements of the same type packed together, enabling the same operation to be performed on multiple items in parallel.

Instructions operate on vectors held in 64-bit or 128-bit registers. [Figure F1-2](#) shows an operation on two 64-bit operand vectors, generating a 64-bit vector result.

———— **Note** ————

[Figure F1-2](#) and other similar figures show 64-bit vectors that consist of four 16-bit elements, and 128-bit vectors that consist of four 32-bit elements. Other element sizes produce similar figures, but with one, two, eight, or sixteen operations performed in parallel instead of four.

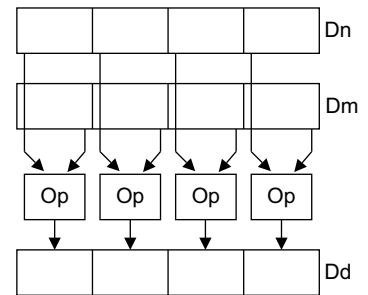

Figure F1-2 Advanced SIMD instruction operating on 64-bit registers

Many Advanced SIMD instructions have variants that produce vectors of elements double the size of the inputs. In this case, the number of elements in the result vector is the same as the number of elements in the operand vectors, but each element, and the whole vector, is double the size.

[Figure F1-3](#) shows an example of an Advanced SIMD instruction operating on 64-bit registers, and generating a 128-bit result.

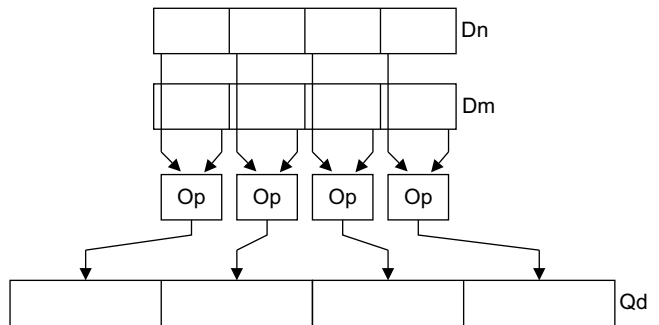

Figure F1-3 Advanced SIMD instruction producing wider result

There are also Advanced SIMD instructions that have variants that produce vectors containing elements half the size of the inputs. [Figure F1-4 on page F1-2402](#) shows an example of an Advanced SIMD instruction operating on one 128-bit register, and generating a 64-bit result.

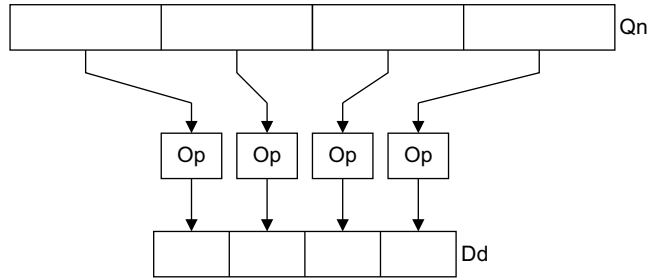

Figure F1-4 Advanced SIMD instruction producing narrower result

Some Advanced SIMD instructions do not conform to these standard patterns. Their operation patterns are described in the individual instruction descriptions.

Advanced SIMD instructions that perform floating-point arithmetic use the ARM standard floating-point arithmetic defined in *Floating-point and Advanced SIMD support* on page A1-46.

F1.12.1 Advanced SIMD parallel addition and subtraction

Table F1-19 shows the Advanced SIMD parallel add and subtract instructions.

Table F1-19 Advanced SIMD parallel add and subtract instructions

Instruction	See
Vector Add	VADD (integer) on page F8-3102 VADD (floating-point) on page F8-3104
Vector Add and Narrow, returning High Half	VADDHN on page F8-3106
Vector Add Long, Vector Add Wide	VADDL , VADDW on page F8-3108
Vector Halving Add, Vector Halving Subtract	VHADD , VHSUB on page F8-3172
Vector Pairwise Add and Accumulate Long	VPADAL on page F8-3256
Vector Pairwise Add	VPADD (integer) on page F8-3258 VPADD (floating-point) on page F8-3260
Vector Pairwise Add Long	VPADDL on page F8-3262
Vector Rounding Add and Narrow, returning High Half	VRADDHN on page F8-3300
Vector Rounding Halving Add	VRHADD on page F8-3308
Vector Rounding Subtract and Narrow, returning High Half	VRSUBHN on page F8-3334
Vector Saturating Add	VQADD on page F8-3274
Vector Saturating Subtract	VQSUB on page F8-3298
Vector Subtract	VSUB (integer) on page F8-3376 VSUB (floating-point) on page F8-3378
Vector Subtract and Narrow, returning High Half	VSUBHN on page F8-3380
Vector Subtract Long, Vector Subtract Wide	VSUBL , VSUBW on page F8-3382

F1.12.2 Bitwise Advanced SIMD data-processing instructions

Table F1-20 shows bitwise Advanced SIMD data-processing instructions. These operate on the doubleword (64-bit) or quadword (128-bit) extension registers, and there is no division into vector elements.

Table F1-20 Bitwise Advanced SIMD data-processing instructions

Instruction	See
Vector Bitwise AND	<i>VAND (register)</i> on page F8-3110
Vector Bitwise Bit Clear (AND complement)	<i>VBIC (immediate)</i> on page F8-3112 <i>VBIC (register)</i> on page F8-3114
Vector Bitwise Exclusive OR	<i>VEOR</i> on page F8-3164
Vector Bitwise Insert if False	<i>VBIF, VBIT, VBSL</i> on page F8-3116
Vector Bitwise Insert if True	
Vector Bitwise Move	<i>VMOV (immediate)</i> on page F8-3214 <i>VMOV (register)</i> on page F8-3216
Vector Bitwise NOT	<i>VMVN (immediate)</i> on page F8-3242 <i>VMVN (register)</i> on page F8-3244
Vector Bitwise OR	<i>VORR (immediate)</i> on page F8-3252 <i>VORR (register)</i> on page F8-3254
Vector Bitwise OR NOT	<i>VORN (register)</i> on page F8-3250
Vector Bitwise Select	<i>VBIF, VBIT, VBSL</i> on page F8-3116

F1.12.3 Advanced SIMD comparison instructions

Table F1-21 shows Advanced SIMD comparison instructions.

Table F1-21 Advanced SIMD comparison instructions

Instruction	See
Vector Absolute Compare	<i>VACGE, VACGT, VACLE, VACLT</i> on page F8-3100
Vector Compare Equal	<i>VCEQ (register)</i> on page F8-3118
Vector Compare Equal to Zero	<i>VCEQ (immediate #0)</i> on page F8-3120
Vector Compare Greater Than or Equal	<i>VCGE (register)</i> on page F8-3122
Vector Compare Greater Than or Equal to Zero	<i>VCGE (immediate #0)</i> on page F8-3124
Vector Compare Greater Than	<i>VCGT (register)</i> on page F8-3126
Vector Compare Greater Than Zero	<i>VCGT (immediate #0)</i> on page F8-3128
Vector Compare Less Than or Equal to Zero	<i>VCLE (immediate #0)</i> on page F8-3130
Vector Compare Less Than Zero	<i>VCLT (immediate #0)</i> on page F8-3134
Vector Test Bits	<i>VTST</i> on page F8-3390

F1.12.4 Advanced SIMD shift instructions

Table F1-22 lists the shift instructions in the Advanced SIMD instruction set.

Table F1-22 Advanced SIMD shift instructions

Instruction	See
Vector Saturating Rounding Shift Left	VQRSHL on page F8-3288
Vector Saturating Rounding Shift Right and Narrow	VQRSHRN , VQRSHRUN on page F8-3290
Vector Saturating Shift Left	VQSHL (register) on page F8-3292 VQSHL , VQSHLU (immediate) on page F8-3294
Vector Saturating Shift Right and Narrow	VQSHRN , VQSHRUN on page F8-3296
Vector Rounding Shift Left	VRSHL on page F8-3322
Vector Rounding Shift Right	VRSHR on page F8-3324
Vector Rounding Shift Right and Accumulate	VRSRA on page F8-3332
Vector Rounding Shift Right and Narrow	VRSHRN on page F8-3326
Vector Shift Left	VSHL (immediate) on page F8-3338 VSHL (register) on page F8-3340
Vector Shift Left Long	VSHLL on page F8-3342
Vector Shift Right	VSHR on page F8-3344
Vector Shift Right and Narrow	VSHRN on page F8-3346
Vector Shift Left and Insert	VSLI on page F8-3348
Vector Shift Right and Accumulate	VSRA on page F8-3352
Vector Shift Right and Insert	VSRI on page F8-3354

F1.12.5 Advanced SIMD multiply instructions

Table F1-23 summarizes the Advanced SIMD multiply instructions.

Table F1-23 Advanced SIMD multiply instructions

Instruction	See
Vector Multiply Accumulate	
Vector Multiply Accumulate Long	VMLA, VMLAL, VMLS, VMLSL (integer) on page F8-3208
Vector Multiply Subtract	VMLA, VMLS (floating-point) on page F8-3210
Vector Multiply Subtract Long	VMLA, VMLAL, VMLS, VMLSL (by scalar) on page F8-3212
Vector Multiply	VMUL, VMULL (integer and polynomial) on page F8-3236
Vector Multiply Long	VMUL (floating-point) on page F8-3238 VMUL, VMULL (by scalar) on page F8-3240
Vector Fused Multiply Accumulate	VFMA, VFMS on page F8-3168
Vector Fused Multiply Subtract	
Vector Saturating Doubling Multiply Accumulate Long	
Vector Saturating Doubling Multiply Subtract Long	VQDMLAL, VQDMLSL on page F8-3276
Vector Saturating Doubling Multiply Returning High Half	VQDMULH on page F8-3278
Vector Saturating Rounding Doubling Multiply Returning High Half	VQRDMULH on page F8-3286
Vector Saturating Doubling Multiply Long	VQDMULL on page F8-3280

Advanced SIMD multiply instructions can operate on vectors of:

- 8-bit, 16-bit, or 32-bit unsigned integers.
- 8-bit, 16-bit, or 32-bit signed integers.
- 8-bit polynomials over {0, 1}. VMUL and VMULL are the only instructions that operate on polynomials. VMULL produces a 16-bit polynomial over {0, 1}.
- Single-precision (32-bit) floating-point numbers.

They can also act on one vector and one scalar.

Long instructions have doubleword (64-bit) operands, and produce quadword (128-bit) results. Other Advanced SIMD multiply instructions can have either doubleword or quadword operands, and produce results of the same size.

Floating-point multiply instructions can operate on:

- Single-precision (32-bit) floating-point numbers.
- Double-precision (64-bit) floating-point numbers.

Some Floating-point Extension implementations do not support double-precision numbers.

F1.12.6 Miscellaneous Advanced SIMD data-processing instructions

Table F1-24 shows miscellaneous Advanced SIMD data-processing instructions.

Table F1-24 Miscellaneous Advanced SIMD data-processing instructions

Instruction	See
Vector Absolute Difference and Accumulate	VABA , VABAL on page F8-3092
Vector Absolute Difference	VABD , VABDL (integer) on page F8-3094 VABD (floating-point) on page F8-3096
Vector Absolute	VABS on page F8-3098
Vector Convert between floating-point and fixed point	VCVT (between floating-point and fixed-point, Advanced SIMD) on page F8-3146
Vector Convert between floating-point and integer	VCVT (between floating-point and integer, Advanced SIMD) on page F8-3142
Vector Convert between half-precision and single-precision	VCVT (between half-precision and single-precision, Advanced SIMD) on page F8-3151
Vector Count Leading Sign Bits	VCLS on page F8-3132
Vector Count Leading Zeros	VCLZ on page F8-3136
Vector Count Set Bits	VCNT on page F8-3140
Vector Duplicate scalar	VDUP (scalar) on page F8-3160
Vector Extract	VEXT on page F8-3166
Vector Move and Narrow	VMOVN on page F8-3230
Vector Move Long	VMOVL on page F8-3228
Vector Maximum, Minimum	VMAX , VMIN (integer) on page F8-3202 VMAX , VMIN (floating-point) on page F8-3204
Vector Negate	VNEG on page F8-3246
Vector Pairwise Maximum, Minimum	VPMAX , VPMIN (integer) on page F8-3264 VPMAX , VPMIN (floating-point) on page F8-3266
Vector Reciprocal Estimate	VRECPE on page F8-3302
Vector Reciprocal Step	VRECPS on page F8-3304
Vector Reciprocal Square Root Estimate	VRSQRTE on page F8-3328
Vector Reciprocal Square Root Step	VRSQRTS on page F8-3330
Vector Reverse	VREV16 , VREV32 , VREV64 on page F8-3306
Vector Saturating Absolute	VQABS on page F8-3272
Vector Saturating Move and Narrow	VQMOVN , VQMOVUN on page F8-3282
Vector Saturating Negate	VQNEG on page F8-3284
Vector Swap	VSWP on page F8-3384
Vector Table Lookup	VTBL , VTBX on page F8-3386

Table F1-24 Miscellaneous Advanced SIMD data-processing instructions (continued)

Instruction	See
Vector Transpose	VTRN on page F8-3388
Vector Unzip	VUZP on page F8-3392
Vector Zip	VZIP on page F8-3394

F1.13 Floating-point data-processing instructions

Table F1-25 summarizes the data-processing instructions in the floating-point instruction set.

For details of the floating-point arithmetic used by floating-point instructions, see *Floating-point and Advanced SIMD support* on page A1-46.

Table F1-25 Floating-point data-processing instructions

Instruction	See
Absolute value	<i>VABS</i> on page F8-3098
Add	<i>VADD (floating-point)</i> on page F8-3104
Compare, optionally with exceptions enabled	<i>VCMP, VCMPE</i> on page F8-3138
Convert between floating-point and integer	<i>VCVT, VCVTR (between floating-point and integer, floating-point)</i> on page F8-3144
Convert between floating-point and fixed-point	<i>VCVT (between floating-point and fixed-point, floating-point)</i> on page F8-3148
Convert between double-precision and single-precision	<i>VCVT (between double-precision and single-precision)</i> on page F8-3150
Convert between half-precision and single-precision	<i>VCVTB, VCVTT</i> on page F8-3156
Divide	<i>VDIV</i> on page F8-3158
Multiply Accumulate	<i>VMLA, VMLS (floating-point)</i> on page F8-3210
Multiply Subtract	
Fused Multiply Accumulate	<i>VFMA, VFMS</i> on page F8-3168
Fused Multiply Subtract	
Move immediate value to extension register	<i>VMOV (immediate)</i> on page F8-3214
Copy from one extension register to another	<i>VMOV (register)</i> on page F8-3216
Multiply	<i>VMUL (floating-point)</i> on page F8-3238
Negate, by inverting the sign bit	<i>VNEG</i> on page F8-3246
Multiply Accumulate and Negate	<i>VNMLA, VNMLS, VNMUL</i> on page F8-3248
Multiply Subtract and Negate	
Multiply and Negate	
Fused Negate Multiply Accumulate	<i>VFNMA, VFNMS</i> on page F8-3170
Fused Negate Multiply Subtract	
Square Root	<i>VSQRT</i> on page F8-3350
Subtract	<i>VSUB (floating-point)</i> on page F8-3378

Chapter F2

About the T32 and A32 Instruction Descriptions

This chapter describes each instruction. It contains the following sections:

- *Format of instruction descriptions* on page F2-2410.
- *Standard assembler syntax fields* on page F2-2415.
- *Conditional execution* on page F2-2416.
- *Shifts applied to a register* on page F2-2419.
- *Memory accesses* on page F2-2422.
- *Integer arithmetic in the T32 and A32 instruction sets* on page F2-2423.
- *Encoding of lists of general-purpose registers and the PC* on page F2-2426.
- *Additional pseudocode support for instruction descriptions* on page F2-2427.

F2.1 Format of instruction descriptions

The instruction descriptions in [Alphabetical list of T32 and A32 base instruction set instructions on page F7-2534](#) normally use the following format:

- Instruction section title.
- Introduction to the instruction.
- Instruction encoding(s) with architecture information.
- Assembler syntax.
- Pseudocode describing how the instruction operates.
- Exception information.
- Notes (where applicable).

Each of these items is described in more detail in the following subsections.

A few instruction descriptions describe alternative mnemonics for other instructions and use an abbreviated and modified version of this format.

F2.1.1 Instruction section title

The instruction section title gives the base mnemonic for the instructions described in the section. When one mnemonic has multiple forms described in separate instruction sections, this is followed by a short description of the form in parentheses. The most common use of this is to distinguish between forms of an instruction in which one of the operands is an immediate value and forms in which it is a register.

Another use of parenthesized text is to indicate the former mnemonic in some cases where a mnemonic has been replaced entirely by another mnemonic in the new assembler syntax.

F2.1.2 Introduction to the instruction

The instruction section title is followed by text that briefly describes the main features of the instruction. This description is not necessarily complete and is not definitive. If there is any conflict between it and the more detailed information that follows, the latter takes priority.

F2.1.3 Instruction encodings

This is a list of one or more instruction encodings. Each instruction encoding is labelled as:

- T1, T2, T3 ... for the first, second, third and any additional T32 encodings.
- A1, A2, A3 ... for the first, second, third and any additional A32 encodings.

Where T32 and A32 encodings are very closely related, the two encodings are described together, for example as encoding T1/A1.

Each instruction encoding description consists of:

- Information about which architecture variants include the particular encoding of the instruction. This is presented in one of two ways:
 - For instruction encodings that are in the main instruction set architecture, as a list of the architecture variants that include the encoding.
 - For instruction encodings that are in architecture extensions, as a list of the architecture extensions that include the encoding.

This architecture variant information is included for completeness. For more information about versions of AArch32 before ARMv8 see the *ARM® Architecture Reference Manual, ARMv7-A and ARMv7-R edition*.

In architecture variant lists:

- ARMv7 means ARMv7-A and ARMv7-R profiles. The architecture variant information in this manual does not cover the ARMv7-M profile.
- * is used as a wildcard. For example, ARMv5T* means ARMv5T, ARMv5TE, and ARMv5TEJ.

- *Security Extensions* indicates that, before ARMv8, the instruction was implemented as part of the Security Extensions. Unless qualified by a later architecture version number, this label indicates that the instruction was first implemented in VMSAv6 implementations of the ARMv6K architecture version that included the Security Extensions.
- An assembly syntax that ensures that the assembler selects the encoding in preference to any other encoding. In some cases, multiple syntaxes are given. The correct one to use is sometimes indicated by annotations to the syntax, such as *Inside IT block* and *Outside IT block*. In other cases, the correct one to use can be determined by looking at the assembler syntax description and using it to determine which syntax corresponds to the instruction being disassembled.

There is usually more than one syntax that ensures re-assembly to any particular encoding, and the exact set of syntaxes that do so usually depends on the register numbers, immediate constants and other operands to the instruction. For example, when assembling to the T32 instruction set, the syntax `AND R0, R0, R8` ensures selection of a 32-bit encoding but `AND R0, R0, R1` selects a 16-bit encoding.

The assembly syntax documented for the encoding is chosen to be the simplest one that ensures selection of that encoding for all operand combinations supported by that encoding. This often means that it includes elements that are only necessary for a small subset of operand combinations. For example, the assembler syntax documented for the 32-bit T32 `AND` (register) encoding includes the `.W` qualifier to ensure that the 32-bit encoding is selected even for the small proportion of operand combinations for which the 16-bit encoding is also available.

The assembly syntax given for an encoding is therefore a suitable one for a disassembler to disassemble that encoding to. However, disassemblers might wish to use simpler syntaxes when they are suitable for the operand combination, in order to produce more readable disassembled code.
- An encoding diagram, or a T32 encoding diagram followed by an A32 encoding diagram when they are being described together. This is half-width for 16-bit T32 encodings and full-width for 32-bit T32 and A32 encodings. The 32-bit A32 encoding diagrams number the bits from 31 to 0, while the 32-bit T32 encoding diagrams number the bits from 15 to 0 for each halfword, to distinguish them from A32 encodings and to act as a reminder that a 32-bit T32 instruction consists of two consecutive halfwords rather than a word.

In particular, if instructions are stored using the standard little-endian instruction endianness, the encoding diagram for an A32 instruction at address *A* shows the bytes at addresses *A*+3, *A*+2, *A*+1, *A* from left to right, but the encoding diagram for a 32-bit T32 instruction shows them in the order *A*+1, *A* for the first halfword, followed by *A*+3, *A*+2 for the second halfword.
- Encoding-specific pseudocode. This is pseudocode that translates the encoding-specific instruction fields into inputs to the encoding-independent pseudocode in the later *Operation* subsection, and that picks out any special cases in the encoding. For a detailed description of the pseudocode used and of the relationship between the encoding diagram, the encoding-specific pseudocode and the encoding-independent pseudocode, see [Appendix H ARM Pseudocode Definition](#).

F2.1.4 Assembler syntax

The *Assembly syntax* subsection describes the standard UAL syntax for the instruction.

Each syntax description consists of the following elements:

- One or more syntax prototype lines written in a typewriter font, using the conventions described in [Assembler syntax prototype line conventions on page F2-2412](#). Each prototype line documents the mnemonic and (where appropriate) operand parts of a full line of assembler code. When there is more than one such line, each prototype line is annotated to indicate required results of the encoding-specific pseudocode.

For each instruction encoding belonging to a target instruction set, an assembler can use this information to determine whether it can use that encoding to encode the instruction requested by the UAL source. If multiple encodings can encode the instruction then:

 - If both a 16-bit encoding and a 32-bit encoding can encode the instruction, the architecture *prefers* the 16-bit encoding. This means the assembler must use the 16-bit encoding rather than the 32-bit encoding.

Software can use the `.W` and `.N` qualifiers to specify the required encoding width, see [Standard assembler syntax fields on page F2-2415](#).

- If multiple encodings of the same length can encode the instruction, the *Assembler syntax* subsection says which encoding is preferred, and how software can, instead, select the other encodings.

Each encoding also documents UAL syntax that selects it in preference to any other encoding.

If no encodings of the target instruction set can encode the instruction requested by the UAL source, normally the assembler generates an error saying that the instruction is not available in that instruction set.

———— **Note** —————

Often, an instruction is available in one instruction set but not in another. The *Assembler syntax* subsection identifies many of these cases. For example, the A32 instructions with bits<31:28> == 0b1111 described in [Unconditional instructions on page F4-2488](#) cannot have a condition code, but the equivalent T32 instructions often can, and this usually appears in the *Assembler syntax* subsection as a statement that the A32 instruction cannot be conditional.

However, some such cases are too complex to describe in the available space, so the definitive test of whether an instruction is available in a given instruction set is whether there is an available encoding for it in that instruction set.

- The line *where:* followed by descriptions of all of the variable or optional fields of the prototype syntax line. Some syntax fields are standardized across all or most instructions. [Standard assembler syntax fields on page F2-2415](#) describes these fields.

By default, syntax fields that specify registers, such as <Rd>, <Rn>, or <Rt>, can be any of R0-R12 or LR in T32 instructions, and any of R0-R12, SP or LR in A32 instructions. These require that the encoding-specific pseudocode set the corresponding integer variable (such as d, n, or t) to the corresponding register number, using 0-12 for R0-R12, 13 for SP, or 14 for LR:

- Normally, software can do this by setting the corresponding field in the instruction, typically named Rd, Rn, Rt, to the binary encoding of that number.
- In the case of 16-bit T32 encodings, the field is normally of length 3, and so the encoding is only available when the assembler syntax specifies one of R0-R7. Such encodings often use a register field name like Rdn. This indicates that the encoding is only available if <Rd> and <Rn> specify the same register, and that the register number of that register is encoded in the field if they do.

The description of a syntax field that specifies a register sometimes extends or restricts the permitted range of registers or documents other differences from the default rules for such fields. Examples of extensions are permitting the use of the SP in a T32 instruction, or permitting the use of the PC, identified using register number 15.

- Where appropriate, text that briefly describes changes from the pre-UAL assembler syntax. Where present, this usually consists of an alternative pre-UAL form of the assembler mnemonic. The pre-UAL assembler syntax does not conflict with UAL. ARM recommends that it is supported, as an optional extension to UAL, so that pre-UAL assembler source files can be assembled.

Assembler syntax prototype line conventions

The following conventions are used in assembler syntax prototype lines and their subfields:

- < > Any item bracketed by < and > is a short description of a type of value to be supplied by the user in that position. A longer description of the item is normally supplied by subsequent text. Such items often correspond to a similarly named field in an encoding diagram for an instruction. When the correspondence only requires the binary encoding of an integer value or register number to be substituted into the instruction encoding, it is not described explicitly. For example, if the assembler syntax for an instruction contains an item <Rn> and the instruction encoding diagram contains a 4-bit field named Rn, the number of the register specified in the assembler syntax is encoded in binary in the instruction field.

If the correspondence between the assembler syntax item and the instruction encoding is more complex than simple binary encoding of an integer or register number, the item description indicates how it is encoded. This is often done by specifying a required output from the encoding-specific pseudocode, such as `add = TRUE`. The assembler must only use encodings that produce that output.

- { } Any item bracketed by { and } is optional. A description of the item and of how its presence or absence is encoded in the instruction is normally supplied by subsequent text.
- Many instructions have an optional destination register. Unless otherwise stated, if such a destination register is omitted, it is the same as the immediately following source register in the instruction syntax.
- # In the assembler syntax, numeric constants are normally preceded by a #. Some UAL instruction syntax descriptions explicitly show this # as optional. Any UAL assembler:
- Must treat the # as optional where an instruction syntax description shows it as optional.
 - Can treat the # either as mandatory or as optional where an instruction syntax description does not show it as optional.

———— **Note** ————

ARM recommends that UAL assemblers treat all uses of # shown in this manual as optional.

spaces Single spaces are used for clarity, to separate items. When a space is obligatory in the assembler syntax, two or more consecutive spaces are used.

+/- This indicates an optional + or - sign. If neither is coded, + is assumed.

All other characters must be encoded precisely as they appear in the assembler syntax. Apart from { and }, the special characters described above do not appear in the basic forms of assembler instructions documented in this manual. The { and } characters need to be encoded in a few places as part of a variable item. When this happens, the long description of the variable item indicates how they must be used.

F2.1.5 Pseudocode describing how the instruction operates

The *Operation* subsection contains encoding-independent pseudocode that describes the main operation of the instruction. For a detailed description of the pseudocode used and of the relationship between the encoding diagram, the encoding-specific pseudocode and the encoding-independent pseudocode, see [Appendix H ARM Pseudocode Definition](#).

F2.1.6 Exception information

The *Exceptions* subsection contains a list of the exceptional conditions that can be caused by execution of the instruction.

Processor exceptions are listed as follows:

- Resets and interrupts (both IRQs and FIQs) are not listed. They can occur before or after the execution of any instruction, and in some cases during the execution of an instruction, but they are not in general caused by the instruction concerned.
- Prefetch Abort exceptions are normally caused by a memory abort when an instruction is fetched, followed by an attempt to execute that instruction. This can happen for any instruction, but is caused by the aborted attempt to fetch the instruction rather than by the instruction itself, and so is not listed. A special case is the BKPT instruction, that is defined as causing a Prefetch Abort exception in some circumstances.
- Data Abort exceptions are listed for all instructions that perform data memory accesses.
- Undefined Instruction exceptions are listed when they are part of the effects of a defined instruction. For example, all coprocessor instructions are defined to produce the Undefined Instruction exception if not accepted by their coprocessor. Undefined Instruction exceptions caused by the execution of an undefined instruction are not listed, even when the undefined instruction is a special case of one or more of the encodings of the instruction. Such special cases are instead indicated in the encoding-specific pseudocode for the encoding.
- Supervisor Call and Secure Monitor Call exceptions are listed for the SVC and SMC instructions respectively. Supervisor Call exceptions and the SVC instruction were previously called Software Interrupt exceptions and the SWI instruction. Secure Monitor Call exceptions and the SMC instruction were previously called Secure Monitor interrupts and the SMI instruction.

Floating-point exceptions are listed for instructions that can produce them. [Floating-point exceptions on page E1-2307](#) describes these exceptions. They do not normally result in processor exceptions.

F2.1.7 Notes

Where appropriate, other notes about the instruction appear under additional subheadings.

———— **Note** —————

Information that was documented in notes in previous versions of the ARM Architecture Reference Manual and its supplements has often been moved elsewhere. For example, operand restrictions on the values of fields in an instruction encoding are now normally documented in the encoding-specific pseudocode for that encoding.

F2.2 Standard assembler syntax fields

The following assembler syntax fields are standard across all or most instructions:

<c> Is an optional field. It specifies the condition under which the instruction is executed. See [Conditional execution on page F2-2416](#) for the range of available conditions and their encoding. If <c> is omitted, it defaults to *always* (AL).

<q> Specifies optional assembler qualifiers on the instruction. The following qualifiers are defined:

.N Meaning narrow, specifies that the assembler must select a 16-bit encoding for the instruction. If this is not possible, an assembler error is produced.

.W Meaning wide, specifies that the assembler must select a 32-bit encoding for the instruction. If this is not possible, an assembler error is produced.

If neither .W nor .N is specified, the assembler can select either 16-bit or 32-bit encodings. If both are available, it must select a 16-bit encoding. In a few cases, more than one encoding of the same length can be available for an instruction. The rules for selecting between such encodings are instruction-specific and are part of the instruction description.

———— **Note** ————

When assembling to the A32 instruction set, the .N qualifier produces an assembler error and the .W qualifier has no effect.

—————

F2.3 Conditional execution

Most A32 instructions, and most T32 instructions from ARMv6T2 onwards, can be executed conditionally, based on the values of the APSR condition flags. Before ARMv6T2, the only conditional T32 instruction was the 16-bit conditional branch instruction. [Table F2-1](#) lists the available conditions.

Table F2-1 Condition codes

cond	Mnemonic extension	Meaning (integer)	Meaning (floating-point) ^a	Condition flags
0000	EQ	Equal	Equal	Z == 1
0001	NE	Not equal	Not equal, or unordered	Z == 0
0010	CS ^b	Carry set	Greater than, equal, or unordered	C == 1
0011	CC ^c	Carry clear	Less than	C == 0
0100	MI	Minus, negative	Less than	N == 1
0101	PL	Plus, positive or zero	Greater than, equal, or unordered	N == 0
0110	VS	Overflow	Unordered	V == 1
0111	VC	No overflow	Not unordered	V == 0
1000	HI	Unsigned higher	Greater than, or unordered	C == 1 and Z == 0
1001	LS	Unsigned lower or same	Less than or equal	C == 0 or Z == 1
1010	GE	Signed greater than or equal	Greater than or equal	N == V
1011	LT	Signed less than	Less than, or unordered	N != V
1100	GT	Signed greater than	Greater than	Z == 0 and N == V
1101	LE	Signed less than or equal	Less than, equal, or unordered	Z == 1 or N != V
1110	None (AL) ^d	Always (unconditional)	Always (unconditional)	Any

- a. Unordered means at least one NaN operand.
- b. HS (unsigned higher or same) is a synonym for CS.
- c. LO (unsigned lower) is a synonym for CC.
- d. AL is an optional mnemonic extension for always, except in IT instructions. For details see [IT on page F7-2610](#).

In T32 instructions, the condition, if it is not AL, is normally encoded in a preceding IT instruction. For more information see [Conditional instructions on page F1-2380](#) and [IT on page F7-2610](#). Some conditional branch instructions do not require a preceding IT instruction, because they include a condition code in their encoding.

In A32 instructions, bits[31:28] of the instruction contain the condition code, or contain 0b1111 for some A32 instructions that can only be executed unconditionally.

ARM deprecates the conditional execution of any instruction encoding provided by Advanced SIMD that is not also provided by floating-point, and strongly recommends that:

- For A32 instructions, any such Advanced SIMD instruction that can be conditionally executed is executed with the <c> field omitted or set to AL.

———— **Note** —————

This applies only to VDUP, see [VDUP \(general-purpose register\) on page F8-3162](#). The other A32 instructions do not permit conditional execution.

- For T32 instructions, such Advanced SIMD instructions are never included in an IT block. This means they must be specified with the <c> field omitted or set to AL.

This deprecation does not apply to Advanced SIMD instruction encodings that are also available as floating-point instruction encodings. That is, it does not apply to the Advanced SIMD encodings of the instructions described in the following sections:

- [VLDM](#) on page F8-3198.
- [VLDR](#) on page F8-3200.
- [VMOV \(general-purpose register to scalar\)](#) on page F8-3218.
- [VMOV \(between two general-purpose registers and a doubleword extension register\)](#) on page F8-3226.
- [VMRS](#) on page F8-3232.
- [VMSR](#) on page F8-3234.
- [VPOP](#) on page F8-3268.
- [VPUSH](#) on page F8-3270.
- [VSTM](#) on page F8-3372.
- [VSTR](#) on page F8-3374.

See also [Conditional execution of undefined instructions](#) on page G1-3478.

F2.3.1 Pseudocode details of conditional execution

The CurrentCond() pseudocode function has prototype:

```
bits(4) AArch32.CurrentCond();
```

This function returns a 4-bit condition specifier as follows:

- For A32 instructions, it returns bits[31:28] of the instruction.
- For the T1 and T3 encodings of the Branch instruction (see [B](#) on page F7-2566), it returns the 4-bit cond field of the encoding.
- For all other T32 instructions:
 - If ITSTATE.IT<3:0> != '0000' it returns ITSTATE.IT<7:4>.
 - If ITSTATE.IT<7:0> == '00000000' it returns '1110'.
 - Otherwise, execution of the instruction is UNPREDICTABLE.

For more information, see [IT block state register, ITSTATE](#) on page E1-2300.

The ConditionPassed() function uses this condition specifier and the condition flags to determine whether the instruction must be executed:

```
// ConditionPassed()
// =====

boolean ConditionPassed()
    return ConditionHolds(AArch32.CurrentCond());

// ConditionHolds()
// =====

// Return TRUE iff COND currently holds

boolean ConditionHolds(bits(4) cond)
    // Evaluate base condition.
    case cond<3:1> of
        when '000' result = (PSTATE.Z == '1');           // EQ or NE
        when '001' result = (PSTATE.C == '1');           // CS or CC
        when '010' result = (PSTATE.N == '1');           // MI or PL
        when '011' result = (PSTATE.V == '1');           // VS or VC
        when '100' result = (PSTATE.C == '1' && PSTATE.Z == '0'); // HI or LS
        when '101' result = (PSTATE.N == PSTATE.V);     // GE or LT
```

```
    when '110' result = (PSTATE.N == PSTATE.V && PSTATE.Z == '0'); // GT or LE
    when '111' result = TRUE; // AL

// Condition flag values in the set '111x' indicate always true
// Otherwise, invert condition if necessary.
if cond<0> == '1' && cond != '1111' then
    result = !result;

return result;
```

[Undefined Instruction exception on page G1-3476](#) describes the handling of conditional instructions that are UNDEFINED or UNPREDICTABLE. The pseudocode in the manual, as a sequential description of the instructions, has limitations in this respect. For more information, see [Limitations of the instruction pseudocode on page AppxH-5062](#).

F2.4 Shifts applied to a register

A32 register offset load/store word and unsigned byte instructions can apply a wide range of different constant shifts to the offset register. Both T32 and A32 data-processing instructions can apply the same range of different constant shifts to the second operand register. For details see *Constant shifts*.

A32 data-processing instructions can apply a register-controlled shift to the second operand register.

F2.4.1 Constant shifts

These are the same in T32 and A32 instructions, except that the input bits come from different positions.

<shift> is an optional shift to be applied to <Rm>. It can be any one of:

(omitted)	No shift.
LSL #<n>	Logical shift left <n> bits. 1 <= <n> <= 31.
LSR #<n>	Logical shift right <n> bits. 1 <= <n> <= 32.
ASR #<n>	Arithmetic shift right <n> bits. 1 <= <n> <= 32.
ROR #<n>	Rotate right <n> bits. 1 <= <n> <= 31.
RRX	Rotate right one bit, with extend. Bit[0] is written to shifter_carry_out, bits[31:1] are shifted right one bit, and the Carry flag is shifted into bit[31].

————— Note —————

Assemblers can permit the use of some or all of ASR #0, LSL #0, LSR #0, and ROR #0 to specify that no shift is to be performed. This is not standard UAL, and the encoding selected for T32 instructions might vary between UAL assemblers if it is used. To ensure disassembled code assembles to the original instructions, disassemblers must omit the shift specifier when the instruction specifies no shift.

Similarly, assemblers can permit the use of #0 in the immediate forms of ASR, LSL, LSR, and ROR instructions to specify that no shift is to be performed, that is, that a MOV (register) instruction is wanted. Again, this is not standard UAL, and the encoding selected for T32 instructions might vary between UAL assemblers if it is used. To ensure disassembled code assembles to the original instructions, disassemblers must use the MOV (register) syntax when the instruction specifies no shift.

Encoding

The assembler encodes <shift> into two type bits and five immediate bits, as follows:

(omitted)	type = 0b00, immediate = 0.
LSL #<n>	type = 0b00, immediate = <n>.
LSR #<n>	type = 0b01. If <n> < 32, immediate = <n>. If <n> == 32, immediate = 0.
ASR #<n>	type = 0b10. If <n> < 32, immediate = <n>. If <n> == 32, immediate = 0.
ROR #<n>	type = 0b11, immediate = <n>.
RRX	type = 0b11, immediate = 0.

F2.4.2 Register controlled shifts

These are only available in A32 instructions.

<type> is the type of shift to apply to the value read from <Rm>. It must be one of:

ASR	Arithmetic shift right, encoded as type = 0b10.
LSL	Logical shift left, encoded as type = 0b00.
LSR	Logical shift right, encoded as type = 0b01.
ROR	Rotate right, encoded as type = 0b11.

The bottom byte of <Rs> contains the shift amount.

F2.4.3 Pseudocode details of instruction-specified shifts and rotates

```
enumeration SRTYPE {SRTYPE_LSL, SRTYPE_LSR, SRTYPE_ASR, SRTYPE_ROR, SRTYPE_RRX};
```

```
// DecodeImmShift()  
// =====
```

```
(SRTYPE, integer) DecodeImmShift(bits(2) type, bits(5) imm5)
```

```
case type of  
  when '00'  
    shift_t = SRTYPE_LSL; shift_n = UInt(imm5);  
  when '01'  
    shift_t = SRTYPE_LSR; shift_n = if imm5 == '00000' then 32 else UInt(imm5);  
  when '10'  
    shift_t = SRTYPE_ASR; shift_n = if imm5 == '00000' then 32 else UInt(imm5);  
  when '11'  
    if imm5 == '00000' then  
      shift_t = SRTYPE_RRX; shift_n = 1;  
    else  
      shift_t = SRTYPE_ROR; shift_n = UInt(imm5);  
  
  return (shift_t, shift_n);
```

```
// DecodeRegShift()  
// =====
```

```
SRTYPE DecodeRegShift(bits(2) type)
```

```
case type of  
  when '00' shift_t = SRTYPE_LSL;  
  when '01' shift_t = SRTYPE_LSR;  
  when '10' shift_t = SRTYPE_ASR;  
  when '11' shift_t = SRTYPE_ROR;  
  return shift_t;
```

```
// Shift()  
// =====
```

```
bits(N) Shift(bits(N) value, SRTYPE type, integer amount, bit carry_in)  
(result, -) = Shift_C(value, type, amount, carry_in);  
return result;
```

```
// Shift_C()  
// =====
```

```
(bits(N), bit) Shift_C(bits(N) value, SRTYPE type, integer amount, bit carry_in)  
assert !(type == SRTYPE_RRX && amount != 1);
```

```
if amount == 0 then  
  (result, carry_out) = (value, carry_in);  
else  
  case type of  
    when SRTYPE_LSL  
      (result, carry_out) = LSL_C(value, amount);
```

```
when SRTYPE_LSR
    (result, carry_out) = LSR_C(value, amount);
when SRTYPE_ASR
    (result, carry_out) = ASR_C(value, amount);
when SRTYPE_ROR
    (result, carry_out) = ROR_C(value, amount);
when SRTYPE_RRX
    (result, carry_out) = RRX_C(value, carry_in);

return (result, carry_out);
```

F2.5 Memory accesses

Commonly, the following addressing modes are permitted for memory access instructions:

Offset addressing

The offset value is applied to an address obtained from the base register. The result is used as the address for the memory access. The value of the base register is unchanged.

The assembly language syntax for this mode is:

[<Rn>, <offset>]

Pre-indexed addressing

The offset value is applied to an address obtained from the base register. The result is used as the address for the memory access, and written back into the base register.

The assembly language syntax for this mode is:

[<Rn>, <offset>]!

Post-indexed addressing

The address obtained from the base register is used, unchanged, as the address for the memory access. The offset value is applied to the address, and written back into the base register.

The assembly language syntax for this mode is:

[<Rn>], <offset>

In each case, <Rn> is the base register. <offset> can be:

- An immediate constant, such as <imm8> or <imm12>.
- An index register, <Rm>.
- A shifted index register, such as <Rm>, LSL #<shift>.

For information about unaligned access, endianness, and exclusive access, see:

- [Alignment support on page E2-2341](#).
- [Endian support on page E2-2343](#).
- [Synchronization and semaphores on page E2-2369](#).

F2.6 Integer arithmetic in the T32 and A32 instruction sets

The instruction set provides a wide variety of operations on the values in registers, including bitwise logical operations, shifts, additions, subtractions, multiplications and divisions.

F2.6.1 Shift and rotate operations

The following types of shift and rotate operations are used in instructions:

Logical Shift Left

LSL moves each bit of a bitstring left by a specified number of bits. Zeros are shifted in at the right end of the bitstring. Bits that are shifted off the left end of the bitstring are discarded, except that the last such bit can be produced as a carry output.

Logical Shift Right

LSR moves each bit of a bitstring right by a specified number of bits. Zeros are shifted in at the left end of the bitstring. Bits that are shifted off the right end of the bitstring are discarded, except that the last such bit can be produced as a carry output.

Arithmetic Shift Right

ASR moves each bit of a bitstring right by a specified number of bits. Copies of the leftmost bit are shifted in at the left end of the bitstring. Bits that are shifted off the right end of the bitstring are discarded, except that the last such bit can be produced as a carry output.

Rotate Right ROR moves each bit of a bitstring right by a specified number of bits. Each bit that is shifted off the right end of the bitstring is re-introduced at the left end. The last bit shifted off the right end of the bitstring can be produced as a carry output.

Rotate Right with Extend

RRX moves each bit of a bitstring right by one bit. A carry input is shifted in at the left end of the bitstring. The bit shifted off the right end of the bitstring can be produced as a carry output. This type applies to AArch32 state only.

F2.6.2 Pseudocode details of addition and subtraction

Addition and subtraction can be performed on any combination of unbounded integers and bitstrings, provided that if they are performed on two bitstrings, the two bitstrings are of identical length. The result is another unbounded integer if both operands are unbounded integers. Otherwise it is a bitstring of the same length as the bitstring operand or operands.

The addition and subtraction instructions can produce status information. If required, software can synthesize multi-word additions and subtractions from this status information. The `AddWithCarry()` function provides an addition with a carry input and carry and overflow outputs:

```
// AddWithCarry()
// =====
// Integer addition with carry input, returning result and NZCV flags

(bits(N), bits(4)) AddWithCarry(bits(N) x, bits(N) y, bit carry_in)
    integer unsigned_sum = UInt(x) + UInt(y) + UInt(carry_in);
    integer signed_sum = SInt(x) + SInt(y) + UInt(carry_in);
    bits(N) result = unsigned_sum<N-1:0>; // same value as signed_sum<N-1:0>
    bit n = result<N-1>;
    bit z = if IsZero(result) then '1' else '0';
    bit c = if UInt(result) == unsigned_sum then '0' else '1';
    bit v = if SInt(result) == signed_sum then '0' else '1';
    return (result, n:z:c:v);
```

An important property of the `AddWithCarry()` function can be illustrated by the following line:

```
(result, carry_out, overflow) = AddWithCarry(x, NOT(y), carry_in)
```

In this case:

- If `carry_in == '1'`, then `result == x-y` with:
 - `overflow == '1'` if signed overflow occurred during the subtraction.
 - `carry_out == '1'` if unsigned borrow did not occur during the subtraction, that is, if $x \geq y$.
- If `carry_in == '0'`, then `result == x-y-1` with:
 - `overflow == '1'` if signed overflow occurred during the subtraction.
 - `carry_out == '1'` if unsigned borrow did not occur during the subtraction, that is, if $x > y$.

Together, these mean that the `carry_in` and `carry_out` bits in `AddWithCarry()` calls can act as *NOT borrow* flags for subtractions as well as *carry* flags for additions.

F2.6.3 Pseudocode details of saturation

Some instructions perform *saturating arithmetic*, that is, if the result of the arithmetic overflows the destination signed or unsigned N-bit integer range, the result produced is the largest or smallest value in that range, rather than wrapping around modulo 2^N . This is supported in pseudocode by:

- The `SignedSatQ()` and `UnsignedSatQ()` functions when an operation requires, in addition to the saturated result, a Boolean argument that indicates whether saturation occurred.
- The `SignedSat()` and `UnsignedSat()` functions when only the saturated result is required.

```
// SignedSatQ()
// =====

(bits(N), boolean) SignedSatQ(integer i, integer N)
  if i > 2^(N-1) - 1 then
    result = 2^(N-1) - 1; saturated = TRUE;
  elsif i < -(2^(N-1)) then
    result = -(2^(N-1)); saturated = TRUE;
  else
    result = i; saturated = FALSE;
  return (result<N-1:0>, saturated);

// UnsignedSatQ()
// =====

(bits(N), boolean) UnsignedSatQ(integer i, integer N)
  if i > 2^N - 1 then
    result = 2^N - 1; saturated = TRUE;
  elsif i < 0 then
    result = 0; saturated = TRUE;
  else
    result = i; saturated = FALSE;
  return (result<N-1:0>, saturated);

// SignedSat()
// =====

(bits(N) SignedSat(integer i, integer N)
  (result, -) = SignedSatQ(i, N);
  return result;

// UnsignedSat()
// =====

(bits(N) UnsignedSat(integer i, integer N)
  (result, -) = UnsignedSatQ(i, N);
  return result;
```

SatQ(i, N, unsigned) returns either UnsignedSatQ(i, N) or SignedSatQ(i, N) depending on the value of its third argument, and Sat(i, N, unsigned) returns either UnsignedSat(i, N) or SignedSat(i, N) depending on the value of its third argument:

```
// SatQ()
// =====

(bits(N), boolean) SatQ(integer i, integer N, boolean unsigned)
    (result, sat) = if unsigned then UnsignedSatQ(i, N) else SignedSatQ(i, N);
    return (result, sat);

// Sat()
// =====

bits(N) Sat(integer i, integer N, boolean unsigned)
    result = if unsigned then UnsignedSat(i, N) else SignedSat(i, N);
    return result;
```

F2.7 Encoding of lists of general-purpose registers and the PC

A number of instructions operate on lists of general-purpose registers. For some load instructions, the list of registers to be loaded can include the PC. For these instructions, the assembler syntax includes a <registers> field, that provides a list of the registers to be operated on, with list entries separated by commas.

The registers list is encoded in the instruction encoding. Most often, this is done using an 8-bit, 13-bit, or 16-bit register_list field. This section gives more information about these and other possible register list encodings.

In a register_list field, each bit corresponds to a single register, and if the <registers> field of the assembler instruction includes Rt then register_list<t> is set to 1, otherwise it is set to 0.

The full rules for the encoding of lists of general-purpose registers, and possibly the PC, are:

- Except for the cases listed here, 16-bit T32 encodings use an 8-bit register list, and can access only registers R0-R7.

The exceptions to this rule are:

- The T1 encoding of POP uses an 8-bit register list, and an additional bit, P, that corresponds to the PC. This means it can access any of R0-R7 and the PC.
- The T1 encoding of PUSH uses an 8-bit register list, and an additional bit, M, that corresponds to the LR. This means it can access any of R0-R7 and the LR.

- 32-bit T32 encodings of load operations use a 13-bit register list, and two additional bits, M, corresponding to the LR, and P, corresponding to the PC. This means these instructions can access any of R0-R12 and the LR and PC.
- 32-bit T32 encodings of store operations use a 13-bit register list, and one additional bit, M, corresponding to the LR. This means these instructions can access any of R0-R12 and the LR.
- Except for the case listed here, A32 encodings use a 16-bit register list. This means these instructions can access any of R0-R12 and the SP, LR, and PC.

The exception to this rule is:

- The system instructions LDM (exception return) and LDM (User registers) use a 15-bit register list. This means these instructions can access any of R0-R12 and the SP and LR.

- The T3 and A2 encodings of POP, and the T3 and A2 encodings of PUSH, access a single register from the set of registers {R0-R12, LR, PC} and encode the register number in the Rt field.

———— Note —————

POP is a load operation, and PUSH is a store operation.

In every case, the encoding-specific pseudocode converts the register list into a 32-bit variable, registers, with a bit corresponding to each of the registers R0-R12, SP, LR, and PC.

———— Note —————

Some floating-point and Advanced SIMD instructions operate on lists of SIMD and floating-point registers. The assembler syntax of these instructions includes a <list> field that specifies the registers to be operated on, and the description of the instruction in [Alphabetical list of T32 and A32 base instruction set instructions on page F7-2534](#) defines the use and encoding of this field.

F2.8 Additional pseudocode support for instruction descriptions

Earlier sections of this chapter include pseudocode that describes features of the execution of A32 and T32 instructions, see:

- [Pseudocode details of conditional execution on page F2-2417.](#)
- [Pseudocode details of instruction-specified shifts and rotates on page F2-2420](#)

The following subsection gives additional pseudocode support functions for some of the instructions described in [Alphabetical list of T32 and A32 base instruction set instructions on page F7-2534:](#)

F2.8.1 Pseudocode details of coprocessor operations

The Coproc_Accepted() pseudocode function determines whether a coprocessor instruction is accepted for execution.

```
// Coproc_Accepted()
// =====
// Determines whether the AArch32 CP14 or CP15 coprocessor instruction is accepted.

boolean Coproc_Accepted(integer cp_num, bits(32) instr)
  assert UsingAArch32();
  assert !(cp_num IN {10,11});
  assert cp_num == UInt(instr<11:8>);

  if instr<27:24> == '1110' && instr<4> == '1' && instr<31:28> != '1111' then
    // MRC/MCR
    nreg = 1;
    opc1 = UInt(instr<23:21>);
    opc2 = UInt(instr<7:5>);
    CRn = UInt(instr<19:16>);
    CRm = UInt(instr<3:0>);
  elseif instr<27:21> == '110010' && instr<31:28> != '1111' then
    // MRRC/MCRR
    nreg = 2;
    opc1 = UInt(instr<7:4>);
    CRm = UInt(instr<3:0>);
  elseif instr<27:25> == '110' && instr<31:28> != '1111' then
    // LDC/STC
    nreg = 0;
    CRn = UInt(instr<15:12>);
  else
    Unreachable();

  case cp_num of
  when 14
    if Coproc_UnallocatedAtEL(PSTATE.EL, instr) then UNDEFINED;
    // Coarse-grained decode of CP14 based on opc1 field
    case opc1 of
    when 0 accepted = CP14DebugInstrDecode(instr);
    when 1 accepted = CP14TraceInstrDecode(instr);
    when 6 accepted = CP14TEEInstrDecode(instr);
    otherwise
      Unreachable(); // All other codes are UNDEFINED

  when 15
    // Check for coarse-grained Hyp traps
    if HaveEL(EL2) && !IsSecure() then
      // Disabled in HSTR
      if CRn != 14 && HSTR<CRn> == '1' then
        if (PSTATE.EL == EL0 && Coproc_UnallocatedAtEL(EL0, instr) &&
            boolean IMPLEMENTATION_DEFINED "choice to be UNDEFINED") then
          UNDEFINED;
        AArch32.CPRegTrap(EL2, instr);

    // Check for TIDCP as a coarse-grain check for PL1 accesses
    if (HCR.TIDCP == '1' && nreg == 1 &&
```

```
((CRn == 9 && CRm IN {0, 2, 5,6,7,8 }) ||  
(CRn == 10 && CRm IN {0,1, 4, 8 }) ||  
(CRn == 11 && CRm IN {0,1,2,3,4,5,6,7,8,15})) then  
if (PSTATE.EL == EL0 && Coproc_UnallocatedAtEL(EL0, instr) &&  
    boolean IMPLEMENTATION_DEFINED "choice to be UNDEFINED") then  
    UNDEFINED;  
    AArch32.CPRegTrap(EL2, instr);  
  
if Coproc_UnallocatedAtEL(PSTATE.EL, instr) then  
    UNDEFINED;  
else  
    accepted = CP15InstrDecode(instr);  
  
otherwise  
    // In ARMv8 this case should be Unreachable()  
    Unreachable();  
  
return accepted;
```

The Coproc_DoneLoading() pseudocode function determines, for an LDC instruction, whether enough words have been loaded:

```
boolean Coproc_DoneLoading(integer cp_num, bits(32) instr);
```

The Coproc_DoneStoring() function determines for an STC instruction whether enough words have been stored:

```
boolean Coproc_DoneStoring(integer cp_num, bits(32) instr);
```

The Coproc_GetOneWord() function obtains the word for an MRC instruction from the coprocessor:

```
bits(32) Coproc_GetOneWord(integer cp_num, bits(32) instr);
```

The Coproc_GetTwoWords() function obtains the two words for an MRRC instruction from the coprocessor:

```
(bits(32), bits(32)) Coproc_GetTwoWords(integer cp_num, bits(32) instr);
```

———— **Note** —————

The relative significance of the two words returned is IMPLEMENTATION DEFINED, but all uses within this manual present the two words in the order (most significant, least significant).

The Coproc_GetWordToStore() function obtains the next word to store for an STC instruction from the coprocessor:

```
bits(32) Coproc_GetWordToStore(integer cp_num, bits(32) instr);
```

The Coproc_InternalOperation() procedure instructs a coprocessor to perform the internal operation requested by a CDP instruction:

```
Coproc_InternalOperation(integer cp_num, bits(32) instr);
```

The Coproc_SendLoadedWord() procedure sends a loaded word for an LDC instruction to the coprocessor:

```
Coproc_SendLoadedWord(bits(32) word, integer cp_num, bits(32) instr);
```

The Coproc_SendOneWord() procedure sends the word for an MCR instruction to the coprocessor:

```
Coproc_SendOneWord(bits(32) word, integer cp_num, bits(32) instr);
```

The Coproc_SendTwoWords() procedure sends the two words for an MCRR instruction to the coprocessor:

```
Coproc_SendTwoWords(bits(32) word2, bits(32) word1, integer cp_num, bits(32) instr);
```

———— **Note** —————

The relative significance of word2 and word1 is IMPLEMENTATION DEFINED, but all uses within this manual treat word2 as more significant than word1.

The CP14DebugInstrDecode() pseudocode function decodes an accepted access to a CP14 debug register:

```
boolean CP15InstrDecode(bits(32) instr);
```

The CP14JazelleInstrDecode() pseudocode function decodes an accepted access to a CP14 Jazelle register:

```
boolean CP14JazelleInstrDecode(bits(32) instr);
```

The CP14TraceInstrDecode() pseudocode function decodes an accepted access to a CP14 Trace register:

```
boolean CP14TraceInstrDecode(bits(32) instr);
```

The CP15InstrDecode() pseudocode function decodes an accepted access to a CP15 register:

```
boolean CP15InstrDecode(bits(32) instr);
```

F2.8.2 Calling the supervisor

The CallSupervisor() pseudocode function generates a Supervisor Call exception, after setting up the *Use of the HSR on page G3-3672* if the exception must be taken to Hyp mode. Valid execution of the SVC instruction calls this function.

```
// AArch32.CallSupervisor()
// =====
// Calls the Supervisor

AArch32.CallSupervisor(bits(16) immediate)

    if AArch32.CurrentCond() != '1110' then
        immediate = bits(16) UNKNOWN;

    if AArch32.GeneralExceptionsToAArch64() then
        AArch64.CallSupervisor(immediate);

    AArch32.TakeSVCException(immediate);
```

Chapter F3

T32 Base Instruction Set Encoding

This chapter introduces the T32 instruction set and describes how it uses the ARM programmers' model. It contains the following sections:

- [T32 instruction set encoding on page F3-2432.](#)
- [16-bit T32 instruction encoding on page F3-2435.](#)
- [32-bit T32 instruction encoding on page F3-2442.](#)

Note

- Architecture variant information in this chapter describes the architecture variant or extension in which the instruction encoding was introduced into the T32 instruction set.
 - In the decode tables in this chapter, an entry of - for a field value means the value of the field does not affect the decoding.
-

F3.1 T32 instruction set encoding

The T32 instruction stream is a sequence of halfword-aligned halfwords. Each T32 instruction is either a single 16-bit halfword in that stream, or a 32-bit instruction consisting of two consecutive halfwords in that stream.

If the value of bits[15:11] of the halfword being decoded is one of the following, the halfword is the first halfword of a 32-bit instruction:

- 0b11101.
- 0b11110.
- 0b11111.

Otherwise, the halfword is a 16-bit instruction.

For details of the encoding of 16-bit T32 instructions see [16-bit T32 instruction encoding on page F3-2435](#).

For details of the encoding of 32-bit T32 instructions see [32-bit T32 instruction encoding on page F3-2442](#).

F3.1.1 UNDEFINED and UNPREDICTABLE instruction set space

An attempt to execute an unallocated instruction results in either:

- Unpredictable behavior. The instruction is described as UNPREDICTABLE.
ARMv8-A greatly reduces the architecturally UNPREDICTABLE behavior in AArch32 state. Many cases that earlier versions of the architecture describe as unpredictable become either:
 - CONSTRAINED UNPREDICTABLE, meaning the architecture defines a limited range of permitted behaviors.
 - Fully predictable.For more information see [Appendix A Architectural Constraints on UNPREDICTABLE behaviors](#).
The AArch32 parts of this manual might sometimes describe as UNPREDICTABLE behavior that ARMv8-A makes CONSTRAINED UNPREDICTABLE.
- An Undefined Instruction exception. The instruction is described as UNDEFINED.

An instruction is UNDEFINED if it is declared as UNDEFINED in an instruction description, or in this chapter.

An instruction is UNPREDICTABLE if:

- A bit marked (0) in the encoding diagram of an instruction is not 0, and the pseudocode for that encoding does not indicate that a different special case applies when that bit is not 0.
- A bit marked (1) in the encoding diagram of an instruction is not 1, and the pseudocode for that encoding does not indicate that a different special case applies when that bit is not 1.
- It is declared as UNPREDICTABLE in an instruction description or in this chapter.

For more information about UNDEFINED and UNPREDICTABLE instruction behavior, see [Undefined Instruction exception on page G1-3476](#).

Unless otherwise specified:

- T32 instructions introduced in an architecture variant are either UNPREDICTABLE or UNDEFINED in earlier architecture variants.
- A T32 instruction that is provided by one or more of the architecture extensions is either UNPREDICTABLE or UNDEFINED in an implementation that does not include any of those extensions.

For more information about the behavior of T32 instructions in earlier versions of the architecture see the *ARM® Architecture Reference Manual, ARMv7-A and ARMv7-R edition*.

F3.1.2 Use of the PC, and use of 0b1111 as a register specifier

The use of 0b1111 as a register specifier is not normally permitted in T32 instructions. When a value of 0b1111 is permitted, a variety of meanings is possible. For register reads, these meanings include:

- Read the PC value, that is, the address of the current instruction + 4. The base register of the table branch instructions TBB and TBH can be the PC. This means branch tables can be placed in memory immediately after the instruction.

———— **Note** —————

In ARMv7, ARM deprecates use of the PC as the base register in the STC instruction.

- Read the word-aligned PC value, that is, the address of the current instruction + 4, with bits[1:0] forced to zero. The base register of LDC, LDR, LDRB, LDRD (pre-indexed, no writeback), LDRH, LDRSB, and LDRSH instructions can be the word-aligned PC. This provides PC-relative data addressing. In addition, some encodings of the ADD and SUB instructions permit their source registers to be 0b1111 for the same purpose.
- Read zero. This is done in some cases when one instruction is a special case of another, more general instruction, but with one operand zero. In these cases, the instructions are listed on separate pages, with a special case in the pseudocode for the more general instruction cross-referencing the other page.

For register writes, these meanings include:

- The PC can be specified as the destination register of an LDR instruction. This is done by encoding Rt as 0b1111. The loaded value is treated as an address, and the effect of execution is a branch to that address. Bit[0] of the loaded value selects whether to execute A32 or T32 instructions after the branch.
- Some other instructions write the PC in similar ways. An instruction can specify that the PC is written:
 - Implicitly, for example, branch instructions.
 - Explicitly by a register specifier of 0b1111, for example 16-bit MOV (register) instructions.
 - Explicitly by using a register mask, for example LDM instructions.

The address to branch to can be:

- A loaded value, for example, RFE.
- A register value, for example, BX.
- The result of a calculation, for example, TBB or TBH.

The method of choosing the instruction set used after the branch can be:

- Similar to the LDR case, for example, LDM or BX.
- A fixed instruction set other than the one currently being used, for example, the immediate form of BLX.
- Unchanged, for example, branch instructions or 16-bit MOV (register) instructions.
- Set from the {J, T} bits of the SPSR, for RFE and SUBS PC, LR, #imm8.

- Discard the result of a calculation. This is done in some cases when one instruction is a special case of another, more general instruction, but with the result discarded. In these cases, the instructions are listed on separate pages, with a special case in the pseudocode for the more general instruction cross-referencing the other page.
- If the destination register specifier of an LDRB, LDRH, LDRSB, or LDRSH instruction is 0b1111, the instruction is a memory hint instead of a load operation.
- If the destination register specifier of an MRC instruction is 0b1111, bits[31:28] of the value transferred from the coprocessor are written to the N, Z, C, and V condition flags in the APSR, and bits[27:0] are discarded.

F3.1.3 Use of the SP, and use of 0b1101 as a register specifier

In T32 instructions, ARM recommends that the use of 0b1101 as a register specifier specifies the SP.

———— **Note** —————

- The recommendation that register specifier 0b1101 is used only to specify the SP applies to both the T32 and the A32 instruction sets.
- Despite this recommendation, in ARMv8, most T32 uses of R13 as a general-purpose register behave predictably. This differs from ARMv7, where many uses of R13 are UNPREDICTABLE. For more information, see the *ARM® Architecture Reference Manual, ARMv7-A and ARMv7-R edition*.

F3.2 16-bit T32 instruction encoding

The encoding of a 16-bit T32 instruction is:

15	14	13	12	11	10	9	8	7	6	5	4	3	2	1	0
Opcode															

Table F3-1 shows the allocation of 16-bit instruction encodings.

Table F3-1 16-bit T32 instruction encoding

Opcode	Instruction or instruction class	Variant
00xxxx	<i>Shift (immediate), add, subtract, move, and compare</i> on page F3-2436	-
010000	<i>Data-processing</i> on page F3-2437	-
010001	<i>Special data instructions and branch and exchange</i> on page F3-2438	-
01001x	Load from Literal Pool, see <i>LDR (literal)</i> on page F7-2638	v4T
0101xx 011xxx 100xxx	<i>Load/store single data item</i> on page F3-2439	-
10100x	Generate PC-relative address, see <i>ADR</i> on page F7-2554	v4T
10101x	Generate SP-relative address, see <i>ADD (SP plus register, T32)</i> on page F7-2550	v4T
1011xx	<i>Miscellaneous 16-bit instructions</i> on page F3-2440	-
11000x	Store multiple registers, see <i>STM (STMIA, STMEA)</i> on page F7-2870	v4T
11001x	Load multiple registers, see <i>LDM/LDMIA/LDMFD (T32)</i> on page F7-2624	v4T
1101xx	<i>Conditional branch, and Supervisor Call</i> on page F3-2441	-
11100x	Unconditional Branch, see <i>B</i> on page F7-2566	v4T

F3.2.1 Shift (immediate), add, subtract, move, and compare

The encoding of 16-bit T32 shift (immediate), add, subtract, move, and compare instructions is:

15	14	13	12	11	10	9	8	7	6	5	4	3	2	1	0
0	0	Opcode													

Table F3-2 shows the allocation of encodings in this space.

All these instructions are available since the T32 instruction set was introduced in ARMv4T.

Table F3-2 16-bit T32 shift (immediate), add, subtract, move, and compare instructions

Opcode	Instruction	See
000xx	Logical Shift Left ^a	<i>LSL (immediate)</i> on page F7-2692
001xx	Logical Shift Right	<i>LSR (immediate)</i> on page F7-2696
010xx	Arithmetic Shift Right	<i>ASR (immediate)</i> on page F7-2562
01100	Add register	<i>ADD (register, T32)</i> on page F7-2544
01101	Subtract register	<i>SUB (register)</i> on page F7-2918
01110	Add 3-bit immediate	<i>ADD (immediate, T32)</i> on page F7-2540
01111	Subtract 3-bit immediate	<i>SUB (immediate, T32)</i> on page F7-2914
100xx	Move	<i>MOV (immediate)</i> on page F7-2708
101xx	Compare	<i>CMP (immediate)</i> on page F7-2589
110xx	Add 8-bit immediate	<i>ADD (immediate, T32)</i> on page F7-2540
111xx	Subtract 8-bit immediate	<i>SUB (immediate, T32)</i> on page F7-2914

a. When Opcode is 0b00000, and bits[8:6] are 0b000, this is an encoding for MOV, see *MOV (register, T32)* on page F7-2710.

F3.2.2 Data-processing

The encoding of 16-bit T32 data-processing instructions is:

15	14	13	12	11	10	9	8	7	6	5	4	3	2	1	0
0	1	0	0	0	0	Opcode									

Table F3-3 shows the allocation of encodings in this space.

All these instructions are available since the T32 instruction set was introduced in ARMv4T.

Table F3-3 16-bit T32 data-processing instructions

Opcode	Instruction	See
0000	Bitwise AND	<i>AND (register)</i> on page F7-2558
0001	Bitwise Exclusive OR	<i>EOR (register)</i> on page F7-2604
0010	Logical Shift Left	<i>LSL (register)</i> on page F7-2694
0011	Logical Shift Right	<i>LSR (register)</i> on page F7-2698
0100	Arithmetic Shift Right	<i>ASR (register)</i> on page F7-2564
0101	Add with Carry	<i>ADC (register)</i> on page F7-2536
0110	Subtract with Carry	<i>SBC (register)</i> on page F7-2794
0111	Rotate Right	<i>ROR (register)</i> on page F7-2778
1000	Test	<i>TST (register)</i> on page F7-2950
1001	Reverse Subtract from 0	<i>RSB (immediate)</i> on page F7-2782
1010	Compare	<i>CMP (register)</i> on page F7-2590
1011	Compare Negative	<i>CMN (register)</i> on page F7-2587
1100	Bitwise OR	<i>ORR (register)</i> on page F7-2740
1101	Multiply	<i>MUL</i> on page F7-2726
1110	Bitwise Bit Clear	<i>BIC (register)</i> on page F7-2572
1111	Bitwise NOT	<i>MVN (register)</i> on page F7-2730

F3.2.3 Special data instructions and branch and exchange

The encoding of 16-bit T32 special data instructions and branch and exchange instructions is:

15	14	13	12	11	10	9	8	7	6	5	4	3	2	1	0
0	1	0	0	0	1	Opcode									

Table F3-4 shows the allocation of encodings in this space.

Table F3-4 16-bit T32 special data instructions and branch and exchange

Opcode	Instruction	See	Variant
0000	Add Low Registers	<i>ADD (register, T32)</i> on page F7-2544	v6T2 ^a
0001 001x	Add High Registers	<i>ADD (register, T32)</i> on page F7-2544	v4T
01xx	Compare High Registers	<i>CMP (register)</i> on page F7-2590	v4T
1000	Move Low Registers	<i>MOV (register, T32)</i> on page F7-2710	v6 ^a
1001 101x	Move High Registers	<i>MOV (register, T32)</i> on page F7-2710	v4T
110x	Branch and Exchange	<i>BX</i> on page F7-2579	v4T
111x	Branch with Link and Exchange	<i>BLX (register)</i> on page F7-2578	v5T ^a

a. UNPREDICTABLE in earlier variants.

F3.2.4 Load/store single data item

The encoding of 16-bit T32 instructions that load or store a single data item is:

15	14	13	12	11	10	9	8	7	6	5	4	3	2	1	0
opA				opB											

These instructions have one of the following values of opA:

- 0b0101
- 0b011x
- 0b100x

Table F3-5 shows the allocation of encodings in this space.

All these instructions are available since the T32 instruction set was introduced in ARMv4T.

Table F3-5 16-bit T32 Load/store single data item instructions

opA	opB	Instruction	See
0101	000	Store Register	<i>STR (register)</i> on page F7-2882
	001	Store Register Halfword	<i>STRH (register)</i> on page F7-2908
	010	Store Register Byte	<i>STRB (register)</i> on page F7-2888
	011	Load Register Signed Byte	<i>LDRSB (register)</i> on page F7-2678
	100	Load Register	<i>LDR (register, T32)</i> on page F7-2640
	101	Load Register Halfword	<i>LDRH (register)</i> on page F7-2670
	110	Load Register Byte	<i>LDRB (register)</i> on page F7-2650
	111	Load Register Signed Halfword	<i>LDRSH (register)</i> on page F7-2686
0110	0xx	Store Register	<i>STR (immediate, T32)</i> on page F7-2878
	1xx	Load Register	<i>LDR (immediate, T32)</i> on page F7-2634
0111	0xx	Store Register Byte	<i>STRB (immediate, T32)</i> on page F7-2884
	1xx	Load Register Byte	<i>LDRB (immediate, T32)</i> on page F7-2644
1000	0xx	Store Register Halfword	<i>STRH (immediate, T32)</i> on page F7-2904
	1xx	Load Register Halfword	<i>LDRH (immediate, T32)</i> on page F7-2664
1001	0xx	Store Register SP relative	<i>STR (immediate, T32)</i> on page F7-2878
	1xx	Load Register SP relative	<i>LDR (immediate, T32)</i> on page F7-2634

F3.2.5 Miscellaneous 16-bit instructions

The encoding of 16-bit T32 miscellaneous instructions is:

15	14	13	12	11	10	9	8	7	6	5	4	3	2	1	0
1	0	1	1	Opcode											

Table F3-6 shows the allocation of encodings in this space. Other encodings in this space are UNDEFINED.

Table F3-6 Miscellaneous 16-bit instructions

Opcode	Instruction	See	Variant
0000xx	Add Immediate to SP	<i>ADD (SP plus immediate)</i> on page F7-2548	v4T
00001xx	Subtract Immediate from SP	<i>SUB (SP minus immediate)</i> on page F7-2922	v4T
0001xxx	Compare and Branch on Zero	<i>CBNZ, CBZ</i> on page F7-2581	v6T2
001000x	Signed Extend Halfword	<i>SXTH</i> on page F7-2938	v6
001001x	Signed Extend Byte	<i>SXTB</i> on page F7-2934	v6
001010x	Unsigned Extend Halfword	<i>UXTH</i> on page F7-3020	v6
001011x	Unsigned Extend Byte	<i>UXTB</i> on page F7-3016	v6
0011xxx	Compare and Branch on Zero	<i>CBNZ, CBZ</i> on page F7-2581	v6T2
010xxxx	Push Multiple Registers	<i>PUSH</i> on page F7-2760	v4T
0110010	Set Endianness	<i>SETEND</i> on page F7-2803	v6
0110011	Change Processor State	<i>CPS (T32)</i> on page F7-3034	v6
1001xxx	Compare and Branch on Nonzero	<i>CBNZ, CBZ</i> on page F7-2581	v6T2
101000x	Byte-Reverse Word	<i>REV</i> on page F7-2773	v6
101001x	Byte-Reverse Packed Halfword	<i>REV16</i> on page F7-2774	v6
101010x	Halting Breakpoint	<i>HLT</i> on page F7-2608	v8
101011x	Byte-Reverse Signed Halfword	<i>REVSH</i> on page F7-2775	v6
1011xxx	Compare and Branch on Nonzero	<i>CBNZ, CBZ</i> on page F7-2581	v6T2
110xxxx	Pop Multiple Registers	<i>POP (T32)</i> on page F7-2756	v4T
1110xxx	Breakpoint	<i>BKPT</i> on page F7-2575	v5
1111xxx	If-Then, and hints	<i>If-Then, and hints</i> on page F3-2441	-

If-Then, and hints

The encoding of 16-bit T32 If-Then and hint instructions is:

15	14	13	12	11	10	9	8	7	6	5	4	3	2	1	0
1	0	1	1	1	1	1	1	opA				opB			

Table F3-7 shows the allocation of encodings in this space.

Other encodings in this space are unallocated hints. They execute as NOPs, but software must not use them.

Table F3-7 16-bit If-Then and hint instructions

opA	opB	Instruction	See	Variant
-	not 0000	If-Then	IT on page F7-2610	v6T2
0000	0000	No Operation hint	NOP on page F7-2734	v6T2
0001	0000	Yield hint	YIELD on page F7-3026	v7
0010	0000	Wait For Event hint	WFE on page F7-3022	v7
0011	0000	Wait For Interrupt hint	WFI on page F7-3024	v7
0100	0000	Send Event hint	SEV on page F7-2804	v7
0101	0000	Send Event Local hint	SEVL on page F7-2805	v8

F3.2.6 Conditional branch, and Supervisor Call

The encoding of 16-bit T32 conditional branch and Supervisor Call instructions is:

15	14	13	12	11	10	9	8	7	6	5	4	3	2	1	0
1	1	0	1	Opcode											

Table F3-8 shows the allocation of encodings in this space.

All these instructions are available since the T32 instruction set was introduced in ARMv4T.

Table F3-8 Conditional branch and Supervisor Call instructions

Opcode	Instruction	See
not 111x	Conditional branch	B on page F7-2566
1110	Permanently UNDEFINED	UDF on page F7-2962^a
1111	Supervisor Call	SVC (previously SWI) on page F7-2926

a. Issue C.a of this manual first defines an assembler mnemonic for this encoding.

F3.3 32-bit T32 instruction encoding

The encoding of a 32-bit T32 instruction is:

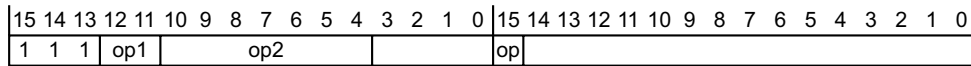

If op1 == 0b00, a 16-bit instruction is encoded, see [16-bit T32 instruction encoding on page F3-2435](#).

Otherwise, [Table F3-9](#) shows the allocation of encodings in this space.

Table F3-9 32-bit T32 instruction encoding

op1	op2	op	Instruction class, see
01	00xx0xx	-	Load/store multiple on page F3-2449
	00xx1xx	-	Load/store dual, load/store exclusive, table branch on page F3-2450
	01xxxxx	-	Data-processing (shifted register) on page F3-2456
	1xxxxxx	-	Coprocessor, Advanced SIMD, and floating-point instructions on page F3-2464
10	x0xxxxx	0	Data-processing (modified immediate) on page F3-2443
	x1xxxxx	0	Data-processing (plain binary immediate) on page F3-2446
	-	1	Branches and miscellaneous control on page F3-2447
11	000xxx0	-	Store single data item on page F3-2455
	00xx001	-	Load byte, memory hints on page F3-2454
	00xx011	-	Load halfword, memory hints on page F3-2453
	00xx101	-	Load word on page F3-2452
	00xx111	-	UNDEFINED
	001xxx0	-	Advanced SIMD element or structure load/store instructions on page F5-2515
	010xxxx	-	Data-processing (register) on page F3-2458
	0110xxx	-	Multiply, multiply accumulate, and absolute difference on page F3-2462
	0111xxx	-	Long multiply, long multiply accumulate, and divide on page F3-2463
	1xxxxxx	-	Coprocessor, Advanced SIMD, and floating-point instructions on page F3-2464

F3.3.1 Data-processing (modified immediate)

The encoding of the 32-bit T32 data-processing (modified immediate) instructions is:

15	14	13	12	11	10	9	8	7	6	5	4	3	2	1	0	15	14	13	12	11	10	9	8	7	6	5	4	3	2	1	0
1	1	1	1	0	0		op	S		Rn	0											Rd									

Table F3-10 shows the allocation of encodings in this space. Other encodings in this space are UNDEFINED.

These encodings are all available in ARMv6T2 and above.

Table F3-10 32-bit modified immediate data-processing instructions

op	Rn	Rd:S	Instruction	See
0000	-	not 11111	Bitwise AND	AND (immediate) on page F7-2556
		11111	Test	TST (immediate) on page F7-2948
0001	-	-	Bitwise Bit Clear	BIC (immediate) on page F7-2570
0010	not 1111	-	Bitwise OR	ORR (immediate) on page F7-2738
		1111	Move	MOV (immediate) on page F7-2708
0011	not 1111	-	Bitwise OR NOT	ORN (immediate) on page F7-2735
		1111	Bitwise NOT	MVN (immediate) on page F7-2728
0100	-	not 11111	Bitwise Exclusive OR	EOR (immediate) on page F7-2602
		11111	Test Equivalence	TEQ (immediate) on page F7-2942
1000	-	not 11111	Add	ADD (immediate, T32) on page F7-2540
		11111	Compare Negative	CMN (immediate) on page F7-2586
1010	-	-	Add with Carry	ADC (immediate) on page F7-2534
1011	-	-	Subtract with Carry	SBC (immediate) on page F7-2793
1101	-	not 11111	Subtract	SUB (immediate, T32) on page F7-2914
		11111	Compare	CMP (immediate) on page F7-2589
1110	-	-	Reverse Subtract	RSB (immediate) on page F7-2782

These instructions all have modified immediate constants, rather than a simple 12-bit binary number. This provides a more useful range of values. For details see [Modified immediate constants in T32 instructions on page F3-2444](#).

F3.3.2 Modified immediate constants in T32 instructions

The encoding of a modified immediate constant in a 32-bit T32 instruction is:

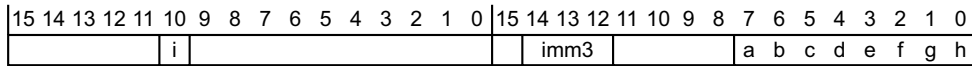

Table F3-11 shows the range of modified immediate constants available in T32 data-processing instructions, and their encoding in the a, b, c, d, e, f, g, h, and i bits, and the imm3 field, in the instruction.

Table F3-11 Encoding of modified immediates in T32 data-processing instructions

i:imm3:a	<const> ^a
0000x	00000000 00000000 00000000 abcdefgh
0001x	00000000 abcdefgh 00000000 abcdefgh ^b
0010x	abcdefgh 00000000 abcdefgh 00000000 ^b
0011x	abcdefgh abcdefgh abcdefgh abcdefgh ^b
01000	1bcdefgh 00000000 00000000 00000000
01001	01bcdefg h0000000 00000000 00000000 ^c
01010	001bcdef gh000000 00000000 00000000
01011	0001bcde fgh00000 00000000 00000000 ^c
.	.
.	. 8-bit values shifted to other positions
.	.
11101	00000000 00000000 000001bc defgh000 ^c
11110	00000000 00000000 0000001b cdefgh00
11111	00000000 00000000 00000001 bcdefgh0 ^c

- a. This table shows the immediate constant value in binary form, to relate abcdefgh to the encoding diagram. In assembly syntax, the immediate value is specified in the usual way (a decimal number by default).
- b. ARM deprecates using a modified immediate with abcdefgh == 00000000.
- c. Not available in A32 instructions if h == 1.

———— **Note** ————

As the footnotes to Table F3-11 show, the range of values available in T32 modified immediate constants is slightly different from the range of values available in A32 instructions. See *Modified immediate constants in A32 instructions* on page F4-2472 for the A32 values.

Carry out

A logical instruction with i:imm3:a == '00xxx' does not affect the Carry flag. Otherwise, a logical flag-setting instruction sets the Carry flag to the value of bit[31] of the modified immediate constant.

Operation of modified immediate constants, T32 instructions

```
// ThumbExpandImm()
// =====

bits(32) ThumbExpandImm(bits(12) imm12)

    // APSR.C argument to following function call does not affect the imm32 result.
    (imm32, -) = ThumbExpandImm_C(imm12, APSR.C);

    return imm32;

// ThumbExpandImm_C()
// =====

(bits(32), bit) ThumbExpandImm_C(bits(12) imm12, bit carry_in)

    if imm12<11:10> == '00' then

        case imm12<9:8> of
            when '00'
                imm32 = ZeroExtend(imm12<7:0>, 32);
            when '01'
                if imm12<7:0> == '00000000' then UNPREDICTABLE;
                imm32 = '00000000' : imm12<7:0> : '00000000' : imm12<7:0>;
            when '10'
                if imm12<7:0> == '00000000' then UNPREDICTABLE;
                imm32 = imm12<7:0> : '00000000' : imm12<7:0> : '00000000';
            when '11'
                if imm12<7:0> == '00000000' then UNPREDICTABLE;
                imm32 = imm12<7:0> : imm12<7:0> : imm12<7:0> : imm12<7:0>;
        carry_out = carry_in;

    else

        unrotated_value = ZeroExtend('1':imm12<6:0>, 32);
        (imm32, carry_out) = ROR_C(unrotated_value, UInt(imm12<11:7>));

    return (imm32, carry_out);
```

F3.3.3 Data-processing (plain binary immediate)

The encoding of the 32-bit T32 data-processing (plain binary immediate) instructions is:

15	14	13	12	11	10	9	8	7	6	5	4	3	2	1	0	15	14	13	12	11	10	9	8	7	6	5	4	3	2	1	0
1	1	1	1	0	1	op				Rn				0																	

Table F3-12 shows the allocation of encodings in this space. Other encodings in this space are UNDEFINED.

These encodings are all available in ARMv6T2 and above.

Table F3-12 32-bit unmodified immediate data-processing instructions

op	Rn	Instruction	See
00000	not 1111	Add Wide (12-bit)	ADD (immediate, T32) on page F7-2540
	1111	Form PC-relative Address	ADR on page F7-2554
00100	-	Move Wide (16-bit)	MOV (immediate) on page F7-2708
01010	not 1111	Subtract Wide (12-bit)	SUB (immediate, T32) on page F7-2914
	1111	Form PC-relative Address	ADR on page F7-2554
01100	-	Move Top (16-bit)	MOVT on page F7-2714
10000 10010 ^a	-	Signed Saturate	SSAT on page F7-2844
10010 ^b	-	Signed Saturate, two 16-bit	SSAT16 on page F7-2846
10100	-	Signed Bit Field Extract	SBFX on page F7-2798
10110	not 1111	Bit Field Insert	BFI on page F7-2569
	1111	Bit Field Clear	BFC on page F7-2568
11000 11010 ^a	-	Unsigned Saturate	USAT on page F7-3000
11010 ^b	-	Unsigned Saturate, two 16-bit	USAT16 on page F7-3002
11100	-	Unsigned Bit Field Extract	UBFX on page F7-2960

- a. In the second halfword of the instruction, bits[14:12, 7:6] != 0b00000.
- b. In the second halfword of the instruction, bits[14:12, 7:6] == 0b00000.

F3.3.4 Branches and miscellaneous control

The encoding of the 32-bit T32 branch instructions and miscellaneous control instructions is:

15	14	13	12	11	10	9	8	7	6	5	4	3	2	1	0	15	14	13	12	11	10	9	8	7	6	5	4	3	2	1	0
1	1	1	1	0	op						1	op1			op2			imm8													

Table F3-13 shows the allocation of encodings in this space. Other encodings in this space are UNDEFINED.

Table F3-13 Branches and miscellaneous control instructions

op1	imm8	op	op2	Instruction	See	Variant
0x0	-	not x111xxx	-	Conditional branch	B on page F7-2566	v6T2
	xx1xxxxx	011100x	-	Move to Banked or Special register	MSR (Banked register) on page F7-3050	v7VE
	xx0xxxxx	0111000	xx00	Move to Special register, Application level	MSR (register) on page F7-2724	All
			xx01 xx1x	Move to Special register, System level	MSR (register) on page F7-3054	All
		0111001	-	Move to Special register, System level	MSR (register) on page F7-3054	All
-		0111010	-	-	Change Processor State, and hints on page F3-2448	
-		0111011	-	-	Miscellaneous control instructions on page F3-2449	
-		0111100	-	Branch and Exchange Jazelle	BXJ on page F7-2580	v6T2
	00000000	0111101	-	Exception Return	ERET on page F7-3038	v6T2 ^a
	not 00000000	0111101	-	Exception Return	SUBS PC, LR and related instructions (T32) on page F7-3066	v6T2
	xx1xxxxx	011111x	-	Move from Banked or Special register	MRS (Banked register) on page F7-3048	v7VE
	xx0xxxxx	0111110	-	Move from Special register, Application level	MRS on page F7-2720	v6T2
		0111111	-	Move from Special register, System level	MRS on page F7-3046	v6T2
000	-	1111000	-	Debug Change Processor State	DCPS1, DCPS2, DCPS3 on page F7-2597	v8
		1111110	-	Hypervisor Call	HVC on page F7-3040	v7VE
		1111111	-	Secure Monitor Call	SMC (previously SMI) on page F7-3058	Security Extensions
0x1	-	-	-	Branch	B on page F7-2566	v6T2
010	-	1111111	-	Permanently UNDEFINED	UDF on page F7-2962	All ^b

Table F3-13 Branches and miscellaneous control instructions (continued)

op1	imm8	op	op2	Instruction	See	Variant
1x0	-	-	-	Branch with Link and Exchange	BL, BLX (immediate) on page F7-2576	v5T ^c
1x1	-	-	-	Branch with Link	BL, BLX (immediate) on page F7-2576	v4T

- a. v7VE, that is, ARMv7 with the Virtualization Extensions, first defines ERET as an assembler mnemonic for this encoding. From ARMv6T2 this is an encoding for *SUBS PC, LR and related instructions (T32)* on page F7-3066 with an imm8 value of zero. This reuse of this encoding for ERET does not change the behavior of the encoded instruction when executing at EL1.
- b. Issue C.a of this manual first defines an assembler mnemonic for this encoding.
- c. UNDEFINED in ARMv4T.

Change Processor State, and hints

The encoding of 32-bit T32 Change Processor State and hint instructions is:

15	14	13	12	11	10	9	8	7	6	5	4	3	2	1	0	15	14	13	12	11	10	9	8	7	6	5	4	3	2	1	0
1	1	1	1	0	0	1	1	1	0	1	0					1	0														
												op1		op2																	

Table F3-14 shows the allocation of encodings in this space. Encodings with op1 set to 0b000 and a value of op2 that is not shown in the table are unallocated hints, and behave as if op2 is set to 0b00000000. These unallocated hint encodings are reserved and software must not use them.

Table F3-14 Change Processor State, and hint instructions

op1	op2	Instruction	See	Variant
not 000	-	Change Processor State	CPS (T32) on page F7-3034	v6T2
000	00000000	No Operation hint	NOP on page F7-2734	v6T2
	00000001	Yield hint	YIELD on page F7-3026	v7
	00000010	Wait For Event hint	WFE on page F7-3022	v7
	00000011	Wait For Interrupt hint	WFI on page F7-3024	v7
	00000100	Send Event hint	SEV on page F7-2804	v7
	00000101	Send Event Local hint	SEVL on page F7-2805	v8
	1111xxxx	Debug hint	DBG on page F7-2596	v7

Miscellaneous control instructions

The encoding of some 32-bit T32 miscellaneous control instructions is:

15	14	13	12	11	10	9	8	7	6	5	4	3	2	1	0	15	14	13	12	11	10	9	8	7	6	5	4	3	2	1	0
1	1	1	1	0	0	1	1	1	0	1	1					1	0		0					op							

Table F3-15 shows the allocation of encodings in this space. Other encodings in this space are UNDEFINED in ARMv7. They are UNPREDICTABLE in ARMv6T2.

Table F3-15 Miscellaneous control instructions

op	Instruction	See	Variant
0010	Clear-Exclusive	CLREX on page F7-2584	v7
0100	Data Synchronization Barrier	DSB on page F7-2600	v7
0101	Data Memory Barrier	DMB on page F7-2598	v7
0110	Instruction Synchronization Barrier	ISB on page F7-2609	v7

F3.3.5 Load/store multiple

The encoding of 32-bit T32 load/store multiple instructions is:

15	14	13	12	11	10	9	8	7	6	5	4	3	2	1	0	15	14	13	12	11	10	9	8	7	6	5	4	3	2	1	0
1	1	1	0	1	0	0	op	0	W	L			Rn																		

Table F3-16 shows the allocation of encodings in this space.

These encodings are all available in ARMv6T2 and above.

Table F3-16 Load/store multiple instructions

op	L	W:Rn	Instruction	See
00	0	-	Store Return State	SRS (T32) on page F7-3060
	1	-	Return From Exception	RFE on page F7-3056
01	0	-	Store Multiple (Increment After, Empty Ascending)	STM (STMIA, STMEA) on page F7-2870
	1	not 11101	Load Multiple (Increment After, Full Descending)	LDM/LDMIA/LDMFD (T32) on page F7-2624
		11101	Pop Multiple Registers from the stack	POP (T32) on page F7-2756
10	0	not 11101	Store Multiple (Decrement Before, Full Descending)	STMDB (STMFD) on page F7-2874
		11101	Push Multiple Registers to the stack.	PUSH on page F7-2760
	1	-	Load Multiple (Decrement Before, Empty Ascending)	LDMDB/LDMEA on page F7-2630
		-		
11	0	-	Store Return State	SRS (T32) on page F7-3060
	1	-	Return From Exception	RFE on page F7-3056

F3.3.6 Load/store dual, load/store exclusive, table branch

The encoding of 32-bit T32 load/store dual, load/store exclusive and table branch instructions is:

15	14	13	12	11	10	9	8	7	6	5	4	3	2	1	0	15	14	13	12	11	10	9	8	7	6	5	4	3	2	1	0
1	1	1	0	1	0	0	op1	1	op2	Rn						op3															

Table F3-17 shows the allocation of encodings in this space. Other encodings in this space are UNDEFINED.

Table F3-17 Load/store double or exclusive, table branch

op1	op2	op3	Rn	Instruction	See	Variant
00	00	-	-	Store Register Exclusive	STREX on page F7-2896	v6T2
	01	-	-	Load Register Exclusive	LDREX on page F7-2660	v6T2
0x	10	-	-	Store Register Dual	STRD (immediate) on page F7-2892	v6T2
1x	x0	-	-			
0x	11	-	not 1111	Load Register Dual (immediate)	LDRD (immediate) on page F7-2654	v6T2
1x	x1	-	not 1111			
0x	11	-	1111	Load Register Dual (literal)	LDRD (literal) on page F7-2656	v6T2
1x	x1	-	1111			

Table F3-17 Load/store double or exclusive, table branch (continued)

op1	op2	op3	Rn	Instruction	See	Variant
01	00	0100	-	Store Register Exclusive Byte	STREXB on page F7-2898	v7
		0101	-	Store Register Exclusive Halfword	STREXH on page F7-2902	v7
		0111	-	Store Register Exclusive Doubleword	STREXD on page F7-2900	v7
		1000	-	Store Release Byte	STLB on page F7-2858	v8
		1001	-	Store Release Halfword	STLH on page F7-2868	v8
		1010	-	Store Release Word	STL on page F7-2856	v8
		1100	-	Store Release Exclusive Byte	STLEXB on page F7-2862	v8
		1101	-	Store Release Exclusive Halfword	STLEXH on page F7-2866	v8
		1110	-	Store Release Exclusive Word	STLEX on page F7-2860	v8
		1111	-	Store Release Exclusive Dual	STLEXD on page F7-2864	v8
		01	0000	-	Table Branch Byte	TBB, TBH on page F7-2940
-	Table Branch Halfword			TBB, TBH on page F7-2940	v6T2	
0100	-			Load Register Exclusive Byte	LDREXB on page F7-2661	v7
0101	-			Load Register Exclusive Halfword	LDREXH on page F7-2663	v7
0111	-			Load Register Exclusive Doubleword	LDREXD on page F7-2662	v7
1000	-			Load Acquire Byte	LDAB on page F7-2613	v8
1001	-			Load Acquire Halfword	LDAH on page F7-2618	v8
1010	-			Load Acquire Word	LDA on page F7-2612	v8
1100	-			Load Acquire Exclusive Byte	LDAEXB on page F7-2615	v8
1101	-			Load Acquire Exclusive Halfword	LDAEXH on page F7-2617	v8
1110	-			Load Acquire Exclusive Word	LDAEX on page F7-2614	v8
1111	-			Load Acquire Exclusive Dual	LDAEXD on page F7-2616	v8

F3.3.7 Load word

The encoding of 32-bit T32 load word instructions is:

15	14	13	12	11	10	9	8	7	6	5	4	3	2	1	0	15	14	13	12	11	10	9	8	7	6	5	4	3	2	1	0
1	1	1	1	1	0	0	op1	1	0	1	Rn							op2													

Table F3-18 shows the allocation of encodings in this space. Other encodings in this space are UNDEFINED.

These encodings are all available in ARMv6T2 and above.

Table F3-18 Load word

op1	op2	Rn	Instruction	See
00	000000	not 1111	Load Register	LDR (register, T32) on page F7-2640
00	1xx1xx	not 1111	Load Register	LDR (immediate, T32) on page F7-2634
	1100xx	not 1111		
01	-	not 1111		
00	1110xx	not 1111	Load Register Unprivileged	LDRT on page F7-2690
0x	-	1111	Load Register	LDR (literal) on page F7-2638

F3.3.8 Load halfword, memory hints

The encoding of 32-bit T32 load halfword instructions and some memory hint instructions is:

15	14	13	12	11	10	9	8	7	6	5	4	3	2	1	0	15	14	13	12	11	10	9	8	7	6	5	4	3	2	1	0
1	1	1	1	1	0	0	op1	0	1	1		Rn				Rt						op2									

Table F3-19 shows the allocation of encodings in this space. Other encodings in this space are UNDEFINED.

Except where otherwise noted, these encodings are available in ARMv6T2 and above.

Table F3-19 Load halfword, preload

op1	op2	Rn	Rt	Instruction	See
0x	-	1111	not 1111	Load Register Halfword	LDRH (literal) on page F7-2668
			1111	Preload Data	PLD (literal) on page F7-2748
00	1xx1xx	not 1111	-	Load Register Halfword	LDRH (immediate, T32) on page F7-2664
	1100xx	not 1111	not 1111		
01	-	not 1111	not 1111		
00	000000	not 1111	not 1111	Load Register Halfword	LDRH (register) on page F7-2670
	1110xx	not 1111	-	Load Register Halfword Unprivileged	LDRHT on page F7-2672
	000000	not 1111	1111	Preload Data with intent to Write ^a	PLD, PLDW (register) on page F7-2750
	1100xx	not 1111	1111	Preload Data with intent to Write ^a	PLD, PLDW (immediate) on page F7-2746
01	-	not 1111	1111		
10	1xx1xx	not 1111	-	Load Register Signed Halfword	LDRSH (immediate) on page F7-2682
	1100xx	not 1111	not 1111		
11	-	not 1111	not 1111		
1x	-	1111	not 1111	Load Register Signed Halfword	LDRSH (literal) on page F7-2684
10	000000	not 1111	not 1111	Load Register Signed Halfword	LDRSH (register) on page F7-2686
	1110xx	not 1111	-	Load Register Signed Halfword Unprivileged	LDRSHT on page F7-2688
10	000000	not 1111	1111	Unallocated memory hint (treat as NOP)	-
	1100xx	not 1111	1111		
1x	-	1111	1111		
11	-	not 1111	1111	Unallocated memory hint (treat as NOP)	-

a. Available in ARMv7 with the Multiprocessing Extensions. In an ARMv7 implementation that does not include the Multiprocessing Extensions, and in ARMv6T2, these are unallocated memory hints, that are treated as NOPs.

F3.3.9 Load byte, memory hints

The encoding of 32-bit T32 load byte instructions and some memory hint instructions is:

15	14	13	12	11	10	9	8	7	6	5	4	3	2	1	0	15	14	13	12	11	10	9	8	7	6	5	4	3	2	1	0
1	1	1	1	1	0	0	op1	0	0	1		Rn				Rt						op2									

Table F3-20 shows the allocation of encodings in this space. Other encodings in this space are UNDEFINED.

These encodings are all available in ARMv6T2 and above.

Table F3-20 Load byte, memory hints

op1	op2	Rn	Rt	Instruction	See
00	000000	not 1111	not 1111	Load Register Byte	LDRB (register) on page F7-2650
			1111	Preload Data	PLD, PLDW (register) on page F7-2750
0x	-	1111	not 1111	Load Register Byte	LDRB (literal) on page F7-2648
			1111	Preload Data	PLD (literal) on page F7-2748
00	1xx1xx	not 1111	-	Load Register Byte	LDRB (immediate, T32) on page F7-2644
	1100xx	not 1111	not 1111	Load Register Byte	
			1111	Preload Data	PLD, PLDW (immediate) on page F7-2746
1110xx	not 1111	-	Load Register Byte Unprivileged	LDRBT on page F7-2652	
01	-	not 1111	not 1111	Load Register Byte	LDRB (immediate, T32) on page F7-2644
			1111	Preload Data	PLD, PLDW (immediate) on page F7-2746
10	000000	not 1111	not 1111	Load Register Signed Byte	LDRSB (register) on page F7-2678
			1111	Preload Instruction	PLI (register) on page F7-2754
1x	-	1111	not 1111	Load Register Signed Byte	LDRSB (literal) on page F7-2676
			1111	Preload Instruction	PLI (immediate, literal) on page F7-2752
10	1xx1xx	not 1111	-	Load Register Signed Byte	LDRSB (immediate) on page F7-2674
	1100xx	not 1111	not 1111	Load Register Signed Byte	LDRSB (immediate) on page F7-2674
			1111	Preload Instruction	PLI (immediate, literal) on page F7-2752
1110xx	not 1111	-	Load Register Signed Byte Unprivileged	LDRSBT on page F7-2680	
11	-	not 1111	not 1111	Load Register Signed Byte	LDRSB (immediate) on page F7-2674
			1111	Preload Instruction	PLI (immediate, literal) on page F7-2752

F3.3.10 Store single data item

The encoding of 32-bit T32 store single data item instructions is:

15	14	13	12	11	10	9	8	7	6	5	4	3	2	1	0	15	14	13	12	11	10	9	8	7	6	5	4	3	2	1	0
1	1	1	1	1	0	0	0	op1	0													op2									

Table F3-21 show the allocation of encodings in this space. Other encodings in this space are UNDEFINED.

These encodings are all available in ARMv6T2 and above.

Table F3-21 Store single data item

op1	op2	Instruction	See
000	1xx1xx 1100xx	Store Register Byte	STRB (immediate, T32) on page F7-2884
100	-		
000	000000 1110xx	Store Register Byte Store Register Byte Unprivileged	STRB (register) on page F7-2888 STRBT on page F7-2890
001	1xx1xx 1100xx	Store Register Halfword	STRH (immediate, T32) on page F7-2904
101	-		
001	000000 1110xx	Store Register Halfword Store Register Halfword Unprivileged	STRH (register) on page F7-2908 STRHT on page F7-2910
010	1xx1xx 1100xx	Store Register	STR (immediate, T32) on page F7-2878
110	-		
010	000000 1110xx	Store Register Store Register Unprivileged	STR (register) on page F7-2882 STRT on page F7-2912

F3.3.11 Data-processing (shifted register)

The encoding of 32-bit T32 data-processing (shifted register) instructions is:

15	14	13	12	11	10	9	8	7	6	5	4	3	2	1	0	15	14	13	12	11	10	9	8	7	6	5	4	3	2	1	0
1	1	1	0	1	0	1		op		S		Rn									Rd										

Table F3-22 shows the allocation of encodings in this space. Other encodings in this space are UNDEFINED.

These encodings are all available in ARMv6T2 and above.

Table F3-22 Data-processing (shifted register)

op	Rn	Rd:S	Instruction	See
0000	-	not 11111	Bitwise AND	AND (register) on page F7-2558
		11111	Test	TST (register) on page F7-2950
0001	-	-	Bitwise Bit Clear	BIC (register) on page F7-2572
0010	not 1111	-	Bitwise OR	ORR (register) on page F7-2740
		1111	-	Move register and immediate shifts on page F3-2457
0011	not 1111	-	Bitwise OR NOT	ORN (register) on page F7-2736
		1111	-	Bitwise NOT
0100	-	not 11111	Bitwise Exclusive OR	EOR (register) on page F7-2604
		11111	Test Equivalence	TEQ (register) on page F7-2944
0110	-	-	Pack Halfword	PKH on page F7-2744
1000	-	not 11111	Add	ADD (register, T32) on page F7-2544
		11111	Compare Negative	CMN (register) on page F7-2587
1010	-	-	Add with Carry	ADC (register) on page F7-2536
1011	-	-	Subtract with Carry	SBC (register) on page F7-2794
1101	-	not 11111	Subtract	SUB (register) on page F7-2918
		11111	Compare	CMP (register) on page F7-2590
1110	-	-	Reverse Subtract	RSB (register) on page F7-2784

Move register and immediate shifts

The encoding of the 32-bit T32 move register and immediate shift instructions is:

15	14	13	12	11	10	9	8	7	6	5	4	3	2	1	0	15	14	13	12	11	10	9	8	7	6	5	4	3	2	1	0			
1	1	1	0	1	0	1	0	0	1	0		1	1	1	1		imm3												imm2	type				

Table F3-23 shows the allocation of encodings in this space.

These encodings are all available in ARMv6T2 and above.

Table F3-23 Move register and immediate shifts

type	imm3:imm2	Instruction	See
00	00000	Move	<i>MOV (register, T32)</i> on page F7-2710
	not 00000	Logical Shift Left	<i>LSL (immediate)</i> on page F7-2692
01	-	Logical Shift Right	<i>LSR (immediate)</i> on page F7-2696
10	-	Arithmetic Shift Right	<i>ASR (immediate)</i> on page F7-2562
11	00000	Rotate Right with Extend	<i>RRX</i> on page F7-2780
	not 00000	Rotate Right	<i>ROR (immediate)</i> on page F7-2776

F3.3.12 Data-processing (register)

The encoding of 32-bit T32 data-processing (register) instructions is:

15	14	13	12	11	10	9	8	7	6	5	4	3	2	1	0	15	14	13	12	11	10	9	8	7	6	5	4	3	2	1	0
1	1	1	1	1	0	1	0	op1				Rn				1	1	1	1					op2							

If, in the second halfword of the instruction, bits[15:12] != 0b1111, the instruction is UNDEFINED.

Table F3-24 shows the allocation of encodings in this space. Other encodings in this space are UNDEFINED.

These encodings are all available in ARMv6T2 and above.

Table F3-24 Data-processing (register)

op1	op2	Rn	Instruction	See
000x	0000	-	Logical Shift Left	<i>LSL (register)</i> on page F7-2694
001x	0000	-	Logical Shift Right	<i>LSR (register)</i> on page F7-2698
010x	0000	-	Arithmetic Shift Right	<i>ASR (register)</i> on page F7-2564
011x	0000	-	Rotate Right	<i>ROR (register)</i> on page F7-2778
0000	1xxx	not 1111	Signed Extend and Add Halfword	<i>SXTAH</i> on page F7-2932
		1111	Signed Extend Halfword	<i>SXTH</i> on page F7-2938
0001	1xxx	not 1111	Unsigned Extend and Add Halfword	<i>UXTAH</i> on page F7-3014
		1111	Unsigned Extend Halfword	<i>UXTH</i> on page F7-3020
0010	1xxx	not 1111	Signed Extend and Add Byte 16-bit	<i>SXTAB16</i> on page F7-2930
		1111	Signed Extend Byte 16-bit	<i>SXTB16</i> on page F7-2936
0011	1xxx	not 1111	Unsigned Extend and Add Byte 16-bit	<i>UXTAB16</i> on page F7-3012
		1111	Unsigned Extend Byte 16-bit	<i>UXTB16</i> on page F7-3018
0100	1xxx	not 1111	Signed Extend and Add Byte	<i>SXTAB</i> on page F7-2928
		1111	Signed Extend Byte	<i>SXTB</i> on page F7-2934
0101	1xxx	not 1111	Unsigned Extend and Add Byte	<i>UXTAB</i> on page F7-3010
		1111	Unsigned Extend Byte	<i>UXTB</i> on page F7-3016
1xxx	00xx	-	-	<i>Parallel addition and subtraction, signed</i> on page F3-2459
	01xx	-	-	<i>Parallel addition and subtraction, unsigned</i> on page F3-2460
	10xx	-	-	<i>Miscellaneous operations</i> on page F3-2461

F3.3.13 Parallel addition and subtraction, signed

The encoding of 32-bit T32 signed parallel addition and subtraction instructions is:

15	14	13	12	11	10	9	8	7	6	5	4	3	2	1	0	15	14	13	12	11	10	9	8	7	6	5	4	3	2	1	0	
1	1	1	1	1	0	1	0	1	op1									1	1	1	1					0	0	op2				

If, in the second halfword of the instruction, bits[15:12] != 0b1111, the instruction is UNDEFINED.

Table F3-25 shows the allocation of encodings in this space. Other encodings in this space are UNDEFINED. These encodings are all available in ARMv6T2 and above.

Table F3-25 Signed parallel addition and subtraction instructions

op1	op2	Instruction	See
001	00	Add 16-bit	SADD16 on page F7-2791
010	00	Add and Subtract with Exchange, 16-bit	SASX on page F7-2792
110	00	Subtract and Add with Exchange, 16-bit	SSAX on page F7-2848
101	00	Subtract 16-bit	SSUB16 on page F7-2852
000	00	Add 8-bit	SADD8 on page F7-2790
100	00	Subtract 8-bit	SSUB8 on page F7-2850
Saturating instructions			
001	01	Saturating Add 16-bit	QADD16 on page F7-2764
010	01	Saturating Add and Subtract with Exchange, 16-bit	QASX on page F7-2765
110	01	Saturating Subtract and Add with Exchange, 16-bit	QSAX on page F7-2768
101	01	Saturating Subtract 16-bit	QSUB16 on page F7-2771
000	01	Saturating Add 8-bit	QADD8 on page F7-2763
100	01	Saturating Subtract 8-bit	QSUB8 on page F7-2770
Halving instructions			
001	10	Halving Add 16-bit	SHADD16 on page F7-2807
010	10	Halving Add and Subtract with Exchange, 16-bit	SHASX on page F7-2808
110	10	Halving Subtract and Add with Exchange, 16-bit	SHSAX on page F7-2809
101	10	Halving Subtract 16-bit	SHSUB16 on page F7-2811
000	10	Halving Add 8-bit	SHADD8 on page F7-2806
100	10	Halving Subtract 8-bit	SHSUB8 on page F7-2810

F3.3.14 Parallel addition and subtraction, unsigned

The encoding of 32-bit T32 unsigned parallel addition and subtraction instructions is:

15	14	13	12	11	10	9	8	7	6	5	4	3	2	1	0	15	14	13	12	11	10	9	8	7	6	5	4	3	2	1	0
1	1	1	1	1	0	1	0	1	op1						1	1	1	1	op2												

If, in the second halfword of the instruction, bits[15:12] != 0b1111, the instruction is UNDEFINED.

Table F3-26 shows the allocation of encodings in this space. Other encodings in this space are UNDEFINED. These encodings are all available in ARMv6T2 and above.

Table F3-26 Unsigned parallel addition and subtraction instructions

op1	op2	Instruction	See
001	00	Add 16-bit	UADD16 on page F7-2956
010	00	Add and Subtract with Exchange, 16-bit	UASX on page F7-2958
110	00	Subtract and Add with Exchange, 16-bit	USAX on page F7-3004
101	00	Subtract 16-bit	USUB16 on page F7-3008
000	00	Add 8-bit	UADD8 on page F7-2954
100	00	Subtract 8-bit	USUB8 on page F7-3006
Saturating instructions			
001	01	Saturating Add 16-bit	UQADD16 on page F7-2986
010	01	Saturating Add and Subtract with Exchange, 16-bit	UQASX on page F7-2988
110	01	Saturating Subtract and Add with Exchange, 16-bit	UQSAX on page F7-2990
101	01	Saturating Subtract 16-bit	UQSUB16 on page F7-2994
000	01	Saturating Add 8-bit	UQADD8 on page F7-2984
100	01	Saturating Subtract 8-bit	UQSUB8 on page F7-2992
Halving instructions			
001	10	Halving Add 16-bit	UHADD16 on page F7-2968
010	10	Halving Add and Subtract with Exchange, 16-bit	UHASX on page F7-2970
110	10	Halving Subtract and Add with Exchange, 16-bit	UHSAX on page F7-2972
101	10	Halving Subtract 16-bit	UHSUB16 on page F7-2976
000	10	Halving Add 8-bit	UHADD8 on page F7-2966
100	10	Halving Subtract 8-bit	UHSUB8 on page F7-2974

F3.3.15 Miscellaneous operations

The encoding of some 32-bit T32 miscellaneous instructions is:

15	14	13	12	11	10	9	8	7	6	5	4	3	2	1	0	15	14	13	12	11	10	9	8	7	6	5	4	3	2	1	0	
1	1	1	1	1	0	1	0	1	op1									1	1	1	1					1	0	op2				

If, in the second halfword of the instruction, bits[15:12] != 0b1111, the instruction is UNDEFINED.

Table F3-27 shows the allocation of encodings in this space. Other encodings in this space are UNDEFINED.

Table F3-27 Miscellaneous operations

op1	op2	Instruction	See	Variant
000	00	Saturating Add	QADD on page F7-2762	v6T
	01	Saturating Double and Add	QDADD on page F7-2766	v6T
	10	Saturating Subtract	QSUB on page F7-2769	v6T
	11	Saturating Double and Subtract	QDSUB on page F7-2767	v6T
001	00	Byte-Reverse Word	REV on page F7-2773	v6T
	01	Byte-Reverse Packed Halfword	REV16 on page F7-2774	v6T
	10	Reverse Bits	RBIT on page F7-2772	v6T
	11	Byte-Reverse Signed Halfword	REVSH on page F7-2775	v6T
010	00	Select Bytes	SEL on page F7-2802	v6T
011	00	Count Leading Zeros	CLZ on page F7-2585	v6T
10x	xx	CRC32	CRC32, CRC32C on page F7-2594	v8

F3.3.16 Multiply, multiply accumulate, and absolute difference

The encoding of 32-bit T32 multiply, multiply accumulate, and absolute difference instructions is:

15	14	13	12	11	10	9	8	7	6	5	4	3	2	1	0	15	14	13	12	11	10	9	8	7	6	5	4	3	2	1	0
1	1	1	1	1	0	1	1	0	op1							Ra						0	0	op2							

If, in the second halfword of the instruction, bits[7:6] != 0b00, the instruction is UNDEFINED.

Table F3-28 shows the allocation of encodings in this space. Other encodings in this space are UNDEFINED. These encodings are all available in ARMv6T2 and above.

Table F3-28 Multiply, multiply accumulate, and absolute difference operations

op1	op2	Ra	Instruction	See
000	00	not 1111	Multiply Accumulate	MLA on page F7-2704
		1111	Multiply	MUL on page F7-2726
	01	-	Multiply and Subtract	MLS on page F7-2706
001	-	not 1111	Signed Multiply Accumulate (Halfwords)	SMLABB, SMLABT, SMLATB, SMLATT on page F7-2812
		1111	Signed Multiply (Halfwords)	SMULBB, SMULBT, SMULTB, SMULTT on page F7-2836
010	0x	not 1111	Signed Multiply Accumulate Dual	SMLAD on page F7-2814
		1111	Signed Dual Multiply Add	SMUAD on page F7-2834
011	0x	not 1111	Signed Multiply Accumulate (Word by halfword)	SMLAWB, SMLAWT on page F7-2822
		1111	Signed Multiply (Word by halfword)	SMULWB, SMULWT on page F7-2840
100	0x	not 1111	Signed Multiply Subtract Dual	SMLSD on page F7-2824
		1111	Signed Dual Multiply Subtract	SMUSD on page F7-2842
101	0x	not 1111	Signed Most Significant Word Multiply Accumulate	SMMLA on page F7-2828
		1111	Signed Most Significant Word Multiply	SMMUL on page F7-2832
110	0x	-	Signed Most Significant Word Multiply Subtract	SMMLS on page F7-2830
111	00	not 1111	Unsigned Sum of Absolute Differences, Accumulate	USADA8 on page F7-2998
		1111	Unsigned Sum of Absolute Differences	USAD8 on page F7-2996

F3.3.17 Long multiply, long multiply accumulate, and divide

The encoding of 32-bit T32 long multiply, long multiply accumulate, and divide instructions is:

15	14	13	12	11	10	9	8	7	6	5	4	3	2	1	0	15	14	13	12	11	10	9	8	7	6	5	4	3	2	1	0
1	1	1	1	1	0	1	1	1	op1									op2													

Table F3-29 shows the allocation of encodings in this space. Other encodings in this space are UNDEFINED.

Table F3-29 Multiply, multiply accumulate, and absolute difference operations

op1	op2	Instruction	See	Variant
000	0000	Signed Multiply Long	SMULL on page F7-2838	v6T2
001	1111	Signed Divide	SDIV on page F7-2800	v7-R ^a
010	0000	Unsigned Multiply Long	UMULL on page F7-2982	v6T2
011	1111	Unsigned Divide	UDIV on page F7-2964	v7-R ^a
100	0000	Signed Multiply Accumulate Long	SMLAL on page F7-2816	v6T2
	10xx	Signed Multiply Accumulate Long (Halfwords)	SMLALBB, SMLALBT, SMLALTB, SMLALTT on page F7-2818	v6T2
	110x	Signed Multiply Accumulate Long Dual	SMLALD on page F7-2820	v6T2
101	110x	Signed Multiply Subtract Long Dual	SMLS LD on page F7-2826	v6T2
110	0000	Unsigned Multiply Accumulate Long	UMLAL on page F7-2980	v6T2
	0110	Unsigned Multiply Accumulate Accumulate Long	UMAAL on page F7-2978	v6T2

a. Optional in some ARMv7 implementations, see [Format of instruction descriptions on page F2-2410](#).

F3.3.18 Coprocessor, Advanced SIMD, and floating-point instructions

The encoding of 32-bit T32 coprocessor instructions is:

15	14	13	12	11	10	9	8	7	6	5	4	3	2	1	0	15	14	13	12	11	10	9	8	7	6	5	4	3	2	1	0
1	1	1		1	1		op1			Rn						coproc						op									

Table F3-30 shows the allocation of encodings in this space. These encodings are all available in ARMv6T2 and above.

Table F3-30 Coprocessor, Advanced SIMD, and floating-point instructions

coproc	op1	op	Rn	Instructions	See
-	0000x	-	-	UNDEFINED	-
	11xxxx	-	-	Advanced SIMD	Advanced SIMD data-processing instructions on page F1-2401
not 101x	0xxxx0 not 000x0x	-	-	Store Coprocessor	STC, STC2 on page F7-2854
	0xxxx1 not 000x0x	-	not 1111	Load Coprocessor (immediate)	LDC, LDC2 (immediate) on page F7-2620
			1111	Load Coprocessor (literal)	LDC, LDC2 (literal) on page F7-2622
	000100	-	-	Move to Coprocessor from two ARM core registers	MCRR, MCRR2 on page F7-2702
	000101	-	-	Move to two general-purpose registers from Coprocessor	MRRC, MRRC2 on page F7-2718
	10xxxx	0	-	Coprocessor data operations	CDP, CDP2 on page F7-2582
	10xxx0	1	-	Move to Coprocessor from general-purpose register	MCR, MCR2 on page F7-2700
	10xxx1	1	-	Move to general-purpose register from Coprocessor	MRC, MRC2 on page F7-2716
101x	0xxxxx not 000x0x	-	-	Advanced SIMD, floating-point	Extension register load/store instructions on page F5-2514
	00010x	-	-	Advanced SIMD, floating-point	64-bit transfers between general-purpose and extension registers on page F5-2519
	10xxxx	0	-	Floating-point data processing	Floating-point data-processing instructions on page F5-2511
	10xxxx	1	-	Advanced SIMD, floating-point	8, 16, and 32-bit transfer between general-purpose and extension registers on page F5-2518

For more information about specific coprocessors see [Coprocessor support](#) on page E1-2331.

Chapter F4

A32 Base Instruction Set Encoding

This chapter describes the encoding of the A32 instruction set. It contains the following sections:

- *A32 instruction set encoding* on page F4-2466.
- *Data-processing and miscellaneous instructions* on page F4-2468.
- *Load/store word and unsigned byte* on page F4-2480.
- *Media instructions* on page F4-2481.
- *Branch, branch with link, and block data transfer* on page F4-2486.
- *Coprocessor instructions, and Supervisor Call* on page F4-2487.
- *Unconditional instructions* on page F4-2488.

Note

- Architecture variant information in this chapter describes the architecture variant or extension in which the instruction encoding was introduced into the A32 instruction set. *All* means that the instruction encoding was introduced in ARMv4 or earlier, and so is in all variants of the A32 instruction set covered by this manual.
 - In the decode tables in this chapter, an entry of - for a field value means the value of the field does not affect the decoding.
-

F4.1 A32 instruction set encoding

The A32 instruction stream is a sequence of word-aligned words. Each A32 instruction is a single 32-bit word in that stream. The encoding of an A32 instruction is:

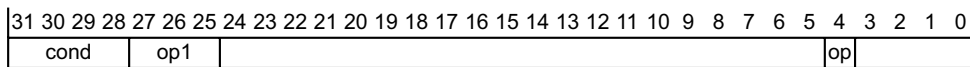

Table F4-1 shows the major subdivisions of the A32 instruction set, determined by bits[31:25, 4].

Most A32 instructions can be conditional, with a condition determined by bits[31:28] of the instruction, the cond field. For more information see *The condition code field*. This applies to all instructions except those with the cond field equal to 0b1111.

Table F4-1 A32 instruction encoding

cond	op1	op	Instruction classes
not 1111	00x	-	<i>Data-processing and miscellaneous instructions on page F4-2468.</i>
	010	-	<i>Load/store word and unsigned byte on page F4-2480.</i>
	011	0	<i>Load/store word and unsigned byte on page F4-2480.</i>
		1	<i>Media instructions on page F4-2481.</i>
	10x	-	<i>Branch, branch with link, and block data transfer on page F4-2486.</i>
	11x	-	<i>Coprocessor instructions, and Supervisor Call on page F4-2487.</i> Includes floating-point instructions and Advanced SIMD data transfers, see Chapter F5 T32 and A32 Instruction Sets Advanced SIMD and floating-point Encodings .
1111	-	-	If the cond field is 0b1111, the instruction can only be executed unconditionally, see <i>Unconditional instructions on page F4-2488</i> . Includes Advanced SIMD instructions, see Chapter F5 T32 and A32 Instruction Sets Advanced SIMD and floating-point Encodings .

F4.1.1 The condition code field

Every conditional instruction contains a 4-bit condition code field, the cond field, in bits 31 to 28:

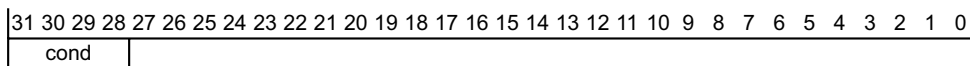

This field contains one of the values 0b0000-0b1110, as shown in [Table F2-1 on page F2-2416](#). Most instruction mnemonics can be extended with the letters defined in the *mnemonic extension* column of this table.

If the *always* (AL) condition is specified, the instruction is executed irrespective of the value of the condition flags. The absence of a condition code on an instruction mnemonic implies the AL condition code.

F4.1.2 UNDEFINED and UNPREDICTABLE instruction set space

An attempt to execute an unallocated instruction results in either:

- Unpredictable behavior. The instruction is described as UNPREDICTABLE.
ARMv8-A greatly reduces the architecturally UNPREDICTABLE behavior in AArch32 state. Many cases that earlier versions of the architecture describe as unpredictable become either:
 - CONSTRAINED UNPREDICTABLE, meaning the architecture defines a limited range of permitted behaviors.
 - Fully predictable.

For more information see [Appendix A Architectural Constraints on UNPREDICTABLE behaviors](#).

The AArch32 parts of this manual might sometimes describe as UNPREDICTABLE behavior that ARMv8-A makes CONSTRAINED UNPREDICTABLE.

- An Undefined Instruction exception. The instruction is described as UNDEFINED.

An instruction is UNDEFINED if it is declared as UNDEFINED in an instruction description, or in this chapter.

An instruction is UNPREDICTABLE if:

- It is declared as UNPREDICTABLE in an instruction description or in this chapter.
- The pseudocode for that encoding does not indicate that a different special case applies, and a bit marked (0) or (1) in the encoding diagram of an instruction is not 0 or 1 respectively.

For more information about UNDEFINED and UNPREDICTABLE instruction behavior, see [Undefined Instruction exception on page G1-3476](#).

Unless otherwise specified:

- A32 instructions introduced in an architecture variant are UNDEFINED in earlier architecture variants.
- A32 instructions introduced in one or more architecture extensions are UNDEFINED in an implementation that does not include any of those extensions.

F4.1.3 The PC and the use of 0b1111 as a register specifier

In A32 instructions, the use of 0b1111 as a register specifier specifies the PC.

Many instructions are UNPREDICTABLE if they use 0b1111 as a register specifier. This is specified by pseudocode in the instruction description. ARMv8-A constrains the resulting UNPREDICTABLE behavior, see [Using R15 on page AppxA-4760](#).

———— **Note** —————

In ARMv7, ARM deprecates use of the PC as the base register in any store instruction.

F4.1.4 The SP and the use of 0b1101 as a register specifier

In A32 instructions, the use of 0b1101 as a register specifier specifies the SP.

This applies to both A32 and T32 in AArch32 state. ARM deprecates using SP for any purpose other than as a stack pointer.

F4.2 Data-processing and miscellaneous instructions

The encoding of A32 data-processing instructions, and some miscellaneous, instructions is:

31	30	29	28	27	26	25	24	23	22	21	20	19	18	17	16	15	14	13	12	11	10	9	8	7	6	5	4	3	2	1	0
cond			0	0	op		op1										op2														

Table F4-2 shows the allocation of encodings in this space.

Table F4-2 Data-processing and miscellaneous instructions

op	op1	op2	Instruction or instruction class	Variant
0	not 10xx0	xxx0	<i>Data-processing (register) on page F4-2469</i>	-
		0xx1	<i>Data-processing (register-shifted register) on page F4-2470</i>	-
	10xx0	0xxx	<i>Miscellaneous instructions on page F4-2479</i>	-
		1xx0	<i>Halfword multiply and multiply accumulate on page F4-2475</i>	-
	0xxxx	1001	<i>Multiply and multiply accumulate on page F4-2474</i>	-
	1xxxx	1001	<i>Synchronization primitives on page F4-2477</i>	-
	not 0xx1x	1011	<i>Extra load/store instructions on page F4-2475</i>	-
		11x1	<i>Extra load/store instructions on page F4-2475</i>	-
	0xx1x	1011	<i>Extra load/store instructions, unprivileged on page F4-2476</i>	-
		11x1	<i>Extra load/store instructions on page F4-2475</i>	-
1	not 10xx0	-	<i>Data-processing (immediate) on page F4-2471</i>	-
	10000	-	16-bit immediate load, <i>MOV (immediate) on page F7-2708</i>	v6T2
	10100	-	High halfword 16-bit immediate load, <i>MOVT on page F7-2714</i>	v6T2
	10x10	-	<i>MSR (immediate), and hints on page F4-2478</i>	-

F4.2.1 Data-processing (register)

The encoding of A32 data-processing (register) instructions is:

31	30	29	28	27	26	25	24	23	22	21	20	19	18	17	16	15	14	13	12	11	10	9	8	7	6	5	4	3	2	1	0
cond				0	0	0	op									imm5			op2		0										

Table F4-3 shows the allocation of encodings in this space. These encodings are in all architecture variants.

Table F4-3 Data-processing (register) instructions

op	op2	imm5	Instruction	See
0000x	-	-	Bitwise AND	<i>AND (register)</i> on page F7-2558
0001x	-	-	Bitwise Exclusive OR	<i>EOR (register)</i> on page F7-2604
0010x	-	-	Subtract	<i>SUB (register)</i> on page F7-2918
0011x	-	-	Reverse Subtract	<i>RSB (register)</i> on page F7-2784
0100x	-	-	Add	<i>ADD (register, A32)</i> on page F7-2546
0101x	-	-	Add with Carry	<i>ADC (register)</i> on page F7-2536
0110x	-	-	Subtract with Carry	<i>SBC (register)</i> on page F7-2794
0111x	-	-	Reverse Subtract with Carry	<i>RSC (register)</i> on page F7-2788
10xx0	-	-	See <i>Data-processing and miscellaneous instructions</i> on page F4-2468	
10001	-	-	Test	<i>TST (register)</i> on page F7-2950
10011	-	-	Test Equivalence	<i>TEQ (register)</i> on page F7-2944
10101	-	-	Compare	<i>CMP (register)</i> on page F7-2590
10111	-	-	Compare Negative	<i>CMN (register)</i> on page F7-2587
1100x	-	-	Bitwise OR	<i>ORR (register)</i> on page F7-2740
1101x	00	00000	Move	<i>MOV (register, A32)</i> on page F7-2712
		not 00000	Logical Shift Left	<i>LSL (immediate)</i> on page F7-2692
	01	-	Logical Shift Right	<i>LSR (immediate)</i> on page F7-2696
	10	-	Arithmetic Shift Right	<i>ASR (immediate)</i> on page F7-2562
	11	00000	Rotate Right with Extend	<i>RRX</i> on page F7-2780
		not 00000	Rotate Right	<i>ROR (immediate)</i> on page F7-2776
1110x	-	-	Bitwise Bit Clear	<i>BIC (register)</i> on page F7-2572
1111x	-	-	Bitwise NOT	<i>MVN (register)</i> on page F7-2730

F4.2.2 Data-processing (register-shifted register)

The encoding of A32 data-processing (register-shifted register) instructions is:

31	30	29	28	27	26	25	24	23	22	21	20	19	18	17	16	15	14	13	12	11	10	9	8	7	6	5	4	3	2	1	0
cond			0	0	0	op1																		0	op2		1				

Table F4-4 shows the allocation of encodings in this space. These encodings are in all architecture variants.

Table F4-4 Data-processing (register-shifted register) instructions

op1	op2	Instruction	See
0000x	-	Bitwise AND	<i>AND</i> (register-shifted register) on page F7-2560
0001x	-	Bitwise Exclusive OR	<i>EOR</i> (register-shifted register) on page F7-2606
0010x	-	Subtract	<i>SUB</i> (register-shifted register) on page F7-2920
0011x	-	Reverse Subtract	<i>RSB</i> (register-shifted register) on page F7-2786
0100x	-	Add	<i>ADD</i> (register-shifted register) on page F7-2547
0101x	-	Add with Carry	<i>ADC</i> (register-shifted register) on page F7-2538
0110x	-	Subtract with Carry	<i>SBC</i> (register-shifted register) on page F7-2796
0111x	-	Reverse Subtract with Carry	<i>RSC</i> (register-shifted register) on page F7-2789
10xx0	-	See <i>Data-processing and miscellaneous instructions</i> on page F4-2468	
10001	-	Test	<i>TST</i> (register-shifted register) on page F7-2952
10011	-	Test Equivalence	<i>TEQ</i> (register-shifted register) on page F7-2946
10101	-	Compare	<i>CMP</i> (register-shifted register) on page F7-2592
10111	-	Compare Negative	<i>CMN</i> (register-shifted register) on page F7-2588
1100x	-	Bitwise OR	<i>ORR</i> (register-shifted register) on page F7-2742
1101x	00	Logical Shift Left	<i>LSL</i> (register) on page F7-2694
	01	Logical Shift Right	<i>LSR</i> (register) on page F7-2698
	10	Arithmetic Shift Right	<i>ASR</i> (register) on page F7-2564
	11	Rotate Right	<i>ROR</i> (register) on page F7-2778
1110x	-	Bitwise Bit Clear	<i>BIC</i> (register-shifted register) on page F7-2574
1111x	-	Bitwise NOT	<i>MVN</i> (register-shifted register) on page F7-2732

F4.2.3 Data-processing (immediate)

The encoding of A32 data-processing (immediate) instructions is:

31	30	29	28	27	26	25	24	23	22	21	20	19	18	17	16	15	14	13	12	11	10	9	8	7	6	5	4	3	2	1	0
cond				0	0	1	op				Rn																				

Table F4-5 shows the allocation of encodings in this space. These encodings are in all architecture variants.

Table F4-5 Data-processing (immediate) instructions

op	Rn	Instruction	See
0000x	-	Bitwise AND	<i>AND (immediate)</i> on page F7-2556
0001x	-	Bitwise Exclusive OR	<i>EOR (immediate)</i> on page F7-2602
0010x	not 1111	Subtract	<i>SUB (immediate, A32)</i> on page F7-2916
	1111	Form PC-relative address	<i>ADR</i> on page F7-2554
0011x	-	Reverse Subtract	<i>RSB (immediate)</i> on page F7-2782
0100x	not 1111	Add	<i>ADD (immediate, A32)</i> on page F7-2542
	1111	Form PC-relative address	<i>ADR</i> on page F7-2554
0101x	-	Add with Carry	<i>ADC (immediate)</i> on page F7-2534
0110x	-	Subtract with Carry	<i>SBC (immediate)</i> on page F7-2793
0111x	-	Reverse Subtract with Carry	<i>RSC (immediate)</i> on page F7-2787
10xx0	-	See <i>Data-processing and miscellaneous instructions</i> on page F4-2468	
10001	-	Test	<i>TST (immediate)</i> on page F7-2948
10011	-	Test Equivalence	<i>TEQ (immediate)</i> on page F7-2942
10101	-	Compare	<i>CMP (immediate)</i> on page F7-2589
10111	-	Compare Negative	<i>CMN (immediate)</i> on page F7-2586
1100x	-	Bitwise OR	<i>ORR (immediate)</i> on page F7-2738
1101x	-	Move	<i>MOV (immediate)</i> on page F7-2708
1110x	-	Bitwise Bit Clear	<i>BIC (immediate)</i> on page F7-2570
1111x	-	Bitwise NOT	<i>MVN (immediate)</i> on page F7-2728

These instructions all have modified immediate constants, rather than a simple 12-bit binary number. This provides a more useful range of values. For details see *Modified immediate constants in A32 instructions* on page F4-2472.

F4.2.4 Modified immediate constants in A32 instructions

The encoding of a modified immediate constant in an A32 instruction is:

31	30	29	28	27	26	25	24	23	22	21	20	19	18	17	16	15	14	13	12	11	10	9	8	7	6	5	4	3	2	1	0
														rotation		a	b	c	d	e	f	g	h								

Table F4-6 shows the range of modified immediate constants available in A32 data-processing instructions, and their encoding in the a, b, c, d, e, f, g, and h bits and the rotation field in the instruction.

Table F4-6 Encoding of modified immediates in A32 processing instructions

rotation	<const> ^a
0000	00000000 00000000 00000000 abcdefgh
0001	gh000000 00000000 00000000 00abcdef
0010	efgh0000 00000000 00000000 0000abcd
0011	cdefgh00 00000000 00000000 000000ab
0100	abcdefgh 00000000 00000000 00000000
.	.
.	. 8-bit values shifted to other even-numbered positions
.	.
1001	00000000 00abcdef gh000000 00000000
.	.
.	. 8-bit values shifted to other even-numbered positions
.	.
1110	00000000 00000000 0000abcd efgh0000
1111	00000000 00000000 000000ab cdefgh00

a. This table shows the immediate constant value in binary form, to relate abcdefgh to the encoding diagram. In assembly syntax, the immediate value is specified in the usual way (a decimal number by default).

Note

The range of values available in A32 modified immediate constants is slightly different from the range of values available in 32-bit T32 instructions. See *Modified immediate constants in T32 instructions* on page F3-2444.

Carry out

A logical instruction with the rotation field set to 0b0000 does not affect APSR.C. Otherwise, a logical flag-setting instruction sets APSR.C to the value of bit[31] of the modified immediate constant.

Constants with multiple encodings

Some constant values have multiple possible encodings. In this case, a UAL assembler must select the encoding with the lowest unsigned value of the rotation field. This is the encoding that appears first in Table F4-6. For example, the constant #3 must be encoded with (rotation, abcdefgh) == (0b0000, 0b00000011), not (0b0001, 0b00001100), (0b0010, 0b00110000), or (0b0011, 0b11000000).

In particular, this means that all constants in the range 0-255 are encoded with rotation == 0b0000, and permitted constants outside that range are encoded with rotation != 0b0000. A flag-setting logical instruction with a modified immediate constant therefore leaves APSR.C unchanged if the constant is in the range 0-255 and sets it to the most significant bit of the constant otherwise. This matches the behavior of T32 modified immediate constants for all constants that are permitted in both the A32 and T32 instruction sets.

An alternative syntax is available for a modified immediate constant that permits the programmer to specify the encoding directly. In this syntax, #<const> is instead written as #<byte>, #<rot>, where:

<byte> Is the numeric value of abcdefgh, in the range 0-255.

<rot> Is twice the numeric value of rotation, an even number in the range 0-30.

This syntax permits all A32 data-processing instructions with modified immediate constants to be disassembled to assembler syntax that assembles to the original instruction.

This syntax also makes it possible to write variants of some flag-setting logical instructions that have different effects on APSR.C to those obtained with the normal #<const> syntax. For example, ANDS R1, R2, #12, #2 has the same behavior as ANDS R1, R2, #3 except that it sets APSR.C to 0 instead of leaving it unchanged. Such variants of flag-setting logical instructions do not have equivalents in the T32 instruction set, and ARM deprecates their use.

Operation of modified immediate constants, A32 instructions

```
// ARMEExpandImm()
// =====

bits(32) ARMEExpandImm(bits(12) imm12)

    // APSR.C argument to following function call does not affect the imm32 result.
    (imm32, -) = ARMEExpandImm_C(imm12, APSR.C);

    return imm32;

// ARMEExpandImm_C()
// =====

(bits(32), bit) ARMEExpandImm_C(bits(12) imm12, bit carry_in)

    unrotated_value = ZeroExtend(imm12<7:0>, 32);
    (imm32, carry_out) = Shift_C(unrotated_value, SRTYPE_ROR, 2*UInt(imm12<11:8>), carry_in);

    return (imm32, carry_out);
```

F4.2.5 Multiply and multiply accumulate

The encoding of A32 multiply and multiply accumulate instructions is:

31	30	29	28	27	26	25	24	23	22	21	20	19	18	17	16	15	14	13	12	11	10	9	8	7	6	5	4	3	2	1	0
cond				0	0	0	0	op																1	0	0	1				

Table F4-7 shows the allocation of encodings in this space.

Table F4-7 Multiply and multiply accumulate instructions

op	Instruction	See	Variant
000x	Multiply	MUL on page F7-2726	All
001x	Multiply Accumulate	MLA on page F7-2704	All
0100	Unsigned Multiply Accumulate Accumulate Long	UMAAL on page F7-2978	v6
0101	UNDEFINED	-	-
0110	Multiply and Subtract	MLS on page F7-2706	v6T2
0111	UNDEFINED	-	-
100x	Unsigned Multiply Long	UMULL on page F7-2982	All
101x	Unsigned Multiply Accumulate Long	UMLAL on page F7-2980	All
110x	Signed Multiply Long	SMULL on page F7-2838	All
111x	Signed Multiply Accumulate Long	SMLAL on page F7-2816	All

F4.2.6 Saturating addition and subtraction

The encoding of A32 saturating addition and subtraction instructions is:

31	30	29	28	27	26	25	24	23	22	21	20	19	18	17	16	15	14	13	12	11	10	9	8	7	6	5	4	3	2	1	0
cond				0	0	0	1	0	op				0													0	1	0	1		

Table F4-8 shows the allocation of encodings in this space. These encodings are all available in ARMv5TE and above, and are UNDEFINED in earlier variants of the architecture.

Table F4-8 Saturating addition and subtraction instructions

op	Instruction	See
00	Saturating Add	QADD on page F7-2762
01	Saturating Subtract	QSUB on page F7-2769
10	Saturating Double and Add	QDADD on page F7-2766
11	Saturating Double and Subtract	QDSUB on page F7-2767

F4.2.7 Halfword multiply and multiply accumulate

The encoding of A32 halfword multiply and multiply accumulate instructions is:

31	30	29	28	27	26	25	24	23	22	21	20	19	18	17	16	15	14	13	12	11	10	9	8	7	6	5	4	3	2	1	0	
cond				0	0	0	1	0	op1				0													1	op		0			

Table F4-9 shows the allocation of encodings in this space.

These encodings are signed multiply (SMUL) and signed multiply accumulate (SMLA) instructions, operating on 16-bit values, or mixed 16-bit and 32-bit values. The results and accumulators are 32-bit or 64-bit.

These encodings are all available in ARMv5TE and above, and are UNDEFINED in earlier variants of the architecture.

Table F4-9 Halfword multiply and multiply accumulate instructions

op1	op	Instruction	See
00	-	Signed 16-bit multiply, 32-bit accumulate	SMLABB , SMLABT , SMLATB , SMLATT on page F7-2812
01	0	Signed 16-bit × 32-bit multiply, 32-bit accumulate	SMLAWB , SMLAWT on page F7-2822
	1	Signed 16-bit × 32-bit multiply, 32-bit result	SMULWB , SMULWT on page F7-2840
10	-	Signed 16-bit multiply, 64-bit accumulate	SMLALBB , SMLALBT , SMLALTB , SMLALTT on page F7-2818
11	-	Signed 16-bit multiply, 32-bit result	SMULBB , SMULBT , SMULTB , SMULTT on page F7-2836

F4.2.8 Extra load/store instructions

The encoding of extra A32 load/store instructions is:

31	30	29	28	27	26	25	24	23	22	21	20	19	18	17	16	15	14	13	12	11	10	9	8	7	6	5	4	3	2	1	0		
cond				0	0	0	op1				Rn																1	op2		1			

If (op2 == 0b00) or (op1 == 0b0xx11) or (op1 == 0b0xx10 AND op2 == 0b0x) then see [Data-processing and miscellaneous instructions on page F4-2468](#).

Otherwise, Table F4-10 shows the allocation of encodings in this space.

Table F4-10 Extra load/store instructions

op2	op1	Rn	Instruction	See	Variant
01	xx0x0	-	Store Halfword	STRH (register) on page F7-2908	All
	xx0x1	-	Load Halfword	LDRH (register) on page F7-2670	All
	xx1x0	-	Store Halfword	STRH (immediate, A32) on page F7-2906	All
	xx1x1	not 1111	Load Halfword	LDRH (immediate, A32) on page F7-2666	All
		1111	Load Halfword	LDRH (literal) on page F7-2668	All
10	xx0x0	-	Load Dual	LDRD (register) on page F7-2658	v5TE
	xx0x1	-	Load Signed Byte	LDRSB (register) on page F7-2678	All
	xx1x0	not 1111	Load Dual	LDRD (immediate) on page F7-2654	v5TE
		1111	Load Dual	LDRD (literal) on page F7-2656	v5TE
	xx1x1	not 1111	Load Signed Byte	LDRSB (immediate) on page F7-2674	All
		1111	Load Signed Byte	LDRSB (literal) on page F7-2676	All

Table F4-10 Extra load/store instructions (continued)

op2	op1	Rn	Instruction	See	Variant
11	xx0x0	-	Store Dual	STRD (register) on page F7-2894	All
	xx0x1	-	Load Signed Halfword	LDRSH (register) on page F7-2686	All
	xx1x0	-	Store Dual	STRD (immediate) on page F7-2892	All
	xx1x1	not 1111	Load Signed Halfword	LDRSH (immediate) on page F7-2682	All
		1111	Load Signed Halfword	LDRSH (literal) on page F7-2684	All

F4.2.9 Extra load/store instructions, unprivileged

The encoding of unprivileged extra A32 load/store instructions is:

31	30	29	28	27	26	25	24	23	22	21	20	19	18	17	16	15	14	13	12	11	10	9	8	7	6	5	4	3	2	1	0
cond				0	0	0	0		1	op													1	op2	1						

If op2 == 0b00 then see [Data-processing and miscellaneous instructions on page F4-2468](#).

If (op == 0b0 AND op2 == 0b1x) then see [Extra load/store instructions on page F4-2475](#).

Otherwise, [Table F4-11](#) shows the allocation of encodings in this space.

Table F4-11 Extra load/store instructions, unprivileged

op2	op	Instruction	See	Variant
01	0	Store Halfword Unprivileged	STRHT on page F7-2910	v6T2
	1	Load Halfword Unprivileged	LDRHT on page F7-2672	v6T2
10	1	Load Signed Byte Unprivileged	LDRSBT on page F7-2680	v6T2
11	1	Load Signed Halfword Unprivileged	LDRSHT on page F7-2688	v6T2

F4.2.10 Synchronization primitives

The encoding of A32 synchronization primitive instructions is:

31	30	29	28	27	26	25	24	23	22	21	20	19	18	17	16	15	14	13	12	11	10	9	8	7	6	5	4	3	2	1	0
cond				0	0	0	1	op								op1				1	0	0	1								

Table F4-12 shows the allocation of encodings in this space.

Other encodings in this space are UNDEFINED.

Table F4-12

op	op1	Instruction	See	Variant
1000	00	Store Release Word	STL on page F7-2856	v8
	10	Store Release Exclusive Word	STLEX on page F7-2860	v8
	11	Store Register Exclusive	STREX on page F7-2896	
1001	00	Load Acquire Word	LDA on page F7-2612	v8
	10	Load Acquire Exclusive Word	LDAEX on page F7-2614	v8
	11	Load Register Exclusive	LDREX on page F7-2660	
1010	10	Store Release Exclusive Dual	STLEXD on page F7-2864	v8
	11	Store Register Exclusive Doubleword	STREXD on page F7-2900	
1011	10	Load Acquire Exclusive Dual	LDAEXD on page F7-2616	v8
	11	Load Register Exclusive Doubleword	LDREXD on page F7-2662	
1100	00	Store Release Byte	STLB on page F7-2858	v8
	10	Store Release Exclusive Byte	STLEXB on page F7-2862	v8
	11	Store Register Exclusive Byte	STREXB on page F7-2898	
1101	00	Load Acquire Byte	LDAB on page F7-2613	v8
	10	Load Acquire Exclusive Byte	LDAEXB on page F7-2615	v8
	11	Load Register Exclusive Byte	LDREXB on page F7-2661	
1110	00	Store Release Halfword	STLH on page F7-2868	v8
	10	Store Release Exclusive Halfword	STLEXH on page F7-2866	v8
	11	Store Register Exclusive Halfword	STREXH on page F7-2902	
1111	00	Load Acquire Halfword	LDAH on page F7-2618	v8
	10	Load Acquire Exclusive Halfword	LDAEXH on page F7-2617	v8
	11	Load Register Exclusive Halfword	LDREXH on page F7-2663	

F4.2.11 MSR (immediate), and hints

The encoding of A32 MSR (immediate) and hint instructions is:

31	30	29	28	27	26	25	24	23	22	21	20	19	18	17	16	15	14	13	12	11	10	9	8	7	6	5	4	3	2	1	0
cond				0	0	1	1	0	op	1	0	op1						op2													

Table F4-13 shows the allocation of encodings in this space. Encodings with op set to 0, op1 set to 0b000, and a value of op2 that is not shown in the table, are unallocated hints and behave as if op2 is set to 0b00000000. These unallocated hint encodings are reserved and software must not use them.

Table F4-13 MSR (immediate), and hints

op	op1	op2	Instruction	See	Variant
0	0000	00000000	No Operation hint	NOP on page F7-2734	v6K, v6T2
		00000001	Yield hint	YIELD on page F7-3026	v6K
		00000010	Wait For Event hint	WFE on page F7-3022	v6K
		00000011	Wait For Interrupt hint	WFI on page F7-3024	v6K
		00000100	Send Event hint	SEV on page F7-2804	v6K
		00000101	Send Event Local hint	SEVL on page F7-2805	v8
		1111xxxx	Debug hint	DBG on page F7-2596	v7
0100 1x00	-	-	Move to Special register, Application level	MSR (immediate) on page F7-2722	All
		xx01 xx1x	Move to Special register, System level	MSR (immediate) on page F7-3052	All
1	-	-	Move to Special register, System level	MSR (immediate) on page F7-3052	All

F4.2.12 Miscellaneous instructions

The encoding of some miscellaneous A32 instructions is:

31	30	29	28	27	26	25	24	23	22	21	20	19	18	17	16	15	14	13	12	11	10	9	8	7	6	5	4	3	2	1	0
cond				0	0	0	1	0	op		0	op1								B	0	op2									

Table F4-14 shows the allocation of encodings in this space. Other encodings in this space are UNDEFINED.

Table F4-14 Miscellaneous instructions

op2	B	op	op1	Instruction or instruction class	See	Variant
000	1	x0	xxxx	Move from Banked or Special register	<i>MRS (Banked register) on page F7-3048</i>	v7VE
		x1	xxxx	Move to Banked or Special register	<i>MSR (Banked register) on page F7-3050</i>	v7VE
0	0	x0	xxxx	Move from Special register	<i>MRS on page F7-2720</i> <i>MRS on page F7-3046</i>	All
		01	xx00	Move to Special register, Application level	<i>MSR (register) on page F7-2724</i>	All
			xx01 xx1x	Move to Special register, System level	<i>MSR (register) on page F7-3054</i>	All
		11	-	Move to Special register, System level	<i>MSR (register) on page F7-3054</i>	All
001	-	01	-	Branch and Exchange	<i>BX on page F7-2579</i>	v4T
		11	-	Count Leading Zeros	<i>CLZ on page F7-2585</i>	v5T
010	-	01	-	Branch and Exchange Jazelle	<i>BXJ on page F7-2580</i>	v5TEJ
011	-	01	-	Branch with Link and Exchange	<i>BLX (register) on page F7-2578</i>	v5T
100	-	-	-	CRC32	<i>CRC32, CRC32C on page F7-2594</i>	v8
101	-	-	-	Saturating addition and subtraction	<i>Saturating addition and subtraction on page F4-2474</i>	-
110	-	11	-	Exception Return	<i>ERET on page F7-3038</i>	v7VE
111	-	00	-	Halting Breakpoint	<i>HLT on page F7-2608</i>	v8
		01	-	Breakpoint	<i>BKPT on page F7-2575</i>	v5T
		10	-	Hypervisor Call	<i>HVC on page F7-3040</i>	v7VE
		11	-	Secure Monitor Call	<i>SMC (previously SMI) on page F7-3058</i>	Security Extensions

F4.3 Load/store word and unsigned byte

The encoding of A32 load/store word and unsigned byte instructions is:

31	30	29	28	27	26	25	24	23	22	21	20	19	18	17	16	15	14	13	12	11	10	9	8	7	6	5	4	3	2	1	0
cond				0	1	A	op1				Rn								B												

These instructions have either A == 0 or B == 0. For instructions with A == 1 and B == 1, see [Media instructions on page F4-2481](#).

Otherwise, [Table F4-15](#) shows the allocation of encodings in this space. These encodings are in all architecture variants.

Table F4-15 Single data transfer instructions

A	op1	B	Rn	Instruction	See
0	xx0x0 not 0x010	-	-	Store Register	STR (immediate, A32) on page F7-2880
1	xx0x0 not 0x010	0	-	Store Register	STR (register) on page F7-2882
0	0x010	-	-	Store Register Unprivileged	STRT on page F7-2912
1	0x010	0	-		
0	xx0x1 not 0x011	-	not 1111	Load Register (immediate)	LDR (immediate, A32) on page F7-2636
			1111	Load Register (literal)	LDR (literal) on page F7-2638
1	xx0x1 not 0x011	0	-	Load Register	LDR (register, A32) on page F7-2642
0	0x011	-	-	Load Register Unprivileged	LDRT on page F7-2690
1	0x011	0	-		
0	xx1x0 not 0x110	-	-	Store Register Byte (immediate)	STRB (immediate, A32) on page F7-2886
1	xx1x0 not 0x110	0	-	Store Register Byte (register)	STRB (register) on page F7-2888
0	0x110	-	-	Store Register Byte Unprivileged	STRBT on page F7-2890
1	0x110	0	-		
0	xx1x1 not 0x111	-	not 1111	Load Register Byte (immediate)	LDRB (immediate, A32) on page F7-2646
			1111	Load Register Byte (literal)	LDRB (literal) on page F7-2648
1	xx1x1 not 0x111	0	-	Load Register Byte (register)	LDRB (register) on page F7-2650
0	0x111	-	-	Load Register Byte Unprivileged	LDRBT on page F7-2652
1	0x111	0	-		

F4.4 Media instructions

The encoding of A32 media instructions is:

31	30	29	28	27	26	25	24	23	22	21	20	19	18	17	16	15	14	13	12	11	10	9	8	7	6	5	4	3	2	1	0
cond				0	1	1	op1				Rd				op2				1	Rn											

Table F4-16 shows the allocation of encodings in this space.

Other encodings in this space are UNDEFINED.

Table F4-16 Media instructions

op1	op2	Rd	Rn	cond	Instructions	See	Variant
000xx	-	-	-	-	-	<i>Parallel addition and subtraction, signed on page F4-2482</i>	
001xx	-	-	-	-	-	<i>Parallel addition and subtraction, unsigned on page F4-2483</i>	
01xxx	-	-	-	-	-	<i>Packing, unpacking, saturation, and reversal on page F4-2484</i>	
10xxx	-	-	-	-	-	<i>Signed multiply, signed and unsigned divide on page F4-2485</i>	
11000	000	1111	-	-	Unsigned Sum of Absolute Differences	<i>USAD8 on page F7-2996</i>	v6
	000	not 1111	-	-	Unsigned Sum of Absolute Differences and Accumulate	<i>USADA8 on page F7-2998</i>	v6
1101x	x10	-	-	-	Signed Bit Field Extract	<i>SBFX on page F7-2798</i>	v6T2
1110x	x00	-	1111	-	Bit Field Clear	<i>BFC on page F7-2568</i>	v6T2
			not 1111	-	Bit Field Insert	<i>BFI on page F7-2569</i>	v6T2
1111x	x10	-	-	-	Unsigned Bit Field Extract	<i>UBFX on page F7-2960</i>	v6T2
11111	111	-	-	1110	Permanently UNDEFINED	<i>UDF on page F7-2962</i>	All ^a
				not 1110		- ^a	All

a. Issue C.a of this manual first defines an assembler mnemonic for this encoding. This mnemonic applies only to the unconditional encoding, with cond set to 0b1110.

F4.4.1 Parallel addition and subtraction, signed

The encoding of A32 signed parallel addition and subtraction instructions is:

31	30	29	28	27	26	25	24	23	22	21	20	19	18	17	16	15	14	13	12	11	10	9	8	7	6	5	4	3	2	1	0
cond				0	1	1	0	0	0	op1													op2	1							

Table F4-17 shows the allocation of encodings in this space. These encodings are all available in ARMv6 and above, and are UNDEFINED in earlier variants of the architecture.

Other encodings in this space are UNDEFINED.

Table F4-17 Signed parallel addition and subtraction instructions

op1	op2	Instruction	See
01	000	Add 16-bit	SADD16 on page F7-2791
	001	Add and Subtract with Exchange, 16-bit	SASX on page F7-2792
	010	Subtract and Add with Exchange, 16-bit	SSAX on page F7-2848
	011	Subtract 16-bit	SSUB16 on page F7-2852
	100	Add 8-bit	SADD8 on page F7-2790
	111	Subtract 8-bit	SSUB8 on page F7-2850
Saturating instructions			
10	000	Saturating Add 16-bit	QADD16 on page F7-2764
	001	Saturating Add and Subtract with Exchange, 16-bit	QASX on page F7-2765
	010	Saturating Subtract and Add with Exchange, 16-bit	QSAX on page F7-2768
	011	Saturating Subtract 16-bit	QSUB16 on page F7-2771
	100	Saturating Add 8-bit	QADD8 on page F7-2763
	111	Saturating Subtract 8-bit	QSUB8 on page F7-2770
Halving instructions			
11	000	Halving Add 16-bit	SHADD16 on page F7-2807
	001	Halving Add and Subtract with Exchange, 16-bit	SHASX on page F7-2808
	010	Halving Subtract and Add with Exchange, 16-bit	SHSAX on page F7-2809
	011	Halving Subtract 16-bit	SHSUB16 on page F7-2811
	100	Halving Add 8-bit	SHADD8 on page F7-2806
	111	Halving Subtract 8-bit	SHSUB8 on page F7-2810

F4.4.2 Parallel addition and subtraction, unsigned

The encoding of A32 unsigned parallel addition and subtraction instructions is:

31	30	29	28	27	26	25	24	23	22	21	20	19	18	17	16	15	14	13	12	11	10	9	8	7	6	5	4	3	2	1	0
cond				0	1	1	0	0	1	op1																op2		1			

Table F4-18 shows the allocation of encodings in this space. These encodings are all available in ARMv6 and above, and are UNDEFINED in earlier variants of the architecture.

Other encodings in this space are UNDEFINED.

Table F4-18 Unsigned parallel addition and subtractions instructions

op1	op2	Instruction	See
01	000	Add 16-bit	UADD16 on page F7-2956
	001	Add and Subtract with Exchange, 16-bit	UASX on page F7-2958
	010	Subtract and Add with Exchange, 16-bit	USAX on page F7-3004
	011	Subtract 16-bit	USUB16 on page F7-3008
	100	Add 8-bit	UADD8 on page F7-2954
	111	Subtract 8-bit	USUB8 on page F7-3006
Saturating instructions			
10	000	Saturating Add 16-bit	UQADD16 on page F7-2986
	001	Saturating Add and Subtract with Exchange, 16-bit	UQASX on page F7-2988
	010	Saturating Subtract and Add with Exchange, 16-bit	UQSAX on page F7-2990
	011	Saturating Subtract 16-bit	UQSUB16 on page F7-2994
	100	Saturating Add 8-bit	UQADD8 on page F7-2984
	111	Saturating Subtract 8-bit	UQSUB8 on page F7-2992
Halving instructions			
11	000	Halving Add 16-bit	UHADD16 on page F7-2968
	001	Halving Add and Subtract with Exchange, 16-bit	UHASX on page F7-2970
	010	Halving Subtract and Add with Exchange, 16-bit	UHSAX on page F7-2972
	011	Halving Subtract 16-bit	UHSUB16 on page F7-2976
	100	Halving Add 8-bit	UHADD8 on page F7-2966
	111	Halving Subtract 8-bit	UHSUB8 on page F7-2974

F4.4.3 Packing, unpacking, saturation, and reversal

The encoding of A32 packing, unpacking, saturation, and reversal instructions is:

31	30	29	28	27	26	25	24	23	22	21	20	19	18	17	16	15	14	13	12	11	10	9	8	7	6	5	4	3	2	1	0
cond				0	1	1	0	1	op1				A								op2		1								

Table F4-19 shows the allocation of encodings in this space.

Other encodings in this space are UNDEFINED.

Table F4-19 Packing, unpacking, saturation, and reversal instructions

op1	op2	A	Instructions	See	Variant
000	xx0	-	Pack Halfword	PKH on page F7-2744	v6
	011	not 1111	Signed Extend and Add Byte 16-bit	SXTAB16 on page F7-2930	v6
		1111	Signed Extend Byte 16-bit	SXTB16 on page F7-2936	v6
	101	-	Select Bytes	SEL on page F7-2802	v6
01x	xx0	-	Signed Saturate	SSAT on page F7-2844	v6
010	001	-	Signed Saturate, two 16-bit	SSAT16 on page F7-2846	v6
	011	not 1111	Signed Extend and Add Byte	SXTAB on page F7-2928	v6
		1111	Signed Extend Byte	SXTB on page F7-2934	v6
011	001	-	Byte-Reverse Word	REV on page F7-2773	v6
	011	not 1111	Signed Extend and Add Halfword	SXTAH on page F7-2932	v6
		1111	Signed Extend Halfword	SXTH on page F7-2938	v6
	101	-	Byte-Reverse Packed Halfword	REV16 on page F7-2774	v6
100	011	not 1111	Unsigned Extend and Add Byte 16-bit	UXTAB16 on page F7-3012	v6
		1111	Unsigned Extend Byte 16-bit	UXTB16 on page F7-3018	v6
11x	xx0	-	Unsigned Saturate	USAT on page F7-3000	v6
110	001	-	Unsigned Saturate, two 16-bit	USAT16 on page F7-3002	v6
	011	not 1111	Unsigned Extend and Add Byte	UXTAB on page F7-3010	v6
		1111	Unsigned Extend Byte	UXTB on page F7-3016	v6
111	001	-	Reverse Bits	RBIT on page F7-2772	v6T2
	011	not 1111	Unsigned Extend and Add Halfword	UXTAH on page F7-3014	v6
		1111	Unsigned Extend Halfword	UXTH on page F7-3020	v6
	101	-	Byte-Reverse Signed Halfword	REVSH on page F7-2775	v6

F4.4.4 Signed multiply, signed and unsigned divide

The encoding of A32 signed multiply and divide instructions is:

31	30	29	28	27	26	25	24	23	22	21	20	19	18	17	16	15	14	13	12	11	10	9	8	7	6	5	4	3	2	1	0
cond				0	1	1	1	0	op1				A				op2				1										

Table F4-20 shows the allocation of encodings in this space.

Other encodings in this space are UNDEFINED.

Table F4-20 Signed multiply instructions

op1	op2	A	Instruction	See	Variant
000	00x	not 1111	Signed Multiply Accumulate Dual	SMLAD on page F7-2814	v6
		1111	Signed Dual Multiply Add	SMUAD on page F7-2834	v6
	01x	not 1111	Signed Multiply Subtract Dual	SMLSD on page F7-2824	v6
		1111	Signed Dual Multiply Subtract	SMUSD on page F7-2842	v6
001	000	-	Signed Divide	SDIV on page F7-2800	v7 ^a
011	000	-	Unsigned Divide	UDIV on page F7-2964	v7 ^a
100	00x	-	Signed Multiply Accumulate Long Dual	SMLALD on page F7-2820	v6
	01x	-	Signed Multiply Subtract Long Dual	SMLS LD on page F7-2826	v6
101	00x	not 1111	Signed Most Significant Word Multiply Accumulate	SMMLA on page F7-2828	v6
		1111	Signed Most Significant Word Multiply	SMMUL on page F7-2832	v6
	11x	-	Signed Most Significant Word Multiply Subtract	SMMLS on page F7-2830	v6

a. Optional in some ARMv7 implementations, see the *ARM® Architecture Reference Manual, ARMv7-A and ARMv7-R edition*.

F4.5 Branch, branch with link, and block data transfer

The encoding of A32 branch, branch with link, and block data transfer instructions is:

31	30	29	28	27	26	25	24	23	22	21	20	19	18	17	16	15	14	13	12	11	10	9	8	7	6	5	4	3	2	1	0
cond			1	0	op				Rn				R																		

Table F4-21 shows the allocation of encodings in this space. These encodings are in all architecture variants.

Table F4-21 Branch, branch with link, and block data transfer instructions

op	R	Rn	Instructions	See
0000x0	-	-	Store Multiple Decrement After	STMDA (STMED) on page F7-2872
0000x1	-	-	Load Multiple Decrement After	LMDA/LDMFA on page F7-2628
0010x0	-	-	Store Multiple Increment After	STM (STMIA, STMEA) on page F7-2870
001001	-	-	Load Multiple Increment After	LDM/LDMIA/LDMFD (A32) on page F7-2626
001011	-	not 1101	Load Multiple Increment After	LDM/LDMIA/LDMFD (A32) on page F7-2626
		1101	Pop multiple registers	POP (A32) on page F7-2758
010000	-	-	Store Multiple Decrement Before	STMDB (STMFD) on page F7-2874
010010	-	not 1101	Store Multiple Decrement Before	STMDB (STMFD) on page F7-2874
		1101	Push multiple registers	PUSH on page F7-2760
0100x1	-	-	Load Multiple Decrement Before	LDMDB/LDMEA on page F7-2630
0110x0	-	-	Store Multiple Increment Before	STMIB (STMFA) on page F7-2876
0110x1	-	-	Load Multiple Increment Before	LDMIB/LDMED on page F7-2632
0xx1x0	-	-	Store Multiple (user registers)	STM (User registers) on page F7-3064
0xx1x1	0	-	Load Multiple (user registers)	LDM (User registers) on page F7-3044
		1	Load Multiple (exception return)	LDM (exception return) on page F7-3042
10xxxx	-	-	Branch	B on page F7-2566
11xxxx	-	-	Branch with Link	BL, BLX (immediate) on page F7-2576

F4.6 Coprocessor instructions, and Supervisor Call

The encoding of A32 coprocessor instructions and the Supervisor Call instruction is:

31	30	29	28	27	26	25	24	23	22	21	20	19	18	17	16	15	14	13	12	11	10	9	8	7	6	5	4	3	2	1	0
cond			1	1	op1				Rn				coproc				op														

Table F4-22 shows the allocation of encodings in this space:

Table F4-22 Coprocessor instructions, and Supervisor Call

coproc	op1	op	Rn	Instructions	See	Variant
-	00000x	-	-	UNDEFINED	-	-
	11xxxx	-	-	Supervisor Call	SVC (previously SWI) on page F7-2926	All
not 101x	0xxxx0 not 000x00	-	-	Store Coprocessor	STC, STC2 on page F7-2854	All
	0xxxx1 not 000x01	-	not 1111	Load Coprocessor (immediate)	LDC, LDC2 (immediate) on page F7-2620	All
			1111	Load Coprocessor (literal)	LDC, LDC2 (literal) on page F7-2622	All
	000100	-	-	Move to Coprocessor from two general-purpose registers	MCRR, MCRR2 on page F7-2702	v5TE
	000101	-	-	Move to two general-purpose registers from Coprocessor	MRRC, MRRC2 on page F7-2718	v5TE
	10xxxx	0	-	Coprocessor data operations	CDP, CDP2 on page F7-2582	All
	10xxx0	1	-	Move to Coprocessor from general-purpose register	MCR, MCR2 on page F7-2700	All
	10xxx1	1	-	Move to general-purpose register from Coprocessor	MRC, MRC2 on page F7-2716	All
101x	0xxxxx not 000x0x	-	-	Advanced SIMD, floating-point	Extension register load/store instructions on page F5-2514	
	00010x	-	-	Advanced SIMD, floating-point	64-bit transfers between general-purpose and extension registers on page F5-2519	
	10xxxx	0	-	Floating-point data processing	Floating-point data-processing instructions on page F5-2511	
	10xxxx	1	-	Advanced SIMD, floating-point	8, 16, and 32-bit transfer between general-purpose and extension registers on page F5-2518	

For more information about specific coprocessors see [Coprocessor support](#) on page E1-2331.

F4.7 Unconditional instructions

The encoding of A32 unconditional instructions is:

31	30	29	28	27	26	25	24	23	22	21	20	19	18	17	16	15	14	13	12	11	10	9	8	7	6	5	4	3	2	1	0
1	1	1	1	op1								Rn								op											

Table F4-23 shows the allocation of encodings in this space.

Other encodings in this space are UNDEFINED in ARMv5 and above.

All encodings in this space are UNPREDICTABLE in ARMv4 and ARMv4T.

Table F4-23 Unconditional instructions

op1	op	Rn	Instruction	See	Variant
0xxxxxxx	-	-	-	<i>Memory hints, Advanced SIMD instructions, and miscellaneous instructions on page F4-2489</i>	
100xx1x0	-	-	Store Return State	<i>SRS (A32) on page F7-3062</i>	v6
100xx0x1	-	-	Return From Exception	<i>RFE on page F7-3056</i>	v6
101xxxxx	-	-	Branch with Link and Exchange	<i>BL, BLX (immediate) on page F7-2576</i>	v5
110xxxx0 not 11000x00	-	-	Store Coprocessor	<i>STC, STC2 on page F7-2854</i>	v5
110xxxx1 not 11000x01	-	not 1111	Load Coprocessor (immediate)	<i>LDC, LDC2 (immediate) on page F7-2620</i>	v5
		1111	Load Coprocessor (literal)	<i>LDC, LDC2 (literal) on page F7-2622</i>	v5
11000100	-	-	Move to Coprocessor from two general-purpose registers	<i>MCRR, MCRR2 on page F7-2702</i>	v6
11000101	-	-	Move to two general-purpose registers from Coprocessor	<i>MRRC, MRRC2 on page F7-2718</i>	v6
1110xxxx	0	-	Coprocessor data operations	<i>CDP, CDP2 on page F7-2582</i>	v5
1110xxx0	1	-	Move to Coprocessor from general-purpose register	<i>MCR, MCR2 on page F7-2700</i>	v5
1110xxx1	1	-	Move to general-purpose register from Coprocessor	<i>MRC, MRC2 on page F7-2716</i>	v5

F4.7.1 Memory hints, Advanced SIMD instructions, and miscellaneous instructions

The encoding of A32 memory hint and Advanced SIMD instructions, and some miscellaneous instruction is:

31	30	29	28	27	26	25	24	23	22	21	20	19	18	17	16	15	14	13	12	11	10	9	8	7	6	5	4	3	2	1	0
1	1	1	1	0	op1					Rn					op2																

Table F4-24 shows the allocation of encodings in this space.

Other encodings in this space are UNDEFINED in ARMv5 and above. All these encodings are UNPREDICTABLE in ARMv4 and ARMv4T.

Table F4-24 Hints, and Advanced SIMD instructions

op1	op2	Rn	Instruction	See	Variant
0010000	xx0x	xxx0	Change Processor State	CPS (A32) on page F7-3036	v6
0010000	0000	xxx1	Set Endianness	SETEND on page F7-2803	v6
01xxxxx	-	-	See Advanced SIMD data-processing instructions on page F5-2499		v7
100xxx0	-	-	See Advanced SIMD element or structure load/store instructions on page F5-2515		v7
100x001	-	-	Unallocated memory hint (treat as NOP)		MP Ext ^a
100x101	-	-	Preload Instruction	PLI (immediate, literal) on page F7-2752	v7
100xx11	-	-	UNPREDICTABLE	-	-
101x001	-	not 1111	Preload Data with intent to Write	PLD, PLDW (immediate) on page F7-2746	MP Ext ^a
		1111	UNPREDICTABLE	-	-
101x101	-	not 1111	Preload Data	PLD, PLDW (immediate) on page F7-2746	v5TE
		1111	Preload Data	PLD (literal) on page F7-2748	v5TE
1010011	-	-	UNPREDICTABLE	-	-
1010111	0000	-	UNPREDICTABLE	-	-
	0001	-	Clear-Exclusive	CLREX on page F7-2584	v6K
	001x	-	UNPREDICTABLE	-	-
	0100	-	Data Synchronization Barrier	DSB on page F7-2600	v6T2
	0101	-	Data Memory Barrier	DMB on page F7-2598	v7
	0110	-	Instruction Synchronization Barrier	ISB on page F7-2609	v6T2
	0111	-	UNPREDICTABLE	-	-
1xxx	-	-	UNPREDICTABLE	-	-
1011x11	-	-	UNPREDICTABLE	-	-
110x001	xxx0	-	Unallocated memory hint (treat as NOP)		MP Ext ^a
110x101	xxx0	-	Preload Instruction	PLI (register) on page F7-2754	v7
111x001	xxx0	-	Preload Data with intent to Write	PLD, PLDW (register) on page F7-2750	MP Ext ^a

Table F4-24 Hints, and Advanced SIMD instructions (continued)

op1	op2	Rn	Instruction	See	Variant
111x101	xxx0	-	Preload Data	<i>PLD, PLDW (register) on page F7-2750</i>	v5TE
11xxx11	xxx0	-	UNPREDICTABLE	-	-
1111111	1111		Permanently UNDEFINED ^b	-	v5

- a. Multiprocessing Extensions.
- b. See [Table F4-16 on page F4-2481](#) for the full range of encodings in this permanently UNDEFINED group.

Chapter F5

T32 and A32 Instruction Sets Advanced SIMD and floating-point Encodings

This chapter gives an overview of the Advanced SIMD and floating-point instruction sets. It contains the following sections:

- *Overview on page F5-2492.*
- *Advanced SIMD and floating-point instruction syntax on page F5-2493.*
- *Register encoding on page F5-2497.*
- *Advanced SIMD data-processing instructions on page F5-2499.*
- *Floating-point data-processing instructions on page F5-2511.*
- *Extension register load/store instructions on page F5-2514.*
- *Advanced SIMD element or structure load/store instructions on page F5-2515.*
- *8, 16, and 32-bit transfer between general-purpose and extension registers on page F5-2518.*
- *64-bit transfers between general-purpose and extension registers on page F5-2519.*

Note

- The Advanced SIMD architecture, its associated implementations, and supporting software, are commonly referred to as NEON™ technology.
 - In the decode tables in this chapter, an entry of - for a field value means the value of the field does not affect the decoding.
-

F5.1 Overview

All Advanced SIMD and floating-point instructions are available in both A32 and T32 instruction sets.

F5.1.1 Advanced SIMD

The following sections describe the classes of Advanced SIMD instructions:

- [Advanced SIMD data-processing instructions](#) on page F5-2499.
- [Advanced SIMD element or structure load/store instructions](#) on page F5-2515.
- [Extension register load/store instructions](#) on page F5-2514.
- [8, 16, and 32-bit transfer between general-purpose and extension registers](#) on page F5-2518.
- [64-bit transfers between general-purpose and extension registers](#) on page F5-2519.

F5.1.2 Floating-point

The following sections describe the classes of floating-point instructions:

- [Extension register load/store instructions](#) on page F5-2514.
- [8, 16, and 32-bit transfer between general-purpose and extension registers](#) on page F5-2518.
- [64-bit transfers between general-purpose and extension registers](#) on page F5-2519.
- [Floating-point data-processing instructions](#) on page F5-2511.

F5.2 Advanced SIMD and floating-point instruction syntax

Advanced SIMD and floating-point instructions use the general conventions of the T32 and A32 instruction sets.

Advanced SIMD and floating-point data-processing instructions use the following general format:

```
V{<modifier>}<operation>{<shape>}{<c>}{<q>}{.<dt>} {<dest>}, <src1>, <src2>
```

All Advanced SIMD and floating-point instructions begin with a V. This distinguishes Advanced SIMD vector and floating-point instructions from scalar instructions.

The main operation is specified in the <operation> field. It is usually a three letter mnemonic the same as or similar to the corresponding scalar integer instruction.

The <c> and <q> fields are standard assembler syntax fields. For details see [Standard assembler syntax fields on page F2-2415](#).

F5.2.1 Advanced SIMD instruction modifiers

The <modifier> field provides additional variants of some instructions. [Table F5-1](#) provides definitions of the modifiers. Modifiers are not available for every instruction.

Table F5-1 Advanced SIMD instruction modifiers

<modifier>	Meaning
Q	The operation uses saturating arithmetic.
R	The operation performs rounding.
D	The operation doubles the result (before accumulation, if any).
H	The operation halves the result.

F5.2.2 Advanced SIMD operand shapes

The <shape> field provides additional variants of some instructions. [Table F5-2](#) provides definitions of the shapes. Operand shapes are not available for every instruction.

Table F5-2 Advanced SIMD operand shapes

<shape>	Meaning	Typical register shape
(none)	The operands and result are all the same width.	Dd, Dn, Dm Qd, Qn, Qm
L	Long operation - result is twice the width of both operands	Qd, Dn, Dm
N	Narrow operation - result is half the width of both operands	Dd, Qn, Qm
W	Wide operation - result and first operand are twice the width of the second operand	Qd, Qn, Dm

Note

- Some assemblers support a Q shape specifier, that requires all operands to be Q registers. An example of using this specifier is `VADDQ.S32 q0, q1, q2`. This is not standard UAL, and ARM recommends that programmers do not use a Q shape specifier.
- A disassembler must not generate any shape specifier not shown in [Table F5-2](#).

F5.2.3 Data type specifiers

The <dt> field normally contains one data type specifier. Unless the assembler syntax description for the instruction indicates otherwise, this indicates the data type contained in:

- The second operand, if any.
- The operand, if there is no second operand.
- The result, if there are no operand registers.

The data types of the other operand and result are implied by the <dt> field combined with the instruction shape. For information about data type formats see [Data types supported by the Advanced SIMD implementation on page E1-2305](#).

In the instruction syntax descriptions in [Chapter F2 About the T32 and A32 Instruction Descriptions](#), the <dt> field is usually specified as a single field. However, where more convenient, it is sometimes specified as a concatenation of two fields, <type><size>.

Syntax flexibility

There is some flexibility in the data type specifier syntax:

- Software can specify three data types, specifying the result and both operand data types. For example:
 VSUBW.I16.I16.S8 Q3, Q5, D0 instead of VSUBW.S8 Q3, Q5, D0
- Software can specify two data types, specifying the data types of the two operands. The data type of the result is implied by the instruction shape. For example:
 VSUBW.I16.S8 Q3, Q5, D0 instead of VSUBW.S8 Q3, Q5, D0
- Software can specify two data types, specifying the data types of the single operand and the result. For example:
 VMOVN.I16.I32 D0, Q1 instead of VMOVN.I32 D0, Q1
- Where an instruction requires a less specific data type, software can instead specify a more specific type, as shown in [Table F5-3](#).
- Where an instruction does not require a data type, software can provide one.
- The F32 data type can be abbreviated to F.
- The F64 data type can be abbreviated to D.

In all cases, if software provides additional information, the additional information must match the instruction shape. Disassembly does not regenerate this additional information.

Table F5-3 Data type specification flexibility

Specified data type	Permitted more specific data types				
None	Any				
.I<size>	-	.S<size>	.U<size>	-	-
.8	.I8	.S8	.U8	.P8	-
.16	.I16	.S16	.U16	.P16	.F16
.32	.I32	.S32	.U32	-	.F32 or .F
.64	.I64	.S64	.U64	-	.F64 or .D

F5.2.4 Register specifiers

The <dest>, <src1>, and <src2> fields contain register specifiers, or in some cases scalar specifiers or register lists. [Table F5-4](#) shows the register and scalar specifier formats that appear in the instruction descriptions.

If <dest> is omitted, it is the same as <src1>.

Table F5-4 Advanced SIMD and floating-point register specifier formats

<specifier>	Usual meaning ^a	Used in
<Qd>	A quadword destination register for the result vector.	Advanced SIMD
<Qn>	A quadword source register for the first operand vector.	Advanced SIMD
<Qm>	A quadword source register for the second operand vector.	Advanced SIMD
<Dd>	A doubleword destination register for the result vector.	Both
<Dn>	A doubleword source register for the first operand vector.	Both
<Dm>	A doubleword source register for the second operand vector.	Both
<Sd>	A singleword destination register for the result vector.	Floating-point
<Sn>	A singleword source register for the first operand vector.	Floating-point
<Sm>	A singleword source register for the second operand vector.	Floating-point
<Dd[x]>	A destination scalar for the result. Element x of vector <Dd>.	Advanced SIMD
<Dn[x]>	A source scalar for the first operand. Element x of vector <Dn>.	Both ^b
<Dm[x]>	A source scalar for the second operand. Element x of vector <Dm>.	Advanced SIMD
<Rt>	A general-purpose register, used for a source or destination address.	Both
<Rt2>	A general-purpose register, used for a source or destination address.	Both
<Rn>	A general-purpose register, used as a load or store base address.	Both
<Rm>	A general-purpose register, used as a post-indexed address source.	Both

a. In some instructions the roles of registers are different.

b. In the floating-point instructions, <Dn[x]> is used only in *VMOV* (scalar to general-purpose register), see [VMOV \(scalar to general-purpose register\)](#) on page F8-3220.

F5.2.5 Register lists

A register list is a list of register specifiers separated by commas and enclosed in brackets { and }. There are restrictions on what registers can appear in a register list. These restrictions are described in the individual instruction descriptions. Table F5-5 shows some register list formats, with examples of actual register lists corresponding to those formats.

———— **Note** —————

Register lists must not wrap around the end of the register bank.

Syntax flexibility

There is some flexibility in the register list syntax:

- Where a register list contains consecutive registers, they can be specified as a range, instead of listing every register, for example {D0-D3} instead of {D0, D1, D2, D3}.
- Where a register list contains an even number of consecutive doubleword registers starting with an even numbered register, it can be written as a list of quadword registers instead, for example {Q1, Q2} instead of {D2-D5}.
- Where a register list contains only one register, the enclosing braces can be omitted, for example VLD1.8 D0, [R0] instead of VLD1.8 {D0}, [R0].

Table F5-5 Example register lists

Format	Example	Alternative
{<Dd>}	{D3}	D3
{<Dd>, <Dd+1>, <Dd+2>}	{D3, D4, D5}	{D3-D5}
{<Dd[x]>, <Dd+2[x]>}	{D0[3], D2[3]}	-
{<Dd[]>}	{D7[]}	D7[]

F5.3 Register encoding

An Advanced SIMD register is either:

- *quadword*, meaning it is 128 bits wide.
- *doubleword*, meaning it is 64 bits wide.

Some instructions have options for either doubleword or quadword registers. This is normally encoded in Q, bit[6], as Q = 0 for doubleword operations, or Q = 1 for quadword operations.

A floating-point register is either:

- Double-precision, meaning it is 64 bits wide.
- Single-precision, meaning it is 32 bits wide.

This is encoded in the sz field, bit[8], as sz = 1 for double-precision operations, or sz = 0 for single-precision operations.

The T32 instruction encoding of Advanced SIMD or floating-point registers is:

15	14	13	12	11	10	9	8	7	6	5	4	3	2	1	0	15	14	13	12	11	10	9	8	7	6	5	4	3	2	1	0
										D	Vn					Vd					sz	N	Q	M	Vm						

The A32 instruction encoding of Advanced SIMD or floating-point registers is:

31	30	29	28	27	26	25	24	23	22	21	20	19	18	17	16	15	14	13	12	11	10	9	8	7	6	5	4	3	2	1	0
										D	Vn					Vd					sz	N	Q	M	Vm						

Some instructions use only one or two registers, and use the unused register fields as additional opcode bits.

Table F5-6 shows the encodings for the registers.

Table F5-6 Encoding of register numbers

Register mnemonic	Usual usage	Register number encoded in ^a	Notes ^a	Used in
<Qd>	Destination (quadword)	D, Vd (bits[22, 15:13])	bit[12] == 0 ^b	Advanced SIMD
<Qn>	First operand (quadword)	N, Vn (bits[7, 19:17])	bit[16] == 0 ^b	Advanced SIMD
<Qm>	Second operand (quadword)	M, Vm (bits[5, 3:1])	bit[0] == 0 ^b	Advanced SIMD
<Dd>	Destination (doubleword)	D, Vd (bits[22, 15:12])	-	Both
<Dn>	First operand (doubleword)	N, Vn (bits[7, 19:16])	-	Both
<Dm>	Second operand (doubleword)	M, Vm (bits[5, 3:0])	-	Both
<Sd>	Destination (single-precision)	Vd, D (bits[15:12, 22])	-	Floating-point
<Sn>	First operand (single-precision)	Vn, N (bits[19:16, 7])	-	Floating-point
<Sm>	Second operand (single-precision)	Vm, M (bits[3:0, 5])	-	Floating-point

a. Bit numbers given for the A32 instruction encoding. See the figures in this section for the equivalent bits in the T32 encoding.

b. If this bit is 1, the instruction is UNDEFINED.

F5.3.1 Advanced SIMD scalars

Advanced SIMD scalars can be 8-bit, 16-bit, 32-bit, or 64-bit. Instructions other than multiply instructions can access any element in the register set. The instruction syntax refers to the scalars using an index into a doubleword vector. The descriptions of the individual instructions contain details of the encodings.

Table F5-7 shows the form of encoding for scalars used in multiply instructions. These instructions cannot access scalars in some registers. The descriptions of the individual instructions contain cross references to this section where appropriate.

32-bit Advanced SIMD scalars, when used as single-precision floating-point numbers, are equivalent to Floating-point single-precision registers. That is, $D_m[x]$ in a 32-bit context ($0 \leq m \leq 15, 0 \leq x \leq 1$) is equivalent to $S[2m + x]$.

Table F5-7 Encoding of scalars in multiply instructions

Scalar mnemonic	Usual usage	Scalar size	Register specifier	Index specifier	Accessible registers
< $D_m[x]$ >	Second operand	16-bit	$V_m[2:0]$	M, $V_m[3]$	D0-D7
		32-bit	$V_m[3:0]$	M	D0-D15

F5.4 Advanced SIMD data-processing instructions

The T32 encoding of Advanced SIMD data processing instructions is:

15	14	13	12	11	10	9	8	7	6	5	4	3	2	1	0	15	14	13	12	11	10	9	8	7	6	5	4	3	2	1	0
1	1	1	U	1	1	1	1	A								B				C											

The A32 encoding of Advanced SIMD data processing instructions is:

31	30	29	28	27	26	25	24	23	22	21	20	19	18	17	16	15	14	13	12	11	10	9	8	7	6	5	4	3	2	1	0
1	1	1	1	0	0	1	U	A												B				C							

Table F5-8 shows the encoding for Advanced SIMD data-processing instructions. Other encodings in this space are UNDEFINED.

In these instructions, the U bit is in a different location in A32 and T32 instructions. This is bit[12] of the first halfword in the T32 encoding, and bit[24] in the A32 encoding. Other variable bits are in identical locations in the two encodings, after adjusting for the fact that the A32 encoding is held in memory as a single word and the T32 encoding is held as two consecutive halfwords.

The A32 instructions can only be executed unconditionally. The T32 instructions can be executed conditionally by using the IT instruction. For details see *IT* on page F7-2610.

Table F5-8 Data-processing instructions

U	A	B	C	See
-	0xxxx	-	-	<i>Three registers of the same length on page F5-2500</i>
	1x000	-	0xx1	<i>One register and a modified immediate value on page F5-2508</i>
	1x001	-	0xx1	<i>Two registers and a shift amount on page F5-2505</i>
	1x01x	-	0xx1	
	1x1xx	-	0xx1	
	1xxxx	-	1xx1	
	1x0xx	-	x0x0	<i>Three registers of different lengths on page F5-2503</i>
	1x10x	-	x0x0	
	1x0xx	-	x1x0	<i>Two registers and a scalar on page F5-2504</i>
	1x10x	-	x1x0	
0	1x11x	-	xxx0	Vector Extract, <i>VEXT</i> on page F8-3166
1	1x11x	0xxx	xxx0	<i>Two registers, miscellaneous on page F5-2506</i>
		10xx	xxx0	Vector Table Lookup, <i>VTBL</i> , <i>VTBX</i> on page F8-3386
		1100	0xx0	Vector Duplicate, <i>VDUP (scalar)</i> on page F8-3160

F5.4.1 Three registers of the same length

The T32 encoding of these instructions is:

15	14	13	12	11	10	9	8	7	6	5	4	3	2	1	0	15	14	13	12	11	10	9	8	7	6	5	4	3	2	1	0
1	1	1	U	1	1	1	1	0		C						A								B							

The A32 encoding of these instructions is:

31	30	29	28	27	26	25	24	23	22	21	20	19	18	17	16	15	14	13	12	11	10	9	8	7	6	5	4	3	2	1	0
1	1	1	1	0	0	1	U	0		C																					

Table F5-9 shows the allocation of encodings in this space. Other encodings in this space are UNDEFINED.

Table F5-9 Three registers of the same length

A	B	U	C	Instruction	See	Variant ^a
0000	0	-	-	Vector Halving Add	<i>VHADD</i> , <i>VHSUB</i> on page F8-3172	ASIMD
	1	-	-	Vector Saturating Add	<i>VQADD</i> on page F8-3274	ASIMD
0001	0	-	-	Vector Rounding Halving Add	<i>VRHADD</i> on page F8-3308	ASIMD
	1	0	00	Vector Bitwise AND	<i>VAND</i> (<i>register</i>) on page F8-3110	ASIMD
			01	Vector Bitwise Bit Clear, AND complement	<i>VBIC</i> (<i>register</i>) on page F8-3114	ASIMD
			10	Vector Bitwise OR, if source registers differ	<i>VORR</i> (<i>register</i>) on page F8-3254	ASIMD
				Vector Move, if source registers identical	<i>VMOV</i> (<i>register</i>) on page F8-3216	ASIMD
11	Vector Bitwise OR NOT	<i>VORN</i> (<i>register</i>) on page F8-3250	ASIMD			
0001	1	1	00	Vector Bitwise Exclusive OR	<i>VEOR</i> on page F8-3164	ASIMD
			01	Vector Bitwise Select	<i>VBIF</i> , <i>VBIT</i> , <i>VBSL</i> on page F8-3116	ASIMD
			10	Vector Bitwise Insert if True	<i>VBIF</i> , <i>VBIT</i> , <i>VBSL</i> on page F8-3116	ASIMD
			11	Vector Bitwise Insert if False	<i>VBIF</i> , <i>VBIT</i> , <i>VBSL</i> on page F8-3116	ASIMD
0010	0	-	-	Vector Halving Subtract	<i>VHADD</i> , <i>VHSUB</i> on page F8-3172	ASIMD
	1	-	-	Vector Saturating Subtract	<i>VQSUB</i> on page F8-3298	ASIMD
0011	0	-	-	Vector Compare Greater Than	<i>VCGT</i> (<i>register</i>) on page F8-3126	ASIMD
	1	-	-	Vector Compare Greater Than or Equal	<i>VCGE</i> (<i>register</i>) on page F8-3122	ASIMD
0100	0	-	-	Vector Shift Left	<i>VSHL</i> (<i>register</i>) on page F8-3340	ASIMD
	1	-	-	Vector Saturating Shift Left	<i>VQSHL</i> (<i>register</i>) on page F8-3292	ASIMD
0101	0	-	-	Vector Rounding Shift Left	<i>VRSHL</i> on page F8-3322	ASIMD
	1	-	-	Vector Saturating Rounding Shift Left	<i>VQRSHL</i> on page F8-3288	ASIMD
0110	-	-	-	Vector Maximum or Minimum	<i>VMAX</i> , <i>VMIN</i> (<i>integer</i>) on page F8-3202	ASIMD
0111	0	-	-	Vector Absolute Difference	<i>VABD</i> , <i>VABDL</i> (<i>integer</i>) on page F8-3094	ASIMD
	1	-	-	Vector Absolute Difference and Accumulate	<i>VABA</i> , <i>VABAL</i> on page F8-3092	ASIMD

Table F5-9 Three registers of the same length (continued)

A	B	U	C	Instruction	See	Variant ^a			
1000	0	0	-	Vector Add	VADD (integer) on page F8-3102	ASIMD			
			1	Vector Subtract	VSUB (integer) on page F8-3376	ASIMD			
	1	0	-	Vector Test Bits	VTST on page F8-3390	ASIMD			
			1	Vector Compare Equal	VCEQ (register) on page F8-3118	ASIMD			
1001	0	-	-	Vector Multiply Accumulate or Subtract	VMLA, VMLAL, VMLS, VMLSL (integer) on page F8-3208	ASIMD			
			1	Vector Multiply	VMUL, VMULL (integer and polynomial) on page F8-3236	ASIMD			
1010	-	-	-	Vector Pairwise Maximum or Minimum	VPMAX, VPMIN (integer) on page F8-3264	ASIMD			
1011	0	0	-	Vector Saturating Doubling Multiply Returning High Half	VQDMULH on page F8-3278	ASIMD			
			1	Vector Saturating Rounding Doubling Multiply Returning High Half	VQRDMULH on page F8-3286	ASIMD			
	1	0	-	Vector Pairwise Add	VPADD (integer) on page F8-3258	ASIMD			
1100	0	0	00	SHA1 Hash Update (Choose)	SHA1C on page F8-3081	ARMv8 ASIMD			
			01	SHA1 Hash Update (Parity)	SHA1P on page F8-3084	ARMv8 ASIMD			
			10	SHA1 Hash Update (Majority)	SHA1M on page F8-3083	ARMv8 ASIMD			
			11	SHA1 Schedule Update 0	SHA1SU0 on page F8-3085	ARMv8 ASIMD			
			1	00	SHA256 Hash Update (part 1)	SHA256H on page F8-3087	ARMv8 ASIMD		
				01	SHA256 Hash Update (part 2)	SHA256H2 on page F8-3088	ARMv8 ASIMD		
				10	SHA256 Schedule Update 1	SHA256SU1 on page F8-3090	ARMv8 ASIMD		
			1	0	-	Vector Fused Multiply Accumulate or Subtract	VFMA, VFMS on page F8-3168	ASIMDv2	
			1101	0	0	0x	Vector Add	VADD (floating-point) on page F8-3104	ASIMD
						1x	Vector Subtract	VSUB (floating-point) on page F8-3378	ASIMD
1	0x	-		Vector Pairwise Add	VPADD (floating-point) on page F8-3260	ASIMD			
		1x		Vector Absolute Difference	VABD (floating-point) on page F8-3096	ASIMD			
1	0	-		Vector Multiply Accumulate or Subtract	VMLA, VMLS (floating-point) on page F8-3210	ASIMD			
		1		0x	Vector Multiply	VMUL (floating-point) on page F8-3238	ASIMD		

Table F5-9 Three registers of the same length (continued)

A	B	U	C	Instruction	See	Variant ^a	
1110	0	0	0x	Vector Compare Equal	VCEQ (register) on page F8-3118	ASIMD	
			1	0x	Vector Compare Greater Than or Equal	VCGE (register) on page F8-3122	ASIMD
			1x	Vector Compare Greater Than	VCGT (register) on page F8-3126	ASIMD	
	1	1	-	Vector Absolute Compare Greater or Less Than (or Equal)	VACGE, VACGT, VACLE, VACL on page F8-3100	ASIMD	
1111	0	0	-	Vector Maximum or Minimum	VMAX, VMIN (floating-point) on page F8-3204	ASIMD	
			1	-	Vector Pairwise Maximum or Minimum	VPMAX, VPMIN (floating-point) on page F8-3266	ASIMD
	1	0	0x	Vector Reciprocal Step	VRECPS on page F8-3304	ASIMD	
			1x	Vector Reciprocal Square Root Step	VRSQRTS on page F8-3330	ASIMD	
			xx	Floating-point Maximum or Minimum Number	VMAXNM, VMINNM on page F8-3206	ARMv8 ASIMD	

a. In this column, ASIMD indicates Advanced SIMD, and ASIMDv2 indicates Advanced SIMDv2.

F5.4.2 Three registers of different lengths

The T32 encoding of these instructions is:

15	14	13	12	11	10	9	8	7	6	5	4	3	2	1	0	15	14	13	12	11	10	9	8	7	6	5	4	3	2	1	0
1	1	1	U	1	1	1	1	1			B											A		0	0						

The A32 encoding of these instructions is:

31	30	29	28	27	26	25	24	23	22	21	20	19	18	17	16	15	14	13	12	11	10	9	8	7	6	5	4	3	2	1	0
1	1	1	1	0	0	1	U	1			B											A		0	0						

If B == 0b11, see [Advanced SIMD data-processing instructions on page F5-2499](#).

Otherwise, [Table F5-10](#) shows the allocation of encodings in this space. Other encodings in this space are UNDEFINED.

Table F5-10 Data-processing instructions with three registers of different lengths

A	U	Instruction	See
000x	-	Vector Add Long or Wide	VADDL, VADDW on page F8-3108
001x	-	Vector Subtract Long or Wide	VSUBL, VSUBW on page F8-3382
0100	0	Vector Add and Narrow, returning High Half	VADDHN on page F8-3106
	1	Vector Rounding Add and Narrow, returning High Half	VRADDHN on page F8-3300
0101	-	Vector Absolute Difference and Accumulate	VABA, VABAL on page F8-3092
0110	0	Vector Subtract and Narrow, returning High Half	VSUBHN on page F8-3380
	1	Vector Rounding Subtract and Narrow, returning High Half	VRSUBHN on page F8-3334
0111	-	Vector Absolute Difference	VABD, VABDL (integer) on page F8-3094
10x0	-	Vector Multiply Accumulate or Subtract	VMLA, VMLAL, VMLS, VMLSL (integer) on page F8-3208
10x1	0	Vector Saturating Doubling Multiply Accumulate or Subtract Long	VQDMLAL, VQDMLSL on page F8-3276
1100	-	Vector Multiply (integer)	VMUL, VMULL (integer and polynomial) on page F8-3236
1101	0	Vector Saturating Doubling Multiply Long	VQDMULL on page F8-3280
1110	-	Vector Multiply (polynomial)	VMUL, VMULL (integer and polynomial) on page F8-3236

F5.4.3 Two registers and a scalar

The T32 encoding of these instructions is:

15	14	13	12	11	10	9	8	7	6	5	4	3	2	1	0	15	14	13	12	11	10	9	8	7	6	5	4	3	2	1	0
1	1	1	U	1	1	1	1	1		B												A		1		0					

The A32 encoding of these instructions is:

31	30	29	28	27	26	25	24	23	22	21	20	19	18	17	16	15	14	13	12	11	10	9	8	7	6	5	4	3	2	1	0
1	1	1	1	0	0	1	U	1			B												A		1		0				

If B == 0b11, see [Advanced SIMD data-processing instructions on page F5-2499](#).

Otherwise, [Table F5-11](#) shows the allocation of encodings in this space. Other encodings in this space are UNDEFINED.

Table F5-11 Data-processing instructions with two registers and a scalar

A	U	Instruction	See
0x0x	-	Vector Multiply Accumulate or Subtract	VMLA, VMLAL, VMLS, VMLSL (by scalar) on page F8-3212
0x10	-	Vector Multiply Accumulate or Subtract Long	VMLA, VMLAL, VMLS, VMLSL (by scalar) on page F8-3212
0x11	0	Vector Saturating Doubling Multiply Accumulate or Subtract Long	VQDMLAL, VQDMLSL on page F8-3276
100x	-	Vector Multiply	VMUL, VMULL (by scalar) on page F8-3240
1010	-	Vector Multiply Long	VMUL, VMULL (by scalar) on page F8-3240
1011	0	Vector Saturating Doubling Multiply Long	VQDMULL on page F8-3280
1100	-	Vector Saturating Doubling Multiply returning High Half	VQDMULH on page F8-3278
1101	-	Vector Saturating Rounding Doubling Multiply returning High Half	VQRDMULH on page F8-3286

F5.4.4 Two registers and a shift amount

The T32 encoding of these instructions is:

15	14	13	12	11	10	9	8	7	6	5	4	3	2	1	0	15	14	13	12	11	10	9	8	7	6	5	4	3	2	1	0
1	1	1	U	1	1	1	1	1		imm3						A	L	B													

The A32 encoding of these instructions is:

31	30	29	28	27	26	25	24	23	22	21	20	19	18	17	16	15	14	13	12	11	10	9	8	7	6	5	4	3	2	1	0
1	1	1	1	0	0	1	U	1		imm3																					

If [L, imm3] == 0b0000, see [One register and a modified immediate value on page F5-2508](#).

Otherwise, [Table F5-12](#) shows the allocation of encodings in this space. Other encodings in this space are UNDEFINED.

Table F5-12 Data-processing instructions with two registers and a shift amount

A	U	B	L	Instruction	See
0000	-	-	-	Vector Shift Right	VSHR on page F8-3344
0001	-	-	-	Vector Shift Right and Accumulate	VSRA on page F8-3352
0010	-	-	-	Vector Rounding Shift Right	VRSR on page F8-3324
0011	-	-	-	Vector Rounding Shift Right and Accumulate	VRSRA on page F8-3332
0100	1	-	-	Vector Shift Right and Insert	VSRI on page F8-3354
0101	0	-	-	Vector Shift Left	VSHL (immediate) on page F8-3338
	1	-	-	Vector Shift Left and Insert	VSLI on page F8-3348
011x	-	-	-	Vector Saturating Shift Left	VQSHL, VQSHLU (immediate) on page F8-3294
1000	0	0	0	Vector Shift Right Narrow	VSHRN on page F8-3346
			1	0	Vector Rounding Shift Right Narrow
	1	0	0	Vector Saturating Shift Right, Unsigned Narrow	VQSHRN, VQSHRUN on page F8-3296
			1	0	Vector Saturating Shift Right, Rounded Unsigned Narrow
1001	-	0	0	Vector Saturating Shift Right, Narrow	VQSHRN, VQSHRUN on page F8-3296
			1	0	Vector Saturating Shift Right, Rounded Narrow
1010	-	0	0	Vector Shift Left Long	VSHLL on page F8-3342
					Vector Move Long
111x	-	-	0	Vector Convert	VCVT (between floating-point and fixed-point, Advanced SIMD) on page F8-3146

F5.4.5 Two registers, miscellaneous

The T32 encoding of these instructions is:

15	14	13	12	11	10	9	8	7	6	5	4	3	2	1	0	15	14	13	12	11	10	9	8	7	6	5	4	3	2	1	0
1	1	1	1	1	1	1	1	1		1	1			A			0			B			0								

The A32 encoding of these instructions is:

31	30	29	28	27	26	25	24	23	22	21	20	19	18	17	16	15	14	13	12	11	10	9	8	7	6	5	4	3	2	1	0
1	1	1	1	0	0	1	1	1		1	1			A			0			B			0								

The allocation of encodings in this space is shown in [Table F5-13](#). Other encodings in this space are UNDEFINED.

Table F5-13 Instructions with two registers, miscellaneous

A	B	Instruction	See
00	0000x	Vector Reverse in doublewords	VREV16 , VREV32 , VREV64 on page F8-3306
	0001x	Vector Reverse in words	VREV16 , VREV32 , VREV64 on page F8-3306
	0010x	Vector Reverse in halfwords	VREV16 , VREV32 , VREV64 on page F8-3306
	010xx	Vector Pairwise Add Long	VPADDL on page F8-3262
	01100	AES Single Round Encryption	AESE on page F8-3077
	01101	AES Single Round Decryption	AESD on page F8-3076
	01110	AES Inverse Mix Columns	AESIMC on page F8-3078
	01111	AES Mix Columns	AESMC on page F8-3079
	1000x	Vector Count Leading Sign Bits	VCLS on page F8-3132
	1001x	Vector Count Leading Zeros	VCLZ on page F8-3136
	1010x	Vector Count	VCNT on page F8-3140
	1011x	Vector Bitwise NOT	VMVN (register) on page F8-3244
	110xx	Vector Pairwise Add and Accumulate Long	VPADAL on page F8-3256
00	1110x	Vector Saturating Absolute	VQABS on page F8-3272
	1111x	Vector Saturating Negate	VQNEG on page F8-3284
01	x000x	Vector Compare Greater Than Zero	VCGT (immediate #0) on page F8-3128
	x001x	Vector Compare Greater Than or Equal to Zero	VCGE (immediate #0) on page F8-3124
	x010x	Vector Compare Equal to zero	VCEQ (immediate #0) on page F8-3120
	x011x	Vector Compare Less Than or Equal to Zero	VCLE (immediate #0) on page F8-3130
	x100x	Vector Compare Less Than Zero	VCLT (immediate #0) on page F8-3134
	x110x	Vector Absolute	VABS on page F8-3098
	x111x	Vector Negate	VNEG on page F8-3246
	01011	SHA1 Fixed Rotate	SHAIH on page F8-3082

Table F5-13 Instructions with two registers, miscellaneous (continued)

A	B	Instruction	See
10	0000x	Vector Swap	<i>VSWP</i> on page F8-3384
	0001x	Vector Transpose	<i>VTRN</i> on page F8-3388
	0010x	Vector Unzip	<i>VUZP</i> on page F8-3392
	0011x	Vector Zip	<i>VZIP</i> on page F8-3394
	01000	Vector Move and Narrow	<i>VMOVN</i> on page F8-3230
	01001	Vector Saturating Move and Unsigned Narrow	<i>VQMOVN</i> , <i>VQMOVUN</i> on page F8-3282
	0101x	Vector Saturating Move and Narrow	<i>VQMOVN</i> , <i>VQMOVUN</i> on page F8-3282
	01100	Vector Shift Left Long (maximum shift)	<i>VSHLL</i> on page F8-3342
	01110	SHA1 Schedule Update 1	<i>SHA1SU1</i> on page F8-3086
	01111	SHA256 Schedule Update 0	<i>SHA256SU0</i> on page F8-3089
	1xxxx	Vector Round to Integer	<i>VRINTA</i> , <i>VRINTN</i> , <i>VRINTP</i> , <i>VRINTM</i> (<i>Advanced SIMD</i>) on page F8-3310
	1001x	Vector Round to Integer	<i>VRINTX</i> (<i>Advanced SIMD</i>) on page F8-3314
	1011x	Vector Round to Integer	<i>VRINTZ</i> (<i>Advanced SIMD</i>) on page F8-3318
	11x00	Vector Convert	<i>VCVT</i> (<i>between half-precision and single-precision, Advanced SIMD</i>) on page F8-3151
11	0xxxx	Vector Convert	<i>VCVTA</i> , <i>VCVTN</i> , <i>VCVTP</i> , <i>VCVTM</i> (<i>between floating-point and integer, Advanced SIMD</i>) on page F8-3152
	10x0x	Vector Reciprocal Estimate	<i>VRECPE</i> on page F8-3302
	10x1x	Vector Reciprocal Square Root Estimate	<i>VRSQRTE</i> on page F8-3328
	11xxx	Vector Convert	<i>VCVT</i> (<i>between floating-point and integer, Advanced SIMD</i>) on page F8-3142

F5.4.6 One register and a modified immediate value

The T32 encoding of these instructions is:

15	14	13	12	11	10	9	8	7	6	5	4	3	2	1	0	15	14	13	12	11	10	9	8	7	6	5	4	3	2	1	0
1	1	1	a	1	1	1	1	1		0	0	0	b	c	d																
																cmode			0		op	1	e f g h								

The A32 encoding of these instructions is:

31	30	29	28	27	26	25	24	23	22	21	20	19	18	17	16	15	14	13	12	11	10	9	8	7	6	5	4	3	2	1	0		
1	1	1	1	0	0	1	a	1		0	0	0	b	c	d																		
																cmode			0		op	1	e f g h										

Table F5-14 shows the allocation of encodings in this space.

Table F5-14 Data-processing instructions with one register and a modified immediate value

op	cmode	Instruction	See
0	0xx0	Vector Move	<i>VMOV (immediate)</i> on page F8-3214
	0xx1	Vector Bitwise OR	<i>VORR (immediate)</i> on page F8-3252
	10x0	Vector Move	<i>VMOV (immediate)</i> on page F8-3214
	10x1	Vector Bitwise OR	<i>VORR (immediate)</i> on page F8-3252
	11xx	Vector Move	<i>VMOV (immediate)</i> on page F8-3214
1	0xx0	Vector Bitwise NOT	<i>VMVN (immediate)</i> on page F8-3242
	0xx1	Vector Bit Clear	<i>VBIC (immediate)</i> on page F8-3112
	10x0	Vector Bitwise NOT	<i>VMVN (immediate)</i> on page F8-3242
	10x1	Vector Bit Clear	<i>VBIC (immediate)</i> on page F8-3112
	110x	Vector Bitwise NOT	<i>VMVN (immediate)</i> on page F8-3242
	1110	Vector Move	<i>VMOV (immediate)</i> on page F8-3214
	1111	UNDEFINED	-

Table F5-15 shows the modified immediate constants available with these instructions, and how they are encoded.

Table F5-15 Modified immediate values for Advanced SIMD instructions

op	cmode	Constant ^a	<dt> ^b	Notes
-	000x	00000000 00000000 00000000 abcdefgh 00000000 00000000 00000000 abcdefgh	I32	c
	001x	00000000 00000000 abcdefgh 00000000 00000000 00000000 abcdefgh 00000000	I32	c, d
	010x	00000000 abcdefgh 00000000 00000000 00000000 abcdefgh 00000000 00000000	I32	c, d
	011x	abcdefgh 00000000 00000000 00000000 abcdefgh 00000000 00000000 00000000	I32	c, d
	100x	00000000 abcdefgh 00000000 abcdefgh 00000000 abcdefgh 00000000 abcdefgh	I16	c
	101x	abcdefgh 00000000 abcdefgh 00000000 abcdefgh 00000000 abcdefgh 00000000	I16	c, d
	1100	00000000 00000000 abcdefgh 11111111 00000000 00000000 abcdefgh 11111111	I32	d, e
	1101	00000000 abcdefgh 11111111 11111111 00000000 abcdefgh 11111111 11111111	I32	d, e

Table F5-15 Modified immediate values for Advanced SIMD instructions (continued)

op	cmode	Constant ^a	<dt> ^b	Notes
0	1110	abcdefgh abcdefgh abcdefgh abcdefgh abcdefgh abcdefgh abcdefgh abcdefgh	I8	f
	1111	aBbbbbbc defgh000 00000000 00000000 aBbbbbbc defgh000 00000000 00000000	F32	f, g
1	1110	aaaaaaaa bbbbbbbb cccccccc dddddddd eeeeeeee ffffffff gggggggg hhhhhhhh	I64	f
	1111	UNDEFINED	-	-

- a. In this table, the immediate value is shown in binary form, to relate abcdefgh to the encoding diagram. In assembler syntax, the constant is specified by a data type and a value of that type. That value is specified in the normal way (a decimal number by default) and is replicated enough times to fill the 64-bit immediate. For example, a data type of I32 and a value of 10 specify the 64-bit constant 0x0000000A0000000A.
- b. This specifies the data type used when the instruction is disassembled. On assembly, the data type must be matched in the table if possible. Other data types are permitted as pseudo-instructions when a program is assembled, provided the 64-bit constant specified by the data type and value is available for the instruction. If a constant is available in more than one way, the first entry in this table that can produce it is used. For example, VMOV.I64 D0, #0x8000000080000000 does not specify a 64-bit constant that is available from the I64 line of the table, but does specify one that is available from the fourth I32 line or the F32 line. It is assembled to the first of these, and therefore is disassembled as VMOV.I32 D0, #0x80000000.
- c. This constant is available for the VBIC, VMOV, VMVN, and VORR instructions.
- d. UNPREDICTABLE if abcdefgh == 00000000.
- e. This constant is available for the VMOV and VMVN instructions only.
- f. This constant is available for the VMOV instruction only.
- g. In this entry, B = NOT(b). The bit pattern represents the floating-point number $(-1)^S \times 2^{\text{exp}} \times \text{mantissa}$, where $S = \text{UInt}(a)$, $\text{exp} = \text{UInt}(\text{NOT}(b):c:d)-3$ and $\text{mantissa} = (16+\text{UInt}(e:f:g:h))/16$.

Advanced SIMD expand immediate pseudocode

```
// AdvSIMDExpandImm()
// =====

bits(64) AdvSIMDExpandImm(bit op, bits(4) cmode, bits(8) imm8)
  case cmode<3:1> of
    when '000'
      imm64 = Replicate(Zeros(24):imm8, 2);
    when '001'
      imm64 = Replicate(Zeros(16):imm8:Zeros(8), 2);
    when '010'
      imm64 = Replicate(Zeros(8):imm8:Zeros(16), 2);
    when '011'
      imm64 = Replicate(imm8:Zeros(24), 2);
    when '100'
      imm64 = Replicate(Zeros(8):imm8, 4);
    when '101'
      imm64 = Replicate(imm8:Zeros(8), 4);
    when '110'
      if cmode<0> == '0' then
        imm64 = Replicate(Zeros(16):imm8:Ones(8), 2);
      else
        imm64 = Replicate(Zeros(8):imm8:Ones(16), 2);
    when '111'
      if cmode<0> == '0' && op == '0' then
        imm64 = Replicate(imm8, 8);
      if cmode<0> == '0' && op == '1' then
        imm8a = Replicate(imm8<7>, 8); imm8b = Replicate(imm8<6>, 8);
        imm8c = Replicate(imm8<5>, 8); imm8d = Replicate(imm8<4>, 8);
        imm8e = Replicate(imm8<3>, 8); imm8f = Replicate(imm8<2>, 8);
        imm8g = Replicate(imm8<1>, 8); imm8h = Replicate(imm8<0>, 8);
        imm64 = imm8a:imm8b:imm8c:imm8d:imm8e:imm8f:imm8g:imm8h;
      if cmode<0> == '1' && op == '0' then
        imm32 = imm8<7>:NOT(imm8<6>):Replicate(imm8<6>,5):imm8<5>:Zeros(19);
        imm64 = Replicate(imm32, 2);
      if cmode<0> == '1' && op == '1' then
        if UsingAArch32() then ReservedEncoding();
        imm64 = imm8<7>:NOT(imm8<6>):Replicate(imm8<6>,8):imm8<5>:Zeros(48);

  return imm64;
```

F5.5 Floating-point data-processing instructions

The T32 encoding of floating-point data processing instructions is:

15	14	13	12	11	10	9	8	7	6	5	4	3	2	1	0	15	14	13	12	11	10	9	8	7	6	5	4	3	2	1	0
1	1	1	T	1	1	1	0	opc1	opc2					1	0	1	opc3	0	opc4												

The A32 encoding of floating-point data processing instructions is:

31	30	29	28	27	26	25	24	23	22	21	20	19	18	17	16	15	14	13	12	11	10	9	8	7	6	5	4	3	2	1	0		
cond	1	1	1	0	opc1	opc2						1	0	1	opc3	0	opc4																

- [Table F5-16](#) shows the encodings for three-register floating-point data-processing instructions. Other encodings in this space are UNDEFINED.
- [Table F5-17](#) applies only if [Table F5-16](#) indicates that it does. It shows the encodings for floating-point data-processing instructions with two registers or a register and an immediate. Other encodings in this space are UNDEFINED.
- [Table F5-18 on page F5-2512](#) shows the immediate constants available in the VMOV (immediate) instruction.

These instructions are CDP instructions for coprocessors 10 and 11.

Table F5-16 Three-register floating-point data-processing instructions

opc1	opc3	Instruction	See	Variant
0xxx	x0	Floating-point Selection	VSEL on page F8-3336	ARMv8 FP
0x00	-	Vector Multiply Accumulate or Subtract	VMLA, VMLS (floating-point) on page F8-3210	VFPv2
0x01	-	Vector Negate Multiply Accumulate or Subtract	VNMLA, VNMLS, VNMUL on page F8-3248	VFPv2
0x10	x1			
	x0	Vector Multiply	VMUL (floating-point) on page F8-3238	VFPv2
0x11	x0	Vector Add	VADD (floating-point) on page F8-3104	VFPv2
	x1	Vector Subtract	VSUB (floating-point) on page F8-3378	VFPv2
1x00	xx	Floating-point Maximum or Minimum Number	VMAXNM, VMINNM on page F8-3206	ARMv8 FP
	x0	Vector Divide	VDIV on page F8-3158	
1x01	-	Vector Fused Negate Multiply Accumulate or Subtract	VFNMA, VFNMS on page F8-3170	VFPv4
1x10	-	Vector Fused Multiply Accumulate or Subtract	VFMA, VFMS on page F8-3168	VFPv4
1x11	-	Other floating-point data-processing instructions	Table F5-17	-

Table F5-17 Other floating-point data-processing instructions

opc2	opc3	Instruction	See	Variant
-	x0	Vector Move	VMOV (immediate) on page F8-3214	VFPv3
0000	01	Vector Move	VMOV (register) on page F8-3216	VFPv2
	11	Vector Absolute	VABS on page F8-3098	VFPv2

Table F5-17 Other floating-point data-processing instructions (continued)

opc2	opc3	Instruction	See	Variant
0001	01	Vector Negate	<i>VNEG</i> on page F8-3246	VFPv2
	11	Vector Square Root	<i>VSQRT</i> on page F8-3350	VFPv2
001x	x1	Vector Convert	<i>VCVTB</i> , <i>VCVTT</i> on page F8-3156	VFPv3HP ^a
010x	x1	Vector Compare	<i>VCMP</i> , <i>VCMPPE</i> on page F8-3138	VFPv2
0110	x1	Floating-point Round to Integer	<i>VRINTZ</i> , <i>VRINTR</i> (<i>floating-point</i>) on page F8-3320	ARMv8 FP
0111	01	Floating-point Round to Integer	<i>VRINTX</i> (<i>floating-point</i>) on page F8-3316	ARMv8 FP
	11	Vector Convert	<i>VCVT</i> (<i>between double-precision and single-precision</i>) on page F8-3150	VFPv2
10xx	01	Floating-point Round to Integer	<i>VRINTA</i> , <i>VRINTN</i> , <i>VRINTP</i> , <i>VRINTM</i> (<i>floating-point</i>) on page F8-3312	ARMv8 FP
1000	x1	Vector Convert	<i>VCVT</i> , <i>VCVTR</i> (<i>between floating-point and integer, floating-point</i>) on page F8-3144	VFPv2
101x	x1	Vector Convert	<i>VCVT</i> (<i>between floating-point and fixed-point, floating-point</i>) on page F8-3148	VFPv3
11xx	x1	Vector Convert	<i>VCVTA</i> , <i>VCVTN</i> , <i>VCVTP</i> , <i>VCVTM</i> (<i>between floating-point and integer, floating-point</i>) on page F8-3154	ARMv8 FP
110x	x1	Vector Convert	<i>VCVT</i> , <i>VCVTR</i> (<i>between floating-point and integer, floating-point</i>) on page F8-3144	VFPv2
111x	x1	Vector Convert	<i>VCVT</i> (<i>between floating-point and fixed-point, floating-point</i>) on page F8-3148	VFPv3

a. VFPv3 Half-precision Extension.

Table F5-18 Floating-point modified immediate constants

Data type	opc2	opc4	Constant ^a
F32	abcd	efgh	aBbbbbbc defgh000 00000000 00000000
F64	abcd	efgh	aBbbbbbb bbcdefgh 00000000 00000000 00000000 00000000 00000000 00000000

a. In this column, B = NOT(b). The bit pattern represents the floating-point number $(-1)^S \times 2^{\text{exp}} \times \text{mantissa}$, where $S = \text{UInt}(a)$, $\text{exp} = \text{UInt}(\text{NOT}(b) : c : d) - 3$ and $\text{mantissa} = (16 + \text{UInt}(e : f : g : h)) / 16$.

F5.5.1 Operation of modified immediate constants, floating-point

The VFPEExpandImm() pseudocode function describes the operation of an immediate constant in a floating-point instruction.

```
// VFPEExpandImm()
// =====

bits(N) VFPEExpandImm(bits(8) imm8)
    assert N IN {32,64};
    constant integer E = (if N == 32 then 8 else 11);
    constant integer F = N - E - 1;
    sign = imm8<7>;
    exp = NOT(imm8<6>):Replicate(imm8<6>,E-3):imm8<5:4>;
    frac = imm8<3:0>:Zeros(F-4);
    return sign : exp : frac;
```

F5.6 Extension register load/store instructions

The T32 encoding of Advanced SIMD and floating-point register load and store instructions is:

15	14	13	12	11	10	9	8	7	6	5	4	3	2	1	0	15	14	13	12	11	10	9	8	7	6	5	4	3	2	1	0
1	1	1	T	1	1	0	Opcode				Rn				1 0 1																

The A32 encoding of Advanced SIMD and floating-point register load and store instructions is:

31	30	29	28	27	26	25	24	23	22	21	20	19	18	17	16	15	14	13	12	11	10	9	8	7	6	5	4	3	2	1	0
cond			1	1	0	Opcode				Rn				1 0 1																	

If T == 1 in the T32 encoding or cond == 0b1111 in the A32 encoding, the instruction is UNDEFINED.

Otherwise, the allocation of encodings in this space is shown in [Table F5-19](#). Other encodings in this space are UNDEFINED.

These instructions are LDC and STC instructions for coprocessors 10 and 11.

Table F5-19 Extension register load/store instructions

Opcode	Rn	Instruction	See
0010x	-	-	<i>64-bit transfers between general-purpose and extension registers on page F5-2519</i>
01x00	-	Vector Store Multiple (Increment After, no writeback)	<i>VSTM on page F8-3372</i>
01x10	-	Vector Store Multiple (Increment After, writeback)	<i>VSTM on page F8-3372</i>
1xx00	-	Vector Store Register	<i>VSTR on page F8-3374</i>
10x10	not 1101	Vector Store Multiple (Decrement Before, writeback)	<i>VSTM on page F8-3372</i>
	1101	Vector Push Registers	<i>VPUSH on page F8-3270</i>
01x01	-	Vector Load Multiple (Increment After, no writeback)	<i>VLDM on page F8-3198</i>
01x11	not 1101	Vector Load Multiple (Increment After, writeback)	<i>VLDM on page F8-3198</i>
	1101	Vector Pop Registers	<i>VPOP on page F8-3268</i>
1xx01	-	Vector Load Register	<i>VLDR on page F8-3200</i>
10x11	-	Vector Load Multiple (Decrement Before, writeback)	<i>VLDM on page F8-3198</i>

F5.7 Advanced SIMD element or structure load/store instructions

The T32 encoding of Advanced SIMD element load and store instructions is:

15	14	13	12	11	10	9	8	7	6	5	4	3	2	1	0	15	14	13	12	11	10	9	8	7	6	5	4	3	2	1	0
1	1	1	1	1	0	0	1	A		L	0														B						

The A32 encoding of Advanced SIMD element load and store instructions is:

31	30	29	28	27	26	25	24	23	22	21	20	19	18	17	16	15	14	13	12	11	10	9	8	7	6	5	4	3	2	1	0
1	1	1	1	0	1	0	0	A		L	0																				B

The allocation of encodings in this space is shown in:

- [Table F5-20](#) if L == 0. These are the encodings for store instructions.
- [Table F5-21 on page F5-2516](#) if L == 1. These are the encodings for load instructions.

Other encodings in this space are UNDEFINED.

The variable bits are in identical locations in the two encodings, after adjusting for the fact that the A32 encoding is held in memory as a single word and the T32 encoding is held as two consecutive halfwords.

The A32 instructions can only be executed unconditionally. The T32 instructions can be executed conditionally by using the IT instruction. For details see *IT* on page F7-2610.

Table F5-20 Element and structure store instructions (L == 0)

A	B	Instruction	See
0	0010 011x 1010	Vector Store	VST1 (multiple single elements) on page F8-3356
	0011 100x	Vector Store	VST2 (multiple 2-element structures) on page F8-3360
	010x	Vector Store	VST3 (multiple 3-element structures) on page F8-3364
	000x	Vector Store	VST4 (multiple 4-element structures) on page F8-3368
1	0x00 1000	Vector Store	VST1 (single element from one lane) on page F8-3358
	0x01 1001	Vector Store	VST2 (single 2-element structure from one lane) on page F8-3362
	0x10 1010	Vector Store	VST3 (single 3-element structure from one lane) on page F8-3366
	0x11 1011	Vector Store	VST4 (single 4-element structure from one lane) on page F8-3370

Table F5-21 Element and structure load instructions (L == 1)

A	B	Instruction	See
0	0010 011x 1010	Vector Load	<i>VLD1 (multiple single elements)</i> on page F8-3174
	0011 100x	Vector Load	<i>VLD2 (multiple 2-element structures)</i> on page F8-3180
	010x	Vector Load	<i>VLD3 (multiple 3-element structures)</i> on page F8-3186
	000x	Vector Load	<i>VLD4 (multiple 4-element structures)</i> on page F8-3192
1	0x00 1000	Vector Load	<i>VLD1 (single element to one lane)</i> on page F8-3176
	1100	Vector Load	<i>VLD1 (single element to all lanes)</i> on page F8-3178
	0x01 1001	Vector Load	<i>VLD2 (single 2-element structure to one lane)</i> on page F8-3182
	1101	Vector Load	<i>VLD2 (single 2-element structure to all lanes)</i> on page F8-3184
	0x10 1010	Vector Load	<i>VLD3 (single 3-element structure to one lane)</i> on page F8-3188
	1110	Vector Load	<i>VLD3 (single 3-element structure to all lanes)</i> on page F8-3190
	0x11 1011	Vector Load	<i>VLD4 (single 4-element structure to one lane)</i> on page F8-3194
	1111	Vector Load	<i>VLD4 (single 4-element structure to all lanes)</i> on page F8-3196

F5.7.1 Advanced SIMD addressing mode

All the element and structure load/store instructions use this addressing mode. There is a choice of three formats:

- [<Rn>{:<align>}] The address is contained in general-purpose register Rn.
Rn is not updated by this instruction.
Encoded as Rm = 0b1111.
If Rn is encoded as 0b1111, the instruction is UNPREDICTABLE.
- [<Rn>{:<align>}]! The address is contained in general-purpose register Rn.
Rn is updated by this instruction: $Rn = Rn + transfer_size$
Encoded as Rm = 0b1101.

transfer_size is the number of bytes transferred by the instruction. This means that, after the instruction is executed, Rn points to the address in memory immediately following the last address loaded from or stored to.
If Rn is encoded as 0b1111, the instruction is UNPREDICTABLE.
This addressing mode can also be written as:
[<Rn>{:<align>}], #<transfer_size>
However, disassembly produces the [<Rn>{:<align>}]! form.
- [<Rn>{:<align>}], <Rm>
The address is contained in general-purpose register <Rn>.
Rn is updated by this instruction: $Rn = Rn + Rm$
Encoded as Rm = Rm. Rm must not be encoded as 0b1111 or 0b1101, the PC or the SP.
If Rn is encoded as 0b1111, the instruction is UNPREDICTABLE.

In all cases, <align> specifies an alignment. Details are given in the individual instruction descriptions.

Previous versions of the document used the @ character for alignment. So, for example, the first format in this section was shown as [<Rn>{@<align>}]. Both @ and : are supported. However, to ensure portability of code to assemblers that treat @ as a comment character, : is preferred.

F5.8 8, 16, and 32-bit transfer between general-purpose and extension registers

The T32 encoding of Advanced SIMD and floating-point 8-bit, 16-bit, and 32-bit register data transfer instructions is:

15	14	13	12	11	10	9	8	7	6	5	4	3	2	1	0	15	14	13	12	11	10	9	8	7	6	5	4	3	2	1	0
1	1	1	T	1	1	1	0	A	L							1	0	1	C			B	1								

The A32 encoding of Advanced SIMD and floating-point 8-bit, 16-bit, and 32-bit register data transfer instructions is:

31	30	29	28	27	26	25	24	23	22	21	20	19	18	17	16	15	14	13	12	11	10	9	8	7	6	5	4	3	2	1	0	
cond				1	1	1	0	A	L														1	0	1	C			B	1		

If T == 1 in the T32 encoding or cond == 0b1111 in the A32 encoding, the instruction is UNDEFINED.

Otherwise, the allocation of encodings in this space is shown in [Table F5-22](#). Other encodings in this space are UNDEFINED.

These instructions are MRC and MCR instructions for coprocessors 10 and 11.

Table F5-22 8-bit, 16-bit and 32-bit data transfer instructions

L	C	A	B	Instruction	See
0	0	000	-	Vector Move	<i>VMOV</i> (between general-purpose register and single-precision register) on page F8-3222
		111	-	Move to floating-point Special register from general-purpose register	<i>VMSR</i> on page F8-3234 <i>VMSR</i> on page F7-3072, System level view
0	1	0xx	-	Vector Move	<i>VMOV</i> (general-purpose register to scalar) on page F8-3218
		1xx	0x	Vector Duplicate	<i>VDUP</i> (general-purpose register) on page F8-3162
1	0	000	-	Vector Move	<i>VMOV</i> (between general-purpose register and single-precision register) on page F8-3222
		111	-	Move to general-purpose register from floating-point Special register	<i>VMRS</i> on page F8-3232 <i>VMRS</i> on page F7-3070, System level view
1	xxx	-	Vector Move	<i>VMOV</i> (scalar to general-purpose register) on page F8-3220	

F5.9 64-bit transfers between general-purpose and extension registers

The T32 encoding of Advanced SIMD and floating-point 64-bit register data transfer instructions is:

15	14	13	12	11	10	9	8	7	6	5	4	3	2	1	0	15	14	13	12	11	10	9	8	7	6	5	4	3	2	1	0
1	1	1	T	1	1	0	0	0	1	0						1	0	1	C		op										

The A32 encoding of Advanced SIMD and floating-point 64-bit register data transfer instructions is:

31	30	29	28	27	26	25	24	23	22	21	20	19	18	17	16	15	14	13	12	11	10	9	8	7	6	5	4	3	2	1	0																
	cond					1	1	0	0	0	1	0																				1	0	1	C		op										

If T == 1 in the T32 encoding or cond == 0b1111 in the A32 encoding, the instruction is UNDEFINED.

Otherwise, the allocation of encodings in this space is shown in [Table F5-23](#). Other encodings in this space are UNDEFINED.

These instructions are MRRC and MCRR instructions for coprocessors 10 and 11.

Table F5-23 64-bit data transfer instructions

C	op	Instruction
0	00x1	<i>VMOV</i> (between two general-purpose registers and two single-precision registers) on page F8-3224
1	00x1	<i>VMOV</i> (between two general-purpose registers and a doubleword extension register) on page F8-3226

Chapter F6

ARMv8 Changes to the T32 and A32 Instruction Sets

This chapter summarizes the changes that ARMv8 makes to the T32 and A32 instruction sets. It contains the following section:

- *The A32 and T32 instruction sets on page F6-2522.*
- *Partial Deprecation of IT on page F6-2523.*
- *New A32 and T32 Load-Acquire/Store-Release instructions on page F6-2524.*
- *New A32 and T32 scalar floating-point instructions on page F6-2525.*
- *New A32 and T32 Advanced SIMD floating-point instructions on page F6-2528.*
- *New A32 and T32 cryptography instructions on page F6-2530.*
- *New A32 and T32 System instructions on page F6-2531.*

F6.1 The A32 and T32 instruction sets

This chapter describes the changes that ARMv8-A makes to the T32 and A32 instruction sets, compared to an ARMv7-A implementation that includes all of the following extensions:

- Multiprocessing Extensions.
- Large Physical Address Extension.
- Virtualization Extensions.
- Security Extensions.
- VFPv4.
- Advanced SIMDv2.

The implemented instructions are not affected by whether the ARMv8-A implementation includes either or both of EL2 and EL3.

ARMv8-A obsoletes the A32 SWP and SWPB instructions.

ARM deprecates any use of the following instructions. In ARMv8-A, privileged software can disable these instructions:

- A32 and T32 CP15 barriers [CP15DSB](#), [CP15ISB](#), and [CP15DMB](#).
- A32 and T32 SETEND instruction.
- A subset of T32 IT instruction functionality, as described in [Partial Deprecation of IT on page F6-2523](#).

ARMv8-A adds new A32 and T32 instructions to align with some of the features introduced in the A64 instruction set. These are described in:

- [Partial Deprecation of IT on page F6-2523](#).
- [New A32 and T32 Load-Acquire/Store-Release instructions on page F6-2524](#).
- [New A32 and T32 scalar floating-point instructions on page F6-2525](#).
- [New A32 and T32 Advanced SIMD floating-point instructions on page F6-2528](#).
- [New A32 and T32 cryptography instructions on page F6-2530](#).
- [New A32 and T32 System instructions on page F6-2531](#).

Note

The existing A32 and T32 assembler syntax is unchanged from ARMv7 UAL. Where the syntax term <c> is used in this chapter, it represents a standard ARM condition code. Mnemonics that do not include <c> can not be conditionally executed.

F6.2 Partial Deprecation of IT

ARMv8-A deprecates some uses of the T32 IT instruction. All uses of IT that apply to instructions other than a single subsequent 16-bit instruction from a restricted set are deprecated, as are explicit references to the PC within that single 16-bit instruction. This permits the non-deprecated forms of IT and subsequent instructions to be treated as a single 32-bit conditional instruction. The restricted set of 16-bit instructions which are not deprecated when used in conjunction with IT are listed in [Table F6-1](#).

Table F6-1 Non-deprecated IT 16-bit conditional instructions

Permitted 16-bit instructions	Class	Notes
MOV, MVN	Move	Deprecated when Rm or Rd is the PC.
LDR, LDRB, LDRH, LDRSB, LDRSH	Load	Deprecated for PC-relative load literal forms
STR, STRB, STRH	Store	-
ADD, ADC, RSB, SBC, SUB	Add/Subtract	Deprecated for ADD SP, SP, #imm, SUB SP, SP, #imm, and when Rm, Rdn, or Rdm is the PC
CMP, CMN	Compare	Deprecated when Rm or Rn is the PC
MUL	Multiply	-
ASR, LSL, LSR, ROR	Shift	-
AND, BIC, EOR, ORR, TST	Logical	-
BX, BLX	Branch to register	Deprecated when Rm is the PC

———— **Note** —————

The ARMv7 IT instruction functionality remains available in order to execute ARMv7 T32 code. However, to verify conformance with the deprecation, a new control bit permits privileged software to disable the deprecated forms of the IT instruction, so that their use generates an Undefined Instruction exception. See [HSCTLR.ITD](#).

F6.3 New A32 and T32 Load-Acquire/Store-Release instructions

The new Load-Acquire/Store-Release instructions must be naturally aligned. LDRAEXD and STRLEXD must be aligned to 8 bytes. An unaligned address causes an alignment fault. For more information about the ordering of Load-Acquire/Store-Release, see [Load-Acquire, Store-Release on page E2-2355](#).

F6.3.1 A32 and T32 Load-Acquire/Store-Release (non-exclusive) instructions

[Table F6-2](#) lists the new A32 and T32 Load-Acquire/Store-Release (non-exclusive) instructions.

Table F6-2 A32 and T32 Load-Acquire/Store-Release (non-exclusive) instructions

Mnemonic	Instruction	See
LDA	Load-Acquire Word	LDA on page F7-2612
LDAB	Load-Acquire Byte	LDAB on page F7-2613
LDAH	Load-Acquire Halfword	LDAH on page F7-2618
STL	Store-Release Word	STL on page F7-2856
STLB	Store-Release Byte	STLB on page F7-2858
STLH	Store-Release Halfword	STLH on page F7-2868

F6.3.2 A32 and T32 Load-Acquire/Store-Release Exclusive instructions

[Table F6-3](#) lists the new A32 and T32 Load-Acquire/Store-Release Exclusive instructions.

Table F6-3 A32 and T32 Load-Acquire/Store-Release Exclusive instructions

Mnemonic	Instruction	See
LDAEX	Load-Acquire Exclusive Word	LDAEX on page F7-2614
LDAEXB	Load-Acquire Exclusive Byte	LDAEXB on page F7-2615
LDAEXD	Load-Acquire Exclusive Double	LDAEXD on page F7-2616
LDAEXH	Load-Acquire Exclusive Halfword	LDAEXH on page F7-2617
STLEX	Store-Release Exclusive	STLEX on page F7-2860
STLEXB	Store-Release Exclusive Byte	STLEXB on page F7-2862
STLEXD	Store-Release Exclusive Double	STLEXD on page F7-2864
STLEXH	Store-Release Exclusive Halfword	STLEXH on page F7-2866

F6.4 New A32 and T32 scalar floating-point instructions

This section describes the new A32 and T32 scalar floating-point instructions. It contains the following subsections:

- [A32 and T32 floating-point conditional select.](#)
- [A32 and T32 floating-point minimum and maximum numeric.](#)
- [A32 and T32 floating-point to integer conversion.](#)
- [A32 and T32 floating-point conversion between half-precision and double-precision on page F6-2526.](#)
- [A32 and T32 floating-point round to integral on page F6-2526.](#)

F6.4.1 A32 and T32 floating-point conditional select

The new VSEL instruction conditionally copies one of its two source registers to the destination register. For A32 it provides an alternative to a pair of conditional VMOV instructions, while for T32 it compensates for the partial deprecation of IT instruction described in [Partial Deprecation of IT on page F6-2523](#), since it does not require an IT prefix.

[Table F6-4](#) lists the A32 and T32 floating-point conditional select instructions

Table F6-4 A32 and T32 Conditional select

Mnemonic	Instruction	See
VSEL	Conditional select	VSEL on page F8-3336

F6.4.2 A32 and T32 floating-point minimum and maximum numeric

The new VMAXNM and VMINNM instructions implement the `minNum(x,y)` and `maxNum(x,y)` operations defined by the IEEE754-2008 standard. They return the numerical operand when one operand is numerical and the other is a quiet NaN, but otherwise the result is identical to VFP VMAX and VMIN. These instructions cannot be conditionally executed.

[Table F6-5](#) lists the A32 and T32 floating-point minNum and maxNum instructions.

Table F6-5 A32 and T32 floating-point minNum and maxNum instructions

Mnemonic	Instruction	See
VMAXNM	Single-precision maxNum (scalar)	on page F8-3204 VMAXNM, VMINNM on page F8-3206
VMINNM	Double-precision minNum (scalar)	

F6.4.3 A32 and T32 floating-point to integer conversion

These new instructions extend the ARMv7 VFP VCVT instructions by providing four additional explicit rounding modes. The syntax term `<r>` selects the rounding direction as follows:

- N** Round to nearest, with ties to even.
- A** Round to nearest, with ties to away.
- P** Round towards positive infinity.
- M** Round towards minus infinity.

These instructions cannot be conditionally executed.

Table F6-6 lists the A32 and T32 FP to integer conversion instructions.

Table F6-6 A32 and T32 floating-point to integer conversion instructions

Mnemonic	Instruction	See
VCVT	Floating-point convert to integer	<i>VCVTIA, VCVTN, VCVTP, VCVTM (between floating-point and integer, floating-point) on page F8-3154</i>

F6.4.4 A32 and T32 floating-point conversion between half-precision and double-precision

The VFP VCVTT and VCVTB instructions are extended to permit direct conversion between half-precision and double-precision floating-point as a single operation, preventing double rounding errors. The syntax term <y> in Table F6-7 is either T, top half, and B, bottom half.

Table F6-7 lists the A32 and T32 instructions to convert between half-precision and double-precision floating-point values.

Table F6-7 A32 and T32 floating-point precision conversion

Mnemonic	Instruction	See
VCVTB	Floating-point convert single-precision to double-precision	<i>VCVTB, VCVTT on page F8-3156</i>
VCVTT	Floating-point convert double-precision to single-precision	

F6.4.5 A32 and T32 floating-point round to integral

The new round to integral instructions round a floating-point value to the nearest integral floating-point value of the same size. The floating-point exceptions that can be raised by these instructions are the Invalid operation, for a signaling NaN input, or Input Denormal, for a denormal input when flush-to-zero mode is enabled. For VRINTX only an Inexact exception can be raised if the result is numeric and does not have the same numerical value as the source. A zero input gives a zero result with the same sign, an infinite input gives an infinite result with the same sign, and a NaN is propagated as for normal floating-point arithmetic.

A subset of the rounding instructions can be conditionally executed when the syntax term <x> selects the rounding direction as follows:

- Z** Round towards zero.
- R** FPSCR rounding mode.
- X** FPSCR rounding mode and signaling inexactness.

Table F6-9 on page F6-2527 lists the A32 and T32 round to integral instructions that can be conditionally executed.

Table F6-8 A32 and T32 floating-point round to integral instruction (unconditional)

Mnemonic	Instruction	See
VRINT	Floating-point round to integral	<ul style="list-style-type: none"> • <i>VRINTX (floating-point) on page F8-3316</i> • <i>VRINTZ, VRINTR (floating-point) on page F8-3320</i>

The remaining rounding instructions cannot be conditionally executed when the syntax term <r> selects the rounding directions as follows:

- N** Round to nearest, with ties to even.
- A** Round to nearest, with ties to away.
- P** Round towards positive infinity.

M Round towards minus infinity.

Table F6-9 A32 and T32 floating-point round to integral instruction (conditional)

Mnemonic	Instruction	See
VRINT on page F8-3310	Floating-point round to integral	VRINTA , VRINTN , VRINTP , VRINTM (<i>floating-point</i>) on page F8-3312

[Table F6-8 on page F6-2526](#) lists the A32 and T32 round to integral instructions that cannot be conditionally executed.

F6.5 New A32 and T32 Advanced SIMD floating-point instructions

The AArch32 Advanced SIMD extension continues to support only single-precision, 32-bit, floating-point data types, with fixed operating modes of Round to Nearest, Default NaN, and Flush-to-Zero. However, it is extended with the addition of the instructions in the following subsections:

- [A32 and T32 floating-point minimum and maximum numeric](#).
- [A32 and T32 floating-point conversion](#).
- [A32 and T32 floating-point round to integral](#).

F6.5.1 A32 and T32 floating-point minimum and maximum numeric

Vector forms of the new VMAXNM and VMINNM instructions are described in [A32 and T32 floating-point minimum and maximum numeric](#) on page F6-2525.

Table F6-10 lists the A32 and T32 floating-point minNum/maxNum instructions.

Table F6-10 A32 and T32 floating-point minNum/maxNum instructions

Mnemonic	Instruction	See
VMAXNM	Single-precision maxNum (vector)	VMAXNM , VMINNM on page F8-3206
VMINNM	Double-precision minNum (vector)	

F6.5.2 A32 and T32 floating-point conversion

Vector forms of the floating-point to integer conversion instructions are described in [A32 and T32 floating-point to integer conversion](#) on page F6-2525. The syntax term <r> selects the rounding direction as follows:

- N** Round to nearest, with ties to even.
- A** Round to nearest, with ties to away.
- P** Round towards positive infinity.
- M** Round towards minus infinity.

Table F6-11 lists the A32 and T32 floating-point conversion instructions.

Table F6-11 A32 and T32 floating-point conversion instructions

Mnemonic	Instruction	See
VCVT	Floating-point convert to integer	VCVTA , VCVTN , VCVTP , VCVTM (between floating-point and integer, Advanced SIMD) on page F8-3152

F6.5.3 A32 and T32 floating-point round to integral

Vector forms of the floating-point rounding instructions are described in [A32 and T32 floating-point round to integral](#) on page F6-2526. The syntax term <rx> selects the rounding direction as follows:

- N** Round to the nearest, with ties to even.
- A** Round to the nearest, with ties to away.
- P** Round towards positive infinity.
- M** Round towards minus infinity.
- Z** Round towards zero.
- X** Round to the nearest, with ties to even, signaling inexactness.

Table F6-12 on page F6-2529 lists the A32 and T32 floating-point round to integral instructions.

Table F6-12 A32 and T32 SIMD floating-point round to integral instructions

Mnemonic	Instruction	See
VRINT	Floating-point round to integral	<ul style="list-style-type: none">• VRINTX (Advanced SIMD) on page F8-3314• VRINTZ (Advanced SIMD) on page F8-3318• VRINTA, VRINTN, VRINTP, VRINTM (Advanced SIMD) on page F8-3310

F6.6 New A32 and T32 cryptography instructions

The optional Cryptography extension instructions share the SIMD and floating-point register file. For more information see:

- *Announcing the Advanced Encryption Standard.*
- *The Galois/Counter Mode of Operation.*
- *Announcing the Secure Hash Standard.*

Table F6-13 lists the A32 and T32 cryptography instructions.

Table F6-13 A32 and T32 Cryptography instructions

Mnemonic	Instruction	See
AESD	AES single round decryption	AESD on page F8-3076
AESE	AED single round encryption	AESE on page F8-3077
AESIMC	AES inverse mix columns	AESIMC on page F8-3078
AESMC	AES mix columns	AESMC on page F8-3079
SHA1C	SHA1 hash update accelerator, choose	SHA1C on page F8-3081
SHA1M	SHA1 hash update accelerator, majority	SHA1M on page F8-3083
SHA1P	SHA1 hash update accelerator, parity	SHA1P on page F8-3084
SHA1H	SHA1 hash update accelerator, rotate left by 30	SHA1H on page F8-3082
SHA1SU0	SHA1 schedule update accelerator, first part	SHA1SU0 on page F8-3085
SHA1SU1	SHA1 schedule update accelerator, second part	SHA1SU1 on page F8-3086
SHA256H	SHA256 hash update accelerator	SHA256H on page F8-3087
SHA256H2	SHA256 hash update accelerator upper part	SHA256H2 on page F8-3088
SHA256SU0	SHA256 schedule update accelerator, first part	SHA256SU0 on page F8-3089
SHA256SU1	SHA256 schedule update accelerator, second part	SHA256SU1 on page F8-3090
VMULL	Polynomial multiply long, 64×64 to 128-bit	VMUL, VMULL (integer and polynomial) on page F8-3236

F6.7 New A32 and T32 System instructions

The section describes the system instructions. It contains the following subsections:

- [External Debug](#).
- [Barriers and hints](#).
- [TLB Maintenance](#).

F6.7.1 External Debug

[Table F6-14](#) lists the new External Debug support instructions.

Table F6-14 External Debug support instructions

Mnemonic	Instructions	Note
DCPS1	Debug switch to EL1, valid in External Debug state only	-
DCPS2	Debug switch to EL2, valid in External Debug state only	-
DCPS3	Debug switch to EL3, valid in External Debug state only	-
HLT #uimm6	Halting mode software breakpoint	Enters External Debug state if enabled, else treated as UNALLOCATED, with a 6-bit payload in uimm6

F6.7.2 Barriers and hints

There are new A32 and T32 barrier options and hint instructions.

[Table F6-15](#) lists the new A32 and T32 barrier instructions.

Table F6-15 Additional barrier instructions

Mnemonic	Notes
DMB {ISHLD, OSHLD, NSHLD, LD}	Data Memory Barrier is extended to support the new Load-Load/Store options
DSB {ISHLD, OSHLD, NSHLD, LD}	Data Synchronization Barrier is extended to support the new Load-Load/Store options
SEVL	Send Event Locally without the requirement to affect other processors, for example to prime a wait-loop which starts with a WFE instructions

F6.7.3 TLB Maintenance

TLB maintenance operations that are only required to apply to the last level translation table walk of the first stage of translation are added to A32 and T32 as shown in [Table F6-16](#). See [Translation Lookaside Buffers \(TLBs\)](#) on page G3-3630 and [TLB maintenance requirements](#) on page G3-3633

Table F6-16 Additional A32 and T32 TLB maintenance instructions

Mnemonic	Relation to existing A32/T32 operation
TLBIMVALIS	Related to the TLBIMVAIS operation
TLBIMVAALIS	Related to the TLBIMVAAIS operation
TLBIMVALHIS	Related to the TLBIMVAHIS operation
TLBIMVAL	Related to the TLBIMVA operation

Table F6-16 Additional A32 and T32 TLB maintenance instructions (continued)

Mnemonic	Relation to existing A32/T32 operation
TLBIMVAAL	Related to the TLBIMVAA operation
TLBIMVALH	Related to the TLBIMVAH operation

A32 and T32 instructions contain TLB maintenance operations that must apply to individual entries from stage2 TLB structures, which hold IPA to PA translations. These are consistent with the A64 TLBI system instructions described in *New A32 and T32 System instructions on page F6-2531*. The relation between the A32 and T32 instructions and the A64 instructions is shown in [Table F6-17](#)

Table F6-17 Relation of A32 TLB maintenance instructions to A64 instructions

Instruction	Relation to A64 operation
TLBIIPAS2IS	Equivalent to IPAS2E1IS
TLBIIPAS2LIS	Equivalent to IPAS2LE1IS Related to existing A32/T32 TLBIIPAS2IS operation
TLBIIPAS2	Equivalent to the A64 IPAS2E1 operation
TLBIIPAS2L	Equivalent to IPAS2LE1 operation Related to existing A32/T32 TLBIIPAS2 operation

Note

These new system operations are accessed using the MCR instruction or, if implemented, by an assembler using the SYS mnemonic followed by the TLBI operation name.

Chapter F7

T32 and A32 Base Instruction Set Instruction Descriptions

This chapter describes each instruction. It contains the following sections:

- *Alphabetical list of T32 and A32 base instruction set instructions on page F7-2534.*
- *General restrictions on system instructions on page F7-3028.*
- *Encoding and use of Banked register transfer instructions on page F7-3029.*
- *Alphabetical list of system instructions on page F7-3033.*

F7.1 Alphabetical list of T32 and A32 base instruction set instructions

This section lists every instruction in the T32 and A32 base instruction sets. For details of the format used see [Format of instruction descriptions on page F2-2410](#).

This section is formatted so that a full description of an instruction uses a double page.

F7.1.1 ADC (immediate)

Add with Carry (immediate) adds an immediate value and the Carry flag value to a register value, and writes the result to the destination register. It can optionally update the condition flags based on the result.

Encoding T1 ARMv6T2, ARMv7

ADC{S}<c> <Rd>, <Rn>, #<const>

15	14	13	12	11	10	9	8	7	6	5	4	3	2	1	0	15	14	13	12	11	10	9	8	7	6	5	4	3	2	1	0
1	1	1	1	0	i	0	1	0	1	0	S		Rn		0	imm3		Rd											imm8		

d = UInt(Rd); n = UInt(Rn); setflags = (S == '1'); imm32 = ThumbExpandImm(i:imm3:imm8);
 if d == 15 || n == 15 then UNPREDICTABLE; // ARMv8-A removes UNPREDICTABLE for R13

Encoding A1 ARMv4*, ARMv5T*, ARMv6*, ARMv7

ADC{S}<c> <Rd>, <Rn>, #<const>

31	30	29	28	27	26	25	24	23	22	21	20	19	18	17	16	15	14	13	12	11	10	9	8	7	6	5	4	3	2	1	0
cond		0	0	1	0	1	0	1	S		Rn		Rd	imm12																	

if Rd == '1111' && S == '1' then SEE SUBS PC, LR and related instructions;
 d = UInt(Rd); n = UInt(Rn); setflags = (S == '1'); imm32 = ARMEExpandImm(imm12);

For information about the CONstrained UNPREDICTABLE behavior, see [Appendix A Architectural Constraints on UNPREDICTABLE behaviors](#).

Assembler syntax

ADC{S}{<c>}{<q>} {<Rd>}, <Rn>, #<const>

where:

- S If S is present, the instruction updates the flags. Otherwise, the flags are not updated.
- <c>, <q> See *Standard assembler syntax fields* on page F2-2415.
- <Rd> The destination register. If S is specified and <Rd> is the PC, see *SUBS PC, LR and related instructions (T32)* on page F7-3066 or *SUBS PC, LR and related instructions (A32)* on page F7-3068.
- In A32 instructions, if S is not specified and <Rd> is the PC, the instruction is a branch to the address calculated by the operation. This is an interworking branch, see *Pseudocode details of operations on the AArch32 general-purpose registers and the PC* on page E1-2296.
- <Rn> The first operand register. The PC can be used in A32 instructions.
- <const> The immediate value to be added to the value obtained from <Rn>. See *Modified immediate constants in T32 instructions* on page F3-2444 or *Modified immediate constants in A32 instructions* on page F4-2472 for the range of values.

The pre-UAL syntax ADC<c>S is equivalent to ADCS<c>.

Operation

```
if ConditionPassed() then
    EncodingSpecificOperations();
    (result, nzcvc) = AddWithCarry(R[n], imm32, APSR.C);
    if d == 15 then // Can only occur for ARM encoding
        ALUWritePC(result); // setflags is always FALSE here
    else
        R[d] = result;
        if setflags then
            APSR.<N,Z,C,V> = nzcvc;
```

F7.1.2 ADC (register)

Add with Carry (register) adds a register value, the Carry flag value, and an optionally-shifted register value, and writes the result to the destination register. It can optionally update the condition flags based on the result.

Encoding T1 ARMv4T, ARMv5T*, ARMv6*, ARMv7
 ADCS <Rdn>, <Rm> Outside IT block.
 ADC<c> <Rdn>, <Rm> Inside IT block.

15	14	13	12	11	10	9	8	7	6	5	4	3	2	1	0
0	1	0	0	0	0	0	1	0	1	Rm	Rdn				

d = UInt(Rdn); n = UInt(Rdn); m = UInt(Rm); setflags = !InITBlock();
 (shift_t, shift_n) = (SRTYPE_LSL, 0);

Encoding T2 ARMv6T2, ARMv7
 ADC{S}<c>.W <Rd>, <Rn>, <Rm>{, <shift>}

15	14	13	12	11	10	9	8	7	6	5	4	3	2	1	0	15	14	13	12	11	10	9	8	7	6	5	4	3	2	1	0
1	1	1	0	1	0	1	1	0	1	0	S	Rn				(0)	imm3			Rd			imm2		type	Rm					

d = UInt(Rd); n = UInt(Rn); m = UInt(Rm); setflags = (S == '1');
 (shift_t, shift_n) = DecodeImmShift(type, imm3:imm2);
 if d == 15 || n == 15 || m == 15 then UNPREDICTABLE; // ARMv8-A removes UNPREDICTABLE for R13

Encoding A1 ARMv4*, ARMv5T*, ARMv6*, ARMv7
 ADC{S}<c> <Rd>, <Rn>, <Rm>{, <shift>}

31	30	29	28	27	26	25	24	23	22	21	20	19	18	17	16	15	14	13	12	11	10	9	8	7	6	5	4	3	2	1	0
cond			0	0	0	0	1	0	1	S	Rn				Rd				imm5			type	0	Rm							

if Rd == '1111' && S == '1' then SEE SUBS PC, LR and related instructions;
 d = UInt(Rd); n = UInt(Rn); m = UInt(Rm); setflags = (S == '1');
 (shift_t, shift_n) = DecodeImmShift(type, imm5);

For information about the CONSTRAINED UNPREDICTABLE behavior, see [Appendix A Architectural Constraints on UNPREDICTABLE behaviors](#).

Assembler syntax

ADC{S}{<c>}{<q>} {<Rd>}, <Rn>, <Rm> {, <shift>}

where:

- S If S is present, the instruction updates the flags. Otherwise, the flags are not updated.
- <c>, <q> See *Standard assembler syntax fields* on page F2-2415.
- <Rd> The destination register. If S is specified and <Rd> is the PC, see *SUBS PC, LR and related instructions (T32)* on page F7-3066 or *SUBS PC, LR and related instructions (A32)* on page F7-3068.
- In A32 instructions, if S is not specified and <Rd> is the PC, the instruction is a branch to the address calculated by the operation. This is an interworking branch, see *Pseudocode details of operations on the AArch32 general-purpose registers and the PC* on page E1-2296.
- <Rn> The first operand register. The PC can be used in A32 instructions.
- <Rm> The optionally shifted second operand register. The PC can be used in A32 instructions.
- <shift> The shift to apply to the value read from <Rm>. If present, encoding T1 is not permitted. If absent, no shift is applied and any encoding is permitted. *Shifts applied to a register* on page F2-2419 describes the shifts and how they are encoded.

In T32 assembly:

- Outside an IT block, if ADCS <Rd>, <Rn>, <Rd> has <Rd> and <Rn> both in the range R0-R7, it is assembled using encoding T1 as though ADCS <Rd>, <Rn> had been written.
- Inside an IT block, if ADC<c> <Rd>, <Rn>, <Rd> has <Rd> and <Rn> both in the range R0-R7, it is assembled using encoding T1 as though ADC<c> <Rd>, <Rn> had been written.

To prevent either of these happening, use the .W qualifier.

The pre-UAL syntax ADC<c>S is equivalent to ADCS<c>.

Operation

```
if ConditionPassed() then
    EncodingSpecificOperations();
    shifted = Shift(R[m], shift_t, shift_n, APSR.C);
    (result, nzcvc) = AddWithCarry(R[n], shifted, APSR.C);
    if d == 15 then // Can only occur for ARM encoding
        ALUWritePC(result); // setflags is always FALSE here
    else
        R[d] = result;
        if setflags then
            APSR.<N,Z,C,V> = nzcvc;
```

F7.1.3 ADC (register-shifted register)

Add with Carry (register-shifted register) adds a register value, the Carry flag value, and a register-shifted register value. It writes the result to the destination register, and can optionally update the condition flags based on the result.

Encoding A1 ARMv4*, ARMv5T*, ARMv6*, ARMv7

ADC{S}<c> <Rd>, <Rn>, <Rm>, <type> <Rs>

31	30	29	28	27	26	25	24	23	22	21	20	19	18	17	16	15	14	13	12	11	10	9	8	7	6	5	4	3	2	1	0
cond			0	0	0	0	1	0	1	S	Rn				Rd				Rs		0	type		1	Rm						

```
d = UInt(Rd); n = UInt(Rn); m = UInt(Rm); s = UInt(Rs);
setflags = (S == '1'); shift_t = DecodeRegShift(type);
if d == 15 || n == 15 || m == 15 || s == 15 then UNPREDICTABLE;
```

For information about the CONSTRAINED UNPREDICTABLE behavior, see [Appendix A Architectural Constraints on UNPREDICTABLE behaviors](#).

Assembler syntax

ADC{S}{<c>}{<q>} {<Rd>}, <Rn>, <Rm>, <type> <Rs>

where:

S If S is present, the instruction updates the flags. Otherwise, the flags are not updated.

<c>, <q> See [Standard assembler syntax fields on page F2-2415](#).

<Rd> The destination register.

<Rn> The first operand register.

<Rm> The register that is shifted and used as the second operand.

<type> The type of shift to apply to the value read from <Rm>. It must be one of:

ASR Arithmetic shift right, encoded as type = 0b10.

LSL Logical shift left, encoded as type = 0b00.

LSR Logical shift right, encoded as type = 0b01.

ROR Rotate right, encoded as type = 0b11.

<Rs> The register whose bottom byte contains the amount to shift by.

The pre-UAL syntax ADC<c>S is equivalent to ADCS<c>.

Operation

```
if ConditionPassed() then
    EncodingSpecificOperations();
    shift_n = UInt(R[s]<7:0>);
    shifted = Shift(R[m], shift_t, shift_n, APSR.C);
    (result, nzcv) = AddWithCarry(R[n], shifted, APSR.C);
    R[d] = result;
    if setflags then
        APSR.<N,Z,C,V> = nzcv;
```

F7.1.4 ADD (immediate, T32)

This instruction adds an immediate value to a register value, and writes the result to the destination register. It can optionally update the condition flags based on the result.

Encoding T1 ARMv4T, ARMv5T*, ARMv6*, ARMv7
 ADDS <Rd>, <Rn>, #<imm3> Outside IT block.
 ADD<c> <Rd>, <Rn>, #<imm3> Inside IT block.

15	14	13	12	11	10	9	8	7	6	5	4	3	2	1	0
0	0	0	1	1	1	0	imm3			Rn			Rd		

d = UInt(Rd); n = UInt(Rn); setflags = !InITBlock(); imm32 = ZeroExtend(imm3, 32);

Encoding T2 ARMv4T, ARMv5T*, ARMv6*, ARMv7
 ADDS <Rdn>, #<imm8> Outside IT block.
 ADD<c> <Rdn>, #<imm8> Inside IT block.

15	14	13	12	11	10	9	8	7	6	5	4	3	2	1	0
0	0	1	1	0	Rdn			imm8							

d = UInt(Rdn); n = UInt(Rdn); setflags = !InITBlock(); imm32 = ZeroExtend(imm8, 32);

Encoding T3 ARMv6T2, ARMv7
 ADD{S}<c>.W <Rd>, <Rn>, #<const>

15	14	13	12	11	10	9	8	7	6	5	4	3	2	1	0	15	14	13	12	11	10	9	8	7	6	5	4	3	2	1	0
1	1	1	1	0	i	0	1	0	0	0	S	Rn			0	imm3			Rd			imm8									

if Rd == '1111' && S == '1' then SEE CMN (immediate);
 if Rn == '1101' then SEE ADD (SP plus immediate);
 d = UInt(Rd); n = UInt(Rn); setflags = (S == '1'); imm32 = ThumbExpandImm(i:imm3:imm8);
 if (d == 15 && S == '0') || n == 15 then UNPREDICTABLE; // ARMv8-A removes UNPREDICTABLE for R13

Encoding T4 ARMv6T2, ARMv7
 ADDW<c> <Rd>, <Rn>, #<imm12>

15	14	13	12	11	10	9	8	7	6	5	4	3	2	1	0	15	14	13	12	11	10	9	8	7	6	5	4	3	2	1	0
1	1	1	1	0	i	1	0	0	0	0	0	Rn			0	imm3			Rd			imm8									

if Rn == '1111' then SEE ADR;
 if Rn == '1101' then SEE ADD (SP plus immediate);
 d = UInt(Rd); n = UInt(Rn); setflags = FALSE; imm32 = ZeroExtend(i:imm3:imm8, 32);
 if d == 15 then UNPREDICTABLE; // ARMv8-A removes UNPREDICTABLE for R13

For information about the CONSTRAINED UNPREDICTABLE behavior, see [Appendix A Architectural Constraints on UNPREDICTABLE behaviors](#).

Assembler syntax

ADD{S}{<C>}{<q>} {<Rd>}, <Rn>, #<const> All encodings permitted
ADDW{<C>}{<q>} {<Rd>}, <Rn>, #<const> Only encoding T4 permitted

where:

S If S is present, the instruction updates the flags. Otherwise, the flags are not updated.
<C>, <q> See [Standard assembler syntax fields on page F2-2415](#).
<Rd> The destination register.
<Rn> The first operand register. If <Rn> is SP, see [ADD \(SP plus immediate\) on page F7-2548](#). If <Rn> is PC, see [ADR on page F7-2554](#).
<const> The immediate value to be added to the value obtained from <Rn>. The range of values is 0-7 for encoding T1, 0-255 for encoding T2 and 0-4095 for encoding T4. See [Modified immediate constants in T32 instructions on page F3-2444](#) for the range of values for encoding T3.

When multiple encodings of the same length are available for an instruction, encoding T3 is preferred to encoding T4 (if encoding T4 is required, use the ADDW syntax). Encoding T1 is preferred to encoding T2 if <Rd> is specified and encoding T2 is preferred to encoding T1 if <Rd> is omitted.

The pre-UAL syntax ADD<C>S is equivalent to ADDS<C>.

Operation

```
if ConditionPassed() then
    EncodingSpecificOperations();
    (result, nzcV) = AddWithCarry(R[n], imm32, '0');
    R[d] = result;
    if setflags then
        APSR.<N,Z,C,V> = nzcV;
```

F7.1.5 ADD (immediate, A32)

This instruction adds an immediate value to a register value, and writes the result to the destination register. It can optionally update the condition flags based on the result.

Encoding A1 ARMv4*, ARMv5T*, ARMv6*, ARMv7

ADD{S}<c> <Rd>, <Rn>, #<const>

31	30	29	28	27	26	25	24	23	22	21	20	19	18	17	16	15	14	13	12	11	10	9	8	7	6	5	4	3	2	1	0
cond			0	0	1	0	1	0	0	S	Rn				Rd				imm12												

if Rn == '1111' && S == '0' then SEE ADR;
 if Rn == '1101' then SEE ADD (SP plus immediate);
 if Rd == '1111' && S == '1' then SEE SUBS PC, LR and related instructions;
 d = UInt(Rd); n = UInt(Rn); setflags = (S == '1'); imm32 = ARMEExpandImm(imm12);

Assembler syntax

ADD{S}{<c>}{<q>} {<Rd>}, {<Rn>, #<const>

where:

- S If S is present, the instruction updates the flags. Otherwise, the flags are not updated.
- <c>, <q> See *Standard assembler syntax fields* on page F2-2415.
- <Rd> The destination register. If S is specified and <Rd> is the PC, see *SUBS PC, LR and related instructions (T32)* on page F7-3066 or *SUBS PC, LR and related instructions (A32)* on page F7-3068.
- If S is not specified and <Rd> is the PC, the instruction is a branch to the address calculated by the operation. This is an interworking branch, see *Pseudocode details of operations on the AArch32 general-purpose registers and the PC* on page E1-2296.
- <Rn> The first operand register. If the SP is specified for <Rn>, see *ADD (SP plus immediate)* on page F7-2548. If the PC is specified for <Rn>, see *ADR* on page F7-2554.
- <const> The immediate value to be added to the value obtained from <Rn>. See *Modified immediate constants in A32 instructions* on page F4-2472 for the range of values.

The pre-UAL syntax ADD<c>S is equivalent to ADDS<c>.

Operation

```
if ConditionPassed() then
    EncodingSpecificOperations();
    (result, nzcv) = AddWithCarry(R[n], imm32, '0');
    if d == 15 then
        ALUWritePC(result); // setflags is always FALSE here
    else
        R[d] = result;
        if setflags then
            APSR.<N,Z,C,V> = nzcv;
```

F7.1.6 ADD (register, T32)

This instruction adds a register value and an optionally-shifted register value, and writes the result to the destination register. It can optionally update the condition flags based on the result.

Encoding T1 ARMv4T, ARMv5T*, ARMv6*, ARMv7
 ADDS <Rd>, <Rn>, <Rm> Outside IT block.
 ADD<c> <Rd>, <Rn>, <Rm> Inside IT block.

15	14	13	12	11	10	9	8	7	6	5	4	3	2	1	0
0	0	0	1	1	0	0	Rm			Rn			Rd		

```
d = UInt(Rd); n = UInt(Rn); m = UInt(Rm); setflags = !InITBlock();
(shift_t, shift_n) = (SRTYPE_LSL, 0);
```

Encoding T2 ARMv6T2, ARMv7 if <Rdn> and <Rm> are both from R0-R7
 ARMv4T, ARMv5T*, ARMv6*, ARMv7 otherwise
 ADD<c> <Rdn>, <Rm> If <Rdn> is the PC, must be outside or last in IT block.

15	14	13	12	11	10	9	8	7	6	5	4	3	2	1	0
0	1	0	0	0	1	0	0	Rm			Rdn				

DN┘

```
if (DN:Rdn) == '1101' || Rm == '1101' then SEE ADD (SP plus register);
d = UInt(DN:Rdn); n = d; m = UInt(Rm); setflags = FALSE; (shift_t, shift_n) = (SRTYPE_LSL, 0);
if n == 15 && m == 15 then UNPREDICTABLE;
if d == 15 && InITBlock() && !LastInITBlock() then UNPREDICTABLE;
```

Encoding T3 ARMv6T2, ARMv7
 ADD{S}<c>.W <Rd>, <Rn>, <Rm>{, <shift>}

15	14	13	12	11	10	9	8	7	6	5	4	3	2	1	0	15	14	13	12	11	10	9	8	7	6	5	4	3	2	1	0
1	1	1	0	1	0	1	1	0	0	0	S	Rn				(0)	imm3			Rd			imm2		type	Rm					

```
if Rd == '1111' && S == '1' then SEE CMN (register);
if Rn == '1101' then SEE ADD (SP plus register);
d = UInt(Rd); n = UInt(Rn); m = UInt(Rm); setflags = (S == '1');
(shift_t, shift_n) = DecodeImmShift(type, imm3:imm2);
if (d == 15 && S == '0') || n == 15 || m == 15 then UNPREDICTABLE;
// ARMv8-A removes UNPREDICTABLE for R13
```

For information about the CONSTRAINED UNPREDICTABLE behavior, see [Appendix A Architectural Constraints on UNPREDICTABLE behaviors](#).

Assembler syntax

ADD{S}{<c>}{<q>} {<Rd>}, <Rn>, <Rm> {, <shift>}

where:

- S If S is present, the instruction updates the flags. Otherwise, the flags are not updated.
- <c>, <q> See [Standard assembler syntax fields on page F2-2415](#).
- <Rd> The destination register. If S is specified and <Rd> is the PC, see [CMN \(register\) on page F7-2587](#). If omitted, <Rd> is the same as <Rn> and encoding T2 is preferred to encoding T1 inside an IT block. If <Rd> is present, encoding T1 is preferred to encoding T2.
- If <Rd> is the PC and S is not specified, encoding T2 is used and the instruction is a branch to the address calculated by the operation. This is a simple branch, see [Pseudocode details of operations on the AArch32 general-purpose registers and the PC on page E1-2296](#).
- <Rn> The first operand register. The PC can be used in encoding T2. If <Rn> is SP, see [ADD \(SP plus register, T32\) on page F7-2550](#).
- <Rm> The register that is optionally shifted and used as the second operand. The PC can be used in encoding T2.
- <shift> The shift to apply to the value read from <Rm>. If present, only encoding T3 is permitted. If omitted, no shift is applied and any encoding is permitted. [Shifts applied to a register on page F2-2419](#) describes the shifts and how they are encoded.

Inside an IT block, if ADD<c> <Rd>, <Rn>, <Rd> cannot be assembled using encoding T1, it is assembled using encoding T2 as though ADD<c> <Rd>, <Rn> had been written. To prevent this happening, use the .W qualifier.

The pre-UAL syntax ADD<c>S is equivalent to ADDS<c>.

Operation

```
if ConditionPassed() then
    EncodingSpecificOperations();
    shifted = Shift(R[m], shift_t, shift_n, APSR.C);
    (result, nzcvc) = AddWithCarry(R[n], shifted, '0');
    if d == 15 then
        ALUWritePC(result); // setflags is always FALSE here
    else
        R[d] = result;
        if setflags then
            APSR.<N,Z,C,V> = nzcvc;
```

F7.1.7 ADD (register, A32)

This instruction adds a register value and an optionally-shifted register value, and writes the result to the destination register. It can optionally update the condition flags based on the result.

Encoding A1 ARMv4*, ARMv5T*, ARMv6*, ARMv7

ADD{S}<c> <Rd>, <Rn>, <Rm>{, <shift>}

31	30	29	28	27	26	25	24	23	22	21	20	19	18	17	16	15	14	13	12	11	10	9	8	7	6	5	4	3	2	1	0
cond		0	0	0	0	1	0	0	S	Rn				Rd				imm5			type	0	Rm								

if Rd == '1111' && S == '1' then SEE SUBS PC, LR and related instructions;

if Rn == '1101' then SEE ADD (SP plus register);

d = UInt(Rd); n = UInt(Rn); m = UInt(Rm); setflags = (S == '1');

(shift_t, shift_n) = DecodeImmShift(type, imm5);

Assembler syntax

ADD{S}{<c>}{<q>} {<Rd>,} <Rn>, <Rm> {, <shift>}

where:

S If S is present, the instruction updates the flags. Otherwise, the flags are not updated.

<c>, <q> See [Standard assembler syntax fields on page F2-2415](#).

<Rd> The destination register. If S is specified and <Rd> is the PC, see [SUBS PC, LR and related instructions \(A32\) on page F7-3068](#). If omitted, <Rd> is the same as <Rn>.

If <Rd> is the PC and S is not specified, the instruction is a branch to the address calculated by the operation. This is an interworking branch, see [Pseudocode details of operations on the AArch32 general-purpose registers and the PC on page E1-2296](#).

<Rn> The first operand register. The PC can be used. If <Rn> is SP, see [ADD \(SP plus register, T32\) on page F7-2550](#).

<Rm> The register that is optionally shifted and used as the second operand. The PC can be used.

<shift> The shift to apply to the value read from <Rm>. If present, only encoding T3 or A1 is permitted. If omitted, no shift is applied and any encoding is permitted. [Shifts applied to a register on page F2-2419](#) describes the shifts and how they are encoded.

The pre-UAL syntax ADD<c>S is equivalent to ADDS<c>.

Operation

```

if ConditionPassed() then
    EncodingSpecificOperations();
    shifted = Shift(R[m], shift_t, shift_n, APSR.C);
    (result, nzcvc) = AddWithCarry(R[n], shifted, '0');
    if d == 15 then
        ALUWritePC(result); // setflags is always FALSE here
    else
        R[d] = result;
        if setflags then
            APSR.<N,Z,C,V> = nzcvc;
  
```

F7.1.8 ADD (register-shifted register)

Add (register-shifted register) adds a register value and a register-shifted register value. It writes the result to the destination register, and can optionally update the condition flags based on the result.

Encoding A1 ARMv4*, ARMv5T*, ARMv6*, ARMv7

ADD{S}<C> <Rd>, <Rn>, <Rm>, <type> <Rs>

31	30	29	28	27	26	25	24	23	22	21	20	19	18	17	16	15	14	13	12	11	10	9	8	7	6	5	4	3	2	1	0
cond			0	0	0	0	1	0	0	S	Rn				Rd				Rs				0	type		1	Rm				

```
d = UInt(Rd); n = UInt(Rn); m = UInt(Rm); s = UInt(Rs);
setflags = (S == '1'); shift_t = DecodeRegShift(type);
if d == 15 || n == 15 || m == 15 || s == 15 then UNPREDICTABLE;
```

For information about the CONSTRAINED UNPREDICTABLE behavior, see [Appendix A Architectural Constraints on UNPREDICTABLE behaviors](#).

Assembler syntax

ADD{S}{<C>}{<q>} {<Rd>}, <Rn>, <Rm>, <type> <Rs>

where:

S If S is present, the instruction updates the flags. Otherwise, the flags are not updated.

<C>, <q> See [Standard assembler syntax fields on page F2-2415](#).

<Rd> The destination register.

<Rn> The first operand register.

<Rm> The register that is shifted and used as the second operand.

<type> The type of shift to apply to the value read from <Rm>. It must be one of:

ASR Arithmetic shift right, encoded as type = 0b10.

LSL Logical shift left, encoded as type = 0b00.

LSR Logical shift right, encoded as type = 0b01.

ROR Rotate right, encoded as type = 0b11.

<Rs> The register whose bottom byte contains the amount to shift by.

The pre-UAL syntax ADD<C>S is equivalent to ADDS<C>.

Operation

```
if ConditionPassed() then
    EncodingSpecificOperations();
    shift_n = UInt(R[s]<7:0>);
    shifted = Shift(R[m], shift_t, shift_n, APSR.C);
    (result, nzcvc) = AddWithCarry(R[n], shifted, '0');
    R[d] = result;
    if setflags then
        APSR.<N,Z,C,V> = nzcvc;
```

F7.1.9 ADD (SP plus immediate)

This instruction adds an immediate value to the SP value, and writes the result to the destination register.

Encoding T1 ARMv4T, ARMv5T*, ARMv6*, ARMv7

ADD<c> <Rd>, SP, #<imm>

15	14	13	12	11	10	9	8	7	6	5	4	3	2	1	0
1	0	1	0	1			Rd	imm8							

d = UInt(Rd); setflags = FALSE; imm32 = ZeroExtend(imm8:'00', 32);

Encoding T2 ARMv4T, ARMv5T*, ARMv6*, ARMv7

ADD<c> SP, SP, #<imm>

15	14	13	12	11	10	9	8	7	6	5	4	3	2	1	0
1	0	1	1	0	0	0	0	0	imm7						

d = 13; setflags = FALSE; imm32 = ZeroExtend(imm7:'00', 32);

Encoding T3 ARMv6T2, ARMv7

ADD{S}<c>.W <Rd>, SP, #<const>

15	14	13	12	11	10	9	8	7	6	5	4	3	2	1	0	15	14	13	12	11	10	9	8	7	6	5	4	3	2	1	0
1	1	1	1	0	i	0	1	0	0	0	S	1	1	0	1	0	imm3		Rd	imm8											

if Rd == '1111' && S == '1' then SEE CMN (immediate);
 d = UInt(Rd); setflags = (S == '1'); imm32 = ThumbExpandImm(i:imm3:imm8);
 if d == 15 && S == '0' then UNPREDICTABLE;

Encoding T4 ARMv6T2, ARMv7

ADDW<c> <Rd>, SP, #<imm12>

15	14	13	12	11	10	9	8	7	6	5	4	3	2	1	0	15	14	13	12	11	10	9	8	7	6	5	4	3	2	1	0
1	1	1	1	0	i	1	0	0	0	0	0	1	1	0	1	0	imm3		Rd	imm8											

d = UInt(Rd); setflags = FALSE; imm32 = ZeroExtend(i:imm3:imm8, 32);
 if d == 15 then UNPREDICTABLE;

Encoding A1 ARMv4*, ARMv5T*, ARMv6*, ARMv7

ADD{S}<c> <Rd>, SP, #<const>

31	30	29	28	27	26	25	24	23	22	21	20	19	18	17	16	15	14	13	12	11	10	9	8	7	6	5	4	3	2	1	0
cond		0	0	1	0	1	0	0	S	1	1	0	1		Rd	imm12															

if Rd == '1111' && S == '1' then SEE SUBS PC, LR and related instructions;
 d = UInt(Rd); setflags = (S == '1'); imm32 = ARMEExpandImm(imm12);

For information about the CONSTRAINED UNPREDICTABLE behavior, see [Appendix A Architectural Constraints on UNPREDICTABLE behaviors](#).

Assembler syntax

ADD{S}{<c>}{<q>} {<Rd>}, SP, #<const> All encodings permitted
ADDW{<c>}{<q>} {<Rd>}, SP, #<const> Only encoding T4 is permitted

where:

S If S is present, the instruction updates the flags. Otherwise, the flags are not updated.

<c>, <q> See [Standard assembler syntax fields on page F2-2415](#).

<Rd> The destination register. If S is specified and <Rd> is the PC, see [SUBS PC, LR and related instructions \(T32\) on page F7-3066](#) or [SUBS PC, LR and related instructions \(A32\) on page F7-3068](#). If omitted, <Rd> is SP.

 In A32 instructions, if S is not specified and <Rd> is the PC, the instruction is a branch to the address calculated by the operation. This is an interworking branch, see [Pseudocode details of operations on the AArch32 general-purpose registers and the PC on page E1-2296](#).

<const> The immediate value to be added to the value obtained from SP. Values are multiples of 4 in the range 0-1020 for encoding T1, multiples of 4 in the range 0-508 for encoding T2 and any value in the range 0-4095 for encoding T4. See [Modified immediate constants in T32 instructions on page F3-2444](#) or [Modified immediate constants in A32 instructions on page F4-2472](#) for the range of values for encodings T3 and A1.

 When both 32-bit encodings are available for an instruction, encoding T3 is preferred to encoding T4.

Note

If encoding T4 is required, use the ADDW syntax.

The pre-UAL syntax ADD<c>S is equivalent to ADDS<c>.

Operation

```
if ConditionPassed() then
    EncodingSpecificOperations();
    (result, nzcv) = AddWithCarry(SP, imm32, '0');
    if d == 15 then                    // Can only occur for ARM encoding
        ALUWritePC(result); // setflags is always FALSE here
    else
        R[d] = result;
        if setflags then
            APSR.<N,Z,C,V> = nzcv;
```

F7.1.10 ADD (SP plus register, T32)

This instruction adds an optionally-shifted register value to the SP value, and writes the result to the destination register.

Encoding T1 ARMv4T, ARMv5T*, ARMv6*, ARMv7
 ADD<c> <Rdm>, SP, <Rdm>

15	14	13	12	11	10	9	8	7	6	5	4	3	2	1	0
0	1	0	0	0	1	0	0	1	1	0	1	Rdm			

DM ─┐

```
d = UInt(DM:Rdm); m = UInt(DM:Rdm); setflags = FALSE;
(shift_t, shift_n) = (SRTYPE_LSL, 0);
if d == 15 && InITBlock() && !LastInITBlock() then UNPREDICTABLE;
```

Encoding T2 ARMv4T, ARMv5T*, ARMv6*, ARMv7
 ADD<c> SP, <Rm>

15	14	13	12	11	10	9	8	7	6	5	4	3	2	1	0
0	1	0	0	0	1	0	0	1	Rm			1	0	1	

```
if Rm == '1101' then SEE encoding T1;
d = 13; m = UInt(Rm); setflags = FALSE;
(shift_t, shift_n) = (SRTYPE_LSL, 0);
```

Encoding T3 ARMv6T2, ARMv7
 ADD{S}<c>.W <Rd>, SP, <Rm>{, <shift>}

15	14	13	12	11	10	9	8	7	6	5	4	3	2	1	0	15	14	13	12	11	10	9	8	7	6	5	4	3	2	1	0
1	1	1	0	1	0	1	1	0	0	0	S	1	1	0	1	(0)	imm3			Rd	imm2		type	Rm							

```
if Rd == '1111' && S == '1' then SEE CMN (register);
d = UInt(Rd); m = UInt(Rm); setflags = (S == '1');
(shift_t, shift_n) = DecodeImmShift(type, imm3:imm2);
if (d == 15 && S == '0') || m == 15 then UNPREDICTABLE; // ARMv8-A removes UNPREDICTABLE for R13
```

For information about the CONSTRAINED UNPREDICTABLE behavior, see [Appendix A Architectural Constraints on UNPREDICTABLE behaviors](#).

Assembler syntax

ADD{S}{<c>}{<q>} {<Rd>}, SP, <Rm>{, <shift>}

where:

- S If S is present, the instruction updates the flags. Otherwise, the flags are not updated.
- <c>, <q> See [Standard assembler syntax fields on page F2-2415](#).
- <Rd> The destination register. If S is specified and <Rd> is the PC, see [CMN \(register\) on page F7-2587](#). This register can be SP. If omitted, <Rd> is SP. This register can be the PC, but if it is, encoding T3 is not permitted. ARM deprecates using the PC.
- If <Rd> is the PC and S is not specified, encoding T1 is used and the instruction is a branch to the address calculated by the operation. This is a simple branch, see [Pseudocode details of operations on the AArch32 general-purpose registers and the PC on page E1-2296](#).
- <Rm> The register that is optionally shifted and used as the second operand. This register can be the PC, but if it is, encoding T3 is not permitted. ARM deprecates using the PC. This register can be the SP, but:
- ARM deprecates using the SP.
 - Only encoding T1 is available and so the instruction can only be ADD SP, SP, SP.
- <shift> The shift to apply to the value read from <Rm>. If omitted, no shift is applied and any encoding is permitted. If present, only encoding T3 is permitted. [Shifts applied to a register on page F2-2419](#) describes the shifts and how they are encoded.
- If <Rd> is SP or omitted, <shift> is only permitted to be omitted, LSL #1, LSL #2, or LSL #3.

The pre-UAL syntax ADD<c>S is equivalent to ADDS<c>.

Operation

```
if ConditionPassed() then
    EncodingSpecificOperations();
    shifted = Shift(R[m], shift_t, shift_n, APSR.C);
    (result, nzcvc) = AddWithCarry(SP, shifted, '0');
    if d == 15 then
        ALUWritePC(result); // setflags is always FALSE here
    else
        R[d] = result;
        if setflags then
            APSR.<N,Z,C,V> = nzcvc;
```

F7.1.11 ADD (SP plus register, A32)

This instruction adds an optionally-shifted register value to the SP value, and writes the result to the destination register.

Encoding A1 ARMv4*, ARMv5T*, ARMv6*, ARMv7

ADD{S}<c> <Rd>, SP, <Rm>{, <shift>}

31	30	29	28	27	26	25	24	23	22	21	20	19	18	17	16	15	14	13	12	11	10	9	8	7	6	5	4	3	2	1	0
cond				0	0	0	0	1	0	0	S	1	1	0	1	Rd				imm5				type	0	Rm					

if Rd == '1111' && S == '1' then SEE SUBS PC, LR and related instructions;
 d = UInt(Rd); m = UInt(Rm); setflags = (S == '1');
 (shift_t, shift_n) = DecodeImmShift(type, imm5);

Assembler syntax

ADD{S}{<c>}{<q>} {<Rd>}, SP, <Rm>{, <shift>}

where:

- S If S is present, the instruction updates the flags. Otherwise, the flags are not updated.
- <c>, <q> See *Standard assembler syntax fields on page F2-2415*.
- <Rd> The destination register. If S is specified and <Rd> is the PC, see *SUBS PC, LR and related instructions (A32) on page F7-3068*. This register can be SP. If omitted, <Rd> is SP. This register can be the PC, but ARM deprecates using the PC.
- If S is not specified and <Rd> is the PC, the instruction is a branch to the address calculated by the operation. This is an interworking branch, see *Pseudocode details of operations on the AArch32 general-purpose registers and the PC on page E1-2296*.
- <Rm> The register that is optionally shifted and used as the second operand. This register can be the PC, but ARM deprecates using the PC. This register can be the SP, but ARM deprecates using the SP.
- <shift> The shift to apply to the value read from <Rm>. If omitted, no shift is applied and any encoding is permitted. *Shifts applied to a register on page F2-2419* describes the shifts and how they are encoded.

The pre-UAL syntax ADD<c>S is equivalent to ADDS<c>.

Operation

```
if ConditionPassed() then
    EncodingSpecificOperations();
    shifted = Shift(R[m], shift_t, shift_n, APSR.C);
    (result, nzcvc) = AddWithCarry(SP, shifted, '0');
    if d == 15 then
        ALUWritePC(result); // setflags is always FALSE here
    else
        R[d] = result;
        if setflags then
            APSR.<N,Z,C,V> = nzcvc;
```

F7.1.12 ADR

This instruction adds an immediate value to the PC value to form a PC-relative address, and writes the result to the destination register.

Encoding T1 ARMv4T, ARMv5T*, ARMv6*, ARMv7

ADR<c> <Rd>, <label>

15	14	13	12	11	10	9	8	7	6	5	4	3	2	1	0
1	0	1	0	0	Rd				imm8						

d = UInt(Rd); imm32 = ZeroExtend(imm8:'00', 32); add = TRUE;

Encoding T2 ARMv6T2, ARMv7

ADR<c>.W <Rd>, <label>

<label> before current instruction

SUB <Rd>, PC, #0

Special case for subtraction of zero

15	14	13	12	11	10	9	8	7	6	5	4	3	2	1	0	15	14	13	12	11	10	9	8	7	6	5	4	3	2	1	0
1	1	1	1	0	i	1	0	1	0	1	0	1	1	1	1	0	imm3	Rd				imm8									

d = UInt(Rd); imm32 = ZeroExtend(i:imm3:imm8, 32); add = FALSE;
 if d == 15 then UNPREDICTABLE; // ARMv8-A removes UNPREDICTABLE for R13

Encoding T3 ARMv6T2, ARMv7

ADR<c>.W <Rd>, <label>

<label> after current instruction

15	14	13	12	11	10	9	8	7	6	5	4	3	2	1	0	15	14	13	12	11	10	9	8	7	6	5	4	3	2	1	0
1	1	1	1	0	i	1	0	0	0	0	0	1	1	1	1	0	imm3	Rd				imm8									

d = UInt(Rd); imm32 = ZeroExtend(i:imm3:imm8, 32); add = TRUE;
 if d == 15 then UNPREDICTABLE; // ARMv8-A removes UNPREDICTABLE for R13

Encoding A1 ARMv4*, ARMv5T*, ARMv6*, ARMv7

ADR<c> <Rd>, <label>

<label> after current instruction

31	30	29	28	27	26	25	24	23	22	21	20	19	18	17	16	15	14	13	12	11	10	9	8	7	6	5	4	3	2	1	0
cond		0	0	1	0	1	0	0	0	1	1	1	1	Rd				imm12													

d = UInt(Rd); imm32 = ARMEExpandImm(imm12); add = TRUE;

Encoding A2 ARMv4*, ARMv5T*, ARMv6*, ARMv7

ADR<c> <Rd>, <label>

<label> before current instruction

SUB <Rd>, PC, #0

Special case for subtraction of zero

31	30	29	28	27	26	25	24	23	22	21	20	19	18	17	16	15	14	13	12	11	10	9	8	7	6	5	4	3	2	1	0
cond		0	0	1	0	0	1	0	0	1	1	1	1	Rd				imm12													

d = UInt(Rd); imm32 = ARMEExpandImm(imm12); add = FALSE;

For information about the CONSTRAINED UNPREDICTABLE behavior, see [Appendix A Architectural Constraints on UNPREDICTABLE behaviors](#).

Assembler syntax

ADR{<c>}{<q>} <Rd>, <label>	Normal syntax
ADD{<c>}{<q>} <Rd>, PC, #<const>	Alternative for encodings T1, T3, A1
SUB{<c>}{<q>} <Rd>, PC, #<const>	Alternative for encoding T2, A2

where:

<c>, <q>	See Standard assembler syntax fields on page F2-2415 .
<Rd>	The destination register. In A32 instructions, if <Rd> is the PC, the instruction is a branch to the address calculated by the operation. This is an interworking branch, see Pseudocode details of operations on the AArch32 general-purpose registers and the PC on page E1-2296 .
<label>	The label of an instruction or literal data item whose address is to be loaded into <Rd>. The assembler calculates the required value of the offset from the <code>Align(PC, 4)</code> value of the ADR instruction to this label. If the offset is zero or positive, encodings T1, T3, and A1 are permitted, with <code>imm32</code> equal to the offset. If the offset is negative, encodings T2 and A2 are permitted, with <code>imm32</code> equal to the size of the offset. That is, the use of encoding T2 or A2 indicates that the required offset is minus the value of <code>imm32</code> . Permitted values of the size of the offset are: Encoding T1 Multiples of 4 in the range 0 to 1020. Encodings T2, T3 Any value in the range 0 to 4095. Encodings A1, A2 Any of the constants described in Modified immediate constants in A32 instructions on page F4-2472 .

The alternative syntax permits the addition or subtraction of the offset and the immediate offset to be specified separately, including permitting a subtraction of 0 that cannot be specified using the normal syntax. For more information, see [Use of labels in UAL instruction syntax on page F1-2380](#).

Operation

```
if ConditionPassed() then
    EncodingSpecificOperations();
    result = if add then (Align(PC,4) + imm32) else (Align(PC,4) - imm32);
    if d == 15 then // Can only occur for ARM encodings
        ALUWritePC(result);
    else
        R[d] = result;
```

F7.1.13 AND (immediate)

This instruction performs a bitwise AND of a register value and an immediate value, and writes the result to the destination register.

Encoding T1 ARMv6T2, ARMv7

AND{S}<c> <Rd>, <Rn>, #<const>

15	14	13	12	11	10	9	8	7	6	5	4	3	2	1	0	15	14	13	12	11	10	9	8	7	6	5	4	3	2	1	0
1	1	1	1	0	i	0	0	0	0	0	S	Rn				0	imm3			Rd			imm8								

```
if Rd == '1111' && S == '1' then SEE TST (immediate);
d = UInt(Rd); n = UInt(Rn); setflags = (S == '1');
(imm32, carry) = ThumbExpandImm_C(i:imm3:imm8, APSR.C);
if (d == 15 && S == '0') || n == 15 then UNPREDICTABLE; // ARMv8-A removes UNPREDICTABLE for R13
```

Encoding A1 ARMv4*, ARMv5T*, ARMv6*, ARMv7

AND{S}<c> <Rd>, <Rn>, #<const>

31	30	29	28	27	26	25	24	23	22	21	20	19	18	17	16	15	14	13	12	11	10	9	8	7	6	5	4	3	2	1	0
cond			0	0	1	0	0	0	0	S	Rn				Rd			imm12													

```
if Rd == '1111' && S == '1' then SEE SUBS PC, LR and related instructions;
d = UInt(Rd); n = UInt(Rn); setflags = (S == '1');
(imm32, carry) = ARMEExpandImm_C(imm12, APSR.C);
```

For information about the CONSTRAINED UNPREDICTABLE behavior, see [Appendix A Architectural Constraints on UNPREDICTABLE behaviors](#).

Assembler syntax

AND{S}{<c>}{<q>} {<Rd>}, <Rn>, #<const>

where:

- S If S is present, the instruction updates the flags. Otherwise, the flags are not updated.
- <c>, <q> See [Standard assembler syntax fields on page F2-2415](#).
- <Rd> The destination register. If S is specified and <Rd> is the PC, see [SUBS PC, LR and related instructions \(T32\) on page F7-3066](#) or [SUBS PC, LR and related instructions \(A32\) on page F7-3068](#).
In A32 instructions, if S is not specified and <Rd> is the PC, the instruction is a branch to the address calculated by the operation. This is an interworking branch, see [Pseudocode details of operations on the AArch32 general-purpose registers and the PC on page E1-2296](#).
- <Rn> The first operand register. The PC can be used in A32 instructions.
- <const> The immediate value to be ANDed with the value obtained from <Rn>. See [Modified immediate constants in T32 instructions on page F3-2444](#) or [Modified immediate constants in A32 instructions on page F4-2472](#) for the range of values.

The pre-UAL syntax AND<c>S is equivalent to ANDS<c>.

Operation

```
if ConditionPassed() then
    EncodingSpecificOperations();
    result = R[n] AND imm32;
    if d == 15 then // Can only occur for ARM encoding
        ALUWritePC(result); // setflags is always FALSE here
    else
        R[d] = result;
        if setflags then
            APSR.N = result<31>;
            APSR.Z = IsZeroBit(result);
            APSR.C = carry;
            // APSR.V unchanged
```

F7.1.14 AND (register)

This instruction performs a bitwise AND of a register value and an optionally-shifted register value, and writes the result to the destination register. It can optionally update the condition flags based on the result.

Encoding T1 ARMv4T, ARMv5T*, ARMv6*, ARMv7

ANDS <Rdn>, <Rm> Outside IT block.
 AND<c> <Rdn>, <Rm> Inside IT block.

15	14	13	12	11	10	9	8	7	6	5	4	3	2	1	0
0	1	0	0	0	0	0	0	0	0	Rm	Rdn				

```
d = UInt(Rdn); n = UInt(Rdn); m = UInt(Rm); setflags = !InITBlock();
(shift_t, shift_n) = (SRTYPE_LSL, 0);
```

Encoding T2 ARMv6T2, ARMv7

AND{S}<c>.W <Rd>, <Rn>, <Rm>{, <shift>}

15	14	13	12	11	10	9	8	7	6	5	4	3	2	1	0	15	14	13	12	11	10	9	8	7	6	5	4	3	2	1	0
1	1	1	0	1	0	1	0	0	0	0	S	Rn				(0)	imm3			Rd			imm2		type	Rm					

```
if Rd == '1111' && S == '1' then SEE TST (register);
d = UInt(Rd); n = UInt(Rn); m = UInt(Rm); setflags = (S == '1');
(shift_t, shift_n) = DecodeImmShift(type, imm3:imm2);
if (d == 15 && S == '0') || n == 15 || m == 15 then UNPREDICTABLE;
// ARMv8-A removes UNPREDICTABLE for R13
```

Encoding A1 ARMv4*, ARMv5T*, ARMv6*, ARMv7

AND{S}<c> <Rd>, <Rn>, <Rm>{, <shift>}

31	30	29	28	27	26	25	24	23	22	21	20	19	18	17	16	15	14	13	12	11	10	9	8	7	6	5	4	3	2	1	0
cond			0	0	0	0	0	0	0	S	Rn				Rd				imm5					type	0	Rm					

```
if Rd == '1111' && S == '1' then SEE SUBS PC, LR and related instructions;
d = UInt(Rd); n = UInt(Rn); m = UInt(Rm); setflags = (S == '1');
(shift_t, shift_n) = DecodeImmShift(type, imm5);
```

For information about the CONSTRAINED UNPREDICTABLE behavior, see [Appendix A Architectural Constraints on UNPREDICTABLE behaviors](#).

Assembler syntax

AND{S}{<c>}{<q>} {<Rd>}, <Rn>, <Rm> {, <shift>}

where:

- S If S is present, the instruction updates the flags. Otherwise, the flags are not updated.
- <c>, <q> See [Standard assembler syntax fields on page F2-2415](#).
- <Rd> The destination register. If S is specified and <Rd> is the PC, see [SUBS PC, LR and related instructions \(T32\) on page F7-3066](#) or [SUBS PC, LR and related instructions \(A32\) on page F7-3068](#).
In A32 instructions, if S is not specified and <Rd> is the PC, the instruction is a branch to the address calculated by the operation. This is an interworking branch, see [Pseudocode details of operations on the AArch32 general-purpose registers and the PC on page E1-2296](#).
- <Rn> The first operand register. The PC can be used in A32 instructions.
- <Rm> The register that is optionally shifted and used as the second operand. The PC can be used in A32 instructions.
- <shift> The shift to apply to the value read from <Rm>. If present, encoding T1 is not permitted. If absent, no shift is applied and all encodings are permitted. [Shifts applied to a register on page F2-2419](#) describes the shifts and how they are encoded.

In T32 assembly:

- Outside an IT block, if ANDS <Rd>, <Rn>, <Rd> has <Rd> and <Rn> both in the range R0-R7, it is assembled using encoding T1 as though ANDS <Rd>, <Rn> had been written.
- Inside an IT block, if AND<c> <Rd>, <Rn>, <Rd> has <Rd> and <Rn> both in the range R0-R7, it is assembled using encoding T1 as though AND<c> <Rd>, <Rn> had been written.

To prevent either of these happening, use the .W qualifier.

The pre-UAL syntax AND<c>S is equivalent to ANDS<c>.

Operation

```
if ConditionPassed() then
    EncodingSpecificOperations();
    (shifted, carry) = Shift_C(R[m], shift_t, shift_n, APSR.C);
    result = R[n] AND shifted;
    if d == 15 then // Can only occur for ARM encoding
        ALUWritePC(result); // setflags is always FALSE here
    else
        R[d] = result;
        if setflags then
            APSR.N = result<31>;
            APSR.Z = IsZeroBit(result);
            APSR.C = carry;
            // APSR.V unchanged
```

F7.1.15 AND (register-shifted register)

This instruction performs a bitwise AND of a register value and a register-shifted register value. It writes the result to the destination register, and can optionally update the condition flags based on the result.

Encoding A1 ARMv4*, ARMv5T*, ARMv6*, ARMv7

AND{S}<c> <Rd>, <Rn>, <Rm>, <type> <Rs>

31	30	29	28	27	26	25	24	23	22	21	20	19	18	17	16	15	14	13	12	11	10	9	8	7	6	5	4	3	2	1	0
cond			0	0	0	0	0	0	0	S	Rn				Rd				Rs		0	type		1	Rm						

```
d = UInt(Rd); n = UInt(Rn); m = UInt(Rm); s = UInt(Rs);
setflags = (S == '1'); shift_t = DecodeRegShift(type);
if d == 15 || n == 15 || m == 15 || s == 15 then UNPREDICTABLE;
```

For information about the CONSTRAINED UNPREDICTABLE behavior, see [Appendix A Architectural Constraints on UNPREDICTABLE behaviors](#).

Assembler syntax

AND{S}{<c>}{<q>} {<Rd>}, <Rn>, <Rm>, <type> <Rs>

where:

S If S is present, the instruction updates the flags. Otherwise, the flags are not updated.

<c>, <q> See [Standard assembler syntax fields on page F2-2415](#).

<Rd> The destination register.

<Rn> The first operand register.

<Rm> The register that is shifted and used as the second operand.

<type> The type of shift to apply to the value read from <Rm>. It must be one of:

ASR Arithmetic shift right, encoded as type = 0b10.

LSL Logical shift left, encoded as type = 0b00.

LSR Logical shift right, encoded as type = 0b01.

ROR Rotate right, encoded as type = 0b11.

<Rs> The register whose bottom byte contains the amount to shift by.

The pre-UAL syntax AND<c>S is equivalent to ANDS<c>.

Operation

```
if ConditionPassed() then
    EncodingSpecificOperations();
    shift_n = UInt(R[s]<7:0>);
    (shifted, carry) = Shift_C(R[m], shift_t, shift_n, APSR.C);
    result = R[n] AND shifted;
    R[d] = result;
    if setflags then
        APSR.N = result<31>;
        APSR.Z = IsZeroBit(result);
        APSR.C = carry;
    // APSR.V unchanged
```

F7.1.16 ASR (immediate)

Arithmetic Shift Right (immediate) shifts a register value right by an immediate number of bits, shifting in copies of its sign bit, and writes the result to the destination register. It can optionally update the condition flags based on the result.

Encoding T1 ARMv4T, ARMv5T*, ARMv6*, ARMv7

ASRS <Rd>, <Rm>, #<imm> Outside IT block.
 ASR<c> <Rd>, <Rm>, #<imm> Inside IT block.

15	14	13	12	11	10	9	8	7	6	5	4	3	2	1	0
0	0	0	1	0	imm5					Rm	Rd				

```
d = UInt(Rd); m = UInt(Rm); setflags = !InITBlock();
(-, shift_n) = DecodeImmShift('10', imm5);
```

Encoding T2 ARMv6T2, ARMv7

ASR{S}<c>.W <Rd>, <Rm>, #<imm>

15	14	13	12	11	10	9	8	7	6	5	4	3	2	1	0	15	14	13	12	11	10	9	8	7	6	5	4	3	2	1	0
1	1	1	0	1	0	1	0	0	1	0	S	1	1	1	1	(0)	imm3	Rd	imm2	1	0	Rm									

```
d = UInt(Rd); m = UInt(Rm); setflags = (S == '1');
(-, shift_n) = DecodeImmShift('10', imm3:imm2);
if d == 15 || m == 15 then UNPREDICTABLE; // ARMv8-A removes UNPREDICTABLE for R13
```

Encoding A1 ARMv4*, ARMv5T*, ARMv6*, ARMv7

ASR{S}<c> <Rd>, <Rm>, #<imm>

31	30	29	28	27	26	25	24	23	22	21	20	19	18	17	16	15	14	13	12	11	10	9	8	7	6	5	4	3	2	1	0
cond			0	0	0	1	1	0	1	S	(0)	(0)	(0)	(0)	Rd	imm5					1	0	0	Rm							

```
if Rd == '1111' && S == '1' then SEE SUBS PC, LR and related instructions;
d = UInt(Rd); m = UInt(Rm); setflags = (S == '1');
(-, shift_n) = DecodeImmShift('10', imm5);
```

For information about the CONSTRAINED UNPREDICTABLE behavior, see [Appendix A Architectural Constraints on UNPREDICTABLE behaviors](#).

Assembler syntax

ASR{S}{<c>}{<q>} {<Rd>}, <Rm>, #<imm>

where:

S If S is present, the instruction updates the flags. Otherwise, the flags are not updated.

<c>, <q> See [Standard assembler syntax fields on page F2-2415](#).

<Rd> The destination register.

In A32 instructions, if S is not specified and <Rd> is the PC, the instruction is a branch to the address calculated by the operation. This is an interworking branch, see [Pseudocode details of operations on the AArch32 general-purpose registers and the PC on page E1-2296](#).

<Rm> The first operand register. The PC can be used in A32 instructions.

<imm> The shift amount, in the range 1 to 32. See [Shifts applied to a register on page F2-2419](#).

Operation

```
if ConditionPassed() then
    EncodingSpecificOperations();
    (result, carry) = Shift_C(R[m], SRTYPE_ASR, shift_n, APSR.C);
    if d == 15 then // Can only occur for ARM encoding
        ALUWritePC(result); // setflags is always FALSE here
    else
        R[d] = result;
        if setflags then
            APSR.N = result<31>;
            APSR.Z = IsZeroBit(result);
            APSR.C = carry;
            // APSR.V unchanged
```

F7.1.17 ASR (register)

Arithmetic Shift Right (register) shifts a register value right by a variable number of bits, shifting in copies of its sign bit, and writes the result to the destination register. The variable number of bits is read from the bottom byte of a register. It can optionally update the condition flags based on the result.

Encoding T1 ARMv4T, ARMv5T*, ARMv6*, ARMv7

ASRS <Rdn>, <Rm> Outside IT block.
 ASR<c> <Rdn>, <Rm> Inside IT block.

15	14	13	12	11	10	9	8	7	6	5	4	3	2	1	0
0	1	0	0	0	0	0	1	0	0	Rm	Rdn				

d = UInt(Rdn); n = UInt(Rdn); m = UInt(Rm); setFlags = !InITBlock();

Encoding T2 ARMv6T2, ARMv7

ASR{S}<c>.W <Rd>, <Rn>, <Rm>

15	14	13	12	11	10	9	8	7	6	5	4	3	2	1	0	15	14	13	12	11	10	9	8	7	6	5	4	3	2	1	0
1	1	1	1	1	0	1	0	0	1	0	S	Rn				1	1	1	1	Rd				0	0	0	0	Rm			

d = UInt(Rd); n = UInt(Rn); m = UInt(Rm); setFlags = (S == '1');
 if d == 15 || n == 15 || m == 15 then UNPREDICTABLE; // ARMv8-A removes UNPREDICTABLE for R13

Encoding A1 ARMv4*, ARMv5T*, ARMv6*, ARMv7

ASR{S}<c> <Rd>, <Rn>, <Rm>

31	30	29	28	27	26	25	24	23	22	21	20	19	18	17	16	15	14	13	12	11	10	9	8	7	6	5	4	3	2	1	0
cond		0	0	0	1	1	0	1	(S)	(0)	(0)	(0)	(0)	Rd				Rm				0	1	0	1	Rn					

d = UInt(Rd); n = UInt(Rn); m = UInt(Rm); setFlags = (S == '1');
 if d == 15 || n == 15 || m == 15 then UNPREDICTABLE;

For information about the CONSTRAINED UNPREDICTABLE behavior, see [Appendix A Architectural Constraints on UNPREDICTABLE behaviors](#).

Assembler syntax

ASR{S}{<c>}{<q>} {<Rd>}, <Rn>, <Rm>

where:

S If S is present, the instruction updates the flags. Otherwise, the flags are not updated.

<c>, <q> See [Standard assembler syntax fields on page F2-2415](#).

<Rd> The destination register.

<Rn> The first operand register.

<Rm> The register whose bottom byte contains the amount to shift by.

Operation

```
if ConditionPassed() then
    EncodingSpecificOperations();
    shift_n = UInt(R[m]<7:0>);
    (result, carry) = Shift_C(R[n], SRTYPE_ASR, shift_n, APSR.C);
    R[d] = result;
    if setflags then
        APSR.N = result<31>;
        APSR.Z = IsZeroBit(result);
        APSR.C = carry;
        // APSR.V unchanged
```

F7.1.18 B

Branch causes a branch to a target address.

Encoding T1 ARMv4T, ARMv5T*, ARMv6*, ARMv7

B<c> <label> Not permitted in IT block.

15	14	13	12	11	10	9	8	7	6	5	4	3	2	1	0
1	1	0	1	cond				imm8							

```
if cond == '1110' then SEE UDF;
if cond == '1111' then SEE SVC;
imm32 = SignExtend(imm8:'0', 32);
if InITBlock() then UNPREDICTABLE;
```

Encoding T2 ARMv4T, ARMv5T*, ARMv6*, ARMv7

B<c> <label> Outside or last in IT block

15	14	13	12	11	10	9	8	7	6	5	4	3	2	1	0
1	1	1	0	0	imm11										

```
imm32 = SignExtend(imm11:'0', 32);
if InITBlock() && !LastInITBlock() then UNPREDICTABLE;
```

Encoding T3 ARMv6T2, ARMv7

B<c>.W <label> Not permitted in IT block.

15	14	13	12	11	10	9	8	7	6	5	4	3	2	1	0	15	14	13	12	11	10	9	8	7	6	5	4	3	2	1	0
1	1	1	1	0	S	cond				imm6				1	0	J1	0	J2	imm11												

```
if cond<3:1> == '111' then SEE "Related encodings";
imm32 = SignExtend(S:J2:J1:imm6:imm11:'0', 32);
if InITBlock() then UNPREDICTABLE;
```

Encoding T4 ARMv6T2, ARMv7

B<c>.W <label> Outside or last in IT block

15	14	13	12	11	10	9	8	7	6	5	4	3	2	1	0	15	14	13	12	11	10	9	8	7	6	5	4	3	2	1	0
1	1	1	1	0	S	imm10								1	0	J1	1	J2	imm11												

```
I1 = NOT(J1 EOR S); I2 = NOT(J2 EOR S); imm32 = SignExtend(S:I1:I2:imm10:imm11:'0', 32);
if InITBlock() && !LastInITBlock() then UNPREDICTABLE;
```

Encoding A1 ARMv4*, ARMv5T*, ARMv6*, ARMv7

B<c> <label>

31	30	29	28	27	26	25	24	23	22	21	20	19	18	17	16	15	14	13	12	11	10	9	8	7	6	5	4	3	2	1	0
cond				1	0	1	0	imm24																							

```
imm32 = SignExtend(imm24:'00', 32);
```

For information about the CONSTRAINED UNPREDICTABLE behavior, see [Appendix A Architectural Constraints on UNPREDICTABLE behaviors](#).

Related encodings See [Branches and miscellaneous control](#) on page F3-2447.

Assembler syntax

B{<c>}{<q>} <label>

where:

<c>, <q> See [Standard assembler syntax fields on page F2-2415](#).

Note

Encodings T1 and T3 are conditional in their own right, and do not require an IT instruction to make them conditional.

For encodings T1 and T3, <c> must not be AL or omitted. The 4-bit encoding of the condition is placed in the instruction and not in a preceding IT instruction, and the instruction must not be in an IT block. As a result, encodings T1 and T2 are never both available to the assembler, nor are encodings T3 and T4.

<label> The label of the instruction that is to be branched to. The assembler calculates the required value of the offset from the PC value of the B instruction to this label, then selects an encoding that sets imm32 to that offset.

Permitted offsets are:

Encoding T1	Even numbers in the range –256 to 254.
Encoding T2	Even numbers in the range –2048 to 2046.
Encoding T3	Even numbers in the range –1048576 to 1048574.
Encoding T4	Even numbers in the range –16777216 to 16777214.
Encoding A1	Multiples of 4 in the range –33554432 to 33554428.

Operation

```
if ConditionPassed() then
    EncodingSpecificOperations();
    BranchWritePC(PC + imm32);
```

F7.1.19 BFC

Bit Field Clear clears any number of adjacent bits at any position in a register, without affecting the other bits in the register.

Encoding T1 ARMv6T2, ARMv7

BFC<c> <Rd>, #<lsb>, #<width>

15	14	13	12	11	10	9	8	7	6	5	4	3	2	1	0	15	14	13	12	11	10	9	8	7	6	5	4	3	2	1	0
1	1	1	1	0	(0)	1	1	0	1	1	0	1	1	1	1	0	imm3		Rd		imm2	(0)						msb			

```
d = UInt(Rd); msbit = UInt(msb); lsbbit = UInt(imm3:imm2);
if d == 15 then UNPREDICTABLE; // ARMv8-A removes UNPREDICTABLE for R13
```

Encoding A1 ARMv6T2, ARMv7

BFC<c> <Rd>, #<lsb>, #<width>

31	30	29	28	27	26	25	24	23	22	21	20	19	18	17	16	15	14	13	12	11	10	9	8	7	6	5	4	3	2	1	0
cond		0	1	1	1	1	1	0	msb				Rd				lsb				0	0	1	1	1	1					

```
d = UInt(Rd); msbit = UInt(msb); lsbbit = UInt(lsb);
if d == 15 then UNPREDICTABLE;
```

For information about the CONSTRAINED UNPREDICTABLE behavior of this instruction, see [Appendix A Architectural Constraints on UNPREDICTABLE behaviors](#), and particularly *BFC* on page AppxA-4702.

Assembler syntax

BFC{<c>}{<q>} <Rd>, #<lsb>, #<width>

where:

<c>, <q> See [Standard assembler syntax fields on page F2-2415](#).

<Rd> The destination register.

<lsb> The least significant bit that is to be cleared, in the range 0 to 31. This determines the required value of lsbbit.

<width> The number of bits to be cleared, in the range 1 to 32-<lsb>. The required value of msbit is <lsb>+<width>-1.

Operation

```
if ConditionPassed() then
  EncodingSpecificOperations();
  if msbit >= lsbbit then
    R[d]<msbit:lsbit> = Replicate('0', msbit-lsbbit+1);
    // Other bits of R[d] are unchanged
  else
    UNPREDICTABLE;
```

F7.1.20 BFI

Bit Field Insert copies any number of low order bits from a register into the same number of adjacent bits at any position in the destination register.

Encoding T1 ARMv6T2, ARMv7

BFI<c> <Rd>, <Rn>, #<lsb>, #<width>

15	14	13	12	11	10	9	8	7	6	5	4	3	2	1	0	15	14	13	12	11	10	9	8	7	6	5	4	3	2	1	0
1	1	1	1	0	(0)	1	1	0	1	1	0	Rn			0	imm3			Rd			imm2(0)			msb						

```
if Rn == '1111' then SEE BFC;
d = UInt(Rd); n = UInt(Rn); msbit = UInt(msb); lsbit = UInt(imm3:imm2);
if d == 15 then UNPREDICTABLE; // ARMv8-A removes UNPREDICTABLE for R13
```

Encoding A1 ARMv6T2, ARMv7

BFI<c> <Rd>, <Rn>, #<lsb>, #<width>

31	30	29	28	27	26	25	24	23	22	21	20	19	18	17	16	15	14	13	12	11	10	9	8	7	6	5	4	3	2	1	0
cond		0	1	1	1	1	1	0	msb			Rd			lsb			0	0	1	Rn										

```
if Rn == '1111' then SEE BFC;
d = UInt(Rd); n = UInt(Rn); msbit = UInt(msb); lsbit = UInt(lsbit);
if d == 15 then UNPREDICTABLE;
```

For information about the CONSTRAINED UNPREDICTABLE behavior of this instruction, see [Appendix A Architectural Constraints on UNPREDICTABLE behaviors](#), and particularly [BFI on page AppxA-4703](#).

Assembler syntax

BFI{<c>}{<q>} <Rd>, <Rn>, #<lsb>, #<width>

where:

- <c>, <q> See [Standard assembler syntax fields on page F2-2415](#).
- <Rd> The destination register.
- <Rn> The source register.
- <lsb> The least significant destination bit, in the range 0 to 31. This determines the required value of lsbit.
- <width> The number of bits to be copied, in the range 1 to 32-<lsb>. The required value of msbit is <lsb>+<width>-1.

Operation

```
if ConditionPassed() then
  EncodingSpecificOperations();
  if msbit >= lsbit then
    R[d]<msbit:lsbit> = R[n]<(msbit-lsbit):0>;
    // Other bits of R[d] are unchanged
  else
    UNPREDICTABLE;
```

F7.1.21 BIC (immediate)

Bitwise Bit Clear (immediate) performs a bitwise AND of a register value and the complement of an immediate value, and writes the result to the destination register. It can optionally update the condition flags based on the result.

Encoding T1 ARMv6T2, ARMv7

BIC{S}<c> <Rd>, <Rn>, #<const>

15	14	13	12	11	10	9	8	7	6	5	4	3	2	1	0	15	14	13	12	11	10	9	8	7	6	5	4	3	2	1	0
1	1	1	1	0	i	0	0	0	0	1	S	Rn				0	imm3			Rd			imm8								

```
d = UInt(Rd); n = UInt(Rn); setflags = (S == '1');
(imm32, carry) = ThumbExpandImm_C(i:imm3:imm8, APSR.C);
if d == 15 || n == 15 then UNPREDICTABLE; // ARMv8-A removes UNPREDICTABLE for R13
```

Encoding A1 ARMv4*, ARMv5T*, ARMv6*, ARMv7

BIC{S}<c> <Rd>, <Rn>, #<const>

31	30	29	28	27	26	25	24	23	22	21	20	19	18	17	16	15	14	13	12	11	10	9	8	7	6	5	4	3	2	1	0
cond		0	0	1	1	1	1	0	S	Rn				Rd				imm12													

```
if Rd == '1111' && S == '1' then SEE SUBS PC, LR and related instructions;
d = UInt(Rd); n = UInt(Rn); setflags = (S == '1');
(imm32, carry) = ARMEExpandImm_C(imm12, APSR.C);
```

For information about the CONSTRAINED UNPREDICTABLE behavior, see [Appendix A Architectural Constraints on UNPREDICTABLE behaviors](#).

Assembler syntax

BIC{S}{<c>}{<q>} {<Rd>}, <Rn>, #<const>

where:

- S If S is present, the instruction updates the flags. Otherwise, the flags are not updated.
- <c>, <q> See [Standard assembler syntax fields on page F2-2415](#).
- <Rd> The destination register. If S is specified and <Rd> is the PC, see [SUBS PC, LR and related instructions \(T32\) on page F7-3066](#) or [SUBS PC, LR and related instructions \(A32\) on page F7-3068](#).
In A32 instructions, if S is not specified and <Rd> is the PC, the instruction is a branch to the address calculated by the operation. This is an interworking branch, see [Pseudocode details of operations on the AArch32 general-purpose registers and the PC on page E1-2296](#).
- <Rn> The register that contains the operand. The PC can be used in A32 instructions.
- <const> The immediate value to be bitwise inverted and ANDed with the value obtained from <Rn>. See [Modified immediate constants in T32 instructions on page F3-2444](#) or [Modified immediate constants in A32 instructions on page F4-2472](#) for the range of values.

The pre-UAL syntax BIC<c>S is equivalent to BICS<c>.

Operation

```
if ConditionPassed() then
    EncodingSpecificOperations();
    result = R[n] AND NOT(imm32);
    if d == 15 then // Can only occur for ARM encoding
        ALUWritePC(result); // setflags is always FALSE here
    else
        R[d] = result;
        if setflags then
            APSR.N = result<31>;
            APSR.Z = IsZeroBit(result);
            APSR.C = carry;
            // APSR.V unchanged
```

F7.1.22 BIC (register)

Bitwise Bit Clear (register) performs a bitwise AND of a register value and the complement of an optionally-shifted register value, and writes the result to the destination register. It can optionally update the condition flags based on the result.

Encoding T1 ARMv4T, ARMv5T*, ARMv6*, ARMv7

BICS <Rdn>, <Rm> Outside IT block.
 BIC<c> <Rdn>, <Rm> Inside IT block.

15	14	13	12	11	10	9	8	7	6	5	4	3	2	1	0
0	1	0	0	0	0	1	1	1	0	Rm	Rdn				

```
d = UInt(Rdn); n = UInt(Rdn); m = UInt(Rm); setflags = !InITBlock();
(shift_t, shift_n) = (SRTYPE_LSL, 0);
```

Encoding T2 ARMv6T2, ARMv7

BIC{S}<c>.W <Rd>, <Rn>, <Rm>{, <shift>}

15	14	13	12	11	10	9	8	7	6	5	4	3	2	1	0	15	14	13	12	11	10	9	8	7	6	5	4	3	2	1	0
1	1	1	0	1	0	1	0	0	0	1	S	Rn	(0)	imm3	Rd	imm2	type	Rm													

```
d = UInt(Rd); n = UInt(Rn); m = UInt(Rm); setflags = (S == '1');
(shift_t, shift_n) = DecodeImmShift(type, imm3:imm2);
if d == 15 || n == 15 || m == 15 then UNPREDICTABLE; // ARMv8-A removes UNPREDICTABLE for R13
```

Encoding A1 ARMv4*, ARMv5T*, ARMv6*, ARMv7

BIC{S}<c> <Rd>, <Rn>, <Rm>{, <shift>}

31	30	29	28	27	26	25	24	23	22	21	20	19	18	17	16	15	14	13	12	11	10	9	8	7	6	5	4	3	2	1	0
cond			0	0	0	1	1	1	0	S	Rn	Rd	imm5			type	0	Rm													

```
if Rd == '1111' && S == '1' then SEE SUBS PC, LR and related instructions;
d = UInt(Rd); n = UInt(Rn); m = UInt(Rm); setflags = (S == '1');
(shift_t, shift_n) = DecodeImmShift(type, imm5);
```

For information about the CONSTRAINED UNPREDICTABLE behavior, see [Appendix A Architectural Constraints on UNPREDICTABLE behaviors](#).

Assembler syntax

BIC{S}{<c>}{<q>} {<Rd>}, <Rn>, <Rm> {, <shift>}

where:

- S If S is present, the instruction updates the flags. Otherwise, the flags are not updated.
- <c>, <q> See [Standard assembler syntax fields on page F2-2415](#).
- <Rd> The destination register. If S is specified and <Rd> is the PC, see [SUBS PC, LR and related instructions \(T32\) on page F7-3066](#) or [SUBS PC, LR and related instructions \(A32\) on page F7-3068](#).
In A32 instructions, if S is not specified and <Rd> is the PC, the instruction is a branch to the address calculated by the operation. This is an interworking branch, see [Pseudocode details of operations on the AArch32 general-purpose registers and the PC on page E1-2296](#).
- <Rn> The first operand register. The PC can be used in A32 instructions.
- <Rm> The register that is optionally shifted and used as the second operand. The PC can be used in A32 instructions.
- <shift> The shift to apply to the value read from <Rm>. If present, encoding T1 is not permitted. If absent, no shift is applied and all encodings are permitted. [Shifts applied to a register on page F2-2419](#) describes the shifts and how they are encoded.

The pre-UAL syntax BIC<c>S is equivalent to BICS<c>.

Operation

```
if ConditionPassed() then
    EncodingSpecificOperations();
    (shifted, carry) = Shift_C(R[m], shift_t, shift_n, APSR.C);
    result = R[n] AND NOT(shifted);
    if d == 15 then // Can only occur for ARM encoding
        ALUWritePC(result); // setflags is always FALSE here
    else
        R[d] = result;
        if setflags then
            APSR.N = result<31>;
            APSR.Z = IsZeroBit(result);
            APSR.C = carry;
            // APSR.V unchanged
```

F7.1.23 BIC (register-shifted register)

Bitwise Bit Clear (register-shifted register) performs a bitwise AND of a register value and the complement of a register-shifted register value. It writes the result to the destination register, and can optionally update the condition flags based on the result.

Encoding A1 ARMv4*, ARMv5T*, ARMv6*, ARMv7

BIC{S}<C> <Rd>, <Rn>, <Rm>, <type> <Rs>

31	30	29	28	27	26	25	24	23	22	21	20	19	18	17	16	15	14	13	12	11	10	9	8	7	6	5	4	3	2	1	0
cond			0	0	0	1	1	1	0	S	Rn			Rd			Rs			0	type	1	Rm								

```
d = UInt(Rd); n = UInt(Rn); m = UInt(Rm); s = UInt(Rs);
setflags = (S == '1'); shift_t = DecodeRegShift(type);
if d == 15 || n == 15 || m == 15 || s == 15 then UNPREDICTABLE;
```

For information about the CONSTRAINED UNPREDICTABLE behavior, see [Appendix A Architectural Constraints on UNPREDICTABLE behaviors](#).

Assembler syntax

BIC{S}{<C>}{<q>} {<Rd>,<Rn>, <Rm>, <type> <Rs>

where:

S If S is present, the instruction updates the flags. Otherwise, the flags are not updated.

<C>, <q> See [Standard assembler syntax fields on page F2-2415](#).

<Rd> The destination register.

<Rn> The first operand register.

<Rm> The register that is shifted and used as the second operand.

<type> The type of shift to apply to the value read from <Rm>. It must be one of:

ASR Arithmetic shift right, encoded as type = 0b10.

LSL Logical shift left, encoded as type = 0b00.

LSR Logical shift right, encoded as type = 0b01.

ROR Rotate right, encoded as type = 0b11.

<Rs> The register whose bottom byte contains the amount to shift by.

The pre-UAL syntax BIC<C>S is equivalent to BICS<C>.

Operation

```
if ConditionPassed() then
  EncodingSpecificOperations();
  shift_n = UInt(R[s]<7:0>);
  (shifted, carry) = Shift_C(R[m], shift_t, shift_n, APSR.C);
  result = R[n] AND NOT(shifted);
  R[d] = result;
  if setflags then
    APSR.N = result<31>;
    APSR.Z = IsZeroBit(result);
    APSR.C = carry;
  // APSR.V unchanged
```

F7.1.24 BKPT

Breakpoint causes a software breakpoint to occur.

Breakpoint is always unconditional, even when inside an IT block.

Encoding T1 ARMv5T*, ARMv6*, ARMv7

BKPT #<imm8>

15	14	13	12	11	10	9	8	7	6	5	4	3	2	1	0
1	0	1	1	1	1	1	0	imm8							

imm16 = ZeroExtend(imm8, 16);

Encoding A1 ARMv5T*, ARMv6*, ARMv7

BKPT #<imm16>

31	30	29	28	27	26	25	24	23	22	21	20	19	18	17	16	15	14	13	12	11	10	9	8	7	6	5	4	3	2	1	0
cond		0	0	0	1	0	0	1	0	imm12												0	1	1	1	imm4					

imm16 = imm12:imm4;

if cond != '1110' then UNPREDICTABLE; // BKPT must be encoded with AL condition

For information about the CONSTRAINED UNPREDICTABLE behavior of this instruction, see [Appendix A Architectural Constraints on UNPREDICTABLE behaviors](#), and particularly *BKPT* on page AppxA-4703.

Assembler syntax

BKPT{<q>} {#}<imm>

where:

<q> See [Standard assembler syntax fields on page F2-2415](#). A BKPT instruction must be unconditional.

<imm> Specifies a value that is stored in the instruction, in the range 0-255 for a T32 instruction or 0-65535 for an A32 instruction. This value is ignored by the PE, but can be used by a debugger to store more information about the breakpoint.

Operation

```
EncodingSpecificOperations();
AArch32.BKPTInstrDebugEvent(imm16);
```

F7.1.25 BL, BLX (immediate)

Branch with Link calls a subroutine at a PC-relative address.

Branch with Link and Exchange Instruction Sets (immediate) calls a subroutine at a PC-relative address, and changes instruction set from A32 to T32, or from T32 to A32.

Encoding T1 ARMv4T, ARMv5T*, ARMv6*, ARMv7 if J1 == J2 == 1
 ARMv6T2, ARMv7 otherwise

BL<c> <label> Outside or last in IT block

15	14	13	12	11	10	9	8	7	6	5	4	3	2	1	0	15	14	13	12	11	10	9	8	7	6	5	4	3	2	1	0
1	1	1	1	0	S	imm10								1	1	J1	1	J2	imm11												

I1 = NOT(J1 EOR S); I2 = NOT(J2 EOR S); imm32 = SignExtend(S:I1:I2:imm10:imm11:'0', 32);
 targetInstrSet = CurrentInstrSet();
 if InITBlock() && !LastInITBlock() then UNPREDICTABLE;

Encoding T2 ARMv5T*, ARMv6*, ARMv7 if J1 == J2 == 1
 ARMv6T2, ARMv7 otherwise

BLX<c> <label> Outside or last in IT block

15	14	13	12	11	10	9	8	7	6	5	4	3	2	1	0	15	14	13	12	11	10	9	8	7	6	5	4	3	2	1	0
1	1	1	1	0	S	imm10H								1	1	J1	0	J2	imm10L								H				

if CurrentInstrSet() == InstrSet_T32EE || H == '1' then UNDEFINED;
 I1 = NOT(J1 EOR S); I2 = NOT(J2 EOR S); imm32 = SignExtend(S:I1:I2:imm10H:imm10L:'00', 32);
 targetInstrSet = InstrSet_A32;
 if InITBlock() && !LastInITBlock() then UNPREDICTABLE;

Encoding A1 ARMv4*, ARMv5T*, ARMv6*, ARMv7

BL<c> <label>

31	30	29	28	27	26	25	24	23	22	21	20	19	18	17	16	15	14	13	12	11	10	9	8	7	6	5	4	3	2	1	0
cond				1	0	1	1	imm24																							

imm32 = SignExtend(imm24:'00', 32); targetInstrSet = InstrSet_A32;

Encoding A2 ARMv5T*, ARMv6*, ARMv7

BLX <label>

31	30	29	28	27	26	25	24	23	22	21	20	19	18	17	16	15	14	13	12	11	10	9	8	7	6	5	4	3	2	1	0
1	1	1	1	1	0	1	H	imm24																							

imm32 = SignExtend(imm24:H:'0', 32); targetInstrSet = InstrSet_T32;

For information about the CONSTRAINED UNPREDICTABLE behavior, see [Appendix A Architectural Constraints on UNPREDICTABLE behaviors](#).

Assembler syntax

BL{X}{<c>}{<q>} <label>

where:

- <c>, <q> See *Standard assembler syntax fields on page F2-2415*. An A32 BLX (immediate) instruction must be unconditional.
- X If present, specifies a change of instruction set (from A32 to T32 or from T32 to A32). If X is omitted, the PE remains in the same state.
- <label> The label of the instruction that is to be branched to.
- BL uses encoding T1 or A1. The assembler calculates the required value of the offset from the PC value of the BL instruction to this label, then selects an encoding with imm32 set to that offset.
- BLX uses encoding T2 or A2. The assembler calculates the required value of the offset from the Align(PC, 4) value of the BLX instruction to this label, then selects an encoding with imm32 set to that offset.
- Permitted offsets are:
- | | |
|--------------------|--|
| Encoding T1 | Even numbers in the range –16777216 to 16777214. |
| Encoding T2 | Multiples of 4 in the range –16777216 to 16777212. |
| Encoding A1 | Multiples of 4 in the range –33554432 to 33554428. |
| Encoding A2 | Even numbers in the range –33554432 to 33554430. |

Operation

```
if ConditionPassed() then
    EncodingSpecificOperations();
    if CurrentInstrSet() == InstrSet_A32 then
        LR = PC - 4;
    else
        LR = PC<31:1> : '1';
    if targetInstrSet == InstrSet_A32 then
        targetAddress = Align(PC,4) + imm32;
    else
        targetAddress = PC + imm32;
    SelectInstrSet(targetInstrSet);
    BranchWritePC(targetAddress);
```

F7.1.26 BLX (register)

Branch with Link and Exchange (register) calls a subroutine at an address and instruction set specified by a register.

Encoding T1 ARMv5T*, ARMv6*, ARMv7

BLX<c> <Rm>

Outside or last in IT block

15	14	13	12	11	10	9	8	7	6	5	4	3	2	1	0
0	1	0	0	0	1	1	1	1	Rm				(0)	(0)	(0)

```
m = UInt(Rm);
if m == 15 then UNPREDICTABLE;
if InITBlock() && !LastInITBlock() then UNPREDICTABLE;
```

Encoding A1 ARMv5T*, ARMv6*, ARMv7

BLX<c> <Rm>

31	30	29	28	27	26	25	24	23	22	21	20	19	18	17	16	15	14	13	12	11	10	9	8	7	6	5	4	3	2	1	0
cond		0	0	0	1	0	0	1	0	(1)	(1)	(1)	(1)	(1)	(1)	(1)	(1)	(1)	(1)	(1)	(1)	(1)	(1)	0	0	1	1	Rm			

```
m = UInt(Rm);
if m == 15 then UNPREDICTABLE;
```

For information about the CONSTRAINED UNPREDICTABLE behavior, see [Appendix A Architectural Constraints on UNPREDICTABLE behaviors](#).

Assembler syntax

BLX{<c>}{<q>} <Rm>

where:

<c>, <q> See [Standard assembler syntax fields on page F2-2415](#).

<Rm> The register that contains the branch target address and instruction set selection bit. This register can be the SP in both A32 and T32 instructions, but ARM deprecates this use of the SP.

Operation

```
if ConditionPassed() then
    EncodingSpecificOperations();
    target = R[m];
    if CurrentInstrSet() == InstrSet_A32 then
        next_instr_addr = PC - 4;
        LR = next_instr_addr;
    else
        next_instr_addr = PC - 2;
        LR = next_instr_addr<31:1> : '1';
    BXWritePC(target);
```

F7.1.27 BX

Branch and Exchange causes a branch to an address and instruction set specified by a register.

Encoding T1 ARMv4T, ARMv5T*, ARMv6*, ARMv7

BX<c> <Rm>

Outside or last in IT block

15	14	13	12	11	10	9	8	7	6	5	4	3	2	1	0
0	1	0	0	0	1	1	1	0	Rm				(0)	(0)	(0)

m = UInt(Rm);
 if InITBlock() && !LastInITBlock() then UNPREDICTABLE;

Encoding A1 ARMv4T, ARMv5T*, ARMv6*, ARMv7

BX<c> <Rm>

31	30	29	28	27	26	25	24	23	22	21	20	19	18	17	16	15	14	13	12	11	10	9	8	7	6	5	4	3	2	1	0
cond		0	0	0	1	0	0	1	0	(1)	(1)	(1)	(1)	(1)	(1)	(1)	(1)	(1)	(1)	(1)	(1)	(1)	0	0	0	1	Rm				

m = UInt(Rm);

For information about the CONSTRAINED UNPREDICTABLE behavior, see [Appendix A Architectural Constraints on UNPREDICTABLE behaviors](#).

Assembler syntax

BX{<c>}{<q>} <Rm>

where:

<c>, <q> See [Standard assembler syntax fields on page F2-2415](#).

<Rm> The register that contains the branch target address and instruction set selection bit. This can be the PC. This register can be the SP in both A32 and T32 instructions, but ARM deprecates this use of the SP.

Note

If <Rm> is the PC in a T32 instruction at a non word-aligned address, it results in UNPREDICTABLE behavior because the address passed to the BXWritePC() pseudocode function has bits<1:0> = '10'.

Operation

```
if ConditionPassed() then
    EncodingSpecificOperations();
    BXWritePC(R[m]);
```

F7.1.28 BXJ

In ARMv8, BXJ behaves as a BX instruction, see [BX on page F7-2579](#). This means it causes a branch to an address and instruction set specified by a register.

Encoding T1 ARMv6T2, ARMv7

BXJ<c> <Rm>

Outside or last in IT block

15	14	13	12	11	10	9	8	7	6	5	4	3	2	1	0	15	14	13	12	11	10	9	8	7	6	5	4	3	2	1	0
1	1	1	1	0	0	1	1	1	1	0	0	Rm				1	0	(0)	0	(1)	(1)	(1)	(1)	(0)	(0)	(0)	(0)	(0)	(0)	(0)	

```
m = UInt(Rm);
if m == 15 then UNPREDICTABLE; // ARMv8-A removes UNPREDICTABLE for R13
if InITBlock() && !LastInITBlock() then UNPREDICTABLE;
```

Encoding A1 ARMv5TEJ, ARMv6*, ARMv7

BXJ<c> <Rm>

31	30	29	28	27	26	25	24	23	22	21	20	19	18	17	16	15	14	13	12	11	10	9	8	7	6	5	4	3	2	1	0
cond		0	0	0	1	0	0	1	0	(1)	(1)	(1)	(1)	(1)	(1)	(1)	(1)	(1)	(1)	(1)	(1)	(1)	(1)	0	0	1	0	Rm			

```
m = UInt(Rm);
if m == 15 then UNPREDICTABLE;
```

For information about the CONSTRAINED UNPREDICTABLE behavior, see [Appendix A Architectural Constraints on UNPREDICTABLE behaviors](#).

Assembler syntax

BXJ{<c>}{<q>} <Rm>

where:

<c>, <q> See [Standard assembler syntax fields on page F2-2415](#).

<Rm> The register that specifies the branch target address and instruction set selection bit.

Operation

```
if ConditionPassed() then
    EncodingSpecificOperations();
    BXWritePC(R[m]);
```

F7.1.29 CBNZ, CBZ

Compare and Branch on Nonzero and Compare and Branch on Zero compare the value in a register with zero, and conditionally branch forward a constant value. They do not affect the condition flags.

Encoding T1 ARMv6T2, ARMv7

CB{N}Z <Rn>, <label>

Not permitted in IT block.

15	14	13	12	11	10	9	8	7	6	5	4	3	2	1	0
1	0	1	1	op	0	i	1	imm5					Rn		

```
n = UInt(Rn); imm32 = ZeroExtend(i:imm5:'0', 32); nonzero = (op == '1');
if InITBlock() then UNPREDICTABLE;
```

For information about the CONSTRAINED UNPREDICTABLE behavior, see [Appendix A Architectural Constraints on UNPREDICTABLE behaviors](#).

Assembler syntax

CB{N}Z{<q>} <Rn>, <label>

where:

- N If specified, causes the branch to occur when the contents of <Rn> are nonzero (encoded as op = 1). If omitted, causes the branch to occur when the contents of <Rn> are zero (encoded as op = 0).
- <q> See [Standard assembler syntax fields on page F2-2415](#). A CBZ or CBNZ instruction must be unconditional.
- <Rn> The operand register.
- <label> The label of the instruction that is to be branched to. The assembler calculates the required value of the offset from the PC value of the CBZ or CBNZ instruction to this label, then selects an encoding that sets imm32 to that offset. Permitted offsets are even numbers in the range 0 to 126.

Operation

```
EncodingSpecificOperations();
if nonzero != IsZero(R[n]) then
  BranchWritePC(PC + imm32);
```

F7.1.30 CDP, CDP2

Coprocessor Data Processing is a generic coprocessor instruction. None of the fields have any functionality defined by the architecture and are free for use by the coprocessor instruction set designer. These are the `opc1`, `opc2`, `CRd`, `CRn`, and `CRm` fields. However, coprocessors CP8-CP15 are reserved for use by A32, and this manual defines the valid CDP and CDP2 instructions when `coproc` is in the range p8-p15. For more information see [Coprocessor support on page E1-2331](#).

Encoding T1/A1 ARMv6T2, ARMv7 for encoding T1
 ARMv4*, ARMv5T*, ARMv6*, ARMv7 for encoding A1

CDP<c> <coproc>, <opc1>, <CRd>, <CRn>, <CRm>, <opc2>

15	14	13	12	11	10	9	8	7	6	5	4	3	2	1	0	15	14	13	12	11	10	9	8	7	6	5	4	3	2	1	0	
1	1	1	0	1	1	1	0	opc1				CRn				CRd				coproc				opc2				0	CRm			

31	30	29	28	27	26	25	24	23	22	21	20	19	18	17	16	15	14	13	12	11	10	9	8	7	6	5	4	3	2	1	0	
cond				1 1 1 0				opc1				CRn				CRd				coproc				opc2				0	CRm			

if `coproc == '101x'` then SEE "Floating-point instructions";
`cp = UInt(coproc);`

Encoding T2/A2 ARMv6T2, ARMv7 for encoding T2
 ARMv5T*, ARMv6*, ARMv7 for encoding A2

CDP2<c> <coproc>, <opc1>, <CRd>, <CRn>, <CRm>, <opc2>

15	14	13	12	11	10	9	8	7	6	5	4	3	2	1	0	15	14	13	12	11	10	9	8	7	6	5	4	3	2	1	0	
1	1	1	1	1	1	1	0	opc1				CRn				CRd				coproc				opc2				0	CRm			

31	30	29	28	27	26	25	24	23	22	21	20	19	18	17	16	15	14	13	12	11	10	9	8	7	6	5	4	3	2	1	0	
1 1 1 1				1 1 1 0				opc1				CRn				CRd				coproc				opc2				0	CRm			

if `coproc == '101x'` then SEE "Floating-point instructions";
`cp = UInt(coproc);`

Floating-point instructions See [Floating-point data-processing instructions on page F5-2511](#)

Assembler syntax

CDP{2}{<c>}{<q>} <coproc>, {#}<opc1>, <CRd>, <CRn>, <CRm> {, {#}<opc2>}

where:

- 2 If specified, selects encoding T2/A2. If omitted, selects encoding T1/A1.
- <c>, <q> See [Standard assembler syntax fields on page F2-2415](#). An A32 CDP2 instruction must be unconditional.
- <coproc> The name of the coprocessor, and causes the corresponding coprocessor number to be placed in the cp_num field of the instruction. The generic coprocessor names are p0-p15.
- <opc1> Is a coprocessor-specific opcode, in the range 0 to 15.
- <CRd> The destination coprocessor register for the instruction.
- <CRn> The coprocessor register that contains the first operand.
- <CRm> The coprocessor register that contains the second operand.
- <opc2> Is a coprocessor-specific opcode in the range 0 to 7. If it is omitted, <opc2> is 0.

Operation

```
if ConditionPassed() then
    EncodingSpecificOperations();
    if !Cproc_Accepted(cp, ThisInstr()) then
        GenerateCoproprocessorException();
    else
        Cproc_InternalOperation(cp, ThisInstr());
```

F7.1.31 CLREX

Clear-Exclusive clears the local monitor of the executing PE.

Encoding T1 ARMv7

CLREX<c>

15	14	13	12	11	10	9	8	7	6	5	4	3	2	1	0	15	14	13	12	11	10	9	8	7	6	5	4	3	2	1	0
1	1	1	1	0	0	1	1	1	0	1	1	(1)	(1)	(1)	(1)	1	0	(0)	0	(1)	(1)	(1)	(1)	0	0	1	0	(1)	(1)	(1)	(1)

// No additional decoding required

Encoding A1 ARMv6K, ARMv7

CLREX

31	30	29	28	27	26	25	24	23	22	21	20	19	18	17	16	15	14	13	12	11	10	9	8	7	6	5	4	3	2	1	0
1	1	1	1	0	1	0	1	0	1	1	1	(1)	(1)	(1)	(1)	(1)	(1)	(1)	(1)	(0)	(0)	(0)	(0)	0	0	0	1	(1)	(1)	(1)	(1)

// No additional decoding required

For information about the CONSTRAINED UNPREDICTABLE behavior, see [Appendix A Architectural Constraints on UNPREDICTABLE behaviors](#).

Assembler syntax

CLREX{<c>}{<q>}

where:

<c>, <q> See [Standard assembler syntax fields on page F2-2415](#). An A32 CLREX instruction must be unconditional.

Operation

```
if ConditionPassed() then
    EncodingSpecificOperations();
    ClearExclusiveLocal(ProcessorID());
```

F7.1.32 CLZ

Count Leading Zeros returns the number of binary zero bits before the first binary one bit in a value.

Encoding T1 ARMv6T2, ARMv7

CLZ<c> <Rd>, <Rm>

15	14	13	12	11	10	9	8	7	6	5	4	3	2	1	0	15	14	13	12	11	10	9	8	7	6	5	4	3	2	1	0
1	1	1	1	1	0	1	0	1	0	1	1	Rm				1	1	1	1	Rd				1	0	0	0	Rm			

```

if !Consistent(Rm) then UNPREDICTABLE;
d = UInt(Rd); m = UInt(Rm);
if d == 15 || m == 15 then UNPREDICTABLE; // ARMv8-A removes UNPREDICTABLE for R13
    
```

Encoding A1 ARMv5T*, ARMv6*, ARMv7

CLZ<c> <Rd>, <Rm>

31	30	29	28	27	26	25	24	23	22	21	20	19	18	17	16	15	14	13	12	11	10	9	8	7	6	5	4	3	2	1	0
cond		0	0	0	1	0	1	1	0	(1)	(1)	(1)	(1)	Rd				(1)	(1)	(1)	(1)	0	0	0	1	Rm					

```

d = UInt(Rd); m = UInt(Rm);
if d == 15 || m == 15 then UNPREDICTABLE;
    
```

For information about the CONSTRAINED UNPREDICTABLE behavior of this instruction, see [Appendix A Architectural Constraints on UNPREDICTABLE behaviors](#), and particularly [CLZ on page AppxA-4703](#).

Assembler syntax

CLZ{<c>}{<q>} <Rd>, <Rm>

where:

<c>, <q> See [Standard assembler syntax fields on page F2-2415](#).

<Rd> The destination register.

<Rm> The register that contains the operand. Its number must be encoded twice in encoding T1.

Operation

```

if ConditionPassed() then
    EncodingSpecificOperations();
    result = CountLeadingZeroBits(R[m]);
    R[d] = result<31:0>;
    
```

F7.1.33 CMN (immediate)

Compare Negative (immediate) adds a register value and an immediate value. It updates the condition flags based on the result, and discards the result.

Encoding T1 ARMv6T2, ARMv7

CMN<c> <Rn>, #<const>

15	14	13	12	11	10	9	8	7	6	5	4	3	2	1	0	15	14	13	12	11	10	9	8	7	6	5	4	3	2	1	0
1	1	1	1	0	i	0	1	0	0	0	1	Rn				0	imm3			1	1	1	1	imm8							

n = UInt(Rn); imm32 = ThumbExpandImm(i:imm3:imm8);
 if n == 15 then UNPREDICTABLE;

Encoding A1 ARMv4*, ARMv5T*, ARMv6*, ARMv7

CMN<c> <Rn>, #<const>

31	30	29	28	27	26	25	24	23	22	21	20	19	18	17	16	15	14	13	12	11	10	9	8	7	6	5	4	3	2	1	0
cond		0	0	1	1	0	1	1	1	Rn			(0)	(0)	(0)	(0)	imm12														

n = UInt(Rn); imm32 = ARMEExpandImm(imm12);

For information about the CONSTRAINED UNPREDICTABLE behavior, see [Appendix A Architectural Constraints on UNPREDICTABLE behaviors](#).

Assembler syntax

CMN{<c>}{<q>} <Rn>, #<const>

where:

- <c>, <q> See [Standard assembler syntax fields on page F2-2415](#).
- <Rn> The register that contains the operand. SP can be used in T32 and A32 instructions. The PC can be used in A32 instructions.
- <const> The immediate value to be added to the value obtained from <Rn>. See [Modified immediate constants in T32 instructions on page F3-2444](#) or [Modified immediate constants in A32 instructions on page F4-2472](#) for the range of values.

Operation

```
if ConditionPassed() then
    EncodingSpecificOperations();
    (result, nzcV) = AddWithCarry(R[n], imm32, '0');
    APSR.<N,Z,C,V> = nzcV;
```

F7.1.34 CMN (register)

Compare Negative (register) adds a register value and an optionally-shifted register value. It updates the condition flags based on the result, and discards the result.

Encoding T1 ARMv4T, ARMv5T*, ARMv6*, ARMv7

CMN<c> <Rn>, <Rm>

15	14	13	12	11	10	9	8	7	6	5	4	3	2	1	0
0	1	0	0	0	0	1	0	1	1	Rm			Rn		

n = UInt(Rn); m = UInt(Rm);
 (shift_t, shift_n) = (SRTYPE_LSL, 0);

Encoding T2 ARMv6T2, ARMv7

CMN<c>.W <Rn>, <Rm>{, <shift>}

15	14	13	12	11	10	9	8	7	6	5	4	3	2	1	0	15	14	13	12	11	10	9	8	7	6	5	4	3	2	1	0
1	1	1	0	1	0	1	1	0	0	0	1	Rn			(0)	imm3			1	1	1	1	imm2		type	Rm					

n = UInt(Rn); m = UInt(Rm);
 (shift_t, shift_n) = DecodeImmShift(type, imm3:imm2);
 if n == 15 || m == 15 then UNPREDICTABLE; // ARMv8-A removes UNPREDICTABLE for R13

Encoding A1 ARMv4*, ARMv5T*, ARMv6*, ARMv7

CMN<c> <Rn>, <Rm>{, <shift>}

31	30	29	28	27	26	25	24	23	22	21	20	19	18	17	16	15	14	13	12	11	10	9	8	7	6	5	4	3	2	1	0
cond			0	0	0	1	0	1	1	1	Rn			(0)	(0)	(0)	(0)	imm5				type		0	Rm						

n = UInt(Rn); m = UInt(Rm);
 (shift_t, shift_n) = DecodeImmShift(type, imm5);

For information about the CONSTRAINED UNPREDICTABLE behavior, see [Appendix A Architectural Constraints on UNPREDICTABLE behaviors](#).

Assembler syntax

CMN{<c>}{<q>} <Rn>, <Rm> {, <shift>}

where:

- <c>, <q> See [Standard assembler syntax fields on page F2-2415](#).
- <Rn> The first operand register. SP can be used in T32 instructions (encoding T2) and in A32 instructions. The PC can be used in A32 instructions.
- <Rm> The register that is optionally shifted and used as the second operand. The PC can be used in A32 instructions.
- <shift> The shift to apply to the value read from <Rm>. If present, encoding T1 is not permitted. If absent, no shift is applied and all encodings are permitted. [Shifts applied to a register on page F2-2419](#) describes the shifts and how they are encoded.

Operation

```
if ConditionPassed() then
    EncodingSpecificOperations();
    shifted = Shift(R[m], shift_t, shift_n, APSR.C);
    (result, nzcvc) = AddWithCarry(R[n], shifted, '0');
    APSR.<N,Z,C,V> = nzcvc;
```

F7.1.35 CMN (register-shifted register)

Compare Negative (register-shifted register) adds a register value and a register-shifted register value. It updates the condition flags based on the result, and discards the result.

Encoding A1 ARMv4*, ARMv5T*, ARMv6*, ARMv7
 CMN<c> <Rn>, <Rm>, <type> <Rs>

31	30	29	28	27	26	25	24	23	22	21	20	19	18	17	16	15	14	13	12	11	10	9	8	7	6	5	4	3	2	1	0
cond		0	0	0	1	0	1	1	1	Rn				(0)(0)(0)(0)				Rs		0	type		1	Rm							

```
n = UInt(Rn); m = UInt(Rm); s = UInt(Rs);
shift_t = DecodeRegShift(type);
if n == 15 || m == 15 || s == 15 then UNPREDICTABLE;
```

For information about the CONSTRAINED UNPREDICTABLE behavior, see [Appendix A Architectural Constraints on UNPREDICTABLE behaviors](#).

Assembler syntax

CMN{<c>}{<q>} <Rn>, <Rm>, <type> <Rs>

where:

- <c>, <q> See [Standard assembler syntax fields on page F2-2415](#).
- <Rn> The first operand register.
- <Rm> The register that is shifted and used as the second operand.
- <type> The type of shift to apply to the value read from <Rm>. It must be one of:
 - ASR Arithmetic shift right, encoded as type = 0b10.
 - LSL Logical shift left, encoded as type = 0b00.
 - LSR Logical shift right, encoded as type = 0b01.
 - ROR Rotate right, encoded as type = 0b11.
- <Rs> The register whose bottom byte contains the amount to shift by.

Operation

```
if ConditionPassed() then
    EncodingSpecificOperations();
    shift_n = UInt(R[s]<7:0>);
    shifted = Shift(R[m], shift_t, shift_n, APSR.C);
    (result, nzc) = AddWithCarry(R[n], shifted, '0');
    APSR.<N,Z,C,V> = nzc;
```

F7.1.36 CMP (immediate)

Compare (immediate) subtracts an immediate value from a register value. It updates the condition flags based on the result, and discards the result.

Encoding T1 ARMv4T, ARMv5T*, ARMv6*, ARMv7

CMP<c> <Rn>, #<imm8>

15	14	13	12	11	10	9	8	7	6	5	4	3	2	1	0
0	0	1	0	1	Rn			imm8							

n = UInt(Rn); imm32 = ZeroExtend(imm8, 32);

Encoding T2 ARMv6T2, ARMv7

CMP<c>.W <Rn>, #<const>

15	14	13	12	11	10	9	8	7	6	5	4	3	2	1	0	15	14	13	12	11	10	9	8	7	6	5	4	3	2	1	0
1	1	1	1	0	i	0	1	1	0	1	1	Rn			0	imm3			1	1	1	1	imm8								

n = UInt(Rn); imm32 = ThumbExpandImm(i:imm3:imm8);
 if n == 15 then UNPREDICTABLE;

Encoding A1 ARMv4*, ARMv5T*, ARMv6*, ARMv7

CMP<c> <Rn>, #<const>

31	30	29	28	27	26	25	24	23	22	21	20	19	18	17	16	15	14	13	12	11	10	9	8	7	6	5	4	3	2	1	0
cond		0	0	1	1	0	1	0	1	Rn			(0)	(0)	(0)	(0)	imm12														

n = UInt(Rn); imm32 = ARMEExpandImm(imm12);

For information about the CONSTRAINED UNPREDICTABLE behavior, see [Appendix A Architectural Constraints on UNPREDICTABLE behaviors](#).

Assembler syntax

CMP{<c>}{<q>} <Rn>, #<const>

where:

- <c>, <q> See [Standard assembler syntax fields on page F2-2415](#).
- <Rn> The first operand register. SP can be used in T32 instructions (encoding T2) and in A32 instructions. The PC can be used in A32 instructions.
- <const> The immediate value to be compared with the value obtained from <Rn>. The range of values is 0-255 for encoding T1. See [Modified immediate constants in T32 instructions on page F3-2444](#) or [Modified immediate constants in A32 instructions on page F4-2472](#) for the range of values for encoding T2 and A1.

Operation

```
if ConditionPassed() then
    EncodingSpecificOperations();
    (result, nzcvc) = AddWithCarry(R[n], NOT(imm32), '1');
    APSR.<N,Z,C,V> = nzcvc;
```

F7.1.37 CMP (register)

Compare (register) subtracts an optionally-shifted register value from a register value. It updates the condition flags based on the result, and discards the result.

Encoding T1 ARMv4T, ARMv5T*, ARMv6*, ARMv7

CMP<c> <Rn>, <Rm> <Rn> and <Rm> both from R0-R7

15	14	13	12	11	10	9	8	7	6	5	4	3	2	1	0
0	1	0	0	0	0	1	0	1	0	Rm	Rn				

n = UInt(Rn); m = UInt(Rm);
 (shift_t, shift_n) = (SRTYPE_LSL, 0);

Encoding T2 ARMv4T, ARMv5T*, ARMv6*, ARMv7

CMP<c> <Rn>, <Rm> <Rn> and <Rm> not both from R0-R7

15	14	13	12	11	10	9	8	7	6	5	4	3	2	1	0
0	1	0	0	0	1	0	1	N	Rm			Rn			

n = UInt(N:Rn); m = UInt(Rm);
 (shift_t, shift_n) = (SRTYPE_LSL, 0);
 if n < 8 && m < 8 then UNPREDICTABLE;
 if n == 15 || m == 15 then UNPREDICTABLE;

Encoding T3 ARMv6T2, ARMv7

CMP<c>.W <Rn>, <Rm> {, <shift>}

15	14	13	12	11	10	9	8	7	6	5	4	3	2	1	0	15	14	13	12	11	10	9	8	7	6	5	4	3	2	1	0
1	1	1	0	1	0	1	1	1	0	1	1	Rn			(0)	imm3	1	1	1	1	imm2	type	Rm								

n = UInt(Rn); m = UInt(Rm);
 (shift_t, shift_n) = DecodeImmShift(type, imm3:imm2);
 if n == 15 || m == 15 then UNPREDICTABLE; // ARMv8-A removes UNPREDICTABLE for R13

Encoding A1 ARMv4*, ARMv5T*, ARMv6*, ARMv7

CMP<c> <Rn>, <Rm>{, <shift>}

31	30	29	28	27	26	25	24	23	22	21	20	19	18	17	16	15	14	13	12	11	10	9	8	7	6	5	4	3	2	1	0
cond			0	0	0	1	0	1	0	1	Rn			(0)	(0)	(0)	(0)	imm5			type	0	Rm								

n = UInt(Rn); m = UInt(Rm);
 (shift_t, shift_n) = DecodeImmShift(type, imm5);

For information about the CONSTRAINED UNPREDICTABLE behavior of this instruction, see [Appendix A Architectural Constraints on UNPREDICTABLE behaviors](#), and particularly [CMP \(register\)](#) on page AppxA-4703.

Assembler syntax

CMP{<c>}{<q>} <Rn>, <Rm> {, <shift>}

where:

- <c>, <q> See [Standard assembler syntax fields on page F2-2415](#).
- <Rn> The first operand register. The SP can be used. The PC can be used in A32 instructions.
- <Rm> The register that is optionally shifted and used as the second operand. The PC can be used in A32 instructions. The SP can be used in both A32 and T32 instructions, but:
- ARM deprecates the use of SP.
 - When assembling for the T32 instruction set, only encoding T2 is available.
- <shift> The shift to apply to the value read from <Rm>. If present, encodings T1 and T2 are not permitted. If absent, no shift is applied and all encodings are permitted. [Shifts applied to a register on page F2-2419](#) describes the shifts and how they are encoded.

Operation

```
if ConditionPassed() then
    EncodingSpecificOperations();
    shifted = Shift(R[m], shift_t, shift_n, APSR.C);
    (result, nzc) = AddWithCarry(R[n], NOT(shifted), '1');
    APSR.<N,Z,C,V> = nzc;
```

F7.1.38 CMP (register-shifted register)

Compare (register-shifted register) subtracts a register-shifted register value from a register value. It updates the condition flags based on the result, and discards the result.

Encoding A1 ARMv4*, ARMv5T*, ARMv6*, ARMv7

CMP<c> <Rn>, <Rm>, <type> <Rs>

31	30	29	28	27	26	25	24	23	22	21	20	19	18	17	16	15	14	13	12	11	10	9	8	7	6	5	4	3	2	1	0
cond			0	0	0	1	0	1	0	1	Rn				(0)(0)(0)(0)				Rs		0	type		1	Rm						

```
n = UInt(Rn); m = UInt(Rm); s = UInt(Rs);
shift_t = DecodeRegShift(type);
if n == 15 || m == 15 || s == 15 then UNPREDICTABLE;
```

For information about the CONSTRAINED UNPREDICTABLE behavior, see [Appendix A Architectural Constraints on UNPREDICTABLE behaviors](#).

Assembler syntax

CMP{<c>}{<q>} <Rn>, <Rm>, <type> <Rs>

where:

- <c>, <q> See [Standard assembler syntax fields on page F2-2415](#).
- <Rn> The first operand register.
- <Rm> The register that is shifted and used as the second operand.
- <type> The type of shift to apply to the value read from <Rm>. It must be one of:
 - ASR Arithmetic shift right, encoded as type = 0b10.
 - LSL Logical shift left, encoded as type = 0b00.
 - LSR Logical shift right, encoded as type = 0b01.
 - ROR Rotate right, encoded as type = 0b11.
- <Rs> The register whose bottom byte contains the amount to shift by.

Operation

```
if ConditionPassed() then
    EncodingSpecificOperations();
    shift_n = UInt(R[s]<7:0>);
    shifted = Shift(R[m], shift_t, shift_n, APSR.C);
    (result, nzc) = AddWithCarry(R[n], NOT(shifted), '1');
    APSR.<N,Z,C,V> = nzc;
```

F7.1.39 CPS

Change PE State is a system instruction, see [CPS \(T32\) on page F7-3034](#) and [CPS \(A32\) on page F7-3036](#).

F7.1.40 CPY

Copy is a pre-UAL synonym for MOV (register). See [MOV \(register, T32\) on page F7-2710](#) and [MOV \(register, A32\) on page F7-2712](#).

Assembler syntax

CPY <Rd>, <Rn>

This is equivalent to:

MOV <Rd>, <Rn>

F7.1.41 CRC32, CRC32C

CRC32 performs a cyclic redundancy check (CRC) calculation on a value held in a general-purpose register. It is an OPTIONAL instruction, introduced in ARMv8. It performs a CRC on an input value that can be 8, 16, or 32 bits, taking an input CRC value from a second register, and returning the output CRC value to the that supplied the input CRC. To align with common usage, the bit order of the values is reversed as part of the operation, and:

- The CRC32 form of the instruction uses the polynomial 0x04C11DB7 for the CRC calculation.
- The CRC32C form of the instruction uses the polynomial 0x1EDC6F41 for the CRC calculation.

———— **Note** —————

[ID_ISAR5](#).CRC32 indicates whether this instruction is supported in the T32 and A32 instruction sets.

Encoding T1 ARMv8

CRC32{C}<y> Rd, Rn, Rm

15	14	13	12	11	10	9	8	7	6	5	4	3	2	1	0	15	14	13	12	11	10	9	8	7	6	5	4	3	2	1	0
1	1	1	1	1	0	1	0	1	1	0	C		Rn			1	1	1	1		Rd		1	0	sz		Rm				

```
d = UInt(Rd); n = UInt(Rn); m = UInt(Rm);
size = 8 << UInt(sz);
crc32c = (C == '1');
if d == 15 || n == 15 || m == 15 then UNPREDICTABLE;
if size == 64 then UNPREDICTABLE;
if InITBlock() then UNPREDICTABLE;
```

Encoding A1 ARMv8

CRC32{C}<y><c> Rd, Rn, Rm

31	30	29	28	27	26	25	24	23	22	21	20	19	18	17	16	15	14	13	12	11	10	9	8	7	6	5	4	3	2	1	0
cond				0	0	0	1	0	sz	0		Rn		Rd	(0)	(0)	C	(0)	0	1	0	0									Rm

```
d = UInt(Rd); n = UInt(Rn); m = UInt(Rm);
size = 8 << UInt(sz);
crc32c = (C == '1');
if d == 15 || n == 15 || m == 15 then UNPREDICTABLE;
if size == 64 then UNPREDICTABLE;
if cond != '1110' then UNPREDICTABLE;
```

For information about the CONSTRAINED UNPREDICTABLE behavior, see [Appendix A Architectural Constraints on UNPREDICTABLE behaviors](#), and particularly [CRC32, CRC32C on page AppxA-4704](#).

Assembler syntax

CRC32{C}<y><c> Rd, Rn, Rm

where:

- C Specified the polynomial to be used for the CRC calculation:
- If C is omitted, the calculation uses the polynomial 0x04C11DB7.
 - If C is included, the calculation uses the polynomial 0x1EDC6F41.
- <y> Is one of:
- B Specifies that the instruction takes a byte of new data, encoded as sz = '00'.
- H Specifies that the instruction takes a halfword of new data, encoded as sz = '01'.
- H Specifies that the instruction takes a word of new data, encoded as sz = '10'.
- <c> See [Standard assembler syntax fields on page F2-2415](#).
- <Rd> The destination register for the output CRC value.
- <Rn> The first operand register, that holds the input CRC value.
- <Rm> The second operand register, that holds the data that the CRC is to be performed on.

Operation

```
if ConditionPassed() then
    EncodingSpecificOperations();
    acc = R[n];           // accumulator
    val = R[m]<size-1:0>; // input value
    poly = (if crc32c then 0x1EDC6F41 else 0x04C11DB7)<31:0>;
    tempacc = BitReverse(acc):Zeros(size);
    tempval = BitReverse(val):Zeros(32);
    // Poly32Mod2 on a bitstring does a polynomial Modulus over {0,1} operation
    R[d] = BitReverse(Poly32Mod2(tempacc EOR tempval, poly));
```

F7.1.42 DBG

Debug Hint provides a hint to debug and related systems. See their documentation for what use (if any) they make of this instruction.

Encoding T1 ARMv7 (executes as NOP in ARMv6T2)

DBG<c> #<option>

15	14	13	12	11	10	9	8	7	6	5	4	3	2	1	0	15	14	13	12	11	10	9	8	7	6	5	4	3	2	1	0
1	1	1	1	0	0	1	1	1	0	1	0	(1)	(1)	(1)	(1)	1	0	(0)	0	(0)	0	0	0	1	1	1	1	option			

// Any decoding of 'option' is specified by the debug system

Encoding A1 ARMv7 (executes as NOP in ARMv6K and ARMv6T2)

DBG<c> #<option>

31	30	29	28	27	26	25	24	23	22	21	20	19	18	17	16	15	14	13	12	11	10	9	8	7	6	5	4	3	2	1	0
cond	0	0	1	1	0	0	1	0	0	0	0	0	(1)	(1)	(1)	(1)	(0)	(0)	(0)	(0)	1	1	1	1	option						

// Any decoding of 'option' is specified by the debug system

For information about the CONSTRAINED UNPREDICTABLE behavior, see [Appendix A Architectural Constraints on UNPREDICTABLE behaviors](#).

Assembler syntax

DBG{<c>}{<q>} #<option>

where:

<c>, <q> See [Standard assembler syntax fields on page F2-2415](#).

<option> Provides extra information about the hint, and is in the range 0 to 15.

Operation

```
if ConditionPassed() then
    EncodingSpecificOperations();
    Hint_Debug(option);
```

F7.1.43 DCPS1, DCPS2, DCPS3

DCPS_x allows the debugger to move the PE into a higher Exception Level or to a specific mode at the current Exception Level.

DCPS_x is always UNDEFINED in Non-debug state.

For more information see *DCPS* on page H2-4351.

Encoding T1 ARMv8

DCPS<opt>

15	14	13	12	11	10	9	8	7	6	5	4	3	2	1	0	15	14	13	12	11	10	9	8	7	6	5	4	3	2	1	0
1	1	1	1	0	1	1	1	1	0	0	0	1	1	1	1	1	0	0	0	0	0	0	0	0	0	0	0	0	0	0	opt

if !Halted() || opt == '00' then UNDEFINED;

Assembler syntax

DCPS<opt>

where:

<opt> Specifies the target Exception Level and the mode the PE enters.

Is one of:

- 1 The target Exception Level is EL1 and:
 - If EL1 is using AArch32, the PE enters SVC mode.

Note

If EL3 is using AArch32, Secure SVC mode is an EL3 mode. This means DCPS1 causes the PE to enter EL3.

 - If EL1 is using AArch64, the PE enters EL1h, and executes future instructions as A64 instructions.

Encoded as opt = 01.
- 2 The target Exception Level is EL2 and:
 - If EL2 is using AArch32, the PE enters Hyp mode.
 - If EL2 is using AArch64, the PE enters EL2h, and executes future instructions as A64 instructions.

Encoded as opt = 10.
- 3 The target Exception Level is EL3 and:
 - If EL3 is using AArch32, the PE enters Monitor mode.
 - If EL3 is using AArch64, the PE enters EL3h, and executes future instructions as A64 instructions.

Encoded as opt = 11.

Operation

DCPSInstruction(opt);

F7.1.44 DMB

Data Memory Barrier is a memory barrier that ensures the ordering of observations of memory accesses, see [Data Memory Barrier \(DMB\) on page E2-2353](#).

Encoding T1 ARMv7

DMB<c> <option>

15	14	13	12	11	10	9	8	7	6	5	4	3	2	1	0	15	14	13	12	11	10	9	8	7	6	5	4	3	2	1	0
1	1	1	1	0	0	1	1	1	0	1	1	(1)	(1)	(1)	(1)	1	0	(0)	0	(1)	(1)	(1)	(1)	0	1	0	1	option			

// No additional decoding required

Encoding A1 ARMv7

DMB <option>

31	30	29	28	27	26	25	24	23	22	21	20	19	18	17	16	15	14	13	12	11	10	9	8	7	6	5	4	3	2	1	0
1	1	1	1	0	1	0	1	0	1	1	1	(1)	(1)	(1)	(1)	(1)	(1)	(1)	(1)	(1)	(0)	(0)	(0)	(0)	0	1	0	1	option		

// No additional decoding required

For information about the CONSTRAINED UNPREDICTABLE behavior, see [Appendix A Architectural Constraints on UNPREDICTABLE behaviors](#).

Assembler syntax

DMB{<c>}{<q>} {<option>}

where:

<c>, <q> See [Standard assembler syntax fields on page F2-2415](#). An A32 DMB instruction must be unconditional.

<option> Specifies an optional limitation on the DMB operation. Values are:

SY	Full system is the required shareability domain, reads and writes are the required access types. Can be omitted. This option is referred to as the full system DMB. Encoded as option = 0b1111.
ST	Full system is the required shareability domain, writes are the required access type. SYST is a synonym for ST. Encoded as option = 0b1110.
LD	Full system is the required shareability domain, reads are the required access type. Encoded as option = 0b1101.
ISH	Inner Shareable is the required shareability domain, reads and writes are the required access types. Encoded as option = 0b1011.
ISHST	Inner Shareable is the required shareability domain, writes are the required access type. Encoded as option = 0b1010.
ISHLD	Inner Shareable is the required shareability domain, reads are the required access type. Encoded as option = 0b1001.
NSH	Non-shareable is the required shareability domain, reads and writes are the required access types. Encoded as option = 0b0111.
NSHST	Non-shareable is the required shareability domain, writes are the required access type. Encoded as option = 0b0110.
NSHLD	Non-shareable is the required shareability domain, reads are the required access type. Encoded as option = 0b0101.
OSH	Outer Shareable is the required shareability domain, reads and writes are the required access types. Encoded as option = 0b0011.

OSHST Outer Shareable is the required shareability domain, writes are the required access type.
Encoded as option = 0b0010.

OSHLD Outer Shareable is the required shareability domain, reads are the required access type.
Encoded as option = 0b0001.

All other encodings of option are reserved. It is IMPLEMENTATION DEFINED whether options other than SY are implemented. All unsupported and reserved options must execute as a full system DMB operation, but software must not rely on this behavior.

———— **Note** —————

The instruction supports the following alternative <option> values, but ARM recommends that software does not use these alternative values:

- SH as an alias for ISH.
- SHST as an alias for ISHST.
- UN as an alias for NSH.
- UNST is an alias for NSHST.

Operation

```
if ConditionPassed() then
    EncodingSpecificOperations();
    case option of
        when '0001' domain = MBReqDomain_OuterShareable; types = MBReqTypes_Reads;
        when '0010' domain = MBReqDomain_OuterShareable; types = MBReqTypes_Writes;
        when '0011' domain = MBReqDomain_OuterShareable; types = MBReqTypes_All;
        when '0101' domain = MBReqDomain_Nonshareable; types = MBReqTypes_Reads;
        when '0110' domain = MBReqDomain_Nonshareable; types = MBReqTypes_Writes;
        when '0111' domain = MBReqDomain_Nonshareable; types = MBReqTypes_All;
        when '1001' domain = MBReqDomain_InnerShareable; types = MBReqTypes_Reads;
        when '1010' domain = MBReqDomain_InnerShareable; types = MBReqTypes_Writes;
        when '1011' domain = MBReqDomain_InnerShareable; types = MBReqTypes_All;
        when '1101' domain = MBReqDomain_FullSystem; types = MBReqTypes_Reads;
        when '1110' domain = MBReqDomain_FullSystem; types = MBReqTypes_Writes;
        otherwise domain = MBReqDomain_FullSystem; types = MBReqTypes_All;

    if HaveEL(EL2) && !IsSecure() && !CurrentModeIsHyp() then
        if HCR.BSU == '11' then
            domain = MBReqDomain_FullSystem;
        if HCR.BSU == '10' && domain != MBReqDomain_FullSystem then
            domain = MBReqDomain_OuterShareable;
        if HCR.BSU == '01' && domain == MBReqDomain_Nonshareable then
            domain = MBReqDomain_InnerShareable;

    DataMemoryBarrier(domain, types);
```

F7.1.45 DSB

Data Synchronization Barrier is a memory barrier that ensures the completion of memory accesses, see [Data Synchronization Barrier \(DSB\) on page E2-2354](#).

Encoding T1 ARMv7

DSB<c> <option>

15	14	13	12	11	10	9	8	7	6	5	4	3	2	1	0	15	14	13	12	11	10	9	8	7	6	5	4	3	2	1	0
1	1	1	1	0	0	1	1	1	0	1	1	(1)	(1)	(1)	(1)	1	0	(0)	0	(1)	(1)	(1)	(1)	0	1	0	0	option			

// No additional decoding required

Encoding A1 ARMv7

DSB <option>

31	30	29	28	27	26	25	24	23	22	21	20	19	18	17	16	15	14	13	12	11	10	9	8	7	6	5	4	3	2	1	0
1	1	1	1	0	1	0	1	0	1	1	1	(1)	(1)	(1)	(1)	(1)	(1)	(1)	(1)	(1)	(0)	(0)	(0)	(0)	0	1	0	0	option		

// No additional decoding required

For information about the CONSTRAINED UNPREDICTABLE behavior, see [Appendix A Architectural Constraints on UNPREDICTABLE behaviors](#).

Assembler syntax

DSB{<c>}{<q>} {<option>}

where:

<c>, <q> See [Standard assembler syntax fields on page F2-2415](#). An A32 DSB instruction must be unconditional.

<option> Specifies an optional limitation on the DSB operation. Values are:

SY	Full system is the required shareability domain, reads and writes are the required access types. Can be omitted. This option is referred to as the full system DSB. Encoded as option = 0b1111.
ST	Full system is the required shareability domain, writes are the required access type. SYST is a synonym for ST. Encoded as option = 0b1110.
LD	Full system is the required shareability domain, reads are the required access type. Encoded as option = 0b1101.
ISH	Inner Shareable is the required shareability domain, reads and writes are the required access types. Encoded as option = 0b1011.
ISHST	Inner Shareable is the required shareability domain, writes are the required access type. Encoded as option = 0b1010.
ISHLD	Inner Shareable is the required shareability domain, reads are the required access type. Encoded as option = 0b1001.
NSH	Non-shareable is the required shareability domain, reads and writes are the required access types. Encoded as option = 0b0111.
NSHST	Non-shareable is the required shareability domain, writes are the required access type. Encoded as option = 0b0110.
NSHLD	Non-shareable is the required shareability domain, reads are the required access type. Encoded as option = 0b0101.
OSH	Outer Shareable is the required shareability domain, reads and writes are the required access types. Encoded as option = 0b0011.

OSHST Outer Shareable is the required shareability domain, writes are the required access type.
Encoded as option = 0b0010.

OSHLD Outer Shareable is the required shareability domain, reads are the required access type.
Encoded as option = 0b0001.

All other encodings of option are reserved. It is IMPLEMENTATION DEFINED whether options other than SY are implemented. All unsupported and reserved options must execute as a full system DSB operation, but software must not rely on this behavior.

———— **Note** —————

The instruction supports the following alternative <option> values, but ARM recommends that software does not use these alternative values:

- SH as an alias for ISH.
- SHST as an alias for ISHST.
- UN as an alias for NSH.
- UNST is an alias for NSHST.

Operation

```
if ConditionPassed() then
    EncodingSpecificOperations();
    case option of
        when '0001' domain = MBReqDomain_OuterShareable; types = MBReqTypes_Reads;
        when '0010' domain = MBReqDomain_OuterShareable; types = MBReqTypes_Writes;
        when '0011' domain = MBReqDomain_OuterShareable; types = MBReqTypes_All;
        when '0101' domain = MBReqDomain_Nonshareable; types = MBReqTypes_Reads;
        when '0110' domain = MBReqDomain_Nonshareable; types = MBReqTypes_Writes;
        when '0111' domain = MBReqDomain_Nonshareable; types = MBReqTypes_All;
        when '1001' domain = MBReqDomain_InnerShareable; types = MBReqTypes_Reads;
        when '1010' domain = MBReqDomain_InnerShareable; types = MBReqTypes_Writes;
        when '1011' domain = MBReqDomain_InnerShareable; types = MBReqTypes_All;
        when '1101' domain = MBReqDomain_FullSystem; types = MBReqTypes_Reads;
        when '1110' domain = MBReqDomain_FullSystem; types = MBReqTypes_Writes;
        otherwise domain = MBReqDomain_FullSystem; types = MBReqTypes_All;

    if HaveEL(EL2) && !IsSecure() && !CurrentModeIsHyp() then
        if HCR.BSU == '11' then
            domain = MBReqDomain_FullSystem;
        if HCR.BSU == '10' && domain != MBReqDomain_FullSystem then
            domain = MBReqDomain_OuterShareable;
        if HCR.BSU == '01' && domain == MBReqDomain_Nonshareable then
            domain = MBReqDomain_InnerShareable;

    DataSynchronizationBarrier(domain, types);
```

F7.1.46 EOR (immediate)

Bitwise Exclusive OR (immediate) performs a bitwise Exclusive OR of a register value and an immediate value, and writes the result to the destination register. It can optionally update the condition flags based on the result.

Encoding T1 ARMv6T2, ARMv7

EOR{S}<c> <Rd>, <Rn>, #<const>

15	14	13	12	11	10	9	8	7	6	5	4	3	2	1	0	15	14	13	12	11	10	9	8	7	6	5	4	3	2	1	0
1	1	1	1	0	i	0	0	1	0	0	S	Rn				0	imm3			Rd			imm8								

```

if Rd == '1111' && S == '1' then SEE TEQ (immediate);
d = UInt(Rd); n = UInt(Rn); setflags = (S == '1');
(imm32, carry) = ThumbExpandImm_C(i:imm3:imm8, APSR.C);
if (d == 15 && S == '0') || n == 15 then UNPREDICTABLE;
// ARMv8-A removes UNPREDICTABLE for R13
    
```

Encoding A1 ARMv4*, ARMv5T*, ARMv6*, ARMv7

EOR{S}<c> <Rd>, <Rn>, #<const>

31	30	29	28	27	26	25	24	23	22	21	20	19	18	17	16	15	14	13	12	11	10	9	8	7	6	5	4	3	2	1	0
cond		0	0	1	0	0	0	1	S	Rn				Rd			imm12														

```

if Rd == '1111' && S == '1' then SEE SUBS PC, LR and related instructions;
d = UInt(Rd); n = UInt(Rn); setflags = (S == '1');
(imm32, carry) = ARMEExpandImm_C(imm12, APSR.C);
    
```

For information about the CONSTRAINED UNPREDICTABLE behavior, see [Appendix A Architectural Constraints on UNPREDICTABLE behaviors](#).

Assembler syntax

EOR{S}{<c>}{<q>} {<Rd>}, <Rn>, #<const>

where:

- S If S is present, the instruction updates the flags. Otherwise, the flags are not updated.
- <c>, <q> See [Standard assembler syntax fields on page F2-2415](#).
- <Rd> The destination register. If S is specified and <Rd> is the PC, see [SUBS PC, LR and related instructions \(T32\) on page F7-3066](#) or [SUBS PC, LR and related instructions \(A32\) on page F7-3068](#).
In A32 instructions, if S is not specified and <Rd> is the PC, the instruction is a branch to the address calculated by the operation. This is an interworking branch, see [Pseudocode details of operations on the AArch32 general-purpose registers and the PC on page E1-2296](#).
- <Rn> The register that contains the operand. The PC can be used in A32 instructions.
- <const> The immediate value to be exclusive ORed with the value obtained from <Rn>. See [Modified immediate constants in T32 instructions on page F3-2444](#) or [Modified immediate constants in A32 instructions on page F4-2472](#) for the range of values.

The pre-UAL syntax EOR<c>S is equivalent to EORS<c>.

Operation

```
if ConditionPassed() then
    EncodingSpecificOperations();
    result = R[n] EOR imm32;
    if d == 15 then // Can only occur for ARM encoding
        ALUWritePC(result); // setflags is always FALSE here
    else
        R[d] = result;
        if setflags then
            APSR.N = result<31>;
            APSR.Z = IsZeroBit(result);
            APSR.C = carry;
            // APSR.V unchanged
```

F7.1.47 EOR (register)

Bitwise Exclusive OR (register) performs a bitwise Exclusive OR of a register value and an optionally-shifted register value, and writes the result to the destination register. It can optionally update the condition flags based on the result.

Encoding T1 ARMv4T, ARMv5T*, ARMv6*, ARMv7
 EORS <Rdn>, <Rm> Outside IT block.
 EOR<c> <Rdn>, <Rm> Inside IT block.

15	14	13	12	11	10	9	8	7	6	5	4	3	2	1	0
0	1	0	0	0	0	0	0	0	1	Rm					Rdn

```
d = UInt(Rdn); n = UInt(Rdn); m = UInt(Rm); setflags = !InITBlock();
(shift_t, shift_n) = (SRTYPE_LSL, 0);
```

Encoding T2 ARMv6T2, ARMv7
 EOR{S}<c>.W <Rd>, <Rn>, <Rm>{, <shift>}

15	14	13	12	11	10	9	8	7	6	5	4	3	2	1	0	15	14	13	12	11	10	9	8	7	6	5	4	3	2	1	0
1	1	1	0	1	0	1	0	1	0	0	S		Rn		(0)	imm3		Rd		imm2	type			Rm							

```
if Rd == '1111' && S == '1' then SEE TEQ (register);
d = UInt(Rd); n = UInt(Rn); m = UInt(Rm); setflags = (S == '1');
(shift_t, shift_n) = DecodeImmShift(type, imm3:imm2);
if (d == 15 && S == '0') || n == 15 || m == 15 then UNPREDICTABLE;
// ARMv8-A removes UNPREDICTABLE for R13
```

Encoding A1 ARMv4*, ARMv5T*, ARMv6*, ARMv7
 EOR{S}<c> <Rd>, <Rn>, <Rm>{, <shift>}

31	30	29	28	27	26	25	24	23	22	21	20	19	18	17	16	15	14	13	12	11	10	9	8	7	6	5	4	3	2	1	0
cond		0	0	0	0	0	0	0	1	S		Rn		Rd		imm5		type	0												Rm

```
if Rd == '1111' && S == '1' then SEE SUBS PC, LR and related instructions;
d = UInt(Rd); n = UInt(Rn); m = UInt(Rm); setflags = (S == '1');
(shift_t, shift_n) = DecodeImmShift(type, imm5);
```

For information about the CONSTRAINED UNPREDICTABLE behavior, see [Appendix A Architectural Constraints on UNPREDICTABLE behaviors](#).

Assembler syntax

EOR{S}{<c>}{<q>} {<Rd>}, <Rn>, <Rm> {, <shift>}

where:

- S If S is present, the instruction updates the flags. Otherwise, the flags are not updated.
- <c>, <q> See [Standard assembler syntax fields on page F2-2415](#).
- <Rd> The destination register. If S is specified and <Rd> is the PC, see [SUBS PC, LR and related instructions \(T32\) on page F7-3066](#) or [SUBS PC, LR and related instructions \(A32\) on page F7-3068](#).
In A32 instructions, if S is not specified and <Rd> is the PC, the instruction is a branch to the address calculated by the operation. This is an interworking branch, see [Pseudocode details of operations on the AArch32 general-purpose registers and the PC on page E1-2296](#).
- <Rn> The first operand register. The PC can be used in A32 instructions.
- <Rm> The register that is optionally shifted and used as the second operand. The PC can be used in A32 instructions.
- <shift> The shift to apply to the value read from <Rm>. If present, encoding T1 is not permitted. If absent, no shift is applied and all encodings are permitted. [Shifts applied to a register on page F2-2419](#) describes the shifts and how they are encoded.

In T32 assembly:

- Outside an IT block, if EORS <Rd>, <Rn>, <Rd> has <Rd> and <Rn> both in the range R0-R7, it is assembled using encoding T1 as though EORS <Rd>, <Rn> had been written
- Inside an IT block, if EOR<c> <Rd>, <Rn>, <Rd> has <Rd> and <Rn> both in the range R0-R7, it is assembled using encoding T1 as though EOR<c> <Rd>, <Rn> had been written.

To prevent either of these happening, use the .W qualifier.

The pre-UAL syntax EOR<c>S is equivalent to EORS<c>.

Operation

```
if ConditionPassed() then
    EncodingSpecificOperations();
    (shifted, carry) = Shift_C(R[m], shift_t, shift_n, APSR.C);
    result = R[n] EOR shifted;
    if d == 15 then // Can only occur for ARM encoding
        ALUWritePC(result); // setflags is always FALSE here
    else
        R[d] = result;
        if setflags then
            APSR.N = result<31>;
            APSR.Z = IsZeroBit(result);
            APSR.C = carry;
            // APSR.V unchanged
```

F7.1.48 EOR (register-shifted register)

Bitwise Exclusive OR (register-shifted register) performs a bitwise Exclusive OR of a register value and a register-shifted register value. It writes the result to the destination register, and can optionally update the condition flags based on the result.

Encoding A1 ARMv4*, ARMv5T*, ARMv6*, ARMv7
 EOR{S}<C> <Rd>, <Rn>, <Rm>, <type> <Rs>

31	30	29	28	27	26	25	24	23	22	21	20	19	18	17	16	15	14	13	12	11	10	9	8	7	6	5	4	3	2	1	0
cond			0	0	0	0	0	0	1	S	Rn				Rd				Rs				0	type			1	Rm			

```
d = UInt(Rd); n = UInt(Rn); m = UInt(Rm); s = UInt(Rs);
setflags = (S == '1'); shift_t = DecodeRegShift(type);
if d == 15 || n == 15 || m == 15 || s == 15 then UNPREDICTABLE;
```

For information about the CONSTRAINED UNPREDICTABLE behavior, see [Appendix A Architectural Constraints on UNPREDICTABLE behaviors](#).

Assembler syntax

EOR{S}{<C>}{<q>} {<Rd>,<Rn>, <Rm>, <type> <Rs>

where:

S If S is present, the instruction updates the flags. Otherwise, the flags are not updated.

<C>, <q> See [Standard assembler syntax fields on page F2-2415](#).

<Rd> The destination register.

<Rn> The first operand register.

<Rm> The register that is shifted and used as the second operand.

<type> The type of shift to apply to the value read from <Rm>. It must be one of:

ASR Arithmetic shift right, encoded as type = 0b10.

LSL Logical shift left, encoded as type = 0b00.

LSR Logical shift right, encoded as type = 0b01.

ROR Rotate right, encoded as type = 0b11.

<Rs> The register whose bottom byte contains the amount to shift by.

The pre-UAL syntax EOR<C>S is equivalent to EORS<C>.

Operation

```
if ConditionPassed() then
  EncodingSpecificOperations();
  shift_n = UInt(R[s]<7:0>);
  (shifted, carry) = Shift_C(R[m], shift_t, shift_n, APSR.C);
  result = R[n] EOR shifted;
  R[d] = result;
  if setflags then
    APSR.N = result<31>;
    APSR.Z = IsZeroBit(result);
    APSR.C = carry;
  // APSR.V unchanged
```

F7.1.49 ERET

Exception Return is a system instruction, see [ERET](#) on page F7-3038.

F7.1.50 HLT

Halting breakpoint causes a software breakpoint to occur.

Halting breakpoint is always unconditional, even inside an IT block.

Encoding T1 ARMv8

HLT #<imm8>

15	14	13	12	11	10	9	8	7	6	5	4	3	2	1	0
1	0	1	1	1	0	1	0	1	0	imm6					

if EDSCR.HDE == '0' || !HaltingAllowed() then UNDEFINED;
 // imm8 is for assembly/disassembly only and ignored by hardware

Encoding A1 ARMv8

HLT #<imm16>

31	30	29	28	27	26	25	24	23	22	21	20	19	18	17	16	15	14	13	12	11	10	9	8	7	6	5	4	3	2	1	0
cond				0	0	0	1	0	0	0	imm12												0	1	1	1	imm4				

if EDSCR.HDE == '0' || !HaltingAllowed() then UNDEFINED;
 if cond != '1110' then UNPREDICTABLE; // HLT must be encoded with AL condition
 // imm12:imm4 are for assembly/disassembly only and ignored by hardware

For information about the CONSTRAINED UNPREDICTABLE behavior of this instruction, see [Appendix A Architectural Constraints on UNPREDICTABLE behaviors](#), and particularly [HLT on page AppxA-4704](#).

Assembler syntax

HLT{<q>} {#}<imm>

where:

- <q> See [Standard assembler syntax fields on page F2-2415](#). An HLT instruction must be unconditional.
- <imm> Specifies a value that is stored in the instruction, in the range 0-63 for a T32 instruction or 0-65535 for an A32 instruction. This value is ignored by the PE, but can be used by a debugger to store more information about the halting breakpoint.

Operation

```
EncodingSpecificOperations();
Halt(DebugHalt_HaltInstruction);
```

F7.1.51 HVC

Hypervisor Call is a system instruction, see [HVC](#) on page F7-3040.

F7.1.52 ISB

Instruction Synchronization Barrier flushes the pipeline in the PE, so that all instructions following the ISB are fetched from cache or memory, after the instruction has been completed. It ensures that the effects of context changing operations executed before the ISB instruction are visible to the instructions fetched after the ISB. Context changing operations include changing the *Address Space Identifier* (ASID), TLB maintenance operations, branch predictor maintenance operations, and all changes to the System registers. In addition, any branches that appear in program order after the ISB instruction are written into the branch prediction logic with the context that is visible after the ISB instruction. This is needed to ensure correct execution of the instruction stream.

Encoding T1 ARMv7

ISB<c> <option>

15	14	13	12	11	10	9	8	7	6	5	4	3	2	1	0	15	14	13	12	11	10	9	8	7	6	5	4	3	2	1	0
1	1	1	1	0	0	1	1	1	0	1	1	(1)	(1)	(1)	(1)	1	0	(0)	0	(1)	(1)	(1)	(1)	0	1	1	0	option			

// No additional decoding required

Encoding A1 ARMv7

ISB <option>

31	30	29	28	27	26	25	24	23	22	21	20	19	18	17	16	15	14	13	12	11	10	9	8	7	6	5	4	3	2	1	0
1	1	1	1	0	1	0	1	0	1	1	1	(1)	(1)	(1)	(1)	(1)	(1)	(1)	(1)	(1)	(0)	(0)	(0)	(0)	0	1	1	0	option		

// No additional decoding required

For information about the CONSTRAINED UNPREDICTABLE behavior, see [Appendix A Architectural Constraints on UNPREDICTABLE behaviors](#).

Assembler syntax

ISB{<c>}{<q>} {<option>}

where:

<c>, <q> See [Standard assembler syntax fields](#) on page F2-2415. An A32 ISB instruction must be unconditional.

<option> Specifies an optional limitation on the ISB operation. Values are:

SY Full system ISB operation, encoded as option = 0b1111. Can be omitted.

All other encodings of option are reserved. The corresponding instructions execute as full system ISB operations, but must not be relied upon by software.

Operation

```
if ConditionPassed() then
    EncodingSpecificOperations();
    InstructionSynchronizationBarrier();
```

F7.1.53 IT

If-Then makes up to four following instructions (the *IT block*) conditional. The conditions for the instructions in the IT block are the same as, or the inverse of, the condition the IT instruction specifies for the first instruction in the block.

The IT instruction itself does not affect the condition flags, but the execution of the instructions in the IT block can change the condition flags.

16-bit instructions in the IT block, other than `CMP`, `CMN` and `TST`, do not set the condition flags. An IT instruction with the AL condition can change the behavior without conditional execution.

The architecture permits exception return to an instruction in the IT block only if the restoration of the `CPSR` restores `ITSTATE` to a state consistent with the conditions specified by the IT instruction. Any other exception return to an instruction in an IT block is UNPREDICTABLE. Any branch to a target instruction in an IT block is not permitted, and if such a branch is made it is UNPREDICTABLE what condition is used when executing that target instruction and any subsequent instruction in the IT block.

See also [Conditional instructions on page F1-2380](#) and [Conditional execution on page F2-2416](#).

Encoding T1 ARMv6T2, ARMv7

IT{<x>{<y>{<z>}}} <firstcond>

Not permitted in IT block

15	14	13	12	11	10	9	8	7	6	5	4	3	2	1	0
1	0	1	1	1	1	1	1	firstcond				mask			

if mask == '0000' then SEE "Related encodings";
 if firstcond == '1111' || (firstcond == '1110' && BitCount(mask) != 1) then UNPREDICTABLE;
 if InITBlock() then UNPREDICTABLE;

For information about the CONSTRAINED UNPREDICTABLE behavior of this instruction, see [Appendix A Architectural Constraints on UNPREDICTABLE behaviors](#), and particularly [IT on page AppxA-4704](#).

Related encodings See [If-Then, and hints on page F3-2441](#).

Assembler syntax

IT{<x>{<y>{<z>}}}{<q>} <firstcond>

where:

- <x> The condition for the second instruction in the IT block.
- <y> The condition for the third instruction in the IT block.
- <z> The condition for the fourth instruction in the IT block.
- <q> See [Standard assembler syntax fields on page F2-2415](#). An IT instruction must be unconditional.
- <firstcond> The condition for the first instruction in the IT block. See [Table F2-1 on page F2-2416](#) for the range of conditions available, and the encodings.

Each of <x>, <y>, and <z> can be either:

- T Then. The condition for the instruction is <firstcond>.
- E Else. The condition for the instruction is the inverse of <firstcond>. The condition code is the same as <firstcond>, except that the least significant bit is inverted. E must not be specified if <firstcond> is AL.

[Table F7-1 on page F7-2611](#) shows how the values of <x>, <y>, and <z> determine the value of the mask field.

Table F7-1 Determination of mask field

<x>	<y>	<z>	mask[3]	mask[2]	mask[1]	mask[0]
Omitted	Omitted	Omitted	1	0	0	0
T	Omitted	Omitted	firstcond[0]	1	0	0
E	Omitted	Omitted	NOT firstcond[0]	1	0	0
T	T	Omitted	firstcond[0]	firstcond[0]	1	0
E	T	Omitted	NOT firstcond[0]	firstcond[0]	1	0
T	E	Omitted	firstcond[0]	NOT firstcond[0]	1	0
E	E	Omitted	NOT firstcond[0]	NOT firstcond[0]	1	0
T	T	T	firstcond[0]	firstcond[0]	firstcond[0]	1
E	T	T	NOT firstcond[0]	firstcond[0]	firstcond[0]	1
T	E	T	firstcond[0]	NOT firstcond[0]	firstcond[0]	1
E	E	T	NOT firstcond[0]	NOT firstcond[0]	firstcond[0]	1
T	T	E	firstcond[0]	firstcond[0]	NOT firstcond[0]	1
E	T	E	NOT firstcond[0]	firstcond[0]	NOT firstcond[0]	1
T	E	E	firstcond[0]	NOT firstcond[0]	NOT firstcond[0]	1
E	E	E	NOT firstcond[0]	NOT firstcond[0]	NOT firstcond[0]	1

The conditions specified in an IT instruction must match those specified in the syntax of the instructions in its IT block. When assembling to A32 code, assemblers check IT instruction syntax for validity but do not generate assembled instructions for them. See [Conditional instructions on page F1-2380](#).

Operation

```
EncodingSpecificOperations();
ITSTATE.IT<7:0> = firstcond:mask;
```

F7.1.54 LDA

Load Acquire Word loads a word from memory and writes it to a register. The instruction also has memory ordering semantics as described in [Load-Acquire, Store-Release](#) on page E2-2355

For more information about support for shared memory see [Synchronization and semaphores](#) on page E2-2369. For information about memory accesses see [Memory accesses](#) on page F2-2422.

Encoding T1 ARMv8

LDA<c> <Rt>, [<Rn>]

15	14	13	12	11	10	9	8	7	6	5	4	3	2	1	0	15	14	13	12	11	10	9	8	7	6	5	4	3	2	1	0
1	1	1	0	1	0	0	0	1	1	0	1	Rn				Rt				(1)	(1)	(1)	(1)	1	0	1	0	(1)	(1)	(1)	(1)

t = UInt(Rt); n = UInt(Rn);
 if t == 15 || n == 15 then UNPREDICTABLE;

Encoding A1 ARMv8

LDA <Rt>, [<Rn>]

31	30	29	28	27	26	25	24	23	22	21	20	19	18	17	16	15	14	13	12	11	10	9	8	7	6	5	4	3	2	1	0
cond		0	0	0	1	1	0	0	1	Rn				Rt				(1)	(1)	0	0	1	0	0	1	(1)	(1)	(1)	(1)		

t = UInt(Rt); n = UInt(Rn);
 if t == 15 || n == 15 then UNPREDICTABLE;

For information about the CONSTRAINED UNPREDICTABLE behavior, see [Appendix A Architectural Constraints on UNPREDICTABLE behaviors](#).

Assembler syntax

LDA{<c>}{<q>} <Rt>, [<Rn>]

where:

<c>, <q> See [Standard assembler syntax fields](#) on page F2-2415.

<Rt> The destination register.

<Rn> The base register. The SP can be used.

Operation

```

if ConditionPassed() then
    EncodingSpecificOperations(); NullCheckIfThumbEE(n);
    address = R[n];
    acctype = AccType_ORDERED;
    aligned = (address == Align(address, 4));
    R[t] = MemA_with_type[address, 4, acctype, aligned];
    
```

F7.1.55 LDAB

Load-Acquire Byte loads a byte from memory, zero-extends it to form a 32-bit word and writes it to a register. The instruction also has memory ordering semantics as described in *Load-Acquire, Store-Release* on page E2-2355.

For more information about support for shared memory see *Synchronization and semaphores* on page E2-2369. For information about memory accesses see *Memory accesses* on page F2-2422.

Encoding T1 ARMv8

LDAB<c> <Rt>, [<Rn>]

15	14	13	12	11	10	9	8	7	6	5	4	3	2	1	0	15	14	13	12	11	10	9	8	7	6	5	4	3	2	1	0
1	1	1	0	1	0	0	0	1	1	0	1	Rn				Rt				(1)	(1)	(1)	(1)	1	0	0	0	(1)	(1)	(1)	(1)

t = UInt(Rt); n = UInt(Rn);
 if t == 15 || n == 15 then UNPREDICTABLE;

Encoding A1 ARMv8

LDAB <Rt>, [<Rn>]

31	30	29	28	27	26	25	24	23	22	21	20	19	18	17	16	15	14	13	12	11	10	9	8	7	6	5	4	3	2	1	0
cond		0	0	0	1	1	1	0	1	Rn				Rt				(1)	(1)	0	0	1	0	0	1	(1)	(1)	(1)	(1)		

t = UInt(Rt); n = UInt(Rn);
 if t == 15 || n == 15 then UNPREDICTABLE;

For information about the CONSTRAINED UNPREDICTABLE behavior, see *Appendix A Architectural Constraints on UNPREDICTABLE behaviors*.

Assembler syntax

LDAB{<c>}{<q>} <Rt>, [<Rn>]

where:

<c>, <q> See *Standard assembler syntax fields* on page F2-2415.

<Rt> The destination register.

<Rn> The base register. The SP can be used.

Operation

```

if ConditionPassed() then
    EncodingSpecificOperations(); NullCheckIfThumbEE(n);
    address = R[n];
    acctype = AccType_ORDERED;
    aligned = TRUE;
    R[t] = ZeroExtend(MemA_with_type[address, 4, acctype, aligned], 32);
  
```

F7.1.56 LDAEX

Load-Acquire Exclusive Word loads a word from memory, writes it to a register and:

- If the address has the Shared Memory attribute, marks the physical address as exclusive access for the executing PE in a global monitor.
- Causes the executing PE to indicate an active exclusive access in the local monitor.

The instruction also has memory ordering semantics as described in *Load-Acquire, Store-Release* on page E2-2355.

For more information about support for shared memory see *Synchronization and semaphores* on page E2-2369. For information about memory accesses see *Memory accesses* on page F2-2422.

Encoding T1 ARMv8

LDAEX<c> <Rt>, [<Rn>]

15	14	13	12	11	10	9	8	7	6	5	4	3	2	1	0	15	14	13	12	11	10	9	8	7	6	5	4	3	2	1	0
1	1	1	0	1	0	0	0	1	1	0	1	Rn				Rt				(1)	(1)	(1)	(1)	1	1	1	0	(1)	(1)	(1)	(1)

t = UInt(Rt); n = UInt(Rn);
 if t == 15 || n == 15 then UNPREDICTABLE;

Encoding A1 ARMv8

LDAEX <Rt>, [<Rn>]

31	30	29	28	27	26	25	24	23	22	21	20	19	18	17	16	15	14	13	12	11	10	9	8	7	6	5	4	3	2	1	0
cond		0	0	0	1	1	0	0	1	Rn				Rt				(1)	(1)	1	0	1	0	0	1	(1)	(1)	(1)	(1)		

t = UInt(Rt); n = UInt(Rn);
 if t == 15 || n == 15 then UNPREDICTABLE;

For information about the CONSTRAINED UNPREDICTABLE behavior of this instruction, see [Appendix A Architectural Constraints on UNPREDICTABLE behaviors](#), and particularly *LDAEX* on page AppxA-4718.

Assembler syntax

LDAEX{<c>}{<q>} <Rt>, [<Rn>]

where:

<c>, <q> See *Standard assembler syntax fields* on page F2-2415.

<Rt> The destination register.

<Rn> The base register. The SP can be used.

Operation

```

if ConditionPassed() then
    EncodingSpecificOperations(); NullCheckIfThumbEE(n);
    address = R[n];
    acctype = AccType_ORDERED;
    aligned = (address == Align(address, 4));
    AArch32.SetExclusiveMonitors(address, 4);
    R[t] = MemA_with_type[address, 4, acctype, aligned];
    
```

F7.1.57 LDAEXB

Load-Acquire Exclusive Byte loads a byte from memory, zero-extends it to form a 32-bit word, writes it to a register and:

- If the address has the Shared Memory attribute, marks the physical address as exclusive access for the executing PE in a global monitor.
- Causes the executing PE to indicate an active exclusive access in the local monitor.

The instruction also has memory ordering semantics as described in *Load-Acquire, Store-Release* on page E2-2355.

For more information about support for shared memory see *Synchronization and semaphores* on page E2-2369. For information about memory accesses see *Memory accesses* on page F2-2422.

Encoding T1 ARMv8

LDAEXB<c> <Rt>, [<Rn>]

15	14	13	12	11	10	9	8	7	6	5	4	3	2	1	0	15	14	13	12	11	10	9	8	7	6	5	4	3	2	1	0
1	1	1	0	1	0	0	0	1	1	0	1	Rn				Rt				(1)	(1)	(1)	(1)	1	1	0	0	(1)	(1)	(1)	(1)

t = UInt(Rt); n = UInt(Rn);
 if t == 15 || n == 15 then UNPREDICTABLE;

Encoding A1 ARMv8

LDAEXB <Rt>, [<Rn>]

31	30	29	28	27	26	25	24	23	22	21	20	19	18	17	16	15	14	13	12	11	10	9	8	7	6	5	4	3	2	1	0
cond		0	0	0	1	1	1	0	1	Rn				Rt				(1)	(1)	1	0	1	0	0	1	(1)	(1)	(1)	(1)		

t = UInt(Rt); n = UInt(Rn);
 if t == 15 || n == 15 then UNPREDICTABLE;

For information about the CONSTRAINED UNPREDICTABLE behavior of this instruction, see [Appendix A Architectural Constraints on UNPREDICTABLE behaviors](#), and particularly *LDAEXB* on page AppxA-4718.

Assembler syntax

LDAEXB{<c>}{<q>} <Rt>, [<Rn>]

where:

<c>, <q> See *Standard assembler syntax fields* on page F2-2415.

<Rt> The destination register.

<Rn> The base register. The SP can be used.

Operation

```

if ConditionPassed() then
    EncodingSpecificOperations(); NullCheckIfThumbEE(n);
    address = R[n];
    acctype = AccType_ORDERED;
    aligned = TRUE;
    AArch32.SetExclusiveMonitors(address, 1);
    R[t] = ZeroExtend(MemA_with_type[address, 1, acctype, aligned], 32);
  
```

F7.1.58 LDAEXD

Load-Acquire Exclusive Dual loads a doubleword from memory, writes it to two registers and:

- If the address has the Shared Memory attribute, marks the physical address as exclusive access for the executing PE in a global monitor
- Causes the executing PE to indicate an active exclusive access in the local monitor.

The instruction also acts as a barrier instruction with the ordering requirements described in [Load-Acquire, Store-Release on page E2-2355](#).

For more information about support for shared memory see [Synchronization and semaphores on page E2-2369](#). For information about memory accesses see [Memory accesses on page F2-2422](#).

Encoding T1 ARMv8

LDAEXD<c> <Rt>, <Rt2>, [<Rn>]

15	14	13	12	11	10	9	8	7	6	5	4	3	2	1	0	15	14	13	12	11	10	9	8	7	6	5	4	3	2	1	0
1	1	1	0	1	0	0	0	1	1	0	1	Rn				Rt				Rt2				1	1	1	1	(1)	(1)	(1)	(1)

t = UInt(Rt); t2 = UInt(Rt2); n = UInt(Rn);
 if t == 15 || t2 == 15 || t == t2 || n == 15 then UNPREDICTABLE;

Encoding A1 ARMv8

LDAEXD <Rt>, <Rt2>, [<Rn>]

31	30	29	28	27	26	25	24	23	22	21	20	19	18	17	16	15	14	13	12	11	10	9	8	7	6	5	4	3	2	1	0
cond		0	0	0	1	1	0	1	1	Rn				Rt				(1)	(1)	1	0	1	0	0	1	(1)	(1)	(1)	(1)		

t = UInt(Rt); t2 = t + 1; n = UInt(Rn);
 if Rt<0> == '1' || t2 == 15 || n == 15 then UNPREDICTABLE;

For information about the CONSTRAINED UNPREDICTABLE behavior of this instruction, see [Appendix A Architectural Constraints on UNPREDICTABLE behaviors](#), and particularly [LDAEXD on page AppxA-4719](#).

Assembler syntax

LDAEXD{<c>}{<q>} <Rt>, <Rt2>, [<Rn>]

where:

- <c>, <q> See [Standard assembler syntax fields on page F2-2415](#).
- <Rt> The first destination register. For an A32 instruction, <Rt> must be even-numbered and not R14.
- <Rt2> The second destination register. For an A32 instruction, <Rt2> must be <R(t+1)>.
- <Rn> The base register. The SP can be used.

Operation

```

if ConditionPassed() then
    EncodingSpecificOperations(); NullCheckIfThumbEE(n);
    address = R[n];
    AArch32.SetExclusiveMonitors(address, 8);
    acctype = AccType_ORDERED;
    aligned = (address == Align(address, 8));
    value = MemA_with_type[address, 8, acctype, aligned];
    // Extract words from 64-bit loaded value such that R[t] is
    // loaded from address and R[t2] from address+4.
    R[t] = if BigEndian() then value<63:32> else value<31:0>;
    R[t2] = if BigEndian() then value<31:0> else value<63:32>;
    
```

F7.1.59 LDAEXH

Load-Acquire Exclusive Halfword loads a halfword from memory, zero-extends it to form a 32-bit word, writes it to a register and:

- If the address has the Shared Memory attribute, marks the physical address as exclusive access for the executing PE in a global monitor.
- Causes the executing PE to indicate an active exclusive access in the local monitor.

The instruction also has memory ordering semantics as described in *Load-Acquire, Store-Release* on page E2-2355.

For more information about support for shared memory see *Synchronization and semaphores* on page E2-2369. For information about memory accesses see *Memory accesses* on page F2-2422.

Encoding T1 ARMv8

LDAEXH<c> <Rt>, [<Rn>]

15	14	13	12	11	10	9	8	7	6	5	4	3	2	1	0	15	14	13	12	11	10	9	8	7	6	5	4	3	2	1	0
1	1	1	0	1	0	0	0	1	1	0	1	Rn				Rt				(1)	(1)	(1)	(1)	1	1	0	1	(1)	(1)	(1)	(1)

t = UInt(Rt); n = UInt(Rn);
 if t == 15 || n == 15 then UNPREDICTABLE;

Encoding A1 ARMv8

LDAEXH <Rt>, [<Rn>]

31	30	29	28	27	26	25	24	23	22	21	20	19	18	17	16	15	14	13	12	11	10	9	8	7	6	5	4	3	2	1	0
cond		0	0	0	1	1	1	1	1	Rn				Rt				(1)	(1)	1	0	1	0	0	1	(1)	(1)	(1)	(1)		

t = UInt(Rt); n = UInt(Rn);
 if t == 15 || n == 15 then UNPREDICTABLE;

For information about the CONSTRAINED UNPREDICTABLE behavior of this instruction, see [Appendix A Architectural Constraints on UNPREDICTABLE behaviors](#), and particularly *LDAEXH* on page AppxA-4718.

Assembler syntax

LDAEXH{<c>}{<q>} <Rt>, [<Rn>]

where:

<c>, <q> See *Standard assembler syntax fields* on page F2-2415.

<Rt> The destination register.

<Rn> The base register. The SP can be used.

Operation

```

if ConditionPassed() then
    EncodingSpecificOperations(); NullCheckIfThumbEE(n);
    address = R[n];
    acctype = AccType_ORDERED;
    aligned = (address == Align(address, 2));
    AArch32.SetExclusiveMonitors(address, 2);
    R[t] = ZeroExtend(MemA_with_type[address, 2, acctype, aligned], 32);
  
```

F7.1.60 LDAH

Load-Acquire Halfword loads a halfword from memory, zero-extends it to form a 32-bit word and writes it to a register. The instruction also has memory ordering semantics as described in [Load-Acquire, Store-Release](#) on page E2-2355.

For more information about support for shared memory see [Synchronization and semaphores](#) on page E2-2369. For information about memory accesses see [Memory accesses](#) on page F2-2422.

Encoding T1 ARMv8

LDAH<C> <Rt>, [<Rn>]

15	14	13	12	11	10	9	8	7	6	5	4	3	2	1	0	15	14	13	12	11	10	9	8	7	6	5	4	3	2	1	0
1	1	1	0	1	0	0	0	1	1	0	1	Rn				Rt				(1)	(1)	(1)	(1)	1	0	0	1	(1)	(1)	(1)	(1)

t = UInt(Rt); n = UInt(Rn);
 if t == 15 || n == 15 then UNPREDICTABLE;

Encoding A1 ARMv8

LDAH <Rt>, [<Rn>]

31	30	29	28	27	26	25	24	23	22	21	20	19	18	17	16	15	14	13	12	11	10	9	8	7	6	5	4	3	2	1	0
cond				0	0	0	1	1	1	1	Rn				Rt				(1)	(1)	0	0	1	0	0	1	(1)	(1)	(1)	(1)	

t = UInt(Rt); n = UInt(Rn);
 if t == 15 || n == 15 then UNPREDICTABLE;

For information about the CONSTRAINED UNPREDICTABLE behavior, see [Appendix A Architectural Constraints on UNPREDICTABLE behaviors](#).

Assembler syntax

LDAH{<c>}{<q>} <Rt>, [<Rn>]

where:

<c>, <q> See *Standard assembler syntax fields* on page F2-2415.

<Rt> The destination register.

<Rn> The base register. The SP can be used.

Operation

```
if ConditionPassed() then
    EncodingSpecificOperations(); NullCheckIfThumbEE(n);
    address = R[n];
    acctype = AccType_ORDERED;
    aligned = (address == Align(address, 2));
    R[t] = ZeroExtend(MemA_with_type[address, 2, acctype, aligned], 32);
```

F7.1.61 LDC, LDC2 (immediate)

Load Coprocessor loads memory data from a sequence of consecutive memory addresses to a conceptual coprocessor. If no coprocessor can execute the instruction, an Undefined Instruction exception is generated.

This is a generic coprocessor instruction. Some of the fields have no functionality defined by the architecture and are free for use by the coprocessor instruction set designer. These are the D bit, the CRd field, and in the Unindexed addressing mode only, the imm8 field. However, coprocessors CP8-CP15 are reserved for use by A32, and this manual defines the valid LDC and LDC2 instructions when coproc is in the range p8-p15. For more information see [Coprocesor support on page E1-2331](#).

In an implementation that includes EL2, the permitted LDC access to a system control register can be trapped to Hyp mode, meaning that an attempt to execute an LDC instruction in a Non-secure mode other than Hyp mode, that would be permitted in the absence of the Hyp trap controls, generates a Hyp Trap exception. For more information, see [Trapping general CP14 accesses to debug registers on page G1-3515](#).

———— **Note** —————

For simplicity, the LDC pseudocode does not show this possible trap to Hyp mode.

Encoding T1/A1 ARMv6T2, ARMv7 for encoding T1
 ARMv4*, ARMv5T*, ARMv6*, ARMv7 for encoding A1

LDC{L}<C> <coproc>, <CRd>, [<Rn>, #+/-<imm>]{!}
 LDC{L}<C> <coproc>, <CRd>, [<Rn>], #+/-<imm>
 LDC{L}<C> <coproc>, <CRd>, [<Rn>], <option>

15	14	13	12	11	10	9	8	7	6	5	4	3	2	1	0	15	14	13	12	11	10	9	8	7	6	5	4	3	2	1	0
1	1	1	0	1	1	0	P	U	D	W	1		Rn		CRd		coproc														

31	30	29	28	27	26	25	24	23	22	21	20	19	18	17	16	15	14	13	12	11	10	9	8	7	6	5	4	3	2	1	0
	cond																														

```

if Rn == '1111' then SEE LDC (literal);
if P == '0' && U == '0' && D == '0' && W == '0' then UNDEFINED;
if P == '0' && U == '0' && D == '1' && W == '0' then SEE MRRC, MRRC2;
if coproc == '101x' then SEE "Advanced SIMD and Floating-point";
n = UInt(Rn); cp = UInt(coproc);
imm32 = ZeroExtend(imm8:'00', 32); index = (P == '1'); add = (U == '1'); wback = (W == '1');
    
```

Encoding T2/A2 ARMv6T2, ARMv7 for encoding T2
 ARMv5T*, ARMv6*, ARMv7 for encoding A2

LDC2{L}<C> <coproc>, <CRd>, [<Rn>, #+/-<imm>]{!}
 LDC2{L}<C> <coproc>, <CRd>, [<Rn>], #+/-<imm>
 LDC2{L}<C> <coproc>, <CRd>, [<Rn>], <option>

15	14	13	12	11	10	9	8	7	6	5	4	3	2	1	0	15	14	13	12	11	10	9	8	7	6	5	4	3	2	1	0
1	1	1	1	1	1	0	P	U	D	W	1		Rn		CRd		coproc														

31	30	29	28	27	26	25	24	23	22	21	20	19	18	17	16	15	14	13	12	11	10	9	8	7	6	5	4	3	2	1	0
	1	1	1	1	1	0	P	U	D	W	1		Rn		CRd		coproc														

```

if Rn == '1111' then SEE LDC (literal);
if P == '0' && U == '0' && D == '0' && W == '0' then UNDEFINED;
if P == '0' && U == '0' && D == '1' && W == '0' then SEE MRRC, MRRC2;
if coproc == '101x' then UNDEFINED;
n = UInt(Rn); cp = UInt(coproc);
imm32 = ZeroExtend(imm8:'00', 32); index = (P == '1'); add = (U == '1'); wback = (W == '1');
    
```

Advanced SIMD and floating-point See [Extension register load/store instructions on page F5-2514](#)

Assembler syntax

LDC{2}{L}{<c>}{<q>} <coproc>, <CRd>, [<Rn>{, #+/-<imm>}] Offset. P = 1, W = 0.
 LDC{2}{L}{<c>}{<q>} <coproc>, <CRd>, [<Rn>, #+/-<imm>]! Pre-indexed. P = 1, W = 1.
 LDC{2}{L}{<c>}{<q>} <coproc>, <CRd>, [<Rn>], #+/-<imm> Post-indexed. P = 0, W = 1.
 LDC{2}{L}{<c>}{<q>} <coproc>, <CRd>, [<Rn>], <option> Unindexed. P = 0, W = 0, U = 1.

where:

2 If specified, selects encoding T2/A2. If omitted, selects encoding T1/A1.
 L If specified, selects the D == 1 form of the encoding. If omitted, selects the D == 0 form.
 <c>, <q> See *Standard assembler syntax fields on page F2-2415*. An A32 LDC2 instruction must be unconditional.
 <coproc> The name of the coprocessor. The generic coprocessor names are p0-p15.
 <CRd> The coprocessor destination register.
 <Rn> The base register. The SP can be used. For PC use see *LDC, LDC2 (literal) on page F7-2622*.
 +/- Is + or omitted if the immediate offset is to be added to the base register value (add == TRUE, encoded as U == 1), or – if it is to be subtracted (add == FALSE, encoded as U == 0). #0 and #-0 generate different instructions.
 <imm> The immediate offset used for forming the address. Values are multiples of 4 in the range 0-1020. For the offset addressing syntax, <imm> can be omitted, meaning an offset of +0.
 <option> A coprocessor option. An integer in the range 0-255 enclosed in { }. Encoded in imm8.

The pre-UAL syntax LDC<c>L is equivalent to LDCL<c>.

Operation

```

if ConditionPassed() then
    EncodingSpecificOperations();
    if !Cproc_Accepted(cp, ThisInstr()) then
        GenerateCoproprocessorException();
    else
        NullCheckIfThumbEE(n);
        offset_addr = if add then (R[n] + imm32) else (R[n] - imm32);
        address = if index then offset_addr else R[n];
        repeat
            Cproc_SendLoadedWord(MemA[address,4], cp, ThisInstr());
            address = address + 4;
        until Cproc_DoneLoading(cp, ThisInstr());
        if wback then R[n] = offset_addr;
  
```

F7.1.62 LDC, LDC2 (literal)

Load Coprocessor loads memory data from a sequence of consecutive memory addresses to a conceptual coprocessor. If no coprocessor can execute the instruction, an Undefined Instruction exception is generated.

This is a generic coprocessor instruction. Some of the fields have no functionality defined by the architecture and are free for use by the coprocessor instruction set designer. These are the D bit, the CRd field, and in the Unindexed addressing mode only, the imm8 field. However, coprocessors CP8-CP15 are reserved for use by A32, and this manual defines the valid LDC and LDC2 instructions when coproc is in the range p8-p15. For more information see [Coprocessor support on page E1-2331](#).

In an implementation that includes EL2, the permitted LDC access to a system control register can be trapped to Hyp mode, meaning that an attempt to execute an LDC instruction in a Non-secure mode other than Hyp mode, that would be permitted in the absence of the Hyp trap controls, generates a Hyp Trap exception. For more information, see [Trapping general CP14 accesses to debug registers on page G1-3515](#).

———— Note ————

For simplicity, the LDC pseudocode does not show this possible trap to Hyp mode.

Encoding T1/A1 ARMv6T2, ARMv7 for encoding T1
 ARMv4*, ARMv5T*, ARMv6*, ARMv7 for encoding A1

LDC{L}<C> <coproc>, <CRd>, <label>

LDC{L}<C> <coproc>, <CRd>, [PC, #-0] Special case

LDC{L}<C> <coproc>, <CRd>, [PC], <option>

15	14	13	12	11	10	9	8	7	6	5	4	3	2	1	0	15	14	13	12	11	10	9	8	7	6	5	4	3	2	1	0
1	1	1	0	1	1	0	P	U	D	W	1	1	1	1	1	CRd	coproc				imm8										

31	30	29	28	27	26	25	24	23	22	21	20	19	18	17	16	15	14	13	12	11	10	9	8	7	6	5	4	3	2	1	0
cond		1	1	0	P	U	D	W	1	1	1	1	1	1	1	CRd	coproc				imm8										

```

if P == '0' && U == '0' && D == '0' && W == '0' then UNDEFINED;
if P == '0' && U == '0' && D == '1' && W == '0' then SEE MRRC, MRRC2;
if coproc == '101x' then SEE "Advanced SIMD and Floating-point";
index = (P == '1'); add = (U == '1'); cp = UInt(coproc); imm32 = ZeroExtend(imm8:'00', 32);
if W == '1' || (P == '0' && CurrentInstrSet() != InstrSet_A32) then UNPREDICTABLE;
    
```

Encoding T2/A2 ARMv6T2, ARMv7 for encoding T2
 ARMv5T*, ARMv6*, ARMv7 for encoding A2

LDC2{L}<C> <coproc>, <CRd>, <label>

LDC2{L}<C> <coproc>, <CRd>, [PC, #-0] Special case

LDC2{L}<C> <coproc>, <CRd>, [PC], <option>

15	14	13	12	11	10	9	8	7	6	5	4	3	2	1	0	15	14	13	12	11	10	9	8	7	6	5	4	3	2	1	0
1	1	1	1	1	1	0	P	U	D	W	1	1	1	1	1	CRd	coproc				imm8										

31	30	29	28	27	26	25	24	23	22	21	20	19	18	17	16	15	14	13	12	11	10	9	8	7	6	5	4	3	2	1	0
1	1	1	1	1	1	0	P	U	D	W	1	1	1	1	1	CRd	coproc				imm8										

```

if P == '0' && U == '0' && D == '0' && W == '0' then UNDEFINED;
if P == '0' && U == '0' && D == '1' && W == '0' then SEE MRRC, MRRC2;
if coproc == '101x' then UNDEFINED;
index = (P == '1'); add = (U == '1'); cp = UInt(coproc); imm32 = ZeroExtend(imm8:'00', 32);
if W == '1' || (P == '0' && CurrentInstrSet() != InstrSet_A32) then UNPREDICTABLE;
    
```

For information about the CONSTRAINED UNPREDICTABLE behavior of this instruction, see [Appendix A Architectural Constraints on UNPREDICTABLE behaviors](#), and particularly [LDC/LDC2 \(literal\) on page AppxA-4704](#).

Advanced SIMD and floating-point See [Extension register load/store instructions on page F5-2514](#)

Assembler syntax

LDC{2}{L}{<c>}{<q>}	<coproc>, <CRd>, <label>	Normal form with P = 1, W = 0
LDC{2}{L}{<c>}{<q>}	<coproc>, <CRd>, [PC, #+/-<imm>]	Alternative form with P = 1, W = 0
LDC{2}{L}{<c>}{<q>}	<coproc>, <CRd>, [PC], <option>	Unindexed form with P = 0, U = 1, W = 0, encoding A1/A2 only

where:

2	If specified, selects encoding T2/A2. If omitted, selects encoding T1/A1.
L	If specified, selects the D == 1 form of the encoding. If omitted, selects the D == 0 form.
<c>, <q>	See Standard assembler syntax fields on page F2-2415 . An A32 LDC2 instruction must be unconditional.
<coproc>	The name of the coprocessor. The generic coprocessor names are p0-p15.
<CRd>	The coprocessor destination register.
<label>	The label of the literal data item that is to be loaded into <Rt>. The assembler calculates the required value of the offset from the Align(PC, 4) value of the instruction to this label. Permitted values of the offset are multiples of 4 in the range -1020 to 1020. If the offset is zero or positive, imm32 is equal to the offset and add == TRUE (encoded as U == 1). If the offset is negative, imm32 is equal to minus the offset and add == FALSE (encoded as U == 0).

The alternative syntax permits the addition or subtraction of the offset and the immediate offset to be specified separately, including permitting a subtraction of 0 that cannot be specified using the normal syntax. For more information, see [Use of labels in UAL instruction syntax on page F1-2380](#).

The unindexed form is permitted for the A32 instruction set only. In it, <option> is a coprocessor option, written as an integer 0-255 enclosed in { } and encoded in imm8.

The pre-UAL syntax LDC<c>L is equivalent to LDCL<c>.

Operation

```

if ConditionPassed() then
    EncodingSpecificOperations();
    if !Cproc_Accepted(cp, ThisInstr()) then
        GenerateCoproprocessorException();
    else
        NullCheckIfThumbEE(15);
        offset_addr = if add then (Align(PC,4) + imm32) else (Align(PC,4) - imm32);
        address = if index then offset_addr else Align(PC,4);
        repeat
            Cproc_SendLoadedWord(MemA[address,4], cp, ThisInstr());
            address = address + 4;
        until Cproc_DoneLoading(cp, ThisInstr());
  
```

F7.1.63 LDM/LDMIA/LDMFD (T32)

Load Multiple Increment After (Load Multiple Full Descending) loads multiple registers from consecutive memory locations using an address from a base register. The consecutive memory locations start at this address, and the address just above the highest of those locations can optionally be written back to the base register. The registers loaded can include the PC, causing a branch to a loaded address. Related system instructions are *LDM (User registers)* on page F7-3044 and *LDM (exception return)* on page F7-3042.

Encoding T1 ARMv4T, ARMv5T*, ARMv6*, ARMv7 (not in ThumbEE)

LDM<c> <Rn>!, <registers> <Rn> not included in <registers>

LDM<c> <Rn>, <registers> <Rn> included in <registers>

15	14	13	12	11	10	9	8	7	6	5	4	3	2	1	0
1	1	0	0	1	Rn					register_list					

```
if CurrentInstrSet() == InstrSet_T32EE then SEE "ThumbEE instructions";
n = UInt(Rn); registers = '00000000':register_list; wback = (registers<n> == '0');
if BitCount(registers) < 1 then UNPREDICTABLE;
```

Encoding T2 ARMv6T2, ARMv7

LDM<c>.W <Rn>{!}, <registers>

15	14	13	12	11	10	9	8	7	6	5	4	3	2	1	0	15	14	13	12	11	10	9	8	7	6	5	4	3	2	1	0
1	1	1	0	1	0	0	0	1	0	W	1	Rn			P	M	(0)	register_list													

```
if W == '1' && Rn == '1101' then SEE POP (Thumb);
n = UInt(Rn); registers = P:M:'0':register_list; wback = (W == '1');
if n == 15 || BitCount(registers) < 2 || (P == '1' && M == '1') then UNPREDICTABLE;
if wback && registers<n> == '1' then UNPREDICTABLE;
if registers<15> == '1' && InITBlock() && !LastInITBlock() then UNPREDICTABLE;
```

For information about the CONSTRAINED UNPREDICTABLE behavior of this instruction, see [Appendix A Architectural Constraints on UNPREDICTABLE behaviors](#), and particularly *LDM/LDMIA/LDMFD (T32)* on page AppxA-4705.

ThumbEE instructions ARM deprecates any use of ThumbEE instructions and they are not documented in this manual.

Assembler syntax

LDM{<c>}{<q>} <Rn>{!}, <registers>

where:

<c>, <q> See [Standard assembler syntax fields on page F2-2415](#).

<Rn> The base register. SP can be used. If it is the SP and ! is specified, the instruction is treated as described in [POP \(T32\) on page F7-2756](#).

! Causes the instruction to write a modified value back to <Rn>. Encoded as W = 1. If ! is omitted, the instruction does not change <Rn> in this way. Encoded as W = 0.

<registers> Is a list of one or more registers to be loaded, separated by commas and surrounded by { and }. The lowest-numbered register is loaded from the lowest memory address, through to the highest-numbered register from the highest memory address. See also [Encoding of lists of general-purpose registers and the PC on page F2-2426](#).

Encoding T2 does not support a list containing only one register. If an LDMIA instruction with just one register <Rt> in the list is assembled to T32 and encoding T1 is not available, it is assembled to the equivalent LDR{<c>}{<q>} <Rt>, [<Rn>]{, #4} instruction.

The SP cannot be in the list.

The PC can be in the list. If it is, the instruction branches to the address loaded to the PC. In ARMv5T and above, this is an interworking branch, see [Pseudocode details of operations on the AArch32 general-purpose registers and the PC on page E1-2296](#). If the PC is in the list:

- The LR must not be in the list.
- The instruction must be either outside any IT block, or the last instruction in an IT block.

If ! is specified, <registers> cannot include the base register.

LDMIA and LDMFD are pseudo-instructions for LDM. LDMFD refers to its use for popping data from Full Descending stacks.

The pre-UAL syntaxes LDM<c>IA and LDM<c>FD are equivalent to LDM<c>.

Operation

```
if ConditionPassed() then
    EncodingSpecificOperations(); NullCheckIfThumbEE(n);
    address = R[n];
    for i = 0 to 14
        if registers<i> == '1' then
            R[i] = MemA[address,4]; address = address + 4;
    if registers<15> == '1' then
        LoadWritePC(MemA[address,4]);
    if wback && registers<n> == '0' then R[n] = R[n] + 4*BitCount(registers);
    if wback && registers<n> == '1' then R[n] = bits(32) UNKNOWN;
```

F7.1.64 LDM/LDMIA/LDMFD (A32)

Load Multiple Increment After (Load Multiple Full Descending) loads multiple registers from consecutive memory locations using an address from a base register. The consecutive memory locations start at this address, and the address just above the highest of those locations can optionally be written back to the base register. The registers loaded can include the PC, causing a branch to a loaded address. Related system instructions are [LDM \(User registers\)](#) on page F7-3044 and [LDM \(exception return\)](#) on page F7-3042.

Encoding A1 ARMv4*, ARMv5T*, ARMv6*, ARMv7

LDM<c> <Rn>{!}, <registers>

31	30	29	28	27	26	25	24	23	22	21	20	19	18	17	16	15	14	13	12	11	10	9	8	7	6	5	4	3	2	1	0
cond			1	0	0	0	1	0	W	1	Rn					register_list															

```

if W == '1' && Rn == '1101' && BitCount(register_list) > 1 then SEE POP (ARM);
n = UInt(Rn); registers = register_list; wback = (W == '1');
if n == 15 || BitCount(registers) < 1 then UNPREDICTABLE;
if wback && registers<n> == '1' then UNPREDICTABLE;
    
```

For information about the CONSTRAINED UNPREDICTABLE behavior of this instruction, see [Appendix A Architectural Constraints on UNPREDICTABLE behaviors](#), and particularly [LDM/LDMIA/LDMFD \(A32\)](#) on page AppxA-4705.

Assembler syntax

LDM{<c>}{<q>} <Rn>{!}, <registers>

where:

- <c>, <q> See [Standard assembler syntax fields on page F2-2415](#).
- <Rn> The base register. SP can be used. If the SP is used, ! is specified, and there is more than one register in the <registers> list, the instruction is treated as described in [POP \(A32\) on page F7-2758](#).
- ! Causes the instruction to write a modified value back to <Rn>. Encoded as W = 1. If ! is omitted, the instruction does not change <Rn> in this way. Encoded as W = 0.
- <registers> Is a list of one or more registers to be loaded, separated by commas and surrounded by { and }. The lowest-numbered register is loaded from the lowest memory address, through to the highest-numbered register from the highest memory address. See also [Encoding of lists of general-purpose registers and the PC on page F2-2426](#).
- The SP can be in the list. However, ARM deprecates using these instructions with SP in the list.
- The PC can be in the list. If it is, the instruction branches to the address loaded to the PC. In ARMv5T and above, this is an interworking branch, see [Pseudocode details of operations on the AArch32 general-purpose registers and the PC on page E1-2296](#).
- ARM deprecates using these instructions with both the LR and the PC in the list.

LDMIA and LDMFD are pseudo-instructions for LDM. LDMFD refers to its use for popping data from Full Descending stacks.

The pre-UAL syntaxes LDM<c>IA and LDM<c>FD are equivalent to LDM<c>.

Operation

```
if ConditionPassed() then
    EncodingSpecificOperations(); NullCheckIfThumbEE(n);
    address = R[n];
    for i = 0 to 14
        if registers<i> == '1' then
            R[i] = MemA[address,4]; address = address + 4;
    if registers<15> == '1' then
        LoadWritePC(MemA[address,4]);
    if wback && registers<n> == '0' then R[n] = R[n] + 4*BitCount(registers);
    if wback && registers<n> == '1' then R[n] = bits(32) UNKNOWN;
```

F7.1.65 LDMDA/LDMFA

Load Multiple Decrement After (Load Multiple Full Ascending) loads multiple registers from consecutive memory locations using an address from a base register. The consecutive memory locations end at this address, and the address just below the lowest of those locations can optionally be written back to the base register. The registers loaded can include the PC, causing a branch to a loaded address.

Related system instructions are [LDM \(User registers\) on page F7-3044](#) and [LDM \(exception return\) on page F7-3042](#).

Encoding A1 ARMv4*, ARMv5T*, ARMv6*, ARMv7
 LDMDA<c> <Rn>{!}, <registers>

31	30	29	28	27	26	25	24	23	22	21	20	19	18	17	16	15	14	13	12	11	10	9	8	7	6	5	4	3	2	1	0
cond		1	0	0	0	0	0	W	1	Rn		register_list																			

```
n = UInt(Rn); registers = register_list; wback = (W == '1');
if n == 15 || BitCount(registers) < 1 then UNPREDICTABLE;
if wback && registers<n> == '1' then UNPREDICTABLE;
```

For information about the CONSTRAINED UNPREDICTABLE behavior of this instruction, see [Appendix A Architectural Constraints on UNPREDICTABLE behaviors](#), and particularly [LDMDA/LDMFA on page AppxA-4706](#).

Assembler syntax

LMDMA{<c>}{<q>} <Rn>{!}, <registers>

where:

<c>, <q> See [Standard assembler syntax fields on page F2-2415](#).

<Rn> The base register. SP can be used.

! Causes the instruction to write a modified value back to <Rn>. Encoded as W = 1.
If ! is omitted, the instruction does not change <Rn> in this way. Encoded as W = 0.

<registers> Is a list of one or more registers to be loaded, separated by commas and surrounded by { and }. The lowest-numbered register is loaded from the lowest memory address, through to the highest-numbered register from the highest memory address. See also [Encoding of lists of general-purpose registers and the PC on page F2-2426](#).

The SP can be in the list. However, instructions that include the SP in the list are deprecated.

The PC can be in the list. If it is, the instruction branches to the address (data) loaded to the PC. In ARMv5T and above, this branch is an interworking branch, see [Pseudocode details of operations on the AArch32 general-purpose registers and the PC on page E1-2296](#).

Instructions that include both the LR and the PC in the list are deprecated.

LDMFA is a pseudo-instruction for LMDMA, referring to its use for popping data from Full Ascending stacks.

The pre-UAL syntaxes LDM<c>DA and LDM<c>FA are equivalent to LMDMA<c>.

Operation

```
if ConditionPassed() then
    EncodingSpecificOperations();
    address = R[n] - 4*BitCount(registers) + 4;
    for i = 0 to 14
        if registers<i> == '1' then
            R[i] = MemA[address,4]; address = address + 4;
    if registers<15> == '1' then
        LoadWritePC(MemA[address,4]);
    if wback && registers<n> == '0' then R[n] = R[n] - 4*BitCount(registers);
    if wback && registers<n> == '1' then R[n] = bits(32) UNKNOWN;
```

F7.1.66 LDMDB/LDMEA

Load Multiple Decrement Before (Load Multiple Empty Ascending) loads multiple registers from consecutive memory locations using an address from a base register. The consecutive memory locations end just below this address, and the address of the lowest of those locations can optionally be written back to the base register. The registers loaded can include the PC, causing a branch to a loaded address.

Related system instructions are [LDM \(User registers\) on page F7-3044](#) and [LDM \(exception return\) on page F7-3042](#).

Encoding T1 ARMv6T2, ARMv7

LDMDB<c> <Rn>{!}, <registers>

15	14	13	12	11	10	9	8	7	6	5	4	3	2	1	0	15	14	13	12	11	10	9	8	7	6	5	4	3	2	1	0	
1	1	1	0	1	0	0	1	0	0	W	1			Rn		P	M	(0)	register_list													

```
n = UInt(Rn); registers = P:M:'0':register_list; wback = (W == '1');
if n == 15 || BitCount(registers) < 2 || (P == '1' && M == '1') then UNPREDICTABLE;
if wback && registers<n> == '1' then UNPREDICTABLE;
if registers<15> == '1' && InITBlock() && !LastInITBlock() then UNPREDICTABLE;
```

Encoding A1 ARMv4*, ARMv5T*, ARMv6*, ARMv7

LDMDB<c> <Rn>{!}, <registers>

31	30	29	28	27	26	25	24	23	22	21	20	19	18	17	16	15	14	13	12	11	10	9	8	7	6	5	4	3	2	1	0
cond		1	0	0	1	0	0	W	1			Rn	register_list																		

```
n = UInt(Rn); registers = register_list; wback = (W == '1');
if n == 15 || BitCount(registers) < 1 then UNPREDICTABLE;
if wback && registers<n> == '1' then UNPREDICTABLE;
```

For information about the CONSTRAINED UNPREDICTABLE behavior of this instruction, see [Appendix A Architectural Constraints on UNPREDICTABLE behaviors](#), and particularly [LDMDB/LDMEA on page AppxA-4707](#).

Assembler syntax

LDMDB{<c>}{<q>} <Rn>{!}, <registers>

where:

<c>, <q> See [Standard assembler syntax fields on page F2-2415](#).

<Rn> The base register. The SP can be used.

! Causes the instruction to write a modified value back to <Rn>. Encoded as W = 1.
If ! is omitted, the instruction does not change <Rn> in this way. Encoded as W = 0.

<registers> Is a list of one or more registers to be loaded, separated by commas and surrounded by { and }. The lowest-numbered register is loaded from the lowest memory address, through to the highest-numbered register from the highest memory address. See also [Encoding of lists of general-purpose registers and the PC on page F2-2426](#).

Encoding T1 does not support a list containing only one register. If an LDMDB instruction with just one register <Rt> in the list is assembled to T32, it is assembled to the equivalent LDR{<c>}{<q>} <Rt>, [<Rn>, #-4]{!} instruction.

The SP can be in the list in A32 instructions, but not in T32 instructions. However, A32 instructions that include the SP in the list are deprecated.

The PC can be in the list. If it is, the instruction branches to the address loaded to the PC. In ARMv5T and above, this is an interworking branch, see [Pseudocode details of operations on the AArch32 general-purpose registers and the PC on page E1-2296](#). In T32 instructions, if the PC is in the list:

- The LR must not be in the list.
- The instruction must be either outside any IT block, or the last instruction in an IT block.

A32 instructions that include both the LR and the PC in the list are deprecated.

LDMEA is a pseudo-instruction for LDMDB, referring to its use for popping data from Empty Ascending stacks.

The pre-UAL syntaxes LDM<c>DB and LDM<c>EA are equivalent to LDMDB<c>.

Operation

```
if ConditionPassed() then
    EncodingSpecificOperations(); NullCheckIfThumbEE(n);
    address = R[n] - 4*BitCount(registers);
    for i = 0 to 14
        if registers<i> == '1' then
            R[i] = MemA[address,4]; address = address + 4;
    if registers<15> == '1' then
        LoadWritePC(MemA[address,4]);
    if wback && registers<n> == '0' then R[n] = R[n] - 4*BitCount(registers);
    if wback && registers<n> == '1' then R[n] = bits(32) UNKNOWN;
```

F7.1.67 LDMIB/LDMED

Load Multiple Increment Before (Load Multiple Empty Descending) loads multiple registers from consecutive memory locations using an address from a base register. The consecutive memory locations start just above this address, and the address of the last of those locations can optionally be written back to the base register. The registers loaded can include the PC, causing a branch to a loaded address.

Related system instructions are [LDM \(User registers\) on page F7-3044](#) and [LDM \(exception return\) on page F7-3042](#).

Encoding A1 ARMv4*, ARMv5T*, ARMv6*, ARMv7
 LDMIB<c> <Rn>{!}, <registers>

31	30	29	28	27	26	25	24	23	22	21	20	19	18	17	16	15	14	13	12	11	10	9	8	7	6	5	4	3	2	1	0
cond		1	0	0	1	1	0	W	1	Rn		register_list																			

```
n = UInt(Rn); registers = register_list; wback = (W == '1');
if n == 15 || BitCount(registers) < 1 then UNPREDICTABLE;
if wback && registers<n> == '1' then UNPREDICTABLE;
```

For information about the CONSTRAINED UNPREDICTABLE behavior of this instruction, see [Appendix A Architectural Constraints on UNPREDICTABLE behaviors](#), and particularly [LDMIB/LDMED on page AppxA-4706](#).

Assembler syntax

LDMIB{<c>}{<q>} <Rn>{!}, <registers>

where:

<c>, <q> See [Standard assembler syntax fields on page F2-2415](#).

<Rn> The base register. The SP can be used.

! Causes the instruction to write a modified value back to <Rn>. Encoded as W = 1.
If ! is omitted, the instruction does not change <Rn> in this way. Encoded as W = 0.

<registers> Is a list of one or more registers to be loaded, separated by commas and surrounded by { and }. The lowest-numbered register is loaded from the lowest memory address, through to the highest-numbered register from the highest memory address. See also [Encoding of lists of general-purpose registers and the PC on page F2-2426](#).

The SP can be in the list. However, instructions that include the SP in the list are deprecated.

The PC can be in the list. If it is, the instruction branches to the address (data) loaded to the PC. In ARMv5T and above, this branch is an interworking branch, see [Pseudocode details of operations on the AArch32 general-purpose registers and the PC on page E1-2296](#).

Instructions that include both the LR and the PC in the list are deprecated.

LDMED is a pseudo-instruction for LDMIB, referring to its use for popping data from Empty Descending stacks.

The pre-UAL syntaxes LDM<c>IB and LDM<c>ED are equivalent to LDMIB<c>.

Operation

```
if ConditionPassed() then
    EncodingSpecificOperations();
    address = R[n] + 4;
    for i = 0 to 14
        if registers<i> == '1' then
            R[i] = MemA[address,4]; address = address + 4;
    if registers<15> == '1' then
        LoadWritePC(MemA[address,4]);
    if wback && registers<n> == '0' then R[n] = R[n] + 4*BitCount(registers);
    if wback && registers<n> == '1' then R[n] = bits(32) UNKNOWN;
```

F7.1.68 LDR (immediate, T32)

Load Register (immediate) calculates an address from a base register value and an immediate offset, loads a word from memory, and writes it to a register. It can use offset, post-indexed, or pre-indexed addressing. For information about memory accesses see [Memory accesses](#) on page F2-2422.

Encoding T1 ARMv4T, ARMv5T*, ARMv6*, ARMv7
 LDR<c> <Rt>, [<Rn>{, #<imm>}]

15	14	13	12	11	10	9	8	7	6	5	4	3	2	1	0
0	1	1	0	1	imm5				Rn			Rt			

t = UInt(Rt); n = UInt(Rn); imm32 = ZeroExtend(imm5:'00', 32);
 index = TRUE; add = TRUE; wback = FALSE;

Encoding T2 ARMv4T, ARMv5T*, ARMv6*, ARMv7
 LDR<c> <Rt>, [SP{, #<imm>}]

15	14	13	12	11	10	9	8	7	6	5	4	3	2	1	0
1	0	0	1	1	Rt			imm8							

t = UInt(Rt); n = 13; imm32 = ZeroExtend(imm8:'00', 32);
 index = TRUE; add = TRUE; wback = FALSE;

Encoding T3 ARMv6T2, ARMv7
 LDR<c>.W <Rt>, [<Rn>{, #<imm12>}]

15	14	13	12	11	10	9	8	7	6	5	4	3	2	1	0	15	14	13	12	11	10	9	8	7	6	5	4	3	2	1	0
1	1	1	1	1	0	0	0	1	1	0	1	Rn			Rt			imm12													

if Rn == '1111' then SEE LDR (literal);
 t = UInt(Rt); n = UInt(Rn); imm32 = ZeroExtend(imm12, 32); index = TRUE; add = TRUE;
 wback = FALSE; if t == 15 && InITBlock() && !LastInITBlock() then UNPREDICTABLE;

Encoding T4 ARMv6T2, ARMv7
 LDR<c> <Rt>, [<Rn>, #-<imm8>]
 LDR<c> <Rt>, [<Rn>], #+/-<imm8>
 LDR<c> <Rt>, [<Rn>, #+/-<imm8>!]

15	14	13	12	11	10	9	8	7	6	5	4	3	2	1	0	15	14	13	12	11	10	9	8	7	6	5	4	3	2	1	0
1	1	1	1	1	0	0	0	0	1	0	1	Rn			Rt			1	P	U	W	imm8									

if Rn == '1111' then SEE LDR (literal);
 if P == '1' && U == '1' && W == '0' then SEE LDRT;
 if Rn == '1101' && P == '0' && U == '1' && W == '1' && imm8 == '00000100' then SEE POP;
 if P == '0' && W == '0' then UNDEFINED;
 t = UInt(Rt); n = UInt(Rn);
 imm32 = ZeroExtend(imm8, 32); index = (P == '1'); add = (U == '1'); wback = (W == '1');
 if (wback && n == t) || (t == 15 && InITBlock() && !LastInITBlock()) then UNPREDICTABLE;

For information about the CONSTRAINED UNPREDICTABLE behavior of this instruction, see [Appendix A Architectural Constraints on UNPREDICTABLE behaviors](#), and particularly [LDR \(immediate, T32\)](#) on page AppxA-4707.

Assembler syntax

LDR{<c>}{<q>} <Rt>, [<Rn> {, #+/-<imm>}]	Offset: index==TRUE, wback==FALSE
LDR{<c>}{<q>} <Rt>, [<Rn>, #+/-<imm>]!	Pre-indexed: index==TRUE, wback==TRUE
LDR{<c>}{<q>} <Rt>, [<Rn>], #+/-<imm>	Post-indexed: index==FALSE, wback==TRUE

where:

<c>, <q>	See <i>Standard assembler syntax fields</i> on page F2-2415.
<Rt>	The destination register. The SP can be used. The PC can be used, provided the instruction is either outside an IT block or the last instruction of an IT block. If the PC is used, the instruction branches to the address (data) loaded to the PC. In ARMv5T and above, this branch is an interworking branch, see <i>Pseudocode details of operations on the AArch32 general-purpose registers and the PC</i> on page E1-2296.
<Rn>	The base register. The SP can be used. For PC use see <i>LDR (literal)</i> on page F7-2638.
+/-	+ or omitted The immediate offset is to be added to the base register value (add == TRUE, encoded as U == 1 in encoding T4). - The immediate offset is to be subtracted from the base register value. Encoding T4 must be used, with add == FALSE, encoded as U == 0. #0 and #-0 generate different instructions.
<imm>	The immediate offset used for forming the address. For the offset addressing syntax, <imm> can be omitted, meaning an offset of 0. Values are: Encoding T1 Multiples of 4 in the range 0-124. Encoding T2 Multiples of 4 in the range 0-1020. Encoding T3 Any value in the range 0-4095. Encoding T4 Any value in the range 0-255.

Operation

```

if ConditionPassed() then
    EncodingSpecificOperations(); NullCheckIfThumbEE(n);
    offset_addr = if add then (R[n] + imm32) else (R[n] - imm32);
    address = if index then offset_addr else R[n];
    data = MemU[address,4];
    if wback then R[n] = offset_addr;
    if t == 15 then
        if address<1:0> == '00' then
            LoadWritePC(data);
        else
            UNPREDICTABLE;
    else
        R[t] = data;
  
```

F7.1.69 LDR (immediate, A32)

Load Register (immediate) calculates an address from a base register value and an immediate offset, loads a word from memory, and writes it to a register. It can use offset, post-indexed, or pre-indexed addressing. For information about memory accesses see [Memory accesses](#) on page F2-2422.

Encoding A1 ARMv4*, ARMv5T*, ARMv6*, ARMv7

LDR<c> <Rt>, [<Rn>{, #+/-<imm12>}]

LDR<c> <Rt>, [<Rn>], #+/-<imm12>

LDR<c> <Rt>, [<Rn>, #+/-<imm12>]!

31	30	29	28	27	26	25	24	23	22	21	20	19	18	17	16	15	14	13	12	11	10	9	8	7	6	5	4	3	2	1	0
cond				0	1	0	P	U	0	W	1	Rn				Rt				imm12											

```

if Rn == '1111' then SEE LDR (literal);
if P == '0' && W == '1' then SEE LDRT;
if Rn == '1101' && P == '0' && U == '1' && W == '0' && imm12 == '00000000100' then SEE POP;
t = UInt(Rt); n = UInt(Rn); imm32 = ZeroExtend(imm12, 32);
index = (P == '1'); add = (U == '1'); wback = (P == '0') || (W == '1');
if wback && n == t then UNPREDICTABLE;
    
```

For information about the CONSTRAINED UNPREDICTABLE behavior of this instruction, see [Appendix A Architectural Constraints on UNPREDICTABLE behaviors](#), and particularly [LDR \(immediate, A32\)](#) on page AppxA-4708.

Assembler syntax

LDR{<c>}{<q>} <Rt>, [<Rn> {, #+/-<imm>}]	Offset: index==TRUE, wback==FALSE
LDR{<c>}{<q>} <Rt>, [<Rn>, #+/-<imm>]!	Pre-indexed: index==TRUE, wback==TRUE
LDR{<c>}{<q>} <Rt>, [<Rn>], #+/-<imm>	Post-indexed: index==FALSE, wback==TRUE

where:

<c>, <q>	See Standard assembler syntax fields on page F2-2415 .
<Rt>	The destination register. The SP or the PC can be used. If the PC is used, the instruction branches to the address (data) loaded to the PC. In ARMv5T and above, this branch is an interworking branch, see Pseudocode details of operations on the AArch32 general-purpose registers and the PC on page E1-2296 .
<Rn>	The base register. The SP can be used. For PC use see LDR (literal) on page F7-2638 .
+/-	Is + or omitted if the immediate offset is to be added to the base register value (add == TRUE, encoded as U ==1), or – if it is to be subtracted (add == FALSE, encoded as U ==0). #0 and #-0 generate different instructions.
<imm>	The immediate offset used for forming the address. For the offset addressing syntax, <imm> can be omitted, meaning an offset of 0. Any value in the range 0-4095 is permitted.

Operation

```

if ConditionPassed() then
    EncodingSpecificOperations();
    offset_addr = if add then (R[n] + imm32) else (R[n] - imm32);
    address = if index then offset_addr else R[n];
    data = MemU[address,4];
    if wback then R[n] = offset_addr;
    if t == 15 then
        if address<1:0> == '00' then
            LoadWritePC(data);
        else
            UNPREDICTABLE;
    else
        R[t] = data;
  
```

F7.1.70 LDR (literal)

Load Register (literal) calculates an address from the PC value and an immediate offset, loads a word from memory, and writes it to a register. For information about memory accesses see [Memory accesses](#) on page F2-2422.

Encoding T1 ARMv4T, ARMv5T*, ARMv6*, ARMv7

LDR<c> <Rt>, <label>

15	14	13	12	11	10	9	8	7	6	5	4	3	2	1	0
0	1	0	0	1	Rt			imm8							

t = UInt(Rt); imm32 = ZeroExtend(imm8:'00', 32); add = TRUE;

Encoding T2 ARMv6T2, ARMv7

LDR<c>.W <Rt>, <label>

LDR<c>.W <Rt>, [PC, #-0] Special case

15	14	13	12	11	10	9	8	7	6	5	4	3	2	1	0	15	14	13	12	11	10	9	8	7	6	5	4	3	2	1	0
1	1	1	1	1	0	0	0	U	1	0	1	1	1	1	1	Rt	imm12														

t = UInt(Rt); imm32 = ZeroExtend(imm12, 32); add = (U == '1');
 if t == 15 && InITBlock() && !LastInITBlock() then UNPREDICTABLE;

Encoding A1 ARMv4*, ARMv5T*, ARMv6*, ARMv7

LDR<c> <Rt>, <label>

LDR<c> <Rt>, [PC, #-0] Special case

31	30	29	28	27	26	25	24	23	22	21	20	19	18	17	16	15	14	13	12	11	10	9	8	7	6	5	4	3	2	1	0
cond		0	1	0	(1)	U	0	(0)	1	1	1	1	1	Rt			imm12														

t = UInt(Rt); imm32 = ZeroExtend(imm12, 32); add = (U == '1');

For information about the CONSTRAINED UNPREDICTABLE behavior of this instruction, see [Appendix A Architectural Constraints on UNPREDICTABLE behaviors](#), and particularly [LDR \(literal\)](#) on page AppxA-4713.

Assembler syntax

LDR{<c>}{<q>} <Rt>, <label> Normal form
LDR{<c>}{<q>} <Rt>, [PC, #+/-<imm>] Alternative form

where:

- <c>, <q> See [Standard assembler syntax fields on page F2-2415](#).
- <Rt> The destination register. The SP can be used. The PC can be used, provided the instruction is either outside an IT block or the last instruction of an IT block. If the PC is used, the instruction branches to the address (data) loaded to the PC. In ARMv5T and above, this branch is an interworking branch, see [Pseudocode details of operations on the AArch32 general-purpose registers and the PC on page E1-2296](#).
- <label> The label of the literal data item that is to be loaded into <Rt>. The assembler calculates the required value of the offset from the `Align(PC, 4)` value of the instruction to this label. Permitted values of the offset are:
Encoding T1 Multiples of four in the range 0 to 1020.
Encoding T2 or A1 Any value in the range -4095 to 4095.
If the offset is zero or positive, `imm32` is equal to the offset and `add == TRUE`, encoded as `U == 1` in encoding T2.
If the offset is negative, `imm32` is equal to minus the offset and `add == FALSE`, encoded as `U == 0`. Negative offset is not available in encoding T1.

Note

In examples in this manual, the syntax `=<value>` is used for the label of a memory word whose contents is constant and equal to `<value>`. The actual syntax for such a label is assembler-dependent.

The alternative syntax permits the addition or subtraction of the offset and the immediate offset to be specified separately, including permitting a subtraction of 0 that cannot be specified using the normal syntax. For more information, see [Use of labels in UAL instruction syntax on page F1-2380](#).

Operation

```
if ConditionPassed() then
    EncodingSpecificOperations(); NullCheckIfThumbEE(15);
    base = Align(PC,4);
    address = if add then (base + imm32) else (base - imm32);
    data = MemU[address,4];
    if t == 15 then
        if address<1:0> == '00' then
            LoadWritePC(data);
        else
            UNPREDICTABLE;
    else
        R[t] = data;
```

F7.1.71 LDR (register, T32)

Load Register (register) calculates an address from a base register value and an offset register value, loads a word from memory, and writes it to a register. The offset register value can optionally be shifted. For information about memory accesses, see [Memory accesses](#) on page F2-2422.

The T32 form of LDR (register) does not support register writeback.

Encoding T1 ARMv4T, ARMv5T*, ARMv6*, ARMv7

LDR<c> <Rt>, [<Rn>, <Rm>]

15	14	13	12	11	10	9	8	7	6	5	4	3	2	1	0
0	1	0	1	1	0	0	Rm			Rn			Rt		

if CurrentInstrSet() == InstrSet_T32EE then SEE "Modified operation in ThumbEE";
 t = UInt(Rt); n = UInt(Rn); m = UInt(Rm);
 (shift_t, shift_n) = (SRTYPE_LSL, 0);

Encoding T2 ARMv6T2, ARMv7

LDR<c>.W <Rt>, [<Rn>, <Rm>{, LSL #<imm2>}]

15	14	13	12	11	10	9	8	7	6	5	4	3	2	1	0	15	14	13	12	11	10	9	8	7	6	5	4	3	2	1	0
1	1	1	1	1	0	0	0	0	1	0	1	Rn			Rt			0	0	0	0	0	0	imm2	Rm						

if Rn == '1111' then SEE LDR (literal);
 t = UInt(Rt); n = UInt(Rn); m = UInt(Rm);
 (shift_t, shift_n) = (SRTYPE_LSL, UInt(imm2));
 if m == 15 then UNPREDICTABLE; // ARMv8-A removes UNPREDICTABLE for R13
 if t == 15 && InITBlock() && !LastInITBlock() then UNPREDICTABLE;

For information about the CONSTRAINED UNPREDICTABLE behavior of this instruction, see [Appendix A Architectural Constraints on UNPREDICTABLE behaviors](#).

Modified operation in ThumbEE ARM deprecates any use of ThumbEE instructions and they are not documented in this manual.

Assembler syntax

LDR{<c>}{<q>} <Rt>, [<Rn>, {+}<Rm>{, <shift>}] Offset addressing

where:

- <c>, <q> See *Standard assembler syntax fields* on page F2-2415.
- <Rt> The destination register. The SP can be used. The PC can be used, provided the instruction is either outside an IT block or the last instruction of an IT block. If the PC is used, the instruction branches to the address (data) loaded to the PC. In ARMv5T and above, this branch is an interworking branch, see *Pseudocode details of operations on the AArch32 general-purpose registers and the PC* on page E1-2296.
- <Rn> The base register. The SP can be used. In the T32 instruction set, the PC cannot be used with this form of the LDR instruction.
- + In T32 instructions, the optionally shifted value of <Rm> is added to the base register value. T32 instructions cannot subtract <Rm> from the base register value.
- <Rm> The offset that is optionally shifted and applied to the value of <Rn> to form the address.
- <shift> The shift to apply to the value read from <Rm>. If present, encoding T1 is not permitted. If absent, no shift is applied and all encodings are permitted. For encoding T2, <shift> can only be omitted, encoded as imm2 = 0b00, or LSL #<imm> with <imm> = 1, 2, or 3, and <imm> encoded in imm2.

Operation

```
if ConditionPassed() then
    EncodingSpecificOperations(); NullCheckIfThumbEE(n);
    offset = Shift(R[m], shift_t, shift_n, APSR.C);
    offset_addr = (R[n] + offset);
    address = offset_addr;
    data = MemU[address,4];
    if t == 15 then
        if address<1:0> == '00' then
            LoadWritePC(data);
        else
            UNPREDICTABLE;
    else
        R[t] = data;
```

F7.1.72 LDR (register, A32)

Load Register (register) calculates an address from a base register value and an offset register value, loads a word from memory, and writes it to a register. The offset register value can optionally be shifted. For information about memory accesses, see [Memory accesses](#) on page F2-2422.

Encoding A1 ARMv4*, ARMv5T*, ARMv6*, ARMv7

LDR<c> <Rt>, [<Rn>, +/-<Rm>{, <shift>}]{!}

LDR<c> <Rt>, [<Rn>], +/-<Rm>{, <shift>}

31	30	29	28	27	26	25	24	23	22	21	20	19	18	17	16	15	14	13	12	11	10	9	8	7	6	5	4	3	2	1	0
cond		0	1	1	P	U	0	W	1	Rn				Rt				imm5			type	0	Rm								

```

if P == '0' && W == '1' then SEE LDRT;
t = UInt(Rt); n = UInt(Rn); m = UInt(Rm);
index = (P == '1'); add = (U == '1'); wback = (P == '0') || (W == '1');
(shift_t, shift_n) = DecodeImmShift(type, imm5);
if m == 15 then UNPREDICTABLE;
if wback && (n == 15 || n == t) then UNPREDICTABLE;
    
```

For information about the CONSTRAINED UNPREDICTABLE behavior of this instruction, see [Appendix A Architectural Constraints on UNPREDICTABLE behaviors](#), and particularly [LDR \(register, A32\)](#) on page AppxA-4708.

Assembler syntax

LDR{<c>}{<q>} <Rt>, [<Rn>, {+/-}<Rm>{, <shift>}] Offset: index==TRUE, wback==FALSE
LDR{<c>}{<q>} <Rt>, [<Rn>, {+/-}<Rm>{, <shift>}]! Pre-indexed: index==TRUE, wback==TRUE
LDR{<c>}{<q>} <Rt>, [<Rn>], {+/-}<Rm>{, <shift>} Post-indexed: index==FALSE, wback==TRUE

where:

<c>, <q> See [Standard assembler syntax fields on page F2-2415](#).

<Rt> The destination register. The SP can be used. The PC can be used. If the PC is used, the instruction branches to the address (data) loaded to the PC. In ARMv5T and above, this branch is an interworking branch, see [Pseudocode details of operations on the AArch32 general-purpose registers and the PC on page E1-2296](#).

<Rn> The base register. The SP can be used. The PC can be used for offset addressing only.

+/- If + or omitted, the optionally shifted value of <Rm> is added to the base register value (add == TRUE encoded as U == 1).
If -, the optionally shifted value of <Rm> is subtracted from the base register value (add == FALSE encoded as U == 0).

<Rm> The offset that is optionally shifted and applied to the value of <Rn> to form the address.

<shift> The shift to apply to the value read from <Rm>. If absent, no shift is applied. Otherwise, see [Shifts applied to a register on page F2-2419](#).

Operation

```
if ConditionPassed() then
    EncodingSpecificOperations();
    offset = Shift(R[m], shift_t, shift_n, APSR.C);
    offset_addr = if add then (R[n] + offset) else (R[n] - offset);
    address = if index then offset_addr else R[n];
    data = MemU[address,4];
    if wback then R[n] = offset_addr;
    if t == 15 then
        if address<1:0> == '00' then
            LoadWritePC(data);
        else
            UNPREDICTABLE;
    else
        R[t] = data;
```

F7.1.73 LDRB (immediate, T32)

Load Register Byte (immediate) calculates an address from a base register value and an immediate offset, loads a byte from memory, zero-extends it to form a 32-bit word, and writes it to a register. It can use offset, post-indexed, or pre-indexed addressing. For information about memory accesses see [Memory accesses on page F2-2422](#).

Encoding T1 ARMv4T, ARMv5T*, ARMv6*, ARMv7
 LDRB<c> <Rt>, [<Rn>{, #<imm5>}]

15	14	13	12	11	10	9	8	7	6	5	4	3	2	1	0
0	1	1	1	1	imm5					Rn			Rt		

t = UInt(Rt); n = UInt(Rn); imm32 = ZeroExtend(imm5, 32);
 index = TRUE; add = TRUE; wback = FALSE;

Encoding T2 ARMv6T2, ARMv7
 LDRB<c>.W <Rt>, [<Rn>{, #<imm12>}]

15	14	13	12	11	10	9	8	7	6	5	4	3	2	1	0	15	14	13	12	11	10	9	8	7	6	5	4	3	2	1	0
1	1	1	1	1	0	0	0	1	0	0	1	Rn			Rt			imm12													

if Rt == '1111' then SEE PLD;
 if Rn == '1111' then SEE LDRB (literal);
 t = UInt(Rt); n = UInt(Rn); imm32 = ZeroExtend(imm12, 32);
 index = TRUE; add = TRUE; wback = FALSE;
 // ARMv8-A removes UNPREDICTABLE for R13

Encoding T3 ARMv6T2, ARMv7
 LDRB<c> <Rt>, [<Rn>, #-<imm8>]
 LDRB<c> <Rt>, [<Rn>], #+/-<imm8>
 LDRB<c> <Rt>, [<Rn>, #+/-<imm8>!]

15	14	13	12	11	10	9	8	7	6	5	4	3	2	1	0	15	14	13	12	11	10	9	8	7	6	5	4	3	2	1	0
1	1	1	1	1	0	0	0	0	0	0	1	Rn			Rt			1	P	U	W	imm8									

if Rt == '1111' && P == '1' && U == '0' && W == '0' then SEE PLD, PLDW (immediate);
 if Rn == '1111' then SEE LDRB (literal);
 if P == '1' && U == '1' && W == '0' then SEE LDRBT;
 if P == '0' && W == '0' then UNDEFINED;
 t = UInt(Rt); n = UInt(Rn); imm32 = ZeroExtend(imm8, 32);
 index = (P == '1'); add = (U == '1'); wback = (W == '1');
 if (t == 15 && W == '1') || (wback && n == t) then UNPREDICTABLE;
 // ARMv8-A removes UNPREDICTABLE for R13

For information about the CONSTRAINED UNPREDICTABLE behavior of this instruction, see [Appendix A Architectural Constraints on UNPREDICTABLE behaviors](#), and particularly [LDRB \(immediate, T32\) on page AppxA-4708](#).

Assembler syntax

LDRB{<c>}{<q>} <Rt>, [<Rn> {, #+/-<imm>}]	Offset: index==TRUE, wback==FALSE
LDRB{<c>}{<q>} <Rt>, [<Rn>, #+/-<imm>]!	Pre-indexed: index==TRUE, wback==TRUE
LDRB{<c>}{<q>} <Rt>, [<Rn>], #+/-<imm>	Post-indexed: index==FALSE, wback==TRUE

where:

<c>, <q>	See Standard assembler syntax fields on page F2-2415 .						
<Rt>	The destination register.						
<Rn>	The base register. The SP can be used. For PC use see LDRB (literal) on page F7-2648 .						
+/-	Is + or omitted if the immediate offset is to be added to the base register value (add == TRUE, encoded as U == 1), or – if it is to be subtracted (add == FALSE, encoded as U == 0). #0 and #-0 generate different instructions.						
<imm>	The immediate offset used for forming the address. For the offset addressing syntax, <imm> can be omitted, meaning an offset of 0. Values are: <table> <tr> <td>Encoding T1</td> <td>Any value in the range 0-31.</td> </tr> <tr> <td>Encoding T2</td> <td>Any value in the range 0-4095.</td> </tr> <tr> <td>Encoding T3</td> <td>Any value in the range 0-255.</td> </tr> </table>	Encoding T1	Any value in the range 0-31.	Encoding T2	Any value in the range 0-4095.	Encoding T3	Any value in the range 0-255.
Encoding T1	Any value in the range 0-31.						
Encoding T2	Any value in the range 0-4095.						
Encoding T3	Any value in the range 0-255.						

The pre-UAL syntax LDR<c>B is equivalent to LDRB<c>.

Operation

```

if ConditionPassed() then
    EncodingSpecificOperations();
    NullCheckIfThumbEE(n);
    offset_addr = if add then (R[n] + imm32) else (R[n] - imm32);
    address = if index then offset_addr else R[n];
    R[t] = ZeroExtend(MemU[address,1], 32);
    if wback then R[n] = offset_addr;
  
```

F7.1.74 LDRB (immediate, A32)

Load Register Byte (immediate) calculates an address from a base register value and an immediate offset, loads a byte from memory, zero-extends it to form a 32-bit word, and writes it to a register. It can use offset, post-indexed, or pre-indexed addressing. For information about memory accesses see [Memory accesses on page F2-2422](#).

Encoding A1 ARMv4*, ARMv5T*, ARMv6*, ARMv7

LDRB<c> <Rt>, [<Rn>{, #+/-<imm12>}]

LDRB<c> <Rt>, [<Rn>], #+/-<imm12>

LDRB<c> <Rt>, [<Rn>, #+/-<imm12>]!

31	30	29	28	27	26	25	24	23	22	21	20	19	18	17	16	15	14	13	12	11	10	9	8	7	6	5	4	3	2	1	0
cond				0	1	0	P	U	1	W	1	Rn				Rt				imm12											

```

if Rn == '1111' then SEE LDRB (literal);
if P == '0' && W == '1' then SEE LDRBT;
t = UInt(Rt); n = UInt(Rn); imm32 = ZeroExtend(imm12, 32);
index = (P == '1'); add = (U == '1'); wback = (P == '0') || (W == '1');
if t == 15 || (wback && n == t) then UNPREDICTABLE;
    
```

For information about the CONSTRAINED UNPREDICTABLE behavior of this instruction, see [Appendix A Architectural Constraints on UNPREDICTABLE behaviors](#), and particularly [LDRB \(immediate, A32\) on page AppxA-4709](#).

Assembler syntax

LDRB{<c>}{<q>} <Rt>, [<Rn> {, #+/-<imm>}]	Offset: index==TRUE, wback==FALSE
LDRB{<c>}{<q>} <Rt>, [<Rn>, #+/-<imm>]!	Pre-indexed: index==TRUE, wback==TRUE
LDRB{<c>}{<q>} <Rt>, [<Rn>], #+/-<imm>	Post-indexed: index==FALSE, wback==TRUE

where:

<c>, <q> See [Standard assembler syntax fields on page F2-2415](#).

<Rt> The destination register.

<Rn> The base register. The SP can be used. For PC use see [LDRB \(literal\) on page F7-2648](#).

+/- Is + or omitted if the immediate offset is to be added to the base register value (add == TRUE, encoded as U == 1), or – if it is to be subtracted (add == FALSE, encoded as U == 0). #0 and #-0 generate different instructions.

<imm> The immediate offset used for forming the address. For the offset addressing syntax, <imm> can be omitted, meaning an offset of 0. Any value in the range 0-4095 is permitted.

The pre-UAL syntax LDR<c>B is equivalent to LDRB<c>.

Operation

```
if ConditionPassed() then
    EncodingSpecificOperations();
    offset_addr = if add then (R[n] + imm32) else (R[n] - imm32);
    address = if index then offset_addr else R[n];
    R[t] = ZeroExtend(MemU[address,1], 32);
    if wback then R[n] = offset_addr;
```

F7.1.75 LDRB (literal)

Load Register Byte (literal) calculates an address from the PC value and an immediate offset, loads a byte from memory, zero-extends it to form a 32-bit word, and writes it to a register. For information about memory accesses see [Memory accesses on page F2-2422](#).

Encoding T1 ARMv6T2, ARMv7

LDRB<c> <Rt>, <label>

LDRB<c> <Rt>, [PC, #-0] Special case

15	14	13	12	11	10	9	8	7	6	5	4	3	2	1	0	15	14	13	12	11	10	9	8	7	6	5	4	3	2	1	0
1	1	1	1	1	0	0	0	U	0	0	1	1	1	1	1	Rt	imm12														

```
if Rt == '1111' then SEE PLD;
t = UInt(Rt); imm32 = ZeroExtend(imm12, 32); add = (U == '1');
// ARMv8-A removes UNPREDICTABLE for R13
```

Encoding A1 ARMv4*, ARMv5T*, ARMv6*, ARMv7

LDRB<c> <Rt>, <label>

LDRB<c> <Rt>, [PC, #-0] Special case

31	30	29	28	27	26	25	24	23	22	21	20	19	18	17	16	15	14	13	12	11	10	9	8	7	6	5	4	3	2	1	0
cond			0	1	0	(1)	U	1	(0)	1	1	1	1	1	Rt	imm12															

```
t = UInt(Rt); imm32 = ZeroExtend(imm12, 32); add = (U == '1');
if t == 15 then UNPREDICTABLE;
```

For information about the CONSTRAINED UNPREDICTABLE behavior of this instruction, see [Appendix A Architectural Constraints on UNPREDICTABLE behaviors](#), and particularly [LDRB \(literal\) on page AppxA-4713](#).

Assembler syntax

LDRB{<c>}{<q>} <Rt>, <label> Normal form
LDRB{<c>}{<q>} <Rt>, [PC, #+/-<imm>] Alternative form

where:

<c>, <q> See [Standard assembler syntax fields on page F2-2415](#).

<Rt> The destination register.

<label> The label of the literal data item that is to be loaded into <Rt>. The assembler calculates the required value of the offset from the `Align(PC, 4)` value of the instruction to this label. Permitted values of the offset are -4095 to 4095.

If the offset is zero or positive, `imm32` is equal to the offset and `add == TRUE`, encoded as `U == 1`.

If the offset is negative, `imm32` is equal to minus the offset and `add == FALSE`, encoded as `U == 0`.

The alternative syntax permits the addition or subtraction of the offset and the immediate offset to be specified separately, including permitting a subtraction of 0 that cannot be specified using the normal syntax. For more information, see [Use of labels in UAL instruction syntax on page F1-2380](#).

The pre-UAL syntax `LDR<c>B` is equivalent to `LDRB<c>`.

Operation

```
if ConditionPassed() then
    EncodingSpecificOperations(); NullCheckIfThumbEE(15);
    base = Align(PC,4);
    address = if add then (base + imm32) else (base - imm32);
    R[t] = ZeroExtend(MemU[address,1], 32);
```

F7.1.76 LDRB (register)

Load Register Byte (register) calculates an address from a base register value and an offset register value, loads a byte from memory, zero-extends it to form a 32-bit word, and writes it to a register. The offset register value can optionally be shifted. For information about memory accesses see [Memory accesses on page F2-2422](#).

Encoding T1 ARMv4T, ARMv5T*, ARMv6*, ARMv7

LDRB<c> <Rt>, [<Rn>, <Rm>]

15	14	13	12	11	10	9	8	7	6	5	4	3	2	1	0
0	1	0	1	1	1	0	Rm			Rn			Rt		

t = UInt(Rt); n = UInt(Rn); m = UInt(Rm);
 index = TRUE; add = TRUE; wback = FALSE;
 (shift_t, shift_n) = (SRTYPE_LSL, 0);

Encoding T2 ARMv6T2, ARMv7

LDRB<c>.W <Rt>, [<Rn>, <Rm>{, LSL #<imm2>}]

15	14	13	12	11	10	9	8	7	6	5	4	3	2	1	0	15	14	13	12	11	10	9	8	7	6	5	4	3	2	1	0
1	1	1	1	1	0	0	0	0	0	0	1	Rn			Rt			0	0	0	0	0	0	imm2	Rm						

if Rt == '1111' then SEE PLD;
 if Rn == '1111' then SEE LDRB (literal);
 t = UInt(Rt); n = UInt(Rn); m = UInt(Rm);
 index = TRUE; add = TRUE; wback = FALSE;
 (shift_t, shift_n) = (SRTYPE_LSL, UInt(imm2));
 if m == 15 then UNPREDICTABLE; // ARMv8-A removes UNPREDICTABLE for R13

Encoding A1 ARMv4*, ARMv5T*, ARMv6*, ARMv7

LDRB<c> <Rt>, [<Rn>, +/-<Rm>{, <shift>}]{!}

LDRB<c> <Rt>, [<Rn>], +/-<Rm>{, <shift>}

31	30	29	28	27	26	25	24	23	22	21	20	19	18	17	16	15	14	13	12	11	10	9	8	7	6	5	4	3	2	1	0
cond		0	1	1	P	U	1	W	1	Rn			Rt			imm5			type	0	Rm										

if P == '0' && W == '1' then SEE LDRBT;
 t = UInt(Rt); n = UInt(Rn); m = UInt(Rm);
 index = (P == '1'); add = (U == '1'); wback = (P == '0') || (W == '1');
 (shift_t, shift_n) = DecodeImmShift(type, imm5);
 if t == 15 || m == 15 then UNPREDICTABLE;
 if wback && (n == 15 || n == t) then UNPREDICTABLE;

For information about the CONSTRAINED UNPREDICTABLE behavior of this instruction, see [Appendix A Architectural Constraints on UNPREDICTABLE behaviors](#), and particularly [LDRB \(register\) on page AppxA-4709](#).

Assembler syntax

LDRB{<c>}{<q>} <Rt>, [<Rn>, +/-<Rm>{, <shift>}] Offset: index==TRUE, wback==FALSE
LDRB{<c>}{<q>} <Rt>, [<Rn>, +/-<Rm>{, <shift>}]! Pre-indexed: index==TRUE, wback==TRUE
LDRB{<c>}{<q>} <Rt>, [<Rn>], +/-<Rm>{, <shift>} Post-indexed: index==FALSE, wback==TRUE

where:

<c>, <q> See [Standard assembler syntax fields on page F2-2415](#).

<Rt> The destination register.

<Rn> The base register. The SP can be used. In the A32 instruction set the PC can be used, for the offset addressing form of the instruction only. In the T32 instruction set, the PC cannot be used with any of these forms of the LDRB instruction.

+/- Is + or omitted if the optionally shifted value of <Rm> is to be added to the base register value (add == TRUE, encoded as U == 1 in encoding A1), or – if it is to be subtracted (permitted in A32 instructions only, add == FALSE, encoded as U == 0).

<Rm> Contains the offset that is optionally shifted and applied to the value of <Rn> to form the address.

<shift> The shift to apply to the value read from <Rm>. If present, encoding T1 is not permitted. If absent, no shift is applied and all encodings are permitted. For encoding T2, <shift> can only be omitted, encoded as imm2 = 0b00, or LSL #<imm> with <imm> = 1, 2, or 3, and <imm> encoded in imm2. For encoding A1, see [Shifts applied to a register on page F2-2419](#).

The pre-UAL syntax LDR<c>B is equivalent to LDRB<c>.

Operation

```
if ConditionPassed() then
    EncodingSpecificOperations();  NullCheckIfThumbEE(n);
    offset = Shift(R[m], shift_t, shift_n, APSR.C);
    offset_addr = if add then (R[n] + offset) else (R[n] - offset);
    address = if index then offset_addr else R[n];
    R[t] = ZeroExtend(MemU[address,1],32);
    if wback then R[n] = offset_addr;
```

F7.1.77 LDRBT

Load Register Byte Unprivileged loads a byte from memory, zero-extends it to form a 32-bit word, and writes it to a register. For information about memory accesses see [Memory accesses on page F2-2422](#).

The memory access is restricted as if the PE were running in User mode. This makes no difference if the PE is actually running in User mode.

LDRBT is UNPREDICTABLE in Hyp mode.

The T32 instruction uses an offset addressing mode, that calculates the address used for the memory access from a base register value and an immediate offset, and leaves the base register unchanged.

The A32 instruction uses a post-indexed addressing mode, that uses a base register value as the address for the memory access, and calculates a new address from a base register value and an offset and writes it back to the base register. The offset can be an immediate value or an optionally-shifted register value.

Encoding T1 ARMv6T2, ARMv7

LDRBT<c> <Rt>, [<Rn>, #<imm8>]

15	14	13	12	11	10	9	8	7	6	5	4	3	2	1	0	15	14	13	12	11	10	9	8	7	6	5	4	3	2	1	0
1	1	1	1	1	0	0	0	0	0	0	1	Rn				Rt		1	1	1	0	imm8									

```
if Rn == '1111' then SEE LDRB (literal);
t = UInt(Rt); n = UInt(Rn); postindex = FALSE; add = TRUE;
register_form = FALSE; imm32 = ZeroExtend(imm8, 32);
if t == 15 then UNPREDICTABLE; // ARMv8-A removes UNPREDICTABLE for R13
```

Encoding A1 ARMv4*, ARMv5T*, ARMv6*, ARMv7

LDRBT<c> <Rt>, [<Rn>], #+/-<imm12>

31	30	29	28	27	26	25	24	23	22	21	20	19	18	17	16	15	14	13	12	11	10	9	8	7	6	5	4	3	2	1	0
cond		0	1	0	0	U	1	1	1	Rn				Rt		imm12															

```
t = UInt(Rt); n = UInt(Rn); postindex = TRUE; add = (U == '1');
register_form = FALSE; imm32 = ZeroExtend(imm12, 32);
if t == 15 || n == 15 || n == t then UNPREDICTABLE;
```

Encoding A2 ARMv4*, ARMv5T*, ARMv6*, ARMv7

LDRBT<c> <Rt>, [<Rn>], +/-<Rm>{, <shift>}

31	30	29	28	27	26	25	24	23	22	21	20	19	18	17	16	15	14	13	12	11	10	9	8	7	6	5	4	3	2	1	0
cond		0	1	1	0	U	1	1	1	Rn				Rt		imm5			type	0	Rm										

```
t = UInt(Rt); n = UInt(Rn); m = UInt(Rm); postindex = TRUE; add = (U == '1');
register_form = TRUE; (shift_t, shift_n) = DecodeImmShift(type, imm5);
if t == 15 || n == 15 || n == t || m == 15 then UNPREDICTABLE;
```

For information about the CONSTRAINED UNPREDICTABLE behavior of this instruction, see [Appendix A Architectural Constraints on UNPREDICTABLE behaviors](#), and particularly [LDRBT on page AppxA-4709](#).

Assembler syntax

LDRBT{<c>}{<q>} <Rt>, [<Rn> {, #<imm>}]	Offset: T32 only
LDRBT{<c>}{<q>} <Rt>, [<Rn>] {, #+/-<imm>}	Post-indexed: A32 only
LDRBT{<c>}{<q>} <Rt>, [<Rn>], +/-<Rm> {, <shift>}	Post-indexed: A32 only

where:

<c>, <q>	See Standard assembler syntax fields on page F2-2415 .
<Rt>	The destination register.
<Rn>	The base register. The SP can be used.
+/-	Is + or omitted if <imm> or the optionally shifted value of <Rm> is to be added to the base register value (add == TRUE, encoded as U == 1 in encodings A1 and A2), or – if it is to be subtracted (permitted in A32 instructions only, add == FALSE, encoded as U == 0).
<imm>	The immediate offset applied to the value of <Rn>. Values are 0-255 for encoding T1, and 0-4095 for encoding A1. <imm> can be omitted, meaning an offset of 0.
<Rm>	Contains the offset that is optionally shifted and applied to the value of <Rn> to form the address.
<shift>	The shift to apply to the value read from <Rm>. If omitted, no shift is applied. Shifts applied to a register on page F2-2419 describes the shifts and how they are encoded.

The pre-UAL syntax LDR<c>BT is equivalent to LDRBT<c>.

Operation

```

if ConditionPassed() then
    if CurrentModeIsHyp() then UNPREDICTABLE;           // Hyp mode
    EncodingSpecificOperations();  NullCheckIfThumbEE(n);
    offset = if register_form then Shift(R[m], shift_t, shift_n, APSR.C) else imm32;
    offset_addr = if add then (R[n] + offset) else (R[n] - offset);
    address = if postindex then R[n] else offset_addr;
    R[t] = ZeroExtend(MemU_unpriv[address,1],32);
    if postindex then R[n] = offset_addr;
  
```

F7.1.78 LDRD (immediate)

Load Register Dual (immediate) calculates an address from a base register value and an immediate offset, loads two words from memory, and writes them to two registers. It can use offset, post-indexed, or pre-indexed addressing. For information about memory accesses see [Memory accesses on page F2-2422](#).

Encoding T1 ARMv6T2, ARMv7

LDRD<c> <Rt>, <Rt2>, [<Rn>{, #+/-<imm>}]

LDRD<c> <Rt>, <Rt2>, [<Rn>], #+/-<imm>

LDRD<c> <Rt>, <Rt2>, [<Rn>, #+/-<imm>]!

15	14	13	12	11	10	9	8	7	6	5	4	3	2	1	0	15	14	13	12	11	10	9	8	7	6	5	4	3	2	1	0
1	1	1	0	1	0	0	P	U	1	W	1	Rn				Rt				Rt2				imm8							

if P == '0' && W == '0' then SEE "ReLated encodings";
 if Rn == '1111' then SEE LDRD (literal);
 t = UInt(Rt); t2 = UInt(Rt2); n = UInt(Rn); imm32 = ZeroExtend(imm8:'00', 32);
 index = (P == '1'); add = (U == '1'); wback = (W == '1');
 if wback && (n == t || n == t2) then UNPREDICTABLE;
 if t == 15 || t2 == 15 || t == t2 then UNPREDICTABLE; // ARMv8-A removes UNPREDICTABLE for R13

Encoding A1 ARMv5TE*, ARMv6*, ARMv7

LDRD<c> <Rt>, <Rt2>, [<Rn>{, #+/-<imm8>}]

LDRD<c> <Rt>, <Rt2>, [<Rn>], #+/-<imm8>

LDRD<c> <Rt>, <Rt2>, [<Rn>, #+/-<imm8>]!

31	30	29	28	27	26	25	24	23	22	21	20	19	18	17	16	15	14	13	12	11	10	9	8	7	6	5	4	3	2	1	0
cond				0	0	0	P	U	1	W	0	Rn				Rt				imm4H				1	1	0	1	imm4L			

if Rn == '1111' then SEE LDRD (literal);
 if Rt<0> == '1' then UNPREDICTABLE;
 t = UInt(Rt); t2 = t+1; n = UInt(Rn); imm32 = ZeroExtend(imm4H:imm4L, 32);
 index = (P == '1'); add = (U == '1'); wback = (P == '0') || (W == '1');
 if P == '0' && W == '1' then UNPREDICTABLE;
 if wback && (n == t || n == t2) then UNPREDICTABLE;
 if t2 == 15 then UNPREDICTABLE;

For information about the CONSTRAINED UNPREDICTABLE behavior of this instruction, see [Appendix A Architectural Constraints on UNPREDICTABLE behaviors](#), and particularly [LDRD \(immediate\) on page AppxA-4715](#).

Related encodings See [Load/store dual, load/store exclusive, table branch on page F3-2450](#).

Assembler syntax

LDRD{<c>}{<q>} <Rt>, <Rt2>, [<Rn> {, #+/-<imm>}] Offset: index==TRUE, wback==FALSE
 LDRD{<c>}{<q>} <Rt>, <Rt2>, [<Rn>, #+/-<imm>]! Pre-indexed: index==TRUE, wback==TRUE
 LDRD{<c>}{<q>} <Rt>, <Rt2>, [<Rn>], #+/-<imm> Post-indexed: index==FALSE, wback==TRUE

where:

<c>, <q> See [Standard assembler syntax fields on page F2-2415](#).

<Rt> The first destination register. For an A32 instruction, <Rt> must be even-numbered and not R14.

<Rt2> The second destination register. For an A32 instruction, <Rt2> must be <R(t+1)>.

<Rn> The base register. The SP can be used. For PC use see [LDRD \(literal\) on page F7-2656](#).

+/- Is + or omitted if the immediate offset is to be added to the base register value (add == TRUE, encoded as U == 1), or - if it is to be subtracted (add == FALSE, encoded as U == 0). #0 and #-0 generate different instructions.

<imm> The immediate offset used for forming the address. For the offset addressing syntax, <imm> can be omitted, meaning an offset of 0. Values are:

Encoding T1	Multiples of 4 in the range 0-1020.
Encoding A1	Any value in the range 0-255.

The pre-UAL syntax LDR<c>D is equivalent to LDRD<c>.

Operation

```

if ConditionPassed() then
    EncodingSpecificOperations(); NullCheckIfThumbEE(n);
    offset_addr = if add then (R[n] + imm32) else (R[n] - imm32);
    address = if index then offset_addr else R[n];
    if address == Align(address, 8) then
        data = MemA[address,8];
        if BigEndian() then
            R[t] = data<63:32>;
            R[t2] = data<31:0>;
        else
            R[t] = data<31:0>;
            R[t2] = data<63:32>;
    else
        R[t] = MemA[address,4];
        R[t2] = MemA[address+4,4];
    if wback then R[n] = offset_addr;
  
```

F7.1.79 LDRD (literal)

Load Register Dual (literal) calculates an address from the PC value and an immediate offset, loads two words from memory, and writes them to two registers. For information about memory accesses see [Memory accesses](#) on page F2-2422.

Encoding T1 ARMv6T2, ARMv7

LDRD<c> <Rt>, <Rt2>, <label>

LDRD<c> <Rt>, <Rt2>, [PC, #-0] Special case

15	14	13	12	11	10	9	8	7	6	5	4	3	2	1	0	15	14	13	12	11	10	9	8	7	6	5	4	3	2	1	0
1	1	1	0	1	0	0	P	U	1	W	1	1	1	1	1	Rt	Rt2	imm8													

```

if P == '0' && W == '0' then SEE "Related encodings";
t = UInt(Rt); t2 = UInt(Rt2);
imm32 = ZeroExtend(imm8:'00', 32); add = (U == '1');
if t == 15 || t2 == 15 || t == t2 then UNPREDICTABLE; // ARMv8-A removes UNPREDICTABLE for R13
if W == '1' then UNPREDICTABLE;
    
```

Encoding A1 ARMv5TE*, ARMv6*, ARMv7

LDRD<c> <Rt>, <Rt2>, <label>

LDRD<c> <Rt>, <Rt2>, [PC, #-0] Special case

31	30	29	28	27	26	25	24	23	22	21	20	19	18	17	16	15	14	13	12	11	10	9	8	7	6	5	4	3	2	1	0
cond		0	0	0	(1)	U	1	(0)	0	1	1	1	1	Rt	imm4H	1	1	0	1	imm4L											

```

if Rt<0> == '1' then UNPREDICTABLE;
t = UInt(Rt); t2 = t+1; imm32 = ZeroExtend(imm4H:imm4L, 32); add = (U == '1');
if t2 == 15 then UNPREDICTABLE;
    
```

For information about the CONSTRAINED UNPREDICTABLE behavior of this instruction, see [Appendix A Architectural Constraints on UNPREDICTABLE behaviors](#), and particularly [LDRD \(literal\)](#) on page AppxA-4717.

Related encodings See [Load/store dual, load/store exclusive, table branch](#) on page F3-2450.

Assembler syntax

LDRD{<c>}{<q>} <Rt>, <Rt2>, <label> Normal form
LDRD{<c>}{<q>} <Rt>, <Rt2>, [PC, #+/-<imm>] Alternative form

where:

<c>, <q> See [Standard assembler syntax fields on page F2-2415](#).
<Rt> The first destination register. For an A32 instruction, <Rt> must be even-numbered and not R14.
<Rt2> The second destination register. For an A32 instruction, <Rt2> must be <R(t+1)>.
<label> The label of the literal data item that is to be loaded into <Rt>. The assembler calculates the required value of the offset from the Align(PC, 4) value of the instruction to this label. Permitted values of the offset are:

Encoding T1 Multiples of 4 in the range -1020 to 1020.

Encoding A1 Any value in the range -255 to 255.

If the offset is zero or positive, imm32 is equal to the offset and add == TRUE, encoded as U == 1.

If the offset is negative, imm32 is equal to minus the offset and add == FALSE, encoded as U == 0.

The alternative syntax permits the addition or subtraction of the offset and the immediate offset to be specified separately, including permitting a subtraction of 0 that cannot be specified using the normal syntax. For more information, see [Use of labels in UAL instruction syntax on page F1-2380](#).

The pre-UAL syntax LDR<c>D is equivalent to LDRD<c>.

Operation

```
if ConditionPassed() then
    EncodingSpecificOperations(); NullCheckIfThumbEE(15);
    address = if add then (Align(PC,4) + imm32) else (Align(PC,4) - imm32);
    if address == Align(address, 8) then
        data = MemA[address,8];
        if BigEndian() then
            R[t] = data<63:32>;
            R[t2] = data<31:0>;
        else
            R[t] = data<31:0>;
            R[t2] = data<63:32>;
    else
        R[t] = MemA[address,4];
        R[t2] = MemA[address+4,4];
```

F7.1.80 LDRD (register)

Load Register Dual (register) calculates an address from a base register value and a register offset, loads two words from memory, and writes them to two registers. It can use offset, post-indexed, or pre-indexed addressing. For information about memory accesses see [Memory accesses on page F2-2422](#).

Encoding A1 ARMv5TE*, ARMv6*, ARMv7

LDRD<c> <Rt>, <Rt2>, [<Rn>, +/-<Rm>]{!}

LDRD<c> <Rt>, <Rt2>, [<Rn>], +/-<Rm>

31	30	29	28	27	26	25	24	23	22	21	20	19	18	17	16	15	14	13	12	11	10	9	8	7	6	5	4	3	2	1	0
cond			0	0	0	P	U	0	W	0	Rn				Rt				(0)	(0)	(0)	(0)	1	1	0	1	Rm				

```

if Rt<0> == '1' then UNPREDICTABLE;
t = UInt(Rt); t2 = t+1; n = UInt(Rn); m = UInt(Rm);
index = (P == '1'); add = (U == '1'); wback = (P == '0') || (W == '1');
if P == '0' && W == '1' then UNPREDICTABLE;
if t2 == 15 || m == 15 || m == t || m == t2 then UNPREDICTABLE;
if wback && (n == 15 || n == t || n == t2) then UNPREDICTABLE;
    
```

For information about the CONSTRAINED UNPREDICTABLE behavior of this instruction, see [Appendix A Architectural Constraints on UNPREDICTABLE behaviors](#), and particularly [LDRD \(register\) on page AppxA-4716](#).

Assembler syntax

LDRD{<c>}{<q>} <Rt>, <Rt2>, [<Rn>, +/-<Rm>]	Offset: index==TRUE, wback==FALSE
LDRD{<c>}{<q>} <Rt>, <Rt2>, [<Rn>, +/-<Rm>]!	Pre-indexed: index==TRUE, wback==TRUE
LDRD{<c>}{<q>} <Rt>, <Rt2>, [<Rn>], +/-<Rm>	Post-indexed: index==FALSE, wback==TRUE

where:

<c>, <q> See [Standard assembler syntax fields on page F2-2415](#).

<Rt> The first destination register. This register must be even-numbered and not R14.

<Rt2> The second destination register. This register must be <R(t+1)>.

<Rn> The base register. The SP can be used. The PC can be used, for offset addressing only.

+/- Is + or omitted if the value of <Rm> is to be added to the base register value (add == TRUE, encoded as U == 1), or – if it is to be subtracted (add == FALSE, encoded as U == 0).

<Rm> Contains the offset that is applied to the value of <Rn> to form the address.

The pre-UAL syntax LDR<c>D is equivalent to LDRD<c>.

Operation

```

if ConditionPassed() then
    EncodingSpecificOperations();
    offset_addr = if add then (R[n] + R[m]) else (R[n] - R[m]);
    address = if index then offset_addr else R[n];
    if address == Align(address, 8) then
        data = MemA[address,8];
        if BigEndian() then
            R[t] = data<63:32>;
            R[t2] = data<31:0>;
        else
            R[t] = data<31:0>;
            R[t2] = data<63:32>;
    else
        R[t] = MemA[address,4];
        R[t2] = MemA[address+4,4];

    if wback then R[n] = offset_addr;
  
```

F7.1.81 LDREX

Load Register Exclusive calculates an address from a base register value and an immediate offset, loads a word from memory, writes it to a register and:

- If the address has the Shared Memory attribute, marks the physical address as exclusive access for the executing PE in a global monitor.
- Causes the executing PE to indicate an active exclusive access in the local monitor.

For more information about support for shared memory see [Synchronization and semaphores on page E2-2369](#). For information about memory accesses see [Memory accesses on page F2-2422](#).

Encoding T1 ARMv6T2, ARMv7

LDREX<c> <Rt>, [<Rn>{, #<imm>}]

15	14	13	12	11	10	9	8	7	6	5	4	3	2	1	0	15	14	13	12	11	10	9	8	7	6	5	4	3	2	1	0
1	1	1	0	1	0	0	0	0	1	0	1	Rn				Rt				(1)(1)(1)(1)				imm8							

t = UInt(Rt); n = UInt(Rn); imm32 = ZeroExtend(imm8:'00', 32);
 if t == 15 || n == 15 then UNPREDICTABLE; // ARMv8-A removes UNPREDICTABLE for R13

Encoding A1 ARMv8

LDREX <Rt>, [<Rn>]

31	30	29	28	27	26	25	24	23	22	21	20	19	18	17	16	15	14	13	12	11	10	9	8	7	6	5	4	3	2	1	0						
cond		0		0		0		1		1		0		0		1		Rn				Rt				(1)(1) 1 1				(1) 0 0 1				(1)(1)(1)(1)			

t = UInt(Rt); n = UInt(Rn); imm32 = Zeros(32); // Zero offset
 if t == 15 || n == 15 then UNPREDICTABLE;

For information about the CONSTRAINED UNPREDICTABLE behavior of this instruction, see [Appendix A Architectural Constraints on UNPREDICTABLE behaviors](#), and particularly [LDREX on page AppxA-4717](#).

Assembler syntax

LDREX{<c>}{<q>} <Rt>, [<Rn> {, #<imm>}]

where:

<c>, <q> See [Standard assembler syntax fields on page F2-2415](#).

<Rt> The destination register.

<Rn> The base register. The SP can be used.

<imm> The immediate offset added to the value of <Rn> to form the address. <imm> can be omitted, meaning an offset of 0. Values are:

Encoding T1 Multiples of 4 in the range 0-1020.

Encoding A1 Omitted or 0.

Operation

```
if ConditionPassed() then
    EncodingSpecificOperations(); NullCheckIfThumbEE(n);
    address = R[n] + imm32;
    AArch32.SetExclusiveMonitors(address,4);
    R[t] = MemA[address,4];
```

F7.1.82 LDREXB

Load Register Exclusive Byte derives an address from a base register value, loads a byte from memory, zero-extends it to form a 32-bit word, writes it to a register and:

- If the address has the Shared Memory attribute, marks the physical address as exclusive access for the executing PE in a global monitor.
- Causes the executing PE to indicate an active exclusive access in the local monitor.

For more information about support for shared memory see [Synchronization and semaphores on page E2-2369](#). For information about memory accesses see [Memory accesses on page F2-2422](#).

Encoding T1 ARMv7

LDREXB<c> <Rt>, [<Rn>]

15	14	13	12	11	10	9	8	7	6	5	4	3	2	1	0	15	14	13	12	11	10	9	8	7	6	5	4	3	2	1	0
1	1	1	0	1	0	0	0	1	1	0	1		Rn		Rt	(1)	(1)	(1)	(1)	0	1	0	0	(1)	(1)	(1)	(1)				

t = UInt(Rt); n = UInt(Rn);
 if t == 15 || n == 15 then UNPREDICTABLE; // ARMv8-A removes UNPREDICTABLE for R13

Encoding A1 ARMv8

LDREXB <Rt>, [<Rn>]

31	30	29	28	27	26	25	24	23	22	21	20	19	18	17	16	15	14	13	12	11	10	9	8	7	6	5	4	3	2	1	0
cond				0	0	0	1	1	1	0	1		Rn		Rt	(1)	(1)	1	1	1	0	0	1	(1)	(1)	(1)	(1)				

t = UInt(Rt); n = UInt(Rn);
 if t == 15 || n == 15 then UNPREDICTABLE;

For information about the CONSTRAINED UNPREDICTABLE behavior of this instruction, see [Appendix A Architectural Constraints on UNPREDICTABLE behaviors](#), and particularly [LDREXB on page AppxA-4718](#).

Assembler syntax

LDREXB{<c>}{<q>} <Rt>, [<Rn>]

where:

<c>, <q> See [Standard assembler syntax fields on page F2-2415](#).

<Rt> The destination register.

<Rn> The base register. The SP can be used.

Operation

```
if ConditionPassed() then
    EncodingSpecificOperations(); NullCheckIfThumbEE(n);
    address = R[n];
    AArch32.SetExclusiveMonitors(address,1);
    R[t] = ZeroExtend(MemA[address,1], 32);
```

F7.1.83 LDREXD

Load Register Exclusive Doubleword derives an address from a base register value, loads a 64-bit doubleword from memory, writes it to two registers and:

- If the address has the Shared Memory attribute, marks the physical address as exclusive access for the executing PE in a global monitor.
- Causes the executing PE to indicate an active exclusive access in the local monitor.

For more information about support for shared memory see *Synchronization and semaphores* on page E2-2369. For information about memory accesses see *Memory accesses* on page F2-2422.

Encoding T1 ARMv7

LDREXD<c> <Rt>, <Rt2>, [<Rn>]

15	14	13	12	11	10	9	8	7	6	5	4	3	2	1	0	15	14	13	12	11	10	9	8	7	6	5	4	3	2	1	0	
1	1	1	0	1	0	0	0	1	1	0	1		Rn			Rt							Rt2		0	1	1	1	(1)	(1)	(1)	(1)

```
t = UInt(Rt); t2 = UInt(Rt2); n = UInt(Rn);
if t == 15 || t2 == 15 || t == t2 || n == 15 then UNPREDICTABLE;
// ARMv8-A removes UNPREDICTABLE for R13
```

Encoding A1 ARMv8

LDREXD <Rt>, <Rt2>, [<Rn>]

31	30	29	28	27	26	25	24	23	22	21	20	19	18	17	16	15	14	13	12	11	10	9	8	7	6	5	4	3	2	1	0												
cond		0	0	0	1	1	0	1	1		Rn																					(1)	(1)	1	1	1	0	0	1	(1)	(1)	(1)	(1)

```
t = UInt(Rt); t2 = t + 1; n = UInt(Rn);
if Rt<0> == '1' || t2 == 15 || n == 15 then UNPREDICTABLE;
```

For information about the CONSTRAINED UNPREDICTABLE behavior of this instruction, see [Appendix A Architectural Constraints on UNPREDICTABLE behaviors](#), and particularly [LDREXD](#) on page AppxA-4718.

Assembler syntax

LDREXD{<c>}{<q>} <Rt>, <Rt2>, [<Rn>]

where:

- <c>, <q> See *Standard assembler syntax fields* on page F2-2415.
- <Rt> The first destination register. For an A32 instruction, <Rt> must be even-numbered and not R14.
- <Rt2> The second destination register. For an A32 instruction, <Rt2> must be <R(t+1)>.
- <Rn> The base register. The SP can be used.

Operation

```
if ConditionPassed() then
    EncodingSpecificOperations(); NullCheckIfThumbEE(n);
    address = R[n];
    AArch32.SetExclusiveMonitors(address,8);
    value = MemA[address,8];
    // Extract words from 64-bit loaded value such that R[t] is
    // loaded from address and R[t2] from address+4.
    R[t] = if BigEndian() then value<63:32> else value<31:0>;
    R[t2] = if BigEndian() then value<31:0> else value<63:32>;
```

F7.1.84 LDREXH

Load Register Exclusive Halfword derives an address from a base register value, loads a halfword from memory, zero-extends it to form a 32-bit word, writes it to a register and:

- If the address has the Shared Memory attribute, marks the physical address as exclusive access for the executing PE in a global monitor.
- Causes the executing PE to indicate an active exclusive access in the local monitor.

For more information about support for shared memory see [Synchronization and semaphores on page E2-2369](#). For information about memory accesses see [Memory accesses on page F2-2422](#).

Encoding T1 ARMv7

LDREXH<c> <Rt>, [<Rn>]

15	14	13	12	11	10	9	8	7	6	5	4	3	2	1	0	15	14	13	12	11	10	9	8	7	6	5	4	3	2	1	0
1	1	1	0	1	0	0	0	1	1	0	1		Rn		Rt	(1)	(1)	(1)	(1)	0	1	0	1	(1)	(1)	(1)	(1)				

t = UInt(Rt); n = UInt(Rn);
 if t == 15 || n == 15 then UNPREDICTABLE; // ARMv8-A removes UNPREDICTABLE for R13

Encoding A1 ARMv8

LDREXH <Rt>, [<Rn>]

31	30	29	28	27	26	25	24	23	22	21	20	19	18	17	16	15	14	13	12	11	10	9	8	7	6	5	4	3	2	1	0
cond	0	0	0	1	1	1	1	1		Rn		Rt	(1)	(1)	(1)	(1)	1	0	0	1	(1)	(1)	(1)	(1)							

t = UInt(Rt); n = UInt(Rn);
 if t == 15 || n == 15 then UNPREDICTABLE;

For information about the CONSTRAINED UNPREDICTABLE behavior of this instruction, see [Appendix A Architectural Constraints on UNPREDICTABLE behaviors](#), and particularly [LDREXH on page AppxA-4717](#).

Assembler syntax

LDREXH{<c>}{<q>} <Rt>, [<Rn>]

where:

<c>, <q> See [Standard assembler syntax fields on page F2-2415](#).

<Rt> The destination register.

<Rn> The base register. The SP can be used.

Operation

```
if ConditionPassed() then
    EncodingSpecificOperations(); NullCheckIfThumbEE(n);
    address = R[n];
    AArch32.SetExclusiveMonitors(address,2);
    R[t] = ZeroExtend(MemA[address,2], 32);
```

F7.1.85 LDRH (immediate, T32)

Load Register Halfword (immediate) calculates an address from a base register value and an immediate offset, loads a halfword from memory, zero-extends it to form a 32-bit word, and writes it to a register. It can use offset, post-indexed, or pre-indexed addressing. For information about memory accesses see [Memory accesses on page F2-2422](#).

Encoding T1 ARMv4T, ARMv5T*, ARMv6*, ARMv7
 LDRH<c> <Rt>, [<Rn>{, #<imm>}]

15	14	13	12	11	10	9	8	7	6	5	4	3	2	1	0
1	0	0	0	1	imm5				Rn			Rt			

t = UInt(Rt); n = UInt(Rn); imm32 = ZeroExtend(imm5:'0', 32);
 index = TRUE; add = TRUE; wback = FALSE;

Encoding T2 ARMv6T2, ARMv7
 LDRH<c>.W <Rt>, [<Rn>{, #<imm12>}]

15	14	13	12	11	10	9	8	7	6	5	4	3	2	1	0	15	14	13	12	11	10	9	8	7	6	5	4	3	2	1	0
1	1	1	1	1	0	0	0	1	0	1	1	Rn			Rt		imm12														

if Rt == '1111' then SEE PLD (immediate);
 if Rn == '1111' then SEE LDRH (literal);
 t = UInt(Rt); n = UInt(Rn); imm32 = ZeroExtend(imm12, 32);
 index = TRUE; add = TRUE; wback = FALSE;
 // ARMv8-A removes UNPREDICTABLE for R13

Encoding T3 ARMv6T2, ARMv7
 LDRH<c> <Rt>, [<Rn>, #-<imm8>]
 LDRH<c> <Rt>, [<Rn>], #+/-<imm8>
 LDRH<c> <Rt>, [<Rn>, #+/-<imm8>!]

15	14	13	12	11	10	9	8	7	6	5	4	3	2	1	0	15	14	13	12	11	10	9	8	7	6	5	4	3	2	1	0
1	1	1	1	1	0	0	0	0	0	1	1	Rn			Rt		1	P	U	W	imm8										

if Rn == '1111' then SEE LDRH (literal);
 if P == '1' && U == '0' && W == '0' then SEE PLDW (immediate);
 if P == '1' && U == '1' && W == '0' then SEE LDRHT;
 if P == '0' && W == '0' then UNDEFINED;
 t = UInt(Rt); n = UInt(Rn); imm32 = ZeroExtend(imm8, 32);
 index = (P == '1'); add = (U == '1'); wback = (W == '1');
 if (t == 15 && W == '1') || (wback && n == t) then UNPREDICTABLE;
 // ARMv8-A removes UNPREDICTABLE for R13

For information about the CONSTRAINED UNPREDICTABLE behavior of this instruction, see [Appendix A Architectural Constraints on UNPREDICTABLE behaviors](#), and particularly [LDRH \(immediate, T32\) on page AppxA-4709](#).

Assembler syntax

LDRH{<c>}{<q>} <Rt>, [<Rn> {, #+/-<imm>}]	Offset: index==TRUE, wback==FALSE
LDRH{<c>}{<q>} <Rt>, [<Rn>, #+/-<imm>]!	Pre-indexed: index==TRUE, wback==TRUE
LDRH{<c>}{<q>} <Rt>, [<Rn>], #+/-<imm>	Post-indexed: index==FALSE, wback==TRUE

where:

<c>, <q>	See Standard assembler syntax fields on page F2-2415 .						
<Rt>	The destination register.						
<Rn>	The base register. The SP can be used. For PC use see LDRH (literal) on page F7-2668 .						
+/-	Is + or omitted to indicate that the immediate offset is added to the base register value (add == TRUE), or – to indicate that the offset is to be subtracted (add == FALSE). Different instructions are generated for #0 and #-0.						
<imm>	The immediate offset used for forming the address. For the offset addressing syntax, <imm> can be omitted, meaning an offset of 0. Values are: <table> <tr> <td>Encoding T1</td> <td>Multiples of 2 in the range 0-62.</td> </tr> <tr> <td>Encoding T2</td> <td>Any value in the range 0-4095.</td> </tr> <tr> <td>Encoding T3</td> <td>Any value in the range 0-255.</td> </tr> </table>	Encoding T1	Multiples of 2 in the range 0-62.	Encoding T2	Any value in the range 0-4095.	Encoding T3	Any value in the range 0-255.
Encoding T1	Multiples of 2 in the range 0-62.						
Encoding T2	Any value in the range 0-4095.						
Encoding T3	Any value in the range 0-255.						

The pre-UAL syntax LDR<c>H is equivalent to LDRH<c>.

Operation

```

if ConditionPassed() then
    EncodingSpecificOperations();
    NullCheckIfThumbEE(n);
    offset_addr = if add then (R[n] + imm32) else (R[n] - imm32);
    address = if index then offset_addr else R[n];
    data = MemU[address,2];
    if wback then R[n] = offset_addr;
    R[t] = ZeroExtend(data, 32);
  
```

F7.1.86 LDRH (immediate, A32)

Load Register Halfword (immediate) calculates an address from a base register value and an immediate offset, loads a halfword from memory, zero-extends it to form a 32-bit word, and writes it to a register. It can use offset, post-indexed, or pre-indexed addressing. For information about memory accesses see [Memory accesses on page F2-2422](#).

Encoding A1 ARMv4*, ARMv5T*, ARMv6*, ARMv7

LDRH<c> <Rt>, [<Rn>{, #+/-<imm8>}]

LDRH<c> <Rt>, [<Rn>], #+/-<imm8>

LDRH<c> <Rt>, [<Rn>, #+/-<imm8>]!

31	30	29	28	27	26	25	24	23	22	21	20	19	18	17	16	15	14	13	12	11	10	9	8	7	6	5	4	3	2	1	0
cond				0	0	0	P	U	1	W	1	Rn				Rt				imm4H				1	0	1	1	imm4L			

```

if Rn == '1111' then SEE LDRH (literal);
if P == '0' && W == '1' then SEE LDRHT;
t = UInt(Rt); n = UInt(Rn); imm32 = ZeroExtend(imm4H:imm4L, 32);
index = (P == '1'); add = (U == '1'); wback = (P == '0') || (W == '1');
if t == 15 || (wback && n == t) then UNPREDICTABLE;
    
```

For information about the CONSTRAINED UNPREDICTABLE behavior of this instruction, see [Appendix A Architectural Constraints on UNPREDICTABLE behaviors](#), and particularly [LDRH \(immediate, A32\)](#) on page AppxA-4710.

Assembler syntax

LDRH{<c>}{<q>} <Rt>, [<Rn> {, #+/-<imm>}]	Offset: index==TRUE, wback==FALSE
LDRH{<c>}{<q>} <Rt>, [<Rn>, #+/-<imm>]!	Pre-indexed: index==TRUE, wback==TRUE
LDRH{<c>}{<q>} <Rt>, [<Rn>], #+/-<imm>	Post-indexed: index==FALSE, wback==TRUE

where:

<c>, <q>	See Standard assembler syntax fields on page F2-2415 .
<Rt>	The destination register.
<Rn>	The base register. The SP can be used. For PC use see LDRH (literal) on page F7-2668 .
+/-	Is + or omitted to indicate that the immediate offset is added to the base register value (add == TRUE), or – to indicate that the offset is to be subtracted (add == FALSE). Different instructions are generated for #0 and #-0.
<imm>	The immediate offset used for forming the address. For the offset addressing syntax, <imm> can be omitted, meaning an offset of 0. Any value in the range 0-255 is permitted.

The pre-UAL syntax LDR<c>H is equivalent to LDRH<c>.

Operation

```
if ConditionPassed() then
    EncodingSpecificOperations();
    offset_addr = if add then (R[n] + imm32) else (R[n] - imm32);
    address = if index then offset_addr else R[n];
    data = MemU[address,2];
    if wback then R[n] = offset_addr;
    R[t] = ZeroExtend(data, 32);
```

F7.1.87 LDRH (literal)

Load Register Halfword (literal) calculates an address from the PC value and an immediate offset, loads a halfword from memory, zero-extends it to form a 32-bit word, and writes it to a register. For information about memory accesses see [Memory accesses](#) on page F2-2422.

Encoding T1 ARMv6T2, ARMv7

LDRH<c> <Rt>, <label>

LDRH<c> <Rt>, [PC, #-0] Special case

15	14	13	12	11	10	9	8	7	6	5	4	3	2	1	0	15	14	13	12	11	10	9	8	7	6	5	4	3	2	1	0
1	1	1	1	1	0	0	0	U	0	1	1	1	1	1	1	Rt	imm12														

```
if Rt == '1111' then SEE PLD (literal);
t = UInt(Rt); imm32 = ZeroExtend(imm12, 32); add = (U == '1');
// ARMv8-A removes UNPREDICTABLE for R13
```

Encoding A1 ARMv4*, ARMv5T*, ARMv6*, ARMv7

LDRH<c> <Rt>, <label>

LDRH<c> <Rt>, [PC, #-0] Special case

31	30	29	28	27	26	25	24	23	22	21	20	19	18	17	16	15	14	13	12	11	10	9	8	7	6	5	4	3	2	1	0
cond			0	0	0	P	U	1	W	1	1	1	1	1	Rt	imm4H			1	0	1	1	imm4L								

```
t = UInt(Rt); imm32 = ZeroExtend(imm4H:imm4L, 32); add = (U == '1');
if P == '0' && W == '1' then SEE LDRHT;
if P == W then UNPREDICTABLE;
if t == 15 then UNPREDICTABLE;
```

For information about the CONSTRAINED UNPREDICTABLE behavior of this instruction, see [Appendix A Architectural Constraints on UNPREDICTABLE behaviors](#), and particularly [LDRH \(literal\)](#) on page AppxA-4714.

Assembler syntax

LDRH{<c>}{<q>} <Rt>, <label> Normal form
LDRH{<c>}{<q>} <Rt>, [PC, #+/-<imm>] Alternative form

where:

<c>, <q> See [Standard assembler syntax fields on page F2-2415](#).

<Rt> The destination register.

<label> The label of the literal data item that is to be loaded into <Rt>. The assembler calculates the required value of the offset from the `Align(PC, 4)` value of the instruction to this label. Permitted values of the offset are:

Encoding T1 Any value in the range -4095 to 4095.

Encoding A1 Any value in the range -255 to 255.

If the offset is zero or positive, `imm32` is equal to the offset and `add == TRUE`.

If the offset is negative, `imm32` is equal to minus the offset and `add == FALSE`.

The alternative syntax permits the addition or subtraction of the offset and the immediate offset to be specified separately, including permitting a subtraction of 0 that cannot be specified using the normal syntax. For more information, see [Use of labels in UAL instruction syntax on page F1-2380](#).

The pre-UAL syntax `LDR<c>H` is equivalent to `LDRH<c>`.

Operation

```
if ConditionPassed() then
    EncodingSpecificOperations();  NullCheckIfThumbEE(15);
    base = Align(PC,4);
    address = if add then (base + imm32) else (base - imm32);
    data = MemU[address,2];
    R[t] = ZeroExtend(data, 32);
```

F7.1.88 LDRH (register)

Load Register Halfword (register) calculates an address from a base register value and an offset register value, loads a halfword from memory, zero-extends it to form a 32-bit word, and writes it to a register. The offset register value can be shifted left by 0, 1, 2, or 3 bits. For information about memory accesses see [Memory accesses on page F2-2422](#).

Encoding T1 ARMv4T, ARMv5T*, ARMv6*, ARMv7

LDRH<c> <Rt>, [<Rn>, <Rm>]

15	14	13	12	11	10	9	8	7	6	5	4	3	2	1	0
0	1	0	1	1	0	1	Rm		Rn		Rt				

if CurrentInstrSet() == InstrSet_T32EE then SEE "Modified operation in ThumbEE";

t = UInt(Rt); n = UInt(Rn); m = UInt(Rm);

index = TRUE; add = TRUE; wback = FALSE;

(shift_t, shift_n) = (SRTYPE_LSL, 0);

Encoding T2 ARMv6T2, ARMv7

LDRH<c>.W <Rt>, [<Rn>, <Rm>{, LSL #<imm2>}]

15	14	13	12	11	10	9	8	7	6	5	4	3	2	1	0	15	14	13	12	11	10	9	8	7	6	5	4	3	2	1	0
1	1	1	1	1	0	0	0	0	0	1	1	Rn		Rt		0	0	0	0	0	0	imm2	Rm								

if Rn == '1111' then SEE LDRH (literal);

if Rt == '1111' then SEE PLDW (register);

t = UInt(Rt); n = UInt(Rn); m = UInt(Rm);

index = TRUE; add = TRUE; wback = FALSE;

(shift_t, shift_n) = (SRTYPE_LSL, UInt(imm2));

if m == 15 then UNPREDICTABLE; // ARMv8-A removes UNPREDICTABLE for R13

Encoding A1 ARMv4*, ARMv5T*, ARMv6*, ARMv7

LDRH<c> <Rt>, [<Rn>, +/-<Rm>]{}]

LDRH<c> <Rt>, [<Rn>], +/-<Rm>

31	30	29	28	27	26	25	24	23	22	21	20	19	18	17	16	15	14	13	12	11	10	9	8	7	6	5	4	3	2	1	0
cond		0	0	0	P	U	0	W	1	Rn		Rt		(0)	(0)	(0)	(0)	1	0	1	1	Rm									

if P == '0' && W == '1' then SEE LDRHT;

t = UInt(Rt); n = UInt(Rn); m = UInt(Rm);

index = (P == '1'); add = (U == '1'); wback = (P == '0') || (W == '1');

(shift_t, shift_n) = (SRTYPE_LSL, 0);

if t == 15 || m == 15 then UNPREDICTABLE;

if wback && (n == 15 || n == t) then UNPREDICTABLE;

For information about the CONSTRAINED UNPREDICTABLE behavior of this instruction, see [Appendix A Architectural Constraints on UNPREDICTABLE behaviors](#), and particularly [LDRH \(register\) on page AppxA-4710](#).

Modified operation in ThumbEE

ARM deprecates any use of ThumbEE instructions and they are not documented in this manual.

Assembler syntax

LDRH{<c>}{<q>} <Rt>, [<Rn>, <Rm>{, LSL #<imm>}]	Offset: index==TRUE, wback==FALSE
LDRH{<c>}{<q>} <Rt>, [<Rn>, +/-<Rm>]	Offset: index==TRUE, wback==FALSE
LDRH{<c>}{<q>} <Rt>, [<Rn>, +/-<Rm>!]	Pre-indexed: index==TRUE, wback==TRUE
LDRH{<c>}{<q>} <Rt>, [<Rn>], +/-<Rm>	Post-indexed: index==FALSE, wback==TRUE

where:

<c>, <q>	See Standard assembler syntax fields on page F2-2415 .
<Rt>	The destination register.
<Rn>	The base register. The SP can be used. In the A32 instruction set the PC can be used, for offset addressing forms of the instruction only. In the T32 instruction set, the PC cannot be used for any of these forms of the LDRH instruction.
+/-	Is + or omitted if the optionally shifted value of <Rm> is to be added to the base register value (add == TRUE), or – if it is to be subtracted (permitted in A32 instructions only, add == FALSE).
<Rm>	Contains the offset that is optionally left shifted and added to the value of <Rn> to form the address.
<imm>	If present, the size of the left shift to apply to the value from <Rm>, in the range 1-3. Only encoding T2 is permitted, and <imm> is encoded in imm2. If absent, no shift is specified and all encodings are permitted. In encoding T2, imm2 is encoded as 0b00.

The pre-UAL syntax LDR<c>H is equivalent to LDRH<c>.

Operation

```

if ConditionPassed() then
    EncodingSpecificOperations(); NullCheckIfThumbEE(n);
    offset = Shift(R[m], shift_t, shift_n, APSR.C);
    offset_addr = if add then (R[n] + offset) else (R[n] - offset);
    address = if index then offset_addr else R[n];
    data = MemU[address,2];
    if wback then R[n] = offset_addr;
    R[t] = ZeroExtend(data, 32);
  
```

F7.1.89 LDRHT

Load Register Halfword Unprivileged loads a halfword from memory, zero-extends it to form a 32-bit word, and writes it to a register. For information about memory accesses see [Memory accesses on page F2-2422](#).

The memory access is restricted as if the PE were running in User mode. This makes no difference if the PE is actually running in User mode.

LDRHT is UNPREDICTABLE in Hyp mode.

The T32 instruction uses an offset addressing mode, that calculates the address used for the memory access from a base register value and an immediate offset, and leaves the base register unchanged.

The A32 instruction uses a post-indexed addressing mode, that uses a base register value as the address for the memory access, and calculates a new address from a base register value and an offset and writes it back to the base register. The offset can be an immediate value or a register value.

Encoding T1 ARMv6T2, ARMv7

LDRHT<c> <Rt>, [<Rn>, #<imm8>]

15	14	13	12	11	10	9	8	7	6	5	4	3	2	1	0	15	14	13	12	11	10	9	8	7	6	5	4	3	2	1	0
1	1	1	1	1	0	0	0	0	0	1	1	Rn				Rt		1	1	1	0	imm8									

```
if Rn == '1111' then SEE LDRH (literal);
t = UInt(Rt); n = UInt(Rn); postindex = FALSE; add = TRUE;
register_form = FALSE; imm32 = ZeroExtend(imm8, 32);
if t == 15 then UNPREDICTABLE; // ARMv8-A removes UNPREDICTABLE for R13
```

Encoding A1 ARMv6T2, ARMv7

LDRHT<c> <Rt>, [<Rn>] {, #+/-<imm8>}

31	30	29	28	27	26	25	24	23	22	21	20	19	18	17	16	15	14	13	12	11	10	9	8	7	6	5	4	3	2	1	0
cond		0	0	0	0	U	1	1	1	Rn			Rt		imm4H		1	0	1	1	imm4L										

```
t = UInt(Rt); n = UInt(Rn); postindex = TRUE; add = (U == '1');
register_form = FALSE; imm32 = ZeroExtend(imm4H:imm4L, 32);
if t == 15 || n == 15 || n == t then UNPREDICTABLE;
```

Encoding A2 ARMv6T2, ARMv7

LDRHT<c> <Rt>, [<Rn>], +/-<Rm>

31	30	29	28	27	26	25	24	23	22	21	20	19	18	17	16	15	14	13	12	11	10	9	8	7	6	5	4	3	2	1	0
cond		0	0	0	0	U	0	1	1	Rn			Rt		(0)	(0)	(0)	(0)	1	0	1	1	Rm								

```
t = UInt(Rt); n = UInt(Rn); m = UInt(Rm); postindex = TRUE; add = (U == '1');
register_form = TRUE;
if t == 15 || n == 15 || n == t || m == 15 then UNPREDICTABLE;
```

For information about the CONSTRAINED UNPREDICTABLE behavior of this instruction, see [Appendix A Architectural Constraints on UNPREDICTABLE behaviors](#), and particularly [LDRHT on page AppxA-4710](#).

Assembler syntax

LDRHT{<c>}{<q>} <Rt>, [<Rn> {, #<imm>}]	Offset: T32 only
LDRHT{<c>}{<q>} <Rt>, [<Rn>] {, #+/-<imm>}	Post-indexed: A32 only
LDRHT{<c>}{<q>} <Rt>, [<Rn>], +/-<Rm>	Post-indexed: A32 only

where:

<c>, <q>	See Standard assembler syntax fields on page F2-2415 .
<Rt>	The destination register.
<Rn>	The base register. The SP can be used.
+/-	Is + or omitted if <imm> or the optionally shifted value of <Rm> is to be added to the base register value. Encoded as add = TRUE. Is - if <imm> or the optionally shifted value of <Rm> is to be subtracted from the base register value. This is permitted in A32 instructions only, and is encoded as add = FALSE.
<imm>	The immediate offset applied to the value of <Rn>. Any value in the range 0-255 is permitted. <imm> can be omitted, meaning an offset of 0.
<Rm>	Contains the offset that is applied to the value of <Rn> to form the address.

Operation

```
if ConditionPassed() then
    if CurrentModeIsHyp() then UNPREDICTABLE;           // Hyp mode
    EncodingSpecificOperations(); NullCheckIfThumbEE(n);
    offset = if register_form then R[m] else imm32;
    offset_addr = if add then (R[n] + offset) else (R[n] - offset);
    address = if postindex then R[n] else offset_addr;
    data = MemU_unpriv[address,2];
    if postindex then R[n] = offset_addr;
    R[t] = ZeroExtend(data, 32);
```

F7.1.90 LDRSB (immediate)

Load Register Signed Byte (immediate) calculates an address from a base register value and an immediate offset, loads a byte from memory, sign-extends it to form a 32-bit word, and writes it to a register. It can use offset, post-indexed, or pre-indexed addressing. For information about memory accesses see [Memory accesses on page F2-2422](#).

Encoding T1 ARMv6T2, ARMv7

LDRSB<c> <Rt>, [<Rn>, #<imm12>]

15	14	13	12	11	10	9	8	7	6	5	4	3	2	1	0	15	14	13	12	11	10	9	8	7	6	5	4	3	2	1	0
1	1	1	1	1	0	0	1	1	0	0	1	Rn				Rt		imm12													

```

if Rt == '1111' then SEE PLI;
if Rn == '1111' then SEE LDRSB (literal);
t = UInt(Rt); n = UInt(Rn); imm32 = ZeroExtend(imm12, 32);
index = TRUE; add = TRUE; wback = FALSE;
// ARMv8-A removes UNPREDICTABLE for R13
    
```

Encoding T2 ARMv6T2, ARMv7

LDRSB<c> <Rt>, [<Rn>, #-<imm8>]

LDRSB<c> <Rt>, [<Rn>], #+/-<imm8>

LDRSB<c> <Rt>, [<Rn>, #+/-<imm8>]!

15	14	13	12	11	10	9	8	7	6	5	4	3	2	1	0	15	14	13	12	11	10	9	8	7	6	5	4	3	2	1	0
1	1	1	1	1	0	0	1	0	0	0	1	Rn				Rt		1	P	U	W	imm8									

```

if Rt == '1111' && P == '1' && U == '0' && W == '0' then SEE PLI;
if Rn == '1111' then SEE LDRSB (literal);
if P == '1' && U == '1' && W == '0' then SEE LDRSBT;
if P == '0' && W == '0' then UNDEFINED;
t = UInt(Rt); n = UInt(Rn); imm32 = ZeroExtend(imm8, 32);
index = (P == '1'); add = (U == '1'); wback = (W == '1');
if (t == 15 && W == '1') || (wback && n == t) then UNPREDICTABLE;
// ARMv8-A removes UNPREDICTABLE for R13
    
```

Encoding A1 ARMv4*, ARMv5T*, ARMv6*, ARMv7

LDRSB<c> <Rt>, [<Rn>{, #+/-<imm8>}]

LDRSB<c> <Rt>, [<Rn>], #+/-<imm8>

LDRSB<c> <Rt>, [<Rn>, #+/-<imm8>]!

31	30	29	28	27	26	25	24	23	22	21	20	19	18	17	16	15	14	13	12	11	10	9	8	7	6	5	4	3	2	1	0
cond		0	0	0	P	U	1	W	1	Rn				Rt		imm4H				1	1	0	1	imm4L							

```

if Rn == '1111' then SEE LDRSB (literal);
if P == '0' && W == '1' then SEE LDRSBT;
t = UInt(Rt); n = UInt(Rn); imm32 = ZeroExtend(imm4H:imm4L, 32);
index = (P == '1'); add = (U == '1'); wback = (P == '0') || (W == '1');
if t == 15 || (wback && n == t) then UNPREDICTABLE;
    
```

For information about the CONSTRAINED UNPREDICTABLE behavior of this instruction, see [Appendix A Architectural Constraints on UNPREDICTABLE behaviors](#), and particularly [LDRSB \(immediate\) on page AppxA-4711](#).

Assembler syntax

LDRSB{<c>}{<q>} <Rt>, [<Rn> {, #+/-<imm>}]	Offset: index==TRUE, wback==FALSE
LDRSB{<c>}{<q>} <Rt>, [<Rn>, #+/-<imm>]!	Pre-indexed: index==TRUE, wback==TRUE
LDRSB{<c>}{<q>} <Rt>, [<Rn>], #+/-<imm>	Post-indexed: index==FALSE, wback==TRUE

where:

<c>, <q> See [Standard assembler syntax fields on page F2-2415](#).

<Rt> The destination register.

<Rn> The base register. The SP can be used. For PC use see [LDRSB \(literal\) on page F7-2676](#).

+/- Is + or omitted to indicate that the immediate offset is added to the base register value (add == TRUE), or – to indicate that the offset is to be subtracted (add == FALSE). Different instructions are generated for #0 and #-0.

<imm> The immediate offset used for forming the address. For the offset addressing syntax, <imm> can be omitted, meaning an offset of 0. Values are:

Encoding T1 Any value in the range 0-4095.

Encoding T2 or A1 Any value in the range 0-255.

The pre-UAL syntax LDR<c>SB is equivalent to LDRSB<c>.

Operation

```
if ConditionPassed() then
    EncodingSpecificOperations(); NullCheckIfThumbEE(n);
    offset_addr = if add then (R[n] + imm32) else (R[n] - imm32);
    address = if index then offset_addr else R[n];
    R[t] = SignExtend(MemU[address,1], 32);
    if wback then R[n] = offset_addr;
```

F7.1.91 LDRSB (literal)

Load Register Signed Byte (literal) calculates an address from the PC value and an immediate offset, loads a byte from memory, sign-extends it to form a 32-bit word, and writes it to a register. For information about memory accesses see [Memory accesses](#) on page F2-2422.

Encoding T1 ARMv6T2, ARMv7

LDRSB<c> <Rt>, <label>

LDRSB<c> <Rt>, [PC, #-0] Special case

15	14	13	12	11	10	9	8	7	6	5	4	3	2	1	0	15	14	13	12	11	10	9	8	7	6	5	4	3	2	1	0
1	1	1	1	1	0	0	1	U	0	0	1	1	1	1	1	Rt	imm12														

```
if Rt == '1111' then SEE PLI;
t = UInt(Rt); imm32 = ZeroExtend(imm12, 32); add = (U == '1');
// ARMv8-A removes UNPREDICTABLE for R13
```

Encoding A1 ARMv4*, ARMv5T*, ARMv6*, ARMv7

LDRSB<c> <Rt>, <label>

LDRSB<c> <Rt>, [PC, #-0] Special case

31	30	29	28	27	26	25	24	23	22	21	20	19	18	17	16	15	14	13	12	11	10	9	8	7	6	5	4	3	2	1	0
cond				0	0	0	(1)	U	1	(0)	1	1	1	1	1	Rt	imm4H				1	1	0	1	imm4L						

```
t = UInt(Rt); imm32 = ZeroExtend(imm4H:imm4L, 32); add = (U == '1');
if t == 15 then UNPREDICTABLE;
```

For information about the CONSTRAINED UNPREDICTABLE behavior of this instruction, see [Appendix A Architectural Constraints on UNPREDICTABLE behaviors](#), and particularly [LDRSB \(literal\)](#) on page AppxA-4714.

Assembler syntax

LDRSB{<c>}{<q>} <Rt>, <label> Normal form
LDRSB{<c>}{<q>} <Rt>, [PC, #+/-<imm>] Alternative form

where:

<c>, <q> See [Standard assembler syntax fields on page F2-2415](#).

<Rt> The destination register.

<label> The label of the literal data item that is to be loaded into <Rt>. The assembler calculates the required value of the offset from the `Align(PC, 4)` value of the instruction to this label. Permitted values of the offset are:

Encoding T1 Any value in the range -4095 to 4095.

Encoding A1 Any value in the range -255 to 255.

If the offset is zero or positive, `imm32` is equal to the offset and `add == TRUE`.

If the offset is negative, `imm32` is equal to minus the offset and `add == FALSE`.

The alternative syntax permits the addition or subtraction of the offset and the immediate offset to be specified separately, including permitting a subtraction of 0 that cannot be specified using the normal syntax. For more information, see [Use of labels in UAL instruction syntax on page F1-2380](#).

The pre-UAL syntax `LDR<c>SB` is equivalent to `LDRSB<c>`.

Operation

```
if ConditionPassed() then
    EncodingSpecificOperations();  NullCheckIfThumbEE(15);
    base = Align(PC,4);
    address = if add then (base + imm32) else (base - imm32);
    R[t] = SignExtend(MemU[address,1], 32);
```

F7.1.92 LDRSB (register)

Load Register Signed Byte (register) calculates an address from a base register value and an offset register value, loads a byte from memory, sign-extends it to form a 32-bit word, and writes it to a register. The offset register value can be shifted left by 0, 1, 2, or 3 bits. For information about memory accesses see [Memory accesses on page F2-2422](#).

Encoding T1 ARMv4T, ARMv5T*, ARMv6*, ARMv7

LDRSB<c> <Rt>, [<Rn>, <Rm>]

15	14	13	12	11	10	9	8	7	6	5	4	3	2	1	0
0	1	0	1	0	1	1	Rm		Rn		Rt				

t = UInt(Rt); n = UInt(Rn); m = UInt(Rm);
 index = TRUE; add = TRUE; wback = FALSE;
 (shift_t, shift_n) = (SRTYPE_LSL, 0);

Encoding T2 ARMv6T2, ARMv7

LDRSB<c>.W <Rt>, [<Rn>, <Rm>{, LSL #<imm2>}]

15	14	13	12	11	10	9	8	7	6	5	4	3	2	1	0	15	14	13	12	11	10	9	8	7	6	5	4	3	2	1	0
1	1	1	1	1	0	0	1	0	0	0	1	Rn			Rt		0	0	0	0	0	0	imm2		Rm						

if Rt == '1111' then SEE PLI;
 if Rn == '1111' then SEE LDRSB (literal);
 t = UInt(Rt); n = UInt(Rn); m = UInt(Rm);
 index = TRUE; add = TRUE; wback = FALSE;
 (shift_t, shift_n) = (SRTYPE_LSL, UInt(imm2));
 if m == 15 then UNPREDICTABLE; // ARMv8-A removes UNPREDICTABLE for R13

Encoding A1 ARMv4*, ARMv5T*, ARMv6*, ARMv7

LDRSB<c> <Rt>, [<Rn>, +/-<Rm>]{!}

LDRSB<c> <Rt>, [<Rn>], +/-<Rm>

31	30	29	28	27	26	25	24	23	22	21	20	19	18	17	16	15	14	13	12	11	10	9	8	7	6	5	4	3	2	1	0
cond		0	0	0	P	U	0	W	1	Rn			Rt		(0)	(0)	(0)	(0)	1	1	0	1	Rm								

if P == '0' && W == '1' then SEE LDRSBT;
 t = UInt(Rt); n = UInt(Rn); m = UInt(Rm);
 index = (P == '1'); add = (U == '1'); wback = (P == '0') || (W == '1');
 (shift_t, shift_n) = (SRTYPE_LSL, 0);
 if t == 15 || m == 15 then UNPREDICTABLE;
 if wback && (n == 15 || n == t) then UNPREDICTABLE;

For information about the CONSTRAINED UNPREDICTABLE behavior of this instruction, see [Appendix A Architectural Constraints on UNPREDICTABLE behaviors](#), and particularly [LDRSB \(register\) on page AppxA-4711](#).

Assembler syntax

LDRSB{<c>}{<q>} <Rt>, [<Rn>, <Rm>{, LSL #<imm>}]	Offset: index==TRUE, wback==FALSE
LDRSB{<c>}{<q>} <Rt>, [<Rn>, +/-<Rm>]	Offset: index==TRUE, wback==FALSE
LDRSB{<c>}{<q>} <Rt>, [<Rn>, +/-<Rm>]!	Pre-indexed: index==TRUE, wback==TRUE
LDRSB{<c>}{<q>} <Rt>, [<Rn>], +/-<Rm>	Post-indexed: index==FALSE, wback==TRUE

where:

<c>, <q>	See Standard assembler syntax fields on page F2-2415 .
<Rt>	The destination register.
<Rn>	The base register. The SP can be used. In the A32 instruction set the PC can be used, for the offset addressing forms of the instruction only. In the T32 instruction set, the PC cannot be used for any of these forms of the LDRSB instruction.
+/-	Is + or omitted if the optionally shifted value of <Rm> is to be added to the base register value (add == TRUE), or – if it is to be subtracted (permitted in A32 instructions only, add == FALSE).
<Rm>	Contains the offset that is optionally left shifted and added to the value of <Rn> to form the address.
<imm>	If present, the size of the left shift to apply to the value from <Rm>, in the range 1-3. Only encoding T2 is permitted, and <imm> is encoded in imm2. If absent, no shift is specified and all encodings are permitted. In encoding T2, imm2 is encoded as 0b00.

The pre-UAL syntax LDR<c>SB is equivalent to LDRSB<c>.

Operation

```

if ConditionPassed() then
    EncodingSpecificOperations(); NullCheckIfThumbEE(n);
    offset = Shift(R[m], shift_t, shift_n, APSR.C);
    offset_addr = if add then (R[n] + offset) else (R[n] - offset);
    address = if index then offset_addr else R[n];
    R[t] = SignExtend(MemU[address,1], 32);
    if wback then R[n] = offset_addr;
  
```

F7.1.93 LDRSBT

Load Register Signed Byte Unprivileged loads a byte from memory, sign-extends it to form a 32-bit word, and writes it to a register. For information about memory accesses see [Memory accesses on page F2-2422](#).

The memory access is restricted as if the PE were running in User mode. This makes no difference if the PE is actually running in User mode.

LDRSBT is UNPREDICTABLE in Hyp mode.

The T32 instruction uses an offset addressing mode, that calculates the address used for the memory access from a base register value and an immediate offset, and leaves the base register unchanged.

The A32 instruction uses a post-indexed addressing mode, that uses a base register value as the address for the memory access, and calculates a new address from a base register value and an offset and writes it back to the base register. The offset can be an immediate value or a register value.

Encoding T1 ARMv6T2, ARMv7

LDRSBT<c> <Rt>, [<Rn>, #<imm8>]

15	14	13	12	11	10	9	8	7	6	5	4	3	2	1	0	15	14	13	12	11	10	9	8	7	6	5	4	3	2	1	0
1	1	1	1	1	0	0	1	0	0	0	1	Rn				Rt		1	1	1	0	imm8									

```
if Rn == '1111' then SEE LDRSB (literal);
t = UInt(Rt); n = UInt(Rn); postindex = FALSE; add = TRUE;
register_form = FALSE; imm32 = ZeroExtend(imm8, 32);
if t == 15 then UNPREDICTABLE; // ARMv8-A removes UNPREDICTABLE for R13
```

Encoding A1 ARMv6T2, ARMv7

LDRSBT<c> <Rt>, [<Rn>] {, #+/-<imm8>}

31	30	29	28	27	26	25	24	23	22	21	20	19	18	17	16	15	14	13	12	11	10	9	8	7	6	5	4	3	2	1	0
cond		0	0	0	0	U	1	1	1	Rn			Rt		imm4H		1	1	0	1	imm4L										

```
t = UInt(Rt); n = UInt(Rn); postindex = TRUE; add = (U == '1');
register_form = FALSE; imm32 = ZeroExtend(imm4H:imm4L, 32);
if t == 15 || n == 15 || n == t then UNPREDICTABLE;
```

Encoding A2 ARMv6T2, ARMv7

LDRSBT<c> <Rt>, [<Rn>], +/-<Rm>

31	30	29	28	27	26	25	24	23	22	21	20	19	18	17	16	15	14	13	12	11	10	9	8	7	6	5	4	3	2	1	0
cond		0	0	0	0	U	0	1	1	Rn			Rt		(0)	(0)	(0)	(0)	1	1	0	1	Rm								

```
t = UInt(Rt); n = UInt(Rn); m = UInt(Rm); postindex = TRUE; add = (U == '1');
register_form = TRUE;
if t == 15 || n == 15 || n == t || m == 15 then UNPREDICTABLE;
```

For information about the CONSTRAINED UNPREDICTABLE behavior of this instruction, see [Appendix A Architectural Constraints on UNPREDICTABLE behaviors](#), and particularly [LDRSBT on page AppxA-4711](#).

Assembler syntax

LDRSBT{<c>}{<q>} <Rt>, [<Rn> {, #<imm>}]	Offset: T32 only
LDRSBT{<c>}{<q>} <Rt>, [<Rn>] {, #+/-<imm>}	Post-indexed: A32 only
LDRSBT{<c>}{<q>} <Rt>, [<Rn>], +/-<Rm>	Post-indexed: A32 only

where:

<c>, <q>	See Standard assembler syntax fields on page F2-2415 .
<Rt>	The destination register.
<Rn>	The base register. The SP can be used.
+/-	Is + or omitted if <imm> or the optionally shifted value of <Rm> is to be added to the base register value (add == TRUE), or – if it is to be subtracted (permitted in A32 instructions only, add == FALSE).
<imm>	The immediate offset applied to the value of <Rn>. Any value in the range 0-255 is permitted. <imm> can be omitted, meaning an offset of 0.
<Rm>	Contains the offset that is applied to the value of <Rn> to form the address.

Operation

```
if ConditionPassed() then
    if CurrentModeIsHyp() then UNPREDICTABLE;           // Hyp mode
    EncodingSpecificOperations(); NullCheckIfThumbEE(n);
    offset = if register_form then R[m] else imm32;
    offset_addr = if add then (R[n] + offset) else (R[n] - offset);
    address = if postindex then R[n] else offset_addr;
    R[t] = SignExtend(MemU_unpriv[address,1], 32);
    if postindex then R[n] = offset_addr;
```

F7.1.94 LDRSH (immediate)

Load Register Signed Halfword (immediate) calculates an address from a base register value and an immediate offset, loads a halfword from memory, sign-extends it to form a 32-bit word, and writes it to a register. It can use offset, post-indexed, or pre-indexed addressing. For information about memory accesses see [Memory accesses on page F2-2422](#).

Encoding T1 ARMv6T2, ARMv7

LDRSH<c> <Rt>, [<Rn>, #<imm12>]

15	14	13	12	11	10	9	8	7	6	5	4	3	2	1	0	15	14	13	12	11	10	9	8	7	6	5	4	3	2	1	0
1	1	1	1	1	0	0	1	1	0	1	1	Rn				Rt		imm12													

```

if Rn == '1111' then SEE LDRSH (literal);
if Rt == '1111' then SEE "Related instructions";
t = UInt(Rt); n = UInt(Rn); imm32 = ZeroExtend(imm12, 32);
index = TRUE; add = TRUE; wback = FALSE;
// ARMv8-A removes UNPREDICTABLE for R13
    
```

Encoding T2 ARMv6T2, ARMv7

LDRSH<c> <Rt>, [<Rn>, #-<imm8>]

LDRSH<c> <Rt>, [<Rn>], #+/-<imm8>

LDRSH<c> <Rt>, [<Rn>, #+/-<imm8>]!

15	14	13	12	11	10	9	8	7	6	5	4	3	2	1	0	15	14	13	12	11	10	9	8	7	6	5	4	3	2	1	0
1	1	1	1	1	0	0	1	0	0	1	1	Rn				Rt		1	P	U	W	imm8									

```

if Rn == '1111' then SEE LDRSH (literal);
if Rt == '1111' && P == '1' && U == '0' && W == '0' then SEE "Related instructions";
if P == '1' && U == '1' && W == '0' then SEE LDRSHT;
if P == '0' && W == '0' then UNDEFINED;
t = UInt(Rt); n = UInt(Rn); imm32 = ZeroExtend(imm8, 32);
index = (P == '1'); add = (U == '1'); wback = (W == '1');
if (t == 15 && W == '1') || (wback && n == t) then UNPREDICTABLE;
// ARMv8-A removes UNPREDICTABLE for R13
    
```

Encoding A1 ARMv4*, ARMv5T*, ARMv6*, ARMv7

LDRSH<c> <Rt>, [<Rn>{, #+/-<imm8>}]

LDRSH<c> <Rt>, [<Rn>], #+/-<imm8>

LDRSH<c> <Rt>, [<Rn>, #+/-<imm8>]!

31	30	29	28	27	26	25	24	23	22	21	20	19	18	17	16	15	14	13	12	11	10	9	8	7	6	5	4	3	2	1	0
cond		0	0	0	P	U	1	W	1	Rn				Rt		imm4H				1	1	1	1	imm4L							

```

if Rn == '1111' then SEE LDRSH (literal);
if P == '0' && W == '1' then SEE LDRSHT;
t = UInt(Rt); n = UInt(Rn); imm32 = ZeroExtend(imm4H:imm4L, 32);
index = (P == '1'); add = (U == '1'); wback = (P == '0') || (W == '1');
if t == 15 || (wback && n == t) then UNPREDICTABLE;
    
```

For information about the CONSTRAINED UNPREDICTABLE behavior of this instruction, see [Appendix A Architectural Constraints on UNPREDICTABLE behaviors](#), and particularly [LDRSH \(immediate\) on page AppxA-4712](#).

Related instructions

See [Load halfword, memory hints on page F3-2453](#)

Assembler syntax

LDRSH{<c>}{<q>} <Rt>, [<Rn> {, #+/-<imm>}]	Offset: index==TRUE, wback==FALSE
LDRSH{<c>}{<q>} <Rt>, [<Rn>, #+/-<imm>]!	Pre-indexed: index==TRUE, wback==TRUE
LDRSH{<c>}{<q>} <Rt>, [<Rn>], #+/-<imm>	Post-indexed: index==FALSE, wback==TRUE

where:

<c>, <q> See [Standard assembler syntax fields on page F2-2415](#).

<Rt> The destination register.

<Rn> The base register. The SP can be used. For PC use see [LDRSH \(literal\) on page F7-2684](#).

+/- Is + or omitted to indicate that the immediate offset is added to the base register value (add == TRUE), or – to indicate that the offset is to be subtracted (add == FALSE). Different instructions are generated for #0 and #-0.

<imm> The immediate offset used for forming the address, Values are 0-4095 for encoding T1, and 0-255 for encoding T2 or A1. For the offset syntax, <imm> can be omitted, meaning an offset of 0.

The pre-UAL syntax LDR<c>SH is equivalent to LDRSH<c>.

Operation

```
if ConditionPassed() then
    EncodingSpecificOperations(); NullCheckIfThumbEE(n);
    offset_addr = if add then (R[n] + imm32) else (R[n] - imm32);
    address = if index then offset_addr else R[n];
    data = MemU[address,2];
    if wback then R[n] = offset_addr;
    R[t] = SignExtend(data, 32);
```

F7.1.95 LDRSH (literal)

Load Register Signed Halfword (literal) calculates an address from the PC value and an immediate offset, loads a halfword from memory, sign-extends it to form a 32-bit word, and writes it to a register. For information about memory accesses see [Memory accesses on page F2-2422](#).

Encoding T1 ARMv6T2, ARMv7

LDRSH<c> <Rt>, <label>

LDRSH<c> <Rt>, [PC, #-0] Special case

15	14	13	12	11	10	9	8	7	6	5	4	3	2	1	0	15	14	13	12	11	10	9	8	7	6	5	4	3	2	1	0
1	1	1	1	1	0	0	1	U	0	1	1	1	1	1	1	Rt	imm12														

if Rt == '1111' then SEE "Related instructions";
 t = UInt(Rt); imm32 = ZeroExtend(imm12, 32); add = (U == '1');
 // ARMv8-A removes UNPREDICTABLE for R13

Encoding A1 ARMv4*, ARMv5T*, ARMv6*, ARMv7

LDRSH<c> <Rt>, <label>

LDRSH<c> <Rt>, [PC, #-0] Special case

31	30	29	28	27	26	25	24	23	22	21	20	19	18	17	16	15	14	13	12	11	10	9	8	7	6	5	4	3	2	1	0
cond			0	0	0	(1)	U	1	(0)	1	1	1	1	1	1	Rt	imm4H		1	1	1	1	imm4L								

t = UInt(Rt); imm32 = ZeroExtend(imm4H:imm4L, 32); add = (U == '1');
 if t == 15 then UNPREDICTABLE;

For information about the CONSTRAINED UNPREDICTABLE behavior of this instruction, see [Appendix A Architectural Constraints on UNPREDICTABLE behaviors](#), and particularly [LDRSH \(literal\) on page AppxA-4715 on page AppxA-4760](#).

Related instructions

See [Load halfword, memory hints on page F3-2453](#)

Assembler syntax

LDRSH{<c>}{<q>} <Rt>, <label> Normal form
LDRSH{<c>}{<q>} <Rt>, [PC, #+/-<imm>] Alternative form

where:

<c>, <q> See [Standard assembler syntax fields on page F2-2415](#).

<Rt> The destination register.

<label> The label of the literal data item that is to be loaded into <Rt>. The assembler calculates the required value of the offset from the `Align(PC, 4)` value of the instruction to this label. Permitted values of the offset are:

Encoding T1 Any value in the range -4095 to 4095.

Encoding A1 Any value in the range -255 to 255.

If the offset is zero or positive, `imm32` is equal to the offset and `add == TRUE`.

If the offset is negative, `imm32` is equal to minus the offset and `add == FALSE`.

The alternative syntax permits the addition or subtraction of the offset and the immediate offset to be specified separately, including permitting a subtraction of 0 that cannot be specified using the normal syntax. For more information, see [Use of labels in UAL instruction syntax on page F1-2380](#).

The pre-UAL syntax `LDR<c>SH` is equivalent to `LDRSH<c>`.

Operation

```
if ConditionPassed() then
    EncodingSpecificOperations();  NullCheckIfThumbEE(15);
    base = Align(PC,4);
    address = if add then (base + imm32) else (base - imm32);
    data = MemU[address,2];
    R[t] = SignExtend(data, 32);
```

F7.1.96 LDRSH (register)

Load Register Signed Halfword (register) calculates an address from a base register value and an offset register value, loads a halfword from memory, sign-extends it to form a 32-bit word, and writes it to a register. The offset register value can be shifted left by 0, 1, 2, or 3 bits. For information about memory accesses see [Memory accesses on page F2-2422](#).

Encoding T1 ARMv4T, ARMv5T*, ARMv6*, ARMv7

LDRSH<c> <Rt>, [<Rn>, <Rm>]

15	14	13	12	11	10	9	8	7	6	5	4	3	2	1	0
0	1	0	1	1	1	1	Rm		Rn			Rt			

if CurrentInstrSet() == InstrSet_T32EE then SEE "Modified operation in ThumbEE";

t = UInt(Rt); n = UInt(Rn); m = UInt(Rm);

index = TRUE; add = TRUE; wback = FALSE;

(shift_t, shift_n) = (SRTYPE_LSL, 0);

Encoding T2 ARMv6T2, ARMv7

LDRSH<c>.W <Rt>, [<Rn>, <Rm>{, LSL #<imm2>}]

15	14	13	12	11	10	9	8	7	6	5	4	3	2	1	0	15	14	13	12	11	10	9	8	7	6	5	4	3	2	1	0
1	1	1	1	1	0	0	1	0	0	1	1	Rn			Rt	0	0	0	0	0	0	imm2	Rm								

if Rn == '1111' then SEE LDRSH (literal);

if Rt == '1111' then SEE "Related instructions";

t = UInt(Rt); n = UInt(Rn); m = UInt(Rm);

index = TRUE; add = TRUE; wback = FALSE;

(shift_t, shift_n) = (SRTYPE_LSL, UInt(imm2));

if m == 15 then UNPREDICTABLE; // ARMv8-A removes UNPREDICTABLE for R13

Encoding A1 ARMv4*, ARMv5T*, ARMv6*, ARMv7

LDRSH<c> <Rt>, [<Rn>, +/-<Rm>]{!}

LDRSH<c> <Rt>, [<Rn>], +/-<Rm>

31	30	29	28	27	26	25	24	23	22	21	20	19	18	17	16	15	14	13	12	11	10	9	8	7	6	5	4	3	2	1	0
cond		0	0	0	P	U	0	W	1	Rn			Rt	(0)	(0)	(0)	(0)	1	1	1	1	Rm									

if P == '0' && W == '1' then SEE LDRSHT;

t = UInt(Rt); n = UInt(Rn); m = UInt(Rm);

index = (P == '1'); add = (U == '1'); wback = (P == '0') || (W == '1');

(shift_t, shift_n) = (SRTYPE_LSL, 0);

if t == 15 || m == 15 then UNPREDICTABLE;

if wback && (n == 15 || n == t) then UNPREDICTABLE;

For information about the CONSTRAINED UNPREDICTABLE behavior of this instruction, see [Appendix A Architectural Constraints on UNPREDICTABLE behaviors](#), and particularly [LDRSH \(register\) on page AppxA-4712](#).

Related instructions

See [Load halfword, memory hints on page F3-2453](#)

Modified operation in ThumbEE

ARM deprecates any use of ThumbEE instructions and they are not documented in this manual.

Assembler syntax

LDRSH{<c>}{<q>} <Rt>, [<Rn>, <Rm>{, LSL #<imm>}]	Offset: index==TRUE, wback==FALSE
LDRSH{<c>}{<q>} <Rt>, [<Rn>, +/-<Rm>]	Offset: index==TRUE, wback==FALSE
LDRSH{<c>}{<q>} <Rt>, [<Rn>, +/-<Rm>!]	Pre-indexed: index==TRUE, wback==TRUE
LDRSH{<c>}{<q>} <Rt>, [<Rn>], +/-<Rm>	Post-indexed: index==FALSE, wback==TRUE

where:

<c>, <q>	See Standard assembler syntax fields on page F2-2415 .
<Rt>	The destination register.
<Rn>	The base register. The SP can be used. In the A32 instruction set the PC can be used, for the offset addressing forms of the instruction only. In the T32 instruction set, the PC cannot be used for any of these forms of the LDRSH instruction.
+/-	Is + or omitted if the optionally shifted value of <Rm> is to be added to the base register value (add == TRUE), or – if it is to be subtracted (permitted in A32 instructions only, add == FALSE).
<Rm>	Contains the offset that is optionally left shifted and added to the value of <Rn> to form the address.
<imm>	If present, the size of the left shift to apply to the value from <Rm>, in the range 1-3. Only encoding T2 is permitted, and <imm> is encoded in imm2. If absent, no shift is specified and all encodings are permitted. In encoding T2, imm2 is encoded as 0b00.

The pre-UAL syntax LDR<c>SH is equivalent to LDRSH<c>.

Operation

```
if ConditionPassed() then
    EncodingSpecificOperations(); NullCheckIfThumbEE(n);
    offset = Shift(R[m], shift_t, shift_n, APSR.C);
    offset_addr = if add then (R[n] + offset) else (R[n] - offset);
    address = if index then offset_addr else R[n];
    data = MemU[address,2];
    if wback then R[n] = offset_addr;
    R[t] = SignExtend(data, 32);
```

F7.1.97 LDRSHT

Load Register Signed Halfword Unprivileged loads a halfword from memory, sign-extends it to form a 32-bit word, and writes it to a register. For information about memory accesses see [Memory accesses](#) on page F2-2422.

The memory access is restricted as if the PE were running in User mode. This makes no difference if the PE is actually running in User mode.

LDRSHT is UNPREDICTABLE in Hyp mode.

The T32 instruction uses an offset addressing mode, that calculates the address used for the memory access from a base register value and an immediate offset, and leaves the base register unchanged.

The A32 instruction uses a post-indexed addressing mode, that uses a base register value as the address for the memory access, and calculates a new address from a base register value and an offset and writes it back to the base register. The offset can be an immediate value or a register value.

Encoding T1 ARMv6T2, ARMv7

LDRSHT<c> <Rt>, [<Rn>, #<imm8>]

15	14	13	12	11	10	9	8	7	6	5	4	3	2	1	0	15	14	13	12	11	10	9	8	7	6	5	4	3	2	1	0
1	1	1	1	1	0	0	1	0	0	1	1	Rn				Rt		1	1	1	0	imm8									

if Rn == '1111' then SEE LDRSH (literal);
 t = UInt(Rt); n = UInt(Rn); postindex = FALSE; add = TRUE;
 register_form = FALSE; imm32 = ZeroExtend(imm8, 32);
 if t == 15 then UNPREDICTABLE; // ARMv8-A removes UNPREDICTABLE for R13

Encoding A1 ARMv6T2, ARMv7

LDRSHT<c> <Rt>, [<Rn>] {, #+/-<imm8>}

31	30	29	28	27	26	25	24	23	22	21	20	19	18	17	16	15	14	13	12	11	10	9	8	7	6	5	4	3	2	1	0
cond		0	0	0	0	U	1	1	1	Rn				Rt		imm4H				1	1	1	1	imm4L							

t = UInt(Rt); n = UInt(Rn); postindex = TRUE; add = (U == '1');
 register_form = FALSE; imm32 = ZeroExtend(imm4H:imm4L, 32);
 if t == 15 || n == 15 || n == t then UNPREDICTABLE;

Encoding A2 ARMv6T2, ARMv7

LDRSHT<c> <Rt>, [<Rn>], +/-<Rm>

31	30	29	28	27	26	25	24	23	22	21	20	19	18	17	16	15	14	13	12	11	10	9	8	7	6	5	4	3	2	1	0
cond		0	0	0	0	U	0	1	1	Rn				Rt		(0)(0)(0)(0)				1	1	1	1	Rm							

t = UInt(Rt); n = UInt(Rn); m = UInt(Rm); postindex = TRUE; add = (U == '1');
 register_form = TRUE;
 if t == 15 || n == 15 || n == t || m == 15 then UNPREDICTABLE;

For information about the CONSTRAINED UNPREDICTABLE behavior of this instruction, see [Appendix A Architectural Constraints on UNPREDICTABLE behaviors](#), and particularly [LDRSHT](#) on page AppxA-4712.

Assembler syntax

LDRSHT{<c>}{<q>} <Rt>, [<Rn> {, #<imm>}]	Offset: T32 only
LDRSHT{<c>}{<q>} <Rt>, [<Rn>] {, #+/-<imm>}	Post-indexed: A32 only
LDRSHT{<c>}{<q>} <Rt>, [<Rn>], +/-<Rm>	Post-indexed: A32 only

where:

<c>, <q>	See Standard assembler syntax fields on page F2-2415 .
<Rt>	The destination register.
<Rn>	The base register. The SP can be used.
+/-	Is + or omitted if <imm> or the optionally shifted value of <Rm> is to be added to the base register value (add == TRUE), or – if it is to be subtracted (permitted in A32 instructions only, add == FALSE).
<imm>	The immediate offset applied to the value of <Rn>. Any value in the range 0-255 is permitted. <imm> can be omitted, meaning an offset of 0.
<Rm>	Contains the offset that is applied to the value of <Rn> to form the address.

Operation

```
if ConditionPassed() then
    if CurrentModeIsHyp() then UNPREDICTABLE;           // Hyp mode
    EncodingSpecificOperations(); NullCheckIfThumbEE(n);
    offset = if register_form then R[m] else imm32;
    offset_addr = if add then (R[n] + offset) else (R[n] - offset);
    address = if postindex then R[n] else offset_addr;
    data = MemU_unpriv[address,2];
    if postindex then R[n] = offset_addr;
    R[t] = SignExtend(data, 32);
```

F7.1.98 LDRT

Load Register Unprivileged loads a word from memory, and writes it to a register. For information about memory accesses see [Memory accesses on page F2-2422](#).

The memory access is restricted as if the PE were running in User mode. This makes no difference if the PE is actually running in User mode.

LDRT is UNPREDICTABLE in Hyp mode.

The T32 instruction uses an offset addressing mode, that calculates the address used for the memory access from a base register value and an immediate offset, and leaves the base register unchanged.

The A32 instruction uses a post-indexed addressing mode, that uses a base register value as the address for the memory access, and calculates a new address from a base register value and an offset and writes it back to the base register. The offset can be an immediate value or an optionally-shifted register value.

Encoding T1 ARMv6T2, ARMv7

LDRT<<> <Rt>, [<Rn>, #<imm8>]

15	14	13	12	11	10	9	8	7	6	5	4	3	2	1	0	15	14	13	12	11	10	9	8	7	6	5	4	3	2	1	0
1	1	1	1	1	0	0	0	0	1	0	1	Rn				Rt		1	1	1	0	imm8									

```
if Rn == '1111' then SEE LDR (literal);
t = UInt(Rt); n = UInt(Rn); postindex = FALSE; add = TRUE;
register_form = FALSE; imm32 = ZeroExtend(imm8, 32);
if t == 15 then UNPREDICTABLE; // ARMv8-A removes UNPREDICTABLE for R13
```

Encoding A1 ARMv4*, ARMv5T*, ARMv6*, ARMv7

LDRT<<> <Rt>, [<Rn>] {, #+/-<imm12>}

31	30	29	28	27	26	25	24	23	22	21	20	19	18	17	16	15	14	13	12	11	10	9	8	7	6	5	4	3	2	1	0
cond		0	1	0	0	U	0	1	1	Rn				Rt		imm12															

```
t = UInt(Rt); n = UInt(Rn); postindex = TRUE; add = (U == '1');
register_form = FALSE; imm32 = ZeroExtend(imm12, 32);
if t == 15 || n == 15 || n == t then UNPREDICTABLE;
```

Encoding A2 ARMv4*, ARMv5T*, ARMv6*, ARMv7

LDRT<<> <Rt>, [<Rn>],+/-<Rm>{, <shift>}

31	30	29	28	27	26	25	24	23	22	21	20	19	18	17	16	15	14	13	12	11	10	9	8	7	6	5	4	3	2	1	0
cond		0	1	1	0	U	0	1	1	Rn				Rt		imm5			type	0	Rm										

```
t = UInt(Rt); n = UInt(Rn); m = UInt(Rm); postindex = TRUE; add = (U == '1');
register_form = TRUE; (shift_t, shift_n) = DecodeImmShift(type, imm5);
if t == 15 || n == 15 || n == t || m == 15 then UNPREDICTABLE;
```

For information about the CONSTRAINED UNPREDICTABLE behavior of this instruction, see [Appendix A Architectural Constraints on UNPREDICTABLE behaviors](#), and particularly [LDRT on page AppxA-4713](#).

Assembler syntax

LDRT{<c>}{<q>} <Rt>, [<Rn> {, #<imm>}]	Offset: T32 only
LDRT{<c>}{<q>} <Rt>, [<Rn>] {, #+/-<imm>}	Post-indexed: A32 only
LDRT{<c>}{<q>} <Rt>, [<Rn>], +/-<Rm> {, <shift>}	Post-indexed: A32 only

where:

<c>, <q>	See Standard assembler syntax fields on page F2-2415 .
<Rt>	The destination register.
<Rn>	The base register. The SP can be used.
+/-	Is + or omitted if <imm> or the optionally shifted value of <Rm> is to be added to the base register value (add == TRUE), or – if it is to be subtracted (permitted in A32 instructions only, add == FALSE).
<imm>	The immediate offset applied to the value of <Rn>. Values are 0-255 for encoding T1, and 0-4095 for encoding A1. <imm> can be omitted, meaning an offset of 0.
<Rm>	Contains the offset that is optionally shifted and applied to the value of <Rn> to form the address.
<shift>	The shift to apply to the value read from <Rm>. If omitted, no shift is applied. Shifts applied to a register on page F2-2419 describes the shifts and how they are encoded.

The pre-UAL syntax LDR<c>T is equivalent to LDRT<c>.

Operation

```

if ConditionPassed() then
    if CurrentModeIsHyp() then UNPREDICTABLE;           // Hyp mode
    EncodingSpecificOperations(); NullCheckIfThumbEE(n);
    offset = if register_form then Shift(R[m], shift_t, shift_n, APSR.C) else imm32;
    offset_addr = if add then (R[n] + offset) else (R[n] - offset);
    address = if postindex then R[n] else offset_addr;
    data = MemU_unpriv[address,4];
    if postindex then R[n] = offset_addr;
    R[t] = data;
  
```

F7.1.99 LSL (immediate)

Logical Shift Left (immediate) shifts a register value left by an immediate number of bits, shifting in zeros, and writes the result to the destination register. It can optionally update the condition flags based on the result.

Encoding T1 ARMv4T, ARMv5T*, ARMv6*, ARMv7

LSLS <Rd>, <Rm>, #<imm5> Outside IT block.
 LSL<c> <Rd>, <Rm>, #<imm5> Inside IT block.

15	14	13	12	11	10	9	8	7	6	5	4	3	2	1	0
0	0	0	0	0	imm5					Rm	Rd				

```
if imm5 == '00000' then SEE MOV (register);
d = UInt(Rd); m = UInt(Rm); setflags = !InITBlock();
(-, shift_n) = DecodeImmShift('00', imm5);
```

Encoding T2 ARMv6T2, ARMv7

LSL{S}<c>.W <Rd>, <Rm>, #<imm5>

15	14	13	12	11	10	9	8	7	6	5	4	3	2	1	0	15	14	13	12	11	10	9	8	7	6	5	4	3	2	1	0
1	1	1	0	1	0	1	0	0	1	0	S	1	1	1	1	(0)	imm3			Rd	imm2		0	0	Rm						

```
if (imm3:imm2) == '00000' then SEE MOV (register);
d = UInt(Rd); m = UInt(Rm); setflags = (S == '1');
(-, shift_n) = DecodeImmShift('00', imm3:imm2);
if d == 15 || m == 15 then UNPREDICTABLE; // ARMv8-A removes UNPREDICTABLE for R13
```

Encoding A1 ARMv4*, ARMv5T*, ARMv6*, ARMv7

LSL{S}<c> <Rd>, <Rm>, #<imm5>

31	30	29	28	27	26	25	24	23	22	21	20	19	18	17	16	15	14	13	12	11	10	9	8	7	6	5	4	3	2	1	0
cond		0	0	0	1	1	0	1	S	(0)	(0)	(0)	(0)	Rd				imm5				0	0	0	Rm						

```
if Rd == '1111' && S == '1' then SEE SUBS PC, LR and related instructions;
if imm5 == '00000' then SEE MOV (register);
d = UInt(Rd); m = UInt(Rm); setflags = (S == '1');
(-, shift_n) = DecodeImmShift('00', imm5);
```

For information about the CONSTRAINED UNPREDICTABLE behavior of this instruction, see [Appendix A Architectural Constraints on UNPREDICTABLE behaviors](#).

Assembler syntax

LSL{S}{<c>}{<q>} {<Rd>}, <Rm>, #<imm5>

where:

- S If S is present, the instruction updates the flags. Otherwise, the flags are not updated.
- <c>, <q> See [Standard assembler syntax fields on page F2-2415](#).
- <Rd> The destination register.
In A32 instructions, if S is not specified and <Rd> is the PC, the instruction is a branch to the address calculated by the operation. This is an interworking branch, see [Pseudocode details of operations on the AArch32 general-purpose registers and the PC on page E1-2296](#).
- <Rm> The first operand register. The PC can be used in A32 instructions.
- <imm5> The shift amount, in the range 1 to 31. See [Shifts applied to a register on page F2-2419](#).

Operation

```
if ConditionPassed() then
    EncodingSpecificOperations();
    (result, carry) = Shift_C(R[m], SRTYPE_LSL, shift_n, APSR.C);
    if d == 15 then // Can only occur for ARM encoding
        ALUWritePC(result); // setflags is always FALSE here
    else
        R[d] = result;
        if setflags then
            APSR.N = result<31>;
            APSR.Z = IsZeroBit(result);
            APSR.C = carry;
            // APSR.V unchanged
```

F7.1.100 LSL (register)

Logical Shift Left (register) shifts a register value left by a variable number of bits, shifting in zeros, and writes the result to the destination register. The variable number of bits is read from the bottom byte of a register. It can optionally update the condition flags based on the result.

Encoding T1 ARMv4T, ARMv5T*, ARMv6*, ARMv7
 LSLS <Rdn>, <Rm> Outside IT block.
 LSL<c> <Rdn>, <Rm> Inside IT block.

15	14	13	12	11	10	9	8	7	6	5	4	3	2	1	0
0	1	0	0	0	0	0	0	1	0	Rm	Rdn				

d = UInt(Rdn); n = UInt(Rdn); m = UInt(Rm); setFlags = !InITBlock();

Encoding T2 ARMv6T2, ARMv7
 LSL{S}<c>.W <Rd>, <Rn>, <Rm>

15	14	13	12	11	10	9	8	7	6	5	4	3	2	1	0	15	14	13	12	11	10	9	8	7	6	5	4	3	2	1	0
1	1	1	1	1	0	1	0	0	0	0	S	Rn				1	1	1	1	Rd				0	0	0	0	Rm			

d = UInt(Rd); n = UInt(Rn); m = UInt(Rm); setFlags = (S == '1');
 if d == 15 || n == 15 || m == 15 then UNPREDICTABLE; // ARMv8-A removes UNPREDICTABLE for R13

Encoding A1 ARMv4*, ARMv5T*, ARMv6*, ARMv7
 LSL{S}<c> <Rd>, <Rn>, <Rm>

31	30	29	28	27	26	25	24	23	22	21	20	19	18	17	16	15	14	13	12	11	10	9	8	7	6	5	4	3	2	1	0
cond		0	0	0	1	1	0	1	S	(0)	(0)	(0)	(0)	Rd				Rm				0	0	0	1	Rn					

d = UInt(Rd); n = UInt(Rn); m = UInt(Rm); setFlags = (S == '1');
 if d == 15 || n == 15 || m == 15 then UNPREDICTABLE;

For information about the CONSTRAINED UNPREDICTABLE behavior of this instruction, see [Appendix A Architectural Constraints on UNPREDICTABLE behaviors](#).

Assembler syntax

LSL{S}{<c>}{<q>} {<Rd>}, <Rn>, <Rm>

where:

S If S is present, the instruction updates the flags. Otherwise, the flags are not updated.

<c>, <q> See [Standard assembler syntax fields on page F2-2415](#).

<Rd> The destination register.

<Rn> The first operand register.

<Rm> The register whose bottom byte contains the amount to shift by.

Operation

```
if ConditionPassed() then
    EncodingSpecificOperations();
    shift_n = UInt(R[m]<7:0>);
    (result, carry) = Shift_C(R[n], SRTYPE_LSL, shift_n, APSR.C);
    R[d] = result;
    if setflags then
        APSR.N = result<31>;
        APSR.Z = IsZeroBit(result);
        APSR.C = carry;
        // APSR.V unchanged
```

F7.1.101 LSR (immediate)

Logical Shift Right (immediate) shifts a register value right by an immediate number of bits, shifting in zeros, and writes the result to the destination register. It can optionally update the condition flags based on the result.

Encoding T1 ARMv4T, ARMv5T*, ARMv6*, ARMv7

LSRS <Rd>, <Rm>, #<imm> Outside IT block.
 LSR<c> <Rd>, <Rm>, #<imm> Inside IT block.

15	14	13	12	11	10	9	8	7	6	5	4	3	2	1	0
0	0	0	0	1	imm5					Rm			Rd		

```
d = UInt(Rd); m = UInt(Rm); setflags = !InITBlock();
(-, shift_n) = DecodeImmShift('01', imm5);
```

Encoding T2 ARMv6T2, ARMv7

LSR{S}<c>.W <Rd>, <Rm>, #<imm>

15	14	13	12	11	10	9	8	7	6	5	4	3	2	1	0	15	14	13	12	11	10	9	8	7	6	5	4	3	2	1	0
1	1	1	0	1	0	1	0	0	1	0	S	1	1	1	1	(0)	imm3			Rd			imm2		0	1	Rm				

```
d = UInt(Rd); m = UInt(Rm); setflags = (S == '1');
(-, shift_n) = DecodeImmShift('01', imm3:imm2);
if d == 15 || m == 15 then UNPREDICTABLE; // ARMv8-A removes UNPREDICTABLE for R13
```

Encoding A1 ARMv4*, ARMv5T*, ARMv6*, ARMv7

LSR{S}<c> <Rd>, <Rm>, #<imm>

31	30	29	28	27	26	25	24	23	22	21	20	19	18	17	16	15	14	13	12	11	10	9	8	7	6	5	4	3	2	1	0
cond				0	0	0	1	1	0	1	S	(0)	(0)	(0)	(0)	Rd				imm5				0	1	0	Rm				

```
if Rd == '1111' && S == '1' then SEE SUBS PC, LR and related instructions;
d = UInt(Rd); m = UInt(Rm); setflags = (S == '1');
(-, shift_n) = DecodeImmShift('01', imm5);
```

For information about the CONSTRAINED UNPREDICTABLE behavior of this instruction, see [Appendix A Architectural Constraints on UNPREDICTABLE behaviors](#).

Assembler syntax

LSR{S}{<c>}{<q>} {<Rd>}, <Rm>, #<imm>

where:

S If S is present, the instruction updates the flags. Otherwise, the flags are not updated.

<c>, <q> See [Standard assembler syntax fields on page F2-2415](#).

<Rd> The destination register.

In A32 instructions, if S is not specified and <Rd> is the PC, the instruction is a branch to the address calculated by the operation. This is an interworking branch, see [Pseudocode details of operations on the AArch32 general-purpose registers and the PC on page E1-2296](#).

<Rm> The first operand register. The PC can be used in A32 instructions.

<imm> The shift amount, in the range 1 to 32. See [Shifts applied to a register on page F2-2419](#).

Operation

```
if ConditionPassed() then
    EncodingSpecificOperations();
    (result, carry) = Shift_C(R[m], SRTYPE_LSR, shift_n, APSR.C);
    if d == 15 then // Can only occur for ARM encoding
        ALUWritePC(result); // setflags is always FALSE here
    else
        R[d] = result;
        if setflags then
            APSR.N = result<31>;
            APSR.Z = IsZeroBit(result);
            APSR.C = carry;
            // APSR.V unchanged
```

F7.1.102 LSR (register)

Logical Shift Right (register) shifts a register value right by a variable number of bits, shifting in zeros, and writes the result to the destination register. The variable number of bits is read from the bottom byte of a register. It can optionally update the condition flags based on the result.

Encoding T1 ARMv4T, ARMv5T*, ARMv6*, ARMv7
 LSRS <Rdn>, <Rm> Outside IT block.
 LSR<c> <Rdn>, <Rm> Inside IT block.

15	14	13	12	11	10	9	8	7	6	5	4	3	2	1	0
0	1	0	0	0	0	0	0	1	1	Rm					Rdn

d = UInt(Rdn); n = UInt(Rdn); m = UInt(Rm); setFlags = !InITBlock();

Encoding T2 ARMv6T2, ARMv7
 LSR{S}<c>.W <Rd>, <Rn>, <Rm>

15	14	13	12	11	10	9	8	7	6	5	4	3	2	1	0	15	14	13	12	11	10	9	8	7	6	5	4	3	2	1	0
1	1	1	1	1	0	1	0	0	0	1	S			Rn		1	1	1	1		Rd		0	0	0	0		Rm			

d = UInt(Rd); n = UInt(Rn); m = UInt(Rm); setFlags = (S == '1');
 if d == 15 || n == 15 || m == 15 then UNPREDICTABLE; // ARMv8-A removes UNPREDICTABLE for R13

Encoding A1 ARMv4*, ARMv5T*, ARMv6*, ARMv7
 LSR{S}<c> <Rd>, <Rn>, <Rm>

31	30	29	28	27	26	25	24	23	22	21	20	19	18	17	16	15	14	13	12	11	10	9	8	7	6	5	4	3	2	1	0	
cond		0	0	0	1	1	0	1	S	(0)	(0)	(0)	(0)		Rd																	Rn

d = UInt(Rd); n = UInt(Rn); m = UInt(Rm); setFlags = (S == '1');
 if d == 15 || n == 15 || m == 15 then UNPREDICTABLE;

For information about the CONSTRAINED UNPREDICTABLE behavior of this instruction, see [Appendix A Architectural Constraints on UNPREDICTABLE behaviors](#).

Assembler syntax

LSR{S}{<c>}{<q>} {<Rd>}, <Rn>, <Rm>

where:

S If S is present, the instruction updates the flags. Otherwise, the flags are not updated.

<c>, <q> See [Standard assembler syntax fields on page F2-2415](#).

<Rd> The destination register.

<Rn> The first operand register.

<Rm> The register whose bottom byte contains the amount to shift by.

Operation

```
if ConditionPassed() then
    EncodingSpecificOperations();
    shift_n = UInt(R[m]<7:0>);
    (result, carry) = Shift_C(R[n], SRTYPE_LSR, shift_n, APSR.C);
    R[d] = result;
    if setflags then
        APSR.N = result<31>;
        APSR.Z = IsZeroBit(result);
        APSR.C = carry;
        // APSR.V unchanged
```

F7.1.103 MCR, MCR2

Move to Coprocessor from general-purpose register passes the value of a general-purpose register to a coprocessor. If no coprocessor can execute the instruction, an Undefined Instruction exception is generated.

This is a generic coprocessor instruction. Some of the fields have no functionality defined by the architecture and are free for use by the coprocessor instruction set designer. These are the `opc1`, `opc2`, `CRn`, and `CRm` fields. However, coprocessors CP8-CP15 are reserved for use by A32, and this manual defines the valid MCR and MCR2 instructions when `coproc` is in the range p8-p15. For more information see [Coprocessor support on page E1-2331](#).

In an implementation that includes EL2, MCR accesses to system control registers can be trapped to Hyp mode, meaning that an attempt to execute an MCR instruction in a Non-secure mode other than Hyp mode, that would be permitted in the absence of the Hyp trap controls, generates a Hyp Trap exception. For more information, see [AArch32 control of traps to the hypervisor on page G1-3503](#).

———— **Note** —————

Because of the range of possible traps to Hyp mode, the MCR pseudocode does not show these possible traps.

Encoding T1/A1 ARMv6T2, ARMv7 for encoding T1
 ARMv4*, ARMv5T*, ARMv6*, ARMv7 for encoding A1
 MCR<c> <coproc>, <opc1>, <Rt>, <CRn>, <CRm>{, <opc2>}

15	14	13	12	11	10	9	8	7	6	5	4	3	2	1	0	15	14	13	12	11	10	9	8	7	6	5	4	3	2	1	0
1	1	1	0	1	1	1	0	opc1		0	CRn		Rt		coproc		opc2		1	CRm											

31	30	29	28	27	26	25	24	23	22	21	20	19	18	17	16	15	14	13	12	11	10	9	8	7	6	5	4	3	2	1	0
cond		1		1		1		0		opc1		0	CRn		Rt		coproc		opc2		1	CRm									

```
if coproc == '101x' then SEE "Advanced SIMD and Floating-point";
t = UInt(Rt); cp = UInt(coproc);
if t == 15 then UNPREDICTABLE; // ARMv8-A removes UNPREDICTABLE for R13
```

Encoding T2/A2 ARMv6T2, ARMv7 for encoding T2
 ARMv5T*, ARMv6*, ARMv7 for encoding A2
 MCR2<c> <coproc>, <opc1>, <Rt>, <CRn>, <CRm>{, <opc2>}

15	14	13	12	11	10	9	8	7	6	5	4	3	2	1	0	15	14	13	12	11	10	9	8	7	6	5	4	3	2	1	0
1	1	1	1	1	1	1	0	opc1		0	CRn		Rt		coproc		opc2		1	CRm											

31	30	29	28	27	26	25	24	23	22	21	20	19	18	17	16	15	14	13	12	11	10	9	8	7	6	5	4	3	2	1	0
1	1	1	1	1	1	1	0	opc1		0	CRn		Rt		coproc		opc2		1	CRm											

```
if coproc == '101x' then UNDEFINED;
t = UInt(Rt); cp = UInt(coproc);
if t == 15 then UNPREDICTABLE; // ARMv8-A removes UNPREDICTABLE for R13
```

For information about the CONSTRAINED UNPREDICTABLE behavior of this instruction, see [Appendix A Architectural Constraints on UNPREDICTABLE behaviors](#).

Advanced SIMD and floating-point See [8, 16, and 32-bit transfer between general-purpose and extension registers on page F5-2518](#)

Assembler syntax

MCR{2}{<c>}{<q>} <coproc>, {#}<opc1>, <Rt>, <CRn>, <CRm>{, {#}<opc2>}

where:

- 2 If specified, selects encoding T2/A2. If omitted, selects encoding T1/A1.
- <c>, <q> See [Standard assembler syntax fields on page F2-2415](#). An A32 MCR2 instruction must be unconditional.
- <coproc> The name of the coprocessor. The generic coprocessor names are p0-p15.
- <opc1> Is a coprocessor-specific opcode in the range 0 to 7.
- <Rt> Is the general-purpose register whose value is transferred to the coprocessor.
- <CRn> Is the destination coprocessor register.
- <CRm> Is an additional destination coprocessor register.
- <opc2> Is a coprocessor-specific opcode in the range 0-7. If omitted, <opc2> is assumed to be 0.

Operation

```
if ConditionPassed() then
    EncodingSpecificOperations();
    if !Cproc_Accepted(cp, ThisInstr()) then
        GenerateCoproprocessorException();
    else
        Cproc_SendOneWord(R[t], cp, ThisInstr());
```

F7.1.104 MCRR, MCRR2

Move to Coprocessor from two general-purpose registers passes the values of two general-purpose registers to a coprocessor. If no coprocessor can execute the instruction, an Undefined Instruction exception is generated.

This is a generic coprocessor instruction. Some of the fields have no functionality defined by the architecture and are free for use by the coprocessor instruction set designer. These are the `opc1` and `CRm` fields. However, coprocessors CP8-CP15 are reserved for use by A32, and this manual defines the valid MCRR and MCRR2 instructions when coproc is in the range p8-p15. For more information see [Coprocessor support on page E1-2331](#).

In an implementation that includes EL2, MCRR accesses to system control registers can be trapped to Hyp mode, meaning that an attempt to execute an MCRR instruction in a Non-secure mode other than Hyp mode, that would be permitted in the absence of the Hyp trap controls, generates a Hyp Trap exception. For more information, see [AArch32 control of traps to the hypervisor on page G1-3503](#).

———— Note ————

Because of the range of possible traps to Hyp mode, the MCRR pseudocode does not show these possible traps.

Encoding T1/A1 ARMv6T2, ARMv7 for encoding T1
 ARMv5TE*, ARMv6*, ARMv7 for encoding A1

MCRR<c> <coproc>, <opc1>, <Rt>, <Rt2>, <CRm>

15	14	13	12	11	10	9	8	7	6	5	4	3	2	1	0	15	14	13	12	11	10	9	8	7	6	5	4	3	2	1	0
1	1	1	0	1	1	0	0	0	1	0	0	Rt2				Rt		coproc		opc1		CRm									

31	30	29	28	27	26	25	24	23	22	21	20	19	18	17	16	15	14	13	12	11	10	9	8	7	6	5	4	3	2	1	0
cond		1	1	0	0	0	1	0	0	Rt2				Rt		coproc		opc1		CRm											

```
if coproc == '101x' then SEE "Advanced SIMD and Floating-point";
t = UInt(Rt); t2 = UInt(Rt2); cp = UInt(coproc);
if t == 15 || t2 == 15 then UNPREDICTABLE;
// ARMv8-A removes UNPREDICTABLE for R13
```

Encoding T2/A2 ARMv6T2, ARMv7 for encoding T2
 ARMv6*, ARMv7 for encoding A2

MCRR2<c> <coproc>, <opc1>, <Rt>, <Rt2>, <CRm>

15	14	13	12	11	10	9	8	7	6	5	4	3	2	1	0	15	14	13	12	11	10	9	8	7	6	5	4	3	2	1	0
1	1	1	1	1	1	0	0	0	1	0	0	Rt2				Rt		coproc		opc1		CRm									

31	30	29	28	27	26	25	24	23	22	21	20	19	18	17	16	15	14	13	12	11	10	9	8	7	6	5	4	3	2	1	0
1	1	1	1	1	1	0	0	0	1	0	0	Rt2				Rt		coproc		opc1		CRm									

```
if coproc == '101x' then UNDEFINED;
t = UInt(Rt); t2 = UInt(Rt2); cp = UInt(coproc);
if t == 15 || t2 == 15 then UNPREDICTABLE;
// ARMv8-A removes UNPREDICTABLE for R13
```

For information about the CONSTRAINED UNPREDICTABLE behavior of this instruction, see [Appendix A Architectural Constraints on UNPREDICTABLE behaviors](#), and particularly [MRRC, MRRC2 on page AppxA-4720](#).

Advanced SIMD and floating-point

See [64-bit transfers between general-purpose and extension registers on page F5-2519](#)

Assembler syntax

MCRR{2}{<c>}{<q>} <coproc>, {#}<opc1>, <Rt>, <Rt2>, <CRm>

where:

- 2 If specified, selects encoding T2/A2. If omitted, selects encoding T1/A1.
- <c>, <q> See [Standard assembler syntax fields on page F2-2415](#). An A32 MCRR2 instruction must be unconditional.
- <coproc> The name of the coprocessor.
 The generic coprocessor names are p0-p15.
- <opc1> Is a coprocessor-specific opcode in the range 0 to 15.
- <Rt> Is the first general-purpose register whose value is transferred to the coprocessor.
- <Rt2> Is the second general-purpose register whose value is transferred to the coprocessor.
- <CRm> Is the destination coprocessor register.

Note

The relative significance of Rt2 and Rt is IMPLEMENTATION DEFINED, but all uses within this manual treat Rt2 as more significant than Rt

Operation

```
if ConditionPassed() then
    EncodingSpecificOperations();
    if !Coprocc_Accepted(cp, ThisInstr()) then
        GenerateCoproccorException();
    else
        Coproc_SendTwoWords(R[t2], R[t], cp, ThisInstr());
```

F7.1.105 MLA

Multiply Accumulate multiplies two register values, and adds a third register value. The least significant 32 bits of the result are written to the destination register. These 32 bits do not depend on whether the source register values are considered to be signed values or unsigned values.

In an A32 instruction, the condition flags can optionally be updated based on the result. Use of this option adversely affects performance on many implementations.

Encoding T1 ARMv6T2, ARMv7

MLA<C> <Rd>, <Rn>, <Rm>, <Ra>

15	14	13	12	11	10	9	8	7	6	5	4	3	2	1	0	15	14	13	12	11	10	9	8	7	6	5	4	3	2	1	0
1	1	1	1	1	0	1	1	0	0	0	0	Rn				Ra				Rd				0	0	0	0	Rm			

```
if Ra == '1111' then SEE MUL;
d = UInt(Rd); n = UInt(Rn); m = UInt(Rm); a = UInt(Ra); setflags = FALSE;
if d == 15 || n == 15 || m == 15 then UNPREDICTABLE; // ARMv8-A removes UNPREDICTABLE for R13
```

Encoding A1 ARMv4*, ARMv5T*, ARMv6*, ARMv7

MLA{S}<C> <Rd>, <Rn>, <Rm>, <Ra>

31	30	29	28	27	26	25	24	23	22	21	20	19	18	17	16	15	14	13	12	11	10	9	8	7	6	5	4	3	2	1	0
cond		0	0	0	0	0	0	1	S	Rd				Ra				Rm				1	0	0	1	Rn					

```
d = UInt(Rd); n = UInt(Rn); m = UInt(Rm); a = UInt(Ra); setflags = (S == '1');
if d == 15 || n == 15 || m == 15 || a == 15 then UNPREDICTABLE;
```

For information about the CONSTRAINED UNPREDICTABLE behavior of this instruction, see [Appendix A Architectural Constraints on UNPREDICTABLE behaviors](#).

Assembler syntax

MLA{S}{<c>}{<q>} <Rd>, <Rn>, <Rm>, <Ra>

where:

S If S is present, the instruction updates the flags. Otherwise, the flags are not updated.
S can be specified only for the A32 instruction set.

<c>, <q> See *Standard assembler syntax fields* on page F2-2415.

<Rd> The destination register.

<Rn> The first operand register.

<Rm> The second operand register.

<Ra> The register containing the accumulate value.

The pre-UAL syntax MLA<c>S is equivalent to MLAS<c>.

Operation

```
if ConditionPassed() then
    EncodingSpecificOperations();
    operand1 = SInt(R[n]); // operand1 = UInt(R[n]) produces the same final results
    operand2 = SInt(R[m]); // operand2 = UInt(R[m]) produces the same final results
    addend = SInt(R[a]); // addend = UInt(R[a]) produces the same final results
    result = operand1 * operand2 + addend;
    R[d] = result<31:0>;
    if setflags then
        APSR.N = result<31>;
        APSR.Z = IsZeroBit(result<31:0>);
        // APSR.C, APSR.V unchanged
```

F7.1.106 MLS

Multiply and Subtract multiplies two register values, and subtracts the product from a third register value. The least significant 32 bits of the result are written to the destination register. These 32 bits do not depend on whether the source register values are considered to be signed values or unsigned values.

Encoding T1 ARMv6T2, ARMv7

MLS<c> <Rd>, <Rn>, <Rm>, <Ra>

15	14	13	12	11	10	9	8	7	6	5	4	3	2	1	0	15	14	13	12	11	10	9	8	7	6	5	4	3	2	1	0
1	1	1	1	1	0	1	1	0	0	0	0	Rn			Ra			Rd			0	0	0	1	Rm						

```
d = UInt(Rd); n = UInt(Rn); m = UInt(Rm); a = UInt(Ra);
if d == 15 || n == 15 || m == 15 || a == 15 then UNPREDICTABLE;
// ARMv8-A removes UNPREDICTABLE for R13
```

Encoding A1 ARMv6T2, ARMv7

MLS<c> <Rd>, <Rn>, <Rm>, <Ra>

31	30	29	28	27	26	25	24	23	22	21	20	19	18	17	16	15	14	13	12	11	10	9	8	7	6	5	4	3	2	1	0
cond		0	0	0	0	0	1	1	0	Rd			Ra			Rm			1	0	0	1	Rn								

```
d = UInt(Rd); n = UInt(Rn); m = UInt(Rm); a = UInt(Ra);
if d == 15 || n == 15 || m == 15 || a == 15 then UNPREDICTABLE;
```

For information about the CONSTRAINED UNPREDICTABLE behavior of this instruction, see [Appendix A Architectural Constraints on UNPREDICTABLE behaviors](#).

Assembler syntax

MLS{<c>}{<q>} <Rd>, <Rn>, <Rm>, <Ra>

where:

<c>, <q> See *Standard assembler syntax fields* on page F2-2415.

<Rd> The destination register.

<Rn> The first operand register.

<Rm> The second operand register.

<Ra> The register containing the accumulate value.

Operation

```
if ConditionPassed() then
    EncodingSpecificOperations();
    operand1 = SInt(R[n]); // operand1 = UInt(R[n]) produces the same final results
    operand2 = SInt(R[m]); // operand2 = UInt(R[m]) produces the same final results
    addend = SInt(R[a]); // addend = UInt(R[a]) produces the same final results
    result = addend - operand1 * operand2;
    R[d] = result<31:0>;
```

F7.1.107 MOV (immediate)

Move (immediate) writes an immediate value to the destination register. It can optionally update the condition flags based on the value.

Encoding T1 ARMv4T, ARMv5T*, ARMv6*, ARMv7
 MOV<S> <Rd>, #<imm8> Outside IT block.
 MOV<C> <Rd>, #<imm8> Inside IT block.

15	14	13	12	11	10	9	8	7	6	5	4	3	2	1	0
0	0	1	0	0	Rd		imm8								

d = UInt(Rd); setflags = !InITBlock(); imm32 = ZeroExtend(imm8, 32); carry = APSR.C;

Encoding T2 ARMv6T2, ARMv7
 MOV{S}<C>.W <Rd>, #<const>

15	14	13	12	11	10	9	8	7	6	5	4	3	2	1	0	15	14	13	12	11	10	9	8	7	6	5	4	3	2	1	0
1	1	1	1	0	i	0	0	0	1	0	S	1	1	1	1	0	imm3	Rd		imm8											

d = UInt(Rd); setflags = (S == '1'); (imm32, carry) = ThumbExpandImm_C(i:imm3:imm8, APSR.C);
 if d == 15 then UNPREDICTABLE; // ARMv8-A removes UNPREDICTABLE for R13

Encoding T3 ARMv6T2, ARMv7
 MOVW<C> <Rd>, #<imm16>

15	14	13	12	11	10	9	8	7	6	5	4	3	2	1	0	15	14	13	12	11	10	9	8	7	6	5	4	3	2	1	0
1	1	1	1	0	i	1	0	0	1	0	0	imm4		0	imm3	Rd		imm8													

d = UInt(Rd); setflags = FALSE; imm32 = ZeroExtend(imm4:i:imm3:imm8, 32);
 if d == 15 then UNPREDICTABLE; // ARMv8-A removes UNPREDICTABLE for R13

Encoding A1 ARMv4*, ARMv5T*, ARMv6*, ARMv7
 MOV{S}<C> <Rd>, #<const>

31	30	29	28	27	26	25	24	23	22	21	20	19	18	17	16	15	14	13	12	11	10	9	8	7	6	5	4	3	2	1	0
cond		0	0	1	1	1	0	1	S	(0)	(0)	(0)	(0)	Rd		imm12															

if Rd == '1111' && S == '1' then SEE SUBS PC, LR and related instructions;
 d = UInt(Rd); setflags = (S == '1'); (imm32, carry) = ARMEExpandImm_C(imm12, APSR.C);

Encoding A2 ARMv6T2, ARMv7
 MOVW<C> <Rd>, #<imm16>

31	30	29	28	27	26	25	24	23	22	21	20	19	18	17	16	15	14	13	12	11	10	9	8	7	6	5	4	3	2	1	0
cond		0	0	1	1	0	0	0	0	imm4		Rd		imm12																	

d = UInt(Rd); setflags = FALSE; imm32 = ZeroExtend(imm4:imm12, 32);
 if d == 15 then UNPREDICTABLE;

For information about the CONSTRAINED UNPREDICTABLE behavior of this instruction, see [Appendix A Architectural Constraints on UNPREDICTABLE behaviors](#).

Assembler syntax

MOV{S}{<c>}{<q>} <Rd>, #<const> All encodings permitted
MOVW{<c>}{<q>} <Rd>, #<const> Only encoding T3 or A2 permitted

where:

- S If S is present, the instruction updates the flags. Otherwise, the flags are not updated.
- <c>, <q> See *Standard assembler syntax fields* on page F2-2415.
- <Rd> The destination register. If S is specified and <Rd> is the PC, see *SUBS PC, LR and related instructions (T32)* on page F7-3066 or *SUBS PC, LR and related instructions (A32)* on page F7-3068.
- In A32 instructions, if S is not specified and <Rd> is the PC, encoding A2 is not permitted, and for encoding A1 the instruction is a branch to the address calculated by the operation. This is an interworking branch, see *Pseudocode details of operations on the AArch32 general-purpose registers and the PC* on page E1-2296.
- <const> The immediate value to be placed in <Rd>. The range of values is 0-255 for encoding T1 and 0-65535 for encoding T3 or A2. See *Modified immediate constants in T32 instructions* on page F3-2444 or *Modified immediate constants in A32 instructions* on page F4-2472 for the range of values for encoding T2 or A1.
- When both 32-bit encodings are available for an instruction, encoding T2 or A1 is preferred to encoding T3 or A2 (if encoding T3 or A2 is required, use the MOVW syntax).

The pre-UAL syntax MOV<c>S is equivalent to MOV{S}<c>.

Operation

```
if ConditionPassed() then
    EncodingSpecificOperations();
    result = imm32;
    if d == 15 then                      // Can only occur for encoding A1
        ALUWritePC(result); // setflags is always FALSE here
    else
        R[d] = result;
        if setflags then
            APSR.N = result<31>;
            APSR.Z = IsZeroBit(result);
            APSR.C = carry;
            // APSR.V unchanged
```

F7.1.108 MOV (register, T32)

Move (register) copies a value from a register to the destination register. It can optionally update the condition flags based on the value.

Encoding T1 ARMv6*, ARMv7 if <Rd> and <Rm> both from R0-R7
 ARMv4T, ARMv5T*, ARMv6*, ARMv7 otherwise
 MOV<c> <Rd>, <Rm> If <Rd> is the PC, must be outside or last in IT block.

15	14	13	12	11	10	9	8	7	6	5	4	3	2	1	0
0	1	0	0	0	1	1	0	D	Rm				Rd		

d = UInt(D:Rd); m = UInt(Rm); setflags = FALSE;
 if d == 15 && InITBlock() && !LastInITBlock() then UNPREDICTABLE;

Encoding T2 ARMv4T, ARMv5T*, ARMv6*, ARMv7
 MOVS <Rd>, <Rm> Not permitted in IT block

15	14	13	12	11	10	9	8	7	6	5	4	3	2	1	0	
0	0	0	0	0	0	0	0	0	0	Rm				Rd		

d = UInt(Rd); m = UInt(Rm); setflags = TRUE;
 if InITBlock() then UNPREDICTABLE;

Encoding T3 ARMv6T2, ARMv7
 MOV{S}<c>.W <Rd>, <Rm>

15	14	13	12	11	10	9	8	7	6	5	4	3	2	1	0	15	14	13	12	11	10	9	8	7	6	5	4	3	2	1	0
1	1	1	0	1	0	1	0	0	1	0	S	1	1	1	1	(0)	0	0	0	Rd				Rm							

d = UInt(Rd); m = UInt(Rm); setflags = (S == '1');
 if d == 15 || m == 15 then UNPREDICTABLE; // ARMv8-A removes UNPREDICTABLE for R13

For information about the CONSTRAINED UNPREDICTABLE behavior of this instruction, see [Appendix A Architectural Constraints on UNPREDICTABLE behaviors](#), and particularly *MOV (register, T32)* on page AppxA-4719.

Assembler syntax

MOV{S}{<c>}{<q>} <Rd>, <Rm>

where:

S If S is present, the instruction updates the flags. Otherwise, the flags are not updated.

<c>, <q> See [Standard assembler syntax fields on page F2-2415](#).

<Rd> The destination register. This register can be the SP or PC. S must not be specified if <Rd> is the SP. If <Rd> is the PC and S is not specified:

- The instruction causes a branch to the address moved to the PC. This is a simple branch, see [Pseudocode details of operations on the AArch32 general-purpose registers and the PC on page E1-2296](#).
- The instruction must either be outside an IT block or the last instruction of an IT block.

<Rm> The source register. This register can be the SP or PC. S must not be specified if <Rm> is the SP or PC.

Encoding T3 is not permitted if <Rd> or <Rm> is the PC.

Note

- ARM deprecates the use of the following MOV (register) instructions:
 - Ones in which <Rd> is the SP or PC and <Rm> is also the SP or PC.
 - Ones in which S is specified and <Rm> is the SP, or <Rm> is the PC.
- See also [Branch instructions on page F1-2382](#) about the use of the MOV PC, LR instruction.

The pre-UAL syntax MOV<c>S is equivalent to MOV{S}<c>.

Operation

```
if ConditionPassed() then
    EncodingSpecificOperations();
    result = R[m];
    if d == 15 then
        ALUWritePC(result); // setflags is always FALSE here
    else
        R[d] = result;
        if setflags then
            APSR.N = result<31>;
            APSR.Z = IsZeroBit(result);
            // APSR.C unchanged
            // APSR.V unchanged
```

F7.1.109 MOV (register, A32)

Move (register) copies a value from a register to the destination register. It can optionally update the condition flags based on the value.

Encoding A1 ARMv4*, ARMv5T*, ARMv6*, ARMv7

MOV{S}<c> <Rd>, <Rm>

31	30	29	28	27	26	25	24	23	22	21	20	19	18	17	16	15	14	13	12	11	10	9	8	7	6	5	4	3	2	1	0
cond			0	0	0	1	1	0	1	S	(0)	(0)	(0)	(0)	Rd				0	0	0	0	0	0	0	0	Rm				

if Rd == '1111' && S == '1' then SEE SUBS PC, LR and related instructions;
 d = UInt(Rd); m = UInt(Rm); setflags = (S == '1');

For information about the CONSTRAINED UNPREDICTABLE behavior of this instruction, see [Appendix A Architectural Constraints on UNPREDICTABLE behaviors](#).

Assembler syntax

MOV{S}{<c>}{<q>} <Rd>, <Rm>

where:

- S If S is present, the instruction updates the flags. Otherwise, the flags are not updated.
- <c>, <q> See [Standard assembler syntax fields on page F2-2415](#).
- <Rd> The destination register. If S is specified and <Rd> is the PC, see [SUBS PC, LR and related instructions \(A32\) on page F7-3068](#). This register can be the SP or PC.
 If <Rd> is the PC and S is not specified, the instruction causes a branch to the address moved to the PC. This is an interworking branch, see [Pseudocode details of operations on the AArch32 general-purpose registers and the PC on page E1-2296](#).
- <Rm> The source register. This register can be the SP or PC.

Note

- ARM deprecates the use of the following MOV (register) instructions:
 - Ones in which <Rd> is the SP or PC and <Rm> is also the SP or PC.
 - Ones in which S is specified and <Rd> is the SP, <Rm> is the SP, or <Rm> is the PC.
- See also [Branch instructions on page F1-2382](#) about the use of the MOV PC, LR instruction.

The pre-UAL syntax MOV<c>S is equivalent to MOV<c>.

Operation

```

if ConditionPassed() then
    EncodingSpecificOperations();
    result = R[m];
    if d == 15 then
        ALUWritePC(result); // setflags is always FALSE here
    else
        R[d] = result;
        if setflags then
            APSR.N = result<31>;
            APSR.Z = IsZeroBit(result);
            // APSR.C unchanged
            // APSR.V unchanged
  
```

F7.1.110 MOV (shifted register)

For the special case of MOV_S where <Rd> is the PC, see *SUBS PC, LR and related instructions (T32)* on page F7-3066 and *SUBS PC, LR and related instructions (A32)* on page F7-3068. Otherwise, MOV (shifted register) is a pseudo-instruction for ASR, LSL, LSR, ROR, and RRX. For more information see the following sections:

- *ASR (immediate)* on page F7-2562.
- *ASR (register)* on page F7-2564.
- *LSL (immediate)* on page F7-2692.
- *LSL (register)* on page F7-2694.
- *LSR (immediate)* on page F7-2696.
- *LSR (register)* on page F7-2698.
- *ROR (immediate)* on page F7-2776.
- *ROR (register)* on page F7-2778.
- *RRX* on page F7-2780.

Assembler syntax

Table F7-2 shows the equivalences between MOV (shifted register) and other instructions.

Table F7-2 MOV (shifted register) equivalences

MOV instruction	Canonical form
MOV{S} <Rd>, <Rm>, ASR #<n>	ASR{S} <Rd>, <Rm>, #<n>
MOV{S} <Rd>, <Rm>, LSL #<n>	LSL{S} <Rd>, <Rm>, #<n>
MOV{S} <Rd>, <Rm>, LSR #<n>	LSR{S} <Rd>, <Rm>, #<n>
MOV{S} <Rd>, <Rm>, ROR #<n>	ROR{S} <Rd>, <Rm>, #<n>
MOV{S} <Rd>, <Rm>, ASR <Rs>	ASR{S} <Rd>, <Rm>, <Rs>
MOV{S} <Rd>, <Rm>, LSL <Rs>	LSL{S} <Rd>, <Rm>, <Rs>
MOV{S} <Rd>, <Rm>, LSR <Rs>	LSR{S} <Rd>, <Rm>, <Rs>
MOV{S} <Rd>, <Rm>, ROR <Rs>	ROR{S} <Rd>, <Rm>, <Rs>
MOV{S} <Rd>, <Rm>, RRX	RRX{S} <Rd>, <Rm>

Disassembly produces the canonical form of the instruction.

F7.1.111 MOV_T

Move Top writes an immediate value to the top halfword of the destination register. It does not affect the contents of the bottom halfword.

Encoding T1 ARMv6T2, ARMv7

MOV_T<c> <Rd>, #<imm16>

15	14	13	12	11	10	9	8	7	6	5	4	3	2	1	0	15	14	13	12	11	10	9	8	7	6	5	4	3	2	1	0
1	1	1	1	0	i	1	0	1	1	0	0	imm4				0	imm3			Rd			imm8								

d = UInt(Rd); imm16 = imm4:i:imm3:imm8;
 if d == 15 then UNPREDICTABLE; // ARMv8-A removes UNPREDICTABLE for R13

Encoding A1 ARMv6T2, ARMv7

MOV_T<c> <Rd>, #<imm16>

31	30	29	28	27	26	25	24	23	22	21	20	19	18	17	16	15	14	13	12	11	10	9	8	7	6	5	4	3	2	1	0
cond		0		0		1		1		0		1		0		0		imm4				Rd				imm12					

d = UInt(Rd); imm16 = imm4:imm12;
 if d == 15 then UNPREDICTABLE;

For information about the CONSTRAINED UNPREDICTABLE behavior of this instruction, see [Appendix A Architectural Constraints on UNPREDICTABLE behaviors](#).

Assembler syntax

MOVT{<c>}{<q>} <Rd>, #<imm16>

where:

<c>, <q> See [Standard assembler syntax fields on page F2-2415](#).

<Rd> The destination register.

<imm16> The immediate value to be written to <Rd>. It must be in the range 0-65535.

Operation

```
if ConditionPassed() then
    EncodingSpecificOperations();
    R[d]<31:16> = imm16;
    // R[d]<15:0> unchanged
```

F7.1.112 MRC, MRC2

Move to general-purpose register from Coprocessor causes a coprocessor to transfer a value to a general-purpose register or to the condition flags. If no coprocessor can execute the instruction, an Undefined Instruction exception is generated.

This is a generic coprocessor instruction. Some of the fields have no functionality defined by the architecture and are free for use by the coprocessor instruction set designer. These are the `opc1`, `opc2`, `CRn`, and `CRm` fields. However, coprocessors CP8-CP15 are reserved for use by A32, and this manual defines the valid MRC and MRC2 instructions when `coproc` is in the range p8-p15. For more information see [Coprocessor support on page E1-2331](#).

In an implementation that includes EL2, MRC accesses to system control registers can be trapped to Hyp mode, meaning that an attempt to execute an MRC instruction in a Non-secure mode other than Hyp mode, that would be permitted in the absence of the Hyp trap controls, generates a Hyp Trap exception. For more information, see [AArch32 control of traps to the hypervisor on page G1-3503](#).

———— Note —————

Because of the range of possible traps to Hyp mode, the MRC pseudocode does not show these possible traps.

Encoding T1/A1 ARMv6T2, ARMv7 for encoding T1
 ARMv4*, ARMv5T*, ARMv6*, ARMv7 for encoding A1

MRC<c> <coproc>, <opc1>, <Rt>, <CRn>, <CRm>{, <opc2>}

15	14	13	12	11	10	9	8	7	6	5	4	3	2	1	0	15	14	13	12	11	10	9	8	7	6	5	4	3	2	1	0
1	1	1	0	1	1	1	0	opc1	1	CRn	Rt	coproc	opc2	1	CRm																

31	30	29	28	27	26	25	24	23	22	21	20	19	18	17	16	15	14	13	12	11	10	9	8	7	6	5	4	3	2	1	0
cond	1	1	1	0	opc1	1	CRn	Rt	coproc	opc2	1	CRm																			

```
if coproc == '101x' then SEE "Advanced SIMD and Floating-point";
t = UInt(Rt); cp = UInt(coproc);
// ARMv8-A removes UNPREDICTABLE for R13
```

Encoding T2/A2 ARMv6T2, ARMv7 for encoding T2
 ARMv5T*, ARMv6*, ARMv7 for encoding A2

MRC2<c> <coproc>, <opc1>, <Rt>, <CRn>, <CRm>{, <opc2>}

15	14	13	12	11	10	9	8	7	6	5	4	3	2	1	0	15	14	13	12	11	10	9	8	7	6	5	4	3	2	1	0
1	1	1	1	1	1	1	0	opc1	1	CRn	Rt	coproc	opc2	1	CRm																

31	30	29	28	27	26	25	24	23	22	21	20	19	18	17	16	15	14	13	12	11	10	9	8	7	6	5	4	3	2	1	0	
1	1	1	1	1	1	1	0	opc1	1	CRn	Rt	coproc	opc2	1	CRm																	

```
if coproc == '101x' then UNDEFINED;
t = UInt(Rt); cp = UInt(coproc);
// ARMv8-A removes UNPREDICTABLE for R13
```

For information about the CONSTRAINED UNPREDICTABLE behavior of this instruction, see [Appendix A Architectural Constraints on UNPREDICTABLE behaviors](#).

Advanced SIMD and floating-point See [8, 16, and 32-bit transfer between general-purpose and extension registers on page F5-2518](#)

Assembler syntax

MRC{2}{<c>}{<q>} <coproc>, {#}<opc1>, <Rt>, <CRn>, <CRm>{, {#}<opc2>}

where:

- 2 If specified, selects encoding T2/A2. If omitted, selects encoding T1/A1.
- <c>, <q> See [Standard assembler syntax fields on page F2-2415](#). An A32 MRC2 instruction must be unconditional.
- <coproc> The name of the coprocessor. The generic coprocessor names are p0-p15.
- <opc1> Is a coprocessor-specific opcode in the range 0 to 7.
- <Rt> Is the destination general-purpose register. This register can be R0-R14 or APSR_nzcv. The last form writes bits[31:28] of the transferred value to the N, Z, C and V condition flags and is specified by setting the Rt field of the encoding to 0b1111. In pre-UAL assembler syntax, PC was written instead of APSR_nzcv to select this form.
- <CRn> Is the coprocessor register that contains the first operand.
- <CRm> Is an additional source or destination coprocessor register.
- <opc2> Is a coprocessor-specific opcode in the range 0 to 7. If omitted, <opc2> is assumed to be 0.

Operation

```
if ConditionPassed() then
    EncodingSpecificOperations();
    if !Coproc_Accepted(cp, ThisInstr()) then
        GenerateCoproprocessorException();
    else
        value = Coproc_GetOneWord(cp, ThisInstr());
        if t != 15 then
            R[t] = value;
        else
            APSR.N = value<31>;
            APSR.Z = value<30>;
            APSR.C = value<29>;
            APSR.V = value<28>;
            // value<27:0> are not used.
```

F7.1.113 MRRC, MRRC2

Move to two general-purpose registers from Coprocessor causes a coprocessor to transfer values to two general-purpose registers. If no coprocessor can execute the instruction, an Undefined Instruction exception is generated.

This is a generic coprocessor instruction. Some of the fields have no functionality defined by the architecture and are free for use by the coprocessor instruction set designer. These are the `opc1` and `CRm` fields. However, coprocessors CP8-CP15 are reserved for use by A32, and this manual defines the valid MRRC and MRRC2 instructions when coproc is in the range p8-p15. For more information see [Coprocessor support on page E1-2331](#).

In an implementation that includes EL2, MRRC accesses to system control registers can be trapped to Hyp mode, meaning that an attempt to execute an MRRC instruction in a Non-secure mode other than Hyp mode, that would be permitted in the absence of the Hyp trap controls, generates a Hyp Trap exception. For more information, see [AArch32 control of traps to the hypervisor on page G1-3503](#).

———— **Note** —————

Because of the range of possible traps to Hyp mode, the MRRC pseudocode does not show these possible traps.

Encoding T1/A1 ARMv6T2, ARMv7 for encoding T1
 ARMv5TE*, ARMv6*, ARMv7 for encoding A1

MRRC<c> <coproc>, <opc>, <Rt>, <Rt2>, <CRm>

15	14	13	12	11	10	9	8	7	6	5	4	3	2	1	0	15	14	13	12	11	10	9	8	7	6	5	4	3	2	1	0																																																														
1	1	1	0	1	1	0	0	0	1	0	1					Rt2															Rt															coproc																opc1																CRm															

31	30	29	28	27	26	25	24	23	22	21	20	19	18	17	16	15	14	13	12	11	10	9	8	7	6	5	4	3	2	1	0																																																																																																																																																																																																																															
																																	cond																															1	1	0	0	0	1	0	1																									Rt2																															Rt																																coproc																																opc1																																CRm																															

```
if coproc == '101x' then SEE "Advanced SIMD and Floating-point";
t = UInt(Rt); t2 = UInt(Rt2); cp = UInt(coproc);
if t == 15 || t2 == 15 || t == t2 then UNPREDICTABLE; // ARMv8-A removes UNPREDICTABLE for R13
```

For information about the CONSTRAINED UNPREDICTABLE behavior of this instruction, see [Appendix A Architectural Constraints on UNPREDICTABLE behaviors](#), and particularly [MRRC, MRRC2 on page AppxA-4720](#).

Encoding T2/A2 ARMv6T2, ARMv7 for encoding T2
 ARMv6*, ARMv7 for encoding A2

MRRC2<c> <coproc>, <opc>, <Rt>, <Rt2>, <CRm>

15	14	13	12	11	10	9	8	7	6	5	4	3	2	1	0	15	14	13	12	11	10	9	8	7	6	5	4	3	2	1	0																																																																		
1	1	1	1	1	1	0	0	0	1	0	1					Rt2																Rt																coproc																opc1																	CRm																

31	30	29	28	27	26	25	24	23	22	21	20	19	18	17	16	15	14	13	12	11	10	9	8	7	6	5	4	3	2	1	0																																																																																																																																																																																														
																																	1	1	1	1	1	1	0	0	0	1	0	1																				Rt2																															Rt																															coproc																																opc1																																CRm																															

```
if coproc == '101x' then UNDEFINED;
t = UInt(Rt); t2 = UInt(Rt2); cp = UInt(coproc);
if t == 15 || t2 == 15 || t == t2 then UNPREDICTABLE;
// ARMv8-A removes UNPREDICTABLE for R13
```

Advanced SIMD and floating-point See [64-bit transfers between general-purpose and extension registers on page F5-2519](#)

Assembler syntax

MRRC{2}{<c>}{<q>} <coproc>, {#}<opc1>, <Rt>, <Rt2>, <CRm>

where:

- 2 If specified, selects encoding T2/A2. If omitted, selects encoding T1/A1.
- <c>, <q> See [Standard assembler syntax fields on page F2-2415](#). An A32 MRRC2 instruction must be unconditional.
- <coproc> The name of the coprocessor. The generic coprocessor names are p0-p15.
- <opc1> Is a coprocessor-specific opcode in the range 0 to 15.
- <Rt> Is the first destination general-purpose register.
- <Rt2> Is the second destination general-purpose register.
- <CRm> Is the coprocessor register that supplies the data to be transferred.

Note

The relative significance of Rt2 and Rt is IMPLEMENTATION DEFINED, but all uses within this manual treat Rt2 as more significant than Rt

Operation

```
if ConditionPassed() then
    EncodingSpecificOperations();
    if !Coprocc_Accepted(cp, ThisInstr()) then
        GenerateCoproccorException();
    else
        (R[t2], R[t]) = Coproc_GetTwoWords(cp, ThisInstr());
```

F7.1.114 MRS

Move to Register from Special register moves the value from the APSR into a general-purpose register.

For details of system level use of this instruction, see [MRS on page F7-3046](#).

Encoding T1 ARMv6T2, ARMv7

MRS<c> <Rd>, <spec_reg>

15	14	13	12	11	10	9	8	7	6	5	4	3	2	1	0	15	14	13	12	11	10	9	8	7	6	5	4	3	2	1	0
1	1	1	1	0	0	1	1	1	1	1	0	(1)	(1)	(1)	(1)	1	0	(0)	0		Rd	(0)	(0)	0	(0)	(0)	(0)	(0)	(0)		

d = UInt(Rd);
 if d == 15 then UNPREDICTABLE; // ARMv8-A removes UNPREDICTABLE for R13

Encoding A1 ARMv4*, ARMv5T*, ARMv6*, ARMv7

MRS<c> <Rd>, <spec_reg>

31	30	29	28	27	26	25	24	23	22	21	20	19	18	17	16	15	14	13	12	11	10	9	8	7	6	5	4	3	2	1	0
cond		0	0	0	1	0	0	0	0	(1)	(1)	(1)	(1)		Rd	(0)	(0)	0	(0)	0	0	0	0	(0)	(0)	(0)	(0)	(0)	(0)	(0)	

d = UInt(Rd);
 if d == 15 then UNPREDICTABLE;

For information about the CONSTRAINED UNPREDICTABLE behavior of this instruction, see [Appendix A Architectural Constraints on UNPREDICTABLE behaviors](#).

Assembler syntax

MRS{<c>}{<q>} <Rd>, <spec_reg>

where:

<c>, <q> See [Standard assembler syntax fields on page F2-2415](#).

<Rd> The destination register.

<spec_reg> Is one of:

- APSR.
- CPSR.

When the MRS instruction is executed in User mode, CPSR is treated as a synonym of APSR.

ARM recommends that application level software uses the APSR form. For more information, see [The Application Program Status Register \(APSR\) on page E1-2297](#).

Operation

```
if ConditionPassed() then
    EncodingSpecificOperations();
    R[d] = APSR;
```

F7.1.115 MRS (Banked register)

Move to Register from Banked or Special register is a system instruction, see [MRS \(Banked register\)](#) on page F7-3048.

F7.1.116 MSR (immediate)

Move immediate value to Special register moves selected bits of an immediate value to the corresponding bits in the APSR.

For details of system level use of this instruction, see [MSR \(immediate\)](#) on page F7-3052.

Encoding A1 ARMv4*, ARMv5T*, ARMv6*, ARMv7

MSR<c> <spec_reg>, #<const>

31	30	29	28	27	26	25	24	23	22	21	20	19	18	17	16	15	14	13	12	11	10	9	8	7	6	5	4	3	2	1	0
cond		0	0	1	1	0	0	1	0	mask	0	0	(1)	(1)	(1)	(1)	imm12														

if mask == '00' then SEE "Related encodings";
 imm32 = ARMEExpandImm(imm12); write_nzcvq = (mask<1> == '1'); write_g = (mask<0> == '1');

For information about the CONSTRAINED UNPREDICTABLE behavior of this instruction, see [Appendix A Architectural Constraints on UNPREDICTABLE behaviors](#).

Related encodings See [MSR \(immediate\)](#), and [hints](#) on page F4-2478.

Assembler syntax

MSR{<c>}{<q>} <spec_reg>, #<imm>

where:

<c>, <q>	See Standard assembler syntax fields on page F2-2415.
<spec_reg>	Is one of: <ul style="list-style-type: none">• APSR_<bits>.• CPSR_<fields>. ARM recommends that application level software uses the APSR forms. For more information, see The Application Program Status Register (APSR) on page E1-2297.
<imm>	Is the immediate value to be transferred to <spec_reg>. See Modified immediate constants in A32 instructions on page F4-2472 for the range of values.
<bits>	Is one of nzcvcq, g, or nzcvcqg. In the A and R profiles: <ul style="list-style-type: none">• APSR_nzcvcq is the same as CPSR_f.• APSR_g is the same as CPSR_s.• APSR_nzcvcqg is the same as CPSR_fs.
<fields>	Is a sequence of one or more of the following: s, f.

Operation

```
if ConditionPassed() then
    EncodingSpecificOperations();
    if write_nzcvcq then
        APSR.N = imm32<31>;
        APSR.Z = imm32<30>;
        APSR.C = imm32<29>;
        APSR.V = imm32<28>;
        APSR.Q = imm32<27>;
    if write_g then
        APSR.GE = imm32<19:16>;
```

Usage

For details of the APSR see [The Application Program Status Register \(APSR\)](#) on page E1-2297. Because of the Do-Not-Modify nature of its reserved bits, the immediate form of MSR is normally only useful at the Application level for writing to APSR_nzcvcq (CPSR_f).

For the A and R profiles, [MSR \(immediate\)](#) on page F7-3052 describes additional functionality that is available using the reserved bits. This includes some deprecated functionality that is also available to unprivileged software and therefore can be used at the Application level.

F7.1.117 MSR (register)

Move to Special register from general-purpose register moves selected bits of a general-purpose register to the APSR.

For details of system level use of this instruction, see [MSR \(register\) on page F7-3054](#).

Encoding T1 ARMv6T2, ARMv7

MSR<c> <spec_reg>, <Rn>

15	14	13	12	11	10	9	8	7	6	5	4	3	2	1	0	15	14	13	12	11	10	9	8	7	6	5	4	3	2	1	0
1	1	1	1	0	0	1	1	1	0	0	0	Rn				1	0	(0)	0	mask	0	0	(0)	(0)	0	(0)	(0)	(0)	(0)	(0)	

n = UInt(Rn); write_nzcvq = (mask<1> == '1'); write_g = (mask<0> == '1');
 if mask == '00' then UNPREDICTABLE;
 if n == 15 then UNPREDICTABLE; // ARMv8-A removes UNPREDICTABLE for R13

Encoding A1 ARMv4*, ARMv5T*, ARMv6*, ARMv7

MSR<c> <spec_reg>, <Rn>

31	30	29	28	27	26	25	24	23	22	21	20	19	18	17	16	15	14	13	12	11	10	9	8	7	6	5	4	3	2	1	0
cond		0	0	0	1	0	0	1	0	mask	0	0	(1)	(1)	(1)	(1)	(0)	(0)	0	(0)	0	0	0	0	0	0	0	Rn			

n = UInt(Rn); write_nzcvq = (mask<1> == '1'); write_g = (mask<0> == '1');
 if mask == '00' then UNPREDICTABLE;
 if n == 15 then UNPREDICTABLE;

For information about the CONSTRAINED UNPREDICTABLE behavior of this instruction, see [Appendix A Architectural Constraints on UNPREDICTABLE behaviors](#), and particularly [MSR \(register\) on page AppxA-4720](#).

Assembler syntax

MSR{<c>}{<q>} <spec_reg>, <Rn>

where:

<c>, <q> See [Standard assembler syntax fields on page F2-2415](#).

<spec_reg> Is one of:

- APSR_<bits>.
- CPSR_<fields>.

ARM recommends that application level software uses the APSR form. For more information, see [The Application Program Status Register \(APSR\) on page E1-2297](#).

<Rn> Is the general-purpose register to be transferred to <spec_reg>.

<bits> Is one of nzcvcq, g, or nzcvcqg.

In the A and R profiles:

- APSR_nzcvcq is the same as CPSR_f.
- APSR_g is the same as CPSR_s.
- APSR_nzcvcqg is the same as CPSR_fs.

<fields> Is a sequence of one or more of the following: s, f.

Operation

```
if ConditionPassed() then
    EncodingSpecificOperations();
    if write_nzcvcq then
        APSR.N = R[n]<31>;
        APSR.Z = R[n]<30>;
        APSR.C = R[n]<29>;
        APSR.V = R[n]<28>;
        APSR.Q = R[n]<27>;
    if write_g then
        APSR.GE = R[n]<19:16>;
```

Usage

For details of the APSR see [The Application Program Status Register \(APSR\) on page E1-2297](#). Because of the Do-Not-Modify nature of its reserved bits, a read-modify-write sequence is normally needed when the MSR instruction is being used at Application level and its destination is not APSR_nzcvcq (CPSR_f).

For the A and R profiles, [MSR \(register\) on page F7-3054](#) describes additional functionality that is available using the reserved bits. This includes some deprecated functionality that is also available to unprivileged software and therefore can be used at the Application level.

F7.1.118 MSR (Banked register)

Move to Banked or Special register from general-purpose register is a system instruction, see [MSR \(Banked register\)](#) on page F7-3050.

F7.1.119 MUL

Multiply multiplies two register values. The least significant 32 bits of the result are written to the destination register. These 32 bits do not depend on whether the source register values are considered to be signed values or unsigned values.

Optionally, it can update the condition flags based on the result. In the T32 instruction set, this option is limited to only a few forms of the instruction. Use of this option adversely affects performance on many implementations.

Encoding T1 ARMv4T, ARMv5T*, ARMv6*, ARMv7

MULS <Rdm>, <Rn>, <Rdm> Outside IT block.

MUL<C> <Rdm>, <Rn>, <Rdm> Inside IT block.

15	14	13	12	11	10	9	8	7	6	5	4	3	2	1	0
0	1	0	0	0	0	1	1	0	1	Rn				Rdm	

d = UInt(Rdm); n = UInt(Rn); m = UInt(Rdm); setflags = !InITBlock();

Encoding T2 ARMv6T2, ARMv7

MUL<C> <Rd>, <Rn>, <Rm>

15	14	13	12	11	10	9	8	7	6	5	4	3	2	1	0	15	14	13	12	11	10	9	8	7	6	5	4	3	2	1	0
1	1	1	1	1	0	1	1	0	0	0	0	Rn				1	1	1	1	Rd				0	0	0	0	Rm			

d = UInt(Rd); n = UInt(Rn); m = UInt(Rm); setflags = FALSE;
 if d == 15 || n == 15 || m == 15 then UNPREDICTABLE; // ARMv8-A removes UNPREDICTABLE for R13

Encoding A1 ARMv4*, ARMv5T*, ARMv6*, ARMv7

MUL{S}<C> <Rd>, <Rn>, <Rm>

31	30	29	28	27	26	25	24	23	22	21	20	19	18	17	16	15	14	13	12	11	10	9	8	7	6	5	4	3	2	1	0
cond		0	0	0	0	0	0	0	0	S	Rd				(0)(0)(0)(0)				Rm				1	0	0	1	Rn				

d = UInt(Rd); n = UInt(Rn); m = UInt(Rm); setflags = (S == '1');
 if d == 15 || n == 15 || m == 15 then UNPREDICTABLE;

For information about the CONSTRAINED UNPREDICTABLE behavior of this instruction, see [Appendix A Architectural Constraints on UNPREDICTABLE behaviors](#).

Assembler syntax

MUL{S}{<c>}{<q>} <Rd>, <Rn>{, <Rm>}

where:

S If S is present, the instruction updates the flags. Otherwise, the flags are not updated.
 In the T32 instruction set, S can be specified only if both <Rn> and <Rm> are R0-R7 and the instruction is outside an IT block.

<c>, <q> See [Standard assembler syntax fields on page F2-2415](#).

<Rd> The destination register.

<Rn> The first operand register.

<Rm> The second operand register. If omitted, <Rd> is used.

The pre-UAL syntax MUL<c>S is equivalent to MULS<c>.

Operation

```
if ConditionPassed() then
    EncodingSpecificOperations();
    operand1 = SInt(R[n]); // operand1 = UInt(R[n]) produces the same final results
    operand2 = SInt(R[m]); // operand2 = UInt(R[m]) produces the same final results
    result = operand1 * operand2;
    R[d] = result<31:0>;
    if setflags then
        APSR.N = result<31>;
        APSR.Z = IsZeroBit(result<31:0>);
        // APSR.C, APSR.V unchanged
```

F7.1.120 MVN (immediate)

Bitwise NOT (immediate) writes the bitwise inverse of an immediate value to the destination register. It can optionally update the condition flags based on the value.

Encoding T1 ARMv6T2, ARMv7

MVN{S}<c> <Rd>, #<const>

15	14	13	12	11	10	9	8	7	6	5	4	3	2	1	0	15	14	13	12	11	10	9	8	7	6	5	4	3	2	1	0
1	1	1	1	0	i	0	0	0	1	1	S	1	1	1	1	0	imm3	Rd	imm8												

```
d = UInt(Rd); setflags = (S == '1');
(imm32, carry) = ThumbExpandImm_C(i:imm3:imm8, APSR.C);
if d == 15 then UNPREDICTABLE; // ARMv8-A removes UNPREDICTABLE for R13
```

Encoding A1 ARMv4*, ARMv5T*, ARMv6*, ARMv7

MVN{S}<c> <Rd>, #<const>

31	30	29	28	27	26	25	24	23	22	21	20	19	18	17	16	15	14	13	12	11	10	9	8	7	6	5	4	3	2	1	0
cond		0	0	1	1	1	1	S	(0)	(0)	(0)	(0)	Rd	imm12																	

```
if Rd == '1111' && S == '1' then SEE SUBS PC, LR and related instructions;
d = UInt(Rd); setflags = (S == '1');
(imm32, carry) = ARMEExpandImm_C(imm12, APSR.C);
```

For information about the CONSTRAINED UNPREDICTABLE behavior of this instruction, see [Appendix A Architectural Constraints on UNPREDICTABLE behaviors](#).

Assembler syntax

MVN{S}{<c>}{<q>} <Rd>, #<const>

where:

- S If S is present, the instruction updates the flags. Otherwise, the flags are not updated.
- <c>, <q> See *Standard assembler syntax fields* on page F2-2415.
- <Rd> The destination register. If S is specified and <Rd> is the PC, see *SUBS PC, LR and related instructions (T32)* on page F7-3066 or *SUBS PC, LR and related instructions (A32)* on page F7-3068.
- In A32 instructions, if S is not specified and <Rd> is the PC, the instruction is a branch to the address calculated by the operation. This is an interworking branch, see *Pseudocode details of operations on the AArch32 general-purpose registers and the PC* on page E1-2296.
- <const> The immediate value to be bitwise inverted. See *Modified immediate constants in T32 instructions* on page F3-2444 or *Modified immediate constants in A32 instructions* on page F4-2472 for the range of values.

The pre-UAL syntax MVN<c>S is equivalent to MVNS<c>.

Operation

```
if ConditionPassed() then
    EncodingSpecificOperations();
    result = NOT(imm32);
    if d == 15 then        // Can only occur for ARM encoding
        ALUWritePC(result); // setflags is always FALSE here
    else
        R[d] = result;
        if setflags then
            APSR.N = result<31>;
            APSR.Z = IsZeroBit(result);
            APSR.C = carry;
            // APSR.V unchanged
```

F7.1.121 MVN (register)

Bitwise NOT (register) writes the bitwise inverse of a register value to the destination register. It can optionally update the condition flags based on the result.

Encoding T1 ARMv4T, ARMv5T*, ARMv6*, ARMv7
 MVNS <Rd>, <Rm> Outside IT block.
 MVN<c> <Rd>, <Rm> Inside IT block.

15	14	13	12	11	10	9	8	7	6	5	4	3	2	1	0
0	1	0	0	0	0	1	1	1	1	Rm	Rd				

d = UInt(Rd); m = UInt(Rm); setflags = !InITBlock();
 (shift_t, shift_n) = (SRTYPE_LSL, 0);

Encoding T2 ARMv6T2, ARMv7
 MVN{S}<c>.W <Rd>, <Rm>{, <shift>}

15	14	13	12	11	10	9	8	7	6	5	4	3	2	1	0	15	14	13	12	11	10	9	8	7	6	5	4	3	2	1	0
1	1	1	0	1	0	1	0	0	1	1	S	1	1	1	1	(0)	imm3	Rd	imm2	type	Rm										

d = UInt(Rd); m = UInt(Rm); setflags = (S == '1');
 (shift_t, shift_n) = DecodeImmShift(type, imm3:imm2);
 if d == 15 || m == 15 then UNPREDICTABLE; // ARMv8-A removes UNPREDICTABLE for R13

Encoding A1 ARMv4*, ARMv5T*, ARMv6*, ARMv7
 MVN{S}<c> <Rd>, <Rm>{, <shift>}

31	30	29	28	27	26	25	24	23	22	21	20	19	18	17	16	15	14	13	12	11	10	9	8	7	6	5	4	3	2	1	0
cond		0	0	0	1	1	1	1	S	(0)	(0)	(0)	(0)	Rd	imm5				type	0	Rm										

if Rd == '1111' && S == '1' then SEE SUBS PC, LR and related instructions;
 d = UInt(Rd); m = UInt(Rm); setflags = (S == '1');
 (shift_t, shift_n) = DecodeImmShift(type, imm5);

For information about the CONSTRAINED UNPREDICTABLE behavior of this instruction, see [Appendix A Architectural Constraints on UNPREDICTABLE behaviors](#).

Assembler syntax

MVN{S}{<c>}{<q>} <Rd>, <Rm> {, <shift>}

where:

- S If S is present, the instruction updates the flags. Otherwise, the flags are not updated.
- <c>, <q> See *Standard assembler syntax fields* on page F2-2415.
- <Rd> The destination register. If S is specified and <Rd> is the PC, see *SUBS PC, LR and related instructions (T32)* on page F7-3066 or *SUBS PC, LR and related instructions (A32)* on page F7-3068.
In A32 instructions, if S is not specified and <Rd> is the PC, the instruction is a branch to the address calculated by the operation. This is an interworking branch, see *Pseudocode details of operations on the AArch32 general-purpose registers and the PC* on page E1-2296.
- <Rm> The register that is optionally shifted and used as the source register. The PC can be used in A32 instructions.
- <shift> The shift to apply to the value read from <Rm>. If present, encoding T1 is not permitted. If absent, no shift is applied and all encodings are permitted. *Shifts applied to a register* on page F2-2419 describes the shifts and how they are encoded.

The pre-UAL syntax MVN<c>S is equivalent to MVNS<c>.

Operation

```
if ConditionPassed() then
    EncodingSpecificOperations();
    (shifted, carry) = Shift_C(R[m], shift_t, shift_n, APSR.C);
    result = NOT(shifted);
    if d == 15 then          // Can only occur for ARM encoding
        ALUWritePC(result); // setflags is always FALSE here
    else
        R[d] = result;
        if setflags then
            APSR.N = result<31>;
            APSR.Z = IsZeroBit(result);
            APSR.C = carry;
            // APSR.V unchanged
```

F7.1.122 MVN (register-shifted register)

Bitwise NOT (register-shifted register) writes the bitwise inverse of a register-shifted register value to the destination register. It can optionally update the condition flags based on the result.

Encoding A1 ARMv4*, ARMv5T*, ARMv6*, ARMv7
 MVN{S}<c> <Rd>, <Rm>, <type> <Rs>

31	30	29	28	27	26	25	24	23	22	21	20	19	18	17	16	15	14	13	12	11	10	9	8	7	6	5	4	3	2	1	0
cond		0	0	0	1	1	1	1	S	(0)	(0)	(0)	(0)	Rd				Rs		0	type	1	Rm								

```
d = UInt(Rd); m = UInt(Rm); s = UInt(Rs);
setflags = (S == '1'); shift_t = DecodeRegShift(type);
if d == 15 || m == 15 || s == 15 then UNPREDICTABLE;
```

For information about the CONSTRAINED UNPREDICTABLE behavior of this instruction, see [Appendix A Architectural Constraints on UNPREDICTABLE behaviors](#).

Assembler syntax

MVN{S}{<c>}{<q>} <Rd>, <Rm>, <type> <Rs>

where:

S If S is present, the instruction updates the flags. Otherwise, the flags are not updated.

<c>, <q> See [Standard assembler syntax fields on page F2-2415](#).

<Rd> The destination register.

<Rm> The register that is shifted and used as the operand.

<type> The type of shift to apply to the value read from <Rm>. It must be one of:

ASR Arithmetic shift right, encoded as type = 0b10.
 LSL Logical shift left, encoded as type = 0b00.
 LSR Logical shift right, encoded as type = 0b01.
 ROR Rotate right, encoded as type = 0b11.

<Rs> The register whose bottom byte contains the amount to shift by.

The pre-UAL syntax MVN<c>S is equivalent to MVNS<c>.

Operation

```
if ConditionPassed() then
  EncodingSpecificOperations();
  shift_n = UInt(R[s]<7:0>);
  (shifted, carry) = Shift_C(R[m], shift_t, shift_n, APSR.C);
  result = NOT(shifted);
  R[d] = result;
  if setflags then
    APSR.N = result<31>;
    APSR.Z = IsZeroBit(result);
    APSR.C = carry;
    // APSR.V unchanged
```

F7.1.123 NEG

Negate is a pre-UAL synonym for RSB (immediate) with an immediate value of 0. For details see [RSB \(immediate\)](#) on page F7-2782.

Assembler syntax

NEG{<c>}{<q>} <Rd>, <Rm>

This is equivalent to:

RSBS{<c>}{<q>} <Rd>, <Rm>, #0

F7.1.124 NOP

No Operation does nothing. This instruction can be used for instruction alignment purposes.

———— **Note** —————

The timing effects of including a NOP instruction in a program are not guaranteed. It can increase execution time, leave it unchanged, or even reduce it. Therefore, NOP instructions are not suitable for timing loops.

Encoding T1 ARMv6T2, ARMv7

NOP<c>

15	14	13	12	11	10	9	8	7	6	5	4	3	2	1	0
1	0	1	1	1	1	1	1	0	0	0	0	0	0	0	0

// No additional decoding required

Encoding T2 ARMv6T2, ARMv7

NOP<c>.W

15	14	13	12	11	10	9	8	7	6	5	4	3	2	1	0	15	14	13	12	11	10	9	8	7	6	5	4	3	2	1	0
1	1	1	1	0	0	1	1	1	0	1	0	(1)	(1)	(1)	(1)	1	0	(0)	0	(0)	0	0	0	0	0	0	0	0	0	0	

// No additional decoding required

Encoding A1 ARMv6K, ARMv6T2, ARMv7

NOP<c>

31	30	29	28	27	26	25	24	23	22	21	20	19	18	17	16	15	14	13	12	11	10	9	8	7	6	5	4	3	2	1	0
cond	0	0	1	1	0	0	1	0	0	0	0	0	(1)	(1)	(1)	(1)	(0)	(0)	(0)	(0)	0	0	0	0	0	0	0	0	0	0	0

// No additional decoding required

For information about the CONSTRAINED UNPREDICTABLE behavior of this instruction, see [Appendix A Architectural Constraints on UNPREDICTABLE behaviors](#).

Assembler syntax

NOP{<c>}{<q>}

where:

{<c>}{<q>} See [Standard assembler syntax fields on page F2-2415](#).

Operation

```
if ConditionPassed() then
    EncodingSpecificOperations();
    // Do nothing
```

F7.1.125 ORN (immediate)

Bitwise OR NOT (immediate) performs a bitwise (inclusive) OR of a register value and the complement of an immediate value, and writes the result to the destination register. It can optionally update the condition flags based on the result.

Encoding T1 ARMv6T2, ARMv7

ORN{S}<c> <Rd>, <Rn>, #<const>

15	14	13	12	11	10	9	8	7	6	5	4	3	2	1	0	15	14	13	12	11	10	9	8	7	6	5	4	3	2	1	0
1	1	1	1	0	i	0	0	0	1	1	S		Rn		0	imm3		Rd									imm8				

```

if Rn == '1111' then SEE MVN (immediate);
d = UInt(Rd); n = UInt(Rn); setflags = (S == '1');
(imm32, carry) = ThumbExpandImm_C(i:imm3:imm8, APSR.C);
if d == 15 then UNPREDICTABLE; // ARMv8-A removes UNPREDICTABLE for R13
  
```

For information about the CONSTRAINED UNPREDICTABLE behavior of this instruction, see [Appendix A Architectural Constraints on UNPREDICTABLE behaviors](#).

Assembler syntax

ORN{S}{<c>}{<q>} {<Rd>}, <Rn>, #<const>

where:

- S If S is present, the instruction updates the flags. Otherwise, the flags are not updated.
- <c>, <q> See [Standard assembler syntax fields on page F2-2415](#).
- <Rd> The destination register.
- <Rn> The register that contains the operand.
- <const> The immediate value to be bitwise inverted and ORed with the value obtained from <Rn>. See [Modified immediate constants in T32 instructions on page F3-2444](#) for the range of values.

Operation

```

if ConditionPassed() then
    EncodingSpecificOperations();
    result = R[n] OR NOT(imm32);
    R[d] = result;
    if setflags then
        APSR.N = result<31>;
        APSR.Z = IsZeroBit(result);
        APSR.C = carry;
        // APSR.V unchanged
  
```

F7.1.126 ORN (register)

Bitwise OR NOT (register) performs a bitwise (inclusive) OR of a register value and the complement of an optionally-shifted register value, and writes the result to the destination register. It can optionally update the condition flags based on the result.

Encoding T1 ARMv6T2, ARMv7

ORN{S}<C> <Rd>, <Rn>, <Rm>{, <shift>}

15	14	13	12	11	10	9	8	7	6	5	4	3	2	1	0	15	14	13	12	11	10	9	8	7	6	5	4	3	2	1	0
1	1	1	0	1	0	1	0	0	1	1	S		Rn	(0)	imm3		Rd		imm2	type		Rm									

```

if Rn == '1111' then SEE MVN (register);
d = UInt(Rd); n = UInt(Rn); m = UInt(Rm); setflags = (S == '1');
(shift_t, shift_n) = DecodeImmShift(type, imm3:imm2);
if d == 15 || m == 15 then UNPREDICTABLE; // ARMv8-A removes UNPREDICTABLE for R13
    
```

For information about the CONSTRAINED UNPREDICTABLE behavior of this instruction, see [Appendix A Architectural Constraints on UNPREDICTABLE behaviors](#).

Assembler syntax

ORN{S}{<c>}{<q>} {<Rd>}, <Rn>, <Rm> {, <shift>}

where:

- S If S is present, the instruction updates the flags. Otherwise, the flags are not updated.
- <c>, <q> See [Standard assembler syntax fields on page F2-2415](#).
- <Rd> The destination register.
- <Rn> The first operand register.
- <Rm> The register that is optionally shifted and used as the second operand.
- <shift> The shift to apply to the value read from <Rm>. If omitted, no shift is applied. [Shifts applied to a register on page F2-2419](#) describes the shifts and how they are encoded.

Operation

```
if ConditionPassed() then
    EncodingSpecificOperations();
    (shifted, carry) = Shift_C(R[m], shift_t, shift_n, APSR.C);
    result = R[n] OR NOT(shifted);
    R[d] = result;
    if setflags then
        APSR.N = result<31>;
        APSR.Z = IsZeroBit(result);
        APSR.C = carry;
        // APSR.V unchanged
```

F7.1.127 ORR (immediate)

Bitwise OR (immediate) performs a bitwise (inclusive) OR of a register value and an immediate value, and writes the result to the destination register. It can optionally update the condition flags based on the result.

Encoding T1 ARMv6T2, ARMv7

ORR{S}<c> <Rd>, <Rn>, #<const>

15	14	13	12	11	10	9	8	7	6	5	4	3	2	1	0	15	14	13	12	11	10	9	8	7	6	5	4	3	2	1	0
1	1	1	1	0	i	0	0	0	1	0	S	Rn				0	imm3			Rd			imm8								

```

if Rn == '1111' then SEE MOV (immediate);
d = UInt(Rd); n = UInt(Rn); setflags = (S == '1');
(imm32, carry) = ThumbExpandImm_C(i:imm3:imm8, APSR.C);
if d == 15 then UNPREDICTABLE; // ARMv8-A removes UNPREDICTABLE for R13
    
```

Encoding A1 ARMv4*, ARMv5T*, ARMv6*, ARMv7

ORR{S}<c> <Rd>, <Rn>, #<const>

31	30	29	28	27	26	25	24	23	22	21	20	19	18	17	16	15	14	13	12	11	10	9	8	7	6	5	4	3	2	1	0
cond		0	0	1	1	1	0	0	S	Rn				Rd			imm12														

```

if Rd == '1111' && S == '1' then SEE SUBS PC, LR and related instructions;
d = UInt(Rd); n = UInt(Rn); setflags = (S == '1');
(imm32, carry) = ARMEExpandImm_C(imm12, APSR.C);
    
```

For information about the CONSTRAINED UNPREDICTABLE behavior of this instruction, see [Appendix A Architectural Constraints on UNPREDICTABLE behaviors](#).

Assembler syntax

ORR{S}{<C>}{<q>} {<Rd>}, <Rn>, #<const>

where:

- S If S is present, the instruction updates the flags. Otherwise, the flags are not updated.
- <C>, <q> See *Standard assembler syntax fields* on page F2-2415.
- <Rd> The destination register. If S is specified and <Rd> is the PC, see *SUBS PC, LR and related instructions (T32)* on page F7-3066 or *SUBS PC, LR and related instructions (A32)* on page F7-3068.
- In A32 instructions, if S is not specified and <Rd> is the PC, the instruction is a branch to the address calculated by the operation. This is an interworking branch, see *Pseudocode details of operations on the AArch32 general-purpose registers and the PC* on page E1-2296.
- <Rn> The register that contains the operand. The PC can be used in A32 instructions.
- <const> The immediate value to be bitwise ORed with the value obtained from <Rn>. See *Modified immediate constants in T32 instructions* on page F3-2444 or *Modified immediate constants in A32 instructions* on page F4-2472 for the range of values.

The pre-UAL syntax ORR<C>S is equivalent to ORRS<C>.

Operation

```
if ConditionPassed() then
    EncodingSpecificOperations();
    result = R[n] OR imm32;
    if d == 15 then        // Can only occur for ARM encoding
        ALUWritePC(result); // setflags is always FALSE here
    else
        R[d] = result;
        if setflags then
            APSR.N = result<31>;
            APSR.Z = IsZeroBit(result);
            APSR.C = carry;
            // APSR.V unchanged
```

F7.1.128 ORR (register)

Bitwise OR (register) performs a bitwise (inclusive) OR of a register value and an optionally-shifted register value, and writes the result to the destination register. It can optionally update the condition flags based on the result.

Encoding T1 ARMv4T, ARMv5T*, ARMv6*, ARMv7

ORRS <Rdn>, <Rm> Outside IT block.
 ORR<c> <Rdn>, <Rm> Inside IT block.

15	14	13	12	11	10	9	8	7	6	5	4	3	2	1	0
0	1	0	0	0	0	1	1	0	0	Rm	Rdn				

d = UInt(Rdn); n = UInt(Rdn); m = UInt(Rm); setflags = !InITBlock();
 (shift_t, shift_n) = (SRTYPE_LSL, 0);

Encoding T2 ARMv6T2, ARMv7

ORR{S}<c>.W <Rd>, <Rn>, <Rm>{, <shift>}

15	14	13	12	11	10	9	8	7	6	5	4	3	2	1	0	15	14	13	12	11	10	9	8	7	6	5	4	3	2	1	0
1	1	1	0	1	0	1	0	0	1	0	S	Rn				(0)	imm3			Rd			imm2		type	Rm					

if Rn == '1111' then SEE "Related encodings";
 d = UInt(Rd); n = UInt(Rn); m = UInt(Rm); setflags = (S == '1');
 (shift_t, shift_n) = DecodeImmShift(type, imm3:imm2);
 if d == 15 || m == 15 then UNPREDICTABLE; // ARMv8-A removes UNPREDICTABLE for R13

Encoding A1 ARMv4*, ARMv5T*, ARMv6*, ARMv7

ORR{S}<c> <Rd>, <Rn>, <Rm>{, <shift>}

31	30	29	28	27	26	25	24	23	22	21	20	19	18	17	16	15	14	13	12	11	10	9	8	7	6	5	4	3	2	1	0
cond			0	0	0	1	1	0	0	S	Rn				Rd			imm5			type	0	Rm								

if Rd == '1111' && S == '1' then SEE SUBS PC, LR and related instructions;
 d = UInt(Rd); n = UInt(Rn); m = UInt(Rm); setflags = (S == '1');
 (shift_t, shift_n) = DecodeImmShift(type, imm5);

For information about the CONSTRAINED UNPREDICTABLE behavior of this instruction, see [Appendix A Architectural Constraints on UNPREDICTABLE behaviors](#).

Related encodings See *Move register and immediate shifts* on page F3-2457.

Assembler syntax

ORR{S}{<c>}{<q>} {<Rd>}, <Rn>, <Rm> {, <shift>}

where:

- S If S is present, the instruction updates the flags. Otherwise, the flags are not updated.
- <c>, <q> See [Standard assembler syntax fields on page F2-2415](#).
- <Rd> The destination register. If S is specified and <Rd> is the PC, see [SUBS PC, LR and related instructions \(T32\) on page F7-3066](#) or [SUBS PC, LR and related instructions \(A32\) on page F7-3068](#).
In A32 instructions, if S is not specified and <Rd> is the PC, the instruction is a branch to the address calculated by the operation. This is an interworking branch, see [Pseudocode details of operations on the AArch32 general-purpose registers and the PC on page E1-2296](#).
- <Rn> The first operand register. The PC can be used in A32 instructions.
- <Rm> The register that is optionally shifted and used as the second operand. The PC can be used in A32 instructions.
- <shift> The shift to apply to the value read from <Rm>. If present, encoding T1 is not permitted. If absent, no shift is applied and all encodings are permitted. [Shifts applied to a register on page F2-2419](#) describes the shifts and how they are encoded.

In T32 assembly:

- Outside an IT block, if ORRS <Rd>, <Rn>, <Rd> is written with <Rd> and <Rn> both in the range R0-R7, it is assembled using encoding T1 as though ORRS <Rd>, <Rn> had been written.
- Inside an IT block, if ORR<c> <Rd>, <Rn>, <Rd> is written with <Rd> and <Rn> both in the range R0-R7, it is assembled using encoding T1 as though ORR<c> <Rd>, <Rn> had been written.

To prevent either of these happening, use the .W qualifier.

The pre-UAL syntax ORR<c>S is equivalent to ORRS<c>.

Operation

```
if ConditionPassed() then
    EncodingSpecificOperations();
    (shifted, carry) = Shift_C(R[m], shift_t, shift_n, APSR.C);
    result = R[n] OR shifted;
    if d == 15 then // Can only occur for ARM encoding
        ALUWritePC(result); // setflags is always FALSE here
    else
        R[d] = result;
        if setflags then
            APSR.N = result<31>;
            APSR.Z = IsZeroBit(result);
            APSR.C = carry;
            // APSR.V unchanged
```

F7.1.129 ORR (register-shifted register)

Bitwise OR (register-shifted register) performs a bitwise (inclusive) OR of a register value and a register-shifted register value, and writes the result to the destination register. It can optionally update the condition flags based on the result.

Encoding A1 ARMv4*, ARMv5T*, ARMv6*, ARMv7

ORR{S}<C> <Rd>, <Rn>, <Rm>, <type> <Rs>

31	30	29	28	27	26	25	24	23	22	21	20	19	18	17	16	15	14	13	12	11	10	9	8	7	6	5	4	3	2	1	0
cond				0	0	0	1	1	0	0	S	Rn				Rd				Rs				0	type		1	Rm			

```
d = UInt(Rd); n = UInt(Rn); m = UInt(Rm); s = UInt(Rs);
setflags = (S == '1'); shift_t = DecodeRegShift(type);
if d == 15 || n == 15 || m == 15 || s == 15 then UNPREDICTABLE;
```

For information about the CONSTRAINED UNPREDICTABLE behavior of this instruction, see [Appendix A Architectural Constraints on UNPREDICTABLE behaviors](#).

Assembler syntax

ORR{S}{<c>}{<q>} {<Rd>}, <Rn>, <Rm>, <type> <Rs>

where:

S If S is present, the instruction updates the flags. Otherwise, the flags are not updated.

<c>, <q> See [Standard assembler syntax fields on page F2-2415](#).

<Rd> The destination register.

<Rn> The first operand register.

<Rm> The register that is shifted and used as the second operand.

<type> The type of shift to apply to the value read from <Rm>. It must be one of:

ASR Arithmetic shift right, encoded as type = 0b10.

LSL Logical shift left, encoded as type = 0b00.

LSR Logical shift right, encoded as type = 0b01.

ROR Rotate right, encoded as type = 0b11.

<Rs> The register whose bottom byte contains the amount to shift by.

The pre-UAL syntax ORR<c>S is equivalent to ORRS<c>.

Operation

```
if ConditionPassed() then
    EncodingSpecificOperations();
    shift_n = UInt(R[s]<7:0>);
    (shifted, carry) = Shift_C(R[m], shift_t, shift_n, APSR.C);
    result = R[n] OR shifted;
    R[d] = result;
    if setflags then
        APSR.N = result<31>;
        APSR.Z = IsZeroBit(result);
        APSR.C = carry;
    // APSR.V unchanged
```

F7.1.130 PKH

Pack Halfword combines one halfword of its first operand with the other halfword of its shifted second operand.

Encoding T1 ARMv6T2, ARMv7

PKHBT<c> <Rd>, <Rn>, <Rm>{, LSL #<imm>}

PKHTB<c> <Rd>, <Rn>, <Rm>{, ASR #<imm>}

15	14	13	12	11	10	9	8	7	6	5	4	3	2	1	0	15	14	13	12	11	10	9	8	7	6	5	4	3	2	1	0
1	1	1	0	1	0	1	0	1	1	0	S		Rn		(0)	imm3		Rd		imm2	tb	T			Rm						

```

if S == '1' || T == '1' then UNDEFINED;
d = UInt(Rd); n = UInt(Rn); m = UInt(Rm); tbform = (tb == '1');
(shift_t, shift_n) = DecodeImmShift(tb:'0', imm3:imm2);
if d == 15 || n == 15 || m == 15 then UNPREDICTABLE; // ARMv8-A removes UNPREDICTABLE for R13
    
```

Encoding A1 ARMv6*, ARMv7

PKHBT<c> <Rd>, <Rn>, <Rm>{, LSL #<imm>}

PKHTB<c> <Rd>, <Rn>, <Rm>{, ASR #<imm>}

31	30	29	28	27	26	25	24	23	22	21	20	19	18	17	16	15	14	13	12	11	10	9	8	7	6	5	4	3	2	1	0
cond		0	1	1	0	1	0	0	0		Rn		Rd		imm5		tb	0	1											Rm	

```

d = UInt(Rd); n = UInt(Rn); m = UInt(Rm); tbform = (tb == '1');
(shift_t, shift_n) = DecodeImmShift(tb:'0', imm5);
if d == 15 || n == 15 || m == 15 then UNPREDICTABLE;
    
```

For information about the CONSTRAINED UNPREDICTABLE behavior of this instruction, see [Appendix A Architectural Constraints on UNPREDICTABLE behaviors](#).

Assembler syntax

PKHBT{<c>}{<q>} {<Rd>}, <Rn>, <Rm> {, LSL #<imm>} tbform == FALSE
PKHTB{<c>}{<q>} {<Rd>}, <Rn>, <Rm> {, ASR #<imm>} tbform == TRUE

where:

<c>, <q> See *Standard assembler syntax fields* on page F2-2415.
<Rd> The destination register.
<Rn> The first operand register.
<Rm> The register that is optionally shifted and used as the second operand.
<imm> The shift to apply to the value read from <Rm>, encoded in imm3:imm2 for encoding T1 and imm5 for encoding A1.

For PKHBT, it is one of:

- omitted** No shift, encoded as `0b00000`.
- 1-31** Left shift by specified number of bits, encoded as a binary number.

For PKHTB, it is one of:

- omitted** Instruction is a pseudo-instruction and is assembled as though PKHBT{<c>}{<q>} <Rd>, <Rm>, <Rn> had been written.
- 1-32** Arithmetic right shift by specified number of bits. A shift by 32 bits is encoded as `0b00000`. Other shift amounts are encoded as binary numbers.

————— Note —————

An assembler can permit <imm> = 0 to mean the same thing as omitting the shift, but this is not standard UAL and must not be used for disassembly.

Operation

```
if ConditionPassed() then
    EncodingSpecificOperations();
operand2 = Shift(R[m], shift_t, shift_n, APSR.C); // APSR.C ignored
R[d]<15:0> = if tbform then operand2<15:0> else R[n]<15:0>;
R[d]<31:16> = if tbform then R[n]<31:16>    else operand2<31:16>;
```

F7.1.131 PLD, PLDW (immediate)

Preload Data signals the memory system that data memory accesses from a specified address are likely in the near future. The memory system can respond by taking actions that are expected to speed up the memory accesses when they do occur, such as pre-loading the cache line containing the specified address into the data cache.

On an architecture variant that includes both the PLD and PLDW instructions, the PLD instruction signals that the likely memory access is a read, and the PLDW instruction signals that it is a write.

The effect of a PLD or PLDW instruction is IMPLEMENTATION DEFINED. For more information, see [Preloading caches on page E2-2340](#).

Encoding T1 ARMv6T2, ARMv7 for PLD
 ARMv7 with MP Extensions for PLDW

PLD{W}<c> [<Rn>, #<imm12>]

15	14	13	12	11	10	9	8	7	6	5	4	3	2	1	0	15	14	13	12	11	10	9	8	7	6	5	4	3	2	1	0
1	1	1	1	1	0	0	0	1	0	W	1	Rn				1	1	1	1	imm12											

if Rn == '1111' then SEE PLD (literal);
 n = UInt(Rn); imm32 = ZeroExtend(imm12, 32); add = TRUE; is_pldw = (W == '1');

Encoding T2 ARMv6T2, ARMv7 for PLD
 ARMv7 with MP Extensions for PLDW

PLD{W}<c> [<Rn>, #-<imm8>]

15	14	13	12	11	10	9	8	7	6	5	4	3	2	1	0	15	14	13	12	11	10	9	8	7	6	5	4	3	2	1	0
1	1	1	1	1	0	0	0	0	0	W	1	Rn				1	1	1	1	1	1	0	0	imm8							

if Rn == '1111' then SEE PLD (literal);
 n = UInt(Rn); imm32 = ZeroExtend(imm8, 32); add = FALSE; is_pldw = (W == '1');

Encoding A1 ARMv5TE*, ARMv6*, ARMv7 for PLD
 ARMv7 with MP Extensions for PLDW

PLD{W} [<Rn>, #+/-<imm12>]

31	30	29	28	27	26	25	24	23	22	21	20	19	18	17	16	15	14	13	12	11	10	9	8	7	6	5	4	3	2	1	0
1	1	1	1	0	1	0	1	U	R	0	1	Rn				(1)	(1)	(1)	(1)	imm12											

if Rn == '1111' then SEE PLD (literal);
 n = UInt(Rn); imm32 = ZeroExtend(imm12, 32); add = (U == '1'); is_pldw = (R == '0');

For information about the CONSTRAINED UNPREDICTABLE behavior of this instruction, see [Appendix A Architectural Constraints on UNPREDICTABLE behaviors](#).

Assembler syntax

PLD{W}{<C>}{<q>} [<Rn> {, #+/-<imm>}]

where:

W	If specified, selects PLDW, encoded as W = 1 in T32 encodings and R = 0 in A32 encodings. If omitted, selects PLD, encoded as W = 0 in T32 encodings and R = 1 in A32 encodings.
<C>, <q>	See <i>Standard assembler syntax fields</i> on page F2-2415. An A32 PLD or PLDW instruction must be unconditional.
<Rn>	The base register. The SP can be used. For PC use in the PLD instruction, see <i>PLD (literal)</i> on page F7-2748.
+/-	Is + or omitted to indicate that the immediate offset is added to the base register value (add == TRUE), or – to indicate that the offset is to be subtracted (add == FALSE). Different instructions are generated for #0 and #-0.
<imm>	The immediate offset used for forming the address. This offset can be omitted, meaning an offset of 0. Values are: Encoding T1, A1 Any value in the range 0-4095. Encoding T2 Any value in the range 0-255.

Operation

```
if ConditionPassed() then
    EncodingSpecificOperations();
    address = if add then (R[n] + imm32) else (R[n] - imm32);
    if is_pldw then
        Hint_PreloadDataForWrite(address);
    else
        Hint_PreloadData(address);
```

F7.1.132 PLD (literal)

Preload Data signals the memory system that data memory accesses from a specified address are likely in the near future. The memory system can respond by taking actions that are expected to speed up the memory accesses when they do occur, such as pre-loading the cache line containing the specified address into the data cache.

The effect of a PLD instruction is IMPLEMENTATION DEFINED. For more information, see [Preloading caches on page E2-2340](#).

Encoding T1 ARMv6T2, ARMv7

PLD<c> <label>

PLD<c> [PC, #-0]

Special case

15	14	13	12	11	10	9	8	7	6	5	4	3	2	1	0	15	14	13	12	11	10	9	8	7	6	5	4	3	2	1	0
1	1	1	1	1	0	0	0	U	0	(0)	1	1	1	1	1	1	1	1	1	imm12											

imm32 = ZeroExtend(imm12, 32); add = (U == '1');

Encoding A1 ARMv5TE*, ARMv6*, ARMv7

PLD <label>

PLD [PC, #-0]

Special case

31	30	29	28	27	26	25	24	23	22	21	20	19	18	17	16	15	14	13	12	11	10	9	8	7	6	5	4	3	2	1	0
1	1	1	1	0	1	0	1	U	(1)	0	1	1	1	1	1	(1)	(1)	(1)	(1)	imm12											

imm32 = ZeroExtend(imm12, 32); add = (U == '1');

For information about the CONSTRAINED UNPREDICTABLE behavior of this instruction, see [Appendix A Architectural Constraints on UNPREDICTABLE behaviors](#).

Assembler syntax

PLD{<c>}{<q>} <label>	Normal form
PLD{<c>}{<q>} [PC, #+/-<imm>]	Alternative form

where:

<c>, <q> See [Standard assembler syntax fields on page F2-2415](#). An A32 PLD instruction must be unconditional.

<label> The label of the literal data item that is likely to be accessed in the near future. The assembler calculates the required value of the offset from the `Align(PC, 4)` value of the instruction to this label. The offset must be in the range `-4095` to `4095`.
If the offset is zero or positive, `imm32` is equal to the offset and `add == TRUE`.
If the offset is negative, `imm32` is equal to minus the offset and `add == FALSE`.

+/- Is + or omitted to indicate that the immediate offset is added to the `Align(PC, 4)` value (`add == TRUE`), or - to indicate that the offset is to be subtracted (`add == FALSE`). Different instructions are generated for #0 and #-0.

<imm> The immediate offset used for forming the address. Values are in the range 0-4095.

The alternative syntax permits the addition or subtraction of the offset and the immediate offset to be specified separately, including permitting a subtraction of 0 that cannot be specified using the normal syntax. For more information, see [Use of labels in UAL instruction syntax on page F1-2380](#).

Operation

```
if ConditionPassed() then
    EncodingSpecificOperations();
    address = if add then (Align(PC,4) + imm32) else (Align(PC,4) - imm32);
    Hint_PreloadData(address);
```

F7.1.133 PLD, PLDW (register)

Preload Data signals the memory system that data memory accesses from a specified address are likely in the near future. The memory system can respond by taking actions that are expected to speed up the memory accesses when they do occur, such as pre-loading the cache line containing the specified address into the data cache.

On an architecture variant that includes both the PLD and PLDW instructions, the PLD instruction signals that the likely memory access is a read, and the PLDW instruction signals that it is a write.

The effect of a PLD or PLDW instruction is IMPLEMENTATION DEFINED. For more information, see [Preloading caches on page E2-2340](#).

Encoding T1 ARMv6T2, ARMv7 for PLD
 ARMv7 with MP Extensions for PLDW

PLD{W}<c> [<Rn>, <Rm>{, LSL #<imm2>}]

15	14	13	12	11	10	9	8	7	6	5	4	3	2	1	0	15	14	13	12	11	10	9	8	7	6	5	4	3	2	1	0
1	1	1	1	1	0	0	0	0	0	W	1			Rn		1	1	1	1	0	0	0	0	0	0	imm2		Rm			

```
if Rn == '1111' then SEE PLD (literal);
n = UInt(Rn); m = UInt(Rm); add = TRUE; is_pldw = (W == '1');
(shift_t, shift_n) = (SRTYPE_LSL, UInt(imm2));
if m == 15 then UNPREDICTABLE; // ARMv8-A removes UNPREDICTABLE for R13
```

Encoding A1 ARMv5TE*, ARMv6*, ARMv7 for PLD
 ARMv7 with MP Extensions for PLDW

PLD{W} [<Rn>, +/-<Rm>{, <shift>}]

31	30	29	28	27	26	25	24	23	22	21	20	19	18	17	16	15	14	13	12	11	10	9	8	7	6	5	4	3	2	1	0
1	1	1	1	0	1	1	1	U	R	0	1			Rn		(1)	(1)	(1)	(1)		imm5		type	0					Rm		

```
n = UInt(Rn); m = UInt(Rm); add = (U == '1'); is_pldw = (R == '0');
(shift_t, shift_n) = DecodeImmShift(type, imm5);
if m == 15 || (n == 15 && is_pldw) then UNPREDICTABLE;
```

For information about the CONSTRAINED UNPREDICTABLE behavior of this instruction, see [Appendix A Architectural Constraints on UNPREDICTABLE behaviors](#).

Assembler syntax

PLD[W]{<C>}{<q>} [<Rn>, +/-<Rm> {, <shift>}]

where:

- W If specified, selects PLDW, encoded as W = 1 in T32 encodings and R = 0 in A32 encodings. If omitted, selects PLD, encoded as W = 0 in T32 encodings and R = 1 in A32 encodings.
- <C>, <q> See [Standard assembler syntax fields on page F2-2415](#). An A32 PLD or PLDW instruction must be unconditional.
- <Rn> Is the base register. The SP can be used. The PC can be used in A32 PLD instructions, but not in T32 PLD instructions or in any PLDW instructions.
- +/- Is + or omitted if the optionally shifted value of <Rm> is to be added to the base register value (add == TRUE), or – if it is to be subtracted (permitted in A32 instructions only, add == FALSE).
- <Rm> Contains the offset that is optionally shifted and applied to the value of <Rn> to form the address.
- <shift> The shift to apply to the value read from <Rm>. If absent, no shift is applied. For encoding T1, <shift> can only be omitted, encoded as imm2 = 0b00, or LSL #<imm> with <imm> = 1, 2, or 3, with <imm> encoded in imm2. For encoding A1, see [Shifts applied to a register on page F2-2419](#).

Operation

```
if ConditionPassed() then
    EncodingSpecificOperations();
    offset = Shift(R[m], shift_t, shift_n, APSR.C);
    address = if add then (R[n] + offset) else (R[n] - offset);
    if is_pldw then
        Hint_PreloadDataForWrite(address);
    else
        Hint_PreloadData(address);
```

F7.1.134 PLI (immediate, literal)

Preload Instruction signals the memory system that instruction memory accesses from a specified address are likely in the near future. The memory system can respond by taking actions that are expected to speed up the memory accesses when they do occur, such as pre-loading the cache line containing the specified address into the instruction cache.

The effect of a PLI instruction is IMPLEMENTATION DEFINED. For more information, see [Preloading caches on page E2-2340](#).

Encoding T1 ARMv7

PLI<c> [<Rn>, #<imm12>]

15	14	13	12	11	10	9	8	7	6	5	4	3	2	1	0	15	14	13	12	11	10	9	8	7	6	5	4	3	2	1	0
1	1	1	1	1	0	0	1	1	0	0	1		Rn			1	1	1	1												imm12

if Rn == '1111' then SEE encoding T3;
 n = UInt(Rn); imm32 = ZeroExtend(imm12, 32); add = TRUE;

Encoding T2 ARMv7

PLI<c> [<Rn>, #-<imm8>]

15	14	13	12	11	10	9	8	7	6	5	4	3	2	1	0	15	14	13	12	11	10	9	8	7	6	5	4	3	2	1	0
1	1	1	1	1	0	0	1	0	0	0	1		Rn			1	1	1	1	1	1	1	0	0							imm8

if Rn == '1111' then SEE encoding T3;
 n = UInt(Rn); imm32 = ZeroExtend(imm8, 32); add = FALSE;

Encoding T3 ARMv7

PLI<c> <label>

PLI<c> [PC, #-0] Special case

15	14	13	12	11	10	9	8	7	6	5	4	3	2	1	0	15	14	13	12	11	10	9	8	7	6	5	4	3	2	1	0
1	1	1	1	1	0	0	1	U	0	0	1	1	1	1	1	1	1	1	1											imm12	

n = 15; imm32 = ZeroExtend(imm12, 32); add = (U == '1');

Encoding A1 ARMv7

PLI [<Rn>, #+/-<imm12>]

PLI <label>

PLI [PC, #-0] Special case

31	30	29	28	27	26	25	24	23	22	21	20	19	18	17	16	15	14	13	12	11	10	9	8	7	6	5	4	3	2	1	0		
1	1	1	1	0	1	0	0	U	1	0	1		Rn			(1)	(1)	(1)	(1)														imm12

n = UInt(Rn); imm32 = ZeroExtend(imm12, 32); add = (U == '1');

For information about the CONSTRAINED UNPREDICTABLE behavior of this instruction, see [Appendix A Architectural Constraints on UNPREDICTABLE behaviors](#).

Assembler syntax

PLI{<c>}{<q>} [<Rn> {, #+/-<imm>}]	Immediate form
PLI{<c>}{<q>} <label>	Normal literal form
PLI{<c>}{<q>} [PC, #+/-<imm>]	Alternative literal form

where:

<c>, <q>	See Standard assembler syntax fields on page F2-2415 . An A32 PLI instruction must be unconditional.
<Rn>	Is the base register. The SP can be used.
+/-	Is + or omitted to indicate that the immediate offset is added to the base register value (add == TRUE), or – to indicate that the offset is to be subtracted (add == FALSE). Different instructions are generated for #0 and #-0.
<imm>	The immediate offset used for forming the address. For the immediate form of the syntax, <imm> can be omitted, in which case the #0 form of the instruction is assembled. Values are: Encoding T1, T3, A1 Any value in the range 0 to 4095. Encoding T2 Any value in the range 0 to 255.
<label>	The label of the instruction that is likely to be accessed in the near future. The assembler calculates the required value of the offset from the Align(PC, 4) value of the instruction to this label. The offset must be in the range –4095 to 4095. If the offset is zero or positive, imm32 is equal to the offset and add == TRUE. If the offset is negative, imm32 is equal to minus the offset and add == FALSE.

For the literal forms of the instruction, encoding T3 is used, or Rn is encoded as 0b1111 in encoding A1, to indicate that the PC is the base register.

The alternative literal syntax permits the addition or subtraction of the offset and the immediate offset to be specified separately, including permitting a subtraction of 0 that cannot be specified using the normal syntax. For more information, see [Use of labels in UAL instruction syntax on page F1-2380](#).

Operation

```

if ConditionPassed() then
    EncodingSpecificOperations();
    base = if n == 15 then Align(PC,4) else R[n];
    address = if add then (base + imm32) else (base - imm32);
    Hint_PreloadInstr(address);
  
```

F7.1.135 PLI (register)

Preload Instruction signals the memory system that instruction memory accesses from a specified address are likely in the near future. The memory system can respond by taking actions that are expected to speed up the memory accesses when they do occur, such as pre-loading the cache line containing the specified address into the instruction cache.

The effect of a PLI instruction is IMPLEMENTATION DEFINED. For more information, see [Preloading caches on page E2-2340](#).

Encoding T1 ARMv7

PLI<c> [<Rn>, <Rm>{, LSL #<imm2>}]

15	14	13	12	11	10	9	8	7	6	5	4	3	2	1	0	15	14	13	12	11	10	9	8	7	6	5	4	3	2	1	0
1	1	1	1	1	0	0	1	0	0	0	1		Rn			1	1	1	1	0	0	0	0	0	0	imm2		Rm			

```

if Rn == '1111' then SEE PLI (immediate, literal);
n = UInt(Rn); m = UInt(Rm); add = TRUE;
(shift_t, shift_n) = (SRTYPE_LSL, UInt(imm2));
if m == 15 then UNPREDICTABLE; // ARMv8-A removes UNPREDICTABLE for R13
    
```

Encoding A1 ARMv7

PLI [<Rn>, +/-<Rm>{, <shift>}]

31	30	29	28	27	26	25	24	23	22	21	20	19	18	17	16	15	14	13	12	11	10	9	8	7	6	5	4	3	2	1	0
1	1	1	1	0	1	1	0	U	1	0	1		Rn			(1)	(1)	(1)	(1)		imm5		type	0				Rm			

```

n = UInt(Rn); m = UInt(Rm); add = (U == '1');
(shift_t, shift_n) = DecodeImmShift(type, imm5);
if m == 15 then UNPREDICTABLE;
    
```

For information about the CONSTRAINED UNPREDICTABLE behavior of this instruction, see [Appendix A Architectural Constraints on UNPREDICTABLE behaviors](#).

Assembler syntax

PLI{<c>}{<q>} [<Rn>, +/-<Rm> {, <shift>}]

where:

- <c>, <q> See [Standard assembler syntax fields on page F2-2415](#). An A32 PLI instruction must be unconditional.
- <Rn> Is the base register. The SP can be used.
- +/- Is + or omitted if the optionally shifted value of <Rm> is to be added to the base register value (add == TRUE), or – if it is to be subtracted (permitted in A32 instructions only, add == FALSE).
- <Rm> Contains the offset that is optionally shifted and applied to the value of <Rn> to form the address.
- <shift> The shift to apply to the value read from <Rm>. If absent, no shift is applied. For encoding T1, <shift> can only be omitted, encoded as imm2 = 0b00, or LSL #<imm> with <imm> = 1, 2, or 3, with <imm> encoded in imm2. For encoding A1, see [Shifts applied to a register on page F2-2419](#).

Operation

```
if ConditionPassed() then
    EncodingSpecificOperations();
    offset = Shift(R[m], shift_t, shift_n, APSR.C);
    address = if add then (R[n] + offset) else (R[n] - offset);
    Hint_PreloadInstr(address);
```

F7.1.136 POP (T32)

Pop Multiple Registers loads multiple registers from the stack, loading from consecutive memory locations starting at the address in SP, and updates SP to point just above the loaded data.

Encoding T1 ARMv4T, ARMv5T*, ARMv6*, ARMv7
 POP<c> <registers>

15	14	13	12	11	10	9	8	7	6	5	4	3	2	1	0
1	0	1	1	1	1	0	P	register_list							

```
registers = P:'000000':register_list; UnalignedAllowed = FALSE;
if BitCount(registers) < 1 then UNPREDICTABLE;
if registers<15> == '1' && InITBlock() && !LastInITBlock() then UNPREDICTABLE;
```

Encoding T2 ARMv6T2, ARMv7
 POP<c>.W <registers> <registers> contains more than one register

15	14	13	12	11	10	9	8	7	6	5	4	3	2	1	0	15	14	13	12	11	10	9	8	7	6	5	4	3	2	1	0
1	1	1	0	1	0	0	0	1	0	1	1	1	1	0	1	P	M	(0)	register_list												

```
registers = P:M:'0':register_list; UnalignedAllowed = FALSE;
if BitCount(registers) < 2 || (P == '1' && M == '1') then UNPREDICTABLE;
if registers<15> == '1' && InITBlock() && !LastInITBlock() then UNPREDICTABLE;
```

Encoding T3 ARMv6T2, ARMv7
 POP<c>.W <registers> <registers> contains one register, <Rt>

15	14	13	12	11	10	9	8	7	6	5	4	3	2	1	0	15	14	13	12	11	10	9	8	7	6	5	4	3	2	1	0
1	1	1	1	1	0	0	0	0	1	0	1	1	1	0	1	Rt	1	0	1	1	0	0	0	0	0	1	0	0			

```
t = UInt(Rt); registers = Zeros(16); registers<t> = '1'; UnalignedAllowed = TRUE;
if t == 13 || (t == 15 && InITBlock() && !LastInITBlock()) then UNPREDICTABLE;
```

For information about the CONSTRAINED UNPREDICTABLE behavior of this instruction, see [Appendix A Architectural Constraints on UNPREDICTABLE behaviors](#), and particularly [POP \(T32\)](#) on page AppxA-4720.

Assembler syntax

POP{<c>}{<q>} <registers> Standard syntax
LDM{<c>}{<q>} SP!, <registers> Equivalent LDM syntax

where:

<c>, <q> See [Standard assembler syntax fields on page F2-2415](#).

<registers> Is a list of one or more registers to be loaded, separated by commas and surrounded by { and }. The lowest-numbered register is loaded from the lowest memory address, through to the highest-numbered register from the highest memory address. See also [Encoding of lists of general-purpose registers and the PC on page F2-2426](#).

If the list contains more than one register, the instruction is assembled to encoding T1 or T2. If the list contains exactly one register, the instruction is assembled to encoding T1 or T3.

The PC can be in the list. If it is, the instruction branches to the address loaded to the PC. In ARMv5T and above, this is an interworking branch, see [Pseudocode details of operations on the AArch32 general-purpose registers and the PC on page E1-2296](#). If the PC is in the list:

- The LR must not be in the list.
- The instruction must be either outside any IT block, or the last instruction in an IT block.

Operation

```
if ConditionPassed() then
    EncodingSpecificOperations(); NullCheckIfThumbEE(13);
    address = SP;
    for i = 0 to 14
        if registers<i> == '1' then
            R[i] = if UnalignedAllowed then MemU[address,4] else MemA[address,4];
            address = address + 4;
    if registers<15> == '1' then
        if UnalignedAllowed then
            if address<1:0> == '00' then
                LoadWritePC(MemU[address,4]);
            else
                UNPREDICTABLE;
        else
            LoadWritePC(MemA[address,4]);
    if registers<13> == '0' then SP = SP + 4*BitCount(registers);
    if registers<13> == '1' then SP = bits(32) UNKNOWN;
```

F7.1.137 POP (A32)

Pop Multiple Registers loads multiple registers from the stack, loading from consecutive memory locations starting at the address in SP, and updates SP to point just above the loaded data.

Encoding A1 ARMv4*, ARMv5T*, ARMv6*, ARMv7

POP<c> <registers> <registers> contains more than one register

31	30	29	28	27	26	25	24	23	22	21	20	19	18	17	16	15	14	13	12	11	10	9	8	7	6	5	4	3	2	1	0
cond		1	0	0	0	1	0	1	1	1	1	0	1	register_list																	

```
if BitCount(register_list) < 2 then SEE LDM / LDMIA / LDMFD;
registers = register_list; UnalignedAllowed = FALSE;
if registers<13> == '1' then UNPREDICTABLE;
```

Encoding A2 ARMv4*, ARMv5T*, ARMv6*, ARMv7

POP<c> <registers> <registers> contains one register, <Rt>

31	30	29	28	27	26	25	24	23	22	21	20	19	18	17	16	15	14	13	12	11	10	9	8	7	6	5	4	3	2	1	0
cond		0	1	0	0	1	0	0	1	1	1	0	1	Rt	0	0	0	0	0	0	0	0	0	0	0	0	1	0	0		

```
t = UInt(Rt); registers = Zeros(16); registers<t> = '1'; UnalignedAllowed = TRUE;
// ARMv8-A removes UNPREDICTABLE for R13
```

For information about the CONSTRAINED UNPREDICTABLE behavior of this instruction, see [Appendix A Architectural Constraints on UNPREDICTABLE behaviors](#), and particularly [POP \(A32\)](#) on page AppxA-4721.

Assembler syntax

POP{<c>}{<q>} <registers> Standard syntax
LDM{<c>}{<q>} SP!, <registers> Equivalent LDM syntax

where:

<c>, <q> See [Standard assembler syntax fields on page F2-2415](#).

<registers> Is a list of one or more registers to be loaded, separated by commas and surrounded by { and }. The lowest-numbered register is loaded from the lowest memory address, through to the highest-numbered register from the highest memory address. See also [Encoding of lists of general-purpose registers and the PC on page F2-2426](#).

If the list contains more than one register, the instruction is assembled to encoding A1. If the list contains exactly one register, the instruction is assembled to encoding A2.

ARM deprecates any use of A32 instructions that include the SP, and the value of the SP after such an instruction is UNKNOWN.

The PC can be in the list. If it is, the instruction branches to the address loaded to the PC. In ARMv5T and above, this is an interworking branch, see [Pseudocode details of operations on the AArch32 general-purpose registers and the PC on page E1-2296](#).

ARM deprecates the use of this instruction with both the LR and the PC in the list.

Operation

```
if ConditionPassed() then
    EncodingSpecificOperations(); NullCheckIfThumbEE(13);
    address = SP;
    for i = 0 to 14
        if registers<i> == '1' then
            R[i] = if UnalignedAllowed then MemU[address,4] else MemA[address,4];
            address = address + 4;
    if registers<15> == '1' then
        if UnalignedAllowed then
            if address<1:0> == '00' then
                LoadWritePC(MemU[address,4]);
            else
                UNPREDICTABLE;
        else
            LoadWritePC(MemA[address,4]);
    if registers<13> == '0' then SP = SP + 4*BitCount(registers);
    if registers<13> == '1' then SP = bits(32) UNKNOWN;
```

F7.1.138 PUSH

Push Multiple Registers stores multiple registers to the stack, storing to consecutive memory locations ending just below the address in SP, and updates SP to point to the start of the stored data.

Encoding T1 ARMv4T, ARMv5T*, ARMv6*, ARMv7
 PUSH<c> <registers>

15	14	13	12	11	10	9	8	7	6	5	4	3	2	1	0
1	0	1	1	0	1	0	M	register_list							

```
registers = '0':M:'000000':register_list; UnalignedAllowed = FALSE;
if BitCount(registers) < 1 then UNPREDICTABLE;
```

Encoding T2 ARMv6T2, ARMv7
 PUSH<c>.W <registers> <registers> contains more than one register

15	14	13	12	11	10	9	8	7	6	5	4	3	2	1	0	15	14	13	12	11	10	9	8	7	6	5	4	3	2	1	0
1	1	1	0	1	0	0	1	0	0	1	0	1	1	0	1	(0)	M	(0)	register_list												

```
registers = '0':M:'0':register_list; UnalignedAllowed = FALSE;
if BitCount(registers) < 2 then UNPREDICTABLE;
```

Encoding T3 ARMv6T2, ARMv7
 PUSH<c>.W <registers> <registers> contains one register, <Rt>

15	14	13	12	11	10	9	8	7	6	5	4	3	2	1	0	15	14	13	12	11	10	9	8	7	6	5	4	3	2	1	0
1	1	1	1	1	0	0	0	0	1	0	0	1	1	0	1	Rt	1	1	0	1	0	0	0	0	0	1	0	0			

```
t = UInt(Rt); registers = Zeros(16); registers<t> = '1'; UnalignedAllowed = TRUE;
if t == 15 then UNPREDICTABLE; // ARMv8-A removes UNPREDICTABLE for R13
```

Encoding A1 ARMv4*, ARMv5T*, ARMv6*, ARMv7
 PUSH<c> <registers> <registers> contains more than one register

31	30	29	28	27	26	25	24	23	22	21	20	19	18	17	16	15	14	13	12	11	10	9	8	7	6	5	4	3	2	1	0
cond		1	0	0	1	0	0	1	0	1	1	0	1	register_list																	

```
if BitCount(register_list) < 2 then SEE STMDB / STMFD;
registers = register_list; UnalignedAllowed = FALSE;
```

Encoding A2 ARMv4*, ARMv5T*, ARMv6*, ARMv7
 PUSH<c> <registers> <registers> contains one register, <Rt>

31	30	29	28	27	26	25	24	23	22	21	20	19	18	17	16	15	14	13	12	11	10	9	8	7	6	5	4	3	2	1	0
cond		0	1	0	1	0	0	1	0	1	1	0	1	Rt	0	0	0	0	0	0	0	0	0	0	0	0	0	1	0	0	

```
t = UInt(Rt); registers = Zeros(16); registers<t> = '1'; UnalignedAllowed = TRUE;
// ARMv8-A removes UNPREDICTABLE for R13
```

For information about the CONSTRAINED UNPREDICTABLE behavior of this instruction, see [Appendix A Architectural Constraints on UNPREDICTABLE behaviors](#), and particularly [PUSH on page AppxA-4721](#).

Assembler syntax

PUSH{<c>}{<q>} <registers> Standard syntax
STMDB{<c>}{<q>} SP!, <registers> Equivalent STM syntax

where:

<c>, <q> See *Standard assembler syntax fields* on page F2-2415.

<registers> Is a list of one or more registers to be stored, separated by commas and surrounded by { and }. The lowest-numbered register is stored to the lowest memory address, through to the highest-numbered register to the highest memory address. See also *Encoding of lists of general-purpose registers and the PC* on page F2-2426.

If the list contains more than one register, the instruction is assembled to encoding T1, T2, or A1. If the list contains exactly one register, the instruction is assembled to encoding T1, T3, or A2.

The SP and PC can be in the list in A32 instructions, but not in T32 instructions. However:

- ARM deprecates the use of A32 instructions that include the PC in the list.
- If the SP is in the list, and it is not the lowest-numbered register in the list, the instruction stores an UNKNOWN value for the SP.

Operation

```
if ConditionPassed() then
    EncodingSpecificOperations(); NullCheckIfThumbEE(13);
    address = SP - 4*BitCount(registers);
    for i = 0 to 14
        if registers<i> == '1' then
            if i == 13 && i != LowestSetBit(registers) then // Only possible for encoding A1
                MemA[address,4] = bits(32) UNKNOWN;
            else
                if UnalignedAllowed then
                    MemU[address,4] = R[i];
                else
                    MemA[address,4] = R[i];
                address = address + 4;
    if registers<15> == '1' then // Only possible for encoding A1 or A2
        if UnalignedAllowed then
            MemU[address,4] = PCStoreValue();
        else
            MemA[address,4] = PCStoreValue();
    SP = SP - 4*BitCount(registers);
```

F7.1.139 QADD

Saturating Add adds two register values, saturates the result to the 32-bit signed integer range -2^{31} to $(2^{31} - 1)$, and writes the result to the destination register. If saturation occurs, it sets the Q flag in the APSR.

Encoding T1 ARMv6T2, ARMv7

QADD<c> <Rd>, <Rm>, <Rn>

15	14	13	12	11	10	9	8	7	6	5	4	3	2	1	0	15	14	13	12	11	10	9	8	7	6	5	4	3	2	1	0
1	1	1	1	1	0	1	0	1	0	0	0	Rn			1	1	1	1	Rd			1	0	0	0	Rm					

d = UInt(Rd); n = UInt(Rn); m = UInt(Rm);
 if d == 15 || n == 15 || m == 15 then UNPREDICTABLE; // ARMv8-A removes UNPREDICTABLE for R13

Encoding A1 ARMv5TE*, ARMv6*, ARMv7

QADD<c> <Rd>, <Rm>, <Rn>

31	30	29	28	27	26	25	24	23	22	21	20	19	18	17	16	15	14	13	12	11	10	9	8	7	6	5	4	3	2	1	0
cond		0	0	0	1	0	0	0	0	Rn			Rd			(0)	(0)	(0)	(0)	0	1	0	1	Rm							

d = UInt(Rd); n = UInt(Rn); m = UInt(Rm);
 if d == 15 || n == 15 || m == 15 then UNPREDICTABLE;

For information about the CONSTRAINED UNPREDICTABLE behavior of this instruction, see [Appendix A Architectural Constraints on UNPREDICTABLE behaviors](#).

Assembler syntax

QADD{<c>}{<q>} {<Rd>}, {<Rm>, <Rn>

where:

<c>, <q> See [Standard assembler syntax fields on page F2-2415](#).

<Rd> The destination register.

<Rm> The first operand register.

<Rn> The second operand register.

Operation

```

if ConditionPassed() then
    EncodingSpecificOperations();
    (R[d], sat) = SignedSatQ(SInt(R[m]) + SInt(R[n]), 32);
    if sat then
        APSR.Q = '1';
    
```

F7.1.140 QADD8

Saturating Add 8 performs four 8-bit integer additions, saturates the results to the 8-bit signed integer range $-2^7 \leq x \leq 2^7 - 1$, and writes the results to the destination register.

Encoding T1 ARMv6T2, ARMv7

QADD8<c> <Rd>, <Rn>, <Rm>

15	14	13	12	11	10	9	8	7	6	5	4	3	2	1	0	15	14	13	12	11	10	9	8	7	6	5	4	3	2	1	0
1	1	1	1	1	0	1	0	1	0	0	0	Rn			1	1	1	1	Rd			0	0	0	1	Rm					

d = UInt(Rd); n = UInt(Rn); m = UInt(Rm);
 if d == 15 || n == 15 || m == 15 then UNPREDICTABLE; // ARMv8-A removes UNPREDICTABLE for R13

Encoding A1 ARMv6*, ARMv7

QADD8<c> <Rd>, <Rn>, <Rm>

31	30	29	28	27	26	25	24	23	22	21	20	19	18	17	16	15	14	13	12	11	10	9	8	7	6	5	4	3	2	1	0
cond		0	1	1	0	0	0	1	0	Rn			Rd			(1)	(1)	(1)	(1)	1	0	0	1	Rm							

d = UInt(Rd); n = UInt(Rn); m = UInt(Rm);
 if d == 15 || n == 15 || m == 15 then UNPREDICTABLE;

For information about the CONSTRAINED UNPREDICTABLE behavior of this instruction, see [Appendix A Architectural Constraints on UNPREDICTABLE behaviors](#).

Assembler syntax

QADD8{<c>}{<q>} {<Rd>}, <Rn>, <Rm>

where:

<c>, <q> See [Standard assembler syntax fields on page F2-2415](#).

<Rd> The destination register.

<Rn> The first operand register.

<Rm> The second operand register.

Operation

```

if ConditionPassed() then
    EncodingSpecificOperations();
    sum1 = SInt(R[n]<7:0>) + SInt(R[m]<7:0>);
    sum2 = SInt(R[n]<15:8>) + SInt(R[m]<15:8>);
    sum3 = SInt(R[n]<23:16>) + SInt(R[m]<23:16>);
    sum4 = SInt(R[n]<31:24>) + SInt(R[m]<31:24>);
    R[d]<7:0> = SignedSat(sum1, 8);
    R[d]<15:8> = SignedSat(sum2, 8);
    R[d]<23:16> = SignedSat(sum3, 8);
    R[d]<31:24> = SignedSat(sum4, 8);
    
```

F7.1.141 QADD16

Saturating Add 16 performs two 16-bit integer additions, saturates the results to the 16-bit signed integer range $-2^{15} \leq x \leq 2^{15} - 1$, and writes the results to the destination register.

Encoding T1 ARMv6T2, ARMv7

QADD16<c> <Rd>, <Rn>, <Rm>

15	14	13	12	11	10	9	8	7	6	5	4	3	2	1	0	15	14	13	12	11	10	9	8	7	6	5	4	3	2	1	0
1	1	1	1	1	0	1	0	1	1	0	0	1	Rn			1	1	1	1	Rd			0	0	0	1	Rm				

d = UInt(Rd); n = UInt(Rn); m = UInt(Rm);
 if d == 15 || n == 15 || m == 15 then UNPREDICTABLE; // ARMv8-A removes UNPREDICTABLE for R13

Encoding A1 ARMv6*, ARMv7

QADD16<c> <Rd>, <Rn>, <Rm>

31	30	29	28	27	26	25	24	23	22	21	20	19	18	17	16	15	14	13	12	11	10	9	8	7	6	5	4	3	2	1	0
cond		0	1	1	0	0	0	1	0	Rn			Rd			(1)	(1)	(1)	(1)	0	0	0	1	Rm							

d = UInt(Rd); n = UInt(Rn); m = UInt(Rm);
 if d == 15 || n == 15 || m == 15 then UNPREDICTABLE;

For information about the CONSTRAINED UNPREDICTABLE behavior of this instruction, see [Appendix A Architectural Constraints on UNPREDICTABLE behaviors](#).

Assembler syntax

QADD16{<c>}{<q>} {<Rd>}, <Rn>, <Rm>

where:

<c>, <q> See [Standard assembler syntax fields on page F2-2415](#).

<Rd> The destination register.

<Rn> The first operand register.

<Rm> The second operand register.

Operation

```

if ConditionPassed() then
    EncodingSpecificOperations();
    sum1 = SInt(R[n]<15:0>) + SInt(R[m]<15:0>);
    sum2 = SInt(R[n]<31:16>) + SInt(R[m]<31:16>);
    R[d]<15:0> = SignedSat(sum1, 16);
    R[d]<31:16> = SignedSat(sum2, 16);
    
```

F7.1.142 QASX

Saturating Add and Subtract with Exchange exchanges the two halfwords of the second operand, performs one 16-bit integer addition and one 16-bit subtraction, saturates the results to the 16-bit signed integer range $-2^{15} \leq x \leq 2^{15} - 1$, and writes the results to the destination register.

Encoding T1 ARMv6T2, ARMv7

QASX<c> <Rd>, <Rn>, <Rm>

15	14	13	12	11	10	9	8	7	6	5	4	3	2	1	0	15	14	13	12	11	10	9	8	7	6	5	4	3	2	1	0
1	1	1	1	1	0	1	0	1	0	1	0	Rn				1	1	1	1	Rd				0	0	0	1	Rm			

d = UInt(Rd); n = UInt(Rn); m = UInt(Rm);
 if d == 15 || n == 15 || m == 15 then UNPREDICTABLE; // ARMv8-A removes UNPREDICTABLE for R13

Encoding A1 ARMv6*, ARMv7

QASX<c> <Rd>, <Rn>, <Rm>

31	30	29	28	27	26	25	24	23	22	21	20	19	18	17	16	15	14	13	12	11	10	9	8	7	6	5	4	3	2	1	0
cond		0	1	1	0	0	0	1	0	Rn				Rd				(1)	(1)	(1)	(1)	0	0	1	1	Rm					

d = UInt(Rd); n = UInt(Rn); m = UInt(Rm);
 if d == 15 || n == 15 || m == 15 then UNPREDICTABLE;

For information about the CONSTRAINED UNPREDICTABLE behavior of this instruction, see [Appendix A Architectural Constraints on UNPREDICTABLE behaviors](#).

Assembler syntax

QASX{<c>}{<q>} {<Rd>,<Rn>, <Rm>

where:

<c>, <q> See [Standard assembler syntax fields on page F2-2415](#).

<Rd> The destination register.

<Rn> The first operand register.

<Rm> The second operand register.

The pre-UAL syntax QADDSUBX<c> is equivalent to QASX<c>.

Operation

```

if ConditionPassed() then
    EncodingSpecificOperations();
    diff = SInt(R[n]<15:0>) - SInt(R[m]<31:16>);
    sum = SInt(R[n]<31:16>) + SInt(R[m]<15:0>);
    R[d]<15:0> = SignedSat(diff, 16);
    R[d]<31:16> = SignedSat(sum, 16);
  
```

F7.1.143 QDADD

Saturating Double and Add adds a doubled register value to another register value, and writes the result to the destination register. Both the doubling and the addition have their results saturated to the 32-bit signed integer range $-2^{31} \leq x \leq 2^{31} - 1$. If saturation occurs in either operation, it sets the Q flag in the APSR.

Encoding T1 ARMv6T2, ARMv7

QDADD<c> <Rd>, <Rm>, <Rn>

15	14	13	12	11	10	9	8	7	6	5	4	3	2	1	0	15	14	13	12	11	10	9	8	7	6	5	4	3	2	1	0
1	1	1	1	1	0	1	0	1	0	0	0	Rn			1	1	1	1	Rd			1	0	0	1	Rm					

d = UInt(Rd); n = UInt(Rn); m = UInt(Rm);
 if d == 15 || n == 15 || m == 15 then UNPREDICTABLE; // ARMv8-A removes UNPREDICTABLE for R13

Encoding A1 ARMv5TE*, ARMv6*, ARMv7

QDADD<c> <Rd>, <Rm>, <Rn>

31	30	29	28	27	26	25	24	23	22	21	20	19	18	17	16	15	14	13	12	11	10	9	8	7	6	5	4	3	2	1	0
cond		0	0	0	1	0	1	0	0	Rn			Rd			(0)	(0)	(0)	(0)	0	1	0	1	Rm							

d = UInt(Rd); n = UInt(Rn); m = UInt(Rm);
 if d == 15 || n == 15 || m == 15 then UNPREDICTABLE;

For information about the CONSTRAINED UNPREDICTABLE behavior of this instruction, see [Appendix A Architectural Constraints on UNPREDICTABLE behaviors](#).

Assembler syntax

QDADD{<c>}{<q>} {<Rd>}, <Rm>, <Rn>

where:

<c>, <q> See [Standard assembler syntax fields on page F2-2415](#).

<Rd> The destination register.

<Rm> The first operand register.

<Rn> The second operand register.

Operation

```

if ConditionPassed() then
    EncodingSpecificOperations();
    (doubled, sat1) = SignedSatQ(2 * SInt(R[n]), 32);
    (R[d], sat2) = SignedSatQ(SInt(R[m]) + SInt(doubled), 32);
    if sat1 || sat2 then
        APSR.Q = '1';
    
```

F7.1.144 QDSUB

Saturating Double and Subtract subtracts a doubled register value from another register value, and writes the result to the destination register. Both the doubling and the subtraction have their results saturated to the 32-bit signed integer range $-2^{31} \leq x \leq 2^{31} - 1$. If saturation occurs in either operation, it sets the Q flag in the APSR.

Encoding T1 ARMv6T2, ARMv7

QDSUB<c> <Rd>, <Rm>, <Rn>

15	14	13	12	11	10	9	8	7	6	5	4	3	2	1	0	15	14	13	12	11	10	9	8	7	6	5	4	3	2	1	0
1	1	1	1	1	0	1	0	1	0	0	0	Rn			1	1	1	1	Rd			1	0	1	1	Rm					

d = UInt(Rd); n = UInt(Rn); m = UInt(Rm);
 if d == 15 || n == 15 || m == 15 then UNPREDICTABLE; // ARMv8-A removes UNPREDICTABLE for R13

Encoding A1 ARMv5TE*, ARMv6*, ARMv7

QDSUB<c> <Rd>, <Rm>, <Rn>

31	30	29	28	27	26	25	24	23	22	21	20	19	18	17	16	15	14	13	12	11	10	9	8	7	6	5	4	3	2	1	0
cond		0	0	0	1	0	1	1	0	Rn			Rd			(0)	(0)	(0)	(0)	0	1	0	1	Rm							

d = UInt(Rd); n = UInt(Rn); m = UInt(Rm);
 if d == 15 || n == 15 || m == 15 then UNPREDICTABLE;

For information about the CONSTRAINED UNPREDICTABLE behavior of this instruction, see [Appendix A Architectural Constraints on UNPREDICTABLE behaviors](#).

Assembler syntax

QDSUB{<c>}{<q>} {<Rd>}, <Rm>, <Rn>

where:

- <c>, <q> See [Standard assembler syntax fields on page F2-2415](#).
- <Rd> The destination register.
- <Rm> The first operand register.
- <Rn> The second operand register.

Operation

```

if ConditionPassed() then
    EncodingSpecificOperations();
    (doubled, sat1) = SignedSatQ(2 * SInt(R[n]), 32);
    (R[d], sat2) = SignedSatQ(SInt(R[m]) - SInt(doubled), 32);
    if sat1 || sat2 then
        APSR.Q = '1';
  
```

F7.1.145 QSAX

Saturating Subtract and Add with Exchange exchanges the two halfwords of the second operand, performs one 16-bit integer subtraction and one 16-bit addition, saturates the results to the 16-bit signed integer range $-2^{15} \leq x \leq 2^{15} - 1$, and writes the results to the destination register.

Encoding T1 ARMv6T2, ARMv7

QSAX<c> <Rd>, <Rn>, <Rm>

15	14	13	12	11	10	9	8	7	6	5	4	3	2	1	0	15	14	13	12	11	10	9	8	7	6	5	4	3	2	1	0
1	1	1	1	1	0	1	0	1	1	1	0	Rn				1	1	1	1	Rd				0	0	0	1	Rm			

d = UInt(Rd); n = UInt(Rn); m = UInt(Rm);
 if d == 15 || n == 15 || m == 15 then UNPREDICTABLE; // ARMv8-A removes UNPREDICTABLE for R13

Encoding A1 ARMv6*, ARMv7

QSAX<c> <Rd>, <Rn>, <Rm>

31	30	29	28	27	26	25	24	23	22	21	20	19	18	17	16	15	14	13	12	11	10	9	8	7	6	5	4	3	2	1	0
cond		0	1	1	0	0	0	1	0	Rn				Rd				(1)	(1)	(1)	(1)	0	1	0	1	Rm					

d = UInt(Rd); n = UInt(Rn); m = UInt(Rm);
 if d == 15 || n == 15 || m == 15 then UNPREDICTABLE;

For information about the CONSTRAINED UNPREDICTABLE behavior of this instruction, see [Appendix A Architectural Constraints on UNPREDICTABLE behaviors](#).

Assembler syntax

QSAX{<c>}{<q>} {<Rd>}, <Rn>, <Rm>

where:

<c>, <q> See [Standard assembler syntax fields on page F2-2415](#).

<Rd> The destination register.

<Rn> The first operand register.

<Rm> The second operand register.

The pre-UAL syntax QSUBADDX<c> is equivalent to QSAX<c>.

Operation

```

if ConditionPassed() then
    EncodingSpecificOperations();
    sum = SInt(R[n]<15:0>) + SInt(R[m]<31:16>);
    diff = SInt(R[n]<31:16>) - SInt(R[m]<15:0>);
    R[d]<15:0> = SignedSat(sum, 16);
    R[d]<31:16> = SignedSat(diff, 16);
    
```

F7.1.146 QSUB

Saturating Subtract subtracts one register value from another register value, saturates the result to the 32-bit signed integer range $-2^{31} \leq x \leq 2^{31} - 1$, and writes the result to the destination register. If saturation occurs, it sets the Q flag in the APSR.

Encoding T1 ARMv6T2, ARMv7

QSUB<c> <Rd>, <Rm>, <Rn>

15	14	13	12	11	10	9	8	7	6	5	4	3	2	1	0	15	14	13	12	11	10	9	8	7	6	5	4	3	2	1	0
1	1	1	1	1	0	1	0	1	0	0	0	Rn			1	1	1	1	Rd			1	0	1	0	Rm					

d = UInt(Rd); n = UInt(Rn); m = UInt(Rm);
 if d == 15 || n == 15 || m == 15 then UNPREDICTABLE; // ARMv8-A removes UNPREDICTABLE for R13

Encoding A1 ARMv5TE*, ARMv6*, ARMv7

QSUB<c> <Rd>, <Rm>, <Rn>

31	30	29	28	27	26	25	24	23	22	21	20	19	18	17	16	15	14	13	12	11	10	9	8	7	6	5	4	3	2	1	0
cond		0	0	0	1	0	0	1	0	Rn			Rd			(0)	(0)	(0)	(0)	0	1	0	1	Rm							

d = UInt(Rd); n = UInt(Rn); m = UInt(Rm);
 if d == 15 || n == 15 || m == 15 then UNPREDICTABLE;

For information about the CONSTRAINED UNPREDICTABLE behavior of this instruction, see [Appendix A Architectural Constraints on UNPREDICTABLE behaviors](#).

Assembler syntax

QSUB{<c>}{<q>} {<Rd>}, {<Rm>, <Rn>

where:

- <c>, <q> See [Standard assembler syntax fields on page F2-2415](#).
- <Rd> The destination register.
- <Rm> The first operand register.
- <Rn> The second operand register.

Operation

```

if ConditionPassed() then
    EncodingSpecificOperations();
    (R[d], sat) = SignedSatQ(SInt(R[m]) - SInt(R[n]), 32);
    if sat then
        APSR.Q = '1';
    
```

F7.1.147 QSUB8

Saturating Subtract 8 performs four 8-bit integer subtractions, saturates the results to the 8-bit signed integer range $-2^7 \leq x \leq 2^7 - 1$, and writes the results to the destination register.

Encoding T1 ARMv6T2, ARMv7

QSUB8<c> <Rd>, <Rn>, <Rm>

15	14	13	12	11	10	9	8	7	6	5	4	3	2	1	0	15	14	13	12	11	10	9	8	7	6	5	4	3	2	1	0
1	1	1	1	1	0	1	0	1	1	0	0	Rn			1	1	1	1	Rd			0	0	0	1	Rm					

d = UInt(Rd); n = UInt(Rn); m = UInt(Rm);
 if d == 15 || n == 15 || m == 15 then UNPREDICTABLE; // ARMv8-A removes UNPREDICTABLE for R13

Encoding A1 ARMv6*, ARMv7

QSUB8<c> <Rd>, <Rn>, <Rm>

31	30	29	28	27	26	25	24	23	22	21	20	19	18	17	16	15	14	13	12	11	10	9	8	7	6	5	4	3	2	1	0
cond		0	1	1	0	0	0	1	0	Rn			Rd			(1)	(1)	(1)	(1)	1	1	1	1	Rm							

d = UInt(Rd); n = UInt(Rn); m = UInt(Rm);
 if d == 15 || n == 15 || m == 15 then UNPREDICTABLE;

For information about the CONSTRAINED UNPREDICTABLE behavior of this instruction, see [Appendix A Architectural Constraints on UNPREDICTABLE behaviors](#).

Assembler syntax

QSUB8{<c>}{<q>} {<Rd>}, <Rn>, <Rm>

where:

- <c>, <q> See [Standard assembler syntax fields on page F2-2415](#).
- <Rd> The destination register.
- <Rn> The first operand register.
- <Rm> The second operand register.

Operation

```

if ConditionPassed() then
    EncodingSpecificOperations();
    diff1 = SInt(R[n]<7:0>) - SInt(R[m]<7:0>);
    diff2 = SInt(R[n]<15:8>) - SInt(R[m]<15:8>);
    diff3 = SInt(R[n]<23:16>) - SInt(R[m]<23:16>);
    diff4 = SInt(R[n]<31:24>) - SInt(R[m]<31:24>);
    R[d]<7:0> = SignedSat(diff1, 8);
    R[d]<15:8> = SignedSat(diff2, 8);
    R[d]<23:16> = SignedSat(diff3, 8);
    R[d]<31:24> = SignedSat(diff4, 8);
    
```

F7.1.148 QSUB16

Saturating Subtract 16 performs two 16-bit integer subtractions, saturates the results to the 16-bit signed integer range $-2^{15} \leq x \leq 2^{15} - 1$, and writes the results to the destination register.

Encoding T1 ARMv6T2, ARMv7

QSUB16<c> <Rd>, <Rn>, <Rm>

15	14	13	12	11	10	9	8	7	6	5	4	3	2	1	0	15	14	13	12	11	10	9	8	7	6	5	4	3	2	1	0
1	1	1	1	1	0	1	0	1	1	0	1	Rn				1	1	1	1	Rd				0	0	0	1	Rm			

d = UInt(Rd); n = UInt(Rn); m = UInt(Rm);
 if d == 15 || n == 15 || m == 15 then UNPREDICTABLE; // ARMv8-A removes UNPREDICTABLE for R13

Encoding A1 ARMv6*, ARMv7

QSUB16<c> <Rd>, <Rn>, <Rm>

31	30	29	28	27	26	25	24	23	22	21	20	19	18	17	16	15	14	13	12	11	10	9	8	7	6	5	4	3	2	1	0
cond		0	1	1	0	0	0	1	0	Rn				Rd				(1)	(1)	(1)	(1)	0	1	1	1	Rm					

d = UInt(Rd); n = UInt(Rn); m = UInt(Rm);
 if d == 15 || n == 15 || m == 15 then UNPREDICTABLE;

For information about the CONSTRAINED UNPREDICTABLE behavior of this instruction, see [Appendix A Architectural Constraints on UNPREDICTABLE behaviors](#).

Assembler syntax

QSUB16{<c>}{<q>} {<Rd>}, <Rn>, <Rm>

where:

<c>, <q> See [Standard assembler syntax fields on page F2-2415](#).

<Rd> The destination register.

<Rn> The first operand register.

<Rm> The second operand register.

Operation

```

if ConditionPassed() then
    EncodingSpecificOperations();
    diff1 = SInt(R[n]<15:0>) - SInt(R[m]<15:0>);
    diff2 = SInt(R[n]<31:16>) - SInt(R[m]<31:16>);
    R[d]<15:0> = SignedSat(diff1, 16);
    R[d]<31:16> = SignedSat(diff2, 16);
  
```

F7.1.149 RBIT

Reverse Bits reverses the bit order in a 32-bit register.

Encoding T1 ARMv6T2, ARMv7

RBIT<c> <Rd>, <Rm>

15	14	13	12	11	10	9	8	7	6	5	4	3	2	1	0	15	14	13	12	11	10	9	8	7	6	5	4	3	2	1	0
1	1	1	1	1	0	1	0	1	0	0	1	Rm				1	1	1	1	Rd				1	0	1	0	Rm			

```

if !Consistent(Rm) then UNPREDICTABLE;
d = UInt(Rd); m = UInt(Rm);
if d == 15 || m == 15 then UNPREDICTABLE; // ARMv8-A removes UNPREDICTABLE for R13
    
```

Encoding A1 ARMv6T2, ARMv7

RBIT<c> <Rd>, <Rm>

31	30	29	28	27	26	25	24	23	22	21	20	19	18	17	16	15	14	13	12	11	10	9	8	7	6	5	4	3	2	1	0
cond		0	1	1	0	1	1	1	1	(1)(1)(1)(1)				Rd				(1)(1)(1)(1)				0	0	1	1	Rm					

```

d = UInt(Rd); m = UInt(Rm);
if d == 15 || m == 15 then UNPREDICTABLE;
    
```

For information about the CONSTRAINED UNPREDICTABLE behavior of this instruction, see [Appendix A Architectural Constraints on UNPREDICTABLE behaviors](#), and particularly *RBIT* on page AppxA-4722.

Assembler syntax

RBIT{<c>}{<q>} <Rd>, <Rm>

where:

<c>, <q> See [Standard assembler syntax fields on page F2-2415](#).

<Rd> The destination register.

<Rm> The register that contains the operand. In encoding T1, its number must be encoded twice.

Operation

```

if ConditionPassed() then
    EncodingSpecificOperations();
    bits(32) result;
    for i = 0 to 31
        result<31-i> = R[m]<i>;
    R[d] = result;
    
```

F7.1.150 REV

Byte-Reverse Word reverses the byte order in a 32-bit register.

Encoding T1 ARMv6*, ARMv7

REV<c> <Rd>, <Rm>

15	14	13	12	11	10	9	8	7	6	5	4	3	2	1	0
1	0	1	1	1	0	1	0	0	0	Rm				Rd	

d = UInt(Rd); m = UInt(Rm);

Encoding T2 ARMv6T2, ARMv7

REV<c>.W <Rd>, <Rm>

15	14	13	12	11	10	9	8	7	6	5	4	3	2	1	0	15	14	13	12	11	10	9	8	7	6	5	4	3	2	1	0
1	1	1	1	1	0	1	0	1	0	0	1	Rm				1	1	1	1	Rd				1	0	0	0	Rm			

if !Consistent(Rm) then UNPREDICTABLE;

d = UInt(Rd); m = UInt(Rm);

if d == 15 || m == 15 then UNPREDICTABLE; // ARMv8-A removes UNPREDICTABLE for R13

Encoding A1 ARMv6*, ARMv7

REV<c> <Rd>, <Rm>

31	30	29	28	27	26	25	24	23	22	21	20	19	18	17	16	15	14	13	12	11	10	9	8	7	6	5	4	3	2	1	0
cond		0	1	1	0	1	0	1	1	(1)	(1)	(1)	(1)	Rd				(1)	(1)	(1)	(1)	0	0	1	1	Rm					

d = UInt(Rd); m = UInt(Rm);

if d == 15 || m == 15 then UNPREDICTABLE;

For information about the CONSTRAINED UNPREDICTABLE behavior of this instruction, see [Appendix A Architectural Constraints on UNPREDICTABLE behaviors](#), and particularly [REV on page AppxA-4722](#).

Assembler syntax

REV{<c>}{<q>} <Rd>, <Rm>

where:

<c>, <q> See [Standard assembler syntax fields on page F2-2415](#).

<Rd> The destination register.

<Rm> The register that contains the operand. Its number must be encoded twice in encoding T2.

Operation

```

if ConditionPassed() then
    EncodingSpecificOperations();
    bits(32) result;
    result<31:24> = R[m]<7:0>;
    result<23:16> = R[m]<15:8>;
    result<15:8> = R[m]<23:16>;
    result<7:0> = R[m]<31:24>;
    R[d] = result;
  
```

F7.1.151 REV16

Byte-Reverse Packed Halfword reverses the byte order in each 16-bit halfword of a 32-bit register.

Encoding T1 ARMv6*, ARMv7

REV16<c> <Rd>, <Rm>

15	14	13	12	11	10	9	8	7	6	5	4	3	2	1	0
1	0	1	1	1	0	1	0	0	1	Rm				Rd	

d = UInt(Rd); m = UInt(Rm);

Encoding T2 ARMv6T2, ARMv7

REV16<c>.W <Rd>, <Rm>

15	14	13	12	11	10	9	8	7	6	5	4	3	2	1	0	15	14	13	12	11	10	9	8	7	6	5	4	3	2	1	0
1	1	1	1	1	0	1	0	0	1	Rm				1	1	1	1	Rd				1	0	0	1	Rm					

if !Consistent(Rm) then UNPREDICTABLE;
 d = UInt(Rd); m = UInt(Rm);
 if d == 15 || m == 15 then UNPREDICTABLE; // ARMv8-A removes UNPREDICTABLE for R13

Encoding A1 ARMv6*, ARMv7

REV16<c> <Rd>, <Rm>

31	30	29	28	27	26	25	24	23	22	21	20	19	18	17	16	15	14	13	12	11	10	9	8	7	6	5	4	3	2	1	0
cond		0	1	1	0	1	0	1	1	(1)	(1)	(1)	(1)	Rd				(1)	(1)	(1)	(1)	1	0	1	1	Rm					

d = UInt(Rd); m = UInt(Rm);
 if d == 15 || m == 15 then UNPREDICTABLE;

For information about the CONSTRAINED UNPREDICTABLE behavior of this instruction, see [Appendix A Architectural Constraints on UNPREDICTABLE behaviors](#), and particularly [REV16 on page AppxA-4723](#).

Assembler syntax

REV16{<c>}{<q>} <Rd>, <Rm>

where:

<c>, <q> See [Standard assembler syntax fields on page F2-2415](#).

<Rd> The destination register.

<Rm> The register that contains the operand. Its number must be encoded twice in encoding T2.

Operation

```
if ConditionPassed() then
    EncodingSpecificOperations();
    bits(32) result;
    result<31:24> = R[m]<23:16>;
    result<23:16> = R[m]<31:24>;
    result<15:8> = R[m]<7:0>;
    result<7:0> = R[m]<15:8>;
    R[d] = result;
```

F7.1.152 REVSH

Byte-Reverse Signed Halfword reverses the byte order in the lower 16-bit halfword of a 32-bit register, and sign-extends the result to 32 bits.

Encoding T1 ARMv6*, ARMv7

REVSH<c> <Rd>, <Rm>

15	14	13	12	11	10	9	8	7	6	5	4	3	2	1	0
1	0	1	1	1	0	1	0	1	1	Rm			Rd		

d = UInt(Rd); m = UInt(Rm);

Encoding T2 ARMv6T2, ARMv7

REVSH<c>.W <Rd>, <Rm>

15	14	13	12	11	10	9	8	7	6	5	4	3	2	1	0	15	14	13	12	11	10	9	8	7	6	5	4	3	2	1	0
1	1	1	1	1	0	1	0	1	0	0	1	Rm			1	1	1	1	Rd			1	0	1	1	Rm					

if !Consistent(Rm) then UNPREDICTABLE;

d = UInt(Rd); m = UInt(Rm);

if d == 15 || m == 15 then UNPREDICTABLE; // ARMv8-A removes UNPREDICTABLE for R13

Encoding A1 ARMv6*, ARMv7

REVSH<c> <Rd>, <Rm>

31	30	29	28	27	26	25	24	23	22	21	20	19	18	17	16	15	14	13	12	11	10	9	8	7	6	5	4	3	2	1	0
cond		0	1	1	0	1	1	1	1	(1)	(1)	(1)	(1)	Rd				(1)	(1)	(1)	(1)	1	0	1	1	Rm					

d = UInt(Rd); m = UInt(Rm);

if d == 15 || m == 15 then UNPREDICTABLE;

For information about the CONSTRAINED UNPREDICTABLE behavior of this instruction, see [Appendix A Architectural Constraints on UNPREDICTABLE behaviors](#), and particularly [REVSH on page AppxA-4723](#).

Assembler syntax

REVSH{<c>}{<q>} <Rd>, <Rm>

where:

<c>, <q> See [Standard assembler syntax fields on page F2-2415](#).

<Rd> The destination register.

<Rm> The register that contains the operand. Its number must be encoded twice in encoding T2.

Operation

```

if ConditionPassed() then
    EncodingSpecificOperations();
    bits(32) result;
    result<31:8> = SignExtend(R[m]<7:0>, 24);
    result<7:0> = R[m]<15:8>;
    R[d] = result;
  
```

F7.1.153 RFE

Return From Exception is a system instruction. For details see [RFE on page F7-3056](#).

F7.1.154 ROR (immediate)

Rotate Right (immediate) provides the value of the contents of a register rotated by a constant value. The bits that are rotated off the right end are inserted into the vacated bit positions on the left. It can optionally update the condition flags based on the result.

Encoding T1 ARMv6T2, ARMv7

ROR{S}<c> <Rd>, <Rm>, #<imm>

15	14	13	12	11	10	9	8	7	6	5	4	3	2	1	0	15	14	13	12	11	10	9	8	7	6	5	4	3	2	1	0
1	1	1	0	1	0	1	0	0	1	0	S	1	1	1	1	(0)	imm3	Rd	imm2	1	1	Rm									

```
if (imm3:imm2) == '00000' then SEE RRX;
d = UInt(Rd); m = UInt(Rm); setflags = (S == '1');
(-, shift_n) = DecodeImmShift('11', imm3:imm2);
if d == 15 || m == 15 then UNPREDICTABLE; // ARMv8-A removes UNPREDICTABLE for R13
```

Encoding A1 ARMv4*, ARMv5T*, ARMv6*, ARMv7

ROR{S}<c> <Rd>, <Rm>, #<imm>

31	30	29	28	27	26	25	24	23	22	21	20	19	18	17	16	15	14	13	12	11	10	9	8	7	6	5	4	3	2	1	0
cond		0	0	0	1	1	0	1	S	(0)	(0)	(0)	(0)	Rd	imm5	1	1	0	Rm												

```
if Rd == '1111' && S == '1' then SEE SUBS PC, LR and related instructions;
if imm5 == '00000' then SEE RRX;
d = UInt(Rd); m = UInt(Rm); setflags = (S == '1');
(-, shift_n) = DecodeImmShift('11', imm5);
```

For information about the CONSTRAINED UNPREDICTABLE behavior of this instruction, see [Appendix A Architectural Constraints on UNPREDICTABLE behaviors](#).

Assembler syntax

ROR{S}{<c>}{<q>} {<Rd>}, <Rm>, #<imm>

where:

- S If S is present, the instruction updates the flags. Otherwise, the flags are not updated.
- <c>, <q> See [Standard assembler syntax fields on page F2-2415](#).
- <Rd> The destination register.
In A32 instructions, if S is not specified and <Rd> is the PC, the instruction is a branch to the address calculated by the operation. This is an interworking branch, see [Pseudocode details of operations on the AArch32 general-purpose registers and the PC on page E1-2296](#).
- <Rm> The first operand register. The PC can be used in A32 instructions.
- <imm> The shift amount, in the range 1 to 31. See [Shifts applied to a register on page F2-2419](#).

Operation

```
if ConditionPassed() then
    EncodingSpecificOperations();
    (result, carry) = Shift_C(R[m], SRTYPE_ROR, shift_n, APSR.C);
    if d == 15 then // Can only occur for ARM encoding
        ALUWritePC(result); // setflags is always FALSE here
    else
        R[d] = result;
        if setflags then
            APSR.N = result<31>;
            APSR.Z = IsZeroBit(result);
            APSR.C = carry;
            // APSR.V unchanged
```

F7.1.155 ROR (register)

Rotate Right (register) provides the value of the contents of a register rotated by a variable number of bits. The bits that are rotated off the right end are inserted into the vacated bit positions on the left. The variable number of bits is read from the bottom byte of a register. It can optionally update the condition flags based on the result.

Encoding T1 ARMv4T, ARMv5T*, ARMv6*, ARMv7
 RORS <Rdn>, <Rm> Outside IT block.
 ROR<c> <Rdn>, <Rm> Inside IT block.

15	14	13	12	11	10	9	8	7	6	5	4	3	2	1	0
0	1	0	0	0	0	0	0	1	1	1	Rm	Rdn			

d = UInt(Rdn); n = UInt(Rdn); m = UInt(Rm); setFlags = !InITBlock();

Encoding T2 ARMv6T2, ARMv7
 ROR{S}<c>.W <Rd>, <Rn>, <Rm>

15	14	13	12	11	10	9	8	7	6	5	4	3	2	1	0	15	14	13	12	11	10	9	8	7	6	5	4	3	2	1	0
1	1	1	1	1	0	1	0	0	1	1	S	Rn				1	1	1	1	Rd				0	0	0	0	Rm			

d = UInt(Rd); n = UInt(Rn); m = UInt(Rm); setFlags = (S == '1');
 if d == 15 || n == 15 || m == 15 then UNPREDICTABLE; // ARMv8-A removes UNPREDICTABLE for R13

Encoding A1 ARMv4*, ARMv5T*, ARMv6*, ARMv7
 ROR{S}<c> <Rd>, <Rn>, <Rm>

31	30	29	28	27	26	25	24	23	22	21	20	19	18	17	16	15	14	13	12	11	10	9	8	7	6	5	4	3	2	1	0
cond		0	0	0	1	1	0	1	S	(0)	(0)	(0)	(0)	Rd				Rm				0	1	1	1	Rn					

d = UInt(Rd); n = UInt(Rn); m = UInt(Rm); setFlags = (S == '1');
 if d == 15 || n == 15 || m == 15 then UNPREDICTABLE;

For information about the CONSTRAINED UNPREDICTABLE behavior of this instruction, see [Appendix A Architectural Constraints on UNPREDICTABLE behaviors](#).

Assembler syntax

ROR{S}{<c>}{<q>} {<Rd>}, <Rn>, <Rm>

where:

S If S is present, the instruction updates the flags. Otherwise, the flags are not updated.

<c>, <q> See [Standard assembler syntax fields on page F2-2415](#).

<Rd> The destination register.

<Rn> The first operand register.

<Rm> The register whose bottom byte contains the amount to rotate by.

Operation

```
if ConditionPassed() then
    EncodingSpecificOperations();
    shift_n = UInt(R[m]<7:0>);
    (result, carry) = Shift_C(R[n], SRTYPE_ROR, shift_n, APSR.C);
    R[d] = result;
    if setflags then
        APSR.N = result<31>;
        APSR.Z = IsZeroBit(result);
        APSR.C = carry;
        // APSR.V unchanged
```

F7.1.156 RRX

Rotate Right with Extend provides the value of the contents of a register shifted right by one place, with the Carry flag shifted into bit[31].

RRX can optionally update the condition flags based on the result. In that case, bit[0] is shifted into the Carry flag.

Encoding T1 ARMv6T2, ARMv7

RRX{S}<c> <Rd>, <Rm>

15	14	13	12	11	10	9	8	7	6	5	4	3	2	1	0	15	14	13	12	11	10	9	8	7	6	5	4	3	2	1	0	
1	1	1	0	1	0	1	0	0	1	0	S	1	1	1	1	(0)	0	0	0						Rd		0	0	1	1		Rm

d = UInt(Rd); m = UInt(Rm); setflags = (S == '1');
 if d == 15 || m == 15 then UNPREDICTABLE; // ARMv8-A removes UNPREDICTABLE for R13

Encoding A1 ARMv4*, ARMv5T*, ARMv6*, ARMv7

RRX{S}<c> <Rd>, <Rm>

31	30	29	28	27	26	25	24	23	22	21	20	19	18	17	16	15	14	13	12	11	10	9	8	7	6	5	4	3	2	1	0		
cond			0	0	0	1	1	0	1	S	(0)	(0)	(0)	(0)			Rd																Rm

if Rd == '1111' && S == '1' then SEE SUBS PC, LR and related instructions;
 d = UInt(Rd); m = UInt(Rm); setflags = (S == '1');

For information about the CONSTRAINED UNPREDICTABLE behavior of this instruction, see [Appendix A Architectural Constraints on UNPREDICTABLE behaviors](#).

Assembler syntax

RRX{S}{<c>}{<q>} {<Rd> ,} <Rm>

where:

S If S is present, the instruction updates the flags. Otherwise, the flags are not updated.

<c>, <q> See [Standard assembler syntax fields on page F2-2415](#).

<Rd> The destination register.

In A32 instructions, if S is not specified and <Rd> is the PC, the instruction is a branch to the address calculated by the operation. This is an interworking branch, see [Pseudocode details of operations on the AArch32 general-purpose registers and the PC on page E1-2296](#).

<Rm> The register that contains the operand. The PC can be used in A32 instructions.

Operation

```
if ConditionPassed() then
    EncodingSpecificOperations();
    (result, carry) = Shift_C(R[m], SRTYPE_RRX, 1, APSR.C);
    if d == 15 then // Can only occur for ARM encoding
        ALUWritePC(result); // setflags is always FALSE here
    else
        R[d] = result;
        if setflags then
            APSR.N = result<31>;
            APSR.Z = IsZeroBit(result);
            APSR.C = carry;
            // APSR.V unchanged
```

F7.1.157 RSB (immediate)

Reverse Subtract (immediate) subtracts a register value from an immediate value, and writes the result to the destination register. It can optionally update the condition flags based on the result.

Encoding T1 ARMv4T, ARMv5T*, ARMv6*, ARMv7
 RSBS <Rd>, <Rn>, #0 Outside IT block.
 RSB<c> <Rd>, <Rn>, #0 Inside IT block.

15	14	13	12	11	10	9	8	7	6	5	4	3	2	1	0
0	1	0	0	0	0	1	0	0	1	Rn			Rd		

d = UInt(Rd); n = UInt(Rn); setflags = !InITBlock(); imm32 = Zeros(32); // immediate = #0

Encoding T2 ARMv6T2, ARMv7
 RSB{S}<c>.W <Rd>, <Rn>, #<const>

15	14	13	12	11	10	9	8	7	6	5	4	3	2	1	0	15	14	13	12	11	10	9	8	7	6	5	4	3	2	1	0
1	1	1	1	0	i	0	1	1	1	0	S	Rn			0	imm3			Rd			imm8									

d = UInt(Rd); n = UInt(Rn); setflags = (S == '1'); imm32 = ThumbExpandImm(i:imm3:imm8);
 if d == 15 || n == 15 then UNPREDICTABLE; // ARMv8-A removes UNPREDICTABLE for R13

Encoding A1 ARMv4*, ARMv5T*, ARMv6*, ARMv7
 RSB{S}<c> <Rd>, <Rn>, #<const>

31	30	29	28	27	26	25	24	23	22	21	20	19	18	17	16	15	14	13	12	11	10	9	8	7	6	5	4	3	2	1	0
cond				0	0	1	0	0	1	1	S	Rn			Rd			imm12													

if Rd == '1111' && S == '1' then SEE SUBS PC, LR and related instructions;
 d = UInt(Rd); n = UInt(Rn); setflags = (S == '1'); imm32 = ARMEExpandImm(imm12);

For information about the CONSTRAINED UNPREDICTABLE behavior of this instruction, see [Appendix A Architectural Constraints on UNPREDICTABLE behaviors](#).

Assembler syntax

RSB{S}{<c>}{<q>} {<Rd>}, <Rn>, #<const>

where:

- S If S is present, the instruction updates the flags. Otherwise, the flags are not updated.
- <c>, <q> See *Standard assembler syntax fields* on page F2-2415.
- <Rd> The destination register. If S is specified and <Rd> is the PC, see *SUBS PC, LR and related instructions (T32)* on page F7-3066 or *SUBS PC, LR and related instructions (A32)* on page F7-3068.
- In A32 instructions, if S is not specified and <Rd> is the PC, the instruction is a branch to the address calculated by the operation. This is an interworking branch, see *Pseudocode details of operations on the AArch32 general-purpose registers and the PC* on page E1-2296.
- <Rn> The first operand register. The PC can be used in A32 instructions.
- <const> The immediate value to be added to the value obtained from <Rn>. The only permitted value for encoding T1 is 0. See *Modified immediate constants in T32 instructions* on page F3-2444 or *Modified immediate constants in A32 instructions* on page F4-2472 for the range of values for encoding T2 or A1.

The pre-UAL syntax RSB<c>S is equivalent to RSBS<c>.

Operation

```
if ConditionPassed() then
    EncodingSpecificOperations();
    (result, nzcV) = AddWithCarry(NOT(R[n]), imm32, '1');
    if d == 15 then // Can only occur for ARM encoding
        ALUWritePC(result); // setflags is always FALSE here
    else
        R[d] = result;
        if setflags then
            APSR.<N,Z,C,V> = nzcV;
```

F7.1.158 RSB (register)

Reverse Subtract (register) subtracts a register value from an optionally-shifted register value, and writes the result to the destination register. It can optionally update the condition flags based on the result.

Encoding T1 ARMv6T2, ARMv7

RSB{S}<c> <Rd>, <Rn>, <Rm>{, <shift>}

15	14	13	12	11	10	9	8	7	6	5	4	3	2	1	0	15	14	13	12	11	10	9	8	7	6	5	4	3	2	1	0
1	1	1	0	1	0	1	1	1	1	0	S	Rn				(0)	imm3			Rd			imm2		type	Rm					

```
d = UInt(Rd); n = UInt(Rn); m = UInt(Rm); setflags = (S == '1');
(shift_t, shift_n) = DecodeImmShift(type, imm3:imm2);
if d == 15 || n == 15 || m == 15 then UNPREDICTABLE; // ARMv8-A removes UNPREDICTABLE for R13
```

Encoding A1 ARMv4*, ARMv5T*, ARMv6*, ARMv7

RSB{S}<c> <Rd>, <Rn>, <Rm>{, <shift>}

31	30	29	28	27	26	25	24	23	22	21	20	19	18	17	16	15	14	13	12	11	10	9	8	7	6	5	4	3	2	1	0
cond			0	0	0	0	0	1	1	S	Rn				Rd			imm5			type	0	Rm								

```
if Rd == '1111' && S == '1' then SEE SUBS PC, LR and related instructions;
d = UInt(Rd); n = UInt(Rn); m = UInt(Rm); setflags = (S == '1');
(shift_t, shift_n) = DecodeImmShift(type, imm5);
```

For information about the CONSTRAINED UNPREDICTABLE behavior of this instruction, see [Appendix A Architectural Constraints on UNPREDICTABLE behaviors](#).

Assembler syntax

RSB{S}{<c>}{<q>} {<Rd>}, <Rn>, <Rm> {, <shift>}

where:

- S If S is present, the instruction updates the flags. Otherwise, the flags are not updated.
- <c>, <q> See [Standard assembler syntax fields on page F2-2415](#).
- <Rd> The destination register. If S is specified and <Rd> is the PC, see [SUBS PC, LR and related instructions \(T32\) on page F7-3066](#) or [SUBS PC, LR and related instructions \(A32\) on page F7-3068](#).
In A32 instructions, if S is not specified and <Rd> is the PC, the instruction is a branch to the address calculated by the operation. This is an interworking branch, see [Pseudocode details of operations on the AArch32 general-purpose registers and the PC on page E1-2296](#).
- <Rn> The first operand register. The PC can be used in A32 instructions.
- <Rm> The register that is optionally shifted and used as the second operand. The PC can be used in A32 instructions.
- <shift> The shift to apply to the value read from <Rm>. If omitted, no shift is applied. [Shifts applied to a register on page F2-2419](#) describes the shifts and how they are encoded.

The pre-UAL syntax RSB<c>S is equivalent to RSBS<c>.

Operation

```
if ConditionPassed() then
    EncodingSpecificOperations();
    shifted = Shift(R[m], shift_t, shift_n, APSR.C);
    (result, nzcvc) = AddWithCarry(NOT(R[n]), shifted, '1');
    if d == 15 then // Can only occur for ARM encoding
        ALUWritePC(result); // setflags is always FALSE here
    else
        R[d] = result;
        if setflags then
            APSR.<N,Z,C,V> = nzcvc;
```

F7.1.159 RSB (register-shifted register)

Reverse Subtract (register-shifted register) subtracts a register value from a register-shifted register value, and writes the result to the destination register. It can optionally update the condition flags based on the result.

Encoding A1 ARMv4*, ARMv5T*, ARMv6*, ARMv7

RSB{S}<C> <Rd>, <Rn>, <Rm>, <type> <Rs>

31	30	29	28	27	26	25	24	23	22	21	20	19	18	17	16	15	14	13	12	11	10	9	8	7	6	5	4	3	2	1	0
cond		0	0	0	0	0	1	1	S	Rn				Rd				Rs				0	type		1	Rm					

```
d = UInt(Rd); n = UInt(Rn); m = UInt(Rm); s = UInt(Rs);
setflags = (S == '1'); shift_t = DecodeRegShift(type);
if d == 15 || n == 15 || m == 15 || s == 15 then UNPREDICTABLE;
```

For information about the CONSTRAINED UNPREDICTABLE behavior of this instruction, see [Appendix A Architectural Constraints on UNPREDICTABLE behaviors](#).

Assembler syntax

RSB{S}<C>{<q>} {<Rd>}, <Rn>, <Rm>, <type> <Rs>

where:

S If S is present, the instruction updates the flags. Otherwise, the flags are not updated.

<C>, <q> See [Standard assembler syntax fields on page F2-2415](#).

<Rd> The destination register.

<Rn> The first operand register.

<Rm> The register that is shifted and used as the second operand.

<type> The type of shift to apply to the value read from <Rm>. It must be one of:

ASR Arithmetic shift right, encoded as type = 0b10.

LSL Logical shift left, encoded as type = 0b00.

LSR Logical shift right, encoded as type = 0b01.

ROR Rotate right, encoded as type = 0b11.

<Rs> The register whose bottom byte contains the amount to shift by.

The pre-UAL syntax RSB<C>S is equivalent to RSBS<C>.

Operation

```
if ConditionPassed() then
    EncodingSpecificOperations();
    shift_n = UInt(R[s]<7:0>);
    shifted = Shift(R[m], shift_t, shift_n, APSR.C);
    (result, nzcvc) = AddWithCarry(NOT(R[n]), shifted, '1');
    R[d] = result;
    if setflags then
        APSR.<N,Z,C,V> = nzcvc;
```

F7.1.160 RSC (immediate)

Reverse Subtract with Carry (immediate) subtracts a register value and the value of NOT (Carry flag) from an immediate value, and writes the result to the destination register. It can optionally update the condition flags based on the result.

Encoding A1 ARMv4*, ARMv5T*, ARMv6*, ARMv7

RSC{S}<c> <Rd>, <Rn>, #<const>

31	30	29	28	27	26	25	24	23	22	21	20	19	18	17	16	15	14	13	12	11	10	9	8	7	6	5	4	3	2	1	0
cond			0	0	1	0	1	1	1	S	Rn				Rd				imm12												

if Rd == '1111' && S == '1' then SEE SUBS PC, LR and related instructions;
 d = UInt(Rd); n = UInt(Rn); setflags = (S == '1'); imm32 = ARMEExpandImm(imm12);

Assembler syntax

RSC{S}{<c>}{<q>} {<Rd>,<Rn>, #<const>

where:

- S If S is present, the instruction updates the flags. Otherwise, the flags are not updated.
- <c>, <q> See [Standard assembler syntax fields on page F2-2415](#).
- <Rd> The destination register. If S is specified and <Rd> is the PC, see [SUBS PC, LR and related instructions \(T32\) on page F7-3066](#) or [SUBS PC, LR and related instructions \(A32\) on page F7-3068](#).
- <Rn> The first operand register. The PC can be used.
- <const> The immediate value that the value obtained from <Rn> is to be subtracted from. See [Modified immediate constants in A32 instructions on page F4-2472](#) for the range of values.

The pre-UAL syntax RSC<c>S is equivalent to RSCS<c>.

Operation

```

if ConditionPassed() then
    EncodingSpecificOperations();
    (result, nzcvc) = AddWithCarry(NOT(R[n]), imm32, APSR.C);
    if d == 15 then
        ALUWritePC(result); // setflags is always FALSE here
    else
        R[d] = result;
        if setflags then
            APSR.<N,Z,C,V> = nzcvc;
  
```

F7.1.161 RSC (register)

Reverse Subtract with Carry (register) subtracts a register value and the value of NOT (Carry flag) from an optionally-shifted register value, and writes the result to the destination register. It can optionally update the condition flags based on the result.

Encoding A1 ARMv4*, ARMv5T*, ARMv6*, ARMv7

RSC{S}<c> <Rd>, <Rn>, <Rm>{, <shift>}

31	30	29	28	27	26	25	24	23	22	21	20	19	18	17	16	15	14	13	12	11	10	9	8	7	6	5	4	3	2	1	0
cond			0	0	0	0	1	1	1	S	Rn			Rd			imm5			type	0	Rm									

```
if Rd == '1111' && S == '1' then SEE SUBS PC, LR and related instructions;
d = UInt(Rd); n = UInt(Rn); m = UInt(Rm); setflags = (S == '1');
(shift_t, shift_n) = DecodeImmShift(type, imm5);
```

Assembler syntax

RSC{S}{<c>}{<q>} {<Rd>}, <Rn>, <Rm> {, <shift>}

where:

S If S is present, the instruction updates the flags. Otherwise, the flags are not updated.

<c>, <q> See [Standard assembler syntax fields on page F2-2415](#).

<Rd> The destination register. If S is specified and <Rd> is the PC, see [SUBS PC, LR and related instructions \(T32\) on page F7-3066](#) or [SUBS PC, LR and related instructions \(A32\) on page F7-3068](#).

In A32 instructions, if S is not specified and <Rd> is the PC, the instruction is a branch to the address calculated by the operation. This is an interworking branch, see [Pseudocode details of operations on the AArch32 general-purpose registers and the PC on page E1-2296](#).

<Rn> The first operand register. The PC can be used.

<Rm> The register that is optionally shifted and used as the second operand. The PC can be used.

<shift> The shift to apply to the value read from <Rm>. If omitted, no shift is applied. [Shifts applied to a register on page F2-2419](#) describes the shifts and how they are encoded.

The pre-UAL syntax RSC<c>S is equivalent to RSCS<c>.

Operation

```
if ConditionPassed() then
  EncodingSpecificOperations();
  shifted = Shift(R[m], shift_t, shift_n, APSR.C);
  (result, nzc) = AddWithCarry(NOT(R[n]), shifted, APSR.C);
  if d == 15 then
    ALUWritePC(result); // setflags is always FALSE here
  else
    R[d] = result;
    if setflags then
      APSR.<N,Z,C,V> = nzc;
```

F7.1.162 RSC (register-shifted register)

Reverse Subtract (register-shifted register) subtracts a register value and the value of NOT (Carry flag) from a register-shifted register value, and writes the result to the destination register. It can optionally update the condition flags based on the result.

Encoding A1 ARMv4*, ARMv5T*, ARMv6*, ARMv7

RSC{S}<C> <Rd>, <Rn>, <Rm>, <type> <Rs>

31	30	29	28	27	26	25	24	23	22	21	20	19	18	17	16	15	14	13	12	11	10	9	8	7	6	5	4	3	2	1	0
cond			0	0	0	0	1	1	1	S	Rn				Rd				Rs				0	type		1	Rm				

```
d = UInt(Rd); n = UInt(Rn); m = UInt(Rm); s = UInt(Rs);
setflags = (S == '1'); shift_t = DecodeRegShift(type);
if d == 15 || n == 15 || m == 15 || s == 15 then UNPREDICTABLE;
```

For information about the CONSTRAINED UNPREDICTABLE behavior of this instruction, see [Appendix A Architectural Constraints on UNPREDICTABLE behaviors](#).

Assembler syntax

RSC{S}{<C>}{<q>} {<Rd>,<Rn>, <Rm>, <type> <Rs>

where:

S If S is present, the instruction updates the flags. Otherwise, the flags are not updated.

<C>, <q> See [Standard assembler syntax fields on page F2-2415](#).

<Rd> The destination register.

<Rn> The first operand register.

<Rm> The register that is shifted and used as the second operand.

<type> The type of shift to apply to the value read from <Rm>. It must be one of:

ASR Arithmetic shift right, encoded as type = 0b10.

LSL Logical shift left, encoded as type = 0b00.

LSR Logical shift right, encoded as type = 0b01.

ROR Rotate right, encoded as type = 0b11.

<Rs> The register whose bottom byte contains the amount to shift by.

The pre-UAL syntax RSC<C>S is equivalent to RSCS<C>.

Operation

```
if ConditionPassed() then
    EncodingSpecificOperations();
    shift_n = UInt(R[S]<7:0>);
    shifted = Shift(R[m], shift_t, shift_n, APSR.C);
    (result, nzcvc) = AddWithCarry(NOT(R[n]), shifted, APSR.C);
    R[d] = result;
    if setflags then
        APSR.<N,Z,C,V> = nzcvc;
```

F7.1.163 SADD8

Signed Add 8 performs four 8-bit signed integer additions, and writes the results to the destination register. It sets the APSR.GE bits according to the results of the additions.

Encoding T1 ARMv6T2, ARMv7

SADD8<c> <Rd>, <Rn>, <Rm>

15	14	13	12	11	10	9	8	7	6	5	4	3	2	1	0	15	14	13	12	11	10	9	8	7	6	5	4	3	2	1	0
1	1	1	1	1	0	1	0	1	0	0	0	Rn			1	1	1	1	Rd			0	0	0	0	Rm					

d = UInt(Rd); n = UInt(Rn); m = UInt(Rm);
 if d == 15 || n == 15 || m == 15 then UNPREDICTABLE; // ARMv8-A removes UNPREDICTABLE for R13

Encoding A1 ARMv6*, ARMv7

SADD8<c> <Rd>, <Rn>, <Rm>

31	30	29	28	27	26	25	24	23	22	21	20	19	18	17	16	15	14	13	12	11	10	9	8	7	6	5	4	3	2	1	0
cond		0	1	1	0	0	0	0	1	Rn			Rd			(1)	(1)	(1)	(1)	1	0	0	1	Rm							

d = UInt(Rd); n = UInt(Rn); m = UInt(Rm);
 if d == 15 || n == 15 || m == 15 then UNPREDICTABLE;

For information about the CONSTRAINED UNPREDICTABLE behavior of this instruction, see [Appendix A Architectural Constraints on UNPREDICTABLE behaviors](#).

Assembler syntax

SADD8{<c>}{<q>} {<Rd>}, <Rn>, <Rm>

where:

- <c>, <q> See [Standard assembler syntax fields on page F2-2415](#).
- <Rd> The destination register.
- <Rn> The first operand register.
- <Rm> The second operand register.

Operation

```

if ConditionPassed() then
    EncodingSpecificOperations();
    sum1 = SInt(R[n]<7:0>) + SInt(R[m]<7:0>);
    sum2 = SInt(R[n]<15:8>) + SInt(R[m]<15:8>);
    sum3 = SInt(R[n]<23:16>) + SInt(R[m]<23:16>);
    sum4 = SInt(R[n]<31:24>) + SInt(R[m]<31:24>);
    R[d]<7:0> = sum1<7:0>;
    R[d]<15:8> = sum2<7:0>;
    R[d]<23:16> = sum3<7:0>;
    R[d]<31:24> = sum4<7:0>;
    APSR.GE<0> = if sum1 >= 0 then '1' else '0';
    APSR.GE<1> = if sum2 >= 0 then '1' else '0';
    APSR.GE<2> = if sum3 >= 0 then '1' else '0';
    APSR.GE<3> = if sum4 >= 0 then '1' else '0';
    
```

F7.1.164 SADD16

Signed Add 16 performs two 16-bit signed integer additions, and writes the results to the destination register. It sets the APSR.GE bits according to the results of the additions.

Encoding T1 ARMv6T2, ARMv7

SADD16<c> <Rd>, <Rn>, <Rm>

15	14	13	12	11	10	9	8	7	6	5	4	3	2	1	0	15	14	13	12	11	10	9	8	7	6	5	4	3	2	1	0
1	1	1	1	1	0	1	0	1	0	0	1	Rn				1	1	1	1	Rd				0	0	0	0	Rm			

d = UInt(Rd); n = UInt(Rn); m = UInt(Rm);
 if d == 15 || n == 15 || m == 15 then UNPREDICTABLE; // ARMv8-A removes UNPREDICTABLE for R13

Encoding A1 ARMv6*, ARMv7

SADD16<c> <Rd>, <Rn>, <Rm>

31	30	29	28	27	26	25	24	23	22	21	20	19	18	17	16	15	14	13	12	11	10	9	8	7	6	5	4	3	2	1	0
cond		0	1	1	0	0	0	0	1	Rn				Rd				(1)	(1)	(1)	(1)	0	0	0	1	Rm					

d = UInt(Rd); n = UInt(Rn); m = UInt(Rm);
 if d == 15 || n == 15 || m == 15 then UNPREDICTABLE;

For information about the CONSTRAINED UNPREDICTABLE behavior of this instruction, see [Appendix A Architectural Constraints on UNPREDICTABLE behaviors](#).

Assembler syntax

SADD16{<c>}{<q>} {<Rd>}, <Rn>, <Rm>

where:

<c>, <q> See [Standard assembler syntax fields on page F2-2415](#).

<Rd> The destination register.

<Rn> The first operand register.

<Rm> The second operand register.

Operation

```

if ConditionPassed() then
    EncodingSpecificOperations();
    sum1 = SInt(R[n]<15:0>) + SInt(R[m]<15:0>);
    sum2 = SInt(R[n]<31:16>) + SInt(R[m]<31:16>);
    R[d]<15:0> = sum1<15:0>;
    R[d]<31:16> = sum2<15:0>;
    APSR.GE<1:0> = if sum1 >= 0 then '11' else '00';
    APSR.GE<3:2> = if sum2 >= 0 then '11' else '00';
  
```

F7.1.165 SASX

Signed Add and Subtract with Exchange exchanges the two halfwords of the second operand, performs one 16-bit integer addition and one 16-bit subtraction, and writes the results to the destination register. It sets the APSR.GE bits according to the results.

Encoding T1 ARMv6T2, ARMv7

SASX<c> <Rd>, <Rn>, <Rm>

15	14	13	12	11	10	9	8	7	6	5	4	3	2	1	0	15	14	13	12	11	10	9	8	7	6	5	4	3	2	1	0
1	1	1	1	1	0	1	0	1	0	1	0	Rn				1	1	1	1	Rd				0	0	0	0	Rm			

d = UInt(Rd); n = UInt(Rn); m = UInt(Rm);
 if d == 15 || n == 15 || m == 15 then UNPREDICTABLE; // ARMv8-A removes UNPREDICTABLE for R13

Encoding A1 ARMv6*, ARMv7

SASX<c> <Rd>, <Rn>, <Rm>

31	30	29	28	27	26	25	24	23	22	21	20	19	18	17	16	15	14	13	12	11	10	9	8	7	6	5	4	3	2	1	0
cond		0	1	1	0	0	0	0	1	Rn				Rd				(1)	(1)	(1)	(1)	0	0	1	1	Rm					

d = UInt(Rd); n = UInt(Rn); m = UInt(Rm);
 if d == 15 || n == 15 || m == 15 then UNPREDICTABLE;

For information about the CONSTRAINED UNPREDICTABLE behavior of this instruction, see [Appendix A Architectural Constraints on UNPREDICTABLE behaviors](#).

Assembler syntax

SASX{<c>}{<q>} {<Rd>,<Rn>, <Rm>

where:

<c>, <q> See [Standard assembler syntax fields on page F2-2415](#).

<Rd> The destination register.

<Rn> The first operand register.

<Rm> The second operand register.

The pre-UAL syntax SADDSUBX<c> is equivalent to SASX<c>.

Operation

```

if ConditionPassed() then
    EncodingSpecificOperations();
    diff = SInt(R[n]<15:0>) - SInt(R[m]<31:16>);
    sum = SInt(R[n]<31:16>) + SInt(R[m]<15:0>);
    R[d]<15:0> = diff<15:0>;
    R[d]<31:16> = sum<15:0>;
    APSR.GE<1:0> = if diff >= 0 then '11' else '00';
    APSR.GE<3:2> = if sum >= 0 then '11' else '00';
    
```

F7.1.166 SBC (immediate)

Subtract with Carry (immediate) subtracts an immediate value and the value of NOT (Carry flag) from a register value, and writes the result to the destination register. It can optionally update the condition flags based on the result.

Encoding T1 ARMv6T2, ARMv7

SBC{S}<c> <Rd>, <Rn>, #<const>

15	14	13	12	11	10	9	8	7	6	5	4	3	2	1	0	15	14	13	12	11	10	9	8	7	6	5	4	3	2	1	0
1	1	1	1	0	i	0	1	0	1	1	S	Rn				0	imm3			Rd			imm8								

```
d = UInt(Rd); n = UInt(Rn); setflags = (S == '1'); imm32 = ThumbExpandImm(i:imm3:imm8);
if d == 15 || n == 15 then UNPREDICTABLE; // ARMv8-A removes UNPREDICTABLE for R13
```

Encoding A1 ARMv4*, ARMv5T*, ARMv6*, ARMv7

SBC{S}<c> <Rd>, <Rn>, #<const>

31	30	29	28	27	26	25	24	23	22	21	20	19	18	17	16	15	14	13	12	11	10	9	8	7	6	5	4	3	2	1	0
cond		0	0	1	0	1	1	0	S	Rn				Rd				imm12													

```
if Rd == '1111' && S == '1' then SEE SUBS PC, LR and related instructions;
d = UInt(Rd); n = UInt(Rn); setflags = (S == '1'); imm32 = ARMEExpandImm(imm12);
```

For information about the CONSTRAINED UNPREDICTABLE behavior of this instruction, see [Appendix A Architectural Constraints on UNPREDICTABLE behaviors](#).

Assembler syntax

SBC{S}{<c>}{<q>} {<Rd>}, {<Rn>}, #<const>

where:

- S If S is present, the instruction updates the flags. Otherwise, the flags are not updated.
- <c>, <q> See [Standard assembler syntax fields on page F2-2415](#).
- <Rd> The destination register. If S is specified and <Rd> is the PC, see [SUBS PC, LR and related instructions \(T32\) on page F7-3066](#) or [SUBS PC, LR and related instructions \(A32\) on page F7-3068](#).
In A32 instructions, if S is not specified and <Rd> is the PC, the instruction is a branch to the address calculated by the operation. This is an interworking branch, see [Pseudocode details of operations on the AArch32 general-purpose registers and the PC on page E1-2296](#).
- <Rn> The first operand register. The PC can be used in A32 instructions.
- <const> The immediate value to be subtracted from the value obtained from <Rn>. See [Modified immediate constants in T32 instructions on page F3-2444](#) or [Modified immediate constants in A32 instructions on page F4-2472](#) for the range of values.

The pre-UAL syntax SBC<c>S is equivalent to SBCS<c>.

Operation

```
if ConditionPassed() then
    EncodingSpecificOperations();
    (result, nzcvc) = AddWithCarry(R[n], NOT(imm32), APSR.C);
    if d == 15 then // Can only occur for ARM encoding
        ALUWritePC(result); // setflags is always FALSE here
    else
        R[d] = result;
        if setflags then
            APSR.<N,Z,C,V> = nzcvc;
```

F7.1.167 SBC (register)

Subtract with Carry (register) subtracts an optionally-shifted register value and the value of NOT (Carry flag) from a register value, and writes the result to the destination register. It can optionally update the condition flags based on the result.

Encoding T1 ARMv4T, ARMv5T*, ARMv6*, ARMv7
 SBCS <Rdn>, <Rm> Outside IT block.
 SBC<c> <Rdn>, <Rm> Inside IT block.

15	14	13	12	11	10	9	8	7	6	5	4	3	2	1	0
0	1	0	0	0	0	0	1	1	0	Rm	Rdn				

d = UInt(Rdn); n = UInt(Rdn); m = UInt(Rm); setflags = !InITBlock();
 (shift_t, shift_n) = (SRTYPE_LSL, 0);

Encoding T2 ARMv6T2, ARMv7
 SBC{S}<c>.W <Rd>, <Rn>, <Rm>{, <shift>}

15	14	13	12	11	10	9	8	7	6	5	4	3	2	1	0	15	14	13	12	11	10	9	8	7	6	5	4	3	2	1	0
1	1	1	0	1	0	1	1	0	1	1	S	Rn				(0)	imm3			Rd			imm2	type	Rm						

d = UInt(Rd); n = UInt(Rn); m = UInt(Rm); setflags = (S == '1');
 (shift_t, shift_n) = DecodeImmShift(type, imm3:imm2);
 if d == 15 || n == 15 || m == 15 then UNPREDICTABLE; // ARMv8-A removes UNPREDICTABLE for R13

Encoding A1 ARMv4*, ARMv5T*, ARMv6*, ARMv7
 SBC{S}<c> <Rd>, <Rn>, <Rm>{, <shift>}

31	30	29	28	27	26	25	24	23	22	21	20	19	18	17	16	15	14	13	12	11	10	9	8	7	6	5	4	3	2	1	0
cond				0	0	0	0	1	1	0	S	Rn				Rd				imm5			type	0	Rm						

if Rd == '1111' && S == '1' then SEE SUBS PC, LR and related instructions;
 d = UInt(Rd); n = UInt(Rn); m = UInt(Rm); setflags = (S == '1');
 (shift_t, shift_n) = DecodeImmShift(type, imm5);

For information about the CONSTRAINED UNPREDICTABLE behavior of this instruction, see [Appendix A Architectural Constraints on UNPREDICTABLE behaviors](#).

Assembler syntax

SBC{S}{<c>}{<q>} {<Rd>}, <Rn>, <Rm> {, <shift>}

where:

- S If S is present, the instruction updates the flags. Otherwise, the flags are not updated.
- <c>, <q> See [Standard assembler syntax fields on page F2-2415](#).
- <Rd> The destination register. If S is specified and <Rd> is the PC, see [SUBS PC, LR and related instructions \(T32\) on page F7-3066](#) or [SUBS PC, LR and related instructions \(A32\) on page F7-3068](#).
In A32 instructions, if S is not specified and <Rd> is the PC, the instruction is a branch to the address calculated by the operation. This is an interworking branch, see [Pseudocode details of operations on the AArch32 general-purpose registers and the PC on page E1-2296](#).
- <Rn> The first operand register. The PC can be used in A32 instructions.
- <Rm> The register that is optionally shifted and used as the second operand. The PC can be used in A32 instructions.
- <shift> The shift to apply to the value read from <Rm>. If present, encoding T1 is not permitted. If absent, no shift is applied and all encodings are permitted. [Shifts applied to a register on page F2-2419](#) describes the shifts and how they are encoded.

The pre-UAL syntax SBC<c>S is equivalent to SBCS<c>.

Operation

```
if ConditionPassed() then
    EncodingSpecificOperations();
    shifted = Shift(R[m], shift_t, shift_n, APSR.C);
    (result, nzcV) = AddWithCarry(R[n], NOT(shifted), APSR.C);
    if d == 15 then // Can only occur for ARM encoding
        ALUWritePC(result); // setflags is always FALSE here
    else
        R[d] = result;
        if setflags then
            APSR.<N,Z,C,V> = nzcV;
```

F7.1.168 SBC (register-shifted register)

Subtract with Carry (register-shifted register) subtracts a register-shifted register value and the value of NOT (Carry flag) from a register value, and writes the result to the destination register. It can optionally update the condition flags based on the result.

Encoding A1 ARMv4*, ARMv5T*, ARMv6*, ARMv7

SBC{S}<C> <Rd>, <Rn>, <Rm>, <type> <Rs>

31	30	29	28	27	26	25	24	23	22	21	20	19	18	17	16	15	14	13	12	11	10	9	8	7	6	5	4	3	2	1	0
cond				0	0	0	0	1	1	0	S	Rn				Rd				Rs				0	type		1	Rm			

```
d = UInt(Rd); n = UInt(Rn); m = UInt(Rm); s = UInt(Rs);
setflags = (S == '1'); shift_t = DecodeRegShift(type);
if d == 15 || n == 15 || m == 15 || s == 15 then UNPREDICTABLE;
```

For information about the CONSTRAINED UNPREDICTABLE behavior of this instruction, see [Appendix A Architectural Constraints on UNPREDICTABLE behaviors](#).

Assembler syntax

SBC{S}{<c>}{<q>} {<Rd>}, <Rn>, <Rm>, <type> <Rs>

where:

S If S is present, the instruction updates the flags. Otherwise, the flags are not updated.

<c>, <q> See [Standard assembler syntax fields on page F2-2415](#).

<Rd> The destination register.

<Rn> The first operand register.

<Rm> The register that is shifted and used as the second operand.

<type> The type of shift to apply to the value read from <Rm>. It must be one of:

ASR Arithmetic shift right, encoded as type = 0b10.

LSL Logical shift left, encoded as type = 0b00.

LSR Logical shift right, encoded as type = 0b01.

ROR Rotate right, encoded as type = 0b11.

<Rs> The register whose bottom byte contains the amount to shift by.

The pre-UAL syntax SBC<c>S is equivalent to SBCS<c>.

Operation

```
if ConditionPassed() then
    EncodingSpecificOperations();
    shift_n = UInt(R[s]<7:0>);
    shifted = Shift(R[m], shift_t, shift_n, APSR.C);
    (result, nzc) = AddWithCarry(R[n], NOT(shifted), APSR.C);
    R[d] = result;
    if setflags then
        APSR.<N,Z,C,V> = nzc;
```

F7.1.169 SBFX

Signed Bit Field Extract extracts any number of adjacent bits at any position from a register, sign-extends them to 32 bits, and writes the result to the destination register.

Encoding T1 ARMv6T2, ARMv7

SBFX<< <Rd>, <Rn>, #<lsb>, #<width>

15	14	13	12	11	10	9	8	7	6	5	4	3	2	1	0	15	14	13	12	11	10	9	8	7	6	5	4	3	2	1	0
1	1	1	1	0	(0)	1	1	0	1	0	0	Rn			0	imm3			Rd			imm2(0)			widthm1						

```
d = UInt(Rd); n = UInt(Rn);
lsbit = UInt(imm3:imm2); widthminus1 = UInt(widthm1);
if d == 15 || n == 15 then UNPREDICTABLE; // ARMv8-A removes UNPREDICTABLE for R13
```

Encoding A1 ARMv6T2, ARMv7

SBFX<< <Rd>, <Rn>, #<lsb>, #<width>

31	30	29	28	27	26	25	24	23	22	21	20	19	18	17	16	15	14	13	12	11	10	9	8	7	6	5	4	3	2	1	0
cond		0	1	1	1	1	0	1	widthm1			Rd			lsb			1			0	1	Rn								

```
d = UInt(Rd); n = UInt(Rn);
lsbit = UInt(1sb); widthminus1 = UInt(widthm1);
if d == 15 || n == 15 then UNPREDICTABLE;
```

For information about the CONSTRAINED UNPREDICTABLE behavior of this instruction, see [Appendix A Architectural Constraints on UNPREDICTABLE behaviors](#), and particularly [SBFX on page AppxA-4723](#).

Assembler syntax

SBFX{<c>}{<q>} <Rd>, <Rn>, #<lsb>, #<width>

where:

- <c>, <q> See [Standard assembler syntax fields on page F2-2415](#).
- <Rd> The destination register.
- <Rn> The first operand register.
- <lsb> Is the bit number of the least significant bit in the field, in the range 0-31. This determines the required value of `lsbit`.
- <width> Is the width of the field, in the range 1 to 32-`<lsb>`. The required value of `widthminus1` is `<width>-1`.

Operation

```
if ConditionPassed() then
    EncodingSpecificOperations();
    msbit = lsbit + widthminus1;
    if msbit <= 31 then
        R[d] = SignExtend(R[n]<msbit:lsbit>, 32);
    else
        UNPREDICTABLE;
```

F7.1.170 SDIV

Signed Divide divides a 32-bit signed integer register value by a 32-bit signed integer register value, and writes the result to the destination register. The condition flags are not affected.

Encoding T1 ARMv7-R, ARMv7VE, otherwise OPTIONAL in ARMv7-A

SDIV<c> <Rd>, <Rn>, <Rm>

15	14	13	12	11	10	9	8	7	6	5	4	3	2	1	0	15	14	13	12	11	10	9	8	7	6	5	4	3	2	1	0
1	1	1	1	1	0	1	1	1	0	0	1	Rn				(1)	(1)	(1)	(1)	Rd				1	1	1	1	Rm			

d = UInt(Rd); n = UInt(Rn); m = UInt(Rm);
 if d == 15 || n == 15 || m == 15 then UNPREDICTABLE; // ARMv8-A removes UNPREDICTABLE for R13

Encoding A1 ARMv7VE, otherwise OPTIONAL in ARMv7-A and ARMv7-R

SDIV<c> <Rd>, <Rn>, <Rm>

31	30	29	28	27	26	25	24	23	22	21	20	19	18	17	16	15	14	13	12	11	10	9	8	7	6	5	4	3	2	1	0
cond		0	1	1	1	0	0	0	1	Rd				(1)	(1)	(1)	(1)	Rm				0	0	0	1	Rn					

d = UInt(Rd); n = UInt(Rn); m = UInt(Rm);
 if d == 15 || n == 15 || m == 15 then UNPREDICTABLE;

For information about the CONSTRAINED UNPREDICTABLE behavior of this instruction, see [SDIV on page AppxA-4724](#).

Assembler syntax

SDIV{<C>}{<q>} {<Rd>}, <Rn>, <Rm>

where:

<C>, <q> See [Standard assembler syntax fields on page F2-2415](#).

<Rd> The destination register.

<Rn> The register that contains the dividend.

<Rm> The register that contains the divisor.

Operation

```
if ConditionPassed() then
    EncodingSpecificOperations();
    if SInt(R[m]) == 0 then
        if IntegerZeroDivideTrappingEnabled() then
            GenerateIntegerZeroDivide();
        else
            result = 0;
    else
        result = RoundTowardsZero(SInt(R[n]) / SInt(R[m]));
    R[d] = result<31:0>;
```

Overflow

If the signed integer division $0x80000000 / 0xFFFFFFFF$ is performed, the pseudocode produces the intermediate integer result $+2^{31}$, that overflows the 32-bit signed integer range. No indication of this overflow case is produced, and the 32-bit result written to R[d] must be the bottom 32 bits of the binary representation of $+2^{31}$. So the result of the division is $0x80000000$.

F7.1.171 SEL

Select Bytes selects each byte of its result from either its first operand or its second operand, according to the values of the GE flags.

Encoding T1 ARMv6T2, ARMv7

SEL<c> <Rd>, <Rn>, <Rm>

15	14	13	12	11	10	9	8	7	6	5	4	3	2	1	0	15	14	13	12	11	10	9	8	7	6	5	4	3	2	1	0
1	1	1	1	1	0	1	0	1	0	1	0	Rn			1	1	1	1	Rd			1	0	0	0	Rm					

d = UInt(Rd); n = UInt(Rn); m = UInt(Rm);
 if d == 15 || n == 15 || m == 15 then UNPREDICTABLE; // ARMv8-A removes UNPREDICTABLE for R13

Encoding A1 ARMv6*, ARMv7

SEL<c> <Rd>, <Rn>, <Rm>

31	30	29	28	27	26	25	24	23	22	21	20	19	18	17	16	15	14	13	12	11	10	9	8	7	6	5	4	3	2	1	0
cond		0	1	1	0	1	0	0	0	Rn			Rd			(1)	(1)	(1)	(1)	1	0	1	1	Rm							

d = UInt(Rd); n = UInt(Rn); m = UInt(Rm);
 if d == 15 || n == 15 || m == 15 then UNPREDICTABLE;

For information about the CONSTRAINED UNPREDICTABLE behavior of this instruction, see [Appendix A Architectural Constraints on UNPREDICTABLE behaviors](#).

Assembler syntax

SEL{<c>}{<q>} {<Rd>}, <Rn>, <Rm>

where:

- <c>, <q> See [Standard assembler syntax fields on page F2-2415](#).
- <Rd> The destination register.
- <Rn> The first operand register.
- <Rm> The second operand register.

Operation

```
if ConditionPassed() then
    EncodingSpecificOperations();
    R[d]<7:0> = if APSR.GE<0> == '1' then R[n]<7:0> else R[m]<7:0>;
    R[d]<15:8> = if APSR.GE<1> == '1' then R[n]<15:8> else R[m]<15:8>;
    R[d]<23:16> = if APSR.GE<2> == '1' then R[n]<23:16> else R[m]<23:16>;
    R[d]<31:24> = if APSR.GE<3> == '1' then R[n]<31:24> else R[m]<31:24>;
```

F7.1.172 SETEND

Set Endianness writes a new value to ENDIANSTATE.

Encoding T1 ARMv6*, ARMv7

SETEND <endian_specifier>

Not permitted in IT block

15	14	13	12	11	10	9	8	7	6	5	4	3	2	1	0
1	0	1	1	0	1	1	0	0	1	0	(1)	E	(0)	(0)	(0)

set_bigend = (E == '1');
 if InITBlock() then UNPREDICTABLE;

Encoding A1 ARMv6*, ARMv7

SETEND <endian_specifier>

Cannot be conditional

31	30	29	28	27	26	25	24	23	22	21	20	19	18	17	16	15	14	13	12	11	10	9	8	7	6	5	4	3	2	1	0
1	1	1	1	0	0	0	1	0	0	0	0	(0)	(0)	(0)	1	(0)	(0)	(0)	(0)	(0)	(0)	E	(0)	0	0	0	0	(0)	(0)	(0)	(0)

set_bigend = (E == '1');

For information about the CONSTRAINED UNPREDICTABLE behavior of this instruction, see [Appendix A Architectural Constraints on UNPREDICTABLE behaviors](#).

Assembler syntax

SETEND{<q>} <endian_specifier>

where:

<q> See [Standard assembler syntax fields on page F2-2415](#). A SETEND instruction must be unconditional.

<endian_specifier>

Is one of:

BE Sets the E bit in the instruction. This sets ENDIANSTATE.

LE Clears the E bit in the instruction. This clears ENDIANSTATE.

Operation

EncodingSpecificOperations();
 ENDIANSTATE = if set_bigend then '1' else '0';

F7.1.173 SEV

Send Event is a hint instruction. It causes an event to be signaled to all PEs in the multiprocessor system. For more information, see [Wait For Event and Send Event](#) on page G1-3460.

Encoding T1 ARMv7 (executes as NOP in ARMv6T2)

SEV<c>

15	14	13	12	11	10	9	8	7	6	5	4	3	2	1	0
1	0	1	1	1	1	1	1	0	1	0	0	0	0	0	0

// No additional decoding required

Encoding T2 ARMv7 (executes as NOP in ARMv6T2)

SEV<c>.W

15	14	13	12	11	10	9	8	7	6	5	4	3	2	1	0	15	14	13	12	11	10	9	8	7	6	5	4	3	2	1	0
1	1	1	1	0	0	1	1	1	0	1	0	(1)	(1)	(1)	(1)	1	0	(0)	0	(0)	0	0	0	0	0	0	1	0	0		

// No additional decoding required

Encoding A1 ARMv6K, ARMv7 (executes as NOP in ARMv6T2)

SEV<c>

31	30	29	28	27	26	25	24	23	22	21	20	19	18	17	16	15	14	13	12	11	10	9	8	7	6	5	4	3	2	1	0
cond	0	0	1	1	0	0	1	0	0	0	0	0	(1)	(1)	(1)	(1)	(0)	(0)	(0)	(0)	0	0	0	0	0	0	0	1	0	0	

// No additional decoding required

For information about the CONSTRAINED UNPREDICTABLE behavior of this instruction, see [Appendix A Architectural Constraints on UNPREDICTABLE behaviors](#).

Assembler syntax

SEV{<c>}{<q>}

where:

<c>, <q> See [Standard assembler syntax fields](#) on page F2-2415.

Operation

```
if ConditionPassed() then
    EncodingSpecificOperations();
    SendEvent();
```

F7.1.174 SEVL

Send Event Local is a hint instruction. It causes an event to be signaled locally without the requirement to affect other PEs in the multiprocessor system. It can prime a wait-loop which starts with a WFE instruction.

Encoding T1 ARMv8

SEVL<c>

15	14	13	12	11	10	9	8	7	6	5	4	3	2	1	0
1	0	1	1	1	1	1	1	0	1	0	1	0	0	0	0

// No additional decoding required

Encoding T2 ARMv8

SEVL<c>.W

15	14	13	12	11	10	9	8	7	6	5	4	3	2	1	0	15	14	13	12	11	10	9	8	7	6	5	4	3	2	1	0
1	1	1	1	0	0	1	1	1	0	1	0	(1)	(1)	(1)	(1)	1	0	(0)	0	(0)	0	0	0	0	0	0	1	0	1		

// No additional decoding required

Encoding A1 ARMv8

SEVL<c>

31	30	29	28	27	26	25	24	23	22	21	20	19	18	17	16	15	14	13	12	11	10	9	8	7	6	5	4	3	2	1	0
cond	0	0	1	1	0	0	1	0	0	0	0	0	(1)	(1)	(1)	(1)	(0)	(0)	(0)	(0)	0	0	0	0	0	0	0	1	0	1	

// No additional decoding required

For information about the CONSTRAINED UNPREDICTABLE behavior of this instruction, see [Appendix A Architectural Constraints on UNPREDICTABLE behaviors](#).

Assembler syntax

SEV{<c>}{<q>}

where:

<c>, <q> See [Standard assembler syntax fields on page F2-2415](#).

Operation

```
if ConditionPassed() then
    EncodingSpecificOperations();
    SendEvent();
```

F7.1.175 SHADD8

Signed Halving Add 8 performs four signed 8-bit integer additions, halves the results, and writes the results to the destination register.

Encoding T1 ARMv6T2, ARMv7

SHADD8<c> <Rd>, <Rn>, <Rm>

15	14	13	12	11	10	9	8	7	6	5	4	3	2	1	0	15	14	13	12	11	10	9	8	7	6	5	4	3	2	1	0
1	1	1	1	1	0	1	0	1	0	0	0	Rn			1	1	1	1	Rd			0	0	1	0	Rm					

d = UInt(Rd); n = UInt(Rn); m = UInt(Rm);
 if d == 15 || n == 15 || m == 15 then UNPREDICTABLE; // ARMv8-A removes UNPREDICTABLE for R13

Encoding A1 ARMv6*, ARMv7

SHADD8<c> <Rd>, <Rn>, <Rm>

31	30	29	28	27	26	25	24	23	22	21	20	19	18	17	16	15	14	13	12	11	10	9	8	7	6	5	4	3	2	1	0
cond		0	1	1	0	0	0	1	1	Rn			Rd			(1)	(1)	(1)	(1)	1	0	0	1	Rm							

d = UInt(Rd); n = UInt(Rn); m = UInt(Rm);
 if d == 15 || n == 15 || m == 15 then UNPREDICTABLE;

For information about the CONSTRAINED UNPREDICTABLE behavior of this instruction, see [Appendix A Architectural Constraints on UNPREDICTABLE behaviors](#).

Assembler syntax

SHADD8{<c>}{<q>} {<Rd>}, <Rn>, <Rm>

where:

- <c>, <q> See [Standard assembler syntax fields on page F2-2415](#).
- <Rd> The destination register.
- <Rn> The first operand register.
- <Rm> The second operand register.

Operation

```

if ConditionPassed() then
    EncodingSpecificOperations();
    sum1 = SInt(R[n]<7:0>) + SInt(R[m]<7:0>);
    sum2 = SInt(R[n]<15:8>) + SInt(R[m]<15:8>);
    sum3 = SInt(R[n]<23:16>) + SInt(R[m]<23:16>);
    sum4 = SInt(R[n]<31:24>) + SInt(R[m]<31:24>);
    R[d]<7:0> = sum1<8:1>;
    R[d]<15:8> = sum2<8:1>;
    R[d]<23:16> = sum3<8:1>;
    R[d]<31:24> = sum4<8:1>;
    
```

F7.1.176 SHADD16

Signed Halving Add 16 performs two signed 16-bit integer additions, halves the results, and writes the results to the destination register.

Encoding T1 ARMv6T2, ARMv7

SHADD16<c> <Rd>, <Rn>, <Rm>

15	14	13	12	11	10	9	8	7	6	5	4	3	2	1	0	15	14	13	12	11	10	9	8	7	6	5	4	3	2	1	0
1	1	1	1	1	0	1	0	1	0	0	1	Rn				1	1	1	1	Rd				0	0	1	0	Rm			

d = UInt(Rd); n = UInt(Rn); m = UInt(Rm);
 if d == 15 || n == 15 || m == 15 then UNPREDICTABLE; // ARMv8-A removes UNPREDICTABLE for R13

Encoding A1 ARMv6*, ARMv7

SHADD16<c> <Rd>, <Rn>, <Rm>

31	30	29	28	27	26	25	24	23	22	21	20	19	18	17	16	15	14	13	12	11	10	9	8	7	6	5	4	3	2	1	0
cond		0	1	1	0	0	0	1	1	Rn				Rd				(1)	(1)	(1)	(1)	0	0	0	1	Rm					

d = UInt(Rd); n = UInt(Rn); m = UInt(Rm);
 if d == 15 || n == 15 || m == 15 then UNPREDICTABLE;

For information about the CONSTRAINED UNPREDICTABLE behavior of this instruction, see [Appendix A Architectural Constraints on UNPREDICTABLE behaviors](#).

Assembler syntax

SHADD16{<c>}{<q>} {<Rd>}, {<Rn>, <Rm>

where:

<c>, <q> See [Standard assembler syntax fields on page F2-2415](#).

<Rd> The destination register.

<Rn> The first operand register.

<Rm> The second operand register.

Operation

```
if ConditionPassed() then
    EncodingSpecificOperations();
    sum1 = SInt(R[n]<15:0>) + SInt(R[m]<15:0>);
    sum2 = SInt(R[n]<31:16>) + SInt(R[m]<31:16>);
    R[d]<15:0> = sum1<16:1>;
    R[d]<31:16> = sum2<16:1>;
```

F7.1.177 SHASX

Signed Halving Add and Subtract with Exchange exchanges the two halfwords of the second operand, performs one signed 16-bit integer addition and one signed 16-bit subtraction, halves the results, and writes the results to the destination register.

Encoding T1 ARMv6T2, ARMv7

SHASX<c> <Rd>, <Rn>, <Rm>

15	14	13	12	11	10	9	8	7	6	5	4	3	2	1	0	15	14	13	12	11	10	9	8	7	6	5	4	3	2	1	0
1	1	1	1	1	0	1	0	1	0	1	0	Rn				1	1	1	1	Rd				0	0	1	0	Rm			

d = UInt(Rd); n = UInt(Rn); m = UInt(Rm);
 if d == 15 || n == 15 || m == 15 then UNPREDICTABLE; // ARMv8-A removes UNPREDICTABLE for R13

Encoding A1 ARMv6*, ARMv7

SHASX<c> <Rd>, <Rn>, <Rm>

31	30	29	28	27	26	25	24	23	22	21	20	19	18	17	16	15	14	13	12	11	10	9	8	7	6	5	4	3	2	1	0
cond		0	1	1	0	0	0	1	1	Rn				Rd				(1)	(1)	(1)	(1)	0	0	1	1	Rm					

d = UInt(Rd); n = UInt(Rn); m = UInt(Rm);
 if d == 15 || n == 15 || m == 15 then UNPREDICTABLE;

For information about the CONSTRAINED UNPREDICTABLE behavior of this instruction, see [Appendix A Architectural Constraints on UNPREDICTABLE behaviors](#).

Assembler syntax

SHASX{<c>}{<q>} {<Rd>}, <Rn>, <Rm>

where:

<c>, <q> See [Standard assembler syntax fields on page F2-2415](#).

<Rd> The destination register.

<Rn> The first operand register.

<Rm> The second operand register.

The pre-UAL syntax SHADDSUBX<c> is equivalent to SHASX<c>.

Operation

```

if ConditionPassed() then
    EncodingSpecificOperations();
    diff = SInt(R[n]<15:0>) - SInt(R[m]<31:16>);
    sum = SInt(R[n]<31:16>) + SInt(R[m]<15:0>);
    R[d]<15:0> = diff<16:1>;
    R[d]<31:16> = sum<16:1>;
    
```

F7.1.178 SHSAX

Signed Halving Subtract and Add with Exchange exchanges the two halfwords of the second operand, performs one signed 16-bit integer subtraction and one signed 16-bit addition, halves the results, and writes the results to the destination register.

Encoding T1 ARMv6T2, ARMv7

SHSAX<c> <Rd>, <Rn>, <Rm>

15	14	13	12	11	10	9	8	7	6	5	4	3	2	1	0	15	14	13	12	11	10	9	8	7	6	5	4	3	2	1	0
1	1	1	1	1	0	1	0	1	1	1	0	Rn				1	1	1	1	Rd				0	0	1	0	Rm			

d = UInt(Rd); n = UInt(Rn); m = UInt(Rm);
 if d == 15 || n == 15 || m == 15 then UNPREDICTABLE; // ARMv8-A removes UNPREDICTABLE for R13

Encoding A1 ARMv6*, ARMv7

SHSAX<c> <Rd>, <Rn>, <Rm>

31	30	29	28	27	26	25	24	23	22	21	20	19	18	17	16	15	14	13	12	11	10	9	8	7	6	5	4	3	2	1	0
cond		0	1	1	0	0	0	1	1	Rn				Rd				(1)	(1)	(1)	(1)	0	1	0	1	Rm					

d = UInt(Rd); n = UInt(Rn); m = UInt(Rm);
 if d == 15 || n == 15 || m == 15 then UNPREDICTABLE;

For information about the CONSTRAINED UNPREDICTABLE behavior of this instruction, see [Appendix A Architectural Constraints on UNPREDICTABLE behaviors](#).

Assembler syntax

SHSAX{<c>}{<q>} {<Rd>}, <Rn>, <Rm>

where:

<c>, <q> See [Standard assembler syntax fields on page F2-2415](#).

<Rd> The destination register.

<Rn> The first operand register.

<Rm> The second operand register.

The pre-UAL syntax SHSUBADDX<c> is equivalent to SHSAX<c>.

Operation

```

if ConditionPassed() then
    EncodingSpecificOperations();
    sum = SInt(R[n]<15:0>) + SInt(R[m]<31:16>);
    diff = SInt(R[n]<31:16>) - SInt(R[m]<15:0>);
    R[d]<15:0> = sum<16:1>;
    R[d]<31:16> = diff<16:1>;
    
```

F7.1.179 SHSUB8

Signed Halving Subtract 8 performs four signed 8-bit integer subtractions, halves the results, and writes the results to the destination register.

Encoding T1 ARMv6T2, ARMv7

SHSUB8<c> <Rd>, <Rn>, <Rm>

15	14	13	12	11	10	9	8	7	6	5	4	3	2	1	0	15	14	13	12	11	10	9	8	7	6	5	4	3	2	1	0
1	1	1	1	1	0	1	0	1	1	0	0	Rn			1	1	1	1	Rd			0	0	1	0	Rm					

d = UInt(Rd); n = UInt(Rn); m = UInt(Rm);
 if d == 15 || n == 15 || m == 15 then UNPREDICTABLE; // ARMv8-A removes UNPREDICTABLE for R13

Encoding A1 ARMv6*, ARMv7

SHSUB8<c> <Rd>, <Rn>, <Rm>

31	30	29	28	27	26	25	24	23	22	21	20	19	18	17	16	15	14	13	12	11	10	9	8	7	6	5	4	3	2	1	0
cond		0	1	1	0	0	0	1	1	Rn			Rd			(1)	(1)	(1)	(1)	1	1	1	1	Rm							

d = UInt(Rd); n = UInt(Rn); m = UInt(Rm);
 if d == 15 || n == 15 || m == 15 then UNPREDICTABLE;

For information about the CONSTRAINED UNPREDICTABLE behavior of this instruction, see [Appendix A Architectural Constraints on UNPREDICTABLE behaviors](#).

Assembler syntax

SHSUB8{<c>}{<q>} {<Rd>}, <Rn>, <Rm>

where:

- <c>, <q> See [Standard assembler syntax fields on page F2-2415](#).
- <Rd> The destination register.
- <Rn> The first operand register.
- <Rm> The second operand register.

Operation

```

if ConditionPassed() then
    EncodingSpecificOperations();
    diff1 = SInt(R[n]<7:0>) - SInt(R[m]<7:0>);
    diff2 = SInt(R[n]<15:8>) - SInt(R[m]<15:8>);
    diff3 = SInt(R[n]<23:16>) - SInt(R[m]<23:16>);
    diff4 = SInt(R[n]<31:24>) - SInt(R[m]<31:24>);
    R[d]<7:0> = diff1<8:1>;
    R[d]<15:8> = diff2<8:1>;
    R[d]<23:16> = diff3<8:1>;
    R[d]<31:24> = diff4<8:1>;
    
```

F7.1.180 SHSUB16

Signed Halving Subtract 16 performs two signed 16-bit integer subtractions, halves the results, and writes the results to the destination register.

Encoding T1 ARMv6T2, ARMv7

SHSUB16<c> <Rd>, <Rn>, <Rm>

15	14	13	12	11	10	9	8	7	6	5	4	3	2	1	0	15	14	13	12	11	10	9	8	7	6	5	4	3	2	1	0
1	1	1	1	1	0	1	0	1	1	0	1	Rn				1	1	1	1	Rd				0	0	1	0	Rm			

d = UInt(Rd); n = UInt(Rn); m = UInt(Rm);
 if d == 15 || n == 15 || m == 15 then UNPREDICTABLE; // ARMv8-A removes UNPREDICTABLE for R13

Encoding A1 ARMv6*, ARMv7

SHSUB16<c> <Rd>, <Rn>, <Rm>

31	30	29	28	27	26	25	24	23	22	21	20	19	18	17	16	15	14	13	12	11	10	9	8	7	6	5	4	3	2	1	0
cond		0	1	1	0	0	0	1	1	Rn				Rd				(1)	(1)	(1)	(1)	0	1	1	1	Rm					

d = UInt(Rd); n = UInt(Rn); m = UInt(Rm);
 if d == 15 || n == 15 || m == 15 then UNPREDICTABLE;

For information about the CONSTRAINED UNPREDICTABLE behavior of this instruction, see [Appendix A Architectural Constraints on UNPREDICTABLE behaviors](#).

Assembler syntax

SHSUB16{<c>}{<q>} {<Rd>}, {<Rn>, <Rm>

where:

<c>, <q> See [Standard assembler syntax fields on page F2-2415](#).

<Rd> The destination register.

<Rn> The first operand register.

<Rm> The second operand register.

Operation

```
if ConditionPassed() then
    EncodingSpecificOperations();
    diff1 = SInt(R[n]<15:0>) - SInt(R[m]<15:0>);
    diff2 = SInt(R[n]<31:16>) - SInt(R[m]<31:16>);
    R[d]<15:0> = diff1<16:1>;
    R[d]<31:16> = diff2<16:1>;
```

F7.1.181 SMC (previously SMI)

Secure Monitor Call is a system instruction. For details see [SMC \(previously SMI\)](#) on page F7-3058.

F7.1.182 SMLABB, SMLABT, SMLATB, SMLATT

Signed Multiply Accumulate (halfwords) performs a signed multiply accumulate operation. The multiply acts on two signed 16-bit quantities, taken from either the bottom or the top half of their respective source registers. The other halves of these source registers are ignored. The 32-bit product is added to a 32-bit accumulate value and the result is written to the destination register.

If overflow occurs during the addition of the accumulate value, the instruction sets the Q flag in the APSR. It is not possible for overflow to occur during the multiplication.

Encoding T1 ARMv6T2, ARMv7

SMLA<x><y><c> <Rd>, <Rn>, <Rm>, <Ra>

15	14	13	12	11	10	9	8	7	6	5	4	3	2	1	0	15	14	13	12	11	10	9	8	7	6	5	4	3	2	1	0
1	1	1	1	1	0	1	1	0	0	0	1	Rn				Ra				Rd				0	0	N	M	Rm			

if Ra == '1111' then SEE SMULBB, SMULBT, SMULTB, SMULTT;
 d = UInt(Rd); n = UInt(Rn); m = UInt(Rm); a = UInt(Ra);
 n_high = (N == '1'); m_high = (M == '1');
 if d == 15 || n == 15 || m == 15 then UNPREDICTABLE; // ARMv8-A removes UNPREDICTABLE for R13

Encoding A1 ARMv5TE*, ARMv6*, ARMv7

SMLA<x><y><c> <Rd>, <Rn>, <Rm>, <Ra>

31	30	29	28	27	26	25	24	23	22	21	20	19	18	17	16	15	14	13	12	11	10	9	8	7	6	5	4	3	2	1	0
cond		0	0	0	1	0	0	0	0	Rd				Ra				Rm				1	M	N	0	Rn					

d = UInt(Rd); n = UInt(Rn); m = UInt(Rm); a = UInt(Ra);
 n_high = (N == '1'); m_high = (M == '1');
 if d == 15 || n == 15 || m == 15 || a == 15 then UNPREDICTABLE;

For information about the CONSTRAINED UNPREDICTABLE behavior of this instruction, see [Appendix A Architectural Constraints on UNPREDICTABLE behaviors](#).

Assembler syntax

SMLA<x><y>{<c>}{<q>} <Rd>, <Rn>, <Rm>, <Ra>

where:

- <x> Specifies which half of the source register <Rn> is used as the first multiply operand. If <x> is B, then the bottom half (bits[15:0]) of <Rn> is used. If <x> is T, then the top half (bits[31:16]) of <Rn> is used.
- <y> Specifies which half of the source register <Rm> is used as the second multiply operand. If <y> is B, then the bottom half (bits[15:0]) of <Rm> is used. If <y> is T, then the top half (bits[31:16]) of <Rm> is used.
- <c>, <q> See [Standard assembler syntax fields on page F2-2415](#).
- <Rd> The destination register.
- <Rn> The source register whose bottom or top half (selected by <x>) is the first multiply operand.
- <Rm> The source register whose bottom or top half (selected by <y>) is the second multiply operand.
- <Ra> The register that contains the accumulate value.

Operation

```
if ConditionPassed() then
    EncodingSpecificOperations();
    operand1 = if n_high then R[n]<31:16> else R[n]<15:0>;
    operand2 = if m_high then R[m]<31:16> else R[m]<15:0>;
    result = SInt(operand1) * SInt(operand2) + SInt(R[a]);
    R[d] = result<31:0>;
    if result != SInt(result<31:0>) then // Signed overflow
        APSR.Q = '1';
```

F7.1.183 SMLAD

Signed Multiply Accumulate Dual performs two signed 16×16 -bit multiplications. It adds the products to a 32-bit accumulate operand.

Optionally, the instruction can exchange the halfwords of the second operand before performing the arithmetic. This produces top \times bottom and bottom \times top multiplication.

This instruction sets the Q flag if the accumulate operation overflows. Overflow cannot occur during the multiplications.

Encoding T1 ARMv6T2, ARMv7

SMLAD{X}<C> <Rd>, <Rn>, <Rm>, <Ra>

15	14	13	12	11	10	9	8	7	6	5	4	3	2	1	0	15	14	13	12	11	10	9	8	7	6	5	4	3	2	1	0
1	1	1	1	1	0	1	1	0	0	1	0	Rn			Ra			Rd			0	0	0	M	Rm						

```

if Ra == '1111' then SEE SMUAD;
d = UInt(Rd); n = UInt(Rn); m = UInt(Rm); a = UInt(Ra);
m_swap = (M == '1');
if d == 15 || n == 15 || m == 15 then UNPREDICTABLE; // ARMv8-A removes UNPREDICTABLE for R13
    
```

Encoding A1 ARMv6*, ARMv7

SMLAD{X}<C> <Rd>, <Rn>, <Rm>, <Ra>

31	30	29	28	27	26	25	24	23	22	21	20	19	18	17	16	15	14	13	12	11	10	9	8	7	6	5	4	3	2	1	0
cond		0	1	1	1	0	0	0	0	Rd			Ra			Rm			0	0	M	1	Rn								

```

if Ra == '1111' then SEE SMUAD;
d = UInt(Rd); n = UInt(Rn); m = UInt(Rm); a = UInt(Ra);
m_swap = (M == '1');
if d == 15 || n == 15 || m == 15 then UNPREDICTABLE;
    
```

For information about the CONSTRAINED UNPREDICTABLE behavior of this instruction, see [Appendix A Architectural Constraints on UNPREDICTABLE behaviors](#).

Assembler syntax

SMLAD{X}{<c>}{<q>} <Rd>, <Rn>, <Rm>, <Ra>

where:

- X If X is present (encoded as M = 1), the multiplications are bottom × top and top × bottom.
 If the X is omitted (encoded as M = 0), the multiplications are bottom × bottom and top × top.
- <c>, <q> See [Standard assembler syntax fields on page F2-2415](#).
- <Rd> The destination register.
- <Rn> The first operand register.
- <Rm> The second operand register.
- <Ra> The register that contains the accumulate value.

Operation

```
if ConditionPassed() then
    EncodingSpecificOperations();
    operand2 = if m_swap then ROR(R[m],16) else R[m];
    product1 = SInt(R[n]<15:0>) * SInt(operand2<15:0>);
    product2 = SInt(R[n]<31:16>) * SInt(operand2<31:16>);
    result = product1 + product2 + SInt(R[a]);
    R[d] = result<31:0>;
    if result != SInt(result<31:0>) then // Signed overflow
        APSR.Q = '1';
```

F7.1.184 SMLAL

Signed Multiply Accumulate Long multiplies two signed 32-bit values to produce a 64-bit value, and accumulates this with a 64-bit value.

In A32 instructions, the condition flags can optionally be updated based on the result. Use of this option adversely affects performance on many implementations.

Encoding T1 ARMv6T2, ARMv7

SMLAL<C> <RdLo>, <RdHi>, <Rn>, <Rm>

15	14	13	12	11	10	9	8	7	6	5	4	3	2	1	0	15	14	13	12	11	10	9	8	7	6	5	4	3	2	1	0
1	1	1	1	1	0	1	1	1	1	0	0	Rn				RdLo				RdHi				0	0	0	0	Rm			

```
dLo = UInt(RdLo); dHi = UInt(RdHi); n = UInt(Rn); m = UInt(Rm); setflags = FALSE;
if dLo == 15 || dHi == 15 || n == 15 || m == 15 then UNPREDICTABLE;
// ARMv8-A removes UNPREDICTABLE for R13
if dHi == dLo then UNPREDICTABLE;
```

Encoding A1 ARMv4*, ARMv5T*, ARMv6*, ARMv7

SMLAL{S}<C> <RdLo>, <RdHi>, <Rn>, <Rm>

31	30	29	28	27	26	25	24	23	22	21	20	19	18	17	16	15	14	13	12	11	10	9	8	7	6	5	4	3	2	1	0
cond		0	0	0	0	1	1	1	S	RdHi				RdLo				Rm				1	0	0	1	Rn					

```
dLo = UInt(RdLo); dHi = UInt(RdHi); n = UInt(Rn); m = UInt(Rm); setflags = (S == '1');
if dLo == 15 || dHi == 15 || n == 15 || m == 15 then UNPREDICTABLE;
if dHi == dLo then UNPREDICTABLE;
```

For information about the CONSTRAINED UNPREDICTABLE behavior of this instruction, see [Appendix A Architectural Constraints on UNPREDICTABLE behaviors](#), and particularly *SMLAL* on page AppxA-4725.

Assembler syntax

SMLAL{S}{<c>}{<q>} <RdLo>, <RdHi>, <Rn>, <Rm>

where:

- S If S is present, the instruction updates the flags. Otherwise, the flags are not updated.
S can be specified only for the A32 instruction set.
- <c>, <q> See [Standard assembler syntax fields on page F2-2415](#).
- <RdLo> Supplies the lower 32 bits of the accumulate value, and is the destination register for the lower 32 bits of the result.
- <RdHi> Supplies the upper 32 bits of the accumulate value, and is the destination register for the upper 32 bits of the result.
- <Rn> The first operand register.
- <Rm> The second operand register.

The pre-UAL syntax SMLAL<c>S is equivalent to SMLALS<c>.

Operation

```
if ConditionPassed() then
    EncodingSpecificOperations();
    result = SInt(R[n]) * SInt(R[m]) + SInt(R[dHi]:R[dLo]);
    R[dHi] = result<63:32>;
    R[dLo] = result<31:0>;
    if setflags then
        APSR.N = result<63>;
        APSR.Z = IsZeroBit(result<63:0>);
        // APSR.C, APSR.V unchanged
```

F7.1.185 SMLALBB, SMLALBT, SMLALTB, SMLALTT

Signed Multiply Accumulate Long (halfwords) multiplies two signed 16-bit values to produce a 32-bit value, and accumulates this with a 64-bit value. The multiply acts on two signed 16-bit quantities, taken from either the bottom or the top half of their respective source registers. The other halves of these source registers are ignored. The 32-bit product is sign-extended and accumulated with a 64-bit accumulate value.

Overflow is possible during this instruction, but only as a result of the 64-bit addition. This overflow is not detected if it occurs. Instead, the result wraps around modulo 2^{64} .

Encoding T1 ARMv6T2, ARMv7

SMLAL<x><y><c> <RdLo>, <RdHi>, <Rn>, <Rm>

15	14	13	12	11	10	9	8	7	6	5	4	3	2	1	0	15	14	13	12	11	10	9	8	7	6	5	4	3	2	1	0
1	1	1	1	1	0	1	1	1	1	0	0	Rn				RdLo				RdHi				1	0	N	M	Rm			

```
dLo = UInt(RdLo); dHi = UInt(RdHi); n = UInt(Rn); m = UInt(Rm);
n_high = (N == '1'); m_high = (M == '1');
if dLo == 15 || dHi == 15 || n == 15 || m == 15 then UNPREDICTABLE;
// ARMv8-A removes UNPREDICTABLE for R13
if dHi == dLo then UNPREDICTABLE;
```

Encoding A1 ARMv5TE*, ARMv6*, ARMv7

SMLAL<x><y><c> <RdLo>, <RdHi>, <Rn>, <Rm>

31	30	29	28	27	26	25	24	23	22	21	20	19	18	17	16	15	14	13	12	11	10	9	8	7	6	5	4	3	2	1	0
cond				0	0	0	1	0	1	0	0	RdHi				RdLo				Rm				1	M	N	0	Rn			

```
dLo = UInt(RdLo); dHi = UInt(RdHi); n = UInt(Rn); m = UInt(Rm);
n_high = (N == '1'); m_high = (M == '1');
if dLo == 15 || dHi == 15 || n == 15 || m == 15 then UNPREDICTABLE;
if dHi == dLo then UNPREDICTABLE;
```

For information about the CONSTRAINED UNPREDICTABLE behavior of this instruction, see [Appendix A Architectural Constraints on UNPREDICTABLE behaviors](#), and particularly [SMLALBB](#), [SMLALBT](#), [SMLALTB](#), [SMLALTT](#) on page AppxA-4725.

Assembler syntax

SMLAL<x><y>{<c>}{<q>} <RdLo>, <RdHi>, <Rn>, <Rm>

where:

- <x> Specifies which half of the source register <Rn> is used as the first multiply operand. If <x> is B, then the bottom half (bits[15:0]) of <Rn> is used. If <x> is T, then the top half (bits[31:16]) of <Rn> is used.
- <y> Specifies which half of the source register <Rm> is used as the second multiply operand. If <y> is B, then the bottom half (bits[15:0]) of <Rm> is used. If <y> is T, then the top half (bits[31:16]) of <Rm> is used.
- <c>, <q> See *Standard assembler syntax fields* on page F2-2415.
- <RdLo> Supplies the lower 32 bits of the accumulate value, and is the destination register for the lower 32 bits of the result.
- <RdHi> Supplies the upper 32 bits of the accumulate value, and is the destination register for the upper 32 bits of the result.
- <Rn> The source register whose bottom or top half (selected by <x>) is the first multiply operand.
- <Rm> The source register whose bottom or top half (selected by <y>) is the second multiply operand.

Operation

```
if ConditionPassed() then
    EncodingSpecificOperations();
    operand1 = if n_high then R[n]<31:16> else R[n]<15:0>;
    operand2 = if m_high then R[m]<31:16> else R[m]<15:0>;
    result = SInt(operand1) * SInt(operand2) + SInt(R[dHi]:R[dLo]);
    R[dHi] = result<63:32>;
    R[dLo] = result<31:0>;
```

F7.1.186 SMLALD

Signed Multiply Accumulate Long Dual performs two signed 16×16 -bit multiplications. It adds the products to a 64-bit accumulate operand.

Optionally, the instruction can exchange the halfwords of the second operand before performing the arithmetic. This produces top \times bottom and bottom \times top multiplication.

Overflow is possible during this instruction, but only as a result of the 64-bit addition. This overflow is not detected if it occurs. Instead, the result wraps around modulo 2^{64} .

Encoding T1 ARMv6T2, ARMv7

SMLALD{X}<c> <RdLo>, <RdHi>, <Rn>, <Rm>

15	14	13	12	11	10	9	8	7	6	5	4	3	2	1	0	15	14	13	12	11	10	9	8	7	6	5	4	3	2	1	0
1	1	1	1	1	0	1	1	1	1	0	0	Rn				RdLo		RdHi		1		1		0		M	Rm				

```
dLo = UInt(RdLo); dHi = UInt(RdHi); n = UInt(Rn); m = UInt(Rm); m_swap = (M == '1');
if dLo == 15 || dHi == 15 || n == 15 || m == 15 then UNPREDICTABLE;
// ARMv8-A removes UNPREDICTABLE for R13
if dHi == dLo then UNPREDICTABLE;
```

Encoding A1 ARMv6*, ARMv7

SMLALD{X}<c> <RdLo>, <RdHi>, <Rn>, <Rm>

31	30	29	28	27	26	25	24	23	22	21	20	19	18	17	16	15	14	13	12	11	10	9	8	7	6	5	4	3	2	1	0																						
cond		0				1				1				0				1				0				0				RdHi				RdLo				Rm				0		0		M		1		Rn			

```
dLo = UInt(RdLo); dHi = UInt(RdHi); n = UInt(Rn); m = UInt(Rm); m_swap = (M == '1');
if dLo == 15 || dHi == 15 || n == 15 || m == 15 then UNPREDICTABLE;
if dHi == dLo then UNPREDICTABLE;
```

For information about the CONSTRAINED UNPREDICTABLE behavior of this instruction, see [Appendix A Architectural Constraints on UNPREDICTABLE behaviors](#), and particularly [SMLALD on page AppxA-4725](#).

Assembler syntax

SMLALD{X}{<c>}{<q>} <RdLo>, <RdHi>, <Rn>, <Rm>

where:

- X If X is present, the multiplications are bottom \times top and top \times bottom.
 If the X is omitted, the multiplications are bottom \times bottom and top \times top.
- <c>, <q> See *Standard assembler syntax fields* on page F2-2415.
- <RdLo> Supplies the lower 32 bits of the accumulate value, and is the destination register for the lower 32 bits of the result.
- <RdHi> Supplies the upper 32 bits of the accumulate value, and is the destination register for the upper 32 bits of the result.
- <Rn> The first operand register.
- <Rm> The second operand register.

Operation

```
if ConditionPassed() then
    EncodingSpecificOperations();
    operand2 = if m_swap then ROR(R[m],16) else R[m];
    product1 = SInt(R[n]<15:0>) * SInt(operand2<15:0>);
    product2 = SInt(R[n]<31:16>) * SInt(operand2<31:16>);
    result = product1 + product2 + SInt(R[dHi]:R[dLo]);
    R[dHi] = result<63:32>;
    R[dLo] = result<31:0>;
```

F7.1.187 SMLAWB, SMLAWT

Signed Multiply Accumulate (word by halfword) performs a signed multiply accumulate operation. The multiply acts on a signed 32-bit quantity and a signed 16-bit quantity. The signed 16-bit quantity is taken from either the bottom or the top half of its source register. The other half of the second source register is ignored. The top 32 bits of the 48-bit product are added to a 32-bit accumulate value and the result is written to the destination register. The bottom 16 bits of the 48-bit product are ignored.

If overflow occurs during the addition of the accumulate value, the instruction sets the Q flag in the APSR. No overflow can occur during the multiplication.

Encoding T1 ARMv6T2, ARMv7

SMLAW<y><c> <Rd>, <Rn>, <Rm>, <Ra>

15	14	13	12	11	10	9	8	7	6	5	4	3	2	1	0	15	14	13	12	11	10	9	8	7	6	5	4	3	2	1	0
1	1	1	1	1	0	1	1	0	0	1	1	Rn			Ra			Rd			0	0	0	M	Rm						

```
if Ra == '1111' then SEE SMULWB, SMULWT;
d = UInt(Rd); n = UInt(Rn); m = UInt(Rm); a = UInt(Ra); m_high = (M == '1');
if d == 15 || n == 15 || m == 15 then UNPREDICTABLE; // ARMv8-A removes UNPREDICTABLE for R13
```

Encoding A1 ARMv5TE*, ARMv6*, ARMv7

SMLAW<y><c> <Rd>, <Rn>, <Rm>, <Ra>

31	30	29	28	27	26	25	24	23	22	21	20	19	18	17	16	15	14	13	12	11	10	9	8	7	6	5	4	3	2	1	0
cond		0	0	0	1	0	0	1	0	Rd			Ra			Rm			1	M	0	0	Rn								

```
d = UInt(Rd); n = UInt(Rn); m = UInt(Rm); a = UInt(Ra); m_high = (M == '1');
if d == 15 || n == 15 || m == 15 || a == 15 then UNPREDICTABLE;
```

For information about the CONSTRAINED UNPREDICTABLE behavior of this instruction, see [Appendix A Architectural Constraints on UNPREDICTABLE behaviors](#).

Assembler syntax

SMLAW<y>{<c>}{<q>} <Rd>, <Rn>, <Rm>, <Ra>

where:

- <y> Specifies which half of the source register <Rm> is used as the second multiply operand. If <y> is B, then the bottom half (bits[15:0]) of <Rm> is used. If <y> is T, then the top half (bits[31:16]) of <Rm> is used.
- <c>, <q> See [Standard assembler syntax fields on page F2-2415](#).
- <Rd> The destination register.
- <Rn> The first operand register.
- <Rm> The source register whose bottom or top half (selected by <y>) is the second multiply operand.
- <Ra> The register that contains the accumulate value.

Operation

```
if ConditionPassed() then
    EncodingSpecificOperations();
    operand2 = if m_high then R[m]<31:16> else R[m]<15:0>;
    result = SInt(R[n]) * SInt(operand2) + (SInt(R[a]) << 16);
    R[d] = result<47:16>;
    if (result >> 16) != SInt(R[d]) then // Signed overflow
        APSR.Q = '1';
```

F7.1.188 SMLSD

Signed Multiply Subtract Dual performs two signed 16×16 -bit multiplications. It adds the difference of the products to a 32-bit accumulate operand.

Optionally, the instruction can exchange the halfwords of the second operand before performing the arithmetic. This produces top \times bottom and bottom \times top multiplication.

This instruction sets the Q flag if the accumulate operation overflows. Overflow cannot occur during the multiplications or subtraction.

Encoding T1 ARMv6T2, ARMv7

SMLSD{X}<C> <Rd>, <Rn>, <Rm>, <Ra>

15	14	13	12	11	10	9	8	7	6	5	4	3	2	1	0	15	14	13	12	11	10	9	8	7	6	5	4	3	2	1	0
1	1	1	1	1	0	1	1	0	1	0	0	Rn				Ra				Rd				0	0	0	M	Rm			

```
if Ra == '1111' then SEE SMUSD;
d = UInt(Rd); n = UInt(Rn); m = UInt(Rm); a = UInt(Ra); m_swap = (M == '1');
if d == 15 || n == 15 || m == 15 then UNPREDICTABLE; // ARMv8-A removes UNPREDICTABLE for R13
```

Encoding A1 ARMv6*, ARMv7

SMLSD{X}<C> <Rd>, <Rn>, <Rm>, <Ra>

31	30	29	28	27	26	25	24	23	22	21	20	19	18	17	16	15	14	13	12	11	10	9	8	7	6	5	4	3	2	1	0
cond				0	1	1	1	0	0	0	0	Rd				Ra				Rm				0	1	M	1	Rn			

```
if Ra == '1111' then SEE SMUSD;
d = UInt(Rd); n = UInt(Rn); m = UInt(Rm); a = UInt(Ra); m_swap = (M == '1');
if d == 15 || n == 15 || m == 15 then UNPREDICTABLE;
```

For information about the CONSTRAINED UNPREDICTABLE behavior of this instruction, see [Appendix A Architectural Constraints on UNPREDICTABLE behaviors](#).

Assembler syntax

SMLSD{X}{<c>}{<q>} <Rd>, <Rn>, <Rm>, <Ra>

where:

X	If X is present, the multiplications are bottom \times top and top \times bottom. If the X is omitted, the multiplications are bottom \times bottom and top \times top.
<c>, <q>	See <i>Standard assembler syntax fields</i> on page F2-2415.
<Rd>	The destination register.
<Rn>	The first operand register.
<Rm>	The second operand register.
<Ra>	The register that contains the accumulate value.

Operation

```
if ConditionPassed() then
    EncodingSpecificOperations();
    operand2 = if m_swap then ROR(R[m],16) else R[m];
    product1 = SInt(R[n]<15:0>) * SInt(operand2<15:0>);
    product2 = SInt(R[n]<31:16>) * SInt(operand2<31:16>);
    result = product1 - product2 + SInt(R[a]);
    R[d] = result<31:0>;
    if result != SInt(result<31:0>) then // Signed overflow
        APSR.Q = '1';
```

F7.1.189 SMLS LD

Signed Multiply Subtract Long Dual performs two signed 16×16 -bit multiplications. It adds the difference of the products to a 64-bit accumulate operand.

Optionally, the instruction can exchange the halfwords of the second operand before performing the arithmetic. This produces top \times bottom and bottom \times top multiplication.

Overflow is possible during this instruction, but only as a result of the 64-bit addition. This overflow is not detected if it occurs. Instead, the result wraps around modulo 2^{64} .

Encoding T1 ARMv6T2, ARMv7

SMLS LD{X}<c> <RdLo>, <RdHi>, <Rn>, <Rm>

15	14	13	12	11	10	9	8	7	6	5	4	3	2	1	0	15	14	13	12	11	10	9	8	7	6	5	4	3	2	1	0
1	1	1	1	1	0	1	1	1	1	0	1	Rn				RdLo		RdHi		1		1		M	Rm						

```
dLo = UInt(RdLo); dHi = UInt(RdHi); n = UInt(Rn); m = UInt(Rm); m_swap = (M == '1');
if dLo == 15 || dHi == 15 || n == 15 || m == 15 then UNPREDICTABLE;
// ARMv8-A removes UNPREDICTABLE for R13
if dHi == dLo then UNPREDICTABLE;
```

Encoding A1 ARMv6*, ARMv7

SMLS LD{X}<c> <RdLo>, <RdHi>, <Rn>, <Rm>

31	30	29	28	27	26	25	24	23	22	21	20	19	18	17	16	15	14	13	12	11	10	9	8	7	6	5	4	3	2	1	0																					
cond		0				1				1				0				1				0				0				RdHi				RdLo				Rm				0		1		M	1		Rn			

```
dLo = UInt(RdLo); dHi = UInt(RdHi); n = UInt(Rn); m = UInt(Rm); m_swap = (M == '1');
if dLo == 15 || dHi == 15 || n == 15 || m == 15 then UNPREDICTABLE;
if dHi == dLo then UNPREDICTABLE;
```

For information about the CONSTRAINED UNPREDICTABLE behavior of this instruction, see [Appendix A Architectural Constraints on UNPREDICTABLE behaviors](#), and particularly [SMLS LD on page AppxA-4725](#).

Assembler syntax

SMLS_{LD}{X}{<C>}{<q>} <RdLo>, <RdHi>, <Rn>, <Rm>

where:

- X If X is present, the multiplications are bottom × top and top × bottom.
 If the X is omitted, the multiplications are bottom × bottom and top × top.
- <C>, <q> See *Standard assembler syntax fields* on page F2-2415.
- <RdLo> Supplies the lower 32 bits of the accumulate value, and is the destination register for the lower 32 bits of the result.
- <RdHi> Supplies the upper 32 bits of the accumulate value, and is the destination register for the upper 32 bits of the result.
- <Rn> The first operand register.
- <Rm> The second operand register.

Operation

```
if ConditionPassed() then
    EncodingSpecificOperations();
    operand2 = if m_swap then ROR(R[m],16) else R[m];
    product1 = SInt(R[n]<15:0>) * SInt(operand2<15:0>);
    product2 = SInt(R[n]<31:16>) * SInt(operand2<31:16>);
    result = product1 - product2 + SInt(R[dHi]:R[dLo]);
    R[dHi] = result<63:32>;
    R[dLo] = result<31:0>;
```

F7.1.190 SMMLA

Signed Most Significant Word Multiply Accumulate multiplies two signed 32-bit values, extracts the most significant 32 bits of the result, and adds an accumulate value.

Optionally, the instruction can specify that the result is rounded instead of being truncated. In this case, the constant $0x80000000$ is added to the product before the high word is extracted.

Encoding T1 ARMv6T2, ARMv7

SMMLA{R}<C> <Rd>, <Rn>, <Rm>, <Ra>

15	14	13	12	11	10	9	8	7	6	5	4	3	2	1	0	15	14	13	12	11	10	9	8	7	6	5	4	3	2	1	0
1	1	1	1	1	0	1	1	0	1	0	1	Rn				Ra				Rd				0	0	0	R	Rm			

if Ra == '1111' then SEE SMMUL;
 d = UInt(Rd); n = UInt(Rn); m = UInt(Rm); a = UInt(Ra); round = (R == '1');
 if d == 15 || n == 15 || m == 15 then UNPREDICTABLE; // ARMv8-A removes UNPREDICTABLE for R13

Encoding A1 ARMv6*, ARMv7

SMMLA{R}<C> <Rd>, <Rn>, <Rm>, <Ra>

31	30	29	28	27	26	25	24	23	22	21	20	19	18	17	16	15	14	13	12	11	10	9	8	7	6	5	4	3	2	1	0
cond		0	1	1	1	0	1	0	1	Rd				Ra				Rm				0	0	R	1	Rn					

if Ra == '1111' then SEE SMMUL;
 d = UInt(Rd); n = UInt(Rn); m = UInt(Rm); a = UInt(Ra); round = (R == '1');
 if d == 15 || n == 15 || m == 15 then UNPREDICTABLE;

For information about the CONSTRAINED UNPREDICTABLE behavior of this instruction, see [Appendix A Architectural Constraints on UNPREDICTABLE behaviors](#).

Assembler syntax

SMMLA{R}{<c>}{<q>} <Rd>, <Rn>, <Rm>, <Ra>

where:

- R If R is present, the multiplication is rounded.
 If the R is omitted, the multiplication is truncated.
- <c>, <q> See [Standard assembler syntax fields on page F2-2415](#).
- <Rd> The destination register.
- <Rn> The register that contains the first multiply operand.
- <Rm> The register that contains the second multiply operand.
- <Ra> The register that contains the accumulate value.

Operation

```
if ConditionPassed() then
    EncodingSpecificOperations();
    result = (SInt(R[a]) << 32) + SInt(R[n]) * SInt(R[m]);
    if round then result = result + 0x80000000;
    R[d] = result<63:32>;
```

F7.1.191 SMMLS

Signed Most Significant Word Multiply Subtract multiplies two signed 32-bit values, subtracts the result from a 32-bit accumulate value that is shifted left by 32 bits, and extracts the most significant 32 bits of the result of that subtraction.

Optionally, the instruction can specify that the result of the instruction is rounded instead of being truncated. In this case, the constant `0x80000000` is added to the result of the subtraction before the high word is extracted.

Encoding T1 ARMv6T2, ARMv7

SMMLS{R}<C> <Rd>, <Rn>, <Rm>, <Ra>

15	14	13	12	11	10	9	8	7	6	5	4	3	2	1	0	15	14	13	12	11	10	9	8	7	6	5	4	3	2	1	0
1	1	1	1	1	0	1	1	0	1	1	0	Rn				Ra				Rd				0	0	0	R	Rm			

```
d = UInt(Rd); n = UInt(Rn); m = UInt(Rm); a = UInt(Ra); round = (R == '1');
if d == 15 || n == 15 || m == 15 || a == 15 then UNPREDICTABLE;
// ARMv8-A removes UNPREDICTABLE for R13
```

Encoding A1 ARMv6*, ARMv7

SMMLS{R}<C> <Rd>, <Rn>, <Rm>, <Ra>

31	30	29	28	27	26	25	24	23	22	21	20	19	18	17	16	15	14	13	12	11	10	9	8	7	6	5	4	3	2	1	0
cond				0	1	1	1	0	1	0	1	Rd				Ra				Rm				1	1	R	1	Rn			

```
d = UInt(Rd); n = UInt(Rn); m = UInt(Rm); a = UInt(Ra); round = (R == '1');
if d == 15 || n == 15 || m == 15 || a == 15 then UNPREDICTABLE;
```

For information about the CONSTRAINED UNPREDICTABLE behavior of this instruction, see [Appendix A Architectural Constraints on UNPREDICTABLE behaviors](#).

Assembler syntax

SMMLS{R}{<c>}{<q>} <Rd>, <Rn>, <Rm>, <Ra>

where:

- R If R is present, the multiplication is rounded.
 If the R is omitted, the multiplication is truncated.
- <c>, <q> See [Standard assembler syntax fields on page F2-2415](#).
- <Rd> The destination register.
- <Rn> The register that contains the first multiply operand.
- <Rm> The register that contains the second multiply operand.
- <Ra> The register that contains the accumulate value.

Operation

```
if ConditionPassed() then
    EncodingSpecificOperations();
    result = (SInt(R[a]) << 32) - SInt(R[n]) * SInt(R[m]);
    if round then result = result + 0x80000000;
    R[d] = result<63:32>;
```

F7.1.192 SMMUL

Signed Most Significant Word Multiply multiplies two signed 32-bit values, extracts the most significant 32 bits of the result, and writes those bits to the destination register.

Optionally, the instruction can specify that the result is rounded instead of being truncated. In this case, the constant $0x80000000$ is added to the product before the high word is extracted.

Encoding T1 ARMv6T2, ARMv7

SMMUL{R}<C> <Rd>, <Rn>, <Rm>

15	14	13	12	11	10	9	8	7	6	5	4	3	2	1	0	15	14	13	12	11	10	9	8	7	6	5	4	3	2	1	0
1	1	1	1	1	0	1	1	0	1	0	1	Rn				1	1	1	1	Rd				0	0	0	R	Rm			

d = UInt(Rd); n = UInt(Rn); m = UInt(Rm); round = (R == '1');
 if d == 15 || n == 15 || m == 15 then UNPREDICTABLE; // ARMv8-A removes UNPREDICTABLE for R13

Encoding A1 ARMv6*, ARMv7

SMMUL{R}<C> <Rd>, <Rn>, <Rm>

31	30	29	28	27	26	25	24	23	22	21	20	19	18	17	16	15	14	13	12	11	10	9	8	7	6	5	4	3	2	1	0
cond		0	1	1	1	0	1	0	1	Rd				1	1	1	1	Rm				0	0	R	1	Rn					

d = UInt(Rd); n = UInt(Rn); m = UInt(Rm); round = (R == '1');
 if d == 15 || n == 15 || m == 15 then UNPREDICTABLE;

For information about the CONSTRAINED UNPREDICTABLE behavior of this instruction, see [Appendix A Architectural Constraints on UNPREDICTABLE behaviors](#).

Assembler syntax

SMMUL{R}{<c>}{<q>} {<Rd>}, <Rn>, <Rm>

where:

- R If R is present, the multiplication is rounded.
 If the R is omitted, the multiplication is truncated.
- <c>, <q> See [Standard assembler syntax fields on page F2-2415](#).
- <Rd> The destination register.
- <Rn> The first operand register.
- <Rm> The second operand register.

Operation

```
if ConditionPassed() then
    EncodingSpecificOperations();
    result = SInt(R[n]) * SInt(R[m]);
    if round then result = result + 0x80000000;
    R[d] = result<63:32>;
```

F7.1.193 SMUAD

Signed Dual Multiply Add performs two signed 16×16 -bit multiplications. It adds the products together, and writes the result to the destination register.

Optionally, the instruction can exchange the halfwords of the second operand before performing the arithmetic. This produces top \times bottom and bottom \times top multiplication.

This instruction sets the Q flag if the addition overflows. The multiplications cannot overflow.

Encoding T1 ARMv6T2, ARMv7

SMUAD{X}<C> <Rd>, <Rn>, <Rm>

15	14	13	12	11	10	9	8	7	6	5	4	3	2	1	0	15	14	13	12	11	10	9	8	7	6	5	4	3	2	1	0
1	1	1	1	1	0	1	1	0	0	1	0	Rn			1	1	1	1	Rd			0	0	0	M	Rm					

d = UInt(Rd); n = UInt(Rn); m = UInt(Rm); m_swap = (M == '1');
 if d == 15 || n == 15 || m == 15 then UNPREDICTABLE; // ARMv8-A removes UNPREDICTABLE for R13

Encoding A1 ARMv6*, ARMv7

SMUAD{X}<C> <Rd>, <Rn>, <Rm>

31	30	29	28	27	26	25	24	23	22	21	20	19	18	17	16	15	14	13	12	11	10	9	8	7	6	5	4	3	2	1	0
cond		0	1	1	1	0	0	0	0	Rd			1	1	1	1	Rm			0	0	M	1	Rn							

d = UInt(Rd); n = UInt(Rn); m = UInt(Rm); m_swap = (M == '1');
 if d == 15 || n == 15 || m == 15 then UNPREDICTABLE;

For information about the CONSTRAINED UNPREDICTABLE behavior of this instruction, see [Appendix A Architectural Constraints on UNPREDICTABLE behaviors](#).

Assembler syntax

SMUAD{X}{<c>}{<q>} {<Rd>}, <Rn>, <Rm>

where:

- X If X is present, the multiplications are bottom \times top and top \times bottom.
 If the X is omitted, the multiplications are bottom \times bottom and top \times top.
- <c>, <q> See [Standard assembler syntax fields on page F2-2415](#).
- <Rd> The destination register.
- <Rn> The first operand register.
- <Rm> The second operand register.

Operation

```
if ConditionPassed() then
    EncodingSpecificOperations();
    operand2 = if m_swap then ROR(R[m],16) else R[m];
    product1 = SInt(R[n]<15:0>) * SInt(operand2<15:0>);
    product2 = SInt(R[n]<31:16>) * SInt(operand2<31:16>);
    result = product1 + product2;
    R[d] = result<31:0>;
    if result != SInt(result<31:0>) then // Signed overflow
        APSR.Q = '1';
```

F7.1.194 SMULBB, SMULBT, SMULTB, SMULTT

Signed Multiply (halfwords) multiplies two signed 16-bit quantities, taken from either the bottom or the top half of their respective source registers. The other halves of these source registers are ignored. The 32-bit product is written to the destination register. No overflow is possible during this instruction.

Encoding T1 ARMv6T2, ARMv7

SMUL<x><y><c> <Rd>, <Rn>, <Rm>

15	14	13	12	11	10	9	8	7	6	5	4	3	2	1	0	15	14	13	12	11	10	9	8	7	6	5	4	3	2	1	0
1	1	1	1	1	0	1	1	0	0	0	1	Rn			1	1	1	1	Rd			0	0	N	M	Rm					

d = UInt(Rd); n = UInt(Rn); m = UInt(Rm);
 n_high = (N == '1'); m_high = (M == '1');
 if d == 15 || n == 15 || m == 15 then UNPREDICTABLE; // ARMv8-A removes UNPREDICTABLE for R13

Encoding A1 ARMv5TE*, ARMv6*, ARMv7

SMUL<x><y><c> <Rd>, <Rn>, <Rm>

31	30	29	28	27	26	25	24	23	22	21	20	19	18	17	16	15	14	13	12	11	10	9	8	7	6	5	4	3	2	1	0
cond		0	0	0	1	0	1	1	0	Rd			(0)	(0)	(0)	(0)	Rm			1	M	N	0	Rn							

d = UInt(Rd); n = UInt(Rn); m = UInt(Rm);
 n_high = (N == '1'); m_high = (M == '1');
 if d == 15 || n == 15 || m == 15 then UNPREDICTABLE;

For information about the CONSTRAINED UNPREDICTABLE behavior of this instruction, see [Appendix A Architectural Constraints on UNPREDICTABLE behaviors](#).

Assembler syntax

SMUL<x><y>{<c>}{<q>} {<Rd>}, <Rn>, <Rm>

where:

- <x> Specifies which half of the source register <Rn> is used as the first multiply operand. If <x> is B, then the bottom half (bits[15:0]) of <Rn> is used. If <x> is T, then the top half (bits[31:16]) of <Rn> is used.
- <y> Specifies which half of the source register <Rm> is used as the second multiply operand. If <y> is B, then the bottom half (bits[15:0]) of <Rm> is used. If <y> is T, then the top half (bits[31:16]) of <Rm> is used.
- <c>, <q> See [Standard assembler syntax fields on page F2-2415](#).
- <Rd> The destination register.
- <Rn> The source register whose bottom or top half (selected by <x>) is the first multiply operand.
- <Rm> The source register whose bottom or top half (selected by <y>) is the second multiply operand.

Operation

```
if ConditionPassed() then
    EncodingSpecificOperations();
    operand1 = if n_high then R[n]<31:16> else R[n]<15:0>;
    operand2 = if m_high then R[m]<31:16> else R[m]<15:0>;
    result = SInt(operand1) * SInt(operand2);
    R[d] = result<31:0>;
    // Signed overflow cannot occur
```

F7.1.195 SMULL

Signed Multiply Long multiplies two 32-bit signed values to produce a 64-bit result.

In A32 instructions, the condition flags can optionally be updated based on the result. Use of this option adversely affects performance on many implementations.

Encoding T1 ARMv6T2, ARMv7

SMULL<C> <RdLo>, <RdHi>, <Rn>, <Rm>

15	14	13	12	11	10	9	8	7	6	5	4	3	2	1	0	15	14	13	12	11	10	9	8	7	6	5	4	3	2	1	0
1	1	1	1	1	0	1	1	1	0	0	0	Rn				RdLo				RdHi				0	0	0	0	Rm			

```
dLo = UInt(RdLo); dHi = UInt(RdHi); n = UInt(Rn); m = UInt(Rm); setflags = FALSE;
if dLo == 15 || dHi == 15 || n == 15 || m == 15 then UNPREDICTABLE;
// ARMv8-A removes UNPREDICTABLE for R13
if dHi == dLo then UNPREDICTABLE;
```

Encoding A1 ARMv4*, ARMv5T*, ARMv6*, ARMv7

SMULL{S}<C> <RdLo>, <RdHi>, <Rn>, <Rm>

31	30	29	28	27	26	25	24	23	22	21	20	19	18	17	16	15	14	13	12	11	10	9	8	7	6	5	4	3	2	1	0
cond		0	0	0	0	1	1	0	S	RdHi				RdLo				Rm				1	0	0	1	Rn					

```
dLo = UInt(RdLo); dHi = UInt(RdHi); n = UInt(Rn); m = UInt(Rm); setflags = (S == '1');
if dLo == 15 || dHi == 15 || n == 15 || m == 15 then UNPREDICTABLE;
if dHi == dLo then UNPREDICTABLE;
```

For information about the CONSTRAINED UNPREDICTABLE behavior of this instruction, see [Appendix A Architectural Constraints on UNPREDICTABLE behaviors](#), and particularly *SMULL* on page AppxA-4724.

Assembler syntax

SMULL{S}{<c>}{<q>} <RdLo>, <RdHi>, <Rn>, <Rm>

where:

S If S is present, the instruction updates the flags. Otherwise, the flags are not updated.
S can be specified only for the A32 instruction set.

<c>, <q> See *Standard assembler syntax fields* on page F2-2415.

<RdLo> Stores the lower 32 bits of the result.

<RdHi> Stores the upper 32 bits of the result.

<Rn> The first operand register.

<Rm> The second operand register.

The pre-UAL syntax SMULL<c>S is equivalent to SMULLS<c>.

Operation

```
if ConditionPassed() then
    EncodingSpecificOperations();
    result = SInt(R[n]) * SInt(R[m]);
    R[dHi] = result<63:32>;
    R[dLo] = result<31:0>;
    if setflags then
        APSR.N = result<63>;
        APSR.Z = IsZeroBit(result<63:0>);
        // APSR.C, APSR.V unchanged
```

F7.1.196 SMULWB, SMULWT

Signed Multiply (word by halfword) multiplies a signed 32-bit quantity and a signed 16-bit quantity. The signed 16-bit quantity is taken from either the bottom or the top half of its source register. The other half of the second source register is ignored. The top 32 bits of the 48-bit product are written to the destination register. The bottom 16 bits of the 48-bit product are ignored. No overflow is possible during this instruction.

Encoding T1 ARMv6T2, ARMv7

SMULW<y><c> <Rd>, <Rn>, <Rm>

15	14	13	12	11	10	9	8	7	6	5	4	3	2	1	0	15	14	13	12	11	10	9	8	7	6	5	4	3	2	1	0
1	1	1	1	1	0	1	1	0	0	1	1	Rn			1	1	1	1	Rd			0	0	0	M	Rm					

d = UInt(Rd); n = UInt(Rn); m = UInt(Rm); m_high = (M == '1');
 if d == 15 || n == 15 || m == 15 then UNPREDICTABLE; // ARMv8-A removes UNPREDICTABLE for R13

Encoding A1 ARMv5TE*, ARMv6*, ARMv7

SMULW<y><c> <Rd>, <Rn>, <Rm>

31	30	29	28	27	26	25	24	23	22	21	20	19	18	17	16	15	14	13	12	11	10	9	8	7	6	5	4	3	2	1	0
cond		0	0	0	1	0	0	1	0	Rd			(0)	(0)	(0)	(0)	Rm			1	M	1	0	Rn							

d = UInt(Rd); n = UInt(Rn); m = UInt(Rm); m_high = (M == '1');
 if d == 15 || n == 15 || m == 15 then UNPREDICTABLE;

For information about the CONSTRAINED UNPREDICTABLE behavior of this instruction, see [Appendix A Architectural Constraints on UNPREDICTABLE behaviors](#).

Assembler syntax

SMULW<y>{<c>}{<q>} {<Rd>}, <Rn>, <Rm>

where:

- <y> Specifies which half of the source register <Rm> is used as the second multiply operand. If <y> is B, then the bottom half (bits[15:0]) of <Rm> is used. If <y> is T, then the top half (bits[31:16]) of <Rm> is used.
- <c>, <q> See [Standard assembler syntax fields on page F2-2415](#).
- <Rd> The destination register.
- <Rn> The first operand register.
- <Rm> The source register whose bottom or top half (selected by <y>) is the second multiply operand.

Operation

```
if ConditionPassed() then
    EncodingSpecificOperations();
    operand2 = if m_high then R[m]<31:16> else R[m]<15:0>;
    product = SInt(R[n]) * SInt(operand2);
    R[d] = product<47:16>;
    // Signed overflow cannot occur
```

F7.1.197 SMUSD

Signed Multiply Subtract Dual performs two signed 16×16 -bit multiplications. It subtracts one of the products from the other, and writes the result to the destination register.

Optionally, the instruction can exchange the halfwords of the second operand before performing the arithmetic. This produces top \times bottom and bottom \times top multiplication.

Overflow cannot occur.

Encoding T1 ARMv6T2, ARMv7

SMUSD{X}<C> <Rd>, <Rn>, <Rm>

15	14	13	12	11	10	9	8	7	6	5	4	3	2	1	0	15	14	13	12	11	10	9	8	7	6	5	4	3	2	1	0
1	1	1	1	1	0	1	1	0	1	0	0	Rn			1	1	1	1	Rd			0	0	0	M	Rm					

d = UInt(Rd); n = UInt(Rn); m = UInt(Rm); m_swap = (M == '1');
 if d == 15 || n == 15 || m == 15 then UNPREDICTABLE; // ARMv8-A removes UNPREDICTABLE for R13

Encoding A1 ARMv6*, ARMv7

SMUSD{X}<C> <Rd>, <Rn>, <Rm>

31	30	29	28	27	26	25	24	23	22	21	20	19	18	17	16	15	14	13	12	11	10	9	8	7	6	5	4	3	2	1	0
cond		0	1	1	1	0	0	0	0	Rd			1	1	1	1	Rm			0	1	M	1	Rn							

d = UInt(Rd); n = UInt(Rn); m = UInt(Rm); m_swap = (M == '1');
 if d == 15 || n == 15 || m == 15 then UNPREDICTABLE;

For information about the CONSTRAINED UNPREDICTABLE behavior of this instruction, see [Appendix A Architectural Constraints on UNPREDICTABLE behaviors](#).

Assembler syntax

SMUSD{X}{<c>}{<q>} {<Rd>}, <Rn>, <Rm>

where:

- X If X is present, the multiplications are bottom \times top and top \times bottom.
 If the X is omitted, the multiplications are bottom \times bottom and top \times top.
- <c>, <q> See [Standard assembler syntax fields on page F2-2415](#).
- <Rd> The destination register.
- <Rn> The first operand register.
- <Rm> The second operand register.

Operation

```
if ConditionPassed() then
    EncodingSpecificOperations();
    operand2 = if m_swap then ROR(R[m],16) else R[m];
    product1 = SInt(R[n]<15:0>) * SInt(operand2<15:0>);
    product2 = SInt(R[n]<31:16>) * SInt(operand2<31:16>);
    result = product1 - product2;
    R[d] = result<31:0>;
    // Signed overflow cannot occur
```

F7.1.198 SRS

Store Return State is a system instruction. For details see [SRS \(T32\) on page F7-3060](#) and [SRS \(A32\) on page F7-3062](#).

F7.1.199 SSAT

Signed Saturate saturates an optionally-shifted signed value to a selectable signed range.

The Q flag is set if the operation saturates.

Encoding T1 ARMv6T2, ARMv7

SSAT<c> <Rd>, #<imm>, <Rn>{, <shift>}

15	14	13	12	11	10	9	8	7	6	5	4	3	2	1	0	15	14	13	12	11	10	9	8	7	6	5	4	3	2	1	0
1	1	1	1	0	(0)	1	1	0	0	sh	0		Rn			0	imm3		Rd		imm2	(0)		sat_imm							

```
if sh == '1' && (imm3:imm2) == '0000' then SEE SSAT16;
d = UInt(Rd); n = UInt(Rn); saturate_to = UInt(sat_imm)+1;
(shift_t, shift_n) = DecodeImmShift(sh:'0', imm3:imm2);
if d == 15 || n == 15 then UNPREDICTABLE; // ARMv8-A removes UNPREDICTABLE for R13
```

Encoding A1 ARMv6*, ARMv7

SSAT<c> <Rd>, #<imm>, <Rn>{, <shift>}

31	30	29	28	27	26	25	24	23	22	21	20	19	18	17	16	15	14	13	12	11	10	9	8	7	6	5	4	3	2	1	0
cond		0	1	1	0	1	0	1		sat_imm			Rd		imm5	sh	0	1			Rn										

```
d = UInt(Rd); n = UInt(Rn); saturate_to = UInt(sat_imm)+1;
(shift_t, shift_n) = DecodeImmShift(sh:'0', imm5);
if d == 15 || n == 15 then UNPREDICTABLE;
```

For information about the CONSTRAINED UNPREDICTABLE behavior of this instruction, see [Appendix A Architectural Constraints on UNPREDICTABLE behaviors](#).

Assembler syntax

SSAT{<c>}{<q>} <Rd>, #<imm>, <Rn> {, <shift>}

where:

- <c>, <q> See [Standard assembler syntax fields on page F2-2415](#).
- <Rd> The destination register.
- <imm> The bit position for saturation, in the range 1 to 32. The sat_imm field of the instruction encodes this bit position, by taking the value (<imm>-1).
- <Rn> The register that contains the value to be saturated.
- <shift> The optional shift, encoded in the sh bit and the immsh field, where immsh is:
- imm3:imm2 for encoding T1.
 - imm5 for encoding A1.
- <shift> must be one of:
- omitted** No shift. Encoded as sh = 0, immsh = 0b00000.
- LSL #<n> Left shift by <n> bits, with <n> in the range 1-31.
Encoded as sh = 0, immsh = <n>.
- ASR #<n> Arithmetic right shift by <n> bits, with <n> in the range 1-31.
Encoded as sh = 1, immsh = <n>.
- ASR #32 Arithmetic right shift by 32 bits, permitted only for encoding A1.
Encoded as sh = 1, immsh = 0b00000.

Note

An assembler can permit ASR #0 or LSL #0 to mean the same thing as omitting the shift, but this is not standard UAL and must not be used for disassembly.

Operation

```
if ConditionPassed() then
    EncodingSpecificOperations();
    operand = Shift(R[n], shift_t, shift_n, APSR.C); // APSR.C ignored
    (result, sat) = SignedSatQ(SInt(operand), saturate_to);
    R[d] = SignExtend(result, 32);
    if sat then
        APSR.Q = '1';
```

F7.1.200 SSAT16

Signed Saturate 16 saturates two signed 16-bit values to a selected signed range.

The Q flag is set if the operation saturates.

Encoding T1 ARMv6T2, ARMv7

SSAT16<c> <Rd>, #<imm>, <Rn>

15	14	13	12	11	10	9	8	7	6	5	4	3	2	1	0	15	14	13	12	11	10	9	8	7	6	5	4	3	2	1	0
1	1	1	1	0	(0)	1	1	0	0	1	0	Rn				0	0	0	0	Rd				0	0	(0)	(0)	sat_imm			

d = UInt(Rd); n = UInt(Rn); saturate_to = UInt(sat_imm)+1;
 if d == 15 || n == 15 then UNPREDICTABLE; // ARMv8-A removes UNPREDICTABLE for R13

Encoding A1 ARMv6*, ARMv7

SSAT16<c> <Rd>, #<imm>, <Rn>

31	30	29	28	27	26	25	24	23	22	21	20	19	18	17	16	15	14	13	12	11	10	9	8	7	6	5	4	3	2	1	0
cond		0	1	1	0	1	0	1	0	sat_imm			Rd				(1)	(1)	(1)	(1)	0	0	1	1	Rn						

d = UInt(Rd); n = UInt(Rn); saturate_to = UInt(sat_imm)+1;
 if d == 15 || n == 15 then UNPREDICTABLE;

For information about the CONSTRAINED UNPREDICTABLE behavior of this instruction, see [Appendix A Architectural Constraints on UNPREDICTABLE behaviors](#).

Assembler syntax

SSAT16{<c>}{<q>} <Rd>, #<imm>, <Rn>

where:

- <c>, <q> See [Standard assembler syntax fields on page F2-2415](#).
- <Rd> The destination register.
- <imm> The bit position for saturation, in the range 1 to 16. The sat_imm field of the instruction encodes this bit position, by taking the value (<imm>-1).
- <Rn> The register that contains the values to be saturated.

Operation

```
if ConditionPassed() then
    EncodingSpecificOperations();
    (result1, sat1) = SignedSatQ(SInt(R[n]<15:0>), saturate_to);
    (result2, sat2) = SignedSatQ(SInt(R[n]<31:16>), saturate_to);
    R[d]<15:0> = SignExtend(result1, 16);
    R[d]<31:16> = SignExtend(result2, 16);
    if sat1 || sat2 then
        APSR.Q = '1';
```

F7.1.201 SSAX

Signed Subtract and Add with Exchange exchanges the two halfwords of the second operand, performs one 16-bit integer subtraction and one 16-bit addition, and writes the results to the destination register. It sets the APSR.GE bits according to the results.

Encoding T1 ARMv6T2, ARMv7

SSAX<c> <Rd>, <Rn>, <Rm>

15	14	13	12	11	10	9	8	7	6	5	4	3	2	1	0	15	14	13	12	11	10	9	8	7	6	5	4	3	2	1	0
1	1	1	1	1	0	1	0	1	1	1	0	Rn				1	1	1	1	Rd				0	0	0	0	Rm			

d = UInt(Rd); n = UInt(Rn); m = UInt(Rm);
 if d == 15 || n == 15 || m == 15 then UNPREDICTABLE; // ARMv8-A removes UNPREDICTABLE for R13

Encoding A1 ARMv6*, ARMv7

SSAX<c> <Rd>, <Rn>, <Rm>

31	30	29	28	27	26	25	24	23	22	21	20	19	18	17	16	15	14	13	12	11	10	9	8	7	6	5	4	3	2	1	0		
cond		0	1	1	0	0	0	0	1	Rn				Rd				(1)	(1)	(1)	(1)	0	1	0	1	Rm							

d = UInt(Rd); n = UInt(Rn); m = UInt(Rm);
 if d == 15 || n == 15 || m == 15 then UNPREDICTABLE;

For information about the CONSTRAINED UNPREDICTABLE behavior of this instruction, see [Appendix A Architectural Constraints on UNPREDICTABLE behaviors](#).

Assembler syntax

SSAX{<c>}{<q>} {<Rd>}, <Rn>, <Rm>

where:

<c>, <q> See [Standard assembler syntax fields on page F2-2415](#).

<Rd> The destination register.

<Rn> The first operand register.

<Rm> The second operand register.

The pre-UAL syntax SSUBADDX<c> is equivalent to SSAX<c>.

Operation

```
if ConditionPassed() then
    EncodingSpecificOperations();
    sum = SInt(R[n]<15:0>) + SInt(R[m]<31:16>);
    diff = SInt(R[n]<31:16>) - SInt(R[m]<15:0>);
    R[d]<15:0> = sum<15:0>;
    R[d]<31:16> = diff<15:0>;
    APSR.GE<1:0> = if sum >= 0 then '11' else '00';
    APSR.GE<3:2> = if diff >= 0 then '11' else '00';
```

F7.1.202 SSUB8

Signed Subtract 8 performs four 8-bit signed integer subtractions, and writes the results to the destination register. It sets the APSR.GE bits according to the results of the subtractions.

Encoding T1 ARMv6T2, ARMv7

SSUB8<c> <Rd>, <Rn>, <Rm>

15	14	13	12	11	10	9	8	7	6	5	4	3	2	1	0	15	14	13	12	11	10	9	8	7	6	5	4	3	2	1	0
1	1	1	1	1	0	1	0	1	1	0	0	Rn			1	1	1	1	Rd			0	0	0	0	Rm					

d = UInt(Rd); n = UInt(Rn); m = UInt(Rm);
 if d == 15 || n == 15 || m == 15 then UNPREDICTABLE; // ARMv8-A removes UNPREDICTABLE for R13

Encoding A1 ARMv6*, ARMv7

SSUB8<c> <Rd>, <Rn>, <Rm>

31	30	29	28	27	26	25	24	23	22	21	20	19	18	17	16	15	14	13	12	11	10	9	8	7	6	5	4	3	2	1	0
cond		0	1	1	0	0	0	0	1	Rn			Rd			(1)	(1)	(1)	(1)	1	1	1	1	Rm							

d = UInt(Rd); n = UInt(Rn); m = UInt(Rm);
 if d == 15 || n == 15 || m == 15 then UNPREDICTABLE;

For information about the CONSTRAINED UNPREDICTABLE behavior of this instruction, see [Appendix A Architectural Constraints on UNPREDICTABLE behaviors](#).

Assembler syntax

SSUB8{<c>}{<q>} {<Rd>}, <Rn>, <Rm>

where:

<c>, <q> See *Standard assembler syntax fields* on page F2-2415.

<Rd> The destination register.

<Rn> The first operand register.

<Rm> The second operand register.

Operation

```
if ConditionPassed() then
    EncodingSpecificOperations();
    diff1 = SInt(R[n]<7:0>) - SInt(R[m]<7:0>);
    diff2 = SInt(R[n]<15:8>) - SInt(R[m]<15:8>);
    diff3 = SInt(R[n]<23:16>) - SInt(R[m]<23:16>);
    diff4 = SInt(R[n]<31:24>) - SInt(R[m]<31:24>);
    R[d]<7:0> = diff1<7:0>;
    R[d]<15:8> = diff2<7:0>;
    R[d]<23:16> = diff3<7:0>;
    R[d]<31:24> = diff4<7:0>;
    APSR.GE<0> = if diff1 >= 0 then '1' else '0';
    APSR.GE<1> = if diff2 >= 0 then '1' else '0';
    APSR.GE<2> = if diff3 >= 0 then '1' else '0';
    APSR.GE<3> = if diff4 >= 0 then '1' else '0';
```

F7.1.203 SSUB16

Signed Subtract 16 performs two 16-bit signed integer subtractions, and writes the results to the destination register. It sets the APSR.GE bits according to the results of the subtractions.

Encoding T1 ARMv6T2, ARMv7

SSUB16<c> <Rd>, <Rn>, <Rm>

15	14	13	12	11	10	9	8	7	6	5	4	3	2	1	0	15	14	13	12	11	10	9	8	7	6	5	4	3	2	1	0
1	1	1	1	1	0	1	0	1	1	0	1	Rn				1	1	1	1	Rd				0	0	0	0	Rm			

d = UInt(Rd); n = UInt(Rn); m = UInt(Rm);
 if d == 15 || n == 15 || m == 15 then UNPREDICTABLE; // ARMv8-A removes UNPREDICTABLE for R13

Encoding A1 ARMv6*, ARMv7

SSUB16<c> <Rd>, <Rn>, <Rm>

31	30	29	28	27	26	25	24	23	22	21	20	19	18	17	16	15	14	13	12	11	10	9	8	7	6	5	4	3	2	1	0
cond		0	1	1	0	0	0	0	1	Rn				Rd				(1)	(1)	(1)	(1)	0	1	1	1	Rm					

d = UInt(Rd); n = UInt(Rn); m = UInt(Rm);
 if d == 15 || n == 15 || m == 15 then UNPREDICTABLE;

For information about the CONSTRAINED UNPREDICTABLE behavior of this instruction, see [Appendix A Architectural Constraints on UNPREDICTABLE behaviors](#).

Assembler syntax

SSUB16{<c>}{<q>} {<Rd>}, <Rn>, <Rm>

where:

<c>, <q> See [Standard assembler syntax fields on page F2-2415](#).

<Rd> The destination register.

<Rn> The first operand register.

<Rm> The second operand register.

Operation

```
if ConditionPassed() then
    EncodingSpecificOperations();
    diff1 = SInt(R[n]<15:0>) - SInt(R[m]<15:0>);
    diff2 = SInt(R[n]<31:16>) - SInt(R[m]<31:16>);
    R[d]<15:0> = diff1<15:0>;
    R[d]<31:16> = diff2<15:0>;
    APSR.GE<1:0> = if diff1 >= 0 then '11' else '00';
    APSR.GE<3:2> = if diff2 >= 0 then '11' else '00';
```

F7.1.204 STC, STC2

Store Coprocessor stores data from a coprocessor to a sequence of consecutive memory addresses. If no coprocessor can execute the instruction, an Undefined Instruction exception is generated.

This is a generic coprocessor instruction. Some of the fields have no functionality defined by the architecture and are free for use by the coprocessor instruction set designer. These are the D bit, the CRd field, and in the Unindexed addressing mode only, the imm8 field. However, coprocessors CP8-CP15 are reserved for use by A32, and this manual defines the valid STC and STC2 instructions when coproc is in the range p8-p15. For more information see [Coprocesor support on page E1-2331](#).

In an implementation that includes EL2, the permitted STC access to a system control register can be trapped to Hyp mode, meaning that an attempt to execute an STC instruction in a Non-secure mode other than Hyp mode, that would be permitted in the absence of the Hyp trap controls, generates a Hyp Trap exception. For more information, see [Trapping general CP14 accesses to debug registers on page G1-3515](#).

———— Note ————

For simplicity, the STC pseudocode does not show this possible trap to Hyp mode.

Encoding T1/A1 ARMv6T2, ARMv7 for encoding T1
 ARMv4*, ARMv5T*, ARMv6*, ARMv7 for encoding A1

STC{L}<c> <coproc>, <CRd>, [<Rn>, #+/-<imm>]{!}
 STC{L}<c> <coproc>, <CRd>, [<Rn>], #+/-<imm>
 STC{L}<c> <coproc>, <CRd>, [<Rn>], <option>

15	14	13	12	11	10	9	8	7	6	5	4	3	2	1	0	15	14	13	12	11	10	9	8	7	6	5	4	3	2	1	0
1	1	1	0	1	1	0	P	U	D	W	0	Rn				CRd	coproc				imm8										
31	30	29	28	27	26	25	24	23	22	21	20	19	18	17	16	15	14	13	12	11	10	9	8	7	6	5	4	3	2	1	0
cond		1	1	0	P	U	D	W	0	Rn				CRd	coproc				imm8												

```

if P == '0' && U == '0' && D == '0' && W == '0' then UNDEFINED;
if P == '0' && U == '0' && D == '1' && W == '0' then SEE MCRR, MCRR2;
if coproc == '101x' then SEE "Advanced SIMD and Floating-point";
n = UInt(Rn); cp = UInt(coproc);
imm32 = ZeroExtend(imm8:'00', 32); index = (P == '1'); add = (U == '1'); wback = (W == '1');
if n == 15 && (wback || CurrentInstrSet() != InstrSet_A32) then UNPREDICTABLE;
    
```

Encoding T2/A2 ARMv6T2, ARMv7 for encoding T2
 ARMv5T*, ARMv6*, ARMv7 for encoding A2

STC2{L}<c> <coproc>, <CRd>, [<Rn>, #+/-<imm>]{!}
 STC2{L}<c> <coproc>, <CRd>, [<Rn>], #+/-<imm>
 STC2{L}<c> <coproc>, <CRd>, [<Rn>], <option>

15	14	13	12	11	10	9	8	7	6	5	4	3	2	1	0	15	14	13	12	11	10	9	8	7	6	5	4	3	2	1	0
1	1	1	1	1	1	0	P	U	D	W	0	Rn				CRd	coproc				imm8										
31	30	29	28	27	26	25	24	23	22	21	20	19	18	17	16	15	14	13	12	11	10	9	8	7	6	5	4	3	2	1	0
1		1	1	1	1	0	P	U	D	W	0	Rn				CRd	coproc				imm8										

```

if P == '0' && U == '0' && D == '0' && W == '0' then UNDEFINED;
if P == '0' && U == '0' && D == '1' && W == '0' then SEE MCRR, MCRR2;
if coproc == '101x' then UNDEFINED;
n = UInt(Rn); cp = UInt(coproc);
imm32 = ZeroExtend(imm8:'00', 32); index = (P == '1'); add = (U == '1'); wback = (W == '1');
if n == 15 && (wback || CurrentInstrSet() != InstrSet_A32) then UNPREDICTABLE;
    
```

For information about the CONSTRAINED UNPREDICTABLE behavior of this instruction, see [Appendix A Architectural Constraints on UNPREDICTABLE behaviors](#), and particularly *STC*, *STC2* on page AppxA-4726.

Advanced SIMD and floating-point See [Extension register load/store instructions](#) on page F5-2514

Assembler syntax

STC{2}{L}{<c>}{<q>} <coproc>, <CRd>, [<Rn>{, #+/-<imm>}] Offset. P = 1, W = 0.
 STC{2}{L}{<c>}{<q>} <coproc>, <CRd>, [<Rn>, #+/-<imm>]! Pre-indexed. P = 1, W = 1.
 STC{2}{L}{<c>}{<q>} <coproc>, <CRd>, [<Rn>], #+/-<imm> Post-indexed. P = 0, W = 1.
 STC{2}{L}{<c>}{<q>} <coproc>, <CRd>, [<Rn>], <option> Unindexed. P = 0, W = 0, U = 1.

where:

2 If specified, selects encoding T2/A2. If omitted, selects encoding T1/A1.
 L If specified, selects the D == 1 form of the encoding. If omitted, selects the D == 0 form.
 <c>, <q> See [Standard assembler syntax fields on page F2-2415](#). An A32 STC2 instruction must be unconditional.
 <coproc> The name of the coprocessor. The generic coprocessor names are p0-p15.
 <CRd> The coprocessor source register.
 <Rn> The base register. The SP can be used. In the A32 instruction set, for offset and unindexed addressing only, the PC can be used. However, ARM deprecates use of the PC.
 +/- Is + or omitted if the immediate offset is to be added to the base register value (add == TRUE), or – if it is to be subtracted (add == FALSE). #0 and #-0 generate different instructions.
 <imm> The immediate offset used for forming the address. Values are multiples of 4 in the range 0-1020. For the offset addressing syntax, <imm> can be omitted, meaning an offset of +0.
 <option> A coprocessor option. An integer in the range 0-255 enclosed in { }. Encoded in imm8.

The pre-UAL syntax STC<c>L is equivalent to STCL<c>.

Operation

```

if ConditionPassed() then
    EncodingSpecificOperations();
    if !Cproc_Accepted(cp, ThisInstr()) then
        GenerateCoproprocessorException();
    else
        NullCheckIfThumbEE(n);
        offset_addr = if add then (R[n] + imm32) else (R[n] - imm32);
        address = if index then offset_addr else R[n];
        repeat
            MemA[address,4] = Coproc_GetWordToStore(cp, ThisInstr());
            address = address + 4;
        until Coproc_DoneStoring(cp, ThisInstr());
        if wback then R[n] = offset_addr;
  
```

F7.1.205 STL

Store Release Word stores a word from a register to memory. The instruction also has memory ordering semantics as described in [Load-Acquire, Store-Release](#) on page E2-2355.

For more information about support for shared memory see [Synchronization and semaphores](#) on page E2-2369. For information about memory accesses see [Memory accesses](#) on page F2-2422.

Encoding T1 ARMv8

STL<c> <Rt>, [<Rn>]

15	14	13	12	11	10	9	8	7	6	5	4	3	2	1	0	15	14	13	12	11	10	9	8	7	6	5	4	3	2	1	0
1	1	1	0	1	0	0	0	1	1	0	0	Rn				Rt				(1)	(1)	(1)	(1)	1	0	1	0	(1)	(1)	(1)	(1)

t = UInt(Rt); n = UInt(Rn);
 if t == 15 || n == 15 then UNPREDICTABLE;

Encoding A1 ARMv8

STL <Rt>, [<Rn>]

31	30	29	28	27	26	25	24	23	22	21	20	19	18	17	16	15	14	13	12	11	10	9	8	7	6	5	4	3	2	1	0
cond		0	0	0	1	1	0	0	0	Rn				(1)	(1)	(1)	(1)	(1)	(1)	0	0	1	0	0	1	Rt					

t = UInt(Rt); n = UInt(Rn);
 if t == 15 || n == 15 then UNPREDICTABLE;

For information about the CONSTRAINED UNPREDICTABLE behavior of this instruction, see [Appendix A Architectural Constraints on UNPREDICTABLE behaviors](#).

Assembler syntax

STL{<c>}{<q>} <Rt>, [<Rn>]

where:

<c>, <q> See *Standard assembler syntax fields* on page F2-2415.

<Rt> The source register.

<Rn> The base register. The SP can be used.

Operation

```
if ConditionPassed() then
    EncodingSpecificOperations(); NullCheckIfThumbEE(n);
    address = R[n];
    acctype = AccType_ORDERED;
    aligned = (address == Align(address, 4));
    MemA_with_type[address, 4, acctype, aligned] = R[t];
```

F7.1.206 STLB

Store Release Byte stores a byte from a register to memory. The instruction also has memory ordering semantics as described in *Load-Acquire, Store-Release* on page E2-2355.

For more information about support for shared memory see *Synchronization and semaphores* on page E2-2369. For information about memory accesses see *Memory accesses* on page F2-2422.

Encoding T1 ARMv8

STLB<c> <Rt>, [<Rn>]

15	14	13	12	11	10	9	8	7	6	5	4	3	2	1	0	15	14	13	12	11	10	9	8	7	6	5	4	3	2	1	0
1	1	1	0	1	0	0	0	1	1	0	0	Rn				Rt				(1)	(1)	(1)	(1)	1	0	0	0	(1)	(1)	(1)	(1)

t = UInt(Rt); n = UInt(Rn);
 if t == 15 || n == 15 then UNPREDICTABLE;

Encoding A1 ARMv8

STLB <Rt>, [<Rn>]

31	30	29	28	27	26	25	24	23	22	21	20	19	18	17	16	15	14	13	12	11	10	9	8	7	6	5	4	3	2	1	0
cond				0	0	0	1	1	1	0	0	Rn				(1)	(1)	(1)	(1)	(1)	(1)	0	0	1	0	0	1	Rt			

t = UInt(Rt); n = UInt(Rn);
 if t == 15 || n == 15 then UNPREDICTABLE;

For information about the CONSTRAINED UNPREDICTABLE behavior of this instruction, see [Appendix A Architectural Constraints on UNPREDICTABLE behaviors](#).

Assembler syntax

STLB{<c>}{<q>} <Rt>, [<Rn>]

where:

<c>, <q> See *Standard assembler syntax fields* on page F2-2415.

<Rt> The source register.

<Rn> The base register. The SP can be used.

Operation

```
if ConditionPassed() then
    EncodingSpecificOperations(); NullCheckIfThumbEE(n);
    address = R[n];
    acctype = AccType_ORDERED;
    aligned = TRUE;
    MemA_with_type[address, 1, acctype, aligned] = R[t]<7:0>;
```

F7.1.207 STLEX

Store Release Exclusive Word stores a word from a register to memory if the executing PE has exclusive access to the memory addressed. The instruction also has memory ordering semantics as described in [Load-Acquire, Store-Release](#) on page E2-2355.

For more information about support for shared memory see [Synchronization and semaphores](#) on page E2-2369. For information about memory accesses see [Memory accesses](#) on page F2-2422.

Encoding T1 ARMv8

STLEX<c> <Rd>, <Rt>, [<Rn>]

15	14	13	12	11	10	9	8	7	6	5	4	3	2	1	0	15	14	13	12	11	10	9	8	7	6	5	4	3	2	1	0
1	1	1	0	1	0	0	0	1	1	0	0	Rn				Rt				(1)	(1)	(1)	(1)	1	1	1	0	Rd			

d = UInt(Rd); t = UInt(Rt); n = UInt(Rn);
 if d == 15 || t == 15 || n == 15 then UNPREDICTABLE;
 if d == n || d == t then UNPREDICTABLE;

Encoding A1 ARMv8

STLEX <Rd>, <Rt>, [<Rn>]

31	30	29	28	27	26	25	24	23	22	21	20	19	18	17	16	15	14	13	12	11	10	9	8	7	6	5	4	3	2	1	0
cond				0	0	0	1	1	0	0	0	Rn				Rd				(1)	(1)	1	0	1	0	0	1	Rt			

d = UInt(Rd); t = UInt(Rt); n = UInt(Rn);
 if d == 15 || t == 15 || n == 15 then UNPREDICTABLE;
 if d == n || d == t then UNPREDICTABLE;

For information about the CONSTRAINED UNPREDICTABLE behavior of this instruction, see [Appendix A Architectural Constraints on UNPREDICTABLE behaviors](#).

Assembler syntax

STLEX{<c>}{<q>} <Rd>, <Rt>, [<Rn>]

where:

<c>, <q> See [Standard assembler syntax fields on page F2-2415](#).

<Rd> The destination register for the returned status value. The value returned is:
0 If the operation updates memory.
1 If the operation fails to update memory.

<Rt> The source register.

<Rn> The base register. The SP can be used.

Operation

```
if ConditionPassed() then
    EncodingSpecificOperations(); NullCheckIfThumbEE(n);
    address = R[n];
    if AArch32.ExclusiveMonitorsPass(address,4) then
        acctype = AccType_ORDERED;
        aligned = (address == Align(address, 4));
        MemA_with_type[address, 4, acctype, aligned] = R[t];
        R[d] = ZeroExtend('0');
    else
        R[d] = ZeroExtend('1');
```

Aborts and alignment

If a synchronous Data Abort exception is generated by the execution of this instruction:

- Memory is not updated.
- <Rd> is not updated.

If [SCTLR.A](#) and [SCTLR.U](#) are both 0, a non word-aligned memory address causes UNPREDICTABLE behavior. Otherwise, a non word-aligned memory address causes an Alignment fault Data Abort exception to be generated, subject to the following rules:

- If `ExclusiveMonitorsPass()` returns TRUE, the exception is generated.
- Otherwise, it is IMPLEMENTATION DEFINED whether the exception is generated.

If `ExclusiveMonitorsPass()` returns FALSE and the memory address, if accessed, would generate a synchronous Data Abort exception, it is IMPLEMENTATION DEFINED whether the exception is generated.

F7.1.208 STLEXB

Store Release Exclusive Byte stores a byte from a register to memory if the executing PE has exclusive access to the memory addressed. The instruction also has memory ordering semantics as described in [Load-Acquire, Store-Release](#) on page E2-2355.

For more information about support for shared memory see [Synchronization and semaphores](#) on page E2-2369. For information about memory accesses see [Memory accesses](#) on page F2-2422.

Encoding T1 ARMv8

STLEXB<c> <Rd>, <Rt>, [<Rn>]

15	14	13	12	11	10	9	8	7	6	5	4	3	2	1	0	15	14	13	12	11	10	9	8	7	6	5	4	3	2	1	0
1	1	1	0	1	0	0	0	1	1	0	0	Rn				Rt				(1)	(1)	(1)	(1)	1	1	0	0	Rd			

d = UInt(Rd); t = UInt(Rt); n = UInt(Rn);
 if d == 15 || t == 15 || n == 15 then UNPREDICTABLE;
 if d == n || d == t then UNPREDICTABLE;

Encoding A1 ARMv8

STLEXB <Rd>, <Rt>, [<Rn>]

31	30	29	28	27	26	25	24	23	22	21	20	19	18	17	16	15	14	13	12	11	10	9	8	7	6	5	4	3	2	1	0
cond				0	0	0	1	1	1	0	0	Rn				Rd				(1)	(1)	1	0	1	0	0	1	Rt			

d = UInt(Rd); t = UInt(Rt); n = UInt(Rn);
 if d == 15 || t == 15 || n == 15 then UNPREDICTABLE;
 if d == n || d == t then UNPREDICTABLE;

For information about the CONSTRAINED UNPREDICTABLE behavior of this instruction, see [Appendix A Architectural Constraints on UNPREDICTABLE behaviors](#).

Assembler syntax

STLEXB{<c>}{<q>} <Rd>, <Rt>, [<Rn>]

where:

- <c>, <q> See [Standard assembler syntax fields on page F2-2415](#).
- <Rd> The destination register for the returned status value. The value returned is:
0 If the operation updates memory.
1 If the operation fails to update memory.
- <Rt> The source register.
- <Rn> The base register. The SP can be used.

Operation

```
if ConditionPassed() then
    EncodingSpecificOperations(); NullCheckIfThumbEE(n);
    address = R[n];
    if AArch32.ExclusiveMonitorsPass(address,1) then
        acctype = AccType_ORDERED;
        aligned = TRUE;
        MemA_with_type[address, 1, acctype, aligned] = R[t]<7:0>;
        R[d] = ZeroExtend('0');
    else
        R[d] = ZeroExtend('1');
```

Aborts

If a synchronous Data Abort exception is generated by the execution of this instruction:

- Memory is not updated.
- <Rd> is not updated.

If ExclusiveMonitorsPass() returns FALSE and the memory address, if accessed, would generate a synchronous Data Abort exception, it is IMPLEMENTATION DEFINED whether the exception is generated.

F7.1.209 STLEXD

Store Release Exclusive Dual stores a doubleword from two registers to memory if the executing PE has exclusive access to the memory addressed. The instruction also has memory ordering semantics as described in [Load-Acquire, Store-Release](#) on page E2-2355.

For more information about support for shared memory see [Synchronization and semaphores](#) on page E2-2369. For information about memory accesses see [Memory accesses](#) on page F2-2422.

Encoding T1 ARMv8

STLEXD<c> <Rd>, <Rt>, <Rt2>, [<Rn>]

15	14	13	12	11	10	9	8	7	6	5	4	3	2	1	0	15	14	13	12	11	10	9	8	7	6	5	4	3	2	1	0
1	1	1	0	1	0	0	0	1	1	0	0	Rn				Rt				Rt2				1	1	1	1	Rd			

d = UInt(Rd); t = UInt(Rt); t2 = UInt(Rt2); n = UInt(Rn);
 if d == 15 || t == 15 || t2 == 15 || n == 15 then UNPREDICTABLE;
 if d == n || d == t || d == t2 then UNPREDICTABLE;

Encoding A1 ARMv8

STLEXD <Rd>, <Rt>, <Rt2>, [<Rn>]

31	30	29	28	27	26	25	24	23	22	21	20	19	18	17	16	15	14	13	12	11	10	9	8	7	6	5	4	3	2	1	0
cond				0	0	0	1	1	0	1	0	Rn				Rd				(1)	(1)	1	0	1	0	0	1	Rt			

d = UInt(Rd); t = UInt(Rt); t2 = t+1; n = UInt(Rn);
 if d == 15 || Rt<0> == '1' || t2 == 15 || n == 15 then UNPREDICTABLE;
 if d == n || d == t || d == t2 then UNPREDICTABLE;

For information about the CONSTRAINED UNPREDICTABLE behavior of this instruction, see [Appendix A Architectural Constraints on UNPREDICTABLE behaviors](#), and particularly [STLEXD](#) on page AppxA-4742.

Assembler syntax

STLEXD{<c>}{<q>} <Rd>, <Rt>, <Rt2>, [<Rn>]

where:

- <c>, <q> See [Standard assembler syntax fields on page F2-2415](#).
- <Rd> The destination register for the returned status value. The value returned is:
0 If the operation updates memory.
1 If the operation fails to update memory.
- <Rt> The first source register. For an A32 instruction, <Rt> must be even-numbered and not R14.
- <Rt2> The second source register. For an A32 instruction, <Rt2> must be <R(t+1)>.
- <Rn> The base register. The SP can be used.

Operation

```
if ConditionPassed() then
    EncodingSpecificOperations(); NullCheckIfThumbEE(n);
    address = R[n];
    // Create doubleword to store such that R[t] will be stored at address and R[t2] at address+4.
    value = if BigEndian() then R[t]:R[t2] else R[t2]:R[t];
    if AArch32.ExclusiveMonitorsPass(address, 8) then
        acctype = AccType_ORDERED;
        aligned = (address == Align(address, 8));
        MemA_with_type[address, 8, acctype, aligned] = value;
        R[d] = ZeroExtend('0');
    else
        R[d] = ZeroExtend('1');
```

Aborts and alignment

If a synchronous Data Abort exception is generated by the execution of this instruction:

- Memory is not updated.
- <Rd> is not updated.

If **SCTLR.A** and **SCTLR.U** are both 0, a non word-aligned memory address causes UNPREDICTABLE behavior. Otherwise, a non word-aligned memory address causes an Alignment fault Data Abort exception to be generated, subject to the following rules:

- If `ExclusiveMonitorsPass()` returns TRUE, the exception is generated.
- Otherwise, it is IMPLEMENTATION DEFINED whether the exception is generated.

If `ExclusiveMonitorsPass()` returns FALSE and the memory address, if accessed, would generate a synchronous Data Abort exception, it is IMPLEMENTATION DEFINED whether the exception is generated.

F7.1.210 STLEXH

Store Release Exclusive Halfword stores a halfword from a register to memory if the executing PE has exclusive access to the memory addressed. The instruction also has memory ordering semantics as described in [Load-Acquire, Store-Release](#) on page E2-2355.

For more information about support for shared memory see [Synchronization and semaphores](#) on page E2-2369. For information about memory accesses see [Memory accesses](#) on page F2-2422.

Encoding T1 ARMv8

STLEXH<c> <Rd>, <Rt>, [<Rn>]

15	14	13	12	11	10	9	8	7	6	5	4	3	2	1	0	15	14	13	12	11	10	9	8	7	6	5	4	3	2	1	0
1	1	1	0	1	0	0	0	1	1	0	0	Rn				Rt				(1)	(1)	(1)	(1)	1	1	0	1	Rd			

d = UInt(Rd); t = UInt(Rt); n = UInt(Rn);
 if d == 15 || t == 15 || n == 15 then UNPREDICTABLE;
 if d == n || d == t then UNPREDICTABLE;

Encoding A1 ARMv8

STLEXH <Rd>, <Rt>, [<Rn>]

31	30	29	28	27	26	25	24	23	22	21	20	19	18	17	16	15	14	13	12	11	10	9	8	7	6	5	4	3	2	1	0
cond				0	0	0	1	1	1	1	0	Rn				Rd				(1)	(1)	1	0	1	0	0	1	Rt			

d = UInt(Rd); t = UInt(Rt); n = UInt(Rn);
 if d == 15 || t == 15 || n == 15 then UNPREDICTABLE;
 if d == n || d == t then UNPREDICTABLE;

For information about the CONSTRAINED UNPREDICTABLE behavior of this instruction, see [Appendix A Architectural Constraints on UNPREDICTABLE behaviors](#).

Assembler syntax

STLEXH{<c>}{<q>} <Rd>, <Rt>, [<Rn>]

where:

- <c>, <q> See [Standard assembler syntax fields on page F2-2415](#).
- <Rd> The destination register for the returned status value. The value returned is:
0 If the operation updates memory.
1 If the operation fails to update memory.
- <Rt> The source register.
- <Rn> The base register. The SP can be used.

Operation

```
if ConditionPassed() then
    EncodingSpecificOperations(); NullCheckIfThumbEE(n);
    address = R[n];
    if AArch32.ExclusiveMonitorsPass(address,2) then
        acctype = AccType_ORDERED;
        aligned = (address == Align(address, 2));
        MemA_with_type[address, 2, acctype, aligned] = R[t]<15:0>;
        R[d] = ZeroExtend('0');
    else
        R[d] = ZeroExtend('1');
```

Aborts and alignment

If a synchronous Data Abort exception is generated by the execution of this instruction:

- memory is not updated
- <Rd> is not updated.

If [SCTLR.A](#) and [SCTLR.U](#) are both 0, a non word-aligned memory address causes UNPREDICTABLE behavior. Otherwise, a non word-aligned memory address causes an Alignment fault Data Abort exception to be generated, subject to the following rules:

- If `ExclusiveMonitorsPass()` returns TRUE, the exception is generated.
- Otherwise, it is IMPLEMENTATION DEFINED whether the exception is generated.

If `ExclusiveMonitorsPass()` returns FALSE and the memory address, if accessed, would generate a synchronous Data Abort exception, it is IMPLEMENTATION DEFINED whether the exception is generated.

F7.1.211 STLH

Store Release Halfword stores a halfword from a register to memory. The instruction also has memory ordering semantics as described in *Load-Acquire, Store-Release* on page E2-2355.

For more information about support for shared memory see *Synchronization and semaphores* on page E2-2369. For information about memory accesses see *Memory accesses* on page F2-2422.

Encoding T1 ARMv8

STLH<c> <Rt>, [<Rn>]

15	14	13	12	11	10	9	8	7	6	5	4	3	2	1	0	15	14	13	12	11	10	9	8	7	6	5	4	3	2	1	0
1	1	1	0	1	0	0	0	1	1	0	0	Rn				Rt				(1)	(1)	(1)	(1)	1	0	0	1	(1)	(1)	(1)	(1)

t = UInt(Rt); n = UInt(Rn);
 if t == 15 || n == 15 then UNPREDICTABLE;

Encoding A1 ARMv8

STLH <Rt>, [<Rn>]

31	30	29	28	27	26	25	24	23	22	21	20	19	18	17	16	15	14	13	12	11	10	9	8	7	6	5	4	3	2	1	0
cond		0	0	0	1	1	1	1	0	Rn				(1)	(1)	(1)	(1)	(1)	(1)	0	0	1	0	0	1	Rt					

t = UInt(Rt); n = UInt(Rn);
 if t == 15 || n == 15 then UNPREDICTABLE;

For information about the CONSTRAINED UNPREDICTABLE behavior of this instruction, see [Appendix A Architectural Constraints on UNPREDICTABLE behaviors](#).

Assembler syntax

STLH{<c>}{<q>} <Rt>, [<Rn>]

where:

<c>, <q> See *Standard assembler syntax fields* on page F2-2415.

<Rt> The source register.

<Rn> The base register. The SP can be used.

Operation

```
if ConditionPassed() then
    EncodingSpecificOperations(); NullCheckIfThumbEE(n);
    address = R[n];
    acctype = AccType_ORDERED;
    aligned = (address == Align(address, 2));
    MemA_with_type[address, 2, acctype, aligned] = R[t]<15:0>;
```

F7.1.212 STM (STMIA, STMEA)

Store Multiple Increment After (Store Multiple Empty Ascending) stores multiple registers to consecutive memory locations using an address from a base register. The consecutive memory locations start at this address, and the address just above the last of those locations can optionally be written back to the base register.

For details of related system instructions see [STM \(User registers\) on page F7-3064](#).

Encoding T1 ARMv4T, ARMv5T*, ARMv6*, ARMv7 (not in ThumbEE)

STM<c> <Rn>!, <registers>

15	14	13	12	11	10	9	8	7	6	5	4	3	2	1	0
1	1	0	0	0	Rn	register_list									

if CurrentInstrSet() == InstrSet_T32EE then SEE "ThumbEE instructions";
 n = UInt(Rn); registers = '0000000':register_list; wback = TRUE;
 if BitCount(registers) < 1 then UNPREDICTABLE;

Encoding T2 ARMv6T2, ARMv7

STM<c>.W <Rn>{!}, <registers>

15	14	13	12	11	10	9	8	7	6	5	4	3	2	1	0	15	14	13	12	11	10	9	8	7	6	5	4	3	2	1	0
1	1	1	0	1	0	0	0	1	0	W	0	Rn	(0)	M	(0)	register_list															

n = UInt(Rn); registers = '0':M:'0':register_list; wback = (W == '1');
 if n == 15 || BitCount(registers) < 2 then UNPREDICTABLE;
 if wback && registers<n> == '1' then UNPREDICTABLE;

Encoding A1 ARMv4*, ARMv5T*, ARMv6*, ARMv7

STM<c> <Rn>{!}, <registers>

31	30	29	28	27	26	25	24	23	22	21	20	19	18	17	16	15	14	13	12	11	10	9	8	7	6	5	4	3	2	1	0
cond		1	0	0	0	1	0	W	0	Rn	register_list																				

n = UInt(Rn); registers = register_list; wback = (W == '1');
 if n == 15 || BitCount(registers) < 1 then UNPREDICTABLE;

For information about the CONSTRAINED UNPREDICTABLE behavior of this instruction, see [Appendix A Architectural Constraints on UNPREDICTABLE behaviors](#), and particularly [STM \(STMIA, STMEA\) on page AppxA-4727](#).

ThumbEE instructions

ARM deprecates any use of ThumbEE instructions and they are not documented in this manual.

Assembler syntax

STM{<c>}{<q>} <Rn>{!}, <registers>

where:

<c>, <q> See [Standard assembler syntax fields on page F2-2415](#).

<Rn> The base register. The SP can be used.

! Causes the instruction to write a modified value back to <Rn>. Encoded as W = 1.
If ! is omitted, the instruction does not change <Rn> in this way. Encoded as W = 0.

<registers> Is a list of one or more registers to be stored, separated by commas and surrounded by { and }. The lowest-numbered register is stored to the lowest memory address, through to the highest-numbered register to the highest memory address. See also [Encoding of lists of general-purpose registers and the PC on page F2-2426](#).

Encoding T2 does not support a list containing only one register. If an STM instruction with just one register <Rt> in the list is assembled to T32 and encoding T1 is not available, it is assembled to the equivalent STR{<c>}{<q>} <Rt>, [<Rn>]{, #4} instruction.

The SP and PC can be in the list in A32 instructions, but not in T32 instructions. However, ARM deprecates the use of A32 instructions that include the SP or the PC in the list.

ARM deprecates the use of instructions with the base register in the list and ! specified. If the base register is not the lowest-numbered register in the list, such an instruction stores an UNKNOWN value for the base register.

An instruction with the base register in the list and ! specified cannot use encoding T2.

STMEA and STMIA are pseudo-instructions for STM. STMEA refers to its use for pushing data onto Empty Ascending stacks.

The pre-UAL syntaxes STM<c>IA and STM<c>EA are equivalent to STM<c>.

Operation

```
if ConditionPassed() then
    EncodingSpecificOperations();  NullCheckIfThumbEE(n);
    address = R[n];
    for i = 0 to 14
        if registers<i> == '1' then
            if i == n && wback && i != LowestSetBit(registers) then
                MemA[address,4] = bits(32) UNKNOWN; // Only possible for encodings T1 and A1
            else
                MemA[address,4] = R[i];
                address = address + 4;
    if registers<15> == '1' then // Only possible for encoding A1
        MemA[address,4] = PCStoreValue();
    if wback then R[n] = R[n] + 4*BitCount(registers);
```

F7.1.213 STMDA (STMED)

Store Multiple Decrement After (Store Multiple Empty Descending) stores multiple registers to consecutive memory locations using an address from a base register. The consecutive memory locations end at this address, and the address just below the lowest of those locations can optionally be written back to the base register.

For details of related system instructions see [STM \(User registers\)](#) on page F7-3064.

Encoding A1 ARMv4*, ARMv5T*, ARMv6*, ARMv7

STMDA<c> <Rn>{!}, <registers>

31	30	29	28	27	26	25	24	23	22	21	20	19	18	17	16	15	14	13	12	11	10	9	8	7	6	5	4	3	2	1	0
cond		1	0	0	0	0	0	0	W	0	Rn				register_list																

```
n = UInt(Rn); registers = register_list; wback = (W == '1');
if n == 15 || BitCount(registers) < 1 then UNPREDICTABLE;
```

For information about the CONSTRAINED UNPREDICTABLE behavior of this instruction, see [Appendix A Architectural Constraints on UNPREDICTABLE behaviors](#), and particularly [STMDA \(STMED\)](#) on page AppxA-4727.

Assembler syntax

STMDA{<c>}{<q>} <Rn>{!}, <registers>

where:

- <c>, <q> See [Standard assembler syntax fields on page F2-2415](#).
- <Rn> The base register. The SP can be used.
- ! Causes the instruction to write a modified value back to <Rn>. Encoded as W = 1.
If ! is omitted, the instruction does not change <Rn> in this way. Encoded as W = 0.
- <registers> Is a list of one or more registers to be stored, separated by commas and surrounded by { and }. The lowest-numbered register is stored to the lowest memory address, through to the highest-numbered register to the highest memory address. See also [Encoding of lists of general-purpose registers and the PC on page F2-2426](#).
- The SP and PC can be in the list. However, instructions that include the SP or the PC in the list are deprecated.
- ARM deprecates the use of instructions with the base register in the list and ! specified. If the base register is not the lowest-numbered register in the list, such an instruction stores an UNKNOWN value for the base register.

STMED is a pseudo-instruction for STMDA, referring to its use for pushing data onto Empty Descending stacks.

The pre-UAL syntaxes STM<c>DA and STM<c>ED are equivalent to STMDA<c>.

Operation

```
if ConditionPassed() then
    EncodingSpecificOperations();
    address = R[n] - 4*BitCount(registers) + 4;
    for i = 0 to 14
        if registers<i> == '1' then
            if i == n && wback && i != LowestSetBit(registers) then
                MemA[address,4] = bits(32) UNKNOWN;
            else
                MemA[address,4] = R[i];
            address = address + 4;
    if registers<15> == '1' then
        MemA[address,4] = PCStoreValue();
    if wback then R[n] = R[n] - 4*BitCount(registers);
```

F7.1.214 STMDB (STMTD)

Store Multiple Decrement Before (Store Multiple Full Descending) stores multiple registers to consecutive memory locations using an address from a base register. The consecutive memory locations end just below this address, and the address of the first of those locations can optionally be written back to the base register.

For details of related system instructions see *STM (User registers)* on page F7-3064.

Encoding T1 ARMv6T2, ARMv7

STMDB<c> <Rn>{!}, <registers>

15	14	13	12	11	10	9	8	7	6	5	4	3	2	1	0	15	14	13	12	11	10	9	8	7	6	5	4	3	2	1	0
1	1	1	0	1	0	0	1	0	0	W	0	Rn				(0)	M	(0)	register_list												

if W == '1' && Rn == '1101' then SEE PUSH;
 n = UInt(Rn); registers = '0':M:'0':register_list; wback = (W == '1');
 if n == 15 || BitCount(registers) < 2 then UNPREDICTABLE;
 if wback && registers<n> == '1' then UNPREDICTABLE;

Encoding A1 ARMv4*, ARMv5T*, ARMv6*, ARMv7

STMDB<c> <Rn>{!}, <registers>

31	30	29	28	27	26	25	24	23	22	21	20	19	18	17	16	15	14	13	12	11	10	9	8	7	6	5	4	3	2	1	0
cond		1	0	0	1	0	0	W	0	Rn				register_list																	

if W == '1' && Rn == '1101' && BitCount(register_list) >= 2 then SEE PUSH;
 n = UInt(Rn); registers = register_list; wback = (W == '1');
 if n == 15 || BitCount(registers) < 1 then UNPREDICTABLE;

For information about the CONSTRAINED UNPREDICTABLE behavior of this instruction, see [Appendix A Architectural Constraints on UNPREDICTABLE behaviors](#), and particularly *STMDB (STMTD)* on page AppxA-4728.

Assembler syntax

STMDB{<c>}{<q>} <Rn>{!}, <registers>

where:

<c>, <q> See [Standard assembler syntax fields on page F2-2415](#).

<Rn> The base register. The SP can be used. If the SP is used, and ! is specified:

- For encoding T1, it is treated as described in [PUSH on page F7-2760](#).
- For encoding A1, if there is more than one register in the <registers> list, it is treated as described in [PUSH on page F7-2760](#).

! Causes the instruction to write a modified value back to <Rn>. Encoded as W = 1.

If ! is omitted, the instruction does not change <Rn> in this way. Encoded as W = 0.

<registers> Is a list of one or more registers to be stored, separated by commas and surrounded by { and }. The lowest-numbered register is stored to the lowest memory address, through to the highest-numbered register to the highest memory address. See also [Encoding of lists of general-purpose registers and the PC on page F2-2426](#).

Encoding T1 does not support a list containing only one register. If an STMDB instruction with just one register <Rt> in the list is assembled to T32, it is assembled to the equivalent STR{<c>}{<q>} <Rt>, [<Rn>, #-4]{!} instruction.

The SP and PC can be in the list in A32 instructions, but not in T32 instructions. However, ARM deprecates the use of A32 instructions that include the SP or the PC in the list.

Instructions with the base register in the list and ! specified are only available in the A32 instruction set, and ARM deprecates the use of such instructions. If the base register is not the lowest-numbered register in the list, such an instruction stores an UNKNOWN value for the base register.

STMPD is a pseudo-instruction for STMDB, referring to its use for pushing data onto Full Descending stacks.

The pre-UAL syntaxes STM<c>DB and STM<c>FD are equivalent to STMDB<c>.

Operation

```
if ConditionPassed() then
    EncodingSpecificOperations(); NullCheckIfThumbEE(n);
    address = R[n] - 4*BitCount(registers);
    for i = 0 to 14
        if registers<i> == '1' then
            if i == n && wback && i != LowestSetBit(registers) then
                MemA[address,4] = bits(32) UNKNOWN; // Only possible for encoding A1
            else
                MemA[address,4] = R[i];
            address = address + 4;
    if registers<15> == '1' then // Only possible for encoding A1
        MemA[address,4] = PCStoreValue();
    if wback then R[n] = R[n] - 4*BitCount(registers);
```

F7.1.215 STMIB (STMFA)

Store Multiple Increment Before (Store Multiple Full Ascending) stores multiple registers to consecutive memory locations using an address from a base register. The consecutive memory locations start just above this address, and the address of the last of those locations can optionally be written back to the base register.

For details of related system instructions see [STM \(User registers\)](#) on page F7-3064.

Encoding A1 ARMv4*, ARMv5T*, ARMv6*, ARMv7

STMIB<c> <Rn>{!}, <registers>

31	30	29	28	27	26	25	24	23	22	21	20	19	18	17	16	15	14	13	12	11	10	9	8	7	6	5	4	3	2	1	0
cond		1	0	0	1	1	0	W	0	Rn								register_list													

```
n = UInt(Rn); registers = register_list; wback = (W == '1');
if n == 15 || BitCount(registers) < 1 then UNPREDICTABLE;
```

For information about the CONSTRAINED UNPREDICTABLE behavior of this instruction, see [Appendix A Architectural Constraints on UNPREDICTABLE behaviors](#), and particularly [STMIB \(STMFA\)](#) on page AppxA-4728.

Assembler syntax

STMIB{<c>}{<q>} <Rn>{!}, <registers>

where:

- <c>, <q> See [Standard assembler syntax fields on page F2-2415](#).
- <Rn> The base register. The SP can be used.
- ! Causes the instruction to write a modified value back to <Rn>. Encoded as W = 1.
If ! is omitted, the instruction does not change <Rn> in this way. Encoded as W = 0.
- <registers> Is a list of one or more registers to be stored, separated by commas and surrounded by { and }. The lowest-numbered register is stored to the lowest memory address, through to the highest-numbered register to the highest memory address. See also [Encoding of lists of general-purpose registers and the PC on page F2-2426](#).
- The SP and PC can be in the list. However, instructions that include the SP or the PC in the list are deprecated.
- ARM deprecates the use of instructions with the base register in the list and ! specified. If the base register is not the lowest-numbered register in the list, such an instruction stores an UNKNOWN value for the base register.

STMFA is a pseudo-instruction for STMIB, referring to its use for pushing data onto Full Ascending stacks.

The pre-UAL syntax STM<c>IB and STM<c>FA are equivalent to STMIB<c>.

Operation

```
if ConditionPassed() then
    EncodingSpecificOperations();
    address = R[n] + 4;
    for i = 0 to 14
        if registers<i> == '1' then
            if i == n && wback && i != LowestSetBit(registers) then
                MemA[address,4] = bits(32) UNKNOWN;
            else
                MemA[address,4] = R[i];
            address = address + 4;
        if registers<15> == '1' then
            MemA[address,4] = PCStoreValue();
    if wback then R[n] = R[n] + 4*BitCount(registers);
```

F7.1.216 STR (immediate, T32)

Store Register (immediate) calculates an address from a base register value and an immediate offset, and stores a word from a register to memory. It can use offset, post-indexed, or pre-indexed addressing. For information about memory accesses see [Memory accesses on page F2-2422](#).

Encoding T1 ARMv4T, ARMv5T*, ARMv6*, ARMv7
 STR<c> <Rt>, [<Rn>{, #<imm>}]

15	14	13	12	11	10	9	8	7	6	5	4	3	2	1	0
0	1	1	0	0	imm5				Rn			Rt			

t = UInt(Rt); n = UInt(Rn); imm32 = ZeroExtend(imm5:'00', 32);
 index = TRUE; add = TRUE; wback = FALSE;

Encoding T2 ARMv4T, ARMv5T*, ARMv6*, ARMv7
 STR<c> <Rt>, [SP, #<imm>]

15	14	13	12	11	10	9	8	7	6	5	4	3	2	1	0
1	0	0	1	0	Rt			imm8							

t = UInt(Rt); n = 13; imm32 = ZeroExtend(imm8:'00', 32);
 index = TRUE; add = TRUE; wback = FALSE;

Encoding T3 ARMv6T2, ARMv7
 STR<c>.W <Rt>, [<Rn>, #<imm12>]

15	14	13	12	11	10	9	8	7	6	5	4	3	2	1	0	15	14	13	12	11	10	9	8	7	6	5	4	3	2	1	0
1	1	1	1	1	0	0	0	1	1	0	0	Rn			Rt		imm12														

if Rn == '1111' then UNDEFINED;
 t = UInt(Rt); n = UInt(Rn); imm32 = ZeroExtend(imm12, 32);
 index = TRUE; add = TRUE; wback = FALSE;
 if t == 15 then UNPREDICTABLE;

Encoding T4 ARMv6T2, ARMv7
 STR<c> <Rt>, [<Rn>, #-<imm8>]
 STR<c> <Rt>, [<Rn>], #+/-<imm8>
 STR<c> <Rt>, [<Rn>, #+/-<imm8>]!

15	14	13	12	11	10	9	8	7	6	5	4	3	2	1	0	15	14	13	12	11	10	9	8	7	6	5	4	3	2	1	0
1	1	1	1	1	0	0	0	0	1	0	0	Rn			Rt		1	P	U	W	imm8										

if P == '1' && U == '1' && W == '0' then SEE STRT;
 if Rn == '1101' && P == '1' && U == '0' && W == '1' && imm8 == '00000100' then SEE PUSH;
 if Rn == '1111' || (P == '0' && W == '0') then UNDEFINED;
 t = UInt(Rt); n = UInt(Rn); imm32 = ZeroExtend(imm8, 32);
 index = (P == '1'); add = (U == '1'); wback = (W == '1');
 if t == 15 || (wback && n == t) then UNPREDICTABLE;

For information about the CONSTRAINED UNPREDICTABLE behavior of this instruction, see [Appendix A Architectural Constraints on UNPREDICTABLE behaviors](#), and particularly [STR \(immediate, T32\) on page AppxA-4729](#).

Assembler syntax

STR{<c>}{<q>} <Rt>, [<Rn> {, #+/-<imm>}]	Offset: index==TRUE, wback==FALSE
STR{<c>}{<q>} <Rt>, [<Rn>, #+/-<imm>]!	Pre-indexed: index==TRUE, wback==TRUE
STR{<c>}{<q>} <Rt>, [<Rn>], #+/-<imm>	Post-indexed: index==FALSE, wback==TRUE

where:

<c>, <q> See [Standard assembler syntax fields on page F2-2415](#).

<Rt> The source register. The SP can be used.

<Rn> The base register. The SP can be used.

+/- Is + or omitted if the immediate offset is to be added to the base register value (add == TRUE), or – if it is to be subtracted (add == FALSE). #0 and #-0 generate different instructions.

<imm> The immediate offset used for forming the address. Values are:

Encoding T1	Multiples of 4 in the range 0-124.
Encoding T2	Multiples of 4 in the range 0-1020.
Encoding T3	Any value in the range 0-4095.
Encoding T4	Any value in the range 0-255.

For the offset addressing syntax, <imm> can be omitted, meaning an offset of 0.

Operation

```
if ConditionPassed() then
    EncodingSpecificOperations(); NullCheckIfThumbEE(n);
    offset_addr = if add then (R[n] + imm32) else (R[n] - imm32);
    address = if index then offset_addr else R[n];
    MemU[address,4] = R[t];
    if wback then R[n] = offset_addr;
```

F7.1.217 STR (immediate, A32)

Store Register (immediate) calculates an address from a base register value and an immediate offset, and stores a word from a register to memory. It can use offset, post-indexed, or pre-indexed addressing. For information about memory accesses see [Memory accesses on page F2-2422](#).

Encoding A1 ARMv4*, ARMv5T*, ARMv6*, ARMv7

STR<c> <Rt>, [<Rn>{, #+/-<imm12>}]

STR<c> <Rt>, [<Rn>], #+/-<imm12>

STR<c> <Rt>, [<Rn>, #+/-<imm12>]!

31	30	29	28	27	26	25	24	23	22	21	20	19	18	17	16	15	14	13	12	11	10	9	8	7	6	5	4	3	2	1	0
cond				0	1	0	P	U	0	W	0	Rn				Rt				imm12											

```

if P == '0' && W == '1' then SEE STRT;
if Rn == '1101' && P == '1' && U == '0' && W == '1' && imm12 == '000000000100' then SEE PUSH;
t = UInt(Rt); n = UInt(Rn); imm32 = ZeroExtend(imm12, 32);
index = (P == '1'); add = (U == '1'); wback = (P == '0') || (W == '1');
if wback && (n == 15 || n == t) then UNPREDICTABLE;
    
```

For information about the CONSTRAINED UNPREDICTABLE behavior of this instruction, see [Appendix A Architectural Constraints on UNPREDICTABLE behaviors](#), and particularly [STR \(immediate, A32\)](#) on page AppxA-4730.

Assembler syntax

STR{<c>}{<q>} <Rt>, [<Rn> {, #+/-<imm>}]	Offset: index==TRUE, wback==FALSE
STR{<c>}{<q>} <Rt>, [<Rn>, #+/-<imm>]!	Pre-indexed: index==TRUE, wback==TRUE
STR{<c>}{<q>} <Rt>, [<Rn>], #+/-<imm>	Post-indexed: index==FALSE, wback==TRUE

where:

<c>, <q>	See Standard assembler syntax fields on page F2-2415 .
<Rt>	The source register. The SP or the PC can be used. However, ARM deprecates use of the PC.
<Rn>	The base register. The SP can be used. For offset addressing only, the PC can be used. However, ARM deprecates use of the PC.
+/-	Is + or omitted if the immediate offset is to be added to the base register value (add == TRUE), or – if it is to be subtracted (add == FALSE). #0 and #-0 generate different instructions.
<imm>	The immediate offset used for forming the address. Any value in the range 0-4095 is permitted. For the offset addressing syntax, <imm> can be omitted, meaning an offset of 0.

Operation

```
if ConditionPassed() then
    EncodingSpecificOperations();
    offset_addr = if add then (R[n] + imm32) else (R[n] - imm32);
    address = if index then offset_addr else R[n];
    MemU[address,4] = if t == 15 then PCStoreValue() else R[t];
    if wback then R[n] = offset_addr;
```

F7.1.218 STR (register)

Store Register (register) calculates an address from a base register value and an offset register value, stores a word from a register to memory. The offset register value can optionally be shifted. For information about memory accesses see [Memory accesses](#) on page F2-2422.

Encoding T1 ARMv4T, ARMv5T*, ARMv6*, ARMv7
 STR<c> <Rt>, [<Rn>, <Rm>]

15	14	13	12	11	10	9	8	7	6	5	4	3	2	1	0
0	1	0	1	0	0	0	Rm	Rn	Rt						

if CurrentInstrSet() == InstrSet_T32EE then SEE "Modified operation in ThumbEE";
 t = UInt(Rt); n = UInt(Rn); m = UInt(Rm);
 index = TRUE; add = TRUE; wback = FALSE;
 (shift_t, shift_n) = (SRTYPE_LSL, 0);

Encoding T2 ARMv6T2, ARMv7
 STR<c>.W <Rt>, [<Rn>, <Rm>{, LSL #<imm2>}]

15	14	13	12	11	10	9	8	7	6	5	4	3	2	1	0	15	14	13	12	11	10	9	8	7	6	5	4	3	2	1	0
1	1	1	1	1	0	0	0	0	1	0	0	Rn	Rt	0	0	0	0	0	0	0	imm2	Rm									

if Rn == '1111' then UNDEFINED;
 t = UInt(Rt); n = UInt(Rn); m = UInt(Rm);
 index = TRUE; add = TRUE; wback = FALSE;
 (shift_t, shift_n) = (SRTYPE_LSL, UInt(imm2));
 if t == 15 || m == 15 then UNPREDICTABLE; // ARMv8-A removes UNPREDICTABLE for R13

Encoding A1 ARMv4*, ARMv5T*, ARMv6*, ARMv7
 STR<c> <Rt>, [<Rn>, +/-<Rm>{, <shift>}]{!}
 STR<c> <Rt>, [<Rn>], +/-<Rm>{, <shift>}

31	30	29	28	27	26	25	24	23	22	21	20	19	18	17	16	15	14	13	12	11	10	9	8	7	6	5	4	3	2	1	0
cond		0	1	1	P	U	0	W	0	Rn	Rt	imm5			type	0	Rm														

if P == '0' && W == '1' then SEE STRT;
 t = UInt(Rt); n = UInt(Rn); m = UInt(Rm);
 index = (P == '1'); add = (U == '1'); wback = (P == '0') || (W == '1');
 (shift_t, shift_n) = DecodeImmShift(type, imm5);
 if m == 15 then UNPREDICTABLE;
 if wback && (n == 15 || n == t) then UNPREDICTABLE;

For information about the CONSTRAINED UNPREDICTABLE behavior of this instruction, see [Appendix A Architectural Constraints on UNPREDICTABLE behaviors](#), and particularly [STR \(register\)](#) on page AppxA-4731.

Modified operation in ThumbEE

ARM deprecates any use of ThumbEE instructions and they are not documented in this manual.

Assembler syntax

STR{<c>}{<q>} <Rt>, [<Rn>, <Rm>{, <shift>}]	Offset: index==TRUE, wback==FALSE
STR{<c>}{<q>} <Rt>, [<Rn>, <Rm>{, <shift>}]!	Pre-indexed: index==TRUE, wback==TRUE
STR{<c>}{<q>} <Rt>, [<Rn>], <Rm>{, <shift>}]	Post-indexed: index==FALSE, wback==TRUE

where:

<c>, <q>	See Standard assembler syntax fields on page F2-2415 .
<Rt>	The source register. The SP can be used. In the A32 instruction set, the PC can be used. However, ARM deprecates use of the PC.
<Rn>	The base register. The SP can be used. In the A32 instruction set, for offset addressing only, the PC can be used. However, ARM deprecates use of the PC.
+/-	Is + or omitted if the optionally shifted value of <Rm> is to be added to the base register value (add == TRUE), or – if it is to be subtracted (permitted in A32 instructions only, add == FALSE).
<Rm>	Contains the offset that is optionally shifted and added to the value of <Rn> to form the address.
<shift>	The shift to apply to the value read from <Rm>. If present, encoding T1 is not permitted. If absent, no shift is applied and all encodings are permitted. For encoding T2, <shift> can only be omitted, encoded as imm2 = 0b00, or LSL #<imm> with <imm> = 1, 2, or 3, and <imm> encoded in imm2. For encoding A1, see Shifts applied to a register on page F2-2419 .

Operation

```

if ConditionPassed() then
    EncodingSpecificOperations(); NullCheckIfThumbEE(n);
    offset = Shift(R[m], shift_t, shift_n, APSR.C);
    offset_addr = if add then (R[n] + offset) else (R[n] - offset);
    address = if index then offset_addr else R[n];
    if t == 15 then // Only possible for encoding A1
        data = PCStoreValue();
    else
        data = R[t];
    MemU[address,4] = data;
    if wback then R[n] = offset_addr;
  
```

F7.1.219 STRB (immediate, T32)

Store Register Byte (immediate) calculates an address from a base register value and an immediate offset, and stores a byte from a register to memory. It can use offset, post-indexed, or pre-indexed addressing. For information about memory accesses see [Memory accesses on page F2-2422](#).

Encoding T1 ARMv4T, ARMv5T*, ARMv6*, ARMv7
 STRB<c> <Rt>, [<Rn>, #<imm5>]

15	14	13	12	11	10	9	8	7	6	5	4	3	2	1	0	
0	1	1	1	0	imm5					Rn	Rt					

t = UInt(Rt); n = UInt(Rn); imm32 = ZeroExtend(imm5, 32);
 index = TRUE; add = TRUE; wback = FALSE;

Encoding T2 ARMv6T2, ARMv7
 STRB<c>.W <Rt>, [<Rn>, #<imm12>]

15	14	13	12	11	10	9	8	7	6	5	4	3	2	1	0	15	14	13	12	11	10	9	8	7	6	5	4	3	2	1	0
1	1	1	1	1	0	0	0	1	0	0	0	Rn			Rt	imm12															

if Rn == '1111' then UNDEFINED;
 t = UInt(Rt); n = UInt(Rn); imm32 = ZeroExtend(imm12, 32);
 index = TRUE; add = TRUE; wback = FALSE;
 if t == 15 then UNPREDICTABLE; // ARMv8-A removes UNPREDICTABLE for R13

Encoding T3 ARMv6T2, ARMv7
 STRB<c> <Rt>, [<Rn>, #-<imm8>]
 STRB<c> <Rt>, [<Rn>], #+/-<imm8>
 STRB<c> <Rt>, [<Rn>, #+/-<imm8>!]

15	14	13	12	11	10	9	8	7	6	5	4	3	2	1	0	15	14	13	12	11	10	9	8	7	6	5	4	3	2	1	0
1	1	1	1	1	0	0	0	0	0	0	0	Rn			Rt	1	P	U	W	imm8											

if P == '1' && U == '1' && W == '0' then SEE STRBT;
 if Rn == '1111' || (P == '0' && W == '0') then UNDEFINED;
 t = UInt(Rt); n = UInt(Rn); imm32 = ZeroExtend(imm8, 32);
 index = (P == '1'); add = (U == '1'); wback = (W == '1');
 if t == 15 || (wback && n == t) then UNPREDICTABLE; // ARMv8-A removes UNPREDICTABLE for R13

For information about the CONSTRAINED UNPREDICTABLE behavior of this instruction, see [Appendix A Architectural Constraints on UNPREDICTABLE behaviors](#), and particularly [STRB \(immediate, T32\) on page AppxA-4731](#).

Assembler syntax

STRB{<c>}{<q>} <Rt>, [<Rn> {, #+/-<imm>}]	Offset: index==TRUE, wback==FALSE
STRB{<c>}{<q>} <Rt>, [<Rn>, #+/-<imm>]!	Pre-indexed: index==TRUE, wback==TRUE
STRB{<c>}{<q>} <Rt>, [<Rn>], #+/-<imm>	Post-indexed: index==FALSE, wback==TRUE

where:

<c>, <q> See [Standard assembler syntax fields on page F2-2415](#).

<Rt> The source register.

<Rn> The base register. The SP can be used.

+/- Is + or omitted if the immediate offset is to be added to the base register value (add == TRUE), or – if it is to be subtracted (add == FALSE). #0 and #-0 generate different instructions.

<imm> The immediate offset used for forming the address. Values are:

Encoding T1	Any value in the range 0-31.
Encoding T2	Any value in the range 0-4095.
Encoding T3	Any value in the range 0-255.

For the offset addressing syntax, <imm> can be omitted, meaning an offset of 0.

The pre-UAL syntax STR<c>B is equivalent to STRB<c>.

Operation

```
if ConditionPassed() then
    EncodingSpecificOperations(); NullCheckIfThumbEE(n);
    offset_addr = if add then (R[n] + imm32) else (R[n] - imm32);
    address = if index then offset_addr else R[n];
    MemU[address,1] = R[t]<7:0>;
    if wback then R[n] = offset_addr;
```

F7.1.220 STRB (immediate, A32)

Store Register Byte (immediate) calculates an address from a base register value and an immediate offset, and stores a byte from a register to memory. It can use offset, post-indexed, or pre-indexed addressing. For information about memory accesses see [Memory accesses on page F2-2422](#).

Encoding A1 ARMv4*, ARMv5T*, ARMv6*, ARMv7

STRB<c> <Rt>, [<Rn>{, #+/-<imm12>}]

STRB<c> <Rt>, [<Rn>], #+/-<imm12>

STRB<c> <Rt>, [<Rn>, #+/-<imm12>]!

31	30	29	28	27	26	25	24	23	22	21	20	19	18	17	16	15	14	13	12	11	10	9	8	7	6	5	4	3	2	1	0
cond			0	1	0	P	U	1	W	0	Rn				Rt				imm12												

```

if P == '0' && W == '1' then SEE STRBT;
t = UInt(Rt); n = UInt(Rn); imm32 = ZeroExtend(imm12, 32);
index = (P == '1'); add = (U == '1'); wback = (P == '0') || (W == '1');
if t == 15 then UNPREDICTABLE;
if wback && (n == 15 || n == t) then UNPREDICTABLE;
    
```

For information about the CONSTRAINED UNPREDICTABLE behavior of this instruction, see [Appendix A Architectural Constraints on UNPREDICTABLE behaviors](#), and particularly [STRB \(immediate, A32\) on page AppxA-4732](#).

Assembler syntax

STRB{<c>}{<q>} <Rt>, [<Rn> {, #+/-<imm>}]	Offset: index==TRUE, wback==FALSE
STRB{<c>}{<q>} <Rt>, [<Rn>, #+/-<imm>]!	Pre-indexed: index==TRUE, wback==TRUE
STRB{<c>}{<q>} <Rt>, [<Rn>], #+/-<imm>	Post-indexed: index==FALSE, wback==TRUE

where:

<c>, <q>	See Standard assembler syntax fields on page F2-2415 .
<Rt>	The source register.
<Rn>	The base register. The SP can be used. For offset addressing only, the PC can be used. However, ARM deprecates use of the PC.
+/-	Is + or omitted if the immediate offset is to be added to the base register value (add == TRUE), or – if it is to be subtracted (add == FALSE). #0 and #-0 generate different instructions.
<imm>	The immediate offset used for forming the address. Values are 0-4095. For the offset addressing syntax, <imm> can be omitted, meaning an offset of 0.

The pre-UAL syntax STR<c>B is equivalent to STRB<c>.

Operation

```
if ConditionPassed() then
    EncodingSpecificOperations();
    offset_addr = if add then (R[n] + imm32) else (R[n] - imm32);
    address = if index then offset_addr else R[n];
    MemU[address,1] = R[t]<7:0>;
    if wback then R[n] = offset_addr;
```

F7.1.221 STRB (register)

Store Register Byte (register) calculates an address from a base register value and an offset register value, and stores a byte from a register to memory. The offset register value can optionally be shifted. For information about memory accesses see [Memory accesses](#) on page F2-2422.

Encoding T1 ARMv4T, ARMv5T*, ARMv6*, ARMv7

STRB<c> <Rt>, [<Rn>, <Rm>]

15	14	13	12	11	10	9	8	7	6	5	4	3	2	1	0
0	1	0	1	0	1	0	Rm			Rn			Rt		

t = UInt(Rt); n = UInt(Rn); m = UInt(Rm);
 index = TRUE; add = TRUE; wback = FALSE;
 (shift_t, shift_n) = (SRTYPE_LSL, 0);

Encoding T2 ARMv6T2, ARMv7

STRB<c>.W <Rt>, [<Rn>, <Rm>{, LSL #<imm2>}]

15	14	13	12	11	10	9	8	7	6	5	4	3	2	1	0	15	14	13	12	11	10	9	8	7	6	5	4	3	2	1	0
1	1	1	1	1	0	0	0	0	0	0	0	Rn			Rt			0	0	0	0	0	0	imm2	Rm						

if Rn == '1111' then UNDEFINED;
 t = UInt(Rt); n = UInt(Rn); m = UInt(Rm);
 index = TRUE; add = TRUE; wback = FALSE;
 (shift_t, shift_n) = (SRTYPE_LSL, UInt(imm2));
 if t == 15 || m == 15 then UNPREDICTABLE; // ARMv8-A removes UNPREDICTABLE for R13

Encoding A1 ARMv4*, ARMv5T*, ARMv6*, ARMv7

STRB<c> <Rt>, [<Rn>, +/-<Rm>{, <shift>}]{!}

STRB<c> <Rt>, [<Rn>, +/-<Rm>{, <shift>}]

31	30	29	28	27	26	25	24	23	22	21	20	19	18	17	16	15	14	13	12	11	10	9	8	7	6	5	4	3	2	1	0
cond		0	1	1	P	U	1	W	0	Rn			Rt			imm5			type	0	Rm										

if P == '0' && W == '1' then SEE STRBT;
 t = UInt(Rt); n = UInt(Rn); m = UInt(Rm);
 index = (P == '1'); add = (U == '1'); wback = (P == '0') || (W == '1');
 (shift_t, shift_n) = DecodeImmShift(type, imm5);
 if t == 15 || m == 15 then UNPREDICTABLE;
 if wback && (n == 15 || n == t) then UNPREDICTABLE;

For information about the CONSTRAINED UNPREDICTABLE behavior of this instruction, see [Appendix A Architectural Constraints on UNPREDICTABLE behaviors](#), and particularly [STRB \(register\)](#) on page AppxA-4733.

Assembler syntax

STRB{<c>}{<q>} <Rt>, [<Rn>, <Rm>{, <shift>}] Offset: index==TRUE, wback==FALSE
STRB{<c>}{<q>} <Rt>, [<Rn>, <Rm>{, <shift>}]! Pre-indexed: index==TRUE, wback==TRUE
STRB{<c>}{<q>} <Rt>, [<Rn>], <Rm>{, <shift>} Post-indexed: index==FALSE, wback==TRUE

where:

<c>, <q> See [Standard assembler syntax fields on page F2-2415](#).

<Rt> The source register.

<Rn> The base register. The SP can be used. In the A32 instruction set, for offset addressing only, the PC can be used. However, ARM deprecates use of the PC.

+/- Is + or omitted if the optionally shifted value of <Rm> is to be added to the base register value (add == TRUE), or – if it is to be subtracted (permitted in A32 instructions only, add == FALSE).

<Rm> Contains the offset that is optionally shifted and added to the value of <Rn> to form the address.

<shift> The shift to apply to the value read from <Rm>. If present, encoding T1 is not permitted. If absent, no shift is applied and all encodings are permitted. For encoding T2, <shift> can only be omitted, encoded as imm2 = 0b00, or LSL #<imm> with <imm> = 1, 2, or 3, and <imm> encoded in imm2. For encoding A1, see [Shifts applied to a register on page F2-2419](#).

The pre-UAL syntax STR<c>B is equivalent to STRB<c>.

Operation

```
if ConditionPassed() then
    EncodingSpecificOperations();  NullCheckIfThumbEE(n);
    offset = Shift(R[m], shift_t, shift_n, APSR.C);
    offset_addr = if add then (R[n] + offset) else (R[n] - offset);
    address = if index then offset_addr else R[n];
    MemU[address,1] = R[t]<7:0>;
    if wback then R[n] = offset_addr;
```

F7.1.222 STRBT

Store Register Byte Unprivileged stores a byte from a register to memory. For information about memory accesses see [Memory accesses on page F2-2422](#).

The memory access is restricted as if the PE were running in User mode. This makes no difference if the PE is actually running in User mode.

STRBT is UNPREDICTABLE in Hyp mode.

The T32 instruction uses an offset addressing mode, that calculates the address used for the memory access from a base register value and an immediate offset, and leaves the base register unchanged.

The A32 instruction uses a post-indexed addressing mode, that uses a base register value as the address for the memory access, and calculates a new address from a base register value and an offset and writes it back to the base register. The offset can be an immediate value or an optionally-shifted register value.

Encoding T1 ARMv6T2, ARMv7

STRBT<c> <Rt>, [<Rn>, #<imm8>]

15	14	13	12	11	10	9	8	7	6	5	4	3	2	1	0	15	14	13	12	11	10	9	8	7	6	5	4	3	2	1	0
1	1	1	1	1	0	0	0	0	0	0	0	Rn				Rt		1	1	1	0	imm8									

```

if Rn == '1111' then UNDEFINED;
t = UInt(Rt); n = UInt(Rn); postindex = FALSE; add = TRUE;
register_form = FALSE; imm32 = ZeroExtend(imm8, 32);
if t == 15 then UNPREDICTABLE; // ARMv8-A removes UNPREDICTABLE for R13
    
```

Encoding A1 ARMv4*, ARMv5T*, ARMv6*, ARMv7

STRBT<c> <Rt>, [<Rn>], #+/-<imm12>

31	30	29	28	27	26	25	24	23	22	21	20	19	18	17	16	15	14	13	12	11	10	9	8	7	6	5	4	3	2	1	0
cond		0	1	0	0	U	1	1	0	Rn				Rt		imm12															

```

t = UInt(Rt); n = UInt(Rn); postindex = TRUE; add = (U == '1');
register_form = FALSE; imm32 = ZeroExtend(imm12, 32);
if t == 15 || n == 15 || n == t then UNPREDICTABLE;
    
```

Encoding A2 ARMv4*, ARMv5T*, ARMv6*, ARMv7

STRBT<c> <Rt>, [<Rn>], +/-<Rm>{, <shift>}

31	30	29	28	27	26	25	24	23	22	21	20	19	18	17	16	15	14	13	12	11	10	9	8	7	6	5	4	3	2	1	0
cond		0	1	1	0	U	1	1	0	Rn				Rt		imm5			type	0	Rm										

```

t = UInt(Rt); n = UInt(Rn); m = UInt(Rm); postindex = TRUE; add = (U == '1');
register_form = TRUE; (shift_t, shift_n) = DecodeImmShift(type, imm5);
if t == 15 || n == 15 || n == t || m == 15 then UNPREDICTABLE;
    
```

For information about the CONSTRAINED UNPREDICTABLE behavior of this instruction, see [Appendix A Architectural Constraints on UNPREDICTABLE behaviors](#), and particularly [STRBT on page AppxA-4733](#).

Assembler syntax

STRBT{<c>}{<q>} <Rt>, [<Rn> {, #<imm>}]	Offset: T32 only
STRBT{<c>}{<q>} <Rt>, [<Rn>] {, #<imm>}	Post-indexed: A32 only
STRBT{<c>}{<q>} <Rt>, [<Rn>], +/-<Rm> {, <shift>}	Post-indexed: A32 only

where:

<c>, <q>	See Standard assembler syntax fields on page F2-2415 .
<Rt>	The source register.
<Rn>	The base register. The SP can be used.
+/-	Is + or omitted if <imm> or the optionally shifted value of <Rm> is to be added to the base register value (add == TRUE), or – if it is to be subtracted (permitted in A32 instructions only, add == FALSE).
<imm>	The immediate offset applied to the value of <Rn>. Values are 0-255 for encoding T1, and 0-4095 for encoding A1. <imm> can be omitted, meaning an offset of 0.
<Rm>	Contains the offset that is optionally shifted and added to the value of <Rn> to form the address.
<shift>	The shift to apply to the value read from <Rm>. If omitted, no shift is applied. Shifts applied to a register on page F2-2419 describes the shifts and how they are encoded.

The pre-UAL syntax STR<c>BT is equivalent to STRBT<c>.

Operation

```
if ConditionPassed() then
    if CurrentModeIsHyp() then UNPREDICTABLE;           // Hyp mode
    EncodingSpecificOperations(); NullCheckIfThumbEE(n);
    offset = if register_form then Shift(R[m], shift_t, shift_n, APSR.C) else imm32;
    offset_addr = if add then (R[n] + offset) else (R[n] - offset);
    address = if postindex then R[n] else offset_addr;
    MemU_unpriv[address,1] = R[t]<7:0>;
    if postindex then R[n] = offset_addr;
```

F7.1.223 STRD (immediate)

Store Register Dual (immediate) calculates an address from a base register value and an immediate offset, and stores two words from two registers to memory. It can use offset, post-indexed, or pre-indexed addressing. For information about memory accesses see [Memory accesses](#) on page F2-2422.

Encoding T1 ARMv6T2, ARMv7

STRD<c> <Rt>, <Rt2>, [<Rn>{, #+/-<imm>}]

STRD<c> <Rt>, <Rt2>, [<Rn>], #+/-<imm>

STRD<c> <Rt>, <Rt2>, [<Rn>, #+/-<imm>]!

15	14	13	12	11	10	9	8	7	6	5	4	3	2	1	0	15	14	13	12	11	10	9	8	7	6	5	4	3	2	1	0
1	1	1	0	1	0	0	P	U	1	W	0	Rn				Rt		Rt2		imm8											

if P == '0' && W == '0' then SEE "ReLated encodings";
 t = UInt(Rt); t2 = UInt(Rt2); n = UInt(Rn); imm32 = ZeroExtend(imm8:'00', 32);
 index = (P == '1'); add = (U == '1'); wback = (W == '1');
 if wback && (n == t || n == t2) then UNPREDICTABLE;
 if n == 15 || t == 15 || t2 == 15 then UNPREDICTABLE; // ARMv8-A removes UNPREDICTABLE for R13

Encoding A1 ARMv5TE*, ARMv6*, ARMv7

STRD<c> <Rt>, <Rt2>, [<Rn>{, #+/-<imm8>}]

STRD<c> <Rt>, <Rt2>, [<Rn>], #+/-<imm8>

STRD<c> <Rt>, <Rt2>, [<Rn>, #+/-<imm8>]!

31	30	29	28	27	26	25	24	23	22	21	20	19	18	17	16	15	14	13	12	11	10	9	8	7	6	5	4	3	2	1	0
cond				0	0	0	P	U	1	W	0	Rn				Rt		imm4H				1	1	1	1	imm4L					

if Rt<0> == '1' then UNPREDICTABLE;
 t = UInt(Rt); t2 = t+1; n = UInt(Rn); imm32 = ZeroExtend(imm4H:imm4L, 32);
 index = (P == '1'); add = (U == '1'); wback = (P == '0') || (W == '1');
 if P == '0' && W == '1' then UNPREDICTABLE;
 if wback && (n == 15 || n == t || n == t2) then UNPREDICTABLE;
 if t2 == 15 then UNPREDICTABLE;

For information about the CONSTRAINED UNPREDICTABLE behavior of this instruction, see [Appendix A Architectural Constraints on UNPREDICTABLE behaviors](#), and particularly [STRD \(immediate\)](#) on page AppxA-4738.

Related encodings See [Load/store dual, load/store exclusive, table branch](#) on page F3-2450.

Assembler syntax

STRD{<c>}{<q>} <Rt>, <Rt2>, [<Rn> {, #+/-<imm>}] Offset: index==TRUE, wback==FALSE
 STRD{<c>}{<q>} <Rt>, <Rt2>, [<Rn>, #+/-<imm>]! Pre-indexed: index==TRUE, wback==TRUE
 STRD{<c>}{<q>} <Rt>, <Rt2>, [<Rn>], #+/-<imm> Post-indexed: index==FALSE, wback==TRUE

where:

<c>, <q> See [Standard assembler syntax fields on page F2-2415](#).

<Rt> The first source register. For an A32 instruction, <Rt> must be even-numbered and not R14.

<Rt2> The second source register. For an A32 instruction, <Rt2> must be <R(t+1)>.

<Rn> The base register. The SP can be used. In the A32 instruction set, for offset addressing only, the PC can be used. However, ARM deprecates use of the PC.

+/- Is + or omitted if the immediate offset is to be added to the base register value (add == TRUE), or – if it is to be subtracted (add == FALSE). #0 and #-0 generate different instructions.

<imm> The immediate offset used for forming the address. Values are multiples of 4 in the range 0-1020 for encoding T1, and any value in the range 0-255 for encoding A1. For the offset addressing syntax, <imm> can be omitted, meaning an offset of 0.

The pre-UAL syntax STR<c>D is equivalent to STRD<c>.

Operation

```

if ConditionPassed() then
    EncodingSpecificOperations(); NullCheckIfThumbEE(n);
    offset_addr = if add then (R[n] + imm32) else (R[n] - imm32);
    address = if index then offset_addr else R[n];
    if address == Align(address, 8) then
        bits(64) data;
        if BigEndian() then
            data<63:32> = R[t];
            data<31:0> = R[t2];
        else
            data<31:0> = R[t];
            data<63:32> = R[t2];
        MemA[address,8] = data;
    else
        MemA[address,4] = R[t];
        MemA[address+4,4] = R[t2];
    if wback then R[n] = offset_addr;
  
```

F7.1.224 STRD (register)

Store Register Dual (register) calculates an address from a base register value and a register offset, and stores two words from two registers to memory. It can use offset, post-indexed, or pre-indexed addressing. For information about memory accesses see [Memory accesses on page F2-2422](#).

Encoding A1 ARMv5TE*, ARMv6*, ARMv7

STRD<c> <Rt>, <Rt2>, [<Rn>, +/-<Rm>]{!}

STRD<c> <Rt>, <Rt2>, [<Rn>], +/-<Rm>

31	30	29	28	27	26	25	24	23	22	21	20	19	18	17	16	15	14	13	12	11	10	9	8	7	6	5	4	3	2	1	0
cond			0	0	0	P	U	0	W	0	Rn				Rt				(0)	(0)	(0)	(0)	1	1	1	1	Rm				

```

if Rt<0> == '1' then UNPREDICTABLE;
t = UInt(Rt); t2 = t+1; n = UInt(Rn); m = UInt(Rm);
index = (P == '1'); add = (U == '1'); wback = (P == '0') || (W == '1');
if P == '0' && W == '1' then UNPREDICTABLE;
if t2 == 15 || m == 15 then UNPREDICTABLE;
if wback && (n == 15 || n == t || n == t2) then UNPREDICTABLE;
    
```

For information about the CONSTRAINED UNPREDICTABLE behavior of this instruction, see [Appendix A Architectural Constraints on UNPREDICTABLE behaviors](#), and particularly [STRD \(register\) on page AppxA-4739](#).

Assembler syntax

STRD{<c>}{<q>} <Rt>, <Rt2>, [<Rn>, +/-<Rm>]	Offset: index==TRUE, wback==FALSE
STRD{<c>}{<q>} <Rt>, <Rt2>, [<Rn>, +/-<Rm>]!	Pre-indexed: index==TRUE, wback==TRUE
STRD{<c>}{<q>} <Rt>, <Rt2>, [<Rn>], +/-<Rm>	Post-indexed: index==FALSE, wback==TRUE

where:

<c>, <q> See [Standard assembler syntax fields on page F2-2415](#).

<Rt> The first source register. This register must be even-numbered and not R14.

<Rt2> The second source register. This register must be <R(t+1)>.

<Rn> The base register. The SP can be used. For offset addressing only, the PC can be used. However, ARM deprecates use of the PC.

+/- Is + or omitted if the immediate offset is to be added to the base register value (add == TRUE), or – if it is to be subtracted (add == FALSE).

<Rm> Contains the offset that is added to the value of <Rn> to form the address.

The pre-UAL syntax STR<c>D is equivalent to STRD<c>.

Operation

```

if ConditionPassed() then
    EncodingSpecificOperations();
    offset_addr = if add then (R[n] + R[m]) else (R[n] - R[m]);
    address = if index then offset_addr else R[n];
    if address == Align(address, 8) then
        bits(64) data;
        if BigEndian() then
            data<63:32> = R[t];
            data<31:0> = R[t2];
        else
            data<31:0> = R[t];
            data<63:32> = R[t2];
        MemA[address,8] = data;
    else
        MemA[address,4] = R[t];
        MemA[address+4,4] = R[t2];
    if wback then R[n] = offset_addr;
  
```

F7.1.225 STREX

Store Register Exclusive calculates an address from a base register value and an immediate offset, and stores a word from a register to memory if the executing PE has exclusive access to the memory addressed.

For more information about support for shared memory see [Synchronization and semaphores on page E2-2369](#). For information about memory accesses see [Memory accesses on page F2-2422](#).

Encoding T1 ARMv6T2, ARMv7

STREX<c> <Rd>, <Rt>, [<Rn>{, #<imm>}]

15	14	13	12	11	10	9	8	7	6	5	4	3	2	1	0	15	14	13	12	11	10	9	8	7	6	5	4	3	2	1	0
1	1	1	0	1	0	0	0	0	1	0	0	Rn				Rt				Rd				imm8							

d = UInt(Rd); t = UInt(Rt); n = UInt(Rn); imm32 = ZeroExtend(imm8:'00', 32);
 if d == 15 || t == 15 || n == 15 then UNPREDICTABLE; // ARMv8-A removes UNPREDICTABLE for R13
 if d == n || d == t then UNPREDICTABLE;

Encoding A1 ARMv8

STREX <Rd>, <Rt>, [<Rn>]

31	30	29	28	27	26	25	24	23	22	21	20	19	18	17	16	15	14	13	12	11	10	9	8	7	6	5	4	3	2	1	0
cond				0	0	0	1	1	0	0	0	Rn				Rd				(1)	(1)	1	1	1	0	0	1	Rt			

d = UInt(Rd); t = UInt(Rt); n = UInt(Rn); imm32 = Zeros(32); // Zero offset
 if d == 15 || t == 15 || n == 15 then UNPREDICTABLE;
 if d == n || d == t then UNPREDICTABLE;

For information about the CONSTRAINED UNPREDICTABLE behavior of this instruction, see [Appendix A Architectural Constraints on UNPREDICTABLE behaviors](#), and particularly [STREX on page AppxA-4740](#).

Assembler syntax

STREX{<c>}{<q>} <Rd>, <Rt>, [<Rn> {, #<imm>}]

where:

- <c>, <q> See [Standard assembler syntax fields on page F2-2415](#).
- <Rd> The destination register for the returned status value. The value returned is:
0 If the operation updates memory.
1 If the operation fails to update memory.
- <Rt> The source register.
- <Rn> The base register. The SP can be used.
- <imm> The immediate offset added to the value of <Rn> to form the address. Values are multiples of 4 in the range 0-1020 for encoding T1, and 0 for encoding A1. <imm> can be omitted, meaning an offset of 0.

Operation

```
if ConditionPassed() then
    EncodingSpecificOperations(); NullCheckIfThumbEE(n);
    address = R[n] + imm32;
    if AArch32.ExclusiveMonitorsPass(address,4) then
        MemA[address,4] = R[t];
        R[d] = ZeroExtend('0');
    else
        R[d] = ZeroExtend('1');
```

Aborts and alignment

If a synchronous Data Abort exception is generated by the execution of this instruction:

- Memory is not updated.
- <Rd> is not updated.

If [SCTLR.A](#) and [SCTLR.U](#) are both 0, a non word-aligned memory address causes UNPREDICTABLE behavior. Otherwise, a non word-aligned memory address causes an Alignment fault Data Abort exception to be generated, subject to the following rules:

- If `ExclusiveMonitorsPass()` returns TRUE, the exception is generated.
- Otherwise, it is IMPLEMENTATION DEFINED whether the exception is generated.

If `ExclusiveMonitorsPass()` returns FALSE and the memory address, if accessed, would generate a synchronous Data Abort exception, it is IMPLEMENTATION DEFINED whether the exception is generated.

F7.1.226 STREXB

Store Register Exclusive Byte derives an address from a base register value, and stores a byte from a register to memory if the executing PE has exclusive access to the memory addressed.

For more information about support for shared memory see [Synchronization and semaphores on page E2-2369](#). For information about memory accesses see [Memory accesses on page F2-2422](#).

Encoding T1 ARMv7

STREXB<c> <Rd>, <Rt>, [<Rn>]

15	14	13	12	11	10	9	8	7	6	5	4	3	2	1	0	15	14	13	12	11	10	9	8	7	6	5	4	3	2	1	0
1	1	1	0	1	0	0	0	1	1	0	0	Rn				Rt				(1)	(1)	(1)	(1)	0	1	0	0	Rd			

d = UInt(Rd); t = UInt(Rt); n = UInt(Rn);
 if d == 15 || t == 15 || n == 15 then UNPREDICTABLE; // ARMv8-A removes UNPREDICTABLE for R13
 if d == n || d == t then UNPREDICTABLE;

Encoding A1 ARMv8

STREXB <Rd>, <Rt>, [<Rn>]

31	30	29	28	27	26	25	24	23	22	21	20	19	18	17	16	15	14	13	12	11	10	9	8	7	6	5	4	3	2	1	0
cond				0	0	0	1	1	1	0	0	Rn				Rd				(1)	(1)	1	1	1	0	0	1	Rt			

d = UInt(Rd); t = UInt(Rt); n = UInt(Rn);
 if d == 15 || t == 15 || n == 15 then UNPREDICTABLE;
 if d == n || d == t then UNPREDICTABLE;

For information about the CONSTRAINED UNPREDICTABLE behavior of this instruction, see [Appendix A Architectural Constraints on UNPREDICTABLE behaviors](#), and particularly [STREXB on page AppxA-4740](#).

Assembler syntax

STREXB{<c>}{<q>} <Rd>, <Rt>, [<Rn>]

where:

- <c>, <q> See [Standard assembler syntax fields on page F2-2415](#).
- <Rd> The destination register for the returned status value. The value returned is:
0 If the operation updates memory.
1 If the operation fails to update memory.
- <Rt> The source register.
- <Rn> The base register. The SP can be used.

Operation

```
if ConditionPassed() then
    EncodingSpecificOperations(); NullCheckIfThumbEE(n);
    address = R[n];
    if AArch32.ExclusiveMonitorsPass(address,1) then
        MemA[address,1] = R[t]<7:0>;
        R[d] = ZeroExtend('0');
    else
        R[d] = ZeroExtend('1');
```

Aborts

If a synchronous Data Abort exception is generated by the execution of this instruction:

- Memory is not updated.
- <Rd> is not updated.

If ExclusiveMonitorsPass() returns FALSE and the memory address, if accessed, would generate a synchronous Data Abort exception, it is IMPLEMENTATION DEFINED whether the exception is generated.

F7.1.227 STREXD

Store Register Exclusive Doubleword derives an address from a base register value, and stores a 64-bit doubleword from two registers to memory if the executing PE has exclusive access to the memory addressed.

For more information about support for shared memory see [Synchronization and semaphores on page E2-2369](#). For information about memory accesses see [Memory accesses on page F2-2422](#).

Encoding T1 ARMv7

STREXD<C> <Rd>, <Rt>, <Rt2>, [<Rn>]

15	14	13	12	11	10	9	8	7	6	5	4	3	2	1	0	15	14	13	12	11	10	9	8	7	6	5	4	3	2	1	0
1	1	1	0	1	0	0	0	1	1	0	0	Rn				Rt		Rt2		0			1	1	1	Rd					

```
d = UInt(Rd); t = UInt(Rt); t2 = UInt(Rt2); n = UInt(Rn);
if d == 15 || t == 15 || t2 == 15 || n == 15 then UNPREDICTABLE;
// ARMv8-A removes UNPREDICTABLE for R13
if d == n || d == t || d == t2 then UNPREDICTABLE;
```

Encoding A1 ARMv8

STREXD <Rd>, <Rt>, <Rt2>, [<Rn>]

31	30	29	28	27	26	25	24	23	22	21	20	19	18	17	16	15	14	13	12	11	10	9	8	7	6	5	4	3	2	1	0										
cond		0		0		0		1		1		0		1		0		Rn				Rd				(1)(1)		1		1		1		0		0		1		Rt	

```
d = UInt(Rd); t = UInt(Rt); t2 = t+1; n = UInt(Rn);
if d == 15 || Rt<0> == '1' || t2 == 15 || n == 15 then UNPREDICTABLE;
if d == n || d == t || d == t2 then UNPREDICTABLE;
```

For information about the CONSTRAINED UNPREDICTABLE behavior of this instruction, see [Appendix A Architectural Constraints on UNPREDICTABLE behaviors](#), and particularly [STREXD on page AppxA-4741](#).

Assembler syntax

STREXD{<c>}{<q>} <Rd>, <Rt>, <Rt2>, [<Rn>]

where:

- <c>, <q> See [Standard assembler syntax fields on page F2-2415](#).
- <Rd> The destination register for the returned status value. The value returned is:
0 If the operation updates memory.
1 If the operation fails to update memory.
<Rd> must not be the same as <Rn>, <Rt>, or <Rt2>.
- <Rt> The first source register. For an A32 instruction, <Rt> must be even-numbered and not R14.
- <Rt2> The second source register. For an A32 instruction, <Rt2> must be <R(t+1)>.
- <Rn> The base register. The SP can be used.

Operation

```
if ConditionPassed() then
    EncodingSpecificOperations(); NullCheckIfThumbEE(n);
    address = R[n];
    // Create doubleword to store such that R[t] will be stored at address and R[t2] at address+4.
    value = if BigEndian() then R[t]:R[t2] else R[t2]:R[t];
    if AArch32.ExclusiveMonitorsPass(address,8) then
        MemA[address,8] = value; R[d] = ZeroExtend('0');
    else
        R[d] = ZeroExtend('1');
```

Aborts and alignment

If a synchronous Data Abort exception is generated by the execution of this instruction:

- Memory is not updated.
- <Rd> is not updated.

If [SCTLR.A](#) and [SCTLR.U](#) are both 0, a non doubleword-aligned memory address causes UNPREDICTABLE behavior. Otherwise, a non doubleword-aligned memory address causes an Alignment fault Data Abort exception to be generated, subject to the following rules:

- If [ExclusiveMonitorsPass\(\)](#) returns TRUE, the exception is generated.
- Otherwise, it is IMPLEMENTATION DEFINED whether the exception is generated.

If [ExclusiveMonitorsPass\(\)](#) returns FALSE and the memory address, if accessed, would generate a synchronous Data Abort exception, it is IMPLEMENTATION DEFINED whether the exception is generated.

F7.1.228 STREXH

Store Register Exclusive Halfword derives an address from a base register value, and stores a halfword from a register to memory if the executing PE has exclusive access to the memory addressed.

For more information about support for shared memory see [Synchronization and semaphores on page E2-2369](#). For information about memory accesses see [Memory accesses on page F2-2422](#).

Encoding T1 ARMv7

STREXH<c> <Rd>, <Rt>, [<Rn>]

15	14	13	12	11	10	9	8	7	6	5	4	3	2	1	0	15	14	13	12	11	10	9	8	7	6	5	4	3	2	1	0
1	1	1	0	1	0	0	0	1	1	0	0	Rn				Rt				(1)	(1)	(1)	(1)	0	1	0	1	Rd			

d = UInt(Rd); t = UInt(Rt); n = UInt(Rn);
 if d == 15 || t == 15 || n == 15 then UNPREDICTABLE; // ARMv8-A removes UNPREDICTABLE for R13
 if d == n || d == t then UNPREDICTABLE;

Encoding A1 ARMv8

STREXH <Rd>, <Rt>, [<Rn>]

31	30	29	28	27	26	25	24	23	22	21	20	19	18	17	16	15	14	13	12	11	10	9	8	7	6	5	4	3	2	1	0
cond				0	0	0	1	1	1	1	0	Rn				Rd				(1)	(1)	1	1	1	0	0	1	Rt			

d = UInt(Rd); t = UInt(Rt); n = UInt(Rn);
 if d == 15 || t == 15 || n == 15 then UNPREDICTABLE;
 if d == n || d == t then UNPREDICTABLE;

For information about the CONSTRAINED UNPREDICTABLE behavior of this instruction, see [Appendix A Architectural Constraints on UNPREDICTABLE behaviors](#), and particularly [STREXH on page AppxA-4741](#).

Assembler syntax

STREXH{<c>}{<q>} <Rd>, <Rt>, [<Rn>]

where:

- <c>, <q> See [Standard assembler syntax fields on page F2-2415](#).
- <Rd> The destination register for the returned status value. The value returned is:
0 If the operation updates memory.
1 If the operation fails to update memory.
- <Rt> The source register.
- <Rn> The base register. The SP can be used.

Operation

```
if ConditionPassed() then
    EncodingSpecificOperations(); NullCheckIfThumbEE(n);
    address = R[n];
    if AArch32.ExclusiveMonitorsPass(address,2) then
        MemA[address,2] = R[t]<15:0>;
        R[d] = ZeroExtend('0');
    else
        R[d] = ZeroExtend('1');
```

Aborts and alignment

If a synchronous Data Abort exception is generated by the execution of this instruction:

- Memory is not updated.
- <Rd> is not updated.

If [SCTLR.A](#) and [SCTLR.U](#) are both 0, a non halfword-aligned memory address causes UNPREDICTABLE behavior. Otherwise, a non halfword-aligned memory address causes an Alignment fault Data Abort exception to be generated, subject to the following rules:

- If [ExclusiveMonitorsPass\(\)](#) returns TRUE, the exception is generated.
- Otherwise, it is IMPLEMENTATION DEFINED whether the exception is generated.

If [ExclusiveMonitorsPass\(\)](#) returns FALSE and the memory address, if accessed, would generate a synchronous Data Abort exception, it is IMPLEMENTATION DEFINED whether the exception is generated.

F7.1.229 STRH (immediate, T32)

Store Register Halfword (immediate) calculates an address from a base register value and an immediate offset, and stores a halfword from a register to memory. It can use offset, post-indexed, or pre-indexed addressing. For information about memory accesses see [Memory accesses on page F2-2422](#).

Encoding T1 ARMv4T, ARMv5T*, ARMv6*, ARMv7
 STRH<c> <Rt>, [<Rn>{, #<imm>}]

15	14	13	12	11	10	9	8	7	6	5	4	3	2	1	0
1	0	0	0	0	imm5					Rn			Rt		

t = UInt(Rt); n = UInt(Rn); imm32 = ZeroExtend(imm5:'0', 32);
 index = TRUE; add = TRUE; wback = FALSE;

Encoding T2 ARMv6T2, ARMv7
 STRH<c>.W <Rt>, [<Rn>{, #<imm12>}]

15	14	13	12	11	10	9	8	7	6	5	4	3	2	1	0	15	14	13	12	11	10	9	8	7	6	5	4	3	2	1	0
1	1	1	1	1	0	0	0	1	0	1	0	Rn			Rt			imm12													

if Rn == '1111' then UNDEFINED;
 t = UInt(Rt); n = UInt(Rn); imm32 = ZeroExtend(imm12, 32);
 index = TRUE; add = TRUE; wback = FALSE;
 if t == 15 then UNPREDICTABLE; // ARMv8-A removes UNPREDICTABLE for R13

Encoding T3 ARMv6T2, ARMv7
 STRH<c> <Rt>, [<Rn>, #-<imm8>]
 STRH<c> <Rt>, [<Rn>], #+/-<imm8>
 STRH<c> <Rt>, [<Rn>, #+/-<imm8>!]

15	14	13	12	11	10	9	8	7	6	5	4	3	2	1	0	15	14	13	12	11	10	9	8	7	6	5	4	3	2	1	0
1	1	1	1	1	0	0	0	0	0	1	0	Rn			Rt			1	P	U	W	imm8									

if P == '1' && U == '1' && W == '0' then SEE STRHT;
 if Rn == '1111' || (P == '0' && W == '0') then UNDEFINED;
 t = UInt(Rt); n = UInt(Rn); imm32 = ZeroExtend(imm8, 32);
 index = (P == '1'); add = (U == '1'); wback = (W == '1');
 if t == 15 || (wback && n == t) then UNPREDICTABLE; // ARMv8-A removes UNPREDICTABLE for R13

For information about the CONSTRAINED UNPREDICTABLE behavior of this instruction, see [Appendix A Architectural Constraints on UNPREDICTABLE behaviors](#), and particularly [STRH \(immediate, T32\) on page AppxA-4734](#).

Assembler syntax

STRH{<c>}{<q>} <Rt>, [<Rn> {, #+/-<imm>}]	Offset: index==TRUE, wback==FALSE
STRH{<c>}{<q>} <Rt>, [<Rn>, #+/-<imm>]!	Pre-indexed: index==TRUE, wback==TRUE
STRH{<c>}{<q>} <Rt>, [<Rn>], #+/-<imm>	Post-indexed: index==FALSE, wback==TRUE

where:

<c>, <q> See [Standard assembler syntax fields on page F2-2415](#).

<Rt> The source register.

<Rn> The base register. The SP can be used.

+/- Is + or omitted if the immediate offset is to be added to the base register value (add == TRUE), or – if it is to be subtracted (add == FALSE). #0 and #-0 generate different instructions.

<imm> The immediate offset used for forming the address. Values are:

Encoding T1	Multiples of 2 in the range 0-62.
Encoding T2	Any value in the range 0-4095.
Encoding T3	Any value in the range 0-255.

For the offset addressing syntax, <imm> can be omitted, meaning an offset of 0.

The pre-UAL syntax STR<c>H is equivalent to STRH<c>.

Operation

```
if ConditionPassed() then
    EncodingSpecificOperations(); NullCheckIfThumbEE(n);
    offset_addr = if add then (R[n] + imm32) else (R[n] - imm32);
    address = if index then offset_addr else R[n];
    MemU[address,2] = R[t]<15:0>;
    if wback then R[n] = offset_addr;
```

F7.1.230 STRH (immediate, A32)

Store Register Halfword (immediate) calculates an address from a base register value and an immediate offset, and stores a halfword from a register to memory. It can use offset, post-indexed, or pre-indexed addressing. For information about memory accesses see [Memory accesses on page F2-2422](#).

Encoding A1 ARMv4*, ARMv5T*, ARMv6*, ARMv7

STRH<c> <Rt>, [<Rn>{, #+/-<imm8>}]

STRH<c> <Rt>, [<Rn>], #+/-<imm8>

STRH<c> <Rt>, [<Rn>, #+/-<imm8>]!

31	30	29	28	27	26	25	24	23	22	21	20	19	18	17	16	15	14	13	12	11	10	9	8	7	6	5	4	3	2	1	0
cond			0	0	0	P	U	1	W	0	Rn				Rt				imm4H				1	0	1	1	imm4L				

if P == '0' && W == '1' then SEE STRHT;

t = UInt(Rt); n = UInt(Rn); imm32 = ZeroExtend(imm4H:imm4L, 32);

index = (P == '1'); add = (U == '1'); wback = (P == '0') || (W == '1');

if t == 15 then UNPREDICTABLE;

if wback && (n == 15 || n == t) then UNPREDICTABLE;

For information about the CONSTRAINED UNPREDICTABLE behavior of this instruction, see [Appendix A Architectural Constraints on UNPREDICTABLE behaviors](#), and particularly [STRH \(immediate, A32\) on page AppxA-4735](#).

Assembler syntax

STRH{<c>}{<q>} <Rt>, [<Rn> {, #+/-<imm>}]	Offset: index==TRUE, wback==FALSE
STRH{<c>}{<q>} <Rt>, [<Rn>, #+/-<imm>]!	Pre-indexed: index==TRUE, wback==TRUE
STRH{<c>}{<q>} <Rt>, [<Rn>], #+/-<imm>	Post-indexed: index==FALSE, wback==TRUE

where:

<c>, <q>	See Standard assembler syntax fields on page F2-2415 .
<Rt>	The source register.
<Rn>	The base register. The SP can be used. For offset addressing only, the PC can be used. However, ARM deprecates use of the PC.
+/-	Is + or omitted if the immediate offset is to be added to the base register value (add == TRUE), or – if it is to be subtracted (add == FALSE). #0 and #-0 generate different instructions.
<imm>	The immediate offset used for forming the address. Values are 0-255. For the offset addressing syntax, <imm> can be omitted, meaning an offset of 0.

The pre-UAL syntax STR<c>H is equivalent to STRH<c>.

Operation

```
if ConditionPassed() then
    EncodingSpecificOperations();
    offset_addr = if add then (R[n] + imm32) else (R[n] - imm32);
    address = if index then offset_addr else R[n];
    MemU[address,2] = R[t]<15:0>;
    if wback then R[n] = offset_addr;
```

F7.1.231 STRH (register)

Store Register Halfword (register) calculates an address from a base register value and an offset register value, and stores a halfword from a register to memory. The offset register value can be shifted left by 0, 1, 2, or 3 bits. For information about memory accesses see [Memory accesses on page F2-2422](#).

Encoding T1 ARMv4T, ARMv5T*, ARMv6*, ARMv7
 STRH<c> <Rt>, [<Rn>, <Rm>]

15	14	13	12	11	10	9	8	7	6	5	4	3	2	1	0
0	1	0	1	0	0	1	Rm		Rn		Rt				

```
if CurrentInstrSet() == InstrSet_T32EE then SEE "Modified operation in ThumbEE";
t = UInt(Rt); n = UInt(Rn); m = UInt(Rm);
index = TRUE; add = TRUE; wback = FALSE;
(shift_t, shift_n) = (SRTYPE_LSL, 0);
```

Encoding T2 ARMv6T2, ARMv7
 STRH<c>.W <Rt>, [<Rn>, <Rm>{, LSL #<imm2>}]

15	14	13	12	11	10	9	8	7	6	5	4	3	2	1	0	15	14	13	12	11	10	9	8	7	6	5	4	3	2	1	0
1	1	1	1	1	0	0	0	0	0	1	0	Rn				Rt		0	0	0	0	0	0	imm2	Rm						

```
if Rn == '1111' then UNDEFINED;
t = UInt(Rt); n = UInt(Rn); m = UInt(Rm);
index = TRUE; add = TRUE; wback = FALSE;
(shift_t, shift_n) = (SRTYPE_LSL, UInt(imm2));
if t == 15 || m == 15 then UNPREDICTABLE; // ARMv8-A removes UNPREDICTABLE for R13
```

Encoding A1 ARMv4*, ARMv5T*, ARMv6*, ARMv7
 STRH<c> <Rt>, [<Rn>, +/-<Rm>]{!}
 STRH<c> <Rt>, [<Rn>], +/-<Rm>

31	30	29	28	27	26	25	24	23	22	21	20	19	18	17	16	15	14	13	12	11	10	9	8	7	6	5	4	3	2	1	0
cond		0	0	0	P	U	0	W	0	Rn				Rt		(0)	(0)	(0)	(0)	1	0	1	1	Rm							

```
if P == '0' && W == '1' then SEE STRHT;
t = UInt(Rt); n = UInt(Rn); m = UInt(Rm);
index = (P == '1'); add = (U == '1'); wback = (P == '0') || (W == '1');
(shift_t, shift_n) = (SRTYPE_LSL, 0);
if t == 15 || m == 15 then UNPREDICTABLE;
if wback && (n == 15 || n == t) then UNPREDICTABLE;
```

For information about the CONSTRAINED UNPREDICTABLE behavior of this instruction, see [Appendix A Architectural Constraints on UNPREDICTABLE behaviors](#), and particularly [STRH \(register\) on page AppxA-4736](#).

Modified operation in ThumbEE

ARM deprecates any use of ThumbEE instructions and they are not documented in this manual.

Assembler syntax

STRH{<c>}{<q>} <Rt>, [<Rn>, +/-<Rm>{, LSL #<imm>}] Offset: index==TRUE, wback==FALSE
STRH{<c>}{<q>} <Rt>, [<Rn>, +/-<Rm>! Pre-indexed: index==TRUE, wback==TRUE
STRH{<c>}{<q>} <Rt>, [<Rn>], +/-<Rm> Post-indexed: index==FALSE, wback==TRUE

where:

<c>, <q> See [Standard assembler syntax fields on page F2-2415](#).
<Rt> The source register.
<Rn> The base register. The SP can be used. In the A32 instruction set, for offset addressing only, the PC can be used. However, ARM deprecates use of the PC.
+/- Is + or omitted if the optionally shifted value of <Rm> is to be added to the base register value (add == TRUE), or – if it is to be subtracted (permitted in A32 instructions only, add == FALSE).
<Rm> Contains the offset that is optionally left shifted and added to the value of <Rn> to form the address.
<imm> If present, the size of the left shift to apply to the value from <Rm>, in the range 1-3. Only encoding T2 is permitted, and <imm> is encoded in imm2.
If absent, no shift is specified and all encodings are permitted. In encoding T2, imm2 is encoded as 0b00.

The pre-UAL syntax STR<c>H is equivalent to STRH<c>.

Operation

```
if ConditionPassed() then
    EncodingSpecificOperations(); NullCheckIfThumbEE(n);
    offset = Shift(R[m], shift_t, shift_n, APSR.C);
    offset_addr = if add then (R[n] + offset) else (R[n] - offset);
    address = if index then offset_addr else R[n];
    MemU[address,2] = R[t]<15:0>;
    if wback then R[n] = offset_addr;
```

F7.1.232 STRHT

Store Register Halfword Unprivileged stores a halfword from a register to memory. For information about memory accesses see [Memory accesses on page F2-2422](#).

The memory access is restricted as if the PE were running in User mode. This makes no difference if the PE is actually running in User mode.

STRHT is UNPREDICTABLE in Hyp mode.

The T32 instruction uses an offset addressing mode, that calculates the address used for the memory access from a base register value and an immediate offset, and leaves the base register unchanged.

The A32 instruction uses a post-indexed addressing mode, that uses a base register value as the address for the memory access, and calculates a new address from a base register value and an offset and writes it back to the base register. The offset can be an immediate value or a register value.

Encoding T1 ARMv6T2, ARMv7

STRHT<c> <Rt>, [<Rn>, #<imm8>]

15	14	13	12	11	10	9	8	7	6	5	4	3	2	1	0	15	14	13	12	11	10	9	8	7	6	5	4	3	2	1	0
1	1	1	1	1	0	0	0	0	0	1	0	Rn				Rt		1	1	1	0	imm8									

```
if Rn == '1111' then UNDEFINED;
t = UInt(Rt); n = UInt(Rn); postindex = FALSE; add = TRUE;
register_form = FALSE; imm32 = ZeroExtend(imm8, 32);
if t == 15 then UNPREDICTABLE; // ARMv8-A removes UNPREDICTABLE for R13
```

Encoding A1 ARMv6T2, ARMv7

STRHT<c> <Rt>, [<Rn>] {, #+/-<imm8>}

31	30	29	28	27	26	25	24	23	22	21	20	19	18	17	16	15	14	13	12	11	10	9	8	7	6	5	4	3	2	1	0
cond		0	0	0	0	U	1	1	0	Rn				Rt		imm4H		1	0	1	1	imm4L									

```
t = UInt(Rt); n = UInt(Rn); postindex = TRUE; add = (U == '1');
register_form = FALSE; imm32 = ZeroExtend(imm4H:imm4L, 32);
if t == 15 || n == 15 || n == t then UNPREDICTABLE;
```

Encoding A2 ARMv6T2, ARMv7

STRHT<c> <Rt>, [<Rn>], +/-<Rm>

31	30	29	28	27	26	25	24	23	22	21	20	19	18	17	16	15	14	13	12	11	10	9	8	7	6	5	4	3	2	1	0
cond		0	0	0	0	U	0	1	0	Rn				Rt		(0)	(0)	(0)	(0)	1	0	1	1	Rm							

```
t = UInt(Rt); n = UInt(Rn); m = UInt(Rm); postindex = TRUE; add = (U == '1');
register_form = TRUE;
if t == 15 || n == 15 || n == t || m == 15 then UNPREDICTABLE;
```

For information about the CONSTRAINED UNPREDICTABLE behavior of this instruction, see [Appendix A Architectural Constraints on UNPREDICTABLE behaviors](#), and particularly [STRHT on page AppxA-4736](#).

Assembler syntax

STRHT{<c>}{<q>} <Rt>, [<Rn> {, #<imm>}]	Offset: T32 only
STRHT{<c>}{<q>} <Rt>, [<Rn>] {, #+/-<imm>}	Post-indexed: A32 only
STRHT{<c>}{<q>} <Rt>, [<Rn>], +/-<Rm>	Post-indexed: A32 only

where:

<c>, <q>	See <i>Standard assembler syntax fields</i> on page F2-2415.
<Rt>	The source register.
<Rn>	The base register. The SP can be used.
+/-	Is + or omitted if <imm> or the optionally shifted value of <Rm> is to be added to the base register value (add == TRUE), or – if it is to be subtracted (permitted in A32 instructions only, add == FALSE).
<imm>	The immediate offset applied to the value of <Rn>. Any value in the range 0-255 is permitted. <imm> can be omitted, meaning an offset of 0.
<Rm>	Contains the offset that is applied to the value of <Rn> to form the address.

Operation

```
if ConditionPassed() then
    if CurrentModeIsHyp() then UNPREDICTABLE;           // Hyp mode
    EncodingSpecificOperations(); NullCheckIfThumbEE(n);
    offset = if register_form then R[m] else imm32;
    offset_addr = if add then (R[n] + offset) else (R[n] - offset);
    address = if postindex then R[n] else offset_addr;
    MemU_unpriv[address,2] = R[t]<15:0>;
    if postindex then R[n] = offset_addr;
```

F7.1.233 STRT

Store Register Unprivileged stores a word from a register to memory. For information about memory accesses see [Memory accesses on page F2-2422](#).

The memory access is restricted as if the PE were running in User mode. This makes no difference if the PE is actually running in User mode.

STRT is UNPREDICTABLE in Hyp mode.

The T32 instruction uses an offset addressing mode, that calculates the address used for the memory access from a base register value and an immediate offset, and leaves the base register unchanged.

The A32 instruction uses a post-indexed addressing mode, that uses a base register value as the address for the memory access, and calculates a new address from a base register value and an offset and writes it back to the base register. The offset can be an immediate value or an optionally-shifted register value.

Encoding T1 ARMv6T2, ARMv7

STRT<<> <Rt>, [<Rn>, #<imm8>]

15	14	13	12	11	10	9	8	7	6	5	4	3	2	1	0	15	14	13	12	11	10	9	8	7	6	5	4	3	2	1	0
1	1	1	1	1	0	0	0	0	1	0	0	Rn				Rt		1	1	1	0	imm8									

```
if Rn == '1111' then UNDEFINED;
t = UInt(Rt); n = UInt(Rn); postindex = FALSE; add = TRUE;
register_form = FALSE; imm32 = ZeroExtend(imm8, 32);
if t == 15 then UNPREDICTABLE; // ARMv8-A removes UNPREDICTABLE for R13
```

Encoding A1 ARMv4*, ARMv5T*, ARMv6*, ARMv7

STRT<<> <Rt>, [<Rn>] {, +/-<imm12>}

31	30	29	28	27	26	25	24	23	22	21	20	19	18	17	16	15	14	13	12	11	10	9	8	7	6	5	4	3	2	1	0
cond		0	1	0	0	U	0	1	0	Rn				Rt				imm12													

```
t = UInt(Rt); n = UInt(Rn); postindex = TRUE; add = (U == '1');
register_form = FALSE; imm32 = ZeroExtend(imm12, 32);
if n == 15 || n == t then UNPREDICTABLE;
```

Encoding A2 ARMv4*, ARMv5T*, ARMv6*, ARMv7

STRT<<> <Rt>, [<Rn>], +/-<Rm>{, <shift>}

31	30	29	28	27	26	25	24	23	22	21	20	19	18	17	16	15	14	13	12	11	10	9	8	7	6	5	4	3	2	1	0
cond		0	1	1	0	U	0	1	0	Rn				Rt				imm5			type	0	Rm								

```
t = UInt(Rt); n = UInt(Rn); m = UInt(Rm); postindex = TRUE; add = (U == '1');
register_form = TRUE; (shift_t, shift_n) = DecodeImmShift(type, imm5);
if n == 15 || n == t || m == 15 then UNPREDICTABLE;
```

For information about the CONSTRAINED UNPREDICTABLE behavior of this instruction, see [Appendix A Architectural Constraints on UNPREDICTABLE behaviors](#), and particularly [STRT on page AppxA-4737](#).

Assembler syntax

STRT{<c>}{<q>} <Rt>, [<Rn> {, #<imm>}]	Offset: T32 only
STRT{<c>}{<q>} <Rt>, [<Rn>] {, #+/-<imm>}	Post-indexed: A32 only
STRT{<c>}{<q>} <Rt>, [<Rn>], +/-<Rm> {, <shift>}	Post-indexed: A32 only

where:

<c>, <q>	See Standard assembler syntax fields on page F2-2415 .
<Rt>	The source register. In the A32 instruction set, the PC can be used. However, ARM deprecates use of the PC.
<Rn>	The base register. The SP can be used.
+/-	Is + or omitted if <imm> or the optionally shifted value of <Rm> is to be added to the base register value (add == TRUE), or – if it is to be subtracted (permitted in A32 instructions only, add == FALSE).
<imm>	The immediate offset applied to the value of <Rn>. Values are 0-255 for encoding T1, and 0-4095 for encoding A1. <imm> can be omitted, meaning an offset of 0.
<Rm>	Contains the offset that is optionally shifted and added to the value of <Rn> to form the address.
<shift>	The shift to apply to the value read from <Rm>. If omitted, no shift is applied. Shifts applied to a register on page F2-2419 describes the shifts and how they are encoded.

The pre-UAL syntax STR<c>T is equivalent to STRT<c>.

Operation

```

if ConditionPassed() then
    if CurrentModeIsHyp() then UNPREDICTABLE;           // Hyp mode
    EncodingSpecificOperations(); NullCheckIfThumbEE(n);
    offset = if register_form then Shift(R[m], shift_t, shift_n, APSR.C) else imm32;
    offset_addr = if add then (R[n] + offset) else (R[n] - offset);
    address = if postindex then R[n] else offset_addr;
    if t == 15 then // Only possible for encodings A1 and A2
        data = PCStoreValue();
    else
        data = R[t];
    MemU_unpriv[address,4] = data;
    if postindex then R[n] = offset_addr;
  
```

F7.1.234 SUB (immediate, T32)

This instruction subtracts an immediate value from a register value, and writes the result to the destination register. It can optionally update the condition flags based on the result.

Encoding T1 ARMv4T, ARMv5T*, ARMv6*, ARMv7
 SUBS <Rd>, <Rn>, #<imm3> Outside IT block.
 SUB<c> <Rd>, <Rn>, #<imm3> Inside IT block.

15	14	13	12	11	10	9	8	7	6	5	4	3	2	1	0
0	0	0	1	1	1	1	imm3			Rn			Rd		

d = UInt(Rd); n = UInt(Rn); setflags = !InITBlock(); imm32 = ZeroExtend(imm3, 32);

Encoding T2 ARMv4T, ARMv5T*, ARMv6*, ARMv7
 SUBS <Rdn>, #<imm8> Outside IT block.
 SUB<c> <Rdn>, #<imm8> Inside IT block.

15	14	13	12	11	10	9	8	7	6	5	4	3	2	1	0
0	0	1	1	1	Rdn			imm8							

d = UInt(Rdn); n = UInt(Rdn); setflags = !InITBlock(); imm32 = ZeroExtend(imm8, 32);

Encoding T3 ARMv6T2, ARMv7
 SUB{S}<c>.W <Rd>, <Rn>, #<const>

15	14	13	12	11	10	9	8	7	6	5	4	3	2	1	0	15	14	13	12	11	10	9	8	7	6	5	4	3	2	1	0
1	1	1	1	0	i	0	1	1	0	1	S	Rn			0	imm3			Rd			imm8									

if Rd == '1111' && S == '1' then SEE CMP (immediate);
 if Rn == '1101' then SEE SUB (SP minus immediate);
 d = UInt(Rd); n = UInt(Rn); setflags = (S == '1'); imm32 = ThumbExpandImm(i:imm3:imm8);
 if (d == 15 && S == '0') || n == 15 then UNPREDICTABLE; // ARMv8-A removes UNPREDICTABLE for R13

Encoding T4 ARMv6T2, ARMv7
 SUBW<c> <Rd>, <Rn>, #<imm12>

15	14	13	12	11	10	9	8	7	6	5	4	3	2	1	0	15	14	13	12	11	10	9	8	7	6	5	4	3	2	1	0
1	1	1	1	0	i	1	0	1	0	1	0	Rn			0	imm3			Rd			imm8									

if Rn == '1111' then SEE ADR;
 if Rn == '1101' then SEE SUB (SP minus immediate);
 d = UInt(Rd); n = UInt(Rn); setflags = FALSE; imm32 = ZeroExtend(i:imm3:imm8, 32);
 if d == 15 then UNPREDICTABLE; // ARMv8-A removes UNPREDICTABLE for R13

For information about the CONSTRAINED UNPREDICTABLE behavior of this instruction, see [Appendix A Architectural Constraints on UNPREDICTABLE behaviors](#).

Assembler syntax

SUB{S}{<c>}{<q>} {<Rd>}, <Rn>, #<const> All encodings permitted
SUBW{<c>}{<q>} {<Rd>}, <Rn>, #<const> Only encoding T4 permitted

where:

- S If S is present, the instruction updates the flags. Otherwise, the flags are not updated.
- <c>, <q> See [Standard assembler syntax fields on page F2-2415](#).
- <Rd> The destination register. If S is specified and <Rd> is the PC, see [SUBS PC, LR and related instructions \(T32\) on page F7-3066](#) or [SUBS PC, LR and related instructions \(A32\) on page F7-3068](#).
- <Rn> The first operand register. If the SP is specified for <Rn>, see [SUB \(SP minus immediate\) on page F7-2922](#). If the PC is specified for <Rn>, see [ADR on page F7-2554](#).
- <const> The immediate value to be subtracted from the value obtained from <Rn>. The range of values is 0-7 for encoding T1, 0-255 for encoding T2 and 0-4095 for encoding T4. See [Modified immediate constants in T32 instructions on page F3-2444](#) for the range of values for encoding T3.
- When multiple encodings of the same length are available for an instruction, encoding T3 is preferred to encoding T4. If encoding T4 is required, use the SUBW syntax. Encoding T1 is preferred to encoding T2 if <Rd> is specified and encoding T2 is preferred to encoding T1 if <Rd> is omitted.

The pre-UAL syntax SUB<c>S is equivalent to SUBS<c>.

Operation

```
if ConditionPassed() then
    EncodingSpecificOperations();
    (result, nzc) = AddWithCarry(R[n], NOT(imm32), '1');
    R[d] = result;
    if setflags then
        APSR.<N,Z,C,V> = nzc;
```

F7.1.235 SUB (immediate, A32)

This instruction subtracts an immediate value from a register value, and writes the result to the destination register. It can optionally update the condition flags based on the result.

Encoding A1 ARMv4*, ARMv5T*, ARMv6*, ARMv7
 SUB{S}<c> <Rd>, <Rn>, #<const>

31	30	29	28	27	26	25	24	23	22	21	20	19	18	17	16	15	14	13	12	11	10	9	8	7	6	5	4	3	2	1	0
cond			0	0	1	0	0	1	0	S	Rn				Rd				imm12												

if Rn == '1111' && S == '0' then SEE ADR;
 if Rn == '1101' then SEE SUB (SP minus immediate);
 if Rd == '1111' && S == '1' then SEE SUBS PC, LR and related instructions;
 d = UInt(Rd); n = UInt(Rn); setflags = (S == '1'); imm32 = ARMEExpandImm(imm12);

Assembler syntax

SUB{S}{<c>}{<q>} {<Rd>}, <Rn>, #<const>

where:

- S If S is present, the instruction updates the flags. Otherwise, the flags are not updated.
- <c>, <q> See *Standard assembler syntax fields* on page F2-2415.
- <Rd> The destination register. If S is specified and <Rd> is the PC, see *SUBS PC, LR and related instructions (T32)* on page F7-3066 or *SUBS PC, LR and related instructions (A32)* on page F7-3068.
- If S is not specified and <Rd> is the PC, the instruction is a branch to the address calculated by the operation. This is an interworking branch, see *Pseudocode details of operations on the AArch32 general-purpose registers and the PC* on page E1-2296.
- <Rn> The first operand register. If the SP is specified for <Rn>, see *SUB (SP minus immediate)* on page F7-2922. If the PC is specified for <Rn>, see *ADR* on page F7-2554.
- <const> The immediate value to be subtracted from the value obtained from <Rn>. See *Modified immediate constants in A32 instructions* on page F4-2472 for the range of values.

The pre-UAL syntax SUB<c>S is equivalent to SUBS<c>.

Operation

```
if ConditionPassed() then
    EncodingSpecificOperations();
    (result, nzcv) = AddWithCarry(R[n], NOT(imm32), '1');
    if d == 15 then
        ALUWritePC(result); // setflags is always FALSE here
    else
        R[d] = result;
        if setflags then
            APSR.<N,Z,C,V> = nzcv;
```

F7.1.236 SUB (register)

This instruction subtracts an optionally-shifted register value from a register value, and writes the result to the destination register. It can optionally update the condition flags based on the result.

Encoding T1 ARMv4T, ARMv5T*, ARMv6*, ARMv7
 SUBS <Rd>, <Rn>, <Rm> Outside IT block.
 SUB<c> <Rd>, <Rn>, <Rm> Inside IT block.

15	14	13	12	11	10	9	8	7	6	5	4	3	2	1	0
0	0	0	1	1	0	1	Rm		Rn		Rd				

```
d = UInt(Rd); n = UInt(Rn); m = UInt(Rm); setflags = !InITBlock();
(shift_t, shift_n) = (SRTYPE_LSL, 0);
```

Encoding T2 ARMv6T2, ARMv7
 SUB{S}<c>.W <Rd>, <Rn>, <Rm>{, <shift>}

15	14	13	12	11	10	9	8	7	6	5	4	3	2	1	0	15	14	13	12	11	10	9	8	7	6	5	4	3	2	1	0
1	1	1	0	1	0	1	1	1	0	1	S	Rn		(0)	imm3	Rd		imm2	type	Rm											

```
if Rd == '1111' && S == '1' then SEE CMP (register);
if Rn == '1101' then SEE SUB (SP minus register);
d = UInt(Rd); n = UInt(Rn); m = UInt(Rm); setflags = (S == '1');
(shift_t, shift_n) = DecodeImmShift(type, imm3:imm2);
if (d == 15 && S == '0') || n == 15 || m == 15 then UNPREDICTABLE;
// ARMv8-A removes UNPREDICTABLE for R13
```

Encoding A1 ARMv4*, ARMv5T*, ARMv6*, ARMv7
 SUB{S}<c> <Rd>, <Rn>, <Rm>{, <shift>}

31	30	29	28	27	26	25	24	23	22	21	20	19	18	17	16	15	14	13	12	11	10	9	8	7	6	5	4	3	2	1	0
cond			0	0	0	0	0	1	0	S	Rn		Rd		imm5			type	0	Rm											

```
if Rd == '1111' && S == '1' then SEE SUBS PC, LR and related instructions;
if Rn == '1101' then SEE SUB (SP minus register);
d = UInt(Rd); n = UInt(Rn); m = UInt(Rm); setflags = (S == '1');
(shift_t, shift_n) = DecodeImmShift(type, imm5);
```

For information about the CONSTRAINED UNPREDICTABLE behavior of this instruction, see [Appendix A Architectural Constraints on UNPREDICTABLE behaviors](#).

Assembler syntax

SUB{S}{<c>}{<q>} {<Rd>}, <Rn>, <Rm> {, <shift>}

where:

- S If S is present, the instruction updates the flags. Otherwise, the flags are not updated.
- <c>, <q> See *Standard assembler syntax fields* on page F2-2415.
- <Rd> The destination register. If S is specified and <Rd> is the PC, see *SUBS PC, LR and related instructions (T32)* on page F7-3066 or *SUBS PC, LR and related instructions (A32)* on page F7-3068.
- In A32 instructions, if S is not specified and <Rd> is the PC, the instruction is a branch to the address calculated by the operation. This is an interworking branch, see *Pseudocode details of operations on the AArch32 general-purpose registers and the PC* on page E1-2296.
- <Rn> The first operand register. The PC can be used in A32 instructions. If the SP is specified for <Rn>, see *SUB (SP minus register)* on page F7-2924.
- <Rm> The register that is optionally shifted and used as the second operand. The PC can be used in A32 instructions.
- <shift> The shift to apply to the value read from <Rm>. If present, encoding T1 is not permitted. If absent, no shift is applied and all encodings are permitted. *Shifts applied to a register* on page F2-2419 describes the shifts and how they are encoded.

The pre-UAL syntax SUB<c>S is equivalent to SUBS<c>.

Operation

```
if ConditionPassed() then
    EncodingSpecificOperations();
    shifted = Shift(R[m], shift_t, shift_n, APSR.C);
    (result, nzcvc) = AddWithCarry(R[n], NOT(shifted), '1');
    if d == 15 then // Can only occur for ARM encoding
        ALUWritePC(result); // setflags is always FALSE here
    else
        R[d] = result;
        if setflags then
            APSR.<N,Z,C,V> = nzcvc;
```

F7.1.237 SUB (register-shifted register)

This instruction subtracts a register-shifted register value from a register value, and writes the result to the destination register. It can optionally update the condition flags based on the result.

Encoding A1 ARMv4*, ARMv5T*, ARMv6*, ARMv7

SUB{S}<c> <Rd>, <Rn>, <Rm>, <type> <Rs>

31	30	29	28	27	26	25	24	23	22	21	20	19	18	17	16	15	14	13	12	11	10	9	8	7	6	5	4	3	2	1	0
cond			0	0	0	0	0	1	0	S	Rn				Rd				Rs		0	type		1	Rm						

```
d = UInt(Rd); n = UInt(Rn); m = UInt(Rm); s = UInt(Rs);
setflags = (S == '1'); shift_t = DecodeRegShift(type);
if d == 15 || n == 15 || m == 15 || s == 15 then UNPREDICTABLE;
```

For information about the CONSTRAINED UNPREDICTABLE behavior of this instruction, see [Appendix A Architectural Constraints on UNPREDICTABLE behaviors](#).

Assembler syntax

SUB{S}{<c>}{<q>} {<Rd>}, <Rn>, <Rm>, <type> <Rs>

where:

S If S is present, the instruction updates the flags. Otherwise, the flags are not updated.

<c>, <q> See [Standard assembler syntax fields on page F2-2415](#).

<Rd> The destination register.

<Rn> The first operand register.

<Rm> The register that is shifted and used as the second operand.

<type> The type of shift to apply to the value read from <Rm>. It must be one of:

ASR Arithmetic shift right, encoded as type = 0b10.

LSL Logical shift left, encoded as type = 0b00.

LSR Logical shift right, encoded as type = 0b01.

ROR Rotate right, encoded as type = 0b11.

<Rs> The register whose bottom byte contains the amount to shift by.

The pre-UAL syntax SUB<c>S is equivalent to SUBS<c>.

Operation

```
if ConditionPassed() then
    EncodingSpecificOperations();
    shift_n = UInt(R[s]<7:0>);
    shifted = Shift(R[m], shift_t, shift_n, APSR.C);
    (result, nzc) = AddWithCarry(R[n], NOT(shifted), '1');
    R[d] = result;
    if setflags then
        APSR.<N,Z,C,V> = nzc;
```

F7.1.238 SUB (SP minus immediate)

This instruction subtracts an immediate value from the SP value, and writes the result to the destination register.

Encoding T1 ARMv4T, ARMv5T*, ARMv6*, ARMv7

SUB<c> SP, SP, #<imm>

15	14	13	12	11	10	9	8	7	6	5	4	3	2	1	0
1	0	1	1	0	0	0	0	1	imm7						

d = 13; setflags = FALSE; imm32 = ZeroExtend(imm7:'00', 32);

Encoding T2 ARMv6T2, ARMv7

SUB{S}<c>.W <Rd>, SP, #<const>

15	14	13	12	11	10	9	8	7	6	5	4	3	2	1	0	15	14	13	12	11	10	9	8	7	6	5	4	3	2	1	0
1	1	1	1	0	i	0	1	1	0	1	S	1	1	0	1	0	imm3	Rd	imm8												

if Rd == '1111' && S == '1' then SEE CMP (immediate);
 d = UInt(Rd); setflags = (S == '1'); imm32 = ThumbExpandImm(i:imm3:imm8);
 if d == 15 && S == '0' then UNPREDICTABLE;

Encoding T3 ARMv6T2, ARMv7

SUBW<c> <Rd>, SP, #<imm12>

15	14	13	12	11	10	9	8	7	6	5	4	3	2	1	0	15	14	13	12	11	10	9	8	7	6	5	4	3	2	1	0
1	1	1	1	0	i	1	0	1	0	1	0	1	1	0	1	0	imm3	Rd	imm8												

d = UInt(Rd); setflags = FALSE; imm32 = ZeroExtend(i:imm3:imm8, 32);
 if d == 15 then UNPREDICTABLE;

Encoding A1 ARMv4*, ARMv5T*, ARMv6*, ARMv7

SUB{S}<c> <Rd>, SP, #<const>

31	30	29	28	27	26	25	24	23	22	21	20	19	18	17	16	15	14	13	12	11	10	9	8	7	6	5	4	3	2	1	0
cond		0	0	1	0	0	1	0	S	1	1	0	1	Rd			imm12														

if Rd == '1111' && S == '1' then SEE SUBS PC, LR and related instructions;
 d = UInt(Rd); setflags = (S == '1'); imm32 = ARMEExpandImm(imm12);

For information about the CONSTRAINED UNPREDICTABLE behavior of this instruction, see [Appendix A Architectural Constraints on UNPREDICTABLE behaviors](#).

Assembler syntax

SUB{S}{<c>}{<q>} {<Rd>}, SP, #<const> All encodings permitted
SUBW{<c>}{<q>} {<Rd>}, SP, #<const> Only encoding T3 permitted

where:

- S If S is present, the instruction updates the flags. Otherwise, the flags are not updated.
- <c>, <q> See [Standard assembler syntax fields on page F2-2415](#).
- <Rd> The destination register. If S is specified and <Rd> is the PC, see [SUBS PC, LR and related instructions \(T32\) on page F7-3066](#) or [SUBS PC, LR and related instructions \(A32\) on page F7-3068](#). If omitted, <Rd> is SP.
In A32 instructions, if S is not specified and <Rd> is the PC, the instruction is a branch to the address calculated by the operation. This is an interworking branch, see [Pseudocode details of operations on the AArch32 general-purpose registers and the PC on page E1-2296](#).
- <const> The immediate value to be subtracted from the value obtained from SP. Values are multiples of 4 in the range 0-508 for encoding T1 and any value in the range 0-4095 for encoding T3. See [Modified immediate constants in T32 instructions on page F3-2444](#) or [Modified immediate constants in A32 instructions on page F4-2472](#) for the range of values for encodings T2 and A1.
When both 32-bit encodings are available for an instruction, encoding T2 is preferred to encoding T3 (if encoding T3 is required, use the SUBW syntax).

The pre-UAL syntax SUB<c>S is equivalent to SUBS<c>.

Operation

```
if ConditionPassed() then
    EncodingSpecificOperations();
    (result, nzcV) = AddWithCarry(SP, NOT(imm32), '1');
    if d == 15 then // Can only occur for ARM encoding
        ALUWritePC(result); // setflags is always FALSE here
    else
        R[d] = result;
        if setflags then
            APSR.<N,Z,C,V> = nzcV;
```

F7.1.239 SUB (SP minus register)

This instruction subtracts an optionally-shifted register value from the SP value, and writes the result to the destination register.

Encoding T1 ARMv6T2, ARMv7

SUB{S}<c> <Rd>, SP, <Rm>{, <shift>}

15	14	13	12	11	10	9	8	7	6	5	4	3	2	1	0	15	14	13	12	11	10	9	8	7	6	5	4	3	2	1	0
1	1	1	0	1	0	1	1	1	0	1	S	1	1	0	1	(0)	imm3			Rd			imm2		type	Rm					

if Rd == '1111' && S == '1' then SEE CMP (register);
 d = UInt(Rd); m = UInt(Rm); setflags = (S == '1');
 (shift_t, shift_n) = DecodeImmShift(type, imm3:imm2);
 if (d == 15 && S == '0') || m == 15 then UNPREDICTABLE; // ARMv8-A removes UNPREDICTABLE for R13

Encoding A1 ARMv4*, ARMv5T*, ARMv6*, ARMv7

SUB{S}<c> <Rd>, SP, <Rm>{, <shift>}

31	30	29	28	27	26	25	24	23	22	21	20	19	18	17	16	15	14	13	12	11	10	9	8	7	6	5	4	3	2	1	0
cond			0	0	0	0	0	1	0	S	1	1	0	1	Rd			imm5			type	0	Rm								

if Rd == '1111' && S == '1' then SEE SUBS PC, LR and related instructions;
 d = UInt(Rd); m = UInt(Rm); setflags = (S == '1');
 (shift_t, shift_n) = DecodeImmShift(type, imm5);

For information about the CONSTRAINED UNPREDICTABLE behavior of this instruction, see [Appendix A Architectural Constraints on UNPREDICTABLE behaviors](#).

Assembler syntax

SUB{S}{<c>}{<q>} {<Rd>}, SP, <Rm> {, <shift>}

where:

- S If S is present, the instruction updates the flags. Otherwise, the flags are not updated.
- <c><q> See [Standard assembler syntax fields on page F2-2415](#).
- <Rd> The destination register. If S is specified and <Rd> is the PC, see [SUBS PC, LR and related instructions \(T32\) on page F7-3066](#) or [SUBS PC, LR and related instructions \(A32\) on page F7-3068](#). If omitted, <Rd> is SP.
- In A32 instructions, if S is not specified and <Rd> is the PC, the instruction is a branch to the address calculated by the operation. This is an interworking branch, see [Pseudocode details of operations on the AArch32 general-purpose registers and the PC on page E1-2296](#).
- <Rm> The register that is optionally shifted and used as the second operand. The PC can be used in A32 instructions.
- <shift> The shift to apply to the value read from <Rm>. If omitted, no shift is applied. [Shifts applied to a register on page F2-2419](#) describes the shifts and how they are encoded.
- In the T32 instruction set, if <Rd> is SP or omitted, <shift> is only permitted to be omitted, LSL #1, LSL #2, or LSL #3.

The pre-UAL syntax SUB<c>S is equivalent to SUBS<c>.

Operation

```
if ConditionPassed() then
    EncodingSpecificOperations();
    shifted = Shift(R[m], shift_t, shift_n, APSR.C);
    (result, nzcvc) = AddWithCarry(SP, NOT(shifted), '1');
    if d == 15 then // Can only occur for ARM encoding
        ALUWritePC(result); // setflags is always FALSE here
    else
        R[d] = result;
        if setflags then
            APSR.<N,Z,C,V> = nzcvc;
```

F7.1.240 SUBS PC, LR and related instructions

These instructions are for system level use only. See *SUBS PC, LR and related instructions (T32)* on page F7-3066 and *SUBS PC, LR and related instructions (A32)* on page F7-3068.

F7.1.241 SVC (previously SWI)

Supervisor Call, previously called Software Interrupt, causes a Supervisor Call exception. For more information, see *Supervisor Call (SVC) exception on page G1-3479*.

Software can use this instruction as a call to an operating system to provide a service.

In the following cases, the Supervisor Call exception generated by the SVC instruction is taken to Hyp mode:

- If the SVC is executed in Hyp mode.
- If *HCR.TGE* is set to 1, and the SVC is executed in Non-secure User mode. For more information, see *Supervisor Call exception, when HCR.TGE is set to 1 on page G1-3452*

In these cases, the *HSR* identifies that the exception entry was caused by a Supervisor Call exception, EC value 0x11, see *Use of the HSR on page G3-3672*. The immediate field in the *HSR*:

- If the SVC is unconditional:
 - For the T32 instruction, is the zero-extended value of the *imm8* field.
 - For the A32 instruction, is the least-significant 16 bits the *imm24* field.
- If the SVC is conditional, is UNKNOWN.

Encoding T1 ARMv4T, ARMv5T*, ARMv6*, ARMv7

SVC<c> #<imm8>

15	14	13	12	11	10	9	8	7	6	5	4	3	2	1	0
1	1	0	1	1	1	1	1	imm8							

```
imm32 = ZeroExtend(imm8, 32);
// imm32 is for assembly/disassembly. SVC handlers in some
// systems interpret imm8 in software, for example to determine the required service.
```

Encoding A1 ARMv4*, ARMv5T*, ARMv6*, ARMv7

SVC<c> #<imm24>

31	30	29	28	27	26	25	24	23	22	21	20	19	18	17	16	15	14	13	12	11	10	9	8	7	6	5	4	3	2	1	0
cond				1	1	1	1	imm24																							

```
imm32 = ZeroExtend(imm24, 32);
// imm32 is for assembly/disassembly. SVC handlers in some
// systems interpret imm24 in software, for example to determine the required service.
```

Assembler syntax

SVC{<c>}{<q>} {#}<imm>

where:

<c>, <q> See *Standard assembler syntax fields* on page F2-2415.

<imm> Specifies an immediate constant, 8-bit in T32 instructions, or 24-bit in A32 instructions.

The pre-UAL syntax SWI<c> is equivalent to SVC<c>.

Operation

```
if ConditionPassed() then
    EncodingSpecificOperations();
    AArch32.CallSupervisor(imm32<15:0>);
```

F7.1.242 SXTAB

Signed Extend and Add Byte extracts an 8-bit value from a register, sign-extends it to 32 bits, adds the result to the value in another register, and writes the final result to the destination register. The instruction can specify a rotation by 0, 8, 16, or 24 bits before extracting the 8-bit value.

Encoding T1 ARMv6T2, ARMv7

SXTAB<c> <Rd>, <Rn>, <Rm>{, <rotation>}

15	14	13	12	11	10	9	8	7	6	5	4	3	2	1	0	15	14	13	12	11	10	9	8	7	6	5	4	3	2	1	0
1	1	1	1	1	0	1	0	0	1	0	0	Rn			1	1	1	1	Rd		1	(0)	rotate	Rm							

if Rn == '1111' then SEE SXTB;
 d = UInt(Rd); n = UInt(Rn); m = UInt(Rm); rotation = UInt(rotate:'000');
 if d == 15 || m == 15 then UNPREDICTABLE; // ARMv8-A removes UNPREDICTABLE for R13

Encoding A1 ARMv6*, ARMv7

SXTAB<c> <Rd>, <Rn>, <Rm>{, <rotation>}

31	30	29	28	27	26	25	24	23	22	21	20	19	18	17	16	15	14	13	12	11	10	9	8	7	6	5	4	3	2	1	0
cond		0	1	1	0	1	0	1	0	Rn			Rd			rotate	(0)	(0)	0	1	1	1	Rm								

if Rn == '1111' then SEE SXTB;
 d = UInt(Rd); n = UInt(Rn); m = UInt(Rm); rotation = UInt(rotate:'000');
 if d == 15 || m == 15 then UNPREDICTABLE;

For information about the CONSTRAINED UNPREDICTABLE behavior of this instruction, see [Appendix A Architectural Constraints on UNPREDICTABLE behaviors](#).

Assembler syntax

SXTAB{<c>}{<q>} {<Rd>}, <Rn>, <Rm> {, <rotation>}

where:

<c>, <q> See [Standard assembler syntax fields on page F2-2415](#).

<Rd> The destination register.

<Rn> The first operand register.

<Rm> The second operand register.

<rotation> This can be any one of:

omitted Encoded as rotate = 0b00.

ROR #8 Encoded as rotate = 0b01.

ROR #16 Encoded as rotate = 0b10.

ROR #24 Encoded as rotate = 0b11.

———— **Note** —————

An assembler can permit ROR #0 to mean the same thing as omitting the rotation, possibly with restrictions on the permitted encodings, but this is not standard UAL and must not be used for disassembly.

Operation

```
if ConditionPassed() then
    EncodingSpecificOperations();
    rotated = ROR(R[m], rotation);
    R[d] = R[n] + SignExtend(rotated<7:0>, 32);
```

F7.1.243 SXTAB16

Signed Extend and Add Byte 16 extracts two 8-bit values from a register, sign-extends them to 16 bits each, adds the results to two 16-bit values from another register, and writes the final results to the destination register. The instruction can specify a rotation by 0, 8, 16, or 24 bits before extracting the 8-bit values.

Encoding T1 ARMv6T2, ARMv7
 SXTAB16<c> <Rd>, <Rn>, <Rm>{, <rotation>}

15	14	13	12	11	10	9	8	7	6	5	4	3	2	1	0	15	14	13	12	11	10	9	8	7	6	5	4	3	2	1	0
1	1	1	1	1	0	1	0	0	0	1	0	Rn			1	1	1	1	Rd		1	(0)	rotate	Rm							

if Rn == '1111' then SEE SXTB16;
 d = UInt(Rd); n = UInt(Rn); m = UInt(Rm); rotation = UInt(rotate:'000');
 if d == 15 || m == 15 then UNPREDICTABLE; // ARMv8-A removes UNPREDICTABLE for R13

Encoding A1 ARMv6*, ARMv7
 SXTAB16<c> <Rd>, <Rn>, <Rm>{, <rotation>}

31	30	29	28	27	26	25	24	23	22	21	20	19	18	17	16	15	14	13	12	11	10	9	8	7	6	5	4	3	2	1	0
cond		0	1	1	0	1	0	0	0	Rn			Rd			rotate	(0)	(0)	0	1	1	1	Rm								

if Rn == '1111' then SEE SXTB16;
 d = UInt(Rd); n = UInt(Rn); m = UInt(Rm); rotation = UInt(rotate:'000');
 if d == 15 || m == 15 then UNPREDICTABLE;

For information about the CONSTRAINED UNPREDICTABLE behavior of this instruction, see [Appendix A Architectural Constraints on UNPREDICTABLE behaviors](#).

Assembler syntax

SXTAB16{<c>}{<q>} {<Rd>}, <Rn>, <Rm> {, <rotation>}

where:

<c>, <q> See [Standard assembler syntax fields on page F2-2415](#).

<Rd> The destination register.

<Rn> The first operand register.

<Rm> The second operand register.

<rotation> This can be any one of:

omitted Encoded as rotate = 0b00.

ROR #8 Encoded as rotate = 0b01.

ROR #16 Encoded as rotate = 0b10.

ROR #24 Encoded as rotate = 0b11.

———— Note —————

An assembler can permit ROR #0 to mean the same thing as omitting the rotation, possibly with restrictions on the permitted encodings, but this is not standard UAL and must not be used for disassembly.

Operation

```
if ConditionPassed() then
    EncodingSpecificOperations();
    rotated = ROR(R[m], rotation);
    R[d]<15:0> = R[n]<15:0> + SignExtend(rotated<7:0>, 16);
    R[d]<31:16> = R[n]<31:16> + SignExtend(rotated<23:16>, 16);
```

F7.1.244 SXTAH

Signed Extend and Add Halfword extracts a 16-bit value from a register, sign-extends it to 32 bits, adds the result to a value from another register, and writes the final result to the destination register. The instruction can specify a rotation by 0, 8, 16, or 24 bits before extracting the 16-bit value.

Encoding T1 ARMv6T2, ARMv7
 SXTAH<c> <Rd>, <Rn>, <Rm>{, <rotation>}

15	14	13	12	11	10	9	8	7	6	5	4	3	2	1	0	15	14	13	12	11	10	9	8	7	6	5	4	3	2	1	0
1	1	1	1	1	0	1	0	0	0	0	0	Rn				1	1	1	1	Rd				1	(0)	rotate	Rm				

if Rn == '1111' then SEE SXTB;
 d = UInt(Rd); n = UInt(Rn); m = UInt(Rm); rotation = UInt(rotate:'000');
 if d == 15 || m == 15 then UNPREDICTABLE; // ARMv8-A removes UNPREDICTABLE for R13

Encoding A1 ARMv6*, ARMv7
 SXTAH<c> <Rd>, <Rn>, <Rm>{, <rotation>}

31	30	29	28	27	26	25	24	23	22	21	20	19	18	17	16	15	14	13	12	11	10	9	8	7	6	5	4	3	2	1	0
cond		0	1	1	0	1	0	1	1	Rn				Rd				rotate	(0)	(0)	0	1	1	1	Rm						

if Rn == '1111' then SEE SXTB;
 d = UInt(Rd); n = UInt(Rn); m = UInt(Rm); rotation = UInt(rotate:'000');
 if d == 15 || m == 15 then UNPREDICTABLE;

For information about the CONSTRAINED UNPREDICTABLE behavior of this instruction, see [Appendix A Architectural Constraints on UNPREDICTABLE behaviors](#).

Assembler syntax

SXTAH{<c>}{<q>} {<Rd>}, <Rn>, <Rm> {, <rotation>}

where:

<c>, <q> See [Standard assembler syntax fields on page F2-2415](#).

<Rd> The destination register.

<Rn> The first operand register.

<Rm> The second operand register.

<rotation> This can be any one of:

omitted Encoded as rotate = 0b00.

ROR #8 Encoded as rotate = 0b01.

ROR #16 Encoded as rotate = 0b10.

ROR #24 Encoded as rotate = 0b11.

———— **Note** —————

An assembler can permit ROR #0 to mean the same thing as omitting the rotation, possibly with restrictions on the permitted encodings, but this is not standard UAL and must not be used for disassembly.

Operation

```
if ConditionPassed() then
    EncodingSpecificOperations();
    rotated = ROR(R[m], rotation);
    R[d] = R[n] + SignExtend(rotated<15:0>, 32);
```

F7.1.245 SXTB

Signed Extend Byte extracts an 8-bit value from a register, sign-extends it to 32 bits, and writes the result to the destination register. The instruction can specify a rotation by 0, 8, 16, or 24 bits before extracting the 8-bit value.

Encoding T1 ARMv6*, ARMv7

SXTB<c> <Rd>, <Rm>

15	14	13	12	11	10	9	8	7	6	5	4	3	2	1	0
1	0	1	1	0	0	1	0	0	1	Rm					Rd

d = UInt(Rd); m = UInt(Rm); rotation = 0;

Encoding T2 ARMv6T2, ARMv7

SXTB<c>.W <Rd>, <Rm>{, <rotation>}

15	14	13	12	11	10	9	8	7	6	5	4	3	2	1	0	15	14	13	12	11	10	9	8	7	6	5	4	3	2	1	0
1	1	1	1	1	0	1	0	0	0	1	0	0	1	1	1	1	1	1	1	1		Rd		1	(0)	rotate		Rm			

d = UInt(Rd); m = UInt(Rm); rotation = UInt(rotate:'000');
 if d == 15 || m == 15 then UNPREDICTABLE; // ARMv8-A removes UNPREDICTABLE for R13

Encoding A1 ARMv6*, ARMv7

SXTB<c> <Rd>, <Rm>{, <rotation>}

31	30	29	28	27	26	25	24	23	22	21	20	19	18	17	16	15	14	13	12	11	10	9	8	7	6	5	4	3	2	1	0
cond		0	1	1	0	1	0	1	0	1	0	1	1	1	1		Rd		rotate	(0)	(0)	0	1	1	1					Rm	

d = UInt(Rd); m = UInt(Rm); rotation = UInt(rotate:'000');
 if d == 15 || m == 15 then UNPREDICTABLE;

For information about the CONSTRAINED UNPREDICTABLE behavior of this instruction, see [Appendix A Architectural Constraints on UNPREDICTABLE behaviors](#).

Assembler syntax

SXTB{<c>}{<q>} {<Rd>}, <Rm> {, <rotation>}

where:

<c>, <q> See [Standard assembler syntax fields on page F2-2415](#).

<Rd> The destination register.

<Rm> The register that contains the operand.

<rotation> This can be any one of:

omitted Any encoding, encoded as rotate = 0b00 in encoding T2 or A1.

ROR #8 Encoding T2 or A1, encoded as rotate = 0b01.

ROR #16 Encoding T2 or A1, encoded as rotate = 0b10.

ROR #24 Encoding T2 or A1, encoded as rotate = 0b11.

———— Note —————

An assembler can permit ROR #0 to mean the same thing as omitting the rotation, possibly with restrictions on the permitted encodings, but this is not standard UAL and must not be used for disassembly.

Operation

```
if ConditionPassed() then
    EncodingSpecificOperations();
    rotated = ROR(R[m], rotation);
    R[d] = SignExtend(rotated<7:0>, 32);
```

F7.1.246 SXTB16

Signed Extend Byte 16 extracts two 8-bit values from a register, sign-extends them to 16 bits each, and writes the results to the destination register. The instruction can specify a rotation by 0, 8, 16, or 24 bits before extracting the 8-bit values.

Encoding T1 ARMv6T2, ARMv7

SXTB16<c> <Rd>, <Rm>{, <rotation>}

15	14	13	12	11	10	9	8	7	6	5	4	3	2	1	0	15	14	13	12	11	10	9	8	7	6	5	4	3	2	1	0
1	1	1	1	1	0	1	0	0	0	1	0	1	1	1	1	1	1	1	1		Rd		1	(0)	rotate		Rm				

```
d = UInt(Rd); m = UInt(Rm); rotation = UInt(rotate:'000');
if d == 15 || m == 15 then UNPREDICTABLE; // ARMv8-A removes UNPREDICTABLE for R13
```

Encoding A1 ARMv6*, ARMv7

SXTB16<c> <Rd>, <Rm>{, <rotation>}

31	30	29	28	27	26	25	24	23	22	21	20	19	18	17	16	15	14	13	12	11	10	9	8	7	6	5	4	3	2	1	0
cond		0	1	1	0	1	0	0	0	1	1	1	1		Rd		rotate	(0)	(0)	0	1	1	1		Rm						

```
d = UInt(Rd); m = UInt(Rm); rotation = UInt(rotate:'000');
if d == 15 || m == 15 then UNPREDICTABLE;
```

For information about the CONSTRAINED UNPREDICTABLE behavior of this instruction, see [Appendix A Architectural Constraints on UNPREDICTABLE behaviors](#).

Assembler syntax

SXTB16{<c>}{<q>} {<Rd>}, <Rm> {, <rotation>}

where:

<c>, <q> See [Standard assembler syntax fields on page F2-2415](#).

<Rd> The destination register.

<Rm> The register that contains the operand.

<rotation> This can be any one of:

omitted Encoded as rotate = 0b00.

ROR #8 Encoded as rotate = 0b01.

ROR #16 Encoded as rotate = 0b10.

ROR #24 Encoded as rotate = 0b11.

———— Note —————

An assembler can permit ROR #0 to mean the same thing as omitting the rotation, possibly with restrictions on the permitted encodings, but this is not standard UAL and must not be used for disassembly.

Operation

```
if ConditionPassed() then
    EncodingSpecificOperations();
    rotated = ROR(R[m], rotation);
    R[d]<15:0> = SignExtend(rotated<7:0>, 16);
    R[d]<31:16> = SignExtend(rotated<23:16>, 16);
```

F7.1.247 SXTB

Signed Extend Halfword extracts a 16-bit value from a register, sign-extends it to 32 bits, and writes the result to the destination register. The instruction can specify a rotation by 0, 8, 16, or 24 bits before extracting the 16-bit value.

Encoding T1 ARMv6*, ARMv7

SXTB<c> <Rd>, <Rm>

15	14	13	12	11	10	9	8	7	6	5	4	3	2	1	0
1	0	1	1	0	0	1	0	0	0	Rm					Rd

d = UInt(Rd); m = UInt(Rm); rotation = 0;

Encoding T2 ARMv6T2, ARMv7

SXTB<c>.W <Rd>, <Rm>{, <rotation>}

15	14	13	12	11	10	9	8	7	6	5	4	3	2	1	0	15	14	13	12	11	10	9	8	7	6	5	4	3	2	1	0
1	1	1	1	1	0	1	0	0	0	0	0	1	1	1	1	1	1	1	1		Rd		1	(0)	rotate		Rm				

d = UInt(Rd); m = UInt(Rm); rotation = UInt(rotate:'000');
 if d == 15 || m == 15 then UNPREDICTABLE; // ARMv8-A removes UNPREDICTABLE for R13

Encoding A1 ARMv6*, ARMv7

SXTB<c> <Rd>, <Rm>{, <rotation>}

31	30	29	28	27	26	25	24	23	22	21	20	19	18	17	16	15	14	13	12	11	10	9	8	7	6	5	4	3	2	1	0
cond		0	1	1	0	1	0	1	1	1	1	1				Rd			rotate	(0)	(0)	0	1	1	1					Rm	

d = UInt(Rd); m = UInt(Rm); rotation = UInt(rotate:'000');
 if d == 15 || m == 15 then UNPREDICTABLE;

For information about the CONSTRAINED UNPREDICTABLE behavior of this instruction, see [Appendix A Architectural Constraints on UNPREDICTABLE behaviors](#).

Assembler syntax

SXTH{<c>}{<q>} {<Rd>}, <Rm> {, <rotation>}

where:

<c>, <q> See [Standard assembler syntax fields on page F2-2415](#).

<Rd> The destination register.

<Rm> The register that contains the operand.

<rotation> This can be any one of:

omitted Any encoding, encoded as rotate = 0b00 in encoding T2 or A1.

ROR #8 Encoding T2 or A1, encoded as rotate = 0b01.

ROR #16 Encoding T2 or A1, encoded as rotate = 0b10.

ROR #24 Encoding T2 or A1, encoded as rotate = 0b11.

———— Note ————

An assembler can permit ROR #0 to mean the same thing as omitting the rotation, possibly with restrictions on the permitted encodings, but this is not standard UAL and must not be used for disassembly.

Operation

```
if ConditionPassed() then
    EncodingSpecificOperations();
    rotated = ROR(R[m], rotation);
    R[d] = SignExtend(rotated<15:0>, 32);
```

F7.1.248 TBB, TBH

Table Branch Byte causes a PC-relative forward branch using a table of single byte offsets. A base register provides a pointer to the table, and a second register supplies an index into the table. The branch length is twice the value of the byte returned from the table.

Table Branch Halfword causes a PC-relative forward branch using a table of single halfword offsets. A base register provides a pointer to the table, and a second register supplies an index into the table. The branch length is twice the value of the halfword returned from the table.

Encoding T1 ARMv6T2, ARMv7

TBB<c> [<Rn>, <Rm>] Outside or last in IT block

TBH<c> [<Rn>, <Rm>, LSL #1] Outside or last in IT block

15	14	13	12	11	10	9	8	7	6	5	4	3	2	1	0	15	14	13	12	11	10	9	8	7	6	5	4	3	2	1	0
1	1	1	0	1	0	0	0	1	1	0	1	Rn				(1)	(1)	(1)	(1)	(0)	(0)	(0)	(0)	0	0	0	H	Rm			

```
n = UInt(Rn); m = UInt(Rm); is_tbh = (H == '1');
if m == 15 then UNPREDICTABLE; // ARMv8-A removes UNPREDICTABLE for R13
if InITBlock() && !LastInITBlock() then UNPREDICTABLE;
```

For information about the CONSTRAINED UNPREDICTABLE behavior of this instruction, see [Appendix A Architectural Constraints on UNPREDICTABLE behaviors](#).

Assembler syntax

TBB{<c>}{<q>} [<Rn>, <Rm>]

TBH{<c>}{<q>} [<Rn>, <Rm>, LSL #1]

where:

<c>, <q> See *Standard assembler syntax fields* on page F2-2415.

<Rn> The base register. This contains the address of the table of branch lengths. The PC can be used. If it is, the table immediately follows this instruction.

<Rm> The index register.

For TBB, this contains an integer pointing to a single byte in the table. The offset in the table is the value of the index.

For TBH, this contains an integer pointing to a halfword in the table. The offset in the table is twice the value of the index.

Operation

```
if ConditionPassed() then
    EncodingSpecificOperations(); NullCheckIfThumbEE(n);
    if is_tbb then
        halfwords = UInt(MemU[R[n]+LSL(R[m],1), 2]);
    else
        halfwords = UInt(MemU[R[n]+R[m], 1]);
    BranchWritePC(PC + 2*halfwords);
```

F7.1.249 TEQ (immediate)

Test Equivalence (immediate) performs a bitwise exclusive OR operation on a register value and an immediate value. It updates the condition flags based on the result, and discards the result.

Encoding T1 ARMv6T2, ARMv7

TEQ<c> <Rn>, #<const>

15	14	13	12	11	10	9	8	7	6	5	4	3	2	1	0	15	14	13	12	11	10	9	8	7	6	5	4	3	2	1	0
1	1	1	1	0	i	0	0	1	0	0	1	Rn				0	imm3			1	1	1	1	imm8							

```
n = UInt(Rn);
(imm32, carry) = ThumbExpandImm_C(i:imm3:imm8, APSR.C);
if n == 15 then UNPREDICTABLE; // ARMv8-A removes UNPREDICTABLE for R13
```

Encoding A1 ARMv4*, ARMv5T*, ARMv6*, ARMv7

TEQ<c> <Rn>, #<const>

31	30	29	28	27	26	25	24	23	22	21	20	19	18	17	16	15	14	13	12	11	10	9	8	7	6	5	4	3	2	1	0
cond		0	0	1	1	0	0	1	1	Rn				(0)	(0)	(0)	(0)	imm12													

```
n = UInt(Rn);
(imm32, carry) = ARMEExpandImm_C(imm12, APSR.C);
```

For information about the CONSTRAINED UNPREDICTABLE behavior of this instruction, see [Appendix A Architectural Constraints on UNPREDICTABLE behaviors](#).

Assembler syntax

TEQ{<c>}{<q>} <Rn>, #<const>

where:

<c>, <q> See *Standard assembler syntax fields* on page F2-2415.

<Rn> The operand register. The PC can be used in A32 instructions.

<const> The immediate value to be tested against the value obtained from <Rn>. See *Modified immediate constants in T32 instructions* on page F3-2444 or *Modified immediate constants in A32 instructions* on page F4-2472 for the range of values.

Operation

```
if ConditionPassed() then
    EncodingSpecificOperations();
    result = R[n] EOR imm32;
    APSR.N = result<31>;
    APSR.Z = IsZeroBit(result);
    APSR.C = carry;
    // APSR.V unchanged
```

F7.1.250 TEQ (register)

Test Equivalence (register) performs a bitwise exclusive OR operation on a register value and an optionally-shifted register value. It updates the condition flags based on the result, and discards the result.

Encoding T1 ARMv6T2, ARMv7

TEQ<c> <Rn>, <Rm>{, <shift>}

15	14	13	12	11	10	9	8	7	6	5	4	3	2	1	0	15	14	13	12	11	10	9	8	7	6	5	4	3	2	1	0
1	1	1	0	1	0	1	0	1	0	0	1	Rn				(0)	imm3			1	1	1	1	imm2		type	Rm				

```
n = UInt(Rn); m = UInt(Rm);
(shift_t, shift_n) = DecodeImmShift(type, imm3:imm2);
if n == 15 || m == 15 then UNPREDICTABLE; // ARMv8-A removes UNPREDICTABLE for R13
```

Encoding A1 ARMv4*, ARMv5T*, ARMv6*, ARMv7

TEQ<c> <Rn>, <Rm>{, <shift>}

31	30	29	28	27	26	25	24	23	22	21	20	19	18	17	16	15	14	13	12	11	10	9	8	7	6	5	4	3	2	1	0
cond				0	0	0	1	0	0	1	1	Rn				(0)	(0)	(0)	(0)	imm5					type	0	Rm				

```
n = UInt(Rn); m = UInt(Rm);
(shift_t, shift_n) = DecodeImmShift(type, imm5);
```

For information about the CONSTRAINED UNPREDICTABLE behavior of this instruction, see [Appendix A Architectural Constraints on UNPREDICTABLE behaviors](#).

Assembler syntax

TEQ{<c>}{<q>} <Rn>, <Rm> {, <shift>}

where:

- <c>, <q> See [Standard assembler syntax fields on page F2-2415](#).
- <Rn> The first operand register. The PC can be used in A32 instructions.
- <Rm> The register that is optionally shifted and used as the second operand. The PC can be used in A32 instructions.
- <shift> The shift to apply to the value read from <Rm>. If omitted, no shift is applied. [Shifts applied to a register on page F2-2419](#) describes the shifts and how they are encoded.

Operation

```
if ConditionPassed() then
    EncodingSpecificOperations();
    (shifted, carry) = Shift_C(R[m], shift_t, shift_n, APSR.C);
    result = R[n] EOR shifted;
    APSR.N = result<31>;
    APSR.Z = IsZeroBit(result);
    APSR.C = carry;
    // APSR.V unchanged
```

F7.1.251 TEQ (register-shifted register)

Test Equivalence (register-shifted register) performs a bitwise exclusive OR operation on a register value and a register-shifted register value. It updates the condition flags based on the result, and discards the result.

Encoding A1 ARMv4*, ARMv5T*, ARMv6*, ARMv7

TEQ<c> <Rn>, <Rm>, <type> <Rs>

31	30	29	28	27	26	25	24	23	22	21	20	19	18	17	16	15	14	13	12	11	10	9	8	7	6	5	4	3	2	1	0
cond			0	0	0	1	0	0	1	1	Rn				(0)	(0)	(0)	(0)	Rs		0	type		1	Rm						

```
n = UInt(Rn); m = UInt(Rm); s = UInt(Rs);
shift_t = DecodeRegShift(type);
if n == 15 || m == 15 || s == 15 then UNPREDICTABLE;
```

For information about the CONSTRAINED UNPREDICTABLE behavior of this instruction, see [Appendix A Architectural Constraints on UNPREDICTABLE behaviors](#).

Assembler syntax

TEQ{<c>}{<q>} <Rn>, <Rm>, <type> <Rs>

where:

- <c>, <q> See [Standard assembler syntax fields on page F2-2415](#).
- <Rn> The first operand register.
- <Rm> The register that is shifted and used as the second operand.
- <type> The type of shift to apply to the value read from <Rm>. It must be one of:
- | | |
|-----|---|
| ASR | Arithmetic shift right, encoded as type = 0b10. |
| LSL | Logical shift left, encoded as type = 0b00. |
| LSR | Logical shift right, encoded as type = 0b01. |
| ROR | Rotate right, encoded as type = 0b11. |
- <Rs> The register whose bottom byte contains the amount to shift by.

Operation

```
if ConditionPassed() then
    EncodingSpecificOperations();
    shift_n = UInt(R[s]<7:0>);
    (shifted, carry) = Shift_C(R[m], shift_t, shift_n, APSR.C);
    result = R[n] EOR shifted;
    APSR.N = result<31>;
    APSR.Z = IsZeroBit(result);
    APSR.C = carry;
    // APSR.V unchanged
```

F7.1.252 TST (immediate)

Test (immediate) performs a bitwise AND operation on a register value and an immediate value. It updates the condition flags based on the result, and discards the result.

Encoding T1 ARMv6T2, ARMv7

TST<c> <Rn>, #<const>

15	14	13	12	11	10	9	8	7	6	5	4	3	2	1	0	15	14	13	12	11	10	9	8	7	6	5	4	3	2	1	0
1	1	1	1	0	i	0	0	0	0	0	1	Rn				0	imm3			1	1	1	1	imm8							

```
n = UInt(Rn);
(imm32, carry) = ThumbExpandImm_C(i:imm3:imm8, APSR.C);
if n == 15 then UNPREDICTABLE; // ARMv8-A removes UNPREDICTABLE for R13
```

Encoding A1 ARMv4*, ARMv5T*, ARMv6*, ARMv7

TST<c> <Rn>, #<const>

31	30	29	28	27	26	25	24	23	22	21	20	19	18	17	16	15	14	13	12	11	10	9	8	7	6	5	4	3	2	1	0
cond		0	0	1	1	0	0	0	1	Rn				(0)	(0)	(0)	(0)	imm12													

```
n = UInt(Rn);
(imm32, carry) = ARMEExpandImm_C(imm12, APSR.C);
```

For information about the CONSTRAINED UNPREDICTABLE behavior of this instruction, see [Appendix A Architectural Constraints on UNPREDICTABLE behaviors](#).

Assembler syntax

TST{<c>}{<q>} <Rn>, #<const>

where:

<c>, <q> See *Standard assembler syntax fields* on page F2-2415.

<Rn> The operand register. The PC can be used in A32 instructions.

<const> The immediate value to be tested against the value obtained from <Rn>. See *Modified immediate constants in T32 instructions* on page F3-2444 or *Modified immediate constants in A32 instructions* on page F4-2472 for the range of values.

Operation

```
if ConditionPassed() then
    EncodingSpecificOperations();
    result = R[n] AND imm32;
    APSR.N = result<31>;
    APSR.Z = IsZeroBit(result);
    APSR.C = carry;
    // APSR.V unchanged
```

F7.1.253 TST (register)

Test (register) performs a bitwise AND operation on a register value and an optionally-shifted register value. It updates the condition flags based on the result, and discards the result.

Encoding T1 ARMv4T, ARMv5T*, ARMv6*, ARMv7

TST<c> <Rn>, <Rm>

15	14	13	12	11	10	9	8	7	6	5	4	3	2	1	0
0	1	0	0	0	0	1	0	0	0	Rm					Rn

n = UInt(Rn); m = UInt(Rm);
 (shift_t, shift_n) = (SRTYPE_LSL, 0);

Encoding T2 ARMv6T2, ARMv7

TST<c>.W <Rn>, <Rm>{, <shift>}

15	14	13	12	11	10	9	8	7	6	5	4	3	2	1	0	15	14	13	12	11	10	9	8	7	6	5	4	3	2	1	0
1	1	1	0	1	0	1	0	0	0	0	1	Rn	(0)	imm3	1	1	1	1	imm2	type							Rm				

n = UInt(Rn); m = UInt(Rm);
 (shift_t, shift_n) = DecodeImmShift(type, imm3:imm2);
 if n == 15 || m == 15 then UNPREDICTABLE; // ARMv8-A removes UNPREDICTABLE for R13

Encoding A1 ARMv4*, ARMv5T*, ARMv6*, ARMv7

TST<c> <Rn>, <Rm>{, <shift>}

31	30	29	28	27	26	25	24	23	22	21	20	19	18	17	16	15	14	13	12	11	10	9	8	7	6	5	4	3	2	1	0
cond	0	0	0	1	0	0	0	1	Rn	(0)	(0)	(0)	(0)	imm5	type	0															Rm

n = UInt(Rn); m = UInt(Rm);
 (shift_t, shift_n) = DecodeImmShift(type, imm5);

For information about the CONSTRAINED UNPREDICTABLE behavior of this instruction, see [Appendix A Architectural Constraints on UNPREDICTABLE behaviors](#).

Assembler syntax

TST{<c>}{<q>} <Rn>, <Rm> {, <shift>}

where:

- <c>, <q> See [Standard assembler syntax fields on page F2-2415](#).
- <Rn> The first operand register. The PC can be used in A32 instructions.
- <Rm> The register that is optionally shifted and used as the second operand. The PC can be used in A32 instructions.
- <shift> The shift to apply to the value read from <Rm>. If present, encoding T1 is not permitted. If absent, no shift is applied and all encodings are permitted. [Shifts applied to a register on page F2-2419](#) describes the shifts and how they are encoded.

Operation

```
if ConditionPassed() then
    EncodingSpecificOperations();
    (shifted, carry) = Shift_C(R[m], shift_t, shift_n, APSR.C);
    result = R[n] AND shifted;
    APSR.N = result<31>;
    APSR.Z = IsZeroBit(result);
    APSR.C = carry;
    // APSR.V unchanged
```

F7.1.254 TST (register-shifted register)

Test (register-shifted register) performs a bitwise AND operation on a register value and a register-shifted register value. It updates the condition flags based on the result, and discards the result.

Encoding A1 ARMv4*, ARMv5T*, ARMv6*, ARMv7

TST<c> <Rn>, <Rm>, <type> <Rs>

31	30	29	28	27	26	25	24	23	22	21	20	19	18	17	16	15	14	13	12	11	10	9	8	7	6	5	4	3	2	1	0
cond				0	0	0	1	0	0	0	1	Rn				(0)	(0)	(0)	(0)	Rs				0	type		1	Rm			

```
n = UInt(Rn); m = UInt(Rm); s = UInt(Rs);
shift_t = DecodeRegShift(type);
if n == 15 || m == 15 || s == 15 then UNPREDICTABLE;
```

For information about the CONSTRAINED UNPREDICTABLE behavior of this instruction, see [Appendix A Architectural Constraints on UNPREDICTABLE behaviors](#).

Assembler syntax

TST{<c>}{<q>} <Rn>, <Rm>, <type> <Rs>

where:

- <c>, <q> See [Standard assembler syntax fields on page F2-2415](#).
- <Rn> The first operand register.
- <Rm> The register that is shifted and used as the second operand.
- <type> The type of shift to apply to the value read from <Rm>. It must be one of:
- | | |
|-----|---|
| ASR | Arithmetic shift right, encoded as type = 0b10. |
| LSL | Logical shift left, encoded as type = 0b00. |
| LSR | Logical shift right, encoded as type = 0b01. |
| ROR | Rotate right, encoded as type = 0b11. |
- <Rs> The register whose bottom byte contains the amount to shift by.

Operation

```
if ConditionPassed() then
    EncodingSpecificOperations();
    shift_n = UInt(R[s]<7:0>);
    (shifted, carry) = Shift_C(R[m], shift_t, shift_n, APSR.C);
    result = R[n] AND shifted;
    APSR.N = result<31>;
    APSR.Z = IsZeroBit(result);
    APSR.C = carry;
    // APSR.V unchanged
```

F7.1.255 UADD8

Unsigned Add 8 performs four unsigned 8-bit integer additions, and writes the results to the destination register. It sets the APSR.GE bits according to the results of the additions.

Encoding T1 ARMv6T2, ARMv7

UADD8<c> <Rd>, <Rn>, <Rm>

15	14	13	12	11	10	9	8	7	6	5	4	3	2	1	0	15	14	13	12	11	10	9	8	7	6	5	4	3	2	1	0
1	1	1	1	1	0	1	0	1	0	0	0	Rn			1	1	1	1	Rd			0	1	0	0	Rm					

d = UInt(Rd); n = UInt(Rn); m = UInt(Rm);
 if d == 15 || n == 15 || m == 15 then UNPREDICTABLE; // ARMv8-A removes UNPREDICTABLE for R13

Encoding A1 ARMv6*, ARMv7

UADD8<c> <Rd>, <Rn>, <Rm>

31	30	29	28	27	26	25	24	23	22	21	20	19	18	17	16	15	14	13	12	11	10	9	8	7	6	5	4	3	2	1	0
cond		0	1	1	0	0	1	0	1	Rn			Rd			(1)	(1)	(1)	(1)	1	0	0	1	Rm							

d = UInt(Rd); n = UInt(Rn); m = UInt(Rm);
 if d == 15 || n == 15 || m == 15 then UNPREDICTABLE;

For information about the CONSTRAINED UNPREDICTABLE behavior of this instruction, see [Appendix A Architectural Constraints on UNPREDICTABLE behaviors](#).

Assembler syntax

UADD8{<c>}{<q>} {<Rd>}, <Rn>, <Rm>

where:

<c>, <q> See [Standard assembler syntax fields on page F2-2415](#).

<Rd> The destination register.

<Rn> The first operand register.

<Rm> The second operand register.

Operation

```
if ConditionPassed() then
    EncodingSpecificOperations();
    sum1 = UInt(R[n]<7:0>) + UInt(R[m]<7:0>);
    sum2 = UInt(R[n]<15:8>) + UInt(R[m]<15:8>);
    sum3 = UInt(R[n]<23:16>) + UInt(R[m]<23:16>);
    sum4 = UInt(R[n]<31:24>) + UInt(R[m]<31:24>);
    R[d]<7:0> = sum1<7:0>;
    R[d]<15:8> = sum2<7:0>;
    R[d]<23:16> = sum3<7:0>;
    R[d]<31:24> = sum4<7:0>;
    APSR.GE<0> = if sum1 >= 0x100 then '1' else '0';
    APSR.GE<1> = if sum2 >= 0x100 then '1' else '0';
    APSR.GE<2> = if sum3 >= 0x100 then '1' else '0';
    APSR.GE<3> = if sum4 >= 0x100 then '1' else '0';
```

F7.1.256 UADD16

Unsigned Add 16 performs two 16-bit unsigned integer additions, and writes the results to the destination register. It sets the APSR.GE bits according to the results of the additions.

Encoding T1 ARMv6T2, ARMv7

UADD16<c> <Rd>, <Rn>, <Rm>

15	14	13	12	11	10	9	8	7	6	5	4	3	2	1	0	15	14	13	12	11	10	9	8	7	6	5	4	3	2	1	0
1	1	1	1	1	0	1	0	1	0	0	1	Rn				1	1	1	1	Rd				0	1	0	0	Rm			

d = UInt(Rd); n = UInt(Rn); m = UInt(Rm);
 if d == 15 || n == 15 || m == 15 then UNPREDICTABLE; // ARMv8-A removes UNPREDICTABLE for R13

Encoding A1 ARMv6*, ARMv7

UADD16<c> <Rd>, <Rn>, <Rm>

31	30	29	28	27	26	25	24	23	22	21	20	19	18	17	16	15	14	13	12	11	10	9	8	7	6	5	4	3	2	1	0
cond		0	1	1	0	0	1	0	1	Rn				Rd				(1)	(1)	(1)	(1)	0	0	0	1	Rm					

d = UInt(Rd); n = UInt(Rn); m = UInt(Rm);
 if d == 15 || n == 15 || m == 15 then UNPREDICTABLE;

For information about the CONSTRAINED UNPREDICTABLE behavior of this instruction, see [Appendix A Architectural Constraints on UNPREDICTABLE behaviors](#).

Assembler syntax

UADD16{<c>}{<q>} {<Rd>}, <Rn>, <Rm>

where:

<c>, <q> See *Standard assembler syntax fields* on page F2-2415.

<Rd> The destination register.

<Rn> The first operand register.

<Rm> The second operand register.

Operation

```
if ConditionPassed() then
    EncodingSpecificOperations();
    sum1 = UInt(R[n]<15:0>) + UInt(R[m]<15:0>);
    sum2 = UInt(R[n]<31:16>) + UInt(R[m]<31:16>);
    R[d]<15:0> = sum1<15:0>;
    R[d]<31:16> = sum2<15:0>;
    APSR.GE<1:0> = if sum1 >= 0x10000 then '11' else '00';
    APSR.GE<3:2> = if sum2 >= 0x10000 then '11' else '00';
```

F7.1.257 UASX

Unsigned Add and Subtract with Exchange exchanges the two halfwords of the second operand, performs one unsigned 16-bit integer addition and one unsigned 16-bit subtraction, and writes the results to the destination register. It sets the APSR.GE bits according to the results.

Encoding T1 ARMv6T2, ARMv7

UASX<c> <Rd>, <Rn>, <Rm>

15	14	13	12	11	10	9	8	7	6	5	4	3	2	1	0	15	14	13	12	11	10	9	8	7	6	5	4	3	2	1	0
1	1	1	1	1	0	1	0	1	0	1	0	Rn				1	1	1	1	Rd				0	1	0	0	Rm			

d = UInt(Rd); n = UInt(Rn); m = UInt(Rm);
 if d == 15 || n == 15 || m == 15 then UNPREDICTABLE; // ARMv8-A removes UNPREDICTABLE for R13

Encoding A1 ARMv6*, ARMv7

UASX<c> <Rd>, <Rn>, <Rm>

31	30	29	28	27	26	25	24	23	22	21	20	19	18	17	16	15	14	13	12	11	10	9	8	7	6	5	4	3	2	1	0
cond		0	1	1	0	0	1	0	1	Rn				Rd				(1)	(1)	(1)	(1)	0	0	1	1	Rm					

d = UInt(Rd); n = UInt(Rn); m = UInt(Rm);
 if d == 15 || n == 15 || m == 15 then UNPREDICTABLE;

For information about the CONSTRAINED UNPREDICTABLE behavior of this instruction, see [Appendix A Architectural Constraints on UNPREDICTABLE behaviors](#).

Assembler syntax

UASX{<c>}{<q>} {<Rd>}, <Rn>, <Rm>

where:

<c>, <q> See [Standard assembler syntax fields on page F2-2415](#).

<Rd> The destination register.

<Rn> The first operand register.

<Rm> The second operand register.

The pre-UAL syntax UADDSUBX<c> is equivalent to UASX<c>.

Operation

```
if ConditionPassed() then
    EncodingSpecificOperations();
    diff = UInt(R[n]<15:0>) - UInt(R[m]<31:16>);
    sum = UInt(R[n]<31:16>) + UInt(R[m]<15:0>);
    R[d]<15:0> = diff<15:0>;
    R[d]<31:16> = sum<15:0>;
    APSR.GE<1:0> = if diff >= 0 then '11' else '00';
    APSR.GE<3:2> = if sum >= 0x10000 then '11' else '00';
```

F7.1.258 UBFX

Unsigned Bit Field Extract extracts any number of adjacent bits at any position from a register, zero-extends them to 32 bits, and writes the result to the destination register.

Encoding T1 ARMv6T2, ARMv7

UBFX<<> <Rd>, <Rn>, #<lsb>, #<width>

15	14	13	12	11	10	9	8	7	6	5	4	3	2	1	0	15	14	13	12	11	10	9	8	7	6	5	4	3	2	1	0
1	1	1	1	0	(0)	1	1	1	1	0	0	Rn				0	imm3			Rd			imm2(0)		widthm1						

```
d = UInt(Rd); n = UInt(Rn);
lsbit = UInt(imm3:imm2); widthminus1 = UInt(widthm1);
if d == 15 || n == 15 then UNPREDICTABLE; // ARMv8-A removes UNPREDICTABLE for R13
```

Encoding A1 ARMv6T2, ARMv7

UBFX<<> <Rd>, <Rn>, #<lsb>, #<width>

31	30	29	28	27	26	25	24	23	22	21	20	19	18	17	16	15	14	13	12	11	10	9	8	7	6	5	4	3	2	1	0
cond		0	1	1	1	1	1	1	widthm1				Rd			lsb			1 0 1		Rn										

```
d = UInt(Rd); n = UInt(Rn);
lsbit = UInt(lsb); widthminus1 = UInt(widthm1);
if d == 15 || n == 15 then UNPREDICTABLE;
```

For information about the CONSTRAINED UNPREDICTABLE behavior of this instruction, see [Appendix A Architectural Constraints on UNPREDICTABLE behaviors](#), and particularly [UBFX on page AppxA-4723](#).

Assembler syntax

UBFX{<c>}{<q>} <Rd>, <Rn>, #<lsb>, #<width>

where:

- <c>, <q> See [Standard assembler syntax fields on page F2-2415](#).
- <Rd> The destination register.
- <Rn> The first operand register.
- <lsb> Is the bit number of the least significant bit in the field, in the range 0-31. This determines the required value of `lsbit`.
- <width> Is the width of the field, in the range 1 to 32-<lsb>. The required value of `widthminus1` is <width>-1.

Operation

```
if ConditionPassed() then
    EncodingSpecificOperations();
    msbit = lsbit + widthminus1;
    if msbit <= 31 then
        R[d] = ZeroExtend(R[n]<msbit:lsbit>, 32);
    else
        UNPREDICTABLE;
```

F7.1.259 UDF

Permanently Undefined generates an Undefined Instruction exception.

The encodings for UDF used in this section are defined as permanently UNDEFINED in the ARMv8-A architecture. However:

- With the T32 instruction set, ARM deprecates using the UDF instruction in an IT block.
- In the A32 instruction set, UDF is not conditional.

Encoding T1 ARMv4T, ARMv5T*, ARMv6, ARMv7

UDF<C> #<imm8>

15	14	13	12	11	10	9	8	7	6	5	4	3	2	1	0
1	1	0	1	1	1	1	0	imm8							

imm32 = ZeroExtend(imm8, 32);

// imm32 is for assembly and disassembly only, and is ignored by hardware.

Encoding T2 ARMv6T2, ARMv7

UDF<C>.W #<imm16>

15	14	13	12	11	10	9	8	7	6	5	4	3	2	1	0	15	14	13	12	11	10	9	8	7	6	5	4	3	2	1	0
1	1	1	1	0	1	1	1	1	1	1	1	1	1	1	1	imm4	1	0	1	0	imm12										

imm32 = ZeroExtend(imm4:imm12, 32);

// imm32 is for assembly and disassembly only, and is ignored by hardware.

Encoding A1 ARMv4T, ARMv5T*, ARMv6, ARMv7

UDF<C> #<imm16>

31	30	29	28	27	26	25	24	23	22	21	20	19	18	17	16	15	14	13	12	11	10	9	8	7	6	5	4	3	2	1	0
1	1	1	0	0	1	1	1	1	1	1	1	imm12						1	1	1	1	imm4									

imm32 = ZeroExtend(imm12:imm4, 32);

// imm32 is for assembly and disassembly only, and is ignored by hardware.

Assembler syntax

UDF{<c>}{<q>} {#}<imm>

where:

<c>, <q> See [Standard assembler syntax fields on page F2-2415](#).

In the A32 instruction set, <c> must be AL or omitted.

In the T32 instruction set, ARM deprecates using any <c> value other than AL.

<imm> Specifies an immediate constant, that is 8-bit in encoding T1, and 16-bit in encodings T2 and A1.
The PE ignores the value of this constant.

Operation

```
if ConditionPassed() then
    EncodingSpecificOperations();
    UNDEFINED;
```

F7.1.260 UDIV

Unsigned Divide divides a 32-bit unsigned integer register value by a 32-bit unsigned integer register value, and writes the result to the destination register. The condition flags are not affected.

See [Divide instructions on page F1-2390](#) for more information about this instruction.

Encoding T1 ARMv7-R, ARMv7VE, otherwise OPTIONAL in ARMv7-A

UDIV<c> <Rd>, <Rn>, <Rm>

15	14	13	12	11	10	9	8	7	6	5	4	3	2	1	0	15	14	13	12	11	10	9	8	7	6	5	4	3	2	1	0
1	1	1	1	1	0	1	1	1	0	1	1	Rn				(1)	(1)	(1)	(1)	Rd				1	1	1	1	Rm			

d = UInt(Rd); n = UInt(Rn); m = UInt(Rm);
 if d == 15 || n == 15 || m == 15 then UNPREDICTABLE; // ARMv8-A removes UNPREDICTABLE for R13

Encoding A1 ARMv7VE, otherwise OPTIONAL in ARMv7-A and ARMv7-R

UDIV<c> <Rd>, <Rn>, <Rm>

31	30	29	28	27	26	25	24	23	22	21	20	19	18	17	16	15	14	13	12	11	10	9	8	7	6	5	4	3	2	1	0
cond		0	1	1	1	0	0	1	1	Rd				(1)	(1)	(1)	(1)	Rm				0	0	0	1	Rn					

d = UInt(Rd); n = UInt(Rn); m = UInt(Rm);
 if d == 15 || n == 15 || m == 15 then UNPREDICTABLE;

For information about the CONSTRAINED UNPREDICTABLE behavior of this instruction, see [Appendix A Architectural Constraints on UNPREDICTABLE behaviors](#), and particularly [UDIV on page AppxA-4724](#).

Assembler syntax

UDIV{<C>}{<q>} {<Rd>}, <Rn>, <Rm>

where:

<C>, <q> See *Standard assembler syntax fields* on page F2-2415.

<Rd> The destination register.

<Rn> The register that contains the dividend.

<Rm> The register that contains the divisor.

Operation

```
if ConditionPassed() then
    EncodingSpecificOperations();
    if UInt(R[m]) == 0 then
        if IntegerZeroDivideTrappingEnabled() then
            GenerateIntegerZeroDivide();
        else
            result = 0;
    else
        result = RoundTowardsZero(UInt(R[n]) / UInt(R[m]));
    R[d] = result<31:0>;
```

F7.1.261 UHADD8

Unsigned Halving Add 8 performs four unsigned 8-bit integer additions, halves the results, and writes the results to the destination register.

Encoding T1 ARMv6T2, ARMv7

UHADD8<c> <Rd>, <Rn>, <Rm>

15	14	13	12	11	10	9	8	7	6	5	4	3	2	1	0	15	14	13	12	11	10	9	8	7	6	5	4	3	2	1	0
1	1	1	1	1	0	1	0	1	0	0	0	Rn			1	1	1	1	Rd			0	1	1	0	Rm					

d = UInt(Rd); n = UInt(Rn); m = UInt(Rm);
 if d == 15 || n == 15 || m == 15 then UNPREDICTABLE; // ARMv8-A removes UNPREDICTABLE for R13

Encoding A1 ARMv6*, ARMv7

UHADD8<c> <Rd>, <Rn>, <Rm>

31	30	29	28	27	26	25	24	23	22	21	20	19	18	17	16	15	14	13	12	11	10	9	8	7	6	5	4	3	2	1	0
cond		0	1	1	0	0	1	1	1	Rn			Rd			(1)	(1)	(1)	(1)	1	0	0	1	Rm							

d = UInt(Rd); n = UInt(Rn); m = UInt(Rm);
 if d == 15 || n == 15 || m == 15 then UNPREDICTABLE;

For information about the CONSTRAINED UNPREDICTABLE behavior of this instruction, see [Appendix A Architectural Constraints on UNPREDICTABLE behaviors](#).

Assembler syntax

UHADD8{<c>}{<q>} {<Rd>}, <Rn>, <Rm>

where:

<c>, <q> See *Standard assembler syntax fields* on page F2-2415.

<Rd> The destination register.

<Rn> The first operand register.

<Rm> The second operand register.

Operation

```
if ConditionPassed() then
    EncodingSpecificOperations();
    sum1 = UInt(R[n]<7:0>) + UInt(R[m]<7:0>);
    sum2 = UInt(R[n]<15:8>) + UInt(R[m]<15:8>);
    sum3 = UInt(R[n]<23:16>) + UInt(R[m]<23:16>);
    sum4 = UInt(R[n]<31:24>) + UInt(R[m]<31:24>);
    R[d]<7:0> = sum1<8:1>;
    R[d]<15:8> = sum2<8:1>;
    R[d]<23:16> = sum3<8:1>;
    R[d]<31:24> = sum4<8:1>;
```

F7.1.262 UHADD16

Unsigned Halving Add 16 performs two unsigned 16-bit integer additions, halves the results, and writes the results to the destination register.

Encoding T1 ARMv6T2, ARMv7

UHADD16<c> <Rd>, <Rn>, <Rm>

15	14	13	12	11	10	9	8	7	6	5	4	3	2	1	0	15	14	13	12	11	10	9	8	7	6	5	4	3	2	1	0
1	1	1	1	1	0	1	0	1	0	0	1	Rn				1	1	1	1	Rd				0	1	1	0	Rm			

d = UInt(Rd); n = UInt(Rn); m = UInt(Rm);
 if d == 15 || n == 15 || m == 15 then UNPREDICTABLE; // ARMv8-A removes UNPREDICTABLE for R13

Encoding A1 ARMv6*, ARMv7

UHADD16<c> <Rd>, <Rn>, <Rm>

31	30	29	28	27	26	25	24	23	22	21	20	19	18	17	16	15	14	13	12	11	10	9	8	7	6	5	4	3	2	1	0
cond		0	1	1	0	0	1	1	1	Rn				Rd				(1)	(1)	(1)	(1)	0	0	0	1	Rm					

d = UInt(Rd); n = UInt(Rn); m = UInt(Rm);
 if d == 15 || n == 15 || m == 15 then UNPREDICTABLE;

For information about the CONSTRAINED UNPREDICTABLE behavior of this instruction, see [Appendix A Architectural Constraints on UNPREDICTABLE behaviors](#).

Assembler syntax

UHADD16{<C>}{<Q>} {<Rd>}, <Rn>, <Rm>

where:

<C>, <Q> See *Standard assembler syntax fields* on page F2-2415.

<Rd> The destination register.

<Rn> The first operand register.

<Rm> The second operand register.

Operation

```
if ConditionPassed() then
    EncodingSpecificOperations();
    sum1 = UInt(R[n]<15:0>) + UInt(R[m]<15:0>);
    sum2 = UInt(R[n]<31:16>) + UInt(R[m]<31:16>);
    R[d]<15:0> = sum1<16:1>;
    R[d]<31:16> = sum2<16:1>;
```

F7.1.263 UHASX

Unsigned Halving Add and Subtract with Exchange exchanges the two halfwords of the second operand, performs one unsigned 16-bit integer addition and one unsigned 16-bit subtraction, halves the results, and writes the results to the destination register.

Encoding T1 ARMv6T2, ARMv7

UHASX<c> <Rd>, <Rn>, <Rm>

15	14	13	12	11	10	9	8	7	6	5	4	3	2	1	0	15	14	13	12	11	10	9	8	7	6	5	4	3	2	1	0
1	1	1	1	1	0	1	0	1	0	1	0	Rn				1	1	1	1	Rd				0	1	1	0	Rm			

d = UInt(Rd); n = UInt(Rn); m = UInt(Rm);
 if d == 15 || n == 15 || m == 15 then UNPREDICTABLE; // ARMv8-A removes UNPREDICTABLE for R13

Encoding A1 ARMv6*, ARMv7

UHASX<c> <Rd>, <Rn>, <Rm>

31	30	29	28	27	26	25	24	23	22	21	20	19	18	17	16	15	14	13	12	11	10	9	8	7	6	5	4	3	2	1	0
cond		0	1	1	0	0	1	1	1	Rn				Rd				(1)	(1)	(1)	(1)	0	0	1	1	Rm					

d = UInt(Rd); n = UInt(Rn); m = UInt(Rm);
 if d == 15 || n == 15 || m == 15 then UNPREDICTABLE;

For information about the CONSTRAINED UNPREDICTABLE behavior of this instruction, see [Appendix A Architectural Constraints on UNPREDICTABLE behaviors](#).

Assembler syntax

UHASX{<c>}{<q>} {<Rd>}, <Rn>, <Rm>

where:

<c>, <q> See [Standard assembler syntax fields on page F2-2415](#).

<Rd> The destination register.

<Rn> The first operand register.

<Rm> The second operand register.

The pre-UAL syntax UHADDSUBX<c> is equivalent to UHASX<c>.

Operation

```
if ConditionPassed() then
    EncodingSpecificOperations();
    diff = UInt(R[n]<15:0>) - UInt(R[m]<31:16>);
    sum = UInt(R[n]<31:16>) + UInt(R[m]<15:0>);
    R[d]<15:0> = diff<16:1>;
    R[d]<31:16> = sum<16:1>;
```

F7.1.264 UHSAX

Unsigned Halving Subtract and Add with Exchange exchanges the two halfwords of the second operand, performs one unsigned 16-bit integer subtraction and one unsigned 16-bit addition, halves the results, and writes the results to the destination register.

Encoding T1 ARMv6T2, ARMv7

UHSAX<c> <Rd>, <Rn>, <Rm>

15	14	13	12	11	10	9	8	7	6	5	4	3	2	1	0	15	14	13	12	11	10	9	8	7	6	5	4	3	2	1	0
1	1	1	1	1	0	1	0	1	1	1	0	Rn				1	1	1	1	Rd				0	1	1	0	Rm			

d = UInt(Rd); n = UInt(Rn); m = UInt(Rm);
 if d == 15 || n == 15 || m == 15 then UNPREDICTABLE; // ARMv8-A removes UNPREDICTABLE for R13

Encoding A1 ARMv6*, ARMv7

UHSAX<c> <Rd>, <Rn>, <Rm>

31	30	29	28	27	26	25	24	23	22	21	20	19	18	17	16	15	14	13	12	11	10	9	8	7	6	5	4	3	2	1	0		
cond		0	1	1	0	0	1	1	1	Rn				Rd				(1)	(1)	(1)	(1)	0	1	0	1	Rm							

d = UInt(Rd); n = UInt(Rn); m = UInt(Rm);
 if d == 15 || n == 15 || m == 15 then UNPREDICTABLE;

For information about the CONSTRAINED UNPREDICTABLE behavior of this instruction, see [Appendix A Architectural Constraints on UNPREDICTABLE behaviors](#).

Assembler syntax

UHSAX{<c>}{<q>} {<Rd>}, <Rn>, <Rm>

where:

<c>, <q> See [Standard assembler syntax fields on page F2-2415](#).

<Rd> The destination register.

<Rn> The first operand register.

<Rm> The second operand register.

The pre-UAL syntax UHSUBADDX<c> is equivalent to UHSAX<c>.

Operation

```
if ConditionPassed() then
    EncodingSpecificOperations();
    sum = UInt(R[n]<15:0>) + UInt(R[m]<31:16>);
    diff = UInt(R[n]<31:16>) - UInt(R[m]<15:0>);
    R[d]<15:0> = sum<16:1>;
    R[d]<31:16> = diff<16:1>;
```

F7.1.265 UHSUB8

Unsigned Halving Subtract 8 performs four unsigned 8-bit integer subtractions, halves the results, and writes the results to the destination register.

Encoding T1 ARMv6T2, ARMv7

UHSUB8<c> <Rd>, <Rn>, <Rm>

15	14	13	12	11	10	9	8	7	6	5	4	3	2	1	0	15	14	13	12	11	10	9	8	7	6	5	4	3	2	1	0
1	1	1	1	1	0	1	0	1	1	0	0	Rn			1	1	1	1	Rd			0	1	1	0	Rm					

d = UInt(Rd); n = UInt(Rn); m = UInt(Rm);
 if d == 15 || n == 15 || m == 15 then UNPREDICTABLE; // ARMv8-A removes UNPREDICTABLE for R13

Encoding A1 ARMv6*, ARMv7

UHSUB8<c> <Rd>, <Rn>, <Rm>

31	30	29	28	27	26	25	24	23	22	21	20	19	18	17	16	15	14	13	12	11	10	9	8	7	6	5	4	3	2	1	0
cond		0	1	1	0	0	1	1	1	Rn			Rd			(1)	(1)	(1)	(1)	1	1	1	1	Rm							

d = UInt(Rd); n = UInt(Rn); m = UInt(Rm);
 if d == 15 || n == 15 || m == 15 then UNPREDICTABLE;

For information about the CONSTRAINED UNPREDICTABLE behavior of this instruction, see [Appendix A Architectural Constraints on UNPREDICTABLE behaviors](#).

Assembler syntax

UHSUB8{<c>}{<q>} {<Rd>}, <Rn>, <Rm>

where:

<c>, <q> See [Standard assembler syntax fields on page F2-2415](#).

<Rd> The destination register.

<Rn> The first operand register.

<Rm> The second operand register.

Operation

```
if ConditionPassed() then
    EncodingSpecificOperations();
    diff1 = UInt(R[n]<7:0>) - UInt(R[m]<7:0>);
    diff2 = UInt(R[n]<15:8>) - UInt(R[m]<15:8>);
    diff3 = UInt(R[n]<23:16>) - UInt(R[m]<23:16>);
    diff4 = UInt(R[n]<31:24>) - UInt(R[m]<31:24>);
    R[d]<7:0> = diff1<8:1>;
    R[d]<15:8> = diff2<8:1>;
    R[d]<23:16> = diff3<8:1>;
    R[d]<31:24> = diff4<8:1>;
```

F7.1.266 UHSUB16

Unsigned Halving Subtract 16 performs two unsigned 16-bit integer subtractions, halves the results, and writes the results to the destination register.

Encoding T1 ARMv6T2, ARMv7

UHSUB16<c> <Rd>, <Rn>, <Rm>

15	14	13	12	11	10	9	8	7	6	5	4	3	2	1	0	15	14	13	12	11	10	9	8	7	6	5	4	3	2	1	0
1	1	1	1	1	0	1	0	1	1	0	1	Rn				1	1	1	1	Rd				0	1	1	0	Rm			

d = UInt(Rd); n = UInt(Rn); m = UInt(Rm);
 if d == 15 || n == 15 || m == 15 then UNPREDICTABLE; // ARMv8-A removes UNPREDICTABLE for R13

Encoding A1 ARMv6*, ARMv7

UHSUB16<c> <Rd>, <Rn>, <Rm>

31	30	29	28	27	26	25	24	23	22	21	20	19	18	17	16	15	14	13	12	11	10	9	8	7	6	5	4	3	2	1	0
cond		0	1	1	0	0	1	1	1	Rn				Rd				(1)	(1)	(1)	(1)	0	1	1	1	Rm					

d = UInt(Rd); n = UInt(Rn); m = UInt(Rm);
 if d == 15 || n == 15 || m == 15 then UNPREDICTABLE;

For information about the CONSTRAINED UNPREDICTABLE behavior of this instruction, see [Appendix A Architectural Constraints on UNPREDICTABLE behaviors](#).

Assembler syntax

UHSUB16{<c>}{<q>} {<Rd>}, <Rn>, <Rm>

where:

<c>, <q> See *Standard assembler syntax fields* on page F2-2415.

<Rd> The destination register.

<Rn> The first operand register.

<Rm> The second operand register.

Operation

```
if ConditionPassed() then
    EncodingSpecificOperations();
    diff1 = UInt(R[n]<15:0>) - UInt(R[m]<15:0>);
    diff2 = UInt(R[n]<31:16>) - UInt(R[m]<31:16>);
    R[d]<15:0> = diff1<16:1>;
    R[d]<31:16> = diff2<16:1>;
```

F7.1.267 UMAAL

Unsigned Multiply Accumulate Accumulate Long multiplies two unsigned 32-bit values to produce a 64-bit value, adds two unsigned 32-bit values, and writes the 64-bit result to two registers.

Encoding T1 ARMv6T2, ARMv7

UMAAL<c> <RdLo>, <RdHi>, <Rn>, <Rm>

15	14	13	12	11	10	9	8	7	6	5	4	3	2	1	0	15	14	13	12	11	10	9	8	7	6	5	4	3	2	1	0
1	1	1	1	1	0	1	1	1	1	1	0	Rn				RdLo				RdHi				0 1 1 0				Rm			

```
dLo = UInt(RdLo); dHi = UInt(RdHi); n = UInt(Rn); m = UInt(Rm);
if dLo == 15 || dHi == 15 || n == 15 || m == 15 then UNPREDICTABLE;
// ARMv8-A removes UNPREDICTABLE for R13
if dHi == dLo then UNPREDICTABLE;
```

Encoding A1 ARMv6*, ARMv7

UMAAL<c> <RdLo>, <RdHi>, <Rn>, <Rm>

31	30	29	28	27	26	25	24	23	22	21	20	19	18	17	16	15	14	13	12	11	10	9	8	7	6	5	4	3	2	1	0
cond				0 0 0 0 0 1 0 0				RdHi				RdLo				Rm				1 0 0 1				Rn							

```
dLo = UInt(RdLo); dHi = UInt(RdHi); n = UInt(Rn); m = UInt(Rm);
if dLo == 15 || dHi == 15 || n == 15 || m == 15 then UNPREDICTABLE;
if dHi == dLo then UNPREDICTABLE;
```

For information about the CONSTRAINED UNPREDICTABLE behavior of this instruction, see [Appendix A Architectural Constraints on UNPREDICTABLE behaviors](#), and particularly [UMAAL on page AppxA-4726](#).

Assembler syntax

UMAAL{<c>}{<q>} <RdLo>, <RdHi>, <Rn>, <Rm>

where:

- <c>, <q> See [Standard assembler syntax fields on page F2-2415](#).
- <RdLo> Supplies one of the 32-bit values to be added, and is the destination register for the lower 32 bits of the result.
- <RdHi> Supplies the other of the 32-bit values to be added, and is the destination register for the upper 32 bits of the result.
- <Rn> The register that contains the first multiply operand.
- <Rm> The register that contains the second multiply operand.

Operation

```
if ConditionPassed() then
    EncodingSpecificOperations();
    result = UInt(R[n]) * UInt(R[m]) + UInt(R[dHi]) + UInt(R[dLo]);
    R[dHi] = result<63:32>;
    R[dLo] = result<31:0>;
```

F7.1.268 UMLAL

Unsigned Multiply Accumulate Long multiplies two unsigned 32-bit values to produce a 64-bit value, and accumulates this with a 64-bit value.

In A32 instructions, the condition flags can optionally be updated based on the result. Use of this option adversely affects performance on many implementations.

Encoding T1 ARMv6T2, ARMv7

UMLAL<C> <RdLo>, <RdHi>, <Rn>, <Rm>

15	14	13	12	11	10	9	8	7	6	5	4	3	2	1	0	15	14	13	12	11	10	9	8	7	6	5	4	3	2	1	0
1	1	1	1	1	0	1	1	1	1	1	0	Rn				RdLo				RdHi				0 0 0 0				Rm			

```
dLo = UInt(RdLo); dHi = UInt(RdHi); n = UInt(Rn); m = UInt(Rm); setflags = FALSE;
if dLo == 15 || dHi == 15 || n == 15 || m == 15 then UNPREDICTABLE;
// ARMv8-A removes UNPREDICTABLE for R13
if dHi == dLo then UNPREDICTABLE;
```

Encoding A1 ARMv4*, ARMv5T*, ARMv6*, ARMv7

UMLAL{S}<C> <RdLo>, <RdHi>, <Rn>, <Rm>

31	30	29	28	27	26	25	24	23	22	21	20	19	18	17	16	15	14	13	12	11	10	9	8	7	6	5	4	3	2	1	0
cond		0 0 0 0				1 0 1		S	RdHi				RdLo				Rm				1 0 0 1				Rn						

```
dLo = UInt(RdLo); dHi = UInt(RdHi); n = UInt(Rn); m = UInt(Rm); setflags = (S == '1');
if dLo == 15 || dHi == 15 || n == 15 || m == 15 then UNPREDICTABLE;
if dHi == dLo then UNPREDICTABLE;
```

For information about the CONSTRAINED UNPREDICTABLE behavior of this instruction, see [Appendix A Architectural Constraints on UNPREDICTABLE behaviors](#), and particularly [UMLAL on page AppxA-4726](#).

Assembler syntax

UMLAL{S}{<c>}{<q>} <RdLo>, <RdHi>, <Rn>, <Rm>

where:

- S If S is present, the instruction updates the flags. Otherwise, the flags are not updated.
S can be specified only for the A32 instruction set.
- <c>, <q> See [Standard assembler syntax fields on page F2-2415](#).
- <RdLo> Supplies the lower 32 bits of the accumulate value, and is the destination register for the lower 32 bits of the result.
- <RdHi> Supplies the upper 32 bits of the accumulate value, and is the destination register for the upper 32 bits of the result.
- <Rn> The first operand register.
- <Rm> The second operand register.

The pre-UAL syntax UMLAL<c>S is equivalent to UMLALS<c>.

Operation

```
if ConditionPassed() then
    EncodingSpecificOperations();
    result = UInt(R[n]) * UInt(R[m]) + UInt(R[dHi]:R[dLo]);
    R[dHi] = result<63:32>;
    R[dLo] = result<31:0>;
    if setflags then
        APSR.N = result<63>;
        APSR.Z = IsZeroBit(result<63:0>);
        // APSR.C, APSR.V unchanged
```

F7.1.269 UMULL

Unsigned Multiply Long multiplies two 32-bit unsigned values to produce a 64-bit result.

In A32 instructions, the condition flags can optionally be updated based on the result. Use of this option adversely affects performance on many implementations.

Encoding T1 ARMv6T2, ARMv7

UMULL<C> <RdLo>, <RdHi>, <Rn>, <Rm>

15	14	13	12	11	10	9	8	7	6	5	4	3	2	1	0	15	14	13	12	11	10	9	8	7	6	5	4	3	2	1	0
1	1	1	1	1	0	1	1	1	0	1	0	Rn				RdLo				RdHi				0	0	0	0	Rm			

```
dLo = UInt(RdLo); dHi = UInt(RdHi); n = UInt(Rn); m = UInt(Rm); setflags = FALSE;
if dLo == 15 || dHi == 15 || n == 15 || m == 15 then UNPREDICTABLE;
// ARMv8-A removes UNPREDICTABLE for R13
if dHi == dLo then UNPREDICTABLE;
```

Encoding A1 ARMv4*, ARMv5T*, ARMv6*, ARMv7

UMULL{S}<C> <RdLo>, <RdHi>, <Rn>, <Rm>

31	30	29	28	27	26	25	24	23	22	21	20	19	18	17	16	15	14	13	12	11	10	9	8	7	6	5	4	3	2	1	0
cond		0	0	0	0	1	0	0	S	RdHi				RdLo				Rm				1	0	0	1	Rn					

```
dLo = UInt(RdLo); dHi = UInt(RdHi); n = UInt(Rn); m = UInt(Rm); setflags = (S == '1');
if dLo == 15 || dHi == 15 || n == 15 || m == 15 then UNPREDICTABLE;
if dHi == dLo then UNPREDICTABLE;
```

For information about the CONSTRAINED UNPREDICTABLE behavior of this instruction, see [Appendix A Architectural Constraints on UNPREDICTABLE behaviors](#), and particularly *UMULL* on page AppxA-4725.

Assembler syntax

UMULL{S}{<c>}{<q>} <RdLo>, <RdHi>, <Rn>, <Rm>

where:

S If S is present, the instruction updates the flags. Otherwise, the flags are not updated.
S can be specified only for the A32 instruction set.

<c>, <q> See *Standard assembler syntax fields* on page F2-2415.

<RdLo> Stores the lower 32 bits of the result.

<RdHi> Stores the upper 32 bits of the result.

<Rn> The first operand register.

<Rm> The second operand register.

The pre-UAL syntax UMULL<c>S is equivalent to UMULLS<c>.

Operation

```
if ConditionPassed() then
    EncodingSpecificOperations();
    result = UInt(R[n]) * UInt(R[m]);
    R[dHi] = result<63:32>;
    R[dLo] = result<31:0>;
    if setflags then
        APSR.N = result<63>;
        APSR.Z = IsZeroBit(result<63:0>);
        // APSR.C, APSR.V unchanged
```

F7.1.270 UQADD8

Unsigned Saturating Add 8 performs four unsigned 8-bit integer additions, saturates the results to the 8-bit unsigned integer range $0 \leq x \leq 2^8 - 1$, and writes the results to the destination register.

Encoding T1 ARMv6T2, ARMv7

UQADD8<c> <Rd>, <Rn>, <Rm>

15	14	13	12	11	10	9	8	7	6	5	4	3	2	1	0	15	14	13	12	11	10	9	8	7	6	5	4	3	2	1	0
1	1	1	1	1	0	1	0	1	0	0	0	Rn			1	1	1	1	Rd			0	1	0	1	Rm					

d = UInt(Rd); n = UInt(Rn); m = UInt(Rm);
 if d == 15 || n == 15 || m == 15 then UNPREDICTABLE; // ARMv8-A removes UNPREDICTABLE for R13

Encoding A1 ARMv6*, ARMv7

UQADD8<c> <Rd>, <Rn>, <Rm>

31	30	29	28	27	26	25	24	23	22	21	20	19	18	17	16	15	14	13	12	11	10	9	8	7	6	5	4	3	2	1	0
cond		0	1	1	0	0	1	1	0	Rn			Rd			(1)	(1)	(1)	(1)	1	0	0	1	Rm							

d = UInt(Rd); n = UInt(Rn); m = UInt(Rm);
 if d == 15 || n == 15 || m == 15 then UNPREDICTABLE;

For information about the CONSTRAINED UNPREDICTABLE behavior of this instruction, see [Appendix A Architectural Constraints on UNPREDICTABLE behaviors](#).

Assembler syntax

UQADD8{<c>}{<q>} {<Rd>}, <Rn>, <Rm>

where:

<c>, <q> See *Standard assembler syntax fields* on page F2-2415.

<Rd> The destination register.

<Rn> The first operand register.

<Rm> The second operand register.

Operation

```
if ConditionPassed() then
    EncodingSpecificOperations();
    sum1 = UInt(R[n]<7:0>) + UInt(R[m]<7:0>);
    sum2 = UInt(R[n]<15:8>) + UInt(R[m]<15:8>);
    sum3 = UInt(R[n]<23:16>) + UInt(R[m]<23:16>);
    sum4 = UInt(R[n]<31:24>) + UInt(R[m]<31:24>);
    R[d]<7:0> = UnsignedSat(sum1, 8);
    R[d]<15:8> = UnsignedSat(sum2, 8);
    R[d]<23:16> = UnsignedSat(sum3, 8);
    R[d]<31:24> = UnsignedSat(sum4, 8);
```

F7.1.271 UQADD16

Unsigned Saturating Add 16 performs two unsigned 16-bit integer additions, saturates the results to the 16-bit unsigned integer range $0 \leq x \leq 2^{16} - 1$, and writes the results to the destination register.

Encoding T1 ARMv6T2, ARMv7

UQADD16<c> <Rd>, <Rn>, <Rm>

15	14	13	12	11	10	9	8	7	6	5	4	3	2	1	0	15	14	13	12	11	10	9	8	7	6	5	4	3	2	1	0
1	1	1	1	1	0	1	0	1	0	0	1	Rn				1	1	1	1	Rd				0	1	0	1	Rm			

d = UInt(Rd); n = UInt(Rn); m = UInt(Rm);
 if d == 15 || n == 15 || m == 15 then UNPREDICTABLE; // ARMv8-A removes UNPREDICTABLE for R13

Encoding A1 ARMv6*, ARMv7

UQADD16<c> <Rd>, <Rn>, <Rm>

31	30	29	28	27	26	25	24	23	22	21	20	19	18	17	16	15	14	13	12	11	10	9	8	7	6	5	4	3	2	1	0
cond		0	1	1	0	0	1	1	0	Rn				Rd				(1)	(1)	(1)	(1)	0	0	0	1	Rm					

d = UInt(Rd); n = UInt(Rn); m = UInt(Rm);
 if d == 15 || n == 15 || m == 15 then UNPREDICTABLE;

For information about the CONSTRAINED UNPREDICTABLE behavior of this instruction, see [Appendix A Architectural Constraints on UNPREDICTABLE behaviors](#).

Assembler syntax

UQADD16{<c>}{<q>} {<Rd>}, <Rn>, <Rm>

where:

<c>, <q> See *Standard assembler syntax fields* on page F2-2415.

<Rd> The destination register.

<Rn> The first operand register.

<Rm> The second operand register.

Operation

```
if ConditionPassed() then
    EncodingSpecificOperations();
    sum1 = UInt(R[n]<15:0>) + UInt(R[m]<15:0>);
    sum2 = UInt(R[n]<31:16>) + UInt(R[m]<31:16>);
    R[d]<15:0> = UnsignedSat(sum1, 16);
    R[d]<31:16> = UnsignedSat(sum2, 16);
```

F7.1.272 UQASX

Unsigned Saturating Add and Subtract with Exchange exchanges the two halfwords of the second operand, performs one unsigned 16-bit integer addition and one unsigned 16-bit subtraction, saturates the results to the 16-bit unsigned integer range $0 \leq x \leq 2^{16} - 1$, and writes the results to the destination register.

Encoding T1 ARMv6T2, ARMv7

UQASX<c> <Rd>, <Rn>, <Rm>

15	14	13	12	11	10	9	8	7	6	5	4	3	2	1	0	15	14	13	12	11	10	9	8	7	6	5	4	3	2	1	0
1	1	1	1	1	0	1	0	1	0	1	0	Rn			1	1	1	1	Rd			0	1	0	1	Rm					

d = UInt(Rd); n = UInt(Rn); m = UInt(Rm);
 if d == 15 || n == 15 || m == 15 then UNPREDICTABLE; // ARMv8-A removes UNPREDICTABLE for R13

Encoding A1 ARMv6*, ARMv7

UQASX<c> <Rd>, <Rn>, <Rm>

31	30	29	28	27	26	25	24	23	22	21	20	19	18	17	16	15	14	13	12	11	10	9	8	7	6	5	4	3	2	1	0
cond		0	1	1	0	0	1	1	0	Rn			Rd			(1)	(1)	(1)	(1)	0	0	1	1	Rm							

d = UInt(Rd); n = UInt(Rn); m = UInt(Rm);
 if d == 15 || n == 15 || m == 15 then UNPREDICTABLE;

For information about the CONSTRAINED UNPREDICTABLE behavior of this instruction, see [Appendix A Architectural Constraints on UNPREDICTABLE behaviors](#).

Assembler syntax

UQASX{<c>}{<q>} {<Rd>}, <Rn>, <Rm>

where:

<c>, <q> See *Standard assembler syntax fields* on page F2-2415.

<Rd> The destination register.

<Rn> The first operand register.

<Rm> The second operand register.

The pre-UAL syntax UQADDSUBX<c> is equivalent to UQASX<c>.

Operation

```
if ConditionPassed() then
    EncodingSpecificOperations();
    diff = UInt(R[n]<15:0>) - UInt(R[m]<31:16>);
    sum = UInt(R[n]<31:16>) + UInt(R[m]<15:0>);
    R[d]<15:0> = UnsignedSat(diff, 16);
    R[d]<31:16> = UnsignedSat(sum, 16);
```

F7.1.273 UQSAX

Unsigned Saturating Subtract and Add with Exchange exchanges the two halfwords of the second operand, performs one unsigned 16-bit integer subtraction and one unsigned 16-bit addition, saturates the results to the 16-bit unsigned integer range $0 \leq x \leq 2^{16} - 1$, and writes the results to the destination register.

Encoding T1 ARMv6T2, ARMv7

UQSAX<c> <Rd>, <Rn>, <Rm>

15	14	13	12	11	10	9	8	7	6	5	4	3	2	1	0	15	14	13	12	11	10	9	8	7	6	5	4	3	2	1	0
1	1	1	1	1	0	1	0	1	1	1	0	Rn			1	1	1	1	Rd			0	1	0	1	Rm					

d = UInt(Rd); n = UInt(Rn); m = UInt(Rm);
 if d == 15 || n == 15 || m == 15 then UNPREDICTABLE; // ARMv8-A removes UNPREDICTABLE for R13

Encoding A1 ARMv6*, ARMv7

UQSAX<c> <Rd>, <Rn>, <Rm>

31	30	29	28	27	26	25	24	23	22	21	20	19	18	17	16	15	14	13	12	11	10	9	8	7	6	5	4	3	2	1	0
cond		0	1	1	0	0	1	1	0	Rn			Rd			(1)	(1)	(1)	(1)	0	1	0	1	Rm							

d = UInt(Rd); n = UInt(Rn); m = UInt(Rm);
 if d == 15 || n == 15 || m == 15 then UNPREDICTABLE;

For information about the CONSTRAINED UNPREDICTABLE behavior of this instruction, see [Appendix A Architectural Constraints on UNPREDICTABLE behaviors](#).

Assembler syntax

UQSAX{<c>}{<q>} {<Rd>}, <Rn>, <Rm>

where:

<c>, <q> See [Standard assembler syntax fields on page F2-2415](#).

<Rd> The destination register.

<Rn> The first operand register.

<Rm> The second operand register.

The pre-UAL syntax UQSUBADDX<c> is equivalent to UQSAX<c>.

Operation

```
if ConditionPassed() then
    EncodingSpecificOperations();
    sum = UInt(R[n]<15:0>) + UInt(R[m]<31:16>);
    diff = UInt(R[n]<31:16>) - UInt(R[m]<15:0>);
    R[d]<15:0> = UnsignedSat(sum, 16);
    R[d]<31:16> = UnsignedSat(diff, 16);
```

F7.1.274 UQSUB8

Unsigned Saturating Subtract 8 performs four unsigned 8-bit integer subtractions, saturates the results to the 8-bit unsigned integer range $0 \leq x \leq 2^8 - 1$, and writes the results to the destination register.

Encoding T1 ARMv6T2, ARMv7

UQSUB8<c> <Rd>, <Rn>, <Rm>

15	14	13	12	11	10	9	8	7	6	5	4	3	2	1	0	15	14	13	12	11	10	9	8	7	6	5	4	3	2	1	0
1	1	1	1	1	0	1	0	1	1	0	0	Rn			1	1	1	1	Rd			0	1	0	1	Rm					

d = UInt(Rd); n = UInt(Rn); m = UInt(Rm);
 if d == 15 || n == 15 || m == 15 then UNPREDICTABLE; // ARMv8-A removes UNPREDICTABLE for R13

Encoding A1 ARMv6*, ARMv7

UQSUB8<c> <Rd>, <Rn>, <Rm>

31	30	29	28	27	26	25	24	23	22	21	20	19	18	17	16	15	14	13	12	11	10	9	8	7	6	5	4	3	2	1	0
cond		0	1	1	0	0	1	1	0	Rn			Rd			(1)	(1)	(1)	(1)	1	1	1	1	Rm							

d = UInt(Rd); n = UInt(Rn); m = UInt(Rm);
 if d == 15 || n == 15 || m == 15 then UNPREDICTABLE;

For information about the CONSTRAINED UNPREDICTABLE behavior of this instruction, see [Appendix A Architectural Constraints on UNPREDICTABLE behaviors](#).

Assembler syntax

UQSUB8{<c>}{<q>} {<Rd>}, <Rn>, <Rm>

where:

<c>, <q> See [Standard assembler syntax fields on page F2-2415](#).

<Rd> The destination register.

<Rn> The first operand register.

<Rm> The second operand register.

Operation

```
if ConditionPassed() then
    EncodingSpecificOperations();
    diff1 = UInt(R[n]<7:0>) - UInt(R[m]<7:0>);
    diff2 = UInt(R[n]<15:8>) - UInt(R[m]<15:8>);
    diff3 = UInt(R[n]<23:16>) - UInt(R[m]<23:16>);
    diff4 = UInt(R[n]<31:24>) - UInt(R[m]<31:24>);
    R[d]<7:0> = UnsignedSat(diff1, 8);
    R[d]<15:8> = UnsignedSat(diff2, 8);
    R[d]<23:16> = UnsignedSat(diff3, 8);
    R[d]<31:24> = UnsignedSat(diff4, 8);
```

F7.1.275 UQSUB16

Unsigned Saturating Subtract 16 performs two unsigned 16-bit integer subtractions, saturates the results to the 16-bit unsigned integer range $0 \leq x \leq 2^{16} - 1$, and writes the results to the destination register.

Encoding T1 ARMv6T2, ARMv7
 UQSUB16<c> <Rd>, <Rn>, <Rm>

15	14	13	12	11	10	9	8	7	6	5	4	3	2	1	0	15	14	13	12	11	10	9	8	7	6	5	4	3	2	1	0
1	1	1	1	1	0	1	0	1	1	0	1	Rn				1	1	1	1	Rd				0	1	0	1	Rm			

d = UInt(Rd); n = UInt(Rn); m = UInt(Rm);
 if d == 15 || n == 15 || m == 15 then UNPREDICTABLE; // ARMv8-A removes UNPREDICTABLE for R13

Encoding A1 ARMv6*, ARMv7
 UQSUB16<c> <Rd>, <Rn>, <Rm>

31	30	29	28	27	26	25	24	23	22	21	20	19	18	17	16	15	14	13	12	11	10	9	8	7	6	5	4	3	2	1	0
cond		0	1	1	0	0	1	1	0	Rn				Rd				(1)	(1)	(1)	(1)	0	1	1	1	Rm					

d = UInt(Rd); n = UInt(Rn); m = UInt(Rm);
 if d == 15 || n == 15 || m == 15 then UNPREDICTABLE;

For information about the CONSTRAINED UNPREDICTABLE behavior of this instruction, see [Appendix A Architectural Constraints on UNPREDICTABLE behaviors](#).

Assembler syntax

UQSUB16{<c>}{<q>} {<Rd>}, <Rn>, <Rm>

where:

<c>, <q> See [Standard assembler syntax fields on page F2-2415](#).

<Rd> The destination register.

<Rn> The first operand register.

<Rm> The second operand register.

Operation

```
if ConditionPassed() then
    EncodingSpecificOperations();
    diff1 = UInt(R[n]<15:0>) - UInt(R[m]<15:0>);
    diff2 = UInt(R[n]<31:16>) - UInt(R[m]<31:16>);
    R[d]<15:0> = UnsignedSat(diff1, 16);
    R[d]<31:16> = UnsignedSat(diff2, 16);
```

F7.1.276 USAD8

Unsigned Sum of Absolute Differences performs four unsigned 8-bit subtractions, and adds the absolute values of the differences together.

Encoding T1 ARMv6T2, ARMv7

USAD8<c> <Rd>, <Rn>, <Rm>

15	14	13	12	11	10	9	8	7	6	5	4	3	2	1	0	15	14	13	12	11	10	9	8	7	6	5	4	3	2	1	0
1	1	1	1	1	0	1	1	0	1	1	1	Rn			1	1	1	1	Rd			0	0	0	0	Rm					

d = UInt(Rd); n = UInt(Rn); m = UInt(Rm);
 if d == 15 || n == 15 || m == 15 then UNPREDICTABLE; // ARMv8-A removes UNPREDICTABLE for R13

Encoding A1 ARMv6*, ARMv7

USAD8<c> <Rd>, <Rn>, <Rm>

31	30	29	28	27	26	25	24	23	22	21	20	19	18	17	16	15	14	13	12	11	10	9	8	7	6	5	4	3	2	1	0
cond		0	1	1	1	1	0	0	0	Rd			1	1	1	1	Rm			0	0	0	1	Rn							

d = UInt(Rd); n = UInt(Rn); m = UInt(Rm);
 if d == 15 || n == 15 || m == 15 then UNPREDICTABLE;

For information about the CONSTRAINED UNPREDICTABLE behavior of this instruction, see [Appendix A Architectural Constraints on UNPREDICTABLE behaviors](#).

Assembler syntax

USAD8{<c>}{<q>} {<Rd>}, <Rn>, <Rm>

where:

<c>, <q> See [Standard assembler syntax fields on page F2-2415](#).

<Rd> The destination register.

<Rn> The first operand register.

<Rm> The second operand register.

Operation

```
if ConditionPassed() then
    EncodingSpecificOperations();
    absdiff1 = Abs(UInt(R[n]<7:0>) - UInt(R[m]<7:0>));
    absdiff2 = Abs(UInt(R[n]<15:8>) - UInt(R[m]<15:8>));
    absdiff3 = Abs(UInt(R[n]<23:16>) - UInt(R[m]<23:16>));
    absdiff4 = Abs(UInt(R[n]<31:24>) - UInt(R[m]<31:24>));
    result = absdiff1 + absdiff2 + absdiff3 + absdiff4;
    R[d] = result<31:0>;
```

F7.1.277 USADA8

Unsigned Sum of Absolute Differences and Accumulate performs four unsigned 8-bit subtractions, and adds the absolute values of the differences to a 32-bit accumulate operand.

Encoding T1 ARMv6T2, ARMv7

USADA8<c> <Rd>, <Rn>, <Rm>, <Ra>

15	14	13	12	11	10	9	8	7	6	5	4	3	2	1	0	15	14	13	12	11	10	9	8	7	6	5	4	3	2	1	0
1	1	1	1	1	0	1	1	0	1	1	1	Rn				Ra				Rd				0 0 0 0				Rm			

if Ra == '1111' then SEE USAD8;
 d = UInt(Rd); n = UInt(Rn); m = UInt(Rm); a = UInt(Ra);
 if d == 15 || n == 15 || m == 15 then UNPREDICTABLE; // ARMv8-A removes UNPREDICTABLE for R13

Encoding A1 ARMv6*, ARMv7

USADA8<c> <Rd>, <Rn>, <Rm>, <Ra>

31	30	29	28	27	26	25	24	23	22	21	20	19	18	17	16	15	14	13	12	11	10	9	8	7	6	5	4	3	2	1	0
cond		0 1 1 1 1 0 0 0				Rd				Ra				Rm				0 0 0 1				Rn									

if Ra == '1111' then SEE USAD8;
 d = UInt(Rd); n = UInt(Rn); m = UInt(Rm); a = UInt(Ra);
 if d == 15 || n == 15 || m == 15 then UNPREDICTABLE;

For information about the CONSTRAINED UNPREDICTABLE behavior of this instruction, see [Appendix A Architectural Constraints on UNPREDICTABLE behaviors](#).

Assembler syntax

USADA8{<c>}{<q>} <Rd>, <Rn>, <Rm>, <Ra>

where:

- <c>, <q> See [Standard assembler syntax fields on page F2-2415](#).
- <Rd> The destination register.
- <Rn> The first operand register.
- <Rm> The second operand register.
- <Ra> The register that contains the accumulation value.

Operation

```
if ConditionPassed() then
    EncodingSpecificOperations();
    absdiff1 = Abs(UInt(R[n]<7:0>) - UInt(R[m]<7:0>));
    absdiff2 = Abs(UInt(R[n]<15:8>) - UInt(R[m]<15:8>));
    absdiff3 = Abs(UInt(R[n]<23:16>) - UInt(R[m]<23:16>));
    absdiff4 = Abs(UInt(R[n]<31:24>) - UInt(R[m]<31:24>));
    result = UInt(R[a]) + absdiff1 + absdiff2 + absdiff3 + absdiff4;
    R[d] = result<31:0>;
```

F7.1.278 USAT

Unsigned Saturate saturates an optionally-shifted signed value to a selected unsigned range.

The Q flag is set if the operation saturates.

Encoding T1 ARMv6T2, ARMv7

USAT<c> <Rd>, #<imm5>, <Rn>{, <shift>}

15	14	13	12	11	10	9	8	7	6	5	4	3	2	1	0	15	14	13	12	11	10	9	8	7	6	5	4	3	2	1	0
1	1	1	1	0	(0)	1	1	1	0	sh	0	Rn				0	imm3			Rd			imm2	(0)	sat_imm						

```

if sh == '1' && (imm3:imm2) == '0000' then SEE USAT16;
d = UInt(Rd); n = UInt(Rn); saturate_to = UInt(sat_imm);
(shift_t, shift_n) = DecodeImmShift(sh:'0', imm3:imm2);
if d == 15 || n == 15 then UNPREDICTABLE; // ARMv8-A removes UNPREDICTABLE for R13
    
```

Encoding A1 ARMv6*, ARMv7

USAT<c> <Rd>, #<imm5>, <Rn>{, <shift>}

31	30	29	28	27	26	25	24	23	22	21	20	19	18	17	16	15	14	13	12	11	10	9	8	7	6	5	4	3	2	1	0
cond		0	1	1	0	1	1	1	sat_imm			Rd			imm5			sh	0	1	Rn										

```

d = UInt(Rd); n = UInt(Rn); saturate_to = UInt(sat_imm);
(shift_t, shift_n) = DecodeImmShift(sh:'0', imm5);
if d == 15 || n == 15 then UNPREDICTABLE;
    
```

For information about the CONSTRAINED UNPREDICTABLE behavior of this instruction, see [Appendix A Architectural Constraints on UNPREDICTABLE behaviors](#).

Assembler syntax

USAT{<c>}{<q>} <Rd>, #<imm>, <Rn> {, <shift>}

where:

- <c>, <q> See [Standard assembler syntax fields on page F2-2415](#).
- <Rd> The destination register.
- <imm> The bit position for saturation, in the range 0 to 31. This is encoded directly in the sat_imm field of the instruction, meaning sat_imm takes the value of <imm>.
- <Rn> The register that contains the value to be saturated.
- <shift> The optional shift, encoded in the sh bit and the immsh field, where immsh is:
- imm3:imm2 for encoding T1.
 - imm5 for encoding A1.
- <shift> must be one of:
- omitted** No shift. Encoded as sh = 0, immsh = 0b00000.
- LSL #<n> Left shift by <n> bits, with <n> in the range 1-31.
Encoded as sh = 0, immsh = <n>.
- ASR #<n> Arithmetic right shift by <n> bits, with <n> in the range 1-31.
Encoded as sh = 1, immsh = <n>.
- ASR #32 Arithmetic right shift by 32 bits, permitted only for encoding A1.
Encoded as sh = 1, immsh = 0b00000.

Note

An assembler can permit ASR #0 or LSL #0 to mean the same thing as omitting the shift, but this is not standard UAL and must not be used for disassembly.

Operation

```
if ConditionPassed() then
    EncodingSpecificOperations();
    operand = Shift(R[n], shift_t, shift_n, APSR.C); // APSR.C ignored
    (result, sat) = UnsignedSatQ(SInt(operand), saturate_to);
    R[d] = ZeroExtend(result, 32);
    if sat then
        APSR.Q = '1';
```

F7.1.279 USAT16

Unsigned Saturate 16 saturates two signed 16-bit values to a selected unsigned range.

The Q flag is set if the operation saturates.

Encoding T1 ARMv6T2, ARMv7

USAT16<c> <Rd>, #<imm4>, <Rn>

15	14	13	12	11	10	9	8	7	6	5	4	3	2	1	0	15	14	13	12	11	10	9	8	7	6	5	4	3	2	1	0
1	1	1	1	0	(0)	1	1	1	0	1	0		Rn			0	0	0	0		Rd		0	0	(0)	(0)	sat_imm				

d = UInt(Rd); n = UInt(Rn); saturate_to = UInt(sat_imm);
 if d == 15 || n == 15 then UNPREDICTABLE; // ARMv8-A removes UNPREDICTABLE for R13

Encoding A1 ARMv6*, ARMv7

USAT16<c> <Rd>, #<imm4>, <Rn>

31	30	29	28	27	26	25	24	23	22	21	20	19	18	17	16	15	14	13	12	11	10	9	8	7	6	5	4	3	2	1	0
cond		0	1	1	0	1	1	1	0	sat_imm		Rd			(1)	(1)	(1)	(1)	0	0	1	1	Rn								

d = UInt(Rd); n = UInt(Rn); saturate_to = UInt(sat_imm);
 if d == 15 || n == 15 then UNPREDICTABLE;

For information about the CONSTRAINED UNPREDICTABLE behavior of this instruction, see [Appendix A Architectural Constraints on UNPREDICTABLE behaviors](#).

Assembler syntax

USAT16{<c>}{<q>} <Rd>, #<imm>, <Rn>

where:

- <c>, <q> See [Standard assembler syntax fields on page F2-2415](#).
- <Rd> The destination register.
- <imm> The bit position for saturation, in the range 0 to 15. This is encoded directly in the sat_imm field of the instruction, meaning sat_imm takes the value of <imm>.
- <Rn> The register that contains the values to be saturated.

Operation

```
if ConditionPassed() then
    EncodingSpecificOperations();
    (result1, sat1) = UnsignedSatQ(SInt(R[n]<15:0>), saturate_to);
    (result2, sat2) = UnsignedSatQ(SInt(R[n]<31:16>), saturate_to);
    R[d]<15:0> = ZeroExtend(result1, 16);
    R[d]<31:16> = ZeroExtend(result2, 16);
    if sat1 || sat2 then
        APSR.Q = '1';
```

F7.1.280 USAX

Unsigned Subtract and Add with Exchange exchanges the two halfwords of the second operand, performs one unsigned 16-bit integer subtraction and one unsigned 16-bit addition, and writes the results to the destination register. It sets the APSR.GE bits according to the results.

Encoding T1 ARMv6T2, ARMv7

USAX<c> <Rd>, <Rn>, <Rm>

15	14	13	12	11	10	9	8	7	6	5	4	3	2	1	0	15	14	13	12	11	10	9	8	7	6	5	4	3	2	1	0
1	1	1	1	1	0	1	0	1	1	1	0	Rn				1	1	1	1	Rd				0	1	0	0	Rm			

d = UInt(Rd); n = UInt(Rn); m = UInt(Rm);
 if d == 15 || n == 15 || m == 15 then UNPREDICTABLE; // ARMv8-A removes UNPREDICTABLE for R13

Encoding A1 ARMv6*, ARMv7

USAX<c> <Rd>, <Rn>, <Rm>

31	30	29	28	27	26	25	24	23	22	21	20	19	18	17	16	15	14	13	12	11	10	9	8	7	6	5	4	3	2	1	0		
cond		0	1	1	0	0	1	0	1	Rn				Rd				(1)	(1)	(1)	(1)	0	1	0	1	Rm							

d = UInt(Rd); n = UInt(Rn); m = UInt(Rm);
 if d == 15 || n == 15 || m == 15 then UNPREDICTABLE;

For information about the CONSTRAINED UNPREDICTABLE behavior of this instruction, see [Appendix A Architectural Constraints on UNPREDICTABLE behaviors](#).

Assembler syntax

USAX{<c>}{<q>} {<Rd>}, <Rn>, <Rm>

where:

<c>, <q> See [Standard assembler syntax fields on page F2-2415](#).

<Rd> The destination register.

<Rn> The first operand register.

<Rm> The second operand register.

The pre-UAL syntax USUBADDX<c> is equivalent to USAX<c>.

Operation

```
if ConditionPassed() then
    EncodingSpecificOperations();
    sum = UInt(R[n]<15:0>) + UInt(R[m]<31:16>);
    diff = UInt(R[n]<31:16>) - UInt(R[m]<15:0>);
    R[d]<15:0> = sum<15:0>;
    R[d]<31:16> = diff<15:0>;
    APSR.GE<1:0> = if sum >= 0x10000 then '11' else '00';
    APSR.GE<3:2> = if diff >= 0 then '11' else '00';
```

F7.1.281 USUB8

Unsigned Subtract 8 performs four 8-bit unsigned integer subtractions, and writes the results to the destination register. It sets the APSR.GE bits according to the results of the subtractions.

Encoding T1 ARMv6T2, ARMv7

USUB8<c> <Rd>, <Rn>, <Rm>

15	14	13	12	11	10	9	8	7	6	5	4	3	2	1	0	15	14	13	12	11	10	9	8	7	6	5	4	3	2	1	0
1	1	1	1	1	0	1	0	1	1	0	0	Rn			1	1	1	1	Rd			0	1	0	0	Rm					

d = UInt(Rd); n = UInt(Rn); m = UInt(Rm);
 if d == 15 || n == 15 || m == 15 then UNPREDICTABLE; // ARMv8-A removes UNPREDICTABLE for R13

Encoding A1 ARMv6*, ARMv7

USUB8<c> <Rd>, <Rn>, <Rm>

31	30	29	28	27	26	25	24	23	22	21	20	19	18	17	16	15	14	13	12	11	10	9	8	7	6	5	4	3	2	1	0
cond		0	1	1	0	0	1	0	1	Rn			Rd			(1)	(1)	(1)	(1)	1	1	1	1	Rm							

d = UInt(Rd); n = UInt(Rn); m = UInt(Rm);
 if d == 15 || n == 15 || m == 15 then UNPREDICTABLE;

For information about the CONSTRAINED UNPREDICTABLE behavior of this instruction, see [Appendix A Architectural Constraints on UNPREDICTABLE behaviors](#).

Assembler syntax

USUB8{<c>}{<q>} {<Rd>}, <Rn>, <Rm>

where:

<c>, <q> See [Standard assembler syntax fields on page F2-2415](#).

<Rd> The destination register.

<Rn> The first operand register.

<Rm> The second operand register.

Operation

```
if ConditionPassed() then
    EncodingSpecificOperations();
    diff1 = UInt(R[n]<7:0>) - UInt(R[m]<7:0>);
    diff2 = UInt(R[n]<15:8>) - UInt(R[m]<15:8>);
    diff3 = UInt(R[n]<23:16>) - UInt(R[m]<23:16>);
    diff4 = UInt(R[n]<31:24>) - UInt(R[m]<31:24>);
    R[d]<7:0> = diff1<7:0>;
    R[d]<15:8> = diff2<7:0>;
    R[d]<23:16> = diff3<7:0>;
    R[d]<31:24> = diff4<7:0>;
    APSR.GE<0> = if diff1 >= 0 then '1' else '0';
    APSR.GE<1> = if diff2 >= 0 then '1' else '0';
    APSR.GE<2> = if diff3 >= 0 then '1' else '0';
    APSR.GE<3> = if diff4 >= 0 then '1' else '0';
```

F7.1.282 USUB16

Unsigned Subtract 16 performs two 16-bit unsigned integer subtractions, and writes the results to the destination register. It sets the APSR.GE bits according to the results of the subtractions.

Encoding T1 ARMv6T2, ARMv7

USUB16<c> <Rd>, <Rn>, <Rm>

15	14	13	12	11	10	9	8	7	6	5	4	3	2	1	0	15	14	13	12	11	10	9	8	7	6	5	4	3	2	1	0
1	1	1	1	1	0	1	0	1	1	0	1	Rn			1	1	1	1	Rd			0	1	0	0	Rm					

d = UInt(Rd); n = UInt(Rn); m = UInt(Rm);
 if d == 15 || n == 15 || m == 15 then UNPREDICTABLE; // ARMv8-A removes UNPREDICTABLE for R13

Encoding A1 ARMv6*, ARMv7

USUB16<c> <Rd>, <Rn>, <Rm>

31	30	29	28	27	26	25	24	23	22	21	20	19	18	17	16	15	14	13	12	11	10	9	8	7	6	5	4	3	2	1	0
cond		0	1	1	0	0	1	0	1	Rn			Rd			(1)	(1)	(1)	(1)	0	1	1	1	Rm							

d = UInt(Rd); n = UInt(Rn); m = UInt(Rm);
 if d == 15 || n == 15 || m == 15 then UNPREDICTABLE;

For information about the CONSTRAINED UNPREDICTABLE behavior of this instruction, see [Appendix A Architectural Constraints on UNPREDICTABLE behaviors](#).

Assembler syntax

USUB16{<c>}{<q>} {<Rd>}, <Rn>, <Rm>

where:

<c>, <q> See [Standard assembler syntax fields on page F2-2415](#).

<Rd> The destination register.

<Rn> The first operand register.

<Rm> The second operand register.

Operation

```
if ConditionPassed() then
    EncodingSpecificOperations();
    diff1 = UInt(R[n]<15:0>) - UInt(R[m]<15:0>);
    diff2 = UInt(R[n]<31:16>) - UInt(R[m]<31:16>);
    R[d]<15:0> = diff1<15:0>;
    R[d]<31:16> = diff2<15:0>;
    APSR.GE<1:0> = if diff1 >= 0 then '11' else '00';
    APSR.GE<3:2> = if diff2 >= 0 then '11' else '00';
```

F7.1.283 UXTAB

Unsigned Extend and Add Byte extracts an 8-bit value from a register, zero-extends it to 32 bits, adds the result to the value in another register, and writes the final result to the destination register. The instruction can specify a rotation by 0, 8, 16, or 24 bits before extracting the 8-bit value.

Encoding T1 ARMv6T2, ARMv7
 UXTAB<c> <Rd>, <Rn>, <Rm>{, <rotation>}

15	14	13	12	11	10	9	8	7	6	5	4	3	2	1	0	15	14	13	12	11	10	9	8	7	6	5	4	3	2	1	0
1	1	1	1	1	0	1	0	0	1	0	1	Rn				1	1	1	1	Rd				1	(0)	rotate	Rm				

if Rn == '1111' then SEE UXTB;
 d = UInt(Rd); n = UInt(Rn); m = UInt(Rm); rotation = UInt(rotate:'000');
 if d == 15 || m == 15 then UNPREDICTABLE; // ARMv8-A removes UNPREDICTABLE for R13

Encoding A1 ARMv6*, ARMv7
 UXTAB<c> <Rd>, <Rn>, <Rm>{, <rotation>}

31	30	29	28	27	26	25	24	23	22	21	20	19	18	17	16	15	14	13	12	11	10	9	8	7	6	5	4	3	2	1	0
cond		0	1	1	0	1	1	1	0	Rn				Rd				rotate	(0)	(0)	0	1	1	1	Rm						

if Rn == '1111' then SEE UXTB;
 d = UInt(Rd); n = UInt(Rn); m = UInt(Rm); rotation = UInt(rotate:'000');
 if d == 15 || m == 15 then UNPREDICTABLE;

For information about the CONSTRAINED UNPREDICTABLE behavior of this instruction, see [Appendix A Architectural Constraints on UNPREDICTABLE behaviors](#).

Assembler syntax

UXTAB{<c>}{<q>} {<Rd>}, <Rn>, <Rm> {, <rotation>}

where:

<c>, <q> See [Standard assembler syntax fields on page F2-2415](#).

<Rd> The destination register.

<Rn> The first operand register.

<Rm> The second operand register.

<rotation> This can be any one of:

omitted Encoded as rotate = 0b00.

ROR #8 Encoded as rotate = 0b01.

ROR #16 Encoded as rotate = 0b10.

ROR #24 Encoded as rotate = 0b11.

———— **Note** —————

An assembler can permit ROR #0 to mean the same thing as omitting the rotation, possibly with restrictions on the permitted encodings, but this is not standard UAL and must not be used for disassembly.

Operation

```
if ConditionPassed() then
    EncodingSpecificOperations();
    rotated = ROR(R[m], rotation);
    R[d] = R[n] + ZeroExtend(rotated<7:0>, 32);
```

F7.1.284 UXTAB16

Unsigned Extend and Add Byte 16 extracts two 8-bit values from a register, zero-extends them to 16 bits each, adds the results to two 16-bit values from another register, and writes the final results to the destination register. The instruction can specify a rotation by 0, 8, 16, or 24 bits before extracting the 8-bit values.

Encoding T1 ARMv6T2, ARMv7
 UXTAB16<c> <Rd>, <Rn>, <Rm>{, <rotation>}

15	14	13	12	11	10	9	8	7	6	5	4	3	2	1	0	15	14	13	12	11	10	9	8	7	6	5	4	3	2	1	0
1	1	1	1	1	0	1	0	0	0	1	1	Rd				1	1	1	1	Rd				1	(0)	rotate	Rm				

if Rn == '1111' then SEE UXTB16;
 d = UInt(Rd); n = UInt(Rn); m = UInt(Rm); rotation = UInt(rotate:'000');
 if d == 15 || m == 15 then UNPREDICTABLE; // ARMv8-A removes UNPREDICTABLE for R13

Encoding A1 ARMv6*, ARMv7
 UXTAB16<c> <Rd>, <Rn>, <Rm>{, <rotation>}

31	30	29	28	27	26	25	24	23	22	21	20	19	18	17	16	15	14	13	12	11	10	9	8	7	6	5	4	3	2	1	0
cond		0	1	1	0	1	1	0	0	Rn				Rd				rotate	(0)	(0)	0	1	1	1	Rm						

if Rn == '1111' then SEE UXTB16;
 d = UInt(Rd); n = UInt(Rn); m = UInt(Rm); rotation = UInt(rotate:'000');
 if d == 15 || m == 15 then UNPREDICTABLE;

For information about the CONSTRAINED UNPREDICTABLE behavior of this instruction, see [Appendix A Architectural Constraints on UNPREDICTABLE behaviors](#).

Assembler syntax

UXTAB16{<c>}{<q>} {<Rd>}, <Rn>, <Rm> {, <rotation>}

where:

<c>, <q> See [Standard assembler syntax fields on page F2-2415](#).

<Rd> The destination register.

<Rn> The first operand register.

<Rm> The second operand register.

<rotation> This can be any one of:

omitted Encoded as rotate = 0b00.

ROR #8 Encoded as rotate = 0b01.

ROR #16 Encoded as rotate = 0b10.

ROR #24 Encoded as rotate = 0b11.

———— Note ————

An assembler can permit ROR #0 to mean the same thing as omitting the rotation, possibly with restrictions on the permitted encodings, but this is not standard UAL and must not be used for disassembly.

Operation

```
if ConditionPassed() then
    EncodingSpecificOperations();
    rotated = ROR(R[m], rotation);
    R[d]<15:0> = R[n]<15:0> + ZeroExtend(rotated<7:0>, 16);
    R[d]<31:16> = R[n]<31:16> + ZeroExtend(rotated<23:16>, 16);
```

F7.1.285 UXTAH

Unsigned Extend and Add Halfword extracts a 16-bit value from a register, zero-extends it to 32 bits, adds the result to a value from another register, and writes the final result to the destination register. The instruction can specify a rotation by 0, 8, 16, or 24 bits before extracting the 16-bit value.

Encoding T1 ARMv6T2, ARMv7
 UXTAH<c> <Rd>, <Rn>, <Rm>{, <rotation>}

15	14	13	12	11	10	9	8	7	6	5	4	3	2	1	0	15	14	13	12	11	10	9	8	7	6	5	4	3	2	1	0
1	1	1	1	1	0	1	0	0	0	0	1	Rn				1	1	1	1	Rd				1	(0)	rotate	Rm				

if Rn == '1111' then SEE UXTH;
 d = UInt(Rd); n = UInt(Rn); m = UInt(Rm); rotation = UInt(rotate:'000');
 if d == 15 || m == 15 then UNPREDICTABLE; // ARMv8-A removes UNPREDICTABLE for R13

Encoding A1 ARMv6*, ARMv7
 UXTAH<c> <Rd>, <Rn>, <Rm>{, <rotation>}

31	30	29	28	27	26	25	24	23	22	21	20	19	18	17	16	15	14	13	12	11	10	9	8	7	6	5	4	3	2	1	0
cond		0	1	1	0	1	1	1	1	Rn				Rd				rotate	(0)	(0)	0	1	1	1	Rm						

if Rn == '1111' then SEE UXTH;
 d = UInt(Rd); n = UInt(Rn); m = UInt(Rm); rotation = UInt(rotate:'000');
 if d == 15 || m == 15 then UNPREDICTABLE;

For information about the CONSTRAINED UNPREDICTABLE behavior of this instruction, see [Appendix A Architectural Constraints on UNPREDICTABLE behaviors](#).

Assembler syntax

UXTAH{<c>}{<q>} {<Rd>}, <Rn>, <Rm> {, <rotation>}

where:

<c>, <q> See [Standard assembler syntax fields on page F2-2415](#).

<Rd> The destination register.

<Rn> The first operand register.

<Rm> The second operand register.

<rotation> This can be any one of:

omitted Encoded as rotate = 0b00.

ROR #8 Encoded as rotate = 0b01.

ROR #16 Encoded as rotate = 0b10.

ROR #24 Encoded as rotate = 0b11.

———— **Note** —————

An assembler can permit ROR #0 to mean the same thing as omitting the rotation, possibly with restrictions on the permitted encodings, but this is not standard UAL and must not be used for disassembly.

Operation

```
if ConditionPassed() then
    EncodingSpecificOperations();
    rotated = ROR(R[m], rotation);
    R[d] = R[n] + ZeroExtend(rotated<15:0>, 32);
```

F7.1.286 UXTB

Unsigned Extend Byte extracts an 8-bit value from a register, zero-extends it to 32 bits, and writes the result to the destination register. The instruction can specify a rotation by 0, 8, 16, or 24 bits before extracting the 8-bit value.

Encoding T1 ARMv6*, ARMv7

UXTB<c> <Rd>, <Rm>

15	14	13	12	11	10	9	8	7	6	5	4	3	2	1	0
1	0	1	1	0	0	1	0	1	1	Rm					Rd

d = UInt(Rd); m = UInt(Rm); rotation = 0;

Encoding T2 ARMv6T2, ARMv7

UXTB<c>.W <Rd>, <Rm>{, <rotation>}

15	14	13	12	11	10	9	8	7	6	5	4	3	2	1	0	15	14	13	12	11	10	9	8	7	6	5	4	3	2	1	0
1	1	1	1	1	0	1	0	0	1	0	1	1	1	1	1	1	1	1	1	1	Rd	1	(0)	rotate		Rm					

d = UInt(Rd); m = UInt(Rm); rotation = UInt(rotate:'000');
 if d == 15 || m == 15 then UNPREDICTABLE; // ARMv8-A removes UNPREDICTABLE for R13

Encoding A1 ARMv6*, ARMv7

UXTB<c> <Rd>, <Rm>{, <rotation>}

31	30	29	28	27	26	25	24	23	22	21	20	19	18	17	16	15	14	13	12	11	10	9	8	7	6	5	4	3	2	1	0
cond		0	1	1	0	1	1	1	0	1	1	1	1		Rd		rotate	(0)	(0)	0	1	1	1							Rm	

d = UInt(Rd); m = UInt(Rm); rotation = UInt(rotate:'000');
 if d == 15 || m == 15 then UNPREDICTABLE;

For information about the CONSTRAINED UNPREDICTABLE behavior of this instruction, see [Appendix A Architectural Constraints on UNPREDICTABLE behaviors](#).

Assembler syntax

UXTB{<c>}{<q>} {<Rd>}, <Rm> {, <rotation>}

where:

<c>, <q> See [Standard assembler syntax fields on page F2-2415](#).

<Rd> The destination register.

<Rm> The second operand register.

<rotation> This can be any one of:

omitted Any encoding, encoded as rotate = 0b00 in encoding T2 or A1.

ROR #8 Encoding T2 or A1, encoded as rotate = 0b01.

ROR #16 Encoding T2 or A1, encoded as rotate = 0b10.

ROR #24 Encoding T2 or A1, encoded as rotate = 0b11.

———— Note —————

An assembler can permit ROR #0 to mean the same thing as omitting the rotation, possibly with restrictions on the permitted encodings, but this is not standard UAL and must not be used for disassembly.

The pre-UAL syntax UEXT8<c> is equivalent to UXTB<c>.

Operation

```
if ConditionPassed() then
    EncodingSpecificOperations();
    rotated = ROR(R[m], rotation);
    R[d] = ZeroExtend(rotated<7:0>, 32);
```

F7.1.287 UXTB16

Unsigned Extend Byte 16 extracts two 8-bit values from a register, zero-extends them to 16 bits each, and writes the results to the destination register. The instruction can specify a rotation by 0, 8, 16, or 24 bits before extracting the 8-bit values.

Encoding T1 ARMv6T2, ARMv7

UXTB16<c> <Rd>, <Rm>{, <rotation>}

15	14	13	12	11	10	9	8	7	6	5	4	3	2	1	0	15	14	13	12	11	10	9	8	7	6	5	4	3	2	1	0
1	1	1	1	1	0	1	0	0	0	1	1	1	1	1	1	1	1	1	1		Rd		1	(0)	rotate		Rm				

```
d = UInt(Rd); m = UInt(Rm); rotation = UInt(rotate:'000');
if d == 15 || m == 15 then UNPREDICTABLE; // ARMv8-A removes UNPREDICTABLE for R13
```

Encoding A1 ARMv6*, ARMv7

UXTB16<c> <Rd>, <Rm>{, <rotation>}

31	30	29	28	27	26	25	24	23	22	21	20	19	18	17	16	15	14	13	12	11	10	9	8	7	6	5	4	3	2	1	0
cond		0	1	1	0	1	1	0	0	1	1	1	1		Rd		rotate	(0)	(0)	0	1	1	1		Rm						

```
d = UInt(Rd); m = UInt(Rm); rotation = UInt(rotate:'000');
if d == 15 || m == 15 then UNPREDICTABLE;
```

For information about the CONSTRAINED UNPREDICTABLE behavior of this instruction, see [Appendix A Architectural Constraints on UNPREDICTABLE behaviors](#).

Assembler syntax

UXTB16{<c>}{<q>} {<Rd>}, <Rm> {, <rotation>}

where:

<c>, <q> See [Standard assembler syntax fields on page F2-2415](#).

<Rd> The destination register.

<Rm> The second operand register.

<rotation> This can be any one of:

omitted Encoded as rotate = 0b00.

ROR #8 Encoded as rotate = 0b01.

ROR #16 Encoded as rotate = 0b10.

ROR #24 Encoded as rotate = 0b11.

———— Note —————

An assembler can permit ROR #0 to mean the same thing as omitting the rotation, possibly with restrictions on the permitted encodings, but this is not standard UAL and must not be used for disassembly.

Operation

```
if ConditionPassed() then
    EncodingSpecificOperations();
    rotated = ROR(R[m], rotation);
    R[d]<15:0> = ZeroExtend(rotated<7:0>, 16);
    R[d]<31:16> = ZeroExtend(rotated<23:16>, 16);
```

F7.1.288 UXTH

Unsigned Extend Halfword extracts a 16-bit value from a register, zero-extends it to 32 bits, and writes the result to the destination register. The instruction can specify a rotation by 0, 8, 16, or 24 bits before extracting the 16-bit value.

Encoding T1 ARMv6*, ARMv7

UXTH<c> <Rd>, <Rm>

15	14	13	12	11	10	9	8	7	6	5	4	3	2	1	0
1	0	1	1	0	0	1	0	1	0	Rm			Rd		

d = UInt(Rd); m = UInt(Rm); rotation = 0;

Encoding T2 ARMv6T2, ARMv7

UXTH<c>.W <Rd>, <Rm>{, <rotation>}

15	14	13	12	11	10	9	8	7	6	5	4	3	2	1	0	15	14	13	12	11	10	9	8	7	6	5	4	3	2	1	0
1	1	1	1	1	0	1	0	0	0	0	1	1	1	1	1	1	1	1	1	Rd			1	(0)	rotate	Rm					

d = UInt(Rd); m = UInt(Rm); rotation = UInt(rotate:'000');
 if d == 15 || m == 15 then UNPREDICTABLE; // ARMv8-A removes UNPREDICTABLE for R13

Encoding A1 ARMv6*, ARMv7

UXTH<c> <Rd>, <Rm>{, <rotation>}

31	30	29	28	27	26	25	24	23	22	21	20	19	18	17	16	15	14	13	12	11	10	9	8	7	6	5	4	3	2	1	0
cond		0	1	1	0	1	1	1	1	1	1	1	1	1	Rd			rotate	(0)	(0)	0	1	1	1	Rm						

d = UInt(Rd); m = UInt(Rm); rotation = UInt(rotate:'000');
 if d == 15 || m == 15 then UNPREDICTABLE;

For information about the CONSTRAINED UNPREDICTABLE behavior of this instruction, see [Appendix A Architectural Constraints on UNPREDICTABLE behaviors](#).

Assembler syntax

UXTH{<c>}{<q>} {<Rd>}, <Rm> {, <rotation>}

where:

<c>, <q> See [Standard assembler syntax fields on page F2-2415](#).

<Rd> The destination register.

<Rm> The second operand register.

<rotation> This can be any one of:

omitted Any encoding, encoded as rotate = 0b00 in encoding T2 or A1.

ROR #8 Encoding T2 or A1, encoded as rotate = 0b01.

ROR #16 Encoding T2 or A1, encoded as rotate = 0b10.

ROR #24 Encoding T2 or A1, encoded as rotate = 0b11.

———— **Note** —————

An assembler can permit ROR #0 to mean the same thing as omitting the rotation, possibly with restrictions on the permitted encodings, but this is not standard UAL and must not be used for disassembly.

The pre-UAL syntax UEXT16<c> is equivalent to UXTH<c>.

Operation

```
if ConditionPassed() then
    EncodingSpecificOperations();
    rotated = ROR(R[m], rotation);
    R[d] = ZeroExtend(rotated<15:0>, 32);
```

F7.1.289 WFE

Wait For Event is a hint instruction that permits the PE to enter a low-power state until one of a number of events occurs, including events signaled by executing the SEV instruction on any PE in the multiprocessor system. For more information, see [Wait For Event and Send Event](#) on page G1-3460.

In an implementation that includes EL2, if HCR.TWE is set to 1, execution of a WFE instruction in a Non-secure mode other than Hyp mode generates a Hyp Trap exception if, ignoring the value of the HCR.TWE bit, conditions permit the suspension of execution by the PE. For more information see [Trapping use of the WFI and WFE instructions](#) on page G1-3511.

Encoding T1 ARMv7 (executes as NOP in ARMv6T2)

WFE<c>

15	14	13	12	11	10	9	8	7	6	5	4	3	2	1	0
1	0	1	1	1	1	1	1	0	0	1	0	0	0	0	0

// No additional decoding required

Encoding T2 ARMv7 (executes as NOP in ARMv6T2)

WFE<c>.W

15	14	13	12	11	10	9	8	7	6	5	4	3	2	1	0	15	14	13	12	11	10	9	8	7	6	5	4	3	2	1	0
1	1	1	1	0	0	1	1	1	0	1	0	(1)	(1)	(1)	(1)	1	0	(0)	0	(0)	0	0	0	0	0	0	0	1	0		

// No additional decoding required

Encoding A1 ARMv6K, ARMv7 (executes as NOP in ARMv6T2)

WFE<c>

31	30	29	28	27	26	25	24	23	22	21	20	19	18	17	16	15	14	13	12	11	10	9	8	7	6	5	4	3	2	1	0
cond		0	0	1	1	0	0	1	0	0	0	0	0	(1)	(1)	(1)	(1)	(0)	(0)	(0)	(0)	0	0	0	0	0	0	0	1	0	

// No additional decoding required

For information about the CONSTRAINED UNPREDICTABLE behavior of this instruction, see [Appendix A Architectural Constraints on UNPREDICTABLE behaviors](#).

Assembler syntax

WFE{<c>}{<q>}

where:

<c>, <q> See [Standard assembler syntax fields on page F2-2415](#).

Operation

```
if ConditionPassed() then
    EncodingSpecificOperations();
    if EventRegistered() then
        ClearEventRegister();
    else
        if PSTATE.EL == EL0 && SCTLR.nTWE == '0' then
            AArch32.WFxTrap(EL1, TRUE);
        elsif HaveEL(EL2) && !IsSecure() && PSTATE.EL != EL2 && HCR.TWE == '1' then
            AArch32.WFxTrap(EL2, TRUE);
        elsif HaveEL(EL3) && !ELUsingAArch32(EL3) && SCR_EL3.TWE == '1' then
            AArch64.WFxTrap(EL3, TRUE);
        else
            WaitForEvent();
```

F7.1.290 WFI

Wait For Interrupt is a hint instruction that permits the PE to enter a low-power state until one of a number of asynchronous events occurs. For more information, see [Wait For Interrupt](#) on page G1-3463.

In an implementation that includes EL2, if HCR.TWI is set to 1, execution of a WFI instruction in a Non-secure mode other than Hyp mode generates a Hyp Trap exception if, ignoring the value of the HCR.TWI bit, conditions permit the suspension of execution by the PE. For more information see [Trapping use of the WFI and WFE instructions](#) on page G1-3511.

Encoding T1 ARMv7 (executes as NOP in ARMv6T2)

WFI<C>

15	14	13	12	11	10	9	8	7	6	5	4	3	2	1	0
1	0	1	1	1	1	1	1	0	0	1	1	0	0	0	0

// No additional decoding required

Encoding T2 ARMv7 (executes as NOP in ARMv6T2)

WFI<C>.W

15	14	13	12	11	10	9	8	7	6	5	4	3	2	1	0	15	14	13	12	11	10	9	8	7	6	5	4	3	2	1	0
1	1	1	1	0	0	1	1	1	0	1	0	(1)	(1)	(1)	(1)	1	0	(0)	0	(0)	0	0	0	0	0	0	0	1	1		

// No additional decoding required

Encoding A1 ARMv6K, ARMv7 (executes as NOP in ARMv6T2)

WFI<C>

31	30	29	28	27	26	25	24	23	22	21	20	19	18	17	16	15	14	13	12	11	10	9	8	7	6	5	4	3	2	1	0
cond	0	0	1	1	0	0	1	0	0	0	0	(1)	(1)	(1)	(1)	(0)	(0)	(0)	(0)	0	0	0	0	0	0	0	0	0	1	1	

// No additional decoding required

For information about the CONSTRAINED UNPREDICTABLE behavior of this instruction, see [Appendix A Architectural Constraints on UNPREDICTABLE behaviors](#).

Assembler syntax

WFI{<c>}{<q>}

where:

<c>, <q> See *Standard assembler syntax fields* on page F2-2415.

Operation

```
if ConditionPassed() then
    EncodingSpecificOperations();
    if !InterruptPending() then
        if PSTATE.EL == EL0 && SCTLR.nTWI == '0' then
            AArch32.WFxTrap(EL1, FALSE);
        elsif HaveEL(EL2) && !IsSecure() && PSTATE.EL != EL2 && HCR.TWI == '1' then
            AArch32.WFxTrap(EL2, FALSE);
        elsif HaveEL(EL3) && !ELUsingAArch32(EL3) && SCR_EL3.TWI == '1' then
            AArch64.WFxTrap(EL3, FALSE);
        else
            WaitForInterrupt();
```

F7.1.291 YIELD

YIELD is a hint instruction. Software with a multithreading capability can use a YIELD instruction to indicate to the PE that it is performing a task, for example a spin-lock, that could be swapped out to improve overall system performance. The PE can use this hint to suspend and resume multiple software threads if it supports the capability.

For more information about the recommended use of this instruction see [The Yield instruction on page F1-2395](#).

Encoding T1 ARMv7 (executes as NOP in ARMv6T2)

YIELD<c>

15	14	13	12	11	10	9	8	7	6	5	4	3	2	1	0
1	0	1	1	1	1	1	1	0	0	0	1	0	0	0	0

// No additional decoding required

Encoding T2 ARMv7 (executes as NOP in ARMv6T2)

YIELD<c>.W

15	14	13	12	11	10	9	8	7	6	5	4	3	2	1	0	15	14	13	12	11	10	9	8	7	6	5	4	3	2	1	0
1	1	1	1	0	0	1	1	1	0	1	0	(1)	(1)	(1)	(1)	1	0	(0)	0	(0)	0	0	0	0	0	0	0	0	1		

// No additional decoding required

Encoding A1 ARMv6K, ARMv7 (executes as NOP in ARMv6T2)

YIELD<c>

31	30	29	28	27	26	25	24	23	22	21	20	19	18	17	16	15	14	13	12	11	10	9	8	7	6	5	4	3	2	1	0	
cond				0	0	1	1	0	0	1	0	0	0	0	0	(1)	(1)	(1)	(1)	(0)	(0)	(0)	(0)	0	0	0	0	0	0	0	0	1

// No additional decoding required

For information about the CONSTRAINED UNPREDICTABLE behavior of this instruction, see [Appendix A Architectural Constraints on UNPREDICTABLE behaviors](#).

Assembler syntax

YIELD{<c>}{<q>}

where:

<c>, <q> See [Standard assembler syntax fields on page F2-2415](#).

Operation

```
if ConditionPassed() then
    EncodingSpecificOperations();
    Hint_Yield();
```

F7.2 General restrictions on system instructions

This section describes some restrictions that apply to a number of System instructions. The descriptions of the individual instructions refer to the following subsections when they apply:

- [Restrictions on exception return instructions](#)
- [Restrictions on updates to the CPSR.M field.](#)

F7.2.1 Restrictions on exception return instructions

A System instruction that is an exception return instruction is UNPREDICTABLE if:

- It is executed in User mode.
- For an exception return instruction other than RFE, it is executed in System mode.
- It is executed in ThumbEE state.
- It attempts to return to Hyp mode and ThumbEE state.
- The [SPSR](#) value it restores to the [CPSR](#) is not permitted because of the restrictions described in [Restrictions on updates to the CPSR.M field.](#)

———— **Note** ————

An exception return instruction that is executed in Hyp mode can set [CPSR.M](#) to a value other than '11010', the value for Hyp mode. However, this does not apply to the following exception return instructions, because the instructions are UNDEFINED in Hyp mode:

- LDM (exception return).
- SUBS PC, LR, #<const> with a nonzero constant.

F7.2.2 Restrictions on updates to the CPSR.M field

A System instruction that updates the [CPSR.M](#) field is UNPREDICTABLE if it attempts to change to a mode that is not accessible from the context in which the instruction is executed. This means that a System instruction is UNPREDICTABLE if it:

- Attempts to change [CPSR.M](#) to a value that does not correspond to a PE mode. [Table G1-2 on page G1-3412](#) shows the values of M that correspond to a PE mode.
- Is executed in Non-secure state and attempts to set [CPSR.M](#) to '10110', the value for Monitor mode.
- Attempts to set [CPSR.M](#) to '11010', the value for Hyp mode, when any of the following applies:
 - It is executed in a Non-secure mode other than Hyp mode.
 - It is executed in a Secure mode other than Monitor mode.
 - It is executed in Monitor mode when [SCR.NS](#) is set to 0.
 - It is executed in Monitor mode and it is not an exception return instruction.
- Is not an exception return instruction, and is executed in Hyp mode, and attempts to set [CPSR.M](#) to a value other than '11010', the value for Hyp mode.

F7.3 Encoding and use of Banked register transfer instructions

Software executing at EL1 or higher can use the MRS (Banked register) and MSR (Banked register) instructions to transfer values between the general-purpose registers and Special registers. One particular use of these instructions is for a hypervisor to save or restore the register values of a Guest OS. The following sections give more information about these instructions:

- [Register arguments in the Banked register transfer instructions.](#)
- [Usage restrictions on the Banked register transfer instructions on page F7-3030.](#)
- [Encoding the register argument in the Banked register transfer instructions on page F7-3031.](#)
- [Pseudocode support for the Banked register transfer instructions on page F7-3032.](#)

For descriptions of the instructions see [MRS \(Banked register\) on page F7-3048](#) and [MSR \(Banked register\) on page F7-3050](#).

F7.3.1 Register arguments in the Banked register transfer instructions

Figure F7-1 shows the Banked general-purpose registers and Special registers:

		Associated mode							
		User or System	Hyp	Supervisor	Abort	Undefined	Monitor	IRQ	FIQ
ARM core registers	R8_usr								R8_fiq
	R9_usr								R9_fiq
	R10_usr								R10_fiq
	R11_usr								R11_fiq
	R12_usr								R12_fiq
	SP_usr	SP_hyp	SP_svc	SP_abt	SP_und	SP_mon	SP_irq	SP_fiq	
LR_usr		LR_svc	LR_abt	LR_und	LR_mon	LR_irq	LR_fiq		
Special registers		SPSR_hyp	SPSR_svc	SPSR_abt	SPSR_und	SPSR_mon	SPSR_irq	SPSR_fiq	
		ELR_hyp							

For the ARM core registers, if no other register is shown, the *current mode register* is the `_usr` register. So, for example, the full set of current mode registers, including the registers that are not banked:

- For Hyp mode, is {R0_usr - R12_usr, SP_hyp, LR_usr, SPSR_hyp, ELR_hyp}.
- For Abort mode, is {R0_usr - R12_usr, SP_abt, LR_abt, SPSR_abt}.

Figure F7-1 Banking of general-purpose registers and Special registers

Figure F7-1 is based on [Figure G1-2 on page G1-3415](#), that shows the complete set of general-purpose registers and Special registers accessible in each mode.

Note

- System mode uses the same set of registers as User mode. Neither of these modes can access an **SPSR**, except that System mode can use the MRS (Banked register) and MSR (Banked register) instructions to access some **SPSRs**, as described in [Usage restrictions on the Banked register transfer instructions on page F7-3030](#).
- General-purpose registers R0-R7, that are not Banked, cannot be accessed using the MRS (Banked register) and MSR (Banked register) instructions.

Software using an MRS (Banked register) or MSR (Banked register) instruction specifies one of these registers using a name shown in [Figure F7-1 on page F7-3029](#), or an alternative name for SP or LR. These registers can be grouped as follows:

R8-R12	Each of these registers has two Banked copies, <code>_usr</code> and <code>_fiq</code> , for example <code>R8_usr</code> and <code>R8_fiq</code> .
SP	There is a Banked copy of SP for every mode except System mode. For example, <code>SP_svc</code> is the SP for Supervisor mode.
LR	There is a Banked copy of LR for every mode except System mode and Hyp mode. For example, <code>LR_svc</code> is the SP for Supervisor mode.
SPSR	There is a Banked copy of SPSR for every mode except System mode and User mode.
ELR_hyp	Except for the operations provided by MRS (Banked register) and MSR (Banked register), ELR_hyp is accessible only from Hyp mode. It is not Banked.

F7.3.2 Usage restrictions on the Banked register transfer instructions

When software uses an MRS (Banked register) or MSR (Banked register) instruction, the current mode determines the permitted values of the register argument. This determination depends on the rules that an MRS (Banked register) or MSR (Banked register) instruction cannot access:

- A register that is not accessible from the current privilege level and security state. This means that, for example:
 - Non-secure software executing at EL1 or EL2 cannot access any Monitor mode registers.
 - Non-secure software executing at EL1 cannot access any Hyp mode registers.
 - except in Monitor mode, Secure software cannot access any Hyp mode registers.
- A register that can be accessed, from the current mode, using a different instruction.

This means that, for each mode, the registers that cannot be accessed are as follows:

Hyp mode The current mode registers `R8_usr-R12_usr`, `SP_hyp`, `LR_usr`, and `SPSR_hyp`.
The Monitor mode registers `SP_mon`, `LR_mon`, and `SPSR_mon`.

Monitor mode The current mode registers `R8_usr-R12_usr`, `SP_mon`, `LR_mon`, and `SPSR_mon`.

FIQ mode The current mode registers `R8_fiq-R12_fiq`, `SP_fiq`, `LR_fiq`, and `SPSR_fiq`.
The Hyp mode registers `SP_hyp`, `SPSR_hyp`, and [ELR_hyp](#).
In Non-secure state, the Monitor mode registers `SP_mon`, `LR_mon`, and `SPSR_mon`.

System mode The current mode registers `R8_usr-R12_usr`, `SP_usr`, and `LR_usr`.
The Hyp mode registers `SP_hyp`, `SPSR_hyp`, and [ELR_hyp](#).
In Non-secure state, the Monitor mode registers `SP_mon`, `LR_mon`, and `SPSR_mon`.

Supervisor mode, Abort mode, Undefined mode, and IRQ mode

The current mode registers `R8_usr-R12_usr`, `SP_<current_mode>`, `LR_<current_mode>`, and `SPSR_<current_mode>`.

The Hyp mode registers `SP_hyp`, `SPSR_hyp`, and [ELR_hyp](#).

In Non-secure state, the Monitor mode registers `SP_mon`, `LR_mon`, and `SPSR_mon`.

User mode MRS (Banked register) and MSR (Banked register) instructions are always UNPREDICTABLE.

In Debug state, the behavior of these instructions is identical to their behavior in Non-debug state.

If software attempts to use an MRS (Banked register) or MSR (Banked register) instruction to access a register from a state from which this section states that the register cannot be accessed, the MRS or MSR instruction is UNPREDICTABLE. For more information, see:

- [Encoding the register argument in the Banked register transfer instructions.](#)
- [Pseudocode support for the Banked register transfer instructions on page F7-3032.](#)
- [MRS \(Banked register\) on page F7-3048.](#)
- [MSR \(Banked register\) on page F7-3050.](#)

———— **Note** —————

UNPREDICTABLE behavior must not give access to registers that are associated with a mode that cannot be entered, from the current mode, using a CPS or MSR instruction.

F7.3.3 Encoding the register argument in the Banked register transfer instructions

The MRS (Banked register) and MSR (Banked register) instructions include a 5-bit field, SYSm, and an R bit, that together encode the register argument for the instruction.

When the R bit is set to 0, the argument is a register other than a Banked copy of the SPSR, and [Table F7-3](#) shows how the SYSm field defines the required register argument.

Table F7-3 Banked register encodings when R==0

		SYSm<4:3>			
SYSm<2:0>	0b00	0b01	0b10	0b11	
0b000	R8_usr	R8_fiq	LR_irq	UNPREDICTABLE	
0b001	R9_usr	R9_fiq	SP_irq	UNPREDICTABLE	
0b010	R10_usr	R10_fiq	LR_svc	UNPREDICTABLE	
0b011	R11_usr	R11_fiq	SP_svc	UNPREDICTABLE	
0b100	R12_usr	R12_fiq	LR_abt	LR_mon	
0b101	SP_usr	SP_fiq	SP_abt	SP_mon	
0b110	LR_usr	LR_fiq	LR_und	ELR_hyp	
0b111	UNPREDICTABLE	UNPREDICTABLE	SP_und	SP_hyp	

When the R bit is set to 1, the argument is a Banked copy of the [SPSR](#), and [Table F7-4](#) shows how the SYSm field defines the required register argument.

Table F7-4 Banked register encodings when R==1

SYSm<2:0>	SYSm<4:3>			
	0b00	0b01	0b10	0b11
0b000	UNPREDICTABLE	UNPREDICTABLE	SPSR_irq	UNPREDICTABLE
0b001	UNPREDICTABLE	UNPREDICTABLE	UNPREDICTABLE	UNPREDICTABLE
0b010	UNPREDICTABLE	UNPREDICTABLE	SPSR_svc	UNPREDICTABLE
0b011	UNPREDICTABLE	UNPREDICTABLE	UNPREDICTABLE	UNPREDICTABLE
0b100	UNPREDICTABLE	UNPREDICTABLE	SPSR_abt	SPSR_mon
0b101	UNPREDICTABLE	UNPREDICTABLE	UNPREDICTABLE	UNPREDICTABLE
0b110	UNPREDICTABLE	SPSR_fiq	SPSR_und	SPSR_hyp
0b111	UNPREDICTABLE	UNPREDICTABLE	UNPREDICTABLE	UNPREDICTABLE

F7.3.4 Pseudocode support for the Banked register transfer instructions

The pseudocode functions `BankedRegisterAccessValid()` and `SPSRAccessValid()` check the validity of MRS (Banked register) and MSR (Banked register) accesses. That is, they filter the accesses that are UNPREDICTABLE either because:

- They attempt to access a register that [Usage restrictions on the Banked register transfer instructions on page F7-3030](#) shows is not accessible.
- They use an SYSm<4:0> encoding that [Encoding the register argument in the Banked register transfer instructions on page F7-3031](#) shows as UNPREDICTABLE.

`BankedRegisterAccessValid()` applies to accesses to the banked general-purpose registers, or to [ELR_hyp](#), and `SPSRAccessValid()` applies to accesses to the [SPSRs](#).

F7.4 Alphabetical list of system instructions

This section lists every instruction that behaves differently when executed at EL1 or higher, or that is only available at EL1 or higher. For more information see [Exception levels on page G1-3401](#).

F7.4.1 CPS (T32)

Change PE State changes one or more of the **CPSR**.{A, I, F} interrupt mask bits and the **CPSR.M** mode field, without changing the other **CPSR** bits.

CPS is treated as NOP if executed in User mode.

CPS is UNPREDICTABLE if it is attempting to change to a mode that is not permitted in the context in which it is executed, see [Restrictions on updates to the CPSR.M field on page F7-3028](#).

Encoding T1 ARMv6*, ARMv7

CPS<effect> <iflags> Not permitted in IT block.

15	14	13	12	11	10	9	8	7	6	5	4	3	2	1	0
1	0	1	1	0	1	1	0	0	1	1	im	(0)	A	I	F

```

if A:I:F == '000' then UNPREDICTABLE;
enable = (im == '0'); disable = (im == '1'); changemode = FALSE;
affectA = (A == '1'); affectI = (I == '1'); affectF = (F == '1');
if InITBlock() then UNPREDICTABLE;
  
```

Encoding T2 ARMv6T2, ARMv7

CPS<effect>.W <iflags>{, #<mode>} Not permitted in IT block.

CPS #<mode> Not permitted in IT block.

15	14	13	12	11	10	9	8	7	6	5	4	3	2	1	0	15	14	13	12	11	10	9	8	7	6	5	4	3	2	1	0
1	1	1	1	0	0	1	1	1	0	1	0	(1)	(1)	(1)	(1)	1	0	(0)	0	(0)	imod	M	A	I	F	mode					

```

if imod == '00' && M == '0' then SEE "Hint instructions";
if mode != '0000' && M == '0' then UNPREDICTABLE;
if (imod<1> == '1' && A:I:F == '000') || (imod<1> == '0' && A:I:F != '000') then UNPREDICTABLE;
enable = (imod == '10'); disable = (imod == '11'); changemode = (M == '1');
affectA = (A == '1'); affectI = (I == '1'); affectF = (F == '1');
if imod == '01' || InITBlock() then UNPREDICTABLE;
  
```

For information about the CONSTRAINED UNPREDICTABLE behavior of this instruction, see [Appendix A Architectural Constraints on UNPREDICTABLE behaviors](#), and particularly [CPS \(T32\) on page AppxA-4754](#).

Hint instructions

In encoding T2, if the **imod** field is '00' and the **M** bit is '0', a hint instruction is encoded. To determine which hint instruction, see [Change Processor State, and hints on page F3-2448](#).

Assembler syntax

```
CPS<effect>{<q>} <iflags> {, #<mode>}
CPS{<q>} #<mode>
```

where:

- <effect> The effect required on the A, I, and F bits in the **CPSR**. This is one of:
- IE Interrupt Enable. This sets the specified bits to 0.
 - ID Interrupt Disable. This sets the specified bits to 1.
- If <effect> is specified, the bits to be affected are specified by <iflags>. The mode can optionally be changed by specifying a mode number as <mode>.
- If <effect> is not specified, then:
- <iflags> is not specified and interrupt settings are not changed.
 - <mode> specifies the new mode number.
- <q> See [Standard assembler syntax fields on page F2-2415](#). A CPS instruction must be unconditional.
- <iflags> Is a sequence of one or more of the following, specifying which interrupt mask bits are affected:
- a Sets the A bit in the instruction, causing the specified effect on **CPSR.A**, the asynchronous abort bit.
 - i Sets the I bit in the instruction, causing the specified effect on **CPSR.I**, the IRQ interrupt bit.
 - f Sets the F bit in the instruction, causing the specified effect on **CPSR.F**, the FIQ interrupt bit.
- <mode> The number of the mode to change to. If this option is omitted, no mode change occurs.

Operation

```
EncodingSpecificOperations();
if CurrentModeIsNotUser() then
  cpsr_val = CPSR;
  if enable then
    if affectA then cpsr_val<8> = '0';
    if affectI then cpsr_val<7> = '0';
    if affectF then cpsr_val<6> = '0';
  if disable then
    if affectA then cpsr_val<8> = '1';
    if affectI then cpsr_val<7> = '1';
    if affectF then cpsr_val<6> = '1';
  if changemode then
    cpsr_val<4:0> = mode;
  // Attempts to change to an illegal mode, or Hyp mode with CPSR.<J,T> = '11'
  // will invoke the Illegal Execution State mechanism
  CPSRWriteByInstr(cpsr_val, '1111', FALSE);
```

F7.4.2 CPS (A32)

Change PE State changes one or more of the **CPSR**.{A, I, F} interrupt mask bits and the **CPSR.M** mode field, without changing the other **CPSR** bits.

CPS is treated as NOP if executed in User mode.

CPS is UNPREDICTABLE if it is attempting to change to a mode that is not permitted in the context in which it is executed, see *Restrictions on updates to the CPSR.M field* on page F7-3028.

Encoding A1 ARMv6*, ARMv7

CPS<effect> <iflags>{, #<mode>}

CPS #<mode>

31	30	29	28	27	26	25	24	23	22	21	20	19	18	17	16	15	14	13	12	11	10	9	8	7	6	5	4	3	2	1	0
1	1	1	1	0	0	0	1	0	0	0	0	imod	M	0	(0)	(0)	(0)	(0)	(0)	(0)	(0)	(0)	A	I	F	0	mode				

```

if mode != '00000' && M == '0' then UNPREDICTABLE;
if (imod<1> == '1' && A:I:F == '000') || (imod<1> == '0' && A:I:F != '000') then UNPREDICTABLE;
enable = (imod == '10'); disable = (imod == '11'); changemode = (M == '1');
affectA = (A == '1'); affectI = (I == '1'); affectF = (F == '1');
if (imod == '00' && M == '0') || imod == '01' then UNPREDICTABLE;
    
```

For information about the CONSTRAINED UNPREDICTABLE behavior of this instruction, see [Appendix A Architectural Constraints on UNPREDICTABLE behaviors](#), and particularly *CPS (A32)* on page AppxA-4754.

Assembler syntax

```
CPS<effect>{<q>} <iflags> {, #<mode>}
CPS{<q>} #<mode>
```

where:

- <effect> The effect required on the A, I, and F bits in the **CPSR**. This is one of:
- IE Interrupt Enable. This sets the specified bits to 0.
 - ID Interrupt Disable. This sets the specified bits to 1.
- If <effect> is specified, the bits to be affected are specified by <iflags>. The mode can optionally be changed by specifying a mode number as <mode>.
- If <effect> is not specified, then:
- <iflags> is not specified and interrupt settings are not changed.
 - <mode> specifies the new mode number.
- <q> See [Standard assembler syntax fields on page F2-2415](#). A CPS instruction must be unconditional.
- <iflags> Is a sequence of one or more of the following, specifying which interrupt mask bits are affected:
- a Sets the A bit in the instruction, causing the specified effect on **CPSR.A**, the asynchronous abort bit.
 - i Sets the I bit in the instruction, causing the specified effect on **CPSR.I**, the IRQ interrupt bit.
 - f Sets the F bit in the instruction, causing the specified effect on **CPSR.F**, the FIQ interrupt bit.
- <mode> The number of the mode to change to. If this option is omitted, no mode change occurs.

Operation

```
EncodingSpecificOperations();
if CurrentModeIsNotUser() then
  cpsr_val = CPSR;
  if enable then
    if affectA then cpsr_val<8> = '0';
    if affectI then cpsr_val<7> = '0';
    if affectF then cpsr_val<6> = '0';
  if disable then
    if affectA then cpsr_val<8> = '1';
    if affectI then cpsr_val<7> = '1';
    if affectF then cpsr_val<6> = '1';
  if changemode then
    cpsr_val<4:0> = mode;
  // Attempts to change to an illegal mode, or Hyp mode with CPSR.<J,T> = '11'
  // will invoke the Illegal Execution State mechanism
  CPSRWriteByInstr(cpsr_val, '1111', FALSE);
```

F7.4.3 ERET

When executed in Hyp mode, Exception Return loads the PC from [ELR_hyp](#) and loads the [CPSR](#) from [SPSR_hyp](#).

When executed in a Secure or Non-secure EL1 mode, ERET behaves as:

- MOV_S PC, LR in the A32 instruction set, see [SUBS PC, LR and related instructions \(A32\) on page F7-3068](#).
- The equivalent SUBS PC, LR, #0 in the T32 instruction set, see [SUBS PC, LR and related instructions \(T32\) on page F7-3066](#).

In Debug state, ERET is decoded as DRPS.

ERET is CONstrained UNPREDICTABLE in the cases described in [Restrictions on exception return instructions on page F7-3028](#).

———— **Note** —————

In an implementation that includes EL2:

- The T1 encoding of ERET is not a new encoding but, is the preferred synonym of SUBS PC, LR, #0 in the T32 instruction set. See [SUBS PC, LR and related instructions \(T32\) on page F7-3066](#) for more information.
- Because ERET is the preferred encoding, when decoding T32 instructions, a disassembler reports an ERET where the original assembler code used SUBS PC, LR, #0.

Encoding T1 ARMv6T2, ARMv7VE, see syntax rows.

SUBS PC, LR, #0 ARMv6T2, ARMv7
 ERET<c> ARMv7VE

15	14	13	12	11	10	9	8	7	6	5	4	3	2	1	0	15	14	13	12	11	10	9	8	7	6	5	4	3	2	1	0
1	1	1	1	0	0	1	1	1	1	0	1	(1)	(1)	(1)	(0)	1	0	(0)	0	(1)	(1)	(1)	(1)	imm8							

if imm8 != '00000000' then SEE SUBS PC, LR and related instructions;
 if InITBlock() && !LastInITBlock() then UNPREDICTABLE;

Encoding A1 ARMv7VE

ERET<c>

31	30	29	28	27	26	25	24	23	22	21	20	19	18	17	16	15	14	13	12	11	10	9	8	7	6	5	4	3	2	1	0
cond		0	0	0	1	0	1	1	0	(0)	(0)	(0)	(0)	(0)	(0)	(0)	(0)	(0)	(0)	(0)	(0)	(0)	(0)	0	1	1	0	(1)	(1)	(1)	(0)

// No additional decoding required

For information about the CONstrained UNPREDICTABLE behavior of this instruction, see [Appendix A Architectural Constraints on UNPREDICTABLE behaviors](#).

Assembler syntax

ERET{<c>}{<q>}

where:

<c>, <q> See *Standard assembler syntax fields* on page F2-2415.

Operation

```
if ConditionPassed() then
    EncodingSpecificOperations();
    if CurrentModeIsUserOrSystem() || CurrentInstrSet() == InstrSet_T32EE then
        UNPREDICTABLE; // UNDEFINED or NOP
    else
        new_pc_value = if CurrentModeIsHyp() then ELR_hyp else R[14];
        AArch32.ExceptionReturn(new_pc_value, SPSR[]);
```

F7.4.4 HVC

Hypervisor Call causes a Hypervisor Call exception. For more information see [Hypervisor Call \(HVC\) exception on page G1-3481](#). Non-secure software executing at EL1 can use this instruction to call the hypervisor to request a service.

The HVC instruction is:

- UNDEFINED in Secure state, and in User mode in Non-secure state.
- When `SCR.HCE` is set to 0, UNDEFINED in Non-secure EL1 modes and CONSTRAINED UNPREDICTABLE in Hyp mode.

On executing an HVC instruction, the `HSR` reports the exception as a Hypervisor Call exception, using the EC value `0x12`, and captures the value of the immediate argument, see [Use of the HSR on page G3-3672](#).

Encoding T1 ARMv7VE

HVC #<imm>

15	14	13	12	11	10	9	8	7	6	5	4	3	2	1	0	15	14	13	12	11	10	9	8	7	6	5	4	3	2	1	0
1	1	1	1	0	1	1	1	1	1	1	0	imm4				1	0	0	0	imm12											

```
// imm16 is for assembly/disassembly. It is reported in the HSR but otherwise is ignored by
// hardware. An HVC handler might interpret imm16, for example to determine the required service.
imm16 = imm4:imm12;
if InITBlock() then UNPREDICTABLE;
```

Encoding A1 ARMv7VE

HVC #<imm>

31	30	29	28	27	26	25	24	23	22	21	20	19	18	17	16	15	14	13	12	11	10	9	8	7	6	5	4	3	2	1	0
cond				0	0	0	1	0	1	0	0	imm12										0	1	1	1	imm4					

```
if cond != '1110' then UNPREDICTABLE;
imm16 = imm12:imm4;
// imm16 is for assembly/disassembly. It is reported in the HSR but otherwise is ignored by
// hardware. An HVC handler might interpret imm16, for example to determine the required service.
```

For information about the CONSTRAINED UNPREDICTABLE behavior of this instruction, see [Appendix A Architectural Constraints on UNPREDICTABLE behaviors](#).

Assembler syntax

HVC{<q>} {#}<imm16>

where:

<q> See *Standard assembler syntax fields* on page F2-2415. An HVC instruction must be unconditional.

<imm16> Specifies a 16-bit immediate constant.

Operation

```
EncodingSpecificOperations();
if !HaveEL(EL2) || PSTATE.EL == EL0 || (PSTATE.EL == EL1 && IsSecure()) then
    UNDEFINED;

hvc_enable = if HaveEL(EL3) then SCR_GEN[].HCE else NOT(HCR.HCD);
if hvc_enable == '0' then
    UNDEFINED;
else
    AArch32.CallHypervisor(imm16);
```

F7.4.5 LDM (exception return)

Load Multiple (exception return) loads multiple registers from consecutive memory locations using an address from a base register. The **SPSR** of the current mode is copied to the **CPSR**. An address adjusted by the size of the data loaded can optionally be written back to the base register.

The registers loaded include the PC. The word loaded for the PC is treated as an address and a branch occurs to that address.

LDM (exception return) is:

- UNDEFINED in Hyp mode.
- UNPREDICTABLE in the cases described in [Restrictions on exception return instructions on page F7-3028](#).

Encoding A1 ARMv4*, ARMv5T*, ARMv6*, ARMv7

LDM{<amode>}<c> <Rn>{!}, <registers_with_pc>^

31	30	29	28	27	26	25	24	23	22	21	20	19	18	17	16	15	14	13	12	11	10	9	8	7	6	5	4	3	2	1	0
cond		1	0	0	P	U	1	W	1	Rn								register_list													

```
n = UInt(Rn); registers = register_list;
wback = (W == '1'); increment = (U == '1'); wordhigher = (P == U);
if n == 15 then UNPREDICTABLE;
if wback && registers<n> == '1' then UNPREDICTABLE;
```

For information about the CONSTRAINED UNPREDICTABLE behavior of this instruction, see [Appendix A Architectural Constraints on UNPREDICTABLE behaviors](#), and particularly [LDM \(exception return\) on page AppxA-4755](#).

Assembler syntax

LDM{<amode>}{<c>}{<q>} <Rn>{!}, <registers_with_pc>^

where:

<amode> is one of:

- | | |
|----|--|
| DA | Decrement After. The consecutive memory addresses end at the address in the base register. Encoded as P = 0, U = 0. |
| FA | Full Ascending. For this instruction, a synonym for DA. |
| DB | Decrement Before. The consecutive memory addresses end one word below the address in the base register. Encoded as P = 1, U = 0. |
| EA | Empty Ascending. For this instruction, a synonym for DA. |
| IA | Increment After. The consecutive memory addresses start at the address in the base register. This is the default. Encoded as P = 0, U = 1. |
| FD | Full Descending. For this instruction, a synonym for IA. |
| IB | Increment Before. The consecutive memory addresses start one word above the address in the base register. Encoded as P = 1, U = 1. |
| ED | Empty Descending. For this instruction, a synonym for IB. |

<c>, <q> See [Standard assembler syntax fields on page F2-2415](#).

<Rn> The base register. This register can be the SP.

! Causes the instruction to write a modified value back to <Rn>. Encoded as W = 1.
 If ! is omitted, the instruction does not change <Rn> in this way. Encoded as W = 0.

<registers_with_pc>

Is a list of one or more registers, separated by commas and surrounded by { and }. It specifies the set of registers to be loaded. The registers are loaded with the lowest-numbered register from the lowest memory address, through to the highest-numbered register from the highest memory address. The PC must be specified in the register list, and the instruction causes a branch to the address (data) loaded into the PC. See also *Encoding of lists of general-purpose registers and the PC* on page F2-2426.

The pre-UAL syntax LDM<c>{<amode>} is equivalent to LDM{<amode>}<c>.

———— **Note** ————

Instructions with similar syntax but without the PC included in the registers list are described in *LDM (User registers)* on page F7-3044.

Operation

```

if ConditionPassed() then
  EncodingSpecificOperations();
  if CurrentModeIsHyp() then
    UNDEFINED;
  elseif CurrentModeIsUserOrSystem() || CurrentInstrSet() == InstrSet_T32EE then
    UNPREDICTABLE; // UNDEFINED or NOP
  else
    length = 4*BitCount(registers) + 4;
    address = if increment then R[n] else R[n]-length;
    if wordhigher then address = address+4;

    for i = 0 to 14
      if registers<i> == '1' then
        R[i] = MemA[address,4]; address = address + 4;
    new_pc_value = MemA[address,4];

    if wback && registers<n> == '0' then R[n] = if increment then R[n]+length else R[n]-length;
    if wback && registers<n> == '1' then R[n] = bits(32) UNKNOWN;

    AArch32.ExceptionReturn(new_pc_value, SPSR[]);
  
```

F7.4.6 LDM (User registers)

In an EL1 mode other than System mode, Load Multiple (User registers) loads multiple User mode registers from consecutive memory locations using an address from a base register. The registers loaded cannot include the PC. The PE reads the base register value normally, using the current mode to determine the correct Banked version of the register. This instruction cannot writeback to the base register.

LDM (user registers) is UNDEFINED in Hyp mode, and UNPREDICTABLE in User and System modes.

Encoding A1 ARMv4*, ARMv5T*, ARMv6*, ARMv7

LDM{<amode>}<c> <Rn>, <registers_without_pc>^

31	30	29	28	27	26	25	24	23	22	21	20	19	18	17	16	15	14	13	12	11	10	9	8	7	6	5	4	3	2	1	0
cond			1	0	0	P	U	1	(0)	1	Rn						0	register_list													

n = UInt(Rn); registers = register_list; increment = (U == '1'); wordhigher = (P == U);
 if n == 15 || BitCount(registers) < 1 then UNPREDICTABLE;

For information about the CONSTRAINED UNPREDICTABLE behavior of this instruction, see [Appendix A Architectural Constraints on UNPREDICTABLE behaviors](#), and particularly [LDM \(User registers\) on page AppxA-4755](#).

Assembler syntax

LDM{<amode>}{<c>}{<q>} <Rn>, <registers_without_pc>^

where:

<amode> is one of:

- DA Decrement After. The consecutive memory addresses end at the address in the base register. Encoded as P = 0, U = 0.
- FA Full Ascending. For this instruction, a synonym for DA.
- DB Decrement Before. The consecutive memory addresses end one word below the address in the base register. Encoded as P = 1, U = 0.
- EA Empty Ascending. For this instruction, a synonym for DB.
- IA Increment After. The consecutive memory addresses start at the address in the base register. This is the default. Encoded as P = 0, U = 1.
- FD Full Descending. For this instruction, a synonym for IA.
- IB Increment Before. The consecutive memory addresses start one word above the address in the base register. Encoded as P = 1, U = 1.
- ED Empty Descending. For this instruction, a synonym for IB.

<c>, <q> See [Standard assembler syntax fields on page F2-2415](#).

<Rn> The base register. This register can be the SP.

<registers_without_pc>

Is a list of one or more registers, separated by commas and surrounded by { and }. It specifies the set of registers to be loaded by the LDM instruction. The registers are loaded with the lowest-numbered register from the lowest memory address, through to the highest-numbered register from the highest memory address. The PC must not be in the register list. See also [Encoding of lists of general-purpose registers and the PC on page F2-2426](#).

The pre-UAL syntax LDM<c>{<amode>} is equivalent to LDM{<amode>}<c>.

———— Note —————

Instructions with similar syntax but with the PC included in <registers_without_pc> are described in [LDM \(exception return\) on page F7-3042](#).

Operation

```

if ConditionPassed() then
    EncodingSpecificOperations();
    if CurrentModeIsHyp() then UNDEFINED;
    elsif CurrentModeIsUserOrSystem() then UNPREDICTABLE;
    else
        length = 4*BitCount(registers);
        address = if increment then R[n] else R[n]-length;
        if wordhigher then address = address+4;
        for i = 0 to 14
            if registers<i> == '1' then // Load User mode register
                Rmode[i, M32_User] = MemA[address,4]; address = address + 4;
  
```

F7.4.7 LDRBT, LDRHT, LDRSBT, LDRSHT, and LDRT

Even when executed at EL1 or higher, loads from memory by these instructions are restricted in the same way as unprivileged loads from memory. The MemA_unpriv[] and MemU_unpriv[] pseudocode functions describe this restriction. For more information see [Alignment support on page E2-2341](#).

These instructions are UNPREDICTABLE in Hyp mode.

For descriptions of the instructions see:

- [LDRBT on page F7-2652](#).
- [LDRHT on page F7-2672](#).
- [LDRSBT on page F7-2680](#).
- [LDRSHT on page F7-2688](#).
- [LDRT on page F7-2690](#).

F7.4.8 MRS

Move to Register from Special register moves the value from the [CPSR](#) or [SPSR](#) of the current mode into a general-purpose register.

An MRS that accesses the [SPSR](#) is UNPREDICTABLE if executed in User mode or System mode.

An MRS that is executed in User mode and accesses the [CPSR](#) returns an UNKNOWN value for the [CPSR](#).{E, A, I, F, M} fields.

———— **Note** —————

[MRS on page F7-2720](#) describes the valid application level uses of the MRS instruction.

Encoding T1 ARMv6T2, ARMv7

MRS<c> <Rd>, <spec_reg>

15	14	13	12	11	10	9	8	7	6	5	4	3	2	1	0	15	14	13	12	11	10	9	8	7	6	5	4	3	2	1	0
1	1	1	1	0	0	1	1	1	1	1	R	(1)	(1)	(1)	(1)	1	0	(0)	0	Rd	(0)	(0)	0	(0)	(0)	(0)	(0)	(0)			

d = UInt(Rd); read_spsr = (R == '1');
 if d == 15 then UNPREDICTABLE; // ARMv8-A removes UNPREDICTABLE for R13

Encoding A1 ARMv4*, ARMv5T*, ARMv6*, ARMv7

MRS<c> <Rd>, <spec_reg>

31	30	29	28	27	26	25	24	23	22	21	20	19	18	17	16	15	14	13	12	11	10	9	8	7	6	5	4	3	2	1	0
cond	0	0	0	1	0	R	0	0	(1)	(1)	(1)	(1)	Rd	(0)	(0)	0	(0)	0	0	0	0	(0)	(0)	(0)	(0)	(0)	(0)	(0)	(0)		

d = UInt(Rd); read_spsr = (R == '1');
 if d == 15 then UNPREDICTABLE;

For information about the CONSTRAINED UNPREDICTABLE behavior of this instruction, see [Appendix A Architectural Constraints on UNPREDICTABLE behaviors](#), and particularly [MRS on page AppxA-4756](#).

Assembler syntax

MRS{<c>}{<q>} <Rd>, <spec_reg>

where:

<c>, <q> See [Standard assembler syntax fields on page F2-2415](#).

<Rd> The destination register.

<spec_reg> Is one of:

- APSR
- CPSR
- SPSR.

ARM recommends that software uses the APSR form when only the N, Z, C, V, Q, or GE[3:0] bits of the read value are going to be used, see [The Application Program Status Register \(APSR\) on page E1-2297](#).

Operation

```
if ConditionPassed() then
  EncodingSpecificOperations();
  if read_spsr then
    if CurrentModeIsUserOrSystem() then
      UNPREDICTABLE;
    else
      R[d] = SPSR[];
  else
    // CPSR is read with execution state bits other than E masked out.
    R[d] = CPSR AND '11111000 11111111 00000011 11011111';
    if !CurrentModeIsNotUser() then
      // If accessed from User mode return UNKNOWN values for M, bits<4:0>,
      // and for the E, A, I, F bits, bits<9:6>
      R[d]<4:0> = bits(5) UNKNOWN;
      R[d]<9:6> = bits(4) UNKNOWN;
```

F7.4.9 MRS (Banked register)

Move to Register from Banked or Special register moves the value from the Banked general-purpose register or [SPSR](#) of the specified mode, or the value of [ELR_hyp](#), to a general-purpose register.

MRS (Banked register) is UNPREDICTABLE if executed in User mode.

The effect of using an MRS (Banked register) instruction with a register argument that is not valid for the current mode is UNPREDICTABLE. For more information see [Usage restrictions on the Banked register transfer instructions on page F7-3030](#).

Encoding T1 ARMv7VE

MRS<c> <Rd>, <banked_reg>

15	14	13	12	11	10	9	8	7	6	5	4	3	2	1	0	15	14	13	12	11	10	9	8	7	6	5	4	3	2	1	0
1	1	1	1	0	0	1	1	1	1	1	R		M1			1	0	(0)	0			Rd		(0)	(0)	1	M	(0)	(0)	(0)	(0)

```
d = UInt(Rd); read_spsr = (R == '1');
if d == 15 then UNPREDICTABLE; // ARMv8-A removes UNPREDICTABLE for R13
SYSm = M:M1;
```

Encoding A1 ARMv7VE

MRS<c> <Rd>, <banked_reg>

31	30	29	28	27	26	25	24	23	22	21	20	19	18	17	16	15	14	13	12	11	10	9	8	7	6	5	4	3	2	1	0
cond		0	0	0	1	0	R	0	0			M1			Rd		(0)	(0)	1	M	0	0	0	0		(0)	(0)	(0)	(0)		

```
d = UInt(Rd); read_spsr = (R == '1');
if d == 15 then UNPREDICTABLE;
SYSm = M:M1;
```

For information about the CONSTRAINED UNPREDICTABLE behavior of this instruction, see [Appendix A Architectural Constraints on UNPREDICTABLE behaviors](#).

Assembler syntax

MRS{<c>}{<q>} <Rd>, <banked_reg>

where:

<c>, <q> See [Standard assembler syntax fields on page F2-2415](#).

<Rd> The destination register.

<banked_reg> Is one of:

- <Rm>_<mode>, encoded with R==0.
- ELR_hyp, encoded with R==0.
- SPSR_<mode>, encoded with R==1.

For a full description of the encoding of this field, see [Encoding and use of Banked register transfer instructions on page F7-3029](#).

Operation

```

if ConditionPassed() then
    EncodingSpecificOperations();
    if !CurrentModeIsNotUser() then
        UNPREDICTABLE;
    else
        mode = CPSR.M;
        if read_spsr then
            SPSRAccessValid(SYSm, mode);           // Check for UNPREDICTABLE cases
            case SYSm of
                when '01110' R[d] = SPSR_fiq;
                when '10000' R[d] = SPSR_irq;
                when '10010' R[d] = SPSR_svc;
                when '10100' R[d] = SPSR_abt;
                when '10110' R[d] = SPSR_und;
                when '11100' R[d] = SPSR_mon;
                when '11110' R[d] = SPSR_hyp;
            else
                BankedRegisterAccessValid(SYSm, mode); // Check for UNPREDICTABLE cases

        if SYSm<4:3> == '00' then                    // Access the User registers
            m = UInt(SYSm<2:0>) + 8;
            R[d] = Rmode[m,M32_User];
        elsif SYSm<4:3> == '01' then                // Access the FIQ registers
            m = UInt(SYSm<2:0>) + 8;
            R[d] = Rmode[m,M32_FIQ];
        elsif SYSm<4:3> == '11' then
            if SYSm<1> == '0' then                  // Access Monitor registers
                m = 14 - UInt(SYSm<0>);           // LR when SYSm<0> == 0, otherwise SP
                R[d] = Rmode[m,M32_Monitor];
            else                                    // Access Hyp registers
                if SYSm<0> == '1' then            // ELR_hyp when SYSm<0> == '0', otherwise SP_hyp
                    R[d] = Rmode[13,M32_Hyp];
                else
                    R[d] = ELR_hyp;
            else                                    // Other Banked registers
                bits(5) targetmode;                // (SYSm<4:3> == '10' case)
                targetmode<0> = SYSm<2> OR SYSm<1>;
                targetmode<1> = '1';
                targetmode<2> = SYSm<2> AND NOT SYSm<1>;
                targetmode<3> = SYSm<2> AND SYSm<1>;
                targetmode<4> = '1';
                if mode == targetmode then
                    UNPREDICTABLE;
                else
                    m = 14 - UInt(SYSm<0>);       // LR when SYSm<0> == 0, otherwise SP
                    R[d] = Rmode[m,targetmode];

```

F7.4.10 MSR (Banked register)

Move to Banked or Special register from general-purpose register moves the value of a general-purpose register to the Banked general-purpose register or *SPSR* of the specified mode, or to *ELR_hyp*.

MSR (Banked register) is UNPREDICTABLE if executed in User mode.

The effect of using an MSR (Banked register) instruction with a register argument that is not valid for the current mode is UNPREDICTABLE. For more information see *Usage restrictions on the Banked register transfer instructions on page F7-3030*.

Encoding T1 ARMv7VE

MSR<c> <banked_reg>, <Rn>

15	14	13	12	11	10	9	8	7	6	5	4	3	2	1	0	15	14	13	12	11	10	9	8	7	6	5	4	3	2	1	0
1	1	1	1	0	0	1	1	1	0	0	R		Rn			1	0	(0)	0			M1		(0)	(0)	1	M	(0)	(0)	(0)	(0)

```
n = UInt(Rn); write_spsr = (R == '1');
if n == 15 then UNPREDICTABLE; // ARMv8-A removes UNPREDICTABLE for R13
SYSm = M:M1;
```

Encoding A1 ARMv7VE

MSR<c> <banked_reg>, <Rn>

31	30	29	28	27	26	25	24	23	22	21	20	19	18	17	16	15	14	13	12	11	10	9	8	7	6	5	4	3	2	1	0
cond		0	0	0	1	0	R	1	0			M1	(1)	(1)	(1)	(1)	(0)	(0)	1	M	0	0	0	0						Rn	

```
n = UInt(Rn); write_spsr = (R == '1');
if n == 15 then UNPREDICTABLE;
SYSm = M:M1;
```

For information about the CONSTRAINED UNPREDICTABLE behavior of this instruction, see [Appendix A Architectural Constraints on UNPREDICTABLE behaviors](#).

Assembler syntax

MSR{<c>}{<q>} <banked_reg>, <Rn>

where:

<c>, <q> See *Standard assembler syntax fields on page F2-2415*.

<banked_reg> Is one of:

- <Rm>_<mode>, encoded with R==0.
- ELR_hyp, encoded with R==0.
- SPSR_<mode>, encoded with R==1.

For a full description of the encoding of this field, see *Encoding and use of Banked register transfer instructions on page F7-3029*.

<Rn> Is the general-purpose register to be transferred to <banked_reg>.

Operation

```

if ConditionPassed() then
  EncodingSpecificOperations();
  if !CurrentModeIsNotUser() then
    UNPREDICTABLE;
  else
    mode = CPSR.M;
    if write_spsr then
      SPSRaccessValid(SYSm, mode); // Check for UNPREDICTABLE cases
      case SYSm of
        when '01110' SPSR_fiq = R[n];
        when '10000' SPSR_irq = R[n];
        when '10010' SPSR_svc = R[n];
        when '10100' SPSR_abt = R[n];
        when '10110' SPSR_und = R[n];
        when '11100' SPSR_mon = R[n];
        when '11110' SPSR_hyp = R[n];
      else
        BankedRegisterAccessValid(SYSm, mode); // Check for UNPREDICTABLE cases

        if SYSm<4:3> == '00' then // Access the User registers
          m = UInt(SYSm<2:0>) + 8;
          Rmode[m,M32_User] = R[n];
        elsif SYSm<4:3> == '01' then // Access the FIQ registers
          m = UInt(SYSm<2:0>) + 8;
          Rmode[m,M32_FIQ] = R[n];
        elsif SYSm<4:3> == '11' then
          if SYSm<1> == '0' then // Access Monitor registers
            m = 14 - UInt(SYSm<0>); // LR when SYSm<0> == 0, otherwise SP
            Rmode[m,M32_Monitor] = R[n];
          else // Access Hyp registers
            if SYSm<0> == '1' then // ELR_hyp when SYSm<0> == 0, otherwise SP_hyp
              Rmode[13,M32_Hyp] = R[n];
            else
              ELR_hyp = R[n];
          end
        else // Other Banked registers
          bits(5) targetmode; // (SYSm<4:3> == '10' case)
          targetmode<0> = SYSm<2> OR SYSm<1>;
          targetmode<1> = '1';
          targetmode<2> = SYSm<2> AND NOT SYSm<1>;
          targetmode<3> = SYSm<2> AND SYSm<1>;
          targetmode<4> = '1';
          if mode == targetmode then
            UNPREDICTABLE;
          else
            m = 14 - UInt(SYSm<0>); // LR when SYSm<0> == 0, otherwise SP
            Rmode[m,targetmode] = R[n];
          end
        end
      end
    end
  end

```

F7.4.11 MSR (immediate)

Move immediate value to Special register moves selected bits of an immediate value to the **CPSR** or the **SPSR** of the current mode.

MSR (immediate) is UNPREDICTABLE if it is attempting to update the **CPSR**, and that update would change to a mode that is not permitted in the context in which the instruction is executed, see *Restrictions on updates to the CPSR.M field* on page F7-3028.

An MSR (immediate) executed in User mode:

- Is CONSTRAINED UNPREDICTABLE if it attempts to update the **SPSR**.
- Otherwise, does not update any **CPSR** field that is accessible only at EL1 or higher,

———— **Note** —————

MSR (immediate) on page F7-2722 describes the valid application level uses of the MSR (immediate) instruction.

An MSR (immediate) executed in System mode is CONSTRAINED UNPREDICTABLE if it attempts to update the **SPSR**.

Encoding A1 ARMv4*, ARMv5T*, ARMv6*, ARMv7

MSR<c> <spec_reg>, #<const>

31	30	29	28	27	26	25	24	23	22	21	20	19	18	17	16	15	14	13	12	11	10	9	8	7	6	5	4	3	2	1	0
cond		0	0	1	1	0	R	1	0	mask				(1)	(1)	(1)	(1)	imm12													

```
if mask == '0000' && R == '0' then SEE "Related encodings";
imm32 = ARMEExpandImm(imm12); write_spsr = (R == '1');
if mask == '0000' then UNPREDICTABLE;
```

For information about the CONSTRAINED UNPREDICTABLE behavior of this instruction, see [Appendix A Architectural Constraints on UNPREDICTABLE behaviors](#), and particularly *MSR (immediate)* on page AppxA-4756.

Related encodings See *MSR (immediate)*, and *hints* on page F4-2478.

Assembler syntax

MSR{<c>}{<q>} <spec_reg>, #<const>

where:

<c>, <q> See [Standard assembler syntax fields on page F2-2415](#).

<spec_reg> Is one of:

- APSR_<bits>.
- CPSR_<fields>.
- SPSR_<fields>.

ARM recommends the APSR forms when only the N, Z, C, V, Q, and GE[3:0] bits are being written. For more information, see [The Application Program Status Register \(APSR\) on page E1-2297](#).

<const> The immediate value to be transferred to <spec_reg>. See [Modified immediate constants in A32 instructions on page F4-2472](#) for the range of values.

<bits> Is one of nzcqv, g, or nzcqvq.

In the A and R profiles:

- APSR_nzcqv is the same as CPSR_f (mask == '1000').
- APSR_g is the same as CPSR_s (mask == '0100').
- APSR_nzcqvq is the same as CPSR_fs (mask == '1100').

<fields> Is a sequence of one or more of the following:

- c mask<0> = '1' to enable writing of bits<7:0> of the destination PSR.
- x mask<1> = '1' to enable writing of bits<15:8> of the destination PSR.
- s mask<2> = '1' to enable writing of bits<23:16> of the destination PSR.
- f mask<3> = '1' to enable writing of bits<31:24> of the destination PSR.

Operation

```
if ConditionPassed() then
    EncodingSpecificOperations();
    if write_spsr then
        SPSRWriteByInstr(imm32, mask);
    else
        // Attempts to change to an illegal mode will invoke the Illegal Execution State mechanism
        CPSRWriteByInstr(imm32, mask, FALSE); // Does not affect execution state bits other than E
```

E bit

The **CPSR.E** bit is writable from any mode using an MSR instruction. ARM deprecates using this to change its value. Use the SETEND instruction instead.

F7.4.12 MSR (register)

Move to Special register from general-purpose register moves the value of a general-purpose register to the **CPSR** or the **SPSR** of the current mode.

MSR (register) is UNPREDICTABLE if it is attempting to update the **CPSR**, and that update would change to a mode that is not permitted in the context in which the instruction is executed, see *Restrictions on updates to the CPSR.M field* on page F7-3028.

An MSR (register) executed in User mode:

- Is UNPREDICTABLE if it attempts to update the **SPSR**.
- Otherwise, does not update any **CPSR** field that is accessible only at EL1 or higher,

———— **Note** —————

MSR (register) on page F7-2724 describes the valid application level uses of the MSR (register) instruction.

An MSR (register) executed in System mode is UNPREDICTABLE if it attempts to update the **SPSR**.

Encoding T1 ARMv6T2, ARMv7

MSR<c> <spec_reg>, <Rn>

15	14	13	12	11	10	9	8	7	6	5	4	3	2	1	0	15	14	13	12	11	10	9	8	7	6	5	4	3	2	1	0
1	1	1	1	0	0	1	1	1	0	0	R		Rn			1	0	(0)	0			mask		(0)	(0)	0	(0)	(0)	(0)	(0)	(0)

```
n = UInt(Rn); write_spsr = (R == '1');
if mask == '0000' then UNPREDICTABLE;
if n == 15 then UNPREDICTABLE; // ARMv8-A removes UNPREDICTABLE for R13
```

Encoding A1 ARMv4*, ARMv5T*, ARMv6*, ARMv7

MSR<c> <spec_reg>, <Rn>

31	30	29	28	27	26	25	24	23	22	21	20	19	18	17	16	15	14	13	12	11	10	9	8	7	6	5	4	3	2	1	0
cond		0	0	0	1	0	R	1	0		mask	(1)	(1)	(1)	(1)	(0)	(0)	0	(0)	0	0	0	0								Rn

```
n = UInt(Rn); write_spsr = (R == '1');
if mask == '0000' then UNPREDICTABLE;
if n == 15 then UNPREDICTABLE;
```

For information about the CONSTRAINED UNPREDICTABLE behavior of this instruction, see [Appendix A Architectural Constraints on UNPREDICTABLE behaviors](#), and particularly *MSR (register)* on page AppxA-4756.

Assembler syntax

MSR{<c>}{<q>} <spec_reg>, <Rn>

where:

<c>, <q> See [Standard assembler syntax fields on page F2-2415](#).

<spec_reg> Is one of:

- APSR_<bits>.
- CPSR_<fields>.
- SPSR_<fields>.

ARM recommends the APSR forms when only the N, Z, C, V, Q, and GE[3:0] bits are being written. For more information, see [The Application Program Status Register \(APSR\) on page E1-2297](#).

<Rn> Is the general-purpose register to be transferred to <spec_reg>.

<bits> Is one of nzcvcq, g, or nzcvcqg.

In the A profile:

- APSR_nzcvcq is the same as CPSR_f (mask == '1000').
- APSR_g is the same as CPSR_s (mask == '0100').
- APSR_nzcvcqg is the same as CPSR_fs (mask == '1100').

<fields> Is a sequence of one or more of the following:

- c mask<0> = '1' to enable writing of bits<7:0> of the destination PSR.
- x mask<1> = '1' to enable writing of bits<15:8> of the destination PSR.
- s mask<2> = '1' to enable writing of bits<23:16> of the destination PSR.
- f mask<3> = '1' to enable writing of bits<31:24> of the destination PSR.

Operation

```
if ConditionPassed() then
    EncodingSpecificOperations();
    if write_spsr then
        SPSRWriteByInstr(R[n], mask);
    else
        // Attempts to change to an illegal mode will invoke the Illegal Execution State mechanism
        CPSRWriteByInstr(R[n], mask, FALSE); // Does not affect execution state bits other than E
```

E bit

The [CPSR.E](#) bit is writable from any mode using an MSR instruction. ARM deprecates using this to change its value. Use the SETEND instruction instead.

F7.4.13 RFE

Return From Exception loads the PC and the CPSR from the word at the specified address and the following word respectively. For information about memory accesses see *Memory accesses* on page F2-2422.

RFE is:

- UNDEFINED in Hyp mode.
- UNPREDICTABLE in the cases described in *Restrictions on exception return instructions* on page F7-3028.

———— **Note** ————

As identified in *Restrictions on exception return instructions* on page F7-3028, RFE differs from other exception return instructions in that it can be executed in System mode.

Encoding T1 ARMv6T2, ARMv7

RFEDB<c> <Rn>{!} Outside or last in IT block

15	14	13	12	11	10	9	8	7	6	5	4	3	2	1	0	15	14	13	12	11	10	9	8	7	6	5	4	3	2	1	0
1	1	1	0	1	0	0	0	0	0	W	1			Rn		(1)	(1)	(0)	(0)	(0)	(0)	(0)	(0)	(0)	(0)	(0)	(0)	(0)	(0)		

n = UInt(Rn); wback = (W == '1'); increment = FALSE; wordhigher = FALSE;
 if n == 15 then UNPREDICTABLE;
 if CurrentInstrSet() == InstrSet_T32EE then UNPREDICTABLE;
 if InITBlock() && !LastInITBlock() then UNPREDICTABLE;

Encoding T2 ARMv6T2, ARMv7

RFE{IA}<c> <Rn>{!} Outside or last in IT block

15	14	13	12	11	10	9	8	7	6	5	4	3	2	1	0	15	14	13	12	11	10	9	8	7	6	5	4	3	2	1	0
1	1	1	0	1	0	0	1	1	0	W	1			Rn		(1)	(1)	(0)	(0)	(0)	(0)	(0)	(0)	(0)	(0)	(0)	(0)	(0)	(0)		

n = UInt(Rn); wback = (W == '1'); increment = TRUE; wordhigher = FALSE;
 if n == 15 then UNPREDICTABLE;
 if CurrentInstrSet() == InstrSet_T32EE then UNPREDICTABLE;
 if InITBlock() && !LastInITBlock() then UNPREDICTABLE;

Encoding A1 ARMv6*, ARMv7

RFE{<amode>} <Rn>{!}

31	30	29	28	27	26	25	24	23	22	21	20	19	18	17	16	15	14	13	12	11	10	9	8	7	6	5	4	3	2	1	0	
1	1	1	1	1	0	0	P	U	0	W	1			Rn		(0)	(0)	(0)	(0)	(1)	(0)	(1)	(0)	(0)	(0)	(0)	(0)	(0)	(0)	(0)	(0)	(0)

n = UInt(Rn);
 wback = (W == '1'); inc = (U == '1'); wordhigher = (P == U);
 if n == 15 then UNPREDICTABLE;

For information about the CONSTRAINED UNPREDICTABLE behavior of this instruction, see [Appendix A Architectural Constraints on UNPREDICTABLE behaviors](#), and particularly *RFE* on page AppxA-4757.

Assembler syntax

RFE{<amode>}{<C>}{<q>} <Rn>{!}

where:

<amode> is one of:

- DA Decrement After. A32 instructions only. The consecutive memory addresses end at the address in the base register. Encoded as P = 0, U = 0 in encoding A1.
- DB Decrement Before. The consecutive memory addresses end one word below the address in the base register. Encoding T1, or encoding A1 with P = 1, U = 0.
- IA Increment After. The consecutive memory addresses start at the address in the base register. This is the default. Encoding T2, or encoding A1 with P = 0, U = 1.
- IB Increment Before. A32 instructions only. The consecutive memory addresses start one word above the address in the base register. Encoded as P = 1, U = 1 in encoding A1.

<C>, <q> See [Standard assembler syntax fields on page F2-2415](#). An A32 RFE instruction must be unconditional.

<Rn> The base register.

! Causes the instruction to write a modified value back to <Rn>. If ! is omitted, the instruction does not change <Rn>.

RFEFA, RFEFA, RFEFD, and RFEED are pseudo-instructions for RFEDA, RFEDB, RFEIA, and RFEIB respectively, referring to their use for popping data from Full Ascending, Empty Ascending, Full Descending, and Empty Descending stacks.

Operation

```

if ConditionPassed() then
    EncodingSpecificOperations();
    if CurrentModeIsHyp() then
        UNDEFINED;
    elseif (!CurrentModeIsNotUser() || CurrentInstrSet() == InstrSet_T32EE) then
        UNPREDICTABLE; // UNDEFINED or NOP
    else
        address = if increment then R[n] else R[n]-8;
        if wordhigher then address = address+4;
        if wback then R[n] = if increment then R[n]+8 else R[n]-8;
        new_pc_value = MemA[address,4];
        spsr = MemA[address+4,4];
        AArch32.ExceptionReturn(new_pc_value, spsr);
  
```

F7.4.14 SMC (previously SMI)

Secure Monitor Call causes a Secure Monitor Call exception. For more information see [Secure Monitor Call \(SMC\) exception on page G1-3480](#).

SMC is available only from software executing at EL1 or higher. It is UNDEFINED in User mode.

If `HCR.TSC` is set to 1, execution of an SMC instruction in a Non-secure EL1 mode generates a Hyp Trap exception, regardless of the value of `SCR.SCD`. For more information see [Trapping use of the SMC instruction on page G1-3510](#).

Otherwise, when `SCR.SCD` is set to 1, the SMC instruction is:

- UNDEFINED in Non-secure state.
- UNPREDICTABLE if executed:
 - When EL3 is using AArch32, in a Secure EL3 mode.
 - When EL3 is using AArch32, in a Secure EL1 mode.

Encoding T1 Security Extensions (not in ARMv6K)

SMC<c> #<imm4>

15	14	13	12	11	10	9	8	7	6	5	4	3	2	1	0	15	14	13	12	11	10	9	8	7	6	5	4	3	2	1	0
1	1	1	1	0	1	1	1	1	1	1	1	1	imm4			1	0	0	0	(0)	(0)	(0)	(0)	(0)	(0)	(0)	(0)	(0)	(0)		

// imm4 is for assembly/disassembly only and is ignored by hardware
 if InITBlock() && !LastInITBlock() then UNPREDICTABLE;

Encoding A1 Security Extensions

SMC<c> #<imm4>

31	30	29	28	27	26	25	24	23	22	21	20	19	18	17	16	15	14	13	12	11	10	9	8	7	6	5	4	3	2	1	0
cond		0	0	0	1	0	1	1	0	(0)	(0)	(0)	(0)	(0)	(0)	(0)	(0)	(0)	(0)	(0)	(0)	(0)	(0)	0	1	1	1	imm4			

// imm4 is for assembly/disassembly only and is ignored by hardware

For information about the CONSTRAINED UNPREDICTABLE behavior of this instruction, see [Appendix A Architectural Constraints on UNPREDICTABLE behaviors](#).

Assembler syntax

SMC{<c>}{<q>} {#}<imm4>

where:

<c>, <q> See *Standard assembler syntax fields* on page F2-2415.

<imm4> Is a 4-bit immediate value. This is ignored by the PE.

The Secure Monitor Call exception handler (Secure Monitor code) can use this value to determine what service is being requested, but ARM does not recommend this.

The pre-UAL syntax SMI<c> is equivalent to SMC<c>.

Operation

```
if ConditionPassed() then
    EncodingSpecificOperations();

    if !HaveEL(EL3) || PSTATE.EL == EL0 then
        UNDEFINED;

    route_to_hyp = HaveEL(EL2) && !IsSecure() && HCR.TSC == '1';

    if route_to_hyp then
        AArch32.SMCTrap();
    elseif SCR_GEN[.SCD] == '1' then
        // SMC disabled
        if IsSecure() then
            // Executes either as a NOP or UNALLOCATED.
            c = ConstrainUnpredictable(Unpredictable_SMD);
            assert c IN {Constraint_NOP, Constraint_UNDEF};
            if c == Constraint_NOP then EndOfInstruction();
        UNDEFINED;
    elseif !ELUsingAArch32(EL3) then
        AArch64.CallSecureMonitor(Zeros(16));
    else
        AArch32.TakeSMCException();
```

F7.4.15 SRS (T32)

Store Return State stores the LR and SPSR of the current mode to the stack of a specified mode. For information about memory accesses see [Memory accesses on page F2-2422](#).

SRS is:

- UNDEFINED in Hyp mode.
- UNPREDICTABLE if:
 - It is executed in ThumbEE state.
 - It is executed in User or System mode.
 - It attempts to store the Monitor mode SP when in Non-secure state.
 - It attempts to store the Hyp mode SP.

Encoding T1 ARMv6T2, ARMv7

SRSDB<c> SP{!}, #<mode>

15	14	13	12	11	10	9	8	7	6	5	4	3	2	1	0	15	14	13	12	11	10	9	8	7	6	5	4	3	2	1	0
1	1	1	0	1	0	0	0	0	0	W	0	(1)	(1)	(0)	(1)	(1)	(1)	(0)	(0)	(0)	(0)	(0)	(0)	(0)	(0)	(0)	(0)	(0)	mode		

if CurrentInstrSet() == InstrSet_T32EE then UNPREDICTABLE;
 wback = (W == '1'); increment = FALSE; wordhigher = FALSE;

Encoding T2 ARMv6T2, ARMv7

SRS{IA}<c> SP{!}, #<mode>

15	14	13	12	11	10	9	8	7	6	5	4	3	2	1	0	15	14	13	12	11	10	9	8	7	6	5	4	3	2	1	0
1	1	1	0	1	0	0	1	1	0	W	0	(1)	(1)	(0)	(1)	(1)	(1)	(0)	(0)	(0)	(0)	(0)	(0)	(0)	(0)	(0)	(0)	mode			

if CurrentInstrSet() == InstrSet_T32EE then UNPREDICTABLE;
 wback = (W == '1'); increment = TRUE; wordhigher = FALSE;

For information about the CONSTRAINED UNPREDICTABLE behavior of this instruction, see [Appendix A Architectural Constraints on UNPREDICTABLE behaviors](#), and particularly [SRS \(T32\) on page AppxA-4757](#).

Assembler syntax

SRS{<amode>}{<C>}{<q>} SP{!}, #<mode>

where:

- <amode> is one of:
- DB Decrement Before. The consecutive memory addresses end one word below the address in the base register. Encoding T1.
 - IA Increment After. The consecutive memory addresses start at the address in the base register. This is the default. Encoding T2.
- <C>, <q> See *Standard assembler syntax fields* on page F2-2415.
- ! Causes the instruction to write a modified value back to the base register (encoded as W = 1). If ! is omitted, the instruction does not change the base register (encoded as W = 0).
- <mode> The number of the mode whose Banked SP is used as the base register. For details of PE modes and their numbers see *AArch32 PE mode descriptions* on page G1-3412.

SRSEA is a pseudo-instruction for SRSIA, and SRSFD is a pseudo-instruction for SRSDB, referring to their use for pushing data onto Empty Ascending and Full Descending stacks.

Operation

```

if ConditionPassed() then
    EncodingSpecificOperations();
    if CurrentModeIsHyp() then
        UNDEFINED;
    elseif CurrentModeIsUserOrSystem() then
        UNPREDICTABLE;
    elseif mode == M32_Hyp then // Check for attempt to access Hyp mode SP
        UNPREDICTABLE;
    elseif !IsSecure() && mode == M32_Monitor then
        // In Non-secure state, check for attempts to access Monitor mode.
        // The definition of UNPREDICTABLE does not permit this to be a security hole.
        UNPREDICTABLE;
    base = Rmode[13,mode];
    address = if increment then base else base-8;
    if wordhigher then address = address+4;
    MemA[address,4] = LR;
    MemA[address+4,4] = SPSR[];
    if wback then Rmode[13,mode] = if increment then base+8 else base-8;
  
```

F7.4.16 SRS (A32)

Store Return State stores the LR and SPSR of the current mode to the stack of a specified mode. For information about memory accesses see [Memory accesses on page F2-2422](#).

SRS is:

- UNDEFINED in Hyp mode.
- UNPREDICTABLE if:
 - It is executed in User or System mode.
 - It attempts to store the Monitor mode SP when in Non-secure state.
 - If it attempts to store the Hyp mode SP.

Encoding A1 ARMv6*, ARMv7

SRS{<amode>} SP{!}, #<mode>

31	30	29	28	27	26	25	24	23	22	21	20	19	18	17	16	15	14	13	12	11	10	9	8	7	6	5	4	3	2	1	0
1	1	1	1	1	0	0	P	U	1	W	0	(1)	(1)	(0)	(1)	(0)	(0)	(0)	(0)	(0)	(1)	(0)	(1)	(0)	(0)	(0)	mode				

wback = (W == '1'); increment = (U == '1'); wordhigher = (P == U);

For information about the CONSTRAINED UNPREDICTABLE behavior of this instruction, see [Appendix A Architectural Constraints on UNPREDICTABLE behaviors](#), and particularly [SRS \(A32\) on page AppxA-4758](#).

Assembler syntax

SRS{<amode>}{<C>}{<q>} SP{!}, #<mode>

where:

<amode>	is one of:
DA	Decrement After. The consecutive memory addresses end at the address in the base register. Encoded as P = 0, U = 0.
DB	Decrement Before. The consecutive memory addresses end one word below the address in the base register. Encoded as P = 1, U = 0.
IA	Increment After. The consecutive memory addresses start at the address in the base register. This is the default. Encoded as P = 0, U = 1.
IB	Increment Before. A32 instructions only. The consecutive memory addresses start one word above the address in the base register. Encoded as P = 1, U = 1.
<C>, <q>	See <i>Standard assembler syntax fields on page F2-2415</i> . In the A32 instruction set, an SRS instruction must be unconditional.
!	Causes the instruction to write a modified value back to the base register (encoded as W = 1). If ! is omitted, the instruction does not change the base register (encoded as W = 0).
<mode>	The number of the mode whose Banked SP is used as the base register. For details of PE modes and their numbers see <i>AArch32 PE mode descriptions on page G1-3412</i> .

SRSFA, SRSEA, SRSFD, and SRSED are pseudo-instructions for SRSIB, SRSIA, SRSDB, and SRSDA respectively, referring to their use for pushing data onto Full Ascending, Empty Ascending, Full Descending, and Empty Descending stacks.

Operation

```

if ConditionPassed() then
    EncodingSpecificOperations();
    if CurrentModeIsHyp() then
        UNDEFINED;
    elsif CurrentModeIsUserOrSystem() then
        UNPREDICTABLE;
    elsif mode == M32_Hyp then // Check for attempt to access Hyp mode SP
        UNPREDICTABLE;
    elsif !IsSecure() && mode == M32_Monitor then
        // In Non-secure state, check for attempts to access Monitor mode.
        // The definition of UNPREDICTABLE does not permit this to be a security hole.
        UNPREDICTABLE;
    base = Rmode[13,mode];
    address = if increment then base else base-8;
    if wordhigher then address = address+4;
    MemA[address,4] = LR;
    MemA[address+4,4] = SPSR[];
    if wback then Rmode[13,mode] = if increment then base+8 else base-8;
  
```

F7.4.17 STM (User registers)

In an EL1 mode other than System mode, Store Multiple (user registers) stores multiple User mode registers to consecutive memory locations using an address from a base register. The PE reads the base register value normally, using the current mode to determine the correct Banked version of the register. This instruction cannot writeback to the base register.

STM (User registers) is UNDEFINED in Hyp mode, and CONSTRAINED UNPREDICTABLE in User or System modes.

Encoding A1 ARMv4*, ARMv5T*, ARMv6*, ARMv7

STM{<amode>}<c> <Rn>, <registers>^

31	30	29	28	27	26	25	24	23	22	21	20	19	18	17	16	15	14	13	12	11	10	9	8	7	6	5	4	3	2	1	0
cond				1	0	0	P	U	1	(0)	0	Rn				register_list															

n = UInt(Rn); registers = register_list; increment = (U == '1'); wordhigher = (P == U);
 if n == 15 || BitCount(registers) < 1 then UNPREDICTABLE;

For information about the CONSTRAINED UNPREDICTABLE behavior of this instruction, see [Appendix A Architectural Constraints on UNPREDICTABLE behaviors](#), and particularly [STM \(User registers\)](#) on page AppxA-4758.

Assembler syntax

STM{<amode>}{<c>}{<q>} <Rn>, <registers>^

where:

<amode> is one of:

- DA Decrement After. The consecutive memory addresses end at the address in the base register. Encoded as P = 0, U = 0.
- ED Empty Descending. For this instruction, a synonym for DA.
- DB Decrement Before. The consecutive memory addresses end one word below the address in the base register. Encoded as P = 1, U = 0.
- FD Full Descending. For this instruction, a synonym for DB.
- IA Increment After. The consecutive memory addresses start at the address in the base register. This is the default. Encoded as P = 0, U = 1.
- EA Empty Ascending. For this instruction, a synonym for IA.
- IB Increment Before. The consecutive memory addresses start one word above the address in the base register. Encoded as P = 1, U = 1.
- FA Full Ascending. For this instruction, a synonym for IB.

<c>, <q> See [Standard assembler syntax fields on page F2-2415](#).

<Rn> The base register. This register can be the SP.

<registers> Is a list of one or more registers, separated by commas and surrounded by { and }. It specifies the set of registers to be stored by the STM instruction. The registers are stored with the lowest-numbered register to the lowest memory address, through to the highest-numbered register to the highest memory address. See also [Encoding of lists of general-purpose registers and the PC on page F2-2426](#).

The pre-UAL syntax STM<c>{<amode>} is equivalent to STM{<amode>}<c>.

Operation

```

if ConditionPassed() then
    EncodingSpecificOperations();
    if CurrentModeIsHyp() then
        UNDEFINED;
    elsif CurrentModeIsUserOrSystem() then
        UNPREDICTABLE;
    else
        length = 4*BitCount(registers);
        address = if increment then R[n] else R[n]-length;
        if wordhigher then address = address+4;
        for i = 0 to 14
            if registers<i> == '1' then // Store User mode register
                MemA[address,4] = Rmode[i, M32_User];
                address = address + 4;
            if registers<15> == '1' then
                MemA[address,4] = PCStoreValue();
  
```

F7.4.18 STRBT, STRHT, and STRT

Even in Secure and Non-secure EL1 modes, stores to memory by these instructions are restricted in the same way as unprivileged stores to memory. The MemA_unpriv[] and MemU_unpriv[] pseudocode functions describe this restriction. For more information see [Alignment support on page E2-2341](#).

These instructions are UNPREDICTABLE in Hyp mode.

For descriptions of the instructions see:

- [STRBT on page F7-2890](#).
- [STRHT on page F7-2910](#).
- [STRT on page F7-2912](#).

F7.4.19 SUBS PC, LR and related instructions (T32)

The SUBS PC, LR, #<const> instruction provides an exception return without the use of the stack. It subtracts the immediate constant from LR, branches to the resulting address, and also copies the SPSR to the CPSR.

———— **Note** —————

- The instruction SUBS PC, LR, #0 is equivalent to MOVS PC, LR and ERET.
- For an implementation that includes EL2, ERET is the preferred disassembly of the T1 encoding defined in this section. Therefore, a disassembler might report an ERET where the original assembler code used SUBS PC, LR, #0.

When executing in Hyp mode:

- The encoding for SUBS PC, LR, #0 is the encoding of the ERET instruction, see [ERET on page F7-3038](#).
- SUBS PC, LR, #<const> with a nonzero constant is UNDEFINED.

SUBS PC, LR, #<const> is CONSTRAINED UNPREDICTABLE in the cases described in [Restrictions on exception return instructions on page F7-3028](#).

Encoding T1 ARMv6T2, ARMv7

SUBS<c> PC, LR, #<imm8> Outside or last in IT block

15	14	13	12	11	10	9	8	7	6	5	4	3	2	1	0	15	14	13	12	11	10	9	8	7	6	5	4	3	2	1	0
1	1	1	1	0	0	1	1	1	1	0	1	(1)	(1)	(1)	(0)	1	0	(0)	0	(1)	(1)	(1)	(1)	imm8							

```

if IsZero(imm8) then SEE ERET;
if CurrentInstrSet() == InstrSet_T32EE then UNPREDICTABLE;
if CurrentModeIsHyp() then UNDEFINED; // UNDEFINED in Hyp mode when not ERET
n = 14; imm32 = ZeroExtend(imm8, 32);
if InITBlock() && !LastInITBlock() then UNPREDICTABLE;
    
```

For information about the CONSTRAINED UNPREDICTABLE behavior of this instruction, see [Appendix A Architectural Constraints on UNPREDICTABLE behaviors](#), and particularly [SUBS PC, LR and related instructions \(T32\) on page AppxA-4758](#).

Assembler syntax

SUBS{<c>}{<q>} PC, LR, #<const>

where:

<c>, <q> See *Standard assembler syntax fields* on page F2-2415.

<const> The immediate constant, in the range 0-255.

In the T32 instruction set, MOV{<c>}{<q>} PC, LR is a pseudo-instruction for SUBS{<c>}{<q>} PC, LR, #0.

Operation

```
if ConditionPassed() then
    EncodingSpecificOperations();
    if (CurrentModeIsUserOrSystem() || CurrentInstrSet() == InstrSet_T32EE) then
        UNPREDICTABLE;
    else
        operand2 = imm32;
        (result, -) = AddWithCarry(R[n], NOT(operand2), '1');
        CPSRWriteByInstr(SPSR[], '1111', TRUE);
        if CPSR.M == M32_Hyp && CPSR.J == '1' && CPSR.T == '1' then
            UNPREDICTABLE;
        else
            BranchWritePC(result);
```

F7.4.20 SUBS PC, LR and related instructions (A32)

The SUBS PC, LR, #<const> instruction provides an exception return without the use of the stack. It subtracts the immediate constant from LR, branches to the resulting address, and also copies the SPSR to the CPSR. The A32 instruction set contains similar instructions based on other data-processing operations, or with a wider range of operands, or both. ARM deprecates using these other instructions, except for MOVS PC, LR.

All of these instructions are:

- UNDEFINED in Hyp mode.
- CONSTRAINED UNPREDICTABLE in the cases described in [Restrictions on exception return instructions on page F7-3028](#).

Encoding A1 ARMv4*, ARMv5T*, ARMv6*, ARMv7

<opc1>S<c> PC, <Rn>, #<const>

<opc2>S<c> PC, #<const>

31	30	29	28	27	26	25	24	23	22	21	20	19	18	17	16	15	14	13	12	11	10	9	8	7	6	5	4	3	2	1	0
cond			0	0	1	opcode			1	Rn			1	1	1	1	imm12														

n = UInt(Rn); imm32 = ARMEExpandImm(imm12); register_form = FALSE;

Encoding A2 ARMv4*, ARMv5T*, ARMv6*, ARMv7

<opc1>S<c> PC, <Rn>, <Rm>{, <shift>}

<opc2>S<c> PC, <Rm>{, <shift>}

<opc3>S<c> PC, <Rn>, #<const>

RRXS<c> PC, <Rn>

31	30	29	28	27	26	25	24	23	22	21	20	19	18	17	16	15	14	13	12	11	10	9	8	7	6	5	4	3	2	1	0
cond			0	0	0	opcode			1	Rn			1	1	1	1	imm5			type	0	Rm									

n = UInt(Rn); m = UInt(Rm); register_form = TRUE;
 (shift_t, shift_n) = DecodeImmShift(type, imm5);

For information about the CONSTRAINED UNPREDICTABLE behavior of this instruction, see [Appendix A Architectural Constraints on UNPREDICTABLE behaviors](#), and particularly [SUBS PC, LR and related instructions \(A32\) on page AppxA-4759](#).

Assembler syntax

SUBS{<c>}{<q>} PC, LR, #<const>	Encoding A1
<opc1>S{<c>}{<q>} PC, <Rn>, #<const>	Encoding A1
<opc1>S{<c>}{<q>} PC, <Rn>, <Rm> {, <shift>}	Encoding A2, deprecated
<opc2>S{<c>}{<q>} PC, #<const>	Encoding A1, deprecated
<opc2>S{<c>}{<q>} PC, <Rm> {, <shift>}	Encoding A2
<opc3>S{<c>}{<q>} PC, <Rn>, #<const>	Encoding A2, deprecated
RRXS{<c>}{<q>} PC, <Rn>	Encoding A2, deprecated

where:

- <c>, <q> See [Standard assembler syntax fields on page F2-2415](#).
- <opc1> The operation. <opc1> is one of ADC, ADD, AND, BIC, EOR, ORR, RSB, RSC, SBC, and SUB. ARM deprecates the use of all of these operations except SUB.
- <opc2> The operation. <opc2> is MOV or MVN. ARM deprecates the use of MOV.
- <opc3> The operation. <opc3> is ASR, LSL, LSR, or ROR. ARM deprecates the use of all of these operations.
- <Rn> The first operand register. ARM deprecates the use of any register except LR.

- <const> The immediate constant. See [Modified immediate constants in A32 instructions](#) on page F4-2472 for the range of available values.
- <Rm> The optionally shifted second or only operand register. ARM deprecates the use of any register except LR.
- <shift> The shift to apply to the value read from <Rm>. If absent, no shift is applied. [Constant shifts](#) on page F2-2419 describes the shifts and how they are encoded. ARM deprecates the use of <shift>.

The required operation, <opc1>, <opc2>, <opc3>, or RRRXS, is encoded in the opcode field of the instruction, and in some cases in the imm5 field of encoding T2. For the opcode values for different operations see [Operation](#).

The pre-UAL syntax <opc1><c>S is equivalent to <opc1>S<c>. The pre-UAL syntax <opc2><c>S is equivalent to <opc2>S<c>.

Operation

```

if ConditionPassed() then
    EncodingSpecificOperations();
    if CurrentModeIsHyp() then
        UNDEFINED;
    elsif CurrentModeIsUserOrSystem() || CurrentInstrSet() == InstrSet_T32EE then
        UNPREDICTABLE; // UNDEFINED or NOP
    else
        operand2 = if register_form then Shift(R[m], shift_t, shift_n, APSR.C) else imm32;
        case opcode of
            when '0000' result = R[n] AND operand2; // AND
            when '0001' result = R[n] EOR operand2; // EOR
            when '0010' (result, -) = AddWithCarry(R[n], NOT(operand2), '1'); // SUB
            when '0011' (result, -) = AddWithCarry(NOT(R[n]), operand2, '1'); // RSB
            when '0100' (result, -) = AddWithCarry(R[n], operand2, '0'); // ADD
            when '0101' (result, -) = AddWithCarry(R[n], operand2, APSR.C); // ADC
            when '0110' (result, -) = AddWithCarry(R[n], NOT(operand2), APSR.C); // SBC
            when '0111' (result, -) = AddWithCarry(NOT(R[n]), operand2, APSR.C); // RSC
            when '1100' result = R[n] OR operand2; // ORR
            when '1101' // MOV, if NOT(register_form)
                // Otherwise, ASR, LSL, LSR, ROR, or RRX, and
                // DecodeImmShift() decodes the different shifts
                result = operand2;
            when '1110' result = R[n] AND NOT(operand2); // BIC
            when '1111' result = NOT(operand2); // MVN

AArch32.ExceptionReturn(result, SPSR[]);
  
```

F7.4.21 VMRS

Move to general-purpose register from Advanced SIMD and floating-point System register moves the value of an extension system register to a general-purpose register. When the specified floating-point System register is the **FPSCR**, a form of the instruction transfers the **FPSCR**.{N, Z, C, V} condition flags to the **APSR**.{N, Z, C, V} condition flags.

Depending on settings in the **CPACR**, **NSACR**, **HCPTR**, and **FPEXC** registers, and the security state and mode in which the instruction is executed, an attempt to execute a VMRS instruction might be UNDEFINED, or trapped to Hyp mode. [Summary of general controls of CP10 and CP11 functionality on page G1-3496](#) and [Summary of access controls for Advanced SIMD functionality on page G1-3498](#) summarize these controls.

When these settings permit the execution of floating-point and Advanced SIMD instructions, if the specified floating-point System register is not the **FPSCR**, the instruction is UNDEFINED if executed in User mode.

In an implementation that includes EL2, when **HCR.TID0** is set to 1, any VMRS access to **FPSID**, from a Non-secure EL1 mode, that would be permitted if **HCR.TID0** was set to 0, generates a Hyp Trap exception. For more information, see [ID group 0, Primary device identification registers on page G1-3507](#).

———— **Note** —————

- [VMRS on page F8-3232](#) describes the valid application level uses of the VMRS instruction
- For simplicity, the VMRS pseudocode does not show the possible trap to Hyp mode.

Encoding T1/A1 VFPv2, VFPv3, VFPv4, Advanced SIMD

VMRS<c> <Rt>, <spec_reg>

15	14	13	12	11	10	9	8	7	6	5	4	3	2	1	0	15	14	13	12	11	10	9	8	7	6	5	4	3	2	1	0
1	1	1	0	1	1	1	0	1	1	1	1	reg				Rt		1	0	1	0	(0)	(0)	(0)	1	(0)	(0)	(0)	(0)		
31	30	29	28	27	26	25	24	23	22	21	20	19	18	17	16	15	14	13	12	11	10	9	8	7	6	5	4	3	2	1	0
cond				1	1	1	0	1	1	1	1	reg				Rt		1	0	1	0	(0)	(0)	(0)	1	(0)	(0)	(0)	(0)		

```
t = UInt(Rt);
if t == 15 && reg != '0001' then UNPREDICTABLE; // ARMv8-A removes UNPREDICTABLE for R13
```

For information about the CONSTRAINED UNPREDICTABLE behavior of this instruction, see [Appendix A Architectural Constraints on UNPREDICTABLE behaviors](#), and particularly [VMRS on page AppxA-4759](#).

Assembler syntax

VMRS{<c>}{<q>} <Rt>, <spec_reg>

where:

<c>, <q> See [Standard assembler syntax fields on page F2-2415](#).

<Rt> The destination general-purpose register. This register can be R0-R14.

If <spec_reg> is FPSCR, it is also permitted to be APSR_nzcv, encoded as Rt = '1111'. This instruction transfers the [FPSCR](#).{N, Z, C, V} condition flags to the [APSR](#).{N, Z, C, V} condition flags.

<spec_reg> Is one of:

FPSID reg = '0000'.

FPSCR reg = '0001'.

MVFR1 reg = '0110'.

MVFR0 reg = '0111'.

FPEXC reg = '1000'.

If the Common VFP subarchitecture is implemented, see [Floating-point exception traps, serialization, and floating-point exception barriers on page G1-3501](#) for additional values of <spec_reg>.

The pre-UAL instruction FMSTAT is equivalent to VMRS APSR_nzcv, FPSCR.

Operation

```

if ConditionPassed() then
    EncodingSpecificOperations();
    if reg == '0001' then // FPSCR
        CheckVFPEnabled(TRUE); SerializeVFP(); VFPExcBarrier();
        if t == 15 then
            APSR.N = FPSR.N; APSR.Z = FPSR.Z; APSR.C = FPSR.C; APSR.V = FPSR.V;
        else
            R[t] = FPSCR;
    else // Non-FPSCR registers are accessible only at PL1 or above and not affected by FPEXC.EN
        CheckVFPEnabled(FALSE);
        if !CurrentModeIsNotUser() then
            UNDEFINED;
        else
            case reg of
                when '0000' SerializeVFP(); R[t] = FPSID;
                // Pseudocode does not consider possible trap of Non-secure FPSID access to Hyp mode
                // '0001' already handled
                when '001x', '010x' UNPREDICTABLE;
                when '0110' SerializeVFP(); R[t] = MVFR1;
                when '0111' SerializeVFP(); R[t] = MVFR0;
                when '1000' SerializeVFP(); R[t] = FPEXC;
                otherwise SUBARCHITECTURE_DEFINED register access;
            end case
        end if
    end if
end if
  
```

F7.4.22 VMSR

Move to Advanced SIMD and floating-point System register from general-purpose register moves the value of a general-purpose register to a floating-point System register.

Depending on settings in the CPACR, NSACR, HCPTR, and FPEXC registers, and the security state and mode in which the instruction is executed, an attempt to execute a VMSR instruction might be UNDEFINED, or trapped to Hyp mode. [Summary of general controls of CP10 and CP11 functionality on page G1-3496](#) and [Summary of access controls for Advanced SIMD functionality on page G1-3498](#) summarize these controls.

When these settings permit the execution of floating-point and Advanced SIMD instructions, if the specified floating-point System register is not the FPSCR, the instruction is UNDEFINED if executed in User mode.

———— **Note** —————

[VMSR on page F8-3234](#) describes the valid application level uses of the VMSR instruction.

Encoding T1/A1 VFPv2, VFPv3, VFPv4, Advanced SIMD

VMSR<c> <spec_reg>, <Rt>

15	14	13	12	11	10	9	8	7	6	5	4	3	2	1	0	15	14	13	12	11	10	9	8	7	6	5	4	3	2	1	0
1	1	1	0	1	1	1	0	1	1	1	0	reg			Rt	1	0	1	0	(0)	(0)	(0)	1	(0)	(0)	(0)	(0)				
31	30	29	28	27	26	25	24	23	22	21	20	19	18	17	16	15	14	13	12	11	10	9	8	7	6	5	4	3	2	1	0
cond		1	1	1	0	1	1	1	0	reg			Rt	1	0	1	0	(0)	(0)	(0)	1	(0)	(0)	(0)	(0)						

```
t = UInt(Rt);
if reg == '001x' || reg == '01xx' then UNPREDICTABLE;
if t == 15 then UNPREDICTABLE; // ARMv8-A removes UNPREDICTABLE for R13
```

For information about the CONSTRAINED UNPREDICTABLE behavior of this instruction, see [Appendix A Architectural Constraints on UNPREDICTABLE behaviors](#), and particularly [VMSR on page AppxA-4759](#).

Assembler syntax

VMSR{<c>}{<q>} <spec_reg>, <Rt>

where:

<c>, <q> See [Standard assembler syntax fields on page F2-2415](#).

<spec_reg> Is one of:

FPSID reg = '0000'.

FPSCR reg = '0001'.

FPEXC reg = '1000'.

If the Common VFP subarchitecture is implemented, see [Floating-point exception traps, serialization, and floating-point exception barriers on page G1-3501](#) for additional values of <spec_reg>.

<Rt> The general-purpose register to be transferred to <spec_reg>.

Operation

```
if ConditionPassed() then
    EncodingSpecificOperations();
    if reg == '0001' then // FPSCR
        CheckVFPEEnabled(TRUE); SerializeVFP(); VFPEXCBarrier();
        FPSCR = R[t];
    else // Non-FPSCR registers are accessible only at PL1 or above and not affected by FPEXC.EN
        CheckVFPEEnabled(FALSE);
        if !CurrentModeIsNotUser() then
            UNDEFINED;
        else
            case reg of
                // '001x', '01xx' dealt with in encoding-specific pseudocode
                // '0001' already dealt with above
                when '0000' SerializeVFP(); // FPSID is read-only
                when '1000' SerializeVFP(); FPEXC = R[t];
                otherwise SUBARCHITECTURE_DEFINED "register access";
```

Chapter F8

T32 and A32 Advanced SIMD and floating-point Instruction Descriptions

This chapter describes each instruction. It contains the following sections:

- [Alphabetical list of floating-point and Advanced SIMD instructions on page F8-3076.](#)

———— **Note** —————

Before ARMv8, the Advanced SIMD and floating-point instructions were added to the T32 and A32 instruction sets by the Advanced SIMD Extension and the Floating-point Extension, previously called VFP Extension. Instruction descriptions indicate the first version of the Floating-point extension (VFPv8) or Advanced SIMD Extension that included the instruction.

—————

F8.1 Alphabetical list of floating-point and Advanced SIMD instructions

This section lists every floating-point and Advanced SIMD instruction in the T32 and A32 instruction sets. For details of the format used see [Format of instruction descriptions on page F2-2410](#).

This section is formatted so that a full description of an instruction uses either a single page or two facing pages.

F8.1.1 AESD

AES single round decryption.

Encoding T1 ARMv8 Advanced SIMD

AESD.8 <Qd>, <Qm>

15	14	13	12	11	10	9	8	7	6	5	4	3	2	1	0	15	14	13	12	11	10	9	8	7	6	5	4	3	2	1	0
1	1	1	1	1	1	1	1	1	D	1	1	size	0	0		Vd	0	0	1	1	0	1	M	0		Vm					

```

if size != '00' then UNDEFINED;
if Vd<0> == '1' || Vm<0> == '1' then UNDEFINED;
d = UInt(D:Vd); m = UInt(M:Vm);
if InITBlock() then UNPREDICTABLE;
    
```

Encoding A1 ARMv8 Advanced SIMD

AESD.8 <Qd>, <Qm>

31	30	29	28	27	26	25	24	23	22	21	20	19	18	17	16	15	14	13	12	11	10	9	8	7	6	5	4	3	2	1	0
1	1	1	1	0	0	1	1	1	D	1	1	size	0	0		Vd	0	0	1	1	0	1	M	0		Vm					

```

if size != '00' then UNDEFINED;
if Vd<0> == '1' || Vm<0> == '1' then UNDEFINED;
d = UInt(D:Vd); m = UInt(M:Vm);
    
```

For information about the CONSTRAINED UNPREDICTABLE behavior of this instruction, see [Appendix A Architectural Constraints on UNPREDICTABLE behaviors](#).

Assembler syntax

AESD.8 <Qd>, <Qm>

where:

<Qd>, <Qm> The destination vector and the operand vector, for a quadword operation.

Operation

```

if ConditionPassed() then
    EncodingSpecificOperations(); CheckCryptoEnabled32();
    op1 = Q[d>>1]; op2 = Q[m>>1];
    Q[d>>1] = AESInvSubBytes(AESInvShiftRows(op1 EOR op2));
    
```

F8.1.2 AESE

AES single round encryption.

Encoding T1 ARMv8 Advanced SIMD

AESE.8 <Qd>, <Qm>

15	14	13	12	11	10	9	8	7	6	5	4	3	2	1	0	15	14	13	12	11	10	9	8	7	6	5	4	3	2	1	0
1	1	1	1	1	1	1	1	1	D	1	1	size	0	0		Vd	0	0	1	1	0	0	M	0		Vm					

```

if size != '00' then UNDEFINED;
if Vd<0> == '1' || Vm<0> == '1' then UNDEFINED;
d = UInt(D:Vd); m = UInt(M:Vm);
if InITBlock() then UNPREDICTABLE;
  
```

Encoding A1 ARMv8 Advanced SIMD

AESE.8 <Qd>, <Qm>

31	30	29	28	27	26	25	24	23	22	21	20	19	18	17	16	15	14	13	12	11	10	9	8	7	6	5	4	3	2	1	0
1	1	1	1	0	0	1	1	1	D	1	1	size	0	0		Vd	0	0	1	1	0	0	M	0		Vm					

```

if size != '00' then UNDEFINED;
if Vd<0> == '1' || Vm<0> == '1' then UNDEFINED;
d = UInt(D:Vd); m = UInt(M:Vm);
  
```

For information about the CONSTRAINED UNPREDICTABLE behavior of this instruction, see [Appendix A Architectural Constraints on UNPREDICTABLE behaviors](#).

Assembler syntax

AESE.8 <Qd>, <Qm>

where:

<Qd>, <Qm> The destination vector and the operand vector, for a quadword operation.

Operation

```

if ConditionPassed() then
  EncodingSpecificOperations(); CheckCryptoEnabled32();
  op1 = Q[d>>1]; op2 = Q[m>>1];
  Q[d>>1] = AESSubBytes(AESShiftRows(op1 EOR op2));
  
```

F8.1.3 AESIMC

AES inverse mix columns.

Encoding T1 ARMv8 Advanced SIMD

AESIMC.8 <Qd>, <Qm>

15	14	13	12	11	10	9	8	7	6	5	4	3	2	1	0	15	14	13	12	11	10	9	8	7	6	5	4	3	2	1	0
1	1	1	1	1	1	1	1	1	D	1	1	size	0	0		Vd	0	0	1	1	1	1	M	0		Vm	0				

```

if size != '00' then UNDEFINED;
if Vd<0> == '1' || Vm<0> == '1' then UNDEFINED;
d = UInt(D:Vd); m = UInt(M:Vm);
if InITBlock() then UNPREDICTABLE;
    
```

Encoding A1 ARMv8 Advanced SIMD

AESIMC.8 <Qd>, <Qm>

31	30	29	28	27	26	25	24	23	22	21	20	19	18	17	16	15	14	13	12	11	10	9	8	7	6	5	4	3	2	1	0
1	1	1	1	0	0	1	1	1	D	1	1	size	0	0		Vd	0	0	1	1	1	1	M	0		Vm	0				

```

if size != '00' then UNDEFINED;
if Vd<0> == '1' || Vm<0> == '1' then UNDEFINED;
d = UInt(D:Vd); m = UInt(M:Vm);
    
```

Assembler syntax

AESIMC.8 <Qd>, <Qm>

where:

<Qd>, <Qm> The destination vector and the operand vector, for a quadword operation.

Operation

```

if ConditionPassed() then
    EncodingSpecificOperations(); CheckCryptoEnabled32();
    op1 = Q[d>>1]; op2 = Q[m>>1];
    Q[d>>1] = AESSubBytes(AESShiftRows(op1 EOR op2));
    
```

F8.1.4 AESMC

AES mix columns.

Encoding T1 ARMv8 Advanced SIMD

AESMC.8 <Qd>, <Qm>

15	14	13	12	11	10	9	8	7	6	5	4	3	2	1	0	15	14	13	12	11	10	9	8	7	6	5	4	3	2	1	0
1	1	1	1	1	1	1	1	1	D	1	1	size	0	0	Vd	0	0	1	1	1	0	M	0	Vm							

```

if size != '00' then UNDEFINED;
if Vd<0> == '1' || Vm<0> == '1' then UNDEFINED;
d = UInt(D:Vd); m = UInt(M:Vm);
if InITBlock() then UNPREDICTABLE;
    
```

Encoding A1 ARMv8 Advanced SIMD

AESMC.8 <Qd>, <Qm>

31	30	29	28	27	26	25	24	23	22	21	20	19	18	17	16	15	14	13	12	11	10	9	8	7	6	5	4	3	2	1	0
1	1	1	1	0	0	1	1	1	D	1	1	size	0	0	Vd	0	0	1	1	1	0	M	0	Vm							

```

if size != '00' then UNDEFINED;
if Vd<0> == '1' || Vm<0> == '1' then UNDEFINED;
d = UInt(D:Vd); m = UInt(M:Vm);
    
```

For information about the CONSTRAINED UNPREDICTABLE behavior of this instruction, see [Appendix A Architectural Constraints on UNPREDICTABLE behaviors](#).

Assembler syntax

AESMC.8 <Qd>, <Qm>

where:

<Qd>, <Qm> The destination vector and the operand vector, for a quadword operation.

Operation

```

if ConditionPassed() then
    EncodingSpecificOperations(); CheckCryptoEnabled32();
    op1 = Q[d>>1]; op2 = Q[m>>1];
    Q[d>>1] = AESSubBytes(AESShiftRows(op1 EOR op2));
    
```

F8.1.5 F*, former floating-point instruction mnemonics

Before the introduction of UAL, the floating-point instructions had mnemonics starting with F. In UAL, most of these mnemonics are renamed to start with V. However, as this section describes, UAL does not define new mnemonics for the FLDMX and FSTMX instructions.

FLDMX, FSTMX

Encodings T1/A1 of the VLDM, VPOP, VPUSH, and VSTM instructions contain an imm8 field that is set to twice the number of doubleword registers to be transferred. ARM deprecates use of these encodings with an odd value in imm8, and there is no UAL syntax for them.

The pre-UAL mnemonics FLDMX and FSTMX result in the same instructions as FLDMD (VLDM.64 or VPOP.64) and FSTMD (VSTM.64 or VPUSH.64) respectively, except that imm8 is equal to twice the number of doubleword registers plus one:

- From ARMv6, ARM deprecates use of FLDMX and FSTMX, except for disassembly purposes, and for reassembly of disassembled code.
- If an FLDMX or FSTMX instruction accesses any register in the range D16-D32, the instruction is UNPREDICTABLE.

F8.1.6 SHA1C

SHA1 hash update (choose).

Encoding T1 ARMv8 Advanced SIMD

SHA1C.32 <Qd>, <Qn>, <Qm>

15	14	13	12	11	10	9	8	7	6	5	4	3	2	1	0	15	14	13	12	11	10	9	8	7	6	5	4	3	2	1	0
1	1	1	0	1	1	1	1	0	D	0	0	Vn				Vd	1	1	0	0	N	Q	M	0	Vm						

```

if Q != '1' then UNDEFINED;
if Vd<0> == '1' || Vn<0> == '1' || Vm<0> == '1' then UNDEFINED;
d = UInt(D:Vd); n = UInt(N:Vn); m = UInt(M:Vm);
if InITBlock() then UNPREDICTABLE;
    
```

Encoding A1 ARMv8 Advanced SIMD

SHA1C.32 <Qd>, <Qn>, <Qm>

31	30	29	28	27	26	25	24	23	22	21	20	19	18	17	16	15	14	13	12	11	10	9	8	7	6	5	4	3	2	1	0
1	1	1	1	0	0	1	0	0	D	0	0	Vn				Vd	1	1	0	0	N	Q	M	0	Vm						

```

if Q != '1' then UNDEFINED;
if Vd<0> == '1' || Vn<0> == '1' || Vm<0> == '1' then UNDEFINED;
d = UInt(D:Vd); n = UInt(N:Vn); m = UInt(M:Vm);
    
```

For information about the CONSTRAINED UNPREDICTABLE behavior of this instruction, see [Appendix A Architectural Constraints on UNPREDICTABLE behaviors](#).

Assembler syntax

SHA1C.32 <Qd>, <Qn>, <Qm>

where:

<Qd>, <Qn>, <Qm> The destination vector and the operand vectors, for a quadword operation.

Operation

```

if ConditionPassed() then
    EncodingSpecificOperations(); CheckCryptoEnabled32();
    X = Q[d>>1];
    Y = Q[n>>1]<31:0>; // Note: 32 bits wide
    W = Q[m>>1];
    for e = 0 to 3
        t = SHAchoose(X<63:32>, X<95:64>, X<127:96>);
        Y = Y + ROL(X<31:0>, 5) + t + Elem[W, e, 32];
        X<63:32> = ROL(X<63:32>, 30);
        <Y, X> = ROL(Y:X, 32);
    Q[d>>1] = X;
    
```

F8.1.7 SHA1H

SHA1 fixed rotate.

Encoding T1 ARMv8 Advanced SIMD

SHA1H.32 <Qd>, <Qm>

15	14	13	12	11	10	9	8	7	6	5	4	3	2	1	0	15	14	13	12	11	10	9	8	7	6	5	4	3	2	1	0
1	1	1	1	1	1	1	1	D	1	1	size	0	1		Vd	0	0	1	0	1	1	M	0		Vm						

```

if size != '10' then UNDEFINED;
if Vd<0> == '1' || Vm<0> == '1' then UNDEFINED;
d = UInt(D:Vd); m = UInt(M:Vm);
if InITBlock() then UNPREDICTABLE;
    
```

Encoding A1 ARMv8 Advanced SIMD

SHA1H.32 <Qd>, <Qm>

31	30	29	28	27	26	25	24	23	22	21	20	19	18	17	16	15	14	13	12	11	10	9	8	7	6	5	4	3	2	1	0
1	1	1	1	0	0	1	1	1	D	1	1	size	0	1		Vd	0	0	1	0	1	1	M	0		Vm					

```

if size != '10' then UNDEFINED;
if Vd<0> == '1' || Vm<0> == '1' then UNDEFINED;
d = UInt(D:Vd); m = UInt(M:Vm);
    
```

For information about the CONSTRAINED UNPREDICTABLE behavior of this instruction, see [Appendix A Architectural Constraints on UNPREDICTABLE behaviors](#).

Assembler syntax

SHA1H.32 <Qd>, <Qm>

where:

<Qd>, <Qm> The destination vector and the operand vectors, for a quadword operation.

Operation

```

if ConditionPassed() then
    EncodingSpecificOperations(); CheckCryptoEnabled32();
    Q[d>>1] = ZeroExtend(ROL(Q[m>>1]<31:0>, 30), 128);
    
```

F8.1.8 SHA1M

SHA1 hash update (majority).

Encoding T1 ARMv8 Advanced SIMD

SHA1M.32 <Qd>, <Qn>, <Qm>

15	14	13	12	11	10	9	8	7	6	5	4	3	2	1	0	15	14	13	12	11	10	9	8	7	6	5	4	3	2	1	0
1	1	1	0	1	1	1	1	0	D	1	0	Vn				Vd				1	1	0	0	N	Q	M	0	Vm			

```

if Q != '1' then UNDEFINED;
if Vd<0> == '1' || Vn<0> == '1' || Vm<0> == '1' then UNDEFINED;
d = UInt(D:Vd); n = UInt(N:Vn); m = UInt(M:Vm);
if InITBlock() then UNPREDICTABLE;
    
```

Encoding A1 ARMv8 Advanced SIMD

SHA1M.32 <Qd>, <Qn>, <Qm>

31	30	29	28	27	26	25	24	23	22	21	20	19	18	17	16	15	14	13	12	11	10	9	8	7	6	5	4	3	2	1	0
1	1	1	1	0	0	1	0	0	D	1	0	Vn				Vd				1	1	0	0	N	Q	M	0	Vm			

```

if Q != '1' then UNDEFINED;
if Vd<0> == '1' || Vn<0> == '1' || Vm<0> == '1' then UNDEFINED;
d = UInt(D:Vd); n = UInt(N:Vn); m = UInt(M:Vm);
    
```

For information about the CONSTRAINED UNPREDICTABLE behavior of this instruction, see [Appendix A Architectural Constraints on UNPREDICTABLE behaviors](#).

Assembler syntax

SHA1M.32 <Qd>, <Qn>, <Qm>

where:

<Qd>, <Qn>, <Qm> The destination vector and the operand vectors, for a quadword operation.

Operation

```

if ConditionPassed() then
    EncodingSpecificOperations(); CheckCryptoEnabled32();
    X = Q[d>>1];
    Y = Q[n>>1]<31:0>; // Note: 32 bits wide
    W = Q[m>>1];
    for e = 0 to 3
        t = SHAmajority(X<63:32>, X<95:64>, X<127:96>);
        Y = Y + ROL(X<31:0>, 5) + t + Elem[W, e, 32];
        X<63:32> = ROL(X<63:32>, 30);
        <Y, X> = ROL(Y:X, 32);
    Q[d>>1] = X;
    
```

F8.1.9 SHA1P

SHA1 hash update (parity).

Encoding T1 ARMv8 Advanced SIMD

SHA1P.32 <Qd>, <Qn>, <Qm>

15	14	13	12	11	10	9	8	7	6	5	4	3	2	1	0	15	14	13	12	11	10	9	8	7	6	5	4	3	2	1	0
1	1	1	0	1	1	1	1	0	D	0	1	Vn				Vd				1	1	0	0	N	Q	M	0	Vm			

```

if Q != '1' then UNDEFINED;
if Vd<0> == '1' || Vn<0> == '1' || Vm<0> == '1' then UNDEFINED;
d = UInt(D:Vd); n = UInt(N:Vn); m = UInt(M:Vm);
if InITBlock() then UNPREDICTABLE;
    
```

Encoding A1 ARMv8 Advanced SIMD

SHA1P.32 <Qd>, <Qn>, <Qm>

31	30	29	28	27	26	25	24	23	22	21	20	19	18	17	16	15	14	13	12	11	10	9	8	7	6	5	4	3	2	1	0
1	1	1	1	0	0	1	0	0	D	0	1	Vn				Vd				1	1	0	0	N	Q	M	0	Vm			

```

if Q != '1' then UNDEFINED;
if Vd<0> == '1' || Vn<0> == '1' || Vm<0> == '1' then UNDEFINED;
d = UInt(D:Vd); n = UInt(N:Vn); m = UInt(M:Vm);
    
```

For information about the CONSTRAINED UNPREDICTABLE behavior of this instruction, see [Appendix A Architectural Constraints on UNPREDICTABLE behaviors](#).

Assembler syntax

SHA1P.32 <Qd>, <Qn>, <Qm>

where:

<Qd>, <Qn>, <Qm> The destination vector and the operand vectors, for a quadword operation.

Operation

```

if ConditionPassed() then
    EncodingSpecificOperations(); CheckCryptoEnabled32();
    X = Q[d>>1];
    Y = Q[n>>1]<31:0>; // Note: 32 bits wide
    W = Q[m>>1];
    for e = 0 to 3
        t = SHAparity(X<63:32>, X<95:64>, X<127:96>);
        Y = Y + ROL(X<31:0>, 5) + t + Elem[W, e, 32];
        X<63:32> = ROL(X<63:32>, 30);
        <Y, X> = ROL(Y:X, 32);
    Q[d>>1] = X;
    
```

F8.1.10 SHA1SU0

SHA1 schedule update 0.

Encoding T1 ARMv8 Advanced SIMD

SHA1SU0.32 <Qd>, <Qn>, <Qm>

15	14	13	12	11	10	9	8	7	6	5	4	3	2	1	0	15	14	13	12	11	10	9	8	7	6	5	4	3	2	1	0
1	1	1	0	1	1	1	1	0	D	1	1	Vn				Vd				1	1	0	0	N	Q	M	0	Vm			

```

if Q != '1' then UNDEFINED;
if Vd<0> == '1' || Vn<0> == '1' || Vm<0> == '1' then UNDEFINED;
d = UInt(D:Vd); n = UInt(N:Vn); m = UInt(M:Vm);
if InITBlock() then UNPREDICTABLE;
    
```

Encoding A1 ARMv8 Advanced SIMD

SHA1SU0.32 <Qd>, <Qn>, <Qm>

31	30	29	28	27	26	25	24	23	22	21	20	19	18	17	16	15	14	13	12	11	10	9	8	7	6	5	4	3	2	1	0
1	1	1	1	0	0	1	0	0	D	1	1	Vn				Vd				1	1	0	0	N	Q	M	0	Vm			

```

if Q != '1' then UNDEFINED;
if Vd<0> == '1' || Vn<0> == '1' || Vm<0> == '1' then UNDEFINED;
d = UInt(D:Vd); n = UInt(N:Vn); m = UInt(M:Vm);
    
```

For information about the CONSTRAINED UNPREDICTABLE behavior of this instruction, see [Appendix A Architectural Constraints on UNPREDICTABLE behaviors](#).

Assembler syntax

SHA1SU0.32 <Qd>, <Qn>, <Qm>

where:

<Qd>, <Qn>, <Qm> The destination vector and the operand vectors, for a quadword operation.

Operation

```

if ConditionPassed() then
    EncodingSpecificOperations(); CheckCryptoEnabled32();
    op1 = Q[d>>1]; op2 = Q[n>>1]; op3 = Q[m>>1];
    op2 = op2<63:0> : op1<127:64>;
    Q[d>>1] = op1 EOR op2 EOR op3;
    
```

F8.1.11 SHA1SU1

SHA1 schedule update 1.

Encoding T1 ARMv8 Advanced SIMD

SHA1SU1.32 <Qd>, <Qm>

15	14	13	12	11	10	9	8	7	6	5	4	3	2	1	0	15	14	13	12	11	10	9	8	7	6	5	4	3	2	1	0
1	1	1	1	1	1	1	1	1	D	1	1	size	1	0		Vd	0	0	1	1	1	0	M	0		Vm					

```

if size != '10' then UNDEFINED;
if Vd<0> == '1' || Vm<0> == '1' then UNDEFINED;
d = UInt(D:Vd); m = UInt(M:Vm);
if InITBlock() then UNPREDICTABLE;
    
```

Encoding A1 ARMv8 Advanced SIMD

SHA1SU1.32 <Qd>, <Qm>

31	30	29	28	27	26	25	24	23	22	21	20	19	18	17	16	15	14	13	12	11	10	9	8	7	6	5	4	3	2	1	0
1	1	1	1	0	0	1	1	1	D	1	1	size	1	0		Vd	0	0	1	1	1	0	M	0		Vm					

```

if size != '10' then UNDEFINED;
if Vd<0> == '1' || Vm<0> == '1' then UNDEFINED;
d = UInt(D:Vd); m = UInt(M:Vm);
    
```

For information about the CONSTRAINED UNPREDICTABLE behavior of this instruction, see [Appendix A Architectural Constraints on UNPREDICTABLE behaviors](#).

Assembler syntax

SHA1SU1.32 <Qd>, <Qm>

where:

<Qd>, <Qm> The destination vector and the operand vectors, for a quadword operation.

Operation

```

if ConditionPassed() then
    EncodingSpecificOperations(); CheckCryptoEnabled32();
    X = Q[d>>1]; Y = Q[m>>1];
    T = X EOR LSR(Y, 32);
    W0 = ROL(T<31:0>, 1);
    W1 = ROL(T<63:32>, 1);
    W2 = ROL(T<95:64>, 1);
    W3 = ROL(T<127:96>, 1) EOR ROL(T<31:0>, 2);
    Q[d>>1] = W3:W2:W1:W0;
    
```

F8.1.12 SHA256H

SHA256 hash update part 1.

Encoding T1 ARMv8 Advanced SIMD

SHA256H.32 <Qd>, <Qn>, <Qm>

15	14	13	12	11	10	9	8	7	6	5	4	3	2	1	0	15	14	13	12	11	10	9	8	7	6	5	4	3	2	1	0
1	1	1	1	1	1	1	1	0	D	0	0	Vn			Vd			1	1	0	0	N	Q	M	0	Vm					

```

if Q != '1' then UNDEFINED;
if Vd<0> == '1' || Vn<0> == '1' || Vm<0> == '1' then UNDEFINED;
d = UInt(D:Vd); n = UInt(N:Vn); m = UInt(M:Vm);
if InITBlock() then UNPREDICTABLE;
    
```

Encoding A1 ARMv8 Advanced SIMD

SHA256H.32 <Qd>, <Qn>, <Qm>

31	30	29	28	27	26	25	24	23	22	21	20	19	18	17	16	15	14	13	12	11	10	9	8	7	6	5	4	3	2	1	0
1	1	1	1	0	0	1	1	0	D	0	0	Vn			Vd			1	1	0	0	N	Q	M	0	Vm					

```

if Q != '1' then UNDEFINED;
if Vd<0> == '1' || Vn<0> == '1' || Vm<0> == '1' then UNDEFINED;
d = UInt(D:Vd); n = UInt(N:Vn); m = UInt(M:Vm);
    
```

For information about the CONSTRAINED UNPREDICTABLE behavior of this instruction, see [Appendix A Architectural Constraints on UNPREDICTABLE behaviors](#).

Assembler syntax

SHA256H.32 <Qd>, <Qn>, <Qm>

where:

<Qd>, <Qn>, <Qm> The destination vector and the operand vectors, for a quadword operation.

Operation

```

if ConditionPassed() then
    EncodingSpecificOperations(); CheckCryptoEnabled32();
    X = Q[d>>1]; Y = Q[n>>1]; W = Q[m>>1]; part1 = TRUE;
    Q[d>>1] = SHA256hash(X, Y, W, part1);
    
```

F8.1.13 SHA256H2

SHA256 hash update part 2.

Encoding T1 ARMv8 Advanced SIMD

SHA256H2.32 <Qd>, <Qn>, <Qm>

15	14	13	12	11	10	9	8	7	6	5	4	3	2	1	0	15	14	13	12	11	10	9	8	7	6	5	4	3	2	1	0
1	1	1	1	1	1	1	1	0	D	0	1	Vn				Vd				1	1	0	0	N	Q	M	0	Vm			

```

if Q != '1' then UNDEFINED;
if Vd<0> == '1' || Vn<0> == '1' || Vm<0> == '1' then UNDEFINED;
d = UInt(D:Vd); n = UInt(N:Vn); m = UInt(M:Vm);
if InITBlock() then UNPREDICTABLE;
    
```

Encoding A1 ARMv8 Advanced SIMD

SHA256H2.32 <Qd>, <Qn>, <Qm>

31	30	29	28	27	26	25	24	23	22	21	20	19	18	17	16	15	14	13	12	11	10	9	8	7	6	5	4	3	2	1	0
1	1	1	1	0	0	1	1	0	D	0	1	Vn				Vd				1	1	0	0	N	Q	M	0	Vm			

```

if Q != '1' then UNDEFINED;
if Vd<0> == '1' || Vn<0> == '1' || Vm<0> == '1' then UNDEFINED;
d = UInt(D:Vd); n = UInt(N:Vn); m = UInt(M:Vm);
    
```

For information about the CONSTRAINED UNPREDICTABLE behavior of this instruction, see [Appendix A Architectural Constraints on UNPREDICTABLE behaviors](#).

Assembler syntax

SHA256H2.32 <Qd>, <Qn>, <Qm>

where:

<Qd>, <Qn>, <Qm> The destination vector and the operand vectors, for a quadword operation.

Operation

```

if ConditionPassed() then
    EncodingSpecificOperations(); CheckCryptoEnabled32();
    X = Q[d>>1]; Y = Q[n>>1]; W = Q[m>>1]; part1 = FALSE;
    Q[d>>1] = SHA256hash(X, Y, W, part1);
    
```

F8.1.14 SHA256SU0

SHA256 schedule update 0.

Encoding T1 ARMv8 Advanced SIMD

SHA256SU0.32 <Qd>, <Qm>

15	14	13	12	11	10	9	8	7	6	5	4	3	2	1	0	15	14	13	12	11	10	9	8	7	6	5	4	3	2	1	0
1	1	1	1	1	1	1	1	D	1	1	size	1	0		Vd	0	0	1	1	1	1	M	0		Vm						

```

if size != '10' then UNDEFINED;
if Vd<0> == '1' || Vm<0> == '1' then UNDEFINED;
d = UInt(D:Vd); m = UInt(M:Vm);
if InITBlock() then UNPREDICTABLE;
    
```

Encoding A1 ARMv8 Advanced SIMD

SHA256SU0.32 <Qd>, <Qm>

31	30	29	28	27	26	25	24	23	22	21	20	19	18	17	16	15	14	13	12	11	10	9	8	7	6	5	4	3	2	1	0
1	1	1	1	0	0	1	1	1	D	1	1	size	1	0		Vd	0	0	1	1	1	1	M	0		Vm					

```

if size != '10' then UNDEFINED;
if Vd<0> == '1' || Vm<0> == '1' then UNDEFINED;
d = UInt(D:Vd); m = UInt(M:Vm);
    
```

For information about the CONSTRAINED UNPREDICTABLE behavior of this instruction, see [Appendix A Architectural Constraints on UNPREDICTABLE behaviors](#).

Assembler syntax

SHA256SU0.32 <Qd>, <Qm>

where:

<Qd>, <Qm> The destination vector and the operand vectors, for a quadword operation.

Operation

```

if ConditionPassed() then
    bits(128) result;
    EncodingSpecificOperations(); CheckCryptoEnabled32();
    X = Q[d>>1]; Y = Q[m>>1];
    T = Y<31:0> : X<127:32>;
    for e = 0 to 3
        elt = Elem[T, e, 32];
        elt = ROR(elt, 7) EOR ROR(elt, 18) EOR LSR(elt, 3);
        Elem[result, e, 32] = elt + Elem[X, e, 32];
    Q[d>>1] = result;
    
```

F8.1.15 SHA256SU1

SHA256 schedule update 1.

Encoding T1 ARMv8 Advanced SIMD

SHA256SU1.32 <Qd>, <Qn>, <Qm>

15	14	13	12	11	10	9	8	7	6	5	4	3	2	1	0	15	14	13	12	11	10	9	8	7	6	5	4	3	2	1	0
1	1	1	1	1	1	1	1	0	D	1	0	Vn				Vd				1	1	0	0	N	Q	M	0	Vm			

if Q != '1' then UNDEFINED;
 if Vd<0> == '1' || Vn<0> == '1' || Vm<0> == '1' then UNDEFINED;
 d = UInt(D:Vd); n = UInt(N:Vn); m = UInt(M:Vm);
 if InITBlock() then UNPREDICTABLE;

Encoding A1 ARMv8 Advanced SIMD

SHA256SU1.32 <Qd>, <Qn>, <Qm>

31	30	29	28	27	26	25	24	23	22	21	20	19	18	17	16	15	14	13	12	11	10	9	8	7	6	5	4	3	2	1	0
1	1	1	1	0	0	1	1	0	D	1	0	Vn				Vd				1	1	0	0	N	Q	M	0	Vm			

if Q != '1' then UNDEFINED;
 if Vd<0> == '1' || Vn<0> == '1' || Vm<0> == '1' then UNDEFINED;
 d = UInt(D:Vd); n = UInt(N:Vn); m = UInt(M:Vm);

For information about the CONSTRAINED UNPREDICTABLE behavior of this instruction, see [Appendix A Architectural Constraints on UNPREDICTABLE behaviors](#).

Assembler syntax

SHA256SU1.32 <Qd>, <Qn>, <Qm>

where:

<Qd>, <Qn>, <Qm> The destination vector and the operand vectors, for a quadword operation.

Operation

```
if ConditionPassed() then
    bits(128) result;
    EncodingSpecificOperations(); CheckCryptoEnabled32();
    X = Q[d>>1]; Y = Q[n>>1]; Z = Q[m>>1];
    T0 = Z<31:0> : Y<127:32>;

    T1 = Z<127:64>;
    for e = 0 to 1
        elt = Elem[T1, e, 32];
        elt = ROR(elt, 17) EOR ROR(elt, 19) EOR LSR(elt, 10);
        elt = elt + Elem[X, e, 32] + Elem[T0, e, 32];
        Elem[result, e, 32] = elt;

    T1 = result<63:0>;
    for e = 2 to 3
        elt = Elem[T1, e - 2, 32];
        elt = ROR(elt, 17) EOR ROR(elt, 19) EOR LSR(elt, 10);
        elt = elt + Elem[X, e, 32] + Elem[T0, e, 32];
        Elem[result, e, 32] = elt;

Q[d>>1] = result;
```

F8.1.16 VABA, VABAL

Vector Absolute Difference and Accumulate {Long} subtracts the elements of one vector from the corresponding elements of another vector, and accumulates the absolute values of the results into the elements of the destination vector.

Operand and result elements are either all integers of the same length, or optionally the results can be double the length of the operands.

Depending on settings in the CPACR, NSACR, and HCPTR registers, and the security state and mode in which the instruction is executed, an attempt to execute the instruction might be UNDEFINED, or trapped to Hyp mode. [Summary of access controls for Advanced SIMD functionality on page G1-3498](#) summarizes these controls.

ARM deprecates the conditional execution of any Advanced SIMD instruction that is not also available as a VFP instruction, see [Conditional execution on page F2-2416](#).

Encoding T1/A1 Advanced SIMDv1

VABA<c>.<dt> <Qd>, <Qn>, <Qm>

VABA<c>.<dt> <Dd>, <Dn>, <Dm>

15	14	13	12	11	10	9	8	7	6	5	4	3	2	1	0	15	14	13	12	11	10	9	8	7	6	5	4	3	2	1	0
1	1	1	U	1	1	1	1	0	D	size	Vn	Vd	0	1	1	1	N	Q	M	1	Vm										
31	30	29	28	27	26	25	24	23	22	21	20	19	18	17	16	15	14	13	12	11	10	9	8	7	6	5	4	3	2	1	0
1	1	1	1	0	0	1	U	0	D	size	Vn	Vd	0	1	1	1	N	Q	M	1	Vm										

```

if size == '11' then UNDEFINED;
if Q == '1' && (Vd<0> == '1' || Vn<0> == '1' || Vm<0> == '1') then UNDEFINED;
unsigned = (U == '1'); long_destination = FALSE;
esize = 8 << UInt(size); elements = 64 DIV esize;
d = UInt(D:Vd); n = UInt(N:Vn); m = UInt(M:Vm); regs = if Q == '0' then 1 else 2;
    
```

Encoding T2/A2 Advanced SIMDv1

VABAL<c>.<dt> <Qd>, <Dn>, <Dm>

15	14	13	12	11	10	9	8	7	6	5	4	3	2	1	0	15	14	13	12	11	10	9	8	7	6	5	4	3	2	1	0
1	1	1	U	1	1	1	1	1	D	size	Vn	Vd	0	1	0	1	N	0	M	0	Vm										
31	30	29	28	27	26	25	24	23	22	21	20	19	18	17	16	15	14	13	12	11	10	9	8	7	6	5	4	3	2	1	0
1	1	1	1	0	0	1	U	1	D	size	Vn	Vd	0	1	0	1	N	0	M	0	Vm										

```

if size == '11' then SEE "Related encodings";
if Vd<0> == '1' then UNDEFINED;
unsigned = (U == '1'); long_destination = TRUE;
esize = 8 << UInt(size); elements = 64 DIV esize;
d = UInt(D:Vd); n = UInt(N:Vn); m = UInt(M:Vm); regs = 1;
    
```

Related encodings See [Advanced SIMD data-processing instructions on page F5-2499](#).

Assembler syntax

VABA{<c>}{<q>}.<dt> <Qd>, <Qn>, <Qm> Encoding T1/A1, Q = 1
 VABA{<c>}{<q>}.<dt> <Dd>, <Dn>, <Dm> Encoding T1/A1, Q = 0
 VABAL{<c>}{<q>}.<dt> <Qd>, <Dn>, <Dm> Encoding T2/A2

where:

<c>, <q> See [Standard assembler syntax fields on page F2-2415](#). An A32 VABA or VABAL instruction must be unconditional. ARM strongly recommends that a T32 VABA or VABAL instruction is unconditional, see [Conditional execution on page F2-2416](#).

<dt> The data type for the elements of the operands. It must be one of:
 S8 Encoded as size = 0b00, U = 0.
 S16 Encoded as size = 0b01, U = 0.
 S32 Encoded as size = 0b10, U = 0.
 U8 Encoded as size = 0b00, U = 1.
 U16 Encoded as size = 0b01, U = 1.
 U32 Encoded as size = 0b10, U = 1.

<Qd>, <Qn>, <Qm> The destination vector and the operand vectors, for a quadword operation.

<Dd>, <Dn>, <Dm> The destination vector and the operand vectors, for a doubleword operation.

<Qd>, <Dn>, <Dm> The destination vector and the operand vectors, for a long operation.

Operation

```

if ConditionPassed() then
  EncodingSpecificOperations(); CheckAdvSIMDEnabled();
  for r = 0 to regs-1
    for e = 0 to elements-1
      op1 = Elem[Din[n+r],e,esize];
      op2 = Elem[Din[m+r],e,esize];
      absdiff = Abs(Int(op1,unsigned) - Int(op2,unsigned));
      if long_destination then
        Elem[Q[d>>1],e,2*esize] = Elem[Qin[d>>1],e,2*esize] + absdiff;
      else
        Elem[D[d+r],e,esize] = Elem[Din[d+r],e,esize] + absdiff;
  
```

F8.1.17 VABD, VABDL (integer)

Vector Absolute Difference {Long} (integer) subtracts the elements of one vector from the corresponding elements of another vector, and places the absolute values of the results in the elements of the destination vector.

Operand and result elements are either all integers of the same length, or optionally the results can be double the length of the operands.

Depending on settings in the CPACR, NSACR, and HCPTR registers, and the security state and mode in which the instruction is executed, an attempt to execute the instruction might be UNDEFINED, or trapped to Hyp mode.

[Summary of access controls for Advanced SIMD functionality on page G1-3498](#) summarizes these controls.

ARM deprecates the conditional execution of any Advanced SIMD instruction that is not also available as a VFP instruction, see [Conditional execution on page F2-2416](#).

Encoding T1/A1 Advanced SIMDv1

VABD<c>.<dt> <Qd>, <Qn>, <Qm>

VABD<c>.<dt> <Dd>, <Dn>, <Dm>

15	14	13	12	11	10	9	8	7	6	5	4	3	2	1	0	15	14	13	12	11	10	9	8	7	6	5	4	3	2	1	0
1	1	1	U	1	1	1	1	0	D	size	Vn	Vd	0	1	1	1	N	Q	M	0	Vm										

31	30	29	28	27	26	25	24	23	22	21	20	19	18	17	16	15	14	13	12	11	10	9	8	7	6	5	4	3	2	1	0
1	1	1	1	0	0	1	U	0	D	size	Vn	Vd	0	1	1	1	N	Q	M	0	Vm										

```

if size == '11' then UNDEFINED;
if Q == '1' && (Vd<0> == '1' || Vn<0> == '1' || Vm<0> == '1') then UNDEFINED;
unsigned = (U == '1'); long_destination = FALSE;
esize = 8 << UInt(size); elements = 64 DIV esize;
d = UInt(D:Vd); n = UInt(N:Vn); m = UInt(M:Vm); regs = if Q == '0' then 1 else 2;
    
```

Encoding T2/A2 Advanced SIMDv1

VABDL<c>.<dt> <Qd>, <Dn>, <Dm>

15	14	13	12	11	10	9	8	7	6	5	4	3	2	1	0	15	14	13	12	11	10	9	8	7	6	5	4	3	2	1	0
1	1	1	U	1	1	1	1	1	D	size	Vn	Vd	0	1	1	1	N	0	M	0	Vm										

31	30	29	28	27	26	25	24	23	22	21	20	19	18	17	16	15	14	13	12	11	10	9	8	7	6	5	4	3	2	1	0
1	1	1	1	0	0	1	U	1	D	size	Vn	Vd	0	1	1	1	N	0	M	0	Vm										

```

if size == '11' then SEE "Related encodings";
if Vd<0> == '1' then UNDEFINED;
unsigned = (U == '1'); long_destination = TRUE;
esize = 8 << UInt(size); elements = 64 DIV esize;
d = UInt(D:Vd); n = UInt(N:Vn); m = UInt(M:Vm); regs = 1;
    
```

Related encodings See [Advanced SIMD data-processing instructions on page F5-2499](#).

Assembler syntax

VABD{<c>}{<q>}.<dt> {<Qd>, }<Qn>, <Qm> Encoding T1/A1, Q = 1
 VABD{<c>}{<q>}.<dt> {<Dd>, }<Dn>, <Dm> Encoding T1/A1, Q = 0
 VABDL{<c>}{<q>}.<dt> <Qd>, <Dn>, <Dm> Encoding T2/A2

where:

<c>, <q> See [Standard assembler syntax fields on page F2-2415](#). An A32 VABD or VABDL instruction must be unconditional. ARM strongly recommends that a T32 VABD or VABDL instruction is unconditional, see [Conditional execution on page F2-2416](#).

<dt> The data type for the elements of the operands. It must be one of:
 S8 Encoded as size = 0b00, U = 0.
 S16 Encoded as size = 0b01, U = 0.
 S32 Encoded as size = 0b10, U = 0.
 U8 Encoded as size = 0b00, U = 1.
 U16 Encoded as size = 0b01, U = 1.
 U32 Encoded as size = 0b10, U = 1.

<Qd>, <Qn>, <Qm> The destination vector and the operand vectors, for a quadword operation.

<Dd>, <Dn>, <Dm> The destination vector and the operand vectors, for a doubleword operation.

<Qd>, <Dn>, <Dm> The destination vector and the operand vectors, for a long operation.

Operation

```

if ConditionPassed() then
    EncodingSpecificOperations(); CheckAdvSIMDEnabled();
    for r = 0 to regs-1
        for e = 0 to elements-1
            op1 = Elem[Din[n+r],e,esize];
            op2 = Elem[Din[m+r],e,esize];
            absdiff = Abs(Int(op1,unsigned) - Int(op2,unsigned));
            if long_destination then
                Elem[Q[d>>1],e,2*esize] = absdiff<2*esize-1:0>;
            else
                Elem[D[d+r],e,esize] = absdiff<esize-1:0>;
  
```

F8.1.18 VABD (floating-point)

Vector Absolute Difference (floating-point) subtracts the elements of one vector from the corresponding elements of another vector, and places the absolute values of the results in the elements of the destination vector.

Operand and result elements are all single-precision floating-point numbers.

Depending on settings in the CPACR, NSACR, and HCPTR registers, and the security state and mode in which the instruction is executed, an attempt to execute the instruction might be UNDEFINED, or trapped to Hyp mode. [Summary of access controls for Advanced SIMD functionality on page G1-3498](#) summarizes these controls.

ARM deprecates the conditional execution of any Advanced SIMD instruction that is not also available as a VFP instruction, see [Conditional execution on page F2-2416](#).

Encoding T1/A1 Advanced SIMDv1 (UNDEFINED in integer-only variant)

VABD<c>.F32 <Qd>, <Qn>, <Qm>

VABD<c>.F32 <Dd>, <Dn>, <Dm>

15	14	13	12	11	10	9	8	7	6	5	4	3	2	1	0	15	14	13	12	11	10	9	8	7	6	5	4	3	2	1	0
1	1	1	1	1	1	1	1	0	D	1	sz	Vn				Vd				1	1	0	1	N	Q	M	0	Vm			

31	30	29	28	27	26	25	24	23	22	21	20	19	18	17	16	15	14	13	12	11	10	9	8	7	6	5	4	3	2	1	0
1	1	1	1	0	0	1	1	0	D	1	sz	Vn				Vd				1	1	0	1	N	Q	M	0	Vm			

```

if Q == '1' && (Vd<0> == '1' || Vn<0> == '1' || Vm<0> == '1') then UNDEFINED;
if sz == '1' then UNDEFINED;
esize = 32; elements = 2;
d = UInt(D:Vd); n = UInt(N:Vn); m = UInt(M:Vm); regs = if Q == '0' then 1 else 2;
    
```

Assembler syntax

VABD{<c>}{<q>}.F32 {<Qd>, }<Qn>, <Qm> Encoded as Q = 1, sz = 0
VABD{<c>}{<q>}.F32 {<Dd>, }<Dn>, <Dm> Encoded as Q = 0, sz = 0

where:

<c>, <q> See [Standard assembler syntax fields on page F2-2415](#). An A32 VABD instruction must be unconditional. ARM strongly recommends that a T32 VABD instruction is unconditional, see [Conditional execution on page F2-2416](#).

<Qd>, <Qn>, <Qm> The destination vector and the operand vectors, for a quadword operation.

<Dd>, <Dn>, <Dm> The destination vector and the operand vectors, for a doubleword operation.

Operation

```
if ConditionPassed() then
    EncodingSpecificOperations(); CheckAdvSIMDEnabled();
    for r = 0 to regs-1
        for e = 0 to elements-1
            op1 = Elem[D[n+r],e,esize]; op2 = Elem[D[m+r],e,esize];
            Elem[D[d+r],e,esize] = FPAbs(FPSub(op1,op2,StandardFPCRValue()));
```

F8.1.19 VABS

Vector Absolute takes the absolute value of each element in a vector, and places the results in a second vector. The floating-point version only clears the sign bit.

Depending on settings in the CPACR, NSACR, and HCPTR, and FPEXC registers, and the security state and mode in which the instruction is executed, an attempt to execute the instruction might be UNDEFINED, or trapped to Hyp mode. [Summary of general controls of CP10 and CP11 functionality on page G1-3496](#) and [Summary of access controls for Advanced SIMD functionality on page G1-3498](#) summarize these controls.

ARM deprecates the conditional execution of any Advanced SIMD instruction that is not also available as a VFP instruction, see [Conditional execution on page F2-2416](#).

Encoding T1/A1 Advanced SIMDv1 (F = 1 UNDEFINED in integer-only variants)

VABS<c>.<dt> <Qd>, <Qm>

VABS<c>.<dt> <Dd>, <Dm>

15	14	13	12	11	10	9	8	7	6	5	4	3	2	1	0	15	14	13	12	11	10	9	8	7	6	5	4	3	2	1	0
1	1	1	1	1	1	1	1	1	D	1	1	size	0	1	Vd	0	F	1	1	0	Q	M	0	Vm							

31	30	29	28	27	26	25	24	23	22	21	20	19	18	17	16	15	14	13	12	11	10	9	8	7	6	5	4	3	2	1	0
1	1	1	1	0	0	1	1	1	D	1	1	size	0	1	Vd	0	F	1	1	0	Q	M	0	Vm							

```
if size == '11' || (F == '1' && size != '10') then UNDEFINED;
if Q == '1' && (Vd<0> == '1' || Vm<0> == '1') then UNDEFINED;
advsimd = TRUE; floating_point = (F == '1');
esize = 8 << UInt(size); elements = 64 DIV esize;
d = UInt(D:Vd); m = UInt(M:Vm); regs = if Q == '0' then 1 else 2;
```

Encoding T2/A2 VFPv2, VFPv3, VFPv4 (sz = 1 UNDEFINED in single-precision only variants)

VABS<c>.<F64> <Dd>, <Dm>

VABS<c>.<F32> <Sd>, <Sm>

15	14	13	12	11	10	9	8	7	6	5	4	3	2	1	0	15	14	13	12	11	10	9	8	7	6	5	4	3	2	1	0
1	1	1	0	1	1	1	0	1	D	1	1	0	0	0	0	Vd	1	0	1	sz	1	1	M	0	Vm						

31	30	29	28	27	26	25	24	23	22	21	20	19	18	17	16	15	14	13	12	11	10	9	8	7	6	5	4	3	2	1	0
cond		1	1	1	0	1	D	1	1	0	0	0	0	0	Vd	1	0	1	sz	1	1	M	0	Vm							

```
if FPSCR.Len != '000' || FPSCR.Stride != '00' then UNDEFINED;
advsimd = FALSE; dp_operation = (sz == '1');
d = if dp_operation then UInt(D:Vd) else UInt(Vd:D);
m = if dp_operation then UInt(M:Vm) else UInt(Vm:M);
```

Assembler syntax

VABS{<c>}{<q>}.<dt> <Qd>, <Qm>	Encoding T1/A1
VABS{<c>}{<q>}.<dt> <Dd>, <Dm>	Encoding T1/A1
VABS{<c>}{<q>}.F32 <Sd>, <Sm>	Floating-point only, encoding T2/A2, encoded as sz = 0
VABS{<c>}{<q>}.F64 <Dd>, <Dm>	Encoding T2/A2, encoded as sz = 1

where:

<c>, <q>	See Standard assembler syntax fields on page F2-2415 . An A32 Advanced SIMD VABS instruction must be unconditional. ARM strongly recommends that a T32 Advanced SIMD VABS instruction is unconditional, see Conditional execution on page F2-2416 .
<dt>	The data type for the elements of the vectors. It must be one of: S8 Encoded as size = 0b00, F = 0. S16 Encoded as size = 0b01, F = 0. S32 Encoded as size = 0b10, F = 0. F32 Encoded as size = 0b10, F = 1.
<Qd>, <Qm>	The destination vector and the operand vector, for a quadword operation.
<Dd>, <Dm>	The destination vector and the operand vector, for a doubleword operation.
<Sd>, <Sm>	The destination vector and the operand vector, for a singleword operation.

Operation

```

if ConditionPassed() then
    EncodingSpecificOperations(); CheckAdvSIMDorVFPEEnabled(TRUE, advsimd);
    if advsimd then // Advanced SIMD instruction
        for r = 0 to regs-1
            for e = 0 to elements-1
                if floating_point then
                    Elem[D[d+r],e,esize] = FPAbs(Elem[D[m+r],e,esize]);
                else
                    result = Abs(SInt(Elem[D[m+r],e,esize]));
                    Elem[D[d+r],e,esize] = result<esize-1:0>;
    else // VFP instruction
        if dp_operation then
            D[d] = FPAbs(D[m]);
        else
            S[d] = FPAbs(S[m]);
  
```

F8.1.20 VACGE, VACGT, VACLE, VACL

VACGE (Vector Absolute Compare Greater Than or Equal) and VACGT (Vector Absolute Compare Greater Than) take the absolute value of each element in a vector, and compare it with the absolute value of the corresponding element of a second vector. If the condition is true, the corresponding element in the destination vector is set to all ones. Otherwise, it is set to all zeros.

VACLE (Vector Absolute Compare Less Than or Equal) is a pseudo-instruction, equivalent to a VACGE instruction with the operands reversed. Disassembly produces the VACGE instruction.

VACL (Vector Absolute Compare Less Than) is a pseudo-instruction, equivalent to a VACGT instruction with the operands reversed. Disassembly produces the VACGT instruction.

The operands and result can be quadword or doubleword vectors. They must all be the same size.

The operand vector elements must be 32-bit floating-point numbers.

The result vector elements are 32-bit fields.

Depending on settings in the CPACR, NSACR, and HCPTR registers, and the security state and mode in which the instruction is executed, an attempt to execute the instruction might be UNDEFINED, or trapped to Hyp mode.

[Summary of access controls for Advanced SIMD functionality on page G1-3498](#) summarizes these controls.

ARM deprecates the conditional execution of any Advanced SIMD instruction that is not also available as a VFP instruction, see [Conditional execution on page F2-2416](#).

Encoding T1/A1 Advanced SIMDv1 (UNDEFINED in integer-only variant)

V<op><c>.F32 <Qd>, <Qn>, <Qm>

V<op><c>.F32 <Dd>, <Dn>, <Dm>

15	14	13	12	11	10	9	8	7	6	5	4	3	2	1	0	15	14	13	12	11	10	9	8	7	6	5	4	3	2	1	0
1	1	1	1	1	1	1	1	0	D	op	sz	Vn			Vd			1	1	1	0	N	Q	M	1	Vm					

31	30	29	28	27	26	25	24	23	22	21	20	19	18	17	16	15	14	13	12	11	10	9	8	7	6	5	4	3	2	1	0
1	1	1	1	0	0	1	1	0	D	op	sz	Vn			Vd			1	1	1	0	N	Q	M	1	Vm					

```

if Q == '1' && (Vd<0> == '1' || Vn<0> == '1' || Vm<0> == '1') then UNDEFINED;
if sz == '1' then UNDEFINED;
or_equal = (op == '0');  esize = 32;  elements = 2;
d = UInt(D:Vd);  n = UInt(N:Vn);  m = UInt(M:Vm);  regs = if Q == '0' then 1 else 2;
    
```

Assembler syntax

V<op>{<c>}{<q>}.F32 {<Qd>}, <Qn>, <Qm> Encoded as Q = 1
 V<op>{<c>}{<q>}.F32 {<Dd>}, <Dn>, <Dm> Encoded as Q = 0

where:

<op> The operation. It must be one of:
 ACGE Absolute Compare Greater than or Equal, encoded as op = 0.
 ACGT Absolute Compare Greater Than, encoded as op = 1.

<c>, <q> See [Standard assembler syntax fields on page F2-2415](#). An A32 VACGE, VACGT, VACLE, or VACLT instruction must be unconditional. ARM strongly recommends that a T32 VACGE, VACGT, VACLE, or VACLT instruction is unconditional, see [Conditional execution on page F2-2416](#).

<Qd>, <Qn>, <Qm> The destination vector and the operand vectors, for a quadword operation.

<Dd>, <Dn>, <Dm> The destination vector and the operand vectors, for a doubleword operation.

Operation

```

if ConditionPassed() then
    EncodingSpecificOperations(); CheckAdvSIMDEnabled();
    for r = 0 to regs-1
        for e = 0 to elements-1
            op1 = FPAbs(ElEm[D[n+r],e,esize]); op2 = FPAbs(ElEm[D[m+r],e,esize]);
            if or_equal then
                test_passed = FPCompareGE(op1, op2, StandardFPSCRValue());
            else
                test_passed = FPCompareGT(op1, op2, StandardFPSCRValue());
            ElEm[D[d+r],e,esize] = if test_passed then Ones(esize) else Zeros(esize);
  
```

F8.1.21 VADD (integer)

Vector Add adds corresponding elements in two vectors, and places the results in the destination vector.

Depending on settings in the CPACR, NSACR, and HCPTR registers, and the security state and mode in which the instruction is executed, an attempt to execute the instruction might be UNDEFINED, or trapped to Hyp mode.

[Summary of access controls for Advanced SIMD functionality on page G1-3498](#) summarizes these controls.

ARM deprecates the conditional execution of any Advanced SIMD instruction encoding that is not also available as a VFP instruction encoding, see [Conditional execution on page F2-2416](#).

Encoding T1/A1 Advanced SIMDv1

VADD<c>.<dt> <Qd>, <Qn>, <Qm>

VADD<c>.<dt> <Dd>, <Dn>, <Dm>

15	14	13	12	11	10	9	8	7	6	5	4	3	2	1	0	15	14	13	12	11	10	9	8	7	6	5	4	3	2	1	0
1	1	1	0	1	1	1	1	0	D	size	Vn	Vd	1	0	0	0	N	Q	M	0	Vm										

31	30	29	28	27	26	25	24	23	22	21	20	19	18	17	16	15	14	13	12	11	10	9	8	7	6	5	4	3	2	1	0
1	1	1	1	0	0	1	0	0	D	size	Vn	Vd	1	0	0	0	N	Q	M	0	Vm										

```
if Q == '1' && (Vd<0> == '1' || Vn<0> == '1' || Vm<0> == '1') then UNDEFINED;
esize = 8 << UInt(size); elements = 64 DIV esize;
d = UInt(D:Vd); n = UInt(N:Vn); m = UInt(M:Vm); regs = if Q == '0' then 1 else 2;
```

Assembler syntax

VADD{<c>}{<q>}.<dt> {<Qd>}, <Qn>, <Qm>

VADD{<c>}{<q>}.<dt> {<Dd>}, <Dn>, <Dm>

where:

<c>, <q> See [Standard assembler syntax fields on page F2-2415](#). An A32 Advanced SIMD VADD instruction must be unconditional. ARM strongly recommends that a T32 Advanced SIMD VADD instruction is unconditional, see [Conditional execution on page F2-2416](#).

<dt> The data type for the elements of the vectors. It must be one of:

I8 size = 0b00.

I16 size = 0b01.

I32 size = 0b10.

I64 size = 0b11.

<Qd>, <Qn>, <Qm> The destination vector and the operand vectors, for a quadword operation.

<Dd>, <Dn>, <Dm> The destination vector and the operand vectors, for a doubleword operation.

Operation

```
if ConditionPassed() then
    EncodingSpecificOperations(); CheckAdvSIMDEnabled();
    for r = 0 to regs-1
        for e = 0 to elements-1
            Elem[D[d+r],e,esize] = Elem[D[n+r],e,esize] + Elem[D[m+r],e,esize];
```

F8.1.22 VADD (floating-point)

Vector Add adds corresponding elements in two vectors, and places the results in the destination vector.

Depending on settings in the CPACR, NSACR, and HCPTR, and FPEXC registers, and the security state and mode in which the instruction is executed, an attempt to execute the instruction might be UNDEFINED, or trapped to Hyp mode. *Summary of general controls of CP10 and CP11 functionality on page G1-3496* and *Summary of access controls for Advanced SIMD functionality on page G1-3498* summarize these controls.

ARM deprecates the conditional execution of any Advanced SIMD instruction encoding that is not also available as a VFP instruction encoding, see *Conditional execution on page F2-2416*.

Encoding T1/A1 Advanced SIMDv1 (UNDEFINED in integer-only variant)

VADD<c>.F32 <Qd>, <Qn>, <Qm>

VADD<c>.F32 <Dd>, <Dn>, <Dm>

15	14	13	12	11	10	9	8	7	6	5	4	3	2	1	0	15	14	13	12	11	10	9	8	7	6	5	4	3	2	1	0
1	1	1	0	1	1	1	1	0	D	0	sz		Vn			Vd		1	1	0	1	N	Q	M	0		Vm				

31	30	29	28	27	26	25	24	23	22	21	20	19	18	17	16	15	14	13	12	11	10	9	8	7	6	5	4	3	2	1	0
1	1	1	1	0	0	1	0	0	D	0	sz		Vn			Vd		1	1	0	1	N	Q	M	0		Vm				

```

if Q == '1' && (Vd<0> == '1' || Vn<0> == '1' || Vm<0> == '1') then UNDEFINED;
if sz == '1' then UNDEFINED;
advsimd = TRUE; esize = 32; elements = 2;
d = UInt(D:Vd); n = UInt(N:Vn); m = UInt(M:Vm); regs = if Q == '0' then 1 else 2;
  
```

Encoding T2/A2 VFPv2, VFPv3, VFPv4 (sz = 1 UNDEFINED in single-precision only variants)

VADD<c>.F64 <Dd>, <Dn>, <Dm>

VADD<c>.F32 <Sd>, <Sn>, <Sm>

15	14	13	12	11	10	9	8	7	6	5	4	3	2	1	0	15	14	13	12	11	10	9	8	7	6	5	4	3	2	1	0
1	1	1	0	1	1	1	0	0	D	1	1		Vn			Vd		1	0	1	sz	N	0	M	0		Vm				

31	30	29	28	27	26	25	24	23	22	21	20	19	18	17	16	15	14	13	12	11	10	9	8	7	6	5	4	3	2	1	0
cond		1	1	1	0	0	D	1	1		Vn			Vd		1	0	1	sz	N	0	M	0		Vm						

```

if FPSCR.Len != '000' || FPSCR.Stride != '00' then UNDEFINED;
advsimd = FALSE; dp_operation = (sz == '1');
d = if dp_operation then UInt(D:Vd) else UInt(Vd:D);
n = if dp_operation then UInt(N:Vn) else UInt(Vn:N);
m = if dp_operation then UInt(M:Vm) else UInt(Vm:M);
  
```

Assembler syntax

VADD{<c>}{<q>}.F32 {<Qd>}, <Qn>, <Qm>	Encoding T1/A1, encoded as Q = 1, sz = 0
VADD{<c>}{<q>}.F32 {<Dd>}, <Dn>, <Dm>	Encoding T1/A1, encoded as Q = 0, sz = 0
VADD{<c>}{<q>}.F32 {<Sd>}, <Sn>, <Sm>	Encoding T2/A2, encoded as sz = 0
VADD{<c>}{<q>}.F64 {<Dd>}, <Dn>, <Dm>	Encoding T2/A2, encoded as sz = 1

where:

<c>, <q>	See Standard assembler syntax fields on page F2-2415 . An A32 Advanced SIMD VADD instruction must be unconditional. ARM strongly recommends that a T32 Advanced SIMD VADD instruction is unconditional, see Conditional execution on page F2-2416
<Qd>, <Qn>, <Qm>	The destination vector and the operand vectors, for a quadword operation.
<Dd>, <Dn>, <Dm>	The destination vector and the operand vectors, for a doubleword operation.
<Sd>, <Sn>, <Sm>	The destination vector and the operand vectors, for a singleword operation.

Operation

```

if ConditionPassed() then
    EncodingSpecificOperations(); CheckAdvSIMDorVFPEEnabled(TRUE, advsimd);
    if advsimd then // Advanced SIMD instruction
        for r = 0 to regs-1
            for e = 0 to elements-1
                Elem[D[d+r],e,esize] = FPAAdd(Elem[D[n+r],e,esize], Elem[D[m+r],e,esize],
                    StandardFPSCRValue());
    else // VFP instruction
        if dp_operation then
            D[d] = FPAAdd(D[n], D[m], FPSCR);
        else
            S[d] = FPAAdd(S[n], S[m], FPSCR);
  
```

F8.1.23 VADDHN

Vector Add and Narrow, returning High Half adds corresponding elements in two quadword vectors, and places the most significant half of each result in a doubleword vector. The results are truncated. (For rounded results, see [VRADDHN](#) on page F8-3300).

The operand elements can be 16-bit, 32-bit, or 64-bit integers. There is no distinction between signed and unsigned integers.

Depending on settings in the CPACR, NSACR, and HCPTR registers, and the security state and mode in which the instruction is executed, an attempt to execute the instruction might be UNDEFINED, or trapped to Hyp mode. [Summary of access controls for Advanced SIMD functionality on page G1-3498](#) summarizes these controls.

ARM deprecates the conditional execution of any Advanced SIMD instruction encoding that is not also available as a VFP instruction encoding, see [Conditional execution on page F2-2416](#).

Encoding T1/A1 Advanced SIMDv1

VADDHN<c>.<dt> <Dd>, <Qn>, <Qm>

15	14	13	12	11	10	9	8	7	6	5	4	3	2	1	0	15	14	13	12	11	10	9	8	7	6	5	4	3	2	1	0
1	1	1	0	1	1	1	1	1	D	size	Vn				Vd				0	1	0	0	N	0	M	0	Vm				
31	30	29	28	27	26	25	24	23	22	21	20	19	18	17	16	15	14	13	12	11	10	9	8	7	6	5	4	3	2	1	0
1	1	1	1	0	0	1	0	1	D	size	Vn				Vd				0	1	0	0	N	0	M	0	Vm				

```

if size == '11' then SEE "Related encodings";
if Vn<0> == '1' || Vm<0> == '1' then UNDEFINED;
esize = 8 << UInt(size); elements = 64 DIV esize;
d = UInt(D:Vd); n = UInt(N:Vn); m = UInt(M:Vm);
    
```

Related encodings See [Advanced SIMD data-processing instructions on page F5-2499](#).

Assembler syntax

VADDHN{<c>}{<q>}.<dt> <Dd>, <Qn>, <Qm>

where:

<c>, <q> See [Standard assembler syntax fields on page F2-2415](#). An A32 VADDHN instruction must be unconditional. ARM strongly recommends that a T32 VADDHN instruction is unconditional, see [Conditional execution on page F2-2416](#).

<dt> The data type for the elements of the operands. It must be one of:
I16 size = 0b00.
I32 size = 0b01.
I64 size = 0b10.

<Dd>, <Qn>, <Qm> The destination vector, the first operand vector, and the second operand vector.

Operation

```
if ConditionPassed() then
    EncodingSpecificOperations(); CheckAdvSIMDEnabled();
    for e = 0 to elements-1
        result = Elem[Qin[n>>1],e,2*esize] + Elem[Qin[m>>1],e,2*esize];
        Elem[D[d],e,esize] = result<2*esize-1:esize>;
```

F8.1.24 VADDL, VADDW

VADDL (Vector Add Long) adds corresponding elements in two doubleword vectors, and places the results in a quadword vector. Before adding, it sign-extends or zero-extends the elements of both operands.

VADDW (Vector Add Wide) adds corresponding elements in one quadword and one doubleword vector, and places the results in a quadword vector. Before adding, it sign-extends or zero-extends the elements of the doubleword operand.

Depending on settings in the CPACR, NSACR, and HCPTR registers, and the security state and mode in which the instruction is executed, an attempt to execute the instruction might be UNDEFINED, or trapped to Hyp mode. [Summary of access controls for Advanced SIMD functionality on page G1-3498](#) summarizes these controls.

ARM deprecates the conditional execution of any Advanced SIMD instruction encoding that is not also available as a VFP instruction encoding, see [Conditional execution on page F2-2416](#).

Encoding T1/A1 Advanced SIMDv1

VADDL<c>.<dt> <Qd>, <Dn>, <Dm>

VADDW<c>.<dt> <Qd>, <Qn>, <Dm>

15	14	13	12	11	10	9	8	7	6	5	4	3	2	1	0	15	14	13	12	11	10	9	8	7	6	5	4	3	2	1	0
1	1	1	U	1	1	1	1	1	D	size		Vn		Vd		0	0	0	op	N	0	M	0		Vm						
31	30	29	28	27	26	25	24	23	22	21	20	19	18	17	16	15	14	13	12	11	10	9	8	7	6	5	4	3	2	1	0
1	1	1	1	0	0	1	U	1	D	size		Vn		Vd		0	0	0	op	N	0	M	0		Vm						

```

if size == '11' then SEE "Related encodings";
if Vd<0> == '1' || (op == '1' && Vn<0> == '1') then UNDEFINED;
unsigned = (U == '1');
esize = 8 << UInt(size); elements = 64 DIV esize; is_vaddw = (op == '1');
d = UInt(D:Vd); n = UInt(N:Vn); m = UInt(M:Vm);
    
```

Related encodings See [Advanced SIMD data-processing instructions on page F5-2499](#).

Assembler syntax

VADDL{<c>}{<q>}.<dt> <Qd>, <Dn>, <Dm> Encoded as op = 0
 VADDW{<c>}{<q>}.<dt> {<Qd>}, <Qn>, <Dm> Encoded as op = 1

where:

- <c>, <q> See [Standard assembler syntax fields on page F2-2415](#). An A32 VADDL or VADDW instruction must be unconditional. ARM strongly recommends that a T32 VADDL or VADDW instruction is unconditional, see [Conditional execution on page F2-2416](#).
- <dt> The data type for the elements of the second operand vector. It must be one of:
 - S8 Encoded as size = 0b00, U = 0.
 - S16 Encoded as size = 0b01, U = 0.
 - S32 Encoded as size = 0b10, U = 0.
 - U8 Encoded as size = 0b00, U = 1.
 - U16 Encoded as size = 0b01, U = 1.
 - U32 Encoded as size = 0b10, U = 1.
- <Qd> The destination register. If this register is omitted in a VADDW instruction, it is the same register as <Qn>.
- <Qn>, <Dm> The first and second operand registers for a VADDW instruction.
- <Dn>, <Dm> The first and second operand registers for a VADDL instruction.

Operation

```

if ConditionPassed() then
    EncodingSpecificOperations(); CheckAdvSIMDEnabled();
    for e = 0 to elements-1
        if is_vaddw then
            op1 = Int(Elem[Qin[n>>1],e,2*esize], unsigned);
        else
            op1 = Int(Elem[Din[n],e,esize], unsigned);
        result = op1 + Int(Elem[Din[m],e,esize], unsigned);
        Elem[Q[d>>1],e,2*esize] = result<2*esize-1:0>;
  
```

F8.1.25 VAND (immediate)

This is a pseudo-instruction, equivalent to a VBIC (immediate) instruction with the immediate value bitwise inverted. For details see [VBIC \(immediate\)](#) on page F8-3112.

F8.1.26 VAND (register)

This instruction performs a bitwise AND operation between two registers, and places the result in the destination register.

Depending on settings in the CPACR, NSACR, and HCPTR registers, and the security state and mode in which the instruction is executed, an attempt to execute the instruction might be UNDEFINED, or trapped to Hyp mode. [Summary of access controls for Advanced SIMD functionality](#) on page G1-3498 summarizes these controls.

ARM deprecates the conditional execution of any Advanced SIMD instruction encoding that is not also available as a VFP instruction encoding, see [Conditional execution](#) on page F2-2416.

Encoding T1/A1 Advanced SIMDv1

VAND<c> <Qd>, <Qn>, <Qm>

VAND<c> <Dd>, <Dn>, <Dm>

15	14	13	12	11	10	9	8	7	6	5	4	3	2	1	0	15	14	13	12	11	10	9	8	7	6	5	4	3	2	1	0
1	1	1	0	1	1	1	1	0	D	0	0	Vn				Vd				0	0	0	1	N	Q	M	1	Vm			

31	30	29	28	27	26	25	24	23	22	21	20	19	18	17	16	15	14	13	12	11	10	9	8	7	6	5	4	3	2	1	0
1	1	1	1	0	0	1	0	0	D	0	0	Vn				Vd				0	0	0	1	N	Q	M	1	Vm			

if Q == '1' && (Vd<0> == '1' || Vn<0> == '1' || Vm<0> == '1') then UNDEFINED;
 d = UInt(D:Vd); n = UInt(N:Vn); m = UInt(M:Vm); regs = if Q == '0' then 1 else 2;

Assembler syntax

VAND{<C>}{<q>}{.<dt>} {<Qd>}, <Qn>, <Qm> Encoded as Q = 1
VAND{<C>}{<q>}{.<dt>} {<Dd>}, <Dn>, <Dm> Encoded as Q = 0

where:

<C>, <q> See [Standard assembler syntax fields on page F2-2415](#). An A32 VAND instruction must be unconditional. ARM strongly recommends that a T32 VAND instruction is unconditional, see [Conditional execution on page F2-2416](#).

<dt> An optional data type. It is ignored by assemblers, and does not affect the encoding.

<Qd>, <Qn>, <Qm> The destination vector and the operand vectors, for a quadword operation.

<Dd>, <Dn>, <Dm> The destination vector and the operand vectors, for a doubleword operation.

Operation

```
if ConditionPassed() then
    EncodingSpecificOperations(); CheckAdvSIMDEnabled();
    for r = 0 to regs-1
        D[d+r] = D[n+r] AND D[m+r];
```

F8.1.27 VBIC (immediate)

Vector Bitwise Bit Clear (immediate) performs a bitwise AND between a register value and the complement of an immediate value, and returns the result into the destination vector. For the range of constants available, see [One register and a modified immediate value](#) on page F5-2508.

Depending on settings in the CPACR, NSACR, and HCPTR registers, and the security state and mode in which the instruction is executed, an attempt to execute the instruction might be UNDEFINED, or trapped to Hyp mode. [Summary of access controls for Advanced SIMD functionality](#) on page G1-3498 summarizes these controls.

ARM deprecates the conditional execution of any Advanced SIMD instruction encoding that is not also available as a VFP instruction encoding, see [Conditional execution](#) on page F2-2416.

Encoding T1/A1 Advanced SIMDv1

VBIC<c>.<dt> <Qd>, #<imm>

VBIC<c>.<dt> <Dd>, #<imm>

15	14	13	12	11	10	9	8	7	6	5	4	3	2	1	0	15	14	13	12	11	10	9	8	7	6	5	4	3	2	1	0
1	1	1	i	1	1	1	1	1	D	0	0	0	imm3			Vd		cmode			0	Q	1	1	imm4						
31	30	29	28	27	26	25	24	23	22	21	20	19	18	17	16	15	14	13	12	11	10	9	8	7	6	5	4	3	2	1	0
1	1	1	1	0	0	1	i	1	D	0	0	0	imm3			Vd		cmode			0	Q	1	1	imm4						

```

if cmode<0> == '0' || cmode<3:2> == '11' then SEE "Related encodings";
if Q == '1' && Vd<0> == '1' then UNDEFINED;
imm64 = AdvSIMDExpandImm('1', cmode, i:imm3:imm4);
d = UInt(D:Vd); regs = if Q == '0' then 1 else 2;
    
```

Related encodings See [One register and a modified immediate value](#) on page F5-2508.

Assembler syntax

VBIC{<c>}{<q>}.<dt> {<Qd>}, <Qd>, #<imm> Encoded as Q = 1
VBIC{<c>}{<q>}.<dt> {<Dd>}, <Dd>, #<imm> Encoded as Q = 0

where:

<c>, <q> See [Standard assembler syntax fields on page F2-2415](#). An A32 VBIC instruction must be unconditional. ARM strongly recommends that a T32 VBIC instruction is unconditional, see [Conditional execution on page F2-2416](#).

<dt> The data type used for <imm>. It can be either I16 or I32. I8, I64, and F32 are also permitted, but the resulting syntax is a pseudo-instruction.

<Qd> The destination vector for a quadword operation.

<Dd> The destination vector for a doubleword operation.

<imm> A constant of the type specified by <dt>. This constant is replicated enough times to fill the destination register. For example, VBIC.I32 D0, #10 ANDs the complement of 0x0000000A0000000A with D0, and puts the result into D0.

For details of the range of constants available and the encoding of <dt> and <imm>, see [One register and a modified immediate value on page F5-2508](#).

Operation

```
if ConditionPassed() then
    EncodingSpecificOperations(); CheckAdvSIMDEnabled();
    for r = 0 to regs-1
        D[d+r] = D[d+r] AND NOT(imm64);
```

Pseudo-instructions

VAND can be used with a range of constants that are the bitwise inverse of the available constants for VBIC. This is assembled as the equivalent VBIC instruction. Disassembly produces the VBIC form.

[One register and a modified immediate value on page F5-2508](#) describes pseudo-instructions with a combination of <dt> and <imm> that is not supported by hardware, but that generates the same destination register value as a different combination that is supported by hardware.

F8.1.28 VBIC (register)

Vector Bitwise Bit Clear (register) performs a bitwise AND between a register value and the complement of a register value, and places the result in the destination register.

Depending on settings in the CPACR, NSACR, and HCPTR registers, and the security state and mode in which the instruction is executed, an attempt to execute the instruction might be UNDEFINED, or trapped to Hyp mode. [Summary of access controls for Advanced SIMD functionality on page G1-3498](#) summarizes these controls.

ARM deprecates the conditional execution of any Advanced SIMD instruction encoding that is not also available as a VFP instruction encoding, see [Conditional execution on page F2-2416](#).

Encoding T1/A1 Advanced SIMDv1

VBIC<c> <Qd>, <Qn>, <Qm>

VBIC<c> <Dd>, <Dn>, <Dm>

15	14	13	12	11	10	9	8	7	6	5	4	3	2	1	0	15	14	13	12	11	10	9	8	7	6	5	4	3	2	1	0
1	1	1	0	1	1	1	1	0	D	0	1	Vn				Vd		0	0	0	1	N	Q	M	1	Vm					

31	30	29	28	27	26	25	24	23	22	21	20	19	18	17	16	15	14	13	12	11	10	9	8	7	6	5	4	3	2	1	0
1	1	1	1	0	0	1	0	0	D	0	1	Vn				Vd		0	0	0	1	N	Q	M	1	Vm					

if Q == '1' && (Vd<0> == '1' || Vn<0> == '1' || Vm<0> == '1') then UNDEFINED;
 d = UInt(D:Vd); n = UInt(N:Vn); m = UInt(M:Vm); regs = if Q == '0' then 1 else 2;

Assembler syntax

VBIC{<C>}{<q>}{.<dt>} {<Qd>}, <Qn>, <Qm> Encoded as Q = 1
VBIC{<C>}{<q>}{.<dt>} {<Dd>}, <Dn>, <Dm> Encoded as Q = 0

where:

<C>, <q> See [Standard assembler syntax fields on page F2-2415](#). An A32 VBIC instruction must be unconditional. ARM strongly recommends that a T32 VBIC instruction is unconditional, see [Conditional execution on page F2-2416](#).

<dt> An optional data type. It is ignored by assemblers, and does not affect the encoding.

<Qd>, <Qn>, <Qm> The destination vector and the operand vectors, for a quadword operation.

<Dd>, <Dn>, <Dm> The destination vector and the operand vectors, for a doubleword operation.

Operation

```
if ConditionPassed() then
    EncodingSpecificOperations(); CheckAdvSIMDEnabled();
    for r = 0 to regs-1
        D[d+r] = D[n+r] AND NOT(D[m+r]);
```

F8.1.29 VBIF, VBIT, VBSL

VBIF (Vector Bitwise Insert if False), VBIT (Vector Bitwise Insert if True), and VBSL (Vector Bitwise Select) perform bitwise selection under the control of a mask, and place the results in the destination register. The registers can be either quadword or doubleword, and must all be the same size.

Depending on settings in the CPACR, NSACR, and HCPTR registers, and the security state and mode in which the instruction is executed, an attempt to execute the instruction might be UNDEFINED, or trapped to Hyp mode. [Summary of access controls for Advanced SIMD functionality on page G1-3498](#) summarizes these controls.

ARM deprecates the conditional execution of any Advanced SIMD instruction encoding that is not also available as a VFP instruction encoding, see [Conditional execution on page F2-2416](#).

Encoding T1/A1 Advanced SIMDv1

V<op><c> <Qd>, <Qn>, <Qm>

V<op><c> <Dd>, <Dn>, <Dm>

15	14	13	12	11	10	9	8	7	6	5	4	3	2	1	0	15	14	13	12	11	10	9	8	7	6	5	4	3	2	1	0
1	1	1	1	1	1	1	1	0	D	op		Vn		Vd		0	0	0	1	N	Q	M	1		Vm						

31	30	29	28	27	26	25	24	23	22	21	20	19	18	17	16	15	14	13	12	11	10	9	8	7	6	5	4	3	2	1	0
1	1	1	1	0	0	1	1	0	D	op		Vn		Vd		0	0	0	1	N	Q	M	1		Vm						

```

if Q == '1' && (Vd<0> == '1' || Vn<0> == '1' || Vm<0> == '1') then UNDEFINED;
if op == '00' then SEE VEOR;
if op == '01' then operation = VBitOps_VBSL;
if op == '10' then operation = VBitOps_VBIT;
if op == '11' then operation = VBitOps_VBIF;
d = UInt(D:Vd); n = UInt(N:Vn); m = UInt(M:Vm); regs = if Q == '0' then 1 else 2;
    
```

Assembler syntax

V<op>{<c>}{<q>}{. <dt>} {<Qd>}, <Qn>, <Qm> Encoded as Q = 1
 V<op>{<c>}{<q>}{. <dt>} {<Dd>}, <Dn>, <Dm> Encoded as Q = 0

where:

<op> The operation. It must be one of:

BIF	Bitwise Insert if False, encoded as op = 0b11. Inserts each bit from Vn into Vd if the corresponding bit of Vm is 0, otherwise leaves the Vd bit unchanged.
BIT	Bitwise Insert if True, encoded as op = 0b10. Inserts each bit from Vn into Vd if the corresponding bit of Vm is 1, otherwise leaves the Vd bit unchanged.
BSL	Bitwise Select, encoded as op = 0b01. Selects each bit from Vn into Vd if the corresponding bit of Vd is 1, otherwise selects the bit from Vm.

<c>, <q> See [Standard assembler syntax fields on page F2-2415](#). An A32 VBIF, VBIT, or VBSL instruction must be unconditional. ARM strongly recommends that a T32 VBIF, VBIT, or VBSL instruction is unconditional, see [Conditional execution on page F2-2416](#).

<dt> An optional data type. It is ignored by assemblers, and does not affect the encoding.

<Qd>, <Qn>, <Qm> The destination vector and the operand vectors, for a quadword operation.

<Dd>, <Dn>, <Dm> The destination vector and the operand vectors, for a doubleword operation.

Operation

```
enumeration VBitOps {VBitOps_VBIF, VBitOps_VBIT, VBitOps_VBSL};
```

```
if ConditionPassed() then
    EncodingSpecificOperations(); CheckAdvSIMDEnabled();
    for r = 0 to regs-1
        case operation of
            when VBitOps_VBIF D[d+r] = (D[d+r] AND D[m+r]) OR (D[n+r] AND NOT(D[m+r]));
            when VBitOps_VBIT D[d+r] = (D[n+r] AND D[m+r]) OR (D[d+r] AND NOT(D[m+r]));
            when VBitOps_VBSL D[d+r] = (D[n+r] AND D[d+r]) OR (D[m+r] AND NOT(D[d+r]));
```

F8.1.30 VCEQ (register)

VCEQ (Vector Compare Equal) takes each element in a vector, and compares it with the corresponding element of a second vector. If they are equal, the corresponding element in the destination vector is set to all ones. Otherwise, it is set to all zeros.

The operand vector elements can be any one of:

- 8-bit, 16-bit, or 32-bit integers. There is no distinction between signed and unsigned integers.
- 32-bit floating-point numbers.

The result vector elements are fields the same size as the operand vector elements.

Depending on settings in the CPACR, NSACR, and HCPTR registers, and the security state and mode in which the instruction is executed, an attempt to execute the instruction might be UNDEFINED, or trapped to Hyp mode. [Summary of access controls for Advanced SIMD functionality on page G1-3498](#) summarizes these controls.

ARM deprecates the conditional execution of any Advanced SIMD instruction encoding that is not also available as a VFP instruction encoding, see [Conditional execution on page F2-2416](#).

Encoding T1/A1 Advanced SIMDv1

VCEQ<c>.<dt> <Qd>, <Qn>, <Qm> <dt> an integer type
 VCEQ<c>.<dt> <Dd>, <Dn>, <Dm> <dt> an integer type

15	14	13	12	11	10	9	8	7	6	5	4	3	2	1	0	15	14	13	12	11	10	9	8	7	6	5	4	3	2	1	0
1	1	1	1	1	1	1	1	0	D	size	Vn	Vd	1	0	0	0	N	Q	M	1	Vm										

31	30	29	28	27	26	25	24	23	22	21	20	19	18	17	16	15	14	13	12	11	10	9	8	7	6	5	4	3	2	1	0
1	1	1	1	0	0	1	1	0	D	size	Vn	Vd	1	0	0	0	N	Q	M	1	Vm										

```

if Q == '1' && (Vd<0> == '1' || Vn<0> == '1' || Vm<0> == '1') then UNDEFINED;
if size == '11' then UNDEFINED;
int_operation = TRUE; esize = 8 << UInt(size); elements = 64 DIV esize;
d = UInt(D:Vd); n = UInt(N:Vn); m = UInt(M:Vm); regs = if Q == '0' then 1 else 2;
    
```

Encoding T2/A2 Advanced SIMDv1 (UNDEFINED in integer-only variant)

VCEQ<c>.F32 <Qd>, <Qn>, <Qm>
 VCEQ<c>.F32 <Dd>, <Dn>, <Dm>

15	14	13	12	11	10	9	8	7	6	5	4	3	2	1	0	15	14	13	12	11	10	9	8	7	6	5	4	3	2	1	0
1	1	1	0	1	1	1	1	0	D	0	sz	Vn	Vd	1	1	1	0	N	Q	M	0	Vm									

31	30	29	28	27	26	25	24	23	22	21	20	19	18	17	16	15	14	13	12	11	10	9	8	7	6	5	4	3	2	1	0
1	1	1	1	0	0	1	0	0	D	0	sz	Vn	Vd	1	1	1	0	N	Q	M	0	Vm									

```

if Q == '1' && (Vd<0> == '1' || Vn<0> == '1' || Vm<0> == '1') then UNDEFINED;
if sz == '1' then UNDEFINED;
int_operation = FALSE; esize = 32; elements = 2;
d = UInt(D:Vd); n = UInt(N:Vn); m = UInt(M:Vm); regs = if Q == '0' then 1 else 2;
    
```

Assembler syntax

VCEQ{<c>}{<q>}.<dt> {<Qd>}, <Qn>, <Qm> Encoded as Q = 1
 VCEQ{<c>}{<q>}.<dt> {<Dd>}, <Dn>, <Dm> Encoded as Q = 0

where:

<c>, <q> See [Standard assembler syntax fields on page F2-2415](#). An A32 VCEQ instruction must be unconditional. ARM strongly recommends that a T32 VCEQ instruction is unconditional, see [Conditional execution on page F2-2416](#).

<dt> The data types for the elements of the operands. It must be one of:

I8	Encoding T1/A1, size = 0b00.
I16	Encoding T1/A1, size = 0b01.
I32	Encoding T1/A1, size = 0b10.
F32	Encoding T2/A2, sz = 0.

<Qd>, <Qn>, <Qm> The destination vector and the operand vectors, for a quadword operation.

<Dd>, <Dn>, <Dm> The destination vector and the operand vectors, for a doubleword operation.

Operation

```

if ConditionPassed() then
    EncodingSpecificOperations(); CheckAdvSIMDEnabled();
    for r = 0 to regs-1
        for e = 0 to elements-1
            op1 = Elem[D[n+r],e,esize]; op2 = Elem[D[m+r],e,esize];
            if int_operation then
                test_passed = (op1 == op2);
            else
                test_passed = FPCompareEQ(op1, op2, StandardFPSCRValue());
            Elem[D[d+r],e,esize] = if test_passed then Ones(esize) else Zeros(esize);
  
```

F8.1.31 VCEQ (immediate #0)

VCEQ #0 (Vector Compare Equal to zero) takes each element in a vector, and compares it with zero. If it is equal to zero, the corresponding element in the destination vector is set to all ones. Otherwise, it is set to all zeros.

The operand vector elements can be any one of:

- 8-bit, 16-bit, or 32-bit integers. There is no distinction between signed and unsigned integers.
- 32-bit floating-point numbers.

The result vector elements are fields the same size as the operand vector elements.

Depending on settings in the CPACR, NSACR, and HCPTR registers, and the security state and mode in which the instruction is executed, an attempt to execute the instruction might be UNDEFINED, or trapped to Hyp mode.

[Summary of access controls for Advanced SIMD functionality on page G1-3498](#) summarizes these controls.

ARM deprecates the conditional execution of any Advanced SIMD instruction encoding that is not also available as a VFP instruction encoding, see [Conditional execution on page F2-2416](#).

Encoding T1/A1 Advanced SIMDv1 (F = 1 UNDEFINED in integer-only variants)

VCEQ<c>.<dt> <Qd>, <Qm>, #0

VCEQ<c>.<dt> <Dd>, <Dm>, #0

15	14	13	12	11	10	9	8	7	6	5	4	3	2	1	0	15	14	13	12	11	10	9	8	7	6	5	4	3	2	1	0
1	1	1	1	1	1	1	1	D	1	1	size	0	1		Vd	0	F	0	1	0	Q	M	0		Vm						

31	30	29	28	27	26	25	24	23	22	21	20	19	18	17	16	15	14	13	12	11	10	9	8	7	6	5	4	3	2	1	0
1	1	1	1	0	0	1	1	1	D	1	1	size	0	1		Vd	0	F	0	1	0	Q	M	0		Vm					

```

if size == '11' || (F == '1' && size != '10') then UNDEFINED;
if Q == '1' && (Vd<0> == '1' || Vm<0> == '1') then UNDEFINED;
floating_point = (F == '1');
esize = 8 << UInt(size); elements = 64 DIV esize;
d = UInt(D:Vd); m = UInt(M:Vm); regs = if Q == '0' then 1 else 2;
    
```

Assembler syntax

VCEQ{<c>}{<q>}.<dt> {<Qd>}, <Qm>, #0 Encoded as Q = 1
 VCEQ{<c>}{<q>}.<dt> {<Dd>}, <Dm>, #0 Encoded as Q = 0

where:

<c>, <q> See [Standard assembler syntax fields on page F2-2415](#). An A32 VCEQ instruction must be unconditional. ARM strongly recommends that a T32 VCEQ instruction is unconditional, see [Conditional execution on page F2-2416](#).

<dt> The data types for the elements of the operands. It must be one of:

I8 Encoded as size = 0b00, F = 0.
 I16 Encoded as size = 0b01, F = 0.
 I32 Encoded as size = 0b10, F = 0.
 F32 Encoded as size = 0b10, F = 1.

<Qd>, <Qm> The destination vector and the operand vector, for a quadword operation.

<Dd>, <Dm> The destination vector and the operand vector, for a doubleword operation.

Operation

```
if ConditionPassed() then
    EncodingSpecificOperations(); CheckAdvSIMDEnabled();
    for r = 0 to regs-1
        for e = 0 to elements-1
            if floating_point then
                bits(esize) zero = FPZero('0');
                test_passed = FPCompareEQ(Elem[D[m+r],e,esize], zero, StandardFPSCRValue());
            else
                test_passed = (Elem[D[m+r],e,esize] == Zeros(esize));
            Elem[D[d+r],e,esize] = if test_passed then Ones(esize) else Zeros(esize);
```

F8.1.32 VCGE (register)

VCGE (Vector Compare Greater Than or Equal) takes each element in a vector, and compares it with the corresponding element of a second vector. If the first is greater than or equal to the second, the corresponding element in the destination vector is set to all ones. Otherwise, it is set to all zeros.

The operand vector elements can be any one of:

- 8-bit, 16-bit, or 32-bit signed integers.
- 8-bit, 16-bit, or 32-bit unsigned integers.
- 32-bit floating-point numbers.

The result vector elements are fields the same size as the operand vector elements.

Depending on settings in the CPACR, NSACR, and HCPTR registers, and the security state and mode in which the instruction is executed, an attempt to execute the instruction might be UNDEFINED, or trapped to Hyp mode.

[Summary of access controls for Advanced SIMD functionality on page G1-3498](#) summarizes these controls.

ARM deprecates the conditional execution of any Advanced SIMD instruction encoding that is not also available as a VFP instruction encoding, see [Conditional execution on page F2-2416](#).

Encoding T1/A1 Advanced SIMDv1

VCGE<c>.<dt> <Qd>, <Qn>, <Qm> <dt> an integer type
 VCGE<c>.<dt> <Dd>, <Dn>, <Dm> <dt> an integer type

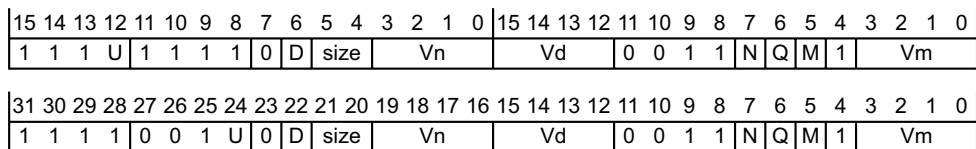

```

if Q == '1' && (Vd<0> == '1' || Vn<0> == '1' || Vm<0> == '1') then UNDEFINED;
if size == '11' then UNDEFINED;
type = if U == '1' then VCGEtype_unsigned else VCGEtype_signed;
esize = 8 << UInt(size); elements = 64 DIV esize;
d = UInt(D:Vd); n = UInt(N:Vn); m = UInt(M:Vm); regs = if Q == '0' then 1 else 2;
    
```

Encoding T2/A2 Advanced SIMDv1 (UNDEFINED in integer-only variant)

VCGE<c>.<F32> <Qd>, <Qn>, <Qm>
 VCGE<c>.<F32> <Dd>, <Dn>, <Dm>

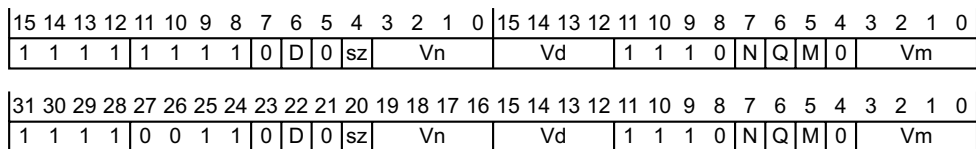

```

if Q == '1' && (Vd<0> == '1' || Vn<0> == '1' || Vm<0> == '1') then UNDEFINED;
if sz == '1' then UNDEFINED;
type = VCGEtype_fp; esize = 32; elements = 2;
d = UInt(D:Vd); n = UInt(N:Vn); m = UInt(M:Vm); regs = if Q == '0' then 1 else 2;
    
```

Assembler syntax

VCGE{<c>}{<q>}.<dt> {<Qd>}, <Qn>, <Qm> Encoded as Q = 1
 VCGE{<c>}{<q>}.<dt> {<Dd>}, <Dn>, <Dm> Encoded as Q = 0

where:

<c>, <q> See [Standard assembler syntax fields on page F2-2415](#). An A32 VCGE instruction must be unconditional. ARM strongly recommends that a T32 VCGE instruction is unconditional, see [Conditional execution on page F2-2416](#).

<dt> The data types for the elements of the operands. It must be one of:

S8	Encoding T1/A1, encoded as size = 0b00, U = 0.
S16	Encoding T1/A1, encoded as size = 0b01, U = 0.
S32	Encoding T1/A1, encoded as size = 0b10, U = 0.
U8	Encoding T1/A1, encoded as size = 0b00, U = 1.
U16	Encoding T1/A1, encoded as size = 0b01, U = 1.
U32	Encoding T1/A1, encoded as size = 0b10, U = 1.
F32	Encoding T2/A2, encoded as sz = 0.

<Qd>, <Qn>, <Qm> The destination vector and the operand vectors, for a quadword operation.

<Dd>, <Dn>, <Dm> The destination vector and the operand vectors, for a doubleword operation.

Operation

```
enumeration VCGEtype {VCGEtype_signed, VCGEtype_unsigned, VCGEtype_fp};
```

```
if ConditionPassed() then
  EncodingSpecificOperations(); CheckAdvSIMDEnabled();
  for r = 0 to regs-1
    for e = 0 to elements-1
      op1 = Elem[D[n+r],e,esize]; op2 = Elem[D[m+r],e,esize];
      case type of
        when VCGEtype_signed test_passed = (SInt(op1) >= SInt(op2));
        when VCGEtype_unsigned test_passed = (UInt(op1) >= UInt(op2));
        when VCGEtype_fp test_passed = FPCompareGE(op1, op2, StandardFPSCRValue());
      Elem[D[d+r],e,esize] = if test_passed then Ones(esize) else Zeros(esize);
```

F8.1.33 VCGE (immediate #0)

VCGE #0 (Vector Compare Greater Than or Equal to Zero) take each element in a vector, and compares it with zero. If it is greater than or equal to zero, the corresponding element in the destination vector is set to all ones. Otherwise, it is set to all zeros.

The operand vector elements can be any one of:

- 8-bit, 16-bit, or 32-bit signed integers.
- 32-bit floating-point numbers.

The result vector elements are fields the same size as the operand vector elements.

Depending on settings in the CPACR, NSACR, and HCPTR registers, and the security state and mode in which the instruction is executed, an attempt to execute the instruction might be UNDEFINED, or trapped to Hyp mode. [Summary of access controls for Advanced SIMD functionality on page G1-3498](#) summarizes these controls.

ARM deprecates the conditional execution of any Advanced SIMD instruction encoding that is not also available as a VFP instruction encoding, see [Conditional execution on page F2-2416](#).

Encoding T1/A1 Advanced SIMDv1 (F = 1 UNDEFINED in integer-only variants)

VCGE<c>.<dt> <Qd>, <Qm>, #0

VCGE<c>.<dt> <Dd>, <Dm>, #0

15	14	13	12	11	10	9	8	7	6	5	4	3	2	1	0	15	14	13	12	11	10	9	8	7	6	5	4	3	2	1	0
1	1	1	1	1	1	1	1	D	1	1	size	0	1		Vd	0	F	0	0	1	Q	M	0		Vm						

31	30	29	28	27	26	25	24	23	22	21	20	19	18	17	16	15	14	13	12	11	10	9	8	7	6	5	4	3	2	1	0
1	1	1	1	0	0	1	1	1	D	1	1	size	0	1		Vd	0	F	0	0	1	Q	M	0		Vm					

```

if size == '11' || (F == '1' && size != '10') then UNDEFINED;
if Q == '1' && (Vd<0> == '1' || Vm<0> == '1') then UNDEFINED;
floating_point = (F == '1');
esize = 8 << UInt(size); elements = 64 DIV esize;
d = UInt(D:Vd); m = UInt(M:Vm); regs = if Q == '0' then 1 else 2;
    
```

Assembler syntax

VCGE{<c>}{<q>}.<dt> {<Qd>}, <Qm>, #0 Encoded as Q = 1
 VCGE{<c>}{<q>}.<dt> {<Dd>}, <Dm>, #0 Encoded as Q = 0

where:

<c>, <q> See [Standard assembler syntax fields on page F2-2415](#). An A32 VCGE instruction must be unconditional. ARM strongly recommends that a T32 VCGE instruction is unconditional, see [Conditional execution on page F2-2416](#).

<dt> The data types for the elements of the operands. It must be one of:

S8 Encoded as size = 0b00, F = 0.
 S16 Encoded as size = 0b01, F = 0.
 S32 Encoded as size = 0b10, F = 0.
 F32 Encoded as size = 0b10, F = 1.

<Qd>, <Qm> The destination vector and the operand vector, for a quadword operation.

<Dd>, <Dm> The destination vector and the operand vector, for a doubleword operation.

Operation

```
if ConditionPassed() then
    EncodingSpecificOperations(); CheckAdvSIMDEnabled();
    for r = 0 to regs-1
        for e = 0 to elements-1
            if floating_point then
                bits(esize) zero = FPZero('0');
                test_passed = FPCompareGE(Elem[D[m+r],e,esize], zero, StandardFPSCRValue());
            else
                test_passed = (SInt(Elem[D[m+r],e,esize]) >= 0);
            Elem[D[d+r],e,esize] = if test_passed then Ones(esize) else Zeros(esize);
```

F8.1.34 VCGT (register)

VCGT (Vector Compare Greater Than) takes each element in a vector, and compares it with the corresponding element of a second vector. If the first is greater than the second, the corresponding element in the destination vector is set to all ones. Otherwise, it is set to all zeros.

The operand vector elements can be any one of:

- 8-bit, 16-bit, or 32-bit signed integers.
- 8-bit, 16-bit, or 32-bit unsigned integers.
- 32-bit floating-point numbers.

The result vector elements are fields the same size as the operand vector elements.

Depending on settings in the CPACR, NSACR, and HCPTR registers, and the security state and mode in which the instruction is executed, an attempt to execute the instruction might be UNDEFINED, or trapped to Hyp mode.

Summary of access controls for Advanced SIMD functionality on page G1-3498 summarizes these controls.

ARM deprecates the conditional execution of any Advanced SIMD instruction encoding that is not also available as a VFP instruction encoding, see *Conditional execution on page F2-2416*.

Encoding T1/A1 Advanced SIMDv1

VCGT<c>.<dt> <Qd>, <Qn>, <Qm> <dt> an integer type
 VCGT<c>.<dt> <Dd>, <Dn>, <Dm> <dt> an integer type

15	14	13	12	11	10	9	8	7	6	5	4	3	2	1	0	15	14	13	12	11	10	9	8	7	6	5	4	3	2	1	0
1	1	1	U	1	1	1	1	0	D	size		Vn		Vd	0	0	1	1	N	Q	M	0		Vm							

31	30	29	28	27	26	25	24	23	22	21	20	19	18	17	16	15	14	13	12	11	10	9	8	7	6	5	4	3	2	1	0
1	1	1	1	0	0	1	U	0	D	size		Vn		Vd	0	0	1	1	N	Q	M	0		Vm							

```
if Q == '1' && (Vd<0> == '1' || Vn<0> == '1' || Vm<0> == '1') then UNDEFINED;
if size == '11' then UNDEFINED;
type = if U == '1' then VCGTtype_unsigned else VCGTtype_signed;
esize = 8 << UInt(size); elements = 64 DIV esize;
d = UInt(D:Vd); n = UInt(N:Vn); m = UInt(M:Vm); regs = if Q == '0' then 1 else 2;
```

Encoding T2/A2 Advanced SIMDv1 (UNDEFINED in integer-only variant)

VCGT<c>.F32 <Qd>, <Qn>, <Qm>
 VCGT<c>.F32 <Dd>, <Dn>, <Dm>

15	14	13	12	11	10	9	8	7	6	5	4	3	2	1	0	15	14	13	12	11	10	9	8	7	6	5	4	3	2	1	0
1	1	1	1	1	1	1	1	0	D	1	sz		Vn		Vd	1	1	1	0	N	Q	M	0		Vm						

31	30	29	28	27	26	25	24	23	22	21	20	19	18	17	16	15	14	13	12	11	10	9	8	7	6	5	4	3	2	1	0
1	1	1	1	0	0	1	1	0	D	1	sz		Vn		Vd	1	1	1	0	N	Q	M	0		Vm						

```
if Q == '1' && (Vd<0> == '1' || Vn<0> == '1' || Vm<0> == '1') then UNDEFINED;
if sz == '1' then UNDEFINED;
type = VCGTtype_fp; esize = 32; elements = 2;
d = UInt(D:Vd); n = UInt(N:Vn); m = UInt(M:Vm); regs = if Q == '0' then 1 else 2;
```

Assembler syntax

VCGT{<c>}{<q>}.<dt> {<Qd>}, <Qn>, <Qm> Encoded as Q = 1
 VCGT{<c>}{<q>}.<dt> {<Dd>}, <Dn>, <Dm> Encoded as Q = 0

where:

<c>, <q> See [Standard assembler syntax fields on page F2-2415](#). An A32 VCGT instruction must be unconditional. ARM strongly recommends that a T32 VCGT instruction is unconditional, see [Conditional execution on page F2-2416](#).

<dt> The data types for the elements of the operands. It must be one of:

S8	Encoding T1/A1, encoded as size = 0b00, U = 0.
S16	Encoding T1/A1, encoded as size = 0b01, U = 0.
S32	Encoding T1/A1, encoded as size = 0b10, U = 0.
U8	Encoding T1/A1, encoded as size = 0b00, U = 1.
U16	Encoding T1/A1, encoded as size = 0b01, U = 1.
U32	Encoding T1/A1, encoded as size = 0b10, U = 1.
F32	Encoding T2/A2, encoded as sz = 0.

<Qd>, <Qn>, <Qm> The destination vector and the operand vectors, for a quadword operation.

<Dd>, <Dn>, <Dm> The destination vector and the operand vectors, for a doubleword operation.

Operation

```
enumeration VCGTtype {VCGTtype_signed, VCGTtype_unsigned, VCGTtype_fp};
```

```
if ConditionPassed() then
  EncodingSpecificOperations(); CheckAdvSIMDEnabled();
  for r = 0 to regs-1
    for e = 0 to elements-1
      op1 = Elem[D[n+r],e,esize]; op2 = Elem[D[m+r],e,esize];
      case type of
        when VCGTtype_signed test_passed = (SInt(op1) > SInt(op2));
        when VCGTtype_unsigned test_passed = (UInt(op1) > UInt(op2));
        when VCGTtype_fp test_passed = FPCompareGT(op1, op2, StandardFPSCRValue());
      Elem[D[d+r],e,esize] = if test_passed then Ones(esize) else Zeros(esize);
```

F8.1.35 VCGT (immediate #0)

VCGT #0 (Vector Compare Greater Than Zero) take each element in a vector, and compares it with zero. If it is greater than zero, the corresponding element in the destination vector is set to all ones. Otherwise, it is set to all zeros.

The operand vector elements can be any one of:

- 8-bit, 16-bit, or 32-bit signed integers.
- 32-bit floating-point numbers.

The result vector elements are fields the same size as the operand vector elements.

Depending on settings in the CPACR, NSACR, and HCPTR registers, and the security state and mode in which the instruction is executed, an attempt to execute the instruction might be UNDEFINED, or trapped to Hyp mode.

[Summary of access controls for Advanced SIMD functionality on page G1-3498](#) summarizes these controls.

ARM deprecates the conditional execution of any Advanced SIMD instruction encoding that is not also available as a VFP instruction encoding, see [Conditional execution on page F2-2416](#).

Encoding T1/A1 Advanced SIMDv1 (F = 1 UNDEFINED in integer-only variants)

VCGT<c>.<dt> <Qd>, <Qm>, #0

VCGT<c>.<dt> <Dd>, <Dm>, #0

15	14	13	12	11	10	9	8	7	6	5	4	3	2	1	0	15	14	13	12	11	10	9	8	7	6	5	4	3	2	1	0
1	1	1	1	1	1	1	1	D	1	1	size	0	1		Vd	0	F	0	0	0	Q	M	0		Vm						

31	30	29	28	27	26	25	24	23	22	21	20	19	18	17	16	15	14	13	12	11	10	9	8	7	6	5	4	3	2	1	0
1	1	1	1	0	0	1	1	1	D	1	1	size	0	1		Vd	0	F	0	0	0	Q	M	0		Vm					

```

if size == '11' || (F == '1' && size != '10') then UNDEFINED;
if Q == '1' && (Vd<0> == '1' || Vm<0> == '1') then UNDEFINED;
floating_point = (F == '1');
esize = 8 << UInt(size); elements = 64 DIV esize;
d = UInt(D:Vd); m = UInt(M:Vm); regs = if Q == '0' then 1 else 2;
    
```

Assembler syntax

VCGT{<c>}{<q>}.<dt> {<Qd>}, <Qm>, #0 Encoded as Q = 1
 VCGT{<c>}{<q>}.<dt> {<Dd>}, <Dm>, #0 Encoded as Q = 0

where:

<c>, <q> See [Standard assembler syntax fields on page F2-2415](#). An A32 VCGT instruction must be unconditional. ARM strongly recommends that a T32 VCGT instruction is unconditional, see [Conditional execution on page F2-2416](#).

<dt> The data types for the elements of the operands. It must be one of:

S8 Encoded as size = 0b00, F = 0.
 S16 Encoded as size = 0b01, F = 0.
 S32 Encoded as size = 0b10, F = 0.
 F32 Encoded as size = 0b10, F = 1.

<Qd>, <Qm> The destination vector and the operand vector, for a quadword operation.

<Dd>, <Dm> The destination vector and the operand vector, for a doubleword operation.

Operation

```
if ConditionPassed() then
    EncodingSpecificOperations(); CheckAdvSIMDEnabled();
    for r = 0 to regs-1
        for e = 0 to elements-1
            if floating_point then
                bits(esize) zero = FPZero('0');
                test_passed = FPCompareGT(Elem[D[m+r],e,esize], zero, StandardFPSCRValue());
            else
                test_passed = (SInt(Elem[D[m+r],e,esize]) > 0);
            Elem[D[d+r],e,esize] = if test_passed then Ones(esize) else Zeros(esize);
```

F8.1.36 VCLE (register)

VCLE is a pseudo-instruction, equivalent to a VCGE instruction with the operands reversed. For details see [VCGE \(register\)](#) on page F8-3122.

F8.1.37 VCLE (immediate #0)

VCLE #0 (Vector Compare Less Than or Equal to Zero) take each element in a vector, and compares it with zero. If it is less than or equal to zero, the corresponding element in the destination vector is set to all ones. Otherwise, it is set to all zeros.

The operand vector elements can be any one of:

- 8-bit, 16-bit, or 32-bit signed integers.
- 32-bit floating-point numbers.

The result vector elements are fields the same size as the operand vector elements.

Depending on settings in the CPACR, NSACR, and HCPTR registers, and the security state and mode in which the instruction is executed, an attempt to execute the instruction might be UNDEFINED, or trapped to Hyp mode. [Summary of access controls for Advanced SIMD functionality](#) on page G1-3498 summarizes these controls.

ARM deprecates the conditional execution of any Advanced SIMD instruction encoding that is not also available as a VFP instruction encoding, see [Conditional execution](#) on page F2-2416.

Encoding T1/A1 Advanced SIMDv1 (F = 1 UNDEFINED in integer-only variants)

VCLE<c>.<dt> <Qd>, <Qm>, #0

VCLE<c>.<dt> <Dd>, <Dm>, #0

15	14	13	12	11	10	9	8	7	6	5	4	3	2	1	0	15	14	13	12	11	10	9	8	7	6	5	4	3	2	1	0
1	1	1	1	1	1	1	1	1	D	1	1	size	0	1		Vd	0	F	0	1	1	Q	M	0		Vm					

31	30	29	28	27	26	25	24	23	22	21	20	19	18	17	16	15	14	13	12	11	10	9	8	7	6	5	4	3	2	1	0
1	1	1	1	0	0	1	1	1	D	1	1	size	0	1		Vd	0	F	0	1	1	Q	M	0		Vm					

```

if size == '11' || (F == '1' && size != '10') then UNDEFINED;
if Q == '1' && (Vd<0> == '1' || Vm<0> == '1') then UNDEFINED;
floating_point = (F == '1');
esize = 8 << UInt(size); elements = 64 DIV esize;
d = UInt(D:Vd); m = UInt(M:Vm); regs = if Q == '0' then 1 else 2;
    
```

Assembler syntax

VCLE{<c>}{<q>}.<dt> {<Qd>}, <Qm>, #0 Encoded as Q = 1
 VCLE{<c>}{<q>}.<dt> {<Dd>}, <Dm>, #0 Encoded as Q = 0

where:

<c>, <q> See [Standard assembler syntax fields on page F2-2415](#). An A32 VCLE instruction must be unconditional. ARM strongly recommends that a T32 VCLE instruction is unconditional, see [Conditional execution on page F2-2416](#).

<dt> The data types for the elements of the operands. It must be one of:

S8 Encoded as size = 0b00, F = 0.
 S16 Encoded as size = 0b01, F = 0.
 S32 Encoded as size = 0b10, F = 0.
 F32 Encoded as size = 0b10, F = 1.

<Qd>, <Qm> The destination vector and the operand vector, for a quadword operation.

<Dd>, <Dm> The destination vector and the operand vector, for a doubleword operation.

Operation

```
if ConditionPassed() then
    EncodingSpecificOperations(); CheckAdvSIMDEnabled();
    for r = 0 to regs-1
        for e = 0 to elements-1
            if floating_point then
                bits(esize) zero = FPZero('0');
                test_passed = FPCompareGE(zero, Elem[D[m+r],e,esize], StandardFPSCRValue());
            else
                test_passed = (SInt(Elem[D[m+r],e,esize]) <= 0);
            Elem[D[d+r],e,esize] = if test_passed then Ones(esize) else Zeros(esize);
```

F8.1.38 VCLS

Vector Count Leading Sign Bits counts the number of consecutive bits following the topmost bit, that are the same as the topmost bit, in each element in a vector, and places the results in a second vector. The count does not include the topmost bit itself.

The operand vector elements can be any one of 8-bit, 16-bit, or 32-bit signed integers.

The result vector elements are the same data type as the operand vector elements.

Depending on settings in the CPACR, NSACR, and HCPTR registers, and the security state and mode in which the instruction is executed, an attempt to execute the instruction might be UNDEFINED, or trapped to Hyp mode.

[Summary of access controls for Advanced SIMD functionality on page G1-3498](#) summarizes these controls.

ARM deprecates the conditional execution of any Advanced SIMD instruction encoding that is not also available as a VFP instruction encoding, see [Conditional execution on page F2-2416](#).

Encoding T1/A1 Advanced SIMDv1

VCLS<c>.<dt> <Qd>, <Qm>

VCLS<c>.<dt> <Dd>, <Dm>

15	14	13	12	11	10	9	8	7	6	5	4	3	2	1	0	15	14	13	12	11	10	9	8	7	6	5	4	3	2	1	0
1	1	1	1	1	1	1	1	1	D	1	1	size	0	0	Vd	0	1	0	0	0	Q	M	0	Vm							

31	30	29	28	27	26	25	24	23	22	21	20	19	18	17	16	15	14	13	12	11	10	9	8	7	6	5	4	3	2	1	0
1	1	1	1	0	0	1	1	1	D	1	1	size	0	0	Vd	0	1	0	0	0	Q	M	0	Vm							

```

if size == '11' then UNDEFINED;
if Q == '1' && (Vd<0> == '1' || Vm<0> == '1') then UNDEFINED;
esize = 8 << UInt(size); elements = 64 DIV esize;
d = UInt(D:Vd); m = UInt(M:Vm); regs = if Q == '0' then 1 else 2;
    
```

Assembler syntax

VCLS{<c>}{<q>}.<dt> <Qd>, <Qm> Encoded as Q = 1
VCLS{<c>}{<q>}.<dt> <Dd>, <Dm> Encoded as Q = 0

where:

<c>, <q> See [Standard assembler syntax fields on page F2-2415](#). An A32 VCLS instruction must be unconditional. ARM strongly recommends that a T32 VCLS instruction is unconditional, see [Conditional execution on page F2-2416](#).

<dt> The data size for the elements of the operands. It must be one of:
S8 Encoded as size = 0b00.
S16 Encoded as size = 0b01.
S32 Encoded as size = 0b10.

<Qd>, <Qm> The destination vector and the operand vector, for a quadword operation.

<Dd>, <Dm> The destination vector and the operand vector, for a doubleword operation.

Operation

```
if ConditionPassed() then
    EncodingSpecificOperations(); CheckAdvSIMDEnabled();
    for r = 0 to regs-1
        for e = 0 to elements-1
            Elem[D[d+r],e,esize] = CountLeadingSignBits(Elem[D[m+r],e,esize])<esize-1:0>;
```

F8.1.39 VCLT (register)

VCLT is a pseudo-instruction, equivalent to a VCGT instruction with the operands reversed. For details see [VCGT \(register\)](#) on page F8-3126.

F8.1.40 VCLT (immediate #0)

VCLT #0 (Vector Compare Less Than Zero) take each element in a vector, and compares it with zero. If it is less than zero, the corresponding element in the destination vector is set to all ones. Otherwise, it is set to all zeros.

The operand vector elements can be any one of:

- 8-bit, 16-bit, or 32-bit signed integers.
- 32-bit floating-point numbers.

The result vector elements are fields the same size as the operand vector elements.

Depending on settings in the CPACR, NSACR, and HCPTR registers, and the security state and mode in which the instruction is executed, an attempt to execute the instruction might be UNDEFINED, or trapped to Hyp mode. [Summary of access controls for Advanced SIMD functionality on page G1-3498](#) summarizes these controls.

ARM deprecates the conditional execution of any Advanced SIMD instruction encoding that is not also available as a VFP instruction encoding, see [Conditional execution on page F2-2416](#).

Encoding T1/A1 Advanced SIMDv1 (F = 1 UNDEFINED in integer-only variants)

VCLT<c>.<dt> <Qd>, <Qm>, #0

VCLT<c>.<dt> <Dd>, <Dm>, #0

15	14	13	12	11	10	9	8	7	6	5	4	3	2	1	0	15	14	13	12	11	10	9	8	7	6	5	4	3	2	1	0
1	1	1	1	1	1	1	1	1	D	1	1	size	0	1	Vd	0	F	1	0	0	Q	M	0	Vm							

31	30	29	28	27	26	25	24	23	22	21	20	19	18	17	16	15	14	13	12	11	10	9	8	7	6	5	4	3	2	1	0
1	1	1	1	0	0	1	1	1	D	1	1	size	0	1	Vd	0	F	1	0	0	Q	M	0	Vm							

```

if size == '11' || (F == '1' && size != '10') then UNDEFINED;
if Q == '1' && (Vd<0> == '1' || Vm<0> == '1') then UNDEFINED;
floating_point = (F == '1');
esize = 8 << UInt(size); elements = 64 DIV esize;
d = UInt(D:Vd); m = UInt(M:Vm); regs = if Q == '0' then 1 else 2;
  
```

Assembler syntax

VCLT{<c>}{<q>}.<dt> {<Qd>}, <Qm>, #0 Encoded as Q = 1
 VCLT{<c>}{<q>}.<dt> {<Dd>}, <Dm>, #0 Encoded as Q = 0

where:

<c>, <q> See [Standard assembler syntax fields on page F2-2415](#). An A32 VCLT instruction must be unconditional. ARM strongly recommends that a T32 VCLT instruction is unconditional, see [Conditional execution on page F2-2416](#).

<dt> The data types for the elements of the operands. It must be one of:

S8 Encoded as size = 0b00, F = 0.
 S16 Encoded as size = 0b01, F = 0.
 S32 Encoded as size = 0b10, F = 0.
 F32 Encoded as size = 0b10, F = 1.

<Qd>, <Qm> The destination vector and the operand vector, for a quadword operation.

<Dd>, <Dm> The destination vector and the operand vector, for a doubleword operation.

Operation

```
if ConditionPassed() then
    EncodingSpecificOperations(); CheckAdvSIMDEnabled();
    for r = 0 to regs-1
        for e = 0 to elements-1
            if floating_point then
                bits(esize) zero = FPZero('0');
                test_passed = FPCompareGT(zero, Elem[D[m+r],e,esize], StandardFPSCRValue());
            else
                test_passed = (SInt(Elem[D[m+r],e,esize]) < 0);
            Elem[D[d+r],e,esize] = if test_passed then Ones(esize) else Zeros(esize);
```

F8.1.41 VCLZ

Vector Count Leading Zeros counts the number of consecutive zeros, starting from the most significant bit, in each element in a vector, and places the results in a second vector.

The operand vector elements can be any one of 8-bit, 16-bit, or 32-bit integers. There is no distinction between signed and unsigned integers.

The result vector elements are the same data type as the operand vector elements.

Depending on settings in the CPACR, NSACR, and HCPTR registers, and the security state and mode in which the instruction is executed, an attempt to execute the instruction might be UNDEFINED, or trapped to Hyp mode.

[Summary of access controls for Advanced SIMD functionality on page G1-3498](#) summarizes these controls.

ARM deprecates the conditional execution of any Advanced SIMD instruction encoding that is not also available as a VFP instruction encoding, see [Conditional execution on page F2-2416](#).

Encoding T1/A1 Advanced SIMDv1

VCLZ<c>.<dt> <Qd>, <Qm>

VCLZ<c>.<dt> <Dd>, <Dm>

15	14	13	12	11	10	9	8	7	6	5	4	3	2	1	0	15	14	13	12	11	10	9	8	7	6	5	4	3	2	1	0
1	1	1	1	1	1	1	1	1	D	1	1	size	0	0	Vd	0	1	0	0	1	Q	M	0	Vm							

31	30	29	28	27	26	25	24	23	22	21	20	19	18	17	16	15	14	13	12	11	10	9	8	7	6	5	4	3	2	1	0
1	1	1	1	0	0	1	1	1	D	1	1	size	0	0	Vd	0	1	0	0	1	Q	M	0	Vm							

```

if size == '11' then UNDEFINED;
if Q == '1' && (Vd<0> == '1' || Vm<0> == '1') then UNDEFINED;
esize = 8 << UInt(size); elements = 64 DIV esize;
d = UInt(D:Vd); m = UInt(M:Vm); regs = if Q == '0' then 1 else 2;
    
```

Assembler syntax

VCLZ{<c>}{<q>}.<dt> <Qd>, <Qm> Encoded as Q = 1
VCLZ{<c>}{<q>}.<dt> <Dd>, <Dm> Encoded as Q = 0

where:

<c>, <q> See [Standard assembler syntax fields on page F2-2415](#). An A32 VCLZ instruction must be unconditional. ARM strongly recommends that a T32 VCLZ instruction is unconditional, see [Conditional execution on page F2-2416](#).

<dt> The data size for the elements of the operands. It must be one of:

I8 Encoded as size = 0b00.
I16 Encoded as size = 0b01.
I32 Encoded as size = 0b10.

<Qd>, <Qm> The destination vector and the operand vector, for a quadword operation.

<Dd>, <Dm> The destination vector and the operand vector, for a doubleword operation.

Operation

```
if ConditionPassed() then
    EncodingSpecificOperations(); CheckAdvSIMDEnabled();
    for r = 0 to regs-1
        for e = 0 to elements-1
            Elem[D[d+r],e,esize] = CountLeadingZeroBits(Elem[D[m+r],e,esize])<esize-1:0>;
```

F8.1.42 VCMP, VCMPE

This instruction compares two floating-point registers, or one floating-point register and zero. It writes the result to the **FPSCR** flags. These are normally transferred to the A32 flags by a subsequent VMRS instruction.

It can optionally raise an Invalid Operation exception if either operand is any type of NaN. It always raises an Invalid Operation exception if either operand is a signaling NaN.

Depending on settings in the **CPACR**, **NSACR**, and **HCPTR** registers, and the security state and mode in which the instruction is executed, an attempt to execute the instruction might be UNDEFINED, or trapped to Hyp mode. [Summary of general controls of CP10 and CP11 functionality on page G1-3496](#) summarizes these controls.

Encoding T1/A1 VFPv2, VFPv3, VFPv4 (sz = 1 UNDEFINED in single-precision only variants)

VCMP{E}<c>.F64 <Dd>, <Dm>

VCMP{E}<c>.F32 <Sd>, <Sm>

15	14	13	12	11	10	9	8	7	6	5	4	3	2	1	0	15	14	13	12	11	10	9	8	7	6	5	4	3	2	1	0
1	1	1	0	1	1	1	0	1	D	1	1	0	1	0	0	Vd	1	0	1	sz	E	1	M	0	Vm						

31	30	29	28	27	26	25	24	23	22	21	20	19	18	17	16	15	14	13	12	11	10	9	8	7	6	5	4	3	2	1	0
cond	1	1	1	0	1	D	1	1	0	1	0	0	Vd	1	0	1	sz	E	1	M	0	Vm									

```
dp_operation = (sz == '1'); quiet_nan_exc = (E == '1'); with_zero = FALSE;
d = if dp_operation then UInt(D:Vd) else UInt(Vd:D);
m = if dp_operation then UInt(M:Vm) else UInt(Vm:M);
```

Encoding T2/A2 VFPv2, VFPv3, VFPv4 (sz = 1 UNDEFINED in single-precision only variants)

VCMP{E}<c>.F64 <Dd>, #0.0

VCMP{E}<c>.F32 <Sd>, #0.0

15	14	13	12	11	10	9	8	7	6	5	4	3	2	1	0	15	14	13	12	11	10	9	8	7	6	5	4	3	2	1	0
1	1	1	0	1	1	1	0	1	D	1	1	0	1	0	1	Vd	1	0	1	sz	E	1	(0)	0	(0)	(0)	(0)	(0)			

31	30	29	28	27	26	25	24	23	22	21	20	19	18	17	16	15	14	13	12	11	10	9	8	7	6	5	4	3	2	1	0
cond	1	1	1	0	1	D	1	1	0	1	0	1	Vd	1	0	1	sz	E	1	(0)	0	(0)	(0)	(0)	(0)	(0)	(0)	(0)	(0)	(0)	

```
dp_operation = (sz == '1'); quiet_nan_exc = (E == '1'); with_zero = TRUE;
d = if dp_operation then UInt(D:Vd) else UInt(Vd:D);
```

For information about the **CONSTRAINED UNPREDICTABLE** behavior of this instruction, see [Appendix A Architectural Constraints on UNPREDICTABLE behaviors](#).

Assembler syntax

VCMP{E}{<C>}{<Q>}.F64 <Dd>, <Dm>	Encoding T1/A1, encoded as sz = 1
VCMP{E}{<C>}{<Q>}.F32 <Sd>, <Sm>	Encoding T1/A1, encoded as sz = 0
VCMP{E}{<C>}{<Q>}.F64 <Dd>, #0.0	Encoding T2/A2, encoded as sz = 1
VCMP{E}{<C>}{<Q>}.F32 <Sd>, #0.0	Encoding T2/A2, encoded as sz = 0

where:

E If present, any NaN operand causes an Invalid Operation exception. Encoded as E = 1.
 Otherwise, only a signaling NaN causes the exception. Encoded as E = 0.

<C>, <Q> See [Standard assembler syntax fields on page F2-2415](#).

<Dd>, <Dm> The operand vectors, for a doubleword operation.

<Sd>, <Sm> The operand vectors, for a singleword operation.

Operation

```

if ConditionPassed() then
    EncodingSpecificOperations(); CheckVFPEnabled(TRUE);
    if dp_operation then
        bits(64) op64 = if with_zero then FPZero('0') else D[m];
        FPSCR.<N,Z,C,V> = FPCompare(D[d], op64, quiet_nan_exc, FPSCR);
    else
        bits(32) op32 = if with_zero then FPZero('0') else S[m];
        FPSCR.<N,Z,C,V> = FPCompare(S[d], op32, quiet_nan_exc, FPSCR);
  
```

NaNs

The IEEE 754 standard specifies that the result of a comparison is precisely one of <, ==, > or *unordered*. If either or both of the operands are NaNs, they are unordered, and all three of (Operand1 < Operand2), (Operand1 == Operand2) and (Operand1 > Operand2) are false. This results in the **FPSCR** flags being set as N=0, Z=0, C=1 and V=1.

VCMP_E raises an Invalid Operation exception if either operand is any type of NaN, and is suitable for testing for <, <=, >, >=, and other predicates that raise an exception when the operands are unordered.

F8.1.43 VCNT

This instruction counts the number of bits that are one in each element in a vector, and places the results in a second vector.

The operand vector elements must be 8-bit fields.

The result vector elements are 8-bit integers.

Depending on settings in the CPACR, NSACR, and HCPTR registers, and the security state and mode in which the instruction is executed, an attempt to execute the instruction might be UNDEFINED, or trapped to Hyp mode. [Summary of access controls for Advanced SIMD functionality on page G1-3498](#) summarizes these controls.

ARM deprecates the conditional execution of any Advanced SIMD instruction encoding that is not also available as a VFP instruction encoding, see [Conditional execution on page F2-2416](#).

Encoding T1/A1 Advanced SIMDv1

VCNT<c>.8 <Qd>, <Qm>

VCNT<c>.8 <Dd>, <Dm>

15	14	13	12	11	10	9	8	7	6	5	4	3	2	1	0	15	14	13	12	11	10	9	8	7	6	5	4	3	2	1	0
1	1	1	1	1	1	1	1	D	1	1	size	0	0		Vd	0	1	0	1	0	Q	M	0		Vm						
31	30	29	28	27	26	25	24	23	22	21	20	19	18	17	16	15	14	13	12	11	10	9	8	7	6	5	4	3	2	1	0
1	1	1	1	0	0	1	1	1	D	1	1	size	0	0		Vd	0	1	0	1	0	Q	M	0		Vm					

```

if size != '00' then UNDEFINED;
if Q == '1' && (Vd<0> == '1' || Vm<0> == '1') then UNDEFINED;
esize = 8; elements = 8;
d = UInt(D:Vd); m = UInt(M:Vm); regs = if Q == '0' then 1 else 2;
    
```

Assembler syntax

VCNT{<C>}{<q>}.8 <Qd>, <Qm> Encoded as Q = 1
VCNT{<C>}{<q>}.8 <Dd>, <Dm> Encoded as Q = 0

where:

<C>, <q> See [Standard assembler syntax fields on page F2-2415](#). An A32 VCNT instruction must be unconditional. ARM strongly recommends that a T32 VCNT instruction is unconditional, see [Conditional execution on page F2-2416](#).

<Qd>, <Qm> The destination vector and the operand vector, for a quadword operation.

<Dd>, <Dm> The destination vector and the operand vector, for a doubleword operation.

Operation

```
if ConditionPassed() then
    EncodingSpecificOperations(); CheckAdvSIMDEnabled();
    for r = 0 to regs-1
        for e = 0 to elements-1
            Elem[D[d+r],e,esize] = BitCount(Elem[D[m+r],e,esize])<esize-1:0>;
```

F8.1.44 VCVT (between floating-point and integer, Advanced SIMD)

This instruction converts each element in a vector from floating-point to integer, or from integer to floating-point, and places the results in a second vector.

The vector elements must be 32-bit floating-point numbers, or 32-bit integers. Signed and unsigned integers are distinct.

The floating-point to integer operation uses the Round towards Zero rounding mode. The integer to floating-point operation uses the Round to Nearest rounding mode.

Depending on settings in the CPACR, NSACR, and HCPTR registers, and the security state and mode in which the instruction is executed, an attempt to execute the instruction might be UNDEFINED, or trapped to Hyp mode. [Summary of access controls for Advanced SIMD functionality on page G1-3498](#) summarizes these controls.

ARM deprecates the conditional execution of any Advanced SIMD instruction encoding that is not also available as a VFP instruction encoding, see [Conditional execution on page F2-2416](#).

Encoding T1/A1 Advanced SIMDv1 (UNDEFINED in integer-only variant)

VCVT<c>.<Td>.<Tm> <Qd>, <Qm>

VCVT<c>.<Td>.<Tm> <Dd>, <Dm>

15	14	13	12	11	10	9	8	7	6	5	4	3	2	1	0	15	14	13	12	11	10	9	8	7	6	5	4	3	2	1	0
1	1	1	1	1	1	1	1	1	D	1	1	size	1	1		Vd	0	1	1	op	Q	M	0		Vm						

31	30	29	28	27	26	25	24	23	22	21	20	19	18	17	16	15	14	13	12	11	10	9	8	7	6	5	4	3	2	1	0
1	1	1	1	0	0	1	1	1	D	1	1	size	1	1		Vd	0	1	1	op	Q	M	0		Vm						

```

if Q == '1' && (Vd<0> == '1' || Vm<0> == '1') then UNDEFINED;
if size != '10' then UNDEFINED;
to_integer = (op<1> == '1'); unsigned = (op<0> == '1');
esize = 32; elements = 2;
d = UInt(D:Vd); m = UInt(M:Vm); regs = if Q == '0' then 1 else 2;
    
```

Assembler syntax

VCVT{<C>}{<q>}.<Td>.<Tm> <Qd>, <Qm> Encoded as Q = 1
 VCVT{<C>}{<q>}.<Td>.<Tm> <Dd>, <Dm> Encoded as Q = 0

where:

<C>, <q> See *Standard assembler syntax fields* on page F2-2415. An A32 Advanced SIMD VCVT instruction must be unconditional. ARM strongly recommends that a T32 Advanced SIMD VCVT instruction is unconditional, see *Conditional execution* on page F2-2416.

.<Td>.<Tm> The data types for the elements of the vectors. They must be one of:

.S32.F32 Encoded as op = 0b10, size = 0b10.

.U32.F32 Encoded as op = 0b11, size = 0b10.

.F32.S32 Encoded as op = 0b00, size = 0b10.

.F32.U32 Encoded as op = 0b01, size = 0b10.

<Qd>, <Qm> The destination vector and the operand vector, for a quadword operation.

<Dd>, <Dm> The destination vector and the operand vector, for a doubleword operation.

Operation

```

if ConditionPassed() then
    EncodingSpecificOperations(); CheckAdvSIMDEnabled();
    bits(esize) result;
    for r = 0 to regs-1
        for e = 0 to elements-1
            op1 = Elem[D[m+r],e,esize];
            if to_integer then
                result = FPToFixed(op1, 0, unsigned, StandardFPSCRValue(), FPRounding_ZERO);
            else
                result = FixedToFP(op1, 0, unsigned, StandardFPSCRValue(), FPRounding_TIEEVEN);
            Elem[D[d+r],e,esize] = result;
  
```

F8.1.45 VCVT, VCVTR (between floating-point and integer, floating-point)

These instructions convert a value in a register from floating-point to a 32-bit integer, or from a 32-bit integer to floating-point, and place the result in a second register.

The floating-point to integer operation normally uses the Round towards Zero rounding mode, but can optionally use the rounding mode specified by the FPSCR. The integer to floating-point operation uses the rounding mode specified by the FPSCR.

VCVT (between floating-point and fixed-point, floating-point) on page F8-3148 describes conversions between floating-point and 16-bit integers.

Depending on settings in the CPACR, NSACR, and HCPTR, and FPEXC registers, and the security state and mode in which the instruction is executed, an attempt to execute the instruction might be UNDEFINED, or trapped to Hyp mode. *Summary of general controls of CP10 and CP11 functionality* on page G1-3496 summarizes these controls.

Encoding T1/A1 VFPv2, VFPv3, VFPv4 (sz = 1 UNDEFINED in single-precision only variants)

VCVT{R}<c>.S32.F64 <Sd>, <Dm>

VCVT{R}<c>.S32.F32 <Sd>, <Sm>

VCVT{R}<c>.U32.F64 <Sd>, <Dm>

VCVT{R}<c>.U32.F32 <Sd>, <Sm>

VCVT<c>.F64.<Tm> <Dd>, <Sm>

VCVT<c>.F32.<Tm> <Sd>, <Sm>

15	14	13	12	11	10	9	8	7	6	5	4	3	2	1	0	15	14	13	12	11	10	9	8	7	6	5	4	3	2	1	0
1	1	1	0	1	1	1	0	1	D	1	1	1	opc2			Vd				1	0	1	sz	op	1	M	0		Vm		

31	30	29	28	27	26	25	24	23	22	21	20	19	18	17	16	15	14	13	12	11	10	9	8	7	6	5	4	3	2	1	0		
cond						1	1	1	0	1	D	1	1	1	opc2					Vd				1	0	1	sz	op	1	M	0		Vm

```

if opc2 != '000' && opc2 != '10x' then SEE "Related encodings";
to_integer = (opc2<2> == '1'); dp_operation = (sz == '1');
if to_integer then
    unsigned = (opc2<0> == '0');
    rounding = if op == '1' then FPRounding_ZERO else FPRoundingMode(FPSCR);
    d = UInt(Vd:D); m = if dp_operation then UInt(M:Vm) else UInt(Vm:M);
else
    unsigned = (op == '0');
    rounding = FPRoundingMode(FPSCR);
    m = UInt(Vm:M); d = if dp_operation then UInt(D:Vd) else UInt(Vd:D);
    
```

Related encodings See *Floating-point data-processing instructions* on page F5-2511.

Assembler syntax

VCVT{R}{<C>}{<Q>}.S32.F64 <Sd>, <Dm>	Encoded as opc2 = 0b101, sz = 1
VCVT{R}{<C>}{<Q>}.S32.F32 <Sd>, <Sm>	Encoded as opc2 = 0b101, sz = 0
VCVT{R}{<C>}{<Q>}.U32.F64 <Sd>, <Dm>	Encoded as opc2 = 0b100, sz = 1
VCVT{R}{<C>}{<Q>}.U32.F32 <Sd>, <Sm>	Encoded as opc2 = 0b100, sz = 0
VCVT{<C>}{<Q>}.F64.<Tm> <Dd>, <Sm>	Encoded as opc2 = 0b000, sz = 1
VCVT{<C>}{<Q>}.F32.<Tm> <Sd>, <Sm>	Encoded as opc2 = 0b000, sz = 0

where:

R If R is specified, the operation uses the rounding mode specified by the [FPSCR](#). Encoded as op = 0.
 If R is omitted, the operation uses the Round towards Zero rounding mode. For syntaxes in which R is optional, op is encoded as 1 if R is omitted.

<C>, <Q> See [Standard assembler syntax fields on page F2-2415](#).

<Tm> The data type for the operand. It must be one of:
 S32 Encoded as op = 1.
 U32 Encoded as op = 0.

<Sd>, <Dm> The destination register and the operand register, for a double-precision operand.

<Dd>, <Sm> The destination register and the operand register, for a double-precision result.

<Sd>, <Sm> The destination register and the operand register, for a single-precision operand or result.

Operation

```

if ConditionPassed() then
    EncodingSpecificOperations(); CheckVFPEnabled(TRUE);
    if to_integer then
        if dp_operation then
            S[d] = FPToFixed(D[m], 0, unsigned, FPSCR, rounding);
        else
            S[d] = FPToFixed(S[m], 0, unsigned, FPSCR, rounding);
    else
        if dp_operation then
            D[d] = FixedToFP(S[m], 0, unsigned, FPSCR, rounding);
        else
            S[d] = FixedToFP(S[m], 0, unsigned, FPSCR, rounding);
  
```

F8.1.46 VCVT (between floating-point and fixed-point, Advanced SIMD)

This instruction converts each element in a vector from floating-point to fixed-point, or from fixed-point to floating-point, and places the results in a second vector.

The vector elements must be 32-bit floating-point numbers, or 32-bit integers. Signed and unsigned integers are distinct.

The floating-point to fixed-point operation uses the Round towards Zero rounding mode. The fixed-point to floating-point operation uses the Round to Nearest rounding mode.

Depending on settings in the CPACR, NSACR, and HCPTR registers, and the security state and mode in which the instruction is executed, an attempt to execute the instruction might be UNDEFINED, or trapped to Hyp mode. [Summary of access controls for Advanced SIMD functionality on page G1-3498](#) summarizes these controls.

ARM deprecates the conditional execution of any Advanced SIMD instruction encoding that is not also available as a VFP instruction encoding, see [Conditional execution on page F2-2416](#).

Encoding T1/A1 Advanced SIMDv1 (UNDEFINED in integer-only variant)

VCVT<c>.<Td>.<Tm> <Qd>, <Qm>, #<fbits>

VCVT<c>.<Td>.<Tm> <Dd>, <Dm>, #<fbits>

15	14	13	12	11	10	9	8	7	6	5	4	3	2	1	0	15	14	13	12	11	10	9	8	7	6	5	4	3	2	1	0
1	1	1	U	1	1	1	1	1	D	imm6						Vd	1	1	1	op	0	Q	M	1	Vm						

31	30	29	28	27	26	25	24	23	22	21	20	19	18	17	16	15	14	13	12	11	10	9	8	7	6	5	4	3	2	1	0
1	1	1	1	0	0	1	U	1	D	imm6						Vd	1	1	1	op	0	Q	M	1	Vm						

```

if imm6 == '000xxx' then SEE "Related encodings";
if imm6 == '0xxxxx' then UNDEFINED;
if Q == '1' && (Vd<0> == '1' || Vm<0> == '1') then UNDEFINED;
to_fixed = (op == '1'); frac_bits = 64 - UInt(imm6);
unsigned = (U == '1'); esize = 32; elements = 2;
d = UInt(D:Vd); m = UInt(M:Vm); regs = if Q == '0' then 1 else 2;
    
```

Related encodings See [One register and a modified immediate value on page F5-2508](#).

Assembler syntax

VCVT{<c>}{<q>}.<Td>.<Tm> <Qd>, <Qm>, #<fbits> Encoded as Q = 1
 VCVT{<c>}{<q>}.<Td>.<Tm> <Dd>, <Dm>, #<fbits> Encoded as Q = 0

where:

<c>, <q> See [Standard assembler syntax fields on page F2-2415](#). An A32 Advanced SIMD VCVT instruction must be unconditional. ARM strongly recommends that a T32 Advanced SIMD VCVT instruction is unconditional, see [Conditional execution on page F2-2416](#).

.<Td>.<Tm> The data types for the elements of the vectors. They must be one of:
 .S32.F32 Encoded as op = 1, U = 0.
 .U32.F32 Encoded as op = 1, U = 1.
 .F32.S32 Encoded as op = 0, U = 0.
 .F32.U32 Encoded as op = 0, U = 1.

<Qd>, <Qm> The destination vector and the operand vector, for a quadword operation.

<Dd>, <Dm> The destination vector and the operand vector, for a doubleword operation.

<fbits> The number of fraction bits in the fixed point number, in the range 1 to 32:
 • (64 - <fbits>) is encoded in imm6.
 An assembler can permit an <fbits> value of 0. This is encoded as floating-point to integer or integer to floating-point instruction, see [VCVT \(between floating-point and integer, Advanced SIMD\) on page F8-3142](#).

Operation

```

if ConditionPassed() then
    EncodingSpecificOperations(); CheckAdvSIMDEnabled();
    bits(esize) result;
    for r = 0 to regs-1
        for e = 0 to elements-1
            op1 = Elem[D[m+r],e,esize];
            if to_fixed then
                result = FPToFixed(op1, frac_bits, unsigned, StandardFPSCRValue(),
                                   FPRounding_ZERO);
            else
                result = FixedToFP(op1, frac_bits, unsigned, StandardFPSCRValue(),
                                   FPRounding_TIEEVEN);
            Elem[D[d+r],e,esize] = result;
  
```

F8.1.47 VCVT (between floating-point and fixed-point, floating-point)

This instruction converts a value in a register from floating-point to fixed-point, or from fixed-point to floating-point. Software can specify the fixed-point value as either signed or unsigned.

The floating-point value can be single-precision or double-precision.

The fixed-point value can be 16-bit or 32-bit. Conversions from fixed-point values take their operand from the low-order bits of the source register and ignore any remaining bits. Signed conversions to fixed-point values sign-extend the result value to the destination register width. Unsigned conversions to fixed-point values zero-extend the result value to the destination register width.

The floating-point to fixed-point operation uses the Round towards Zero rounding mode. The fixed-point to floating-point operation uses the Round to Nearest rounding mode.

Depending on settings in the CPACR, NSACR, and HCPTR, and FPEXC registers, and the security state and mode in which the instruction is executed, an attempt to execute the instruction might be UNDEFINED, or trapped to Hyp mode. *Summary of general controls of CP10 and CP11 functionality on page G1-3496* summarizes these controls.

Encoding T1/A1 VFPv3, VFPv4 (sf = 1 UNDEFINED in single-precision only variants)

VCVT<c>.<Td>.F64 <Dd>, <Dd>, #<fbits>

VCVT<c>.<Td>.F32 <Sd>, <Sd>, #<fbits>

VCVT<c>.F64.<Td> <Dd>, <Dd>, #<fbits>

VCVT<c>.F32.<Td> <Sd>, <Sd>, #<fbits>

15	14	13	12	11	10	9	8	7	6	5	4	3	2	1	0	15	14	13	12	11	10	9	8	7	6	5	4	3	2	1	0
1	1	1	0	1	1	1	0	1	D	1	1	1	op	1	U	Vd															

31	30	29	28	27	26	25	24	23	22	21	20	19	18	17	16	15	14	13	12	11	10	9	8	7	6	5	4	3	2	1	0
cond																															

```

to_fixed = (op == '1'); unsigned = (U == '1');
size = if sx == '0' then 16 else 32;
frac_bits = size - UInt(imm4:i);
dp_operation = (sf == '1');
d = if dp_operation then UInt(D:Vd) else UInt(Vd:D);
if frac_bits < 0 then UNPREDICTABLE;
    
```

For information about the CONSTRAINED UNPREDICTABLE behavior of this instruction, see [Appendix A Architectural Constraints on UNPREDICTABLE behaviors](#), and particularly *VCVT (between floating-point and fixed-point)* on page AppxA-4743.

Assembler syntax

VCVT{<c>}{<q>}.<Td>.F64 <Dd>, <Dd>, #<fbits>	Encoded as op = 1, sf = 1
VCVT{<c>}{<q>}.<Td>.F32 <Sd>, <Sd>, #<fbits>	Encoded as op = 1, sf = 0
VCVT{<c>}{<q>}.F64.<Td> <Dd>, <Dd>, #<fbits>	Encoded as op = 0, sf = 1
VCVT{<c>}{<q>}.F32.<Td> <Sd>, <Sd>, #<fbits>	Encoded as op = 0, sf = 0

where:

<c>, <q>	See Standard assembler syntax fields on page F2-2415 .
<Td>	The data type for the fixed-point number. It must be one of: S16 Encoded as U = 0, sx = 0. U16 Encoded as U = 1, sx = 0. S32 Encoded as U = 0, sx = 1. U32 Encoded as U = 1, sx = 1.
<Dd>	The destination and operand register, for a double-precision operand.
<Sd>	The destination and operand register, for a single-precision operand.
<fbits>	The number of fraction bits in the fixed-point number: • If <Td> is S16 or U16, <fbits> must be in the range 0-16. (16 - <fbits>) is encoded in [imm4, i] • If <Td> is S32 or U32, <fbits> must be in the range 1-32. (32 - <fbits>) is encoded in [imm4, i].

Operation

```

if ConditionPassed() then
    EncodingSpecificOperations(); CheckVFPEnabled(TRUE);
    if to_fixed then
        bits(size) result;
        if dp_operation then
            result = FPToFixed(D[d], frac_bits, unsigned, FPSCR, FPRounding_ZERO);
            D[d] = Extend(result, 64, unsigned);
        else
            result = FPToFixed(S[d], frac_bits, unsigned, FPSCR, FPRounding_ZERO);
            S[d] = Extend(result, 32, unsigned);
    else
        if dp_operation then
            D[d] = FixedToFP(D[d]<size-1:0>, frac_bits, unsigned, FPSCR, FPRounding_TIEEVEN);
        else
            S[d] = FixedToFP(S[d]<size-1:0>, frac_bits, unsigned, FPSCR, FPRounding_TIEEVEN);
  
```

F8.1.48 VCVT (between double-precision and single-precision)

This instruction does one of the following:

- Converts the value in a double-precision register to single-precision and writes the result to a single-precision register.
- Converts the value in a single-precision register to double-precision and writes the result to a double-precision register.

Depending on settings in the CPACR, NSACR, and HCPTR, and FPEXC registers, and the security state and mode in which the instruction is executed, an attempt to execute the instruction might be UNDEFINED, or trapped to Hyp mode. *Summary of general controls of CP10 and CP11 functionality on page G1-3496* summarizes these controls.

Encoding T1/A1 VFPv2, VFPv3, VFPv4 (UNDEFINED in single-precision only variants)

VCVT<c>.F64.F32 <Dd>, <Sm>

VCVT<c>.F32.F64 <Sd>, <Dm>

15	14	13	12	11	10	9	8	7	6	5	4	3	2	1	0	15	14	13	12	11	10	9	8	7	6	5	4	3	2	1	0
1	1	1	0	1	1	1	0	1	D	1	1	0	1	1	1	Vd	1	0	1	sz	1	1	M	0	Vm						
31	30	29	28	27	26	25	24	23	22	21	20	19	18	17	16	15	14	13	12	11	10	9	8	7	6	5	4	3	2	1	0
cond		1	1	1	0	1	D	1	1	0	1	1	1		Vd	1	0	1	sz	1	1	M	0	Vm							

```
double_to_single = (sz == '1');
d = if double_to_single then UInt(Vd:D) else UInt(D:Vd);
m = if double_to_single then UInt(M:Vm) else UInt(Vm:M);
```

Assembler syntax

VCVT{<c>}{<q>}.F64.F32 <Dd>, <Sm>

Encoded as sz = 0

VCVT{<c>}{<q>}.F32.F64 <Sd>, <Dm>

Encoded as sz = 1

where:

<c>, <q> See *Standard assembler syntax fields on page F2-2415*.

<Dd>, <Sm> The destination register and the operand register, for a single-precision operand.

<Sd>, <Dm> The destination register and the operand register, for a double-precision operand.

Operation

```
if ConditionPassed() then
    EncodingSpecificOperations(); CheckVFPEEnabled(TRUE);
    if double_to_single then
        S[d] = FPConvert(D[m], FPSCR);
    else
        D[d] = FPConvert(S[m], FPSCR);
```

F8.1.49 VCVT (between half-precision and single-precision, Advanced SIMD)

This instruction converts each element in a vector from single-precision to half-precision floating-point or from half-precision to single-precision, and places the results in a second vector.

The vector elements must be 32-bit floating-point numbers, or 16-bit floating-point numbers.

Depending on settings in the CPACR, NSACR, and HCPTR registers, and the security state and mode in which the instruction is executed, an attempt to execute the instruction might be UNDEFINED, or trapped to Hyp mode. [Summary of access controls for Advanced SIMD functionality on page G1-3498](#) summarizes these controls.

ARM deprecates the conditional execution of any Advanced SIMD instruction encoding that is not also available as a VFP instruction encoding, see [Conditional execution on page F2-2416](#).

Encoding T1/A1 Advanced SIMDv1 with Half-precision Extension (UNDEFINED in integer-only variant)

VCVT<c>.F32.F16 <Qd>, <Dm>

VCVT<c>.F16.F32 <Dd>, <Qm>

15	14	13	12	11	10	9	8	7	6	5	4	3	2	1	0	15	14	13	12	11	10	9	8	7	6	5	4	3	2	1	0
1	1	1	1	1	1	1	1	1	D	1	1	size	1	0	Vd	0	1	1	op	0	0	M	0	Vm							
31	30	29	28	27	26	25	24	23	22	21	20	19	18	17	16	15	14	13	12	11	10	9	8	7	6	5	4	3	2	1	0
1	1	1	1	0	0	1	1	1	D	1	1	size	1	0	Vd	0	1	1	op	0	0	M	0	Vm							

```

if size != '01' then UNDEFINED;
half_to_single = (op == '1');
if half_to_single && Vd<0> == '1' then UNDEFINED;
if !half_to_single && Vm<0> == '1' then UNDEFINED;
esize = 16; elements = 4;
m = UInt(M:Vm); d = UInt(D:Vd);
    
```

Assembler syntax

VCVT{<c>}{<q>}.F32.F16 <Qd>, <Dm>

Encoded as op = 1

VCVT{<c>}{<q>}.F16.F32 <Dd>, <Qm>

Encoded as op = 0

where:

<c>, <q> See [Standard assembler syntax fields on page F2-2415](#). An A32 VCVT instruction must be unconditional. ARM strongly recommends that a T32 VCVT instruction is unconditional, see [Conditional execution on page F2-2416](#).

<Qd>, <Dm> The destination vector and the operand vector for a half-precision to single-precision operation.

<Dd>, <Qm> The destination vector and the operand vectors for a single-precision to half-precision operation.

Operation

```

if ConditionPassed() then
    EncodingSpecificOperations(); CheckAdvSIMDEnabled();
    for e = 0 to elements-1
        if half_to_single then
            Elem[Q[d>>1],e,32] = FPConvert(Elem[Din[m],e,16], StandardFPSCRValue());
        else
            Elem[D[d],e,16] = FPConvert(Elem[Qin[m>>1],e,32], StandardFPSCRValue());
    
```

F8.1.50 VCVTA, VCVTN, VCVTP, VCVTM (between floating-point and integer, Advanced SIMD)

These instructions convert each element in a vector from floating-point to integer and places the results in a second vector.

The vector elements must be 32-bit floating-point numbers, or 32-bit integers. Signed and unsigned integers are distinct.

These instructions use the following rounding modes:

- VCVTA: Round to Nearest with Ties to Away.
- VCVTN: Round to Nearest with Ties to Even.
- VCVTP: Round toward +Infinity.
- VCVTM: Round toward -Infinity.

Depending on settings in the CPACR, NSACR, and HCPTR, and FPEXC registers, and the security state and mode in which the instruction is executed, an attempt to execute the instruction might be UNDEFINED, or trapped to Hyp mode. *Summary of general controls of CP10 and CP11 functionality on page G1-3496* summarizes these controls.

Encoding T1/A1 ARMv8 Advanced SIMD

VCVT<r>.S32.F32 <Qd>, <Qm>

VCVT<r>.U32.F32 <Qd>, <Qm>

VCVT<r>.S32.F32 <Dd>, <Dm>

VCVT<r>.U32.F32 <Dd>, <Dm>

15	14	13	12	11	10	9	8	7	6	5	4	3	2	1	0	15	14	13	12	11	10	9	8	7	6	5	4	3	2	1	0
1	1	1	1	1	1	1	1	1	D	1	1	size	1	1		Vd	0	0	RM	op	Q	M	0		Vm						

31	30	29	28	27	26	25	24	23	22	21	20	19	18	17	16	15	14	13	12	11	10	9	8	7	6	5	4	3	2	1	0
1	1	1	1	0	0	1	1	1	D	1	1	size	1	1		Vd	0	0	RM	op	Q	M	0		Vm						

```

if Q == '1' && (Vd<0> == '1' || Vm<0> == '1') then UNDEFINED;
if size != '10' then UNDEFINED;
rounding = FPDecodeRM(RM); unsigned = (op == '1');
esize = 32; elements = 2;
d = UInt(D:Vd); m = UInt(M:Vm); regs = if Q == '0' then 1 else 2;
if InITBlock() then UNPREDICTABLE;
    
```

Assembler syntax

VCVT<r>{<q>}.<Tm>.F32 <Qd>, <Qm> Encoded as Q= 1
VCVT<r>{<q>}.<Tm>.F32 <Dd>, <Dm> Encoded as Q= 0

where:

r Selects the rounding mode. It must be one of:
A Encoded as RM = 00.
N Encoded as RM = 01.
P Encoded as RM = 10.
M Encoded as RM = 11.

<q> See [Standard assembler syntax fields on page F2-2415](#).

<Tm> The data type for the operand. It must be one of:
S32 Encoded as op = 0.
U32 Encoded as op = 1.

<Qd>, <Qm> The destination vector and the operand vector, for a quadword operation.

<Dd>, <Dm> The destination vector and the operand vector, for a doubleword operation.

Operation

```
EncodingSpecificOperations(); CheckAdvSIMDEnabled();
bits(esize) result;
for r = 0 to regs-1
    for e = 0 to elements-1
        Elem[D[d+r],e,esize] = FPToFixed(Elem[D[m+r],e,esize], 0, unsigned,
            StandardFPSCRValue(), rounding);
```

F8.1.51 VCVTA, VCVTN, VCVTP, VCVTM (between floating-point and integer, floating-point)

These instructions convert a value in a register from floating-point to a 32-bit integer, or from a 32-bit integer to floating-point, and place the result in a second register.

These instructions use the following rounding modes:

- VCVTA: Round to Nearest with Ties to Away.
- VCVTN: Round to Nearest with Ties to Even.
- VCVTP: Round towards +Infinity.
- VCVTM: Round towards -Infinity.

Depending on settings in the CPACR, NSACR, and HCPTR, and FPEXC registers, and the security state and mode in which the instruction is executed, an attempt to execute the instruction might be UNDEFINED, or trapped to Hyp mode. [Summary of general controls of CP10 and CP11 functionality on page G1-3496](#) summarizes these controls.

Encoding T1/A1 ARMv8 FP

VCVT<r>.S32.F64 <Sd>, <Dm>
 VCVT<r>.S32.F32 <Sd>, <Sm>
 VCVT<r>.U32.F64 <Sd>, <Dm>
 VCVT<r>.U32.F32 <Sd>, <Sm>

15	14	13	12	11	10	9	8	7	6	5	4	3	2	1	0	15	14	13	12	11	10	9	8	7	6	5	4	3	2	1	0
1	1	1	1	1	1	1	0	1	D	1	1	1	1	RM		Vd		1	0	1	sz	op	1	M	0		Vm				
31	30	29	28	27	26	25	24	23	22	21	20	19	18	17	16	15	14	13	12	11	10	9	8	7	6	5	4	3	2	1	0
1	1	1	1	1	1	1	0	1	D	1	1	1	1	RM		Vd		1	0	1	sz	op	1	M	0		Vm				

rounding = FPDecodeRM(RM); unsigned = (op == '0'); dp_operation = (sz == '1');
 d = UInt(Vd:D); m = if dp_operation then UInt(M:Vm) else UInt(Vm:M);
 if InITBlock() then UNPREDICTABLE;

Related encodings See [Floating-point data-processing instructions on page F5-2511](#).

Assembler syntax

VCVT<r>{<q>}.<Tm>.F64 <Sd>, <Dm> Encoded as sz = 1
VCVT<r>{<q>}.<Tm>.F32 <Sd>, <Sm> Encoded as sz = 0

where:

r Selects the rounding mode. It must be one of:
 A Encoded as RM = 00.
 N Encoded as RM = 01.
 P Encoded as RM = 10.
 M Encoded as RM = 11.

<c>, <q> See [Standard assembler syntax fields on page F2-2415](#).

<Tm> The data type for the operand. It must be one of:
 S32 Encoded as op = 1.
 U32 Encoded as op = 0.

<Sd>, <Dm> The destination register and the operand register, for a double-precision operand.

<Sd>, <Sm> The destination register and the operand register, for a single-precision operand or result.

Operation

```
EncodingSpecificOperations(); CheckVFPEnabled(TRUE);  
if dp_operation then  
    S[d] = FPToFixed(D[m], 0, unsigned, FPSCR, rounding);  
else  
    S[d] = FPToFixed(S[m], 0, unsigned, FPSCR, rounding);
```

F8.1.52 VCVTB, VCVTT

Vector Convert Bottom and Vector Convert Top do one of the following:

- Convert the half-precision value in the top or bottom half of a single-precision register to single-precision and write the result to a single-precision or double-precision register.
- Convert the value in a single-precision to half-precision and write the result into the top or bottom half of a single-precision register, preserving the other half of the target register.

Depending on settings in the CPACR, NSACR, and HCPTR, and FPEXC registers, and the security state and mode in which the instruction is executed, an attempt to execute the instruction might be UNDEFINED, or trapped to Hyp mode. *Summary of general controls of CP10 and CP11 functionality on page G1-3496* summarizes these controls.

Encoding T1/A1 VFPv3 Half-precision Extension, VFPv4 for operations using single-precision registers
 v8FP for operations using double-precision registers

VCVT<y><c>.F32.F16 <Sd>, <Sm>

VCVT<y><c>.F16.F32 <Sd>, <Sm>

VCVT<y><c>.F64.F16 <Dd>, <Sm>

VCVT<y><c>.F16.F64 <Sd>, <Dm>

15	14	13	12	11	10	9	8	7	6	5	4	3	2	1	0	15	14	13	12	11	10	9	8	7	6	5	4	3	2	1	0
1	1	1	0	1	1	1	0	1	D	1	1	0	0	1	op	Vd	1	0	1	sz	T	1	M	0	Vm						

31	30	29	28	27	26	25	24	23	22	21	20	19	18	17	16	15	14	13	12	11	10	9	8	7	6	5	4	3	2	1	0
cond	1	1	1	0	1	D	1	1	0	0	1	op	Vd	1	0	1	sz	T	1	M	0	Vm									

```

uses_double = (sz == '1'); convert_from_half = (op == '0');
lowbit = (if T == '1' then 16 else 0);
if uses_double then
    if convert_from_half then
        d = UInt(D:Vd); m = UInt(Vm:M);
    else
        d = UInt(Vd:D); m = UInt(M:Vm);
else
    d = UInt(Vd:D); m = UInt(Vm:M);
    
```

Assembler syntax

VCVT<y>{<c>}{<q>}.F32.F16 <Sd>, <Sm>	Encoded as op = 0, sz = 0
VCVT<y>{<c>}{<q>}.F16.F32 <Sd>, <Sm>	Encoded as op = 1, sz = 0
VCVT<y>{<c>}{<q>}.F64.F16 <Dd>, <Sm>	Encoded as op = 0, sz = 1
VCVT<y>{<c>}{<q>}.F16.F64 <Sd>, <Dm>	Encoded as op = 1, sz = 1

where:

<y>	Specifies which half of the operand or destination register is used for the operand or destination. One of:
B	Encoded as T = 0. Instruction uses the bottom half of the register, bits[15:0].
T	Encoded as T = 1. Instruction uses the top half of the register, bits[31:16].
<c>, <q>	See <i>Standard assembler syntax fields</i> on page F2-2415.
<Sd>	The single-precision destination register.
<Sm>	The single-precision operand register.
<Dd>	The double-precision destination register.
<Dm>	The double-precision operand register.

Operation

```

if ConditionPassed() then
    EncodingSpecificOperations(); CheckVFPEnabled(TRUE);
    bits(16) hp;
    if convert_from_half then
        hp = S[m]<lowbit+15:lowbit>;
        if uses_double then
            D[d] = FPConvert(hp, FPSCR);
        else
            S[d] = FPConvert(hp, FPSCR);
    else
        if uses_double then
            hp = FPConvert(D[m], FPSCR);
        else
            hp = FPConvert(S[m], FPSCR);
    S[d]<lowbit+15:lowbit> = hp;
  
```

F8.1.53 VDIV

This instruction divides one floating-point value by another floating-point value and writes the result to a third floating-point register.

Depending on settings in the CPACR, NSACR, and HCPTR, and FPEXC registers, and the security state and mode in which the instruction is executed, an attempt to execute the instruction might be UNDEFINED, or trapped to Hyp mode. *Summary of general controls of CP10 and CP11 functionality on page G1-3496* summarizes these controls.

Encoding T1/A1 VFPv2, VFPv3, VFPv4 (sz = 1 UNDEFINED in single-precision only variants)

VDIV<c>.F64 <Dd>, <Dn>, <Dm>

VDIV<c>.F32 <Sd>, <Sn>, <Sm>

15	14	13	12	11	10	9	8	7	6	5	4	3	2	1	0	15	14	13	12	11	10	9	8	7	6	5	4	3	2	1	0
1	1	1	0	1	1	1	0	1	D	0	0	Vn				Vd				1	0	1	sz	N	0	M	0	Vm			
31	30	29	28	27	26	25	24	23	22	21	20	19	18	17	16	15	14	13	12	11	10	9	8	7	6	5	4	3	2	1	0
cond				1	1	1	0	1	D	0	0	Vn				Vd				1	0	1	sz	N	0	M	0	Vm			

```

if FPSCR.Len != '000' || FPSCR.Stride != '00' then SEE UNDEFINED;
dp_operation = (sz == '1');
d = if dp_operation then UInt(D:Vd) else UInt(Vd:D);
n = if dp_operation then UInt(N:Vn) else UInt(Vn:N);
m = if dp_operation then UInt(M:Vm) else UInt(Vm:M);
    
```

Assembler syntax

VDIV{<c>}{<q>}.F64 {<Dd>}, <Dn>, <Dm> Encoded as sz = 1
VDIV{<c>}{<q>}.F32 {<Sd>}, <Sn>, <Sm> Encoded as sz = 0

where:

<c>, <q> See [Standard assembler syntax fields on page F2-2415](#).
<Dd>, <Dn>, <Dm> The destination register and the operand registers, for a double-precision operation.
<Sd>, <Sn>, <Sm> The destination register and the operand registers, for a single-precision operation.

Operation

```
if ConditionPassed() then
    EncodingSpecificOperations(); CheckVFPEnabled(TRUE);
    if dp_operation then
        D[d] = FPDIV(D[n], D[m], FPSCR);
    else
        S[d] = FPDIV(S[n], S[m], FPSCR);
```

F8.1.54 VDUP (scalar)

Vector Duplicate duplicates a scalar into every element of the destination vector.

The scalar, and the destination vector elements, can be any one of 8-bit, 16-bit, or 32-bit fields. There is no distinction between data types.

For more information about scalars see [Advanced SIMD scalars on page F5-2498](#).

Depending on settings in the CPACR, NSACR, and HCPTR registers, and the security state and mode in which the instruction is executed, an attempt to execute the instruction might be UNDEFINED, or trapped to Hyp mode. [Summary of access controls for Advanced SIMD functionality on page G1-3498](#) summarizes these controls.

ARM deprecates the conditional execution of any Advanced SIMD instruction encoding that is not also available as a VFP instruction encoding, see [Conditional execution on page F2-2416](#).

Encoding T1/A1 Advanced SIMDv1

VDUP<c>.<size> <Qd>, <Dm[x]>

VDUP<c>.<size> <Dd>, <Dm[x]>

15	14	13	12	11	10	9	8	7	6	5	4	3	2	1	0	15	14	13	12	11	10	9	8	7	6	5	4	3	2	1	0
1	1	1	1	1	1	1	1	D	1	1	imm4					Vd			1	1	0	0	0	Q	M	0	Vm				
31	30	29	28	27	26	25	24	23	22	21	20	19	18	17	16	15	14	13	12	11	10	9	8	7	6	5	4	3	2	1	0
1	1	1	1	0	0	1	1	1	D	1	1	imm4					Vd			1	1	0	0	0	Q	M	0	Vm			

```

if imm4 == 'x000' then UNDEFINED;
if Q == '1' && Vd<0> == '1' then UNDEFINED;
case imm4 of
    when "xxx1" esize = 8; elements = 8; index = UInt(imm4<3:1>);
    when "xx10" esize = 16; elements = 4; index = UInt(imm4<3:2>);
    when "x100" esize = 32; elements = 2; index = UInt(imm4<3>);
d = UInt(D:Vd); m = UInt(M:Vm); regs = if Q == '0' then 1 else 2;
    
```

Assembler syntax

VDUP{<c>}{<q>}.<size> <Qd>, <Dm[x]> Encoded as Q = 1
VDUP{<c>}{<q>}.<size> <Dd>, <Dm[x]> Encoded as Q = 0

where:

<c>, <q> See [Standard assembler syntax fields on page F2-2415](#). An A32 VDUP instruction must be unconditional. ARM strongly recommends that a T32 VDUP instruction is unconditional, see [Conditional execution on page F2-2416](#).

<size> The data size. It must be one of:

8	Encoded as imm4<0> = '1'. imm4<3:1> encodes the index [x] of the scalar.
16	Encoded as imm4<1:0> = '10'. imm4<3:2> encodes the index [x] of the scalar.
32	Encoded as imm4<2:0> = '100'. imm4<3> encodes the index [x] of the scalar.

<Qd> The destination vector for a quadword operation.

<Dd> The destination vector for a doubleword operation.

<Dm[x]> The scalar. For details of how [x] is encoded, see the description of <size>.

Operation

```
if ConditionPassed() then
    EncodingSpecificOperations(); CheckAdvSIMDEnabled();
    scalar = Elem[D[m],index,esize];
    for r = 0 to regs-1
        for e = 0 to elements-1
            Elem[D[d+r],e,esize] = scalar;
```

F8.1.55 VDUP (general-purpose register)

This instruction duplicates an element from a general-purpose register into every element of the destination vector.

The destination vector elements can be 8-bit, 16-bit, or 32-bit fields. The source element is the least significant 8, 16, or 32 bits of the general-purpose register. There is no distinction between data types.

Depending on settings in the CPACR, NSACR, and HCPTR registers, and the security state and mode in which the instruction is executed, an attempt to execute the instruction might be UNDEFINED, or trapped to Hyp mode.

[Summary of access controls for Advanced SIMD functionality on page G1-3498](#) summarizes these controls.

ARM deprecates the conditional execution of any Advanced SIMD instruction encoding that is not also available as a VFP instruction encoding, see [Conditional execution on page F2-2416](#).

Encoding T1/A1 Advanced SIMDv1

VDUP<c>.<size> <Qd>, <Rt>

VDUP<c>.<size> <Dd>, <Rt>

15	14	13	12	11	10	9	8	7	6	5	4	3	2	1	0	15	14	13	12	11	10	9	8	7	6	5	4	3	2	1	0
1	1	1	0	1	1	1	0	1	B	Q	0		Vd		Rt		1	0	1	1	D	0	E	1	(0)	(0)	(0)	(0)			

31	30	29	28	27	26	25	24	23	22	21	20	19	18	17	16	15	14	13	12	11	10	9	8	7	6	5	4	3	2	1	0
cond																															

```

if Q == '1' && Vd<0> == '1' then UNDEFINED;
d = UInt(D:Vd); t = UInt(Rt); regs = if Q == '0' then 1 else 2;
case B:E of
    when '00' esize = 32; elements = 2;
    when '01' esize = 16; elements = 4;
    when '10' esize = 8; elements = 8;
    when '11' UNDEFINED;
if t == 15 then UNPREDICTABLE; // ARMv8-A removes UNPREDICTABLE for R13
    
```

For information about the CONSTRAINED UNPREDICTABLE behavior of this instruction, see [Appendix A Architectural Constraints on UNPREDICTABLE behaviors](#).

Assembler syntax

VDUP{<c>}{<q>}.<size> <Qd>, <Rt> Encoded as Q = 1
VDUP{<c>}{<q>}.<size> <Dd>, <Rt> Encoded as Q = 0

where:

<c>, <q> See [Standard assembler syntax fields on page F2-2415](#). ARM strongly recommends that any VDUP instruction is unconditional, see [Conditional execution on page F2-2416](#).

<size> The data size for the elements of the destination vector. It must be one of:
8 Encoded as [b, e] = 0b10.
16 Encoded as [b, e] = 0b01.
32 Encoded as [b, e] = 0b00.

<Qd> The destination vector for a quadword operation.

<Dd> The destination vector for a doubleword operation.

<Rt> The ARM source register.

Operation

```
if ConditionPassed() then
    EncodingSpecificOperations(); CheckAdvSIMDEnabled();
    scalar = R[t]<size-1:0>;
    for r = 0 to regs-1
        for e = 0 to elements-1
            Elem[D[d+r],e,esize] = scalar;
```

F8.1.56 VEOR

Vector Bitwise Exclusive OR performs a bitwise Exclusive OR operation between two registers, and places the result in the destination register. The operand and result registers can be quadword or doubleword. They must all be the same size.

Depending on settings in the CPACR, NSACR, and HCPTR registers, and the security state and mode in which the instruction is executed, an attempt to execute the instruction might be UNDEFINED, or trapped to Hyp mode. [Summary of access controls for Advanced SIMD functionality on page G1-3498](#) summarizes these controls.

ARM deprecates the conditional execution of any Advanced SIMD instruction encoding that is not also available as a VFP instruction encoding, see [Conditional execution on page F2-2416](#).

Encoding T1/A1 Advanced SIMDv1

VEOR<c> <Qd>, <Qn>, <Qm>

VEOR<c> <Dd>, <Dn>, <Dm>

15	14	13	12	11	10	9	8	7	6	5	4	3	2	1	0	15	14	13	12	11	10	9	8	7	6	5	4	3	2	1	0
1	1	1	1	1	1	1	1	0	D	0	0	Vn				Vd	0	0	0	1	N	Q	M	1	Vm						

31	30	29	28	27	26	25	24	23	22	21	20	19	18	17	16	15	14	13	12	11	10	9	8	7	6	5	4	3	2	1	0
1	1	1	1	0	0	1	1	0	D	0	0	Vn				Vd	0	0	0	1	N	Q	M	1	Vm						

if Q == '1' && (Vd<0> == '1' || Vn<0> == '1' || Vm<0> == '1') then UNDEFINED;
 d = UInt(D:Vd); n = UInt(N:Vn); m = UInt(M:Vm); regs = if Q == '0' then 1 else 2;

Assembler syntax

VEOR{<c>}{<q>}{.<dt>} {<Qd>}, <Qn>, <Qm> Encoded as Q = 1
VEOR{<c>}{<q>}{.<dt>} {<Dd>}, <Dn>, <Dm> Encoded as Q = 0

where:

<c>, <q> See [Standard assembler syntax fields on page F2-2415](#). An A32 VEOE instruction must be unconditional. ARM strongly recommends that a T32 VEOE instruction is unconditional, see [Conditional execution on page F2-2416](#).

<dt> An optional data type. It is ignored by assemblers, and does not affect the encoding.

<Qd>, <Qn>, <Qm> The destination vector and the operand vectors, for a quadword operation.

<Dd>, <Dn>, <Dm> The destination vector and the operand vectors, for a doubleword operation.

Operation

```
if ConditionPassed() then
    EncodingSpecificOperations(); CheckAdvSIMDEnabled();
    for r = 0 to regs-1
        D[d+r] = D[n+r] EOR D[m+r];
```

F8.1.57 VEXT

Vector Extract extracts elements from the bottom end of the second operand vector and the top end of the first, concatenates them and places the result in the destination vector. See [Figure F8-1](#) for an example.

The elements of the vectors are treated as being 8-bit fields. There is no distinction between data types.

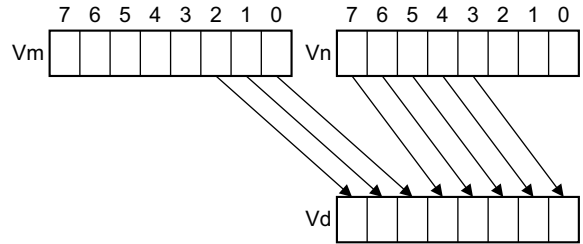

Figure F8-1 VEXT doubleword operation for imm = 3

Depending on settings in the [CPACR](#), [NSACR](#), and [HCPTR](#) registers, and the security state and mode in which the instruction is executed, an attempt to execute the instruction might be UNDEFINED, or trapped to Hyp mode.

[Summary of access controls for Advanced SIMD functionality on page G1-3498](#) summarizes these controls.

ARM deprecates the conditional execution of any Advanced SIMD instruction encoding that is not also available as a VFP instruction encoding, see [Conditional execution on page F2-2416](#).

Encoding T1/A1 Advanced SIMDv1

VEXT<c>.8 <Qd>, <Qn>, <Qm>, #<imm>

VEXT<c>.8 <Dd>, <Dn>, <Dm>, #<imm>

15	14	13	12	11	10	9	8	7	6	5	4	3	2	1	0	15	14	13	12	11	10	9	8	7	6	5	4	3	2	1	0
1	1	1	0	1	1	1	1	1	D	1	1	Vn				Vd				imm4				N	Q	M	0	Vm			
31	30	29	28	27	26	25	24	23	22	21	20	19	18	17	16	15	14	13	12	11	10	9	8	7	6	5	4	3	2	1	0
1	1	1	1	0	0	1	0	1	D	1	1	Vn				Vd				imm4				N	Q	M	0	Vm			

```

if Q == '1' && (Vd<0> == '1' || Vn<0> == '1' || Vm<0> == '1') then UNDEFINED;
if Q == '0' && imm4<3> == '1' then UNDEFINED;
quadword_operation = (Q == '1'); position = 8 * UInt(imm4);
d = UInt(D:Vd); n = UInt(N:Vn); m = UInt(M:Vm);
    
```

Assembler syntax

VEXT{<c>}{<q>}.<size> {<Qd>}, <Qn>, <Qm>, #<imm> Encoded as Q = 1
 VEXT{<c>}{<q>}.<size> {<Dd>}, <Dn>, <Dm>, #<imm> Encoded as Q = 0

where:

<c>, <q> See [Standard assembler syntax fields on page F2-2415](#). An A32 VEXT instruction must be unconditional. ARM strongly recommends that a T32 VEXT instruction is unconditional, see [Conditional execution on page F2-2416](#).

<size> Size of the operation. The value can be:

- 8, 16, or 32 for doubleword operations.
- 8, 16, 32, or 64 for quadword operations.

If the value is 16, 32, or 64, the syntax is a pseudo-instruction for a VEXT instruction specifying the equivalent number of bytes. The following examples show how an assembler treats values greater than 8:

VEXT.16 D0, D1, #x is treated as VEXT.8 D0, D1, #(x*2).
 VEXT.32 D0, D1, #x is treated as VEXT.8 D0, D1, #(x*4).
 VEXT.64 Q0, Q1, #x is treated as VEXT.8 Q0, Q1, #(x*8).

<Qd>, <Qn>, <Qm> The destination vector and the operand vectors, for a quadword operation.

<Dd>, <Dn>, <Dm> The destination vector and the operand vectors, for a doubleword operation.

<imm> The location of the extracted result in the concatenation of the operands, as a number of bytes from the least significant end, in the range 0-7 for a doubleword operation or 0-15 for a quadword operation.

Operation

```
if ConditionPassed() then
  EncodingSpecificOperations(); CheckAdvSIMDEnabled();
  if quadword_operation then
    Q[d>1] = (Q[m>1]:Q[n>1])<position+127:position>;
  else
    D[d] = (D[m]:D[n])<position+63:position>;
```

F8.1.58 VFMA, VFMS

Vector Fused Multiply Accumulate multiplies corresponding elements of two vectors, and accumulates the results into the elements of the destination vector. The instruction does not round the result of the multiply before the accumulation.

Vector Fused Multiply Subtract negates the elements of one vector and multiplies them with the corresponding elements of another vector, adds the products to the corresponding elements of the destination vector, and places the results in the destination vector. The instruction does not round the result of the multiply before the addition.

Depending on settings in the CPACR, NSACR, and HCPTR, and FPEXC registers, and the security state and mode in which the instruction is executed, an attempt to execute the instruction might be UNDEFINED, or trapped to Hyp mode. *Summary of general controls of CP10 and CP11 functionality on page G1-3496* and *Summary of access controls for Advanced SIMD functionality on page G1-3498* summarize these controls.

ARM deprecates the conditional execution of any Advanced SIMD instruction encoding that is not also available as a VFP instruction encoding, see *Conditional execution on page F2-2416*.

Encoding T1/A1 Advanced SIMDv2 (UNDEFINED in integer-only variant)

VFM<y><c>.F32 <Qd>, <Qn>, <Qm>

VFM<y><c>.F32 <Dd>, <Dn>, <Dm>

15	14	13	12	11	10	9	8	7	6	5	4	3	2	1	0	15	14	13	12	11	10	9	8	7	6	5	4	3	2	1	0
1	1	1	0	1	1	1	1	0	D	op	sz		Vn		Vd	1	1	0	0	N	Q	M	1		Vm						

31	30	29	28	27	26	25	24	23	22	21	20	19	18	17	16	15	14	13	12	11	10	9	8	7	6	5	4	3	2	1	0
1	1	1	1	0	0	1	0	0	D	op	sz		Vn		Vd	1	1	0	0	N	Q	M	1		Vm						

```

if Q == '1' && (Vd<0> == '1' || Vn<0> == '1' || Vm<0> == '1') then UNDEFINED;
if sz == '1' then UNDEFINED;
advsimd = TRUE; op1_neg = (op == '1'); esize = 32; elements = 2;
d = UInt(D:Vd); n = UInt(N:Vn); m = UInt(M:Vm);
regs = if Q == '0' then 1 else 2;
    
```

Encoding T2/A2 VFPv4 (sz = 1 UNDEFINED in single-precision only variants)

VFM<y><c>.F64 <Dd>, <Dn>, <Dm>

VFM<y><c>.F32 <Sd>, <Sn>, <Sm>

15	14	13	12	11	10	9	8	7	6	5	4	3	2	1	0	15	14	13	12	11	10	9	8	7	6	5	4	3	2	1	0
1	1	1	0	1	1	1	0	1	D	1	0		Vn		Vd	1	0	1	sz	N	op	M	0		Vm						

31	30	29	28	27	26	25	24	23	22	21	20	19	18	17	16	15	14	13	12	11	10	9	8	7	6	5	4	3	2	1	0
cond		1	1	1	0	1	D	1	0		Vn		Vd	1	0	1	sz	N	op	M	0		Vm								

```

if FPSCR.Len != '000' || FPSCR.Stride != '00' then UNDEFINED;
advsimd = FALSE; dp_operation = (sz == '1'); op1_neg = (op == '1');
d = if dp_operation then UInt(D:Vd) else UInt(Vd:D);
n = if dp_operation then UInt(N:Vn) else UInt(Vn:N);
m = if dp_operation then UInt(M:Vm) else UInt(Vm:M);
    
```

Assembler syntax

VFM<y><c><q>.F32 <Qd>, <Qn>, <Qm>	Encoding T1/A1, encoded as Q = 1, sz = 0
VFM<y><c><q>.F32 <Dd>, <Dn>, <Dm>	Encoding T1/A1, encoded as Q = 0, sz = 0
VFM<y><c><q>.F64 <Dd>, <Dn>, <Dm>	Encoding T2/A2, encoded as sz = 1
VFM<y><c><q>.F32 <Sd>, <Sn>, <Sm>	Encoding T2/A2, encoded as sz = 0

where:

<y>	One of: A Specifies VFMA, encoded as op = 0. S Specifies VFMS, encoded as op = 1.
<c>, <q>	See Standard assembler syntax fields on page F2-2415 . An A32 Advanced SIMD VFMA or VMFS instruction must be unconditional. ARM strongly recommends that a T32 Advanced SIMD VFMA or VMFS instruction is unconditional, see Conditional execution on page F2-2416 .
<Qd>, <Qn>, <Qm>	The destination vector and the operand vectors, for a quadword operation.
<Dd>, <Dn>, <Dm>	The destination vector and the operand vectors, for a doubleword operation.
<Sd>, <Sn>, <Sm>	The destination vector and the operand vectors, for a singleword operation.

Operation

```

if ConditionPassed() then
    EncodingSpecificOperations(); CheckAdvSIMDOrVFPEEnabled(TRUE, advsimd);
    if advsimd then // Advanced SIMD instruction
        for r = 0 to regs-1
            for e = 0 to elements-1
                bits(esize) op1 = Elem[D[n+r],e,esize];
                if op1_neg then op1 = FPNeg(op1);
                Elem[D[d+r],e,esize] = FPMulAdd(Elem[D[d+r],e,esize],
                    op1, Elem[D[m+r],e,esize], StandardFPSCRValue());
    else // VFP instruction
        if dp_operation then
            op64 = if op1_neg then FPNeg(D[n]) else D[n];
            D[d] = FPMulAdd(D[d], op64, D[m], FPSCR);
        else
            op32 = if op1_neg then FPNeg(S[n]) else S[n];
            S[d] = FPMulAdd(S[d], op32, S[m], FPSCR);
  
```

F8.1.59 VFNMA, VFNMS

Vector Fused Negate Multiply Accumulate negates one floating-point register value and multiplies it by another floating-point register value, adds the negation of the floating-point value in the destination register to the product, and writes the result back to the destination register. The instruction does not round the result of the multiply before the addition.

Vector Fused Negate Multiply Subtract multiplies together two floating-point register values, adds the negation of the floating-point value in the destination register to the product, and writes the result back to the destination register. The instruction does not round the result of the multiply before the addition.

Depending on settings in the CPACR, NSACR, and HCPTR, and FPEXC registers, and the security state and mode in which the instruction is executed, an attempt to execute the instruction might be UNDEFINED, or trapped to Hyp mode. *Summary of general controls of CP10 and CP11 functionality on page G1-3496* summarizes these controls.

Encoding T1/A1 VFPv4 (sz = 1 UNDEFINED in single-precision only variants)

VFNM<y><c>.F64 <Dd>, <Dn>, <Dm>

VFNM<y><c>.F32 <Sd>, <Sn>, <Sm>

15	14	13	12	11	10	9	8	7	6	5	4	3	2	1	0	15	14	13	12	11	10	9	8	7	6	5	4	3	2	1	0
1	1	1	0	1	1	1	0	1	D	0	1	Vn				Vd				1	0	1	sz	N	op	M	0	Vm			

31	30	29	28	27	26	25	24	23	22	21	20	19	18	17	16	15	14	13	12	11	10	9	8	7	6	5	4	3	2	1	0
cond				1	1	1	0	1	D	0	1	Vn				Vd				1	0	1	sz	N	op	M	0	Vm			

```

if FPSCR.Len != '000' || FPSCR.Stride != '00' then UNDEFINED;
op1_neg = (op == '1');
dp_operation = (sz == '1');
d = if dp_operation then UInt(D:Vd) else UInt(Vd:D);
n = if dp_operation then UInt(N:Vn) else UInt(Vn:N);
m = if dp_operation then UInt(M:Vm) else UInt(Vm:M);
    
```

Assembler syntax

VFNM<y><c><q>.F64 <Dd>, <Dn>, <Dm> Encoding T1/A1, encoded as sz = 1
VFNM<y><c><q>.F32 <Sd>, <Sn>, <Sm> Encoding T1/A1, encoded as sz = 0

where:

<y> One of:
A Specifies VFNMA, encoded as op = 1.
S Specifies VFNMS, encoded as op = 0.

<c>, <q> See [Standard assembler syntax fields on page F2-2415](#).

<Dd>, <Dn>, <Dm> The destination vector and the operand vectors, for a doubleword operation.

<Sd>, <Sn>, <Sm> The destination vector and the operand vectors, for a singleword operation.

Operation

```
if ConditionPassed() then
    EncodingSpecificOperations(); CheckVFPEEnabled(TRUE);
    if dp_operation then
        op64 = if op1_neg then FPNeg(D[n]) else D[n];
        D[d] = FPMu1Add(FPNeg(D[d]), op64, D[m], FPSCR);
    else
        op32 = if op1_neg then FPNeg(S[n]) else S[n];
        S[d] = FPMu1Add(FPNeg(S[d]), op32, S[m], FPSCR);
```

F8.1.60 VHADD, VHSUB

Vector Halving Add adds corresponding elements in two vectors of integers, shifts each result right one bit, and places the final results in the destination vector. The results of the halving operations are truncated (for rounded results see [VRHADD](#) on page F8-3308).

Vector Halving Subtract subtracts the elements of the second operand from the corresponding elements of the first operand, shifts each result right one bit, and places the final results in the destination vector. The results of the halving operations are truncated (there is no rounding version).

The operand and result elements are all the same type, and can be any one of:

- 8-bit, 16-bit, or 32-bit signed integers.
- 8-bit, 16-bit, or 32-bit unsigned integers.

Depending on settings in the CPACR, NSACR, and HCPTR registers, and the security state and mode in which the instruction is executed, an attempt to execute the instruction might be UNDEFINED, or trapped to Hyp mode. [Summary of access controls for Advanced SIMD functionality](#) on page G1-3498 summarizes these controls.

ARM deprecates the conditional execution of any Advanced SIMD instruction encoding that is not also available as a VFP instruction encoding, see [Conditional execution](#) on page F2-2416.

Encoding T1/A1 Advanced SIMDv1

VH<op><c> <Qd>, <Qn>, <Qm>

VH<op><c> <Dd>, <Dn>, <Dm>

15	14	13	12	11	10	9	8	7	6	5	4	3	2	1	0	15	14	13	12	11	10	9	8	7	6	5	4	3	2	1	0
1	1	1	U	1	1	1	1	0	D	size	Vn	Vd	0	0	op	0	N	Q	M	0	Vm										

31	30	29	28	27	26	25	24	23	22	21	20	19	18	17	16	15	14	13	12	11	10	9	8	7	6	5	4	3	2	1	0
1	1	1	1	0	0	1	U	0	D	size	Vn	Vd	0	0	op	0	N	Q	M	0	Vm										

```

if Q == '1' && (Vd<0> == '1' || Vn<0> == '1' || Vm<0> == '1') then UNDEFINED;
if size == '11' then UNDEFINED;
add = (op == '0'); unsigned = (U == '1');
esize = 8 << UInt(size); elements = 64 DIV esize;
d = UInt(D:Vd); n = UInt(N:Vn); m = UInt(M:Vm); regs = if Q == '0' then 1 else 2;
    
```

Assembler syntax

VH<op>{<c>}{<q>}.<dt> {<Qd>}, <Qn>, <Qm> Encoded as Q = 1
 VH<op>{<c>}{<q>}.<dt> {<Dd>}, <Dn>, <Dm> Encoded as Q = 0

where:

<op> The operation, It must be one of:
 ADD Encoded as op = 0.
 SUB Encoded as op = 1.

<c>, <q> See [Standard assembler syntax fields on page F2-2415](#). An A32 VHADD or VHSUB instruction must be unconditional. ARM strongly recommends that a T32 VHADD or VHSUB instruction is unconditional, see [Conditional execution on page F2-2416](#).

<dt> The data type for the elements of the vectors. It must be one of:
 S8 Encoded as size = 0b00, U = 0.
 S16 Encoded as size = 0b01, U = 0.
 S32 Encoded as size = 0b10, U = 0.
 U8 Encoded as size = 0b00, U = 1.
 U16 Encoded as size = 0b01, U = 1.
 U32 Encoded as size = 0b10, U = 1.

<Qd>, <Qn>, <Qm> The destination vector and the operand vectors, for a quadword operation.

<Dd>, <Dn>, <Dm> The destination vector and the operand vectors, for a doubleword operation.

Operation

```

if ConditionPassed() then
    EncodingSpecificOperations(); CheckAdvSIMDEnabled();
    for r = 0 to regs-1
        for e = 0 to elements-1
            op1 = Int(Elem[D[n+r],e,esize], unsigned);
            op2 = Int(Elem[D[m+r],e,esize], unsigned);
            result = if add then op1+op2 else op1-op2;
            Elem[D[d+r],e,esize] = result<esize:1>;
  
```

F8.1.61 VLD1 (multiple single elements)

This instruction loads elements from memory into one, two, three, or four registers, without de-interleaving. Every element of each register is loaded. For details of the addressing mode see [Advanced SIMD addressing mode on page F5-2517](#).

Depending on settings in the CPACR, NSACR, and HCPTR registers, and the security state and mode in which the instruction is executed, an attempt to execute the instruction might be UNDEFINED, or trapped to Hyp mode. [Summary of access controls for Advanced SIMD functionality on page G1-3498](#) summarizes these controls.

ARM deprecates the conditional execution of any Advanced SIMD instruction encoding that is not also available as a VFP instruction encoding, see [Conditional execution on page F2-2416](#).

Encoding T1/A1 Advanced SIMDv1

VLD1<c>.<size> <list>, [<Rn>{:<align>}]{!}
 VLD1<c>.<size> <list>, [<Rn>{:<align>}], <Rm>

15	14	13	12	11	10	9	8	7	6	5	4	3	2	1	0	15	14	13	12	11	10	9	8	7	6	5	4	3	2	1	0
1	1	1	1	1	0	0	1	0	D	1	0		Rn			Vd		type	size	align						Rm					
31	30	29	28	27	26	25	24	23	22	21	20	19	18	17	16	15	14	13	12	11	10	9	8	7	6	5	4	3	2	1	0
1	1	1	1	0	1	0	0	0	D	1	0		Rn			Vd		type	size	align										Rm	

```

case type of
  when '0111'
    regs = 1; if align<1> == '1' then UNDEFINED;
  when '1010'
    regs = 2; if align == '11' then UNDEFINED;
  when '0110'
    regs = 3; if align<1> == '1' then UNDEFINED;
  when '0010'
    regs = 4;
  otherwise
    SEE "Related encodings";
alignment = if align == '00' then 1 else 4 << UInt(align);
ebytes = 1 << UInt(size); elements = 8 DIV ebytes;
d = UInt(D:Vd); n = UInt(Rn); m = UInt(Rm);
wback = (m != 15); register_index = (m != 15 && m != 13);
if n == 15 || d+regs > 32 then UNPREDICTABLE;
    
```

For information about the CONSTRAINED UNPREDICTABLE behavior of this instruction, see [Appendix A Architectural Constraints on UNPREDICTABLE behaviors](#), and particularly [VLD1 \(multiple single elements\) on page AppxA-4744](#).

Related encodings See [Advanced SIMD element or structure load/store instructions on page F5-2515](#).

Assembler syntax

VLD1{<c>}{<q>}.<size> <list>, [<Rn>{:<align>}] Encoded as Rm = 0b1111
 VLD1{<c>}{<q>}.<size> <list>, [<Rn>{:<align>}]! Encoded as Rm = 0b1101
 VLD1{<c>}{<q>}.<size> <list>, [<Rn>{:<align>}], <Rm> Rm cannot be 0b11x1

where:

<c>, <q> See [Standard assembler syntax fields on page F2-2415](#). An A32 VLD1 instruction must be unconditional. ARM strongly recommends that a T32 VLD1 instruction is unconditional, see [Conditional execution on page F2-2416](#).

<size> The data size. It must be one of:
 8 Encoded as size = 0b00.
 16 Encoded as size = 0b01.
 32 Encoded as size = 0b10.

- 64 Encoded as size = 0b11.
- <list> The list of registers to load. It must be one of:
 {<Dd>} Encoded as D:Vd = <Dd>, type = 0b0111.
 {<Dd>, <Dd+1>} Encoded as D:Vd = <Dd>, type = 0b1010.
 {<Dd>, <Dd+1>, <Dd+2>} Encoded as D:Vd = <Dd>, type = 0b0110.
 {<Dd>, <Dd+1>, <Dd+2>, <Dd+3>}
 encoded as D:Vd = <Dd>, type = 0b0010.
- <Rn> Contains the base address for the access.
- <align> The alignment. It can be one of:
 64 8-byte alignment, encoded as align = 0b01.
 128 16-byte alignment, available only if <list> contains two or four registers, encoded as align = 0b10.
 256 32-byte alignment, available only if <list> contains four registers, encoded as align = 0b11.
omitted Standard alignment, see *Unaligned data access on page E2-2341*. Encoded as align = 0b00.
 : is the preferred separator before the <align> value, but the alignment can be specified as @<align>, see *Advanced SIMD addressing mode on page F5-2517*.
- ! If present, specifies writeback.
- <Rm> Contains an address offset applied after the access.

For more information about <Rn>, !, and <Rm>, see *Advanced SIMD addressing mode on page F5-2517*.

Operation

```

if ConditionPassed() then
    EncodingSpecificOperations(); CheckAdvSIMDEnabled(); NullCheckIfThumbEE(n);
    address = R[n]; if (address MOD alignment) != 0 then GenerateAlignmentException();
    if wback then R[n] = R[n] + (if register_index then R[m] else 8*regs);
    for r = 0 to regs-1
        for e = 0 to elements-1
            bits(ebytes*8) data;
            if ebytes != 8 then
                data = MemU[address,ebytes];
            else
                data<31:0> = if BigEndian() then MemU[address+4,4] else MemU[address,4];
                data<63:32> = if BigEndian() then MemU[address,4] else MemU[address+4,4];
            Elem[D[d+r],e] = data;
            address = address + ebytes;
  
```

F8.1.62 VLD1 (single element to one lane)

This instruction loads one element from memory into one element of a register. Elements of the register that are not loaded are unchanged. For details of the addressing mode see [Advanced SIMD addressing mode on page F5-2517](#).

Depending on settings in the CPACR, NSACR, and HCPTR registers, and the security state and mode in which the instruction is executed, an attempt to execute the instruction might be UNDEFINED, or trapped to Hyp mode. [Summary of access controls for Advanced SIMD functionality on page G1-3498](#) summarizes these controls.

ARM deprecates the conditional execution of any Advanced SIMD instruction encoding that is not also available as a VFP instruction encoding, see [Conditional execution on page F2-2416](#).

Encoding T1/A1 Advanced SIMDv1

VLD1<c>.<size> <list>, [<Rn>{:<align>}]{!}
 VLD1<c>.<size> <list>, [<Rn>{:<align>}], <Rm>

15	14	13	12	11	10	9	8	7	6	5	4	3	2	1	0	15	14	13	12	11	10	9	8	7	6	5	4	3	2	1	0
1	1	1	1	1	0	0	1	1	D	1	0		Rn			Vd		size	0	0	index_align		Rm								

31	30	29	28	27	26	25	24	23	22	21	20	19	18	17	16	15	14	13	12	11	10	9	8	7	6	5	4	3	2	1	0
1	1	1	1	0	1	0	0	1	D	1	0		Rn			Vd		size	0	0	index_align		Rm								

```

if size == '11' then SEE VLD1 (single element to all lanes);
case size of
  when '00'
    if index_align<0> != '0' then UNDEFINED;
    ebytes = 1; index = UInt(index_align<3:1>); alignment = 1;
  when '01'
    if index_align<1> != '0' then UNDEFINED;
    ebytes = 2; index = UInt(index_align<3:2>);
    alignment = if index_align<0> == '0' then 1 else 2;
  when '10'
    if index_align<2> != '0' then UNDEFINED;
    if index_align<1:0> != '00' && index_align<1:0> != '11' then UNDEFINED;
    ebytes = 4; index = UInt(index_align<3>);
    alignment = if index_align<1:0> == '00' then 1 else 4;
d = UInt(D:Vd); n = UInt(Rn); m = UInt(Rm);
wback = (m != 15); register_index = (m != 15 && m != 13);
if n == 15 then UNPREDICTABLE;
    
```

For information about the CONSTRAINED UNPREDICTABLE behavior of this instruction, see [Appendix A Architectural Constraints on UNPREDICTABLE behaviors](#).

Assembler syntax

VLD1{<c>}{<q>}.<size> <list>, [<Rn>{:<align>}] Encoded as Rm = 0b1111
 VLD1{<c>}{<q>}.<size> <list>, [<Rn>{:<align>}]! Encoded as Rm = 0b1101
 VLD1{<c>}{<q>}.<size> <list>, [<Rn>{:<align>}], <Rm> Rm cannot be 0b11x1

where:

<c>, <q> See [Standard assembler syntax fields on page F2-2415](#). An A32 VLD1 instruction must be unconditional. ARM strongly recommends that a T32 VLD1 instruction is unconditional, see [Conditional execution on page F2-2416](#).

<size> The data size. It must be one of:
 8 Encoded as size = 0b00.
 16 Encoded as size = 0b01.
 32 Encoded as size = 0b10.

<list> The register containing the element to load. It must be {<Dd[x]>}. The register <Dd> is encoded in D:Vd.

<Rn> Contains the base address for the access.

<align> The alignment. It can be one of:
 16 2-byte alignment, available only if <size> is 16.
 32 4-byte alignment, available only if <size> is 32.
omitted Standard alignment, see [Unaligned data access on page E2-2341](#).
 : is the preferred separator before the <align> value, but the alignment can be specified as @<align>, see [Advanced SIMD addressing mode on page F5-2517](#).

! If present, specifies writeback.

<Rm> Contains an address offset applied after the access.

For more information about <Rn>, !, and <Rm>, see [Advanced SIMD addressing mode on page F5-2517](#).

[Table F8-1](#) shows the encoding of index and alignment for the different <size> values.

Table F8-1 Encoding of index and alignment

	<size> == 8	<size> == 16	<size> == 32
Index	index_align[3:1] = x	index_align[3:2] = x	index_align[3] = x
<align> omitted	index_align[0] = 0	index_align[1:0] = '00'	index_align[2:0] = '000'
<align> == 16	-	index_align[1:0] = '01'	-
<align> == 32	-	-	index_align[2:0] = '011'

Operation

```

if ConditionPassed() then
    EncodingSpecificOperations(); CheckAdvSIMDEnabled(); NullCheckIfThumbEE(n);
    address = R[n]; if (address MOD alignment) != 0 then GenerateAlignmentException();
    if wback then R[n] = R[n] + (if register_index then R[m] else ebytes);
    Elem[D[d],index] = MemU[address,ebytes];
  
```

F8.1.63 VLD1 (single element to all lanes)

This instruction loads one element from memory into every element of one or two vectors. For details of the addressing mode see [Advanced SIMD addressing mode on page F5-2517](#).

Depending on settings in the CPACR, NSACR, and HCPTR registers, and the security state and mode in which the instruction is executed, an attempt to execute the instruction might be UNDEFINED, or trapped to Hyp mode. [Summary of access controls for Advanced SIMD functionality on page G1-3498](#) summarizes these controls.

ARM deprecates the conditional execution of any Advanced SIMD instruction encoding that is not also available as a VFP instruction encoding, see [Conditional execution on page F2-2416](#).

Encoding T1/A1 Advanced SIMDv1

VLD1<c>.<size> <list>, [<Rn>{:<align>}]{!}
 VLD1<c>.<size> <list>, [<Rn>{:<align>}], <Rm>

15	14	13	12	11	10	9	8	7	6	5	4	3	2	1	0	15	14	13	12	11	10	9	8	7	6	5	4	3	2	1	0
1	1	1	1	1	0	0	1	1	D	1	0			Rn		Vd		1	1	0	0	size	T	a		Rm					

31	30	29	28	27	26	25	24	23	22	21	20	19	18	17	16	15	14	13	12	11	10	9	8	7	6	5	4	3	2	1	0
1	1	1	1	0	1	0	0	1	D	1	0			Rn		Vd		1	1	0	0	size	T	a		Rm					

```

if size == '11' || (size == '00' && a == '1') then UNDEFINED;
ebytes = 1 << UInt(size); regs = if T == '0' then 1 else 2;
alignment = if a == '0' then 1 else ebytes;
d = UInt(D:Vd); n = UInt(Rn); m = UInt(Rm);
wback = (m != 15); register_index = (m != 15 && m != 13);
if n == 15 || d+regs > 32 then UNPREDICTABLE;
    
```

For information about the CONSTRAINED UNPREDICTABLE behavior of this instruction, see [Appendix A Architectural Constraints on UNPREDICTABLE behaviors](#), and particularly [VLD1 \(single element to all lanes\) on page AppxA-4744](#).

Assembler syntax

VLD1{<c>}{<q>}.<size> <list>, [<Rn>{:<align>}] Encoded as Rm = 0b1111
 VLD1{<c>}{<q>}.<size> <list>, [<Rn>{:<align>}]! Encoded as Rm = 0b1101
 VLD1{<c>}{<q>}.<size> <list>, [<Rn>{:<align>}], <Rm> Rm cannot be 0b11x1

where:

<c>, <q> See [Standard assembler syntax fields on page F2-2415](#). An A32 VLD1 instruction must be unconditional. ARM strongly recommends that a T32 VLD1 instruction is unconditional, see [Conditional execution on page F2-2416](#).

<size> The data size. It must be one of:
 8 Encoded as size = 0b00.
 16 Encoded as size = 0b01.
 32 Encoded as size = 0b10.

<list> The list of registers to load. It must be one of:
 {<Dd[>]} Encoded as D:Vd = <Dd>, T = 0.
 {<Dd[>], <Dd+1[>]} Encoded as D:Vd = <Dd>, T = 1.

<Rn> Contains the base address for the access.

<align> The alignment. It can be one of:
 16 2-byte alignment, available only if <size> is 16, encoded as a = 1.
 32 4-byte alignment, available only if <size> is 32, encoded as a = 1.
omitted Standard alignment, see [Unaligned data access on page E2-2341](#). Encoded as a = 0.
 : is the preferred separator before the <align> value, but the alignment can be specified as @<align>, see [Advanced SIMD addressing mode on page F5-2517](#).

! If present, specifies writeback.

<Rm> Contains an address offset applied after the access.

For more information about <Rn>, !, and <Rm>, see [Advanced SIMD addressing mode on page F5-2517](#).

Operation

```

if ConditionPassed() then
    EncodingSpecificOperations(); CheckAdvSIMDEnabled(); NullCheckIfThumbEE(n);
    address = R[n]; if (address MOD alignment) != 0 then GenerateAlignmentException();
    if wback then R[n] = R[n] + (if register_index then R[m] else ebytes);
    bits(64) replicated_element = Replicate(MemU[address,ebytes]);
    for r = 0 to regs-1
        D[d+r] = replicated_element;
  
```

F8.1.64 VLD2 (multiple 2-element structures)

This instruction loads multiple 2-element structures from memory into two or four registers, with de-interleaving. For more information, see [Element and structure load/store instructions](#) on page F1-2398. Every element of each register is loaded. For details of the addressing mode see [Advanced SIMD addressing mode](#) on page F5-2517.

Depending on settings in the CPACR, NSACR, and HCPTR registers, and the security state and mode in which the instruction is executed, an attempt to execute the instruction might be UNDEFINED, or trapped to Hyp mode. [Summary of access controls for Advanced SIMD functionality](#) on page G1-3498 summarizes these controls.

ARM deprecates the conditional execution of any Advanced SIMD instruction encoding that is not also available as a VFP instruction encoding, see [Conditional execution](#) on page F2-2416.

Encoding T1/A1 Advanced SIMDv1

VLD2<c>.<size> <list>, [<Rn>{:<align>}]{!}
 VLD2<c>.<size> <list>, [<Rn>{:<align>}], <Rm>

15	14	13	12	11	10	9	8	7	6	5	4	3	2	1	0	15	14	13	12	11	10	9	8	7	6	5	4	3	2	1	0
1	1	1	1	1	0	0	1	0	D	1	0		Rn			Vd			type	size	align				Rm						

31	30	29	28	27	26	25	24	23	22	21	20	19	18	17	16	15	14	13	12	11	10	9	8	7	6	5	4	3	2	1	0
1	1	1	1	0	1	0	0	0	D	1	0		Rn			Vd			type	size	align									Rm	

```

if size == '11' then UNDEFINED;
case type of
  when '1000'
    regs = 1; inc = 1; if align == '11' then UNDEFINED;
  when '1001'
    regs = 1; inc = 2; if align == '11' then UNDEFINED;
  when '0011'
    regs = 2; inc = 2;
  otherwise
    SEE "Related encodings";
alignment = if align == '00' then 1 else 4 << UInt(align);
ebytes = 1 << UInt(size); elements = 8 DIV ebytes;
d = UInt(D:Vd); d2 = d + inc; n = UInt(Rn); m = UInt(Rm);
wback = (m != 15); register_index = (m != 15 && m != 13);
if n == 15 || d2+regs > 32 then UNPREDICTABLE;
    
```

For information about the CONSTRAINED UNPREDICTABLE behavior of this instruction, see [Appendix A Architectural Constraints on UNPREDICTABLE behaviors](#), and particularly [VLD2 \(multiple 2-element structures\)](#) on page AppxA-4744.

Related encodings See [Advanced SIMD element or structure load/store instructions](#) on page F5-2515.

Assembler syntax

VLD2{<c>}{<q>}.<size> <list>, [<Rn>{:<align>}]	Encoded as Rm = 0b1111
VLD2{<c>}{<q>}.<size> <list>, [<Rn>{:<align>}]!	Encoded as Rm = 0b1101
VLD2{<c>}{<q>}.<size> <list>, [<Rn>{:<align>}], <Rm>	Rm cannot be 0b11x1

where:

<c>, <q>	See Standard assembler syntax fields on page F2-2415 . An A32 VLD2 instruction must be unconditional. ARM strongly recommends that a T32 VLD2 instruction is unconditional, see Conditional execution on page F2-2416 .
<size>	The data size. It must be one of: 8 Encoded as size = 0b00. 16 Encoded as size = 0b01. 32 Encoded as size = 0b10.
<list>	The list of registers to load. It must be one of: {<Dd>, <Dd+1>} Single-spaced registers, encoded as D:Vd = <Dd>, type = 0b1000. {<Dd>, <Dd+2>} Double-spaced registers, encoded as D:Vd = <Dd>, type = 0b1001. {<Dd>, <Dd+1>, <Dd+2>, <Dd+3>} Single-spaced registers, encoded as D:Vd = <Dd>, type = 0b0011.
<Rn>	Contains the base address for the access.
<align>	The alignment. It can be one of: 64 8-byte alignment, encoded as align = 0b01. 128 16-byte alignment, encoded as align = 0b10. 256 32-byte alignment, available only if <list> contains four registers. Encoded as align = 0b11. omitted Standard alignment, see Unaligned data access on page E2-2341 . Encoded as align = 0b00. : is the preferred separator before the <align> value, but the alignment can be specified as @<align>, see Advanced SIMD addressing mode on page F5-2517 .
!	If present, specifies writeback.
<Rm>	Contains an address offset applied after the access.

For more information about <Rn>, !, and <Rm>, see [Advanced SIMD addressing mode on page F5-2517](#).

Operation

```

if ConditionPassed() then
    EncodingSpecificOperations(); CheckAdvSIMDEnabled(); NullCheckIfThumbEE(n);
    address = R[n]; if (address MOD alignment) != 0 then GenerateAlignmentException();
    if wback then R[n] = R[n] + (if register_index then R[m] else 16*regs);
    for r = 0 to regs-1
        for e = 0 to elements-1
            Elem[D[d+r], e] = MemU[address,ebytes];
            Elem[D[d2+r],e] = MemU[address+ebytes,ebytes];
            address = address + 2*ebytes;
  
```

F8.1.65 VLD2 (single 2-element structure to one lane)

This instruction loads one 2-element structure from memory into corresponding elements of two registers. Elements of the registers that are not loaded are unchanged. For details of the addressing mode see [Advanced SIMD addressing mode on page F5-2517](#).

Depending on settings in the CPACR, NSACR, and HCPTR registers, and the security state and mode in which the instruction is executed, an attempt to execute the instruction might be UNDEFINED, or trapped to Hyp mode. [Summary of access controls for Advanced SIMD functionality on page G1-3498](#) summarizes these controls.

ARM deprecates the conditional execution of any Advanced SIMD instruction encoding that is not also available as a VFP instruction encoding, see [Conditional execution on page F2-2416](#).

Encoding T1/A1 Advanced SIMDv1

VLD2<<c>.<size> <list>, [<Rn>{:<align>}]{!}
 VLD2<<c>.<size> <list>, [<Rn>{:<align>}], <Rm>

15	14	13	12	11	10	9	8	7	6	5	4	3	2	1	0	15	14	13	12	11	10	9	8	7	6	5	4	3	2	1	0
1	1	1	1	1	0	0	1	1	D	1	0		Rn			Vd		size	0	1	index_align				Rm						

31	30	29	28	27	26	25	24	23	22	21	20	19	18	17	16	15	14	13	12	11	10	9	8	7	6	5	4	3	2	1	0
1	1	1	1	0	1	0	0	1	D	1	0		Rn			Vd		size	0	1	index_align				Rm						

if size == '11' then SEE VLD2 (single 2-element structure to all lanes);

```

case size of
  when '00'
    ebytes = 1; index = UInt(index_align<3:1>); inc = 1;
    alignment = if index_align<0> == '0' then 1 else 2;
  when '01'
    ebytes = 2; index = UInt(index_align<3:2>);
    inc = if index_align<1> == '0' then 1 else 2;
    alignment = if index_align<0> == '0' then 1 else 4;
  when '10'
    if index_align<1> != '0' then UNDEFINED;
    ebytes = 4; index = UInt(index_align<3>);
    inc = if index_align<2> == '0' then 1 else 2;
    alignment = if index_align<0> == '0' then 1 else 8;
d = UInt(D:Vd); d2 = d + inc; n = UInt(Rn); m = UInt(Rm);
wback = (m != 15); register_index = (m != 15 && m != 13);
if n == 15 || d2 > 31 then UNPREDICTABLE;
    
```

For information about the CONSTRAINED UNPREDICTABLE behavior of this instruction, see [Appendix A Architectural Constraints on UNPREDICTABLE behaviors](#), and particularly [VLD2 \(single 2-element structure to one lane\) on page AppxA-4745](#).

Assembler syntax

VLD2{<c>}{<q>}.<size> <list>, [<Rn>{:<align>}]
 Encoded as Rm = 0b1111
 VLD2{<c>}{<q>}.<size> <list>, [<Rn>{:<align>}]!
 Encoded as Rm = 0b1101
 VLD2{<c>}{<q>}.<size> <list>, [<Rn>{:<align>}], <Rm>
 Rm cannot be 0b11x1

where:

<c>, <q> See [Standard assembler syntax fields on page F2-2415](#). An A32 VLD2 instruction must be unconditional. ARM strongly recommends that a T32 VLD2 instruction is unconditional, see [Conditional execution on page F2-2416](#).

<size> The data size. It must be one of:
 8 Encoded as size = 0b00.
 16 Encoded as size = 0b01.
 32 Encoded as size = 0b10.

- <list> The registers containing the structure. Encoded with D:Vd = <Dd>. It must be one of:
 {<Dd[x]>, <Dd+1[x]>} Single-spaced registers, see [Table F8-2](#).
 {<Dd[x]>, <Dd+2[x]>} Double-spaced registers, see [Table F8-2](#).
 This is not available if <size> == 8.
- <Rn> Contains the base address for the access.
- <align> The alignment. It can be one of:
 16 2-byte alignment, available only if <size> is 8.
 32 4-byte alignment, available only if <size> is 16.
 64 8-byte alignment, available only if <size> is 32.
omitted Standard alignment, see [Unaligned data access on page E2-2341](#).
 : is the preferred separator before the <align> value, but the alignment can be specified as @<align>, see [Advanced SIMD addressing mode on page F5-2517](#).
- ! If present, specifies writeback.
- <Rm> Contains an address offset applied after the access.

For more information about <Rn>, !, and <Rm> see [Advanced SIMD addressing mode on page F5-2517](#).

Table F8-2 Encoding of index, alignment, and register spacing

	<size> == 8	<size> == 16	<size> == 32
Index	index_align[3:1] = x	index_align[3:2] = x	index_align[3] = x
Single-spacing	-	index_align[1] = 0	index_align[2] = 0
Double-spacing	-	index_align[1] = 1	index_align[2] = 1
<align> omitted	index_align[0] = 0	index_align[0] = 0	index_align[1:0] = '00'
<align> == 16	index_align[0] = 1	-	-
<align> == 32	-	index_align[0] = 1	-
<align> == 64	-	-	index_align[1:0] = '01'

Operation

```

if ConditionPassed() then
    EncodingSpecificOperations(); CheckAdvSIMDEnabled(); NullCheckIfThumbEE(n);
    address = R[n]; if (address MOD alignment) != 0 then GenerateAlignmentException();
    if wback then R[n] = R[n] + (if register_index then R[m] else 2*ebytes);
    Elem[D[d], index] = MemU[address,ebytes];
    Elem[D[d2],index] = MemU[address+ebytes,ebytes];
    
```

F8.1.66 VLD2 (single 2-element structure to all lanes)

This instruction loads one 2-element structure from memory into all lanes of two registers. For details of the addressing mode see [Advanced SIMD addressing mode on page F5-2517](#).

Depending on settings in the CPACR, NSACR, and HCPTR registers, and the security state and mode in which the instruction is executed, an attempt to execute the instruction might be UNDEFINED, or trapped to Hyp mode. [Summary of access controls for Advanced SIMD functionality on page G1-3498](#) summarizes these controls.

ARM deprecates the conditional execution of any Advanced SIMD instruction encoding that is not also available as a VFP instruction encoding, see [Conditional execution on page F2-2416](#).

Encoding T1/A1 Advanced SIMDv1

VLD2<c>.<size> <list>, [<Rn>{:<align>}]{!}
 VLD2<c>.<size> <list>, [<Rn>{:<align>}], <Rm>

15	14	13	12	11	10	9	8	7	6	5	4	3	2	1	0	15	14	13	12	11	10	9	8	7	6	5	4	3	2	1	0
1	1	1	1	1	0	0	1	1	D	1	0		Rn			Vd		1	1	0	1	size	T	a		Rm					
31	30	29	28	27	26	25	24	23	22	21	20	19	18	17	16	15	14	13	12	11	10	9	8	7	6	5	4	3	2	1	0
1	1	1	1	0	1	0	0	1	D	1	0		Rn			Vd		1	1	0	1	size	T	a		Rm					

```

if size == '11' then UNDEFINED;
ebytes = 1 << UInt(size);
alignment = if a == '0' then 1 else 2*ebytes;
inc = if T == '0' then 1 else 2;
d = UInt(D:Vd); d2 = d + inc; n = UInt(Rn); m = UInt(Rm);
wback = (m != 15); register_index = (m != 15 && m != 13);
if n == 15 || d2 > 31 then UNPREDICTABLE;
    
```

For information about the CONSTRAINED UNPREDICTABLE behavior of this instruction, see [Appendix A Architectural Constraints on UNPREDICTABLE behaviors](#), and particularly [VLD2 \(single 2-element structure to all lanes\) on page AppxA-4745](#).

Assembler syntax

VLD2{<c>}{<q>}.<size> <list>, [<Rn>{:<align>}] Encoded as Rm = 0b1111
 VLD2{<c>}{<q>}.<size> <list>, [<Rn>{:<align>}]! Encoded as Rm = 0b1101
 VLD2{<c>}{<q>}.<size> <list>, [<Rn>{:<align>}], <Rm> Rm cannot be 0b11x1

where:

<c>, <q> See [Standard assembler syntax fields on page F2-2415](#). An A32 VLD2 instruction must be unconditional. ARM strongly recommends that a T32 VLD2 instruction is unconditional, see [Conditional execution on page F2-2416](#).

<size> The data size. It must be one of:
 8 Encoded as size = 0b00.
 16 Encoded as size = 0b01.
 32 Encoded as size = 0b10.

<list> The registers containing the structure. It must be one of:
 {<Dd[]>, <Dd+1[]>} Single-spaced registers, encoded as D:Vd = <Dd>, T = 0.
 {<Dd[]>, <Dd+2[]>} Double-spaced registers, encoded as D:Vd = <Dd>, T = 1.

<Rn> Contains the base address for the access.

<align> The alignment. It can be one of:
 16 2-byte alignment, available only if <size> is 8, encoded as a = 1.
 32 4-byte alignment, available only if <size> is 16, encoded as a = 1.
 64 8-byte alignment, available only if <size> is 32, encoded as a = 1.
omitted Standard alignment, see [Unaligned data access on page E2-2341](#). Encoded as a = 0.
 : is the preferred separator before the <align> value, but the alignment can be specified as @<align>, see [Advanced SIMD addressing mode on page F5-2517](#).

! If present, specifies writeback.

<Rm> Contains an address offset applied after the access.

For more information about <Rn>, !, and <Rm>, see [Advanced SIMD addressing mode on page F5-2517](#).

Operation

```
if ConditionPassed() then
    EncodingSpecificOperations(); CheckAdvSIMDEnabled(); NullCheckIfThumbEE(n);
    address = R[n]; if (address MOD alignment) != 0 then GenerateAlignmentException();
    if wback then R[n] = R[n] + (if register_index then R[m] else 2*ebytes);
    D[d] = Replicate(MemU[address,ebytes]);
    D[d2] = Replicate(MemU[address+ebytes,ebytes]);
```

F8.1.67 VLD3 (multiple 3-element structures)

This instruction loads multiple 3-element structures from memory into three registers, with de-interleaving. For more information, see [Element and structure load/store instructions on page F1-2398](#). Every element of each register is loaded. For details of the addressing mode see [Advanced SIMD addressing mode on page F5-2517](#).

Depending on settings in the CPACR, NSACR, and HCPTR registers, and the security state and mode in which the instruction is executed, an attempt to execute the instruction might be UNDEFINED, or trapped to Hyp mode. [Summary of access controls for Advanced SIMD functionality on page G1-3498](#) summarizes these controls.

ARM deprecates the conditional execution of any Advanced SIMD instruction encoding that is not also available as a VFP instruction encoding, see [Conditional execution on page F2-2416](#).

Encoding T1/A1 Advanced SIMDv1

VLD3<c>.<size> <list>, [<Rn>{:<align>}]{!}
 VLD3<c>.<size> <list>, [<Rn>{:<align>}], <Rm>

15	14	13	12	11	10	9	8	7	6	5	4	3	2	1	0	15	14	13	12	11	10	9	8	7	6	5	4	3	2	1	0
1	1	1	1	1	0	0	1	0	D	1	0		Rn			Vd			type	size	align			Rm							

31	30	29	28	27	26	25	24	23	22	21	20	19	18	17	16	15	14	13	12	11	10	9	8	7	6	5	4	3	2	1	0
1	1	1	1	0	1	0	0	0	D	1	0		Rn			Vd			type	size	align			Rm							

```

if size == '11' || align<1> == '1' then UNDEFINED;
case type of
    when '0100'
        inc = 1;
    when '0101'
        inc = 2;
    otherwise
        SEE "Related encodings";
alignment = if align<0> == '0' then 1 else 8;
ebytes = 1 << UInt(size); elements = 8 DIV ebytes;
d = UInt(D:Vd); d2 = d + inc; d3 = d2 + inc; n = UInt(Rn); m = UInt(Rm);
wback = (m != 15); register_index = (m != 15 && m != 13);
if n == 15 || d3 > 31 then UNPREDICTABLE;
    
```

For information about the CONSTRAINED UNPREDICTABLE behavior of this instruction, see [Appendix A Architectural Constraints on UNPREDICTABLE behaviors](#), and particularly [VLD3 \(multiple 3-element structures\) on page AppxA-4746](#).

Related encodings See [Advanced SIMD element or structure load/store instructions on page F5-2515](#).

Assembler syntax

VLD3{<c>}{<q>}.<size> <list>, [<Rn>{:<align>}] Encoded as Rm = 0b1111
 VLD3{<c>}{<q>}.<size> <list>, [<Rn>{:<align>}]! Encoded as Rm = 0b1101
 VLD3{<c>}{<q>}.<size> <list>, [<Rn>{:<align>}], <Rm> Rm cannot be 0b11x1

where:

<c>, <q> See [Standard assembler syntax fields on page F2-2415](#). An A32 VLD3 instruction must be unconditional. ARM strongly recommends that a T32 VLD3 instruction is unconditional, see [Conditional execution on page F2-2416](#).

<size> The data size. It must be one of:
 8 Encoded as size = 0b00.
 16 Encoded as size = 0b01.
 32 Encoded as size = 0b10.

<list> The list of registers to load. It must be one of:
 {<Dd>, <Dd+1>, <Dd+2>}
 Single-spaced registers, encoded as D:Vd = <Dd>, type = 0b0100.
 {<Dd>, <Dd+2>, <Dd+4>}
 Double-spaced registers, encoded as D:Vd = <Dd>, type = 0b0101.

<Rn> Contains the base address for the access.

<align> The alignment. It can be:
 64 8-byte alignment, encoded as align = 0b01.
omitted Standard alignment, see [Unaligned data access on page E2-2341](#). Encoded as align = 0b00.
 : is the preferred separator before the <align> value, but the alignment can be specified as @<align>, see [Advanced SIMD addressing mode on page F5-2517](#).

! If present, specifies writeback.

<Rm> Contains an address offset applied after the access.

For more information about <Rn>, !, and <Rm>, see [Advanced SIMD addressing mode on page F5-2517](#).

Operation

```

if ConditionPassed() then
    EncodingSpecificOperations(); CheckAdvSIMDEnabled(); NullCheckIfThumbEE(n);
    address = R[n]; if (address MOD alignment) != 0 then GenerateAlignmentException();
    if wback then R[n] = R[n] + (if register_index then R[m] else 24);
    for e = 0 to elements-1
        Elem[D[d], e] = MemU[address+ebytes];
        Elem[D[d2], e] = MemU[address+ebytes, ebytes];
        Elem[D[d3], e] = MemU[address+2*ebytes, ebytes];
    address = address + 3*ebytes;
  
```

F8.1.68 VLD3 (single 3-element structure to one lane)

This instruction loads one 3-element structure from memory into corresponding elements of three registers. Elements of the registers that are not loaded are unchanged. For details of the addressing mode see [Advanced SIMD addressing mode on page F5-2517](#).

Depending on settings in the CPACR, NSACR, and HCPTR registers, and the security state and mode in which the instruction is executed, an attempt to execute the instruction might be UNDEFINED, or trapped to Hyp mode. [Summary of access controls for Advanced SIMD functionality on page G1-3498](#) summarizes these controls.

ARM deprecates the conditional execution of any Advanced SIMD instruction encoding that is not also available as a VFP instruction encoding, see [Conditional execution on page F2-2416](#).

Encoding T1/A1 Advanced SIMDv1

VLD3<c>.<size> <list>, [<Rn>]{}!

VLD3<c>.<size> <list>, [<Rn>], <Rm>

15	14	13	12	11	10	9	8	7	6	5	4	3	2	1	0	15	14	13	12	11	10	9	8	7	6	5	4	3	2	1	0
1	1	1	1	1	0	0	1	1	D	1	0		Rn			Vd		size	1	0	index_align				Rm						

31	30	29	28	27	26	25	24	23	22	21	20	19	18	17	16	15	14	13	12	11	10	9	8	7	6	5	4	3	2	1	0
1	1	1	1	0	1	0	0	1	D	1	0		Rn			Vd		size	1	0	index_align							Rm			

if size == '11' then SEE VLD3 (single 3-element structure to all lanes);

case size of

when '00'

if index_align<0> != '0' then UNDEFINED;
 ebytes = 1; index = UInt(index_align<3:1>); inc = 1;

when '01'

if index_align<0> != '0' then UNDEFINED;
 ebytes = 2; index = UInt(index_align<3:2>);
 inc = if index_align<1> == '0' then 1 else 2;

when '10'

if index_align<1:0> != '00' then UNDEFINED;
 ebytes = 4; index = UInt(index_align<3>);
 inc = if index_align<2> == '0' then 1 else 2;

d = UInt(D:Vd); d2 = d + inc; d3 = d2 + inc; n = UInt(Rn); m = UInt(Rm);

wback = (m != 15); register_index = (m != 15 && m != 13);

if n == 15 || d3 > 31 then UNPREDICTABLE;

For information about the CONSTRAINED UNPREDICTABLE behavior of this instruction, see [Appendix A Architectural Constraints on UNPREDICTABLE behaviors](#), and particularly [VLD3 \(single 3-element structure to one lane\) on page AppxA-4746](#).

Assembler syntax

VLD3{<c>}{<q>}.<size> <list>, [<Rn>] Encoded as Rm = 0b1111
 VLD3{<c>}{<q>}.<size> <list>, [<Rn>]! Encoded as Rm = 0b1101
 VLD3{<c>}{<q>}.<size> <list>, [<Rn>], <Rm> Rm cannot be 0b11x1

where:

<c>, <q> See [Standard assembler syntax fields on page F2-2415](#). An A32 VLD3 instruction must be unconditional. ARM strongly recommends that a T32 VLD3 instruction is unconditional, see [Conditional execution on page F2-2416](#).

<size> The data size. It must be one of:
 8 Encoded as size = 0b00.
 16 Encoded as size = 0b01.
 32 Encoded as size = 0b10.

<list> The registers containing the structure. Encoded with D:Vd = <Dd>. It must be one of:
 {<Dd[x]>, <Dd+1[x]>, <Dd+2[x]>}
 Single-spaced registers, see [Table F8-3](#).
 {<Dd[x]>, <Dd+2[x]>, <Dd+4[x]>}
 Double-spaced registers, see [Table F8-3](#).
 This is not available if <size> == 8.

<Rn> Contains the base address for the access.

! If present, specifies writeback.

<Rm> Contains an address offset applied after the access.

For more information about <Rn>, !, and <Rm>, see [Advanced SIMD addressing mode on page F5-2517](#).

Table F8-3 Encoding of index and register spacing

	<size> == 8	<size> == 16	<size> == 32
Index	index_align[3:1] = x	index_align[3:2] = x	index_align[3] = x
Single-spacing	index_align[0] = 0	index_align[1:0] = '00'	index_align[2:0] = '000'
Double-spacing	-	index_align[1:0] = '10'	index_align[2:0] = '100'

Alignment

Standard alignment rules apply, see [Alignment support on page E2-2341](#).

Operation

```
if ConditionPassed() then
    EncodingSpecificOperations(); CheckAdvSIMDEnabled(); NullCheckIfThumbEE(n);
    address = R[n];
    if wback then R[n] = R[n] + (if register_index then R[m] else 3*bytes);
    Elem[D[d], index] = MemU[address, ebytes];
    Elem[D[d2], index] = MemU[address+ebytes, ebytes];
    Elem[D[d3], index] = MemU[address+2*ebytes, ebytes];
```

F8.1.69 VLD3 (single 3-element structure to all lanes)

This instruction loads one 3-element structure from memory into all lanes of three registers. For details of the addressing mode see *Advanced SIMD addressing mode* on page F5-2517.

Depending on settings in the CPACR, NSACR, and HCPTR registers, and the security state and mode in which the instruction is executed, an attempt to execute the instruction might be UNDEFINED, or trapped to Hyp mode. *Summary of access controls for Advanced SIMD functionality* on page G1-3498 summarizes these controls.

ARM deprecates the conditional execution of any Advanced SIMD instruction encoding that is not also available as a VFP instruction encoding, see *Conditional execution* on page F2-2416.

Encoding T1/A1 Advanced SIMDv1

VLD3<c>.<size> <list>, [<Rn>]{!}

VLD3<c>.<size> <list>, [<Rn>], <Rm>

15	14	13	12	11	10	9	8	7	6	5	4	3	2	1	0	15	14	13	12	11	10	9	8	7	6	5	4	3	2	1	0
1	1	1	1	1	0	0	1	1	D	1	0		Rn			Vd		1	1	1	0	size	T	a		Rm					

31	30	29	28	27	26	25	24	23	22	21	20	19	18	17	16	15	14	13	12	11	10	9	8	7	6	5	4	3	2	1	0
1	1	1	1	0	1	0	0	1	D	1	0		Rn			Vd		1	1	1	0	size	T	a		Rm					

```

if size == '11' || a == '1' then UNDEFINED;
ebytes = 1 << UInt(size);
inc = if T == '0' then 1 else 2;
d = UInt(D:Vd); d2 = d + inc; d3 = d2 + inc; n = UInt(Rn); m = UInt(Rm);
wback = (m != 15); register_index = (m != 15 && m != 13);
if n == 15 || d3 > 31 then UNPREDICTABLE;
    
```

For information about the CONSTRAINED UNPREDICTABLE behavior of this instruction, see [Appendix A Architectural Constraints on UNPREDICTABLE behaviors](#), and particularly *VLD3 (single 3-element structure to all lanes)* on page AppxA-4746.

Assembler syntax

VLD3{<c>}{<q>}.<size> <list>, [<Rn>]	Encoded as Rm = 0b1111
VLD3{<c>}{<q>}.<size> <list>, [<Rn>]!	Encoded as Rm = 0b1101
VLD3{<c>}{<q>}.<size> <list>, [<Rn>], <Rm>	Rm cannot be 0b11x1

where:

<c>, <q>	See Standard assembler syntax fields on page F2-2415 . An A32 VLD3 instruction must be unconditional. ARM strongly recommends that a T32 VLD3 instruction is unconditional, see Conditional execution on page F2-2416 .
<size>	The data size. It must be one of: 8 Encoded as size = 0b00. 16 Encoded as size = 0b01. 32 Encoded as size = 0b10.
<list>	The registers containing the structures. It must be one of: {<Dd[]>, <Dd+1[]>, <Dd+2[]>} Single-spaced registers, encoded as D:Vd = <Dd>, T = 0. {<Dd[]>, <Dd+2[]>, <Dd+4[]>} Double-spaced registers, encoded as D:Vd = <Dd>, T = 1.
<Rn>	Contains the base address for the access.
!	If present, specifies writeback.
<Rm>	Contains an address offset applied after the access.

For more information about <Rn>, !, and <Rm>, see [Advanced SIMD addressing mode on page F5-2517](#).

Alignment

Standard alignment rules apply, see [Alignment support on page E2-2341](#).

The a bit must be encoded as 0.

Operation

```

if ConditionPassed() then
    EncodingSpecificOperations(); CheckAdvSIMDEnabled(); NullCheckIfThumbEE(n);
    address = R[n];
    if wback then R[n] = R[n] + (if register_index then R[m] else 3*bytes);
    D[d] = Replicate(MemU[address,ebytes]);
    D[d2] = Replicate(MemU[address+ebytes,ebytes]);
    D[d3] = Replicate(MemU[address+2*ebytes,ebytes]);

```

F8.1.70 VLD4 (multiple 4-element structures)

This instruction loads multiple 4-element structures from memory into four registers, with de-interleaving. For more information, see [Element and structure load/store instructions](#) on page F1-2398. Every element of each register is loaded. For details of the addressing mode see [Advanced SIMD addressing mode](#) on page F5-2517.

Depending on settings in the CPACR, NSACR, and HCPTR registers, and the security state and mode in which the instruction is executed, an attempt to execute the instruction might be UNDEFINED, or trapped to Hyp mode. [Summary of access controls for Advanced SIMD functionality](#) on page G1-3498 summarizes these controls.

ARM deprecates the conditional execution of any Advanced SIMD instruction encoding that is not also available as a VFP instruction encoding, see [Conditional execution](#) on page F2-2416.

Encoding T1/A1 Advanced SIMDv1

VLD4<c>.<size> <list>, [<Rn>{:<align>}]{!}
 VLD4<c>.<size> <list>, [<Rn>{:<align>}], <Rm>

15	14	13	12	11	10	9	8	7	6	5	4	3	2	1	0	15	14	13	12	11	10	9	8	7	6	5	4	3	2	1	0
1	1	1	1	1	0	0	1	0	D	1	0		Rn			Vd		type	size	align			Rm								

31	30	29	28	27	26	25	24	23	22	21	20	19	18	17	16	15	14	13	12	11	10	9	8	7	6	5	4	3	2	1	0
1	1	1	1	0	1	0	0	0	D	1	0		Rn			Vd		type	size	align			Rm								

```

if size == '11' then UNDEFINED;
case type of
    when '0000'
        inc = 1;
    when '0001'
        inc = 2;
    otherwise
        SEE "Related encodings";
alignment = if align == '00' then 1 else 4 << UInt(align);
ebytes = 1 << UInt(size); elements = 8 DIV ebytes;
d = UInt(D:Vd); d2 = d + inc; d3 = d2 + inc; d4 = d3 + inc; n = UInt(Rn); m = UInt(Rm);
wback = (m != 15); register_index = (m != 15 && m != 13);
if n == 15 || d4 > 31 then UNPREDICTABLE;
    
```

For information about the CONSTRAINED UNPREDICTABLE behavior of this instruction, see [Appendix A Architectural Constraints on UNPREDICTABLE behaviors](#), and particularly [VLD4 \(multiple 4-element structures\)](#) on page AppxA-4747.

Related encodings See [Advanced SIMD element or structure load/store instructions](#) on page F5-2515.

Assembler syntax

VLD4{<c>}{<q>}.<size> <list>, [<Rn>{:<align>}]	Encoded as Rm = 0b1111
VLD4{<c>}{<q>}.<size> <list>, [<Rn>{:<align>}]!	Encoded as Rm = 0b1101
VLD4{<c>}{<q>}.<size> <list>, [<Rn>{:<align>}], <Rm>	Rm cannot be 0b11x1

where:

<c>, <q>	See Standard assembler syntax fields on page F2-2415 . An A32 VLD4 instruction must be unconditional. ARM strongly recommends that a T32 VLD4 instruction is unconditional, see Conditional execution on page F2-2416 .
<size>	The data size. It must be one of: 8 Encoded as size = 0b00. 16 Encoded as size = 0b01. 32 Encoded as size = 0b10.
<list>	The list of registers to load. It must be one of: {<Dd>, <Dd+1>, <Dd+2>, <Dd+3>} Single-spaced registers, encoded as D:Vd = <Dd>, type = 0b0000. {<Dd>, <Dd+2>, <Dd+4>, <Dd+6>} Double-spaced registers, encoded as D:Vd = <Dd>, type = 0b0001.
<Rn>	Contains the base address for the access.
<align>	The alignment. It can be one of: 64 8-byte alignment, encoded as align = 0b01. 128 16-byte alignment, encoded as align = 0b10. 256 32-byte alignment, encoded as align = 0b11. omitted Standard alignment, see Unaligned data access on page E2-2341 . Encoded as align = 0b00. : is the preferred separator before the <align> value, but the alignment can be specified as @<align>, see Advanced SIMD addressing mode on page F5-2517 .
!	If present, specifies writeback.
<Rm>	Contains an address offset applied after the access.

For more information about <Rn>, !, and <Rm>, see [Advanced SIMD addressing mode on page F5-2517](#).

Operation

```
if ConditionPassed() then
    EncodingSpecificOperations(); CheckAdvSIMDEnabled(); NullCheckIfThumbEE(n);
    address = R[n]; if (address MOD alignment) != 0 then GenerateAlignmentException();
    if wback then R[n] = R[n] + (if register_index then R[m] else 32);
    for e = 0 to elements-1
        Elem[D[d], e] = MemU[address,ebytes];
        Elem[D[d2],e] = MemU[address+ebytes,ebytes];
        Elem[D[d3],e] = MemU[address+2*ebytes,ebytes];
        Elem[D[d4],e] = MemU[address+3*ebytes,ebytes];
    address = address + 4*ebytes;
```

F8.1.71 VLD4 (single 4-element structure to one lane)

This instruction loads one 4-element structure from memory into corresponding elements of four registers. Elements of the registers that are not loaded are unchanged. For details of the addressing mode see [Advanced SIMD addressing mode](#) on page F5-2517.

Depending on settings in the CPACR, NSACR, and HCPTR registers, and the security state and mode in which the instruction is executed, an attempt to execute the instruction might be UNDEFINED, or trapped to Hyp mode. [Summary of access controls for Advanced SIMD functionality](#) on page G1-3498 summarizes these controls.

ARM deprecates the conditional execution of any Advanced SIMD instruction encoding that is not also available as a VFP instruction encoding, see [Conditional execution](#) on page F2-2416.

Encoding T1/A1 Advanced SIMDv1

VLD4<c>.<size> <list>, [<Rn>{:<align>}]{!}
 VLD4<c>.<size> <list>, [<Rn>{:<align>}], <Rm>

15	14	13	12	11	10	9	8	7	6	5	4	3	2	1	0	15	14	13	12	11	10	9	8	7	6	5	4	3	2	1	0
1	1	1	1	1	0	0	1	1	D	1	0		Rn			Vd		size	1	1	index_align				Rm						

31	30	29	28	27	26	25	24	23	22	21	20	19	18	17	16	15	14	13	12	11	10	9	8	7	6	5	4	3	2	1	0
1	1	1	1	0	1	0	0	1	D	1	0		Rn			Vd		size	1	1	index_align				Rm						

if size == '11' then SEE VLD4 (single 4-element structure to all lanes);

```

case size of
  when '00'
    ebytes = 1; index = UInt(index_align<3:1>); inc = 1;
    alignment = if index_align<0> == '0' then 1 else 4;
  when '01'
    ebytes = 2; index = UInt(index_align<3:2>);
    inc = if index_align<1> == '0' then 1 else 2;
    alignment = if index_align<0> == '0' then 1 else 8;
  when '10'
    if index_align<1:0> == '11' then UNDEFINED;
    ebytes = 4; index = UInt(index_align<3>);
    inc = if index_align<2> == '0' then 1 else 2;
    alignment = if index_align<1:0> == '00' then 1 else 4 << UInt(index_align<1:0>);
d = UInt(D:Vd); d2 = d + inc; d3 = d2 + inc; d4 = d3 + inc; n = UInt(Rn); m = UInt(Rm);
wback = (m != 15); register_index = (m != 15 && m != 13);
if n == 15 || d4 > 31 then UNPREDICTABLE;
    
```

For information about the CONSTRAINED UNPREDICTABLE behavior of this instruction, see [Appendix A Architectural Constraints on UNPREDICTABLE behaviors](#), and particularly [VLD4 \(single 4-element structure to one lane\)](#) on page AppxA-4747.

Assembler syntax

VLD4{<c>}{<q>}.<size> <list>, [<Rn>{:<align>}]
 Encoded as Rm = 0b1111
 VLD4{<c>}{<q>}.<size> <list>, [<Rn>{:<align>}]!
 Encoded as Rm = 0b1101
 VLD4{<c>}{<q>}.<size> <list>, [<Rn>{:<align>}], <Rm>
 Rm cannot be 0b11x1

where:

<c>, <q> See [Standard assembler syntax fields](#) on page F2-2415. An A32 VLD4 instruction must be unconditional. ARM strongly recommends that a T32 VLD4 instruction is unconditional, see [Conditional execution](#) on page F2-2416.

<size> The data size. It must be one of:

8	Encoded as size = 0b00.
16	Encoded as size = 0b01.
32	Encoded as size = 0b10.

<list> The registers containing the structure. Encoded with D:Vd = <Dd>. It must be one of:
 {<Dd[x]>, <Dd+1[x]>, <Dd+2[x]>, <Dd+3[x]>}
 Single-spaced registers, see [Table F8-4](#).
 {<Dd[x]>, <Dd+2[x]>, <Dd+4[x]>, <Dd+6[x]>}
 Double-spaced registers, see [Table F8-4](#).
 Not available if <size> == 8.

<Rn> The base address for the access.

<align> The alignment. It can be:
 32 4-byte alignment, available only if <size> is 8.
 64 8-byte alignment, available only if <size> is 16 or 32.
 128 16-byte alignment, available only if <size> is 32.
omitted Standard alignment, see [Unaligned data access on page E2-2341](#).
 : is the preferred separator before the <align> value, but the alignment can be specified as @<align>, see [Advanced SIMD addressing mode on page F5-2517](#).

! If present, specifies writeback.

<Rm> Contains an address offset applied after the access.

For more information about <Rn>, !, and <Rm> see [Advanced SIMD addressing mode on page F5-2517](#).

Table F8-4 Encoding of index, alignment, and register spacing

	<size> == 8	<size> == 16	<size> == 32
Index	index_align[3:1] = x	index_align[3:2] = x	index_align[3] = x
Single-spacing	-	index_align[1] = 0	index_align[2] = 0
Double-spacing	-	index_align[1] = 1	index_align[2] = 1
<align> omitted	index_align[0] = 0	index_align[0] = 0	index_align[1:0] = '00'
<align> == 32	index_align[0] = 1	-	-
<align> == 64	-	index_align[0] = 1	index_align[1:0] = '01'
<align> == 128	-	-	index_align[1:0] = '10'

Operation

```

if ConditionPassed() then
    EncodingSpecificOperations(); CheckAdvSIMDEnabled(); NullCheckIfThumbEE(n);
    address = R[n]; if (address MOD alignment) != 0 then GenerateAlignmentException();
    if wback then R[n] = R[n] + (if register_index then R[m] else 4*ebytes);
    Elem[D[d], index] = MemU[address, ebytes];
    Elem[D[d2], index] = MemU[address+ebytes, ebytes];
    Elem[D[d3], index] = MemU[address+2*ebytes, ebytes];
    Elem[D[d4], index] = MemU[address+3*ebytes, ebytes];
  
```

F8.1.72 VLD4 (single 4-element structure to all lanes)

This instruction loads one 4-element structure from memory into all lanes of four registers. For details of the addressing mode see [Advanced SIMD addressing mode on page F5-2517](#).

Depending on settings in the CPACR, NSACR, and HCPTR registers, and the security state and mode in which the instruction is executed, an attempt to execute the instruction might be UNDEFINED, or trapped to Hyp mode. [Summary of access controls for Advanced SIMD functionality on page G1-3498](#) summarizes these controls.

ARM deprecates the conditional execution of any Advanced SIMD instruction encoding that is not also available as a VFP instruction encoding, see [Conditional execution on page F2-2416](#).

Encoding T1/A1 Advanced SIMDv1

VLD4<c>.<size> <list>, [<Rn>{ :<align>}]{!}

VLD4<c>.<size> <list>, [<Rn>{ :<align>}], <Rm>

15	14	13	12	11	10	9	8	7	6	5	4	3	2	1	0	15	14	13	12	11	10	9	8	7	6	5	4	3	2	1	0
1	1	1	1	1	0	0	1	1	D	1	0		Rn			Vd		1	1	1	1	size	T	a		Rm					

31	30	29	28	27	26	25	24	23	22	21	20	19	18	17	16	15	14	13	12	11	10	9	8	7	6	5	4	3	2	1	0
1	1	1	1	0	1	0	0	1	D	1	0		Rn			Vd		1	1	1	1	size	T	a		Rm					

```

if size == '11' && a == '0' then UNDEFINED;
if size == '11' then
    ebytes = 4; alignment = 16;
else
    ebytes = 1 << UInt(size);
    if size == '10' then
        alignment = if a == '0' then 1 else 8;
    else
        alignment = if a == '0' then 1 else 4*ebytes;
inc = if T == '0' then 1 else 2;
d = UInt(D:Vd); d2 = d + inc; d3 = d2 + inc; d4 = d3 + inc; n = UInt(Rn); m = UInt(Rm);
wback = (m != 15); register_index = (m != 15 && m != 13);
if n == 15 || d4 > 31 then UNPREDICTABLE;
    
```

For information about the CONSTRAINED UNPREDICTABLE behavior of this instruction, see [Appendix A Architectural Constraints on UNPREDICTABLE behaviors](#), and particularly [VLD4 \(single 4-element structure to all lanes\) on page AppxA-4747](#).

Assembler syntax

VLD4{<c>}{<q>}.<size> <list>, [<Rn>{ :<align>}] Encoded as Rm = 0b1111
 VLD4{<c>}{<q>}.<size> <list>, [<Rn>{ :<align>}]! Encoded as Rm = 0b1101
 VLD4{<c>}{<q>}.<size> <list>, [<Rn>{ :<align>}], <Rm> Rm cannot be 0b11x1

where:

<c>, <q> See [Standard assembler syntax fields on page F2-2415](#). An A32 VLD4 instruction must be unconditional. ARM strongly recommends that a T32 VLD4 instruction is unconditional, see [Conditional execution on page F2-2416](#).

<size> The data size. It must be one of:
 8 Encoded as size = 0b00.
 16 Encoded as size = 0b01.
 32 Encoded as size = 0b10, or 0b11 for 16-byte alignment.

<list> The registers containing the structures. It must be one of:
 {<Dd[>], <Dd+1[>], <Dd+2[>], <Dd+3[>]}
 Single-spaced registers, encoded as D:Vd = <Dd>, T = 0.
 {<Dd[>], <Dd+2[>], <Dd+4[>], <Dd+6[>]}
 Double-spaced registers, encoded as D:Vd = <Dd>, T = 1.

<Rn> The base address for the access.

<align> The alignment. It can be one of:
 32 4-byte alignment, available only if <size> is 8, encoded as a = 1.
 64 8-byte alignment, available only if <size> is 16 or 32, encoded as a = 1.
 128 16-byte alignment, available only if <size> is 32, encoded as a = 1, size = 0b11.
omitted Standard alignment, see [Unaligned data access on page E2-2341](#). Encoded as a = 0.
 : is the preferred separator before the <align> value, but the alignment can be specified as @<align>, see [Advanced SIMD addressing mode on page F5-2517](#).

! If present, specifies writeback.

<Rm> Contains an address offset applied after the access.

For more information about <Rn>, !, and <Rm>, see [Advanced SIMD addressing mode on page F5-2517](#).

Operation

```
if ConditionPassed() then
    EncodingSpecificOperations(); CheckAdvSIMDEnabled(); NullCheckIfThumbEE(n);
    address = R[n]; if (address MOD alignment) != 0 then GenerateAlignmentException();
    if wback then R[n] = R[n] + (if register_index then R[m] else 4*ebytes);
    D[d] = Replicate(MemU[address,ebytes]);
    D[d2] = Replicate(MemU[address+ebytes,ebytes]);
    D[d3] = Replicate(MemU[address+2*ebytes,ebytes]);
    D[d4] = Replicate(MemU[address+3*ebytes,ebytes]);
```

F8.1.73 VLDM

Vector Load Multiple loads multiple extension registers from consecutive memory locations using an address from a general-purpose register.

Depending on settings in the CPACR, NSACR, and HCPTR, and FPEXC registers, and the security state and mode in which the instruction is executed, an attempt to execute the instruction might be UNDEFINED, or trapped to Hyp mode. [Summary of general controls of CP10 and CP11 functionality on page G1-3496](#) summarizes these controls.

Encoding T1/A1 VFPv2, VFPv3, VFPv4, Advanced SIMDv1

VLDM{mode}<c> <Rn>{!}, <list> <list> is consecutive 64-bit registers

15	14	13	12	11	10	9	8	7	6	5	4	3	2	1	0	15	14	13	12	11	10	9	8	7	6	5	4	3	2	1	0
1	1	1	0	1	1	0	P	U	D	W	1		Rn		Vd	1	0	1	1												

31	30	29	28	27	26	25	24	23	22	21	20	19	18	17	16	15	14	13	12	11	10	9	8	7	6	5	4	3	2	1	0	
cond				1	1	0	P	U	D	W	1		Rn		Vd	1	0	1	1													

```

if P == '0' && U == '0' && W == '0' then SEE "Related encodings";
if P == '0' && U == '1' && W == '1' && Rn == '1101' then SEE VPOP;
if P == '1' && W == '0' then SEE VLDR;
if P == U && W == '1' then UNDEFINED;
// Remaining combinations are PUW = 010 (IA without !), 011 (IA with !), 101 (DB with !)
single_regs = FALSE; add = (U == '1'); wback = (W == '1');
d = UInt(D:Vd); n = UInt(Rn); imm32 = ZeroExtend(imm8:'00', 32);
regs = UInt(imm8) DIV 2; // If UInt(imm8) is odd, see "FLDMX".
if n == 15 && (wback || CurrentInstrSet() != InstrSet_A32) then UNPREDICTABLE;
if regs == 0 || regs > 16 || (d+regs) > 32 then UNPREDICTABLE;
if VFPsmallRegisterBank() && (d+regs) > 16 then UNPREDICTABLE;
    
```

Encoding T2/A2 VFPv2, VFPv3, VFPv4

VLDM{mode}<c> <Rn>{!}, <list> <list> is consecutive 32-bit registers

15	14	13	12	11	10	9	8	7	6	5	4	3	2	1	0	15	14	13	12	11	10	9	8	7	6	5	4	3	2	1	0
1	1	1	0	1	1	0	P	U	D	W	1		Rn		Vd	1	0	1	0												

31	30	29	28	27	26	25	24	23	22	21	20	19	18	17	16	15	14	13	12	11	10	9	8	7	6	5	4	3	2	1	0	
cond				1	1	0	P	U	D	W	1		Rn		Vd	1	0	1	0													

```

if P == '0' && U == '0' && W == '0' then SEE "Related encodings";
if P == '0' && U == '1' && W == '1' && Rn == '1101' then SEE VPOP;
if P == '1' && W == '0' then SEE VLDR;
if P == U && W == '1' then UNDEFINED;
// Remaining combinations are PUW = 010 (IA without !), 011 (IA with !), 101 (DB with !)
single_regs = TRUE; add = (U == '1'); wback = (W == '1'); d = UInt(Vd:D); n = UInt(Rn);
imm32 = ZeroExtend(imm8:'00', 32); regs = UInt(imm8);
if n == 15 && (wback || CurrentInstrSet() != InstrSet_A32) then UNPREDICTABLE;
if regs == 0 || (d+regs) > 32 then UNPREDICTABLE;
    
```

For information about the CONSTRAINED UNPREDICTABLE behavior of this instruction, see [Appendix A Architectural Constraints on UNPREDICTABLE behaviors](#), and particularly [VLDM on page AppxA-4748](#).

Related encodings See [64-bit transfers between general-purpose and extension registers on page F5-2519](#).

FLDMX Encoding T1/A1 behaves as described by the pseudocode if imm8 is odd. However, there is no UAL syntax for such encodings and ARM deprecates their use. For more information, see [FLDMX, FSTMX on page F8-3080](#).

Assembler syntax

VLDM{<mode>}{<c>}{<q>}{.<size>} <Rn>{!}, <list>

where:

<mode>	The addressing mode:
IA	Increment After. The consecutive addresses start at the address specified in <Rn>. This is the default and can be omitted. Encoded as P = 0, U = 1.
DB	Decrement Before. The consecutive addresses end just before the address specified in <Rn>. Encoded as P = 1, U = 0.
<c>, <q>	See <i>Standard assembler syntax fields</i> on page F2-2415.
<size>	An optional data size specifier. If present, it must be equal to the size in bits, 32 or 64, of the registers in <list>.
<Rn>	The base register. The SP can be used. In the A32 instruction set, if ! is not specified the PC can be used.
!	Causes the instruction to write a modified value back to <Rn>. This is required if <mode> == DB, and is optional if <mode> == IA. Encoded as W = 1. If ! is omitted, the instruction does not change <Rn> in this way. Encoded as W = 0.
<list>	The extension registers to be loaded, as a list of consecutively numbered doubleword (encoding T1/A1) or singleword (encoding T2/A2) registers, separated by commas and surrounded by brackets. It is encoded in the instruction by setting D and Vd to specify the first register in the list, and imm8 to twice the number of registers in the list (encoding T1/A1) or the number of registers in the list (encoding T2/A2). <list> must contain at least one register. If it contains doubleword registers it must not contain more than 16 registers.

Operation

```

if ConditionPassed() then
    EncodingSpecificOperations(); CheckVFPEnabled(TRUE); NullCheckIfThumbEE(n);
    address = if add then R[n] else R[n]-imm32;
    if wback then R[n] = if add then R[n]+imm32 else R[n]-imm32;
    for r = 0 to regs-1
        if single_regs then
            S[d+r] = MemA[address,4]; address = address+4;
        else
            word1 = MemA[address,4]; word2 = MemA[address+4,4]; address = address+8;
            // Combine the word-aligned words in the correct order for current endianness.
            D[d+r] = if BigEndian() then word1:word2 else word2:word1;
  
```

F8.1.74 VLDR

This instruction loads a single extension register from memory, using an address from a general-purpose register, with an optional offset.

Depending on settings in the CPACR, NSACR, and HCPTR, and FPEXC registers, and the security state and mode in which the instruction is executed, an attempt to execute the instruction might be UNDEFINED, or trapped to Hyp mode. *Summary of general controls of CP10 and CP11 functionality on page G1-3496* and *Summary of access controls for Advanced SIMD functionality on page G1-3498* summarize these controls.

Encoding T1/A1 VFPv2, VFPv3, VFPv4, Advanced SIMDv1

VLDR<c> <Dd>, [<Rn>{, #+/-<imm>}]

VLDR<c> <Dd>, <label>

VLDR<c> <Dd>, [PC, #-0] Special case

15	14	13	12	11	10	9	8	7	6	5	4	3	2	1	0	15	14	13	12	11	10	9	8	7	6	5	4	3	2	1	0
1	1	1	0	1	1	0	1	U	D	0	1	Rn				Vd				1	0	1	1	imm8							

31	30	29	28	27	26	25	24	23	22	21	20	19	18	17	16	15	14	13	12	11	10	9	8	7	6	5	4	3	2	1	0
cond				1	1	0	1	U	D	0	1	Rn				Vd				1	0	1	1	imm8							

single_reg = FALSE; add = (U == '1'); imm32 = ZeroExtend(imm8:'00', 32);
 d = UInt(D:Vd); n = UInt(Rn);

Encoding T2/A2 VFPv2, VFPv3, VFPv4

VLDR<c> <Sd>, [<Rn>{, #+/-<imm>}]

VLDR<c> <Sd>, <label>

VLDR<c> <Sd>, [PC, #-0] Special case

15	14	13	12	11	10	9	8	7	6	5	4	3	2	1	0	15	14	13	12	11	10	9	8	7	6	5	4	3	2	1	0
1	1	1	0	1	1	0	1	U	D	0	1	Rn				Vd				1	0	1	0	imm8							

31	30	29	28	27	26	25	24	23	22	21	20	19	18	17	16	15	14	13	12	11	10	9	8	7	6	5	4	3	2	1	0
cond				1	1	0	1	U	D	0	1	Rn				Vd				1	0	1	0	imm8							

single_reg = TRUE; add = (U == '1'); imm32 = ZeroExtend(imm8:'00', 32);
 d = UInt(Vd:D); n = UInt(Rn);

Assembler syntax

VLDR{<c>}{<q>}{.64} <Dd>, [<Rn> {, #+/-<imm>}]	Encoding T1/A1, immediate form
VLDR{<c>}{<q>}{.64} <Dd>, <label>	Encoding T1/A1, normal literal form
VLDR{<c>}{<q>}{.64} <Dd>, [PC, #+/-<imm>]	Encoding T1/A1, alternative literal form
VLDR{<c>}{<q>}{.32} <Sd>, [<Rn> {, #+/-<imm>}]	Encoding T2/A2, immediate form
VLDR{<c>}{<q>}{.32} <Sd>, <label>	Encoding T2/A2, normal literal form
VLDR{<c>}{<q>}{.32} <Sd>, [PC, #+/-<imm>]	Encoding T2/A2, alternative literal form

where:

<c>, <q>	See Standard assembler syntax fields on page F2-2415 .
.32, .64	Optional data size specifiers.
<Dd>	The destination register for a doubleword load.
<Sd>	The destination register for a singleword load.
<Rn>	The base register. The SP can be used.
+/-	Is + or omitted if the immediate offset is to be added to the base register value (add == TRUE), or – if it is to be subtracted (add == FALSE). #0 and #-0 generate different instructions.
<imm>	The immediate offset used for forming the address. For the immediate forms of the syntax, <imm> can be omitted, in which case the #0 form of the instruction is assembled. Permitted values are multiples of 4 in the range 0 to 1020.
<label>	The label of the literal data item to be loaded. The assembler calculates the required value of the offset from the Align(PC, 4) value of the instruction to this label. Permitted values are multiples of 4 in the range -1020 to 1020. If the offset is zero or positive, imm32 is equal to the offset and add == TRUE. If the offset is negative, imm32 is equal to minus the offset and add == FALSE.

For the literal forms of the instruction, the base register is encoded as 0b1111 to indicate that the PC is the base register.

The alternative syntax permits the addition or subtraction of the offset and the immediate offset to be specified separately, including permitting a subtraction of 0 that cannot be specified using the normal syntax. For more information, see [Use of labels in UAL instruction syntax on page F1-2380](#).

Operation

```

if ConditionPassed() then
    EncodingSpecificOperations(); CheckVFPEnabled(TRUE); NullCheckIfThumbEE(n);
    base = if n == 15 then Align(PC,4) else R[n];
    address = if add then (base + imm32) else (base - imm32);
    if single_reg then
        S[d] = MemA[address,4];
    else
        word1 = MemA[address,4]; word2 = MemA[address+4,4];
        // Combine the word-aligned words in the correct order for current endianness.
        D[d] = if BigEndian() then word1:word2 else word2:word1;
  
```

F8.1.75 VMAX, VMIN (integer)

Vector Maximum compares corresponding elements in two vectors, and copies the larger of each pair into the corresponding element in the destination vector.

Vector Minimum compares corresponding elements in two vectors, and copies the smaller of each pair into the corresponding element in the destination vector.

The operand vector elements can be any one of:

- 8-bit, 16-bit, or 32-bit signed integers.
- 8-bit, 16-bit, or 32-bit unsigned integers.

The result vector elements are the same size as the operand vector elements.

Depending on settings in the CPACR, NSACR, and HCPTR registers, and the security state and mode in which the instruction is executed, an attempt to execute the instruction might be UNDEFINED, or trapped to Hyp mode.

[Summary of access controls for Advanced SIMD functionality on page G1-3498](#) summarizes these controls.

ARM deprecates the conditional execution of any Advanced SIMD instruction encoding that is not also available as a VFP instruction encoding, see [Conditional execution on page F2-2416](#).

Encoding T1/A1 Advanced SIMDv1

V<op><c>.<dt> <Qd>, <Qn>, <Qm>

V<op><c>.<dt> <Dd>, <Dn>, <Dm>

15	14	13	12	11	10	9	8	7	6	5	4	3	2	1	0	15	14	13	12	11	10	9	8	7	6	5	4	3	2	1	0
1	1	1	U	1	1	1	1	0	D	size	Vn	Vd	0	1	1	0	N	Q	M	op	Vm										
31	30	29	28	27	26	25	24	23	22	21	20	19	18	17	16	15	14	13	12	11	10	9	8	7	6	5	4	3	2	1	0
1	1	1	1	0	0	1	U	0	D	size	Vn	Vd	0	1	1	0	N	Q	M	op	Vm										

```

if Q == '1' && (Vd<0> == '1' || Vn<0> == '1' || Vm<0> == '1') then UNDEFINED;
if size == '11' then UNDEFINED;
maximum = (op == '0'); unsigned = (U == '1');
esize = 8 << UInt(size); elements = 64 DIV esize;
d = UInt(D:Vd); n = UInt(N:Vn); m = UInt(M:Vm); regs = if Q == '0' then 1 else 2;
    
```

Assembler syntax

V<op>{<c>}{<q>}.<dt> {<Qd>}, <Qn>, <Qm> Encoded as Q = 1
 V<op>{<c>}{<q>}.<dt> {<Dd>}, <Dn>, <Dm> Encoded as Q = 0

where:

<op> The operation. It must be one of:
 MAX Encoded as op = 0.
 MIN Encoded as op = 1.

<c>, <q> See [Standard assembler syntax fields on page F2-2415](#). An A32 VMAX or VMIN instruction must be unconditional. ARM strongly recommends that a T32 VMAX or VMIN instruction is unconditional, see [Conditional execution on page F2-2416](#).

<dt> The data types for the elements of the vectors. It must be one of:
 S8 Encoded as size = 0b00, U = 0.
 S16 Encoded as size = 0b01, U = 0.
 S32 Encoded as size = 0b10, U = 0.
 U8 Encoded as size = 0b00, U = 1.
 U16 Encoded as size = 0b01, U = 1.
 U32 Encoded as size = 0b10, U = 1.

<Qd>, <Qn>, <Qm> The destination vector and the operand vectors, for a quadword operation.

<Dd>, <Dn>, <Dm> The destination vector and the operand vectors, for a doubleword operation.

Operation

```
if ConditionPassed() then
    EncodingSpecificOperations(); CheckAdvSIMDEnabled();
    for r = 0 to regs-1
        for e = 0 to elements-1
            op1 = Int(Elem[D[n+r],e,esize], unsigned);
            op2 = Int(Elem[D[m+r],e,esize], unsigned);
            result = if maximum then Max(op1,op2) else Min(op1,op2);
            Elem[D[d+r],e,esize] = result<esize-1:0>;
```

F8.1.76 VMAX, VMIN (floating-point)

Vector Maximum compares corresponding elements in two vectors, and copies the larger of each pair into the corresponding element in the destination vector.

Vector Minimum compares corresponding elements in two vectors, and copies the smaller of each pair into the corresponding element in the destination vector.

The operand vector elements are 32-bit floating-point numbers.

Depending on settings in the CPACR, NSACR, and HCPTR registers, and the security state and mode in which the instruction is executed, an attempt to execute the instruction might be UNDEFINED, or trapped to Hyp mode.

[Summary of access controls for Advanced SIMD functionality on page G1-3498](#) summarizes these controls.

ARM deprecates the conditional execution of any Advanced SIMD instruction encoding that is not also available as a VFP instruction encoding, see [Conditional execution on page F2-2416](#).

Encoding T1/A1 Advanced SIMDv1 (UNDEFINED in integer-only variant)

V<op><c>.F32 <Qd>, <Qn>, <Qm>

V<op><c>.F32 <Dd>, <Dn>, <Dm>

15	14	13	12	11	10	9	8	7	6	5	4	3	2	1	0	15	14	13	12	11	10	9	8	7	6	5	4	3	2	1	0
1	1	1	0	1	1	1	1	0	D	op	sz	Vn				Vd	1	1	1	1	N	Q	M	0	Vm						
31	30	29	28	27	26	25	24	23	22	21	20	19	18	17	16	15	14	13	12	11	10	9	8	7	6	5	4	3	2	1	0
1	1	1	1	0	0	1	0	0	D	op	sz	Vn				Vd	1	1	1	1	N	Q	M	0	Vm						

```

if Q == '1' && (Vd<0> == '1' || Vn<0> == '1' || Vm<0> == '1') then UNDEFINED;
if sz == '1' then UNDEFINED;
maximum = (op == '0'); esize = 32; elements = 2;
d = UInt(D:Vd); n = UInt(N:Vn); m = UInt(M:Vm); regs = if Q == '0' then 1 else 2;
    
```

Assembler syntax

V<op>{<c>}{<q>}.F32 {<Qd>}, <Qn>, <Qm> Encoded as Q = 1
 V<op>{<c>}{<q>}.F32 {<Dd>}, <Dn>, <Dm> Encoded as Q = 0

where:

<op> The operation. It must be one of:
 MAX Encoded as op = 0.
 MIN Encoded as op = 1.

<c>, <q> See [Standard assembler syntax fields on page F2-2415](#). An A32 VMAX or VMIN instruction must be unconditional. ARM strongly recommends that a T32 VMAX or VMIN instruction is unconditional, see [Conditional execution on page F2-2416](#).

<Qd>, <Qn>, <Qm> The destination vector and the operand vectors, for a quadword operation.

<Dd>, <Dn>, <Dm> The destination vector and the operand vectors, for a doubleword operation.

Operation

```

if ConditionPassed() then
    EncodingSpecificOperations(); CheckAdvSIMDEnabled();
    for r = 0 to regs-1
        for e = 0 to elements-1
            op1 = Elem[D[n+r],e,esize]; op2 = Elem[D[m+r],e,esize];
            if maximum then
                Elem[D[d+r],e,esize] = FPMax(op1, op2, StandardFPSCRValue());
            else
                Elem[D[d+r],e,esize] = FPMin(op1, op2, StandardFPSCRValue());
  
```

Floating-point maximum and minimum

- $\max(+0.0, -0.0) = +0.0$
- $\min(+0.0, -0.0) = -0.0$
- If any input is a NaN, the corresponding result element is the default NaN.

F8.1.77 VMAXNM, VMINNM

These instructions determine the floating-point maximum number and floating point minimum number accordingly.

They handle NaNs in consistence with the IEEE754-2008 specification. They return the numerical operand when one operand is numerical and the other is a quiet NaN, but otherwise the result is identical to VFP VMAX and VMIN.

These instructions are not conditional.

Encoding T1/A1 ARMv8 Advanced SIMD

V<op>.F32 <Qd>, <Qn>, <Qm>

V<op>.F32 <Dd>, <Dn>, <Dm>

15	14	13	12	11	10	9	8	7	6	5	4	3	2	1	0	15	14	13	12	11	10	9	8	7	6	5	4	3	2	1	0
1	1	1	1	1	1	1	1	0	D	op	sz	Vn			Vd			1	1	1	1	N	Q	M	1	Vm					

31	30	29	28	27	26	25	24	23	22	21	20	19	18	17	16	15	14	13	12	11	10	9	8	7	6	5	4	3	2	1	0
1	1	1	1	0	0	1	1	0	D	op	sz	Vn			Vd			1	1	1	1	N	Q	M	1	Vm					

```

if Q == '1' && (Vd<0> == '1' || Vn<0> == '1' || Vm<0> == '1') then UNDEFINED;
if sz == '1' then UNDEFINED;
maximum = (op == '0');
advsimd = TRUE; esize = 32; elements = 2;
d = UInt(D:Vd); n = UInt(N:Vn); m = UInt(M:Vm); regs = if Q == '0' then 1 else 2;
if InITBlock() then UNPREDICTABLE;
    
```

Encoding T2/A2 ARMv8 FP

V<op>.F64 <Dd>, <Dn>, <Dm>

V<op>.F32 <Sd>, <Sn>, <Sm>

15	14	13	12	11	10	9	8	7	6	5	4	3	2	1	0	15	14	13	12	11	10	9	8	7	6	5	4	3	2	1	0
1	1	1	1	1	1	1	0	1	D	0	0	Vn			Vd			1	0	1	sz	N	op	M	0	Vm					

31	30	29	28	27	26	25	24	23	22	21	20	19	18	17	16	15	14	13	12	11	10	9	8	7	6	5	4	3	2	1	0
1	1	1	1	1	1	1	0	1	D	0	0	Vn			Vd			1	0	1	sz	N	op	M	0	Vm					

```

advsimd = FALSE;
maximum = (op == '0'); dp_operation = (sz == '1');
d = if dp_operation then UInt(D:Vd) else UInt(Vd:D);
n = if dp_operation then UInt(N:Vn) else UInt(Vn:N);
m = if dp_operation then UInt(M:Vm) else UInt(Vm:M);
if InITBlock() then UNPREDICTABLE;
    
```

For information about the CONSTRAINED UNPREDICTABLE behavior of this instruction, see [Appendix A Architectural Constraints on UNPREDICTABLE behaviors](#).

Assembler syntax

V<op>NM{<q>}.F32 <Qd>, <Qn>, <Qm>	Encoding T1/A1, encoded as Q = 1, sz = 0
V<op>NM{<q>}.F32 <Dd>, <Dn>, <Dm>	Encoding T1/A1, encoded as Q = 0, sz = 0
V<op>NM{<q>}.F64 <Dd>, <Dn>, <Dm>	Encoding T2/A2, encoded as sz = 1
V<op>NM{<q>}.F32 <Sd>, <Sn>, <Sm>	Encoding T2/A2, encoded as sz = 0

where:

<op>	The operation. It must be one of: MAXNM Maximum Number. Encoded as op = 0. MINNM Minimum Number. Encoded as op = 1.
<q>	See Standard assembler syntax fields on page F2-2415 .
<Qd>, <Qn>, <Qm>	The destination vector and the operand vectors, for a quadword operation.
<Dd>, <Dn>, <Dm>	The destination vector and the operand vectors, for a doubleword operation.
<Sd>, <Sn>, <Sm>	The destination vector and the operand vectors, for a singleword operation.

Operation

```

EncodingSpecificOperations(); CheckAdvSIMDOrVFPEEnabled(TRUE, advsimd);
if advsimd then // Advanced SIMD instruction
  for r = 0 to regs-1
    for e = 0 to elements-1
      op1 = Elem[D[n+r], e, esize]; op2 = Elem[D[m+r], e, esize];
      if maximum then
        Elem[D[d+r], e, esize] = FPMaxNum(op1, op2, StandardFPSCRValue());
      else
        Elem[D[d+r], e, esize] = FPMinNum(op1, op2, StandardFPSCRValue());
else // VFP instruction
  if dp_operation then
    if maximum then
      D[d] = FPMaxNum(D[n], D[m], FPSCR);
    else
      D[d] = FPMinNum(D[n], D[m], FPSCR);
  else
    if maximum then
      S[d] = FPMaxNum(S[n], S[m], FPSCR);
    else
      S[d] = FPMinNum(S[n], S[m], FPSCR);
  
```

F8.1.78 VMLA, VMLAL, VMLS, VMLSL (integer)

Vector Multiply Accumulate and Vector Multiply Subtract multiply corresponding elements in two vectors, and either add the products to, or subtract them from, the corresponding elements of the destination vector. Vector Multiply Accumulate Long and Vector Multiply Subtract Long do the same thing, but with destination vector elements that are twice as long as the elements that are multiplied.

Depending on settings in the CPACR, NSACR, and HCPTR registers, and the security state and mode in which the instruction is executed, an attempt to execute the instruction might be UNDEFINED, or trapped to Hyp mode. [Summary of access controls for Advanced SIMD functionality on page G1-3498](#) summarizes these controls.

ARM deprecates the conditional execution of any Advanced SIMD instruction encoding that is not also available as a VFP instruction encoding, see [Conditional execution on page F2-2416](#).

Encoding T1/A1 Advanced SIMDv1

V<op><c>.<dt> <Qd>, <Qn>, <Qm>

V<op><c>.<dt> <Dd>, <Dn>, <Dm>

15	14	13	12	11	10	9	8	7	6	5	4	3	2	1	0	15	14	13	12	11	10	9	8	7	6	5	4	3	2	1	0
1	1	1	op	1	1	1	1	0	D	size	Vn	Vd	1	0	0	1	N	Q	M	0	Vm										

31	30	29	28	27	26	25	24	23	22	21	20	19	18	17	16	15	14	13	12	11	10	9	8	7	6	5	4	3	2	1	0
1	1	1	1	0	0	1	op	0	D	size	Vn	Vd	1	0	0	1	N	Q	M	0	Vm										

```

if size == '11' then UNDEFINED;
if Q == '1' && (Vd<0> == '1' || Vn<0> == '1' || Vm<0> == '1') then UNDEFINED;
add = (op == '0'); long_destination = FALSE;
unsigned = FALSE; // "Don't care" value: TRUE produces same functionality
esize = 8 << UInt(size); elements = 64 DIV esize;
d = UInt(D:Vd); n = UInt(N:Vn); m = UInt(M:Vm); regs = if Q == '0' then 1 else 2;
  
```

Encoding T2/A2 Advanced SIMDv1

V<op>L<c>.<dt> <Qd>, <Dn>, <Dm>

15	14	13	12	11	10	9	8	7	6	5	4	3	2	1	0	15	14	13	12	11	10	9	8	7	6	5	4	3	2	1	0
1	1	1	U	1	1	1	1	1	D	size	Vn	Vd	1	0	op	0	N	0	M	0	Vm										

31	30	29	28	27	26	25	24	23	22	21	20	19	18	17	16	15	14	13	12	11	10	9	8	7	6	5	4	3	2	1	0
1	1	1	1	0	0	1	U	1	D	size	Vn	Vd	1	0	op	0	N	0	M	0	Vm										

```

if size == '11' then SEE "Related encodings";
if Vd<0> == '1' then UNDEFINED;
add = (op == '0'); long_destination = TRUE; unsigned = (U == '1');
esize = 8 << UInt(size); elements = 64 DIV esize;
d = UInt(D:Vd); n = UInt(N:Vn); m = UInt(M:Vm); regs = 1;
  
```

Related encodings See [Advanced SIMD data-processing instructions on page F5-2499](#).

Assembler syntax

V<op>{<c>}{<q>}.<type><size> <Qd>, <Qn>, <Qm> Encoding T1/A1, encoded as Q = 1
 V<op>{<c>}{<q>}.<type><size> <Dd>, <Dn>, <Dm> Encoding T1/A1, encoded as Q = 0
 V<op>L{<c>}{<q>}.<type><size> <Qd>, <Dn>, <Dm> Encoding T2/A2

where:

<op> The operation. It must be one of:
 MLA Vector Multiply Accumulate. Encoded as op = 0.
 MLS Vector Multiply Subtract. Encoded as op = 1.

<c>, <q> See [Standard assembler syntax fields on page F2-2415](#). An A32 Advanced SIMD VMLA, VMLAL, VMLS, or VMLS instruction must be unconditional. ARM strongly recommends that a T32 Advanced SIMD VMLA, VMLAL, VMLS, or VMLS instruction is unconditional, see [Conditional execution on page F2-2416](#).

<type> The data type for the elements of the operands. It must be one of:
 S Optional in encoding T1/A1. Encoded as U = 0 in encoding T2/A2.
 U Optional in encoding T1/A1. Encoded as U = 1 in encoding T2/A2.
 I Available only in encoding T1/A1.

<size> The data size for the elements of the operands. It must be one of:
 8 Encoded as size = 0b00.
 16 Encoded as size = 0b01.
 32 Encoded as size = 0b10.

<Qd>, <Qn>, <Qm> The destination vector and the operand vectors, for a quadword operation.

<Dd>, <Dn>, <Dm> The destination vector and the operand vectors, for a doubleword operation.

<Qd>, <Dn>, <Dm> The destination vector and the operand vectors, for a long operation.

Operation

```

if ConditionPassed() then
    EncodingSpecificOperations(); CheckAdvSIMDEnabled();
    for r = 0 to regs-1
        for e = 0 to elements-1
            product = Int(Elem[Din[n+r],e,esize],unsigned) * Int(Elem[Din[m+r],e,esize],unsigned);
            addend = if add then product else -product;
            if long_destination then
                Elem[Q[d>>1],e,2*esize] = Elem[Qin[d>>1],e,2*esize] + addend;
            else
                Elem[D[d+r],e,esize] = Elem[Din[d+r],e,esize] + addend;
  
```

F8.1.79 VMLA, VMLS (floating-point)

Vector Multiply Accumulate multiplies corresponding elements in two vectors, and accumulates the results into the elements of the destination vector.

Vector Multiply Subtract multiplies corresponding elements in two vectors, subtracts the products from corresponding elements of the destination vector, and places the results in the destination vector.

———— Note —————

ARM recommends that software does not use the VMLS instruction in the *Round towards Plus Infinity* and *Round towards Minus Infinity* rounding modes, because the rounding of the product and of the sum can change the result of the instruction in opposite directions, defeating the purpose of these rounding modes.

Depending on settings in the CPACR, NSACR, and HCPTR, and FPEXC registers, and the security state and mode in which the instruction is executed, an attempt to execute the instruction might be UNDEFINED, or trapped to Hyp mode. *Summary of general controls of CP10 and CP11 functionality on page G1-3496* and *Summary of access controls for Advanced SIMD functionality on page G1-3498* summarize these controls.

ARM deprecates the conditional execution of any Advanced SIMD instruction encoding that is not also available as a VFP instruction encoding, see *Conditional execution on page F2-2416*.

Encoding T1/A1 Advanced SIMDv1 (UNDEFINED in integer-only variant)

V<op><c>.F32 <Qd>, <Qn>, <Qm>

V<op><c>.F32 <Dd>, <Dn>, <Dm>

15	14	13	12	11	10	9	8	7	6	5	4	3	2	1	0	15	14	13	12	11	10	9	8	7	6	5	4	3	2	1	0
1	1	1	0	1	1	1	1	0	D	op	sz		Vn		Vd	1	1	0	1	N	Q	M	1		Vm						

31	30	29	28	27	26	25	24	23	22	21	20	19	18	17	16	15	14	13	12	11	10	9	8	7	6	5	4	3	2	1	0
1	1	1	1	0	0	1	0	0	D	op	sz		Vn		Vd	1	1	0	1	N	Q	M	1		Vm						

```

if Q == '1' && (Vd<0> == '1' || Vn<0> == '1' || Vm<0> == '1') then UNDEFINED;
if sz == '1' then UNDEFINED;
advsimd = TRUE; add = (op == '0'); esize = 32; elements = 2;
d = UInt(D:Vd); n = UInt(N:Vn); m = UInt(M:Vm); regs = if Q == '0' then 1 else 2;
    
```

Encoding T2/A2 VFPv2, VFPv3, VFPv4 (sz = 1 UNDEFINED in single-precision only variants)

V<op><c>.F64 <Dd>, <Dn>, <Dm>

V<op><c>.F32 <Sd>, <Sn>, <Sm>

15	14	13	12	11	10	9	8	7	6	5	4	3	2	1	0	15	14	13	12	11	10	9	8	7	6	5	4	3	2	1	0
1	1	1	0	1	1	1	0	0	D	0	0		Vn		Vd	1	0	1	sz	N	op	M	0		Vm						

31	30	29	28	27	26	25	24	23	22	21	20	19	18	17	16	15	14	13	12	11	10	9	8	7	6	5	4	3	2	1	0
cond		1	1	1	0	0	D	0	0		Vn		Vd	1	0	1	sz	N	op	M	0		Vm								

```

if FPSCR.Len != '000' || FPSCR.Stride != '00' then UNDEFINED;
advsimd = FALSE; dp_operation = (sz == '1'); add = (op == '0');
d = if dp_operation then UInt(D:Vd) else UInt(Vd:D);
n = if dp_operation then UInt(N:Vn) else UInt(Vn:N);
m = if dp_operation then UInt(M:Vm) else UInt(Vm:M);
    
```

Assembler syntax

V<op>{<c>}{<q>}.F32 <Qd>, <Qn>, <Qm>	Encoding T1/A1, encoded as Q = 1, sz = 0
V<op>{<c>}{<q>}.F32 <Dd>, <Dn>, <Dm>	Encoding T1/A1, encoded as Q = 0, sz = 0
V<op>{<c>}{<q>}.F64 <Dd>, <Dn>, <Dm>	Encoding T2/A2, encoded as sz = 1
V<op>{<c>}{<q>}.F32 <Sd>, <Sn>, <Sm>	Encoding T2/A2, encoded as sz = 0

where:

<op>	The operation. It must be one of: MLA Vector Multiply Accumulate. Encoded as op = 0. MLS Vector Multiply Subtract. Encoded as op = 1.
<c>, <q>	See Standard assembler syntax fields on page F2-2415 . An A32 Advanced SIMD VMLA or VMLS instruction must be unconditional. ARM strongly recommends that a T32 Advanced SIMD VMLA or VMLS instruction is unconditional, see Conditional execution on page F2-2416 .
<Qd>, <Qn>, <Qm>	The destination vector and the operand vectors, for a quadword operation.
<Dd>, <Dn>, <Dm>	The destination vector and the operand vectors, for a doubleword operation.
<Sd>, <Sn>, <Sm>	The destination vector and the operand vectors, for a singleword operation.

Operation

```

if ConditionPassed() then
    EncodingSpecificOperations(); CheckAdvSIMDOrVFPEEnabled(TRUE, advsimd);
    if advsimd then // Advanced SIMD instruction
        for r = 0 to regs-1
            for e = 0 to elements-1
                product = FPMul(Elem[D[n+r],e,esize], Elem[D[m+r],e,esize], StandardFPSCRValue());
                addend = if add then product else FPNeg(product);
                Elem[D[d+r],e,esize] = FPAAdd(Elem[D[d+r],e,esize], addend, StandardFPSCRValue());
    else // VFP instruction
        if dp_operation then
            addend64 = if add then FPMul(D[n], D[m], FPSCR) else FPNeg(FPMul(D[n], D[m], FPSCR));
            D[d] = FPAAdd(D[d], addend64, FPSCR);
        else
            addend32 = if add then FPMul(S[n], S[m], FPSCR) else FPNeg(FPMul(S[n], S[m], FPSCR));
            S[d] = FPAAdd(S[d], addend32, FPSCR);
  
```

F8.1.80 VMLA, VMLAL, VMLS, VMLSL (by scalar)

Vector Multiply Accumulate and Vector Multiply Subtract multiply elements of a vector by a scalar, and either add the products to, or subtract them from, corresponding elements of the destination vector. Vector Multiply Accumulate Long and Vector Multiply Subtract Long do the same thing, but with destination vector elements that are twice as long as the elements that are multiplied.

For more information about scalars see [Advanced SIMD scalars on page F5-2498](#).

Depending on settings in the CPACR, NSACR, and HCPTR registers, and the security state and mode in which the instruction is executed, an attempt to execute the instruction might be UNDEFINED, or trapped to Hyp mode. [Summary of access controls for Advanced SIMD functionality on page G1-3498](#) summarizes these controls.

ARM deprecates the conditional execution of any Advanced SIMD instruction encoding that is not also available as a VFP instruction encoding, see [Conditional execution on page F2-2416](#).

Encoding T1/A1 Advanced SIMDv1 (F = 1 UNDEFINED in integer-only variants)

V<op><c>.<dt> <Qd>, <Qn>, <Dm[x]>

V<op><c>.<dt> <Dd>, <Dn>, <Dm[x]>

15	14	13	12	11	10	9	8	7	6	5	4	3	2	1	0	15	14	13	12	11	10	9	8	7	6	5	4	3	2	1	0
1	1	1	Q	1	1	1	1	1	D	size	Vn	Vd	0	op	0	F	N	1	M	0	Vm										
31	30	29	28	27	26	25	24	23	22	21	20	19	18	17	16	15	14	13	12	11	10	9	8	7	6	5	4	3	2	1	0
1	1	1	1	0	0	1	Q	1	D	size	Vn	Vd	0	op	0	F	N	1	M	0	Vm										

```

if size == '11' then SEE "Related encodings";
if size == '00' || (F == '1' && size == '01') then UNDEFINED;
if Q == '1' && (Vd<0> == '1' || Vn<0> == '1') then UNDEFINED;
unsigned = FALSE; // "Don't care" value: TRUE produces same functionality
add = (op == '0'); floating_point = (F == '1'); long_destination = FALSE;
d = UInt(D:Vd); n = UInt(N:Vn); regs = if Q == '0' then 1 else 2;
if size == '01' then esize = 16; elements = 4; m = UInt(Vm<2:0>); index = UInt(M:Vm<3>);
if size == '10' then esize = 32; elements = 2; m = UInt(Vm); index = UInt(M);
    
```

Encoding T2/A2 Advanced SIMDv1

V<op>L<c>.<dt> <Qd>, <Dn>, <Dm[x]>

15	14	13	12	11	10	9	8	7	6	5	4	3	2	1	0	15	14	13	12	11	10	9	8	7	6	5	4	3	2	1	0
1	1	1	U	1	1	1	1	1	D	size	Vn	Vd	0	op	1	0	N	1	M	0	Vm										
31	30	29	28	27	26	25	24	23	22	21	20	19	18	17	16	15	14	13	12	11	10	9	8	7	6	5	4	3	2	1	0
1	1	1	1	0	0	1	U	1	D	size	Vn	Vd	0	op	1	0	N	1	M	0	Vm										

```

if size == '11' then SEE "Related encodings";
if size == '00' || Vd<0> == '1' then UNDEFINED;
unsigned = (U == '1'); add = (op == '0'); floating_point = FALSE; long_destination = TRUE;
d = UInt(D:Vd); n = UInt(N:Vn); regs = 1;
if size == '01' then esize = 16; elements = 4; m = UInt(Vm<2:0>); index = UInt(M:Vm<3>);
if size == '10' then esize = 32; elements = 2; m = UInt(Vm); index = UInt(M);
    
```

Related encodings See [Advanced SIMD data-processing instructions on page F5-2499](#).

Assembler syntax

V<op>{<c>}{<q>}.<type><size> <Qd>, <Qn>, <Dm[x]> Encoding T1/A1, encoded as Q = 1
 V<op>{<c>}{<q>}.<type><size> <Dd>, <Dn>, <Dm[x]> Encoding T1/A1, encoded as Q = 0
 V<op>L{<c>}{<q>}.<type><size> <Qd>, <Dn>, <Dm[x]> Encoding T2/A2

where:

<op> The operation. It must be one of:
 MLA Vector Multiply Accumulate. Encoded as op = 0.
 MLS Vector Multiply Subtract. Encoded as op = 1.

<c>, <q> See [Standard assembler syntax fields on page F2-2415](#). An A32 Advanced SIMD VMLA, VMLAL, VMLS, or VMLS instruction must be unconditional. ARM strongly recommends that a T32 Advanced SIMD VMLA, VMLAL, VMLS, or VMLS instruction is unconditional, see [Conditional execution on page F2-2416](#).

<type> The data type for the elements of the operands. It must be one of:
 S Encoding T2/A2, encoded as U = 0.
 U Encoding T2/A2, encoded as U = 1.
 I Encoding T1/A1, encoded as F = 0.
 F Encoding T1/A1, encoded as F = 1. <size> must be 32.

<size> The operand element data size. It can be:
 16 Encoded as size = 01.
 32 Encoded as size = 10.

<Qd>, <Qn> The accumulate vector, and the operand vector, for a quadword operation.
 <Dd>, <Dn> The accumulate vector, and the operand vector, for a doubleword operation.
 <Qd>, <Dn> The accumulate vector, and the operand vector, for a long operation.
 <Dm[x]> The scalar. Dm is restricted to D0-D7 if <size> is 16, or D0-D15 otherwise.

Operation

```

if ConditionPassed() then
    EncodingSpecificOperations(); CheckAdvSIMDEnabled();
    op2 = Elem[Din[m],index,esize]; op2val = Int(op2, unsigned);
    for r = 0 to regs-1
        for e = 0 to elements-1
            op1 = Elem[Din[n+r],e,esize]; op1val = Int(op1, unsigned);
            if floating_point then
                fp_addend = if add then FPMul(op1,op2,StandardFPSCRValue()) else
                    FPNeg(FPMul(op1,op2,StandardFPSCRValue()));
                Elem[D[d+r],e,esize] = FPAdd(Elem[Din[d+r],e,esize], fp_addend, StandardFPSCRValue());
            else
                addend = if add then op1val*op2val else -op1val*op2val;
                if long_destination then
                    Elem[Q[d>>1],e,2*esize] = Elem[Qin[d>>1],e,2*esize] + addend;
                else
                    Elem[D[d+r],e,esize] = Elem[Din[d+r],e,esize] + addend;
  
```

F8.1.81 VMOV (immediate)

This instruction places an immediate constant into every element of the destination register.

Depending on settings in the CPACR, NSACR, and HCPTR, and FPEXC registers, and the security state and mode in which the instruction is executed, an attempt to execute the instruction might be UNDEFINED, or trapped to Hyp mode. *Summary of general controls of CP10 and CP11 functionality* on page G1-3496 and *Summary of access controls for Advanced SIMD functionality* on page G1-3498 summarize these controls.

ARM deprecates the conditional execution of any Advanced SIMD instruction encoding that is not also available as a VFP instruction encoding, see *Conditional execution* on page F2-2416.

Encoding T1/A1 Advanced SIMDv1

VMOV<c>.<dt> <Qd>, #<imm>

VMOV<c>.<dt> <Dd>, #<imm>

15	14	13	12	11	10	9	8	7	6	5	4	3	2	1	0	15	14	13	12	11	10	9	8	7	6	5	4	3	2	1	0
1	1	1	i	1	1	1	1	1	D	0	0	0	imm3			Vd	cmode			0	Q	op	1	imm4							

31	30	29	28	27	26	25	24	23	22	21	20	19	18	17	16	15	14	13	12	11	10	9	8	7	6	5	4	3	2	1	0
1	1	1	1	0	0	1	i	1	D	0	0	0	imm3			Vd	cmode			0	Q	op	1	imm4							

```

if op == '0' && cmode<0> == '1' && cmode<3:2> != '11' then SEE VORR (immediate);
if op == '1' && cmode != '1110' then SEE "Related encodings";
if Q == '1' && Vd<0> == '1' then UNDEFINED;
single_register = FALSE; advsimd = TRUE; imm64 = AdvSIMDExpandImm(op, cmode, i:imm3:imm4);
d = UInt(D:Vd); regs = if Q == '0' then 1 else 2;
    
```

Encoding T2/A2 VFPv3, VFPv4 (sz = 1 UNDEFINED in single-precision only variants)

VMOV<c>.F64 <Dd>, #<imm>

VMOV<c>.F32 <Sd>, #<imm>

15	14	13	12	11	10	9	8	7	6	5	4	3	2	1	0	15	14	13	12	11	10	9	8	7	6	5	4	3	2	1	0
1	1	1	0	1	1	1	0	1	D	1	1	imm4H			Vd	1	0	1	sz	(0)	0	(0)	0	imm4L							

31	30	29	28	27	26	25	24	23	22	21	20	19	18	17	16	15	14	13	12	11	10	9	8	7	6	5	4	3	2	1	0
cond				1	1	1	0	1	D	1	1	imm4H			Vd	1	0	1	sz	(0)	0	(0)	0	imm4L							

```

if FPSCR.Len != '000' || FPSCR.Stride != '00' then UNDEFINED;
single_register = (sz == '0'); advsimd = FALSE;
if single_register then
    d = UInt(Vd:D); bits(32) imm32 = VFPEExpandImm(imm4H:imm4L);
else
    d = UInt(D:Vd); bits(64) imm64 = VFPEExpandImm(imm4H:imm4L); regs = 1;
    
```

For information about the CONSTRAINED UNPREDICTABLE behavior of this instruction, see [Appendix A Architectural Constraints on UNPREDICTABLE behaviors](#).

Related encodings See *One register and a modified immediate value* on page F5-2508.

Assembler syntax

VMOV{<c>}{<q>}.<dt> <Qd>, #<imm>	Encoding T1/A1, encoded as Q = 1
VMOV{<c>}{<q>}.<dt> <Dd>, #<imm>	Encoding T1/A1, encoded as Q = 0
VMOV{<c>}{<q>}.F64 <Dd>, #<imm>	Encoding T2/A2, encoded as sz = 1
VMOV{<c>}{<q>}.F32 <Sd>, #<imm>	Encoding T2/A2, encoded as sz = 0

where:

<c>, <q>	See Standard assembler syntax fields on page F2-2415 . An A32 Advanced SIMD VMOV (immediate) instruction must be unconditional. ARM strongly recommends that a T32 Advanced SIMD VMOV (immediate) instruction is unconditional, see Conditional execution on page F2-2416 .
<dt>	The data type. It must be one of I8, I16, I32, I64, or F32.
<Qd>	The destination register for a quadword operation.
<Dd>	The destination register for a doubleword operation.
<Sd>	The destination register for a singleword operation.
<imm>	A constant of the type specified by <dt>. This constant is replicated enough times to fill the destination register. For example, VMOV.I32 D0, #10 writes 0x0000000A0000000A to D0.

For the range of constants available, and the encoding of <dt> and <imm>, see:

- [One register and a modified immediate value on page F5-2508](#) for encoding T1/A1
- [Floating-point data-processing instructions on page F5-2511](#) for encoding T2/A2.

Operation

```

if ConditionPassed() then
    EncodingSpecificOperations(); CheckAdvSIMDorVFPEEnabled(TRUE, advsimd);
    if single_register then
        S[d] = imm32;
    else
        for r = 0 to regs-1
            D[d+r] = imm64;
  
```

Pseudo-instructions

[One register and a modified immediate value on page F5-2508](#) describes pseudo-instructions with a combination of <dt> and <imm> that is not supported by hardware, but that generates the same destination register value as a different combination that is supported by hardware.

F8.1.82 VMOV (register)

This instruction copies the contents of one register to another.

Depending on settings in the CPACR, NSACR, and HCPTR, and FPEXC registers, and the security state and mode in which the instruction is executed, an attempt to execute the instruction might be UNDEFINED, or trapped to Hyp mode. *Summary of general controls of CP10 and CP11 functionality* on page G1-3496 and *Summary of access controls for Advanced SIMD functionality* on page G1-3498 summarize these controls.

ARM deprecates the conditional execution of any Advanced SIMD instruction encoding that is not also available as a VFP instruction encoding, see *Conditional execution* on page F2-2416.

Encoding T1/A1 Advanced SIMDv1

VMOV<c> <Qd>, <Qm>

VMOV<c> <Dd>, <Dm>

15	14	13	12	11	10	9	8	7	6	5	4	3	2	1	0	15	14	13	12	11	10	9	8	7	6	5	4	3	2	1	0
1	1	1	0	1	1	1	1	0	D	1	0			Vm		Vd		0	0	0	1	M	Q	M	1		Vm				

31	30	29	28	27	26	25	24	23	22	21	20	19	18	17	16	15	14	13	12	11	10	9	8	7	6	5	4	3	2	1	0
1	1	1	1	0	0	1	0	0	D	1	0			Vm		Vd		0	0	0	1	M	Q	M	1		Vm				

```
if !Consistent(M) || !Consistent(Vm) then SEE VORR (register);
if Q == '1' && (Vd<0> == '1' || Vm<0> == '1') then UNDEFINED;
single_register = FALSE; advsimd = TRUE;
d = UInt(D:Vd); m = UInt(M:Vm); regs = if Q == '0' then 1 else 2;
```

Encoding T2/A2 VFPv2, VFPv3, VFPv4 (sz = 1 UNDEFINED in single-precision only variants)

VMOV<c>.F64 <Dd>, <Dm>

VMOV<c>.F32 <Sd>, <Sm>

15	14	13	12	11	10	9	8	7	6	5	4	3	2	1	0	15	14	13	12	11	10	9	8	7	6	5	4	3	2	1	0
1	1	1	0	1	1	1	0	1	D	1	1	0	0	0	0		Vd		1	0	1	sz	0	1	M	0		Vm			

31	30	29	28	27	26	25	24	23	22	21	20	19	18	17	16	15	14	13	12	11	10	9	8	7	6	5	4	3	2	1	0
cond		1	1	1	0	1	D	1	1	0	0	0	0		Vd		1	0	1	sz	0	1	M	0		Vm					

```
if FPSCR.Len != '000' || FPSCR.Stride != '00' then UNDEFINED;
single_register = (sz == '0'); advsimd = FALSE;
if single_register then
    d = UInt(Vd:D); m = UInt(Vm:M);
else
    d = UInt(D:Vd); m = UInt(M:Vm); regs = 1;
```

Assembler syntax

VMOV{<c>}{<q>}{.<dt>} <Qd>, <Qm>	Encoding T1/A1, encoded as Q = 1
VMOV{<c>}{<q>}{.<dt>} <Dd>, <Dm>	Encoding T1/A1, encoded as Q = 0
VMOV{<c>}{<q>}.F64 <Dd>, <Dm>	Encoding T2/A2, encoded as sz = 1
VMOV{<c>}{<q>}.F32 <Sd>, <Sm>	Encoding T2/A2, encoded as sz = 0

where:

<c>, <q>	See Standard assembler syntax fields on page F2-2415 . An A32 Advanced SIMD VMOV (register) instruction must be unconditional. ARM strongly recommends that a T32 Advanced SIMD VMOV (register) instruction is unconditional, see Conditional execution on page F2-2416 .
<dt>	An optional data type. <dt> must not be F64, but it is otherwise ignored.
<Qd>, <Qm>	The destination register and the source register, for a quadword operation.
<Dd>, <Dm>	The destination register and the source register, for a doubleword operation.
<Sd>, <Sm>	The destination register and the source register, for a singleword operation.

Operation

```

if ConditionPassed() then
    EncodingSpecificOperations(); CheckAdvSIMDorVFPEEnabled(TRUE, advsimd);
    if single_register then
        S[d] = S[m];
    else
        for r = 0 to regs-1
            D[d+r] = D[m+r];
  
```

F8.1.83 VMOV (general-purpose register to scalar)

This instruction copies a byte, halfword, or word from a general-purpose register into an Advanced SIMD scalar.

On a Floating-point-only system, this instruction transfers one word to the upper or lower half of a double-precision floating-point register from a general-purpose register. This is an identical operation to the Advanced SIMD single word transfer.

For more information about scalars see [Advanced SIMD scalars on page F5-2498](#).

Depending on settings in the CPACR, NSACR, and HCPTR, and FPEXC registers, and the security state and mode in which the instruction is executed, an attempt to execute the instruction might be UNDEFINED, or trapped to Hyp mode. [Summary of general controls of CP10 and CP11 functionality on page G1-3496](#) and [Summary of access controls for Advanced SIMD functionality on page G1-3498](#) summarize these controls.

Encoding T1/A1 Word version (opc1:opc2 == '0x00'): VFPv2, VFPv3, VFPv4, Advanced SIMDv1, other versions Advanced SIMD only

VMOV<c>.<size> <Dd[x]>, <Rt>

15	14	13	12	11	10	9	8	7	6	5	4	3	2	1	0	15	14	13	12	11	10	9	8	7	6	5	4	3	2	1	0																
1	1	1	0	1	1	1	0	0	opc1	0		Vd				Rt																															
																31	30	29	28	27	26	25	24	23	22	21	20	19	18	17	16	15	14	13	12	11	10	9	8	7	6	5	4	3	2	1	0
																cond																															

```

case opc1:opc2 of
    when "1xxx" advsimd = TRUE; esize = 8; index = UInt(opc1<0>:opc2);
    when "0xx1" advsimd = TRUE; esize = 16; index = UInt(opc1<0>:opc2<1>);
    when "0x00" advsimd = FALSE; esize = 32; index = UInt(opc1<0>);
    when "0x10" UNDEFINED;
d = UInt(D:Vd); t = UInt(Rt);
if t == 15 then UNPREDICTABLE; // ARMv8-A removes UNPREDICTABLE for R13
    
```

For information about the CONSTRAINED UNPREDICTABLE behavior of this instruction, see [Appendix A Architectural Constraints on UNPREDICTABLE behaviors](#).

Assembler syntax

VMOV{<c>}{<q>}{.<size>} <Dd[x]>, <Rt>

where:

- <c>, <q> See [Standard assembler syntax fields on page F2-2415](#).
- <size> The data size. It must be one of:
- 8 Encoded as opc1<1> = 1. [x] is encoded in opc1<0>, opc2.
 - 16 Encoded as opc1<1> = 0, opc2<0> = 1. [x] is encoded in opc1<0>, opc2<1>.
 - 32 Encoded as opc1<1> = 0, opc2 = 0b00. [x] is encoded in opc1<0>.
- omitted** Equivalent to 32.
- <Dd[x]> The scalar. The register <Dd> is encoded in D:Vd. For details of how [x] is encoded, see the description of <size>.
- <Rt> The source general-purpose register.

Operation

```
if ConditionPassed() then
    EncodingSpecificOperations(); CheckAdvSIMDorVFPEEnabled(TRUE, advsimd);
    Elem[D[d],index,esize] = R[t]<esize-1:0>;
```

F8.1.84 VMOV (scalar to general-purpose register)

This instruction copies a byte, halfword, or word from an Advanced SIMD scalar to a general-purpose register. Bytes and halfwords can be either zero-extended or sign-extended.

On a floating-point-only system, this instruction transfers one word from the upper or lower half of a double-precision floating-point register to a general-purpose register. This is an identical operation to the Advanced SIMD single word transfer.

For more information about scalars see [Advanced SIMD scalars on page F5-2498](#).

Depending on settings in the CPACR, NSACR, and HCPTR, and the FPEXC registers, and the security state and mode in which the instruction is executed, an attempt to execute the instruction might be UNDEFINED, or trapped to Hyp mode. [Summary of general controls of CP10 and CP11 functionality on page G1-3496](#) and [Summary of access controls for Advanced SIMD functionality on page G1-3498](#) summarize these controls.

Encoding T1/A1 Word version (U:opc1:opc2 == '00x00'): VFPv2, VFPv3, VFPv4, Advanced SIMDv1, other versions Advanced SIMD only

VMOV<c>.<dt> <Rt>, <Dn[x]>

15	14	13	12	11	10	9	8	7	6	5	4	3	2	1	0	15	14	13	12	11	10	9	8	7	6	5	4	3	2	1	0
1	1	1	0	1	1	1	0	U	opc1	1		Vn				Rt	1	0	1	1	N	opc2	1	(0)	(0)	(0)	(0)				

31	30	29	28	27	26	25	24	23	22	21	20	19	18	17	16	15	14	13	12	11	10	9	8	7	6	5	4	3	2	1	0
cond		1	1	1	0	U	opc1	1		Vn						Rt	1	0	1	1	N	opc2	1	(0)	(0)	(0)	(0)				

case U:opc1:opc2 of

```

    when "x1xxx" advsimd = TRUE; esize = 8; index = UInt(opc1<0>:opc2);
    when "x0xx1" advsimd = TRUE; esize = 16; index = UInt(opc1<0>:opc2<1>);
    when "00x00" advsimd = FALSE; esize = 32; index = UInt(opc1<0>);
    when "10x00" UNDEFINED;
    when "x0x10" UNDEFINED;

```

```

t = UInt(Rt); n = UInt(N:Vn); unsigned = (U == '1');
if t == 15 then UNPREDICTABLE; // ARMv8-A removes UNPREDICTABLE for R13

```

For information about the CONSTRAINED UNPREDICTABLE behavior of this instruction, see [Appendix A Architectural Constraints on UNPREDICTABLE behaviors](#).

Assembler syntax

VMOV{<c>}{<q>}{.<dt>} <Rt>, <Dn[x]>

where:

<c>, <q> See *Standard assembler syntax fields* on page F2-2415.

<dt> The data type. It must be one of:

S8 Encoded as U = 0, opc1<1> = 1. [x] is encoded in opc1<0>, opc2.

S16 Encoded as U = 0, opc1<1> = 0, opc2<0> = 1. [x] is encoded in opc1<0>, opc2<1>.

U8 Encoded as U = 1, opc1<1> = 1. [x] is encoded in opc1<0>, opc2.

U16 Encoded as U = 1, opc1<1> = 0, opc2<0> = 1. [x] is encoded in opc1<0>, opc2<1>.

32 Encoded as U = 0, opc1<1> = 0, opc2 = 0b00. [x] is encoded in opc1<0>.

omitted Equivalent to 32.

<Dn[x]> The scalar. For details of how [x] is encoded see the description of <dt>.

<Rt> The destination general-purpose register.

Operation

```
if ConditionPassed() then
    EncodingSpecificOperations(); CheckAdvSIMDorVFPEEnabled(TRUE, advsimd);
    if unsigned then
        R[t] = ZeroExtend(Elem[D[n],index,esize], 32);
    else
        R[t] = SignExtend(Elem[D[n],index,esize], 32);
```

F8.1.85 VMOV (between general-purpose register and single-precision register)

This instruction transfers the contents of a single-precision Floating-point register to a general-purpose register, or the contents of a general-purpose register to a single-precision Floating-point register.

Depending on settings in the CPACR, NSACR, and HCPTR, and FPEXC registers, and the security state and mode in which the instruction is executed, an attempt to execute the instruction might be UNDEFINED, or trapped to Hyp mode. [Summary of general controls of CP10 and CP11 functionality on page G1-3496](#) summarizes these controls.

Encoding T1/A1 VFPv2, VFPv3, VFPv4

VMOV<c> <Sn>, <Rt>

VMOV<c> <Rt>, <Sn>

15	14	13	12	11	10	9	8	7	6	5	4	3	2	1	0	15	14	13	12	11	10	9	8	7	6	5	4	3	2	1	0
1	1	1	0	1	1	1	0	0	0	0	op	Vn				Rt		1	0	1	0	N	(0)	(0)	1	(0)	(0)	(0)	(0)		
31	30	29	28	27	26	25	24	23	22	21	20	19	18	17	16	15	14	13	12	11	10	9	8	7	6	5	4	3	2	1	0
cond				1	1	1	0	0	0	0	op	Vn				Rt		1	0	1	0	N	(0)	(0)	1	(0)	(0)	(0)	(0)		

```
to_arm_register = (op == '1'); t = UInt(Rt); n = UInt(Vn:N);
if t == 15 then UNPREDICTABLE; // ARMv8-A removes UNPREDICTABLE for R13
```

For information about the CONSTRAINED UNPREDICTABLE behavior of this instruction, see [Appendix A Architectural Constraints on UNPREDICTABLE behaviors](#).

Assembler syntax

VMOV{<c>}{<q>} <Sn>, <Rt> Encoded as op = 0
VMOV{<c>}{<q>} <Rt>, <Sn> Encoded as op = 1

where:

<c>, <q> See [Standard assembler syntax fields on page F2-2415](#).
<Sn> The single-precision VFP register.
<Rt> The general-purpose register.

Operation

```
if ConditionPassed() then
    EncodingSpecificOperations(); CheckVFPEEnabled(TRUE);
    if to_arm_register then
        R[t] = S[n];
    else
        S[n] = R[t];
```

F8.1.86 VMOV (between two general-purpose registers and two single-precision registers)

This instruction transfers the contents of two consecutively numbered single-precision Floating-point registers to two general-purpose registers, or the contents of two general-purpose registers to a pair of single-precision floating-point registers. The general-purpose registers do not have to be contiguous.

Depending on settings in the CPACR, NSACR, and HCPTR, and FPEXC registers, and the security state and mode in which the instruction is executed, an attempt to execute the instruction might be UNDEFINED, or trapped to Hyp mode. *Summary of general controls of CP10 and CP11 functionality on page G1-3496* summarizes these controls.

Encoding T1/A1 VFPv2, VFPv3, VFPv4

VMOV<c> <Sm>, <Sm1>, <Rt>, <Rt2>

VMOV<c> <Rt>, <Rt2>, <Sm>, <Sm1>

15	14	13	12	11	10	9	8	7	6	5	4	3	2	1	0	15	14	13	12	11	10	9	8	7	6	5	4	3	2	1	0
1	1	1	0	1	1	0	0	0	1	0	op	Rt2				Rt		1	0	1	0	0	0	M	1	Vm					

31	30	29	28	27	26	25	24	23	22	21	20	19	18	17	16	15	14	13	12	11	10	9	8	7	6	5	4	3	2	1	0
cond				1	1	0	0	0	1	0	op	Rt2				Rt		1	0	1	0	0	0	M	1	Vm					

```
to_arm_registers = (op == '1'); t = UInt(Rt); t2 = UInt(Rt2); m = UInt(Vm:M);
if t == 15 || t2 == 15 || m == 31 then UNPREDICTABLE;
if CurrentInstrSet() != InstrSet_A32 && (t == 13 || t2 == 13) then UNPREDICTABLE;
if to_arm_registers && t == t2 then UNPREDICTABLE;
```

For information about the CONSTRAINED UNPREDICTABLE behavior of this instruction, see [Appendix A Architectural Constraints on UNPREDICTABLE behaviors](#), and particularly *VMOV (between two general-purpose registers and two single-precision registers)* on page AppxA-4749.

Assembler syntax

VMOV{<c>}{<q>} <Sm>, <Sm1>, <Rt>, <Rt2> Encoded as op = 0
VMOV{<c>}{<q>} <Rt>, <Rt2>, <Sm>, <Sm1> Encoded as op = 1

where:

- <c>, <q> See *Standard assembler syntax fields* on page F2-2415.
- <Sm> The first single-precision floating-point register.
- <Sm1> The second single-precision floating-point register. This is the next single-precision floating-point register after <Sm>.
- <Rt> The general-purpose register that <Sm> is transferred to or from.
- <Rt2> The general-purpose register that <Sm1> is transferred to or from.

Operation

```
if ConditionPassed() then
    EncodingSpecificOperations(); CheckVFPEnabled(TRUE);
    if to_arm_registers then
        R[t] = S[m];
        R[t2] = S[m+1];
    else
        S[m] = R[t];
        S[m+1] = R[t2];
```

F8.1.87 VMOV (between two general-purpose registers and a doubleword extension register)

This instruction copies two words from two general-purpose registers into a doubleword extension register, or from a doubleword extension register to two general-purpose registers.

Depending on settings in the CPACR, NSACR, and HCPTR, and FPEXC registers, and the security state and mode in which the instruction is executed, an attempt to execute the instruction might be UNDEFINED, or trapped to Hyp mode. [Summary of general controls of CP10 and CP11 functionality on page G1-3496](#) and [Summary of access controls for Advanced SIMD functionality on page G1-3498](#) summarize these controls.

Encoding T1/A1 VFPv2, VFPv3, VFPv4, Advanced SIMDv1

VMOV<c> <Dm>, <Rt>, <Rt2>

VMOV<c> <Rt>, <Rt2>, <Dm>

15	14	13	12	11	10	9	8	7	6	5	4	3	2	1	0	15	14	13	12	11	10	9	8	7	6	5	4	3	2	1	0
1	1	1	0	1	1	0	0	0	1	0	op	Rt2				Rt				1	0	1	1	0	0	M	1	Vm			

31	30	29	28	27	26	25	24	23	22	21	20	19	18	17	16	15	14	13	12	11	10	9	8	7	6	5	4	3	2	1	0
cond				1	1	0	0	0	1	0	op	Rt2				Rt				1	0	1	1	0	0	M	1	Vm			

```
to_arm_registers = (op == '1'); t = UInt(Rt); t2 = UInt(Rt2); m = UInt(M:Vm);
if t == 15 || t2 == 15 then UNPREDICTABLE; // ARMv8-A removes UNPREDICTABLE for R13
if to_arm_registers && t == t2 then UNPREDICTABLE;
```

For information about the CONSTRAINED UNPREDICTABLE behavior of this instruction, see [Appendix A Architectural Constraints on UNPREDICTABLE behaviors](#), and particularly [VMOV \(between two general-purpose registers and a doubleword extension register\) on page AppxA-4749](#).

Assembler syntax

VMOV{<c>}{<q>} <Dm>, <Rt>, <Rt2> Encoded as op = 0
VMOV{<c>}{<q>} <Rt>, <Rt2>, <Dm> Encoded as op = 1

where:

<c>, <q> See [Standard assembler syntax fields on page F2-2415](#).
<Dm> The doubleword extension register.
<Rt>, <Rt2> The two general-purpose registers.

Operation

```
if ConditionPassed() then
    EncodingSpecificOperations(); CheckVFPEnabled(TRUE);
    if to_arm_registers then
        R[t] = D[m]<31:0>;
        R[t2] = D[m]<63:32>;
    else
        D[m]<31:0> = R[t];
        D[m]<63:32> = R[t2];
```

F8.1.88 VMOVL

Vector Move Long takes each element in a doubleword vector, sign or zero-extends them to twice their original length, and places the results in a quadword vector.

Depending on settings in the CPACR, NSACR, and HCPTR registers, and the security state and mode in which the instruction is executed, an attempt to execute the instruction might be UNDEFINED, or trapped to Hyp mode. [Summary of access controls for Advanced SIMD functionality on page G1-3498](#) summarizes these controls.

ARM deprecates the conditional execution of any Advanced SIMD instruction encoding that is not also available as a VFP instruction encoding, see [Conditional execution on page F2-2416](#).

Encoding T1/A1 Advanced SIMDv1

VMOVL<c>.<dt> <Qd>, <Dm>

15	14	13	12	11	10	9	8	7	6	5	4	3	2	1	0	15	14	13	12	11	10	9	8	7	6	5	4	3	2	1	0
1	1	1	U	1	1	1	1	1	D	imm3	0	0	0			Vd	1	0	1	0	0	0	M	1			Vm				

31	30	29	28	27	26	25	24	23	22	21	20	19	18	17	16	15	14	13	12	11	10	9	8	7	6	5	4	3	2	1	0
1	1	1	1	0	0	1	U	1	D	imm3	0	0	0			Vd	1	0	1	0	0	0	M	1			Vm				

```

if imm3 == '000' then SEE "Related encodings";
if imm3 != '001' && imm3 != '010' && imm3 != '100' then SEE VSHLL;
if Vd<0> == '1' then UNDEFINED;
esize = 8 * UInt(imm3);
unsigned = (U == '1'); elements = 64 DIV esize;
d = UInt(D:Vd); m = UInt(M:Vm);
    
```

Related encodings See [One register and a modified immediate value on page F5-2508](#).

Assembler syntax

`VMOVL{<c>}{<q>}.dt <Qd>, <Dm>`

where:

<c>, <q> See [Standard assembler syntax fields on page F2-2415](#). An A32 VMOVL instruction must be unconditional. ARM strongly recommends that a T32 VMOVL instruction is unconditional, see [Conditional execution on page F2-2416](#).

<dt> The data type for the elements of the operand. It must be one of:

S8	Encoded as U = 0, imm3 = 0b001.
S16	Encoded as U = 0, imm3 = 0b010.
S32	Encoded as U = 0, imm3 = 0b100.
U8	Encoded as U = 1, imm3 = 0b001.
U16	Encoded as U = 1, imm3 = 0b010.
U32	Encoded as U = 1, imm3 = 0b100.

<Qd>, <Dm> The destination vector and the operand vector.

Operation

```
if ConditionPassed() then
    EncodingSpecificOperations(); CheckAdvSIMDEnabled();
    for e = 0 to elements-1
        result = Int(Elem[Din[m],e,esize], unsigned);
        Elem[Q[d>>1],e,2*esize] = result<2*esize-1:0>;
```

F8.1.89 VMOVN

Vector Move and Narrow copies the least significant half of each element of a quadword vector into the corresponding elements of a doubleword vector.

The operand vector elements can be any one of 16-bit, 32-bit, or 64-bit integers. There is no distinction between signed and unsigned integers.

Depending on settings in the CPACR, NSACR, and HCPTR registers, and the security state and mode in which the instruction is executed, an attempt to execute the instruction might be UNDEFINED, or trapped to Hyp mode.

Summary of access controls for Advanced SIMD functionality on page G1-3498 summarizes these controls.

ARM deprecates the conditional execution of any Advanced SIMD instruction encoding that is not also available as a VFP instruction encoding, see *Conditional execution on page F2-2416*.

Encoding T1/A1 Advanced SIMDv1

VMOVN<c>.<dt> <Dd>, <Qm>

15	14	13	12	11	10	9	8	7	6	5	4	3	2	1	0	15	14	13	12	11	10	9	8	7	6	5	4	3	2	1	0
1	1	1	1	1	1	1	1	1	D	1	1	size	1	0	Vd	0	0	1	0	0	0	M	0	Vm							

31	30	29	28	27	26	25	24	23	22	21	20	19	18	17	16	15	14	13	12	11	10	9	8	7	6	5	4	3	2	1	0
1	1	1	1	0	0	1	1	1	D	1	1	size	1	0	Vd	0	0	1	0	0	0	M	0	Vm							

```

if size == '11' then UNDEFINED;
if Vm<0> == '1' then UNDEFINED;
esize = 8 << UInt(size); elements = 64 DIV esize;
d = UInt(D:Vd); m = UInt(M:Vm);
    
```

Assembler syntax

`VMOVN{<c>}{<q>}.<dt> <Dd>, <Qm>`

where:

<c>, <q> See [Standard assembler syntax fields on page F2-2415](#). An A32 VMOVN instruction must be unconditional. ARM strongly recommends that a T32 VMOVN instruction is unconditional, see [Conditional execution on page F2-2416](#).

<dt> The data type for the elements of the operand. It must be one of:
I16 Encoded as size = 0b00.
I32 Encoded as size = 0b01.
I64 Encoded as size = 0b10.

<Dd>, <Qm> The destination vector and the operand vector.

Operation

```
if ConditionPassed() then
    EncodingSpecificOperations(); CheckAdvSIMDEnabled();
    for e = 0 to elements-1
        Elem[D[d],e,esize] = Elem[Qin[m]>>1],e,2*esize]<size-1:0>;
```

F8.1.90 VMRS

Move to general-purpose register from Advanced SIMD and floating-point System register moves the value of the FPSCR to a general-purpose register.

For details of system level use of this instruction, see [VMRS on page F7-3070](#).

Depending on settings in the CPACR, NSACR, and HCPTR, and FPEXC registers, and the security state and mode in which the instruction is executed, an attempt to execute the instruction might be UNDEFINED, or trapped to Hyp mode. [Summary of general controls of CP10 and CP11 functionality on page G1-3496](#) and [Summary of access controls for Advanced SIMD functionality on page G1-3498](#) summarize these controls.

Encoding T1/A1 VFPv2, VFPv3, VFPv4, Advanced SIMDv1

VMRS<c> <Rt>, FPSCR

15	14	13	12	11	10	9	8	7	6	5	4	3	2	1	0	15	14	13	12	11	10	9	8	7	6	5	4	3	2	1	0
1	1	1	0	1	1	1	0	1	1	1	1	0	0	0	1	Rt	1	0	1	0	(0)	(0)	(0)	1	(0)	(0)	(0)	(0)			
31	30	29	28	27	26	25	24	23	22	21	20	19	18	17	16	15	14	13	12	11	10	9	8	7	6	5	4	3	2	1	0
cond	1	1	1	0	1	1	1	1	0	0	0	1	Rt	1	0	1	0	(0)	(0)	(0)	1	(0)	(0)	(0)	(0)						

t = UInt(Rt);
 // ARMv8-A removes UNPREDICTABLE for R13

For information about the CONSTRAINED UNPREDICTABLE behavior of this instruction, see [Appendix A Architectural Constraints on UNPREDICTABLE behaviors](#).

Assembler syntax

VMRS{<c>}{<q>} <Rt>, FPSCR

where:

<c>, <q> See *Standard assembler syntax fields* on page F2-2415.

<Rt> The destination general-purpose register. This register can be R0-R14 or APSR_nzcv. APSR_nzcv is encoded as Rt = 0b1111, and the instruction transfers the FPSCR.{N, Z, C, V} condition flags to the APSR.{N, Z, C, V} condition flags.

The pre-UAL instruction FMSTAT is equivalent to VMRS APSR_nzcv, FPSCR.

Operation

```
if ConditionPassed() then
    EncodingSpecificOperations(); CheckVFPEEnabled(TRUE);
    SerializeVFP(); VFPExcBarrier();
    if t != 15 then
        R[t] = FPSCR;
    else
        APSR.N = FPSR.N;
        APSR.Z = FPSR.Z;
        APSR.C = FPSR.C;
        APSR.V = FPSR.V;
```

F8.1.91 VMSR

Move to Advanced SIMD and floating-point System register from general-purpose register moves the value of a general-purpose register to the **FPSCR**.

For details of system level use of this instruction, see [VMSR on page F7-3072](#).

Depending on settings in the **CPACR**, **NSACR**, and **HCPTR**, and **FPEXC** registers, and the security state and mode in which the instruction is executed, an attempt to execute the instruction might be UNDEFINED, or trapped to Hyp mode. [Summary of general controls of CP10 and CP11 functionality on page G1-3496](#) and [Summary of access controls for Advanced SIMD functionality on page G1-3498](#) summarize these controls.

Encoding T1/A1 VFPv2, VFPv3, VFPv4, Advanced SIMDv1

VMSR<c> FPSCR, <Rt>

15	14	13	12	11	10	9	8	7	6	5	4	3	2	1	0	15	14	13	12	11	10	9	8	7	6	5	4	3	2	1	0
1	1	1	0	1	1	1	0	1	1	1	0	0	0	0	1	Rt	1	0	1	0	(0)	(0)	(0)	1	(0)	(0)	(0)	(0)			
31	30	29	28	27	26	25	24	23	22	21	20	19	18	17	16	15	14	13	12	11	10	9	8	7	6	5	4	3	2	1	0
cond	1	1	1	0	1	1	1	0	0	0	0	1	Rt	1	0	1	0	(0)	(0)	(0)	1	(0)	(0)	(0)	(0)						

```
t = UInt(Rt);
if t == 15 then UNPREDICTABLE; // ARMv8-A removes UNPREDICTABLE for R13
```

For information about the CONSTRAINED UNPREDICTABLE behavior of this instruction, see [Appendix A Architectural Constraints on UNPREDICTABLE behaviors](#).

Assembler syntax

VMSR{<c>}{<q>} FPSCR, <Rt>

where:

<c>, <q> See [Standard assembler syntax fields on page F2-2415](#).

<Rt> The general-purpose register to be transferred to the FPSCR.

Operation

```
if ConditionPassed() then
    EncodingSpecificOperations(); CheckVFPEEnabled(TRUE);
    SerializeVFP(); VFPExcBarrier();
    FPSCR = R[t];
```

F8.1.92 VMUL, VMULL (integer and polynomial)

Vector Multiply multiplies corresponding elements in two vectors. Vector Multiply Long does the same thing, but with destination vector elements that are twice as long as the elements that are multiplied.

For information about multiplying polynomials see [Polynomial arithmetic over {0, 1}](#) on page A1-45.

Depending on settings in the CPACR, NSACR, and HCPTR registers, and the security state and mode in which the instruction is executed, an attempt to execute the instruction might be UNDEFINED, or trapped to Hyp mode. [Summary of access controls for Advanced SIMD functionality on page G1-3498](#) summarizes these controls.

ARM deprecates the conditional execution of any Advanced SIMD instruction encoding that is not also available as a VFP instruction encoding, see [Conditional execution on page F2-2416](#).

Encoding T1/A1 Advanced SIMDv1

VMUL<c>.<dt> <Qd>, <Qn>, <Qm>

VMUL<c>.<dt> <Dd>, <Dn>, <Dm>

15	14	13	12	11	10	9	8	7	6	5	4	3	2	1	0	15	14	13	12	11	10	9	8	7	6	5	4	3	2	1	0
1	1	1	op	1	1	1	1	0	D	size		Vn		Vd		1	0	0	1	N	Q	M	1		Vm						

31	30	29	28	27	26	25	24	23	22	21	20	19	18	17	16	15	14	13	12	11	10	9	8	7	6	5	4	3	2	1	0
1	1	1	1	0	0	1	op	0	D	size		Vn		Vd		1	0	0	1	N	Q	M	1		Vm						

```

if size == '11' || (op == '1' && size != '00') then UNDEFINED;
if Q == '1' && (Vd<0> == '1' || Vn<0> == '1' || Vm<0> == '1') then UNDEFINED;
polynomial = (op == '1'); long_destination = FALSE;
unsigned = FALSE; // "Don't care" value: TRUE produces same functionality
esize = 8 << UInt(size); elements = 64 DIV esize;
d = UInt(D:Vd); n = UInt(N:Vn); m = UInt(M:Vm); regs = if Q == '0' then 1 else 2;
    
```

Encoding T2/A2 Advanced SIMDv1

VMULL<c>.<dt> <Qd>, <Dn>, <Dm>

15	14	13	12	11	10	9	8	7	6	5	4	3	2	1	0	15	14	13	12	11	10	9	8	7	6	5	4	3	2	1	0
1	1	1	U	1	1	1	1	1	D	size		Vn		Vd		1	1	op	0	N	0	M	0		Vm						

31	30	29	28	27	26	25	24	23	22	21	20	19	18	17	16	15	14	13	12	11	10	9	8	7	6	5	4	3	2	1	0
1	1	1	1	0	0	1	U	1	D	size		Vn		Vd		1	1	op	0	N	0	M	0		Vm						

```

if size == '11' then SEE "Related encodings";
esize = 8 << UInt(size); elements = 64 DIV esize;
long_destination = TRUE;
unsigned = (U == '1');
polynomial = (op == '1');
if polynomial then
    if U == '1' || size<0> == '1' then UNDEFINED;
    if size == '10' then
        if !HaveCryptoExt() then UNDEFINED;
        esize = 64; elements = 1;
    if Vd<0> == '1' then UNDEFINED;
d = UInt(D:Vd); n = UInt(N:Vn); m = UInt(M:Vm); regs = 1;
if InITBlock() then UNPREDICTABLE;
    
```

For information about the CONSTRAINED UNPREDICTABLE behavior of this instruction, see [Appendix A Architectural Constraints on UNPREDICTABLE behaviors](#).

Related encodings See [Advanced SIMD data-processing instructions on page F5-2499](#).

Assembler syntax

VMUL{<c>}{<q>}.<type><size> {<Qd>}, <Qn>, <Qm>	Encoding T1/A1, encoded as Q = 1
VMUL{<c>}{<q>}.<type><size> {<Dd>}, <Dn>, <Dm>	Encoding T1/A1, encoded as Q = 0
VMULL{<c>}{<q>}.<type><size> <Qd>, <Dn>, <Dm>	Encoding T2/A2

where:

<c>, <q>	See Standard assembler syntax fields on page F2-2415 . An A32 Advanced SIMD VMUL or VMULL instruction must be unconditional. ARM strongly recommends that a T32 Advanced SIMD VMUL or VMULL instruction is unconditional, see Conditional execution on page F2-2416 .
<type>	The data type for the elements of the operands. It must be one of: S Encoded as op = 0 in both encodings, with U = 0 in encoding T2/A2. U Encoded as op = 0 in both encodings, with U = 1 in encoding T2/A2. I Encoding T1/A1 only, encoded as op = 0. P Encoded as op = 1 in both encodings, with U = 0 in encoding T2/A2. When <type> is P, <size> must be 8 or 64
<size>	The data size for the elements of the operands. For integer types, it must be one of: 8 Encoded as size = 0b00. 16 Encoded as size = 0b01. 32 Encoded as size = 0b10. For polynomial types, it must be one of: 8 Encoded as size = 0b00. 32 Encoded as size = 0b10.
<Qd>, <Qn>, <Qm>	The destination vector and the operand vectors, for a quadword operation.
<Dd>, <Dn>, <Dm>	The destination vector and the operand vectors, for a doubleword operation.
<Qd>, <Dn>, <Dm>	The destination vector and the operand vectors, for a long operation.

Operation

```

if ConditionPassed() then
    EncodingSpecificOperations(); CheckAdvSIMDEnabled();
    for r = 0 to regs-1
        for e = 0 to elements-1
            op1 = Elem[Din[n+r],e,esize]; op1val = Int(op1, unsigned);
            op2 = Elem[Din[m+r],e,esize]; op2val = Int(op2, unsigned);
            if polynomial then
                product = PolynomialMult(op1,op2);
            else
                product = (op1val*op2val)<2*esize-1:0>;
            if long_destination then
                Elem[Q[d>>1],e,2*esize] = product;
            else
                Elem[D[d+r],e,esize] = product<esize-1:0>;
  
```

F8.1.93 VMUL (floating-point)

Vector Multiply multiplies corresponding elements in two vectors, and places the results in the destination vector.

Depending on settings in the CPACR, NSACR, and HCPTR, and FPEXC registers, and the security state and mode in which the instruction is executed, an attempt to execute the instruction might be UNDEFINED, or trapped to Hyp mode. *Summary of general controls of CP10 and CP11 functionality on page G1-3496 and Summary of access controls for Advanced SIMD functionality on page G1-3498* summarize these controls.

ARM deprecates the conditional execution of any Advanced SIMD instruction encoding that is not also available as a VFP instruction encoding, see *Conditional execution on page F2-2416*.

Encoding T1/A1 Advanced SIMDv1 (UNDEFINED in integer-only variant)

VMUL<c>.F32 <Qd>, <Qn>, <Qm>

VMUL<c>.F32 <Dd>, <Dn>, <Dm>

15	14	13	12	11	10	9	8	7	6	5	4	3	2	1	0	15	14	13	12	11	10	9	8	7	6	5	4	3	2	1	0
1	1	1	1	1	1	1	1	0	D	0	sz		Vn		Vd	1	1	0	1	N	Q	M	1		Vm						

31	30	29	28	27	26	25	24	23	22	21	20	19	18	17	16	15	14	13	12	11	10	9	8	7	6	5	4	3	2	1	0
1	1	1	1	0	0	1	1	0	D	0	sz		Vn		Vd	1	1	0	1	N	Q	M	1		Vm						

```

if Q == '1' && (Vd<0> == '1' || Vn<0> == '1' || Vm<0> == '1') then UNDEFINED;
if sz == '1' then UNDEFINED;
advsimd = TRUE;  esize = 32;  elements = 2;
d = UInt(D:Vd);  n = UInt(N:Vn);  m = UInt(M:Vm);  regs = if Q == '0' then 1 else 2;
    
```

Encoding T2/A2 VFPv2, VFPv3, VFPv4 (sz = 1 UNDEFINED in single-precision only variants)

VMUL<c>.F64 <Dd>, <Dn>, <Dm>

VMUL<c>.F32 <Sd>, <Sn>, <Sm>

15	14	13	12	11	10	9	8	7	6	5	4	3	2	1	0	15	14	13	12	11	10	9	8	7	6	5	4	3	2	1	0
1	1	1	0	1	1	1	0	0	D	1	0		Vn		Vd	1	0	1	sz	N	0	M	0		Vm						

31	30	29	28	27	26	25	24	23	22	21	20	19	18	17	16	15	14	13	12	11	10	9	8	7	6	5	4	3	2	1	0
cond		1	1	1	0	0	D	1	0		Vn		Vd	1	0	1	sz	N	0	M	0		Vm								

```

if FPSCR.Len != '000' || FPSCR.Stride != '00' then UNDEFINED;
advsimd = FALSE;  dp_operation = (sz == '1');
d = if dp_operation then UInt(D:Vd) else UInt(Vd:D);
n = if dp_operation then UInt(N:Vn) else UInt(Vn:N);
m = if dp_operation then UInt(M:Vm) else UInt(Vm:M);
    
```

Assembler syntax

VMUL{<c>}{<q>}.F32 {<Qd>}, <Qn>, <Qm>	Encoding T1/A1, encoded as Q = 1, sz = 0
VMUL{<c>}{<q>}.F32 {<Dd>}, <Dn>, <Dm>	Encoding T1/A1, encoded as Q = 0, sz = 0
VMUL{<c>}{<q>}.F64 {<Dd>}, <Dn>, <Dm>	Encoding T2/A2, encoded as sz = 1
VMUL{<c>}{<q>}.F32 {<Sd>}, <Sn>, <Sm>	Encoding T2/A2, encoded as sz = 0

where:

<c>, <q>	See Standard assembler syntax fields on page F2-2415 . An A32 Advanced SIMD VMUL instruction must be unconditional. ARM strongly recommends that a T32 Advanced SIMD VMUL instruction is unconditional, see Conditional execution on page F2-2416 .
<Qd>, <Qn>, <Qm>	The destination vector and the operand vectors, for a quadword operation.
<Dd>, <Dn>, <Dm>	The destination vector and the operand vectors, for a doubleword operation.
<Sd>, <Sn>, <Sm>	The destination vector and the operand vectors, for a singleword operation.

Operation

```

if ConditionPassed() then
    EncodingSpecificOperations(); CheckAdvSIMDorVFPEEnabled(TRUE, advsimd);
    if advsimd then // Advanced SIMD instruction
        for r = 0 to regs-1
            for e = 0 to elements-1
                Elem[D[d+r],e,esize] = FPMul(Elem[D[n+r],e,esize], Elem[D[m+r],e,esize],
StandardFPSCRValue());
    else // VFP instruction
        if dp_operation then
            D[d] = FPMul(D[n], D[m], FPSCR);
        else
            S[d] = FPMul(S[n], S[m], FPSCR);
  
```

F8.1.94 VMUL, VMULL (by scalar)

Vector Multiply multiplies each element in a vector by a scalar, and places the results in a second vector. Vector Multiply Long does the same thing, but with destination vector elements that are twice as long as the elements that are multiplied.

For more information about scalars see [Advanced SIMD scalars on page F5-2498](#).

Depending on settings in the CPACR, NSACR, and HCPTR registers, and the security state and mode in which the instruction is executed, an attempt to execute the instruction might be UNDEFINED, or trapped to Hyp mode. [Summary of access controls for Advanced SIMD functionality on page G1-3498](#) summarizes these controls.

ARM deprecates the conditional execution of any Advanced SIMD instruction encoding that is not also available as a VFP instruction encoding, see [Conditional execution on page F2-2416](#).

Encoding T1/A1 Advanced SIMDv1 (F = 1 UNDEFINED in integer-only variants)

VMUL<c>.<dt> <Qd>, <Qn>, <Dm[x]>

VMUL<c>.<dt> <Dd>, <Dn>, <Dm[x]>

15	14	13	12	11	10	9	8	7	6	5	4	3	2	1	0	15	14	13	12	11	10	9	8	7	6	5	4	3	2	1	0
1	1	1	Q	1	1	1	1	1	D	size	Vn	Vd	1	0	0	F	N	1	M	0	Vm										
31	30	29	28	27	26	25	24	23	22	21	20	19	18	17	16	15	14	13	12	11	10	9	8	7	6	5	4	3	2	1	0
1	1	1	1	0	0	1	Q	1	D	size	Vn	Vd	1	0	0	F	N	1	M	0	Vm										

```

if size == '11' then SEE "Related encodings";
if size == '00' || (F == '1' && size == '01') then UNDEFINED;
if Q == '1' && (Vd<0> == '1' || Vn<0> == '1') then UNDEFINED;
unsigned = FALSE; // "Don't care" value: TRUE produces same functionality
floating_point = (F == '1'); long_destination = FALSE;
d = UInt(D:Vd); n = UInt(N:Vn); regs = if Q == '0' then 1 else 2;
if size == '01' then esize = 16; elements = 4; m = UInt(Vm<2:0>); index = UInt(M:Vm<3>);
if size == '10' then esize = 32; elements = 2; m = UInt(Vm); index = UInt(M);
    
```

Encoding T2/A2 Advanced SIMDv1

VMULL<c>.<dt> <Qd>, <Dn>, <Dm[x]>

15	14	13	12	11	10	9	8	7	6	5	4	3	2	1	0	15	14	13	12	11	10	9	8	7	6	5	4	3	2	1	0
1	1	1	U	1	1	1	1	1	D	size	Vn	Vd	1	0	1	0	N	1	M	0	Vm										
31	30	29	28	27	26	25	24	23	22	21	20	19	18	17	16	15	14	13	12	11	10	9	8	7	6	5	4	3	2	1	0
1	1	1	1	0	0	1	U	1	D	size	Vn	Vd	1	0	1	0	N	1	M	0	Vm										

```

if size == '11' then SEE "Related encodings";
if size == '00' || Vd<0> == '1' then UNDEFINED;
unsigned = (U == '1'); long_destination = TRUE; floating_point = FALSE;
d = UInt(D:Vd); n = UInt(N:Vn); regs = 1;
if size == '01' then esize = 16; elements = 4; m = UInt(Vm<2:0>); index = UInt(M:Vm<3>);
if size == '10' then esize = 32; elements = 2; m = UInt(Vm); index = UInt(M);
    
```

Related encodings See [Advanced SIMD data-processing instructions on page F5-2499](#).

Assembler syntax

VMUL{<c>}{<q>}.<dt> {<Qd>}, <Qn>, <Dm[x]> Encoding T1/A1, encoded as Q = 1
 VMUL{<c>}{<q>}.<dt> {<Dd>}, <Dn>, <Dm[x]> Encoding T1/A1, encoded as Q = 0
 VMULL{<c>}{<q>}.<dt> <Qd>, <Dn>, <Dm[x]> Encoding T2/A2

where:

<c>, <q> See [Standard assembler syntax fields on page F2-2415](#). An A32 Advanced SIMD VMUL or VMULL instruction must be unconditional. ARM strongly recommends that a T32 Advanced SIMD VMUL or VMULL instruction is unconditional, see [Conditional execution on page F2-2416](#).

<dt> The data type for the scalar, and the elements of the operand vector. It must be one of:
 I16 Encoding T1/A1, encoded as size = 0b01, F = 0.
 I32 Encoding T1/A1, encoded as size = 0b10, F = 0.
 F32 Encoding T1/A1, encoded as size = 0b10, F = 1.
 S16 Encoding T2/A2, encoded as size = 0b01, U = 0.
 S32 Encoding T2/A2, encoded as size = 0b10, U = 0.
 U16 Encoding T2/A2, encoded as size = 0b01, U = 1.
 U32 Encoding T2/A2, encoded as size = 0b10, U = 1.

<Qd>, <Qn> The destination vector, and the operand vector, for a quadword operation.

<Dd>, <Dn> The destination vector, and the operand vector, for a doubleword operation.

<Qd>, <Dn> The destination vector, and the operand vector, for a long operation.

<Dm[x]> The scalar. Dm is restricted to D0-D7 if <dt> is I16, S16, or U16, or D0-D15 otherwise.

Operation

```
if ConditionPassed() then
    EncodingSpecificOperations(); CheckAdvSIMDEnabled();
    op2 = Elem[Din[m],index,esize]; op2val = Int(op2, unsigned);
    for r = 0 to regs-1
        for e = 0 to elements-1
            op1 = Elem[Din[n+r],e,esize]; op1val = Int(op1, unsigned);
            if floating_point then
                Elem[D[d+r],e,esize] = FPMul(op1, op2, StandardFPSCRValue());
            else
                if long_destination then
                    Elem[Q[d>1],e,2*esize] = (op1val*op2val)<2*esize-1:0>;
                else
                    Elem[D[d+r],e,esize] = (op1val*op2val)<esize-1:0>;
```

F8.1.95 VMVN (immediate)

Vector Bitwise NOT (immediate) places the bitwise inverse of an immediate integer constant into every element of the destination register. For the range of constants available, see [One register and a modified immediate value on page F5-2508](#).

Depending on settings in the CPACR, NSACR, and HCPTR registers, and the security state and mode in which the instruction is executed, an attempt to execute the instruction might be UNDEFINED, or trapped to Hyp mode. [Summary of access controls for Advanced SIMD functionality on page G1-3498](#) summarizes these controls.

ARM deprecates the conditional execution of any Advanced SIMD instruction encoding that is not also available as a VFP instruction encoding, see [Conditional execution on page F2-2416](#).

Encoding T1/A1 Advanced SIMDv1

VMVN<c>.<dt> <Qd>, #<imm>

VMVN<c>.<dt> <Dd>, #<imm>

15	14	13	12	11	10	9	8	7	6	5	4	3	2	1	0	15	14	13	12	11	10	9	8	7	6	5	4	3	2	1	0
1	1	1	i	1	1	1	1	1	D	0	0	0	imm3			Vd		cmode		0	Q	1	1	imm4							

31	30	29	28	27	26	25	24	23	22	21	20	19	18	17	16	15	14	13	12	11	10	9	8	7	6	5	4	3	2	1	0
1	1	1	1	0	0	1	i	1	D	0	0	0	imm3			Vd		cmode		0	Q	1	1	imm4							

```

if (cmode<0> == '1' && cmode<3:2> != '11') || cmode<3:1> == '111' then SEE "Related encodings";
if Q == '1' && Vd<0> == '1' then UNDEFINED;
imm64 = AdvSIMDEExpandImm('1', cmode, i:imm3:imm4);
d = UInt(D:Vd); regs = if Q == '0' then 1 else 2;
    
```

Related encodings See [One register and a modified immediate value on page F5-2508](#).

Assembler syntax

VMVN{<c>}{<q>}.dt <Qd>, #<imm> Encoding T1/A1, encoded as Q = 1
VMVN{<c>}{<q>}.dt <Dd>, #<imm> Encoding T1/A1, encoded as Q = 0

where:

<c>, <q> See [Standard assembler syntax fields on page F2-2415](#). An A32 VMVN instruction must be unconditional. ARM strongly recommends that a T32 VMVN instruction is unconditional, see [Conditional execution on page F2-2416](#).

<dt> The data type. It must be either I16 or I32.

<Qd> The destination register for a quadword operation.

<Dd> The destination register for a doubleword operation.

<imm> A constant of the specified type.

See [One register and a modified immediate value on page F5-2508](#) for the range of constants available, and the encoding of <dt> and <imm>.

Operation

```
if ConditionPassed() then
    EncodingSpecificOperations(); CheckAdvSIMDEnabled();
    for r = 0 to regs-1
        D[d+r] = NOT(imm64);
```

Pseudo-instructions

[One register and a modified immediate value on page F5-2508](#) describes pseudo-instructions with a combination of <dt> and <imm> that is not supported by hardware, but that generates the same destination register value as a different combination that is supported by hardware.

F8.1.96 VMVN (register)

Vector Bitwise NOT (register) takes a value from a register, inverts the value of each bit, and places the result in the destination register. The registers can be either doubleword or quadword.

Depending on settings in the CPACR, NSACR, and HCPTR registers, and the security state and mode in which the instruction is executed, an attempt to execute the instruction might be UNDEFINED, or trapped to Hyp mode. [Summary of access controls for Advanced SIMD functionality on page G1-3498](#) summarizes these controls.

ARM deprecates the conditional execution of any Advanced SIMD instruction encoding that is not also available as a VFP instruction encoding, see [Conditional execution on page F2-2416](#).

Encoding T1/A1 Advanced SIMDv1

VMVN<c> <Qd>, <Qm>

VMVN<c> <Dd>, <Dm>

15	14	13	12	11	10	9	8	7	6	5	4	3	2	1	0	15	14	13	12	11	10	9	8	7	6	5	4	3	2	1	0
1	1	1	1	1	1	1	1	D	1	1	size	0	0			Vd	0	1	0	1	1	Q	M	0			Vm				

31	30	29	28	27	26	25	24	23	22	21	20	19	18	17	16	15	14	13	12	11	10	9	8	7	6	5	4	3	2	1	0
1	1	1	1	0	0	1	1	1	D	1	1	size	0	0			Vd	0	1	0	1	1	Q	M	0			Vm			

```

if size != '00' then UNDEFINED;
if Q == '1' && (Vd<0> == '1' || Vm<0> == '1') then UNDEFINED;
d = UInt(D:Vd); m = UInt(M:Vm); regs = if Q == '0' then 1 else 2;
    
```

Assembler syntax

VMVN{<c>}{<q>}{.<dt>} <Qd>, <Qm>

VMVN{<c>}{<q>}{.<dt>} <Dd>, <Dm>

where:

<c>, <q> See [Standard assembler syntax fields on page F2-2415](#). An A32 VMVN instruction must be unconditional. ARM strongly recommends that a T32 VMVN instruction is unconditional, see [Conditional execution on page F2-2416](#).

<dt> An optional data type. It is ignored by assemblers, and does not affect the encoding.

<Qd>, <Qm> The destination vector and the operand vector, for a quadword operation.

<Dd>, <Dm> The destination vector and the operand vector, for a doubleword operation.

Operation

```
if ConditionPassed() then
    EncodingSpecificOperations(); CheckAdvSIMDEnabled();
    for r = 0 to regs-1
        D[d+r] = NOT(D[m+r]);
```

F8.1.97 VNEG

Vector Negate negates each element in a vector, and places the results in a second vector. The floating-point version only inverts the sign bit.

Depending on settings in the CPACR, NSACR, and HCPTR, and FPEXC registers, and the security state and mode in which the instruction is executed, an attempt to execute the instruction might be UNDEFINED, or trapped to Hyp mode. [Summary of general controls of CP10 and CP11 functionality on page G1-3496](#) and [Summary of access controls for Advanced SIMD functionality on page G1-3498](#) summarize these controls.

ARM deprecates the conditional execution of any Advanced SIMD instruction encoding that is not also available as a VFP instruction encoding, see [Conditional execution on page F2-2416](#).

Encoding T1/A1 Advanced SIMDv1 (F = 1 UNDEFINED in integer-only variants)

VNEG<c>.<dt> <Qd>, <Qm>

VNEG<c>.<dt> <Dd>, <Dm>

15	14	13	12	11	10	9	8	7	6	5	4	3	2	1	0	15	14	13	12	11	10	9	8	7	6	5	4	3	2	1	0
1	1	1	1	1	1	1	1	1	D	1	1	size	0	1	Vd	0	F	1	1	1	Q	M	0	Vm							

31	30	29	28	27	26	25	24	23	22	21	20	19	18	17	16	15	14	13	12	11	10	9	8	7	6	5	4	3	2	1	0
1	1	1	1	0	0	1	1	1	D	1	1	size	0	1	Vd	0	F	1	1	1	Q	M	0	Vm							

```

if size == '11' || (F == '1' && size != '10') then UNDEFINED;
if Q == '1' && (Vd<0> == '1' || Vm<0> == '1') then UNDEFINED;
advsimd = TRUE; floating_point = (F == '1');
esize = 8 << UInt(size); elements = 64 DIV esize;
d = UInt(D:Vd); m = UInt(M:Vm); regs = if Q == '0' then 1 else 2;
    
```

Encoding T2/A2 VFPv2, VFPv3, VFPv4 (sz = 1 UNDEFINED in single-precision only variants)

VNEG<c>.F64 <Dd>, <Dm>

VNEG<c>.F32 <Sd>, <Sm>

15	14	13	12	11	10	9	8	7	6	5	4	3	2	1	0	15	14	13	12	11	10	9	8	7	6	5	4	3	2	1	0
1	1	1	0	1	1	1	0	1	D	1	1	0	0	0	1	Vd	1	0	1	sz	0	1	M	0	Vm						

31	30	29	28	27	26	25	24	23	22	21	20	19	18	17	16	15	14	13	12	11	10	9	8	7	6	5	4	3	2	1	0
cond		1	1	1	0	1	D	1	1	0	0	0	1	Vd	1	0	1	sz	0	1	M	0	Vm								

```

if FPSCR.Len != '000' || FPSCR.Stride != '00' then UNDEFINED;
advsimd = FALSE; dp_operation = (sz == '1');
d = if dp_operation then UInt(D:Vd) else UInt(Vd:D);
m = if dp_operation then UInt(M:Vm) else UInt(Vm:M);
    
```

Assembler syntax

VNEG{<c>}{<q>}.<dt> <Qd>, <Qm>	Encoding T1/A1
VNEG{<c>}{<q>}.<dt> <Dd>, <Dm>	Encoding T1/A1
VNEG{<c>}{<q>}.F32 <Sd>, <Sm>	Floating-point only, encoding T2/A2, encoded as sz = 0
VNEG{<c>}{<q>}.F64 <Dd>, <Dm>	Encoding T2/A2, encoded as sz = 1

where:

<c>, <q>	See Standard assembler syntax fields on page F2-2415 . An A32 Advanced SIMD VNEG instruction must be unconditional. ARM strongly recommends that a T32 Advanced SIMD VNEG instruction is unconditional, see Conditional execution on page F2-2416 .								
<dt>	The data type for the elements of the vectors. It must be one of: <table> <tr> <td>S8</td> <td>Encoded as size = 0b00, F = 0.</td> </tr> <tr> <td>S16</td> <td>Encoded as size = 0b01, F = 0.</td> </tr> <tr> <td>S32</td> <td>Encoded as size = 0b10, F = 0.</td> </tr> <tr> <td>F32</td> <td>Encoded as size = 0b10, F = 1.</td> </tr> </table>	S8	Encoded as size = 0b00, F = 0.	S16	Encoded as size = 0b01, F = 0.	S32	Encoded as size = 0b10, F = 0.	F32	Encoded as size = 0b10, F = 1.
S8	Encoded as size = 0b00, F = 0.								
S16	Encoded as size = 0b01, F = 0.								
S32	Encoded as size = 0b10, F = 0.								
F32	Encoded as size = 0b10, F = 1.								
<Qd>, <Qm>	The destination vector and the operand vector, for a quadword operation.								
<Dd>, <Dm>	The destination vector and the operand vector, for a doubleword operation.								
<Sd>, <Sm>	The destination vector and the operand vector, for a singleword operation.								

Operation

```

if ConditionPassed() then
    EncodingSpecificOperations(); CheckAdvSIMDorVFPEEnabled(TRUE, advsimd);
    if advsimd then // Advanced SIMD instruction
        for r = 0 to regs-1
            for e = 0 to elements-1
                if floating_point then
                    Elem[D[d+r],e,esize] = FPNeg(Elem[D[m+r],e,esize]);
                else
                    result = -SInt(Elem[D[m+r],e,esize]);
                    Elem[D[d+r],e,esize] = result<esize-1:0>;
            // VFP instruction
    else
        if dp_operation then
            D[d] = FPNeg(D[m]);
        else
            S[d] = FPNeg(S[m]);
  
```

F8.1.98 VNMLA, VNMLS, VNMUL

VNMLA multiplies together two floating-point register values, adds the negation of the floating-point value in the destination register to the negation of the product, and writes the result back to the destination register.

VNMLS multiplies together two floating-point register values, adds the negation of the floating-point value in the destination register to the product, and writes the result back to the destination register.

VNMUL multiplies together two floating-point register values, and writes the negation of the result to the destination register.

———— Note —————

ARM recommends that software does not use the VNMLA instruction in the *Round towards Plus Infinity* and *Round towards Minus Infinity* rounding modes, because the rounding of the product and of the sum can change the result of the instruction in opposite directions, defeating the purpose of these rounding modes.

Depending on settings in the CPACR, NSACR, and HCPTR, and FPEXC registers, and the security state and mode in which the instruction is executed, an attempt to execute the instruction might be UNDEFINED, or trapped to Hyp mode. [Summary of general controls of CP10 and CP11 functionality on page G1-3496](#) summarizes these controls.

Encoding T1/A1 VFPv2, VFPv3, VFPv4 (sz = 1 UNDEFINED in single-precision only variants)

VNMLA<c>.F64 <Dd>, <Dn>, <Dm>

VNMLA<c>.F32 <Sd>, <Sn>, <Sm>

VNMLS<c>.F64 <Dd>, <Dn>, <Dm>

VNMLS<c>.F32 <Sd>, <Sn>, <Sm>

15	14	13	12	11	10	9	8	7	6	5	4	3	2	1	0	15	14	13	12	11	10	9	8	7	6	5	4	3	2	1	0
1	1	1	0	1	1	1	0	0	D	0	1	Vn				Vd	1	0	1	sz	N	op	M	0	Vm						

31	30	29	28	27	26	25	24	23	22	21	20	19	18	17	16	15	14	13	12	11	10	9	8	7	6	5	4	3	2	1	0
cond		1	1	1	0	0	D	0	1	Vn				Vd	1	0	1	sz	N	op	M	0	Vm								

```
if FPSCR.Len != '000' || FPSCR.Stride != '00' then UNDEFINED;
type = if op == '1' then VFPNegMul_VNMLA else VFPNegMul_VNMLS;
dp_operation = (sz == '1');
d = if dp_operation then UInt(D:Vd) else UInt(Vd:D);
n = if dp_operation then UInt(N:Vn) else UInt(Vn:N);
m = if dp_operation then UInt(M:Vm) else UInt(Vm:M);
```

Encoding T2/A2 VFPv2, VFPv3, VFPv4 (sz = 1 UNDEFINED in single-precision only variants)

VNMUL<c>.F64 <Dd>, <Dn>, <Dm>

VNMUL<c>.F32 <Sd>, <Sn>, <Sm>

15	14	13	12	11	10	9	8	7	6	5	4	3	2	1	0	15	14	13	12	11	10	9	8	7	6	5	4	3	2	1	0
1	1	1	0	1	1	1	0	0	D	1	0	Vn				Vd	1	0	1	sz	N	1	M	0	Vm						

31	30	29	28	27	26	25	24	23	22	21	20	19	18	17	16	15	14	13	12	11	10	9	8	7	6	5	4	3	2	1	0
cond		1	1	1	0	0	D	1	0	Vn				Vd	1	0	1	sz	N	1	M	0	Vm								

```
if FPSCR.Len != '000' || FPSCR.Stride != '00' then UNDEFINED;
type = VFPNegMul_VNMUL;
dp_operation = (sz == '1');
d = if dp_operation then UInt(D:Vd) else UInt(Vd:D);
n = if dp_operation then UInt(N:Vn) else UInt(Vn:N);
m = if dp_operation then UInt(M:Vm) else UInt(Vm:M);
```

Assembler syntax

VN<op>{<c>}{<q>}.F64 <Dd>, <Dn>, <Dm>	Encoding T1/A1, encoded as sz = 1
VN<op>{<c>}{<q>}.F32 <Sd>, <Sn>, <Sm>	Encoding T1/A1, encoded as sz = 0
VNMUL{<c>}{<q>}.F64 {<Dd>,} <Dn>, <Dm>	Encoding T2/A2, encoded as sz = 1
VNMUL{<c>}{<q>}.F32 {<Sd>,} <Sn>, <Sm>	Encoding T2/A2, encoded as sz = 0

where:

<op>	The operation. It must be one of: MLA Vector Negate Multiply Accumulate. Encoded as op = 0. MLS Vector Negate Multiply Subtract. Encoded as op = 1.
<c>, <q>	See Standard assembler syntax fields on page F2-2415 .
<Dd>, <Dn>, <Dm>	The destination register and the operand registers, for a double-precision operation.
<Sd>, <Sn>, <Sm>	The destination register and the operand registers, for a single-precision operation.

Operation

```
enumeration VFPNegMul {VFPNegMul_VNMLA, VFPNegMul_VNMMLS, VFPNegMul_VNMUL};
```

```
if ConditionPassed() then
    EncodingSpecificOperations(); CheckVFPEEnabled(TRUE);
    if dp_operation then
        product64 = FPMul(D[n], D[m], FPSCR);
        case type of
            when VFPNegMul_VNMLA D[d] = FAdd(FPNeg(D[d]), FPNeg(product64), FPSCR);
            when VFPNegMul_VNMMLS D[d] = FAdd(FPNeg(D[d]), product64, FPSCR);
            when VFPNegMul_VNMUL D[d] = FPNeg(product64);
        else
            product32 = FPMul(S[n], S[m], FPSCR);
            case type of
                when VFPNegMul_VNMLA S[d] = FAdd(FPNeg(S[d]), FPNeg(product32), FPSCR);
                when VFPNegMul_VNMMLS S[d] = FAdd(FPNeg(S[d]), product32, FPSCR);
                when VFPNegMul_VNMUL S[d] = FPNeg(product32);
```

F8.1.99 VORN (immediate)

VORN (immediate) is a pseudo-instruction, equivalent to a VORR (immediate) instruction with the immediate value bitwise inverted. For details see [VORR \(immediate\)](#) on page F8-3252.

F8.1.100 VORN (register)

This instruction performs a bitwise OR NOT operation between two registers, and places the result in the destination register. The operand and result registers can be quadword or doubleword. They must all be the same size.

Depending on settings in the CPACR, NSACR, and HCPTR registers, and the security state and mode in which the instruction is executed, an attempt to execute the instruction might be UNDEFINED, or trapped to Hyp mode. [Summary of access controls for Advanced SIMD functionality](#) on page G1-3498 summarizes these controls.

ARM deprecates the conditional execution of any Advanced SIMD instruction encoding that is not also available as a VFP instruction encoding, see [Conditional execution](#) on page F2-2416.

Encoding T1/A1 Advanced SIMDv1

VORN<c> <Qd>, <Qn>, <Qm>

VORN<c> <Dd>, <Dn>, <Dm>

15	14	13	12	11	10	9	8	7	6	5	4	3	2	1	0	15	14	13	12	11	10	9	8	7	6	5	4	3	2	1	0
1	1	1	0	1	1	1	1	0	D	1	1	Vn				Vd				0	0	0	1	N	Q	M	1	Vm			

31	30	29	28	27	26	25	24	23	22	21	20	19	18	17	16	15	14	13	12	11	10	9	8	7	6	5	4	3	2	1	0
1	1	1	1	0	0	1	0	0	D	1	1	Vn				Vd				0	0	0	1	N	Q	M	1	Vm			

if Q == '1' && (Vd<0> == '1' || Vn<0> == '1' || Vm<0> == '1') then UNDEFINED;
 d = UInt(D:Vd); n = UInt(N:Vn); m = UInt(M:Vm); regs = if Q == '0' then 1 else 2;

Assembler syntax

VORN{<C>}{<q>}{.<dt>} {<Qd>}, <Qn>, <Qm> Encoded as Q = 1
VORN{<C>}{<q>}{.<dt>} {<Dd>}, <Dn>, <Dm> Encoded as Q = 0

where:

<C>, <q> See [Standard assembler syntax fields on page F2-2415](#). An A32 VORN instruction must be unconditional. ARM strongly recommends that a T32 VORN instruction is unconditional, see [Conditional execution on page F2-2416](#).

<dt> An optional data type. It is ignored by assemblers, and does not affect the encoding.

<Qd>, <Qn>, <Qm> The destination vector and the operand vectors, for a quadword operation.

<Dd>, <Dn>, <Dm> The destination vector and the operand vectors, for a doubleword operation.

Operation

```
if ConditionPassed() then
    EncodingSpecificOperations(); CheckAdvSIMDEnabled();
    for r = 0 to regs-1
        D[d+r] = D[n+r] OR NOT(D[m+r]);
```

F8.1.101 VORR (immediate)

This instruction takes the contents of the destination vector, performs a bitwise OR with an immediate constant, and returns the result into the destination vector. For the range of constants available, see [One register and a modified immediate value on page F5-2508](#).

Depending on settings in the CPACR, NSACR, and HCPTR registers, and the security state and mode in which the instruction is executed, an attempt to execute the instruction might be UNDEFINED, or trapped to Hyp mode. [Summary of access controls for Advanced SIMD functionality on page G1-3498](#) summarizes these controls.

ARM deprecates the conditional execution of any Advanced SIMD instruction encoding that is not also available as a VFP instruction encoding, see [Conditional execution on page F2-2416](#).

Encoding T1/A1 Advanced SIMDv1

VORR<c>.<dt> <Qd>, #<imm>

VORR<c>.<dt> <Dd>, #<imm>

15	14	13	12	11	10	9	8	7	6	5	4	3	2	1	0	15	14	13	12	11	10	9	8	7	6	5	4	3	2	1	0
1	1	1	i	1	1	1	1	1	D	0	0	0	imm3	Vd	cmode	0	Q	0	1	imm4											

31	30	29	28	27	26	25	24	23	22	21	20	19	18	17	16	15	14	13	12	11	10	9	8	7	6	5	4	3	2	1	0
1	1	1	1	0	0	1	i	1	D	0	0	0	imm3	Vd	cmode	0	Q	0	1	imm4											

```

if cmode<0> == '0' || cmode<3:2> == '11' then SEE VMOV (immediate);
if Q == '1' && Vd<0> == '1' then UNDEFINED;
imm64 = AdvSIMDExpandImm('0', cmode, i:imm3:imm4);
d = UInt(D:Vd); regs = if Q == '0' then 1 else 2;
    
```

Assembler syntax

VORR{<c>}{<q>}.<dt> {<Qd>}, <Qd>, #<imm> Encoded as Q = 1
VORR{<c>}{<q>}.<dt> {<Dd>}, <Dd>, #<imm> Encoded as Q = 0

where:

<c>, <q> See [Standard assembler syntax fields on page F2-2415](#). An A32 VORR instruction must be unconditional. ARM strongly recommends that a T32 VORR instruction is unconditional, see [Conditional execution on page F2-2416](#).

<dt> The data type used for <imm>. It can be either I16 or I32. I8, I64, and F32 are also permitted, but the resulting syntax is a pseudo-instruction.

<Qd> The destination vector for a quadword operation.

<Dd> The destination vector for a doubleword operation.

<imm> A constant of the type specified by <dt>. This constant is replicated enough times to fill the destination register. For example, VORR.I32 D0, #10 ORs 0x0000000A0000000A into D0.

For details of the range of constants available, and the encoding of <dt> and <imm>, see [One register and a modified immediate value on page F5-2508](#).

Operation

```
if ConditionPassed() then
    EncodingSpecificOperations(); CheckAdvSIMDEnabled();
    for r = 0 to regs-1
        D[d+r] = D[d+r] OR imm64;
```

Pseudo-instructions

VORN can be used, with a range of constants that are the bitwise inverse of the available constants for VORR. This is assembled as the equivalent VORR instruction. Disassembly produces the VORR form.

[One register and a modified immediate value on page F5-2508](#) describes pseudo-instructions with a combination of <dt> and <imm> that is not supported by hardware, but that generates the same destination register value as a different combination that is supported by hardware.

F8.1.102 VORR (register)

This instruction performs a bitwise OR operation between two registers, and places the result in the destination register. The operand and result registers can be quadword or doubleword. They must all be the same size.

Depending on settings in the CPACR, NSACR, and HCPTR registers, and the security state and mode in which the instruction is executed, an attempt to execute the instruction might be UNDEFINED, or trapped to Hyp mode. [Summary of access controls for Advanced SIMD functionality on page G1-3498](#) summarizes these controls.

ARM deprecates the conditional execution of any Advanced SIMD instruction encoding that is not also available as a VFP instruction encoding, see [Conditional execution on page F2-2416](#).

Encoding T1/A1 Advanced SIMDv1

VORR<c> <Qd>, <Qn>, <Qm>

VORR<c> <Dd>, <Dn>, <Dm>

15	14	13	12	11	10	9	8	7	6	5	4	3	2	1	0	15	14	13	12	11	10	9	8	7	6	5	4	3	2	1	0
1	1	1	0	1	1	1	1	0	D	1	0	Vn				Vd				0	0	0	1	N	Q	M	1	Vm			

31	30	29	28	27	26	25	24	23	22	21	20	19	18	17	16	15	14	13	12	11	10	9	8	7	6	5	4	3	2	1	0
1	1	1	1	0	0	1	0	0	D	1	0	Vn				Vd				0	0	0	1	N	Q	M	1	Vm			

if N == M && Vn == Vm then SEE VMOV (register);
 if Q == '1' && (Vd<0> == '1' || Vn<0> == '1' || Vm<0> == '1') then UNDEFINED;
 d = UInt(D:Vd); n = UInt(N:Vn); m = UInt(M:Vm); regs = if Q == '0' then 1 else 2;

Assembler syntax

VORR{<C>}{<q>}{.<dt>} {<Qd>}, <Qn>, <Qm> Encoded as Q = 1
VORR{<C>}{<q>}{.<dt>} {<Dd>}, <Dn>, <Dm> Encoded as Q = 0

where:

<C>, <q> See [Standard assembler syntax fields on page F2-2415](#). An A32 VORR instruction must be unconditional. ARM strongly recommends that a T32 VORR instruction is unconditional, see [Conditional execution on page F2-2416](#).

<dt> An optional data type. It is ignored by assemblers, and does not affect the encoding.

<Qd>, <Qn>, <Qm> The destination vector and the operand vectors, for a quadword operation.

<Dd>, <Dn>, <Dm> The destination vector and the operand vectors, for a doubleword operation.

Operation

```
if ConditionPassed() then
    EncodingSpecificOperations(); CheckAdvSIMDEnabled();
    for r = 0 to regs-1
        D[d+r] = D[n+r] OR D[m+r];
```

F8.1.103 VPADAL

Vector Pairwise Add and Accumulate Long adds adjacent pairs of elements of a vector, and accumulates the results into the elements of the destination vector.

The vectors can be doubleword or quadword. The operand elements can be 8-bit, 16-bit, or 32-bit integers. The result elements are twice the length of the operand elements.

Figure F8-2 shows an example of the operation of VPADAL.

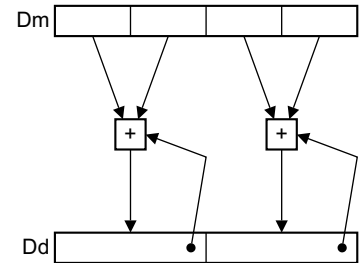

Figure F8-2 VPADAL doubleword operation for data type S16

Depending on settings in the CPACR, NSACR, and HCPTR registers, and the security state and mode in which the instruction is executed, an attempt to execute the instruction might be UNDEFINED, or trapped to Hyp mode. [Summary of access controls for Advanced SIMD functionality on page G1-3498](#) summarizes these controls.

ARM deprecates the conditional execution of any Advanced SIMD instruction encoding that is not also available as a VFP instruction encoding, see [Conditional execution on page F2-2416](#).

Encoding T1/A1 Advanced SIMDv1

VPADAL<c>.<dt> <Qd>, <Qm>

VPADAL<c>.<dt> <Dd>, <Dm>

15	14	13	12	11	10	9	8	7	6	5	4	3	2	1	0	15	14	13	12	11	10	9	8	7	6	5	4	3	2	1	0
1	1	1	1	1	1	1	1	1	D	1	1	size	0	0	Vd	0	1	1	0	op	Q	M	0	Vm							

31	30	29	28	27	26	25	24	23	22	21	20	19	18	17	16	15	14	13	12	11	10	9	8	7	6	5	4	3	2	1	0
1	1	1	1	0	0	1	1	1	D	1	1	size	0	0	Vd	0	1	1	0	op	Q	M	0	Vm							

```

if size == '11' then UNDEFINED;
if Q == '1' && (Vd<0> == '1' || Vm<0> == '1') then UNDEFINED;
unsigned = (op == '1');
esize = 8 << UInt(size); elements = 64 DIV esize;
d = UInt(D:Vd); m = UInt(M:Vm); regs = if Q == '0' then 1 else 2;
    
```

Assembler syntax

VPADAL{<c>}{<q>}.<dt> <Qd>, <Qm> Encoded as Q = 1
 VPADAL{<c>}{<q>}.<dt> <Dd>, <Dm> Encoded as Q = 0

where:

<c>, <q> See [Standard assembler syntax fields on page F2-2415](#). An A32 VPADAL instruction must be unconditional. ARM strongly recommends that a T32 VPADAL instruction is unconditional, see [Conditional execution on page F2-2416](#).

<dt> The data type for the elements of the vectors. It must be one of:

S8	Encoded as size = 0b00, op = 0.
S16	Encoded as size = 0b01, op = 0.
S32	Encoded as size = 0b10, op = 0.
U8	Encoded as size = 0b00, op = 1.
U16	Encoded as size = 0b01, op = 1.
U32	Encoded as size = 0b10, op = 1.

<Qd>, <Qm> The destination vector and the operand vector, for a quadword operation.

<Dd>, <Dm> The destination vector and the operand vector, for a doubleword operation.

Operation

```

if ConditionPassed() then
    EncodingSpecificOperations(); CheckAdvSIMDEnabled();
    h = elements DIV 2;

    for r = 0 to regs-1
        for e = 0 to h-1
            op1 = Elem[D[m+r],2*e,esize]; op2 = Elem[D[m+r],2*e+1,esize];
            result = Int(op1, unsigned) + Int(op2, unsigned);
            Elem[D[d+r],e,2*esize] = Elem[D[d+r],e,2*esize] + result;
  
```

F8.1.104 VPADD (integer)

Vector Pairwise Add (integer) adds adjacent pairs of elements of two vectors, and places the results in the destination vector.

The operands and result are doubleword vectors.

The operand and result elements must all be the same type, and can be 8-bit, 16-bit, or 32-bit integers. There is no distinction between signed and unsigned integers.

Figure F8-3 shows an example of the operation of VPADD.

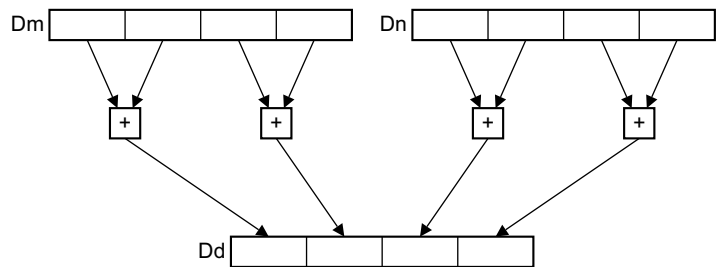

Figure F8-3 VPADD operation for data type I16

Depending on settings in the CPACR, NSACR, and HCPTR registers, and the security state and mode in which the instruction is executed, an attempt to execute the instruction might be UNDEFINED, or trapped to Hyp mode. [Summary of access controls for Advanced SIMD functionality on page G1-3498](#) summarizes these controls.

ARM deprecates the conditional execution of any Advanced SIMD instruction encoding that is not also available as a VFP instruction encoding, see [Conditional execution on page F2-2416](#).

Encoding T1/A1 Advanced SIMDv1

VPADD<c>.<dt> <Dd>, <Dn>, <Dm>

15	14	13	12	11	10	9	8	7	6	5	4	3	2	1	0	15	14	13	12	11	10	9	8	7	6	5	4	3	2	1	0
1	1	1	0	1	1	1	1	0	D	size		Vn		Vd	1	0	1	1	N	Q	M	1		Vm							
31	30	29	28	27	26	25	24	23	22	21	20	19	18	17	16	15	14	13	12	11	10	9	8	7	6	5	4	3	2	1	0
1	1	1	1	0	0	1	0	0	D	size		Vn		Vd	1	0	1	1	N	Q	M	1		Vm							

```
if size == '11' || Q == '1' then UNDEFINED;
esize = 8 << UInt(size);  elements = 64 DIV esize;
d = UInt(D:Vd);  n = UInt(N:Vn);  m = UInt(M:Vm);
```

Assembler syntax

VPADD{<c>}{<q>}.<dt> {<Dd>}, <Dn>, <Dm> Encoded as Q = 0

where:

<c>, <q> See [Standard assembler syntax fields on page F2-2415](#). An A32 VPADD instruction must be unconditional. ARM strongly recommends that a T32 VPADD instruction is unconditional, see [Conditional execution on page F2-2416](#).

<dt> The data type for the elements of the vectors. It must be one of:

I8	Encoding T1/A1, encoded as size = 0b00.
I16	Encoding T1/A1, encoded as size = 0b01.
I32	Encoding T1/A1, encoded as size = 0b10.

<Dd>, <Dn>, <Dm> The destination vector, the first operand vector, and the second operand vector.

Operation

```

if ConditionPassed() then
    EncodingSpecificOperations(); CheckAdvSIMDEnabled();
    bits(64) dest;
    h = elements DIV 2;

    for e = 0 to h-1
        Elem[dest,e,esize] = Elem[D[n],2*e,esize] + Elem[D[n],2*e+1,esize];
        Elem[dest,e+h,esize] = Elem[D[m],2*e,esize] + Elem[D[m],2*e+1,esize];

    D[d] = dest;
  
```

F8.1.105 VPADD (floating-point)

Vector Pairwise Add (floating-point) adds adjacent pairs of elements of two vectors, and places the results in the destination vector.

The operands and result are doubleword vectors.

The operand and result elements are 32-bit floating-point numbers.

Figure F8-3 on page F8-3258 shows an example of the operation of VPADD.

Depending on settings in the CPACR, NSACR, and HCPTR registers, and the security state and mode in which the instruction is executed, an attempt to execute the instruction might be UNDEFINED, or trapped to Hyp mode.

Summary of access controls for Advanced SIMD functionality on page G1-3498 summarizes these controls.

ARM deprecates the conditional execution of any Advanced SIMD instruction encoding that is not also available as a VFP instruction encoding, see Conditional execution on page F2-2416.

Encoding T1/A1 Advanced SIMDv1 (UNDEFINED in integer-only variant)

VPADD<c>.*F32* <Dd>, <Dn>, <Dm>

15	14	13	12	11	10	9	8	7	6	5	4	3	2	1	0	15	14	13	12	11	10	9	8	7	6	5	4	3	2	1	0
1	1	1	1	1	1	1	1	0	D	0	sz	Vn				Vd				1	1	0	1	N	Q	M	0	Vm			
31	30	29	28	27	26	25	24	23	22	21	20	19	18	17	16	15	14	13	12	11	10	9	8	7	6	5	4	3	2	1	0
1	1	1	1	0	0	1	1	0	D	0	sz	Vn				Vd				1	1	0	1	N	Q	M	0	Vm			

```
if sz == '1' || Q == '1' then UNDEFINED;
esize = 32; elements = 2;
d = UInt(D:Vd); n = UInt(N:Vn); m = UInt(M:Vm);
```

Assembler syntax

VPADD{<c>}{<q>}.F32 {<Dd>}, <Dn>, <Dm> Encoded as Q = 0, sz = 0

where:

<c>, <q> See [Standard assembler syntax fields on page F2-2415](#). An A32 VPADD instruction must be unconditional. ARM strongly recommends that a T32 VPADD instruction is unconditional, see [Conditional execution on page F2-2416](#).

<Dd>, <Dn>, <Dm> The destination vector, the first operand vector, and the second operand vector.

Operation

```
if ConditionPassed() then
    EncodingSpecificOperations(); CheckAdvSIMDEnabled();
    bits(64) dest;
    h = elements DIV 2;

    for e = 0 to h-1
        Elem[dest,e,esize] = FPAdd(Elem[D[n],2*e,esize], Elem[D[n],2*e+1,esize], StandardFPSCRValue());
        Elem[dest,e+h,esize] = FPAdd(Elem[D[m],2*e,esize], Elem[D[m],2*e+1,esize], StandardFPSCRValue());

    D[d] = dest;
```

F8.1.106 VPADDL

Vector Pairwise Add Long adds adjacent pairs of elements of two vectors, and places the results in the destination vector.

The vectors can be doubleword or quadword. The operand elements can be 8-bit, 16-bit, or 32-bit integers. The result elements are twice the length of the operand elements.

Figure F8-4 shows an example of the operation of VPADDL.

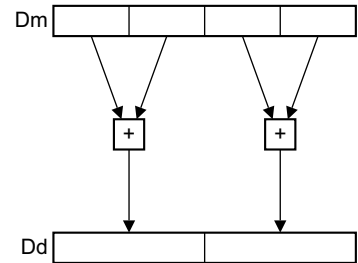

Figure F8-4 VPADDL doubleword operation for data type S16

Depending on settings in the CPACR, NSACR, and HCPTR registers, and the security state and mode in which the instruction is executed, an attempt to execute the instruction might be UNDEFINED, or trapped to Hyp mode. [Summary of access controls for Advanced SIMD functionality on page G1-3498](#) summarizes these controls.

ARM deprecates the conditional execution of any Advanced SIMD instruction encoding that is not also available as a VFP instruction encoding, see [Conditional execution on page F2-2416](#).

Encoding T1/A1 Advanced SIMDv1

VPADDL<c>.<dt> <Qd>, <Qm>

VPADDL<c>.<dt> <Dd>, <Dm>

15	14	13	12	11	10	9	8	7	6	5	4	3	2	1	0	15	14	13	12	11	10	9	8	7	6	5	4	3	2	1	0
1	1	1	1	1	1	1	1	1	D	1	1	size	0	0	Vd	0	0	1	0	op	Q	M	0	Vm							

31	30	29	28	27	26	25	24	23	22	21	20	19	18	17	16	15	14	13	12	11	10	9	8	7	6	5	4	3	2	1	0
1	1	1	1	0	0	1	1	1	D	1	1	size	0	0	Vd	0	0	1	0	op	Q	M	0	Vm							

```

if size == '11' then UNDEFINED;
if Q == '1' && (Vd<0> == '1' || Vm<0> == '1') then UNDEFINED;
unsigned = (op == '1');
esize = 8 << UInt(size); elements = 64 DIV esize;
d = UInt(D:Vd); m = UInt(M:Vm); regs = if Q == '0' then 1 else 2;
    
```

Assembler syntax

VPADDL{<c>}{<q>}.<dt> <Qd>, <Qm> Encoded as Q = 1
 VPADDL{<c>}{<q>}.<dt> <Dd>, <Dm> Encoded as Q = 0

where:

<c>, <q> See [Standard assembler syntax fields on page F2-2415](#). An A32 VPADDL instruction must be unconditional. ARM strongly recommends that a T32 VPADDL instruction is unconditional, see [Conditional execution on page F2-2416](#).

<dt> The data type for the elements of the vectors. It must be one of:

S8	Encoded as size = 0b00, op = 0.
S16	Encoded as size = 0b01, op = 0.
S32	Encoded as size = 0b10, op = 0.
U8	Encoded as size = 0b00, op = 1.
U16	Encoded as size = 0b01, op = 1.
U32	Encoded as size = 0b10, op = 1.

<Qd>, <Qm> The destination vector and the operand vector, for a quadword operation.

<Dd>, <Dm> The destination vector and the operand vector, for a doubleword operation.

Operation

```

if ConditionPassed() then
    EncodingSpecificOperations(); CheckAdvSIMDEnabled();
    h = elements DIV 2;

    for r = 0 to regs-1
        for e = 0 to h-1
            op1 = Elem[D[m+r],2*e,esize]; op2 = Elem[D[m+r],2*e+1,esize];
            result = Int(op1, unsigned) + Int(op2, unsigned);
            Elem[D[d+r],e,2*esize] = result<2*esize-1:0>;
  
```

F8.1.107 VPMAX, VPMIN (integer)

Vector Pairwise Maximum compares adjacent pairs of elements in two doubleword vectors, and copies the larger of each pair into the corresponding element in the destination doubleword vector.

Vector Pairwise Minimum compares adjacent pairs of elements in two doubleword vectors, and copies the smaller of each pair into the corresponding element in the destination doubleword vector.

Figure F8-5 shows an example of the operation of VPMAX.

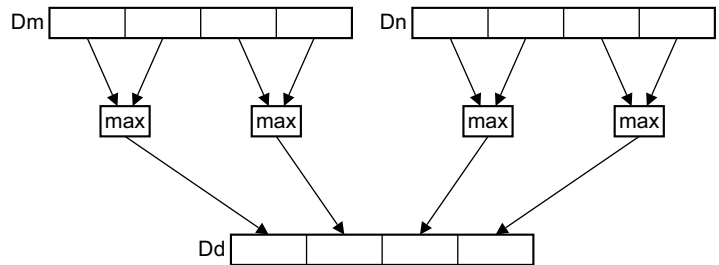

Figure F8-5 VPMAX operation for data type S16 or U16

Depending on settings in the CPACR, NSACR, and HCPTR registers, and the security state and mode in which the instruction is executed, an attempt to execute the instruction might be UNDEFINED, or trapped to Hyp mode. [Summary of access controls for Advanced SIMD functionality on page G1-3498](#) summarizes these controls.

ARM deprecates the conditional execution of any Advanced SIMD instruction encoding that is not also available as a VFP instruction encoding, see [Conditional execution on page F2-2416](#).

Encoding T1/A1 Advanced SIMDv1

VP<op><c>.<dt> <Dd>, <Dn>, <Dm>

15	14	13	12	11	10	9	8	7	6	5	4	3	2	1	0	15	14	13	12	11	10	9	8	7	6	5	4	3	2	1	0
1	1	1	U	1	1	1	1	0	D	size		Vn		Vd	1	0	1	0	N	Q	M	op		Vm							

31	30	29	28	27	26	25	24	23	22	21	20	19	18	17	16	15	14	13	12	11	10	9	8	7	6	5	4	3	2	1	0
1	1	1	1	0	0	1	U	0	D	size		Vn		Vd	1	0	1	0	N	Q	M	op		Vm							

```

if size == '11' || Q == '1' then UNDEFINED;
maximum = (op == '0'); unsigned = (U == '1');
esize = 8 << UInt(size); elements = 64 DIV esize;
d = UInt(D:Vd); n = UInt(N:Vn); m = UInt(M:Vm);
    
```

Assembler syntax

VP<op>{<c>}{<q>}.<dt> {<Dd>}, <Dn>, <Dm> Encoded as Q = 0

where:

<op>	The operation. It must be one of: MAX Encoded as op = 0. MIN Encoded as op = 1.
<c>, <q>	See Standard assembler syntax fields on page F2-2415 . An A32 VPMAX or VPMIN instruction must be unconditional. ARM strongly recommends that a T32 VPMAX or VPMIN instruction is unconditional, see Conditional execution on page F2-2416 .
<dt>	The data type for the elements of the vectors. It must be one of: S8 Encoding T1/A1, encoded as size = 0b00, U = 0. S16 Encoding T1/A1, encoded as size = 0b01, U = 0. S32 Encoding T1/A1, encoded as size = 0b10, U = 0. U8 Encoding T1/A1, encoded as size = 0b00, U = 1. U16 Encoding T1/A1, encoded as size = 0b01, U = 1. U32 Encoding T1/A1, encoded as size = 0b10, U = 1.
<Dd>, <Dn>, <Dm>	The destination vector and the operand vectors.

Operation

```

if ConditionPassed() then
    EncodingSpecificOperations(); CheckAdvSIMDEnabled();
    bits(64) dest;
    h = elements DIV 2;

    for e = 0 to h-1
        op1 = Int(Elem[D[n],2*e,esize], unsigned);
        op2 = Int(Elem[D[n],2*e+1,esize], unsigned);
        result = if maximum then Max(op1,op2) else Min(op1,op2);
        Elem[dest,e,esize] = result<esize-1:0>;
        op1 = Int(Elem[D[m],2*e,esize], unsigned);
        op2 = Int(Elem[D[m],2*e+1,esize], unsigned);
        result = if maximum then Max(op1,op2) else Min(op1,op2);
        Elem[dest,e+h,esize] = result<esize-1:0>;

D[d] = dest;
  
```

F8.1.108 VPMAX, VPMIN (floating-point)

Vector Pairwise Maximum compares adjacent pairs of elements in two doubleword vectors, and copies the larger of each pair into the corresponding element in the destination doubleword vector.

Vector Pairwise Minimum compares adjacent pairs of elements in two doubleword vectors, and copies the smaller of each pair into the corresponding element in the destination doubleword vector.

Figure F8-5 on page F8-3264 shows an example of the operation of VPMAX.

Depending on settings in the CPACR, NSACR, and HCPTR registers, and the security state and mode in which the instruction is executed, an attempt to execute the instruction might be UNDEFINED, or trapped to Hyp mode.

Summary of access controls for Advanced SIMD functionality on page G1-3498 summarizes these controls.

ARM deprecates the conditional execution of any Advanced SIMD instruction encoding that is not also available as a VFP instruction encoding, see Conditional execution on page F2-2416.

Encoding T1/A1 Advanced SIMDv1 (UNDEFINED in integer-only variant)

VP<op><c>.F32 <Dd>, <Dn>, <Dm>

15	14	13	12	11	10	9	8	7	6	5	4	3	2	1	0	15	14	13	12	11	10	9	8	7	6	5	4	3	2	1	0
1	1	1	1	1	1	1	1	0	D	op	sz	Vn			Vd			1	1	1	1	N	Q	M	0	Vm					
31	30	29	28	27	26	25	24	23	22	21	20	19	18	17	16	15	14	13	12	11	10	9	8	7	6	5	4	3	2	1	0
1	1	1	1	0	0	1	1	0	D	op	sz	Vn			Vd			1	1	1	1	N	Q	M	0	Vm					

```
if sz == '1' || Q == '1' then UNDEFINED;
maximum = (op == '0'); esize = 32; elements = 2;
d = UInt(D:Vd); n = UInt(N:Vn); m = UInt(M:Vm);
```

Assembler syntax

VP<op>{<c>}{<q>}.F32 {<Dd>}, <Dn>, <Dm> Encoded as Q = 0, sz = 0

where:

<op> The operation. It must be one of:
MAX Encoded as op = 0.
MIN Encoded as op = 1.

<c>, <q> See [Standard assembler syntax fields on page F2-2415](#). An A32 VPMAX or VPMIN instruction must be unconditional. ARM strongly recommends that a T32 VPMAX or VPMIN instruction is unconditional, see [Conditional execution on page F2-2416](#).

<Dd>, <Dn>, <Dm> The destination vector and the operand vectors.

Operation

```
if ConditionPassed() then
    EncodingSpecificOperations(); CheckAdvSIMDEnabled();
    bits(64) dest;
    h = elements DIV 2;

    for e = 0 to h-1
        op1 = Elem[D[n],2*e,esize]; op2 = Elem[D[n],2*e+1,esize];
        Elem[dest,e,esize] = if maximum then FPMax(op1,op2,StandardFPSCRValue()) else
FPMin(op1,op2,StandardFPSCRValue());
        op1 = Elem[D[m],2*e,esize]; op2 = Elem[D[m],2*e+1,esize];
        Elem[dest,e+h,esize] = if maximum then FPMax(op1,op2,StandardFPSCRValue()) else
FPMin(op1,op2,StandardFPSCRValue());

    D[d] = dest;
```

F8.1.109 VPOP

Vector Pop loads multiple consecutive extension registers from the stack.

Depending on settings in the [CPACR](#), [NSACR](#), and [HCPTR](#), and [FPEXC](#) registers, and the security state and mode in which the instruction is executed, an attempt to execute the instruction might be UNDEFINED, or trapped to Hyp mode. [Summary of general controls of CP10 and CP11 functionality on page G1-3496](#) and [Summary of access controls for Advanced SIMD functionality on page G1-3498](#) summarize these controls.

Encoding T1/A1 VFPv2, VFPv3, VFPv4, Advanced SIMDv1

VPOP <list> <list> is consecutive 64-bit registers

15	14	13	12	11	10	9	8	7	6	5	4	3	2	1	0	15	14	13	12	11	10	9	8	7	6	5	4	3	2	1	0
1	1	1	0	1	1	0	0	1	D	1	1	1	1	0	1	Vd	1	0	1	1	imm8										

31	30	29	28	27	26	25	24	23	22	21	20	19	18	17	16	15	14	13	12	11	10	9	8	7	6	5	4	3	2	1	0
cond		1	1	0	0	1	D	1	1	1	1	0	1	Vd	1	0	1	1	imm8												

```
single_regs = FALSE; d = UInt(D:Vd); imm32 = ZeroExtend(imm8:'00', 32);
regs = UInt(imm8) DIV 2; // If UInt(imm8) is odd, see "FLDMX".
if regs == 0 || regs > 16 || (d+regs) > 32 then UNPREDICTABLE;
if VFPSmallRegisterBank() && (d+regs) > 16 then UNPREDICTABLE;
```

Encoding T2/A2 VFPv2, VFPv3, VFPv4

VPOP <list> <list> is consecutive 32-bit registers

15	14	13	12	11	10	9	8	7	6	5	4	3	2	1	0	15	14	13	12	11	10	9	8	7	6	5	4	3	2	1	0
1	1	1	0	1	1	0	0	1	D	1	1	1	1	0	1	Vd	1	0	1	0	imm8										

31	30	29	28	27	26	25	24	23	22	21	20	19	18	17	16	15	14	13	12	11	10	9	8	7	6	5	4	3	2	1	0
cond		1	1	0	0	1	D	1	1	1	1	0	1	Vd	1	0	1	0	imm8												

```
single_regs = TRUE; d = UInt(Vd:D); imm32 = ZeroExtend(imm8:'00', 32);
regs = UInt(imm8);
if regs == 0 || (d+regs) > 32 then UNPREDICTABLE;
```

For information about the CONSTRAINED UNPREDICTABLE behavior of this instruction, see [Appendix A Architectural Constraints on UNPREDICTABLE behaviors](#), and particularly [VPOP on page AppxA-4748](#).

FLDMX Encoding T1/A1 behaves as described by the pseudocode if imm8 is odd. However, there is no UAL syntax for such encodings and ARM deprecates their use. For more information, see [FLDMX, FSTMX on page F8-3080](#).

Assembler syntax

VPOP{<c>}{<q>}{.<size>} <list>

where:

- <c>, <q> See [Standard assembler syntax fields on page F2-2415](#).
- <size> An optional data size specifier. If present, it must be equal to the size in bits, 32 or 64, of the registers in <list>.
- <list> The extension registers to be loaded, as a list of consecutively numbered doubleword (encoding T1/A1) or singleword (encoding T2/A2) registers, separated by commas and surrounded by brackets. It is encoded in the instruction by setting D and Vd to specify the first register in the list, and imm8 to twice the number of registers in the list (encoding T1/A1) or the number of registers in the list (encoding T2/A2). <list> must contain at least one register, and not more than sixteen.

Operation

```
if ConditionPassed() then
    EncodingSpecificOperations(); CheckVFPEnabled(TRUE); NullCheckIfThumbEE(13);
    address = SP;
    SP = SP + imm32;
    if single_regs then
        for r = 0 to regs-1
            S[d+r] = MemA[address,4]; address = address+4;
    else
        for r = 0 to regs-1
            word1 = MemA[address,4]; word2 = MemA[address+4,4]; address = address+8;
            // Combine the word-aligned words in the correct order for current endianness.
            D[d+r] = if BigEndian() then word1:word2 else word2:word1;
```

F8.1.110 VPUSH

Vector Push stores multiple consecutive extension registers to the stack.

Depending on settings in the CPACR, NSACR, and HCPTR, and FPEXC registers, and the security state and mode in which the instruction is executed, an attempt to execute the instruction might be UNDEFINED, or trapped to Hyp mode. *Summary of general controls of CP10 and CP11 functionality on page G1-3496* and *Summary of access controls for Advanced SIMD functionality on page G1-3498* summarize these controls.

Encoding T1/A1 VFPv2, VFPv3, VFPv4, Advanced SIMDv1

VPUSH<c> <list> <list> is consecutive 64-bit registers

15	14	13	12	11	10	9	8	7	6	5	4	3	2	1	0	15	14	13	12	11	10	9	8	7	6	5	4	3	2	1	0
1	1	1	0	1	1	0	1	0	D	1	0	1	1	0	1	Vd	1	0	1	1	imm8										

31	30	29	28	27	26	25	24	23	22	21	20	19	18	17	16	15	14	13	12	11	10	9	8	7	6	5	4	3	2	1	0
cond		1	1	0	1	0	D	1	0	1	1	0	1	Vd		1	0	1	1	imm8											

```
single_regs = FALSE; d = UInt(D:Vd); imm32 = ZeroExtend(imm8:'00', 32);
regs = UInt(imm8) DIV 2; // If UInt(imm8) is odd, see "FSTMX".
if regs == 0 || regs > 16 || (d+regs) > 32 then UNPREDICTABLE;
if VFPsmallRegisterBank() && (d+regs) > 16 then UNPREDICTABLE;
```

Encoding T2/A2 VFPv2, VFPv3, VFPv4

VPUSH<c> <list> <list> is consecutive 32-bit registers

15	14	13	12	11	10	9	8	7	6	5	4	3	2	1	0	15	14	13	12	11	10	9	8	7	6	5	4	3	2	1	0
1	1	1	0	1	1	0	1	0	D	1	0	1	1	0	1	Vd	1	0	1	0	imm8										

31	30	29	28	27	26	25	24	23	22	21	20	19	18	17	16	15	14	13	12	11	10	9	8	7	6	5	4	3	2	1	0
cond		1	1	0	1	0	D	1	0	1	1	0	1	Vd		1	0	1	0	imm8											

```
single_regs = TRUE; d = UInt(Vd:D);
imm32 = ZeroExtend(imm8:'00', 32); regs = UInt(imm8);
if regs == 0 || (d+regs) > 32 then UNPREDICTABLE;
```

For information about the CONSTRAINED UNPREDICTABLE behavior of this instruction, see [Appendix A Architectural Constraints on UNPREDICTABLE behaviors](#), and particularly *VPUSH on page AppxA-4753*.

FSTMX

Encoding T1/A1 behaves as described by the pseudocode if imm8 is odd. However, there is no UAL syntax for such encodings and ARM deprecates their use. For more information, see *FLDMX, FSTMX on page F8-3080*.

Assembler syntax

VPUSH{<c>}{<q>}{.<size>} <list>

where:

- <c>, <q> See [Standard assembler syntax fields on page F2-2415](#).
- <size> An optional data size specifier. If present, it must be equal to the size in bits, 32 or 64, of the registers in <list>.
- <list> The extension registers to be stored, as a list of consecutively numbered doubleword (encoding T1/A1) or singleword (encoding T2/A2) registers, separated by commas and surrounded by brackets. It is encoded in the instruction by setting D and Vd to specify the first register in the list, and imm8 to twice the number of registers in the list (encoding T1/A1), or the number of registers in the list (encoding T2/A2). <list> must contain at least one register, and not more than sixteen.

Operation

```
if ConditionPassed() then
    EncodingSpecificOperations(); CheckVFPEnabled(TRUE); NullCheckIfThumbEE(13);
    address = SP - imm32;
    SP = SP - imm32;
    if single_regs then
        for r = 0 to regs-1
            MemA[address,4] = S[d+r]; address = address+4;
    else
        for r = 0 to regs-1
            // Store as two word-aligned words in the correct order for current endianness.
            MemA[address,4] = if BigEndian() then D[d+r]<63:32> else D[d+r]<31:0>;
            MemA[address+4,4] = if BigEndian() then D[d+r]<31:0> else D[d+r]<63:32>;
            address = address+8;
```

F8.1.111 VQABS

Vector Saturating Absolute takes the absolute value of each element in a vector, and places the results in the destination vector.

If any of the results overflow, they are saturated. The cumulative saturation bit, `FPSCR.QC`, is set if saturation occurs. For details see [Pseudocode details of saturation on page E1-2293](#).

Depending on settings in the `CPACR`, `NSACR`, and `HCPTR` registers, and the security state and mode in which the instruction is executed, an attempt to execute the instruction might be UNDEFINED, or trapped to Hyp mode. [Summary of access controls for Advanced SIMD functionality on page G1-3498](#) summarizes these controls.

ARM deprecates the conditional execution of any Advanced SIMD instruction encoding that is not also available as a VFP instruction encoding, see [Conditional execution on page F2-2416](#).

Encoding T1/A1 Advanced SIMDv1

VQABS<c>.<dt> <Qd>, <Qm>

VQABS<c>.<dt> <Dd>, <Dm>

15	14	13	12	11	10	9	8	7	6	5	4	3	2	1	0	15	14	13	12	11	10	9	8	7	6	5	4	3	2	1	0
1	1	1	1	1	1	1	1	1	D	1	1	size	0	0	Vd	0	1	1	1	0	Q	M	0	Vm							
31	30	29	28	27	26	25	24	23	22	21	20	19	18	17	16	15	14	13	12	11	10	9	8	7	6	5	4	3	2	1	0
1	1	1	1	0	0	1	1	1	D	1	1	size	0	0	Vd	0	1	1	1	0	Q	M	0	Vm							

```

if size == '11' then UNDEFINED;
if Q == '1' && (Vd<0> == '1' || Vm<0> == '1') then UNDEFINED;
esize = 8 << UInt(size); elements = 64 DIV esize;
d = UInt(D:Vd); m = UInt(M:Vm); regs = if Q == '0' then 1 else 2;
    
```

Assembler syntax

VQABS{<c>}{<q>}.<dt> <Qd>, <Qm> Encoded as Q = 1
VQABS{<c>}{<q>}.<dt> <Dd>, <Dm> Encoded as Q = 0

where:

<c>, <q> See [Standard assembler syntax fields on page F2-2415](#). An A32 VQABS instruction must be unconditional. ARM strongly recommends that a T32 VQABS instruction is unconditional, see [Conditional execution on page F2-2416](#).

<dt> The data type for the elements of the vectors. It must be one of:
S8 Encoded as size = 0b00.
S16 Encoded as size = 0b01.
S32 Encoded as size = 0b10.

<Qd>, <Qm> The destination vector and the operand vector, for a quadword operation.

<Dd>, <Dm> The destination vector and the operand vector, for a doubleword operation.

Operation

```
if ConditionPassed() then
    EncodingSpecificOperations(); CheckAdvSIMDEnabled();
    for r = 0 to regs-1
        for e = 0 to elements-1
            result = Abs(SInt(Elem[D[m+r],e,esize]));
            (Elem[D[d+r],e,esize], sat) = SignedSatQ(result, esize);
            if sat then FPSR.QC = '1';
```

F8.1.112 VQADD

Vector Saturating Add adds the values of corresponding elements of two vectors, and places the results in the destination vector.

If any of the results overflow, they are saturated. The cumulative saturation bit, **FPSCR.QC**, is set if saturation occurs. For details see *Pseudocode details of saturation* on page E1-2293.

Depending on settings in the **CPACR**, **NSACR**, and **HCPTR** registers, and the security state and mode in which the instruction is executed, an attempt to execute the instruction might be UNDEFINED, or trapped to Hyp mode. *Summary of access controls for Advanced SIMD functionality* on page G1-3498 summarizes these controls.

ARM deprecates the conditional execution of any Advanced SIMD instruction encoding that is not also available as a VFP instruction encoding, see *Conditional execution* on page F2-2416.

Encoding T1/A1 Advanced SIMDv1

VQADD<c>.<dt> <Qd>, <Qn>, <Qm>

VQADD<c>.<dt> <Dd>, <Dn>, <Dm>

15	14	13	12	11	10	9	8	7	6	5	4	3	2	1	0	15	14	13	12	11	10	9	8	7	6	5	4	3	2	1	0
1	1	1	U	1	1	1	1	0	D	size	Vn	Vd	0	0	0	0	N	Q	M	1	Vm										
31	30	29	28	27	26	25	24	23	22	21	20	19	18	17	16	15	14	13	12	11	10	9	8	7	6	5	4	3	2	1	0
1	1	1	1	0	0	1	U	0	D	size	Vn	Vd	0	0	0	0	N	Q	M	1	Vm										

```

if Q == '1' && (Vd<0> == '1' || Vn<0> == '1' || Vm<0> == '1') then UNDEFINED;
unsigned = (U == '1');
esize = 8 << UInt(size); elements = 64 DIV esize;
d = UInt(D:Vd); n = UInt(N:Vn); m = UInt(M:Vm); regs = if Q == '0' then 1 else 2;
    
```

Assembler syntax

VQADD{<c>}{<q>}.<type><size> {<Qd>}, <Qn>, <Qm> Encoded as Q = 1
 VQADD{<c>}{<q>}.<type><size> {<Dd>}, <Dn>, <Dm> Encoded as Q = 0

where:

<c>, <q> See [Standard assembler syntax fields on page F2-2415](#). An A32 VQADD instruction must be unconditional. ARM strongly recommends that a T32 VQADD instruction is unconditional, see [Conditional execution on page F2-2416](#).

<type> The data type for the elements of the vectors. It must be one of:

S Signed, encoded as U = 0.
 U Unsigned, encoded as U = 1.

<size> The data size for the elements of the vectors. It must be one of:

8 Encoded as size = 0b00.
 16 Encoded as size = 0b01.
 32 Encoded as size = 0b10.
 64 Encoded as size = 0b11.

<Qd>, <Qn>, <Qm> The destination vector and the operand vectors, for a quadword operation.

<Dd>, <Dn>, <Dm> The destination vector and the operand vectors, for a doubleword operation.

Operation

```
if ConditionPassed() then
    EncodingSpecificOperations(); CheckAdvSIMDEnabled();
    for r = 0 to regs-1
        for e = 0 to elements-1
            sum = Int(Elem[D[n+r],e,esize], unsigned) + Int(Elem[D[m+r],e,esize], unsigned);
            (Elem[D[d+r],e,esize], sat) = SatQ(sum, esize, unsigned);
            if sat then FPSR.QC = '1';
```

F8.1.113 VQDMLAL, VQDMLSL

Vector Saturating Doubling Multiply Accumulate Long multiplies corresponding elements in two doubleword vectors, doubles the products, and accumulates the results into the elements of a quadword vector.

Vector Saturating Doubling Multiply Subtract Long multiplies corresponding elements in two doubleword vectors, subtracts double the products from corresponding elements of a quadword vector, and places the results in the same quadword vector.

In both instructions, the second operand can be a scalar instead of a vector. For more information about scalars see [Advanced SIMD scalars on page F5-2498](#).

If any of the results overflow, they are saturated. The cumulative saturation bit, `FPSCR.QC`, is set if saturation occurs. For details see [Pseudocode details of saturation on page E1-2293](#).

Depending on settings in the `CPACR`, `NSACR`, and `HCPTR` registers, and the security state and mode in which the instruction is executed, an attempt to execute the instruction might be UNDEFINED, or trapped to Hyp mode. [Summary of access controls for Advanced SIMD functionality on page G1-3498](#) summarizes these controls.

ARM deprecates the conditional execution of any Advanced SIMD instruction encoding that is not also available as a VFP instruction encoding, see [Conditional execution on page F2-2416](#).

Encoding T1/A1 Advanced SIMDv1

VQD<op><c>.<dt> <Qd>, <Dn>, <Dm>

15	14	13	12	11	10	9	8	7	6	5	4	3	2	1	0	15	14	13	12	11	10	9	8	7	6	5	4	3	2	1	0
1	1	1	0	1	1	1	1	1	D	size	Vn	Vd	1	0	op	1	N	0	M	0	Vm										
31	30	29	28	27	26	25	24	23	22	21	20	19	18	17	16	15	14	13	12	11	10	9	8	7	6	5	4	3	2	1	0
1	1	1	1	0	0	1	0	1	D	size	Vn	Vd	1	0	op	1	N	0	M	0	Vm										

if size == '11' then SEE "Related encodings";
 if size == '00' || Vd<0> == '1' then UNDEFINED;
 add = (op == '0');
 scalar_form = FALSE; d = UInt(D:Vd); n = UInt(N:Vn); m = UInt(M:Vm);
 esize = 8 << UInt(size); elements = 64 DIV esize;

Encoding T2/A2 Advanced SIMDv1

VQD<op><c>.<dt> <Qd>, <Dn>, <Dm[x]>

15	14	13	12	11	10	9	8	7	6	5	4	3	2	1	0	15	14	13	12	11	10	9	8	7	6	5	4	3	2	1	0
1	1	1	0	1	1	1	1	1	D	size	Vn	Vd	0	op	1	1	N	1	M	0	Vm										
31	30	29	28	27	26	25	24	23	22	21	20	19	18	17	16	15	14	13	12	11	10	9	8	7	6	5	4	3	2	1	0
1	1	1	1	0	0	1	0	1	D	size	Vn	Vd	0	op	1	1	N	1	M	0	Vm										

if size == '11' then SEE "Related encodings";
 if size == '00' || Vd<0> == '1' then UNDEFINED;
 add = (op == '0');
 scalar_form = TRUE; d = UInt(D:Vd); n = UInt(N:Vn);
 if size == '01' then esize = 16; elements = 4; m = UInt(Vm<2:0>); index = UInt(M:Vm<3>);
 if size == '10' then esize = 32; elements = 2; m = UInt(Vm); index = UInt(M);

Related encodings See [Advanced SIMD data-processing instructions on page F5-2499](#).

Assembler syntax

```
VQD<op>{<c>}{<q>}.<dt> <Qd>, <Dn>, <Dm>
VQD<op>{<c>}{<q>}.<dt> <Qd>, <Dn>, <Dm[x]>
```

where:

<op> The operation. It must be one of:

MLAL	Encoded as op = 0.
MLSL	Encoded as op = 1.

<c>, <q> See [Standard assembler syntax fields on page F2-2415](#). An A32 VQDMLAL or VQDMLSL instruction must be unconditional. ARM strongly recommends that a T32 VQDMLAL or VQDMLSL instruction is unconditional, see [Conditional execution on page F2-2416](#).

<dt> The data type for the elements of the operands. It must be one of:

S16	Encoded as size = 0b01.
S32	Encoded as size = 0b10.

<Qd>, <Dn> The destination vector and the first operand vector.

<Dm> The second operand vector, for an all vector operation.

<Dm[x]> The scalar for a scalar operation. If <dt> is S16, Dm is restricted to D0-D7. If <dt> is S32, Dm is restricted to D0-D15.

Operation

```
if ConditionPassed() then
    EncodingSpecificOperations(); CheckAdvSIMDEnabled();
    if scalar_form then op2 = SInt(Elem[Din[m],index,esize]);
    for e = 0 to elements-1
        if !scalar_form then op2 = SInt(Elem[Din[m],e,esize]);
        op1 = SInt(Elem[Din[n],e,esize]);
        // The following only saturates if both op1 and op2 equal -(2^(esize-1))
        (product, sat1) = SignedSatQ(2*op1*op2, 2*esize);
        if add then
            result = SInt(Elem[Qin[d>>1],e,2*esize]) + SInt(product);
        else
            result = SInt(Elem[Qin[d>>1],e,2*esize]) - SInt(product);
        (Elem[Q[d>>1],e,2*esize], sat2) = SignedSatQ(result, 2*esize);
        if sat1 || sat2 then FPSR.QC = '1';
```

F8.1.114 VQDMULH

Vector Saturating Doubling Multiply Returning High Half multiplies corresponding elements in two vectors, doubles the results, and places the most significant half of the final results in the destination vector. The results are truncated, for rounded results see [VQRDMULH](#) on page F8-3286.

The second operand can be a scalar instead of a vector. For more information about scalars see [Advanced SIMD scalars](#) on page F5-2498.

If any of the results overflow, they are saturated. The cumulative saturation bit, `FPSCR.QC`, is set if saturation occurs. For details see [Pseudocode details of saturation](#) on page E1-2293.

Depending on settings in the `CPACR`, `NSACR`, and `HCPTR` registers, and the security state and mode in which the instruction is executed, an attempt to execute the instruction might be UNDEFINED, or trapped to Hyp mode. [Summary of access controls for Advanced SIMD functionality](#) on page G1-3498 summarizes these controls.

ARM deprecates the conditional execution of any Advanced SIMD instruction encoding that is not also available as a VFP instruction encoding, see [Conditional execution](#) on page F2-2416.

Encoding T1/A1 Advanced SIMDv1

VQDMULH<c>.<dt> <Qd>, <Qn>, <Qm>

VQDMULH<c>.<dt> <Dd>, <Dn>, <Dm>

15	14	13	12	11	10	9	8	7	6	5	4	3	2	1	0	15	14	13	12	11	10	9	8	7	6	5	4	3	2	1	0
1	1	1	0	1	1	1	1	0	D	size	Vn	Vd	1	0	1	1	N	Q	M	0	Vm										

31	30	29	28	27	26	25	24	23	22	21	20	19	18	17	16	15	14	13	12	11	10	9	8	7	6	5	4	3	2	1	0
1	1	1	1	0	0	1	0	0	D	size	Vn	Vd	1	0	1	1	N	Q	M	0	Vm										

```
if Q == '1' && (Vd<0> == '1' || Vn<0> == '1' || Vm<0> == '1') then UNDEFINED;
if size == '00' || size == '11' then UNDEFINED;
scalar_form = FALSE; esize = 8 << UInt(size); elements = 64 DIV esize;
d = UInt(D:Vd); n = UInt(N:Vn); m = UInt(M:Vm); regs = if Q == '0' then 1 else 2;
```

Encoding T2/A2 Advanced SIMDv1

VQDMULH<c>.<dt> <Qd>, <Qn>, <Dm[x]>

VQDMULH<c>.<dt> <Dd>, <Dn>, <Dm[x]>

15	14	13	12	11	10	9	8	7	6	5	4	3	2	1	0	15	14	13	12	11	10	9	8	7	6	5	4	3	2	1	0
1	1	1	Q	1	1	1	1	1	D	size	Vn	Vd	1	1	0	0	N	1	M	0	Vm										

31	30	29	28	27	26	25	24	23	22	21	20	19	18	17	16	15	14	13	12	11	10	9	8	7	6	5	4	3	2	1	0
1	1	1	1	0	0	1	Q	1	D	size	Vn	Vd	1	1	0	0	N	1	M	0	Vm										

```
if size == '11' then SEE "Related encodings";
if size == '00' then UNDEFINED;
if Q == '1' && (Vd<0> == '1' || Vn<0> == '1') then UNDEFINED;
scalar_form = TRUE; d = UInt(D:Vd); n = UInt(N:Vn); regs = if Q == '0' then 1 else 2;
if size == '01' then esize = 16; elements = 4; m = UInt(Vm<2:0>); index = UInt(M:Vm<3>);
if size == '10' then esize = 32; elements = 2; m = UInt(Vm); index = UInt(M);
```

Related encodings See [Advanced SIMD data-processing instructions](#) on page F5-2499.

Assembler syntax

VQDMULH{<c>}{<q>}.<dt> {<Qd>}, <Qn>, <Qm>	Encoding T1/A1, encoded as Q = 1
VQDMULH{<c>}{<q>}.<dt> {<Dd>}, <Dn>, <Dm>	Encoding T1/A1, encoded as Q = 0
VQDMULH{<c>}{<q>}.<dt> {<Qd>}, <Qn>, <Dm[x]>	Encoding T2/A2, encoded as Q = 1
VQDMULH{<c>}{<q>}.<dt> {<Dd>}, <Dn>, <Dm[x]>	Encoding T2/A2, encoded as Q = 0

where:

<c>, <q>	See Standard assembler syntax fields on page F2-2415 . An A32 VQDMULH instruction must be unconditional. ARM strongly recommends that a T32 VQDMULH instruction is unconditional, see Conditional execution on page F2-2416 .
<dt>	The data type for the elements of the operands. It must be one of: S16 Encoded as size = 0b01. S32 Encoded as size = 0b10.
<Qd>, <Qn>	The destination vector and the first operand vector, for a quadword operation.
<Dd>, <Dn>	The destination vector and the first operand vector, for a doubleword operation.
<Qm>	The second operand vector, for a quadword all vector operation.
<Dm>	The second operand vector, for a doubleword all vector operation.
<Dm[x]>	The scalar for either a quadword or a doubleword scalar operation. If <dt> is S16, Dm is restricted to D0-D7. If <dt> is S32, Dm is restricted to D0-D15.

Operation

```

if ConditionPassed() then
    EncodingSpecificOperations(); CheckAdvSIMDEnabled();
    if scalar_form then op2 = SInt(Elem[D[m],index,esize]);
    for r = 0 to regs-1
        for e = 0 to elements-1
            if !scalar_form then op2 = SInt(Elem[D[m+r],e,esize]);
            op1 = SInt(Elem[D[n+r],e,esize]);
            // The following only saturates if both op1 and op2 equal -(2^(esize-1))
            (result, sat) = SignedSatQ((2*op1*op2) >> esize, esize);
            Elem[D[d+r],e,esize] = result;
            if sat then FPSR.QC = '1';
  
```

F8.1.115 VQDMULL

Vector Saturating Doubling Multiply Long multiplies corresponding elements in two doubleword vectors, doubles the products, and places the results in a quadword vector.

The second operand can be a scalar instead of a vector. For more information about scalars see [Advanced SIMD scalars](#) on page F5-2498.

If any of the results overflow, they are saturated. The cumulative saturation bit, `FPSCR.QC`, is set if saturation occurs. For details see [Pseudocode details of saturation](#) on page E1-2293.

Depending on settings in the `CPACR`, `NSACR`, and `HCPTTR` registers, and the security state and mode in which the instruction is executed, an attempt to execute the instruction might be UNDEFINED, or trapped to Hyp mode. [Summary of access controls for Advanced SIMD functionality](#) on page G1-3498 summarizes these controls.

ARM deprecates the conditional execution of any Advanced SIMD instruction encoding that is not also available as a VFP instruction encoding, see [Conditional execution](#) on page F2-2416.

Encoding T1/A1 Advanced SIMDv1

VQDMULL<c>.<dt> <Qd>, <Dn>, <Dm>

15	14	13	12	11	10	9	8	7	6	5	4	3	2	1	0	15	14	13	12	11	10	9	8	7	6	5	4	3	2	1	0
1	1	1	0	1	1	1	1	1	D	size		Vn		Vd		1	1	0	1	N	0	M	0		Vm						
31	30	29	28	27	26	25	24	23	22	21	20	19	18	17	16	15	14	13	12	11	10	9	8	7	6	5	4	3	2	1	0
1	1	1	1	0	0	1	0	1	D	size		Vn		Vd		1	1	0	1	N	0	M	0		Vm						

if size == '11' then SEE "Related encodings";
 if size == '00' || Vd<0> == '1' then UNDEFINED;
 scalar_form = FALSE; d = UInt(D:Vd); n = UInt(N:Vn); m = UInt(M:Vm);
 esize = 8 << UInt(size); elements = 64 DIV esize;

Encoding T2/A2 Advanced SIMDv1

VQDMULL<c>.<dt> <Qd>, <Dn>, <Dm[x]>

15	14	13	12	11	10	9	8	7	6	5	4	3	2	1	0	15	14	13	12	11	10	9	8	7	6	5	4	3	2	1	0
1	1	1	0	1	1	1	1	1	D	size		Vn		Vd		1	0	1	1	N	1	M	0		Vm						
31	30	29	28	27	26	25	24	23	22	21	20	19	18	17	16	15	14	13	12	11	10	9	8	7	6	5	4	3	2	1	0
1	1	1	1	0	0	1	0	1	D	size		Vn		Vd		1	0	1	1	N	1	M	0		Vm						

if size == '11' then SEE "Related encodings";
 if size == '00' || Vd<0> == '1' then UNDEFINED;
 scalar_form = TRUE; d = UInt(D:Vd); n = UInt(N:Vn);
 if size == '01' then esize = 16; elements = 4; m = UInt(Vm<2:0>); index = UInt(M:Vm<3>);
 if size == '10' then esize = 32; elements = 2; m = UInt(Vm); index = UInt(M);

Related encodings See [Advanced SIMD data-processing instructions](#) on page F5-2499.

Assembler syntax

```
VQDMULL{<c>}{<q>}.<dt> <Qd>, <Dn>, <Dm>  
VQDMULL{<c>}{<q>}.<dt> <Qd>, <Dn>, <Dm[x]>
```

where:

<c>, <q> See [Standard assembler syntax fields on page F2-2415](#). An A32 VQDMULL instruction must be unconditional. ARM strongly recommends that a T32 VQDMULL instruction is unconditional, see [Conditional execution on page F2-2416](#).

<dt> The data type for the elements of the operands. It must be one of:
S16 Encoded as size = 0b01.
S32 Encoded as size = 0b10.

<Qd>, <Dn> The destination vector and the first operand vector.

<Dm> The second operand vector, for an all vector operation.

<Dm[x]> The scalar for a scalar operation. If <dt> is S16, Dm is restricted to D0-D7. If <dt> is S32, Dm is restricted to D0-D15.

Operation

```
if ConditionPassed() then  
    EncodingSpecificOperations(); CheckAdvSIMDEnabled();  
    if scalar_form then op2 = SInt(Elem[Din[m],index,esize]);  
    for e = 0 to elements-1  
        if !scalar_form then op2 = SInt(Elem[Din[m],e,esize]);  
        op1 = SInt(Elem[Din[n],e,esize]);  
        // The following only saturates if both op1 and op2 equal  $-(2^{(esize-1)})$   
        (product, sat) = SignedSatQ(2*op1*op2, 2*esize);  
        Elem[Q[d>>1],e,2*esize] = product;  
        if sat then FPSR.QC = '1';
```

F8.1.116 VQMOVN, VQMOVUN

Vector Saturating Move and Narrow copies each element of the operand vector to the corresponding element of the destination vector.

The operand is a quadword vector. The elements can be any one of:

- 16-bit, 32-bit, or 64-bit signed integers.
- 16-bit, 32-bit, or 64-bit unsigned integers.

The result is a doubleword vector. The elements are half the length of the operand vector elements. If the operand is unsigned, the results are unsigned. If the operand is signed, the results can be signed or unsigned.

If any of the results overflow, they are saturated. The cumulative saturation bit, `FPSCR.QC`, is set if saturation occurs. For details see [Pseudocode details of saturation on page E1-2293](#).

Depending on settings in the `CPACR`, `NSACR`, and `HCPTR` registers, and the security state and mode in which the instruction is executed, an attempt to execute the instruction might be UNDEFINED, or trapped to Hyp mode. [Summary of access controls for Advanced SIMD functionality on page G1-3498](#) summarizes these controls.

ARM deprecates the conditional execution of any Advanced SIMD instruction encoding that is not also available as a VFP instruction encoding, see [Conditional execution on page F2-2416](#).

Encoding T1/A1 Advanced SIMDv1

VQMOV{U}N<c>.<type><size> <Dd>, <Qm>

15	14	13	12	11	10	9	8	7	6	5	4	3	2	1	0	15	14	13	12	11	10	9	8	7	6	5	4	3	2	1	0
1	1	1	1	1	1	1	1	1	D	1	1	size	1	0	Vd	0	0	1	0	op	M	0	Vm								
31	30	29	28	27	26	25	24	23	22	21	20	19	18	17	16	15	14	13	12	11	10	9	8	7	6	5	4	3	2	1	0
1	1	1	1	0	0	1	1	1	D	1	1	size	1	0	Vd	0	0	1	0	op	M	0	Vm								

```

if op == '00' then SEE VMOVN;
if size == '11' || Vm<0> == '1' then UNDEFINED;
src_unsigned = (op == '11'); dest_unsigned = (op<0> == '1');
esize = 8 << UInt(size); elements = 64 DIV esize;
d = UInt(D:Vd); m = UInt(M:Vm);
    
```

Assembler syntax

VQMOV{U}N{<c>}{<q>}.<type><size> <Dd>, <Qm>

where:

- U If present, specifies that the operation produces unsigned results, even though the operands are signed. Encoded as `op = 0b01`.
- <c>, <q> See [Standard assembler syntax fields on page F2-2415](#). An A32 VQMOVN or VQMOVUN instruction must be unconditional. ARM strongly recommends that a T32 VQMOVN or VQMOVUN instruction is unconditional, see [Conditional execution on page F2-2416](#).
- <type> The data type for the elements of the operand. It must be one of:
- S Encoded as:
- `op = 0b10` for VQMOVN.
 - `op = 0b01` for VQMOVUN.
- U Encoded as `op = 0b11`. Not available for VQMOVUN.
- <size> The data size for the elements of the operand. It must be one of:
- 16 Encoded as `size = 0b00`.
- 32 Encoded as `size = 0b01`.
- 64 Encoded as `size = 0b10`.
- <Dd>, <Qm> The destination vector and the operand vector.

Operation

```
if ConditionPassed() then
    EncodingSpecificOperations(); CheckAdvSIMDEnabled();
    for e = 0 to elements-1
        operand = Int(Elem[Qin[m]>1],e,2*esize], src_unsigned);
        (Elem[D[d],e,esize], sat) = SatQ(operand, esize, dest_unsigned);
        if sat then FPSR.QC = '1';
```

F8.1.117 VQNEG

Vector Saturating Negate negates each element in a vector, and places the results in the destination vector.

If any of the results overflow, they are saturated. The cumulative saturation bit, `FPSCR.QC`, is set if saturation occurs. For details see *Pseudocode details of saturation on page E1-2293*.

Depending on settings in the `CPACR`, `NSACR`, and `HCPTR` registers, and the security state and mode in which the instruction is executed, an attempt to execute the instruction might be UNDEFINED, or trapped to Hyp mode. *Summary of access controls for Advanced SIMD functionality on page G1-3498* summarizes these controls.

ARM deprecates the conditional execution of any Advanced SIMD instruction encoding that is not also available as a VFP instruction encoding, see *Conditional execution on page F2-2416*.

Encoding T1/A1 Advanced SIMDv1

VQNEG<c>.<dt> <Qd>, <Qm>

VQNEG<c>.<dt> <Dd>, <Dm>

15	14	13	12	11	10	9	8	7	6	5	4	3	2	1	0	15	14	13	12	11	10	9	8	7	6	5	4	3	2	1	0
1	1	1	1	1	1	1	1	D	1	1	size	0	0			Vd	0	1	1	1	1	Q	M	0		Vm					

31	30	29	28	27	26	25	24	23	22	21	20	19	18	17	16	15	14	13	12	11	10	9	8	7	6	5	4	3	2	1	0
1	1	1	1	0	0	1	1	1	D	1	1	size	0	0		Vd	0	1	1	1	1	Q	M	0		Vm					

```

if size == '11' then UNDEFINED;
if Q == '1' && (Vd<0> == '1' || Vm<0> == '1') then UNDEFINED;
esize = 8 << UInt(size); elements = 64 DIV esize;
d = UInt(D:Vd); m = UInt(M:Vm); regs = if Q == '0' then 1 else 2;
    
```

Assembler syntax

VQNEG{<c>}{<q>}.<dt> <Qd>, <Qm> Encoded as Q = 1
VQNEG{<c>}{<q>}.<dt> <Dd>, <Dm> Encoded as Q = 0

where:

<c>, <q> See [Standard assembler syntax fields on page F2-2415](#). An A32 VQNEG instruction must be unconditional. ARM strongly recommends that a T32 VQNEG instruction is unconditional, see [Conditional execution on page F2-2416](#).

<dt> The data type for the elements of the vectors. It must be one of:
S8 Encoded as size = 0b00.
S16 Encoded as size = 0b01.
S32 Encoded as size = 0b10.

<Qd>, <Qm> The destination vector and the operand vector, for a quadword operation.

<Dd>, <Dm> The destination vector and the operand vector, for a doubleword operation.

Operation

```
if ConditionPassed() then
    EncodingSpecificOperations(); CheckAdvSIMDEnabled();
    for r = 0 to regs-1
        for e = 0 to elements-1
            result = -SInt(Elem[D[m+r],e,esize]);
            (Elem[D[d+r],e,esize], sat) = SignedSatQ(result, esize);
            if sat then FPSR.QC = '1';
```

F8.1.118 VQRDMULH

Vector Saturating Rounding Doubling Multiply Returning High Half multiplies corresponding elements in two vectors, doubles the results, and places the most significant half of the final results in the destination vector. The results are rounded. For truncated results see [VQDMULH](#) on page F8-3278.

The second operand can be a scalar instead of a vector. For more information about scalars see [Advanced SIMD scalars](#) on page F5-2498.

If any of the results overflow, they are saturated. The cumulative saturation bit, `FPSCR.QC`, is set if saturation occurs. For details see [Pseudocode details of saturation](#) on page E1-2293.

Depending on settings in the `CPACR`, `NSACR`, and `HCPTR` registers, and the security state and mode in which the instruction is executed, an attempt to execute the instruction might be UNDEFINED, or trapped to Hyp mode. [Summary of access controls for Advanced SIMD functionality](#) on page G1-3498 summarizes these controls.

ARM deprecates the conditional execution of any Advanced SIMD instruction encoding that is not also available as a VFP instruction encoding, see [Conditional execution](#) on page F2-2416.

Encoding T1/A1 Advanced SIMDv1

VQRDMULH<c>.<dt> <Qd>, <Qn>, <Qm>

VQRDMULH<c>.<dt> <Dd>, <Dn>, <Dm>

15	14	13	12	11	10	9	8	7	6	5	4	3	2	1	0	15	14	13	12	11	10	9	8	7	6	5	4	3	2	1	0
1	1	1	1	1	1	1	1	0	D	size	Vn	Vd	1	0	1	1	N	Q	M	0	Vm										

31	30	29	28	27	26	25	24	23	22	21	20	19	18	17	16	15	14	13	12	11	10	9	8	7	6	5	4	3	2	1	0
1	1	1	1	0	0	1	1	0	D	size	Vn	Vd	1	0	1	1	N	Q	M	0	Vm										

```
if Q == '1' && (Vd<0> == '1' || Vn<0> == '1' || Vm<0> == '1') then UNDEFINED;
if size == '00' || size == '11' then UNDEFINED;
scalar_form = FALSE; esize = 8 << UInt(size); elements = 64 DIV esize;
d = UInt(D:Vd); n = UInt(N:Vn); m = UInt(M:Vm); regs = if Q == '0' then 1 else 2;
```

Encoding T2/A2 Advanced SIMDv1

VQRDMULH<c>.<dt> <Qd>, <Qn>, <Dm[x]>

VQRDMULH<c>.<dt> <Dd>, <Dn>, <Dm[x]>

15	14	13	12	11	10	9	8	7	6	5	4	3	2	1	0	15	14	13	12	11	10	9	8	7	6	5	4	3	2	1	0
1	1	1	Q	1	1	1	1	1	D	size	Vn	Vd	1	1	0	1	N	1	M	0	Vm										

31	30	29	28	27	26	25	24	23	22	21	20	19	18	17	16	15	14	13	12	11	10	9	8	7	6	5	4	3	2	1	0
1	1	1	1	0	0	1	Q	1	D	size	Vn	Vd	1	1	0	1	N	1	M	0	Vm										

```
if size == '11' then SEE "Related encodings";
if size == '00' then UNDEFINED;
if Q == '1' && (Vd<0> == '1' || Vn<0> == '1') then UNDEFINED;
scalar_form = TRUE; d = UInt(D:Vd); n = UInt(N:Vn); regs = if Q == '0' then 1 else 2;
if size == '01' then esize = 16; elements = 4; m = UInt(Vm<2:0>); index = UInt(M:Vm<3>);
if size == '10' then esize = 32; elements = 2; m = UInt(Vm); index = UInt(M);
```

Related encodings See [Advanced SIMD data-processing instructions](#) on page F5-2499.

Assembler syntax

VQRDMULH{<c>}{<q>}.<dt> {<Qd>}, <Qn>, <Qm>	Encoding T1/A1, encoded as Q = 1
VQRDMULH{<c>}{<q>}.<dt> {<Dd>}, <Dn>, <Dm>	Encoding T1/A1, encoded as Q = 0
VQRDMULH{<c>}{<q>}.<dt> {<Qd>}, <Qn>, <Dm[x]>	Encoding T2/A2, encoded as Q = 1
VQRDMULH{<c>}{<q>}.<dt> {<Dd>}, <Dn>, <Dm[x]>	Encoding T2/A2, encoded as Q = 0

where:

<c>, <q>	See Standard assembler syntax fields on page F2-2415 . An A32 VQRDMULH instruction must be unconditional. ARM strongly recommends that a T32 VQRDMULH instruction is unconditional, see Conditional execution on page F2-2416 .
<dt>	The data type for the elements of the operands. It must be one of: S16 Encoded as size = 0b01. S32 Encoded as size = 0b10.
<Qd>, <Qn>	The destination vector and the first operand vector, for a quadword operation.
<Dd>, <Dn>	The destination vector and the first operand vector, for a doubleword operation.
<Qm>	The second operand vector, for a quadword all vector operation.
<Dm>	The second operand vector, for a doubleword all vector operation.
<Dm[x]>	The scalar for either a quadword or a doubleword scalar operation. If <dt> is S16, Dm is restricted to D0-D7. If <dt> is S32, Dm is restricted to D0-D15.

Operation

```

if ConditionPassed() then
    EncodingSpecificOperations(); CheckAdvSIMDEnabled();
    round_const = 1 << (esize-1);
    if scalar_form then op2 = SInt(Elem[D[m],index,esize]);
    for r = 0 to regs-1
        for e = 0 to elements-1
            op1 = SInt(Elem[D[n+r],e,esize]);
            if !scalar_form then op2 = SInt(Elem[D[m+r],e,esize]);
            (result, sat) = SignedSatQ((2*op1*op2 + round_const) >> esize, esize);
            Elem[D[d+r],e,esize] = result;
            if sat then FPSR.QC = '1';
  
```

F8.1.119 VQRSHL

Vector Saturating Rounding Shift Left takes each element in a vector, shifts them by a value from the least significant byte of the corresponding element of a second vector, and places the results in the destination vector. If the shift value is positive, the operation is a left shift. Otherwise, it is a right shift.

For truncated results see [VQSHL \(register\)](#) on page F8-3292.

The first operand and result elements are the same data type, and can be any one of:

- 8-bit, 16-bit, 32-bit, or 64-bit signed integers.
- 8-bit, 16-bit, 32-bit, or 64-bit unsigned integers.

The second operand is a signed integer of the same size.

If any of the results overflow, they are saturated. The cumulative saturation bit, `FPSCR.QC`, is set if saturation occurs. For details see [Pseudocode details of saturation](#) on page E1-2293.

Depending on settings in the `CPACR`, `NSACR`, and `HCPTR` registers, and the security state and mode in which the instruction is executed, an attempt to execute the instruction might be UNDEFINED, or trapped to Hyp mode. [Summary of access controls for Advanced SIMD functionality](#) on page G1-3498 summarizes these controls.

ARM deprecates the conditional execution of any Advanced SIMD instruction encoding that is not also available as a VFP instruction encoding, see [Conditional execution](#) on page F2-2416.

Encoding T1/A1 Advanced SIMDv1

VQRSHL<c>.<type><size> <Qd>, <Qm>, <Qn>

VQRSHL<c>.<type><size> <Dd>, <Dm>, <Dn>

15	14	13	12	11	10	9	8	7	6	5	4	3	2	1	0	15	14	13	12	11	10	9	8	7	6	5	4	3	2	1	0
1	1	1	U	1	1	1	1	0	D	size	Vn	Vd	0	1	0	1	N	Q	M	1	Vm										

31	30	29	28	27	26	25	24	23	22	21	20	19	18	17	16	15	14	13	12	11	10	9	8	7	6	5	4	3	2	1	0
1	1	1	1	0	0	1	U	0	D	size	Vn	Vd	0	1	0	1	N	Q	M	1	Vm										

```

if Q == '1' && (Vd<0> == '1' || Vm<0> == '1' || Vn<0> == '1') then UNDEFINED;
unsigned = (U == '1');
esize = 8 << UInt(size); elements = 64 DIV esize;
d = UInt(D:Vd); m = UInt(M:Vm); n = UInt(N:Vn); regs = if Q == '0' then 1 else 2;
  
```

Assembler syntax

VQRSHL{<c>}{<q>}.<type><size> {<Qd>}, <Qm>, <Qn> Encoded as Q = 1
 VQRSHL{<c>}{<q>}.<type><size> {<Dd>}, <Dm>, <Dn> Encoded as Q = 0

where:

<c>, <q> See [Standard assembler syntax fields on page F2-2415](#). An A32 VQRSHL instruction must be unconditional. ARM strongly recommends that a T32 VQRSHL instruction is unconditional, see [Conditional execution on page F2-2416](#).

<type> The data type for the elements of the vectors. It must be one of:
 S Signed, encoded as U = 0.
 U Unsigned, encoded as U = 1.
 Together with the <size> field, this indicates the data type and size of the first operand and the result.

<size> The data size for the elements of the vectors. It must be one of:
 8 Encoded as size = 0b00.
 16 Encoded as size = 0b01.
 32 Encoded as size = 0b10.
 64 Encoded as size = 0b11.

<Qd>, <Qm>, <Qn> The destination vector and the operand vectors, for a quadword operation.

<Dd>, <Dm>, <Dn> The destination vector and the operand vectors, for a doubleword operation.

Operation

```
if ConditionPassed() then
    EncodingSpecificOperations(); CheckAdvSIMDEnabled();
    for r = 0 to regs-1
        for e = 0 to elements-1
            shift = SInt(Elem[D[n+r],e,esize]<7:0>);
            round_const = 1 << (-1-shift); // 0 for left shift, 2^(n-1) for right shift
            operand = Int(Elem[D[m+r],e,esize], unsigned);
            (result, sat) = SatQ((operand + round_const) << shift, esize, unsigned);
            Elem[D[d+r],e,esize] = result;
            if sat then FPSR.QC = '1';
```

F8.1.120 VQRSHRN, VQRSHRUN

Vector Saturating Rounding Shift Right, Narrow takes each element in a quadword vector of integers, right shifts them by an immediate value, and places the rounded results in a doubleword vector.

For truncated results, see [VQSHRN, VQSHRUN on page F8-3296](#).

The operand elements must all be the same size, and can be any one of:

- 16-bit, 32-bit, or 64-bit signed integers.
- 16-bit, 32-bit, or 64-bit unsigned integers.

The result elements are half the width of the operand elements. If the operand elements are signed, the results can be either signed or unsigned. If the operand elements are unsigned, the result elements must also be unsigned.

If any of the results overflow, they are saturated. The cumulative saturation bit, [FPSCR.QC](#), is set if saturation occurs. For details see [Pseudocode details of saturation on page E1-2293](#).

Depending on settings in the [CPACR](#), [NSACR](#), and [HCPTR](#) registers, and the security state and mode in which the instruction is executed, an attempt to execute the instruction might be UNDEFINED, or trapped to Hyp mode. [Summary of access controls for Advanced SIMD functionality on page G1-3498](#) summarizes these controls.

ARM deprecates the conditional execution of any Advanced SIMD instruction encoding that is not also available as a VFP instruction encoding, see [Conditional execution on page F2-2416](#).

Encoding T1/A1 Advanced SIMDv1

VQRSHR{U}N<c>.<type><size> <Dd>, <Qm>, #<imm>

15	14	13	12	11	10	9	8	7	6	5	4	3	2	1	0	15	14	13	12	11	10	9	8	7	6	5	4	3	2	1	0
1	1	1	U	1	1	1	1	1	D	imm6						Vd	1	0	0	op	0	1	M	1	Vm						
31	30	29	28	27	26	25	24	23	22	21	20	19	18	17	16	15	14	13	12	11	10	9	8	7	6	5	4	3	2	1	0
1	1	1	1	0	0	1	U	1	D	imm6						Vd	1	0	0	op	0	1	M	1	Vm						

```

if imm6 == '000xxx' then SEE "Related encodings";
if U == '0' && op == '0' then SEE VRSHRN;
if Vm<0> == '1' then UNDEFINED;
case imm6 of
    when "001xxx" esize = 8; elements = 8; shift_amount = 16 - UInt(imm6);
    when "01xxxx" esize = 16; elements = 4; shift_amount = 32 - UInt(imm6);
    when "1xxxxx" esize = 32; elements = 2; shift_amount = 64 - UInt(imm6);
src_unsigned = (U == '1' && op == '1'); dest_unsigned = (U == '1');
d = UInt(D:Vd); m = UInt(M:Vm);
    
```

Related encodings See [One register and a modified immediate value on page F5-2508](#).

Assembler syntax

VQRSHR{U}N{<c>}{<q>}.<type><size> <Dd>, <Qm>, #<imm>

where:

U	If present, specifies that the results are unsigned, although the operands are signed.						
<c>, <q>	See <i>Standard assembler syntax fields</i> on page F2-2415. An A32 VQRSHRN or VQRSHRUN instruction must be unconditional. ARM strongly recommends that a T32 VQRSHRN or VQRSHRUN instruction is unconditional, see <i>Conditional execution</i> on page F2-2416.						
<type>	The data type for the elements of the vectors. It must be one of: <table> <tr> <td>S</td> <td>Signed. Encoded as: <ul style="list-style-type: none"> U = 0, op = 1, for VQRSHRN. U = 1, op = 0, for VQRSHRUN. </td> </tr> <tr> <td>U</td> <td>Unsigned: <ul style="list-style-type: none"> Encoded as U = 1, op = 1, for VQRSHRN. Not available for VQRSHRUN. </td> </tr> </table>	S	Signed. Encoded as: <ul style="list-style-type: none"> U = 0, op = 1, for VQRSHRN. U = 1, op = 0, for VQRSHRUN. 	U	Unsigned: <ul style="list-style-type: none"> Encoded as U = 1, op = 1, for VQRSHRN. Not available for VQRSHRUN. 		
S	Signed. Encoded as: <ul style="list-style-type: none"> U = 0, op = 1, for VQRSHRN. U = 1, op = 0, for VQRSHRUN. 						
U	Unsigned: <ul style="list-style-type: none"> Encoded as U = 1, op = 1, for VQRSHRN. Not available for VQRSHRUN. 						
<size>	The data size for the elements of the vectors. It must be one of: <table> <tr> <td>16</td> <td>Encoded as imm6<5:3> = 0b001. (8 – <imm>) is encoded in imm6<2:0>.</td> </tr> <tr> <td>32</td> <td>Encoded as imm6<5:4> = 0b01. (16 – <imm>) is encoded in imm6<3:0>.</td> </tr> <tr> <td>64</td> <td>Encoded as imm6<5> = 0b1. (32 – <imm>) is encoded in imm6<4:0>.</td> </tr> </table>	16	Encoded as imm6<5:3> = 0b001. (8 – <imm>) is encoded in imm6<2:0>.	32	Encoded as imm6<5:4> = 0b01. (16 – <imm>) is encoded in imm6<3:0>.	64	Encoded as imm6<5> = 0b1. (32 – <imm>) is encoded in imm6<4:0>.
16	Encoded as imm6<5:3> = 0b001. (8 – <imm>) is encoded in imm6<2:0>.						
32	Encoded as imm6<5:4> = 0b01. (16 – <imm>) is encoded in imm6<3:0>.						
64	Encoded as imm6<5> = 0b1. (32 – <imm>) is encoded in imm6<4:0>.						
<Dd>, <Qm>	The destination vector and the operand vector.						
<imm>	The immediate value, in the range 1 to <size>/2. See the description of <size> for how <imm> is encoded.						

Operation

```

if ConditionPassed() then
    EncodingSpecificOperations(); CheckAdvSIMDEnabled();
    round_const = 1 << (shift_amount - 1);
    for e = 0 to elements-1
        operand = Int(Elem[Qin[m]>>1],e,2*esize], src_unsigned);
        (result, sat) = SatQ((operand + round_const) >> shift_amount, esize, dest_unsigned);
        Elem[D[d],e,esize] = result;
        if sat then FPSR.QC = '1';
  
```

Pseudo-instructions

VQRSHRN.I<size> <Dd>, <Qm>, #0	is a synonym for	VQMOVN.I<size> <Dd>, <Qm>
VQRSHRUN.I<size> <Dd>, <Qm>, #0	is a synonym for	VQMOVUN.I<size> <Dd>, <Qm>

F8.1.121 VQSHL (register)

Vector Saturating Shift Left (register) takes each element in a vector, shifts them by a value from the least significant byte of the corresponding element of a second vector, and places the results in the destination vector. If the shift value is positive, the operation is a left shift. Otherwise, it is a right shift.

The results are truncated. For rounded results, see [VQRSHL on page F8-3288](#).

The first operand and result elements are the same data type, and can be any one of:

- 8-bit, 16-bit, 32-bit, or 64-bit signed integers.
- 8-bit, 16-bit, 32-bit, or 64-bit unsigned integers.

The second operand is a signed integer of the same size.

If any of the results overflow, they are saturated. The cumulative saturation bit, `FPSCR.QC`, is set if saturation occurs. For details see [Pseudocode details of saturation on page E1-2293](#).

Depending on settings in the `CPACR`, `NSACR`, and `HCPTR` registers, and the security state and mode in which the instruction is executed, an attempt to execute the instruction might be UNDEFINED, or trapped to Hyp mode. [Summary of access controls for Advanced SIMD functionality on page G1-3498](#) summarizes these controls.

ARM deprecates the conditional execution of any Advanced SIMD instruction encoding that is not also available as a VFP instruction encoding, see [Conditional execution on page F2-2416](#).

Encoding T1/A1 Advanced SIMDv1

VQSHL<c>.<type><size> <Qd>, <Qm>, <Qn>

VQSHL<c>.<type><size> <Dd>, <Dm>, <Dn>

15	14	13	12	11	10	9	8	7	6	5	4	3	2	1	0	15	14	13	12	11	10	9	8	7	6	5	4	3	2	1	0
1	1	1	U	1	1	1	1	0	D	size	Vn	Vd	0	1	0	0	N	Q	M	1	Vm										

31	30	29	28	27	26	25	24	23	22	21	20	19	18	17	16	15	14	13	12	11	10	9	8	7	6	5	4	3	2	1	0
1	1	1	1	0	0	1	U	0	D	size	Vn	Vd	0	1	0	0	N	Q	M	1	Vm										

```

if Q == '1' && (Vd<0> == '1' || Vm<0> == '1' || Vn<0> == '1') then UNDEFINED;
unsigned = (U == '1');
esize = 8 << UInt(size); elements = 64 DIV esize;
d = UInt(D:Vd); m = UInt(M:Vm); n = UInt(N:Vn); regs = if Q == '0' then 1 else 2;
    
```

Assembler syntax

VQSHL{<c>}{<q>}.<type><size> {<Qd>}, <Qm>, <Qn> Encoded as Q = 1
 VQSHL{<c>}{<q>}.<type><size> {<Dd>}, <Dm>, <Dn> Encoded as Q = 0

where:

<c>, <q> See [Standard assembler syntax fields on page F2-2415](#). An A32 VQSHL instruction must be unconditional. ARM strongly recommends that a T32 VQSHL instruction is unconditional, see [Conditional execution on page F2-2416](#).

<type> The data type for the elements of the vectors. It must be one of:
 S Signed, encoded as U = 0.
 U Unsigned, encoded as U = 1.
 Together with the <size> field, this indicates the data type and size of the first operand and the result.

<size> The data size for the elements of the vectors. It must be one of:
 8 Encoded as size = 0b00.
 16 Encoded as size = 0b01.
 32 Encoded as size = 0b10.
 64 Encoded as size = 0b11.

<Qd>, <Qm>, <Qn> The destination vector and the operand vectors, for a quadword operation.

<Dd>, <Dm>, <Dn> The destination vector and the operand vectors, for a doubleword operation.

Operation

```

if ConditionPassed() then
    EncodingSpecificOperations(); CheckAdvSIMDEnabled();
    for r = 0 to regs-1
        for e = 0 to elements-1
            shift = SInt(Elem[D[n+r],e,esize]<7:0>);
            operand = Int(Elem[D[m+r],e,esize], unsigned);
            (result,sat) = SatQ(operand << shift, esize, unsigned);
            Elem[D[d+r],e,esize] = result;
            if sat then FPSR.QC = '1';
  
```

F8.1.122 VQSHL, VQSHLU (immediate)

Vector Saturating Shift Left (immediate) takes each element in a vector of integers, left shifts them by an immediate value, and places the results in a second vector.

The operand elements must all be the same size, and can be any one of:

- 8-bit, 16-bit, 32-bit, or 64-bit signed integers.
- 8-bit, 16-bit, 32-bit, or 64-bit unsigned integers.

The result elements are the same size as the operand elements. If the operand elements are signed, the results can be either signed or unsigned. If the operand elements are unsigned, the result elements must also be unsigned.

If any of the results overflow, they are saturated. The cumulative saturation bit, `FPSCR.QC`, is set if saturation occurs. For details see [Pseudocode details of saturation on page E1-2293](#).

Depending on settings in the `CPACR`, `NSACR`, and `HCPTR` registers, and the security state and mode in which the instruction is executed, an attempt to execute the instruction might be UNDEFINED, or trapped to Hyp mode. [Summary of access controls for Advanced SIMD functionality on page G1-3498](#) summarizes these controls.

ARM deprecates the conditional execution of any Advanced SIMD instruction encoding that is not also available as a VFP instruction encoding, see [Conditional execution on page F2-2416](#).

Encoding T1/A1 Advanced SIMDv1

VQSHL{U}<c>.<type><size> <Qd>, <Qm>, #<imm>

VQSHL{U}<c>.<type><size> <Dd>, <Dm>, #<imm>

15	14	13	12	11	10	9	8	7	6	5	4	3	2	1	0	15	14	13	12	11	10	9	8	7	6	5	4	3	2	1	0
1	1	1	U	1	1	1	1	1	D	imm6						Vd	0	1	1	op	L	Q	M	1	Vm						

31	30	29	28	27	26	25	24	23	22	21	20	19	18	17	16	15	14	13	12	11	10	9	8	7	6	5	4	3	2	1	0
1	1	1	1	0	0	1	U	1	D	imm6						Vd	0	1	1	op	L	Q	M	1	Vm						

```

if (L:imm6) == '0000xxx' then SEE "Related encodings";
if U == '0' && op == '0' then UNDEFINED;
if Q == '1' && (Vd<0> == '1' || Vm<0> == '1') then UNDEFINED;
case L:imm6 of
  when "0001xxx" esize = 8; elements = 8; shift_amount = UInt(imm6) - 8;
  when "001xxxx" esize = 16; elements = 4; shift_amount = UInt(imm6) - 16;
  when "01xxxxx" esize = 32; elements = 2; shift_amount = UInt(imm6) - 32;
  when "1xxxxxx" esize = 64; elements = 1; shift_amount = UInt(imm6);
src_unsigned = (U == '1' && op == '1'); dest_unsigned = (U == '1');
d = UInt(D:Vd); m = UInt(M:Vm); regs = if Q == '0' then 1 else 2;
  
```

Related encodings See [One register and a modified immediate value on page F5-2508](#).

Assembler syntax

VQSHL{U}{<c>}{<q>}.<type><size> {<Qd>}, <Qm>, #<imm> Encoded as Q = 1
 VQSHL{U}{<c>}{<q>}.<type><size> {<Dd>}, <Dm>, #<imm> Encoded as Q = 0

where:

U If present, specifies that the results are unsigned, although the operands are signed.

<c>, <q> See [Standard assembler syntax fields on page F2-2415](#). An A32 VQSHL or VQSHLU instruction must be unconditional. ARM strongly recommends that a T32 VQSHL or VQSHLU instruction is unconditional, see [Conditional execution on page F2-2416](#).

<type> The data type for the elements of the vectors. It must be one of:

S Signed. Encoded as:

- U = 0, op = 1, for VQSHL.
- U = 1, op = 0, for VQSHLU.

U Unsigned:

- Encoded as U = 1, op = 1, for VQSHL.
- Not available for VQSHLU.

<size> The data size for the elements of the vectors. It must be one of:

8 Encoded as L = 0, imm6<5:3> = 0b001. <imm> is encoded in imm6<2:0>.

16 Encoded as L = 0, imm6<5:4> = 0b01. <imm> is encoded in imm6<3:0>.

32 Encoded as L = 0, imm6<5> = 0b1. <imm> is encoded in imm6<4:0>.

64 Encoded as L = 1. <imm> is encoded in imm6<5:0>.

<Qd>, <Qm> The destination vector, and the operand vector, for a quadword operation.

<Dd>, <Dm> The destination vector, and the operand vector, for a doubleword operation.

<imm> The immediate value, in the range 0 to <size>-1. See the description of <size> for how <imm> is encoded.

Operation

```

if ConditionPassed() then
    EncodingSpecificOperations(); CheckAdvSIMDEnabled();
    for r = 0 to regs-1
        for e = 0 to elements-1
            operand = Int(Elem[D[m+r],e,esize], src_unsigned);
            (result, sat) = SatQ(operand << shift_amount, esize, dest_unsigned);
            Elem[D[d+r],e,esize] = result;
            if sat then FPSR.QC = '1';
  
```

F8.1.123 VQSHRN, VQSHRUN

Vector Saturating Shift Right, Narrow takes each element in a quadword vector of integers, right shifts them by an immediate value, and places the truncated results in a doubleword vector.

For rounded results, see [VQRSHRN, VQRSHRUN on page F8-3290](#).

The operand elements must all be the same size, and can be any one of:

- 16-bit, 32-bit, or 64-bit signed integers.
- 16-bit, 32-bit, or 64-bit unsigned integers.

The result elements are half the width of the operand elements. If the operand elements are signed, the results can be either signed or unsigned. If the operand elements are unsigned, the result elements must also be unsigned.

If any of the results overflow, they are saturated. The cumulative saturation bit, [FPSCR.QC](#), is set if saturation occurs. For details see [Pseudocode details of saturation on page E1-2293](#).

Depending on settings in the [CPACR](#), [NSACR](#), and [HCPTR](#) registers, and the security state and mode in which the instruction is executed, an attempt to execute the instruction might be UNDEFINED, or trapped to Hyp mode. [Summary of access controls for Advanced SIMD functionality on page G1-3498](#) summarizes these controls.

ARM deprecates the conditional execution of any Advanced SIMD instruction encoding that is not also available as a VFP instruction encoding, see [Conditional execution on page F2-2416](#).

Encoding T1/A1 Advanced SIMDv1

VQSHR{U}N<c>.<type><size> <Dd>, <Qm>, #<imm>

15	14	13	12	11	10	9	8	7	6	5	4	3	2	1	0	15	14	13	12	11	10	9	8	7	6	5	4	3	2	1	0
1	1	1	U	1	1	1	1	1	D	imm6						Vd	1	0	0	op	0	0	M	1	Vm						
31	30	29	28	27	26	25	24	23	22	21	20	19	18	17	16	15	14	13	12	11	10	9	8	7	6	5	4	3	2	1	0
1	1	1	1	0	0	1	U	1	D	imm6						Vd	1	0	0	op	0	0	M	1	Vm						

```

if imm6 == '000xxx' then SEE "Related encodings";
if U == '0' && op == '0' then SEE VSHRN;
if Vm<0> == '1' then UNDEFINED;
case imm6 of
    when "001xxx" esize = 8; elements = 8; shift_amount = 16 - UInt(imm6);
    when "01xxxx" esize = 16; elements = 4; shift_amount = 32 - UInt(imm6);
    when "1xxxxx" esize = 32; elements = 2; shift_amount = 64 - UInt(imm6);
src_unsigned = (U == '1' && op == '1'); dest_unsigned = (U == '1');
d = UInt(D:Vd); m = UInt(M:Vm);
    
```

Related encodings See [One register and a modified immediate value on page F5-2508](#).

Assembler syntax

VQSHR{U}N{<c>}{<q>}.<type><size> <Dd>, <Qm>, #<imm>

where:

- U If present, specifies that the results are unsigned, although the operands are signed.
- <c>, <q> See *Standard assembler syntax fields* on page F2-2415. An A32 VQSHRN or VQSHRUN instruction must be unconditional. ARM strongly recommends that a T32 VQSHRN or VQSHRUN instruction is unconditional, see *Conditional execution* on page F2-2416.
- <type> The data type for the elements of the vectors. It must be one of:
- S Signed. Encoded as:
 - U = 0, op = 1, for VQSHRN.
 - U = 1, op = 0, for VQSHRUN.
 - U Unsigned:
 - Encoded as U = 1, op = 1, for VQSHRN.
 - Not available for VQSHRUN.
- <size> The data size for the elements of the vectors. It must be one of:
- 16 Encoded as imm6<5:3> = 0b001. (8 – <imm>) is encoded in imm6<2:0>.
 - 32 Encoded as imm6<5:4> = 0b01. (16 – <imm>) is encoded in imm6<3:0>.
 - 64 Encoded as imm6<5> = 0b1. (32 – <imm>) is encoded in imm6<4:0>.
- <Dd>, <Qm> The destination vector, and the operand vector.
- <imm> The immediate value, in the range 1 to <size>/2. See the description of <size> for how <imm> is encoded.

Operation

```

if ConditionPassed() then
    EncodingSpecificOperations(); CheckAdvSIMDEnabled();
    for e = 0 to elements-1
        operand = Int(Elem[Qin[m]>>1],e,2*esize), src_unsigned);
        (result, sat) = SatQ(operand >> shift_amount, esize, dest_unsigned);
        Elem[D[d],e,esize] = result;
        if sat then FPSR.QC = '1';
  
```

Pseudo-instructions

VQSHRN.I<size> <Dd>, <Qm>, #0 is a synonym for VQMOVN.I<size> <Dd>, <Qm>

VQSHRUN.I<size> <Dd>, <Qm>, #0 is a synonym for VQMOVUN.I<size> <Dd>, <Qm>

F8.1.124 VQSUB

Vector Saturating Subtract subtracts the elements of the second operand vector from the corresponding elements of the first operand vector, and places the results in the destination vector. Signed and unsigned operations are distinct.

The operand and result elements must all be the same type, and can be any one of:

- 8-bit, 16-bit, 32-bit, or 64-bit signed integers.
- 8-bit, 16-bit, 32-bit, or 64-bit unsigned integers.

If any of the results overflow, they are saturated. The cumulative saturation bit, `FPSCR.QC`, is set if saturation occurs. For details see [Pseudocode details of saturation on page E1-2293](#).

Depending on settings in the `CPACR`, `NSACR`, and `HCPTR` registers, and the security state and mode in which the instruction is executed, an attempt to execute the instruction might be UNDEFINED, or trapped to Hyp mode. [Summary of access controls for Advanced SIMD functionality on page G1-3498](#) summarizes these controls.

ARM deprecates the conditional execution of any Advanced SIMD instruction encoding that is not also available as a VFP instruction encoding, see [Conditional execution on page F2-2416](#).

Encoding T1/A1 Advanced SIMDv1

VQSUB<c>.<type><size> <Qd>, <Qn>, <Qm>

VQSUB<c>.<type><size> <Dd>, <Dn>, <Dm>

15	14	13	12	11	10	9	8	7	6	5	4	3	2	1	0	15	14	13	12	11	10	9	8	7	6	5	4	3	2	1	0
1	1	1	U	1	1	1	1	0	D	size	Vn	Vd	0	0	1	0	N	Q	M	1	Vm										

31	30	29	28	27	26	25	24	23	22	21	20	19	18	17	16	15	14	13	12	11	10	9	8	7	6	5	4	3	2	1	0
1	1	1	1	0	0	1	U	0	D	size	Vn	Vd	0	0	1	0	N	Q	M	1	Vm										

```

if Q == '1' && (Vd<0> == '1' || Vn<0> == '1' || Vm<0> == '1') then UNDEFINED;
unsigned = (U == '1');
esize = 8 << UInt(size); elements = 64 DIV esize;
d = UInt(D:Vd); n = UInt(N:Vn); m = UInt(M:Vm); regs = if Q == '0' then 1 else 2;
    
```

Assembler syntax

VQSUB{<c>}{<q>}.<type><size> {<Qd>}, <Qn>, <Qm> Encoded as Q = 1
 VQSUB{<c>}{<q>}.<type><size> {<Dd>}, <Dn>, <Dm> Encoded as Q = 0

where:

- <c>, <q> See [Standard assembler syntax fields on page F2-2415](#). An A32 VQSUB instruction must be unconditional. ARM strongly recommends that a T32 VQSUB instruction is unconditional, see [Conditional execution on page F2-2416](#).
- <type> The data type for the elements of the vectors. It must be one of:
 S Signed, encoded as U = 0.
 U Unsigned, encoded as U = 1.
- <size> The data size for the elements of the vectors. It must be one of:
 8 Encoded as size = 0b00.
 16 Encoded as size = 0b01.
 32 Encoded as size = 0b10.
 64 Encoded as size = 0b11.
- <Qd>, <Qn>, <Qm> The destination vector and the operand vectors, for a quadword operation.
- <Dd>, <Dn>, <Dm> The destination vector and the operand vectors, for a doubleword operation.

Operation

```

if ConditionPassed() then
    EncodingSpecificOperations(); CheckAdvSIMDEnabled();
    for r = 0 to regs-1
        for e = 0 to elements-1
            diff = Int(Elem[D[n+r],e,esize], unsigned) - Int(Elem[D[m+r],e,esize], unsigned);
            (Elem[D[d+r],e,esize], sat) = SatQ(diff, esize, unsigned);
            if sat then FPSR.QC = '1';
  
```

F8.1.125 VRADDHN

Vector Rounding Add and Narrow, returning High Half adds corresponding elements in two quadword vectors, and places the most significant half of each result in a doubleword vector. The results are rounded. For truncated results, see [VADDHN](#) on page F8-3106.

The operand elements can be 16-bit, 32-bit, or 64-bit integers. There is no distinction between signed and unsigned integers.

Depending on settings in the [CPACR](#), [NSACR](#), and [HCPTR](#) registers, and the security state and mode in which the instruction is executed, an attempt to execute the instruction might be UNDEFINED, or trapped to Hyp mode. [Summary of access controls for Advanced SIMD functionality on page G1-3498](#) summarizes these controls.

ARM deprecates the conditional execution of any Advanced SIMD instruction encoding that is not also available as a VFP instruction encoding, see [Conditional execution on page F2-2416](#).

Encoding T1/A1 Advanced SIMDv1

VRADDHN<c>.<dt> <Dd>, <Qn>, <Qm>

15	14	13	12	11	10	9	8	7	6	5	4	3	2	1	0	15	14	13	12	11	10	9	8	7	6	5	4	3	2	1	0
1	1	1	1	1	1	1	1	1	D	size	Vn				Vd				0	1	0	0	N	0	M	0	Vm				
31	30	29	28	27	26	25	24	23	22	21	20	19	18	17	16	15	14	13	12	11	10	9	8	7	6	5	4	3	2	1	0
1	1	1	1	0	0	1	1	1	D	size	Vn				Vd				0	1	0	0	N	0	M	0	Vm				

if size == '11' then SEE "Related encodings";
 if Vn<0> == '1' || Vm<0> == '1' then UNDEFINED;
 esize = 8 << UInt(size); elements = 64 DIV esize;
 d = UInt(D:Vd); n = UInt(N:Vn); m = UInt(M:Vm);

Related encodings See [Advanced SIMD data-processing instructions on page F5-2499](#).

Assembler syntax

VRADDHN{<c>}{<q>}.<dt> <Dd>, <Qn>, <Qm>

where:

<c>, <q> See [Standard assembler syntax fields on page F2-2415](#). An A32 VRADDHN instruction must be unconditional. ARM strongly recommends that a T32 VRADDHN instruction is unconditional, see [Conditional execution on page F2-2416](#).

<dt> The data type for the elements of the operands. It must be one of:
I16 Encoded as size = 0b00.
I32 Encoded as size = 0b01.
I64 Encoded as size = 0b10.

<Dd>, <Qn>, <Qm> The destination vector and the operand vectors.

Operation

```
if ConditionPassed() then
    EncodingSpecificOperations(); CheckAdvSIMDEnabled();
    round_const = 1 << (esize-1);
    for e = 0 to elements-1
        result = Elem[Qin[n>>1],e,2*esize] + Elem[Qin[m>>1],e,2*esize] + round_const;
        Elem[D[d],e,esize] = result<2*esize-1:esize>;
```

F8.1.126 VRECPE

Vector Reciprocal Estimate finds an approximate reciprocal of each element in the operand vector, and places the results in the destination vector.

The operand and result elements are the same type, and can be 32-bit floating-point numbers, or 32-bit unsigned integers.

For details of the operation performed by this instruction see *Floating-point reciprocal square root estimate and step* on page E1-2325.

Depending on settings in the CPACR, NSACR, and HCPTR registers, and the security state and mode in which the instruction is executed, an attempt to execute the instruction might be UNDEFINED, or trapped to Hyp mode. *Summary of access controls for Advanced SIMD functionality* on page G1-3498 summarizes these controls.

ARM deprecates the conditional execution of any Advanced SIMD instruction encoding that is not also available as a VFP instruction encoding, see *Conditional execution* on page F2-2416.

Encoding T1/A1 Advanced SIMDv1 (F = 1 UNDEFINED in integer-only variants)

VRECPE<c>.<dt> <Qd>, <Qm>

VRECPE<c>.<dt> <Dd>, <Dm>

15	14	13	12	11	10	9	8	7	6	5	4	3	2	1	0	15	14	13	12	11	10	9	8	7	6	5	4	3	2	1	0
1	1	1	1	1	1	1	1	1	D	1	1	size	1	1		Vd	0	1	0	F	0	Q	M	0		Vm					
31	30	29	28	27	26	25	24	23	22	21	20	19	18	17	16	15	14	13	12	11	10	9	8	7	6	5	4	3	2	1	0
1	1	1	1	0	0	1	1	1	D	1	1	size	1	1		Vd	0	1	0	F	0	Q	M	0		Vm					

```

if Q == '1' && (Vd<0> == '1' || Vm<0> == '1') then UNDEFINED;
if size != '10' then UNDEFINED;
floating_point = (F == '1'); esize = 32; elements = 2;
d = UInt(D:Vd); m = UInt(M:Vm); regs = if Q == '0' then 1 else 2;
    
```

Assembler syntax

VRECPE{<c>}{<q>}.<dt> <Qd>, <Qm> Encoded as Q = 1
 VRECPE{<c>}{<q>}.<dt> <Dd>, <Dm> Encoded as Q = 0

where:

<c>, <q> See [Standard assembler syntax fields on page F2-2415](#). An A32 VRECPE instruction must be unconditional. ARM strongly recommends that a T32 VRECPE instruction is unconditional, see [Conditional execution on page F2-2416](#).

<dt> The data types for the elements of the vectors. It must be one of:
 U32 Encoded as F = 0, size = 0b10.
 F32 Encoded as F = 1, size = 0b10.

<Qd>, <Qm> The destination vector and the operand vector, for a quadword operation.

<Dd>, <Dm> The destination vector and the operand vector, for a doubleword operation.

Operation

```

if ConditionPassed() then
    EncodingSpecificOperations(); CheckAdvSIMDEnabled();
    for r = 0 to regs-1
        for e = 0 to elements-1
            if floating_point then
                Elem[D[d+r],e,32] = FPRecipEstimate(Elem[D[m+r],e,32], StandardFPSCRValue());
            else
                Elem[D[d+r],e,32] = UnsignedRecipEstimate(Elem[D[m+r],e,32]);
  
```

Newton-Raphson iteration

For details of the operation performed and how it can be used in a Newton-Raphson iteration to calculate the reciprocal of a number, see [Floating-point reciprocal estimate and step on page E1-2322](#).

F8.1.127 VRECPS

Vector Reciprocal Step multiplies the elements of one vector by the corresponding elements of another vector, subtracts each of the products from 2.0, and places the results into the elements of the destination vector.

The operand and result elements are 32-bit floating-point numbers.

For details of the operation performed by this instruction see [Floating-point reciprocal estimate and step on page E1-2322](#).

Depending on settings in the CPACR, NSACR, and HCPTR registers, and the security state and mode in which the instruction is executed, an attempt to execute the instruction might be UNDEFINED, or trapped to Hyp mode. [Summary of access controls for Advanced SIMD functionality on page G1-3498](#) summarizes these controls.

ARM deprecates the conditional execution of any Advanced SIMD instruction encoding that is not also available as a VFP instruction encoding, see [Conditional execution on page F2-2416](#).

Encoding T1/A1 Advanced SIMDv1 (UNDEFINED in integer-only variant)

VRECPS<c>.F32 <Qd>, <Qn>, <Qm>

VRECPS<c>.F32 <Dd>, <Dn>, <Dm>

15	14	13	12	11	10	9	8	7	6	5	4	3	2	1	0	15	14	13	12	11	10	9	8	7	6	5	4	3	2	1	0
1	1	1	0	1	1	1	1	0	D	0	sz		Vn		Vd	1	1	1	1	N	Q	M	1		Vm						
31	30	29	28	27	26	25	24	23	22	21	20	19	18	17	16	15	14	13	12	11	10	9	8	7	6	5	4	3	2	1	0
1	1	1	1	0	0	1	0	0	D	0	sz		Vn		Vd	1	1	1	1	N	Q	M	1		Vm						

```

if Q == '1' && (Vd<0> == '1' || Vn<0> == '1' || Vm<0> == '1') then UNDEFINED;
if sz == '1' then UNDEFINED;
esize = 32; elements = 2;
d = UInt(D:Vd); n = UInt(N:Vn); m = UInt(M:Vm); regs = if Q == '0' then 1 else 2;
    
```

Assembler syntax

VRECPS{<c>}{<q>}.F32 {<Qd>}, <Qn>, <Qm> Encoded as Q = 1
VRECPS{<c>}{<q>}.F32 {<Dd>}, <Dn>, <Dm> Encoded as Q = 0

where:

<c>, <q> See [Standard assembler syntax fields on page F2-2415](#). An A32 VRECPS instruction must be unconditional. ARM strongly recommends that a T32 VRECPS instruction is unconditional, see [Conditional execution on page F2-2416](#).

<Qd>, <Qn>, <Qm> The destination vector and the operand vectors for a quadword operation.

<Dd>, <Dn>, <Dm> The destination vector and the operand vectors for a doubleword operation.

Operation

```
if ConditionPassed() then
    EncodingSpecificOperations(); CheckAdvSIMDEnabled();
    for r = 0 to regs-1
        for e = 0 to elements-1
            Elem[D[d+r],e,32] = FPREcipStep(Elem[D[n+r],e,32], Elem[D[m+r],e,32]);
```

Newton-Raphson iteration

For details of the operation performed and how it can be used in a Newton-Raphson iteration to calculate the reciprocal of a number, see [Floating-point reciprocal estimate and step on page E1-2322](#).

F8.1.128 VREV16, VREV32, VREV64

VREV16 (Vector Reverse in halfwords) reverses the order of 8-bit elements in each halfword of the vector, and places the result in the corresponding destination vector.

VREV32 (Vector Reverse in words) reverses the order of 8-bit or 16-bit elements in each word of the vector, and places the result in the corresponding destination vector.

VREV64 (Vector Reverse in doublewords) reverses the order of 8-bit, 16-bit, or 32-bit elements in each doubleword of the vector, and places the result in the corresponding destination vector.

There is no distinction between data types, other than size.

Figure F8-6 shows two examples of the operation of VREV.

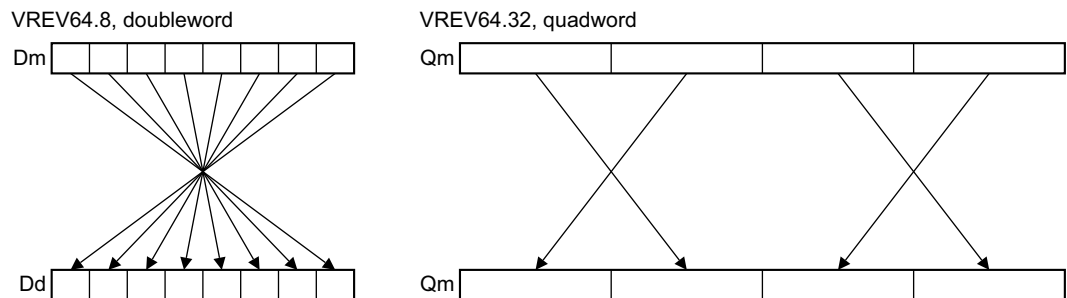

Figure F8-6 VREV operation examples

Depending on settings in the CPACR, NSACR, and HCPTR registers, and the security state and mode in which the instruction is executed, an attempt to execute the instruction might be UNDEFINED, or trapped to Hyp mode.

Summary of access controls for Advanced SIMD functionality on page G1-3498 summarizes these controls.

ARM deprecates the conditional execution of any Advanced SIMD instruction encoding that is not also available as a VFP instruction encoding, see Conditional execution on page F2-2416.

Encoding T1/A1 Advanced SIMDv1

VREV<n><c>.<size> <Qd>, <Qm>

VREV<n><c>.<size> <Dd>, <Dm>

15	14	13	12	11	10	9	8	7	6	5	4	3	2	1	0	15	14	13	12	11	10	9	8	7	6	5	4	3	2	1	0
1	1	1	1	1	1	1	1	1	D	1	1	size	0	0	Vd	0	0	0	op	Q	M	0	Vm								

31	30	29	28	27	26	25	24	23	22	21	20	19	18	17	16	15	14	13	12	11	10	9	8	7	6	5	4	3	2	1	0
1	1	1	1	0	0	1	1	1	D	1	1	size	0	0	Vd	0	0	0	op	Q	M	0	Vm								

```

if UInt(op)+UInt(size) >= 3 then UNDEFINED;
if Q == '1' && (Vd<0> == '1' || Vm<0> == '1') then UNDEFINED;
esize = 8 << UInt(size); elements = 64 DIV esize;
groupsize = (1 << (3-UInt(op)-UInt(size))); // elements per reversing group: 2, 4 or 8
reverse_mask = (groupsize-1)<size-1:0>; // EORing mask used for index calculations
d = UInt(D:Vd); m = UInt(M:Vm); regs = if Q == '0' then 1 else 2;
    
```

Assembler syntax

VREV<n>{<c>}{<q>}.<size> <Qd>, <Qm> Encoded as Q = 1
 VREV<n>{<c>}{<q>}.<size> <Dd>, <Dm> Encoded as Q = 0

where:

<n> The size of the regions in which the vector elements are reversed. It must be one of:
 16 Encoded as op = 0b10.
 32 Encoded as op = 0b01.
 64 Encoded as op = 0b00.

<c>, <q> See [Standard assembler syntax fields on page F2-2415](#). An A32 VREV instruction must be unconditional. ARM strongly recommends that a T32 VREV instruction is unconditional, see [Conditional execution on page F2-2416](#).

<size> The size of the vector elements. It must be one of:
 8 Encoded as size = 0b00.
 16 Encoded as size = 0b01.
 32 Encoded as size = 0b10.
 <size> must specify a smaller size than <n>.

<Qd>, <Qm> The destination vector and the operand vector, for a quadword operation.

<Dd>, <Dm> The destination vector and the operand vector, for a doubleword operation.

If op + size >= 3, the instruction is reserved.

Operation

```
if ConditionPassed() then
    EncodingSpecificOperations(); CheckAdvSIMDEnabled();
    bits(64) dest;

    for r = 0 to regs-1
        for e = 0 to elements-1
            // Calculate destination element index by bitwise EOR on source element index:
            e_bits = e<size-1:0>; d_bits = e_bits EOR reverse_mask; d = UInt(d_bits);
            Elem[dest,d,esize] = Elem[D[m+r],e,esize];
        D[d+r] = dest;
```

F8.1.129 VRHADD

Vector Rounding Halving Add adds corresponding elements in two vectors of integers, shifts each result right one bit, and places the final results in the destination vector.

The operand and result elements are all the same type, and can be any one of:

- 8-bit, 16-bit, or 32-bit signed integers.
- 8-bit, 16-bit, or 32-bit unsigned integers.

The results of the halving operations are rounded. For truncated results see [VHADD](#), [VHSUB](#) on page F8-3172.

Depending on settings in the [CPACR](#), [NSACR](#), and [HCPTR](#) registers, and the security state and mode in which the instruction is executed, an attempt to execute the instruction might be UNDEFINED, or trapped to Hyp mode.

[Summary of access controls for Advanced SIMD functionality on page G1-3498](#) summarizes these controls.

ARM deprecates the conditional execution of any Advanced SIMD instruction encoding that is not also available as a VFP instruction encoding, see [Conditional execution on page F2-2416](#).

Encoding T1/A1 Advanced SIMDv1

VRHADD<c> <Qd>, <Qn>, <Qm>

VRHADD<c> <Dd>, <Dn>, <Dm>

15	14	13	12	11	10	9	8	7	6	5	4	3	2	1	0	15	14	13	12	11	10	9	8	7	6	5	4	3	2	1	0
1	1	1	U	1	1	1	1	0	D	size	Vn	Vd	0	0	0	1	N	Q	M	0	Vm										

31	30	29	28	27	26	25	24	23	22	21	20	19	18	17	16	15	14	13	12	11	10	9	8	7	6	5	4	3	2	1	0
1	1	1	1	0	0	1	U	0	D	size	Vn	Vd	0	0	0	1	N	Q	M	0	Vm										

```

if Q == '1' && (Vd<0> == '1' || Vn<0> == '1' || Vm<0> == '1') then UNDEFINED;
if size == '11' then UNDEFINED;
unsigned = (U == '1');
esize = 8 << UInt(size);  elements = 64 DIV esize;
d = UInt(D:Vd);  n = UInt(N:Vn);  m = UInt(M:Vm);  regs = if Q == '0' then 1 else 2;
    
```

Assembler syntax

VRHADD{<c>}{<q>}.<dt> {<Qd>}, <Qn>, <Qm> Encoded as Q = 1
 VRHADD{<c>}{<q>}.<dt> {<Dd>}, <Dn>, <Dm> Encoded as Q = 0

where:

<c>, <q> See [Standard assembler syntax fields on page F2-2415](#). An A32 VRHADD instruction must be unconditional. ARM strongly recommends that a T32 VRHADD instruction is unconditional, see [Conditional execution on page F2-2416](#).

<dt> The data type for the elements of the vectors. It must be one of:

S8 Encoded as size = 0b00, U = 0.
 S16 Encoded as size = 0b01, U = 0.
 S32 Encoded as size = 0b10, U = 0.
 U8 Encoded as size = 0b00, U = 1.
 U16 Encoded as size = 0b01, U = 1.
 U32 Encoded as size = 0b10, U = 1.

<Qd>, <Qn>, <Qm> The destination vector and the operand vectors, for a quadword operation.

<Dd>, <Dn>, <Dm> The destination vector and the operand vectors, for a doubleword operation.

Operation

```
if ConditionPassed() then
  EncodingSpecificOperations(); CheckAdvSIMDEnabled();
  for r = 0 to regs-1
    for e = 0 to elements-1
      op1 = Int(Elem[D[n+r],e,esize], unsigned);
      op2 = Int(Elem[D[m+r],e,esize], unsigned);
      result = op1 + op2 + 1;
      Elem[D[d+r],e,esize] = result<esize:1>;
```

F8.1.130 VRINTA, VRINTN, VRINTP, VRINTM (Advanced SIMD)

These instructions round a floating-point value to an integral floating-point value of the same size. A zero input gives a zero result with the same sign, an infinite input gives an infinite result with the same sign, and a NaN is propagated as for normal arithmetic.

These instructions use the following rounding modes:

- VRINTA: Round to Nearest with Ties to Away.
- VRINTN: Round to Nearest with Ties to Even.
- VRINTP: Round Toward +Infinity.
- VRINTM: Round towards -Infinity.

Encoding T1/A1 ARMv8 Advanced SIMD

VRINT<r>.F32.F32 <Qd>, <Qm>

VRINT<r>.F32.F32 <Dd>, <Dm>

15	14	13	12	11	10	9	8	7	6	5	4	3	2	1	0	15	14	13	12	11	10	9	8	7	6	5	4	3	2	1	0
1	1	1	1	1	1	1	1	1	D	1	1	size	1	0	Vd	0	1	op	Q	M	0	Vm									

31	30	29	28	27	26	25	24	23	22	21	20	19	18	17	16	15	14	13	12	11	10	9	8	7	6	5	4	3	2	1	0
1	1	1	1	0	0	1	1	1	D	1	1	size	1	0	Vd	0	1	op	Q	M	0	Vm									

```

if op<2> != op<0> then SEE "Related instructions";
if Q == '1' && (Vd<0> == '1' || Vm<0> == '1') then UNDEFINED;
if size != '10' then UNDEFINED;
// Rounding encoded differently from other VCVT and VRINT instructions
rounding = FPDecodeRM(op<2>:NOT(op<1>)); exact = FALSE;
esize = 32; elements = 2;
d = UInt(D:Vd); m = UInt(M:Vm); regs = if Q == '0' then 1 else 2;
if InITBlock() then UNPREDICTABLE;
    
```

Related instructions

See [Two registers, miscellaneous](#) on page F5-2506

Assembler syntax

VRINT<r>{<q>}.F32.F32 <Qd>, <Qm> Encoded as Q = 1
VRINT<r>{<q>}.F32.F32 <Dd>, <Dm> Encoded as Q = 0

where:

r Selects the rounding direction. It must be one of:
 A Encoded as op = 010.
 N Encoded as op = 000.
 P Encoded as op = 111.
 M Encoded as op = 101.

<q> See [Standard assembler syntax fields on page F2-2415](#).

<Qd>, <Qm> The destination vector and the operand vector for a quadword operation.

<Dd>, <Dm> The destination vector and the operand vector for a doubleword operation.

Operation

```
EncodingSpecificOperations(); CheckAdvSIMDEnabled();  
for r = 0 to regs-1  
  for e = 0 to elements-1  
    op1 = Elem[D[m+r],e,esize];  
    result = FPRoundInt(op1, StandardFPSCRValue(), rounding, exact);  
    Elem[D[d+r],e,esize] = result;
```

F8.1.131 VRINTA, VRINTN, VRINTP, VRINTM (floating-point)

These instructions round a floating-point value to an integral floating-point value of the same size. A zero input gives a zero result with the same sign, an infinite input gives an infinite result with the same sign, and a NaN is propagated as for normal arithmetic.

These instructions use the following rounding modes:

- VRINTA: Round to Nearest with Ties to Away.
- VRINTN: Round to Nearest with Ties to Even.
- VRINTP: Round toward +Infinity.
- VRINTM: Round toward -Infinity.

Encoding T1/A1 ARMv8 FP

VRINT<r>.F64.F64 <Dd>, <Dm>

VRINT<r>.F32.F32 <Sd>, <Sm>

15	14	13	12	11	10	9	8	7	6	5	4	3	2	1	0	15	14	13	12	11	10	9	8	7	6	5	4	3	2	1	0
1	1	1	1	1	1	1	0	1	D	1	1	1	0	RM		Vd		1	0	1	sz	0	1	M	0		Vm				
31	30	29	28	27	26	25	24	23	22	21	20	19	18	17	16	15	14	13	12	11	10	9	8	7	6	5	4	3	2	1	0
1	1	1	1	1	1	1	0	1	D	1	1	1	0	RM		Vd		1	0	1	sz	0	1	M	0		Vm				

```

rounding = FPDecodeRM(RM); exact = FALSE; dp_operation = (sz == '1');
d = if dp_operation then UInt(D:Vd) else UInt(Vd:D);
m = if dp_operation then UInt(M:Vm) else UInt(Vm:M);
if InITBlock() then UNPREDICTABLE;
    
```

For information about the CONSTRAINED UNPREDICTABLE behavior of this instruction, see [Appendix A Architectural Constraints on UNPREDICTABLE behaviors](#).

Related encodings See [Floating-point data-processing instructions on page F5-2511](#).

Assembler syntax

VRINT<r>{<q>}.F64.F64 <Dd>, <Dm> Encoded as sz = 1
VRINT<r>{<q>}.F32.F32 <Sd>, <Sm> Encoded as sz = 0

where:

r Selects the rounding mode. It must be one of:
 A Encoded as RM = 00.
 N Encoded as RM = 01.
 P Encoded as RM = 10.
 M Encoded as RM = 11.

<q> See [Standard assembler syntax fields on page F2-2415](#).

<Dd>, <Dm> The destination register and the operand register, for a double-precision operation.

<Sd>, <Sm> The destination register and the operand register, for a single-precision operation.

Operation

```
EncodingSpecificOperations(); CheckVFPEEnabled(TRUE);  
if dp_operation then  
    D[d] = FPRoundInt(D[m], FPSCR, rounding, exact);  
else  
    S[d] = FPRoundInt(S[m], FPSCR, rounding, exact);
```

F8.1.132 VRINTX (Advanced SIMD)

This instruction rounds a floating-point value to an integral floating-point value of the same size. A zero input gives a zero result with the same sign, an infinite input gives an infinite result with the same sign, and a NaN is propagated as for normal arithmetic.

VRINTX uses the Round to Nearest with Ties to Even rounding mode, and raises the Inexact exception when the result value is not numerically equal to the input value.

Encoding T1/A1 ARMv8 Advanced SIMD

VRINTX.F32.F32 <Qd>, <Qm>

VRINTX.F32.F32 <Dd>, <Dm>

15	14	13	12	11	10	9	8	7	6	5	4	3	2	1	0	15	14	13	12	11	10	9	8	7	6	5	4	3	2	1	0
1	1	1	1	1	1	1	1	1	D	1	1	size	1	0	Vd	0	1	0	0	1	Q	M	0	Vm							
31	30	29	28	27	26	25	24	23	22	21	20	19	18	17	16	15	14	13	12	11	10	9	8	7	6	5	4	3	2	1	0
1	1	1	1	0	0	1	1	1	D	1	1	size	1	0	Vd	0	1	0	0	1	Q	M	0	Vm							

```

if Q == '1' && (Vd<0> == '1' || Vm<0> == '1') then UNDEFINED;
if size != '10' then UNDEFINED;
rounding = FPRounding_TIEEVEN; exact = TRUE;
esize = 32; elements = 2;
d = UInt(D:Vd); m = UInt(M:Vm); regs = if Q == '0' then 1 else 2;
if InITBlock() then UNPREDICTABLE;
    
```

For information about the CONSTRAINED UNPREDICTABLE behavior of this instruction, see [Appendix A Architectural Constraints on UNPREDICTABLE behaviors](#).

Assembler syntax

VRINTX{<q>}.F32.F32 <Qd>, <Qm> Encoded as Q = 1
VRINTX{<q>}.F32.F32 <Dd>, <Dm> Encoded as Q = 0

where:

<q> See *Standard assembler syntax fields* on page F2-2415.
<Qd>, <Qm> The destination vector and the operand vector for a quadword operation.
<Dd>, <Dm> The destination vector and the operand vector for a doubleword operation.

Operation

```
EncodingSpecificOperations(); CheckAdvSIMDEnabled();  
for r = 0 to regs-1  
  for e = 0 to elements-1  
    op1 = Elem[D[m+r],e,esize];  
    result = FPRoundInt(op1, StandardFPSCRValue(), rounding, exact);  
    Elem[D[d+r],e,esize] = result;
```

F8.1.133 VRINTX (floating-point)

This instruction rounds a floating-point value to an integral floating-point value of the same size. A zero input gives a zero result with the same sign, an infinite input gives an infinite result with the same sign, and a NaN is propagated as for normal arithmetic.

VRINTX uses the rounding mode specified in the FPSCR, and raises an Inexact exception when the result value is not numerically equal to the input value.

Encoding T1/A1 ARMv8 FP

VRINTX<c>.F64.F64 <Dd>, <Dm>

VRINTX<c>.F32.F32 <Sd>, <Sm>

15	14	13	12	11	10	9	8	7	6	5	4	3	2	1	0	15	14	13	12	11	10	9	8	7	6	5	4	3	2	1	0
1	1	1	0	1	1	1	0	1	D	1	1	0	1	1	1	Vd	1	0	1	sz	0	1	M	0	Vm						
31	30	29	28	27	26	25	24	23	22	21	20	19	18	17	16	15	14	13	12	11	10	9	8	7	6	5	4	3	2	1	0
cond		1	1	1	0	1	D	1	1	0	1	1	1	1	1	Vd	1	0	1	sz	0	1	M	0	Vm						

```
exact = TRUE; dp_operation = (sz == '1');
d = if dp_operation then UInt(D:Vd) else UInt(Vd:D);
m = if dp_operation then UInt(M:Vm) else UInt(Vm:M);
```

Related encodings See [Floating-point data-processing instructions on page F5-2511](#).

Assembler syntax

VRINTX<c>{<q>}.F64.F64 <Dd>, <Dm> Encoded as sz= 1
VRINTX<c>{<q>}.F32.F32 <Sd>, <Sm> Encoded as sz= 0

where:

<c>, <q> See *Standard assembler syntax fields* on page F2-2415.
<Dd>, <Dm> The destination register and the operand register, for a double-precision operation.
<Sd>, <Sm> The destination register and the operand register, for a single-precision operation.

Operation

```
if ConditionPassed() then
    EncodingSpecificOperations(); CheckVFPEnabled(TRUE);
    rounding = FPRoundingMode(FPSCR);
    if dp_operation then
        D[d] = FPRoundInt(D[m], FPSCR, rounding, exact);
    else
        S[d] = FPRoundInt(S[m], FPSCR, rounding, exact);
```

F8.1.134 VRINTZ (Advanced SIMD)

This instruction rounds a floating-point value to an integral floating-point value of the same size. A zero input gives a zero result with the same sign, an infinite input gives an infinite result with the same sign, and a NaN is propagated as for normal arithmetic.

VRINTZ uses the Round toward Zero rounding mode.

Encoding T1/A1 ARMv8 Advanced SIMD

VRINTZ.F32.F32 <Qd>, <Qm>

VRINTZ.F32.F32 <Dd>, <Dm>

15	14	13	12	11	10	9	8	7	6	5	4	3	2	1	0	15	14	13	12	11	10	9	8	7	6	5	4	3	2	1	0
1	1	1	1	1	1	1	1	D	1	1	size	1	0		Vd	0	1	0	1	1	Q	M	0		Vm						
31	30	29	28	27	26	25	24	23	22	21	20	19	18	17	16	15	14	13	12	11	10	9	8	7	6	5	4	3	2	1	0
1	1	1	1	0	0	1	1	1	D	1	1	size	1	0		Vd	0	1	0	1	1	Q	M	0		Vm					

```

if Q == '1' && (Vd<0> == '1' || Vm<0> == '1') then UNDEFINED;
if size != '10' then UNDEFINED;
rounding = FPRounding_ZERO; exact = FALSE;
esize = 32; elements = 2;
d = UInt(D:Vd); m = UInt(M:Vm); regs = if Q == '0' then 1 else 2;
if InITBlock() then UNPREDICTABLE;
    
```

For information about the CONSTRAINED UNPREDICTABLE behavior of this instruction, see [Appendix A Architectural Constraints on UNPREDICTABLE behaviors](#).

Assembler syntax

VRINTZ{<q>}.F32.F32 <Qd>, <Qm> Encoded as Q = 1
VRINTZ{<q>}.F32.F32 <Dd>, <Dm> Encoded as Q = 0

where:

<q> See *Standard assembler syntax fields* on page F2-2415.
<Qd>, <Qm> The destination vector and the operand vector for a quadword operation.
<Dd>, <Dm> The destination vector and the operand vector for a doubleword operation.

Operation

```
EncodingSpecificOperations(); CheckAdvSIMDEnabled();  
for r = 0 to regs-1  
  for e = 0 to elements-1  
    op1 = Elem[D[m+r],e,esize];  
    result = FPRoundInt(op1, StandardFPSCRValue(), rounding, exact);  
    Elem[D[d+r],e,esize] = result;
```

F8.1.135 VRINTZ, VRINTR (floating-point)

These instructions round a floating-point value to an integral floating-point value of the same size. A zero input gives a zero result with the same sign, an infinite input gives an infinite result with the same sign, and a NaN is propagated as for normal arithmetic.

These instructions use the following rounding modes:

- VRINTZ: Round toward Zero.
- VRINTR: Round toward the rounding mode specified in the FPSCR.

Encoding T1/A1 ARMv8 FP

VRINT<r><c>.F64.F64 <Dd>, <Dm>

VRINT<r><c>.F32.F32 <Sd>, <Sm>

15	14	13	12	11	10	9	8	7	6	5	4	3	2	1	0	15	14	13	12	11	10	9	8	7	6	5	4	3	2	1	0
1	1	1	0	1	1	1	0	1	D	1	1	0	1	1	0	Vd	1	0	1	sz	op	1	M	0	Vm						

31	30	29	28	27	26	25	24	23	22	21	20	19	18	17	16	15	14	13	12	11	10	9	8	7	6	5	4	3	2	1	0
cond		1	1	1	0	1	D	1	1	0	1	1	0	Vd	1	0	1	sz	op	1	M	0	Vm								

```

rounding = if op == '1' then FPRounding_ZERO else FPRoundingMode(FPSCR);
dp_operation = (sz == '1'); exact = FALSE;
d = if dp_operation then UInt(D:Vd) else UInt(Vd:D);
m = if dp_operation then UInt(M:Vm) else UInt(Vm:M);
    
```

Related encodings See [Floating-point data-processing instructions on page F5-2511](#).

Assembler syntax

VRINT<r><c>{<q>}.F64.F64 <Dd>, <Dm> Encoded as sz= 1
VRINT<r><c>{<q>}.F32.F32 <Sd>, <Sm> Encoded as sz= 0

where:

<r> Selects the rounding mode. It must be one of:
 Z Encoded as op = 1.
 R Encoded as op = 0.

<c>, <q> See [Standard assembler syntax fields on page F2-2415](#).

<Dd>, <Dm> The destination register and the operand register, for a double-precision operation.

<Sd>, <Sm> The destination register and the operand register, for a single-precision operation.

Operation

```
if ConditionPassed() then
    EncodingSpecificOperations(); CheckVFPEEnabled(TRUE);
    if dp_operation then
        D[d] = FPRoundInt(D[m], FPSCR, rounding, exact);
    else
        S[d] = FPRoundInt(S[m], FPSCR, rounding, exact);
```

F8.1.136 VRSHL

Vector Rounding Shift Left takes each element in a vector, shifts them by a value from the least significant byte of the corresponding element of a second vector, and places the results in the destination vector. If the shift value is positive, the operation is a left shift. If the shift value is negative, it is a rounding right shift. For a truncating shift, see [VSHL \(register\)](#) on page F8-3340.

The first operand and result elements are the same data type, and can be any one of:

- 8-bit, 16-bit, 32-bit, or 64-bit signed integers.
- 8-bit, 16-bit, 32-bit, or 64-bit unsigned integers.

The second operand is always a signed integer of the same size.

Depending on settings in the [CPACR](#), [NSACR](#), and [HCPTR](#) registers, and the security state and mode in which the instruction is executed, an attempt to execute the instruction might be UNDEFINED, or trapped to Hyp mode.

[Summary of access controls for Advanced SIMD functionality](#) on page G1-3498 summarizes these controls.

ARM deprecates the conditional execution of any Advanced SIMD instruction encoding that is not also available as a VFP instruction encoding, see [Conditional execution](#) on page F2-2416.

Encoding T1/A1 Advanced SIMDv1

VRSHL<c>.<type><size> <Qd>, <Qm>, <Qn>

VRSHL<c>.<type><size> <Dd>, <Dm>, <Dn>

15	14	13	12	11	10	9	8	7	6	5	4	3	2	1	0	15	14	13	12	11	10	9	8	7	6	5	4	3	2	1	0
1	1	1	U	1	1	1	1	0	D	size	Vn	Vd	0	1	0	1	N	Q	M	0	Vm										

31	30	29	28	27	26	25	24	23	22	21	20	19	18	17	16	15	14	13	12	11	10	9	8	7	6	5	4	3	2	1	0
1	1	1	1	0	0	1	U	0	D	size	Vn	Vd	0	1	0	1	N	Q	M	0	Vm										

```

if Q == '1' && (Vd<0> == '1' || Vm<0> == '1' || Vn<0> == '1') then UNDEFINED;
unsigned = (U == '1');
esize = 8 << UInt(size); elements = 64 DIV esize;
d = UInt(D:Vd); m = UInt(M:Vm); n = UInt(N:Vn); regs = if Q == '0' then 1 else 2;
    
```

Assembler syntax

VRSHL{<c>}{<q>}.<type><size> {<Qd>}, <Qm>, <Qn> Encoded as Q = 1
 VRSHL{<c>}{<q>}.<type><size> {<Dd>}, <Dm>, <Dn> Encoded as Q = 0

where:

<c>, <q> See [Standard assembler syntax fields on page F2-2415](#). An A32 VRSHL instruction must be unconditional. ARM strongly recommends that a T32 VRSHL instruction is unconditional, see [Conditional execution on page F2-2416](#).

<type> The data type for the elements of the vectors. It must be one of:
 S Signed, encoded as U = 0.
 U Unsigned, encoded as U = 1.
 Together with the <size> field, this indicates the data type and size of the first operand and the result.

<size> The data size for the elements of the vectors. It must be one of:
 8 Encoded as size = 0b00.
 16 Encoded as size = 0b01.
 32 Encoded as size = 0b10.
 64 Encoded as size = 0b11.

<Qd>, <Qm>, <Qn> The destination vector and the operand vectors, for a quadword operation.

<Dd>, <Dm>, <Dn> The destination vector and the operand vectors, for a doubleword operation.

Operation

```
if ConditionPassed() then
    EncodingSpecificOperations(); CheckAdvSIMDEnabled();
    for r = 0 to regs-1
        for e = 0 to elements-1
            shift = SInt(Elem[D[n+r],e,esize]<7:0>);
            round_const = 1 << (-shift-1); // 0 for left shift, 2^(n-1) for right shift
            result = (Int(Elem[D[m+r],e,esize], unsigned) + round_const) << shift;
            Elem[D[d+r],e,esize] = result<esize-1:0>;
```

F8.1.137 VRSHR

Vector Rounding Shift Right takes each element in a vector, right shifts them by an immediate value, and places the rounded results in the destination vector. For truncated results, see [VSHR](#) on page F8-3344.

The operand and result elements must be the same size, and can be any one of:

- 8-bit, 16-bit, 32-bit, or 64-bit signed integers.
- 8-bit, 16-bit, 32-bit, or 64-bit unsigned integers.

Depending on settings in the [CPACR](#), [NSACR](#), and [HCPTR](#) registers, and the security state and mode in which the instruction is executed, an attempt to execute the instruction might be UNDEFINED, or trapped to Hyp mode.

[Summary of access controls for Advanced SIMD functionality](#) on page G1-3498 summarizes these controls.

ARM deprecates the conditional execution of any Advanced SIMD instruction encoding that is not also available as a VFP instruction encoding, see [Conditional execution](#) on page F2-2416.

Encoding T1/A1 Advanced SIMDv1

VRSHR<c>.<type><size> <Qd>, <Qm>, #<imm>

VRSHR<c>.<type><size> <Dd>, <Dm>, #<imm>

15	14	13	12	11	10	9	8	7	6	5	4	3	2	1	0	15	14	13	12	11	10	9	8	7	6	5	4	3	2	1	0
1	1	1	U	1	1	1	1	1	D	imm6						Vd	0	0	1	0	L	Q	M	1	Vm						
31	30	29	28	27	26	25	24	23	22	21	20	19	18	17	16	15	14	13	12	11	10	9	8	7	6	5	4	3	2	1	0
1	1	1	1	0	0	1	U	1	D	imm6						Vd	0	0	1	0	L	Q	M	1	Vm						

```

if (L:imm6) == '0000xxx' then SEE "Related encodings";
if Q == '1' && (Vd<0> == '1' || Vm<0> == '1') then UNDEFINED;
case L:imm6 of
    when "0001xxx" esize = 8; elements = 8; shift_amount = 16 - UInt(imm6);
    when "001xxxx" esize = 16; elements = 4; shift_amount = 32 - UInt(imm6);
    when "01xxxxx" esize = 32; elements = 2; shift_amount = 64 - UInt(imm6);
    when "1xxxxxx" esize = 64; elements = 1; shift_amount = 64 - UInt(imm6);
unsigned = (U == '1'); d = UInt(D:Vd); m = UInt(M:Vm); regs = if Q == '0' then 1 else 2;
    
```

Related encodings See [One register and a modified immediate value](#) on page F5-2508.

Assembler syntax

VRSHR{<c>}{<q>}.<type><size> {<Qd>}, <Qm>, #<imm> Encoded as Q = 1
 VRSHR{<c>}{<q>}.<type><size> {<Dd>}, <Dm>, #<imm> Encoded as Q = 0

where:

- <c>, <q> See [Standard assembler syntax fields on page F2-2415](#). An A32 VRSHR instruction must be unconditional. ARM strongly recommends that a T32 VRSHR instruction is unconditional, see [Conditional execution on page F2-2416](#).
- <type> The data type for the elements of the vectors. It must be one of:
 - S Signed, encoded as U = 0.
 - U Unsigned, encoded as U = 1.
- <size> The data size for the elements of the vectors. It must be one of:
 - 8 Encoded as L = 0, imm6<5:3> = 0b001. (8 – <imm>) is encoded in imm6<2:0>.
 - 16 Encoded as L = 0, imm6<5:4> = 0b01. (16 – <imm>) is encoded in imm6<3:0>.
 - 32 Encoded as L = 0, imm6<5> = 0b1. (32 – <imm>) is encoded in imm6<4:0>.
 - 64 Encoded as L = 1. (64 – <imm>) is encoded in imm6<5:0>.
- <Qd>, <Qm> The destination vector, and the operand vector, for a quadword operation.
- <Dd>, <Dm> The destination vector, and the operand vector, for a doubleword operation.
- <imm> The immediate value, in the range 1 to <size>. See the description of <size> for how <imm> is encoded.

Operation

```

if ConditionPassed() then
    EncodingSpecificOperations(); CheckAdvSIMDEnabled();
    round_const = 1 << (shift_amount - 1);
    for r = 0 to regs-1
        for e = 0 to elements-1
            result = (Int(Elem[D[m+r],e,esize], unsigned) + round_const) >> shift_amount;
            Elem[D[d+r],e,esize] = result<size-1:0>;
  
```

Pseudo-instructions

VRSHR.<type><size> <Qd>, <Qm>, #0 is a synonym for VMOV <Qd>, <Qm>
 VRSHR.<type><size> <Dd>, <Dm>, #0 is a synonym for VMOV <Dd>, <Dm>

For details see [VMOV \(register\) on page F8-3216](#).

F8.1.138 VRSHRN

Vector Rounding Shift Right and Narrow takes each element in a vector, right shifts them by an immediate value, and places the rounded results in the destination vector. For truncated results, see [VSHRN](#) on page F8-3346.

The operand elements can be 16-bit, 32-bit, or 64-bit integers. There is no distinction between signed and unsigned integers. The destination elements are half the size of the source elements.

Depending on settings in the CPACR, NSACR, and HCPTR registers, and the security state and mode in which the instruction is executed, an attempt to execute the instruction might be UNDEFINED, or trapped to Hyp mode. [Summary of access controls for Advanced SIMD functionality](#) on page G1-3498 summarizes these controls.

ARM deprecates the conditional execution of any Advanced SIMD instruction encoding that is not also available as a VFP instruction encoding, see [Conditional execution](#) on page F2-2416.

Encoding T1/A1 Advanced SIMDv1

VRSHRN<c>.I<size> <Dd>, <Qm>, #<imm>

15	14	13	12	11	10	9	8	7	6	5	4	3	2	1	0	15	14	13	12	11	10	9	8	7	6	5	4	3	2	1	0
1	1	1	0	1	1	1	1	1	D	imm6						Vd	1	0	0	0	0	1	M	1	Vm						

31	30	29	28	27	26	25	24	23	22	21	20	19	18	17	16	15	14	13	12	11	10	9	8	7	6	5	4	3	2	1	0
1	1	1	1	0	0	1	0	1	D	imm6						Vd	1	0	0	0	0	1	M	1	Vm						

if imm6 == '000xxx' then SEE "Related encodings";

if Vm<0> == '1' then UNDEFINED;

case imm6 of

 when "001xxx" esize = 8; elements = 8; shift_amount = 16 - UInt(imm6);

 when "01xxxx" esize = 16; elements = 4; shift_amount = 32 - UInt(imm6);

 when "1xxxxx" esize = 32; elements = 2; shift_amount = 64 - UInt(imm6);

d = UInt(D:Vd); m = UInt(M:Vm);

Related encodings See [One register and a modified immediate value](#) on page F5-2508.

Assembler syntax

VRSHRN{<c>}{<q>}.I<size> <Dd>, <Qm>, #<imm>

where:

- <c>, <q> See [Standard assembler syntax fields on page F2-2415](#). An A32 VRSHRN instruction must be unconditional. ARM strongly recommends that a T32 VRSHRN instruction is unconditional, see [Conditional execution on page F2-2416](#).
- <size> The data size for the elements of the vectors. It must be one of:
- | | |
|----|--|
| 16 | Encoded as imm6<5:3> = 0b001. (8 – <imm>) is encoded in imm6<2:0>. |
| 32 | Encoded as imm6<5:4> = 0b01. (16 – <imm>) is encoded in imm6<3:0>. |
| 64 | Encoded as imm6<5> = 0b1. (32 – <imm>) is encoded in imm6<4:0>. |
- <Dd>, <Qm> The destination vector, and the operand vector.
- <imm> The immediate value, in the range 1 to <size>/2. See the description of <size> for how <imm> is encoded.

Operation

```
if ConditionPassed() then
    EncodingSpecificOperations(); CheckAdvSIMDEnabled();
    round_const = 1 << (shift_amount-1);
    for e = 0 to elements-1
        result = LSR(Elem[Qin[m>>1],e,2*esize] + round_const, shift_amount);
        Elem[D[d],e,esize] = result<esize-1:0>;
```

Pseudo-instructions

VRSHRN.I<size> <Dd>, <Qm>, #0 is a synonym for VMOVN.I<size> <Dd>, <Qm>

For details see [VMOVN on page F8-3230](#).

F8.1.139 VRSQRTE

Vector Reciprocal Square Root Estimate finds an approximate reciprocal square root of each element in a vector, and places the results in a second vector.

The operand and result elements are the same type, and can be 32-bit floating-point numbers, or 32-bit unsigned integers.

For details of the operation performed by this instruction see [Floating-point reciprocal estimate and step on page E1-2322](#).

Depending on settings in the CPACR, NSACR, and HCPTR registers, and the security state and mode in which the instruction is executed, an attempt to execute the instruction might be UNDEFINED, or trapped to Hyp mode. [Summary of access controls for Advanced SIMD functionality on page G1-3498](#) summarizes these controls.

ARM deprecates the conditional execution of any Advanced SIMD instruction encoding that is not also available as a VFP instruction encoding, see [Conditional execution on page F2-2416](#).

Encoding T1/A1 Advanced SIMDv1 (F = 1 UNDEFINED in integer-only variants)

VRSQRTE<c>.<dt> <Qd>, <Qm>

VRSQRTE<c>.<dt> <Dd>, <Dm>

15	14	13	12	11	10	9	8	7	6	5	4	3	2	1	0	15	14	13	12	11	10	9	8	7	6	5	4	3	2	1	0
1	1	1	1	1	1	1	1	1	D	1	1	size	1	1	Vd	0	1	0	F	1	Q	M	0	Vm							

31	30	29	28	27	26	25	24	23	22	21	20	19	18	17	16	15	14	13	12	11	10	9	8	7	6	5	4	3	2	1	0
1	1	1	1	0	0	1	1	1	D	1	1	size	1	1	Vd	0	1	0	F	1	Q	M	0	Vm							

```

if Q == '1' && (Vd<0> == '1' || Vm<0> == '1') then UNDEFINED;
if size != '10' then UNDEFINED;
floating_point = (F == '1'); esize = 32; elements = 2;
d = UInt(D:Vd); m = UInt(M:Vm); regs = if Q == '0' then 1 else 2;

```

Assembler syntax

VRSQRTE{<c>}{<q>}.<dt> <Qd>, <Qm> Encoded as Q = 1
 VRSQRTE{<c>}{<q>}.<dt> <Dd>, <Dm> Encoded as Q = 0

where:

<c>, <q> See [Standard assembler syntax fields on page F2-2415](#). An A32 VRSQRTE instruction must be unconditional. ARM strongly recommends that a T32 VRSQRTE instruction is unconditional, see [Conditional execution on page F2-2416](#).

<dt> The data types for the elements of the vectors. It must be one of:
 U32 Encoded as F = 0, size = 0b10.
 F32 Encoded as F = 1, size = 0b10.

<Qd>, <Qm> The destination vector and the operand vector, for a quadword operation.

<Dd>, <Dm> The destination vector and the operand vector, for a doubleword operation.

Operation

```

if ConditionPassed() then
    EncodingSpecificOperations(); CheckAdvSIMDEnabled();
    for r = 0 to regs-1
        for e = 0 to elements-1
            if floating_point then
                Elem[D[d+r],e,32] = FPRSqrtEstimate(Elem[D[m+r],e,32], StandardFPSCRValue());
            else
                Elem[D[d+r],e,32] = UnsignedRSqrtEstimate(Elem[D[m+r],e,32]);
  
```

Newton-Raphson iteration

For details of the operation performed and how it can be used in a Newton-Raphson iteration to calculate the reciprocal of the square root of a number, see [Floating-point reciprocal estimate and step on page E1-2322](#).

F8.1.140 VRSQRTS

Vector Reciprocal Square Root Step multiplies the elements of one vector by the corresponding elements of another vector, subtracts each of the products from 3.0, divides these results by 2.0, and places the results into the elements of the destination vector.

The operand and result elements are 32-bit floating-point numbers.

For details of the operation performed by this instruction see [Floating-point reciprocal estimate and step on page E1-2322](#).

Depending on settings in the CPACR, NSACR, and HCPTR registers, and the security state and mode in which the instruction is executed, an attempt to execute the instruction might be UNDEFINED, or trapped to Hyp mode. [Summary of access controls for Advanced SIMD functionality on page G1-3498](#) summarizes these controls.

ARM deprecates the conditional execution of any Advanced SIMD instruction encoding that is not also available as a VFP instruction encoding, see [Conditional execution on page F2-2416](#).

Encoding T1/A1 Advanced SIMDv1 (UNDEFINED in integer-only variant)

VRSQRTS<c>.F32 <Qd>, <Qn>, <Qm>

VRSQRTS<c>.F32 <Dd>, <Dn>, <Dm>

15	14	13	12	11	10	9	8	7	6	5	4	3	2	1	0	15	14	13	12	11	10	9	8	7	6	5	4	3	2	1	0
1	1	1	0	1	1	1	1	0	D	1	sz	Vn				Vd				1	1	1	1	N	Q	M	1	Vm			

31	30	29	28	27	26	25	24	23	22	21	20	19	18	17	16	15	14	13	12	11	10	9	8	7	6	5	4	3	2	1	0
1	1	1	1	0	0	1	0	0	D	1	sz	Vn				Vd				1	1	1	1	N	Q	M	1	Vm			

```

if Q == '1' && (Vd<0> == '1' || Vn<0> == '1' || Vm<0> == '1') then UNDEFINED;
if sz == '1' then UNDEFINED;
esize = 32; elements = 2;
d = UInt(D:Vd); n = UInt(N:Vn); m = UInt(M:Vm); regs = if Q == '0' then 1 else 2;
    
```

Assembler syntax

VRSQRTS{<c>}{<q>}.F32 {<Qd>}, <Qn>, <Qm> Encoded as Q = 1, sz = 0
VRSQRTS{<c>}{<q>}.F32 {<Dd>}, <Dn>, <Dm> Encoded as Q = 0, sz = 0

where:

<c>, <q> See [Standard assembler syntax fields on page F2-2415](#). An A32 VRSQRTS instruction must be unconditional. ARM strongly recommends that a T32 VRSQRTS instruction is unconditional, see [Conditional execution on page F2-2416](#).

<Qd>, <Qn>, <Qm> The destination vector and the operand vectors for a quadword operation.

<Dd>, <Dn>, <Dm> The destination vector and the operand vectors for a doubleword operation.

Operation

```
if ConditionPassed() then
    EncodingSpecificOperations(); CheckAdvSIMDEnabled();
    for r = 0 to regs-1
        for e = 0 to elements-1
            Elem[D[d+r],e,32] = FPRSqrtStep(Elem[D[n+r],e,32], Elem[D[m+r],e,32]);
```

Newton-Raphson iteration

For details of the operation performed and how it can be used in a Newton-Raphson iteration to calculate the reciprocal of the square root of a number, see [Floating-point reciprocal estimate and step on page E1-2322](#).

F8.1.141 VRSRA

Vector Rounding Shift Right and Accumulate takes each element in a vector, right shifts them by an immediate value, and accumulates the rounded results into the destination vector. (For truncated results, see [VSRA](#) on page F8-3352.)

The operand and result elements must all be the same type, and can be any one of:

- 8-bit, 16-bit, 32-bit, or 64-bit signed integers.
- 8-bit, 16-bit, 32-bit, or 64-bit unsigned integers.

Depending on settings in the CPACR, NSACR, and HCPTR registers, and the security state and mode in which the instruction is executed, an attempt to execute the instruction might be UNDEFINED, or trapped to Hyp mode.

[Summary of access controls for Advanced SIMD functionality](#) on page G1-3498 summarizes these controls.

ARM deprecates the conditional execution of any Advanced SIMD instruction encoding that is not also available as a VFP instruction encoding, see [Conditional execution](#) on page F2-2416.

Encoding T1/A1 Advanced SIMDv1

VRSRA<c>.<type><size> <Qd>, <Qm>, #<imm>

VRSRA<c>.<type><size> <Dd>, <Dm>, #<imm>

15	14	13	12	11	10	9	8	7	6	5	4	3	2	1	0	15	14	13	12	11	10	9	8	7	6	5	4	3	2	1	0
1	1	1	U	1	1	1	1	1	D	imm6						Vd	0	0	1	1	L	Q	M	1	Vm						
31	30	29	28	27	26	25	24	23	22	21	20	19	18	17	16	15	14	13	12	11	10	9	8	7	6	5	4	3	2	1	0
1	1	1	1	0	0	1	U	1	D	imm6						Vd	0	0	1	1	L	Q	M	1	Vm						

```

if (L:imm6) == '0000xxx' then SEE "Related encodings";
if Q == '1' && (Vd<0> == '1' || Vm<0> == '1') then UNDEFINED;
case L:imm6 of
    when "0001xxx" esize = 8; elements = 8; shift_amount = 16 - UInt(imm6);
    when "001xxxx" esize = 16; elements = 4; shift_amount = 32 - UInt(imm6);
    when "01xxxxx" esize = 32; elements = 2; shift_amount = 64 - UInt(imm6);
    when "1xxxxxx" esize = 64; elements = 1; shift_amount = 64 - UInt(imm6);
unsigned = (U == '1'); d = UInt(D:Vd); m = UInt(M:Vm); regs = if Q == '0' then 1 else 2;
    
```

Related encodings See [One register and a modified immediate value](#) on page F5-2508.

Assembler syntax

VRSRA{<c>}{<q>}.<type><size> {<Qd>}, <Qm>, #<imm> Encoded as Q = 1
 VRSRA{<c>}{<q>}.<type><size> {<Dd>}, <Dm>, #<imm> Encoded as Q = 0

where:

<c>, <q> See [Standard assembler syntax fields on page F2-2415](#). An A32 VRSRA instruction must be unconditional. ARM strongly recommends that a T32 VRSRA instruction is unconditional, see [Conditional execution on page F2-2416](#).

<type> The data type for the elements of the vectors. It must be one of:
 S Signed, encoded as U = 0.
 U Unsigned, encoded as U = 1.

<size> The data size for the elements of the vectors. It must be one of:
 8 Encoded as L = 0, imm6<5:3> = 0b001. (8 – <imm>) is encoded in imm6<2:0>.
 16 Encoded as L = 0, imm6<5:4> = 0b01. (16 – <imm>) is encoded in imm6<3:0>.
 32 Encoded as L = 0, imm6<5> = 0b1. (32 – <imm>) is encoded in imm6<4:0>.
 64 Encoded as L = 1. (64 – <imm>) is encoded in imm6<5:0>.

<Qd>, <Qm> The destination vector, and the operand vector, for a quadword operation.

<Dd>, <Dm> The destination vector, and the operand vector, for a doubleword operation.

<imm> The immediate value, in the range 1 to <size>. See the description of <size> for how <imm> is encoded.

Operation

```

if ConditionPassed() then
    EncodingSpecificOperations(); CheckAdvSIMDEnabled();
    round_const = 1 << (shift_amount - 1);
    for r = 0 to regs-1
        for e = 0 to elements-1
            result = (Int(Elem[D[m+r],e,esize], unsigned) + round_const) >> shift_amount;
            Elem[D[d+r],e,esize] = Elem[D[d+r],e,esize] + result;
  
```

F8.1.142 VRSUBHN

Vector Rounding Subtract and Narrow, returning High Half subtracts the elements of one quadword vector from the corresponding elements of another quadword vector takes the most significant half of each result, and places the final results in a doubleword vector. The results are rounded. For truncated results, see [VSUBHN](#) on page F8-3380.

The operand elements can be 16-bit, 32-bit, or 64-bit integers. There is no distinction between signed and unsigned integers.

Depending on settings in the [CPACR](#), [NSACR](#), and [HCPTR](#) registers, and the security state and mode in which the instruction is executed, an attempt to execute the instruction might be UNDEFINED, or trapped to Hyp mode. [Summary of access controls for Advanced SIMD functionality on page G1-3498](#) summarizes these controls.

ARM deprecates the conditional execution of any Advanced SIMD instruction encoding that is not also available as a VFP instruction encoding, see [Conditional execution on page F2-2416](#).

Encoding T1/A1 Advanced SIMDv1

VRSUBHN<c>.<dt> <Dd>, <Qn>, <Qm>

15	14	13	12	11	10	9	8	7	6	5	4	3	2	1	0	15	14	13	12	11	10	9	8	7	6	5	4	3	2	1	0
1	1	1	1	1	1	1	1	1	D	size	Vn				Vd				0	1	1	0	N	0	M	0	Vm				
31	30	29	28	27	26	25	24	23	22	21	20	19	18	17	16	15	14	13	12	11	10	9	8	7	6	5	4	3	2	1	0
1	1	1	1	0	0	1	1	1	D	size	Vn				Vd				0	1	1	0	N	0	M	0	Vm				

```

if size == '11' then SEE "Related encodings";
if Vn<0> == '1' || Vm<0> == '1' then UNDEFINED;
esize = 8 << UInt(size); elements = 64 DIV esize;
d = UInt(D:Vd); n = UInt(N:Vn); m = UInt(M:Vm);
    
```

Related encodings See [Advanced SIMD data-processing instructions on page F5-2499](#).

Assembler syntax

VRSUBHN{<c>}{<q>}.<dt> <Dd>, <Qn>, <Qm>

where:

<c>, <q> See [Standard assembler syntax fields on page F2-2415](#). An A32 VRSUBHN instruction must be unconditional. ARM strongly recommends that a T32 VRSUBHN instruction is unconditional, see [Conditional execution on page F2-2416](#).

<dt> The data type for the elements of the operands. It must be one of:
I16 Encoded as size = 0b00.
I32 Encoded as size = 0b01.
I64 Encoded as size = 0b10.

<Dd>, <Qn>, <Qm> The destination vector and the operand vectors.

Operation

```
if ConditionPassed() then
    EncodingSpecificOperations(); CheckAdvSIMDEnabled();
    round_const = 1 << (esize-1);
    for e = 0 to elements-1
        result = Elem[Qin[n>>1],e,2*esize] - Elem[Qin[m>>1],e,2*esize] + round_const;
        Elem[D[d],e,esize] = result<2*esize-1:esize>;
```

F8.1.143 VSEL

Floating-point selection allows the destination register to take the value in either one or the other source register according to the condition codes in the [APSR](#).

If VSEL generates an exception, it is regarded as unconditional for the purpose of reporting the condition field in the Exception Syndrome register.

VSEL cannot be made conditional using the IT mechanism in T32.

Encoding T1/A1 ARMv8 FP

VSEL<c>.F64 <Dd>, <Dn>, <Dm>

VSEL<c>.F32 <Sd>, <Sn>, <Sm>

15	14	13	12	11	10	9	8	7	6	5	4	3	2	1	0	15	14	13	12	11	10	9	8	7	6	5	4	3	2	1	0
1	1	1	1	1	1	1	0	0	D	cc		Vn		Vd	1	0	1	sz	N	0	M	0			Vm						

31	30	29	28	27	26	25	24	23	22	21	20	19	18	17	16	15	14	13	12	11	10	9	8	7	6	5	4	3	2	1	0
1	1	1	1	1	1	1	0	0	D	cc		Vn		Vd	1	0	1	sz	N	0	M	0			Vm						

```

dp_operation = (sz == '1');
d = if dp_operation then UInt(D:Vd) else UInt(Vd:D);
n = if dp_operation then UInt(N:Vn) else UInt(Vn:N);
m = if dp_operation then UInt(M:Vm) else UInt(Vm:M);
cond = cc:(cc<1> EOR cc<0>):'0';
    
```

Assembler syntax

VSEL<c>.F64 <Dd>, <Dn>, <Dm> Encoded as sz = 1
VSEL<c>.F32 <Sd>, <Sn>, <Sm> Encoded as sz = 0

where:

<c> See [Standard assembler syntax fields on page F2-2415](#). Must be one of {GE, GT, EQ, VS}, see [Conditional execution on page F2-2416](#).

<Dd>, <Dn>, <Dm> The destination vector and the operand vectors, for a doubleword operation.

<Sd>, <Sn>, <Sm> The destination vector and the operand vectors, for a singleword operation.

Operation

```
EncodingSpecificOperations(); CheckVFPEEnabled(TRUE);  
if dp_operation then  
    D[d] = if ConditionPassed() then D[n] else D[m];  
else  
    S[d] = if ConditionPassed() then S[n] else S[m];
```

F8.1.144 VSHL (immediate)

Vector Shift Left (immediate) takes each element in a vector of integers, left shifts them by an immediate value, and places the results in the destination vector.

Bits shifted out of the left of each element are lost.

The elements must all be the same size, and can be 8-bit, 16-bit, 32-bit, or 64-bit integers. There is no distinction between signed and unsigned integers.

Depending on settings in the CPACR, NSACR, and HCPTR registers, and the security state and mode in which the instruction is executed, an attempt to execute the instruction might be UNDEFINED, or trapped to Hyp mode. [Summary of access controls for Advanced SIMD functionality on page G1-3498](#) summarizes these controls.

ARM deprecates the conditional execution of any Advanced SIMD instruction encoding that is not also available as a VFP instruction encoding, see [Conditional execution on page F2-2416](#).

Encoding T1/A1 Advanced SIMDv1

VSHL<c>.I<size> <Qd>, <Qm>, #<imm>

VSHL<c>.I<size> <Dd>, <Dm>, #<imm>

15	14	13	12	11	10	9	8	7	6	5	4	3	2	1	0	15	14	13	12	11	10	9	8	7	6	5	4	3	2	1	0
1	1	1	0	1	1	1	1	1	D	imm6						Vd	0	1	0	1	L	Q	M	1	Vm						
31	30	29	28	27	26	25	24	23	22	21	20	19	18	17	16	15	14	13	12	11	10	9	8	7	6	5	4	3	2	1	0
1	1	1	1	0	0	1	0	1	D	imm6						Vd	0	1	0	1	L	Q	M	1	Vm						

```

if L:imm6 == '0000xxx' then SEE "Related encodings";
if Q == '1' && (Vd<0> == '1' || Vm<0> == '1') then UNDEFINED;
case L:imm6 of
    when "0001xxx" esize = 8; elements = 8; shift_amount = UInt(imm6) - 8;
    when "001xxxx" esize = 16; elements = 4; shift_amount = UInt(imm6) - 16;
    when "01xxxxx" esize = 32; elements = 2; shift_amount = UInt(imm6) - 32;
    when "1xxxxxx" esize = 64; elements = 1; shift_amount = UInt(imm6);
d = UInt(D:Vd); m = UInt(M:Vm); regs = if Q == '0' then 1 else 2;
    
```

Related encodings See [One register and a modified immediate value on page F5-2508](#).

Assembler syntax

VSHL{<C>}{<Q>}.I<size> {<Qd>}, <Qm>, #<imm> Encoded as Q = 1
 VSHL{<C>}{<Q>}.I<size> {<Dd>}, <Dm>, #<imm> Encoded as Q = 0

where:

- <C>, <Q> See [Standard assembler syntax fields on page F2-2415](#). An A32 VSHL instruction must be unconditional. ARM strongly recommends that a T32 VSHL instruction is unconditional, see [Conditional execution on page F2-2416](#).
- <size> The data size for the elements of the vectors. It must be one of:
 - 8 Encoded as L = 0, imm6<5:3> = 0b001. <imm> is encoded in imm6<2:0>.
 - 16 Encoded as L = 0, imm6<5:4> = 0b01. <imm> is encoded in imm6<3:0>.
 - 32 Encoded as L = 0, imm6<5> = 0b1. <imm> is encoded in imm6<4:0>.
 - 64 Encoded as L = 1. <imm> is encoded in imm6<5:0>.
- <Qd>, <Qm> The destination vector, and the operand vector, for a quadword operation.
- <Dd>, <Dm> The destination vector, and the operand vector, for a doubleword operation.
- <imm> The immediate value, in the range 0 to <size>-1. See the description of <size> for how <imm> is encoded.

Operation

```

if ConditionPassed() then
    EncodingSpecificOperations(); CheckAdvSIMDEnabled();
    for r = 0 to regs-1
        for e = 0 to elements-1
            Elem[D[d+r],e,esize] = LSL(Elem[D[m+r],e,esize], shift_amount);
  
```

F8.1.145 VSHL (register)

Vector Shift Left (register) takes each element in a vector, shifts them by a value from the least significant byte of the corresponding element of a second vector, and places the results in the destination vector. If the shift value is positive, the operation is a left shift. If the shift value is negative, it is a truncating right shift.

———— **Note** —————

For a rounding shift, see [VRSHL](#) on page F8-3322.

The first operand and result elements are the same data type, and can be any one of:

- 8-bit, 16-bit, 32-bit, or 64-bit signed integers.
- 8-bit, 16-bit, 32-bit, or 64-bit unsigned integers.

The second operand is always a signed integer of the same size.

Depending on settings in the [CPACR](#), [NSACR](#), and [HCPTR](#) registers, and the security state and mode in which the instruction is executed, an attempt to execute the instruction might be UNDEFINED, or trapped to Hyp mode. [Summary of access controls for Advanced SIMD functionality on page G1-3498](#) summarizes these controls.

ARM deprecates the conditional execution of any Advanced SIMD instruction encoding that is not also available as a VFP instruction encoding, see [Conditional execution on page F2-2416](#).

Encoding T1/A1 Advanced SIMDv1

VSHL<c>.<type><size> <Qd>, <Qm>, <Qn>

VSHL<c>.<type><size> <Dd>, <Dm>, <Dn>

15	14	13	12	11	10	9	8	7	6	5	4	3	2	1	0	15	14	13	12	11	10	9	8	7	6	5	4	3	2	1	0
1	1	1	U	1	1	1	1	0	D	size	Vn	Vd	0	1	0	0	N	Q	M	0	Vm										
31	30	29	28	27	26	25	24	23	22	21	20	19	18	17	16	15	14	13	12	11	10	9	8	7	6	5	4	3	2	1	0
1	1	1	1	0	0	1	U	0	D	size	Vn	Vd	0	1	0	0	N	Q	M	0	Vm										

```

if Q == '1' && (Vd<0> == '1' || Vm<0> == '1' || Vn<0> == '1') then UNDEFINED;
unsigned = (U == '1');
esize = 8 << UInt(size); elements = 64 DIV esize;
d = UInt(D:Vd); m = UInt(M:Vm); n = UInt(N:Vn); regs = if Q == '0' then 1 else 2;
    
```

Assembler syntax

VSHL{<C>}{<q>}.<type><size> {<Qd>}, <Qm>, <Qn> Encoded as Q = 1
 VSHL{<C>}{<q>}.<type><size> {<Dd>}, <Dm>, <Dn> Encoded as Q = 0

where:

<C>, <q> See [Standard assembler syntax fields on page F2-2415](#). An A32 VSHL instruction must be unconditional. ARM strongly recommends that a T32 VSHL instruction is unconditional, see [Conditional execution on page F2-2416](#).

<type> The data type for the elements of the vectors. It must be one of:
 S Signed, encoded as U = 0.
 U Unsigned, encoded as U = 1.
 Together with the <size> field, this indicates the data type and size of the first operand and the result.

<size> The data size for the elements of the vectors. It must be one of:
 8 Encoded as size = 0b00.
 16 Encoded as size = 0b01.
 32 Encoded as size = 0b10.
 64 Encoded as size = 0b11.

<Qd>, <Qm>, <Qn> The destination vector and the operand vectors, for a quadword operation.

<Dd>, <Dm>, <Dn> The destination vector and the operand vectors, for a doubleword operation.

Operation

```
if ConditionPassed() then
    EncodingSpecificOperations(); CheckAdvSIMDEnabled();
    for r = 0 to regs-1
        for e = 0 to elements-1
            shift = SInt(Elem[D[n+r],e,esize]<7:0>);
            result = Int(Elem[D[m+r],e,esize], unsigned) << shift;
            Elem[D[d+r],e,esize] = result<esize-1:0>;
```

F8.1.146 VSHLL

Vector Shift Left Long takes each element in a doubleword vector, left shifts them by an immediate value, and places the results in a quadword vector.

The operand elements can be:

- 8-bit, 16-bit, or 32-bit signed integers.
- 8-bit, 16-bit, or 32-bit unsigned integers.
- 8-bit, 16-bit, or 32-bit untyped integers, maximum shift only.

The result elements are twice the length of the operand elements.

Depending on settings in the CPACR, NSACR, and HCPTR registers, and the security state and mode in which the instruction is executed, an attempt to execute the instruction might be UNDEFINED, or trapped to Hyp mode. [Summary of access controls for Advanced SIMD functionality on page G1-3498](#) summarizes these controls.

ARM deprecates the conditional execution of any Advanced SIMD instruction encoding that is not also available as a VFP instruction encoding, see [Conditional execution on page F2-2416](#).

Encoding T1/A1 Advanced SIMDv1

VSHLL<c>.<type><size> <Qd>, <Dm>, #<imm> (0 <<imm> <<size>)

15	14	13	12	11	10	9	8	7	6	5	4	3	2	1	0	15	14	13	12	11	10	9	8	7	6	5	4	3	2	1	0
1	1	1	U	1	1	1	1	1	D	imm6						Vd	1	0	1	0	0	0	M	1	Vm						
31	30	29	28	27	26	25	24	23	22	21	20	19	18	17	16	15	14	13	12	11	10	9	8	7	6	5	4	3	2	1	0
1	1	1	1	0	0	1	U	1	D	imm6						Vd	1	0	1	0	0	0	M	1	Vm						

if imm6 == '000xxx' then SEE "Related encodings";

if Vd<0> == '1' then UNDEFINED;

case imm6 of

when "001xxx" esize = 8; elements = 8; shift_amount = UInt(imm6) - 8;

when "01xxxx" esize = 16; elements = 4; shift_amount = UInt(imm6) - 16;

when "1xxxxx" esize = 32; elements = 2; shift_amount = UInt(imm6) - 32;

if shift_amount == 0 then SEE VMOVL;

unsigned = (U == '1'); d = UInt(D:Vd); m = UInt(M:Vm);

Encoding T2/A2 Advanced SIMDv1

VSHLL<c>.<type><size> <Qd>, <Dm>, #<imm> (<imm> == <size>)

15	14	13	12	11	10	9	8	7	6	5	4	3	2	1	0	15	14	13	12	11	10	9	8	7	6	5	4	3	2	1	0
1	1	1	1	1	1	1	1	1	D	1	1	size	1	0	Vd	0	0	1	1	0	0	M	0	Vm							
31	30	29	28	27	26	25	24	23	22	21	20	19	18	17	16	15	14	13	12	11	10	9	8	7	6	5	4	3	2	1	0
1	1	1	1	0	0	1	1	1	D	1	1	size	1	0	Vd	0	0	1	1	0	0	M	0	Vm							

if size == '11' || Vd<0> == '1' then UNDEFINED;

esize = 8 << UInt(size); elements = 64 DIV esize; shift_amount = esize;

unsigned = FALSE; // Or TRUE without change of functionality

d = UInt(D:Vd); m = UInt(M:Vm);

Related encodings See [One register and a modified immediate value on page F5-2508](#).

Assembler syntax

VSHLL{<c>}{<q>}.<type><size> <Qd>, <Dm>, #<imm>

where:

- <c>, <q> See [Standard assembler syntax fields on page F2-2415](#). An A32 VSHLL instruction must be unconditional. ARM strongly recommends that a T32 VSHLL instruction is unconditional, see [Conditional execution on page F2-2416](#).
- <type> The data type for the elements of the operand. It must be one of:
- S Signed. In encoding T1/A1, encoded as U = 0.
 - U Unsigned. In encoding T1/A1, encoded as U = 1.
 - I Untyped integer, Available only in encoding T2/A2.
- <size> The data size for the elements of the operand. [Table F8-5](#) shows the permitted values and their encodings:

Table F8-5 VSHLL <size> field encoding

<size>	Encoding T1/A1	Encoding T2/A2
8	Encoded as imm6<5:3> = 0b001	Encoded as size = 0b00
16	Encoded as imm6<5:4> = 0b01	Encoded as size = 0b01
32	Encoded as imm6<5> = 1	Encoded as size = 0b10

- <Qd>, <Dm> The destination vector and the operand vector.
- <imm> The immediate value. <imm> must lie in the range 1 to <size>, and:
- If <size> == <imm>, the encoding is T2/A2.
 - Otherwise, the encoding is T1/A1, and:
 - If <size> == 8, <imm> is encoded in imm6<2:0>.
 - If <size> == 16, <imm> is encoded in imm6<3:0>.
 - If <size> == 32, <imm> is encoded in imm6<4:0>.

Operation

```
if ConditionPassed() then
    EncodingSpecificOperations(); CheckAdvSIMDEnabled();
    for e = 0 to elements-1
        result = Int(Elem[Din[m],e,esize], unsigned) << shift_amount;
        Elem[Q[d>>1],e,2*esize] = result<2*esize-1:0>;
```

F8.1.147 VSHR

Vector Shift Right takes each element in a vector, right shifts them by an immediate value, and places the truncated results in the destination vector. For rounded results, see [VRSHR on page F8-3324](#).

The operand and result elements must be the same size, and can be any one of:

- 8-bit, 16-bit, 32-bit, or 64-bit signed integers.
- 8-bit, 16-bit, 32-bit, or 64-bit unsigned integers.

Depending on settings in the [CPACR](#), [NSACR](#), and [HCPTR](#) registers, and the security state and mode in which the instruction is executed, an attempt to execute the instruction might be UNDEFINED, or trapped to Hyp mode.

[Summary of access controls for Advanced SIMD functionality on page G1-3498](#) summarizes these controls.

ARM deprecates the conditional execution of any Advanced SIMD instruction encoding that is not also available as a VFP instruction encoding, see [Conditional execution on page F2-2416](#).

Encoding T1/A1 Advanced SIMDv1

VSHR<c>.<type><size> <Qd>, <Qm>, #<imm>

VSHR<c>.<type><size> <Dd>, <Dm>, #<imm>

15	14	13	12	11	10	9	8	7	6	5	4	3	2	1	0	15	14	13	12	11	10	9	8	7	6	5	4	3	2	1	0
1	1	1	U	1	1	1	1	1	D	imm6						Vd				0	0	0	0	L	Q	M	1	Vm			
31	30	29	28	27	26	25	24	23	22	21	20	19	18	17	16	15	14	13	12	11	10	9	8	7	6	5	4	3	2	1	0
1	1	1	1	0	0	1	U	1	D	imm6						Vd				0	0	0	0	L	Q	M	1	Vm			

```

if (L:imm6) == '0001xxx' then SEE "Related encodings";
if Q == '1' && (Vd<0> == '1' || Vm<0> == '1') then UNDEFINED;
case L:imm6 of
    when "0001xxx" esize = 8; elements = 8; shift_amount = 16 - UInt(imm6);
    when "001xxxx" esize = 16; elements = 4; shift_amount = 32 - UInt(imm6);
    when "01xxxxx" esize = 32; elements = 2; shift_amount = 64 - UInt(imm6);
    when "1xxxxxx" esize = 64; elements = 1; shift_amount = 64 - UInt(imm6);
unsigned = (U == '1'); d = UInt(D:Vd); m = UInt(M:Vm); regs = if Q == '0' then 1 else 2;
    
```

Related encodings See [One register and a modified immediate value on page F5-2508](#).

Assembler syntax

VSHR{<c>}{<q>}.<type><size> {<Qd>}, <Qm>, #<imm> Encoded as Q = 1
 VSHR{<c>}{<q>}.<type><size> {<Dd>}, <Dm>, #<imm> Encoded as Q = 0

where:

<c>, <q> See [Standard assembler syntax fields on page F2-2415](#). An A32 VSHR instruction must be unconditional. ARM strongly recommends that a T32 VSHR instruction is unconditional, see [Conditional execution on page F2-2416](#).

<type> The data type for the elements of the vectors. It must be one of:
 S Signed, encoded as U = 0.
 U Unsigned, encoded as U = 1.

<size> The data size for the elements of the vectors. It must be one of:
 8 Encoded as L = 0, imm6<5:3> = 0b001. (8 – <imm>) is encoded in imm6<2:0>.
 16 Encoded as L = 0, imm6<5:4> = 0b01. (16 – <imm>) is encoded in imm6<3:0>.
 32 Encoded as L = 0, imm6<5> = 0b1. (32 – <imm>) is encoded in imm6<4:0>.
 64 Encoded as L = 1. (64 – <imm>) is encoded in imm6<5:0>.

<Qd>, <Qm> The destination vector, and the operand vector, for a quadword operation.

<Dd>, <Dm> The destination vector, and the operand vector, for a doubleword operation.

<imm> The immediate value, in the range 1 to <size>. See the description of <size> for how <imm> is encoded.

Operation

```
if ConditionPassed() then
    EncodingSpecificOperations(); CheckAdvSIMDEnabled();
    for r = 0 to regs-1
        for e = 0 to elements-1
            result = Int(Elem[D[m+r],e,esize], unsigned) >> shift_amount;
            Elem[D[d+r],e,esize] = result<esize-1:0>;
```

Pseudo-instructions

VSHR.<type><size> <Qd>, <Qm>, #0 is a synonym for VMOV <Qd>, <Qm>
 VSHR.<type><size> <Dd>, <Dm>, #0 is a synonym for VMOV <Dd>, <Dm>

F8.1.148 VSHRN

Vector Shift Right Narrow takes each element in a vector, right shifts them by an immediate value, and places the truncated results in the destination vector. For rounded results, see [VRSHRN](#) on page F8-3326.

The operand elements can be 16-bit, 32-bit, or 64-bit integers. There is no distinction between signed and unsigned integers. The destination elements are half the size of the source elements.

Depending on settings in the CPACR, NSACR, and HCPTR registers, and the security state and mode in which the instruction is executed, an attempt to execute the instruction might be UNDEFINED, or trapped to Hyp mode. [Summary of access controls for Advanced SIMD functionality](#) on page G1-3498 summarizes these controls.

ARM deprecates the conditional execution of any Advanced SIMD instruction encoding that is not also available as a VFP instruction encoding, see [Conditional execution](#) on page F2-2416.

Encoding T1/A1 Advanced SIMDv1

VSHRN<c>.I<size> <Dd>, <Qm>, #<imm>

15	14	13	12	11	10	9	8	7	6	5	4	3	2	1	0	15	14	13	12	11	10	9	8	7	6	5	4	3	2	1	0
1	1	1	0	1	1	1	1	1	D	imm6						Vd				1	0	0	0	0	0	M	1	Vm			

31	30	29	28	27	26	25	24	23	22	21	20	19	18	17	16	15	14	13	12	11	10	9	8	7	6	5	4	3	2	1	0
1	1	1	1	0	0	1	0	1	D	imm6						Vd				1	0	0	0	0	0	M	1	Vm			

if imm6 == '000xxx' then SEE "Related encodings";

if Vm<0> == '1' then UNDEFINED;

case imm6 of

 when "001xxx" esize = 8; elements = 8; shift_amount = 16 - UInt(imm6);

 when "01xxxx" esize = 16; elements = 4; shift_amount = 32 - UInt(imm6);

 when "1xxxxx" esize = 32; elements = 2; shift_amount = 64 - UInt(imm6);

d = UInt(D:Vd); m = UInt(M:Vm);

Related encodings See [One register and a modified immediate value](#) on page F5-2508.

Assembler syntax

VSHRN{<c>}{<q>}.I<size> <Dd>, <Qm>, #<imm>

where:

- <c>, <q> See [Standard assembler syntax fields on page F2-2415](#). An A32 VSHRN instruction must be unconditional. ARM strongly recommends that a T32 VSHRN instruction is unconditional, see [Conditional execution on page F2-2416](#).
- <size> The data size for the elements of the vectors. It must be one of:
- | | |
|----|--|
| 16 | Encoded as imm6<5:3> = 0b001. (8 – <imm>) is encoded in imm6<2:0>. |
| 32 | Encoded as imm6<5:4> = 0b01. (16 – <imm>) is encoded in imm6<3:0>. |
| 64 | Encoded as imm6<5> = 0b1. (32 – <imm>) is encoded in imm6<4:0>. |
- <Dd>, <Qm> The destination vector, and the operand vector.
- <imm> The immediate value, in the range 1 to <size>/2. See the description of <size> for how <imm> is encoded.

Operation

```
if ConditionPassed() then
    EncodingSpecificOperations(); CheckAdvSIMDEnabled();
    for e = 0 to elements-1
        result = LSR(Elem[Qin[m]>>1], e, 2*esize), shift_amount);
        Elem[D[d], e, esize] = result<size-1:0>;
```

Pseudo-instructions

VSHRN.I<size> <Dd>, <Qm>, #0 is a synonym for VMOVN.I<size> <Dd>, <Qm>

For details see [VMOVN on page F8-3230](#).

F8.1.149 VSLI

Vector Shift Left and Insert takes each element in the operand vector, left shifts them by an immediate value, and inserts the results in the destination vector. Bits shifted out of the left of each element are lost.

The elements must all be the same size, and can be 8-bit, 16-bit, 32-bit, or 64-bit. There is no distinction between data types.

Depending on settings in the CPACR, NSACR, and HCPTR registers, and the security state and mode in which the instruction is executed, an attempt to execute the instruction might be UNDEFINED, or trapped to Hyp mode.

[Summary of access controls for Advanced SIMD functionality on page G1-3498](#) summarizes these controls.

ARM deprecates the conditional execution of any Advanced SIMD instruction encoding that is not also available as a VFP instruction encoding, see [Conditional execution on page F2-2416](#).

Encoding T1/A1 Advanced SIMDv1

VSLI<c>.<size> <Qd>, <Qm>, #<imm>

VSLI<c>.<size> <Dd>, <Dm>, #<imm>

15	14	13	12	11	10	9	8	7	6	5	4	3	2	1	0	15	14	13	12	11	10	9	8	7	6	5	4	3	2	1	0
1	1	1	1	1	1	1	1	1	D	imm6						Vd	0	1	0	1	L	Q	M	1	Vm						
31	30	29	28	27	26	25	24	23	22	21	20	19	18	17	16	15	14	13	12	11	10	9	8	7	6	5	4	3	2	1	0
1	1	1	1	0	0	1	1	1	D	imm6						Vd	0	1	0	1	L	Q	M	1	Vm						

```

if (L:imm6) == '0001xxx' then SEE "Related encodings";
if Q == '1' && (Vd<0> == '1' || Vm<0> == '1') then UNDEFINED;
case L:imm6 of
    when "0001xxx" esize = 8; elements = 8; shift_amount = UInt(imm6) - 8;
    when "001xxxx" esize = 16; elements = 4; shift_amount = UInt(imm6) - 16;
    when "01xxxxx" esize = 32; elements = 2; shift_amount = UInt(imm6) - 32;
    when "1xxxxxx" esize = 64; elements = 1; shift_amount = UInt(imm6);
d = UInt(D:Vd); m = UInt(M:Vm); regs = if Q == '0' then 1 else 2;
    
```

Related encodings See [One register and a modified immediate value on page F5-2508](#).

Assembler syntax

VSLI{<C>}{<q>}.<size> {<Qd>}, <Qm>, #<imm> Encoded as Q = 1
 VSLI{<C>}{<q>}.<size> {<Dd>}, <Dm>, #<imm> Encoded as Q = 0

where:

<C>, <q> See [Standard assembler syntax fields on page F2-2415](#). An A32 VSLI instruction must be unconditional. ARM strongly recommends that a T32 VSLI instruction is unconditional, see [Conditional execution on page F2-2416](#).

<size> The data size for the elements of the vectors. It must be one of:
 8 Encoded as L = 0, imm6<5:3> = 0b001. <imm> is encoded in imm6<2:0>.
 16 Encoded as L = 0, imm6<5:4> = 0b01. <imm> is encoded in imm6<3:0>.
 32 Encoded as L = 0, imm6<5> = 0b1. <imm> is encoded in imm6<4:0>.
 64 Encoded as L = 1. <imm> is encoded in imm6<5:0>.

<Qd>, <Qm> The destination vector, and the operand vector, for a quadword operation.

<Dd>, <Dm> The destination vector, and the operand vector, for a doubleword operation.

<imm> The immediate value, in the range 0 to <size>-1. See the description of <size> for how <imm> is encoded.

Operation

```
if ConditionPassed() then
    EncodingSpecificOperations(); CheckAdvSIMDEnabled();
    mask = LSL(Ones(esize), shift_amount);
    for r = 0 to regs-1
        for e = 0 to elements-1
            shifted_op = LSL(Elem[D[m+r],e,esize], shift_amount);
            Elem[D[d+r],e,esize] = (Elem[D[d+r],e,esize] AND NOT(mask)) OR shifted_op;
```

F8.1.150 VSQRT

This instruction calculates the square root of the value in a floating-point register and writes the result to another floating-point register.

Depending on settings in the CPACR, NSACR, and HCPTR, and FPEXC registers, and the security state and mode in which the instruction is executed, an attempt to execute the instruction might be UNDEFINED, or trapped to Hyp mode. *Summary of general controls of CP10 and CP11 functionality on page G1-3496* summarizes these controls.

Encoding T1/A1 VFPv2, VFPv3, VFPv4 (sz = 1 UNDEFINED in single-precision only variants)

VSQRT<c>.F64 <Dd>, <Dm>

VSQRT<c>.F32 <Sd>, <Sm>

15	14	13	12	11	10	9	8	7	6	5	4	3	2	1	0	15	14	13	12	11	10	9	8	7	6	5	4	3	2	1	0
1	1	1	0	1	1	1	0	1	D	1	1	0	0	0	1	Vd	1	0	1	sz	1	1	M	0	Vm						
31	30	29	28	27	26	25	24	23	22	21	20	19	18	17	16	15	14	13	12	11	10	9	8	7	6	5	4	3	2	1	0
cond		1	1	1	0	1	D	1	1	0	0	0	1	Vd	1	0	1	sz	1	1	M	0	Vm								

```

if FPSCR.Len != '000' || FPSCR.Stride != '00' then UNDEFINED;
dp_operation = (sz == '1');
d = if dp_operation then UInt(D:Vd) else UInt(Vd:D);
m = if dp_operation then UInt(M:Vm) else UInt(Vm:M);
    
```

Assembler syntax

VSQRT{<c>}{<q>}.F64 <Dd>, <Dm> Encoded as sz = 1
VSQRT{<c>}{<q>}.F32 <Sd>, <Sm> Encoded as sz = 0

where:

<c>, <q> See *Standard assembler syntax fields* on page F2-2415.
<Dd>, <Dm> The destination vector and the operand vector, for a double-precision operation.
<Sd>, <Sm> The destination vector and the operand vector, for a single-precision operation.

Operation

```
if ConditionPassed() then
    EncodingSpecificOperations(); CheckVFPEEnabled(TRUE);
    if dp_operation then
        D[d] = FPSqrt(D[m], StandardFPSCRValue());
    else
        S[d] = FPSqrt(S[m], StandardFPSCRValue());
```

F8.1.151 VSRA

Vector Shift Right and Accumulate takes each element in a vector, right shifts them by an immediate value, and accumulates the truncated results into the destination vector. For rounded results, see [VRSRA on page F8-3332](#).

The operand and result elements must all be the same type, and can be any one of:

- 8-bit, 16-bit, 32-bit, or 64-bit signed integers.
- 8-bit, 16-bit, 32-bit, or 64-bit unsigned integers.

Depending on settings in the [CPACR](#), [NSACR](#), and [HCPTR](#) registers, and the security state and mode in which the instruction is executed, an attempt to execute the instruction might be UNDEFINED, or trapped to Hyp mode.

[Summary of access controls for Advanced SIMD functionality on page G1-3498](#) summarizes these controls.

ARM deprecates the conditional execution of any Advanced SIMD instruction encoding that is not also available as a VFP instruction encoding, see [Conditional execution on page F2-2416](#).

Encoding T1/A1 Advanced SIMDv1

VSRA<c>.<type><size> <Qd>, <Qm>, #<imm>

VSRA<c>.<type><size> <Dd>, <Dm>, #<imm>

15	14	13	12	11	10	9	8	7	6	5	4	3	2	1	0	15	14	13	12	11	10	9	8	7	6	5	4	3	2	1	0
1	1	1	U	1	1	1	1	1	D	imm6						Vd	0	0	0	1	L	Q	M	1	Vm						
31	30	29	28	27	26	25	24	23	22	21	20	19	18	17	16	15	14	13	12	11	10	9	8	7	6	5	4	3	2	1	0
1	1	1	1	0	0	1	U	1	D	imm6						Vd	0	0	0	1	L	Q	M	1	Vm						

```

if (L:imm6) == '0001xxx' then SEE "Related encodings";
if Q == '1' && (Vd<0> == '1' || Vm<0> == '1') then UNDEFINED;
case L:imm6 of
  when "0001xxx" esize = 8; elements = 8; shift_amount = 16 - UInt(imm6);
  when "001xxxx" esize = 16; elements = 4; shift_amount = 32 - UInt(imm6);
  when "01xxxxx" esize = 32; elements = 2; shift_amount = 64 - UInt(imm6);
  when "1xxxxxx" esize = 64; elements = 1; shift_amount = 64 - UInt(imm6);
unsigned = (U == '1'); d = UInt(D:Vd); m = UInt(M:Vm); regs = if Q == '0' then 1 else 2;
    
```

Related encodings See [One register and a modified immediate value on page F5-2508](#).

Assembler syntax

VSRA{<c>}{<q>}.<type><size> {<Qd>}, <Qm>, #<imm> Encoded as Q = 1
 VSRA{<c>}{<q>}.<type><size> {<Dd>}, <Dm>, #<imm> Encoded as Q = 0

where:

- <c>, <q> See [Standard assembler syntax fields on page F2-2415](#). An A32 VSRA instruction must be unconditional. ARM strongly recommends that a T32 VSRA instruction is unconditional, see [Conditional execution on page F2-2416](#).
- <type> The data type for the elements of the vectors. It must be one of:
 - S Signed, encoded as U = 0.
 - U Unsigned, encoded as U = 1.
- <size> The data size for the elements of the vectors. It must be one of:
 - 8 Encoded as L = 0, imm6<5:3> = 0b001. (8 – <imm>) is encoded in imm6<2:0>.
 - 16 Encoded as L = 0, imm6<5:4> = 0b01. (16 – <imm>) is encoded in imm6<3:0>.
 - 32 Encoded as L = 0, imm6<5> = 0b1. (32 – <imm>) is encoded in imm6<4:0>.
 - 64 Encoded as L = 1. (64 – <imm>) is encoded in imm6<5:0>.
- <Qd>, <Qm> The destination vector, and the operand vector, for a quadword operation.
- <Dd>, <Dm> The destination vector, and the operand vector, for a doubleword operation.
- <imm> The immediate value, in the range 1 to <size>. See the description of <size> for how <imm> is encoded.

Operation

```

if ConditionPassed() then
    EncodingSpecificOperations(); CheckAdvSIMDEnabled();
    for r = 0 to regs-1
        for e = 0 to elements-1
            result = Int(Elem[D[m+r],e,esize], unsigned) >> shift_amount;
            Elem[D[d+r],e,esize] = Elem[D[d+r],e,esize] + result;
  
```

F8.1.152 VSRI

Vector Shift Right and Insert takes each element in the operand vector, right shifts them by an immediate value, and inserts the results in the destination vector. Bits shifted out of the right of each element are lost.

The elements must all be the same size, and can be 8-bit, 16-bit, 32-bit, or 64-bit. There is no distinction between data types.

Depending on settings in the CPACR, NSACR, and HCPTR registers, and the security state and mode in which the instruction is executed, an attempt to execute the instruction might be UNDEFINED, or trapped to Hyp mode.

[Summary of access controls for Advanced SIMD functionality on page G1-3498](#) summarizes these controls.

ARM deprecates the conditional execution of any Advanced SIMD instruction encoding that is not also available as a VFP instruction encoding, see [Conditional execution on page F2-2416](#).

Encoding T1/A1 Advanced SIMDv1

VSRI<c>.<size> <Qd>, <Qm>, #<imm>

VSRI<c>.<size> <Dd>, <Dm>, #<imm>

15	14	13	12	11	10	9	8	7	6	5	4	3	2	1	0	15	14	13	12	11	10	9	8	7	6	5	4	3	2	1	0
1	1	1	1	1	1	1	1	1	D	imm6						Vd	0	1	0	0	L	Q	M	1	Vm						
31	30	29	28	27	26	25	24	23	22	21	20	19	18	17	16	15	14	13	12	11	10	9	8	7	6	5	4	3	2	1	0
1	1	1	1	0	0	1	1	1	D	imm6						Vd	0	1	0	0	L	Q	M	1	Vm						

```

if (L:imm6) == '0001xxx' then SEE "Related encodings";
if Q == '1' && (Vd<0> == '1' || Vm<0> == '1') then UNDEFINED;
case L:imm6 of
    when "0001xxx" esize = 8; elements = 8; shift_amount = 16 - UInt(imm6);
    when "001xxxx" esize = 16; elements = 4; shift_amount = 32 - UInt(imm6);
    when "01xxxxx" esize = 32; elements = 2; shift_amount = 64 - UInt(imm6);
    when "1xxxxxx" esize = 64; elements = 1; shift_amount = 64 - UInt(imm6);
d = UInt(D:Vd); m = UInt(M:Vm); regs = if Q == '0' then 1 else 2;
    
```

Related encodings See [One register and a modified immediate value on page F5-2508](#).

Assembler syntax

VSRI{<C>}{<q>}.<size> {<Qd>}, <Qm>, #<imm> Encoded as Q = 1
 VSRI{<C>}{<q>}.<size> {<Dd>}, <Dm>, #<imm> Encoded as Q = 0

where:

<C>, <q> See [Standard assembler syntax fields on page F2-2415](#). An A32 VSRI instruction must be unconditional. ARM strongly recommends that a T32 VSRI instruction is unconditional, see [Conditional execution on page F2-2416](#).

<size> The data size for the elements of the vectors. It must be one of:
 8 Encoded as L = 0, imm6<5:3> = 0b001. (8 – <imm>) is encoded in imm6<2:0>.
 16 Encoded as L = 0, imm6<5:4> = 0b01. (16 – <imm>) is encoded in imm6<3:0>.
 32 Encoded as L = 0, imm6<5> = 0b1. (32 – <imm>) is encoded in imm6<4:0>.
 64 Encoded as L = 1. (64 – <imm>) is encoded in imm6<5:0>.

<Qd>, <Qm> The destination vector, and the operand vector, for a quadword operation.

<Dd>, <Dm> The destination vector, and the operand vector, for a doubleword operation.

<imm> The immediate value, in the range 1 to <size>. See the description of <size> for how <imm> is encoded.

Operation

```
if ConditionPassed() then
    EncodingSpecificOperations(); CheckAdvSIMDEnabled();
    mask = LSR(Ones(esize), shift_amount);
    for r = 0 to regs-1
        for e = 0 to elements-1
            shifted_op = LSR(Elem[D[m+r],e,esize], shift_amount);
            Elem[D[d+r],e,esize] = (Elem[D[d+r],e,esize] AND NOT(mask)) OR shifted_op;
```

F8.1.153 VST1 (multiple single elements)

Vector Store (multiple single elements) stores elements to memory from one, two, three, or four registers, without interleaving. Every element of each register is stored. For details of the addressing mode see [Advanced SIMD addressing mode on page F5-2517](#).

Depending on settings in the CPACR, NSACR, and HCPTR registers, and the security state and mode in which the instruction is executed, an attempt to execute the instruction might be UNDEFINED, or trapped to Hyp mode. [Summary of access controls for Advanced SIMD functionality on page G1-3498](#) summarizes these controls.

ARM deprecates the conditional execution of any Advanced SIMD instruction encoding that is not also available as a VFP instruction encoding, see [Conditional execution on page F2-2416](#).

Encoding T1/A1 Advanced SIMDv1

VST1<c>.<size> <list>, [<Rn>{:<align>}]{!}
 VST1<c>.<size> <list>, [<Rn>{:<align>}], <Rm>

15	14	13	12	11	10	9	8	7	6	5	4	3	2	1	0	15	14	13	12	11	10	9	8	7	6	5	4	3	2	1	0
1	1	1	1	1	0	0	1	0	D	0	0		Rn			Vd			type	size	align						Rm				

31	30	29	28	27	26	25	24	23	22	21	20	19	18	17	16	15	14	13	12	11	10	9	8	7	6	5	4	3	2	1	0
1	1	1	1	0	1	0	0	0	D	0	0		Rn			Vd			type	size	align									Rm	

```

case type of
  when '0111'
    regs = 1; if align<1> == '1' then UNDEFINED;
  when '1010'
    regs = 2; if align == '11' then UNDEFINED;
  when '0110'
    regs = 3; if align<1> == '1' then UNDEFINED;
  when '0010'
    regs = 4;
  otherwise
    SEE "Related encodings";
alignment = if align == '00' then 1 else 4 << UInt(align);
ebytes = 1 << UInt(size); elements = 8 DIV ebytes;
d = UInt(D:Vd); n = UInt(Rn); m = UInt(Rm);
wback = (m != 15); register_index = (m != 15 && m != 13);
if n == 15 || d+regs > 32 then UNPREDICTABLE;
    
```

For information about the CONSTRAINED UNPREDICTABLE behavior of this instruction, see [Appendix A Architectural Constraints on UNPREDICTABLE behaviors](#), and particularly [VST1 \(multiple single elements\) on page AppxA-4749](#).

Related encodings See [Advanced SIMD element or structure load/store instructions on page F5-2515](#).

Assembler syntax

VST1{<c>}{<q>}.<size> <list>, [<Rn>{:<align>}] Encoded as Rm = 0b1111
 VST1{<c>}{<q>}.<size> <list>, [<Rn>{:<align>}]! Encoded as Rm = 0b1101
 VST1{<c>}{<q>}.<size> <list>, [<Rn>{:<align>}], <Rm> Rm cannot be 0b11x1

where:

<c>, <q> See [Standard assembler syntax fields on page F2-2415](#). An A32 VST1 instruction must be unconditional. ARM strongly recommends that a T32 VST1 instruction is unconditional, see [Conditional execution on page F2-2416](#).

- <size> The data size. It must be one of:
- 8 Encoded as size = 0b00.
 - 16 Encoded as size = 0b01.
 - 32 Encoded as size = 0b10.
 - 64 Encoded as size = 0b11.
- <list> The list of registers to store. It must be one of:
- {<Dd>} Encoded as D:Vd = <Dd>, type = 0b0111.
 - {<Dd>, <Dd+1>} Encoded as D:Vd = <Dd>, type = 0b1010.
 - {<Dd>, <Dd+1>, <Dd+2>} Encoded as D:Vd = <Dd>, type = 0b0110.
 - {<Dd>, <Dd+1>, <Dd+2>, <Dd+3>} Encoded as D:Vd = <Dd>, type = 0b0010.
- <Rn> Contains the base address for the access.
- <align> The alignment. It can be one of:
- 64 8-byte alignment, encoded as align = 0b01.
 - 128 16-byte alignment, available only if <list> contains two or four registers, encoded as align = 0b10.
 - 256 32-byte alignment, available only if <list> contains four registers, encoded as align = 0b11.
 - omitted** Standard alignment, see *Unaligned data access* on page E2-2341. Encoded as align = 0b00.
- : is the preferred separator before the <align> value, but the alignment can be specified as @<align>, see *Advanced SIMD addressing mode* on page F5-2517.
- ! If present, specifies writeback.
- <Rm> Contains an address offset applied after the access.

For more information about <Rn>, !, and <Rm>, see *Advanced SIMD addressing mode* on page F5-2517.

Operation

```

if ConditionPassed() then
    EncodingSpecificOperations(); CheckAdvSIMDEnabled(); NullCheckIfThumbEE(n);
    address = R[n]; if (address MOD alignment) != 0 then GenerateAlignmentException();
    if wback then R[n] = R[n] + (if register_index then R[m] else 8*regs);
    for r = 0 to regs-1
        for e = 0 to elements-1
            if ebytes != 8 then
                MemU[address,ebytes] = Elem[D[d+r],e];
            else
                bits(64) data = Elem[D[d+r],e];
                MemU[address,4] = if BigEndian() then data<63:32> else data<31:0>;
                MemU[address+4,4] = if BigEndian() then data<31:0> else data<63:32>;
                address = address + ebytes;
  
```

F8.1.154 VST1 (single element from one lane)

This instruction stores one element to memory from one element of a register. For details of the addressing mode see [Advanced SIMD addressing mode on page F5-2517](#).

Depending on settings in the CPACR, NSACR, and HCPTR registers, and the security state and mode in which the instruction is executed, an attempt to execute the instruction might be UNDEFINED, or trapped to Hyp mode. [Summary of access controls for Advanced SIMD functionality on page G1-3498](#) summarizes these controls.

ARM deprecates the conditional execution of any Advanced SIMD instruction encoding that is not also available as a VFP instruction encoding, see [Conditional execution on page F2-2416](#).

Encoding T1/A1 Advanced SIMDv1

VST1<c>.<size> <list>, [<Rn>{:<align>}]{!}
 VST1<c>.<size> <list>, [<Rn>{:<align>}], <Rm>

15	14	13	12	11	10	9	8	7	6	5	4	3	2	1	0	15	14	13	12	11	10	9	8	7	6	5	4	3	2	1	0
1	1	1	1	1	0	0	1	1	D	0	0		Rn			Vd		size	0	0	index_align		Rm								

31	30	29	28	27	26	25	24	23	22	21	20	19	18	17	16	15	14	13	12	11	10	9	8	7	6	5	4	3	2	1	0
1	1	1	1	0	1	0	0	1	D	0	0		Rn			Vd		size	0	0	index_align		Rm								

```

if size == '11' then UNDEFINED;
case size of
  when '00'
    if index_align<0> != '0' then UNDEFINED;
    ebytes = 1; index = UInt(index_align<3:1>); alignment = 1;
  when '01'
    if index_align<1> != '0' then UNDEFINED;
    ebytes = 2; index = UInt(index_align<3:2>);
    alignment = if index_align<0> == '0' then 1 else 2;
  when '10'
    if index_align<2> != '0' then UNDEFINED;
    if index_align<1:0> != '00' && index_align<1:0> != '11' then UNDEFINED;
    ebytes = 4; index = UInt(index_align<3>);
    alignment = if index_align<1:0> == '00' then 1 else 4;
d = UInt(D:Vd); n = UInt(Rn); m = UInt(Rm);
wback = (m != 15); register_index = (m != 15 && m != 13);
if n == 15 then UNPREDICTABLE;
    
```

For information about the CONSTRAINED UNPREDICTABLE behavior of this instruction, see [Appendix A Architectural Constraints on UNPREDICTABLE behaviors](#).

Assembler syntax

VST1{<c>}{<q>}.<size> <list>, [<Rn>{:<align>}] Encoded as Rm = 0b1111
 VST1{<c>}{<q>}.<size> <list>, [<Rn>{:<align>}]! Encoded as Rm = 0b1101
 VST1{<c>}{<q>}.<size> <list>, [<Rn>{:<align>}], <Rm> Rm cannot be 0b11x1

where:

<c>, <q> See [Standard assembler syntax fields on page F2-2415](#). An A32 VST1 instruction must be unconditional. ARM strongly recommends that a T32 VST1 instruction is unconditional, see [Conditional execution on page F2-2416](#).

<size> The data size. It must be one of:
 8 Encoded as size = 0b00.
 16 Encoded as size = 0b01.
 32 Encoded as size = 0b10.

<list> The register containing the element to store. It must be {<Dd[x]>}. The register Dd is encoded in D:Vd

<Rn> Contains the base address for the access.

<align> The alignment. It can be one of:
 16 2-byte alignment, available only if <size> is 16.
 32 4-byte alignment, available only if <size> is 32.
omitted Standard alignment, see [Unaligned data access on page E2-2341](#).
 : is the preferred separator before the <align> value, but the alignment can be specified as @<align>, see [Advanced SIMD addressing mode on page F5-2517](#).

! If present, specifies writeback.

<Rm> Contains an address offset applied after the access.

For more information about <Rn>, !, and <Rm>, see [Advanced SIMD addressing mode on page F5-2517](#).

[Table F8-6](#) shows the encoding of index and alignment for different <size> values.

Table F8-6 Encoding of index and alignment

	<size> == 8	<size> == 16	<size> == 32
Index	index_align[3:1] = x	index_align[3:2] = x	index_align[3] = x
<align> omitted	index_align[0] = 0	index_align[1:0] = '00'	index_align[2:0] = '000'
<align> == 16	-	index_align[1:0] = '01'	-
<align> == 32	-	-	index_align[2:0] = '011'

Operation

```

if ConditionPassed() then
    EncodingSpecificOperations(); CheckAdvSIMDEnabled(); NullCheckIfThumbEE(n);
    address = R[n]; if (address MOD alignment) != 0 then GenerateAlignmentException();
    if wback then R[n] = R[n] + (if register_index then R[m] else ebytes);
    MemU[address,ebytes] = Elem[D[d],index];
  
```

F8.1.155 VST2 (multiple 2-element structures)

This instruction stores multiple 2-element structures from two or four registers to memory, with interleaving. For more information, see *Element and structure load/store instructions* on page F1-2398. Every element of each register is saved. For details of the addressing mode see *Advanced SIMD addressing mode* on page F5-2517.

Depending on settings in the CPACR, NSACR, and HCPTR registers, and the security state and mode in which the instruction is executed, an attempt to execute the instruction might be UNDEFINED, or trapped to Hyp mode. *Summary of access controls for Advanced SIMD functionality* on page G1-3498 summarizes these controls.

ARM deprecates the conditional execution of any Advanced SIMD instruction encoding that is not also available as a VFP instruction encoding, see *Conditional execution* on page F2-2416.

Encoding T1/A1 Advanced SIMDv1

VST2<c>.<size> <list>, [<Rn>{:<align>}]{!}

VST2<c>.<size> <list>, [<Rn>{:<align>}], <Rm>

15	14	13	12	11	10	9	8	7	6	5	4	3	2	1	0	15	14	13	12	11	10	9	8	7	6	5	4	3	2	1	0
1	1	1	1	1	0	0	1	0	D	0	0		Rn			Vd				type	size	align				Rm					

31	30	29	28	27	26	25	24	23	22	21	20	19	18	17	16	15	14	13	12	11	10	9	8	7	6	5	4	3	2	1	0
1	1	1	1	0	1	0	0	0	D	0	0		Rn			Vd				type	size	align				Rm					

```

if size == '11' then UNDEFINED;
case type of
  when '1000'
    regs = 1; inc = 1; if align == '11' then UNDEFINED;
  when '1001'
    regs = 1; inc = 2; if align == '11' then UNDEFINED;
  when '0011'
    regs = 2; inc = 2;
  otherwise
    SEE "Related encodings";
alignment = if align == '00' then 1 else 4 << UInt(align);
ebytes = 1 << UInt(size); elements = 8 DIV ebytes;
d = UInt(D:Vd); d2 = d + inc; n = UInt(Rn); m = UInt(Rm);
wback = (m != 15); register_index = (m != 15 && m != 13);
if n == 15 || d2+regs > 32 then UNPREDICTABLE;
    
```

For information about the CONSTRAINED UNPREDICTABLE behavior of this instruction, see [Appendix A Architectural Constraints on UNPREDICTABLE behaviors](#), and particularly *VST2 (multiple 2-element structures)* on page AppxA-4750.

Related encodings See *Advanced SIMD element or structure load/store instructions* on page F5-2515.

Assembler syntax

VST2{<c>}{<q>}.<size> <list>, [<Rn>{:<align>}]	Encoded as Rm = 0b1111
VST2{<c>}{<q>}.<size> <list>, [<Rn>{:<align>}]!	Encoded as Rm = 0b1101
VST2{<c>}{<q>}.<size> <list>, [<Rn>{:<align>}], <Rm>	Rm cannot be 0b11x1

where:

<c>, <q>	See Standard assembler syntax fields on page F2-2415 . An A32 VST2 instruction must be unconditional. ARM strongly recommends that a T32 VST2 instruction is unconditional, see Conditional execution on page F2-2416 .
<size>	The data size. It must be one of: 8 Encoded as size = 0b00. 16 Encoded as size = 0b01. 32 Encoded as size = 0b10.
<list>	The list of registers to store. It must be one of: {<Dd>, <Dd+1>} Encoded as D:Vd = <Dd>, type = 0b1000. {<Dd>, <Dd+2>} Encoded as D:Vd = <Dd>, type = 0b1001. {<Dd>, <Dd+1>, <Dd+2>, <Dd+3>} Encoded as D:Vd = <Dd>, type = 0b0011.
<Rn>	Contains the base address for the access.
<align>	The alignment. It can be one of: 64 8-byte alignment, encoded as align = 0b01. 128 16-byte alignment, encoded as align = 0b10. 256 32-byte alignment, available only if <list> contains four registers, encoded as align = 0b11. omitted Standard alignment, see Unaligned data access on page E2-2341 . Encoded as align = 0b00. : is the preferred separator before the <align> value, but the alignment can be specified as @<align>, see Advanced SIMD addressing mode on page F5-2517 .
!	If present, specifies writeback.
<Rm>	Contains an address offset applied after the access.

For more information about <Rn>, !, and <Rm>, see [Advanced SIMD addressing mode on page F5-2517](#).

Operation

```

if ConditionPassed() then
    EncodingSpecificOperations(); CheckAdvSIMDEnabled(); NullCheckIfThumbEE(n);
    address = R[n]; if (address MOD alignment) != 0 then GenerateAlignmentException();
    if wback then R[n] = R[n] + (if register_index then R[m] else 16*regs);
    for r = 0 to regs-1
        for e = 0 to elements-1
            MemU[address, ebytes] = Elem[D[d+r], e];
            MemU[address+ebytes, ebytes] = Elem[D[d2+r], e];
            address = address + 2*ebytes;
  
```

F8.1.156 VST2 (single 2-element structure from one lane)

This instruction stores one 2-element structure to memory from corresponding elements of two registers. For details of the addressing mode see *Advanced SIMD addressing mode* on page F5-2517.

Depending on settings in the CPACR, NSACR, and HCPTR registers, and the security state and mode in which the instruction is executed, an attempt to execute the instruction might be UNDEFINED, or trapped to Hyp mode. *Summary of access controls for Advanced SIMD functionality* on page G1-3498 summarizes these controls.

ARM deprecates the conditional execution of any Advanced SIMD instruction encoding that is not also available as a VFP instruction encoding, see *Conditional execution* on page F2-2416.

Encoding T1/A1 Advanced SIMDv1

VST2<c>.<size> <list>, [<Rn>{:<align>}]{!}
 VST2<c>.<size> <list>, [<Rn>{:<align>}], <Rm>

15	14	13	12	11	10	9	8	7	6	5	4	3	2	1	0	15	14	13	12	11	10	9	8	7	6	5	4	3	2	1	0
1	1	1	1	1	0	0	1	1	D	0	0		Rn			Vd		size	0	1	index_align			Rm							

31	30	29	28	27	26	25	24	23	22	21	20	19	18	17	16	15	14	13	12	11	10	9	8	7	6	5	4	3	2	1	0
1	1	1	1	0	1	0	0	1	D	0	0		Rn			Vd		size	0	1	index_align			Rm							

```

if size == '11' then UNDEFINED;
case size of
  when '00'
    ebytes = 1; index = UInt(index_align<3:1>); inc = 1;
    alignment = if index_align<0> == '0' then 1 else 2;
  when '01'
    ebytes = 2; index = UInt(index_align<3:2>);
    inc = if index_align<1> == '0' then 1 else 2;
    alignment = if index_align<0> == '0' then 1 else 4;
  when '10'
    if index_align<1> != '0' then UNDEFINED;
    ebytes = 4; index = UInt(index_align<3>);
    inc = if index_align<2> == '0' then 1 else 2;
    alignment = if index_align<0> == '0' then 1 else 8;
d = UInt(D:Vd); d2 = d + inc; n = UInt(Rn); m = UInt(Rm);
wback = (m != 15); register_index = (m != 15 && m != 13);
if n == 15 || d2 > 31 then UNPREDICTABLE;
    
```

For information about the CONSTRAINED UNPREDICTABLE behavior of this instruction, see [Appendix A Architectural Constraints on UNPREDICTABLE behaviors](#), and particularly *VST2 (single 2-element structure from one lane)* on page AppxA-4750.

Assembler syntax

VST2{<c>}{<q>}.<size> <list>, [<Rn>{:<align>}] Encoded as Rm = 0b1111
 VST2{<c>}{<q>}.<size> <list>, [<Rn>{:<align>}]! Encoded as Rm = 0b1101
 VST2{<c>}{<q>}.<size> <list>, [<Rn>{:<align>}], <Rm> Rm cannot be 0b11x1

where:

<c>, <q> See *Standard assembler syntax fields* on page F2-2415. An A32 VST2 instruction must be unconditional. ARM strongly recommends that a T32 VST2 instruction is unconditional, see *Conditional execution* on page F2-2416.

<size> The data size. It must be one of:

8	Encoded as size = 0b00.
16	Encoded as size = 0b01.
32	Encoded as size = 0b10.

- <list> The registers containing the structure. Encoded with D:Vd = <Dd>. It must be one of:
 {<Dd[x]>, <Dd+1[x]>} Single-spaced registers, see [Table F8-7](#).
 {<Dd[x]>, <Dd+2[x]>} Double-spaced registers, see [Table F8-7](#). This is not available if <size> == 8.
- <Rn> Contains the base address for the access.
- <align> The alignment. It can be one of:
 16 2-byte alignment, available only if <size> is 8.
 32 4-byte alignment, available only if <size> is 16.
 64 8-byte alignment, available only if <size> is 32.
omitted Standard alignment, see [Unaligned data access on page E2-2341](#).
 : is the preferred separator before the <align> value, but the alignment can be specified as @<align>, see [Advanced SIMD addressing mode on page F5-2517](#).
- ! If present, specifies writeback.
- <Rm> Contains an address offset applied after the access.

For more information about <Rn>, !, and <Rm>, see [Advanced SIMD addressing mode on page F5-2517](#).

Table F8-7 Encoding of index, alignment, and register spacing

	<size> == 8	<size> == 16	<size> == 32
Index	index_align[3:1] = x	index_align[3:2] = x	index_align[3] = x
Single-spacing	-	index_align[1] = 0	index_align[2] = 0
Double-spacing	-	index_align[1] = 1	index_align[2] = 1
<align> omitted	index_align[0] = 0	index_align[0] = 0	index_align[1:0] = '00'
<align> == 16	index_align[0] = 1	-	-
<align> == 32	-	index_align[0] = 1	-
<align> == 64	-	-	index_align[1:0] = '01'

Operation

```

if ConditionPassed() then
    EncodingSpecificOperations(); CheckAdvSIMDEnabled(); NullCheckIfThumbEE(n);
    address = R[n]; if (address MOD alignment) != 0 then GenerateAlignmentException();
    if wback then R[n] = R[n] + (if register_index then R[m] else 2*ebytes);
    MemU[address, ebytes] = Elem[D[d], index];
    MemU[address+ebytes, ebytes] = Elem[D[d2], index];
    
```

F8.1.157 VST3 (multiple 3-element structures)

This instruction stores multiple 3-element structures to memory from three registers, with interleaving. For more information, see [Element and structure load/store instructions on page F1-2398](#). Every element of each register is saved. For details of the addressing mode see [Advanced SIMD addressing mode on page F5-2517](#).

Depending on settings in the CPACR, NSACR, and HCPTR registers, and the security state and mode in which the instruction is executed, an attempt to execute the instruction might be UNDEFINED, or trapped to Hyp mode. [Summary of access controls for Advanced SIMD functionality on page G1-3498](#) summarizes these controls.

ARM deprecates the conditional execution of any Advanced SIMD instruction encoding that is not also available as a VFP instruction encoding, see [Conditional execution on page F2-2416](#).

Encoding T1/A1 Advanced SIMDv1

VST3<c>.<size> <list>, [<Rn>{:<align>}]{!}

VST3<c>.<size> <list>, [<Rn>{:<align>}], <Rm>

15	14	13	12	11	10	9	8	7	6	5	4	3	2	1	0	15	14	13	12	11	10	9	8	7	6	5	4	3	2	1	0
1	1	1	1	1	0	0	1	0	D	0	0		Rn			Vd		type	size	align			Rm								

31	30	29	28	27	26	25	24	23	22	21	20	19	18	17	16	15	14	13	12	11	10	9	8	7	6	5	4	3	2	1	0
1	1	1	1	0	1	0	0	0	D	0	0		Rn			Vd		type	size	align			Rm								

```

if size == '11' || align<1> == '1' then UNDEFINED;
case type of
    when '0100'
        inc = 1;
    when '0101'
        inc = 2;
    otherwise
        SEE "Related encodings";
alignment = if align<0> == '0' then 1 else 8;
ebytes = 1 << UInt(size); elements = 8 DIV ebytes;
d = UInt(D:Vd); d2 = d + inc; d3 = d2 + inc; n = UInt(Rn); m = UInt(Rm);
wback = (m != 15); register_index = (m != 15 && m != 13);
if n == 15 || d3 > 31 then UNPREDICTABLE;
    
```

For information about the CONSTRAINED UNPREDICTABLE behavior of this instruction, see [Appendix A Architectural Constraints on UNPREDICTABLE behaviors](#), and particularly [VST3 \(multiple 3-element structures\) on page AppxA-4751](#).

Related encodings See [Advanced SIMD element or structure load/store instructions on page F5-2515](#).

Assembler syntax

VST3{<c>}{<q>}.<size> <list>, [<Rn>{:<align>}] Encoded as Rm = 0b1111
 VST3{<c>}{<q>}.<size> <list>, [<Rn>{:<align>}]! Encoded as Rm = 0b1101
 VST3{<c>}{<q>}.<size> <list>, [<Rn>{:<align>}], <Rm> Rm cannot be 0b11x1

where:

<c>, <q> See [Standard assembler syntax fields on page F2-2415](#). An A32 VST3 instruction must be unconditional. ARM strongly recommends that a T32 VST3 instruction is unconditional, see [Conditional execution on page F2-2416](#).

<size> The data size. It must be one of:
 8 Encoded as size = 0b00.
 16 Encoded as size = 0b01.
 32 Encoded as size = 0b10.

<list> The list of registers to store. It must be one of:
 {<Dd>, <Dd+1>, <Dd+2>}
 Encoded as D:Vd = <Dd>, type = 0b0100.
 {<Dd>, <Dd+2>, <Dd+4>}
 Encoded as D:Vd = <Dd>, type = 0b0101.

<Rn> Contains the base address for the access.

<align> The alignment. It can be:
 64 8-byte alignment, encoded as align = 0b01.
omitted Standard alignment, see [Unaligned data access on page E2-2341](#). Encoded as align = 0b00.
 : is the preferred separator before the <align> value, but the alignment can be specified as @<align>, see [Advanced SIMD addressing mode on page F5-2517](#).

! If present, specifies writeback.

<Rm> Contains an address offset applied after the access.

For more information about <Rn>, !, and <Rm>, see [Advanced SIMD addressing mode on page F5-2517](#).

Operation

```

if ConditionPassed() then
    EncodingSpecificOperations(); CheckAdvSIMDEnabled(); NullCheckIfThumbEE(n);
    address = R[n]; if (address MOD alignment) != 0 then GenerateAlignmentException();
    if wback then R[n] = R[n] + (if register_index then R[m] else 24);
    for e = 0 to elements-1
        MemU[address, ebytes] = Elem[D[d], e];
        MemU[address+ebytes, ebytes] = Elem[D[d2], e];
        MemU[address+2*ebytes, ebytes] = Elem[D[d3], e];
        address = address + 3*ebytes;
  
```

F8.1.158 VST3 (single 3-element structure from one lane)

This instruction stores one 3-element structure to memory from corresponding elements of three registers. For details of the addressing mode see [Advanced SIMD addressing mode on page F5-2517](#).

Depending on settings in the CPACR, NSACR, and HCPTR registers, and the security state and mode in which the instruction is executed, an attempt to execute the instruction might be UNDEFINED, or trapped to Hyp mode. [Summary of access controls for Advanced SIMD functionality on page G1-3498](#) summarizes these controls.

ARM deprecates the conditional execution of any Advanced SIMD instruction encoding that is not also available as a VFP instruction encoding, see [Conditional execution on page F2-2416](#).

Encoding T1/A1 Advanced SIMDv1

VST3<c>.<size> <list>, [<Rn>]{!}

VST3<c>.<size> <list>, [<Rn>], <Rm>

15	14	13	12	11	10	9	8	7	6	5	4	3	2	1	0	15	14	13	12	11	10	9	8	7	6	5	4	3	2	1	0
1	1	1	1	1	0	0	1	1	D	0	0		Rn			Vd		size	1	0	index_align			Rm							

31	30	29	28	27	26	25	24	23	22	21	20	19	18	17	16	15	14	13	12	11	10	9	8	7	6	5	4	3	2	1	0
1	1	1	1	0	1	0	0	1	D	0	0		Rn			Vd		size	1	0	index_align			Rm							

```

if size == '11' then UNDEFINED;
case size of
  when '00'
    if index_align<0> != '0' then UNDEFINED;
    ebytes = 1; index = UInt(index_align<3:1>); inc = 1;
  when '01'
    if index_align<0> != '0' then UNDEFINED;
    ebytes = 2; index = UInt(index_align<3:2>);
    inc = if index_align<1> == '0' then 1 else 2;
  when '10'
    if index_align<1:0> != '00' then UNDEFINED;
    ebytes = 4; index = UInt(index_align<3>);
    inc = if index_align<2> == '0' then 1 else 2;
d = UInt(D:Vd); d2 = d + inc; d3 = d2 + inc; n = UInt(Rn); m = UInt(Rm);
wback = (m != 15); register_index = (m != 15 && m != 13);
if n == 15 || d3 > 31 then UNPREDICTABLE;
    
```

For information about the CONSTRAINED UNPREDICTABLE behavior of this instruction, see [Appendix A Architectural Constraints on UNPREDICTABLE behaviors](#), and particularly [VST3 \(single 3-element structure from one lane\) on page AppxA-4751](#).

Assembler syntax

VST3{<c>}{<q>}.<size> <list>, [<Rn>] Encoded as Rm = 0b1111
 VST3{<c>}{<q>}.<size> <list>, [<Rn>! Encoded as Rm = 0b1101
 VST3{<c>}{<q>}.<size> <list>, [<Rn>], <Rm> Rm cannot be 0b11x1

where:

<c>, <q> See [Standard assembler syntax fields on page F2-2415](#). An A32 VST3 instruction must be unconditional. ARM strongly recommends that a T32 VST3 instruction is unconditional, see [Conditional execution on page F2-2416](#).

<size> The data size. It must be one of:
 8 Encoded as size = 0b00.
 16 Encoded as size = 0b01.
 32 Encoded as size = 0b10.

<list> The registers containing the structure. Encoded with D:Vd = <Dd>. It must be one of:
 {<Dd[x]>, <Dd+1[x]>, <Dd+2[x]>}
 Single-spaced registers, see [Table F8-8](#).
 {<Dd[x]>, <Dd+2[x]>, <Dd+4[x]>}
 Double-spaced registers, see [Table F8-8](#). This is not available if <size> == 8.

<Rn> Contains the base address for the access.

! If present, specifies writeback.

<Rm> Contains an address offset applied after the access.

For more information about <Rn>, !, and <Rm>, see [Advanced SIMD addressing mode on page F5-2517](#).

Table F8-8 Encoding of index and register spacing

	<size> == 8	<size> == 16	<size> == 32
Index	index_align[3:1] = x	index_align[3:2] = x	index_align[3] = x
Single-spacing	index_align[0] = 0	index_align[1:0] = '00'	index_align[2:0] = '000'
Double-spacing	-	index_align[1:0] = '10'	index_align[2:0] = '100'

Alignment

Standard alignment rules apply, see [Alignment support on page E2-2341](#).

Operation

```
if ConditionPassed() then
    EncodingSpecificOperations(); CheckAdvSIMDEnabled(); NullCheckIfThumbEE(n);
    address = R[n];
    if wback then R[n] = R[n] + (if register_index then R[m] else 3*ebytes);
    MemU[address, ebytes] = Elem[D[d], index];
    MemU[address+ebytes, ebytes] = Elem[D[d2], index];
    MemU[address+2*ebytes, ebytes] = Elem[D[d3], index];
```

F8.1.159 VST4 (multiple 4-element structures)

This instruction stores multiple 4-element structures to memory from four registers, with interleaving. For more information, see [Element and structure load/store instructions on page F1-2398](#). Every element of each register is saved. For details of the addressing mode see [Advanced SIMD addressing mode on page F5-2517](#).

Depending on settings in the CPACR, NSACR, and HCPTR registers, and the security state and mode in which the instruction is executed, an attempt to execute the instruction might be UNDEFINED, or trapped to Hyp mode. [Summary of access controls for Advanced SIMD functionality on page G1-3498](#) summarizes these controls.

ARM deprecates the conditional execution of any Advanced SIMD instruction encoding that is not also available as a VFP instruction encoding, see [Conditional execution on page F2-2416](#).

Encoding T1/A1 Advanced SIMDv1

VST4<c>.<size> <list>, [<Rn>{:<align>}]{!}

VST4<c>.<size> <list>, [<Rn>{:<align>}], <Rm>

15	14	13	12	11	10	9	8	7	6	5	4	3	2	1	0	15	14	13	12	11	10	9	8	7	6	5	4	3	2	1	0
1	1	1	1	1	0	0	1	0	D	0	0		Rn			Vd			type		size	align		Rm							

31	30	29	28	27	26	25	24	23	22	21	20	19	18	17	16	15	14	13	12	11	10	9	8	7	6	5	4	3	2	1	0
1	1	1	1	0	1	0	0	0	D	0	0		Rn			Vd			type		size	align		Rm							

```

if size == '11' then UNDEFINED;
case type of
    when '0000'
        inc = 1;
    when '0001'
        inc = 2;
    otherwise
        SEE "Related encodings";
alignment = if align == '00' then 1 else 4 << UInt(align);
ebytes = 1 << UInt(size); elements = 8 DIV ebytes;
d = UInt(D:Vd); d2 = d + inc; d3 = d2 + inc; d4 = d3 + inc; n = UInt(Rn); m = UInt(Rm);
wback = (m != 15); register_index = (m != 15 && m != 13);
if n == 15 || d4 > 31 then UNPREDICTABLE;
    
```

For information about the CONSTRAINED UNPREDICTABLE behavior of this instruction, see [Appendix A Architectural Constraints on UNPREDICTABLE behaviors](#), and particularly [VST4 \(multiple 4-element structures\) on page AppxA-4751](#).

Related encodings See [Advanced SIMD element or structure load/store instructions on page F5-2515](#).

Assembler syntax

VST4{<c>}{<q>}.<size> <list>, [<Rn>{:<align>}]	Encoded as Rm = 0b1111
VST4{<c>}{<q>}.<size> <list>, [<Rn>{:<align>}]!	Encoded as Rm = 0b1101
VST4{<c>}{<q>}.<size> <list>, [<Rn>{:<align>}], <Rm>	Rm cannot be 0b11x1

where:

<c>, <q>	See Standard assembler syntax fields on page F2-2415 . An A32 VST4 instruction must be unconditional. ARM strongly recommends that a T32 VST4 instruction is unconditional, see Conditional execution on page F2-2416 .
<size>	The data size. It must be one of: 8 Encoded as size = 0b00. 16 Encoded as size = 0b01. 32 Encoded as size = 0b10.
<list>	The list of registers to store. It must be one of: {<Dd>, <Dd+1>, <Dd+2>, <Dd+3>} Encoded as D:Vd = <Dd>, type = 0b0000. {<Dd>, <Dd+2>, <Dd+4>, <Dd+6>} Encoded as D:Vd = <Dd>, type = 0b0001.
<Rn>	Contains the base address for the access.
<align>	The alignment. It can be one of: 64 8-byte alignment, encoded as align = 0b01. 128 16-byte alignment, encoded as align = 0b10. 256 32-byte alignment, encoded as align = 0b11. omitted Standard alignment, see Unaligned data access on page E2-2341 . Encoded as align = 0b00. : is the preferred separator before the <align> value, but the alignment can be specified as @<align>, see Advanced SIMD addressing mode on page F5-2517 .
!	If present, specifies writeback.
<Rm>	Contains an address offset applied after the access.

For more information about <Rn>, !, and <Rm>, see [Advanced SIMD addressing mode on page F5-2517](#).

Operation

```

if ConditionPassed() then
    EncodingSpecificOperations(); CheckAdvSIMDEnabled(); NullCheckIfThumbEE(n);
    address = R[n]; if (address MOD alignment) != 0 then GenerateAlignmentException();
    if wback then R[n] = R[n] + (if register_index then R[m] else 32);
    for e = 0 to elements-1
        MemU[address, ebytes] = Elem[D[d], e];
        MemU[address+ebytes, ebytes] = Elem[D[d2], e];
        MemU[address+2*ebytes, ebytes] = Elem[D[d3], e];
        MemU[address+3*ebytes, ebytes] = Elem[D[d4], e];
        address = address + 4*ebytes;
  
```

F8.1.160 VST4 (single 4-element structure from one lane)

This instruction stores one 4-element structure to memory from corresponding elements of four registers. For details of the addressing mode see *Advanced SIMD addressing mode* on page F5-2517.

Depending on settings in the CPACR, NSACR, and HCPTR registers, and the security state and mode in which the instruction is executed, an attempt to execute the instruction might be UNDEFINED, or trapped to Hyp mode. *Summary of access controls for Advanced SIMD functionality* on page G1-3498 summarizes these controls.

ARM deprecates the conditional execution of any Advanced SIMD instruction encoding that is not also available as a VFP instruction encoding, see *Conditional execution* on page F2-2416.

Encoding T1/A1 Advanced SIMDv1

VST4<c>.<size> <list>, [<Rn>{:<align>}]{!}
 VST4<c>.<size> <list>, [<Rn>{:<align>}], <Rm>

15	14	13	12	11	10	9	8	7	6	5	4	3	2	1	0	15	14	13	12	11	10	9	8	7	6	5	4	3	2	1	0
1	1	1	1	1	0	0	1	1	D	0	0		Rn			Vd		size	1	1		index_align			Rm						

31	30	29	28	27	26	25	24	23	22	21	20	19	18	17	16	15	14	13	12	11	10	9	8	7	6	5	4	3	2	1	0
1	1	1	1	0	1	0	0	1	D	0	0		Rn			Vd		size	1	1		index_align			Rm						

```

if size == '11' then UNDEFINED;
case size of
  when '00'
    ebytes = 1; index = UInt(index_align<3:1>); inc = 1;
    alignment = if index_align<0> == '0' then 1 else 4;
  when '01'
    ebytes = 2; index = UInt(index_align<3:2>);
    inc = if index_align<1> == '0' then 1 else 2;
    alignment = if index_align<0> == '0' then 1 else 8;
  when '10'
    if index_align<1:0> == '11' then UNDEFINED;
    ebytes = 4; index = UInt(index_align<3>);
    inc = if index_align<2> == '0' then 1 else 2;
    alignment = if index_align<1:0> == '00' then 1 else 4 << UInt(index_align<1:0>);
d = UInt(D:Vd); d2 = d + inc; d3 = d2 + inc; d4 = d3 + inc; n = UInt(Rn); m = UInt(Rm);
wback = (m != 15); register_index = (m != 15 && m != 13);
if n == 15 || d4 > 31 then UNPREDICTABLE;
    
```

For information about the CONSTRAINED UNPREDICTABLE behavior of this instruction, see [Appendix A Architectural Constraints on UNPREDICTABLE behaviors](#), and particularly *VST4 (single 4-element structure from one lane)* on page AppxA-4752.

Assembler syntax

VST4{<c>}{<q>}.<size> <list>, [<Rn>{:<align>}] Encoded as Rm = 0b1111
 VST4{<c>}{<q>}.<size> <list>, [<Rn>{:<align>}]! Encoded as Rm = 0b1101
 VST4{<c>}{<q>}.<size> <list>, [<Rn>{:<align>}], <Rm> Rm cannot be 0b11x1

where:

<c>, <q> See *Standard assembler syntax fields* on page F2-2415. An A32 VST4 instruction must be unconditional. ARM strongly recommends that a T32 VST4 instruction is unconditional, see *Conditional execution* on page F2-2416.

<size> The data size. It must be one of:
 8 Encoded as size = 0b00.
 16 Encoded as size = 0b01.
 32 Encoded as size = 0b10.

- <list> The registers containing the structure. Encoded with $D:Vd = \langle Dd \rangle$. It must be one of:
 { $\langle Dd[x] \rangle$, $\langle Dd+1[x] \rangle$, $\langle Dd+2[x] \rangle$, $\langle Dd+3[x] \rangle$ }
 Single-spaced registers, see [Table F8-9](#).
 { $\langle Dd[x] \rangle$, $\langle Dd+2[x] \rangle$, $\langle Dd+4[x] \rangle$, $\langle Dd+6[x] \rangle$ }
 Double-spaced registers, see [Table F8-9](#). This is not available if $\langle \text{size} \rangle == 8$.
- <Rn> The base address for the access.
- <align> The alignment. It can be:
 32 4-byte alignment, available only if $\langle \text{size} \rangle$ is 8.
 64 8-byte alignment, available only if $\langle \text{size} \rangle$ is 16 or 32.
 128 16-byte alignment, available only if $\langle \text{size} \rangle$ is 32.
omitted Standard alignment, see [Unaligned data access on page E2-2341](#).
 : is the preferred separator before the <align> value, but the alignment can be specified as @<align>, see [Advanced SIMD addressing mode on page F5-2517](#).
- ! If present, specifies writeback.
- <Rm> Contains an address offset applied after the access.

For more information about <Rn>, !, and <Rm>, see [Advanced SIMD addressing mode on page F5-2517](#).

Table F8-9 Encoding of index, alignment, and register spacing

	$\langle \text{size} \rangle == 8$	$\langle \text{size} \rangle == 16$	$\langle \text{size} \rangle == 32$
Index	$\text{index_align}[3:1] = x$	$\text{index_align}[3:2] = x$	$\text{index_align}[3] = x$
Single-spacing	-	$\text{index_align}[1] = 0$	$\text{index_align}[2] = 0$
Double-spacing	-	$\text{index_align}[1] = 1$	$\text{index_align}[2] = 1$
<align> omitted	$\text{index_align}[0] = 0$	$\text{index_align}[0] = 0$	$\text{index_align}[1:0] = '00'$
<align> == 32	$\text{index_align}[0] = 1$	-	-
<align> == 64	-	$\text{index_align}[0] = 1$	$\text{index_align}[1:0] = '01'$
<align> == 128	-	-	$\text{index_align}[1:0] = '10'$

Operation

```

if ConditionPassed() then
    EncodingSpecificOperations(); CheckAdvSIMDEnabled(); NullCheckIfThumbEE(n);
    address = R[n]; if (address MOD alignment) != 0 then GenerateAlignmentException();
    if wback then R[n] = R[n] + (if register_index then R[m] else 4*ebytes);
    MemU[address, ebytes] = Elem[D[d], index];
    MemU[address+ebytes, ebytes] = Elem[D[d2], index];
    MemU[address+2*ebytes, ebytes] = Elem[D[d3], index];
    MemU[address+3*ebytes, ebytes] = Elem[D[d4], index];
    
```

F8.1.161 VSTM

Vector Store Multiple stores multiple extension registers to consecutive memory locations using an address from a general-purpose register.

Depending on settings in the CPACR, NSACR, and HCPTR, and FPEXC registers, and the security state and mode in which the instruction is executed, an attempt to execute the instruction might be UNDEFINED, or trapped to Hyp mode. [Summary of general controls of CP10 and CP11 functionality on page G1-3496](#) and [Summary of access controls for Advanced SIMD functionality on page G1-3498](#) summarize these controls.

Encoding T1/A1 VFPv2, VFPv3, VFPv4, Advanced SIMDv1

VSTM{mode}<c> <Rn>{!}, <list> <list> is consecutive 64-bit registers

15	14	13	12	11	10	9	8	7	6	5	4	3	2	1	0	15	14	13	12	11	10	9	8	7	6	5	4	3	2	1	0
1	1	1	0	1	1	0	P	U	D	W	0	Rn				Vd	1	0	1	1	imm8										

31	30	29	28	27	26	25	24	23	22	21	20	19	18	17	16	15	14	13	12	11	10	9	8	7	6	5	4	3	2	1	0
cond				1	1	0	P	U	D	W	0	Rn				Vd	1	0	1	1	imm8										

```

if P == '0' && U == '0' && W == '0' then SEE "Related encodings";
if P == '1' && U == '0' && W == '1' && Rn == '1101' then SEE VPUSH;
if P == '1' && W == '0' then SEE VSTR;
if P == U && W == '1' then UNDEFINED;
// Remaining combinations are PUW = 010 (IA without !), 011 (IA with !), 101 (DB with !)
single_regs = FALSE; add = (U == '1'); wback = (W == '1');
d = UInt(D:Vd); n = UInt(Rn); imm32 = ZeroExtend(imm8:'00', 32);
regs = UInt(imm8) DIV 2; // If UInt(imm8) is odd, see "FSTMX".
if n == 15 && (wback || CurrentInstrSet() != InstrSet_A32) then UNPREDICTABLE;
if regs == 0 || regs > 16 || (d+regs) > 32 then UNPREDICTABLE;
if VFPSmallRegisterBank() && (d+regs) > 16 then UNPREDICTABLE;
    
```

Encoding T2/A2 VFPv2, VFPv3, VFPv4

VSTM{mode}<c> <Rn>{!}, <list> <list> is consecutive 32-bit registers

15	14	13	12	11	10	9	8	7	6	5	4	3	2	1	0	15	14	13	12	11	10	9	8	7	6	5	4	3	2	1	0
1	1	1	0	1	1	0	P	U	D	W	0	Rn				Vd	1	0	1	0	imm8										

31	30	29	28	27	26	25	24	23	22	21	20	19	18	17	16	15	14	13	12	11	10	9	8	7	6	5	4	3	2	1	0
cond				1	1	0	P	U	D	W	0	Rn				Vd	1	0	1	0	imm8										

```

if P == '0' && U == '0' && W == '0' then SEE "Related encodings";
if P == '1' && U == '0' && W == '1' && Rn == '1101' then SEE VPUSH;
if P == '1' && W == '0' then SEE VSTR;
if P == U && W == '1' then UNDEFINED;
// Remaining combinations are PUW = 010 (IA without !), 011 (IA with !), 101 (DB with !)
single_regs = TRUE; add = (U == '1'); wback = (W == '1'); d = UInt(Vd:D); n = UInt(Rn);
imm32 = ZeroExtend(imm8:'00', 32); regs = UInt(imm8);
if n == 15 && (wback || CurrentInstrSet() != InstrSet_A32) then UNPREDICTABLE;
if regs == 0 || (d+regs) > 32 then UNPREDICTABLE;
    
```

For information about the CONSTRAINED UNPREDICTABLE behavior of this instruction, see [Appendix A Architectural Constraints on UNPREDICTABLE behaviors](#), and particularly [VSTM on page AppxA-4752](#).

Related encodings See [64-bit transfers between general-purpose and extension registers on page F5-2519](#).

FSTMX Encoding T1/A1 behaves as described by the pseudocode if imm8 is odd. However, there is no UAL syntax for such encodings and ARM deprecates their use. For more information, see [FLDMX, FSTMX on page F8-3080](#).

Assembler syntax

VSTM{<mode>}{<c>}{<q>}{.<size>} <Rn>{!}, <list>

where:

<mode>	The addressing mode:
IA	Increment After. The consecutive addresses start at the address specified in <Rn>. This is the default and can be omitted. Encoded as P = 0, U = 1.
DB	Decrement Before. The consecutive addresses end just before the address specified in <Rn>. Encoded as P = 1, U = 0.
<c>, <q>	See <i>Standard assembler syntax fields</i> on page F2-2415.
<size>	An optional data size specifier. If present, it must be equal to the size in bits, 32 or 64, of the registers in <list>.
<Rn>	The base register. The SP can be used. In the A32 instruction set, if ! is not specified the PC can be used. However, ARM deprecates use of the PC.
!	Causes the instruction to write a modified value back to <Rn>. Required if <mode> == DB. Encoded as W = 1. If ! is omitted, the instruction does not change <Rn> in this way. Encoded as W = 0.
<list>	The extension registers to be stored, as a list of consecutively numbered doubleword (encoding T1/A1) or singleword (encoding T2/A2) registers, separated by commas and surrounded by brackets. It is encoded in the instruction by setting D and Vd to specify the first register in the list, and imm8 to twice the number of registers in the list (encoding T1/A1) or the number of registers (encoding T2/A2). <list> must contain at least one register. If it contains doubleword registers it must not contain more than 16 registers.

Operation

```

if ConditionPassed() then
    EncodingSpecificOperations(); CheckVFPEnabled(TRUE); NullCheckIfThumbEE(n);
    address = if add then R[n] else R[n]-imm32;
    if wback then R[n] = if add then R[n]+imm32 else R[n]-imm32;
    for r = 0 to regs-1
        if single_regs then
            MemA[address,4] = S[d+r]; address = address+4;
        else
            // Store as two word-aligned words in the correct order for current endianness.
            MemA[address,4] = if BigEndian() then D[d+r]<63:32> else D[d+r]<31:0>;
            MemA[address+4,4] = if BigEndian() then D[d+r]<31:0> else D[d+r]<63:32>;
            address = address+8;
  
```

F8.1.162 VSTR

This instruction stores a single extension register to memory, using an address from a general-purpose register, with an optional offset.

Depending on settings in the CPACR, NSACR, and HCPTR, and FPEXC registers, and the security state and mode in which the instruction is executed, an attempt to execute the instruction might be UNDEFINED, or trapped to Hyp mode. [Summary of general controls of CP10 and CP11 functionality on page G1-3496](#) and [Summary of access controls for Advanced SIMD functionality on page G1-3498](#) summarize these controls.

Encoding T1/A1 VFPv2, VFPv3, VFPv4, Advanced SIMDv1

VSTR<c> <Dd>, [<Rn>{, #+/-<imm>}]

15	14	13	12	11	10	9	8	7	6	5	4	3	2	1	0	15	14	13	12	11	10	9	8	7	6	5	4	3	2	1	0
1	1	1	0	1	1	0	1	U	D	0	0	Rn				Vd		1	0	1	1	imm8									

31	30	29	28	27	26	25	24	23	22	21	20	19	18	17	16	15	14	13	12	11	10	9	8	7	6	5	4	3	2	1	0
cond		1	1	0	1	U	D	0	0	Rn				Vd		1	0	1	1	imm8											

```
single_reg = FALSE; add = (U == '1'); imm32 = ZeroExtend(imm8:'00', 32);
d = UInt(D:Vd); n = UInt(Rn);
if n == 15 && CurrentInstrSet() != InstrSet_A32 then UNPREDICTABLE;
```

Encoding T2/A2 VFPv2, VFPv3, VFPv4

VSTR<c> <Sd>, [<Rn>{, #+/-<imm>}]

15	14	13	12	11	10	9	8	7	6	5	4	3	2	1	0	15	14	13	12	11	10	9	8	7	6	5	4	3	2	1	0
1	1	1	0	1	1	0	1	U	D	0	0	Rn				Vd		1	0	1	0	imm8									

31	30	29	28	27	26	25	24	23	22	21	20	19	18	17	16	15	14	13	12	11	10	9	8	7	6	5	4	3	2	1	0
cond		1	1	0	1	U	D	0	0	Rn				Vd		1	0	1	0	imm8											

```
single_reg = TRUE; add = (U == '1'); imm32 = ZeroExtend(imm8:'00', 32);
d = UInt(Vd:D); n = UInt(Rn);
if n == 15 && CurrentInstrSet() != InstrSet_A32 then UNPREDICTABLE;
```

For information about the CONSTRAINED UNPREDICTABLE behavior of this instruction, see [Appendix A Architectural Constraints on UNPREDICTABLE behaviors](#).

Assembler syntax

VSTR{<C>}{<q>}{.64} <Dd>, [<Rn>{, #+/-<imm>}] Encoding T1/A1
 VSTR{<C>}{<q>}{.32} <Sd>, [<Rn>{, #+/-<imm>}] Encoding T2/A2

where:

<C>, <q> See [Standard assembler syntax fields on page F2-2415](#).
 .32, .64 Optional data size specifiers.
 <Dd> The source register for a doubleword store.
 <Sd> The source register for a singleword store.
 <Rn> The base register. The SP can be used. In the A32 instruction set the PC can be used. However, ARM deprecates use of the PC.
 +/- Is + or omitted if the immediate offset is to be added to the base register value (add == TRUE), or – if it is to be subtracted (add == FALSE). #0 and #-0 generate different instructions.
 <imm> The immediate offset used for forming the address. Values are multiples of 4 in the range 0-1020. <imm> can be omitted, meaning an offset of +0.

Operation

```
if ConditionPassed() then
    EncodingSpecificOperations(); CheckVFPEnabled(TRUE); NullCheckIfThumbEE(n);
    address = if add then (R[n] + imm32) else (R[n] - imm32);
    if single_reg then
        MemA[address,4] = S[d];
    else
        // Store as two word-aligned words in the correct order for current endianness.
        MemA[address,4] = if BigEndian() then D[d]<63:32> else D[d]<31:0>;
        MemA[address+4,4] = if BigEndian() then D[d]<31:0> else D[d]<63:32>;
```

F8.1.163 VSUB (integer)

Vector Subtract subtracts the elements of one vector from the corresponding elements of another vector, and places the results in the destination vector.

Depending on settings in the CPACR, NSACR, and HCPTR registers, and the security state and mode in which the instruction is executed, an attempt to execute the instruction might be UNDEFINED, or trapped to Hyp mode.

[Summary of access controls for Advanced SIMD functionality on page G1-3498](#) summarizes these controls.

ARM deprecates the conditional execution of any Advanced SIMD instruction encoding that is not also available as a VFP instruction encoding, see [Conditional execution on page F2-2416](#).

Encoding T1/A1 Advanced SIMDv1

VSUB<c>.<dt> <Qd>, <Qn>, <Qm>

VSUB<c>.<dt> <Dd>, <Dn>, <Dm>

15	14	13	12	11	10	9	8	7	6	5	4	3	2	1	0	15	14	13	12	11	10	9	8	7	6	5	4	3	2	1	0
1	1	1	1	1	1	1	1	0	D	size		Vn		Vd		1	0	0	0	N	Q	M	0		Vm						

31	30	29	28	27	26	25	24	23	22	21	20	19	18	17	16	15	14	13	12	11	10	9	8	7	6	5	4	3	2	1	0
1	1	1	1	0	0	1	1	0	D	size		Vn		Vd		1	0	0	0	N	Q	M	0		Vm						

```
if Q == '1' && (Vd<0> == '1' || Vn<0> == '1' || Vm<0> == '1') then UNDEFINED;
esize = 8 << UInt(size); elements = 64 DIV esize;
d = UInt(D:Vd); n = UInt(N:Vn); m = UInt(M:Vm); regs = if Q == '0' then 1 else 2;
```

Assembler syntax

`VSUB{<c>}{<q>}.<dt> {<Qd>}, <Qn>, <Qm>`

`VSUB{<c>}{<q>}.<dt> {<Dd>}, <Dn>, <Dm>`

where:

<c>, <q> See [Standard assembler syntax fields on page F2-2415](#). An A32 Advanced SIMD VSUB instruction must be unconditional. ARM strongly recommends that a T32 Advanced SIMD VSUB instruction is unconditional, see [Conditional execution on page F2-2416](#).

<dt> The data type for the elements of the vectors. It must be one of:

I8 Encoded as size = 0b00.

I16 Encoded as size = 0b01.

I32 Encoded as size = 0b10.

I64 Encoded as size = 0b11.

<Qd>, <Qn>, <Qm> The destination vector and the operand vectors, for a quadword operation.

<Dd>, <Dn>, <Dm> The destination vector and the operand vectors, for a doubleword operation.

Operation

```
if ConditionPassed() then
    EncodingSpecificOperations(); CheckAdvSIMDEnabled();
    for r = 0 to regs-1
        for e = 0 to elements-1
            Elem[D[d+r],e,esize] = Elem[D[n+r],e,esize] - Elem[D[m+r],e,esize];
```

F8.1.164 VSUB (floating-point)

Vector Subtract subtracts the elements of one vector from the corresponding elements of another vector, and places the results in the destination vector.

Depending on settings in the CPACR, NSACR, and HCPTR, and FPEXC registers, and the security state and mode in which the instruction is executed, an attempt to execute the instruction might be UNDEFINED, or trapped to Hyp mode. *Summary of general controls of CP10 and CP11 functionality on page G1-3496* and *Summary of access controls for Advanced SIMD functionality on page G1-3498* summarize these controls.

ARM deprecates the conditional execution of any Advanced SIMD instruction encoding that is not also available as a VFP instruction encoding, see *Conditional execution on page F2-2416*.

Encoding T1/A1 Advanced SIMDv1 (UNDEFINED in integer-only variant)

VSUB<c>.F32 <Qd>, <Qn>, <Qm>

VSUB<c>.F32 <Dd>, <Dn>, <Dm>

15	14	13	12	11	10	9	8	7	6	5	4	3	2	1	0	15	14	13	12	11	10	9	8	7	6	5	4	3	2	1	0
1	1	1	0	1	1	1	1	0	D	1	sz		Vn			Vd		1	1	0	1	N	Q	M	0		Vm				

31	30	29	28	27	26	25	24	23	22	21	20	19	18	17	16	15	14	13	12	11	10	9	8	7	6	5	4	3	2	1	0
1	1	1	1	0	0	1	0	0	D	1	sz		Vn			Vd		1	1	0	1	N	Q	M	0		Vm				

```
if Q == '1' && (Vd<0> == '1' || Vn<0> == '1' || Vm<0> == '1') then UNDEFINED;
if sz == '1' then UNDEFINED;
advsimd = TRUE; esize = 32; elements = 2;
d = UInt(D:Vd); n = UInt(N:Vn); m = UInt(M:Vm); regs = if Q == '0' then 1 else 2;
```

Encoding T2/A2 VFPv2, VFPv3, VFPv4 (sz = 1 UNDEFINED in single-precision only variants)

VSUB<c>.F64 <Dd>, <Dn>, <Dm>

VSUB<c>.F32 <Sd>, <Sn>, <Sm>

15	14	13	12	11	10	9	8	7	6	5	4	3	2	1	0	15	14	13	12	11	10	9	8	7	6	5	4	3	2	1	0
1	1	1	0	1	1	1	0	0	D	1	1		Vn			Vd		1	0	1	sz	N	1	M	0		Vm				

31	30	29	28	27	26	25	24	23	22	21	20	19	18	17	16	15	14	13	12	11	10	9	8	7	6	5	4	3	2	1	0
cond		1	1	1	0	0	D	1	1		Vn			Vd		1	0	1	sz	N	1	M	0		Vm						

```
if FPSCR.Len != '000' || FPSCR.Stride != '00' then UNDEFINED;
advsimd = FALSE; dp_operation = (sz == '1');
d = if dp_operation then UInt(D:Vd) else UInt(Vd:D);
n = if dp_operation then UInt(N:Vn) else UInt(Vn:N);
m = if dp_operation then UInt(M:Vm) else UInt(Vm:M);
```

Assembler syntax

VSUB{<c>}{<q>}.F32 {<Qd>}, <Qn>, <Qm>	Encoding T1/A1, encoded as Q = 1, sz = 0
VSUB{<c>}{<q>}.F32 {<Dd>}, <Dn>, <Dm>	Encoding T1/A1, encoded as Q = 0, sz = 0
VSUB{<c>}{<q>}.F64 {<Dd>}, <Dn>, <Dm>	Encoding T2/A2, encoded as sz = 1
VSUB{<c>}{<q>}.F32 {<Sd>}, <Sn>, <Sm>	Encoding T2/A2, encoded as sz = 0

where:

<c>, <q>	See Standard assembler syntax fields on page F2-2415 . An A32 Advanced SIMD VSUB instruction must be unconditional. ARM strongly recommends that a T32 Advanced SIMD VSUB instruction is unconditional, see Conditional execution on page F2-2416 .
<Qd>, <Qn>, <Qm>	The destination vector and the operand vectors, for a quadword operation.
<Dd>, <Dn>, <Dm>	The destination vector and the operand vectors, for a doubleword operation.
<Sd>, <Sn>, <Sm>	The destination vector and the operand vectors, for a singleword operation.

Operation

```

if ConditionPassed() then
    EncodingSpecificOperations(); CheckAdvSIMDorVFPEEnabled(TRUE, advsimd);
    if advsimd then // Advanced SIMD instruction
        for r = 0 to regs-1
            for e = 0 to elements-1
                Elem[D[d+r],e,esize] = FPSub(Elem[D[n+r],e,esize], Elem[D[m+r],e,esize],
StandardFPSCRValue());
    else // VFP instruction
        if dp_operation then
            D[d] = FPSub(D[n], D[m], FPSCR);
        else
            S[d] = FPSub(S[n], S[m], FPSCR);
  
```

F8.1.165 VSUBHN

Vector Subtract and Narrow, returning High Half subtracts the elements of one quadword vector from the corresponding elements of another quadword vector, takes the most significant half of each result, and places the final results in a doubleword vector. The results are truncated. For rounded results, see [VRSUBHN on page F8-3334](#).

There is no distinction between signed and unsigned integers.

Depending on settings in the [CPACR](#), [NSACR](#), and [HCPTR](#) registers, and the security state and mode in which the instruction is executed, an attempt to execute the instruction might be UNDEFINED, or trapped to Hyp mode. [Summary of access controls for Advanced SIMD functionality on page G1-3498](#) summarizes these controls.

ARM deprecates the conditional execution of any Advanced SIMD instruction encoding that is not also available as a VFP instruction encoding, see [Conditional execution on page F2-2416](#).

Encoding T1/A1 Advanced SIMDv1

VSUBHN<c>.<dt> <Dd>, <Qn>, <Qm>

15	14	13	12	11	10	9	8	7	6	5	4	3	2	1	0	15	14	13	12	11	10	9	8	7	6	5	4	3	2	1	0
1	1	1	0	1	1	1	1	1	D	size	Vn	Vd	0	1	1	0	N	0	M	0	Vm										
31	30	29	28	27	26	25	24	23	22	21	20	19	18	17	16	15	14	13	12	11	10	9	8	7	6	5	4	3	2	1	0
1	1	1	1	0	0	1	0	1	D	size	Vn	Vd	0	1	1	0	N	0	M	0	Vm										

```

if size == '11' then SEE "Related encodings";
if Vn<0> == '1' || Vm<0> == '1' then UNDEFINED;
esize = 8 << UInt(size);  elements = 64 DIV esize;
d = UInt(D:Vd);  n = UInt(N:Vn);  m = UInt(M:Vm);
    
```

Related encodings See [Advanced SIMD data-processing instructions on page F5-2499](#).

Assembler syntax

VSUBHN{<c>}{<q>}.<dt> <Dd>, <Qn>, <Qm>

where:

<c>, <q> See [Standard assembler syntax fields on page F2-2415](#). An A32 VSUBHN instruction must be unconditional. ARM strongly recommends that a T32 VSUBHN instruction is unconditional, see [Conditional execution on page F2-2416](#).

<dt> The data type for the elements of the operands. It must be one of:
I16 Encoded as size = 0b00.
I32 Encoded as size = 0b01.
I64 Encoded as size = 0b10.

<Dd>, <Qn>, <Qm> The destination vector, the first operand vector, and the second operand vector.

Operation

```
if ConditionPassed() then
    EncodingSpecificOperations(); CheckAdvSIMDEnabled();
    for e = 0 to elements-1
        result = Elem[Qin[n>>1],e,2*esize] - Elem[Qin[m>>1],e,2*esize];
        Elem[D[d],e,esize] = result<2*esize-1:esize>;
```

F8.1.166 VSUBL, VSUBW

Vector Subtract Long subtracts the elements of one doubleword vector from the corresponding elements of another doubleword vector, and places the results in a quadword vector. Before subtracting, it sign-extends or zero-extends the elements of both operands.

Vector Subtract Wide subtracts the elements of a doubleword vector from the corresponding elements of a quadword vector, and places the results in another quadword vector. Before subtracting, it sign-extends or zero-extends the elements of the doubleword operand.

Depending on settings in the CPACR, NSACR, and HCPTR registers, and the security state and mode in which the instruction is executed, an attempt to execute the instruction might be UNDEFINED, or trapped to Hyp mode. [Summary of access controls for Advanced SIMD functionality on page G1-3498](#) summarizes these controls.

ARM deprecates the conditional execution of any Advanced SIMD instruction encoding that is not also available as a VFP instruction encoding, see [Conditional execution on page F2-2416](#).

Encoding T1/A1 Advanced SIMDv1

VSUBL<c>.<dt> <Qd>, <Dn>, <Dm>

VSUBW<c>.<dt> <Qd>, <Qn>, <Dm>

15	14	13	12	11	10	9	8	7	6	5	4	3	2	1	0	15	14	13	12	11	10	9	8	7	6	5	4	3	2	1	0
1	1	1	U	1	1	1	1	1	D	size	Vn	Vd	0	0	1	op	N	0	M	0	Vm										

31	30	29	28	27	26	25	24	23	22	21	20	19	18	17	16	15	14	13	12	11	10	9	8	7	6	5	4	3	2	1	0
1	1	1	1	0	0	1	U	1	D	size	Vn	Vd	0	0	1	op	N	0	M	0	Vm										

```

if size == '11' then SEE "Related encodings";
if Vd<0> == '1' || (op == '1' && Vn<0> == '1') then UNDEFINED;
unsigned = (U == '1');
esize = 8 << UInt(size); elements = 64 DIV esize; is_vsubw = (op == '1');
d = UInt(D:Vd); n = UInt(N:Vn); m = UInt(M:Vm);
    
```

Related encodings See [Advanced SIMD data-processing instructions on page F5-2499](#).

Assembler syntax

VSUBL{<c>}{<q>}.<dt> <Qd>, <Dn>, <Dm> Encoded as op = 0
 VSUBW{<c>}{<q>}.<dt> {<Qd>,} <Qn>, <Dm> Encoded as op = 1

where:

<c>, <q> See [Standard assembler syntax fields on page F2-2415](#). An A32 VSUBL or VSUBW instruction must be unconditional. ARM strongly recommends that a T32 VSUBL or VSUBW instruction is unconditional, see [Conditional execution on page F2-2416](#).

<dt> The data type for the elements of the second operand. It must be one of:

S8	Encoded as size = 0b00, U = 0.
S16	Encoded as size = 0b01, U = 0.
S32	Encoded as size = 0b10, U = 0.
U8	Encoded as size = 0b00, U = 1.
U16	Encoded as size = 0b01, U = 1.
U32	Encoded as size = 0b10, U = 1.

<Qd> The destination register.

<Qn>, <Dm> The first and second operand registers for a VSUBW instruction.

<Dn>, <Dm> The first and second operand registers for a VSUBL instruction.

Operation

```

if ConditionPassed() then
    EncodingSpecificOperations(); CheckAdvSIMDEnabled();
    for e = 0 to elements-1
        if is_vsubw then
            op1 = Int(Elem[Qin[n]>>1],e,2*esize], unsigned);
        else
            op1 = Int(Elem[Din[n],e,esize], unsigned);
            result = op1 - Int(Elem[Din[m],e,esize], unsigned);
            Elem[Q[d]>>1],e,2*esize] = result<2*esize-1:0>;
  
```

F8.1.167 VSWP

VSWP (Vector Swap) exchanges the contents of two vectors. The vectors can be either doubleword or quadword. There is no distinction between data types.

Depending on settings in the CPACR, NSACR, and HCPTR registers, and the security state and mode in which the instruction is executed, an attempt to execute the instruction might be UNDEFINED, or trapped to Hyp mode. [Summary of access controls for Advanced SIMD functionality on page G1-3498](#) summarizes these controls.

ARM deprecates the conditional execution of any Advanced SIMD instruction encoding that is not also available as a VFP instruction encoding, see [Conditional execution on page F2-2416](#).

Encoding T1/A1 Advanced SIMDv1

VSWP<c> <Qd>, <Qm>

VSWP<c> <Dd>, <Dm>

15	14	13	12	11	10	9	8	7	6	5	4	3	2	1	0	15	14	13	12	11	10	9	8	7	6	5	4	3	2	1	0
1	1	1	1	1	1	1	1	1	D	1	1	size	1	0	Vd	0	0	0	0	0	0	Q	M	0	Vm						

31	30	29	28	27	26	25	24	23	22	21	20	19	18	17	16	15	14	13	12	11	10	9	8	7	6	5	4	3	2	1	0
1	1	1	1	0	0	1	1	1	D	1	1	size	1	0	Vd	0	0	0	0	0	0	Q	M	0	Vm						

```

if size != '00' then UNDEFINED;
if Q == '1' && (Vd<0> == '1' || Vm<0> == '1') then UNDEFINED;
d = UInt(D:Vd); m = UInt(M:Vm); regs = if Q == '0' then 1 else 2;
    
```

Assembler syntax

VSWP{<c>}{<q>}{.<dt>} <Qd>, <Qm> Encoded as Q = 1, size = 0b00
VSWP{<c>}{<q>}{.<dt>} <Dd>, <Dm> Encoded as Q = 0, size = 0b00

where:

<c>, <q> See [Standard assembler syntax fields on page F2-2415](#). An A32 VSWP instruction must be unconditional. ARM strongly recommends that a T32 VSWP instruction is unconditional, see [Conditional execution on page F2-2416](#).

<dt> An optional data type. It is ignored by assemblers, and does not affect the encoding.

<Qd>, <Qm> The vectors for a quadword operation.

<Dd>, <Dm> The vectors for a doubleword operation.

Operation

```
if ConditionPassed() then
    EncodingSpecificOperations(); CheckAdvSIMDEnabled();
    for r = 0 to regs-1
        if d == m then
            D[d+r] = bits(64) UNKNOWN;
        else
            D[d+r] = Din[m+r];
            D[m+r] = Din[d+r];
```

F8.1.168 VTBL, VTBX

Vector Table Lookup uses byte indexes in a control vector to look up byte values in a table and generate a new vector. Indexes out of range return 0.

Vector Table Extension works in the same way, except that indexes out of range leave the destination element unchanged.

Depending on settings in the CPACR, NSACR, and HCPTR registers, and the security state and mode in which the instruction is executed, an attempt to execute the instruction might be UNDEFINED, or trapped to Hyp mode. [Summary of access controls for Advanced SIMD functionality on page G1-3498](#) summarizes these controls.

ARM deprecates the conditional execution of any Advanced SIMD instruction encoding that is not also available as a VFP instruction encoding, see [Conditional execution on page F2-2416](#).

Encoding T1/A1 Advanced SIMDv1

V<op><c>.8 <Dd>, <list>, <Dm>

15	14	13	12	11	10	9	8	7	6	5	4	3	2	1	0	15	14	13	12	11	10	9	8	7	6	5	4	3	2	1	0
1	1	1	1	1	1	1	1	1	D	1	1	Vn			Vd			1	0	len	N	op	M	0	Vm						
31	30	29	28	27	26	25	24	23	22	21	20	19	18	17	16	15	14	13	12	11	10	9	8	7	6	5	4	3	2	1	0
1	1	1	1	0	0	1	1	1	D	1	1	Vn			Vd			1	0	len	N	op	M	0	Vm						

```
is_vtbl = (op == '0'); length = UInt(len)+1;
d = UInt(D:Vd); n = UInt(N:Vn); m = UInt(M:Vm);
if n+length > 32 then UNPREDICTABLE;
```

For information about the CONSTRAINED UNPREDICTABLE behavior of this instruction, see [Appendix A Architectural Constraints on UNPREDICTABLE behaviors](#), and particularly [VTBL, VTBX on page AppxA-4753](#).

Assembler syntax

V<op>{<c>}{<q>}.8 <Dd>, <list>, <Dm>

where:

- <op> The operation. It must be one of:
 TBL Vector Table Lookup. Encoded as op = 0.
 TBX Vector Table Extension. Encoded as op = 1.
- <c>, <q> See [Standard assembler syntax fields on page F2-2415](#). An A32 VTBL or VTBX instruction must be unconditional. ARM strongly recommends that a T32 VTBL or VTBX instruction is unconditional, see [Conditional execution on page F2-2416](#).
- <Dd> The destination vector.
- <list> The vectors containing the table. It must be one of:
 {<Dn>} Encoded as len = 0b00.
 {<Dn>, <Dn+1>} Encoded as len = 0b01.
 {<Dn>, <Dn+1>, <Dn+2>} Encoded as len = 0b10.
 {<Dn>, <Dn+1>, <Dn+2>, <Dn+3>}
 Encoded as len = 0b11.
- <Dm> The index vector.

Operation

```

if ConditionPassed() then
    EncodingSpecificOperations(); CheckAdvSIMDEnabled();

    // Create 256-bit = 32-byte table variable, with zeros in entries that will not be used.
    table3 = if length == 4 then D[n+3] else Zeros(64);
    table2 = if length >= 3 then D[n+2] else Zeros(64);
    table1 = if length >= 2 then D[n+1] else Zeros(64);
    table = table3 : table2 : table1 : D[n];

    for i = 0 to 7
        index = UInt(Elem[D[m],i,8]);
        if index < 8*length then
            Elem[D[d],i,8] = Elem[table,index,8];
        else
            if is_vtbl then
                Elem[D[d],i,8] = Zeros(8);
            // else Elem[D[d],i,8] unchanged
  
```

F8.1.169 VTRN

Vector Transpose treats the elements of its operand vectors as elements of 2×2 matrices, and transposes the matrices.

The elements of the vectors can be 8-bit, 16-bit, or 32-bit. There is no distinction between data types.

Figure F8-7 shows the operation of doubleword VTRN. Quadword VTRN performs the same operation as doubleword VTRN twice, once on the upper halves of the quadword vectors, and once on the lower halves

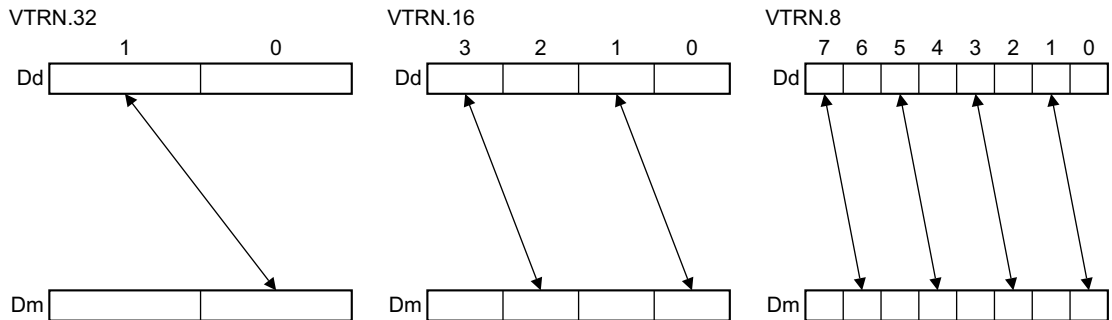

Figure F8-7 VTRN doubleword operation

Depending on settings in the CPACR, NSACR, and HCPTR registers, and the security state and mode in which the instruction is executed, an attempt to execute the instruction might be UNDEFINED, or trapped to Hyp mode.

Summary of access controls for Advanced SIMD functionality on page G1-3498 summarizes these controls.

ARM deprecates the conditional execution of any Advanced SIMD instruction encoding that is not also available as a VFP instruction encoding, see Conditional execution on page F2-2416.

Encoding T1/A1 Advanced SIMDv1

VTRN<c>.<size> <Qd>, <Qm>

VTRN<c>.<size> <Dd>, <Dm>

15	14	13	12	11	10	9	8	7	6	5	4	3	2	1	0	15	14	13	12	11	10	9	8	7	6	5	4	3	2	1	0
1	1	1	1	1	1	1	1	D	1	1	size	1	0			Vd	0	0	0	0	1	Q	M	0		Vm					

31	30	29	28	27	26	25	24	23	22	21	20	19	18	17	16	15	14	13	12	11	10	9	8	7	6	5	4	3	2	1	0
1	1	1	1	0	0	1	1	1	D	1	1	size	1	0			Vd	0	0	0	0	1	Q	M	0		Vm				

```

if size == '11' then UNDEFINED;
if Q == '1' && (Vd<0> == '1' || Vm<0> == '1') then UNDEFINED;
esize = 8 << UInt(size); elements = 64 DIV esize;
d = UInt(D:Vd); m = UInt(M:Vm); regs = if Q == '0' then 1 else 2;
    
```

Assembler syntax

VTRN{<c>}{<q>}.<size> <Qd>, <Qm> Encoded as Q = 1
 VTRN{<c>}{<q>}.<size> <Dd>, <Dm> Encoded as Q = 0

where:

<c>, <q> See [Standard assembler syntax fields on page F2-2415](#). An A32 VTRN instruction must be unconditional. ARM strongly recommends that a T32 VTRN instruction is unconditional, see [Conditional execution on page F2-2416](#).

<size> The data size for the elements of the vectors. It must be one of:

8 Encoded as size = 0b00.
 16 Encoded as size = 0b01.
 32 Encoded as size = 0b10.

<Qd>, <Qm> The destination vector, and the operand vector, for a quadword operation.

<Dd>, <Dm> The destination vector, and the operand vector, for a doubleword operation.

Operation

```
if ConditionPassed() then
    EncodingSpecificOperations(); CheckAdvSIMDEnabled();
    h = elements DIV 2;

    for r = 0 to regs-1
        if d == m then
            D[d+r] = bits(64) UNKNOWN;
        else
            for e = 0 to h-1
                Elem[D[d+r],2*e+1,esize] = Elem[Din[m+r],2*e,esize];
                Elem[D[m+r],2*e,esize] = Elem[Din[d+r],2*e+1,esize];
```

F8.1.170 VTST

Vector Test Bits takes each element in a vector, and bitwise ANDs it with the corresponding element of a second vector. If the result is not zero, the corresponding element in the destination vector is set to all ones. Otherwise, it is set to all zeros.

The operand vector elements can be any one of:

- 8-bit, 16-bit, or 32-bit fields.

The result vector elements are fields the same size as the operand vector elements.

Depending on settings in the CPACR, NSACR, and HCPTR registers, and the security state and mode in which the instruction is executed, an attempt to execute the instruction might be UNDEFINED, or trapped to Hyp mode. [Summary of access controls for Advanced SIMD functionality on page G1-3498](#) summarizes these controls.

ARM deprecates the conditional execution of any Advanced SIMD instruction encoding that is not also available as a VFP instruction encoding, see [Conditional execution on page F2-2416](#).

Encoding T1/A1 Advanced SIMDv1

VTST<c>.<size> <Qd>, <Qn>, <Qm>

VTST<c>.<size> <Dd>, <Dn>, <Dm>

15	14	13	12	11	10	9	8	7	6	5	4	3	2	1	0	15	14	13	12	11	10	9	8	7	6	5	4	3	2	1	0
1	1	1	0	1	1	1	1	0	D	size	Vn	Vd	1	0	0	0	N	Q	M	1	Vm										

31	30	29	28	27	26	25	24	23	22	21	20	19	18	17	16	15	14	13	12	11	10	9	8	7	6	5	4	3	2	1	0
1	1	1	1	0	0	1	0	0	D	size	Vn	Vd	1	0	0	0	N	Q	M	1	Vm										

```

if Q == '1' && (Vd<0> == '1' || Vn<0> == '1' || Vm<0> == '1') then UNDEFINED;
if size == '11' then UNDEFINED;
esize = 8 << UInt(size); elements = 64 DIV esize;
d = UInt(D:Vd); n = UInt(N:Vn); m = UInt(M:Vm); regs = if Q == '0' then 1 else 2;
    
```

Assembler syntax

VTST{<c>}{<q>}.<size> {<Qd>}, <Qn>, <Qm> Encoded as Q = 1
VTST{<c>}{<q>}.<size> {<Dd>}, <Dn>, <Dm> Encoded as Q = 0

where:

<c>, <q> See [Standard assembler syntax fields on page F2-2415](#). An A32 VTST instruction must be unconditional. ARM strongly recommends that a T32 VTST instruction is unconditional, see [Conditional execution on page F2-2416](#).

<size> The data size for the elements of the operands. It must be one of:
8 Encoded as size = 0b00.
16 Encoded as size = 0b01.
32 Encoded as size = 0b10.

<Qd>, <Qn>, <Qm> The destination vector and the operand vectors, for a quadword operation.

<Dd>, <Dn>, <Dm> The destination vector and the operand vectors, for a doubleword operation.

Operation

```
if ConditionPassed() then
    EncodingSpecificOperations(); CheckAdvSIMDEnabled();
    for r = 0 to regs-1
        for e = 0 to elements-1
            if !IsZero(Elem[D[n+r],e,esize] AND Elem[D[m+r],e,esize]) then
                Elem[D[d+r],e,esize] = Ones(esize);
            else
                Elem[D[d+r],e,esize] = Zeros(esize);
```

F8.1.171 VUZP

Vector Unzip de-interleaves the elements of two vectors. See [Table F8-10](#) and [Table F8-11](#) for examples of the operation.

The elements of the vectors can be 8-bit, 16-bit, or 32-bit. There is no distinction between data types.

Depending on settings in the [CPACR](#), [NSACR](#), and [HCPTR](#) registers, and the security state and mode in which the instruction is executed, an attempt to execute the instruction might be UNDEFINED, or trapped to Hyp mode. [Summary of access controls for Advanced SIMD functionality on page G1-3498](#) summarizes these controls.

ARM deprecates the conditional execution of any Advanced SIMD instruction encoding that is not also available as a VFP instruction encoding, see [Conditional execution on page F2-2416](#).

Encoding T1/A1 Advanced SIMDv1

VUZP<c>.<size> <Qd>, <Qm>

VUZP<c>.<size> <Dd>, <Dm>

15	14	13	12	11	10	9	8	7	6	5	4	3	2	1	0	15	14	13	12	11	10	9	8	7	6	5	4	3	2	1	0
1	1	1	1	1	1	1	1	D	1	1	size	1	0			Vd	0	0	0	1	0	Q	M	0			Vm				

31	30	29	28	27	26	25	24	23	22	21	20	19	18	17	16	15	14	13	12	11	10	9	8	7	6	5	4	3	2	1	0
1	1	1	1	0	0	1	1	1	D	1	1	size	1	0			Vd	0	0	0	1	0	Q	M	0			Vm			

```
if size == '11' || (Q == '0' && size == '10') then UNDEFINED;
if Q == '1' && (Vd<0> == '1' || Vm<0> == '1') then UNDEFINED;
quadword_operation = (Q == '1');  esize = 8 << UInt(size);
d = UInt(D:Vd);  m = UInt(M:Vm);
```

[Table F8-10](#) shows the operation of a doubleword VUZP.8 instruction, and [Table F8-11](#) shows the operation of a quadword VUZP.32 instruction, and

Table F8-10 Operation of doubleword VUZP.8

	Register state before operation								Register state after operation							
Dd	A ₇	A ₆	A ₅	A ₄	A ₃	A ₂	A ₁	A ₀	B ₆	B ₄	B ₂	B ₀	A ₆	A ₄	A ₂	A ₀
Dm	B ₇	B ₆	B ₅	B ₄	B ₃	B ₂	B ₁	B ₀	B ₇	B ₅	B ₃	B ₁	A ₇	A ₅	A ₃	A ₁

Table F8-11 Operation of quadword VUZP.32

	Register state before operation				Register state after operation			
Qd	A ₃	A ₂	A ₁	A ₀	B ₂	B ₀	A ₂	A ₀
Qm	B ₃	B ₂	B ₁	B ₀	B ₃	B ₁	A ₃	A ₁

Assembler syntax

VUZP{<c>}{<q>}.<size> <Qd>, <Qm> Encoded as Q = 1
 VUZP{<c>}{<q>}.<size> <Dd>, <Dm> Encoded as Q = 0

where:

<c>, <q> See [Standard assembler syntax fields on page F2-2415](#). An A32 VUZP instruction must be unconditional. ARM strongly recommends that a T32 VUZP instruction is unconditional, see [Conditional execution on page F2-2416](#).

<size> The data size for the elements of the vectors. It must be one of:
 8 Encoded as size = 0b00.
 16 Encoded as size = 0b01.
 32 Encoded as size = 0b10 for a quadword operation.
 Doubleword operation with <size> = 32 is a pseudo-instruction.

<Qd>, <Qm> The vectors for a quadword operation.

<Dd>, <Dm> The vectors for a doubleword operation.

Operation

```

if ConditionPassed() then
    EncodingSpecificOperations(); CheckAdvSIMDEnabled();
    if quadword_operation then
        if d == m then
            Q[d>>1] = bits(128) UNKNOWN; Q[m>>1] = bits(128) UNKNOWN;
        else
            zipped_q = Q[m>>1]:Q[d>>1];
            for e = 0 to (128 DIV esize) - 1
                Elem[Q[d>>1],e,esize] = Elem[zipped_q,2*e,esize];
                Elem[Q[m>>1],e,esize] = Elem[zipped_q,2*e+1,esize];
    else
        if d == m then
            D[d] = bits(64) UNKNOWN; D[m] = bits(64) UNKNOWN;
        else
            zipped_d = D[m]:D[d];
            for e = 0 to (64 DIV esize) - 1
                Elem[D[d],e,esize] = Elem[zipped_d,2*e,esize];
                Elem[D[m],e,esize] = Elem[zipped_d,2*e+1,esize];
  
```

Pseudo-instruction

VUZP.32 <Dd>, <Dm> is a synonym for VTRN.32 <Dd>, <Dm>. For details see [VTRN on page F8-3388](#).

F8.1.172 VZIP

Vector Zip interleaves the elements of two vectors. See [Table F8-12](#) and [Table F8-13](#) for examples of the operation.

The elements of the vectors can be 8-bit, 16-bit, or 32-bit. There is no distinction between data types.

Depending on settings in the CPACR, NSACR, and HCPTR registers, and the security state and mode in which the instruction is executed, an attempt to execute the instruction might be UNDEFINED, or trapped to Hyp mode.

[Summary of access controls for Advanced SIMD functionality on page G1-3498](#) summarizes these controls.

ARM deprecates the conditional execution of any Advanced SIMD instruction encoding that is not also available as a VFP instruction encoding, see [Conditional execution on page F2-2416](#).

Encoding T1/A1 Advanced SIMDv1

VZIP<c>.<size> <Qd>, <Qm>

VZIP<c>.<size> <Dd>, <Dm>

15	14	13	12	11	10	9	8	7	6	5	4	3	2	1	0	15	14	13	12	11	10	9	8	7	6	5	4	3	2	1	0
1	1	1	1	1	1	1	1	D	1	1	size	1	0	Vd	0	0	0	1	1	Q	M	0	Vm								

31	30	29	28	27	26	25	24	23	22	21	20	19	18	17	16	15	14	13	12	11	10	9	8	7	6	5	4	3	2	1	0
1	1	1	1	0	0	1	1	1	D	1	1	size	1	0	Vd	0	0	0	1	1	Q	M	0	Vm							

```

if size == '11' || (Q == '0' && size == '10') then UNDEFINED;
if Q == '1' && (Vd<0> == '1' || Vm<0> == '1') then UNDEFINED;
quadword_operation = (Q == '1');  esize = 8 << UInt(size);
d = UInt(D:Vd);  m = UInt(M:Vm);
    
```

[Table F8-12](#) shows the operation of a doubleword VZIP.8 instruction, and [Table F8-13](#) shows the operation of a quadword VZIP.32 instruction.

Table F8-12 Operation of doubleword VZIP.8

	Register state before operation	Register state after operation
Dd	A ₇ A ₆ A ₅ A ₄ A ₃ A ₂ A ₁ A ₀	B ₃ A ₃ B ₂ A ₂ B ₁ A ₁ B ₀ A ₀
Dm	B ₇ B ₆ B ₅ B ₄ B ₃ B ₂ B ₁ B ₀	B ₇ A ₇ B ₆ A ₆ B ₅ A ₅ B ₄ A ₄

Table F8-13 Operation of quadword VZIP.32

	Register state before operation	Register state after operation
Qd	A ₃ A ₂ A ₁ A ₀	B ₁ A ₁ B ₀ A ₀
Qm	B ₃ B ₂ B ₁ B ₀	B ₃ A ₃ B ₂ A ₂

Assembler syntax

VZIP{<C>}{<q>}.<size> <Qd>, <Qm> Encoded as Q = 1
 VZIP{<C>}{<q>}.<size> <Dd>, <Dm> Encoded as Q = 0

where:

<C>, <q> See [Standard assembler syntax fields on page F2-2415](#). An A32 VZIP instruction must be unconditional. ARM strongly recommends that a T32 VZIP instruction is unconditional, see [Conditional execution on page F2-2416](#).

<size> The data size for the elements of the vectors. It must be one of:
 8 Encoded as size = 0b00.
 16 Encoded as size = 0b01.
 32 Encoded as size = 0b10 for a quadword operation.
 Doubleword operation with <size> = 32 is a pseudo-instruction.

<Qd>, <Qm> The vectors for a quadword operation.
 <Dd>, <Dm> The vectors for a doubleword operation.

Operation

```

if ConditionPassed() then
    EncodingSpecificOperations(); CheckAdvSIMDEnabled();
    if quadword_operation then
        if d == m then
            Q[d>>1] = bits(128) UNKNOWN; Q[m>>1] = bits(128) UNKNOWN;
        else
            bits(256) zipped_q;
            for e = 0 to (128 DIV esize) - 1
                Elem[zipped_q,2*e,esize] = Elem[Q[d>>1],e,esize];
                Elem[zipped_q,2*e+1,esize] = Elem[Q[m>>1],e,esize];
            Q[d>>1] = zipped_q<127:0>; Q[m>>1] = zipped_q<255:128>;
    else
        if d == m then
            D[d] = bits(64) UNKNOWN; D[m] = bits(64) UNKNOWN;
        else
            bits(128) zipped_d;
            for e = 0 to (64 DIV esize) - 1
                Elem[zipped_d,2*e,esize] = Elem[D[d],e,esize];
                Elem[zipped_d,2*e+1,esize] = Elem[D[m],e,esize];
            D[d] = zipped_d<63:0>; D[m] = zipped_d<127:64>;
  
```

Pseudo-instructions

VZIP.32 <Dd>, <Dm> is a synonym for VTRN.32 <Dd>, <Dm>. For details see [VTRN on page F8-3388](#).

Part G

The AArch32 System Level Architecture

Chapter G1

The AArch32 System Level Programmers' Model

This chapter gives a system level description of the programmers' model for execution in AArch32 state. It contains the following sections:

- *About the AArch32 System level programmers' model* on page G1-3400.
- *Exception levels* on page G1-3401.
- *Exception terminology* on page G1-3402.
- *Execution state* on page G1-3404.
- *Instruction Set state* on page G1-3406.
- *Debug state* on page G1-3406.
- *Security state* on page G1-3407.
- *Virtualization* on page G1-3410.
- *AArch32 PE modes, general-purpose registers, and the PC* on page G1-3412.
- *Instruction set states* on page G1-3429.
- *Handling exceptions that are taken to an Exception level using AArch32* on page G1-3431.
- *Asynchronous exception behavior for exceptions taken from AArch32 state* on page G1-3465.
- *AArch32 state exception descriptions* on page G1-3475.
- *The conceptual coprocessor interface and system control* on page G1-3492.
- *Advanced SIMD and floating-point support* on page G1-3494.
- *AArch32 control of traps to the hypervisor* on page G1-3503.

G1.1 About the AArch32 System level programmers' model

An application programmer has only a restricted view of the system. The System level programmers' model supports this application level view of the system, and includes features required for one or both of an operating system (OS) and a hypervisor to provide the programming environment seen by an application. This chapter describes the System level programmers' model when executing at EL1 or higher in an Exception level that is using AArch32.

The system level programmers' model includes all of the system features required to support operating systems and to handle hardware events.

The sections listed below give a system level introduction to the basic concepts of the ARM architecture AArch32 state, and the terminology used for describing the architecture when executing in this state:

- [Exception levels on page G1-3401.](#)
- [Exception terminology on page G1-3402.](#)
- [Execution state on page G1-3404.](#)
- [Instruction Set state on page G1-3406.](#)
- [Debug state on page G1-3406.](#)
- [Security state on page G1-3407.](#)
- [Virtualization on page G1-3410.](#)

The rest of this chapter describes the system level programmers' model when executing in AArch32 state.

The other chapters in this part describe:

- The memory system architecture, as seen when executing in an Exception level that is using AArch32:
 - [Chapter G2 The AArch32 System Level Memory Model](#) describes the general features of the ARMv8 memory model, when executing in AArch32 state, that are not visible at the application level.
- **Note** —————
- [Chapter E2 The AArch32 Application Level Memory Model](#) describes the application level view of the memory model.
-
- [Chapter G3 The AArch32 Virtual Memory System Architecture](#) describes the Virtual Memory System Architecture (VMSA) used in AArch32 state.
- The AArch32 System Registers, see [Chapter G4 AArch32 System Register Descriptions](#).

———— **Note** —————

The T32 and A32 instruction sets include instructions that provide system level functionality, such as returning from an exception. See [Alphabetical list of system instructions on page F7-3033](#).

G1.2 Exception levels

The ARMv8-A architecture defines a set of Exception levels, EL0 to EL3, where:

- If EL n is the Exception level, increased values of n indicate increased software execution privilege.
- Execution at EL0 is called *unprivileged execution*.
- EL2 provides support for virtualization of Non-secure operation.
- EL3 provides support for switching between two Security states, Secure state and Non-secure state.

An implementation might not include all of the Exception levels. All implementations must include EL0 and EL1. EL2 and EL3 are optional.

———— **Note** —————

A PE is not required to implement a contiguous set of Exception levels. For example, it is permissible for an implementation to include only EL0, EL1, and EL3.

[Supported configurations on page D1-1554](#) provides information on implementations.

When executing in AArch32 state, execution can move between Exception levels only on taking an exception or on returning from an exception:

- On taking an exception, the Exception level can only increase or remain the same.
- On returning from an exception, the Exception level can only decrease or remain the same.

The Exception level that execution changes to or remains in on taking an exception is called the *target Exception level* of the exception.

Each exception type has a target Exception level that is either:

- Implicit in the nature of the exception.
- Defined by configuration bits in the system control registers.

An exception cannot target EL0.

Exception levels exist within *Security states*. [The ARMv8-A security model on page G1-3407](#) describes this. When executing at an Exception level, the PE can access both of the following:

- The resources that are available for the combination of the current Exception level and the current Security state.
- The resources that are available at all lower Exception levels, provided that those resources are available to the current Security state.

This means that if the implementation includes EL3, then because EL3 is only implemented in Secure state, execution at EL3 can access all resources available at all Exception levels, for both Security states.

Each exception level other than EL0 has its own translation regime and associated control registers. For information on the translation regimes, see [Chapter G3 The AArch32 Virtual Memory System Architecture](#).

G1.2.1 Typical Exception level usage model

The architecture does not specify what software uses which Exception level. Such choices are outside the scope of the architecture. However, the following is a common usage model for the Exception levels:

EL0	Applications.
EL1	OS kernel and associated functions that are typically described as <i>privileged</i> .
EL2	Hypervisor.
EL3	Secure monitor.

G1.3 Exception terminology

The following subsections define the terms used when describing exceptions:

- [Terminology for taking an exception.](#)
- [Terminology for returning from an exception.](#)
- [Exception levels.](#)
- [Definition of a precise exception.](#)
- [Definitions of synchronous and asynchronous exceptions on page G1-3403.](#)

G1.3.1 Terminology for taking an exception

An exception is *generated* when the PE first responds to an exceptional condition. The PE state at this time is the state the exception is *taken from*. The PE state immediately after taking the exception is the state the exception is *taken to*.

G1.3.2 Terminology for returning from an exception

To return from an exception, the PE must execute an exception return instruction. The PE state when an exception return instruction is committed for execution is the state the exception *returns from*. The PE state immediately after the execution of that instruction is the state the exception *returns to*.

G1.3.3 Exception levels

An Exception level, EL_n , with a larger value of n than another Exception level, is described as being a *higher* Exception level than the other Exception level. For example, EL_3 is a higher Exception level than EL_1 .

An Exception level with a smaller value of n than another Exception level is described as being a *lower* Exception level than the other Exception level. For example, EL_0 is a lower Exception level than EL_1 .

An Exception level is described as:

- *Using AArch64* when execution in that Exception level is in the AArch64 Execution state.
- *Using AArch32* when execution in that Exception level is in the AArch32 Execution state.

G1.3.4 Definition of a precise exception

An exception is described as *precise* when the exception handler receives the PE state and memory system state that is consistent with the PE having executed all of the instructions up to but not including the point in the instruction stream where the exception was taken, and none afterwards.

Where a synchronous exception is generated as part of an instruction that performs more than one single-copy atomic memory access, such as the AArch32 LDM and STM instructions, the definition of precise permits that the values in registers or memory affected by those instructions can be UNKNOWN, provided that:

- The accesses affecting those registers or memory locations do not, themselves, generate exceptions.
- The registers are not involved in the calculation of the memory address used by the instruction.

Other than the *Asynchronous Data Abort*, sometimes referred to as an *external interrupt*, all exceptions taken to AArch32 state are required to be precise.

For each occurrence of an Asynchronous Data Abort, whether the interrupt is precise or imprecise is IMPLEMENTATION DEFINED.

———— **Note** —————

- For the definition of a single-copy atomic access, see [Single-copy atomicity on page E2-2346](#).
 - Asynchronous Data Aborts are known as SError interrupts in AArch64 state.
 - By definition, all synchronous aborts are precise.
-

G1.3.5 Definitions of synchronous and asynchronous exceptions

An exception is described as *synchronous* if all of the following apply:

- The exception is generated as a result of direct execution or attempted execution of an instruction.
- The return address presented to the exception handler is guaranteed to indicate the instruction that caused the exception.
- The exception is precise.

An exception is described as *asynchronous* if any of the following apply:

- The exception is not generated as a result of direct execution or attempted execution of the instruction stream.
- The return address presented to the exception handler is not guaranteed to indicate the instruction that caused the exception.
- The exception is imprecise.

For more information about exceptions, see [Handling exceptions that are taken to an Exception level using AArch32 on page G1-3431](#).

G1.4 Execution state

The Execution states are:

AArch64 The 64-bit Execution state.

AArch32 The 32-bit Execution state. Operation in this state is compatible with ARMv7-A operation.

[Execution state on page A1-33](#) gives more information about them.

Exception levels *use* Execution states. For example, EL0, EL1 and EL2 might all be using AArch32, under EL3 using AArch64.

This means that:

- Different software layers, such as an application, an operating system kernel, and a hypervisor, executing at different Exception levels, can execute in different Execution states.
- The PE can change Execution states only either:
 - At reset.
 - On a change of Exception level.

Note

- [Typical Exception level usage model on page G1-3401](#) shows which Exception levels different software layers might typically use.
 - [Supported configurations on page D1-1554](#) gives information on supported configurations of Exception levels and Execution states.
-

The interaction between the AArch64 and AArch32 Execution states is called *interprocessing*. [Interprocessing on page D1-1542](#) describes this.

G1.4.1 About the AArch32 PE modes

AArch32 state provides a set of *PE modes* that support normal software execution and handle exceptions. The current mode determines the set of registers that are available, as described in [AArch32 general-purpose registers, and the PC on page G1-3418](#).

The AArch32 modes are:

- Monitor mode. This mode always executes at Secure EL3.
- Hyp mode. This mode always executes at Non-secure EL2.
- System, Supervisor, Abort, Undefined, IRQ and FIQ modes. The Exception level these modes execute at depends on the Security state, as described in [Security state on page G1-3407](#).
- User mode. This mode always executes at EL0.

Note

AArch64 state does not support modes. Modes are a concept that is specific to AArch32 state. Modes that execute at a particular Exception level are only implemented if that Exception level supports using AArch32.

For more information on modes see [AArch32 PE mode descriptions on page G1-3412](#).

The mode in use immediately before an exception is taken is described as the mode the exception is *taken from*. The mode that is used on taking the exception is described as the mode the exception is *taken to*.

All of the following define the mode that an exception is taken to:

- The type of exception.
- The mode the exception is taken from.

- Configuration settings defined at EL2 and EL3.

Monitor mode and Hyp mode can create system traps that cause exceptions to EL3 or EL2 respectively. There is an architected hierarchy where EL2 and EL3 configuration settings affect a common condition, for example interrupt routing. When no traps are enabled for a particular condition, the AArch32 mode an exception is taken to is called the *default mode* for that exception.

In AArch32 state, a number of different modes can exist at the same *Privilege level* (PL). All modes at a particular privilege level have the same access rights for accesses to memory and to System registers. The mapping of PE modes to Exception levels depends on the Security state, as described in [Security state on page G1-3407](#).

[Execution privilege, Exception levels, and AArch32 Privilege levels on page G3-3560](#) gives more information about the PE modes, their associated Privilege levels, and how these map onto the Exception levels.

G1.5 Instruction Set state

In AArch32 state, the *Instruction Set state* determines the instruction set that the PE is executing. In an implementation that follows the ARM recommendations, the available Instruction Set states are:

T32 state The PE is executing T32 instructions.

A32 state The PE is executing A32 instructions.

———— **Note** —————

- In previous versions of the ARM architecture:
 - The T32 instruction set was called the Thumb instruction set.
 - The A32 instruction set was called the ARM instruction set.
- An ARMv8-A implementation can support the T32EE instruction set, previously called the ThumbEE instruction set. However, any support for T32EE is OPTIONAL and deprecated.

For more information, see [Instruction set state register, ISETSTATE](#) on page E1-2298.

G1.6 Debug state

Debug state refers to the PE being halted for debug purposes, because a debug event has occurred when the PE is configured to Halting debug-mode.

When the PE is not in Debug state it is described as being in *Non-debug state*.

Except for part H of this manual, or where the context explicitly indicates otherwise, this manual describes PE behavior and instruction execution in Non-debug state. [Chapter H2 Debug State](#) describes the differences in Debug state.

G1.7 Security state

The ARMv8-A architecture provides two Security states, each with an associated physical memory address space, as follows:

Secure state	When in this state, the PE can access both the Secure physical address space and the Non-secure physical address space.
Non-secure state	When in this state, the PE: <ul style="list-style-type: none"> • Can access only the Non-secure physical address space. • Cannot access the Secure system control resources.

For information on how virtual addresses translate onto Secure physical and Non-secure addresses, see [About VMSAv8-32 on page G3-3562](#).

G1.7.1 The ARMv8-A security model

The general principles of the ARMv8-A security model are:

- If the implementation includes EL3 then it has two Security states, Secure and Non-secure, and:
 - EL3 exists only in Secure state.
 - A change from Non-secure state to Secure state can only occur on taking an exception to EL3.
 - A change from Secure state to Non-secure state can only occur on an exception return from EL3.
 - If EL2 is implemented, it exists only in Non-secure state.
- If the implementation does not include EL3 it has one Security state, that is:
 - IMPLEMENTATION DEFINED, if the implementation does not include EL2.
 - Non-secure state if the implementation includes EL2.

The AArch32 security model, and execution privilege

The Exception level hierarchy of four Exception levels, EL0, EL1, EL2, and EL3, applies to execution in both Execution states. This section describes the mapping between Exception levels, AArch32 modes, and Privilege levels.

The AArch32 modes Monitor, System, Supervisor, Abort, Undefined, IRQ, and FIQ all have the same privilege. In the AArch32 Privilege model this is PL1.

In Secure state:

- Monitor mode executes only at EL3, and is accessible only when EL3 is using AArch32.
- System mode, Supervisor mode, Abort mode, Undefined mode, IRQ mode, and FIQ mode all:
 - Execute at EL1 when EL3 is using AArch64.
 - Execute at EL3 when EL3 is using AArch32.

This means that there is a difference in the Secure state hierarchy that the PE is using, depending on which Execution state EL3 is using:

- If EL3 is using AArch64:
 - There is no support for Monitor mode.
 - If EL1 is using AArch32, System mode, Supervisor mode, Abort mode, Undefined mode, IRQ mode, and FIQ mode execute at Secure EL1.
- If EL3 is using AArch32:
 - Monitor mode is supported, and executes at Secure EL3
 - System mode, Supervisor mode, Abort mode, Undefined mode, IRQ mode, and FIQ mode execute at Secure EL3.
 - There is no support for a Secure EL1 Exception level.

See [Security behavior in Exception levels using AArch32 when EL3 is using AArch64](#) on page G1-3441 for more information about operation in a Secure EL1 mode when EL3 is using AArch64.

In Non-secure state, the PL1 modes System, Supervisor, Abort, Undefined, IRQ, and FIQ always execute at EL1.

User mode always executes at EL0 and has Privilege level PL0. Hyp mode always executes at EL2 and has Privilege level PL2. See [About the AArch32 PE modes](#) on page G1-3404.

———— **Note** ————

For more information about the Privilege level terminology, see [Execution privilege, Exception levels, and AArch32 Privilege levels](#) on page G3-3560.

Figure G1-1 shows the security model when EL3 is using AArch32, and shows the expected use of the different Exception levels, and which modes execute at which Exception levels.

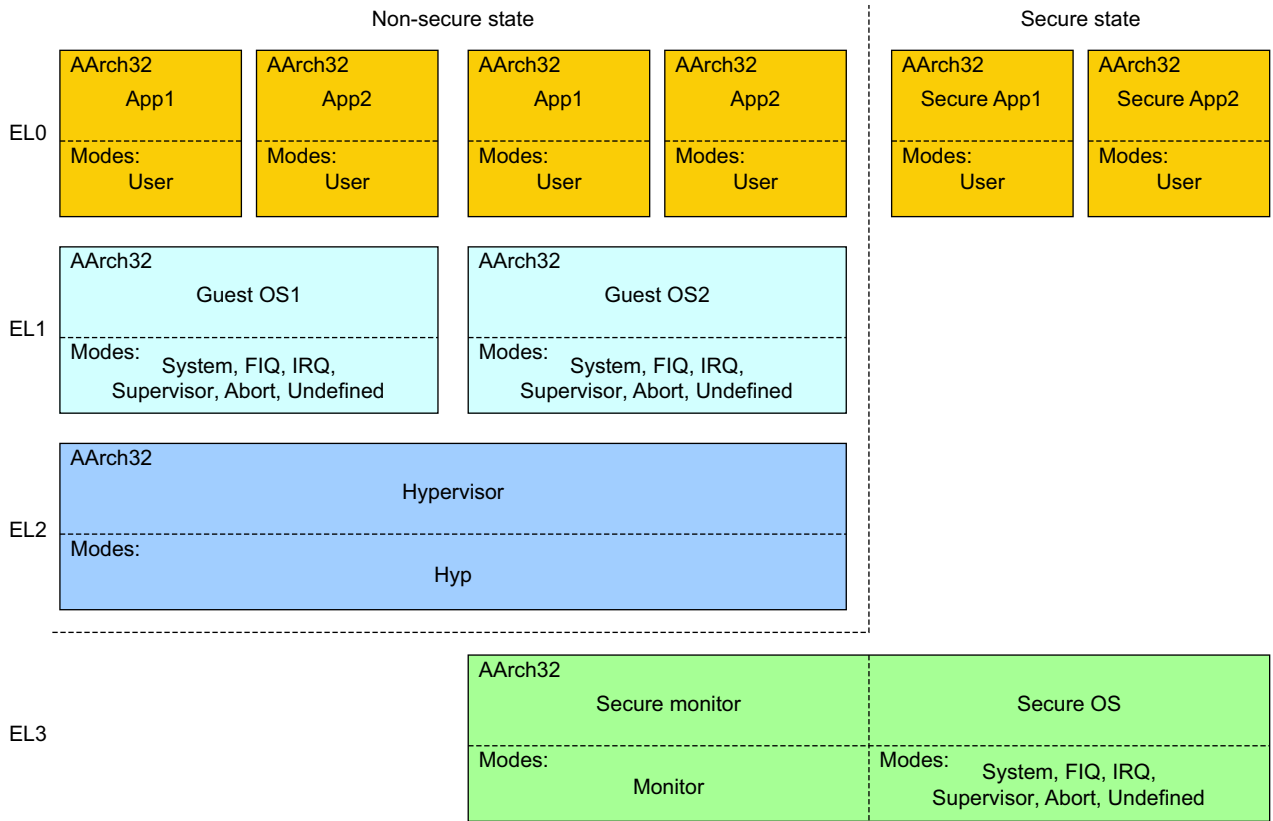

Figure G1-1 ARMv8-A Security model when EL3 is using AArch32

———— **Note** ————

For an overview of the Security models when EL3 is using AArch64:

- See [Figure G1-2 on page G1-3415](#) for the case where EL2, EL1, and EL0 are all using AArch32. This figure shows the implementation of the PE modes.
- See [Figure D1-1 on page D1-1413](#) for an overview of the set of possible implementations.

Figure G1-1 on page G1-3408 shows that when EL3 is using AArch32, the Exception levels and modes available in each Security state are as follows:

Secure state

EL0	User mode.
EL3	Any mode that is available in Secure state, other than User mode.

Non-secure state

EL0	User mode.
EL1	Any mode that is available in Non-secure state, other than Hyp mode and User mode.
EL2	Hyp mode.

Execution at EL0 is described as *unprivileged execution*.

A mode associated with a particular Exception level, EL_n , is described as an EL_n mode.

Note

The Exception level defines the ability to access resources in the current Security state, and does not imply anything about the ability to access resources in the other Security state.

When EL3 is using AArch32, many AArch32 system registers accessible at PL1 are *banked* between the Secure and Non-secure states. This is compatible with the ARMv7-A Security Extensions.

When EL3 is using AArch64 and Secure EL1 is using AArch32, system registers accessible at PL1 are not banked between the Non-secure and Secure states. Software running at EL3 is expected to switch the content of the PL1 accessible system registers between the Secure and Non-secure context, in a similar manner to switching the contents of general purpose registers. For information on the relationship between AArch64 and AArch32 system registers in an interprocessing environment, see [Mapping of the System registers between the Execution states on page D1-1545](#).

For more information on the system registers, see [The conceptual coprocessor interface and system control on page G1-3492](#).

The *Secure Monitor Call* (SMC) instruction provides software with a system call to EL3. When executing at a privileged Exception level, SMC instructions generates exceptions. For more information, see [Secure Monitor Call \(SMC\) exception on page G1-3480](#) and [SMC \(previously SMI\) on page F7-3058](#).

Note

For more information about the Privilege level terminology, see [Execution privilege, Exception levels, and AArch32 Privilege levels on page G3-3560](#).

Changing from Secure state to Non-secure state

Monitor mode is provided to support switching between Secure and Non-secure states. When executing in an Exception level that is using AArch32, except in Monitor mode and Hyp mode, the Security state is controlled:

- By the **SCR.NS** bit, when EL3 is using AArch32.
- By the **SCR_EL3.NS** bit, when EL3 is using AArch64.

The mapping of AArch32 privileged modes to the exception hierarchy means that it is possible when EL3 is using AArch32 to change from EL3 to non-secure EL1 without an exception return. This can occur in one of the following ways:

- Using an MSR or CPS instruction to switch from Monitor mode to another privileged mode while **SCR.NS** is 1.
- Using an MCR instruction that writes **SCR.NS** to change from Secure to Non-secure state when in a privileged mode other than Monitor mode.

ARM strongly recommends that software executing at EL3 using AArch32 does not use either of these mechanisms to change from EL3 to non-secure EL1 without an exception return. The use of both of these mechanisms is deprecated.

G1.8 Virtualization

The support for virtualization described in this section applies only to an implementation that includes EL2. A PE is in *Hyp mode* when it is executing at EL2 in the AArch32 state. An exception return from Hyp mode to software running at EL1 or EL0 is performed using the ERET instruction.

EL2 provides a set of features that support virtualizing the Non-secure state of an ARMv8-A implementation. The basic model of a virtualized system involves:

- A hypervisor, running in EL2, that is responsible for switching between *virtual machines*. A virtual machine is comprised of Non-secure EL1 and Non-secure EL0.
- A number of Guest operating systems, that each run in Non-secure EL1, on a virtual machine.
- For each Guest operating system, applications, that usually run in Non-secure EL0, on a virtual machine.

———— Note ————

In some systems, a Guest OS is unaware that it is running on a virtual machine, and is unaware of any other Guest OS. In other systems, a hypervisor makes the Guest OS aware of these facts. The ARMv8-A architecture supports both of these models.

The hypervisor assigns a *virtual machine identifier* (VMID) to each virtual machine.

EL2 is implemented only in Non-secure state, to support Guest OS management. EL2 provides controls to:

- Provide virtual values for the contents of a small number of identification registers. A read of one of these registers by a Guest OS or the applications for a Guest OS returns the virtual value.
- *Trap* various operations, including memory management operations and accesses to many other registers. A trapped operation generates an exception that is taken to EL2.
- Route interrupts to the appropriate one of:
 - The current Guest OS.
 - A Guest OS that is not currently running.
 - The hypervisor.

In Non-secure state:

- The implementation provides an independent *translation regime* for memory accesses from EL2.
- For the EL1&0 translation regime, address translation occurs in two stages:
 - Stage 1 maps the *Virtual Address* (VA) to an *Intermediate Physical Address* (IPA). This is managed at EL1, usually by a Guest OS. The Guest OS believes that the IPA is the *Physical Address* (PA).
 - Stage 2 maps the IPA to the PA. This is managed at EL2. The Guest OS might be completely unaware of this stage.

For more information on the translation regimes, see [Chapter G3 The AArch32 Virtual Memory System Architecture](#).

G1.8.1 The effect of implementing EL2 on the Exception model

An implementation that includes EL2 implements the following exceptions:

- Hypervisor Call (HVC) exception.
- Traps to EL2. [AArch32 control of traps to the hypervisor on page G1-3503](#), describes these.
- All of the virtual interrupts:
 - Virtual External interrupt.
 - Virtual IRQ.
 - Virtual FIQ.

HVC exceptions are always taken to EL2. All virtual interrupts are always taken to EL1, and can only be taken from Non-secure EL1 or EL0.

Each of the virtual interrupts can be independently enabled using controls at EL2.

Each of the virtual interrupts has a corresponding physical interrupt. See [Virtual interrupts](#).

When a virtual interrupt is enabled, its corresponding physical exception is taken to EL2, unless EL3 has configured that physical exception to be taken to EL3. For more information, see [Asynchronous exception behavior for exceptions taken from AArch32 state](#) on page G1-3465.

An implementation that includes EL2 also:

- Provides controls that can be used to route some synchronous exceptions, taken from Non-secure state, to EL2. For more information see:
 - [Routing general exceptions to EL2](#) on page G1-3452.
 - [Routing Debug exceptions to Hyp mode](#) on page G1-3454.
- Provides mechanisms to trap PE operations to EL2. See [AArch32 control of traps to the hypervisor](#) on page G1-3503.

When an operation is trapped to EL2, the hypervisor typically either:

- Emulates the required operation. The application running in the Guest OS is unaware of the trap.
- Returns an error to the Guest OS.

Virtual interrupts

The virtual interrupts have names that correspond to the physical interrupts, as shown in [Table G1-1](#).

Table G1-1 The virtual interrupts

Physical interrupt	Corresponding virtual interrupt
External abort	Virtual External Abort
IRQ	Virtual IRQ
FIQ	Virtual FIQ

Software executing at EL2 can use virtual interrupts to signal physical interrupts to Non-secure EL1 and Non-secure EL0. [Example G1-1](#) shows a usage model for virtual interrupts.

Example G1-1 Virtual interrupt usage model

A usage model is as follows:

1. Software executing at EL2 routes a physical interrupt to EL2.
2. When a physical interrupt of that type occurs, the exception handler executing in EL2 determines whether the interrupt can be handled in EL2 or requires routing to a Guest OS in EL1. If the interrupt requires routing to a Guest OS:
 - If the Guest OS is currently running, the hypervisor uses the appropriate virtual interrupt type to signal the physical interrupt to the Guest OS.
 - If the Guest OS is not currently running, the physical interrupt is marked as pending for the guest OS. When the hypervisor next switches to the virtual machine that is running that Guest OS, the hypervisor uses the appropriate virtual interrupt type to signal the physical interrupt to the Guest OS.

Non-secure EL1 and Non-secure EL0 modes cannot distinguish a virtual interrupt from the corresponding physical interrupt.

For more information see [Virtual exceptions when an implementation includes EL2](#) on page G1-3465.

G1.9 AArch32 PE modes, general-purpose registers, and the PC

The following sections describe the AArch32 PE modes and the general-purpose registers and the PC:

- [AArch32 PE mode descriptions](#).
- [AArch32 general-purpose registers, and the PC](#) on page G1-3418.
- [Program Status Registers \(PSRs\)](#) on page G1-3422.
- [ELR_hyp](#) on page G1-3428.

———— **Note** —————

The PC is included in the scope of this section because, in AArch32 state, it is defined as being part of the same register file as the general-purpose registers. That is, the AArch32 register file R0-R15 comprises:

- The general-purpose registers R0-R14.
- The PC, that can be described as R15.

G1.9.1 AArch32 PE mode descriptions

Table G1-2 shows the PE modes defined by the ARM architecture, for execution in AArch32 state. In this table:

- The *PE mode* column gives the name of each mode and the abbreviation used, for example, in the general-purpose register name suffixes used in [AArch32 general-purpose registers, and the PC](#) on page G1-3418.
- The *Encoding* column gives the corresponding CPSR.M field.
- The *Exception level* column gives the Exception level at which the mode is implemented, including dependencies on the current Security state and on whether EL3 is using AArch32, see [Exception levels](#) on page G1-3401.

Table G1-2 AArch32 PE modes

PE mode	Encoding	Security state	Exception level	Implemented
User	usr 10000	Both	EL0	Always
FIQ	fiq 10001	Non-secure Secure	EL1 EL1 or EL3 ^a	Always
IRQ	irq 10010	Non-secure Secure	EL1 EL1 or EL3 ^a	Always
Supervisor	svc 10011	Non-secure Secure	EL1 EL1 or EL3 ^a	Always
Monitor	mon 10110	Secure	EL3	If EL3 implemented and using AArch32
Abort	abt 10111	Non-secure Secure	EL1 EL1 or EL3 ^a	Always
Hyp	hyp 11010	Non-secure	EL2	If EL2 implemented and using AArch32
Undefined	und 11011	Non-secure Secure	EL1 EL1 or EL3 ^a	Always
System	sys 11111	Non-secure Secure	EL1 EL1 or EL3 ^a	Always

a. EL3 if EL3 is using AArch32. EL1 if EL3 is using AArch64 and EL1 is using AArch32.

Mode changes can be made under software control, or can be caused by an external or internal exception.

Notes on the AArch32 PE modes

PE modes are defined only in AArch32. Because each mode is implemented as part of a particular Exception level that is using AArch32, the set of available modes depends on which Exception levels are implemented and using AArch32, as described in [Effect of the EL3 Execution state on the PE modes and Exception levels](#) on page G1-3415.

This section gives more information about each of the modes, when it is implemented.

User mode Software executing in User mode executes at EL0. Execution in User mode is sometimes described as unprivileged execution. Application programs normally execute in User mode, and any program executed in User mode:

- Makes only unprivileged accesses to system resources, meaning it cannot access protected system resources.
- Makes only unprivileged access to memory.
- Cannot change mode except by causing an exception, see [Handling exceptions that are taken to an Exception level using AArch32](#) on page G1-3431.

System mode System mode is implemented at EL1 or EL3, see [Effect of the EL3 Execution state on the PE modes and Exception levels](#) on page G1-3415.

System mode has the same registers available as User mode, and is not entered by any exception.

Supervisor mode

Supervisor mode is implemented at EL1 or EL3, see [Effect of the EL3 Execution state on the PE modes and Exception levels](#) on page G1-3415.

Supervisor mode is the default mode to which a Supervisor Call exception is taken. Executing a SVC (Supervisor Call) instruction generates a Supervisor Call exception.

In an implementation where the highest implemented Exception level is using AArch32, if that Exception level is EL3 or EL1, a PE enters Supervisor mode on Reset.

Abort mode Abort mode is implemented at EL1 or EL3, see [Effect of the EL3 Execution state on the PE modes and Exception levels](#) on page G1-3415.

Abort mode is the default mode to which a Data Abort exception or Prefetch Abort exception is taken.

Undefined mode

Undefined mode is implemented at EL1 or EL3, see [Effect of the EL3 Execution state on the PE modes and Exception levels](#) on page G1-3415.

Undefined mode is the default mode to which an instruction-related exception, including any attempt to execute an UNDEFINED instruction, is taken.

FIQ mode FIQ mode is implemented at EL1 or EL3, see [Effect of the EL3 Execution state on the PE modes and Exception levels](#) on page G1-3415.

FIQ mode is the default mode to which an FIQ interrupt is taken.

IRQ mode IRQ mode is implemented at EL1 or EL3, see [Effect of the EL3 Execution state on the PE modes and Exception levels](#) on page G1-3415.

IRQ mode is the default mode to which an IRQ interrupt is taken.

Hyp mode Hyp mode is the Non-secure EL2 mode.

Hyp mode is entered on taking an exception from Non-secure state that must be taken to EL2.

In an implementation where the highest implemented Exception level is EL2 and EL2 uses AArch32 on reset, a PE enters Hyp mode on Reset.

The Hypervisor Call exception and Hyp Trap exception are implemented as part of EL2 and are always taken to Hyp mode.

———— **Note** —————

This means that Hypervisor Call and Hyp Trap exceptions cannot be taken from Secure state.

When the value of the Hypervisor Call enable bit, **SCR.HCE**, is 1, executing a HVC (Hypervisor Call) instruction in a Non-secure EL1 mode generates a Hypervisor Call exception.

For more information, see [Hyp mode on page G1-3416](#).

Monitor mode

Monitor mode is the Secure EL3 mode. This means it is always in the Secure state, regardless of the value of the **SCR.NS** bit.

Monitor mode is the mode to which a Secure Monitor Call exception is taken. In a Non-secure EL1 mode, or a Secure EL3 mode, executing an SMC (Secure Monitor Call) instruction generates a Secure Monitor Call exception.

When EL3 is using AArch32, some exceptions that are taken to a different mode by default can be configured to be taken to EL3, see [PE mode for taking exceptions on page G1-3439](#).

When EL3 is using AArch32, software executing in Monitor mode:

- Has access to both the Secure and Non-secure copies of System registers.
- Can perform an exception return to Secure state, or to Non-secure state.

This means that, when EL3 is using AArch32, Monitor mode provides the only recommended method of changing between the Secure and Non-secure Security states.

Secure and Non-secure modes

In an implementation that includes EL3, the names of most implemented modes can be qualified as Secure or Non-secure, to indicate whether the PE is also in Secure state or Non-secure state. For example:

- If a PE is in Supervisor mode and Secure state, it is in *Secure Supervisor mode*.
- If a PE is in User mode and Non-secure state, it is in *Non-secure User mode*.

———— **Note** —————

As indicated in the appropriate Mode descriptions:

- Monitor mode is a Secure mode, meaning it is always in the Secure state.
- Hyp mode is a Non-secure mode, meaning it is accessible only in Non-secure state.

Effect of the EL3 Execution state on the PE modes and Exception levels

Figure G1-1 on page G1-3408 shows the PE modes, Exception levels, and Security states, for an implementation that includes all of the Exception levels, when EL3 is using AArch32. Figure G1-2 shows how the implemented modes change when EL3 is using AArch64.

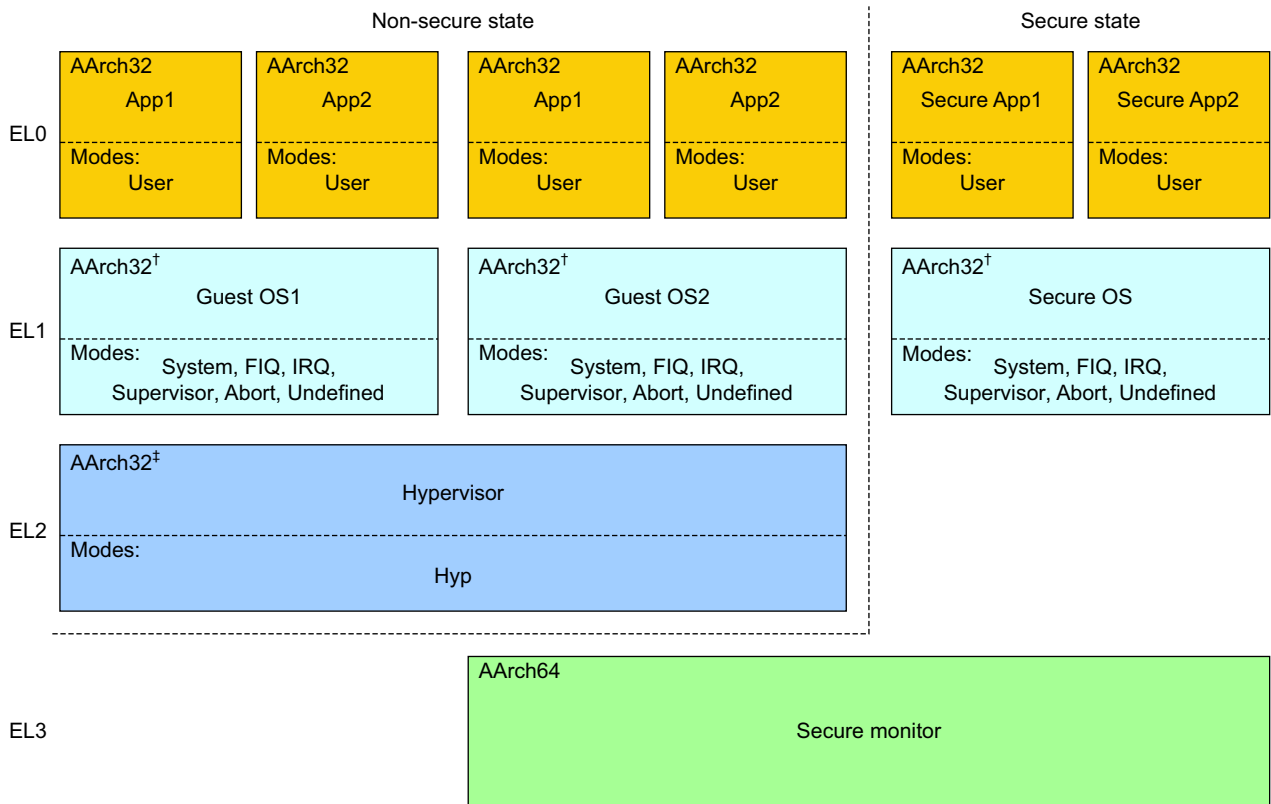

† When EL1 is using AArch64, System, FIQ, IRQ, Supervisor, Abort, and Undefined modes are not implemented

‡ When EL2 is using AArch64, Hyp mode is not implemented

Figure G1-2 ARMv8 Exception levels, and PE modes, when EL3 is using AArch64

Comparing Figure G1-1 on page G1-3408 and Figure G1-2 shows how, in Secure state only, the implementation of System, FIQ, IRQ, Supervisor, Abort, and Undefined mode depends on the Execution state that EL3 is using. That is, these modes are implemented as follows:

Non-secure state

If Non-secure EL1 is using AArch32 then System, FIQ, IRQ, Supervisor, Abort, and Undefined modes are implemented as part of EL1. Otherwise, these modes are not implemented in Non-secure state.

Secure state The implementation of these modes depends on the Execution state that EL3 is using, as follows:

EL3 using AArch64 If Secure EL1 is using AArch32 then System, FIQ, IRQ, Supervisor, Abort, and Undefined modes are implemented as part of EL1. Otherwise, these modes are not implemented in Secure state.

EL3 using AArch32 In Secure state, System, FIQ, IRQ, Supervisor, Abort, and Undefined modes are implemented as part of EL3, see Figure G1-1 on page G1-3408.

Hyp mode

Hyp mode is the Non-secure EL2 mode. When EL2 is using AArch32, it provides the usual method of controlling the virtualization of Non-secure execution at EL1 and EL0.

Note

The alternative method of controlling this functionality is by accessing the EL2 controls from EL3 with the [SCR_EL3.NS](#) or [SCR.NS](#) bit set to 1.

This section summarizes how Hyp mode differs from the other modes, and references where this part of the manual describes the features of Hyp mode in more detail:

- Software executing in Hyp mode executes at EL2, see [Figure G1-1 on page G1-3408](#).
- Hyp mode is accessible only in Non-secure state. When the PE is in Secure state, setting [CPSR.M](#) to 0b11010, the encoding for Hyp mode, has no meaning. Therefore, in Secure state, the effect of attempting to set [CPSR.M](#) to 0b11010 is UNPREDICTABLE. For more information see [The Current Program Status Register \(CPSR\) on page G1-3422](#).
- In Non-debug state, the only mechanisms for changing to Hyp mode are:
 - An exception taken from a Non-secure EL1 or EL0 mode.
 - When EL3 is using AArch32, an exception return from Secure Monitor mode.
 - When EL3 is using AArch64, an exception return from EL3.
- In Hyp mode, the only exception return is execution of an ERET instruction, see [ERET on page F7-3038](#).
- In Hyp mode, the [CPACR](#) has no effect on the execution of coprocessor, floating-point, or Advanced SIMD instructions. The [HCPTR](#) controls execution of these instructions in Hyp mode.
- If software running in Hyp mode executes an SVC instruction, the Supervisor Call exception generated by the instruction is taken to Hyp mode, see [SVC \(previously SWI\) on page F7-2926](#).
- The effect of an exception return with the restored [CPSR](#) specifying Hyp mode is UNPREDICTABLE if any of the following applies:
 - EL3 is using AArch64 and the value of [SCR_EL3.NS](#) is 0.
 - EL3 is using AArch32 and the value of [SCR.NS](#) is 0.
 - The return is from a Non-secure EL1 mode.
- The instructions described in the following sections are UNDEFINED if executed in Hyp mode:
 - [SRS \(T32\) on page F7-3060](#).
 - [SRS \(A32\) on page F7-3062](#).
 - [RFE on page F7-3056](#).
 - [LDM \(exception return\) on page F7-3042](#).
 - [LDM \(User registers\) on page F7-3044](#).
 - [STM \(User registers\) on page F7-3064](#).
 - [SUBS PC, LR and related instructions \(A32\) on page F7-3068](#).
 - [SUBS PC, LR and related instructions \(T32\) on page F7-3066](#), when executed with a nonzero constant.

Note

In T32 state, ERET is encoded as SUBS PC, LR, #0, and therefore this is a valid instruction.

- The unprivileged Load unprivileged and Store unprivileged instructions LDRT, LDRSHT, LDRHT, LDRBT, STRT, STRHT, and STRBT, are UNPREDICTABLE if executed in Hyp mode.

In an implementation that includes EL3, from reset, the HVC instruction is UNDEFINED in Non-secure EL1 modes, meaning entry to Hyp mode is disabled by default. To permit entry to Hyp mode using the Hypervisor Call exception, Secure software must enable use of the HVC instruction:

- By setting the `SCR_EL3.HCE` bit to 1, if EL3 is using AArch64.
- By setting the `SCR.HCE` bit to 1, if EL3 is using AArch32.

When the HVC instruction is UNDEFINED in Non-secure EL1 modes because of the value of the `SCR_EL3.HCE` or `SCR.HCE` bit, HVC is UNPREDICTABLE in Hyp mode.

Pseudocode details of mode operations

The `BadMode()` function tests whether a 5-bit mode number corresponds to one of the permitted modes:

```
// BadMode()
// =====

boolean BadMode(bits(5) mode)
  case mode of
    when M32_User    result = FALSE;
    when M32_FIQ    result = FALSE;
    when M32_IRQ    result = FALSE;
    when M32_Svc    result = FALSE;
    when M32_Monitor result = !HaveEL(EL3);
    when M32_Abort  result = FALSE;
    when M32_Hyp    result = !HaveEL(EL2);
    when M32_Undef  result = FALSE;
    when M32_System result = FALSE;
    otherwise       result = TRUE;
  return result;
```

The following pseudocode functions provide information about the current mode:

```
// CurrentModeIsNotUser()
// =====

boolean CurrentModeIsNotUser()
  if BadMode(CPSR.M) then UNPREDICTABLE;
  if CPSR.M == M32_User then return FALSE;
  return TRUE; // Other modes

// CurrentModeIsUserOrSystem()
// =====

boolean CurrentModeIsUserOrSystem()
  if BadMode(CPSR.M) then UNPREDICTABLE;
  if CPSR.M == M32_User then return TRUE;
  if CPSR.M == M32_System then return TRUE;
  return FALSE; // Other modes

// CurrentModeIsHyp()
// =====

boolean CurrentModeIsHyp()
  if BadMode(CPSR.M) then UNPREDICTABLE;
  if CPSR.M == M32_Hyp then return TRUE;
  return FALSE; // Other modes
```

G1.9.2 AArch32 general-purpose registers, and the PC

The *general-purpose registers, and the PC, in AArch32 state* on page E1-2294 describes the application level view of the general-purpose registers, and the PC. This view provides:

- The general-purpose registers R0-R14, of which:
 - The preferred name for R13 is SP (*stack pointer*).
 - The preferred name for R14 is LR (*link register*).
- The PC (*program counter*), that can be described as R15.

These registers are selected from a larger set of registers, that includes *Banked* copies of some registers, with the current register selected by the execution mode. The implementation and banking of the general-purpose registers depends on whether or not the implementation includes EL2 and EL3, and whether those exception levels are using AArch32. Figure G1-3 shows the full set of Banked general-purpose registers, the Program Status Registers CPSR and SPSR, and the ELR_hyp Special register.

———— **Note** —————

The architecture uses system level register names, such as R0_usr, R8_usr, and R8_fiq, when it must identify a specific register. The application level names refer to the registers for the current mode, and usually are sufficient to identify a register.

Application level view	System level view								
	User	System	Hyp [†]	Supervisor	Abort	Undefined	Monitor [‡]	IRQ	FIQ
R0	R0_usr								
R1	R1_usr								
R2	R2_usr								
R3	R3_usr								
R4	R4_usr								
R5	R5_usr								
R6	R6_usr								
R7	R7_usr								
R8	R8_usr								R8_fiq
R9	R9_usr								R9_fiq
R10	R10_usr								R10_fiq
R11	R11_usr								R11_fiq
R12	R12_usr								R12_fiq
SP	SP_usr		SP_hyp	SP_svc	SP_abt	SP_und	SP_mon	SP_irq	SP_fiq
LR	LR_usr			LR_svc	LR_abt	LR_und	LR_mon	LR_irq	LR_fiq
PC	PC								
APSR	CPSR								
			SPSR_hyp	SPSR_svc	SPSR_abt	SPSR_und	SPSR_mon	SPSR_irq	SPSR_fiq
			ELR_hyp						

‡ Part of EL3. Exists only in Secure state, and only when EL3 is using AArch32.

† Part of EL2. Exists only in Non-secure state, and only when EL2 is using AArch32.

Cells with no entry indicate that the User mode register is used.

Figure G1-3 AArch32 general-purpose registers, the PC, PSRs, and ELR_hyp, showing register banking

As described in *PE mode for taking exceptions* on page G1-3439, on taking an exception the PE changes mode, unless it is already in the mode to which it must take the exception. Each mode that the PE might enter in this way has:

- A Banked copy of the stack pointer, for example SP_irq and SP_hyp.
- A register that holds a preferred return address for the exception. This is:
 - For the EL2 mode, Hyp mode, the special register ELR_hyp.
 - For the other privileged modes to which exceptions can be taken, a Banked copy of the link register, for example LR_und and LR_mon.
- A saved copy of the CPSR, made on exception entry, for example SPSR_irq and SPSR_hyp.

In addition FIQ mode has Banked copies of the general-purpose registers R8 to R12.

User mode and System mode share the same general-purpose registers.

User mode, System mode, and Hyp mode share the same LR.

For more information about the application level view of the SP, LR, and PC, and the alternative descriptions of them as R13, R14 and R15, see *The general-purpose registers, and the PC, in AArch32 state* on page E1-2294.

Pseudocode details of general-purpose register and PC operations

The following pseudocode gives access to the general-purpose registers and the PC,

_R is the array of general-purpose registers. This array is common to AArch32 and AArch64 operation and therefore contains 31 64-bit registers. _PC is the program counter, and its definition is common to AArch32 and AArch64 operation and therefore its size is 64-bit.

```
array bits(64) _R[0..30];
```

```
bits(64) _PC;
```

LookUpRIndex() looks up the _R entry for the specified register number and PE mode, using RBankSelect() to evaluates the result.

```
// LookUpRIndex()
// =====
```

```
integer LookUpRIndex(integer n, bits(5) mode)
  assert n >= 0 && n <= 14;
```

```
  case n of // Select index by mode:   usr fiq irq svc abt und hyp
    when 8   result = RBankSelect(mode, 8, 24, 8, 8, 8, 8, 8);
    when 9   result = RBankSelect(mode, 9, 25, 9, 9, 9, 9, 9);
    when 10  result = RBankSelect(mode, 10, 26, 10, 10, 10, 10, 10);
    when 11  result = RBankSelect(mode, 11, 27, 11, 11, 11, 11, 11);
    when 12  result = RBankSelect(mode, 12, 28, 12, 12, 12, 12, 12);
    when 13  result = RBankSelect(mode, 13, 29, 17, 19, 21, 23, 15);
    when 14  result = RBankSelect(mode, 14, 30, 16, 18, 20, 22, 14);
    otherwise result = n;
```

```
  return result;
```

```
// RBankSelect()
// =====
```

```
integer RBankSelect(bits(5) mode, integer usr, integer fiq, integer irq,
  integer svc, integer abt, integer und, integer hyp)
```

```
  case mode of
    when M32_User   result = usr; // User mode
    when M32_FIQ    result = fiq; // FIQ mode
    when M32_IRQ    result = irq; // IRQ mode
    when M32_Svc    result = svc; // Supervisor mode
    when M32_Abort  result = abt; // Abort mode
    when M32_Hyp    result = hyp; // Hyp mode
```

```

    when M32_Undef    result = und; // Undefined mode
    when M32_System  result = usr; // System mode uses User mode registers
    otherwise        Unreachable(); // Monitor mode

return result;

```

R[] accesses the specified general-purpose register in the current PE mode, using Rmode[] to access the register, accessing _R if necessary. SP accesses the stack pointer, LR accesses the link register, and PC accesses the program counter. Each function has a non-assignment form for register reads and an assignment form for register writes, other than PC, which has only a non-assignment form.

```

// R[] - assignment form
// =====

R[integer n] = bits(32) value
    Rmode[n, PSTATE.M] = value;
    return;

// R[] - non-assignment form
// =====

bits(32) R[integer n]
    if n == 15 then
        offset = (if CurrentInstrSet() == InstrSet_A32 then 8 else 4);
        return _PC<31:0> + offset;
    else
        return Rmode[n, PSTATE.M];

// Rmode[] - non-assignment form
// =====

bits(32) Rmode[integer n, bits(5) mode]
    assert n >= 0 && n <= 14;

    // Check for attempted use of Monitor mode in Non-secure state.
    if !IsSecure() then assert mode != M32_Monitor;
    assert !BadMode(mode);

    if mode == M32_Monitor && n == 13 then
        return SP_mon;
    elsif mode == M32_Monitor && n == 14 then
        return LR_mon;
    else
        return _R[LookUpRIndex(n, mode)]<31:0>;

// Rmode[] - assignment form
// =====

Rmode[integer n, bits(5) mode] = bits(32) value
    assert n >= 0 && n <= 14;

    // Check for attempted use of Monitor mode in Non-secure state.
    if !IsSecure() then assert mode != M32_Monitor;
    assert !BadMode(mode);

    if mode == M32_Monitor && n == 13 then
        SP_mon = value;
    elsif mode == M32_Monitor && n == 14 then
        LR_mon = value;
    else
        // It is CONSTRAINED UNPREDICTABLE whether the upper 32 bits of the X
        // register are unchanged or set to zero. This is also tested for on
        // exception entry, as this applies to all AArch32 registers.
        if ConstrainUnpredictableBool() then
            _R[LookUpRIndex(n, mode)] = ZeroExtend(value);
        else
            _R[LookUpRIndex(n, mode)]<31:0> = value;

```

```

    return;

// SP - assignment form
// =====

SP = bits(32) value
  R[13] = value;
  return;

// SP - non-assignment form
// =====

bits(32) SP
  return R[13];

// LR - assignment form
// =====

LR = bits(32) value
  R[14] = value;
  return;

// LR - non-assignment form
// =====

bits(32) LR
  return R[14];

// PC - non-assignment form
// =====

bits(32) PC
  return R[15];          // This includes the offset from AArch32 state

```

BranchTo() performs a branch to the specified address.

```

// BranchTo()
// =====

// Set program counter to a new address, with a branch reason hint
// for possible use by hardware fetching the next instruction.

BranchTo(bits(N) target, BranchType branch_type)
  HintBranch(branch_type);
  if N == 32 then
    assert UsingAArch32();
    _PC = ZeroExtend(target);
  else
    assert N == 64 && !UsingAArch32();
    // Remove the tag bits from a tagged target
    case PSTATE.EL of
      when EL0, EL1
        if target<55> == '1' && TCR_EL1.TBI1 == '1' then
          target<63:56> = '11111111';
        if target<55> == '0' && TCR_EL1.TBI0 == '1' then
          target<63:56> = '00000000';
      when EL2
        if TCR_EL2.TBI == '1' then
          target<63:56> = '00000000';
      when EL3
        if TCR_EL3.TBI == '1' then
          target<63:56> = '00000000';
    _PC = target<63:0>;
  return;

```

G1.9.3 Program Status Registers (PSRs)

In AArch32 state, the Application level programmers' model provides the Application Program Status Register, see [The Application Program Status Register \(APSR\) on page E1-2297](#). This is an application level alias for the *Current Program Status Register (CPSR)*. The system level view of the **CPSR** extends the register, adding system level information.

Every mode that an exception can be taken to has its own saved copy of the **CPSR**, the *Saved Program Status Register (SPSR)*, as shown in [Figure G1-3 on page G1-3418](#). For example, the **SPSR** for Monitor mode is called **SPSR_mon**.

———— **Note** ————

The information held in the **APSR** and **CPSR** is part of the ARMv8 **PSTATE** information, described in [Process state, PSTATE on page D1-1421](#). Unlike the AArch32 **CPSR**, AArch64 state supports instructions that operate on elements of **PSTATE**, but its programmers' model does not include a register that gives access to all of **PSTATE**.

The Current Program Status Register (CPSR)

In AArch32 state, the *Current Program Status Register (CPSR)* holds PE status and control information. This means it holds:

- The **APSR**, see [The Application Program Status Register \(APSR\) on page E1-2297](#).
- The current instruction set state, see [Instruction set state register, ISETSTATE on page E1-2298](#).
- The execution state bits for the T32 If-Then instruction, see [IT block state register, ITSTATE on page E1-2300](#).
- The current endianness, see [Endianness mapping register, ENDIANSTATE on page E1-2302](#).
- The current PE mode.
- Interrupt and asynchronous abort disable bits.

The non-**APSR** bits of the **CPSR** have defined reset values. These are shown in the `TakeReset()` pseudocode function, see [Reset on page G1-3475](#).

Writes to the **CPSR** have side-effects on various aspects of PE operation. All of these side-effects, except for those on memory accesses associated with fetching instructions, are synchronous to the **CPSR** write. This means they are guaranteed:

- Not to be visible to earlier instructions in the execution stream.
- To be visible to later instructions in the execution stream.

The privilege level and address space of memory accesses associated with fetching instructions depend on the current Exception level and Security state. Writes to **CPSR.M** can change one or both of the Exception level and Security state. The effect, on memory accesses associated with fetching instructions, of a change of Exception level or Security state is:

- Synchronous to the change of Exception level or Security state, if that change is caused by an exception entry or exception return.
- Guaranteed not to be visible to any memory access caused by fetching an earlier instruction in the execution stream.
- Guaranteed to be visible to any memory access caused by fetching any instruction after the next context synchronization operation in the execution stream.

———— **Note** ————

See [Context synchronization operation](#) for the definition of this term.

- Might or might not affect memory accesses caused by fetching instructions between the mode change instruction and the point where the mode change is guaranteed to be visible.

See [Exception return to an Exception level using AArch32 on page G1-3454](#) for the definition of exception return instructions.

The Saved Program Status Registers (SPSRs)

The purpose of an **SPSR** is to record the pre-exception value of the **CPSR**. On taking an exception, the **CPSR** is copied to the **SPSR** of the mode to which the exception is taken. Saving this value means the exception handler can:

- On exception return, restore the **CPSR** to the value it had immediately before the exception was taken.
- Examine the value that the **CPSR** had when the exception was taken, for example to determine the instruction set state and privilege level in which the instruction that caused an Undefined Instruction exception was executed.

Figure G1-3 on page G1-3418 shows the banking of the SPSRs.

The SPSRs are UNKNOWN on reset. Any operation in a Non-secure EL1 or EL0 mode makes **SPSR_hyp** UNKNOWN.

Format of the CPSR and SPSRs

The CPSR and SPSR bit assignments are:

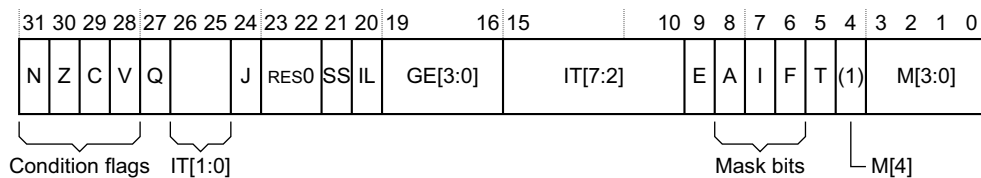

Condition flags, bits[31:28]

Set on the result of instruction execution. The flags are:

N, bit[31] Negative condition flag.

Z, bit[30] Zero condition flag.

C, bit[29] Carry condition flag.

V, bit[28] Overflow condition flag.

The condition flags can be read or written in any mode, and are described in *IT block state register, ITSTATE* on page E1-2300.

Q, bit[27] Cumulative saturation bit. This bit can be read or written in any mode, and is described in *IT block state register, ITSTATE* on page E1-2300.

IT[7:0], bits[15:10, 26:25]

If-Then execution state bits for the T32 IT (If-Then) instruction. *IT block state register, ITSTATE* on page E1-2300 describes the encoding of these bits. **CPSR.IT[7:0]** are the **IT[7:0]** bits described there. For more information, see *IT* on page F7-2610.

For details of how these bits can be accessed see *Accessing the execution state bits* on page G1-3425.

J, bit[24] J bit, see the description of the T bit, bit[5].

Bits[23:22] Reserved. RAZ/SBZP.

SS, bit[21] Software step bit, used for tracking the progress of software step debug. **SPSR.SS** is used by a debugger to initiate a Software Step debug event. It also indicates which software step state machine state the PE was in. See *Software Step exceptions* on page D2-1634.

This bit is **RES0** in the **CPSR**.

IL, bit[20] Illegal state or Mode bit. Holds the value of **PSTATE.IL**. The **IL** bit is set to 1 in AArch32 state to indicate that on exception return or as a result of an explicit change of the **CPSR.M** field, an illegal state or mode was indicated. In an **SPSR**, the **IL** bit shows the value of **PSTATE.IL** immediately before the exception was taken.

This bit is **RES0** in the **CPSR**.

———— **Note** ————

Conceptually, CPSR.IL holds the value of PSTATE.IL. However, when PSTATE.IL is set to 1, execution of any instruction generates an exception, and therefore a CPSR.IL value of 1 could never be observed, and the observed behavior of this CPSR bit is RES0.

For more information see [Illegal exception returns to AArch32 state](#) on page G1-3456.

GE[3:0], bits[19:16]

Greater than or Equal flags, for the parallel addition and subtraction (SIMD) instructions described in [Parallel addition and subtraction instructions](#) on page F1-2389.

The GE[3:0] field can be read or written in any mode, and is described in [The Application Program Status Register \(APSR\)](#) on page E1-2297.

E, bit[9]

Endianness execution state bit. Controls the load and store endianness for data accesses:

0 Little-endian operation.

1 Big-endian operation.

Instruction fetches ignore this bit.

[Endianness mapping register, ENDIANSTATE](#) on page E1-2302 describes the encoding of this bit. CPSR.E is the ENDIANSTATE bit described there.

For details of how this bit can be accessed see [Accessing the execution state bits](#) on page G1-3425.

When the reset value of the SCTL.R.EE bit is defined by a configuration input signal, that value also applies to the CPSR.E bit on reset, and therefore applies to software execution from reset.

Mask bits, bits[8:6]

These bits are:

A, bit[8] Asynchronous abort mask bit.

I, bit[7] IRQ mask bit.

F, bit[6] FIQ mask bit.

The possible values of each bit are:

0 Exception not masked.

1 Exception masked.

The A bit has no effect on any Data Abort exception generated by a Watchpoint debug event, even if that exception is asynchronous. For more information see [Breakpoint and Watchpoint debug events](#) on page H2-4330.

In an implementation that does not include EL3, setting a mask bit masks the corresponding exception, meaning it cannot be taken. However, the implementation of EL3 and EL2 significantly alters the behavior and effect of these bits, see [Effects of EL3 and EL2 on the CPSR.{A, F} bits](#) on page G1-3425 and [Asynchronous exception masking controls](#) on page G1-3468.

The mask bits can be written only at EL1 or higher. Their values can be read in any mode, but ARM deprecates any use of their values, or attempt to change them, by software executing at EL0.

T, bit[5]

T32 execution state bit. This bit and the J execution state bit, bit[24], determine the instruction set state of the PE, A32 or T32. [Instruction set state register, ISETSTATE](#) on page E1-2298 describes the encoding of these bits. CPSR.J and CPSR.T are the same bits as ISETSTATE.J and ISETSTATE.T respectively. For more information, see [Instruction set states](#) on page G1-3429.

For details of how these bits can be accessed see [Accessing the execution state bits](#) on page G1-3425.

M[4:0], bits[4:0]

Mode field. This field determines the current mode of the PE. The permitted values of this field are listed in [Table G1-2](#) on page G1-3412. All other values of M[4:0] are reserved. [Illegal changes to the CPSR.M field](#) on page G1-3458 describes the effect of setting M[4:0] to a reserved value.

ARMv8 redefines M[4] as follows:

M[4], Execution state This bit indicates the Execution state of the PE, as follows:

0	AArch64 state.
1	AArch32 state.

———— **Note** ————

This is consistent with the use of the M[4:0] field in previous versions of the architecture. All of the PE modes have M[4:0] values in which the value of the most significant bit is 1.

For more information about the PE modes see [AArch32 PE mode descriptions on page G1-3412](#). [Figure G1-3 on page G1-3418](#) shows the registers that can be accessed in each mode.

This field can be written only at EL1 or higher. Its value can be read in any mode, but ARM deprecates software executing at EL0 making any use of its value, or attempting to change it.

Accessing the execution state bits

The execution state bits are the IT[7:0], J, E, and T bits. If the current mode has an [SPSR](#), software can read or write these bits in the [SPSR](#).

In the [CPSR](#), unless the PE is in Debug state:

- The execution state bits, other than the E bit, are RAZ when read by an MRS instruction.
- Writes to the execution state bits, other than the E bit, by an MSR instruction are ignored in all modes.

Instructions other than MRS and MSR that access the execution state bits can read and write them in any mode.

Unlike the other execution state bits in the [CPSR](#), [CPSR.E](#) can be read by an MRS instruction and written by an MSR instruction. However, ARM deprecates:

- Using the [CPSR.E](#) value read by an MRS instruction.
- Using an MSR instruction to change the value of [CPSR.E](#).

———— **Note** ————

- Software can use the SETEND instruction to change the current endianness.
- To determine the current endianness, software can use an LDR instruction to load a word of memory with a known value that differs if the endianness is reversed. For example, using an LDR (literal) instruction to load a word whose four bytes are 0x01, 0x00, 0x00, and 0x00 in ascending order of memory address loads the destination register with:
 - 0x00000001 if the current endianness is little-endian.
 - 0x01000000 if the current endianness is big-endian.

For more information about the behavior of these bits in Debug state see [Status register access instructions on page F1-2391](#).

Effects of EL3 and EL2 on the CPSR.{A, F} bits

In an implementation that includes EL3, the [SCR](#).{AW, FW} bits modify the effect of the [CPSR](#).{A, F} bits on exceptions taken from Non-secure state.

In an implementation that includes EL2, the [HCR](#).{AMO, IMO, FMO} bits modify the effect of the [CPSR](#).{A, I, F} bits on exceptions taken from Non-secure state.

For more information see [Asynchronous exception masking controls on page G1-3468](#).

Privileged software can change the `CPSR`.{A, F} and `SPSR`.{A, F} bits. In an implementation that includes EL3, this is true regardless of the value of the corresponding `SCR`.{AW, FW} bits. However, when the `SPSR` is copied to the `CPSR`, a `CPSR`.{A, F} bit is not updated if the value of the corresponding `SCR`.{AW, FW} bit is 0.

———— **Note** ————

In ARMv7 implementations before the introduction of the Virtualization Extensions, the `SCR`.{AW, FW} bits control whether the `CPSR`.{A, F} bits are writable in Non-secure state. In ARMv8, the `SCR`.{AW, FW} bits never have this effect.

Pseudocode details of PSR operations

The following pseudocode gives access to the PSRs. The `SPSR[]` function accesses the current `SPSR`, and is common to AArch32 and AArch64 operation. The `CPSR[]` function accesses the `CPSR`. Each of these functions has non-assignment form for reads and an assignment form for writes.

bits(32) `CPSR`, `SPSR_fiq`, `SPSR_irq`, `SPSR_svc`, `SPSR_mon`, `SPSR_abt`, `SPSR_und`, `SPSR_hyp`;

```
// SPSR[] - non-assignment form
// =====

bits(32) SPSR[]
  bits(32) result;
  if UsingAArch32() then
    case CPSR.M of
      when M32_FIQ      result = SPSR_fiq;
      when M32_IRQ      result = SPSR_irq;
      when M32_Svc      result = SPSR_svc;
      when M32_Monitor  result = SPSR_mon;
      when M32_Abort    result = SPSR_abt;
      when M32_Hyp      result = SPSR_hyp;
      when M32_Undef    result = SPSR_und;
      otherwise         Unreachable();
    else
      case PSTATE.EL of
        when EL1        result = SPSR_EL1;
        when EL2        result = SPSR_EL2;
        when EL3        result = SPSR_EL3;
        otherwise       Unreachable();

  return result;

// SPSR[] - assignment form
// =====

SPSR[] = bits(32) value
  if UsingAArch32() then
    case CPSR.M of
      when M32_FIQ      SPSR_fiq = value;
      when M32_IRQ      SPSR_irq = value;
      when M32_Svc      SPSR_svc = value;
      when M32_Monitor  SPSR_mon = value;
      when M32_Abort    SPSR_abt = value;
      when M32_Hyp      SPSR_hyp = value;
      when M32_Undef    SPSR_und = value;
      otherwise         Unreachable();
    else
      case PSTATE.EL of
        when EL1        SPSR_EL1 = value;
        when EL2        SPSR_EL2 = value;
        when EL3        SPSR_EL3 = value;
        otherwise       Unreachable();

  return;
```



```

// CPSR - non-assignment form
// =====

CPSRType CPSR
  bits(32) cpsr = GetSPSRFromPSTATE();
  return cpsr;

// CPSR - assignment form
// =====

CPSR = CPSRType cpsr
  bits(32) v = cpsr;
  SetPSTATEFromSPSR(v);

// CPSRWriteByInstr()
// =====

CPSRWriteByInstr(bits(32) value, bits(4) bytemask, boolean is_excpt_return)
  privileged = CurrentModeIsNotUser();

  new_cpsr = CPSR;

  if bytemask<3> == '1' then
    new_cpsr<31:27> = value<31:27>; // N,Z,C,V,Q flags
    if is_excpt_return then
      new_cpsr<26:24> = value<26:24>; // IT<1:0>,J execution state bits

  if bytemask<2> == '1' then
    // bits <23:20> are RES0
    new_cpsr<19:16> = value<19:16>; // GE<3:0> flags

  if bytemask<1> == '1' then
    if is_excpt_return then
      new_cpsr<15:10> = value<15:10>; // IT<7:2> execution state bits
    new_cpsr<9> = value<9>; // E bit is user-writable
    if privileged then
      new_cpsr<8> = value<8>; // A interrupt mask

  if bytemask<0> == '1' then
    if privileged then
      new_cpsr<7> = value<7>; // I interrupt mask
      new_cpsr<6> = value<6>; // F interrupt mask
    if is_excpt_return then
      new_cpsr<5> = value<5>; // T execution state bit
    if privileged then
      new_cpsr<4:0> = value<4:0>; // mode bits

  // Attempts to change to an illegal mode, or return to Hyp mode with CPSR.<J,T> = '11'
  // will invoke the Illegal Execution State mechanism
  CPSR = new_cpsr; // Assign new CPSR value

  return;

// SPSRWriteByInstr()
// =====

SPSRWriteByInstr(bits(32) value, bits(4) bytemask)

  if CurrentModeIsUserOrSystem() then UNPREDICTABLE;

  if bytemask<3> == '1' then
    SPSR[]<31:24> = value<31:24>; // N,Z,C,V,Q flags, IT<1:0>,J execution state bits

  if bytemask<2> == '1' then
    // bits <23:20> are reserved SBZP bits
    SPSR[]<19:16> = value<19:16>; // GE<3:0> flags

  if bytemask<1> == '1' then

```

```
SPSR[]<15:8> = value<15:8>; // IT<7:2> execution state bits, E bit, A interrupt mask

if bytemask<0> == '1' then
  SPSR[]<7:5> = value<7:5>; // I,F interrupt masks, T execution state bit
  if BadMode(value<4:0>) then // Mode bits
    UNPREDICTABLE;
  else
    SPSR[]<4:0> = value<4:0>;

return;
```

G1.9.4 ELR_hyp

Hyp mode does not provide its own Banked copy of LR. Instead, on taking an exception to Hyp mode, the preferred return address is stored in ELR_hyp, a 32-bit Special register implemented for this purpose.

ELR_hyp can be accessed explicitly only by executing:

- An MRS or MSR instruction that targets ELR_hyp, see:
 - [MRS \(Banked register\) on page F7-2721](#).
 - [MSR \(Banked register\) on page F7-2726](#).

The ERET instruction uses the value in ELR_hyp as the return address for the exception. For more information, see [ERET on page F7-2607](#).

Software execution in any Non-secure EL1 or EL0 mode makes ELR_hyp UNKNOWN.

G1.10 Instruction set states

The instruction set states are described in [Chapter E2 The AArch32 Application Level Memory Model](#) and application level operations on them are described there. This section supplies more information about how they interact with system level functionality, in the sections:

- [Exceptions and instruction set state](#).
- [Unimplemented instruction sets](#).

G1.10.1 Exceptions and instruction set state

If an exception is taken to a EL1 mode, the [SCTLR.TE](#) bit for the Security state the exception is taken to determines the instruction set state that handles the exception, and if necessary, the PE changes to this instruction set state on exception entry.

If the exception is taken to Hyp mode, the [HSCTLR.TE](#) bit determines the instruction set state that handles the exception, and if necessary, the PE changes to this instruction set state on exception entry.

On coming out of reset, if the highest implemented Exception level is using AArch32:

- If the highest implemented Exception level is EL2, the PE starts execution in Hyp mode, in the instruction set state determined by the reset value of [HSCTLR.TE](#).
- Otherwise, the PE starts execution in Supervisor mode, in the instruction set state determined by the reset value of [SCTLR.TE](#). If the implementation includes EL3, this execution is in Secure Supervisor mode.

For more information about exception entry see [Overview of exception entry on page G1-3436](#).

G1.10.2 Unimplemented instruction sets

The [CPSR.J](#) and [CPSR.T](#) bits define the current instruction set state, see [Instruction set state register, ISETSTATE on page E1-2298](#).

In the ARMv8 architecture:

- There is no support for the hardware acceleration of Java bytecodes, and the Jazelle Instruction set state is obsolete. Every AArch32 implementation must support the Trivial Jazelle implementation described in [Trivial implementation of the Jazelle extension](#).
- The T32EE state is OPTIONAL and deprecated in the ARMv8 architecture. ARM strongly recommends that T23EE state is not supported in any ARMv8 implementation.

Some system instructions permit setting [CPSR.{J, T}](#) to values that select an unimplemented instruction set state, for example setting [CPSR.J](#) to 1 and [CPSR.T](#) to 0 on an PE that does not implement the Jazelle state. If such values are written to [CPSR.{J, T}](#), the implementation behaves in one of these ways:

- Sets [CPSR.{J, T}](#) to the requested values and causes the next instruction to generate an Undefined Instruction exception, as described in [Exception return to an unimplemented instruction set state on page G1-3458](#).
- Does not set [CPSR.{J, T}](#) to the requested values. The PE might change the value of one or both of the bits in such a way that the new values correspond to an implemented instruction set state. If this is done then the instruction set state changes to this new state. The detailed behavior of the attempt to change to an unimplemented state is IMPLEMENTATION DEFINED.

Trivial implementation of the Jazelle extension

ARMv8 requires that the implementation of AArch32 state includes the trivial Jazelle implementation.

A trivial implementation of the Jazelle extension must:

- Implement the [JIDR](#) with the implementer and subarchitecture fields set to zero. The register can be implemented so that the whole register is RAZ.
- Implement the [JMCR](#) as RAZ/WI.

- Implement the [JOSCR](#) either:
 - So that it can be read and written, but its effects are ignored.
 - As RAZ/WI.This ensures that operating systems that support an EJVM execute correctly.
- Implement the BXJ instruction to behave identically to the BX instruction in all circumstances, as required by the fact that the [JMCR.JE](#) bit is always zero. This means that, with a trivial implementation of the Jazelle extension, Jazelle state can never be entered normally.
- Treat Jazelle state as an unimplemented instruction set state, as described in [Exception return to an unimplemented instruction set state on page G1-3458](#).

A trivial implementation does not have to extend the PC to 32 bits, that is, it can implement PC[0] as RAZ/WI. This is because the only way that PC[0] is visible in A32 or T32 state is as a result of an exception occurring during Jazelle state execution, and Jazelle state execution cannot occur on a trivial implementation.

G1.11 Handling exceptions that are taken to an Exception level using AArch32

An exception causes the PE to suspend program execution to handle an event, such as an externally generated interrupt or an attempt to execute an undefined instruction. Exceptions can be generated by internal and external sources.

Normally, when an exception is taken the PE state is preserved immediately, before handling the exception. This means that, when the event has been handled, the original state can be restored and program execution resumed from the point where the exception was taken.

More than one exception might be generated at the same time, and a new exception can be generated while the PE is handling an exception.

The following sections describe exception handling:

- [Exception vectors and the exception base address.](#)
- [Exception priority order on page G1-3435.](#)
- [Overview of exception entry on page G1-3436.](#)
- [PE mode for taking exceptions on page G1-3439.](#)
- [PE state on exception entry on page G1-3450.](#)
- [Routing general exceptions to EL2 on page G1-3452.](#)
- [Routing Debug exceptions to Hyp mode on page G1-3454.](#)
- [Exception return to an Exception level using AArch32 on page G1-3454.](#)
- [Wait For Event and Send Event on page G1-3460.](#)
- [Wait For Interrupt on page G1-3463.](#)

[Asynchronous exception behavior for exceptions taken from AArch32 state on page G1-3465](#) gives a full description of asynchronous exception handling, for exceptions taken asynchronously from AArch32 state.

———— **Note** —————

Because of the common model for handling exceptions, the current section requires some understanding of the asynchronous exception behaviors described in [Asynchronous exception behavior for exceptions taken from AArch32 state on page G1-3465](#).

[AArch32 state exception descriptions on page G1-3475](#) then describes each exception.

G1.11.1 Exception vectors and the exception base address

When an exception is taken, PE execution is forced to an address that corresponds to the type of exception. This address is called the *exception vector* for that exception. The vectors for the different types of exception form a *vector table*.

———— **Note** —————

There are significant differences in the sets of exception vectors for exceptions taken to an Exception level that is using AArch32 and for exceptions taken to an Exception level that is using AArch64. This part of this manual describes only how exceptions are taken to an Exception level that is using AArch32. So, for example, when executing at EL1 or EL0, an exception might be generated that must be taken to EL3. In this case:

- If EL3 is using AArch32 then the exception is taken as described in this chapter, using the exception vectors described in this section.
- If EL3 is using AArch64 then the exception is taken as described in [Chapter D1 The AArch64 System Level Programmers' Model](#) using the exception vectors described in [Exception vectors on page D1-1430](#).

AArch32 state defines exception vector tables for exceptions taken to EL2 and EL3 when those Exception levels are using AArch32. Those vector tables are not used when the corresponding Exception levels are using AArch64.

A set of exception vectors for an Exception level that is using AArch32 comprises eight consecutive word-aligned memory addresses, starting at an *exception base address*. These eight vectors form an AArch32 *vector table*.

The number of possible exception base addresses, and therefore the number of vector tables, depends on the implemented Exception levels, as follows:

Implementation that does not include EL3

Any implementation that does not include EL3 must include the following AArch32 vector table if EL1 can use AArch32:

- An exception table for exceptions taken to EL1 modes other than System mode. This is the EL1 vector table, and is in the address space of the PL1&0 translation regime.

———— **Note** —————

Exceptions cannot be taken to System mode.

For this vector table, the **VBAR** holds the exception base address.

Implementation that includes EL2

Any implementation that includes EL2 must include the following additional AArch32 vector table if EL2 can use AArch32:

- An exception table for exceptions taken to Hyp mode. This is the Hyp vector table, and is in the address space of the Non-secure PL2 translation regime.

For this vector table, **HVBAR** holds the exception base address.

Implementation that includes EL3

Any implementation that includes EL3 must include the following AArch32 vector tables:

- If EL3 can use AArch32, a vector table for exceptions taken to Secure Monitor mode. This is the Monitor vector table, and is in the address space of the Secure PL1&0 translation regime.

For this vector table, **MVBAR** holds the exception base address.

- If Secure EL1 can use AArch32, a vector table for exceptions taken to Secure privileged modes other than Monitor mode and System mode. This is the Secure vector table, and is in the address space of the Secure PL1&0 translation regime.

For this vector table, the Secure **VBAR** holds the exception base address.

- If Non-secure EL1 can use AArch32, a vector table for exceptions taken to Non-secure PL1 modes. This is the Non-secure vector table, and is in the address space of the Non-secure PL1&0 translation regime.

For this vector table, the Non-secure **VBAR** holds the exception base address.

The following subsections give more information:

- [The vector tables and exception offsets.](#)
- [Pseudocode determination of the exception base address on page G1-3434.](#)

The vector tables and exception offsets

Table G1-3 on page G1-3433 defines the AArch32 vector table entries. In this table:

- The *Hyp mode* column defines the vector table entries for exceptions taken to Hyp mode.
- The *Monitor mode* column defines the vector table entries for exceptions taken to Monitor mode.
- The *Secure* and *Non-secure* columns define the Secure and Non-secure vector table entries, that are used for exceptions taken to modes other than Monitor mode, Hyp mode, System mode, and User mode. Table G1-4 on page G1-3433 shows the mode to which each of these exceptions is taken. Each of these modes is described as the *default* mode for taking the corresponding exception.

———— **Note** —————

Exceptions cannot be taken to System mode or User mode.

For more information about determining the mode to which an exception is taken, see *PE mode for taking exceptions* on page G1-3439.

When EL2 is using AArch3, it provides a number of additional exceptions, some of which are not shown explicitly in the vector tables. For more information, see *Offsets of AArch32 exceptions provided by EL2*.

Table G1-3 The AArch32 vector tables

Offset	Vector tables			
	Hyp ^a	Monitor ^b	Secure ^c	Non-secure ^c
0x00	Not used	Not used	Reset	Not used
0x04	Undefined Instruction, from Hyp mode	Not used	Undefined Instruction	Undefined Instruction
0x08	Hypervisor Call, from Hyp mode	Secure Monitor Call	Supervisor Call	Supervisor Call
0x0C	Prefetch Abort, from Hyp mode	Prefetch Abort	Prefetch Abort	Prefetch Abort
0x10	Data Abort, from Hyp mode	Data Abort	Data Abort	Data Abort
0x14	Hyp Trap, or Hyp mode entry ^d	Not used	Not used	Not used
0x18	IRQ interrupt	IRQ interrupt	IRQ interrupt	IRQ interrupt
0x1C	FIQ interrupt	FIQ interrupt	FIQ interrupt	FIQ interrupt

- a. Non-secure state only. Implemented only if the implementation includes EL2 and EL2 can use AArch32.
- b. Secure state only. Implemented only if the implementation includes EL3 and EL3 can use AArch32.
- c. If the implementation does not include EL3 then there is a single vector table for exceptions taken to EL1 when EL1 is using AArch32. That table holds the vectors shown in the Secure column of this table
- d. See *Use of offset 0x14 in the Hyp vector table* on page G1-3434.

Table G1-4 Modes for taking the exceptions shown in the Secure or Non-secure vector table

Exception	Mode taken to
Reset	Supervisor
Undefined Instruction	Undefined
Supervisor Call	Supervisor
Prefetch Abort	Abort
Data Abort	Abort
IRQ interrupt	IRQ
FIQ interrupt	FIQ

For more information about use of the vector tables see *Overview of exception entry* on page G1-3436.

Offsets of AArch32 exceptions provided by EL2

EL2 provides the following exceptions. When EL2 is using AArch32, these exceptions are taken to Hyp mode, and the PE enters the handlers for these exceptions using the following vector table entries shown in [Table G1-3](#):

Hypervisor Call

If taken from Hyp mode, shown explicitly in the Hyp mode vector table. Otherwise, see *Use of offset 0x14 in the Hyp vector table* on page G1-3434.

Hyp Trap Shown explicitly in the Hyp mode vector table.

Virtual Abort Entered through the Data Abort vector in the Non-secure vector table.

Virtual IRQ Entered through the IRQ vector in the Non-secure vector table.

Virtual FIQ Entered through the FIQ vector in the Non-secure vector table.

Note

Virtual exceptions when an implementation includes EL2 on page G1-3465 gives more information about the virtual exceptions.

Use of offset 0x14 in the Hyp vector table

The vector at offset 0x14 in the Hyp vector table is used for exceptions that cause entry to Hyp mode. This means it is:

- Always used for the Hyp Trap exception.
- Used for any Hypervisor Call exception that is taken from a mode other than Hyp mode.
- Used for any Supervisor Call exception that is taken from Non-secure User mode when the value of `HCR.TGE` is 1.
- Used for any Undefined Instruction that is taken from Hyp mode, or is taken from Non-secure User mode when the value of `HCR.TGE` is 1.
- Used for any Prefetch Abort exception that is:
 - Taken from Non-secure User mode when the value of `HCR.TGE` is 1.
 - Generated by a Debug exception from Non-secure state when the value of `HDCR.TGE` is 1.
 - Generated by a stage 2 abort on an address translation operation.
- Used for any Data Abort exception that is:
 - Taken from Non-secure User mode when the value of `HCR.TGE` is 1.
 - Generated by an asynchronous External abort from Non-secure state when the value of `HCR.AMO` is 1.
 - Generated by a Debug exception from Non-secure state when the value of `HDCR.TGE` is 1.
 - Generated by a stage 2 abort on an address translation operation.

Note

Offset 0x14 is never used for IRQ exceptions, Virtual IRQ exceptions, FIQ exceptions, or Virtual FIQ exceptions.

For more information, see *PE mode for taking exceptions on page G1-3439*.

Pseudocode determination of the exception base address

For an exception taken to a PL1 mode, the `ExcVectorBase()` function determines the exception base address:

```
// ExcVectorBase()
// =====

bits(32) ExcVectorBase()
    if SCTL.R.V == '1' then // Hivecs selected, base = 0xFFFF0000
        return Ones(16):Zeros(16);
    else
        return VBAR;
```

Note

The PL1 modes to which exceptions can be taken are Supervisor mode, Undefined mode, Abort mode, IRQ mode, and FIQ mode. In Non-secure state, and in Secure state when EL3 is using AArch64, these are EL1 modes. However, in Secure state when EL3 is using AArch32, these are EL3 modes. For more information see [Execution privilege, Exception levels, and AArch32 Privilege levels on page G3-3560](#).

G1.11.2 Exception priority order

An instruction is not valid if it generates a synchronous Prefetch Abort exception. Therefore, if an instruction generates a synchronous Prefetch Abort exception, no other synchronous exception or debug event is generated on that instruction.

A Breakpoint debug event, or an address matching form of the Vector catch debug event, is associated with the instruction. This means the corresponding exception is taken before the instruction is executed. Therefore, when a Breakpoint or address matching Vector catch debug event occurs, no other synchronous exception or debug event, that might have occurred as a result of executing the instruction, can occur.

Note

An Exception Trapping Vector Catch exception is generated as a result of trapping an exception that has been prioritized as described in this section. This means it is outside the scope of the description in this section. For more information see [Breakpoint debug events and Vector Catch exception on page H2-4333](#).

Otherwise:

- An instruction that generates an Undefined Instruction exception or a Hyp Trap exception cannot cause any memory access, and therefore cannot cause a Data Abort exception.
- If an instruction generates both an Undefined Instruction exception and a Hyp Trap exception then, unless this manual explicitly states otherwise, the Undefined Instruction exception has priority.
- If a system call is configured to generate an Undefined Instruction exception or a Hyp Trap exception, then the Undefined Instruction exception or the Hyp Trap exception has priority over the system call.
The system calls are the SVC, HVC, and SMC instructions.
- A memory access that generates fault on a stage of address translation or a synchronous Watchpoint debug event must not generate an external abort.
- All other synchronous exceptions are mutually exclusive and are derived from a decode of the instruction.

For more information, see:

- [Debug state entry and debug event prioritization on page H2-4331](#) for information about the prioritization of debug events, including their prioritization relative to a fault on a stage of address translation and synchronous external aborts
- [Prioritization of aborts on page G3-3658](#), for information about:
 - The prioritization of aborts on a single memory access in a VMSA implementation.
 - The prioritization of exceptions generated during address translation

Architectural requirements for taking asynchronous exceptions

The ARM architecture does not define when asynchronous exceptions are taken, but sets the following limits on when they are taken:

- An asynchronous exception that is pending before one of the following context synchronizing events is taken before the first instruction after the context synchronizing event completes its execution, provided that the pending asynchronous event is not masked after the context synchronizing event. The context synchronizing events are:
 - Execution of an ISB instruction.
 - Taking an exception.
 - Return from an exception.
 - Exit from Debug state.

The [ISR](#) identifies any pending asynchronous exceptions.

———— **Note** —————

If the first instruction after the context synchronizing event generates a synchronous exception, then the architecture does not define the order in which that synchronous exception and the asynchronous exception are taken.

- In the absence of a specific requirement to take an asynchronous exception because of a context synchronizing event, the only requirement of the architecture is that an unmasked asynchronous exception is taken in finite time.

———— **Note** —————

The taking of an unmasked asynchronous exception in finite time must occur with all code sequences, including with a sequence that consists of unconditional loops.

Within these limits, the prioritization of asynchronous exceptions relative to other exceptions, both synchronous and asynchronous, is IMPLEMENTATION DEFINED.

The [CPSR](#) includes a mask bit for each type of asynchronous exception. Setting one of these bits to 1 can prevent the corresponding asynchronous exception from being taken, although when the PE is in Non-secure state other controls can modify the effect of these bits. For more information, see [Asynchronous exception behavior for exceptions taken from AArch32 state on page G1-3465](#).

Taking an exception sets an exception-dependent subset of these mask bits.

———— **Note** —————

In some contexts, the [CPSR](#).{A, I, F} bits mask the taking of asynchronous exceptions. The way these are set on exception entry, described in [CPSR.{A, I, F, M} values on exception entry on page G1-3451](#), can prevent an exception handler being interrupted by an asynchronous exception.

G1.11.3 Overview of exception entry

There are some significant differences between the handling of exceptions taken to Hyp mode and exceptions taken to other modes. Because Hyp mode is the EL2 mode, this means the following descriptions sometimes distinguish between the *EL2 mode* and the *non-EL2 modes*.

On taking an exception to an Exception level that is using AArch32:

1. The hardware determines the mode to which the exception must be taken, see [PE mode for taking exceptions on page G1-3439](#).

2. A link value, indicating the *preferred return address* for the exception, is saved. This is a possible return address for the exception handler, and depends on:
 - The exception type.
 - Whether the exception is taken to the EL2 mode or to a non-EL2 mode.
 - For some exceptions taken to non-EL2 modes, the instruction set state when the exception was taken.
 Where the link value is saved depends on whether the exception is taken to the EL2 mode.
 For more information see [Link values saved on exception entry on page G1-3438](#).
3. The value of the **CPSR** is saved in the **SPSR** for the mode to which the exception must be taken. The value saved in **SPSR.IT[7:0]** is always correct for the preferred return address.
4. In an implementation that includes EL3, when EL3 is using AArch32:
 - If the exception taken from Monitor mode, **SCR.NS** is cleared to 0.
 - Otherwise, taking the exception leaves **SCR.NS** unchanged.
 When EL3 is using AArch64, Monitor mode is not available.
5. The **CPSR** is updated with new context information for the exception handler. This includes:
 - Setting **CPSR.M** to the PE mode to which the exception is taken.
 - Setting the appropriate **CPSR** mask bits. This can disable the corresponding exceptions, preventing uncontrolled nesting of exception handlers.
 - Setting the instruction set state to the state required for exception entry.
 - Setting the endianness to the required value for exception entry.
 - Clearing the **CPSR.IT[7:0]** bits to 0.
 For more information, see [PE state on exception entry on page G1-3450](#).
6. The appropriate exception vector is loaded into the PC, see [Exception vectors and the exception base address on page G1-3431](#).
7. Execution continues from the address held in the PC.

For an exception taken to a non-EL2 mode, on exception entry, the exception handler can use the SRS instruction to store the return state onto the stack of any mode at the same Exception level and in the same Security state, and can use the CPS instruction to change mode. For more information about the instructions, see [SRS \(T32\) on page F7-3060](#), [SRS \(A32\) on page F7-3062](#), [CPS \(T32\) on page F7-3034](#), and [CPS \(A32\) on page F7-3036](#).

Later sections of this chapter describe each of the possible exceptions, and each of these descriptions includes a pseudocode description of the PE state changes on taking that exception. [Table G1-5](#) gives an index to these descriptions:

Table G1-5 Pseudocode descriptions of exception entry for exceptions taken to AArch32 state

Exception	Description of exception entry
Reset	Pseudocode description of taking the Reset exception on page G1-3476
Undefined Instruction	Pseudocode description of taking the Undefined Instruction exception on page G1-3477
Supervisor Call	Pseudocode description of taking the Supervisor Call exception on page G1-3479
Secure Monitor Call	Pseudocode description of taking the Secure Monitor Call exception on page G1-3480
Hypervisor Call	Pseudocode description of taking the Hypervisor Call exception on page G1-3481
Prefetch Abort	Pseudocode description of taking the Prefetch Abort exception on page G1-3482
Data Abort	Pseudocode description of taking the Data Abort exception on page G1-3484
IRQ	Pseudocode description of taking the IRQ exception on page G1-3488

Table G1-5 Pseudocode descriptions of exception entry for exceptions taken to AArch32 state (continued)

Exception	Description of exception entry
FIQ	<i>Pseudocode description of taking the FIQ exception on page G1-3489</i>
Hyp Trap	<i>Pseudocode description of taking the Hyp Trap exception on page G1-3479</i>
Virtual Abort	<i>Pseudocode description of taking the Virtual Asynchronous Abort exception on page G1-3486</i>
Virtual IRQ	<i>Pseudocode description of taking the Virtual IRQ exception on page G1-3489</i>
Virtual FIQ	<i>Pseudocode description of taking the Virtual FIQ exception on page G1-3490</i>

The following sections give more information about the PE state changes, for different architecture implementations. However, you must refer to the pseudocode for a full description of the state changes:

- *PE mode for taking exceptions on page G1-3439.*
- *PE state on exception entry on page G1-3450.*

Link values saved on exception entry

On exception entry, a link value for use on return from the exception, is saved. This link value is based on the *preferred return address for the exception*, as shown in [Table G1-6](#):

Table G1-6 Exception return addresses for exceptions taken to AArch32 state

Exception	Preferred return address	Taken to a mode at
Undefined Instruction	Address of the UNDEFINED instruction	Non-EL2 ^a , or EL2 ^c
Supervisor Call	Address of the instruction after the SVC instruction	Non-EL2 ^a or EL2 ^c
Secure Monitor Call	Address of the instruction after the SMC instruction	EL3 ^b , and only in Secure state
Hypervisor Call	Address of the instruction after the HVC instruction	EL2 only ^c
Prefetch Abort	Address of aborted instruction fetch	Non-EL2 ^a or EL2 ^c
Data Abort	Address of instruction that generated the abort	Non-EL2 ^a or EL2 ^c
Virtual Abort	Address of next instruction to execute	EL1, and only in Non-secure state
Hyp Trap	Address of the trapped instruction	EL2 only ^c
IRQ or FIQ	Address of next instruction to execute	Non-EL2 ^a or EL2 ^c
Virtual IRQ or Virtual FIQ	Address of next instruction to execute	EL1, and only in Non-secure state

- EL1 if the exception is taken to a Non-secure mode, or is taken to a Secure mode when EL3 is using AArch64. EL3 if the exception is taken to a Secure mode when EL3 is using AArch64.
- A Secure Monitor Call exception is taken to EL3, and therefore is taken to AArch32 state only if EL3 is using AArch32, in which case it is taken to Monitor mode.
- EL2 is implemented only in Non-secure state. Therefore, an exception can be taken to EL2 mode only if it is taken from Non-secure state.

Note

- Although Reset is described as an exception, it differs significantly from other exceptions. The architecture has no concept of a return from a Reset and therefore it is not listed in this section.
- For each exception, the preferred return address is not affected by the Exception level from which the exception was taken.

The link value saved, and where it is saved, depend on whether the exception is taken to a non-EL2 mode, or to a EL2 mode, as follows:

Exception taken to a non-EL2 mode

The link value is saved in the LR for the mode to which the exception is taken.

The saved link value is the preferred return address for the exception, plus an offset that depends on the instruction set state when the exception was taken, as [Table G1-7](#) shows:

Table G1-7 Offsets applied to Link value for exceptions taken to EL1 modes

Exception	Offset, for PE state of:	
	A32	T32 or T32EE
Undefined Instruction	+4	+2
Supervisor Call	None	None
Secure Monitor Call	None	None
Prefetch Abort	+4	+4
Data Abort	+8	+8
Virtual Abort	+8	+8
IRQ or FIQ	+4	+4
Virtual IRQ or Virtual FIQ	+4	+4

Exception taken to a EL2 mode

The link value is saved in the [ELR_hyp](#) Special register.

The saved link value is the preferred return address for the exception, as shown in [Table G1-6 on page G1-3438](#), with no offset.

G1.11.4 PE mode for taking exceptions

The following principles determine the Exception level to which an exception is taken, and if that Exception level is using AArch32, the PE mode to which the exception is taken:

- An exception cannot be taken to the EL0 mode.
- An exception is taken either:
 - To the Exception level at which the PE was executing when it took the exception.
 - To a higher Exception level.

This means that, in Secure state:

- When EL3 is using AArch32, an exception is always taken to an EL3 mode.
- When EL3 is using AArch64, an exception that is taken to AArch32 state is taken to an EL1 mode.
- Configuration options and other features provided by EL2 and EL3 can determine the mode to which some exceptions are taken, as follows:

In an implementation that does not include EL2 or EL3

An exception is always taken to the default mode for that exception.

In an implementation that includes EL3

A Secure Monitor Call exception is always taken to EL3. This means:

- If EL3 is using AArch32 the exception is taken to Secure Monitor mode.
- If EL3 is using AArch64 then executing the instruction generates an exception that is taken to EL3, see *Execution of an SMC instruction from a privileged Exception level that is using AArch32* on page G1-3441.

IRQ, FIQ, and External abort exceptions can be configured to be taken to EL3. Therefore, if EL3 is using AArch32 the exceptions are taken to Secure Monitor mode.

Any exception taken from Secure state that is not taken to Secure Monitor mode is taken to Secure state in the default mode for that exception. As described in *Execution privilege, Exception levels, and AArch32 Privilege levels* on page G3-3560, this means it is taken to:

- An EL3 mode other than Monitor mode if EL3 is using AArch32.
- An EL1 mode if EL3 is using AArch64.

If the implementation does not include EL2, any exception taken from Non-secure state that is not taken to Secure Monitor mode is taken to Non-secure state to the default mode for that exception. The default mode will be an EL1 mode.

In an implementation that includes EL2

An exception taken from Non-secure state that is not taken to Secure Monitor mode is taken to Non-secure state and:

- If the exception is taken from Hyp mode then it is taken to Hyp mode.
- Otherwise, the exception is either taken to Hyp mode, as described in *Exceptions taken to Hyp mode* on page G1-3441, or taken to the default mode for the exception.

————— Note —————

- Hyp mode is the EL2 mode. The other modes to which an exception can be taken in Non-secure state are EL1 modes.
- EL2 has no effect on the handling of exceptions taken from Secure state.

Table G1-4 on page G1-3433 shows the default mode to which each exception is taken.

Asynchronous exception routing controls on page G1-3467 describes the exception routing controls provided by EL2 and EL3.

Routing of aborts taken to AArch32 state on page G3-3647 gives more information about the modes to which memory aborts are taken.

Summary of the possible modes for taking each exception on page G1-3442 shows all modes to which each exception might be taken, in any implementation. That is, it applies to implementations:

- That include neither EL2 nor EL3.
- That include EL2 but not EL3
- That do not include EL2 but include EL3
- That include both EL2 and EL3.

Exceptions taken to Hyp mode

In an implementation that includes EL2 and EL3, when EL2 is using AArch32:

- Any exception taken from Hyp mode, that is not routed to EL3 by the controls described in *Asynchronous exception routing controls* on page G1-3467, is taken to Hyp mode.
 - The following exceptions, if taken from Non-secure state, are taken to Hyp mode:
 - An abort that *Routing of aborts taken to AArch32 state* on page G3-3647 identifies as taken to Hyp mode.
 - A Hyp Trap exception, see *AArch32 control of traps to the hypervisor* on page G1-3503.
 - A Hypervisor Call exception. This is generated by executing a HVC instruction in a Non-secure mode.
 - An asynchronous abort, IRQ exception or FIQ exception that is not routed to EL3 but is explicitly routed to Hyp mode, as described in *Asynchronous exception routing controls* on page G1-3467.
 - A synchronous external abort, Alignment fault, Undefined Instruction exception, or Supervisor Call exception taken from the Non-secure EL0 mode and explicitly routed to Hyp mode, as described in *Routing general exceptions to EL2* on page G1-3452.
- **Note** —————
- A synchronous external abort can be routed to Hyp mode only if it is not routed to EL3.
-
- A debug exception that is explicitly routed to Hyp mode as described in *Routing Debug exceptions to Hyp mode* on page G1-3454.

———— **Note** —————

The virtual exceptions cannot be taken to Hyp mode. They are always taken to a Non-secure EL1 mode.

————

Security behavior in Exception levels using AArch32 when EL3 is using AArch64

As described in *The ARMv8-A security model* on page G1-3407, when EL3 is using AArch64, lower Exception levels, in either Security state, can be using AArch32. This means software executing in those Exception levels might try to access AArch32 security features that are not available. The following subsections describe the associated behaviors:

- *Execution of an SMC instruction from a privileged Exception level that is using AArch32*
- *Non-secure reads of the NSACR*
- *Secure EL1 operations when Secure EL1 is using AArch32* on page G1-3442

Execution of an SMC instruction from a privileged Exception level that is using AArch32

When EL3 is using AArch64, an SMC instruction executed from Secure or Non-secure EL1 using AArch32, or from Non-secure EL2 using AArch32 when the value of HCR.TSC is 0, generates an exception that is taken to EL3. The exception syndrome is reported with an EC value of 0x13, SMC instruction executed in AArch32 state, see *Exception from SMC instruction execution in AArch32 state* on page D1-1522.

Non-secure reads of the NSACR

The NSACR is defined as being RO from Non-secure PE modes other than User mode. When EL3 is using AArch64, a read of the NSACR returns a fixed value of 0x00000C00 in the following cases:

- If the read is from a Non-secure EL1 mode when EL1 is using AArch32.
- If the read is from Hyp mode when EL2 is using AArch32.

Secure EL1 operations when Secure EL1 is using AArch32

When Secure EL1 is using AArch32 and EL3 is using AArch64:

- Any of the following operations performed in a Secure EL1 mode is trapped to Secure EL3:
 - A read or write of any of the [SCR](#), [NSACR](#), [MVBAR](#), and [SDCR](#).
 - Performing any of the [ATS12NSO**](#) operations described in [Address translation stages 1 and 2, Non-secure state only](#) on page G3-3686.
 - Executing an SRS instruction that would use [SP_mon](#), see [SRS \(T32\)](#) on page F7-3060 and [SRS \(T32\)](#) on page F7-3060.
 - Executing a MRS (Banked register) or MSR (Banked register) instruction that would access [SPSR_mon](#), [SP_mon](#), or [LR_mon](#), see [MRS \(Banked register\)](#) on page F7-3048 and [MSR \(Banked register\)](#) on page F7-3050.

For more information about these traps, including the associated exception syndromes, see [Traps to EL3 of monitor functionality from Secure EL1 using AArch32](#) on page D1-1500.

- Writes to the [CNTFRQ](#) register are UNDEFINED.
- Any attempt to move into Monitor mode, either by an exception return or by executing a CPS or MSR instruction, is treated as an illegal operation and is handled as described in [Illegal exception returns to AArch32 state](#) on page G1-3456.

————— **Note** —————

This functionality supports a usage model where:

- EL3 uses AArch64.
- Secure software executed in Secure EL1 using AArch32 and Secure EL0 using AArch32.
- The Non-secure state uses AArch64.

Summary of the possible modes for taking each exception

The following subsections describe the modes to which each exception can be taken:

- [Determining the PE mode to which the Undefined Instruction exception is taken](#) on page G1-3443.
- [Determining the PE mode to which the Supervisor Call exception is taken](#) on page G1-3444.
- [The PE mode to which the Secure Monitor Call exception is taken](#) on page G1-3444.
- [The PE mode to which the Hypervisor Call exception is taken](#) on page G1-3445.
- [The PE mode to which the Hyp Trap exception is taken](#) on page G1-3445.
- [Determining the PE mode to which the Prefetch Abort exception is taken](#) on page G1-3446.
- [Determining the PE mode to which the Data Abort exception is taken](#) on page G1-3447.
- [The PE mode to which the Virtual Abort exception is taken](#) on page G1-3448.
- [Determining the PE mode to which the physical IRQ exception is taken](#) on page G1-3448.
- [The PE mode to which the Virtual IRQ exception is taken](#) on page G1-3448.
- [Determining the PE mode to which the physical FIQ exception is taken](#) on page G1-3449.
- [The PE mode to which the Virtual FIQ exception is taken](#) on page G1-3449.

These descriptions also show the vector offset for the exception entry for each mode. These descriptions assume that all Exception levels are using AArch32, meaning:

- [HCR](#), rather than [HCR_EL2](#), controls the routing of exceptions to EL2.
- [SCR](#), rather than [SCR_EL3](#), controls the routing of exceptions to EL3.

For more information about:

- Vector offsets, see [Exception vectors and the exception base address](#) on page G1-3431.
- The routing of external aborts, IRQ and FIQ exceptions, and the virtual exceptions, see [Asynchronous exception routing controls](#) on page G1-3467.

Determining the PE mode to which the Undefined Instruction exception is taken

Figure G1-4 shows how the implementation, state, and configuration options determine the PE mode to which an Undefined Instruction exception is taken.

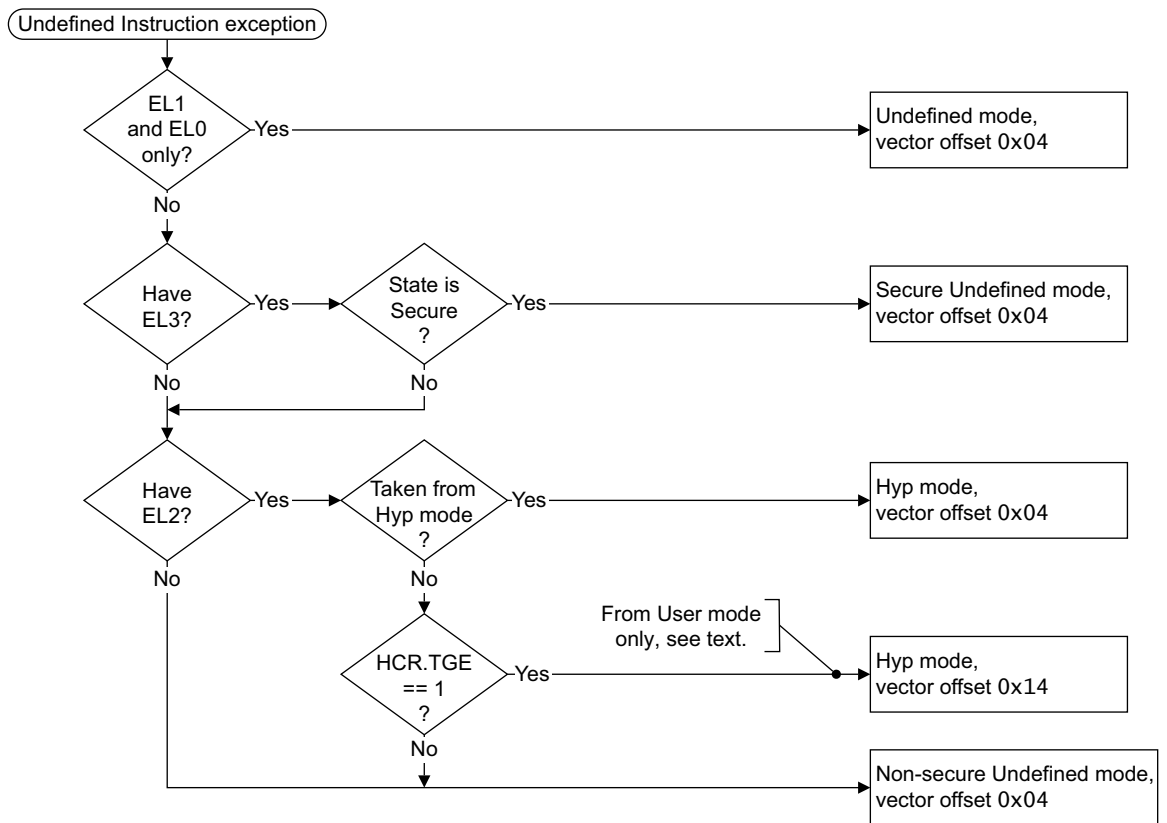

Figure G1-4 The PE mode the Undefined Instruction exception is taken to

See also *UNPREDICTABLE cases when the value of HCR.TGE is 1* on page G1-3449.

Determining the PE mode to which the Supervisor Call exception is taken

Figure G1-5 shows how the implementation, state, and configuration options determine the PE mode to which a Supervisor Call exception is taken.

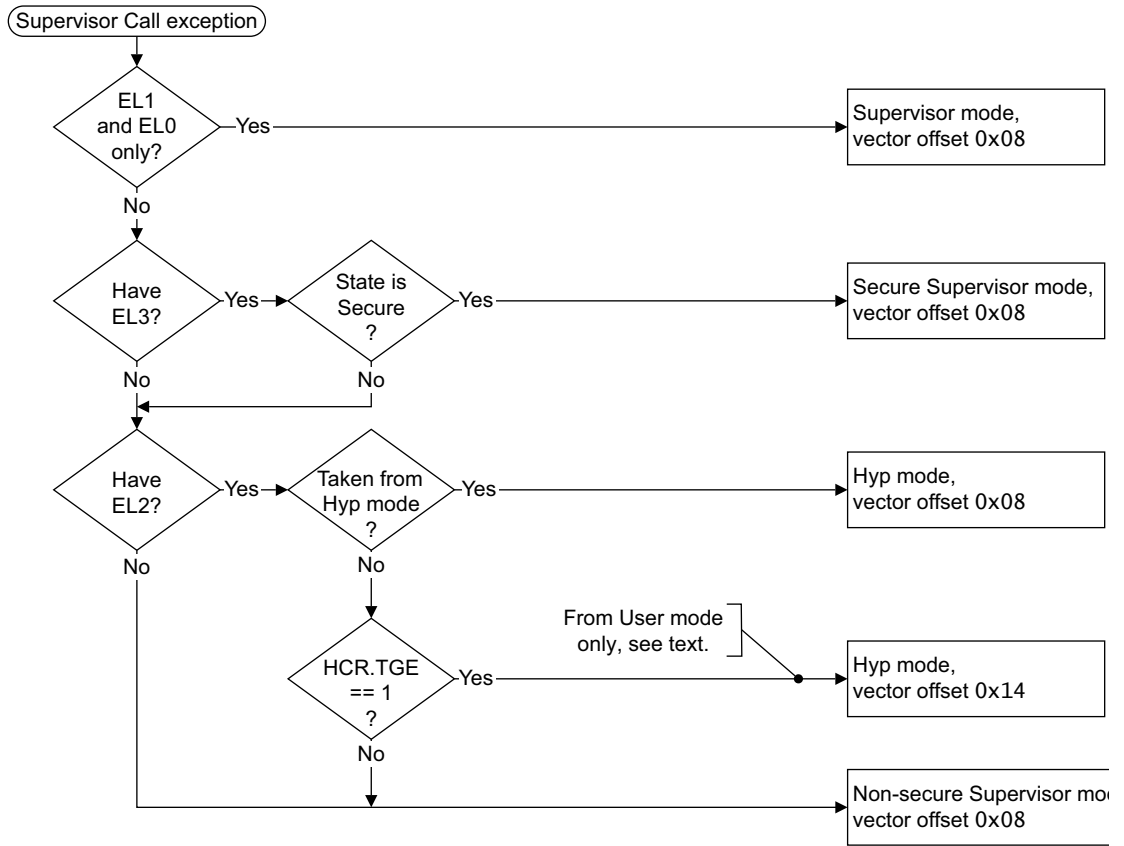

Figure G1-5 The PE mode the Supervisor Call exception is taken to

See also *UNPREDICTABLE cases when the value of HCR.TGE is 1* on page G1-3449.

The PE mode to which the Secure Monitor Call exception is taken

The Secure Monitor Call exception is supported only as part of EL3. When EL3 is using AArch32, a Secure Monitor Call exception is taken to Monitor mode, using vector offset 0x08 from the Monitor exception base address.

Note

- An SMC instruction that is trapped to Hyp mode because HCR.TSC is set to 1 generates a Hyp Trap exception, see *The PE mode to which the Hyp Trap exception is taken* on page G1-3445.
- If EL3 is using AArch64 then *Security behavior in Exception levels using AArch32 when EL3 is using AArch64* on page G1-3441 describes the effect of executing an SMC instruction in a mode that is part of an Exception level that is using EL1.

The PE mode to which the Hypervisor Call exception is taken

The Hypervisor Call exception is supported only as part of EL2. When EL2 is using AArch32, a Hypervisor Call exception is taken to Hyp mode, using a vector offset that depends on the mode from which the exception is taken, as Figure G1-6 shows. This offset is from the Hyp exception base address.

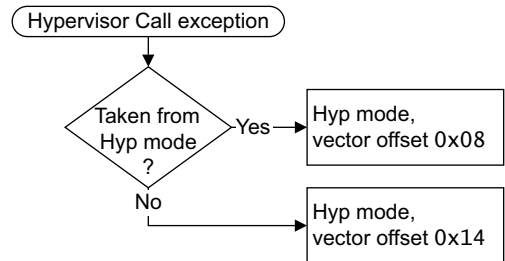

Figure G1-6 The PE mode the Hypervisor Call exception is taken to

The PE mode to which the Hyp Trap exception is taken

The Hyp Trap exception is supported only as part of EL2. When EL2 is using AArch32, a Hyp Trap exception is taken to Hyp mode, using a vector offset of 0x14 from the Hyp exception base address.

Determining the PE mode to which the Prefetch Abort exception is taken

Figure G1-7 shows how the implementation, state, and configuration options determine the PE mode to which a Prefetch Abort exception is taken.

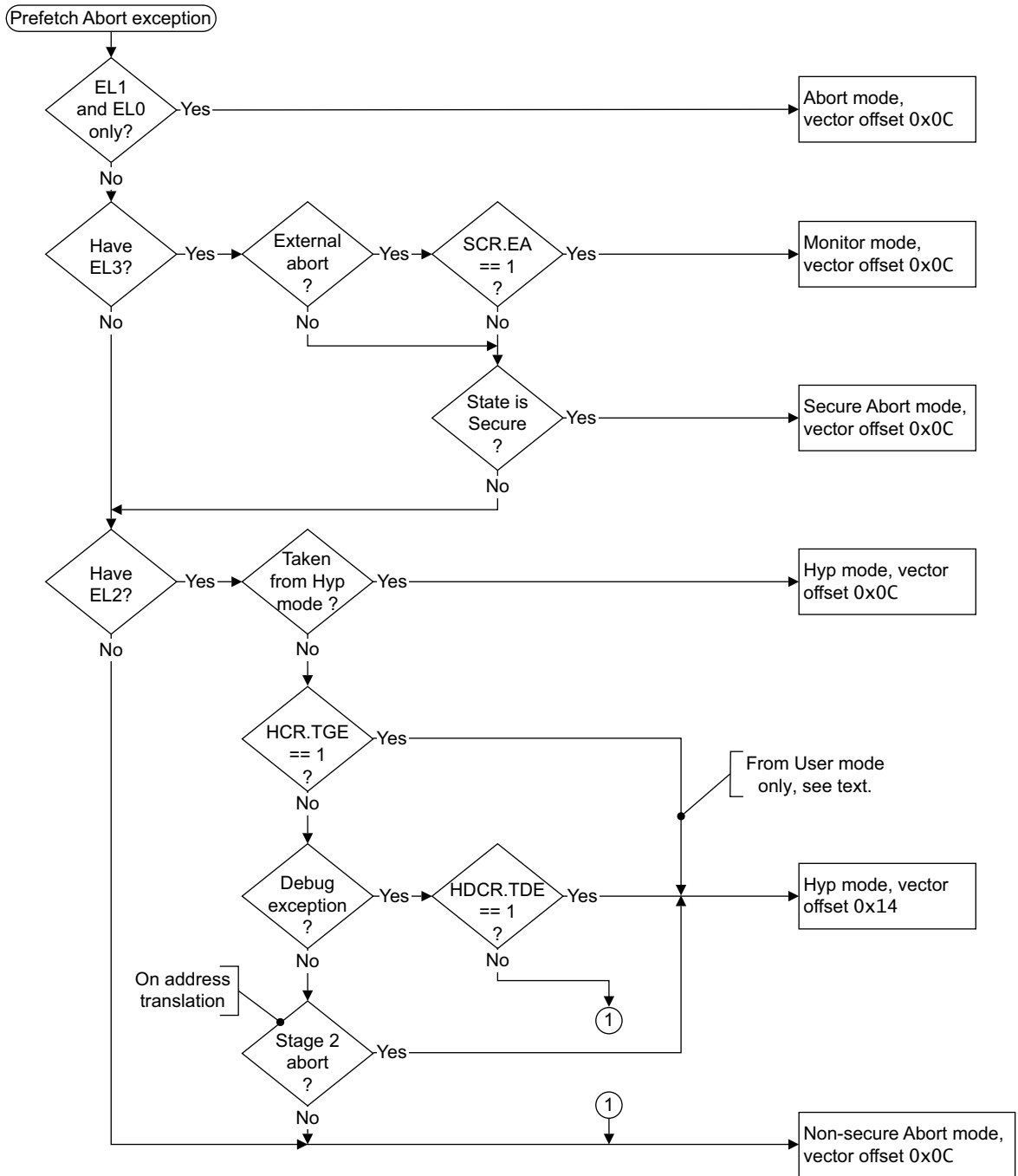

Figure G1-7 The PE mode the Prefetch Abort exception is taken to

See also *UNPREDICTABLE* cases when the value of *HCR.TGE* is 1 on page G1-3449.

Determining the PE mode to which the Data Abort exception is taken

Figure G1-8 shows the determination of the mode to which a Data Abort exception is taken.

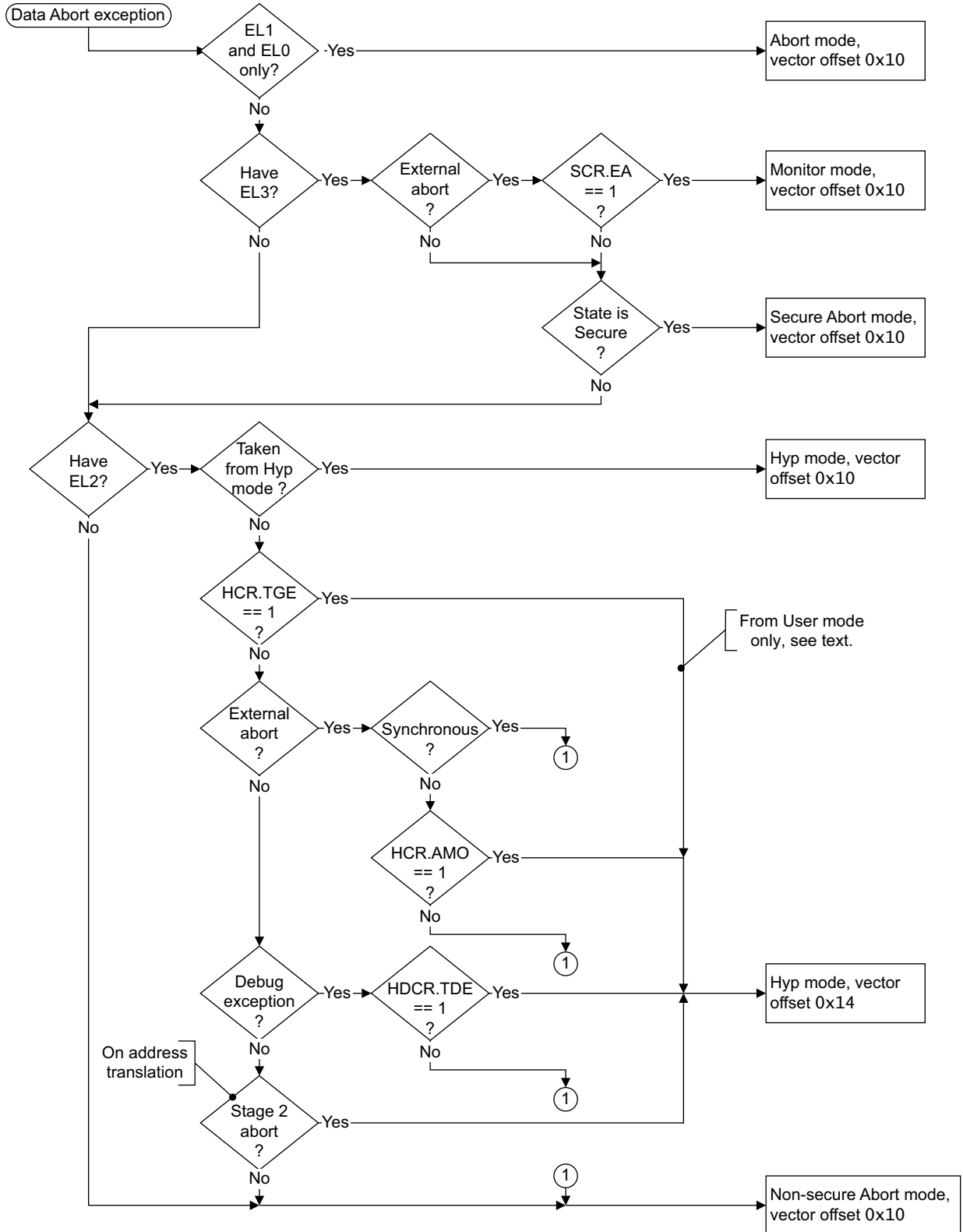

Figure G1-8 The PE mode the Data Abort exception is taken to

See also *UNPREDICTABLE cases when the value of HCR.TGE is 1* on page G1-3449.

The PE mode to which the Virtual Abort exception is taken

The Virtual Abort exception is supported only as part of EL2. A Virtual Abort exception is taken from a Non-secure EL1 or EL0 mode, and is taken to Non-secure Abort mode, using a vector offset of 0x10 from the Non-secure exception base address.

For more information about this exception see *Virtual exceptions when an implementation includes EL2* on page G1-3465.

Determining the PE mode to which the physical IRQ exception is taken

Figure G1-9 shows how the implementation, state, and configuration options determine the mode to which an IRQ exception is taken.

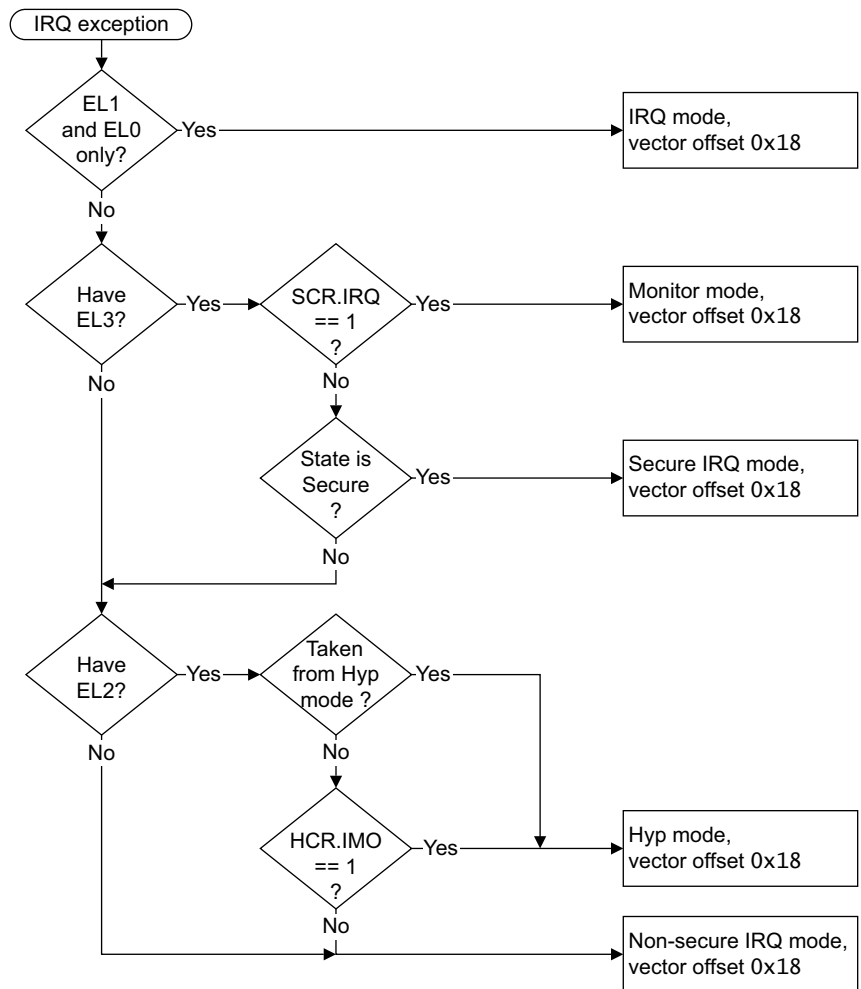

Figure G1-9 The PE mode the IRQ exception is taken to

The PE mode to which the Virtual IRQ exception is taken

The Virtual IRQ exception is supported only as part of EL2. A Virtual IRQ exception is taken from a Non-secure EL1 or EL0 mode, and is taken to Non-secure IRQ mode, using a vector offset of 0x18 from the Non-secure exception base address.

For more information about this exception see *Virtual exceptions when an implementation includes EL2* on page G1-3465.

Determining the PE mode to which the physical FIQ exception is taken

Figure G1-9 on page G1-3448 shows how the implementation, state, and configuration options determine the PE mode to which an FIQ exception is taken.

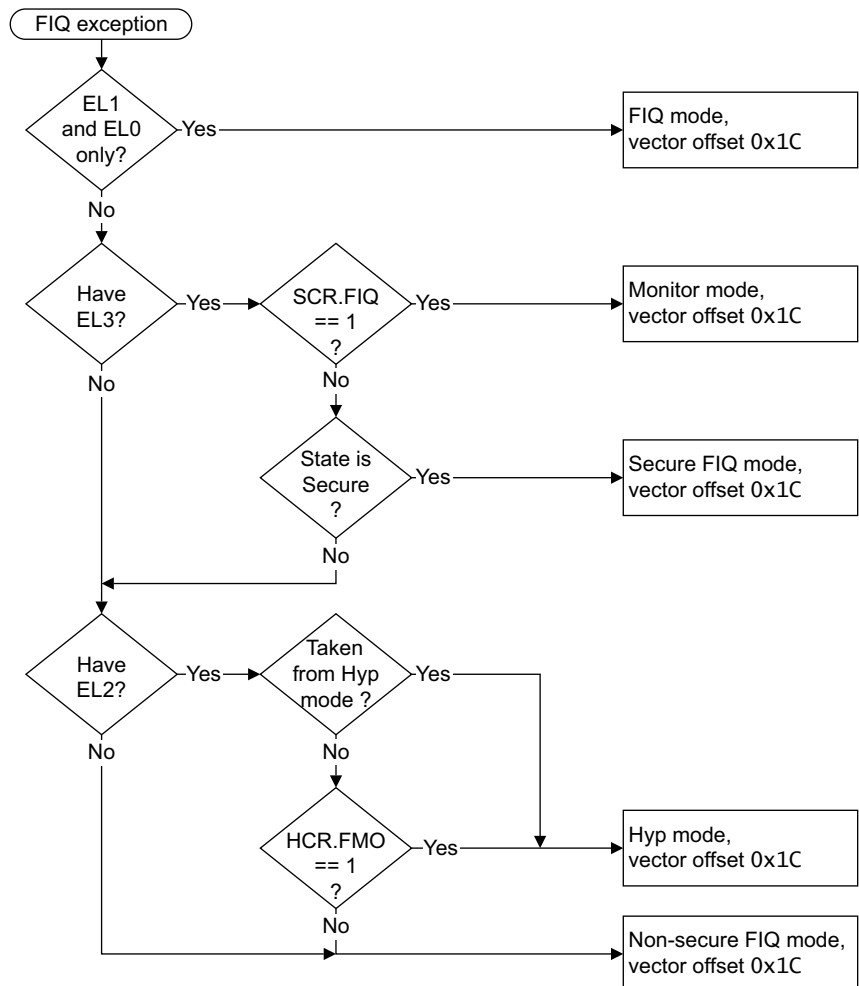

Figure G1-10 The PE mode the FIQ exception is taken to

The PE mode to which the Virtual FIQ exception is taken

The Virtual FIQ exception is supported only as part of EL2. A Virtual FIQ exception is taken from a Non-secure EL1 or EL0 mode, and is taken to Non-secure FIQ mode, using a vector offset of 0x1C from the Non-secure exception base address.

For more information about this exception see [Virtual exceptions when an implementation includes EL2](#) on page G1-3465.

UNPREDICTABLE cases when the value of HCR.TGE is 1

When the value of HCR.TGE is 1, exceptions that would otherwise be taken to EL1 are, instead, routed to EL2, see [Routing general exceptions to EL2](#) on page G1-3452. Related to this, when the value of HCR.TGE is 1, execution in a Non-secure EL1 mode is UNPREDICTABLE. ARMv8 does not constrain this UNPREDICTABLE behavior, but in ARMv8 software that follows the ARM recommendations cannot get to this state. When following the ARM recommendations, any attempt to move to a Non-secure EL1 mode when the value of HCR.TGE is 1 is either:

- An illegal exception return, see [Illegal exception returns to AArch32 state](#) on page G1-3456.
- An illegal PE mode change, see [Illegal changes to the CPSR.M field](#) on page G1-3458.

G1.11.5 PE state on exception entry

The description of each exception includes a pseudocode description of entry to that exception, as [Table G1-5 on page G1-3437](#) shows. The following sections describe the PE state changes on entering an exception, for different implementations and operating states. However, you must always see the exception entry pseudocode for a full description of the state changes on exception entry:

- [Instruction set state on exception entry.](#)
- [CPSR.E bit value on exception entry.](#)
- [CPSR.{A, I, F, M} values on exception entry on page G1-3451.](#)

———— **Note** —————

The descriptions in these sections assume that EL2 and EL3, that control some aspects of the routing of exceptions taken from EL1 or EL0, are both using AArch32. If this is not the case:

- If EL2 is using AArch64:
 - Controls shown as provided by the [HSCTLR](#) are provided by the [SCTLR_EL2](#).
 - Controls shown as provided by the [HCR](#) are provided by the [HCR_EL2](#).
- If EL3 is using AArch64, controls shown as provided by the [SCR](#) are provided by the [SCR_EL3](#).

Instruction set state on exception entry

Exception handlers can execute in either T32 state or A32 state. On exception entry, the [CPSR.{T, J}](#) are set to the required values, with the [CPSR.T](#) value determined by [SCTLR.TE](#) or [HSCTLR.TE](#), depending on the mode the exception is taken to. [Table G1-8](#) shows this:

Table G1-8 CPSR.{J, T} bit values on exception entry

Exception mode	HSCTLR.TE	SCTLR.TE	CPSR.J	CPSR.T	Exception handler state
Not Hyp	x	0	0	0	A32
		1	0	1	T32
Hyp	0	x	0	0	A32
		x	0	1	T32

When an implementation includes EL3 and EL3 is using AArch32, [SCTLR](#) is Banked for Secure and Non-secure states, and therefore the TE bit value might be different for Secure and Non-secure states. For an exception taken to a Secure or Non-secure non-Hyp mode, the [SCTLR.TE](#) bit for the Security state to which the exception is taken determines the instruction set state for the exception handler. This means the non-Hyp mode exception handlers might run in different instruction set states, depending on the Security state.

CPSR.E bit value on exception entry

The [CPSR.E](#) bit controls the load and store endianness for data handling. [Table G1-9](#) show the value to which this bit is set on exception entry:

Table G1-9 CPSR.E bit value on exception entry

Exception mode	HSCTLR.EE	SCTLR.EE	Endianness for data loads and stores	CPSR.E
Secure or Non-secure EL1	x	0	Little-endian	0
		1	Big-endian	1
Hyp	0	x	Little-endian	0
		x	Big-endian	1

For more information, see the bit description in *Format of the CPSR and SPSRs* on page G1-3423.

CPSR.{A, I, F, M} values on exception entry

On exception entry, CPSR.M is set to the value for the mode to which the exception is taken, as described in *PE mode for taking exceptions* on page G1-3439.

Table G1-10 shows the cases where CPSR.{A, I, F} bits are set to 1 on an exception entry, and how this depends on the mode and Security state to which an exception is taken. If the table entry for a particular mode and Security state does not define a value for a CPSR.{A, I, F} bit then that bit is unchanged by the exception entry. In this table:

- The *Exception mode* column is the mode to which the exception is taken.
- The *Non-secure, EL2 not implemented* column applies to exceptions taken to Non-secure state in an implementation that includes EL3 but does not include EL2.
- The *All others* column applies to:
 - Exceptions taken to Secure state.
 - Implementations that do not include the EL3.
 - Exceptions taken to Non-secure state in an implementation that includes EL2.

Table G1-10 CPSR.{A, I, F} values on exception entry

PE mode exception is taken to	Security state	
	Non-secure	Secure
Hyp	If SCR.EA==0 then CPSR.A is set to 1 If SCR.IRQ==0 then CPSR.I is set to 1 If SCR.FIQ==0 then CPSR.F is set to 1	-
Monitor	-	CPSR.A is set to 1 CPSR.I is set to 1 CPSR.F is set to 1
FIQ	CPSR.A is set to 1 CPSR.I is set to 1 CPSR.F is set to 1	CPSR.A is set to 1 CPSR.I is set to 1 CPSR.F is set to 1
IRQ, Abort	CPSR.A is set to 1 CPSR.I is set to 1	CPSR.A is set to 1 CPSR.I is set to 1
Undefined, Supervisor	CPSR.I is set to 1	CPSR.I is set to 1

Asynchronous exception behavior for exceptions taken from AArch32 state on page G1-3465 describes how, in some situations, the CPSR.{A, I, F} bits mask the taking of asynchronous aborts, IRQ interrupts, and FIQ interrupts.

G1.11.6 Routing general exceptions to EL2

Note

The routing provided when the value of [HCR.TGE](#) is 1 permits a usage model where applications execute in User mode under a hypervisor, that executes in Hyp mode, without a Guest OS running in a Non-secure EL1 mode.

When the value of [HCR.TGE](#) is 1, and the PE is in Non-secure User mode, any exception that would otherwise be taken to EL1 is taken to EL2. If EL2 is using AArch32 this means it is taken to Hyp mode, instead of to the default Non-secure mode for handling the exception. This means that, when the value of [HCR.TGE](#) is 1 and EL2 is using AArch32, the following exceptions are taken from User mode to Hyp mode:

- Undefined Instruction exceptions.
- Supervisor Call exceptions.
- Prefetch Abort exceptions that are not routed to EL3.
- Data Abort exceptions that are not routed to EL3.

Note

The only Prefetch Abort and Data Abort exceptions that might be routed to EL3 are those caused by an external abort. These are routed to EL3 when the value of [SCR.EA](#) is 1.

The following sections give more information about the behavior when each of these exceptions is routed in this way:

- [Undefined Instruction exception, when HCR.TGE is set to 1.](#)
- [Supervisor Call exception, when HCR.TGE is set to 1.](#)
- [External abort, when HCR.TGE is set to 1 on page G1-3453.](#)
- [MMU fault, when HCR.TGE is set to 1 on page G1-3453.](#)

When the value of [HCR.TGE](#) is 1:

- Each of the [HDCR](#).{TDE, TDA, TDRA, TDOSA} bits is treated as 0 for all purposes other than reading the [HDCR](#) register.
- If the value of the [SCR.NS](#) bit is 1, then:
 - The [SCTLR.M](#) bit is treated as 0 for all purposes other than reading the [SCTLR](#) register.
 - Each of the [HCR](#).{HCR.FMO, IMO, AMO} bits is treated as 1 for all purposes other than reading the [HCR](#) register
 - An exception return to EL1 is treated as an illegal exception return, see [Illegal exception returns to AArch32 state on page G1-3456.](#)
 - Any IMPLEMENTATION DEFINED mechanisms for signalling virtual interrupts are disabled.

Undefined Instruction exception, when HCR.TGE is set to 1

When [HCR.TGE](#) is set to 1, if the PE is executing in Non-secure User mode and attempts to execute an UNDEFINED instruction, it takes the Hyp Trap exception, instead of an Undefined Instruction exception. On taking the Hyp Trap exception, the [HSR](#) reports an unknown reason for the exception, using the EC value 0x00. For more information see [Use of the HSR on page G3-3672.](#)

Supervisor Call exception, when HCR.TGE is set to 1

When [HCR.TGE](#) is set to 1, if the PE executes an SVC instruction in Non-secure User mode, the Supervisor Call exception generated by the instruction is taken to Hyp mode.

The [HSR](#) reports that entry to Hyp mode was because of a Supervisor Call exception, and:

- If the SVC is unconditional, takes for the `imm16` value in the [HSR](#):
 - A zero-extended 8-bit immediate value for the T32 SVC instruction.

Note

The only T32 encoding for SVC is a 16-bit instruction encoding.

— The bottom 16 bits of the immediate value for the A32 SVC instruction.

- If the SVC is conditional, the `imm16` value in the [HSR](#) is UNKNOWN.

If the SVC is conditional, the PE takes the exception only if the instruction passes its condition code check.

The [HSR](#) reports the exception as a Supervisor Call exception taken to Hyp mode, using the EC value `0x11`. For more information, see [Use of the HSR on page G3-3672](#).

Note

The effect of setting [HCR.TGE](#) to 1 is to route the Supervisor Call exception to Hyp mode, not to trap the execution of the SVC instruction. This means that the preferred return address for the exception, when routed to Hyp mode in this way, is the instruction after the SVC instruction.

External abort, when [HCR.TGE](#) is set to 1

When the value of [HCR.TGE](#) is 1, and [SCR.EA](#) is set to 0, if the PE is executing in Non-secure User mode then any external abort generates an exception that is taken as a Hyp Trap exception. Where an attempt to execute an instruction causes a synchronous external abort, on taking the Hyp Trap exception, the [HSR](#) indicates whether a Data Abort exception or a Prefetch Abort exception caused the Hyp Trap exception entry, and presents a valid syndrome in the [HSR](#).

Note

- When [SCR.EA](#) is set to 1, external aborts are routed to Secure Monitor mode, and this takes priority over the [HCR.TGE](#) routing. For more information, see [Asynchronous exception routing controls on page G1-3467](#). The [SCR.EA](#) control described in that section applies to both synchronous and asynchronous external aborts.
- Any asynchronous external abort generates a Data Abort exception. Therefore, if an asynchronous external abort is routed to Hyp mode because the value of [HCR.TGE](#) is 1 the exception is reported as a Data Abort exception routed to Hyp mode.

For an external abort on an instruction fetch, if the instruction that causes this exception is conditional, the PE takes the exception only if the instruction passes its condition code check.

The [HSR](#) reports the exception either:

- As a Prefetch Abort exception routed to Hyp mode, using the EC value `0x20`.
- As a Data Abort exception routed to Hyp mode, using the EC value `0x24`.

For more information about the exception reporting, see [Use of the HSR on page G3-3672](#).

MMU fault, when [HCR.TGE](#) is set to 1

When the value of [HCR.TGE](#) is 1, if the PE is executing in Non-secure User mode, this control applies to any MMU fault resulting from any memory access.

In these cases, the attempted access generates a Hyp Trap exception, instead of either:

- A Prefetch Abort exception if the MMU fault was on an instruction fetch.
- A Data Abort exception if the MMU fault was on a data access.

For an MMU fault on an instruction fetch, if the instruction that causes this exception is conditional, the PE takes the exception only if the instruction passes its condition code check.

The [HSR](#) reports the exception either:

- As a Prefetch Abort exception routed to Hyp mode, using the EC value `0x20`.
- As a Data Abort exception routed to Hyp mode, using the EC value `0x24`.

For more information about the exception reporting, see [Use of the HSR on page G3-3672](#).

G1.11.7 Routing Debug exceptions to Hyp mode

When the value of `HDCR.TDE` is 1, if the PE is executing in a Non-secure mode other than Hyp mode, any Debug exception is routed to Hyp mode. This means it generates a Hyp Trap exception. This applies to:

- Debug exceptions associated with instruction fetch, that would otherwise generate a Prefetch Abort exception. These are exceptions generated by the Breakpoint, BKPT instruction, and Vector catch debug events, see [Breakpoint debug events and Vector Catch exception on page H2-4333](#).
- Debug exceptions associated with data accesses, that would otherwise generate a Data Abort exception. These are exceptions generated by the Watchpoint debug event, see [Breakpoint and Watchpoint debug events on page H2-4330](#).

When the value of `HDCR.TDE` is 1, each of the `HDCR.{TDRA, TDOSA, TDA}` bits is treated as 1 for all purposes other than reading the `HDCR` register. See also [Permitted combinations of HDCR.{TDRA, TDOSA, TDA, TDE} bits on page G1-3515](#).

———— Note —————

- A debug event generates a debug exception only when invasive debug is enabled and Monitor debug-mode is selected, see [Exception Catch debug event on page H3-4377](#). When self-hosted debug is selected, a debug event causes Debug state entry and cannot be trapped to Hyp mode.
- When `HDCR.TDE` is set to 1, the Hyp Trap exception is generated instead of the Prefetch Abort exception or Data Abort exception that is otherwise generated by the Debug exception.
- Debug exceptions, other than the exception on the BKPT instruction, are not permitted in Hyp mode.

When a Hyp Trap exception is generated because `HDCR.TDE` is set to 1, The `HSR` reports the exception either:

- As a Prefetch Abort exception routed to Hyp mode, using the EC value `0x20`.
- As a Data Abort exception routed to Hyp mode, using the EC value `0x24`.

For more information see [Use of the HSR on page G3-3672](#).

G1.11.8 Exception return to an Exception level using AArch32

In the ARM architecture, *exception return* to an Exception level that is using AArch32 requires the simultaneous restoration of the PC and `CPSR` to values that are consistent with the desired state of execution on returning from the exception. Typically, exception return involves returning to one of:

- The instruction after the instruction boundary at which an asynchronous exception was taken.
- The instruction following an SVC, SMC, or HMC instruction, for an exception generated by one of those instructions.
- The instruction that caused the exception, after the reason for the exception has been removed.
- The subsequent instruction, if the instruction that caused the exception has been emulated in the exception handler.

The ARM architecture defines a *preferred return address* for each exception other than Reset, see [Link values saved on exception entry on page G1-3438](#). The values of the `SPSR.IT[7:0]` bits generated on exception entry are always correct for this preferred return address, but might require adjustment by the exception handler if returning elsewhere.

In some cases, to calculate the appropriate preferred return address for a return to an Exception level that is using AArch32, a subtraction must be performed on the link value saved on taking the exception. The description of each exception includes any value that must be subtracted from the link value, and other information about the required exception return.

On an exception return, the **CPSR** takes either:

- The value loaded by the RFE instruction.
- If the exception return is not performed by executing an RFE instruction, the value of the current **SPSR** at the time of the exception return.

Illegal exception returns to AArch32 state on page G1-3456 describes the behavior if the restored PE state would not be valid for the Exception level, PE mode, and Security state targeted by the exception return.

Exception return instructions

The instructions that an exception handler can use to return from an exception depend on whether the exception was taken to a EL1 mode, or in a EL2 mode, see:

- *Return from an exception taken to a PE mode other than Hyp mode.*
- *Return from an exception taken to Hyp mode.*

Return from an exception taken to a PE mode other than Hyp mode

For an exception taken to a PE mode other than Hyp mode, the ARM AArch32 architecture provides the following *exception return instructions*:

- Data-processing instructions with the S bit set and the PC as a destination, see *SUBS PC, LR and related instructions (T32) on page F7-3066* and *SUBS PC, LR and related instructions (A32) on page F7-3068*.

Typically:

- A return where no subtraction is required uses SUBS with an operand of 0, or the equivalent MOVN instruction.
- A return requiring subtraction uses SUBS with a nonzero operand.
- The RFE instruction, see *RFE on page F7-3056*. If a subtraction is required, typically it is performed before saving the LR value to memory.
- In A32 state, a form of the LDM instruction, see *LDM (exception return) on page F7-3042*. If a subtraction is required, typically it is performed before saving the LR value to memory.

Return from an exception taken to Hyp mode

For an exception taken to Hyp mode, the ARM architecture provides the ERET instruction, see *ERET on page F7-3038*. An exception handler executing in Hyp mode must return using the ERET instruction.

Both Hyp mode and the ERET instruction are implemented only as part of EL2.

Alignment of exception returns

The {J, T} bits of the value transferred to the **CPSR** by an exception return control the target instruction set of that return. The behavior of the hardware for exception returns for different values of the {J, T} bits is as follows:

- {J, T} == 00** The target instruction set state is A32 state. Bits[1:0] of the address transferred to the PC are ignored by the hardware.
- {J, T} == 01** The target instruction set state is T32 state:
 - Bit[0] of the address transferred to the PC is ignored by the hardware.
 - Bit[1] of the address transferred to the PC is part of the instruction address.
- {J, T} == 10** Reserved, see *Exception return to an unimplemented instruction set state on page G1-3458*.

———— **Note** ————

Before ARMv8, these values indicated Jazelle state as the target instruction set state. However, ARMv8 requires a trivial implementation of the Jazelle extension, and therefore Jazelle state is not implemented. For a description of the trivial Jazelle implementation see [Trivial implementation of the Jazelle extension on page G1-3429](#).

- {J, T} == 11** The target instruction set state is T32EE state. If T32EE state is implemented:
- Bit[0] of the address transferred to the PC is ignored by the hardware.
 - Bit[1] of the address transferred to the PC is part of the instruction address.

However, in ARMv8 implementation of T32EE state is OPTIONAL and deprecated See [Exception return to an unimplemented instruction set state on page G1-3458](#) for a description of the behavior if T32EE state is not implemented.

ARM deprecates any dependence on the requirements that the hardware ignores bits of the address. ARM recommends that the address transferred to the PC for an exception return is correctly aligned for the target instruction set.

After an exception entry other than Reset, the LR value has the correct alignment for the instruction set indicated by the [SPSR.{J, T}](#) bits. This means that if exception return instructions are used with the LR and [SPSR](#) values produced by such an exception entry, the only precaution software needs to take to ensure correct alignment is that any subtraction is of a multiple of four if returning to A32 state, or a multiple of two if returning to T32 state or to T32EE state if T32EE state is implemented.

Illegal exception returns to AArch32 state

Throughout this section:

Saved process state

Refers to any of:

- The state held in the [SPSR](#) for any exception return other than an exception return made by executing an RFE instruction in AArch32 state.
- The state held in memory that is to be restored to the [CPSR](#) by the execution of an RFE instruction in AArch32 state.
- The state held in the [DSPSR](#) on a debug state exit.

Exception or debug return

Refers to any of:

- An exception return.
- Execution of a DRPS instruction in debug state
- Exit from debug state.

Configured from reset

Indicates state determined on powerup or reset by a configuration input signal, or by another IMPLEMENTATION DEFINED mechanism.

The ARMv8 architecture has a generic mechanism for handling exception returns to a mode or state that is illegal. This can occur as a result of any of the following situations:

- An exception or debug return where the Exception level being returned to is higher than the current Exception level.
- An exception or debug return to EL1, EL2 or EL3 where the Execution state specified in the saved process state is different from the Execution state used in the exception level being returned to, as determined by the [SCR_EL3.RW](#) or [HCR_EL2_EL2.RW](#) bits, or as configured from reset.

- An exception or debug return to EL0 where the Execution state specified in the saved process state is AArch64 and the target Execution state for EL1, as determined by the [SCR_EL3.RW](#) or [HCR_EL2_EL2.RW](#) bits or as configured from reset, is AArch32.
- An exception or debug return to an Exception level that is not implemented or not accessible, for example:
 - A return to EL2 when the value of [SCR.NS](#) for the Exception level being returned to is 0.
 - Any return to an Exception level that is not implemented.
- An exception or debug return from AArch32 state when the saved process state indicates a return to AArch64 EL0 execution.
- An exception or debug return to Non-secure EL1 when the value of the [HCR.TGE](#) bit is 1.
- In an implementation that includes support for T32EE state, an exception or debug return to an exception level using AArch32 when the values of the saved process state {T, J} bits is {1, 1} and the value of the [SCTLR.THREE](#) bit for the target exception level is 0.
In an implementation that does not support for T32EE state, it is IMPLEMENTATION DEFINED whether:
 - An exception or debug return to an exception level using AArch32 when the values of the saved process state {T, J} bits is {1, 1} is an illegal exception return.
 - The saved process state J bit is treated as 0.See also [Exception return to an unimplemented instruction set state on page G1-3458](#).
- An exception or debug return to an Exception level using AArch64 when the value of the saved process state M[1] bit is 1.
- An exception or debug return to an Exception level using AArch32 when the value of the saved process state M field value is not a valid mode. [Table G1-2 on page G1-3412](#) shows the M value for each of the AArch32 PE modes.
- Debug state exit from EL0 using AArch64 to EL0 using AArch32.

In these cases:

- [PSTATE.IL](#) is set to 1, to indicate an illegal exception or debug return.
- If the exception or debug return is from an Exception level that is using AArch32, the attempted exception or debug return does not change the PE mode. This means the [CPSR.M](#) field is unchanged.
- If the exception or debug return is from an Exception level that is using AArch64, the attempted exception or debug return does not change any of the Exception level, the Execution state, and the current stack pointer selection.
- The SS bit is handled in the same way as any other exception or debug return, see [Software Step exceptions on page D2-1634](#).
- The [CPSR.{GE, N, Z, C, V, Q, A, I, F, E}](#) fields are copied from the saved process state in the [SPSR](#) for the PE mode in which the exception is handled.
- The [CPSR.{IT, T, J}](#) bits are each either:
 - Set to 0
 - Copied from the saved process state in the [SPSR](#) for the PE mode in which the exception is handled.The choice between these two options is determined by an implementation, and might vary dynamically within an implementation. Correspondingly software must regard the value as being an UNKNOWN choice between the two values.

———— **Note** —————

An illegal exception return from an Exception level that is using AArch64 is handled in AArch64 state and therefore is not considered here.

All aspects of the illegal exception or debug return, other than the effects described in this section, occur as they do for a legal exception return.

Exception return to an unimplemented instruction set state

In AArch32 state, the **CPSR**.{J, T} bits identify the current Instruction set state. In an ARMv8 implementation:

Jazelle state Corresponds to the {J, T} values {1, 0}, and is never implemented, because ARMv8 requires a trivial Jazelle implementation.

T32EE state Corresponds to the {J, T} values {1, 1}. Support for T32EE state is OPTIONAL and deprecated.

An ARMv8 implementation does not normally attempt to enter an unimplemented instruction set state, because:

- The trivial Jazelle implementation means the BXJ instruction acts as a BX instruction.
- If the implementation does not include T32EE support, the ENTERX instruction is UNDEFINED.
- Normal exception entry and return preserves the instruction set state.

However, an exception return instruction might set **CPSR**.{J, T} to the values corresponding to an unimplemented instruction set state, see *Unimplemented instruction sets* on page G1-3429. This is most likely to happen because a faulty exception handler restores the wrong value to the **CPSR**.

If the PE attempts to execute an instruction while the **CPSR**.{J, T} bits indicate an unimplemented instruction set state, an Undefined Instruction exception is taken. This happens if either:

- The value of **CPSR**.{J, T} is {1, 0}, the encoding for Jazelle state in previous versions of the architecture.
- The value of **CPSR**.{J, T} is {1, 1} and the implementation does not support T32EE state.

The Undefined Instruction exception handler can detect the cause of this exception because on entry to the handler the **SPSR**.{J, T} bits indicate the unimplemented instruction set state. If the Undefined Instruction exception handler wants to return to a valid instruction set state it can change the values its exception return instruction writes to the **CPSR**.{J, T} bits.

If an exception return writes **CPSR**.{J, T} values that correspond to an unimplemented instruction set state, and also writes the address of an aborting memory location to the PC, it is IMPLEMENTATION DEFINED whether:

- The instruction fetch is attempted, and a Prefetch Abort exception is taken because the memory access aborts.
- An Undefined Instruction exception is taken, without the instruction being fetched.

If an exception return writes **CPSR**.{J, T} values that correspond to an unimplemented instruction set, the width of the instruction fetch is an IMPLEMENTATION DEFINED value that is 2 or 4 bytes.

An ARMv8 implementation that does not support the T32EE state can implement the J bits of the PSRs as RAZ/WI. On such an implementation, a return to an unimplemented instruction set state cannot occur.

Illegal changes to the CPSR.M field

The **CPSR**.M field can be changed explicitly using an MSR or CPS instruction. Changing the M field to any of the following values is an illegal change to the **CPSR**.M field:

- Changing M to a value that [Table G1-2 on page G1-3412](#) does not show as allocated.
- Changing M to the value that corresponds to a PE mode that is not implemented or not accessible.

This includes:

- When executing in Secure EL1, changing M to the value for Monitor mode when EL3 is using AArch64.
- In an implementation that includes EL2, writing the value for Hyp mode to the M field from any PE mode other than Hyp mode.
- In an implementation that includes EL2, when EL2 is using AArch32 and the PE is in Hyp mode, changing M to the value for any mode other than Hyp mode.
- Changing M to a value that would cause an increase in Exception level.
- When executing in Non-secure state, changing M to the value for Monitor mode.

In the ARMv8 Architecture, when in AArch32 state, the IL process state bit is used to catch any illegal explicit change to the **CPSR.M** field using an MSR or CPS instruction. In AArch32 state, the effect of such an illegal change to the **CPSR.M** field is that:

1. The current PE mode remains unchanged.
2. The **PSTATE.IL** bit is set to 1.
3. Any attempt to execute any instruction generates an Illegal Execution state exception.

The Illegal Execution state exception is handled as described in *Illegal exception returns to AArch32 state on page G1-3456*.

———— **Note** —————

In ARMv7, the effect of an illegal change to the **CPSR.M** field is UNPREDICTABLE.

—————

Legal exception returns that set **CPSR.IL** to 1

When a legal exception return to AArch32 would set the **CPSR.IL** bit to 1, either by copying this value from an **SPSR**, or by loading it from memory if the exception return was performed by executing an RFE instruction, then the **CPSR.{IT, T, J}** bits are each either:

- Set to 0.
- Copied from the **SPSR**, or loaded from memory if the exception return was performed by executing an RFE instruction.

The choice between these two options is determined by an implementation, and might vary dynamically within the implementation. This means software must regard each value as being an UNKNOWN choice between the two permitted values.

The exception return sets the **PSTATE.IL** bit to 1. This means that any attempt to execute any instruction generates an Illegal Execution state exception, that is handled as described in *Illegal exception returns to AArch32 state on page G1-3456*.

The Illegal Execution state exception

When the value of **PSTATE.IL** is 1, any attempt to execute any instruction generates an Illegal Execution state exception. In AArch32 state, the **PSTATE.IL** bit can be set to 1 by any of:

- An illegal exception return, as described in *Illegal exception returns to AArch32 state on page G1-3456*.
- An illegal change to **CPSR.M**, as described in *Illegal changes to the CPSR.M field on page G1-3458*.
- A legal exception return that would set **CPSR.IL** to 1, as described in *Legal exception returns that set CPSR.IL to 1*.

An Illegal Execution State exception is taken in the same way as an Undefined Instruction exception in the current Exception level. If the current Exception level is EL2 using AArch32, the **HSR** provides a syndrome for the exception, as follows:

- **HSR.EC** has the value 0xE.
- The **HSR.IL** bit is invalid, and is RES1.
- The **HSR.ISS** field is RES0.

An Illegal Execution State exception has priority over any other Undefined Instruction exception that might arise from instruction execution.

———— **Note** —————

This section only describes the handling of an Illegal Execution State exception that is taken to an Exception level that is using AArch32. *Illegal return events on page D1-1441* describes the cases where an Illegal Execution State exception is taken to an Exception level that is using AArch64.

—————

On taking an Illegal Execution State exception to an Exception level that is using AArch32:

1. The value of the `PSTATE.IL` bit, 1, is copied to the `SPSR.IL` bit for the PE mode to which the exception is taken.
2. The `PSTATE.IL` bit is cleared to 0.

G1.11.9 Wait For Event and Send Event

The Wait For Event (WFE) mechanism permits a PE to request entry to a low-power state, and, if the request succeeds, to remain in that state until an event is generated by a Send Event operation, or another WFE wake-up event occurs. [Example G1-2](#) describes how a spinlock implementation might use this mechanism to save energy.

Example G1-2 Spinlock as an example of using Wait For Event and Send Event

A multiprocessor operating system requires locking mechanisms to protect data structures from being accessed simultaneously by multiple PEs. These mechanisms prevent the data structures becoming inconsistent or corrupted if different PEs try to make conflicting changes. If a lock is busy, because a data structure is being used by one PE, it might not be practical for another PE to do anything except wait for the lock to be released. For example, if a PE is handling an interrupt from a device it might need to add data received from the device to a queue. If another PE is removing data from the queue, it will have locked the memory area that holds the queue. The first PE cannot add the new data until the queue is in a consistent state and the lock has been released. It cannot return from the interrupt handler until the data has been added to the queue, so it must wait.

Typically, a spin-lock mechanism is used in these circumstances:

- A PE requiring access to the protected data attempts to obtain the lock using single-copy atomic synchronization primitives such as the Load-Exclusive and Store-Exclusive operations described in [Synchronization and semaphores on page E2-2369](#).
- If the PE obtains the lock it performs its memory operation and releases the lock.
- If the PE cannot obtain the lock, it reads the lock value repeatedly in a tight loop until the lock becomes available. At this point it again attempts to obtain the lock.

A spin-lock mechanism is not ideal for all situations:

- In a low-power system the tight read loop is undesirable because it uses energy to no effect.
- In a multi-threaded implementation the execution of spin-locks by waiting threads can significantly degrade overall performance.

Using the Wait For Event and Send Event mechanism can improve the energy efficiency of a spinlock. In this situation, a PE that fails to obtain a lock can execute a Wait For Event instruction, WFE, to request entry to a low-power state. When a PE releases a lock, it must execute a Send Event instruction, SEV, causing any waiting PEs to wake up. Then, these PEs can attempt to gain the lock again.

EL2 provides a bit that traps to Hyp mode any attempt to enter a low-power state from a Non-secure EL1 or EL0 mode. For more information see [Trapping use of the WFI and WFE instructions on page G1-3511](#).

The architecture does not define the exact nature of the low power state, but the execution of a WFE instruction must not cause a loss of memory coherency.

———— **Note** —————

Although a complex operating system can contain thousands of distinct locks, the event sent by this mechanism does not indicate which lock has been released. If the event relates to a different lock, or if another PE acquires the lock more quickly, the PE fails to acquire the lock and can re-enter the low-power state waiting for the next event.

The Wait For Event system relies on hardware and software working together to achieve energy saving:

- The hardware provides the mechanism to enter the Wait For Event low-power state.
- The operating system software is responsible for issuing:
 - A Wait For Event instruction, to request entry to the low-power state, used in the example when waiting for a spin-lock.
 - A Send Event instruction, required in the example when releasing a spin-lock.

The mechanism depends on the interaction of:

- WFE wake-up events, see [WFE wake-up events](#).
- The Event Register, see [The Event Register](#).
- The Send Event instruction, see [The Send Event instruction on page G1-3462](#).
- The Wait For Event instruction, see [The Wait For Event instruction on page G1-3462](#).

WFE wake-up events

The following events are *WFE wake-up events*:

- The execution of an SEV instruction on any PE in the system.
- A physical IRQ interrupt, unless masked by the [CPSR.I](#) bit.
- A physical FIQ interrupt, unless masked by the [CPSR.F](#) bit.
- A physical asynchronous abort, unless masked by the [CPSR.A](#) bit.
- In Non-secure state in any mode other than Hyp mode:
 - When [HCR.IMO](#) is set to 1, a virtual IRQ interrupt, unless masked by the [CPSR.I](#) bit.
 - When [HCR.FMO](#) is set to 1, a virtual FIQ interrupt, unless masked by the [CPSR.F](#) bit.
 - When [HCR.AMO](#) is set to 1, a virtual asynchronous abort, unless masked by the [CPSR.A](#) bit.
- An asynchronous debug event, if invasive debug is enabled and the debug event is permitted.
- An event sent by the timer event stream, see [Event streams on page D7-1859](#).
- An event sent by some IMPLEMENTATION DEFINED mechanism.

In addition to the possible masking of WFE wake-up events shown in this list, when invasive debug is enabled and [DBGDSCRint\[15:14\]](#) is not set to 0b00, [DBGDSCRint.INTdis](#) can mask interrupts, including masking them acting as WFE wake-up events. For more information, see [DBGDSCRext, Debug Status and Control Register, External View on page G4-4126](#) and [DBGDSCRint, Debug Status and Control Register, Internal View on page G4-4130](#).

As shown in the list of wake-up events, an implementation can include IMPLEMENTATION DEFINED hardware mechanisms to generate wake-up events.

———— Note —————

For more information about [CPSR](#) masking see [Asynchronous exception masking controls on page G1-3468](#). If the configuration of the masking controls provided by EL2 and EL3 mean that a [CPSR](#) mask bit cannot mask the corresponding exception, then the physical exception is a WFE wake-up event, regardless of the value of the [CPSR](#) mask bit.

The Event Register

The Event Register is a single bit register for each PE. When set, an event register indicates that an event has occurred, since the register was last cleared, that might require some action by the PE. Therefore, the PE must not suspend operation on issuing a WFE instruction.

The reset value of the Event Register is UNKNOWN.

The Event Register is set by:

- An SEV instruction.
- An event sent by some IMPLEMENTATION DEFINED mechanism.

- A debug event that causes entry into Debug state.
- An exception return.

As shown in this list, the Event Register might be set by IMPLEMENTATION DEFINED mechanisms.

The Event Register is cleared only by a Wait For Event instruction.

Software cannot read or write the value of the Event Register directly.

The Send Event instruction

The Send Event instruction, SEV, causes an event to be signaled to all PEs in the system. The mechanism that signals the event to the PEs is IMPLEMENTATION DEFINED. Hardware does not guarantee the ordering of this event with respect to the completion of memory accesses by instructions before the SEV instruction. Therefore, ARM recommends that software includes a DSB instruction before an SEV instruction.

———— Note ————

A DSB instruction ensures that no instruction, including any SEV instruction, that appears in program order after the DSB instruction, can execute until the DSB instruction has completed. For more information, see [Data Synchronization Barrier \(DSB\) on page E2-2354](#).

Execution of the Send Event instruction sets the Event Register.

The Send Event instruction is available at all privilege levels, see [SEV on page F7-2804](#).

The Wait For Event instruction

The action of the Wait For Event instruction depends on the state of the Event Register:

- If the Event Register is set, the instruction clears the register and completes immediately. Normally, if this happens the software makes another attempt to claim the lock.
- If the Event Register is clear the PE can suspend execution, and hardware might enter a low-power state. The PE can remain suspended until a WFE wake-up event or a reset occurs. When a WFE wake-up event occurs, or earlier if the implementation chooses, the WFE instruction completes.

The Wait For Event instruction, WFE, is available at all privilege levels, see [WFE on page F7-3022](#).

Software using the Wait For Event mechanism must tolerate spurious wake-up events, including multiple wake ups.

EL2 provides a bit that traps to EL2 any attempt to enter a low-power state from a Non-secure EL1 or EL0 mode. For more information see [Trapping use of the WFI and WFE instructions on page G1-3511](#).

Pseudocode details of the Wait For Event lock mechanism

This section defines pseudocode functions that describe the operation of the Wait For Event mechanism.

The ClearEventRegister() pseudocode procedure clears the Event Register of the current PE.

The EventRegistered() pseudocode function returns TRUE if the Event Register of the current PE is set and FALSE if it is clear:

```
boolean EventRegistered();
```

The WaitForEvent() pseudocode procedure optionally suspends execution until a WFE wake-up event or reset occurs, or until some earlier time if the implementation chooses. It is IMPLEMENTATION DEFINED whether restarting execution after the period of suspension causes a ClearEventRegister() to occur.

The SendEvent() pseudocode procedure sets the Event Register of every PE in the system.

G1.11.10 Wait For Interrupt

AArch32 state supports Wait For Interrupt through an instruction, WFI, that is provided in the A32 and T32 instruction sets. For more information, see [WFI on page F7-3024](#).

When a PE issues a WFI instruction, its execution can be suspended, and a low-power state can be entered.

EL2 provides a bit that traps to EL2 any attempt to enter a low-power state from a Non-secure EL1 or EL0 mode. For more information see [Trapping use of the WFI and WFE instructions on page G1-3511](#).

The PE can remain suspended in its WFI state until it is reset, or one of the following *WFI wake-up events* occurs:

- A physical IRQ interrupt, regardless of the value of the [CPSR.I](#) bit.
- A physical FIQ interrupt, regardless of the value of the [CPSR.F](#) bit.
- A physical asynchronous abort, regardless of the value of the [CPSR.A](#) bit.
- In Non-secure state in any mode other than Hyp mode:
 - When [HCR.IMO](#) is set to 1, a virtual IRQ interrupt, regardless of the value of the [CPSR.I](#) bit.
 - When [HCR.FMO](#) is set to 1, a virtual FIQ interrupt, regardless of the value of the [CPSR.F](#) bit.
 - When [HCR.AMO](#) is set to 1, a virtual asynchronous abort, regardless of the value of the [CPSR.A](#) bit.
- An asynchronous debug event, when invasive debug is enabled and the debug event is permitted.

An implementation can include other IMPLEMENTATION DEFINED hardware mechanisms to generate WFI wake-up events.

When a WFI wake-up event is detected, or earlier if the implementation chooses, the WFI instruction completes.

WFI wake-up events cannot be masked by the mask bits in the [CPSR](#).

The architecture does not define the exact nature of the low power state, but the execution of a WFI instruction must not cause a loss of memory coherency.

————— Note —————

- Because debug events are WFI wake-up events, ARM strongly recommends that Wait For Interrupt is used as part of an idle loop rather than waiting for a single specific interrupt event to occur and then moving forward. This ensures the intervention of debug while waiting does not significantly change the function of the program being debugged.
- In some previous implementations of Wait For Interrupt, the idle loop is followed by exit functions that must be executed before taking the interrupt. The operation of Wait For Interrupt remains consistent with this model, and therefore differs from the operation of Wait For Event.
- Some implementations of Wait For Interrupt drain down any pending memory activity before suspending execution. The ARM architecture does not require this operation, and software must not rely on Wait For Interrupt operating in this way.

Using WFI to indicate an idle state on bus interfaces

A common implementation practice is to complete any entry into powerdown routines with a WFI instruction. Typically, the WFI instruction:

1. Forces the completion of execution of any instructions that are in progress, and of all associated bus activity.
2. Suspends the execution of instructions by the PE.

The control logic required to do this tracks the activity of the bus interfaces used by the PE. This means it can signal to an external power controller when there is no ongoing bus activity.

However, memory-mapped and external debug interface accesses to debug registers must continue to be processed while the PE is in the WFI state. The indication of idle state to the system normally only applies to the non-debug functional interfaces used by the PE, not the debug interfaces.

When the value of [DBGOSDLR.DLK](#), the OS Double Lock status bit, is set to 1, this idle state must not be signaled to the PE unless the system can guarantee, also, that the debug interface is idle.

Note

When separate core and debug power domains are implemented, the debug interface referred to in this section is the interface between the core and debug power domains, since the signal to the power controller indicates that the core power domain is idle. For more information about the power domains see [Power domains and debug on page H6-4425](#).

The exact nature of this interface is IMPLEMENTATION DEFINED, but the use of Wait For Interrupt as the only architecturally-defined mechanism that completely suspends execution makes it very suitable as the preferred powerdown entry mechanism.

Pseudocode details of Wait For Interrupt

The `WaitForInterrupt()` pseudocode procedure optionally suspends execution until a WFI wake-up event or reset occurs, or until some earlier time if the implementation chooses.

G1.12 Asynchronous exception behavior for exceptions taken from AArch32 state

In an implementation that does not include EL2 or EL3, the asynchronous exceptions behave as follows when EL1 and EL0 are both using AArch32:

- An asynchronous abort is taken to Abort mode.
- An IRQ exception is taken to IRQ mode.
- An FIQ exception is taken to FIQ mode.

These are the *default PE modes* for taking these exceptions.

However, the `CPSR.{A, I, F}` bits *mask* the asynchronous exceptions, meaning that when the value of one of these `CPSR` bits is 1, the corresponding exception is not taken.

If a masked asynchronous exceptions remains signalled, then the exception remains pending unless the value of the `CPSR` bit is changed to 0.

EL2 and EL3 provide controls that affect:

- The routing of these exceptions, see [Asynchronous exception routing controls on page G1-3467](#)
- Masking of these exceptions in Non-secure state, see [Asynchronous exception masking controls on page G1-3468](#).

Similar register control bits are provided regardless of whether EL2 and EL3 are using AArch32 or AArch64:

- The EL2 controls are provided by the `HCR` when EL2 is using AArch32, and by the `HCR_EL2` when EL2 is using AArch64.
- The EL3 controls are provided by the `SCR` when EL3 is using AArch32, and by the `SCR_EL3` when EL3 is using AArch64.

Therefore, most references to the `HCR` or `SCR` in this section are to entries in [Table J-1 on page AppxJ-5088](#), that disambiguates between AArch32 registers and AArch64 registers. However, the Execution states used by EL2 and EL3 do affect some aspects of the routing and masking of the asynchronous exceptions, see [Asynchronous exception routing and masking with higher Exception levels using AArch64 on page G1-3470](#).

G1.12.1 Virtual exceptions when an implementation includes EL2

When implemented, EL2 provides the following virtual exceptions, that correspond to the physical asynchronous exceptions:

- Virtual Abort, that corresponds to a physical external asynchronous abort.
- Virtual IRQ, that corresponds to a physical IRQ.
- Virtual FIQ, that corresponds to a physical FIQ.

When the value of the corresponding `HCR.{AMO, IMO, FMO}` bit is 1, a virtual exception is generated either:

- By setting a virtual interrupt pending bit, `HCR.{VA, VI, VF}`, to 1.
- For a Virtual IRQ or Virtual FIQ, by an IMPLEMENTATION DEFINED mechanism. This might be a signal from an interrupt controller, for example from a Virtual GIC, as defined by the *ARM Generic Interrupt Controller Architecture Specification*.

In AArch32 state, a virtual exception is taken only from a Non-secure EL1 or EL0 mode. In any other mode, if the exception is generated it is not taken.

A virtual exception is taken in Non-secure state to the default mode for the corresponding physical exception. This means:

- A Virtual Abort is taken to Non-secure Abort mode.
- A Virtual IRQ is taken to Non-secure IRQ mode.
- A Virtual FIQ is taken to Non-secure FIQ mode.

Table G1-11 summarizes the HCR bits that route asynchronous exceptions to EL2, and the bits that generate the virtual exceptions.

Table G1-11 HCR bits controlling asynchronous exceptions

Exception	Routing the physical exception to EL2	Generating the virtual exception
Asynchronous abort	HCR.AMO	HCR.VA
IRQ	HCR.IMO	HCR.VI
FIQ	HCR.FMO	HCR.VF

The HCR.{VA, VI, VF} bits generate a virtual exception only if set to 1 when the value of the corresponding HCR.{AMO, IMO, FMO} is 1.

Similarly, if the implementation also includes EL3, the HCR.{AMO, IMO, FMO} bits route the corresponding physical exception to Hyp mode only if the physical exception is not routed to Monitor mode by the SCR.{EA, IRQ, FIQ} bit. For more information, see *Asynchronous exception routing controls* on page G1-3467.

When the value of an HCR.{AMO, IMO, FMO} control bit is 1, the corresponding mask bit in the CPSR:

- Does not mask the physical exception.
- Masks the virtual exception when the PE is executing in a Non-secure EL1 or EL0 mode.

Taking a Virtual Abort exception clears HCR.VA to zero. Taking a Virtual IRQ exception or a Virtual FIQ exception does not affect the value of HCR.VI or HCR.VF.

———— **Note** —————

This means that the exception handler for a Virtual IRQ exception or a Virtual FIQ exception must cause software that is executing at EL2 or EL3 to update the HCR to clear the appropriate virtual exception bit to 0.

See *WFE wake-up events* on page G1-3461 and *Wait For Interrupt* on page G1-3463 for information about how virtual exceptions affect wake up from power-saving states.

———— **Note** —————

A hypervisor can use virtual exceptions to signal exceptions to the current Guest OS. The Guest OS takes a virtual exception exactly as it would take the corresponding physical exception, and is unaware of any distinction between virtual exception and the corresponding physical exception.

Effects of the HCR.{AMO, IMO, FMO} bits

As described in this section, the HCR.{AMO, IMO, FMO} bits are part of the mechanism for enabling the virtual exceptions. In addition, for exceptions generated in Non-secure state:

- As mentioned in this section, affect the routing of the exceptions. See *Asynchronous exception routing controls* on page G1-3467.
- Affect the masking of the exceptions. See *Asynchronous exception masking controls* on page G1-3468.

G1.12.2 Asynchronous exception routing controls

Note

This section describes the behavior when all exception levels are using AArch32. For the differences when this is not the case see [Asynchronous exception routing and masking with higher Exception levels using AArch64 on page G1-3470](#)

In an implementation that includes EL3 the following bits in the **SCR** control the routing of asynchronous exceptions, and also the routing of synchronous external aborts:

SCR.EA When the value of this bit is 1, any external abort is taken to EL3.

Note

- Although this section describes the asynchronous exception routing controls, **SCR.EA** controls the routing of both synchronous and asynchronous external aborts.
 - The other classes of abort cannot be routed to EL3. For more information about the classification of aborts, see [VMSAv8-32 memory aborts on page G3-3647](#).
-

SCR.FIQ When the value of this bit is 1, any FIQ exception is taken to EL3.

SCR.IRQ When the value of this bit is 1, any IRQ exception is taken to EL3.

When EL3 is using AArch32 and the value of one of the **SCR**.{EA, FIQ, IRQ} bits is 1, the exception is taken to Monitor mode.

Only Secure software can change the values of these bits.

In an implementation that includes EL2, the following bits in the **HCR** route asynchronous exceptions to EL2, for exceptions that are both:

- Taken from a Non-secure EL1 or EL0 mode.
- If the implementation also includes EL3, not configured, by the **SCR**.{EA, FIQ, IRQ} controls, to be taken to EL3.

HCR.AMO When the value of this bit is 1, an asynchronous external abort taken from a Non-secure EL1 or EL0 mode is taken to EL2, instead of to Non-secure Abort mode. If the implementation also includes EL3, this control applies only if the value of **SCR.EA** is 0. When the value of **SCR.EA** is 1, the value of the AMO bit is ignored.

Note

[Figure G1-8 on page G1-3447](#) also shows how synchronous external aborts are handled.

HCR.FMO When the value of this bit is 1, an FIQ exception taken from a Non-secure EL1 or EL0 mode is taken to EL2, instead of to Non-secure FIQ mode. If the implementation also includes EL3, this control applies only if the value of **SCR.FIQ** is 0. When the value of **SCR.FIQ** is 1, the value of the FMO bit is ignored.

HCR.IMO When the value of this bit is 1, an IRQ exceptions taken from a Non-secure EL1 or EL0 mode is taken to EL2, instead of to Non-secure IRQ mode. If the implementation also includes EL3, this control applies only if the value of **SCR.IRQ** is 0. When the value of **SCR.IRQ** is 1, the value of the IMO bit is ignored.

When EL2 is using AArch32 and the value of one of the **HCR**.{AMO, FMO, IMO} bits is 1, the exception is taken to Hyp mode.

Only software executing in Hyp mode, or Secure software executing at EL3 with **SCR.NS** set to 1, can change the values of these bits. If EL3 is using AArch32, this requires the Secure software to be executing in Monitor mode.

The **HCR**.{AMO, FMO, IMO} bits also affect the masking of asynchronous exceptions in Non-secure state, as described in [Asynchronous exception masking controls on page G1-3468](#).

The **SCR**.{EA, FIQ, IRQ} and **HCR**.{AMO, FMO, IMO} bits have no effect on the routing of Virtual Abort, Virtual FIQ, and Virtual IRQ exceptions.

———— **Note** —————

When the PE is in Hyp mode:

- Physical asynchronous exceptions that are not routed to Monitor mode are taken to Hyp mode.
- Virtual exceptions are not signaled to the PE.

See also *Asynchronous exception behavior for exceptions taken from AArch32 state* on page G1-3465.

G1.12.3 Asynchronous exception masking controls

———— **Note** —————

This section describes the behavior when all exception levels are using AArch32. For the differences when this is not the case see *Asynchronous exception routing and masking with higher Exception levels using AArch64* on page G1-3470

The **CPSR**.{A, I, F} bits can mask the taking of the corresponding exceptions from AArch32 state, as follows:

- **CPSR**.A can mask asynchronous aborts.
- **CPSR**.I can mask IRQ exceptions.
- **CPSR**.F can mask FIQ exceptions.

In an implementation that does not include either of EL2 and EL3, setting one of these bits to 1 masks the corresponding exception, meaning the exception cannot be taken.

In an implementation that includes EL2, the **HCR**.{AMO, IMO, FMO} bits modify the masking of exceptions taken from Non-secure state.

Similarly, in an implementation that includes EL3, the **SCR**.{AW, FW} bits modify the masking of exceptions taken from Non-secure state by the **CPSR**.{A, F} bits.

An implementation that includes only EL1 and EL0 does not provide any masking of the **CPSR**.{A, I, F} bits. The following subsections describe the masking of these bits in other implementations:

- *Asynchronous exception masking in an implementation that includes EL2 but not EL3.*
- *Asynchronous exception masking in an implementation that includes EL3 but not EL2.*
- *Asynchronous exception masking in an implementation that includes both EL2 and EL3 on page G1-3469.*
- *Summary of the asynchronous exception masking controls on page G1-3469.*

Asynchronous exception masking in an implementation that includes EL2 but not EL3

The **HCR**.{AMO, IMO, FMO} bits modify the effect of the **CPSR**.{A, I, F} bits. When the value of an **HCR**.{AMO, IMO, FMO} mask override bit is 1, the value of the corresponding **CPSR**.{A, I, F} bit is ignored when the exception is taken from a Non-secure mode other than Hyp mode.

Asynchronous exception masking in an implementation that includes EL3 but not EL2

The **SCR**.{AW, FW} bits modify the effect of the **CPSR**.{A, F} bits. When the value of one of the **SCR**.{AW, FW} bits is 0, the corresponding **CPSR** bit is ignored when both of the follow apply:

- The corresponding exception is taken from Non-secure state.
- The value of the corresponding **SCR**.{EA, FIQ} bit is 1, routing the exception to EL3. This means the exception is routed to Monitor mode if EL3 is using AArch32.

———— **Note** —————

Whenever the value of **CPSR**.I is 1, IRQ exceptions are masked and cannot be taken.

Asynchronous exception masking in an implementation that includes both EL2 and EL3

When the value of an **HCR**.{AMO, IMO, FMO} mask override bit is 1, the value of the corresponding **CPSR**.{A, I, F} bit is ignored when both of the following apply:

- The exception is taken from Non-secure state.
- Either:
 - The corresponding **SCR**.{EA, IRQ, FIQ} bit routes the exception to Monitor mode.
 - The exception is taken from a Non-secure mode other than Hyp mode.

In addition, when the value of an **SCR**.{AW, FW} bit is 0, the value of the corresponding **CPSR**.{A, F} bit is ignored when all of the following apply:

- The exception is taken from Non-secure state.
- The corresponding **SCR**.{EA, FIQ} bit routes the exception to Monitor mode.
- The corresponding **HCR**.{AMO, FMO} mask override bit is set to 0.

Summary of the asynchronous exception masking controls

The tables in this section show the masking controls for each of the **CPSR**.{A, I, F} bits. For an implementation that does not include all of the exception levels:

If the implementation includes only EL1 and EL0

The **CPSR** bits cannot be masked. The behavior is as shown in the *Secure* row of the tables.

If the implementation includes EL2 but not EL3

The behavior is as shown in the *Non-secure* table rows when the control bits in the **SCR** are both 0.

If the implementation includes EL3 but not EL2

The behavior is as shown in the table rows where the control bit in the **HCR** is 0.

Table G1-12 shows the controls of the masking of asynchronous exceptions by **CPSR**.A.

Table G1-12 Control of masking by **CPSR.A**

Security state	HCR.AMO	SCR.EA	SCR.AW	Mode	CPSR.A
Secure	x	x	x	x	Masks asynchronous aborts, when set to 1
Non-secure	0	0	x	x	Masks asynchronous aborts, when set to 1
			1	0	x
		1	1	x	Masks asynchronous aborts, when set to 1
	1	x	x	Not Hyp	Ignored
			0	x	Hyp
		1	x	x	Ignored

Table G1-13 shows the controls of the masking of FIQ exceptions by CPSR.F:

Table G1-13 Control of masking by CPSR.I

Security state	HCR.IMO	SCR.IRQ	Mode	CPSR.I
Secure	x	x	x	Masks IRQs, when set to 1
Non-secure	0	x	x	Masks IRQs, when set to 1
		1	Not Hyp	Ignored
	1	0	Hyp	Masks IRQs, when set to 1
		1	x	Ignored

Table G1-14 shows the controls of the masking of FIQ exceptions by CPSR.F:

Table G1-14 Control of masking by CPSR.F

Security state	HCR.FMO	SCR.FIQ	SCR.FW	Mode	CPSR.F	
Secure	x	x	x	x	Masks FIQs, when set to 1	
Non-secure	0	0	x	x	Masks FIQs, when set to 1	
			1	0	x	Ignored
		1	x	x	Not Hyp	Ignored
	1	0	x	x	Hyp	Masks FIQs, when set to 1
			1	x	x	Ignored
		1	1	x	x	Ignored

G1.12.4 Asynchronous exception routing and masking with higher Exception levels using AArch64

[Asynchronous exception routing controls](#) on page G1-3467 and [Asynchronous exception masking controls](#) on page G1-3468 give full descriptions of the routing and masking of the asynchronous exceptions when all Exception levels are using AArch32. However, when EL0 and EL1 are using AArch32:

- As already described, the SCR and HCR controls might be from Exception levels that are using AArch64.
- If EL3 is using AArch64, or EL2 is using AArch64, there are some changes to the asynchronous exception behaviors.

Therefore, the following sections summarize the asynchronous exception behaviors, taking account of the Execution state being used at EL2 and EL3:

- [Summary of physical interrupt routing](#).
- [Summary of physical interrupt masking](#) on page G1-3472.

Summary of physical interrupt routing

The following tables show the routing of physical interrupts. [Table G1-15 on page G1-3471](#) shows the routing of physical FIQ interrupts, [Table G1-16 on page G1-3471](#) shows the routing of physical IRQ interrupts, and [Table G1-17 on page G1-3472](#) shows the routing of physical asynchronous aborts.

In these tables, for exceptions that must be taken to an Exception level that is using AArch32, the table shows the target Exception level and PE mode. In these entries, *Mon* indicates Monitor mode, and *Abt* indicates Abort mode.

Table G1-15 Routing of physical FIQ exceptions

EL3 Execution state	Control bits			Target when take from:					
	SCR	HCR		Non-secure			Secure		
		FIQ	RW ^a	FMO ^b	EL0	EL1	EL2	EL0	EL1 ^c
AArch32	0	x	0	EL1 FIQ	EL1 FIQ	EL2 Hyp	EL3 FIQ	-	EL3 FIQ
			1	EL2 Hyp	EL2 Hyp	EL2 Hyp	EL3 FIQ	-	EL3 FIQ
	1	x	x	EL3 Mon	EL3 Mon	EL3 Mon	EL3 Mon	-	EL3 Mon
AArch64	0	0	0	EL1 FIQ	EL1 FIQ	EL2 Hyp	EL1 FIQ	EL1 FIQ	P ^d
		x	1	EL2 ^e	EL2 ^e	EL2 ^e	EL1 ^f	EL1 ^f	P ^d
		1	0	EL1	EL1	P ^d	EL1	EL1	P ^d
	1	x	x	EL3	EL3	EL3	EL3	EL3	EL3

- a. [SCR_EL3.RW](#). When 1, the next lower Exception level is using AArch64. This control is not present when EL3 is using AArch32.
- b. When the value of [HCR.TGE](#) is 1, the effective value of this bit is 1.
- c. When EL3 is using AArch32, the only Secure Exception levels are EL0 and EL3.
- d. Interrupt is not taken, but remains pending.
- e. If EL2 is using AArch32, taken to Hyp mode.
- f. If EL1 is using AArch32, taken to Abort mode.

Table G1-16 Routing of physical IRQ exceptions

EL3 Execution state	Control bits			Target when take from:					
	SCR	HCR		Non-secure			Secure		
		IRQ	RW ^a	IMO ^b	EL0	EL1	EL2	EL0	EL1 ^c
AArch32	0	x	0	EL1 IRQ	EL1 IRQ	EL2 Hyp	EL3 IRQ	-	EL3 IRQ
			1	EL2 Hyp	EL2 Hyp	EL2 Hyp	EL3 IRQ	-	EL3 IRQ
	1	x	x	EL3 Mon	EL3 Mon	EL3 Mon	EL3 Mon	-	EL3 Mon
AArch64	0	0	0	EL1 IRQ	EL1 IRQ	EL2 Hyp	EL1 IRQ	EL1 IRQ	P ^d
		x	1	EL2 ^e	EL2 ^e	EL2 ^e	EL1 ^f	EL1 ^f	P ^d
		1	0	EL1	EL1	P ^d	EL1	EL1	P ^d
	1	x	x	EL3	EL3	EL3	EL3	EL3	EL3

- a. [SCR_EL3.RW](#). When 1, the next lower Exception level is using AArch64. This control is not present when EL3 is using AArch32.
- b. When the value of [HCR.TGE](#) is 1, the effective value of this bit is 1.
- c. When EL3 is using AArch32, the only Secure Exception levels are EL0 and EL3.
- d. Interrupt is not taken, but remains pending.
- e. If EL2 is using AArch32, taken to Hyp mode.
- f. If EL1 is using AArch32, taken to Abort mode.

Table G1-17 Routing of physical Asynchronous aborts

EL3 Execution state	Control bits			Target when take from:					
	SCR	HCR		Non-secure			Secure		
		EA	RW ^a	AMO ^b	EL0	EL1	EL2	EL0	EL1 ^c
AArch32	0	x	0	EL1 Abt	EL1 Abt	EL2 Hyp	EL3 Abt	-	EL3 Abt
			1	EL2 Hyp	EL2 Hyp	EL2 Hyp	EL3 Abt	-	EL3 Abt
AArch64	0	0	x	EL3 Mon	EL3 Mon	EL3 Mon	EL3 Mon	-	EL3 Mon
			1	EL3 Mon	EL3 Mon	EL3 Mon	EL3 Mon	-	EL3 Mon
	1	x	0	EL1 Abt	EL1 Abt	EL2 Hyp	EL1 Abt	EL1Abt	P ^d
			1	EL2 ^e	EL2 ^e	EL2 ^e	EL1 ^f	EL1 ^f	P ^d
1	x	x	0	EL1	EL1	P ^d	EL1	EL1	P ^d
			1	EL3	EL3	EL3	EL3	EL3	EL3

- a. SCR_EL3.RW. When 1, the next lower Exception level is using AArch64. This control is not present when EL3 is using AArch32.
- b. When the value of HCR.TGE is 1, the effective value of this bit is 1.
- c. When EL3 is using AArch32, the only Secure Exception levels are EL0 and EL3.
- d. Interrupt is not taken, but remains pending.
- e. If EL2 is using AArch32, taken to Hyp mode.
- f. If EL1 is using AArch32, taken to Abort mode.

Summary of physical interrupt masking

The following tables show the masking of physical interrupts. Table G1-18 shows the masking of physical FIQ interrupts, Table G1-19 on page G1-3473 shows the masking of physical IRQ interrupts, and Table G1-20 on page G1-3474 shows the masking of physical asynchronous aborts. In these tables:

- M** Indicates that the exception is masked when the value of the CPSR mask bit is 1.
- T** Indicates that the exception is taken, regardless of the value of the CPSR mask bit.
- P** Indicates that the exception is not taken but remains pending. The value of the CPSR mask bit has no effect on this behavior.

Table G1-18 Masking of physical FIQ exceptions

EL3 Execution state	Control bits			Effect of CPSR.F ^a mask in Exception level						
	SCR	HCR		Non-secure			Secure			
		FIQ	FW	RW ^b	FMO ^c	EL0	EL1	EL2	EL0	EL1 ^d
AArch32	0	x	x	0	M	M	M	M	-	M
			1	T	T	M	M	-	M	
AArch64	1	0	x	0	T	T	T	M	-	M
			1	M	M	M	M	-	M	
	x	x	0	T	T	T	M	-	M	
			1	T	T	T	M	-	M	

Table G1-18 Masking of physical FIQ exceptions (continued)

EL3 Execution state	Control bits			Effect of CPSR.F ^a mask in Exception level							
	SCR	FW	RW ^b	HCR	Non-secure			Secure			
				FMO ^c	EL0	EL1	EL2	EL0	EL1 ^d	EL3	
AArch64	0	x	0	0	M	M	M	M	M	P	
				1	T	T	M	M	M	P	
				1	0	M	M	P	M	M	P
					1	T	T	M	M	M	P
1	x	x	x	T	T	T	T	T	M		

- a. Or the PSTATE.F mask in an Exception level that is using AArch64.
- b. SCR_EL3 only, this control is not present when EL3 is using AArch32. When the value of RW is 1, the next lower Exception level is using AArch64.
- c. When the value of HCR.TGE is 1, the effective value of this bit is 1.
- d. When EL3 is using AArch32, the only Secure Exception levels are EL0 and EL3.

Table G1-19 Masking of physical IRQ exceptions

EL3 Execution state	Control bits			Effect of CPSR.I ^a mask in Exception level							
	SCR	RW ^b	HCR	Non-secure			Secure				
				IRQ	IMO ^c	EL0	EL1	EL2	EL0	EL1 ^d	EL3
AArch32	0	x	0	0	M	M	M	M	-	M	
				1	T	T	M	M	-	M	
				1	0	M	M	M	M	-	M
					1	T	T	T	M	-	M
AArch64	0	0	0	0	M	M	M	M	M	P	
				1	T	T	M	M	M	P	
				1	0	M	M	P	M	M	P
					1	T	T	M	M	M	P
1	x	x	x	T	T	T	T	T	M		

- a. Or the PSTATE.I mask in an Exception level that is using AArch64.
- b. SCR_EL3 only, this control is not present when EL3 is using AArch32. When the value of RW is 1, the next lower Exception level is using AArch64.
- c. When the value of HCR.TGE is 1, the effective value of this bit is 1.
- d. When EL3 is using AArch32, the only Secure Exception levels are EL0 and EL3.

Table G1-20 Masking of physical Asynchronous aborts

EL3 Execution state	Control bits			Effect of CPSR.A ^a mask in Exception level								
	SCR EA	AW	RW ^b	HCR	Non-secure			Secure				
				AMO ^c	EL0	EL1	EL2	EL0	EL1 ^d	EL3		
AArch32	0	x	x	0	M	M	M	M	-	M		
				1	T	T	M	M	-	M		
	1	0	x	0	T	T	T	M	-	M		
		1	x	0	M	M	M	M	-	M		
		x	x	1	T	T	T	M	-	M		
AArch64	0	x	0	0	M	M	M	M	M	P		
				1	T	T	M	M	M	P		
					1	0	M	M	P	M	M	P
					1	T	T	M	M	M	P	
	1	x	x	x	T	T	T	T	T	M		

- a. Or the PSTATE.A mask in an Exception level that is using AArch64.
- b. SCR_EL3 only, this control is not present when EL3 is using AArch32. When the value of RW is 1, the next lower Exception level is using AArch64.
- c. When the value of HCR.TGE is 1, the effective value of this bit is 1.
- d. When EL3 is using AArch32, the only Secure Exception levels are EL0 and EL3.

G1.13 AArch32 state exception descriptions

Handling exceptions that are taken to an Exception level using AArch32 on page G1-3431 gives general information about exception handling. This section describes each of the exceptions, in the following subsections:

- *Reset.*
- *Undefined Instruction exception on page G1-3476.*
- *Hyp Trap exception on page G1-3478.*
- *Supervisor Call (SVC) exception on page G1-3479.*
- *Secure Monitor Call (SMC) exception on page G1-3480.*
- *Hypervisor Call (HVC) exception on page G1-3481.*
- *Prefetch Abort exception on page G1-3481.*
- *Data Abort exception on page G1-3483.*
- *Virtual Abort exception on page G1-3485.*
- *IRQ exception on page G1-3486.*
- *Virtual IRQ exception on page G1-3488.*
- *FIQ exception on page G1-3489.*
- *Virtual FIQ exception on page G1-3490.*

Additional pseudocode functions for exception handling on page G1-3491 gives additional pseudocode that is used in the pseudocode descriptions of a number of the exceptions.

G1.13.1 Reset

On an ARM PE, when the Reset input is asserted the PE stops execution. When Reset is deasserted, the PE then starts executing instructions in the highest implemented Exception level. If that Exception level is using AArch32, then it starts execution:

- In Secure state, if the implementation includes EL3.
- With interrupts disabled:
 - In Hyp mode, if the highest implemented Exception level is EL2.
 - In Supervisor mode, otherwise.

Reset returns some PE state to architecturally-defined or IMPLEMENTATION DEFINED values, and makes other state UNKNOWN. For more information see:

- *Behavior of caches at reset on page G2-3526.*
- *Enabling stages of address translation on page G3-3572.*
- *TLB behavior at reset on page G3-3631.*
- *Reset behavior of CP14 and CP15 registers on page G3-3695.*

When reset is deasserted, execution starts either:

- From an IMPLEMENTATION DEFINED address.
Software might be able to identify this address:
 - If reset is into EL3, by reading the reset value of **MVBAR**. That is, after coming out of reset, by reading **MVBAR** before the boot software has updated it.
 - If reset is into EL2 or EL1, by reading **RVBAR**.

It is IMPLEMENTATION DEFINED whether this discovery mechanism is supported. **RVBAR** can only be implemented at the highest implemented Exception level, and only if that Exception level is not EL3. If **RVBAR** is not implemented, and at all Exception levels other than the highest implemented Exception level, the encoding for **RVBAR** is UNDEFINED.

- If reset is into EL3 or EL1, from the low or high reset vector address, `0x00000000` or `0xFFFF0000`, as determined by the reset value of the **SCTLR.V** bit. This reset value can be determined by an IMPLEMENTATION DEFINED configuration input signal.

When execution starts, system behavior depends on the reset value of the **CPSR**, as defined by the `TakeReset()` pseudocode function that is defined later in this section. See also [The Current Program Status Register \(CPSR\) on page G1-3422](#).

The ARM architecture does not define any way of returning to a previous execution state from a reset.

———— **Note** ————

- A Reset exception does not reset the value of all of the debug registers. For more information see [Reset and debug on page H8-4463](#).
- The ARM architecture does not distinguish between multiple levels of reset. A system can provide multiple distinct levels of reset that reset different parts of the system. These all correspond to this single reset exception.

Pseudocode description of taking the Reset exception

The `TakeReset()` pseudocode procedure describes how the PE takes the exception:

```
// TakeReset()
// =====

TakeReset()
  // Enter Supervisor mode and (if relevant) Secure state, and reset CP15. This affects
  // the Banked versions and values of various registers accessed later in the code.
  // Also reset other system components.
  CPSR.M = '10011'; // Supervisor mode
  if HaveSecurityExt() then SCR.NS = '0';
  ResetControlRegisters();
  if HaveAdvSIMDorVFP() then FPEXC.EN = '0'; SUBARCHITECTURE_DEFINED further resetting;
  if HaveThumbEE() then TEECR.XED = '0';
  if HaveJazelle() then JMCR.JE = '0'; SUBARCHITECTURE_DEFINED further resetting;

  // Further CPSR changes: all interrupts disabled, IT state reset, instruction set
  // and endianness according to the SCTLR values produced by the above call to
  // ResetControlRegisters().
  CPSR.I = '1'; CPSR.F = '1'; CPSR.A = '1';
  CPSR.IT = '00000000';
  CPSR.J = '0'; CPSR.T = SCTLR.TE; // TE=0: ARM, TE=1: Thumb
  CPSR.E = SCTLR.EE; // EE=0: little-endian, EE=1: big-endian

  // All registers, bits and fields not reset by the above pseudocode or by the
  // BranchTo() call below are UNKNOWN bitstrings after reset. In particular, the
  // return information registers R14_svc and SPSR_svc have UNKNOWN values, so that
  // it is impossible to return from a reset in an architecturally defined way.

  // Branch to Reset vector.
  BranchTo(ExcVectorBase() + 0);
```

G1.13.2 Undefined Instruction exception

An Undefined Instruction exception might be caused by:

- A coprocessor instruction that is not accessible because of the settings in one or more of the **CPACR**, **NSACR**, and the **HCPTR**.
- A coprocessor instruction that is not implemented.
- A coprocessor instruction that causes an exception during execution, for example a trapped floating-point exception on a floating-point instruction, see [Floating-point exceptions on page E1-2307](#).
- An instruction that is UNDEFINED.
- An attempt to execute an instruction in an unimplemented instruction set state, see [Exception return to an unimplemented instruction set state on page G1-3458](#).

- Division by zero in an SDIV or UDIV instruction.

By default, an Undefined Instruction exception is taken to Undefined mode, but an Undefined Instruction exception can be taken EL2, meaning it is taken to Hyp mode if EL2 is using AArch32, see [Determining the PE mode to which the Undefined Instruction exception is taken on page G1-3443](#).

The Undefined Instruction exception can provide:

- Signaling of an illegal instruction execution.
- *Lazy context switching* of coprocessor registers.

The preferred return address for an Undefined Instruction exception is the address of the instruction that generated the exception. This return is performed as follows:

- If returning from Secure or Non-secure Undefined mode, the exception return uses the **SPSR** and **LR_und** values generated by the exception entry, as follows:
 - If **SPSR**.{J, T} are both 0, indicating that the exception occurred in A32 state, the return uses an exception return instruction with a subtraction of 4.
 - If **SPSR**.T is 1, indicating that the exception occurred in T32 state, the return uses an exception return instruction with a subtraction of 2.
- If returning from Hyp mode, the exception return is performed by an ERET instruction, using the **SPSR** and **ELR_hyp** values generated by the exception entry.

For more information, see [Exception return to an Exception level using AArch32 on page G1-3454](#).

———— **Note** —————

If handling the Undefined Instruction exception requires instruction emulation, followed by return to the next instruction after the instruction that caused the exception, the instruction emulator must use the instruction length to calculate the correct return address, and to calculate the updated values of the IT bits if necessary.

Pseudocode description of taking the Undefined Instruction exception

The `TakeUndefInstrException()` pseudocode procedure describes how the PE takes the exception:

```
// AArch32.TakeUndefInstrException()
// =====

AArch32.TakeUndefInstrException()
  assert !AArch32.GeneralExceptionsToAArch64();

  take_to_hyp = PSTATE.EL == EL2;
  route_to_hyp = AArch32.GeneralExceptionsToHyp();

  bits(32) preferred_exception_return = ThisInstrAddr();
  vect_offset = 0x4;
  lr_offset = if CurrentInstrSet() == InstrSet_A32 then 8 else 4;

  if take_to_hyp || route_to_hyp then
    exception = ExceptionSyndrome(Exception_Uncategorized);
    if take_to_hyp then
      AArch32.EnterHypMode(exception, preferred_exception_return, vect_offset);
    else
      AArch32.EnterHypMode(exception, preferred_exception_return, 0x14);
  else
    AArch32.EnterMode(M32_Undef, preferred_exception_return, lr_offset, vect_offset);
```

[Additional pseudocode functions for exception handling on page G1-3491](#) defines the `EnterHypMode()` pseudocode procedure.

Conditional execution of undefined instructions

The conditional execution rules described in [Conditional execution on page F2-2416](#) apply to all instructions. This includes undefined instructions and other instructions that would cause entry to the Undefined Instruction exception.

If such an instruction fails its condition check, the behavior depends on the architecture profile and the potential cause of entry to the Undefined Instruction exception, as follows:

- If the potential cause is the execution of the instruction itself and depends on data values used by the instruction, the instruction executes as a NOP and does not cause an Undefined Instruction exception.
- If the potential cause is the execution of an earlier coprocessor instruction, or the execution of the instruction itself without dependence on the data values used by the instruction, it is IMPLEMENTATION DEFINED whether the instruction executes as a NOP or causes an Undefined Instruction exception.

An implementation must handle all such cases in the same way.

———— Note —————

Before ARMv7, all implementations executed any instruction that failed its condition check as a NOP, even if it would otherwise have caused an Undefined Instruction exception. An Undefined Instruction handler written for these implementations might assume without checking that the undefined instruction passed its condition check. Such an Undefined Instruction handler is likely to need rewriting, to check the condition is passed, before it functions correctly on all AArch32 implementations.

Interaction of UNPREDICTABLE and UNDEFINED instruction behavior

If this manual describes an instruction as both UNPREDICTABLE and UNDEFINED then the instruction is UNPREDICTABLE.

———— Note —————

An example of this is where both:

- An instruction, or instruction class, is made UNDEFINED by some general principle, or by a configuration field.
- A particular encoding of that instruction or instruction class is specified as UNPREDICTABLE.

G1.13.3 Hyp Trap exception

The Hyp Trap exception is implemented only as part of EL2.

A Hyp Trap exception is generated if the PE is running in a Non-secure mode other than Hyp mode, and commits for execution an instruction that is trapped to Hyp mode. Instruction traps are enabled by setting bits to 1 in the [HCR](#), [HCPTR](#), [HDCR](#), or [HSTR](#). For more information see [AArch32 control of traps to the hypervisor on page G1-3503](#).

A Hyp Trap exception is taken to Hyp mode.

The preferred return address for a Hyp Trap exception is the address of the trapped instruction. The exception return is performed by an ERET instruction, using the [SPSR](#) and [ELR_hyp](#) values generated by the exception entry.

———— Note —————

The [SPSR](#) and [ELR_hyp](#) values generated on exception entry can be used, without modification, for an exception return to re-execute the trapped instruction. If the exception handler emulates the trapped instruction, and must return to the following instruction, the emulation of the instruction must include modifying [ELR_hyp](#), and possibly updating [SPSR_hyp](#).

For related information, see [General information about traps to the hypervisor on page G1-3504](#).

Pseudocode description of taking the Hyp Trap exception

The TakeHypTrapException() pseudocode procedure describes how the PE takes the exception:

```
// AArch32.TakeHypTrapException()
// =====
// Exceptions routed to Hyp mode as a Hyp Trap exception.

AArch32.TakeHypTrapException(ExceptionRecord exception)
    assert HaveEL(EL2) && !IsSecure() && ELUsingAArch32(EL2);

    bits(32) preferred_exception_return = ThisInstrAddr();
    AArch32.EnterHypMode(exception, preferred_exception_return, 0x14);
```

Additional pseudocode functions for exception handling on page G1-3491 defines the EnterHypMode() pseudocode procedure.

G1.13.4 Supervisor Call (SVC) exception

The Supervisor Call instruction, SVC, requests a supervisor function, typically to request an operating system function. When EL1 is using AArch32, executing an SVC instruction causes the PE to enter Supervisor mode. For more information, see *SVC (previously SWI) on page F7-2926*.

———— Note ————

In an implementation that includes EL2:

- When an SVC instruction is executed in Hyp mode, the Supervisor Call exception is taken to Hyp mode. For more information see *SVC (previously SWI) on page F7-2926*.
- When the HCR.TGE bit is set to 1, the Supervisor Call exception generated by execution of an SVC instruction in Non-secure User mode is routed to Hyp mode. For more information, see *Supervisor Call exception, when HCR.TGE is set to 1 on page G1-3452*.

By default, a Supervisor Call exception is taken to Supervisor mode, but a Supervisor Call exception can be taken to EL2, meaning it is taken to Hyp mode if EL2 is using AArch32, see *Determining the PE mode to which the Supervisor Call exception is taken on page G1-3444*.

The preferred return address for a Supervisor Call exception is the address of the next instruction after the SVC instruction. This return is performed as follows:

- If returning from Secure or Non-secure Supervisor mode, the exception return uses the SPSR and LR_svc values generated by the exception entry, in an exception return instruction without subtraction.
- If returning from Hyp mode, the exception return is performed by an ERET instruction, using the SPSR and ELR_hyp values generated by the exception entry.

For more information, see *Exception return to an Exception level using AArch32 on page G1-3454*.

Pseudocode description of taking the Supervisor Call exception

The TakeSVCEXception() pseudocode procedure describes how the PE takes the exception:

```
// AArch32.TakeSVCEXception()
// =====

AArch32.TakeSVCEXception(bits(16) immediate)
    assert !AArch32.GeneralExceptionsToAArch64();

    AArch32.ITAdvance();
    SSAdvance();

    take_to_hyp = PSTATE.EL == EL2;
    route_to_hyp = AArch32.GeneralExceptionsToHyp();
```

```
bits(32) preferred_exception_return = NextInstrAddr();
vect_offset = 0x08;
lr_offset = 0;

if take_to_hyp || route_to_hyp then
    exception = ExceptionSyndrome(Exception_SupervisorCall);
    exception.syndrome<15:0> = immediate;
    if take_to_hyp then
        AArch32.EnterHypMode(exception, preferred_exception_return, vect_offset);
    else
        AArch32.EnterHypMode(exception, preferred_exception_return, 0x14);
else
    AArch32.EnterMode(M32_Svc, preferred_exception_return, lr_offset, vect_offset);
```

Additional pseudocode functions for exception handling on page G1-3491 defines the EnterHypMode() pseudocode procedure.

G1.13.5 Secure Monitor Call (SMC) exception

The Secure Monitor Call exception is implemented only as part of EL3. When EL3 is using AArch32, the exception is taken to Monitor mode.

The Secure Monitor Call instruction, SMC, requests a Secure Monitor function. When EL3 is using AArch32, executing an SMC instruction causes the PE to enter Monitor mode. For more information, see *SMC (previously SMI) on page F7-3058*.

———— Note —————

In an implementation that includes EL2, execution of an SMC instruction in a Non-secure EL1 mode can be trapped to EL2. When EL2 is using AArch32, this means that when the value of the HCR.TSC bit is 1, execution of an SMC instruction in a Non-secure EL1 mode generates a Hyp Trap Exception that is taken to Hyp mode. For more information see *Trapping use of the SMC instruction on page G1-3510*.

The preferred return address for a Secure Monitor Call exception is the address of the next instruction after the SMC instruction. This return is performed using the SPSR and LR_mon values generated by the exception entry, using an exception return instruction without a subtraction.

For more information, see *Exception return to an Exception level using AArch32 on page G1-3454*.

———— Note —————

The exception handler can return to the SMC instruction itself by returning using a subtraction of 4, without any adjustment to the SPSR.IT[7:0] bits. If it does this, the return occurs, then interrupts or external aborts might occur and be handled, then the SMC instruction is re-executed and another Secure Monitor Call exception occurs.

This relies on:

- The SMC instruction being used correctly, either outside an IT block or as the last instruction in an IT block, so that the SPSR.IT[7:0] bits indicate unconditional execution.
- The Secure Monitor Call handler not changing the result of the original conditional execution test for the SMC instruction.

Pseudocode description of taking the Secure Monitor Call exception

The TakeSMCException() pseudocode procedure describes how the PE takes the exception:

```
// AArch32.TakeSMCException()
// =====

AArch32.TakeSMCException()
    assert HaveEL(EL3) && ELUsingAArch32(EL3);

    AArch32.ITAdvance();
```

```

SSAdvance();

bits(32) preferred_exception_return = NextInstrAddr();
vect_offset = 0x08;
lr_offset = 0;

AArch32.EnterMonitorMode(preferred_exception_return, lr_offset, vect_offset);

```

Additional pseudocode functions for exception handling on page G1-3491 defines the EnterMonitorMode() pseudocode procedure.

G1.13.6 Hypervisor Call (HVC) exception

The Hypervisor Call exception is implemented only as part of EL2.

The Hypervisor Call instruction, HVC, requests a hypervisor function. When EL2 is using AArch32, executing an HVC instruction generates a Hypervisor Call exception that is taken to Hyp mode. For more information, see [HVC on page F7-3040](#).

The preferred return address for a Hypervisor Call exception is the address of the next instruction after the HVC instruction. The exception return is performed by an ERET instruction, using the [SPSR](#) and [ELR_hyp](#) values generated by the exception entry.

For more information, see [Exception return to an Exception level using AArch32 on page G1-3454](#).

When EL2 is using AArch32, executing an HVC instruction transfers the immediate argument of the instruction to the [HSR](#). The exception handler retrieves the argument from the [HSR](#), and therefore does not have to access the original HVC instruction. For more information see [Use of the HSR on page G3-3672](#).

Pseudocode description of taking the Hypervisor Call exception

The TakeHVCEXception() pseudocode procedure describes how the PE takes the exception:

```

// AArch32.TakeHVCEXception()
// =====

AArch32.TakeHVCEXception(bits(16) immediate)
  assert ELUsingAArch32(EL2);

  AArch32.ITAdvance();
  SSAdvance();

  exception = ExceptionSyndrome(Exception_HypervisorCall);
  exception.syndrome<15:0> = immediate;
  bits(32) preferred_exception_return = NextInstrAddr();
  vect_offset = 0x08;

  if PSTATE.EL == EL2 then
    AArch32.EnterHypMode(exception, preferred_exception_return, vect_offset);
  else
    AArch32.EnterHypMode(exception, preferred_exception_return, 0x14);

```

Additional pseudocode functions for exception handling on page G1-3491 defines the EnterHypMode() pseudocode procedure.

G1.13.7 Prefetch Abort exception

A Prefetch Abort exception can be generated by:

- A synchronous memory abort on an instruction fetch.

———— **Note** —————

Asynchronous aborts on instruction fetches are reported using the Data Abort exception, see [Data Abort exception on page G1-3483](#).

A Prefetch Abort exception entry is synchronous to the instruction whose fetch aborted.

For more information about memory aborts see [VMSAv8-32 memory aborts on page G3-3647](#).

- A Breakpoint, Vector catch or BKPT instruction debug event, see [Breakpoint debug events and Vector Catch exception on page H2-4333](#).

———— **Note** —————

If an implementation fetches instructions speculatively, it must handle a synchronous abort on such an instruction fetch by:

- Generating a Prefetch Abort exception only if the instruction would be executed in a simple sequential execution of the program.
- Ignoring the abort if the instruction would not be executed in a simple sequential execution of the program.

By default, when EL1 is using AArch32, a Prefetch Abort exception is taken to Abort mode, but a Prefetch Abort exception can be taken to:

- EL2, meaning it is taken to Hyp mode if EL2 is using AArch32.
- EL3, meaning it is taken to Monitor mode if EL3 is using AArch32.

For more information, see [Determining the PE mode to which the Prefetch Abort exception is taken on page G1-3446](#).

The preferred return address for a Prefetch Abort exception is the address of the aborted instruction. This return is performed as follows:

- If returning from a mode other than Hyp mode, using the [SPSR](#) and LR values generated by the exception entry, using an exception return instruction with a subtraction of 4. This means using:
 - SPSR_abt and LR_abt if returning from Abort mode.
 - SPSR_mon and LR_mon if returning from Monitor mode.
- If returning from Hyp mode, using the [SPSR_hyp](#) and [ELR_hyp](#) values generated by the exception entry, using an ERET instruction.

For more information, see [Exception return to an Exception level using AArch32 on page G1-3454](#).

Pseudocode description of taking the Prefetch Abort exception

The TakePrefetchAbortException() pseudocode procedure describes how the PE takes the exception:

```
// AArch32.TakePrefetchAbortException()
// =====

AArch32.TakePrefetchAbortException(bits(32) vaddress, FaultRecord fault)

    route_to_monitor = HaveEL(EL3) && SCR_GEN[.EA] == '1' && IsExternalAbort(fault);
    take_to_hyp = PSTATE.EL == EL2;
    route_to_hyp = (AArch32.GeneralExceptionsToHyp() || IsSecondStage(fault) ||
        (HaveEL(EL2) && !IsSecure() && IsDebugException(fault) && HDCR.TDE == '1'));

    bits(32) preferred_exception_return = ThisInstrAddr();
    vect_offset = 0x0C;
    lr_offset = 4;

    secure = route_to_monitor || IsSecure();

    if IsDebugException(fault) then DBGDSCRext.MOE = fault.debugmoe;

    if route_to_monitor then
        AArch32.ReportPrefetchAbort(secure, fault, vaddress);
        AArch32.EnterMonitorMode(preferred_exception_return, lr_offset, vect_offset);
    elsif take_to_hyp || route_to_hyp then
        if fault.type == Fault_Alignment then // PC Alignment fault
```



```

    exception = ExceptionSyndrome(Exception_PCAAlignment);
  else
    exception = AArch32.AbortSyndrome(Exception_InstructionAbort, fault, vaddress);
  if take_to_hyp then
    AArch32.EnterHypMode(exception, preferred_exception_return, vect_offset);
  else
    AArch32.EnterHypMode(exception, preferred_exception_return, 0x14);
  else
    AArch32.ReportPrefetchAbort(secure, fault, vaddress);
    AArch32.EnterMode(M32_Abort, preferred_exception_return, lr_offset, vect_offset);

```

Additional pseudocode functions for exception handling on page G1-3491 defines the `EnterMonitorMode()` and `EnterHypMode()` pseudocode procedures.

G1.13.8 Data Abort exception

A Data Abort exception can be generated by:

- A synchronous abort on a data read or write memory access. Exception entry is synchronous to the instruction that generated the memory access.
- An asynchronous abort. The memory access that caused the abort can be any of:
 - A data read or write access.
 - An instruction fetch.
 - In a VMSA memory system, a translation table access.

Exception entry occurs asynchronously, and is similar to an interrupt.

As described in *Asynchronous exception masking controls on page G1-3468*, asynchronous aborts can be masked. When this happens, a generated asynchronous abort is not taken until it is not masked.

———— Note —————

There are no asynchronous internal aborts in the ARM architecture, so asynchronous aborts are always asynchronous external aborts.

- A Watchpoint debug event, see *Breakpoint and Watchpoint debug events on page H2-4330*.

———— Note —————

Data Abort exceptions generated by Watchpoint debug events can be either asynchronous or synchronous. However, the `CPSR.A` bit has no effect on the taking of such an exception, regardless of whether it is asynchronous.

By default, when EL1 is using AArch32 a Data Abort exception is taken to Abort mode, but a Data Abort exception can be taken to:

- EL2, meaning it is taken to Hyp mode if EL2 is using AArch32.
- EL3, meaning it is taken to Monitor mode if EL3 is using AArch32.

For more information see *Determining the PE mode to which the Data Abort exception is taken on page G1-3447*.

For more information about memory aborts see *VMSAv8-32 memory aborts on page G3-3647*.

The preferred return address for a Data Abort exception is the address of the instruction that generated the aborting memory access, or the address of the instruction following the instruction boundary at which an asynchronous Data Abort exception was taken. This return is performed as follows:

- If returning from a mode other than Hyp mode, using the `SPSR` and `LR` values generated by the exception entry, using an exception return instruction with a subtraction of 8. This means using:
 - `SPSR_abt` and `LR_abt` if returning from Abort mode.
 - `SPSR_mon` and `LR_mon` if returning from Monitor mode.
- If returning from Hyp mode, using the `SPSR_hyp` and `ELR_hyp` values generated by the exception entry, using an `ERET` instruction.

For more information, see [Exception return to an Exception level using AArch32](#) on page G1-3454.

Pseudocode description of taking the Data Abort exception

The TakeDataAbortException() pseudocode procedure describes how the PE takes the exception:

```
// AArch32.TakeDataAbortException()
// =====

AArch32.TakeDataAbortException(bits(32) vaddress, FaultRecord fault)

    route_to_monitor = HaveEL(EL3) && SCR_GEN[.EA == '1' && IsExternalAbort(fault)];
    take_to_hyp = PSTATE.EL == EL2;
    route_to_hyp = (AArch32.GeneralExceptionsToHyp() || IsSecondStage(fault) ||
        (HaveEL(EL2) && !IsSecure() && IsDebugException(fault) && HDCR.TDE == '1'));

    bits(32) preferred_exception_return = ThisInstrAddr();
    vect_offset = 0x10;
    lr_offset = 8;

    secure = route_to_monitor || IsSecure();

    if IsDebugException(fault) then DBGDSCRext.MOE = fault.debugmoe;

    if route_to_monitor then
        AArch32.ReportDataAbort(secure, fault, vaddress);
        AArch32.EnterMonitorMode(preferred_exception_return, lr_offset, vect_offset);
    elseif take_to_hyp || route_to_hyp then
        exception = AArch32.AbortSyndrome(Exception_DataAbort, fault, vaddress);
        if take_to_hyp then
            AArch32.EnterHypMode(exception, preferred_exception_return, vect_offset);
        else
            AArch32.EnterHypMode(exception, preferred_exception_return, 0x14);
    else
        AArch32.ReportDataAbort(secure, fault, vaddress);
        AArch32.EnterMode(M32_Abort, preferred_exception_return, lr_offset, vect_offset);
```

[Additional pseudocode functions for exception handling on page G1-3491](#) defines the EnterMonitorMode() and EnterHypMode() pseudocode procedures.

Effects of data-aborted instructions

An instruction that accesses data memory can modify memory by storing one or more values. If the execution of such an instruction generates a Data Abort exception, or causes Debug state entry because of a watchpoint set on the instruction, the value of each memory location that the instruction stores to is:

- Unchanged for any location for which one of the following applies:
 - A stage of address translation fault is generated.
 - A Watchpoint is generated.
 - An external abort is generated, if that external abort is taken synchronously.
- UNKNOWN for any location for which no exception is generated.

If the access to a memory location generates an external abort that is taken asynchronously, it is outside the scope of the architecture to define the effect of the store on that memory location, because this depends on the system-specific nature of the external abort. However, in general, ARM recommends that such locations are unchanged.

For external aborts and Watchpoints, where in principle faulting could be identified at byte or halfword granularity, the size of a location in this definition is the size for which a memory access is single-copy atomic.

In AArch32 state, instructions that access data memory can modify registers in the following ways:

- By loading values into one or more of the general-purpose registers. The registers loaded can include the PC.
- By loading values into one or more of the registers in the Advanced SIMD and floating-point register bank.

- By specifying *base register writeback*, in which the base register used in the address calculation has a modified value written to it. All instructions that support base register writeback have UNPREDICTABLE results if base register writeback is specified with the PC as the base register. Only general-purpose registers can be modified reliably in this way.
- By a direct or indirect write to one or more coprocessor registers, for example:
 - An LDC instruction is a *direct write* to a coprocessor register with a value read from memory.
 - An STC instruction that reads `DBGDTRTXint` makes an *indirect write* to `DBGDSCRint.RXfull`.
- By modifying the `CPSR`.

If the execution of such an instruction generates a synchronous Data Abort exception, the following rules determine the values left in these registers:

- On entry to the Data Abort exception handler:
 - The PC value is the Data Abort vector address, see *Exception vectors and the exception base address on page G1-3431*.
 - The `LR_abt` value is determined from the address of the aborted instruction.Neither value is affected by the results of any load specified by the instruction.
- The base register is restored to its original value if either:
 - The aborted instruction is a load and the list of registers to be loaded includes the base register.
 - The base register is being written back.
- If the instruction only loads one general-purpose register the value in that register is unchanged.
- If the instruction loads more than one general-purpose register, UNKNOWN values are left in destination registers other than the PC and the base register of the instruction.
- If the instruction affects any registers in the Advanced SIMD and floating-point register bank, UNKNOWN values are left in the registers that are affected.
- `CPSR` bits that are not defined as updated on exception entry retain their current value.
- If the instruction is a STREX, STREXB, STREXH, or STREXD, `<Rd>` is not updated.

After taking a Data Abort exception, the state of the exclusive monitors is UNKNOWN. Therefore, ARM strongly recommends that the abort handler performs a CLREX instruction, or a dummy STREX instruction, to clear the exclusive monitor state.

The ARM abort model

The abort model used by an ARM PE is described as a *Base Restored Abort Model*. This means that if a synchronous Data Abort exception is generated by executing an instruction that specifies base register writeback, the value in the base register is unchanged.

The abort model applies uniformly across all instructions.

G1.13.9 Virtual Abort exception

The Virtual Abort exception is implemented only as part of EL2.

A Virtual Abort exception is generated if all of the following apply:

- The PE is in a Non-secure mode other than Hyp mode.
- The value of `CPSR.A` is 0.
- Either:
 - EL2 is using AArch32 and the values of the `HCR.{AMO, VA}` bits are {1, 1}.
 - EL2 is using AArch64 and the values of the `HCR_EL2.{AMO, VA}` bits are {1, 1}.

The conditions for generating a Virtual Abort exception mean the exception is always:

- Taken from a Non-secure EL1 or EL0 mode.
- Taken to Non-secure Abort mode.

For more information see [Virtual exceptions when an implementation includes EL2](#) on page G1-3465.

———— **Note** —————

Because the Virtual Abort exception is always taken to Non-secure Abort mode, on exception entry the preferred return address is always saved to LR_abt.

The preferred return address for a Virtual Abort exception is the address of the instruction immediately after the instruction boundary where the exception was taken. This return is performed using the [SPSR](#) and LR_abt values generated by the exception entry, using an exception return instruction without subtraction.

Pseudocode description of taking the Virtual Asynchronous Abort exception

The TakeVirtualAsyncAbortException() pseudocode procedure describes how the PE takes the exception:

```
// AArch32.TakeVirtualAsyncAbortException()
// =====

AArch32.TakeVirtualAsyncAbortException()
    assert HaveEL(EL2) && !IsSecure() && PSTATE.EL != EL2 && HCR.TGE == '0';

    if !ELUsingAArch32(EL1) then
        AArch64.TakeVirtualSystemErrorException();

    secure = FALSE;
    parity = FALSE;
    extflag = bit IMPLEMENTATION_DEFINED "Virtual Asynchronous Abort Ext bit";
    fault = AArch32.AsyncExternalAbort(parity, extflag);
    vaddress = bits(32) UNKNOWN;

    vect_offset = 0x10;
    bits(32) preferred_exception_return = ThisInstrAddr();
    lr_offset = 8;

    HCR.VA = '0';
    AArch32.ReportDataAbort(secure, fault, vaddress);
    AArch32.EnterMode(M32_Abort, preferred_exception_return, lr_offset, vect_offset);
```

G1.13.10 IRQ exception

The IRQ exception is generated by IMPLEMENTATION DEFINED means. Typically this is by asserting an IRQ interrupt request input to the PE.

When an IRQ exception is taken, exception entry is precise to an instruction boundary.

As described in [Asynchronous exception masking controls](#) on page G1-3468, IRQ exceptions can be masked. When this happens, a generated IRQ exception is not taken until it is not masked.

By default, when EL1 is using AArch32, an IRQ exception is taken to IRQ mode, but an IRQ exception can be taken to:

- EL2, meaning it is taken to Hyp mode if EL2 is using AArch32.
- EL3, meaning it is taken to Monitor mode if EL3 is using AArch32.

For more information, see [Determining the PE mode to which the physical IRQ exception is taken](#) on page G1-3448.

The preferred return address for an IRQ exception is the address of the instruction following the instruction boundary at which the exception was taken. This return is performed as follows:

- If returning from a mode other than Hyp mode, using the [SPSR](#) and LR values generated by the exception entry, using an exception return instruction with a subtraction of 4. This means using:
 - [SPSR_irq](#) and [LR_irq](#) if returning from IRQ mode.
 - [SPSR_mon](#) and [LR_mon](#) if returning from Monitor mode.
- If returning from Hyp mode, using the [SPSR_hyp](#) and [ELR_hyp](#) values generated by the exception entry, using an ERET instruction.

For more information, see [Exception return to an Exception level using AArch32](#) on page G1-3454.

Pseudocode description of taking the IRQ exception

The TakePhysicalIRQException() pseudocode procedure describes how the PE takes the exception:

```
// AArch32.TakePhysicalIRQException()
// =====
// Take an enabled physical IRQ exception.

AArch32.TakePhysicalIRQException()

    route_to_monitor = HaveEL(EL3) && SCR_GEN[].IRQ == '1';
    take_to_hyp = PSTATE.EL == EL2;
    route_to_hyp = (AArch32.GeneralExceptionsToHyp() ||
        (HaveEL(EL2) && !IsSecure() && HCR.IMO == '1'));

    if AArch32.ExceptionToAArch64(route_to_monitor, route_to_hyp) then
        AArch64.TakePhysicalIRQException();

    vect_offset = 0x18;
    bits(32) preferred_exception_return = ThisInstrAddr();
    lr_offset = 4;

    if route_to_monitor then
        AArch32.EnterMonitorMode(preferred_exception_return, lr_offset, vect_offset);
    elseif take_to_hyp || route_to_hyp then
        exception = ExceptionSyndrome(Exception_IRQ);
        AArch32.EnterHypMode(exception, preferred_exception_return, vect_offset);
    else
        AArch32.EnterMode(M32_IRQ, preferred_exception_return, lr_offset, vect_offset);
```

Additional pseudocode functions for exception handling on page G1-3491 defines the EnterMonitorMode() and EnterHypMode() pseudocode procedures.

G1.13.11 Virtual IRQ exception

The Virtual IRQ exception is implemented only as part of EL2.

A Virtual IRQ exception is generated if all of the following apply:

- The PE is in a Non-secure mode other than Hyp mode.
- The value of `CPSR.I` is 0.
- Either:
 - EL2 is using AArch32 and the value of `HCR.IMO` is 1.
 - EL2 is using AArch64 and the value of `HCR_EL2.IMO` is 1.
- One of the following applies:
 - EL2 is using AArch32 and the value of `HCR.VI` is 1.
 - EL2 is using AArch64 and the value of `HCR_EL2.VI` is 1.
 - A Virtual IRQ exception is generated by an IMPLEMENTATION DEFINED mechanism.

The conditions for generating a Virtual IRQ exception mean the exception is always:

- Taken from a Non-secure EL1 or EL0 mode.
- Taken to Non-secure IRQ mode.

For more information see *Virtual exceptions when an implementation includes EL2 on page G1-3465*

The preferred return address for a Virtual IRQ exception is the address of the instruction immediately after the instruction boundary where the exception was taken. This return is performed using the `SPSR` and `LR_irq` values generated by the exception entry, using an exception return instruction with a subtraction of 4.

Pseudocode description of taking the Virtual IRQ exception

The TakeVirtualIRQException() pseudocode procedure describes how the PE takes the exception:

```
// AArch32.TakeVirtualIRQException()
// =====

AArch32.TakeVirtualIRQException()
    assert HaveEL(EL2) && !IsSecure() && PSTATE.EL != EL2 && HCR.TGE == '0';

    if !ELUsingAArch32(EL1) then
        AArch64.TakeVirtualFIQException();

    vect_offset = 0x18;
    bits(32) preferred_exception_return = ThisInstrAddr();
    lr_offset = 4;

    AArch32.EnterMode(M32_IRQ, preferred_exception_return, lr_offset, vect_offset);
```

G1.13.12 FIQ exception

The FIQ exception is generated by IMPLEMENTATION DEFINED means. Typically this is by asserting an FIQ interrupt request input to the PE.

When an FIQ exception is taken, exception entry is precise to an instruction boundary.

As described in *Asynchronous exception masking controls on page G1-3468*, FIQ exceptions can be masked. When this happens, a generated FIQ exception is not taken until it is not masked.

By default, an FIQ exception is taken to FIQ mode, but an FIQ exception can be taken:

- EL2, meaning it is taken to Hyp mode if EL2 is using AArch32.
- EL3, meaning it is taken to Monitor mode if EL3 is using AArch32.

For more information, see *Determining the PE mode to which the physical FIQ exception is taken on page G1-3449*.

The preferred return address for an FIQ exception is the address of the instruction following the instruction boundary at which the exception was taken. This return is performed as follows:

- If returning from a mode other than Hyp mode, using the *SPSR* and *LR* values generated by the exception entry, using an exception return instruction with a subtraction of 4. This means using:
 - *SPSR_fiq* and *LR_fiq* if returning from FIQ mode.
 - *SPSR_mon* and *LR_mon* if returning from Monitor mode.
- If returning from Hyp mode, using the *SPSR_hyp* and *ELR_hyp* values generated by the exception entry, using an ERET instruction.

For more information, see *Exception return to an Exception level using AArch32 on page G1-3454*.

Pseudocode description of taking the FIQ exception

The TakePhysicalFIQException() pseudocode procedure describes how the PE takes the exception:

```
// AArch32.TakePhysicalFIQException()
// =====

AArch32.TakePhysicalFIQException()

    route_to_monitor = HaveEL(EL3) && SCR_GEN[].FIQ == '1';
    take_to_hyp = PSTATE.EL == EL2;
    route_to_hyp = (AArch32.GeneralExceptionsToHyp() ||
        (HaveEL(EL2) && !IsSecure() && HCR.FMO == '1'));

    if AArch32.ExceptionToAArch64(route_to_monitor, route_to_hyp) then
        AArch64.TakePhysicalFIQException();
```

```
vect_offset = 0x1C;
bits(32) preferred_exception_return = ThisInstrAddr();
lr_offset = 4;

if route_to_monitor then
    AArch32.EnterMonitorMode(preferred_exception_return, lr_offset, vect_offset);
elseif take_to_hyp || route_to_hyp then
    exception = ExceptionSyndrome(Exception_FIQ);
    AArch32.EnterHypMode(exception, preferred_exception_return, vect_offset);
else
    AArch32.EnterMode(M32_FIQ, preferred_exception_return, lr_offset, vect_offset);
```

Additional pseudocode functions for exception handling on page G1-3491 defines the `EnterMonitorMode()` and `EnterHypMode()` pseudocode procedures.

G1.13.13 Virtual FIQ exception

The Virtual FIQ exception is implemented only as part of EL2.

A Virtual FIQ exception is generated if all of the following apply:

- The PE is in a Non-secure mode other than Hyp mode.
- The value of `CPSR.F` is 0.
- Either:
 - EL2 is using AArch32 and the value of `HCR.FMO` is 1.
 - EL2 is using AArch64 and the value of `HCR_EL2.IMO` is 1.
- One of the following applies:
 - EL2 is using AArch32 and the value of `HCR.VF` is 1.
 - EL2 is using AArch64 and the value of `HCR_EL2.VF` is 1.
 - A Virtual FIQ exception is generated by an IMPLEMENTATION DEFINED mechanism.

The conditions for generating a Virtual FIQ exception mean the exception is always:

- Taken from a Non-secure EL1 or EL0 mode.
- Taken to Non-secure FIQ mode.

For more information see *Virtual exceptions when an implementation includes EL2 on page G1-3465*.

The preferred return address for a Virtual FIQ exception is the address of the instruction immediately after the instruction boundary where the exception was taken. This return is performed using the `SPSR` and `LR_irq` values generated by the exception entry, using an exception return instruction with a subtraction of 4.

Pseudocode description of taking the Virtual FIQ exception

The `TakeVirtualFIQException()` pseudocode procedure describes how the PE takes the exception:

```
// AArch32.TakeVirtualFIQException()
// =====

AArch32.TakeVirtualFIQException()
    assert HaveEL(EL2) && !IsSecure() && PSTATE.EL != EL2 && HCR.TGE == '0';

    if !ELUsingAArch32(EL1) then
        AArch64.TakeVirtualFIQException();

    vect_offset = 0x1C;
    bits(32) preferred_exception_return = ThisInstrAddr();
    lr_offset = 4;

    AArch32.EnterMode(M32_FIQ, preferred_exception_return, lr_offset, vect_offset);
```

G1.13.14 Additional pseudocode functions for exception handling

The EnterMonitorMode() pseudocode function changes the PE mode to Monitor mode, with the required state changes:

```
// AArch32.EnterMonitorMode()
// =====
// Take an exception to Monitor mode.

AArch32.EnterMonitorMode(bits(32) preferred_exception_return, integer lr_offset,
                          integer vect_offset)
  assert HaveEL(EL3) && ELUsingAArch32(EL3);

  spsr = GetSPSRFromPSTATE();
  if PSTATE.M == M32_Monitor then SCR.NS = '0';
  AArch32.WriteMode(M32_Monitor);
  SPSR[] = spsr;
  R[14] = preferred_exception_return + lr_offset;
  PSTATE.J = '0';
  PSTATE.T = SCTL.R.TE;
  PSTATE.E = SCTL.R.EE;
  PSTATE.<A,I,F> = '111';
  PSTATE.IT = '00000000';
  BranchTo(MVBAR + vect_offset, BranchType_UNKNOWN);
```

The EnterHypMode() pseudocode function changes the PE mode to Hyp mode, with the required state changes:

```
// AArch32.EnterHypMode()
// =====
// Take an exception to Hyp mode.

AArch32.EnterHypMode(ExceptionRecord exception, bits(32) preferred_exception_return,
                      integer vect_offset)
  assert HaveEL(EL2) && !IsSecure() && ELUsingAArch32(EL2);

  spsr = GetSPSRFromPSTATE();
  AArch32.WriteMode(M32_Hyp);
  if !(exception.type IN {Exception_IRQ, Exception_FIQ}) then
    AArch32.ReportHypEntry(exception);
  SPSR[] = spsr;
  R[14] = preferred_exception_return;
  PSTATE.J = '0';
  PSTATE.T = HSCTL.R.TE;
  PSTATE.E = HSCTL.R.EE;
  if !HaveEL(EL3) || SCR_GEN[].EA == '0' then PSTATE.A = '1';
  if !HaveEL(EL3) || SCR_GEN[].IRQ == '0' then PSTATE.I = '1';
  if !HaveEL(EL3) || SCR_GEN[].FIQ == '0' then PSTATE.F = '1';
  PSTATE.IT = '00000000';
  BranchTo(HVBAR + vect_offset, BranchType_UNKNOWN);
```

G1.14 The conceptual coprocessor interface and system control

AArch32 state includes a coprocessor interface that can access sixteen coprocessors, CP0 to CP15. [Coprocessor support on page E1-2331](#) introduces this interface. Part of this interface is reserved for conceptual coprocessors, as follows:

- CP10 and CP11 provide Advanced SIMD and floating-point functionality.
- CP14 and CP15 provide configuration and control related to the architecture:

In ARMv8, AArch32 has no support for coprocessors other than CP10, CP11, CP14, and CP15.

This section gives:

- An introduction to the CP14 and CP15 registers, see [CP14 and CP15 system control registers](#).
- Information about access controls for the other coprocessors, see [Access controls on CP10 and CP11](#).

G1.14.1 CP14 and CP15 system control registers

In AArch32 state:

- CP14 is reserved for the configuration and control of:
 - Debug features, see [Debug registers on page G4-4101](#).
 - Trace features, see the [Embedded Trace Macrocell Architecture Specification](#) and the [CoreSight Program Flow Trace Architecture Specification](#).
 - The T32 Execution Environment, if implemented. In ARMv8, T32EE is OPTIONAL and deprecated.
 - Identification registers for the Trivial Jazelle implementation, see [Trivial implementation of the Jazelle extension on page G1-3429](#).
- CP15 is called the System Control coprocessor, and is reserved for the control and configuration of the PE, including architecture and feature identification. This means CP15 provides access to the System registers that control and return status information for PE operation in non-debug state.

See [Chapter G4 AArch32 System Register Descriptions](#).

Access to CP14 and CP15 registers

Most CP14 and CP15 registers are accessible only from EL1 or higher. For possible accesses from EL0:

- The register descriptions in [Chapter G4 AArch32 System Register Descriptions](#) indicate whether a register is accessible from EL0.

———— **Note** —————

These chapters provide all of the CP14 and CP15 register descriptions in this manual, except for the CP14 debug registers, that are described in [Debug registers on page G4-4101](#).

- The descriptions of the CP14 interface in [Debug registers on page G4-4101](#) include the permitted accesses to the debug registers from EL0.
- [EL0 views of the CP15 registers on page G3-3732](#) summarizes the permitted accesses to CP15 registers from EL0.

G1.14.2 Access controls on CP10 and CP11

The CP10 and CP11 part of the coprocessor interface supports the Advanced SIMD and floating-point instructions, providing access to System registers relating to the use of these instructions, and some instruction encodings. See also [Advanced SIMD and floating-point support on page G1-3494](#).

In ARMv8, the CPACR controls access to CP10 and CP11 from software executing at EL1 or EL0 in AArch32 state.

Initially on powerup or reset into AArch32 state, access to coprocessors CP10 and CP11 is disabled.

Note

The **CPACR** has no effect on accesses from Hyp mode.

If an implementation includes EL3, the **NSACR** determines whether CP10 and CP11 can be accessed from the Non-secure state.

If an implementation includes EL2, the **HCPTR** provides additional controls on Non-secure accesses to CP10 and CP11. For accesses that are otherwise permitted by the **CPACR** and **NSACR** settings, setting **HCPTR** bits to 1:

- Traps otherwise-permitted accesses from EL1 or EL0 to EL2. When EL2 is using AArch32, these accesses are trapped to Hyp mode.
- Makes accesses from EL2 mode UNDEFINED. When EL2 is using AArch32, this makes accesses from Hyp mode UNDEFINED.

For more information, see [Trapping accesses to coprocessors on page G1-3511](#).

Note

The access settings for CP10 and CP11 must be identical. If these settings are not identical the behavior of the Advanced SIMD and floating-point functionality is CONstrained UNPREDICTABLE. ARMv8 constrains the UNPREDICTABLE behavior to be that, for all purposes other than reading the value of the field, behavior is as if the access control field for CP11 has the same value as the access control field for CP10.

G1.15 Advanced SIMD and floating-point support

[Advanced SIMD and floating-point instructions on page E1-2303](#) introduces:

- The scalar floating-point instructions in the A32 and T32 instruction sets.
- The Advanced SIMD integer and floating-point vector instructions in the A32 and T32 instruction sets.
- The Advanced SIMD and floating-point registers file D0 - D31, and its alternative views as S0 - S31 and Q0 - Q15.
- The *Floating-Point Status and Control Register (FPSCR)*.

For more information about the system registers for the Advanced SIMD and floating-point operation see [Advanced SIMD and floating-point system registers on page G1-3500](#). Software can interrogate these registers to discover the implemented Advanced SIMD and floating-point support.

The following subsections give more information about the Advanced SIMD and Floating-point support:

- [Enabling Advanced SIMD and floating-point support](#).
- [Advanced SIMD and floating-point system registers on page G1-3500](#).
- [Context switching when using Advanced SIMD and floating-point functionality on page G1-3501](#).
- [Floating-point exception traps, serialization, and floating-point exception barriers on page G1-3501](#).

G1.15.1 Enabling Advanced SIMD and floating-point support

Software must ensure that the required access to the Advanced SIMD and floating-point features is enabled:

- Any use of Advanced SIMD or floating-point features requires access to CP10 and CP11.
- Additional controls apply to the use of Advanced SIMD features, see [Additional controls on Advanced SIMD functionality on page G1-3498](#).

———— **Note** —————

This section describes the controls when the controlling Exception levels are using AArch32. Similar controls are provided when the Exception levels are using AArch64, and then apply to lower Exception levels that are using AArch32.

The controls of access to CP10 and CP11 are:

- **CPACR**.{cp10, cp11} control access from PE modes other than Hyp mode. The permitted values of these fields are:
 - 0b00** No access. Any access to the Advanced SIMD and floating-point features is UNDEFINED.
 - 0b01** Accessible from privileged modes only. Any access to the Advanced SIMD and floating-point features from User mode is UNDEFINED.
 - 0b11** Accessible from privileged and unprivileged modes.These fields reset to 0b00, no access.
These fields have no effect on accesses to CP10 and CP11 from Hyp mode.
- In an implementation that includes EL3, **NSACR**.{cp10, cp11} control access from Non-secure state. The permitted values of these bits are:
 - 0** Accessible from Secure state only. Any access to the Advanced SIMD and floating-point features from Non-secure state is UNDEFINED.
 - 1** Accessible from both Security states, subject to any other access controls that apply. These include:
 - For accesses from any PE mode other than Hyp mode, the **CPACR**.{cp10, cp11} controls.
 - If the implementation includes EL2, the **HCPTR**.{TCP10, TCP11} control. This applies to accesses from all PE modes in Non-secure state.

- In an implementation that includes EL2, when **NSACR**.{cp10, cp11} are set to 1, to permit Non-secure accesses, **HCPTR**.{TCP10, TCP11} provide an additional control on those accesses. The permitted values of these bits are:
 - 0** Advanced SIMD and floating-point features are accessible from Non-secure state, subject to any other access controls that apply. The **CPACR**.{cp10, cp11} controls:
 - Have no effect on accesses from Hyp mode.
 - Apply to accesses from all other PE modes.
 - 1** Trap coprocessor accesses:
 - Any access from a Non-secure PE mode other than Hyp mode that is permitted by other controls, including the **CPACR**.{cp10, cp11} controls, generates an exception that is taken to Hyp mode.
 - Any access to Advanced SIMD and floating-point features from Hyp mode is UNDEFINED.

When **NSACR**.{cp10, cp11} are set to 0, all accesses to Advanced SIMD and floating-point features from Non-secure state are UNDEFINED.

———— **Note** ————

The **HCPTR** can also trap to Hyp mode otherwise-permitted Non-secure EL1 and EL0 accesses to Advanced SIMD and floating-point functionality. At reset, those traps are disabled.

Access control bits for CP10 and CP11 must be programmed with the same values, otherwise operation of the controlled Advanced SIMD and floating-point features is CONstrained UNPREDICTABLE. This means that operation is CONstrained UNPREDICTABLE:

- In any implementation, if the values of **CPACR**.cp10 and **CPACR**.cp11 are different.
- In an implementation that includes EL3, in Non-secure state, if the values of **NSACR**.cp10 and **NSACR**.cp11 are different.
- In an implementation that includes EL2, in Non-secure state, if the values of **HCPTR**.TCP10 and **HCPTR**.TCP11 are different.

In ARMv8, the CONstrained UNPREDICTABLE behavior is that, for all purposes other than reading the value of the register field, behavior is as if the access control field for CP11 has the same value as the access control field for CP10.

In addition, **FPEXC**.EN is an enable bit for most Advanced SIMD and floating-point operations. When **FPEXC**.EN is 0, all Advanced SIMD and floating-point instructions are treated as UNDEFINED except for:

- A VMSR to the **FPEXC** or **FPSID** register.
- A VMRS from the **FPEXC**, **FPSID**, **MVFR0**, or **MVFR1** register.

These instructions can be executed only at EL1 or higher.

———— **Note** ————

- Although **FPSID** is a read-only register, software can perform a VMSR to the **FPSID** to force Floating-point serialization, as described in *Floating-point exception traps, serialization, and floating-point exception barriers* on page G1-3501.
- When **FPEXC**.EN is 0, these operations are treated as UNDEFINED:
 - A VMSR to the **FPSCR**.
 - A VMRS from the **FPSCR**.

These controls, summarized in *Summary of general controls of CP10 and CP11 functionality* on page G1-3496, apply to all functionality that depends on access to CP10 and CP11. That is, they apply equally to all implemented Advanced SIMD and floating-point functionality.

Additional controls apply to any implemented Advanced SIMD functionality, see *Additional controls on Advanced SIMD functionality* on page G1-3498.

[Pseudocode details of enabling the Advanced SIMD and Floating-point Extensions on page G1-3499](#) gives a pseudocode description of both sets of controls.

Summary of general controls of CP10 and CP11 functionality

Table G1-21 summarizes the access controls for the implemented Advanced SIMD and floating-point functionality, that are based on controlling access to coprocessors CP10 and CP11, and on the `FPEXC.EN` enable bit. The following subsections give more information about the entries in this table:

- [Information about the general controls of CP10 and CP11 functionality on page G1-3497](#).
- [EL0 access to Advanced SIMD and floating-point functionality on page G1-3497](#).

In this table, and in [Table G1-22 on page G1-3498](#), an entry of:

- `UND` indicates that the Advanced SIMD or floating-point access generates an Undefined Instruction exception. For an access made from Hyp mode this exception is taken to Hyp mode, otherwise it is taken to Secure or Non-secure Undefined mode.
- `Trapped` indicates that accesses generate a Hyp Trap exception, that is taken to Hyp mode.

Table G1-21 Summary of access controls for all CP10 and CP11 functionality

Controls				Secure		Non-secure			
<code>CPACR.cpn^a</code>	<code>NSACR.cpn</code>	<code>HCPTR.TCP_n</code>	<code>FPEXC.EN</code>	<code>EL3^b</code>	<code>EL0</code>	<code>EL2</code>	<code>EL1</code>	<code>EL0</code>	
00	0	x ^c	x	UND	UND	UND	UND	UND	
			0	UND	UND	UND ^d	UND	UND	
	1	0	0	UND	UND	Enabled	UND	UND	
			1	UND	UND	UND	UND	UND	
01	0	x ^c	0	UND ^d	UND	UND	UND	UND	
			1	Enabled	UND	UND	UND	UND	
			0	UND ^d	UND	UND ^d	UND ^d	UND	
	1	0	0	UND ^d	UND	UND	UND	UND ^e	UND
			1	Enabled	UND	Enabled	Enabled	UND	
			0	UND ^d	UND	UND	Trapped	UND	
11	0	x ^c	0	UND ^d	UND	UND	UND	UND	
			1	Enabled	Enabled	UND	UND	UND	
			0	UND ^d	UND	UND ^d	UND ^d	UND	
	1	0	0	UND ^d	UND	UND	UND	UND ^e	UND
			1	Enabled	Enabled	Enabled	Enabled	Enabled	
			0	UND ^d	UND	UND	UND ^e	UND	
1	1	0	UND ^d	UND	UND	UND	UND ^e	UND	
		1	Enabled	Enabled	UND	Trapped	Trapped		

- When the corresponding `NSACR` bit is set to 0, for Non-secure accesses the `CPACR` field behaves as RAZ/WI. That is, when `NSACR.cp10` is set to 0, for Non-secure accesses `CPACR.cp10` ignores writes, and reads as `0b00`, regardless of its actual value.
- When `EL3` is implemented and is using AArch64, Monitor mode is not available, and all Secure modes other than User mode are Secure `EL1` modes.
- When the `NSACR` control bits are set to 0, for Non-secure accesses the `HCPTR` control bits behave as RAO/WI.
- Except for `VMSR` to the `FPEXC` or `FPSID` register, or a `VMRS` from the `FPEXC`, `FPSID`, `MVFR0`, or `MVFR1` register.

- e. Except for VMSR to the **FPEXC** or **FPSID** register, or a VMRS from the **FPEXC**, **FPSID**, **MVFR0**, or **MVFR1** register, that are Trapped.

———— **Note** —————

In [Table G1-21 on page G1-3496](#):

- The behavior of Secure accesses depends only on the **CPACR** and **FPEXC** control values.
- The behavior of accesses from Hyp mode depends only on the **NSACR**, **HCPTR**, and **FPEXC** control values.

Information about the general controls of CP10 and CP11 functionality

In [Table G1-21 on page G1-3496](#), the values for each of the registers shown in the *Controls* columns are:

CPACR The value of the **CPACR**.{cp10, cp11} fields. These fields must be programmed to the same value, otherwise behavior is CONSTRAINED UNPREDICTABLE. The table does not show the reserved value of 0b10.

NSACR The value of the **NSACR**.{cp10, cp11} bits. These bits must be programmed to the same value, otherwise behavior is CONSTRAINED UNPREDICTABLE.

These controls are implemented only as part of EL3. For the access controls for an implementation that does not include EL3, consider only:

- The Secure EL3 and EL0 columns. When EL3 is not implemented:
 - Monitor mode is not available.
 - There is only a single Security state, and all AArch32 modes other than User mode and Hyp mode are always EL1 modes.
- The rows for which **NSACR** is 0, and **HCPTR** is 0 or x.

HCPTR The value of the **HCPTR**.{TCP10, TCP11} bits. These bits must be programmed to the same value, otherwise behavior is CONSTRAINED UNPREDICTABLE.

These controls are implemented only as part of EL2. For the access controls for an implementation that does not include EL2:

- Ignore the Non-secure EL2 column.
- Consider only the rows for which **HCPTR** is 0 or x.

FPEXC.EN The value of **FPEXC.EN**. As indicated in this section, and in the table footnote, when this bit is set to 0:

- Most Advanced SIMD and floating-point functionality is disabled.
- A limited number of register accesses are permitted at EL1 or higher.

When this bit is set to 1, Advanced SIMD and floating-point functionality is enabled, but subject to:

- The other access controls shown in the table.
- The restrictions described in [EL0 access to Advanced SIMD and floating-point functionality](#).

In ARMv8, the CONSTRAINED UNPREDICTABLE behavior when the access control fields for CP10 and CP11 have different values is that, for all purposes other than reading the value of the register field, behavior is as if the access control field for CP11 has the same value as the access control field for CP10.

EL0 access to Advanced SIMD and floating-point functionality

When [Table G1-21 on page G1-3496](#) shows that EL0 access to the Advanced SIMD and floating-point functionality is enabled, this applies only to the subset of functionality that is available at EL0. In particular, the only Advanced SIMD and Floating-point system register that is accessible is the **FPSCR**. However, the Advanced SIMD and floating-point instructions are available. Execution at EL0 corresponds to the application level view of the extensions, as described in [Advanced SIMD and Floating-point system registers on page E1-2306](#).

Additional controls on Advanced SIMD functionality

If the general controls summarized in [Summary of general controls of CP10 and CP11 functionality on page G1-3496](#) permit access to CP10 and CP11 functionality, additional controls apply to any implemented Advanced SIMD functionality. The following controls apply to all Advanced SIMD instructions, that is, to all instruction encodings in [Alphabetical list of T32 and A32 base instruction set instructions on page F7-2534](#) that are identified as Advanced SIMD encodings and are not also floating-point encodings:

- When the value of **CPACR.ASEDIS** is 1, all Advanced SIMD instructions are UNDEFINED.
- In an implementation that includes EL3, when the value of **CPACR.ASEDIS** is 0, if the value of **NSACR.NSASEDIS** is 1 and the PE is in Non-secure state, **CPACR.ASEDIS** appears as RAO/WI and all Advanced SIMD instructions are UNDEFINED.
- In an implementation that includes EL2, when the **CPACR** and **NSACR** settings permit Non-secure use of the Advanced SIMD instructions, if **HCPTR.TASE** is set to 1 any use of an Advanced SIMD instruction from:
 - A Non-secure EL1 or EL0 mode is trapped to Hyp mode.
 - Hyp mode generates an Undefined Instruction exception that is taken to Hyp mode.

[Table G1-22](#) references the descriptions of the registers that control this functionality, and [Summary of access controls for Advanced SIMD functionality](#) shows these controls.

Summary of access controls for Advanced SIMD functionality

[Table G1-22](#) summarizes the additional access controls for the use of Advanced SIMD instructions.

- In this table, entries of UND and Enabled have the meanings defined in [Summary of general controls of CP10 and CP11 functionality on page G1-3496](#)
- The entries shown in this table must be combined with the information shown in [Table G1-21 on page G1-3496](#) as follows:
 - If at least one table shows the access as UND then the access is UNDEFINED.
 - Otherwise, if at least one table shows the access as Trapped then the access generates a Hyp Trap exception.
 - Otherwise, both tables show the access as Enabled, meaning the access is permitted.

Table G1-22 Summary of additional access controls for Advanced SIMD functionality

Controls			Secure		Non-secure		
CPACR.ASEDIS	NSACR.NSASEDIS	HCPTR.TASE	EL3^a	EL0	EL2	EL1	EL0
0 ^b	0	0	Enabled	Enabled	Enabled	Enabled	Enabled
		1	Enabled	Enabled	UND	Trapped	Trapped
	1	x ^b	Enabled	Enabled	UND	UND	UND
1	0	0	UND	UND	Enabled	UND	UND
		1	UND	UND	UND	UND	UND
	1	x ^b	UND	UND	UND	UND	UND

- a. When EL3 is implemented and is using AArch64, Monitor mode is not available, and all Secure modes other than User mode are Secure EL1 modes.
- b. When the value of the **NSACR.NSASEDIS** is 1, for Non-secure accesses:
- To **CPACR**, the **ASEDIS** bit behaves as RAO/WI.
 - To **HCPTR**, the **TASE** bit behaves as RAO/WI.

When interpreting [Table G1-22 on page G1-3498](#):

- The **NSACR** is implemented only as part of EL3. For an implementation that does not include EL3, use of the Advanced SIMD instructions:
 - Is enabled when **CPACR.ASEDIS** is set to 0.
 - Is disabled when **CPACR.ASEDIS** is set to 1.
- The **HCPTTR** is implemented only as part of EL2. For an implementation that does not include EL2, when the controls shown in [Table G1-21 on page G1-3496](#) permit Non-secure use of the CP10 and CP11 functionality, use of the Advanced SIMD instructions from Non-secure state:
 - Is enabled when **CPACR.ASEDIS** and **NSACR.NSASEDIS** are both set to 0.
 - Is disabled otherwise.

Pseudocode details of enabling the Advanced SIMD and Floating-point Extensions

The following pseudocode takes appropriate action if an Advanced SIMD or Floating-point instruction is used when the extensions are not enabled:

```
// CheckAdvSIMDOrVFPEEnabled()
// =====

CheckAdvSIMDOrVFPEEnabled(boolean include_fpxc_check, boolean advsimd)
    instr = ThisInstr();
    AArch32.CheckAdvSIMDOrFPEEnabled(include_fpxc_check, advsimd, instr);
    // Return from CheckAdvSIMDOrFPEEnabled() occurs only if VFP access is permitted
    return;

// AArch32.CheckAdvSIMDOrFPEEnabled()
// =====
// Check against CPACR, FPEXC, HCPTTR, NSACR, and CPTR_EL3.

AArch32.CheckAdvSIMDOrFPEEnabled(boolean fpxc_check, boolean advsimd, bits(32) instr)

    if !ELUsingAArch32(EL1) then
        AArch64.CheckFPAdvSIMDEnabled();
    else
        cpacr_asedis = CPACR.ASEDIS;
        cpacr_cp10 = CPACR.cp10;

        if HaveEL(EL2) && !IsSecure() then
            hcptr_tase = if ELUsingAArch32(EL2) then HCPTTR.TASE else '0';
            hcptr_cp10 = HCPTTR.TCP10;

        if HaveEL(EL3) && ELUsingAArch32(EL3) && !IsSecure() then
            // Check if access disabled in NSACR
            if NSACR.NSASEDIS == '1' then
                cpacr_asedis = '1';
                if HaveEL(EL2) then hcptr_tase = '1';
            if NSACR.cp10 == '0' then
                cpacr_cp10 = '00';
                if HaveEL(EL2) then hcptr_cp10 = '1';

        if PSTATE.EL != EL2 then
            // Check if Advanced SIMD disabled in CPACR
            if advsimd && cpacr_asedis == '1' then
                AArch32.AdvSIMDFPAccessTrap(EL1, advsimd, instr);

            // Check if access disabled in CPACR
            if cpacr_cp10<0> == '0' || (cpacr_cp10<1> == '0' && PSTATE.EL == EL0) then
                AArch32.AdvSIMDFPAccessTrap(EL1, advsimd, instr);

        // If required, check FPEXC enabled bit. If EL1 is using AArch64, then do not
        // make this check
        if fpxc_check && FPEXC.EN == '0' then UNDEFINED;
```

```
    if HaveEL(EL2) && !IsSecure() then
        // Check if Advanced SIMD access disabled in HCPTR
        if advsimd && hcptr_tase == '1' then
            AArch32.AdvSIMDFPAccessTrap(EL2, advsimd, instr);

        // Check if access disabled in HCPTR
        if hcptr_cp10 == '1' then
            AArch32.AdvSIMDFPAccessTrap(EL2, advsimd, instr);

    if HaveEL(EL3) && !ELUsingAArch32(EL3) then
        // Check if access disabled in CPTR_EL3
        if CPTR_EL3.TFP == '1' then
            AArch64.AdvSIMDFPAccessTrap(EL3);

    return;

// CheckAdvSIMDEnabled()
// =====

CheckAdvSIMDEnabled()

    fpxc_check = TRUE;
    advsimd = TRUE;
    instr = ThisInstr();

    AArch32.CheckAdvSIMDOrFPEEnabled(fpxc_check, advsimd, instr);
    // Return from CheckAdvSIMDOrFPEEnabled() occurs only if Advanced SIMD access is permitted

    // Make temporary copy of D registers
    // _Dclone[] is used as input data for instruction pseudocode
    for i = 0 to 31
        _Dclone[i] = D[i];

    return;

// CheckVFPEEnabled()
// =====

CheckVFPEEnabled(boolean include_fpxc_check)
    advsimd = FALSE;
    instr = ThisInstr();
    AArch32.CheckAdvSIMDOrFPEEnabled(include_fpxc_check, advsimd, instr);
    // Return from CheckAdvSIMDOrFPEEnabled() occurs only if VFP access is permitted
    return;
```

G1.15.2 Advanced SIMD and floating-point system registers

AArch32 state provides a common set of System registers for the Advanced SIMD and floating-point functionality. This section gives general information about this set of registers, and indicates where each register is described in detail. It contains the following subsections:

- [Register map of the Advanced SIMD and floating-point System registers.](#)
- [Accessing the Advanced SIMD and floating-point System registers on page G1-3501.](#)

Register map of the Advanced SIMD and floating-point System registers

[Table G1-24 on page G1-3506](#) shows the register map of the Advanced SIMD and Floating-point registers. Each register is 32 bits wide. In an implementation that includes EL3, the Advanced SIMD and Floating-point registers are common registers, see [Common System registers on page G3-3702](#).

Accessing the Advanced SIMD and floating-point System registers

Software accesses the Advanced SIMD and floating-point System registers using the VMRS and VMSR instructions, see:

- [VMRS on page F7-3070](#).
- [VMSR on page F7-3072](#).

For example:

```
VMRS <Rt>, FPSID    ; Read Floating-Point System ID Register
VMRS <Rt>, MVFR1    ; Read Media and VFP Feature Register 1
VMSR FPSCR, <Rt>    ; Write Floating-Point System Control Register
```

Software can access the Advanced SIMD and floating-point System registers only if the access controls permit the access, see [Enabling Advanced SIMD and floating-point support on page G1-3494](#).

———— Note ————

All hardware ID information can be accessed only from EL1 or higher. This means:

The FPSID is accessible only from EL1 or higher.

This is a change introduced from VFPv3. Previously, the [FPSID](#) register can be accessed in all modes.

The MVFR registers are accessible only from EL1 or higher.

Unprivileged software must issue a system call to determine what features are supported.

G1.15.3 Context switching when using Advanced SIMD and floating-point functionality

When the Advanced SIMD and floating-point functionality is used by only a subset of processes, the operating system might implement lazy context switching of the Advanced SIMD and floating-point register file and System registers.

In the simplest lazy context switch implementation, the primary context switch software disables the Advanced SIMD and floating-point functionality, by disabling access to coprocessors CP10 and CP11 in the [CPACR](#), see [Enabling Advanced SIMD and floating-point support on page G1-3494](#). Subsequently, when a process or thread attempts to use an Advanced SIMD or Floating-point instruction, it triggers an Undefined Instruction exception. The operating system responds by saving and restoring the Advanced SIMD and floating-point register file and System registers. Typically, it then re-executes the Advanced SIMD or floating-point instruction that generated the Undefined Instruction exception.

G1.15.4 Floating-point exception traps, serialization, and floating-point exception barriers

Execution of a floating-point instruction can generate an exceptional condition, called a *floating-point exception*.

———— Note ————

Do not confuse floating-point exceptions with the AArch32 architectural exceptions summarized in [AArch32 state exception descriptions on page G1-3475](#).

An Advanced SIMD and floating-point implementation can support floating-point exception *traps*, meaning floating-point exceptions are passed back to application software to resolve, see [Floating-point exceptions on page E1-2307](#).

VMRS and VMSR instructions that access the [FPSID](#), [FPSCR](#), or [FPEXC](#) registers are *serializing* instructions. This means that, before they perform any required register transfer, they ensure that any exceptional condition that requires support code processing, from any preceding Floating-point instruction, has been detected and reflected in the extension system registers. A VMSR instruction to the read-only [FPSID](#) register is a serializing NOP.

In addition, a VMRS or VMSR instruction that accesses the [FPSCR](#) acts as a *Floating-point exception barrier*. This means that, before it performs the register transfer, it ensures that any outstanding exceptional conditions in preceding Floating-point instructions have been detected and processed by the support code. If necessary, the VMRS or VMSR instruction takes an asynchronous bounce to force the processing of any outstanding exceptional conditions.

In pseudocode, Floating-point serialization and the Floating-point exception barriers are described by the `SerializeVFP()` and `VFPExcBarrier()` functions respectively.

G1.16 AArch32 control of traps to the hypervisor

This section describes the traps provided by EL2, that software executing at EL2 can use to trap Non-secure operations performed at EL1 or EL0. This section describes the control of these traps when EL2 is using AArch32, meaning the traps must be configured by software executing in Hyp mode. When EL2 is using AArch32:

- The Non-secure EL1 and EL0 exceptions must also be using AArch32,
- The traps to EL2 are taken to Hyp mode.

In addition, software executing in Hyp mode can route a number of exceptions to be taken to Hyp mode, provided EL3 controls are not routing them to be taken at EL3. Therefore, the trapping and related mechanisms provided by EL2 include:

- Trapping attempted execution of certain instructions to Hyp mode, so a hypervisor can emulate the instruction. This section describes these traps.
 - Routing certain synchronous exceptions to Hyp mode, see:
 - [Routing general exceptions to EL2 on page G1-3452.](#)
 - [Routing Debug exceptions to Hyp mode on page G1-3454.](#)
- **Note** —————
- These controls for routing synchronous exceptions to Hyp mode are similar to the controls for the traps described in this section, and [Summary of trap controls on page G1-3517](#) includes these trap controls.
 - In addition, a hypervisor can route interrupts and asynchronous external aborts to itself. For more information see [Asynchronous exception routing controls on page G1-3467.](#)
-
- Providing aliased versions of some system control registers, see [Trapping ID mechanisms on page G1-3506.](#)

Because of the wide range of usage models for virtualization, EL2 provides many trapping options, supporting different levels of granularity of the trapping. The following sections describe these trapping options:

- [General information about traps to the hypervisor on page G1-3504.](#)
- [Trapping ID mechanisms on page G1-3506.](#)
- [Trapping accesses to lockdown, DMA, and TCM operations on page G1-3508.](#)
- [Trapping accesses to cache maintenance operations on page G1-3509.](#)
- [Trapping accesses to TLB maintenance operations on page G1-3509.](#)
- [Trapping accesses to the Auxiliary Control Register on page G1-3509.](#)
- [Trapping accesses to the Performance Monitors Extension on page G1-3510.](#)
- [Trapping use of the SMC instruction on page G1-3510.](#)
- [Trapping use of the WFI and WFE instructions on page G1-3511.](#)
- [Trapping accesses to the T32EE configuration registers on page G1-3511.](#)
- [Trapping accesses to coprocessors on page G1-3511.](#)
- [Trapping writes to virtual memory control registers on page G1-3513.](#)
- [Generic trapping of accesses to CP15 system control registers on page G1-3513.](#)
- [Trapping CP14 accesses to debug registers on page G1-3514.](#)
- [Trapping CP14 accesses to trace registers on page G1-3516.](#)
- [Summary of trap controls on page G1-3517.](#)

———— **Note** —————

Many of these sections include a Note that indicates when or why a hypervisor might use the traps described in that section. This information is not part of the architecture specification.

These sections include descriptions of trapping Debug configuration options that can generate traps when the PE is in Non-debug state. EL2 does not provide any trapping in Debug state.

G1.16.1 General information about traps to the hypervisor

The Hyp Trap exception provides the standard mechanism for trapping Guest OS functions to the hypervisor. When EL2 is using AArch32, the PE always takes a Hyp Trap exception to Hyp mode, and enters the exception handler using the vector at offset 0x14 from the Hyp vector base address. For more information see [Handling exceptions that are taken to an Exception level using AArch32 on page G1-3431](#).

When the PE enters the handler for a Hyp Trap exception, the HSR holds syndrome information for the exception. For more information see [Use of the HSR on page G3-3672](#).

A Hyp Trap exception can be generated only when all of the following apply:

- The PE is both:
 - Not in Debug state.
 - In a Non-secure EL1 or EL0 mode.
- The trapped instruction is not UNPREDICTABLE in the mode in which it is executed. UNPREDICTABLE instructions can generate a Hyp Trap exception, but the architecture does not require them to do so, see [UNPREDICTABLE](#).
- The trapped instruction is not UNDEFINED in the mode in which it is executed, except for the following cases in which an UNDEFINED instruction might cause a Hyp Trap exception:
 - A trapped conditional UNDEFINED instruction that, if it was not trapped, would generate an Undefined Instruction exception, see [Hyp traps on instructions that fail their condition code check on page G1-3505](#).
 - A EL0 mode access to IMPLEMENTATION DEFINED CP15 features in primary CP15 register c9-c11, see [Trapping accesses to lockdown, DMA, and TCM operations on page G1-3508](#).
 - A EL0 mode access to an IMPLEMENTATION DEFINED CP15 register for which there is a generic Hyp trap, see [Generic trapping of accesses to CP15 system control registers on page G1-3513](#).
 - When HCR.TGE is set to 1, any instruction executed in Non-secure User mode that generates an Undefined Instruction exception, see [Undefined Instruction exception, when HCR.TGE is set to 1 on page G1-3452](#).

Note

- These rules mean that, for traps on system control register accesses, unless the specific trap description states otherwise:
 - If the register description in this manual describes the register as not being accessible from User mode in Non-secure state, the implementation of EL2 does not change this behavior. User mode accesses to the register cannot be trapped.
 - If the register description in this manual describes the register as being accessible from User mode in Non-secure state, when accesses to the register are trapped to Hyp mode the trap applies to accesses from both Non-secure EL1 modes and from the Non-secure EL0 mode.
- Traps to Hyp mode never apply in Secure state, regardless of the value of the SCR.NS bit.
- Although a Hyp Trap exception cannot be generated when the PE is in Hyp mode, the HCPTR restricts coprocessor accesses in Hyp mode, as well as in the Non-secure EL1 modes. If the HCPTR settings generate an exception when the PE is in Hyp mode, that exception is taken using the Hyp mode Undefined Instruction vector, not the Hyp Trap vector.
- EL0 mode is a synonym for User mode.

Many instructions that can be trapped by a Hyp trap are UNDEFINED in User mode. For these instructions, enabling a Hyp trap on the instruction has no effect on operation in Non-secure User mode. A small number of traps also apply to operations in Non-secure User mode. This means they trap operations at EL0 and at EL1.

Hyp traps on instructions that fail their condition code check

If the PE executes an instruction that has a Hyp trap set, and that instruction fails its condition code check, unless the specific trap description states otherwise, it is IMPLEMENTATION DEFINED which of the following occurs:

- The instruction generates a Hyp Trap exception.
- The instruction executes as a NOP.

———— Note ————

The architecture requires that a Hyp trap on a conditional SMC instruction generates an exception only if the instruction passes its condition code check, see *Trapping use of the SMC instruction* on page G1-3510.

This is consistent with the treatment of conditional undefined instructions, as described in *Conditional execution of undefined instructions* on page G1-3478. Any implementation must be consistent in its handling of instructions that fail their condition code check, meaning that whenever a Hyp trap is set on such an instruction it must either:

- Always generate a Hyp Trap exception.
- Always treat the instruction as a NOP.

This requirement that an implementation is consistent in its handling of instructions that fail their condition code check also means that the IMPLEMENTATION DEFINED part of the requirements of *Conditional execution of undefined instructions* on page G1-3478 must be consistent with the handling of Hyp traps on instructions that fail their condition code check, as Table G1-23 shows:

Table G1-23 Consistent handling of instructions that fail their condition code check

Behavior of conditional UNDEFINED instruction ^a	Hyp trap on instruction that fails its condition code check ^b
Executes as a NOP	Executes as a NOP
Generates an Undefined Instruction exception	Generates a Hyp Trap exception

- a. As defined in *Conditional execution of undefined instructions* on page G1-3478. In Non-secure EL1 and ELO modes, applies only if no Hyp trap is set for the instruction, otherwise see the behavior in the other column of the table.
- b. For a trapped instruction executed in a Non-secure EL1 or ELO mode.

Hyp traps on instructions that are UNPREDICTABLE

For an instruction that is UNPREDICTABLE, but is in a class that has a Hyp trap, the behavior of the instruction when the Hyp trap is enabled is UNPREDICTABLE. The architecture permits such an instruction to generate a Hyp Trap exception, but does not require it to do so.

———— Note ————

UNPREDICTABLE behavior must not perform any function that cannot be performed at the current or lower Exception level using instructions that are not UNPREDICTABLE. This means that setting a Hyp trap on an instruction changes the set of instructions that might be executed in Non-secure state at EL1 or ELO. This affects, indirectly, the permitted behavior of UNPREDICTABLE instructions.

If no instructions are configured to generate Hyp traps, then the attempted execution of an UNPREDICTABLE instruction in a Non-secure EL1 or ELO mode cannot generate a Hyp Trap exception.

Hyp traps on instructions that are UNDEFINED

Except where explicitly stated in this manual, if an enabled Hyp trap is associated with an instruction that would otherwise be UNDEFINED, attempting to execute that instruction from a Non-secure EL1 or ELO mode generates an Undefined Instruction exception that is taken to EL1, not a Hyp Trap exception.

Traps of register access instructions

When an attempt to execute an instruction is trapped to Hyp mode, the trap is taken before execution of the instruction. This means that, if the trapped instruction is a register access instruction, before taking the Hyp Trap exception:

- No register access is made.
- No side-effects normally associated with the register access occur.

G1.16.2 Trapping ID mechanisms

———— **Note** —————

The PE ID registers that can be accessed from Non-secure state can present a virtualization hole, since system software can use them to determine information about the physical hardware that a hypervisor might want to conceal. However, many uses of virtualization do not require the hypervisor to disguise the identity of the implemented PE.

For a small number of frequently-accessed ID registers, EL2 provides read/write aliases of the registers, accessible only from Hyp mode, or from Secure state. A read of the original ID register from a Non-secure EL1 mode actually returns the value of the read/write alias register. This register substitution is invisible to the software reading the register.

Table G1-24 ID register substitution by EL2 using AArch32

Physical ID register	RW alias register
MIDR	VPIDR
MPIDR	VMPIDR

A reset into AArch32 state sets **VPIDR** to the **MIDR** value, and **VMPIDR** to the **MPIDR** value.

Reads of **MIDR** or **MPIDR** from Hyp mode or from Secure state are unchanged by the implementation of EL2, and access the physical registers. This also applies to accesses from Monitor mode with **SCR.NS** set to 1.

———— **Note** —————

A hypervisor often has to virtualize one or both of the **MIDR** and **MPIDR** because:

- The **MIDR** provides information about the implementer, the PE name, and revision information.
- In a multiprocessor implementation, the **MPIDR** defines the PE position within a cluster.

EL2 divides the remaining ID registers into a number of groups, and provide a bit for each group in the **HCR**, to control trapping of accesses to that group of registers. Setting one of these **HCR** bits to 1 means that any attempt to read a register in that group from a Non-secure mode other than Hyp mode generates a Hyp Trap exception, unless the register description indicates that the attempted access is **UNDEFINED**. These traps have no effect on writes to these registers.

———— **Note** —————

Most but not all of the ID registers are RO registers, and write accesses to these registers behave as described in *Read-only and write-only register encodings* on page G3-3695. Each register description identifies whether the register is RO.

Table G1-25 shows the HCR trap bits, and references the subsections that define the registers in each group. Each group description also indicates how the trap is reported to the exception handler.

Table G1-25 ID register groups for Hyp Trap exceptions

Trap bit	Register group definition
HCR.TID0	ID group 0, Primary device identification registers
HCR.TID1	ID group 1, Implementation identification registers
HCR.TID2	ID group 2, Cache identification registers
HCR.TID3	ID group 3, Detailed feature identification registers on page G1-3508

ID group 0, Primary device identification registers

———— **Note** —————

With [MIDR](#) and [MPIDR](#), these registers provide the coarse-grained identification mechanisms that software is likely to access.

The registers that are in ID group 0 for Hyp traps are the [FPSID](#) register and the [JIDR](#).

When an exception is taken because [HCR.TID0](#) is set to 1, the [HSR](#) reports the exception:

- Using EC value 0x05, trapped CP14 access, for a read of [JIDR](#).
- Using EC value 0x08, trapped CP10 access, for a read of [FPSID](#).

If the [HCPTR](#) traps accesses to CP10 and CP11, then for a read of [FPSID](#) that trap has priority over the ID group 0 trap. For more information, see [Trapping accesses to coprocessors on page G1-3511](#).

For more information about the exception reporting, see [Use of the HSR on page G3-3672](#).

ID group 1, Implementation identification registers

———— **Note** —————

These registers often provide coarse-grained identification mechanisms for implementation-specific features.

The registers that are in ID group 1 for Hyp traps are the [TCMTR](#), [TLBTR](#), [REVIDR](#), and [AIDR](#).

When an exception is taken because [HCR.TID1](#) is set to 1, the [HSR](#) reports the exception as a trapped CP15 access, using the EC value 0x03, see [Use of the HSR on page G3-3672](#).

ID group 2, Cache identification registers

———— **Note** —————

These are the registers that describe and control the cache implementation.

The registers that are in ID group 2 for Hyp traps are the [CTR](#), [CCSIDR](#), [CLIDR](#), and [CSSELR](#).

When an exception is taken because [HCR.TID2](#) is set to 1, the [HSR](#) reports the exception as a trapped CP15 access, using the EC value 0x03, see [Use of the HSR on page G3-3672](#).

ID group 3, Detailed feature identification registers

———— **Note** ————

These are the AArch32 CUID registers, that provide detailed information about the features of the PE implementation. In many implementations of virtualization the hypervisor will not trap accesses to registers in this group. The architecture only requires this trap to apply to the registers listed in this section. There is no requirement for the trap to apply to the registers that the CUID identification scheme defines as reserved.

The registers that are in ID group 3 for Hyp traps are the [ID_PFR0](#), [ID_PFR1](#), [ID_DFR0](#), [ID_AFR0](#), [ID_MMFR0](#), [ID_MMFR1](#), [ID_MMFR2](#), [ID_MMFR3](#), [ID_ISAR0](#), [ID_ISAR1](#), [ID_ISAR2](#), [ID_ISAR3](#), [ID_ISAR4](#), [ID_ISAR5](#), [MVFR0](#), [MVFR1](#), and [MVFR2](#).

When an exception is taken because [HCR.TID3](#) is set to 1, the [HSR](#) reports the exception:

- Using EC value `0x08`, trapped CP10 access, for a read of [MVFR0](#), [MVFR1](#), or [MVFR2](#).
- Using EC value `0x03`, trapped CP15 access, for a read of any other register in the group.

If the [HCPTR](#) traps accesses to CP10 and CP11, then for reads of [MVFR0](#), [MVFR1](#), and [MVFR2](#), that trap has priority over the ID group 3 trap. For more information, see [Trapping accesses to coprocessors on page G1-3511](#).

For more information about the exception reporting, see [Use of the HSR on page G3-3672](#).

G1.16.3 Trapping accesses to lockdown, DMA, and TCM operations

The lockdown, DMA, and TCM features of the ARM architecture are IMPLEMENTATION DEFINED. However, the architecture reserves the following CP 15 register encodings for control of these features:

- CRn==c9, opc1=={0-7}, CRm=={c0-c2, c5-c8}, opc2=={0-7}, see [VMSAv8-32 CP15 c9 register summary on page G3-3719](#)
- CRn==c10, opc1=={0-7}, CRm=={c0, c1, c4, c8}, opc2=={0-7}, see [VMSAv8-32 CP15 c10 register summary on page G3-3720](#)
- CRn==c11, opc1=={0-7}, CRm=={c0-c8, c15}, opc2=={0-7}, see [VMSAv8-32 CP15 c11 register summary on page G3-3721](#).

Setting [HCR.TIDCP](#) to 1 means:

- Any attempt to use an MCR or MRC instruction with one of these encodings from a Non-secure EL1 mode generates a Hyp Trap exception.
- On an attempt to use an MCR or MRC instruction with one of these encodings from Non-secure EL0 mode, it is IMPLEMENTATION DEFINED which of the following occurs:
 - The PE takes the Hyp Trap exception.
 - The PE treats the instruction as UNDEFINED, and takes the Undefined Instruction exception to Non-secure Undefined mode.
- Any lockdown fault in the memory system caused by the use of these operations in Non-secure state generates a Data Abort exception that is taken to Hyp mode.

An implementation can include IMPLEMENTATION DEFINED registers that provide additional controls, to give finer-grained control of the trapping of IMPLEMENTATION DEFINED features.

When an exception is taken because [HCR.TIDCP](#) is set to 1, the [HSR](#) reports the exception as a trapped CP15 access, using the EC value `0x03`, see [Use of the HSR on page G3-3672](#).

———— **Note** ————

- ARM expects the trapping of Non-secure User mode access to these functions to Hyp mode to be unusual, and used only when the hypervisor is virtualizing User mode operation. ARM strongly recommends that, unless the hypervisor must virtualize User mode operation, a Non-secure User mode access to any of these functions generates an Undefined Instruction exception, as it would if the implementation did not include EL2. The PE then takes this exception to Non-secure Undefined mode.

- The trapping of all attempted accesses to these registers from Non-secure EL1 modes overrides the general behavior described in *Hyp traps on instructions that are UNDEFINED* on page G1-3505.

G1.16.4 Trapping accesses to cache maintenance operations

———— **Note** —————

Virtualizing a uniprocessor system within an MP system, permitting a virtual machine to move between different physical devices, makes cache maintenance by set/way difficult. This is because a set/way operation might be interrupted part way through its operation, and therefore the hypervisor must reproduce the effect of the maintenance on both physical devices

Table G1-26 shows the HCR trap bits that trap cache maintenance operations to the hypervisor. When one of these bits is set to 1, any attempt to access one of the corresponding CP15 c7 operations from a Non-secure EL1 mode generates a Hyp Trap exception.

Table G1-26 Control of Hyp traps for cache maintenance operations

Trap bit	Traps	Trapped operations
HCR.TSW	Data cache maintenance by set/way	DCISW, DCCSW, DCCISW
HCR.TPC	Data cache maintenance to point of coherency	DCIMVAC, DCCIMVAC, DCCMVAC
HCR.TPU	Cache maintenance to point of unification	ICIMVAU, ICIALLU, ICIALLUIS, DCCMVAU

For any of these traps, when the exception is taken, the HSR reports the exception as a trapped CP15 access, using the EC value 0x03, see *Use of the HSR* on page G3-3672.

For more information about these operations, see *Cache and branch predictor maintenance operations* on page G3-3743.

G1.16.5 Trapping accesses to TLB maintenance operations

Setting HCR.TTLB to 1 means that any attempt to access one of the CP15 c8 maintenance operations from a Non-secure EL1 mode generates a Hyp Trap exception. The trapped operations are TLBIALLIS, TLBIMVAIS, TLBIASIDIS, TLBIMVAAIS, DTLBIALL, ITLBIALL, DTLBIMVA, ITLBIMVA, DTLBIASID, ITLBIASID, TLBIMVAA.

When an exception is taken because HCR.TTLB is set to 1, the HSR reports the exception as a trapped CP15 access, using the EC value 0x03, see *Use of the HSR* on page G3-3672.

For more information about these operations, see *The scope of TLB maintenance operations* on page G3-3640.

G1.16.6 Trapping accesses to the Auxiliary Control Register

———— **Note** —————

The ACTLR is an IMPLEMENTATION DEFINED register that might implement global control bits for the PE. An attempt by a Guest OS to access the ACTLR is a potential virtualization problem. Trapping these accesses to the hypervisor means the hypervisor can react, typically by emulating the required function or signaling a virtualization error.

Setting HCR.TAC to 1 means that any attempt to access the ACTLR from Non-secure state other than from Hyp mode generates a Hyp Trap exception, unless the IMPLEMENTATION DEFINED register description indicates that the attempted access is UNDEFINED.

When an exception is taken because HCR.TAC is set to 1, the HSR reports the exception as a trapped CP15 access, using the EC value 0x03, see *Use of the HSR* on page G3-3672.

G1.16.7 Trapping accesses to the Performance Monitors Extension

Note

A hypervisor might assign Performance Monitors functionality to a particular Guest OS, or might virtualize performance monitoring. EL2 provides a trap bit that, when set to 1, traps all CP15 accesses to the Performance Monitors to the Hyp Trap exception. A hypervisor might use this as part of a lazy context switch that assigns the Performance Monitors to a particular Guest OS, or might use it as part of a virtualization approach. A second trap bit traps accesses to the [PMCR](#). The hypervisor can use this in emulating the Performance Monitors identification bits.

The Performance Monitors Extension is an OPTIONAL architectural extension. The PE accesses the Performance Monitors Extension registers through the CP15 c9 registers with `opc1 == {0-7}`, `CRm == {c12-c15}`, `opc2 == {0-7}`.

In an implementation that includes the Performance Monitors Extension:

- Setting [HDCR.TPM](#) to 1 traps accesses to the Performance Monitors Extension registers to Hyp mode. When this bit is set to 1, any attempt to access these registers from a Non-secure EL1 or EL0 mode generates a Hyp Trap exception, unless the register description in [Performance Monitors registers on page G4-4170](#) indicates that the attempted access is UNDEFINED.
- Setting [HDCR.TPMCR](#) to 1 traps CP15 accesses to the [PMCR](#) to Hyp mode. The conditions for this trap are identical to those for the trap controlled by [HDCR.TPM](#).

For either of these traps, when the exception is taken, the [HSR](#) reports the exception as a trapped CP15 access, using the EC value `0x03`, see [Use of the HSR on page G3-3672](#).

G1.16.8 Trapping use of the SMC instruction

Note

Typically, a hypervisor determines whether a Guest OS can access Secure state directly. If the hypervisor does not permit a particular Guest OS to access Secure state directly, and that Guest OS attempts to change to Secure state, then the hypervisor must either report a virtualization error or emulate the required Secure state operation. To support this, the [HCR](#) includes a bit that traps use of the SMC instruction to the Hyp Trap exception.

When [HCR.TSC](#) is set to 1, an attempt to execute an SMC instruction from a Non-secure EL1 mode generates a Hyp Trap exception, regardless of the value of [SCR.SCD](#).

Note

When [HCR.TSC](#) is set to 0, [SCR.SCD](#) controls whether SMC instructions can be executed from Non-secure state:

- When the value of [SCR.SCD](#) is 0, the SMC instruction executes normally in Non-secure state.
 - When the value of [SCR.SCD](#) is 1, the SMC instruction is UNDEFINED in Non-secure state.
-

The [HCR.TSC](#) trap mechanism traps the attempted execution of a conditional SMC instruction only if the instruction passes its condition code check.

When an exception is taken because [HCR.TSC](#) is set to 1, the [HSR](#) reports the exception as a trapped SMC instruction, using the EC value `0x13`, see [Use of the HSR on page G3-3672](#).

G1.16.9 Trapping use of the WFI and WFE instructions

———— Note ————

An operating system can use the WFI mechanism to signal to the PE that it can suspend operation until it receives an interrupt. In a virtualized system, the hypervisor might use this signal as an indication that it can switch to another Guest OS. Therefore, the **HCR** includes a bit that traps attempted execution of a WFI instruction to the Hyp Trap exception.

Software can use the WFE mechanism to signal to the PE that it can suspend execution during polling of a variable, such as a spinlock. In a virtualized system, WFE might indicate an opportunity for the hypervisor to reschedule. However, WFE generally requires a shorter wait than WFI, and therefore there might be situations where rescheduling on WFE is not appropriate.

For this reason, the **HCR** includes separate bits for trapping WFI and WFE to the Hyp Trap exception.

When **HCR.TWI** is set to 1, and the PE is in a Non-secure mode other than Hyp mode, execution of a WFI instruction generates a Hyp Trap exception if, ignoring the value of the **HCR.TWI** bit, conditions permit the PE to suspend execution. For more information about when a WFI instruction can cause the PE to suspend execution, see [Wait For Interrupt on page G1-3463](#).

When **HCR.TWE** is set to 1, and the PE is in a Non-secure mode other than Hyp mode, execution of a WFE instruction generates a Hyp Trap exception if, ignoring the value of the **HCR.TWE** bit, conditions permit the PE to suspend execution. For more information about when a WFE instruction can cause the PE to suspend execution, see [Wait For Event and Send Event on page G1-3460](#).

For either of these traps, when the exception is taken, the **HSR** reports the exception as a trapped WFI or WFE instruction, using the EC value 0x01, see [Use of the HSR on page G3-3672](#).

G1.16.10 Trapping accesses to the T32EE configuration registers

Setting **HSTR.TTEE** to 1 means that, when the PE is in a Non-secure mode other than Hyp mode, any access to the T32EE configuration registers **TEECR** and **TEEHBR** that this reference manual does not describe as UNDEFINED, generates a Hyp Trap exception.

When an exception is taken because **HSTR.TTEE** is set to 1, the **HSR** reports the exception as a trapped CP14 access, using the EC value 0x05, see [Use of the HSR on page G3-3672](#).

G1.16.11 Trapping accesses to coprocessors

———— Note ————

- A hypervisor might use the coprocessor access trapping mechanism as part of an implementation of lazy switching of Guest OSs.
- One function of the **CPACR** is as an ID register that identifies what coprocessor functionality is implemented. A hypervisor can trap **CPACR** accesses, to emulate this ID mechanism.

The **HCPTR** provides bits that trap CP10 and CP11 coprocessor operations to Hyp mode. The traps controlled by the **HCPTR** apply regardless of whether the PE is in Debug state.

As described in [Access controls on CP10 and CP11 on page G1-3492](#), the **HCPTR** traps are secondary to the controls provided by the **CPACR** and **NSACR**. Only if those controls permit a Non-secure access to a coprocessor can the **HCPTR** setting trap that access to Hyp mode.

If the **NSACR.cpn** control bit is set to 1, prohibiting Non-secure accesses to coprocessor *n*, then:

- Non-secure accesses to the coprocessor behave as if **HCPTR.TCPn** is set to 1, regardless of the value of that bit.
- Non-secure writes to the corresponding **HCPTR.TCPn** bit are ignored.
- Non-secure reads of **HCPTR.TCPn** return 1, regardless of the actual value of that bit.

In addition, for the **HCPTR** traps on coprocessor accesses, and on the use of Advanced SIMD functionality, if a trap bit is set to 1, an attempt to access the trapped functionality from Hyp mode generates an Undefined Instruction exception, that is taken to Hyp mode.

The following subsections give more information about the **HCPTR** traps:

- [Trapping of Advanced SIMD functionality.](#)
- [General trapping of coprocessor accesses.](#)
- [Trapping CPACR accesses on page G1-3513.](#)

[Trapping CP14 accesses to trace registers on page G1-3516](#) describes an additional **HCPTR** trap.

Trapping of Advanced SIMD functionality

When the settings in the **CPACR** and **NSACR** permit Non-secure accesses to Advanced SIMD functionality, and the values of **HCPTR**.{TCP10, TCP11} are {0, 0}, if the value of **HCPTR**.TASE is 1, execution of any Advanced SIMD instruction:

- From a Non-secure mode other than Hyp mode generates a Hyp Trap exception.

———— **Note** —————

If the value of **CPACR**.ASEDIS is 1, the **CPACR**.ASEDIS setting takes priority. This means any execution of an Advanced SIMD instruction by Non-secure software executing at EL1 or EL0 generates an Undefined Instruction exception, taken to Non-secure Undefined mode, and is not trapped to Hyp mode.

- From Hyp mode generates an Undefined Instruction exception, taken to Hyp mode, with the **HSR** holding a syndrome for the instruction.

———— **Note** —————

When the value of **HCPTR**.TASE is 0, if the **NSACR** settings permit Non-secure use of the Advanced SIMD functionality then Hyp mode can access that functionality, regardless of any settings in the **CPACR**.

When an exception is taken because **HCPTR**.TASE is set to 1, the **HSR** reports the exception as a **HCPTR**-trapped coprocessor access, using the EC value 0x07, see [Use of the HSR on page G3-3672](#).

General trapping of coprocessor accesses

The **HCPTR** defines trap bits TCP10 and TCP11, for trapping accesses to coprocessors CP10 and CP11. Setting **HCPTR**.TCP n to 1 means that an access to coprocessor CP n that is otherwise permitted:

- From a Non-secure mode other than Hyp mode, generates a Hyp Trap exception.

———— **Note** —————

If the **CPACR**.cp n field does not permit the EL1 or EL0 access, then the **CPACR**.cp n setting takes priority. This means the access generates an Undefined Instruction exception, taken to Non-secure Undefined mode, and is not trapped to Hyp mode.

- From Hyp mode, generates an Undefined Instruction exception, taken to Hyp mode, with the **HSR** holding a syndrome for the instruction.

———— **Note** —————

When **HCPTR**.TCP n is set to 0, if the **NSACR** settings permit Non-secure use of coprocessor CP n then Hyp mode can access that coprocessor, regardless of any settings in the **CPACR**.

When an exception is taken because an **HCPTR**.TCP n bit is set to 1, the **HSR** reports the exception as a **HCPTR**-trapped coprocessor access, using the EC value 0x07, see [Use of the HSR on page G3-3672](#).

Trapping CPACR accesses

When [HCPTR.TCPAC](#) is set to 1, any access to [CPACR](#) from a Non-secure EL1 mode generates a Hyp Trap exception.

When an exception is taken because [HCPTR.TCPAC](#) is set to 1, the [HSR](#) reports the exception as a trapped CP15 access, using the EC value 0x03, see [Use of the HSR on page G3-3672](#).

G1.16.12 Trapping writes to virtual memory control registers

———— Note ————

EL2 provides a second stage of address translation, that a hypervisor can use to remap the address map defined by a Guest OS. In addition, a hypervisor can trap attempts by the Guest OS to write to the registers that control the Non-secure memory system. A hypervisor might use this trap as part of its virtualization of memory management.

When the value of [HCR.TVM](#) is 1, any attempt, to write to a Non-secure memory control register from a Non-secure EL1 or EL0 mode, that this reference manual does not describe as UNDEFINED, generates a Hyp Trap exception. This trap applies to accesses to the [SCTLR](#), [TTBR0](#), [TTBR1](#), [TTBCR](#), [DACR](#), [DFSR](#), [IFSR](#), [DFAR](#), [IFAR](#), [ADFSRs](#), [PRRR](#), [NMRR](#), [MAIR0](#), [MAIR1](#), [AMAIR0](#), [AMAIR1](#), and the [CONTEXTIDR](#).

When an exception is taken because [HCR.TVM](#) is set to 1, the [HSR](#) reports the exception:

- As a trapped MCR or MRC CP15 access, using the EC value 0x03, if the access is to a 32-bit register.
- As a trapped MCRR or MRRC CP15 access, using the EC value 0x04, if the access is to a 64-bit register.

For more information about the exception reporting, see [Use of the HSR on page G3-3672](#).

G1.16.13 Generic trapping of accesses to CP15 system control registers

———— Note ————

- Many of the hypervisor traps described in the section [AArch32 control of traps to the hypervisor on page G1-3503](#) trap specific CP15 system control register operations to Hyp mode. However, because of the large number of possible usage models for virtualization, the traps on specific functions might not meet all possible requirements. Therefore, EL2 also provide a set of generic traps for trapping CP15 accesses to Hyp mode, as described in this subsection.
- ARM expects that trapping of Non-secure User mode accesses to CP15 to Hyp mode will be unusual, and used only when the hypervisor must virtualize User mode operation. ARM recommends that, whenever possible, Non-secure User mode accesses to CP15 behave as they would if the implementation did not include EL2, generating an Undefined Instruction exception taken to Non-secure Undefined mode if the architecture does not support the User mode access.

The [HSTR](#) provides trap bits {T0-T3, T5-T13, T15}, for trapping accesses to each implemented primary CP15 register, {c0-c3, c5-c13, c15}. When the value of a trap bit is 0, it has no effect on accesses to the CP15 registers. When the value of a trap bit is 1, the trap applies as follows:

- In MCR and MRC instructions, CRn specifies the primary CP15 register. The trap applies if the value of CRn corresponds to the trapped primary CP15 register.
- In MCRR and MRRC instructions, CRm specifies the primary CP15 register. The trap applies if the value of CRm corresponds to the trapped primary CP15 register.

For a trapped primary CP15 register:

- Any MCR, MRC, MCRR, or MRRC access from a Non-secure EL1 mode, generates a Hyp Trap exception.
- Any MCR, MRC, MCRR, or MRRC access from Non-secure User mode:
 - Generates a Hyp Trap exception if the access would not be UNDEFINED if the corresponding trap bit was set to 0.
 - Otherwise, generates an Undefined Instruction exception, taken to Non-secure Undefined mode.

If it is IMPLEMENTATION DEFINED whether, when the corresponding trap bit is set to 0, an access from Non-secure User mode is UNDEFINED, then, when the corresponding trap bit is set to 1, it is IMPLEMENTATION DEFINED whether an access from Non-secure User mode generates:

- A Hyp trap exception.
- An Undefined Instruction exception, taken to Non-secure Undefined mode.

This behavior is an exception to the general trapping behavior described in *Hyp traps on instructions that are UNDEFINED* on page G1-3505.

Note

- The definition of this trap means that, when **HSTR.Tx** is set to 1, the trap applies to accesses from Non-secure EL1 or EL0 modes:
 - Using an MCR or MRC instruction with CRn set to *x*.
 - Using an MCRR or MRRC instruction with CRm set to *x*.
- An implementation might provide additional controls, in IMPLEMENTATION DEFINED registers, to provide finer-grained control of control of trapping of IMPLEMENTATION DEFINED features.
- **HSTR** bit[14] is RES0 regardless of whether the implementation includes the Generic Timer, that has its System registers in CP15 c14. The **HSTR** does not provide a trap on accesses to the Generic Timer CP15 registers.

For example, when **HSTR.T7** is set to 1:

- Any 32-bit CP15 access from a Non-secure EL1 mode, using an MRC or MCR instruction with CRn set to *c7*, is trapped to Hyp mode.
- Any 64-bit CP15 access from a Non-secure EL1 mode, using an MRRC or MCRR instructions with CRm set to *c7*, is trapped to Hyp mode.

When an exception is taken because an **HSTR.Tn** bit is set to 1, the **HSR** reports the exception:

- As a trapped MCR or MRC CP15 access, using the EC value 0x03, if the access uses an MCR or MRC instruction.
- As a trapped MCRR or MRRC CP15 access, using the EC value 0x04, if the access uses an MCRR or MRRC instruction.

For more information about the exception reporting, see *Use of the HSR* on page G3-3672.

G1.16.14 Trapping CP14 accesses to debug registers

Bits in **HDCR** control the trapping of Non-secure CP14 accesses to Hyp mode. When the value of a **HDCR** control bit is 1, and the PE is executing in a Non-secure mode other than Hyp mode and is in Non-debug state, any access to an associated debug register through the CP14 interface generates a Hyp Trap exception.

CP14 register accesses can have side-effects. When a CP14 register access is trapped to Hyp mode, no side-effects occur before the exception is taken, see *Traps of register access instructions* on page G1-3506.

For more information about the reporting of the exceptions see *Use of the HSR* on page G3-3672.

The following sections summarize the **HDCR** control bits, the associated debug registers, and the **HSR** reporting of the Hyp Trap exception:

- *Trapping CP14 accesses to Debug ROM registers.*
- *Trapping CP14 accesses to OS-related debug registers on page G1-3515.*
- *Trapping general CP14 accesses to debug registers on page G1-3515.*
- *Permitted combinations of HDCR.{TDRA, TDOSA, TDA, TDE} bits on page G1-3515.*

Trapping CP14 accesses to Debug ROM registers

When the value of **HDCR.TDRA** is 1, if the PE is executing in a Non-secure mode other than Hyp mode, and is in Non-debug state, any CP14 access to **DBGDRAR** or **DBGDSAR** generates a Hyp Trap exception.

If the value of `HDCR.TDE` is 1, or the value of `HDCR.TDA` is 1, the value of `HDCR.TDRA` must be 1, otherwise behavior is UNPREDICTABLE. For more information about `HDCR.TDE`, see [Routing Debug exceptions to Hyp mode on page G1-3454](#).

The `HSR` reports the exception as a trapped MCR or MRC access to CP14, using the EC value `0x05`.

Trapping CP14 accesses to OS-related debug registers

When the value of `HDCR.TDOSA` is 1, if the PE is executing in a Non-secure mode other than Hyp mode, and is in Non-debug state, any CP14 access to an OS-related debug register generates a Hyp Trap exception.

If the value of `HDCR.TDE` is 1, or the value of `HDCR.TDA` is 1, the value of `HDCR.TDOSA` must be 1, otherwise behavior is UNPREDICTABLE. For more information about `HDCR.TDE`, see [Routing Debug exceptions to Hyp mode on page G1-3454](#).

The OS-related debug registers are:

- `DBGOSLSR`, `DBGOSLAR`, `DBGOSDLR`, and `DBGPRCR`.
- Any IMPLEMENTATION DEFINED integration registers.
- Any IMPLEMENTATION DEFINED register with similar functionality, that the implementation specifies is trapped by `HDCR.TDOSA`.

Depending on the instruction used for the attempted register access, the `HSR` reports the exception:

- For an access to a 32-bit CP14 register, as a trapped MCR or MRC access to CP14, using the EC value `0x05`.
- For an access to a 64-bit register, as a trapped MRRC access to CP14, using the EC value `0x0C`.

Trapping general CP14 accesses to debug registers

When the value of `HDCR.TDA` is 1, if the PE is executing in a Non-secure mode other than Hyp mode, and is in Non-debug state, any CP14 access to a Debug register generates a Hyp Trap exception, except for:

- Any access that this reference manual describes as UNPREDICTABLE or as causing an Undefined Instruction exception. Accesses described as UNPREDICTABLE can generate a Hyp Trap exception, but the architecture does not require them to do so, see UNPREDICTABLE.
- Any access to `DBGDRAR` or `DBGDSAR`. For more information about trapping accesses to these registers see [Trapping CP14 accesses to Debug ROM registers on page G1-3514](#).
- Any access to an OS-related debug register. For a list of these registers, and more information about trapping accesses to them, see [Trapping CP14 accesses to OS-related debug registers](#).

Accesses trapped to Hyp mode when the value of `HDCR.TDA` is 1 include STC accesses to `DBGDTRTXint`, and LDC accesses to `DBGDTRTXint`.

When the value of `HDCR.TDA` is 1, the value of `HDCR.{TDRA, TDOSA}` must be {1, 1}, otherwise behavior is UNPREDICTABLE.

If the value of `HDCR.TDE` is the value of 1, the value of `HDCR.TDA` must be 1, otherwise behavior is UNPREDICTABLE. For more information about `HDCR.TDE`, see [Routing Debug exceptions to Hyp mode on page G1-3454](#).

Depending on the instruction used for the attempted register access, the `HSR` reports the exception:

- As a trapped MCR or MRC access to CP14, using the EC value `0x05`.
- As a trapped LDC or STC access to CP14, using the EC value `0x06`.

Permitted combinations of HDCR.{TDRA, TDOSA, TDA, TDE} bits

The permitted values of the `HDCR.{TDRA, TDOSA, TDA, TDE}` bits are `0b0000`, `0b0100`, `0b1000`, `0b1100`, `0b1110`, and `0b1111`. When the value of `HDCR.TDE` is 1, each of the `HDCR.{TDRA, TDOSA, TDA}` bits is treated as 1 for all purposes other than reading the `HDCR` register.

G1.16.15 Trapping CP14 accesses to trace registers

When the value of [HCPTR.TTA](#) is 1, any access to a CP14 Trace register through the CP14 interface, except for accesses that the appropriate Trace Architecture Specification describes as UNPREDICTABLE or as causing an Undefined Instruction exception:

- If made from a Non-secure EL1 or EL0 mode, generates a Hyp Trap exception.
- If made from Hyp mode, generates an Undefined Instruction exception, taken to Hyp mode, with the [HSR](#) holding a syndrome for the instruction.

———— **Note** —————

Accesses described as UNPREDICTABLE can generate a Hyp Trap or Undefined Instruction exception, but the architecture does not require them to do so. See [UNPREDICTABLE](#).

CP14 register accesses can have side-effects. When a CP14 register access is trapped to Hyp mode, or generates an Undefined Instruction exception, because of the value of [HCPTR.TTA](#), no side-effects occur before the exception is taken, see [Traps of register access instructions on page G1-3506](#).

When the PE is in Debug state, these register accesses do not generate Hyp Trap exceptions, regardless of the value of [HCPTR.TTA](#).

[Trapping accesses to coprocessors on page G1-3511](#) describes other traps controlled by [HCPTR](#).

When a Hyp Trap exception is generated because the value of [HCPTR.TTA](#) is 1, the [HSR](#) reports the exception as a trapped MCR or MRC access to CP14, using the EC value 0x05. For more information see [Use of the HSR on page G3-3672](#).

G1.16.16 Summary of trap controls

Table G1-27 summarizes the hypervisor trap controls, and the associated trap bits. To provide a single summary of all the controls that can cause entry to Hyp mode, it also includes the exception routing controls described in *Routing general exceptions to EL2* on page G1-3452 and *Routing Debug exceptions to Hyp mode* on page G1-3454.

Table G1-27 Summary of Hyp trap controls

Trap description	Controlled by
<i>Trapping ID mechanisms</i> on page G1-3506	HCR.{TID0, TID1, TID2, TID3}
<i>Trapping accesses to lockdown, DMA, and TCM operations</i> on page G1-3508	HCR.TIDCP
<i>Trapping accesses to cache maintenance operations</i> on page G1-3509	HCR.{TSW, TPC, TPU}
<i>Trapping accesses to TLB maintenance operations</i> on page G1-3509	HCR.TTLB
<i>Trapping accesses to the Auxiliary Control Register</i> on page G1-3509	HCR.TAC
<i>Trapping accesses to the Performance Monitors Extension</i> on page G1-3510	HDCR.{TPM, TPMCR}
<i>Trapping use of the SMC instruction</i> on page G1-3510	HCR.TSC
<i>Trapping use of the WFI and WFE instructions</i> on page G1-3511	HCR.{TWI, TWE}
<i>Trapping accesses to the T32EE configuration registers</i> on page G1-3511	HSTR.TTEE
<i>Trapping of Advanced SIMD functionality</i> on page G1-3512	HCPTR.TASE
<i>General trapping of coprocessor accesses</i> on page G1-3512	HCPTR.{TCP0-TCP13}
<i>Trapping CPACR accesses</i> on page G1-3513	HCPTR.TCPAC
<i>Trapping writes to virtual memory control registers</i> on page G1-3513	HCR.TVM
<i>Generic trapping of accesses to CP15 system control registers</i> on page G1-3513	HSTR.{T0-T3, T5-T13, T15}
<i>Trapping CP14 accesses to Debug ROM registers</i> on page G1-3514	HDCR.TDRA
<i>Trapping CP14 accesses to OS-related debug registers</i> on page G1-3515	HDCR.TDOSA
<i>Trapping general CP14 accesses to debug registers</i> on page G1-3515	HDCR.TDA
<i>Trapping CP14 accesses to trace registers</i> on page G1-3516	HCPTR.TTA
<i>Routing general exceptions to EL2</i> on page G1-3452	HCR.TGE
<i>Routing Debug exceptions to Hyp mode</i> on page G1-3454	HDCR.TDE

Chapter G2

The AArch32 System Level Memory Model

This chapter provides a system level view of the general features of the memory system. It contains the following sections:

- *About the memory system architecture* on page G2-3520.
- *Address space* on page G2-3521.
- *Mixed-endian support* on page G2-3522.
- *Cache support* on page G2-3524.
- *ARMv8 CP15 register support for IMPLEMENTATION DEFINED features* on page G2-3545.
- *External aborts* on page G2-3546.
- *Memory barrier instructions* on page G2-3548.
- *Pseudocode details of general memory system instructions* on page G2-3549.

G2.1 About the memory system architecture

The ARM architecture supports different implementation choices for the memory system microarchitecture and memory hierarchy, depending on the requirements of the system being implemented. In this respect, the memory system architecture describes a design space in which an implementation is made. The architecture does not prescribe a particular form for the memory systems. Key concepts are abstracted in a way that permits implementation choices to be made while enabling the development of common software routines that do not have to be specific to a particular microarchitectural form of the memory system. For more information about the concept of a hierarchical memory system see [Memory hierarchy on page E2-2337](#).

G2.1.1 Form of the memory system architecture

The ARMv8 A-profile architecture includes a *Virtual Memory System Architecture* (VMSA), described in [Chapter G3 The AArch32 Virtual Memory System Architecture](#).

G2.1.2 Memory attributes

[Memory types and attributes on page E2-2357](#) describes the memory attributes, including how different memory types have different attributes. Each location in memory has a set of memory attributes, and the translation tables define the virtual memory locations, and the attributes for each location.

[Table G2-1](#) shows the memory attributes that are visible at the system level.

Table G2-1 Memory attribute summary

Memory type	Shareability	Cacheability
Device ^a	Outer Shareable	Non-cacheable.
Normal	One of: <ul style="list-style-type: none">• Non-shareable.• Inner Shareable.• Outer Shareable.	One of: <ul style="list-style-type: none">• Non-cacheable^b.• Write-Through Cacheable.• Write-Back Cacheable.

a. Takes additional attributes, see [Device memory on page E2-2360](#).

b. See also [Cacheability, cache allocation hints, and cache transient hints on page G2-3526](#).

For more information on cacheability and shareability see [The cacheability and shareability memory attributes on page E2-2338](#), [Non-shareable Normal memory on page E2-2359](#), and [Caches and memory hierarchy on page E2-2337](#).

G2.2 Address space

The ARMv8 architecture is designed to support a wide range of applications with different memory requirements. It supports a range of *physical address* (PA) sizes, and provides associated control and identification mechanisms. For more information, see [About VMSAv8-32 on page G3-3562](#).

G2.2.1 Address space overflow or underflow

When a PE performs a normal, sequential execution of instructions, it calculates:

$$(\text{address_of_current_instruction}) + (\text{size_of_executed_instruction})$$

This calculation is performed after each instruction to determine which instruction to execute next.

Instruction address space overflow

If the address calculation performed after executing an A32 or T32 instruction overflows `0xFFFF FFFF`, the program counter becomes UNKNOWN.

———— **Note** —————

Address tags are not propagated to the program counter, so the tag does not affect the address calculation.

Where an instruction accesses a sequential set of bytes that crosses the `0xFFFF_FFFF` boundary the virtual address accessed for the bytes above this boundary is UNKNOWN.

Data address space overflow and underflow

Address calculations associated with data access can cause a data access to be performed at:

- An incremented address that crosses the `0xFFFF FFFF` boundary.
- A decremented address that crosses the `0x0` boundary.

In both cases the computed address is UNKNOWN.

G2.3 Mixed-endian support

Table G2-2 shows the endianness of explicit data accesses and translation table walks.

Table G2-2 Endianness support

Exception level	Explicit data accesses	Stage 1 translation table walks	Stage 2 translation table walks
EL0	CPSR.E	SCTLR(S/NS).EE	HSCTLR.EE
EL1	CPSR.E	SCTLR(S/NS).EE	HSCTLR.EE
EL2	CPSR.E	HSCTLR.EE	N/A
EL3	CPSR.E	SCTLR(S).EE	N/A

ARMv8 provides the following options for endianness support:

- All Exception levels support mixed-endianness:
 - [SCTLR\(S/NS\).EE](#), [HSCTLR.EE](#), and [CPSR.E](#) are R/W.
- Only EL0 supports mixed-endianness and EL1, EL2, and EL3 support only little-endianness:
 - [SCTLR\(S/NS\).EE](#) and [HSCTLR.EE](#) are RES0. [CPSR.E](#) is R/W when in EL0 and RES0 when in EL1, EL2, or EL3. [SPSR.E](#) is also RES0 when not returning to EL0.
- Only EL0 supports mixed-endianness and EL1, EL2, and EL3 support only big-endianness:
 - [SCTLR\(S/NS\).EE](#) and [HSCTLR.EE](#) are RES1. [CPSR.E](#) is R/W when in EL0 and RES1 when in EL1, EL2, or EL3. [SPSR.E](#) is also RES1 when not returning to EL0.
- All Exception levels support only little-endianness:
 - [SCTLR\(S/NS\).EE](#) and [HSCTLR.EE](#) are RES0, and [CPSR.E](#) is RES0. [SPSR.E](#) is RES0.
- All Exception levels support only big-endianness:
 - [SCTLR\(S/NS\).EE](#) and [HSCTLR.EE](#) are RES1, and [CPSR.E](#) is RES1. [SPSR.E](#) is RES1.

Note

- When using AArch32, ARM deprecates [CPSR.E](#) having a different value from the equivalent System control register EE bit when in EL1, EL2 or EL3. The use of the SETEND instruction is also deprecated.
- If the higher Exception levels are using AArch64, the corresponding registers are:
 - [SCTLR_EL1](#) for [SCTLR\(NS\)](#).
 - [SCTLR_EL2](#) for [HSCTLR](#).
 - [SCTLR_EL3](#) for [SCTLR\(S\)](#).

If mixed endian support is implemented for an Exception level using AArch32, endianness is controlled by [CPSR.E](#). For exception returns to AArch32 state, [CPSR.E](#) is copied from [SPSR_ELx.E](#). If the target Exception level supports only little-endian accesses, [SPSR_ELx.E](#) is RES0. If the target Exception level supports only big-endian accesses, [SPSR_ELx.E](#) is RES1.

The `BigEndian()` function determines whether the current Exception level and execution state is using big-endian data:

```
// BigEndian()
// =====

boolean BigEndian()
    boolean bigend;
    if UsingAArch32() then
        bigend = (PSTATE.E != '0');
    elsif PSTATE.EL == EL0 then
```



```
        bigend = (SCTLR_EL1.E0E != '0');  
else  
        bigend = (SCTLR[].EE != '0');  
return bigend;
```

G2.4 Cache support

Cache support includes:

- Cache identification. See [Cache identification on page G2-3525](#).
- Write-through and Write-back attributes, and cache allocation hints and cache transient hints. See [Cacheability, cache allocation hints, and cache transient hints on page G2-3526](#).
- Caches and reset. See [Behavior of caches at reset on page G2-3526](#).
- Enabling and disabling caches. See [Cache enabling and disabling on page G2-3527](#).
- Cache maintenance. See [Cache maintenance instructions on page G2-3534](#).

Additional information relating to caches is provided in the following subsections:

- [The ARMv8 cache maintenance functionality on page G2-3529](#).
- [Branch predictors on page G2-3532](#).
- [Cache lockdown on page G2-3542](#).
- [System level caches on page G2-3543](#).

See also [Chapter G3 The AArch32 Virtual Memory System Architecture](#).

————— **Note** —————

- Branch predictors typically use a form of cache to hold branch target data. Therefore, they are included in this section.
- In the instruction mnemonics, MVA is a synonym for VA.

G2.4.1 General behavior of the caches

When a memory location is marked with a Normal Cacheable memory attribute, determining whether a copy of the memory location is held in a cache still depends on many aspects of the implementation. The following non-exhaustive list of factors might be involved:

- The size, line length, and associativity of the cache.
- The cache allocation algorithm.
- Activity by other elements of the system that can access the memory.
- Speculative instruction fetching algorithms.
- Speculative data fetching algorithms.
- Interrupt behaviors.

Given this range of factors, and the large variety of cache systems that might be implemented, the architecture cannot guarantee whether:

- A memory location present in the cache remains in the cache.
- A memory location not present in the cache is brought into the cache.

Instead, the following principles apply to the behavior of caches:

- The architecture has a concept of an entry locked down in the cache. How lockdown is achieved is IMPLEMENTATION DEFINED, and lockdown might not be supported by:
 - A particular implementation.
 - Some memory attributes.
- An unlocked entry in a cache might not remain in that cache. The architecture does not guarantee that an unlocked cache entry remains in the cache or remains incoherent with the rest of memory. Software must not assume that an unlocked item that remains in the cache remains dirty.
- A locked entry in a cache is guaranteed to remain in that cache. The architecture does not guarantee that a locked cache entry remains incoherent with the rest of memory, that is, it might not remain dirty.

Note

For more information, see [The interaction of cache lockdown with cache maintenance instructions on page G2-3542](#).

- If a memory location both has permissions that mean it can be accessed, either by reads or by writes, for the translation scheme at either the current Exception level or at a higher Exception level, and is marked as Cacheable for that translation regime, then there is no mechanism that can guarantee that the memory location cannot be allocated to an enabled cache at any time.
Any application must assume that any memory location with such access permissions and cacheability attributes can be allocated to any enabled cache at any time.
- If the cache is disabled, it is guaranteed that no new allocation of memory locations into the cache occurs.
- If the cache is enabled, it is guaranteed that no memory location that does not have a Cacheable attribute is allocated into the cache.
- If the cache is enabled, it is guaranteed that no memory location is allocated to the cache if the access permissions for that location are such that the location cannot be accessed by reads and cannot be accessed by writes in both:
 - The translation regime at the current Exception level.
 - The translation regime at a higher Exception level.
- For data accesses, any memory location that is marked as Normal Shareable is guaranteed to be coherent with all masters in that shareability domain.
- Any memory location is not guaranteed to remain incoherent with the rest of memory.
- The eviction of a cache entry from a cache level can overwrite memory that has been written by another observer only if the entry contains a memory location that has been written to by an observer in the shareability domain of that memory location. The maximum size of the memory that can be overwritten is called the *Cache Write-back Granule*. In some implementations the CTR identifies the Cache Write-back Granule, see [CTR, Cache Type Register on page G4-3815](#).
- The allocation of a memory location into a cache cannot cause the most recent value of that memory location to become invisible to an observer, if it was previously visible to that observer.

For the purpose of these principles, a cache entry covers at least 16 bytes and no more than 2KB of contiguous address space, aligned to its size.

In the following situations it is UNPREDICTABLE whether the location is returned from cache or from memory:

- The location is not marked as Cacheable but is contained in the cache. This situation can occur if a location is marked as Non-cacheable after it has been allocated into the cache.
- The location is marked as Cacheable and might be contained in the cache, but the cache is disabled.

G2.4.2 Cache identification

The ARMv8 cache identification consists of a set of registers that describe the implemented caches that are under the control of the PE:

- A single Cache Type Register defines:
 - The minimum line length of any of the instruction caches affected by the instruction cache maintenance instructions.
 - The minimum line length of any of the data or unified caches, affected by the data cache maintenance instructions.
 - The cache indexing and tagging policy of the Level 1 instruction cache.

For more information, see [CTR, Cache Type Register on page G4-3815](#).

- A single Cache Level ID Register defines:
 - The type of cache implemented at each cache level, up to the maximum of seven levels.

- The Level of Coherence and the Level of Unification for the caches. See *Terms used in describing the maintenance instructions* on page G2-3529 for a definition of these terms.

For more information, see *CLIDR, Cache Level ID Register* on page G4-3801.

- A single Cache Size Selection Register selects the cache level and cache type of the current Cache Size Identification Register, see *CSSELR, Cache Size Selection Register* on page G4-3813.
- For each implemented cache, across all the levels of caching, a Cache Size Identification Register defines:
 - Whether the cache supports Write-Through, Write-Back, Read-Allocate and Write-Allocate.
 - The number of sets, associativity and line length of the cache. See *Terms used in describing the maintenance instructions* on page G2-3529 for a definition of these terms.

For more information, see *CCSIDR, Current Cache Size ID Register* on page G4-3799.

G2.4.3 Cacheability, cache allocation hints, and cache transient hints

Cacheability only applies to Normal memory, and can be defined independently for Inner and Outer cache locations.

As described in *Memory types and attributes* on page E2-2357, the memory attributes include a cacheability attribute that is one of:

- Non-cacheable.
- Write-Through cacheable.
- Write-Back cacheable.

Cacheability attributes other than Non-cacheable can be complemented by a *cache allocation hint*. This is an indication to the memory system of whether allocating a value to a cache is likely to improve performance. A *cache transient hint* provides a hint to the memory system that an access is non-temporal or streaming, and unlikely to be repeated in the near future. These hints are used to limit cache pollution to a part of a cache, such as to a subset of ways.

The following cache allocation hints can be used in ARMv8:

- Read-Allocate, Transient Read-Allocate, or no Read-Allocate.
- Write-Allocate, Transient Write-Allocate, or no Write-Allocate.

———— **Note** —————

A Cacheable location with both no Read-Allocate and no Write-Allocate hints is not the same as a Non-cacheable location. A Non-cacheable location has coherency guarantees for all observers within the system that do not apply for a location that is Cacheable, no Read-Allocate, no Write-Allocate.

The architecture does not require an implementation to make any use of cache allocation hints. This means an implementation might not make any distinction between memory locations with attributes that differ only in their cache allocation hint.

G2.4.4 Behavior of caches at reset

In ARMv8:

- All caches are disabled at reset.
- An implementation can require the use of a specific cache initialization routine to invalidate its storage array before it is enabled. The exact form of any required initialization routine is IMPLEMENTATION DEFINED, and the routine must be documented clearly as part of the documentation of the device.
- If an implementation permits cache hits when the cache is disabled the cache initialization routine must:
 - Provide a mechanism to ensure the correct initialization of the caches.
 - Be documented clearly as part of the documentation of the device.

In particular, if an implementation permits cache hits when the cache is disabled and the cache contents are not invalidated at reset, the initialization routine must avoid any possibility of running from an uninitialized cache. It is acceptable for an initialization routine to require a fixed instruction sequence to be placed in a restricted range of memory.

- ARM recommends that whenever an invalidation routine is required, it is based on the ARMv8 cache maintenance instructions.

When it is enabled, the state of a cache is UNPREDICTABLE if the appropriate initialization routine has not been performed.

Similar rules apply to:

- Branch predictor behavior, see *Behavior of the branch predictors at reset* on page G2-3534.
- TLB behavior, see *TLB behavior at reset* on page G3-3631.

G2.4.5 Cache enabling and disabling

When a data cache or unified cache is disabled for a translation regime, as determined by **SCTLR.C** or **HSCTLR.C**, data accesses and translation table walks from that translation regime to all Normal memory types behave as Non-cacheable for all levels of data caches and unified caches.

For the EL1&0 translation regime:

- When **SCTLR.C** == 0, this makes all stage 1 translations for data accesses to Normal memory Non-cacheable. It also makes all accesses to the EL1&0 stage 1 translation tables Non-cacheable.
- When **HCR2.CD** == 1, this makes all stage 2 translations for data accesses to Normal memory Non-cacheable. It also makes all accesses to the EL1&0 stage 2 translation tables Non-cacheable.

———— Note ————

- The stage 1 and stage 2 cacheability attributes are combined as described in *Combining the cacheability attribute* on page G3-3628.
- The **SCTLR.C** bit has no effect on the EL2 and EL3 translation regimes.
- The **HCR2.CD** bit affects only stage 2 of the Non-secure EL1&0 translation regime.

- If **HCR2.CD** is set to 1, then stage 1 EL1&0 translation regime is cacheable regardless of the value of **SCTLR.C**.

For the EL2 translation regime:

- When the value of the **HSCTLR.C** bit is 0, all data accesses to Normal memory using the EL2 translation regime are Non-cacheable. This means all accesses made by the EL2 translation table walks are Non-cacheable.

———— Note ————

The **HSCTLR.C** bit has no effect on the EL1&0 and EL3 translation regimes.

For the EL3 translation regime:

- When the value of the **SCTLR.C** bit is 0, all data accesses to Normal memory using the EL3 translation regime are Non-cacheable. This means all accessed made by the EL3 translation table walks are Non-cacheable.

———— Note ————

The **SCTLR.C** bit has no effect on the EL1&0 and EL2 translation regimes.

The effect of the **SCTLR.C** or **HSCTLR.C** and **HCR2.CD** bits is reflected in the result of the address translation operations in the PAR.

Disabling the instruction cache for a translation regime, as determined by the [SCTLR.I](#) or [HSCTLR.I](#), makes instruction accesses to all Normal memory types behave as Non-cacheable for all levels of instruction or unified cache.

For the EL1&0 translation regime:

- When [SCTLR.I](#) == 0, all instruction accesses to Normal memory are made Non-cacheable at the first stage of translation.
- When [HCR2.ID](#) == 1, all instruction accesses to Normal memory are made Non-cacheable at the second stage of translation.

———— **Note** —————

- The stage 1 and stage 2 cacheability attributes are combined as described in [Combining the cacheability attribute on page G3-3628](#).
- The [SCTLR.I](#) bit has no effect on the EL2 and EL3 translation regimes.
- The [HCR2.ID](#) bit affects only stage 2 of the Non-secure EL1&0 translation regime.

- If [HCR2.DC](#) is set to 1, then the Non-secure stage 1 EL1&0 translation regime is cacheable regardless of the value of [SCTLR.I](#).

For the EL2 translation regime:

- When the value of the [HSCTLR.I](#) bit is 0, all instruction accesses to Normal memory using the EL2 translation regime are Non-cacheable.

———— **Note** —————

The [HSCTLR.I](#) bit has no effect on the EL1&0 and EL3 translation regimes.

For the EL3 translation regime:

- When the value of the [SCTLR.I](#) bit is 0, all instruction accesses to Normal memory using the EL3 translation regime are Non-cacheable.

———— **Note** —————

The [SCTLR.I](#) bit has no effect on the EL1&0 and EL2 translation regimes

In addition, for the Secure EL1, EL2, and EL3 translation regimes, when the value of [SCTLR.M](#) or [HSCTLR.M](#) is 0, indicating that the stage 1 translations are disabled for that translation regime, [SCTLR.I](#) or [HSCTLR.I](#) has the following effect:

- If [SCTLR.I](#) == 0 or [HSCTLR.I](#) == 0, instruction accesses to Normal memory from stage 1 of that translation regime are Outer Shareable, Inner Non-cacheable, Outer Non-cacheable.
- If [SCTLR.I](#) == 1 or [HSCTLR.I](#) == 0, instruction accesses to Normal memory from stage 1 of that translation regime are Outer Shareable, Inner Write-Through, Outer Write-Through.

For the Non-secure EL1 translation regime, when the value of [SCTLR.M](#) is 0, indicating that the stage 1 translations are disabled for that translation regime, and [HCR_EL2.DC](#) == 0, the [SCTLR.I](#) bit has the following effect:

- If [SCTLR.I](#) == 0 or [HSCTLR.I](#) == 0, instruction accesses to Normal memory from stage 1 of that translation regime are Outer Shareable, Inner Non-cacheable, Outer Non-cacheable.
- If [SCTLR.I](#) == 1 or [HSCTLR.I](#) == 1, instruction accesses to Normal memory from stage 1 of that translation regime are Outer Shareable, Inner Write-Through, Outer Write-Through.

———— **Note** —————

This means that the architecturally required effect of [SCTLR.I](#) or [HSCTLR.I](#) is limited to its effect on caching instruction accesses in unified caches.

G2.4.6 The ARMv8 cache maintenance functionality

The following sections give general information about the ARMv8 cache maintenance functionality:

- [Terms used in describing the maintenance instructions.](#)
- [The ARMv8 abstraction of the cache hierarchy on page G2-3532.](#)

The following sections describe cache maintenance instructions for ARMv8:

- [Instruction cache maintenance instructions \(IC*\) on page G2-3535.](#)
- [Data cache maintenance instructions \(DC*\) on page G2-3535.](#)

Terms used in describing the maintenance instructions

Cache maintenance instructions are defined to act on particular memory locations. Instructions can be defined:

- By the address of the memory location to be maintained, referred to as operating *by VA*.
- By a mechanism that describes the location in the hardware of the cache, referred to as operating *by set/way*.

In addition, for instruction caches and branch predictors, there are instructions that invalidate all entries.

The following subsections define the terms used in the descriptions of the cache maintenance instructions:

- [Terminology for cache maintenance instruction operating by virtual address, VA.](#)
- [Terminology for cache maintenance instructions operating by set/way on page G2-3530.](#)
- [Terminology for Clean, Invalidate, and Clean and Invalidate instructions on page G2-3530.](#)

Terminology for cache maintenance instruction operating by virtual address, VA

In a VMSA implementation, the addresses used by the PE are VAs. When all applicable stages of translation are disabled, the VA is identical to the PA.

———— **Note** —————

For more information about memory system behavior when MMUs are disabled, see [The effects of disabling address translation stages on VMSAv8-32 behavior on page G3-3569.](#)

For the cache maintenance instruction, any instruction described as operating by VA includes as part of any required VA to PA translation:

- For an instruction executed at EL1, the current system *Address Space Identifier (ASID)*.
- The current Security state.
- Whether the instruction was performed from Hyp mode, or from Non-secure EL1 state.
- For an instruction executed from a Non-secure EL1 state, the *Virtual Machine Identifier, VMID*.

For a data or unified cache operation by VA, the operation cannot generate a Data Abort exception for a Domain fault or a Permission fault, except for the Permission fault cases described in:

- [Effects of virtualization and security on the cache maintenance instructions on page G2-3537.](#)
- [Stage 2 fault on a stage 1 translation table walk on page G3-3654.](#)

For an instruction cache operation by VA:

- It is IMPLEMENTATION DEFINED whether the operation can generate a Data Abort exception for a Translation fault or an Access flag fault.
- The operation cannot generate a Data Abort exception for a Domain fault or a Permission fault, except for the Permission fault case described in [Stage 2 fault on a stage 1 translation table walk on page G3-3654.](#)

For more information about these faults, see [MMU faults in AArch32 state on page G3-3655.](#)

Terminology for cache maintenance instructions operating by set/way

Cache maintenance instructions that operate by set/way refer to the particular structures in a cache. Three parameters describe the location in a cache hierarchy that an instruction works on. These parameters are:

- Level** The cache level of the hierarchy. The number of levels of cache is IMPLEMENTATION DEFINED and can be determined from the Cache Level ID register. See [CLIDR, Cache Level ID Register on page G4-3801](#).
In the ARM architecture, the lower numbered levels are those closest to the PE. See [Memory hierarchy on page E2-2337](#).
- Set** Each level of a cache is split up into a number of *sets*. Each set is a set of locations in a cache level to which an address can be assigned. Usually, the set number is an IMPLEMENTATION DEFINED function of an address.
In the ARM architecture, sets are numbered from 0.
- Way** The associativity of a cache is the number of locations in a set to which a specific address can be assigned. The *way* number specifies one of these locations.
In the ARM architecture, ways are numbered from 0.

———— **Note** —————

Because the allocation of a memory address to a cache location is entirely IMPLEMENTATION DEFINED, ARM expects that most portable software will use only the cache maintenance instructions by set/way as single steps in a routine to perform maintenance on the entire cache.

Terminology for Clean, Invalidate, and Clean and Invalidate instructions

Caches introduce coherency problems in two possible directions:

1. An update to a memory location by a PE that accesses a cache might not be visible to other observers that can access memory. This can occur because new updates are still in the cache and are not visible yet to the other observers that do not access that cache.
2. Updates to memory locations by other observers that can access memory might not be visible to a PE that accesses a cache. This can occur when the cache contains an old, or *stale*, copy of the memory location that has been updated.

The *Clean* and *Invalidate* instructions address these two issues. The definitions of these instructions are:

- Clean** A cache clean instruction ensures that updates made by an observer that controls the cache are made visible to other observers that can access memory at the point to which the instruction is performed. Once the Clean has completed, the new memory values are guaranteed to be visible to the point to which the instruction is performed, for example to the point of unification.
The cleaning of a cache entry from a cache can overwrite memory that has been written by another observer only if the entry contains a location that has been written to by an observer in the shareability domain of that memory location.
- Invalidate** A cache invalidate instruction ensures that updates made visible by observers that access memory at the point to which the invalidate is defined, are made visible to an observer that controls the cache. This might result in the loss of updates to the locations affected by the invalidate instruction that have been written by observers that access the cache, if those updates have not been cleaned from the cache since they were made.
If the address of an entry on which the invalidate instruction operates does not have a Normal Cacheable attribute, or if the cache is disabled, then an invalidate instruction also ensures that this address is not present in the cache.

Note

Entries for addresses with a Normal Cacheable attribute can be allocated to an enabled cache at any time, and so the cache invalidate instruction cannot ensure that the address is not present in an enabled cache.

Clean and Invalidate

A cache *clean and invalidate* instruction behaves as the execution of a clean instruction followed immediately by an invalidate instruction. Both instructions are performed to the same location.

The points to which a cache maintenance instruction can be defined differ depending on whether the instruction operates by VA or by set/way:

- For instructions operating by set/way, the point is defined to be to the next level of caching. For the All operations, the point is defined as the point of unification for each location held in the cache.
- For instruction operating by VA, two conceptual points are defined:

Point of coherency (PoC)

For a particular VA, the PoC is the point at which all agents that can access memory are guaranteed to see the same copy of a memory location. In many cases, this is effectively the main system memory, although the architecture does not prohibit the implementation of caches beyond the PoC that have no effect on the coherence between memory system agents.

Point of unification (PoU)

The PoU for a PE is the point by which the instruction and data caches and the translation table walks of that PE are guaranteed to see the same copy of a memory location. In many cases, the point of unification is the point in a uniprocessor memory system by which the instruction and data caches and the translation table walks have merged.

The PoU for an Inner Shareable shareability domain is the point by which the instruction and data caches and the translation table walks of all the PEs in that Inner Shareable shareability domain are guaranteed to see the same copy of a memory location. Defining this point permits self-modifying software to ensure future instruction fetches are associated with the modified version of the software by using the standard correctness policy of:

1. Clean data cache entry by address.
2. Invalidate instruction cache entry by address.

The following fields in the [CLIDR](#) relate to these conceptual points:

LoC, Level of coherence

This field defines the last level of cache that must be cleaned or invalidated when cleaning or invalidating to the point of coherency. The LoC value is a cache level, so, for example, if LoC contains the value 3:

- A clean to the point of coherency operation requires the level 1, level 2 and level 3 caches to be cleaned.
- Level 4 cache is the first level that does not have to be maintained.

If the LoC field value is $0x0$, this means that no levels of cache need to be cleaned or invalidated when cleaning or invalidating to the point of coherency.

If the LoC field value is a nonzero value that corresponds to a level that is not implemented, this indicates that all implemented caches are before the point of coherency.

LoUU, Level of unification, uniprocessor

This field defines the last level of cache that must be cleaned or invalidated when cleaning or invalidating to the point of unification for the PE. As with LoC, the LoUU value is a cache level. If the LoUU field value is $0x0$, this means that no levels of cache need to be cleaned or invalidated when cleaning or invalidating to the point of unification.

If the LoUU field value is a nonzero value that corresponds to a level that is not implemented, this indicates that all implemented caches are before the point of unification.

LoUIS, Level of unification, Inner Shareable

In any implementation:

- This field defines the last level of cache that must be cleaned or invalidated when cleaning or invalidating to the point of unification for the Inner Shareable shareability domain. As with LoC, the LoUIS value is a cache level.
- If the LoUIS field value is 0x0, this means that no levels of cache need to be cleaned or invalidated when cleaning or invalidating to the point of unification for the Inner Shareable shareability domain.
- If the LoUIS field value is a nonzero value that corresponds to a level that is not implemented, this indicates that all implemented caches are before the point of unification.

For more information, see [CLIDR, Cache Level ID Register on page G4-3801](#).

The ARMv8 abstraction of the cache hierarchy

The following subsections describe the ARMv8 abstraction of the cache hierarchy:

- [Cache maintenance instructions that operate by address](#).
- [Cache maintenance instructions that operate by set/way](#).

Cache maintenance instructions that operate by address

The address-based cache maintenance instructions are described as operating by VA. Each of these instructions is always qualified as being either:

- Performed to the point of coherency.
- Performed to the point of unification.

See [Terms used in describing the maintenance instructions on page G2-3529](#) for definitions of point of coherency and point of unification, and more information about possible meanings of VA.

[Cache maintenance instructions on page G2-3534](#) lists the address-based maintenance instructions.

The **CTR** holds minimum line length values for:

- The instruction caches.
- The data and unified caches.

These values support efficient invalidation of a range of addresses, because this value is the most efficient address stride to use to apply a sequence of address-based maintenance instructions to a range of addresses.

For the Invalidate data or unified cache line by VA instruction, the Cache Write-back Granule field of the **CTR** defines the maximum granule that a single invalidate instruction can invalidate. This meaning of the Cache Write-back Granule is in addition to its defining the maximum size that can be written back.

Cache maintenance instructions that operate by set/way

[Cache maintenance instructions on page G2-3534](#) lists the set/way-based maintenance instructions. Some encodings of these instructions include a required field that specifies the cache level for the instruction:

- A clean instruction cleans from the level of cache specified through to at least the next level of cache, moving further from the PE.
- An invalidate instruction invalidates only at the level specified.

G2.4.7 Branch predictors

In AArch32 state it is IMPLEMENTATION DEFINED whether branch prediction is architecturally visible. This means that under some circumstances software must perform branch predictor maintenance to avoid incorrect execution caused by out-of-date entries in the branch predictor. For example, to ensure correct operation it might be necessary to invalidate branch predictor entries on a change to instruction memory, or a change of instruction address mapping. For more information, see [Requirements for branch predictor maintenance operations on page G2-3533](#).

The following branch predictor instructions are part of the AArch32 architecture:

- **BPIMVA:**
 - This instruction invalidates the branch predictor based on a branch address.
- **BPIALLIS:**
 - This instruction invalidates all branch predictors. It operates on all PEs in the Inner Shareable domain of the PE that performs the operation.
- **BPIALL:**
 - This instruction invalidates all branch predictors.

An invalidate all operation on the branch predictor ensures that any location held in the branch predictor has no functional effect on execution. An invalidate branch predictor by VA instruction operates on the address of the branch instruction, but can affect other branch predictor entries.

Note

The architecture does not make visible the range of addresses in a branch predictor to which the invalidate operation applies. This means the address used in the invalidate by VA operation must be the address of the branch to be invalidated.

If branch prediction is architecturally visible, an instruction cache invalidate all operation also invalidates all branch predictors.

Requirements for branch predictor maintenance operations

If, for a given translation regime and a given ASID and VMID as appropriate, the instructions at any virtual address change, then branch predictor maintenance operations must be performed to invalidate entries in the branch predictor, to ensure that the change is visible to subsequent execution. This maintenance is required when writing new values to instruction locations. It can also be required as a result of any of the following situations that change the translation of a virtual address to a physical address, if, as a result of the change to the translation, the instructions at the virtual addresses change:

- Enabling or disabling the MMU.
- Writing new mappings to the translation tables.
- Any change to the **TTBR0**, **TTBR1** or **TTBCR** registers, unless accompanied by a change to the ContextID, or a change to the VMID.
- Changes to the **VTTBR** or **VTCTCR** registers, unless accompanied by a change to the VMID.

Note

Invalidation is not required if the changes to the translations are such that the instructions associated with the non-faulting translations of a virtual address, for a given translation regime and a given ASID and VMID, as appropriate, remain unchanged throughout the sequence of changes to the translations. Examples of translation changes to which this applies are:

- Changing a valid translation to a translation that generates a MMU fault.
 - Changing a translation that generates a MMU fault to a valid translation.
-

Failure to invalidate entries might give UNPREDICTABLE results, caused by the execution of old branches. For more information, see [Ordering of cache and branch predictor maintenance instructions on page G2-3539](#).

Note

- In ARMv8, there is no requirement to use the branch predictor maintenance operations to invalidate the branch predictor after:
 - Changing the ContextID or VMID.
 - A cache operation that is identified as also flushing the branch predictors, see [Cache maintenance instructions on page G2-3534](#).
-

[Cache maintenance operations, functional group on page G3-3743](#) shows the branch predictor maintenance operations in a VMSA implementation.

Behavior of the branch predictors at reset

In ARMv8:

- If branch predictors are not architecturally invisible the branch prediction logic is disabled at reset.
- An implementation can require the use of a specific branch predictor initialization routine to invalidate the branch predictor storage array before it is enabled. The exact form of any required initialization routine is IMPLEMENTATION DEFINED, but the routine must be documented clearly as part of the documentation of the device.
- ARM recommends that whenever an invalidation routine is required, it is based on the ARMv8 branch predictor maintenance operations.

When it is enabled, the state of the branch predictor logic is UNPREDICTABLE if the appropriate initialization routine has not been performed.

Similar rules apply:

- To cache behavior, see [Behavior of caches at reset on page G2-3526](#).
- To TLB behavior, see [TLB behavior at reset on page G3-3631](#).

G2.4.8 Cache maintenance instructions

The instruction and data cache maintenance instructions have the same functionality in AArch32 state and in AArch64 state. [Table G2-3](#) shows these system instructions. Instructions that take an argument include Rt in the instruction description.

————— Note —————

- In [Table G2-3](#) the point of unification is the point of unification of the PE executing the cache maintenance instruction.

Table G2-3 System instructions for cache maintenance

Register	Instruction	Notes
Instruction cache maintenance instructions		
ICIALLUIS	Invalidate all to point of unification, Inner Shareable	EL1 or higher access
ICIALLU	Invalidate all to point of unification	EL1 or higher access
ICIMVAU , Rt	Invalidate by virtual address to point of unification	When SCTLR.UCI == 1, EL0 access. Otherwise, EL1 or higher access
Data cache maintenance instructions		
DCIMVAC , Rt	Invalidate by virtual address to point of coherency	EL1 or higher access
DCISW , Rt	Invalidate by set/way	EL1 or higher access
DCCMVAC , Rt	Clean by virtual address to point of coherency	When SCTLR.UCI == 1, EL0 access Otherwise EL1 or higher access
DCCSW , Rt	Clean by set/way	EL1 or higher access

Table G2-3 System instructions for cache maintenance (continued)

Register	Instruction	Notes
DCCMVAU, Rt	Clean by virtual address to point of unification	When <code>SCTLR.UCI == 1</code> , EL0 access Otherwise EL1 or higher access
DCCIMVAC, Rt	Clean and invalidate by virtual address to point of coherency	When <code>SCTLR.UCI == 1</code> , EL0 access. Otherwise EL1 or higher access
DCCISW, Rt	Clean and invalidate by set/way	EL1 or higher access

Instruction cache maintenance instructions (IC*)

Where an address argument for these instructions is required, it takes the form of a 32-bit register that holds the virtual address argument. No alignment restrictions apply for this address.

All instruction cache maintenance instructions can execute in any order relative to other instruction cache maintenance instructions, data cache maintenance instructions, and loads and stores, unless a DSB is executed between the instructions.

An instruction cache maintenance instruction can complete at any time after it is executed, but is only guaranteed to be complete, and its effects visible to other observers, following a DSB instruction executed by the PE that executed the cache maintenance instruction.

Data cache maintenance instructions (DC*)

Where an address argument for these instructions is required, it takes the form of a 32-bit register that holds the virtual address argument. No alignment restrictions apply for this address.

Data cache maintenance instructions that take a set/way/level argument take a 32-bit register.

A data or unified cache invalidation by MVA operation performed in a Non-secure EL1 mode must change data in any location for which the stage 2 translation permissions do not permit write access. Where such a permission violation occurs, it is IMPLEMENTATION DEFINED whether:

- A stage 2 Permission fault is generated for the `DCIMVAC` operation.
- The `DCIMVAC` operation is upgraded to `DCCIMVAC`.

`DCIMVAC` and `DCISW` at EL1 is performed by hardware as clean and invalidate, that is `DCCIMVAC` or `DCCISW` if all of the following apply:

- EL2 is implemented.
- `HCR.VM` is set to 1 to enable the second stage of address translation, meaning that execution is in Non-secure state.
- `SCR.NS` is set to 1 or EL3 is not implemented.

————— Note —————

Similarly, `DCIMVAC` and `DCISW` at EL1 must be performed as clean and invalidate, that is `DCCIMVAC` and `DCCISW` at EL1 when EL1 is using AArch32, if all of the following apply:

- EL2 is implemented.
- EL2 is using AArch32 and `HCR.VM` is set to the value of 1, or EL2 is using AArch64 and `HCR_EL2.VM` is set to the value of 1.
- EL3 is using AArch32 and `SCR.NS` is set to the value of 1, or EL3 is using AArch64 and `SCR.NS` is set to the value of 1, or EL3 is not implemented.

If a memory fault that sets FAR for the translation regime applicable for the cache maintenance instruction is generated from a data cache maintenance instruction, the FAR holds the address specified in the register argument of the instruction.

General requirements for the scope of cache and branch predictor maintenance instructions

The ARMv8 specification of the cache maintenance and branch predictor instructions describes what each instruction is guaranteed to do in a system. It does not limit other behaviors that might occur, provided they are consistent with the requirements described in [General behavior of the caches on page G2-3524](#), [Behavior of caches at reset on page G2-3526](#), and [Preloading caches on page E2-2340](#).

This means that as a side-effect of a cache maintenance instruction:

- Any location in the cache might be cleaned.
- Any unlocked location in the cache might be cleaned and invalidated.

As a side-effect of a branch predictor maintenance instruction, any entry in the branch predictor might be invalidated.

———— Note —————

ARM recommends that, for best performance, such side-effects are kept to a minimum. ARM strongly recommends that the side-effects of operations performed in Non-secure state do not have a significant performance impact on execution in Secure state.

Effects of instructions that operate to the point of coherency

For Normal memory that is not Inner Non-cacheable, Outer Non-cacheable, these instructions must affect the caches of other PEs in the shareability domain described by the shareability attributes of the VA supplied with the instruction.

For Device memory and Normal memory that is Inner Non-cacheable, Outer Non-cacheable, these instructions must affect the caches of all PEs in the Outer Shareable shareability domain of the PE on which the instruction is operating.

In all cases, for any affected PE, these instructions affect all data and unified caches to the point of coherency.

Table G2-4 PEs affected by Data and Unified cache operations

Shareability	PEs affected	Effective to
Non-shareable	The PE performing the operation	The point of coherency of the entire system
Inner Shareable	All PEs in the same Inner Shareable shareability domain as the PE performing the operation	The point of coherency of the entire system
Outer Shareable	All PEs in the same Outer Shareable shareability domain as the PE performing the operation	The point of coherency of the entire system

Effects of instructions that do not operate to the point of coherency

For these instructions, [Table G2-5](#) shows how, for a VA in a Normal or Device memory location, the shareability attribute of the VA determines the minimum set of PEs affected, and the point to which the instruction must be effective.

Table G2-5 PEs affected by address-based cache maintenance instructions

Shareability	PEs affected	Effective to
Non-shareable	The PE executing the instruction	The point of unification of instruction cache fills, data cache fills and write-backs, and translation table walks, on the PE executing the instruction
Inner Shareable or Outer Shareable	All PEs in the same Inner Shareable shareability domain as the PE executing the instruction	The point of unification of instruction cache fills, data cache fills and write-backs, and translation table walks, of all PEs in the same Inner Shareable shareability domain as the PE executing the instruction

———— **Note** ————

The set of PEs guaranteed to be affected is never greater than the PEs in the Inner Shareable shareability domain containing the PE executing the instruction.

Effects of virtualization and security on the cache maintenance instructions

Each Security state has its own physical address space, and therefore cache entries are associated with physical address space. In addition, cache maintenance and branch predictor instructions performed in Non-secure state have to take account of:

- Whether the instruction was performed at EL1 or at EL2.
- For instructions that operate by VA, the current VMID.

[Table G2-6](#) shows the effects of virtualization and security on these maintenance instructions.

Table G2-6 Effects of virtualization and security on the maintenance instructions

Cache maintenance instructions	Security state	Targeted entry
Data or unified cache maintenance instructions		
Invalidate, Clean, or Clean and Invalidate by VA: DCIMVAC, DCCMVAC, DCCMVAU, DCCIMVAC	Either	All lines that hold the PA that, in the current security state, is mapped to by the combination of all of: <ul style="list-style-type: none"> • The specified VA. • For an instruction executed at EL1, the current ASID. • For an instruction executed at Non-secure EL1, the current VMID^b.
Invalidate, Clean, or Clean and Invalidate by set/way: DCISW, DCCSW, DCCISW	Non- secure	Line specified by set/way provided that the entry comes from the Non-secure PA space.
	Secure	Line specified by set/way regardless of the PA space that the entry has come from.

Instruction cache maintenance instructions

Table G2-6 Effects of virtualization and security on the maintenance instructions (continued)

Cache maintenance instructions	Security state	Targeted entry
Invalidate by VA: ICIMVAU	Either	Implementation without the IVIPT Extension ^a : All Lines that match the specified VA, and, for an instruction executed at EL1, the current ASID, and come from the same VA space as the current security state. For an instruction executed in Non-secure state, lines are invalidated only if they also match the current VMID ^b and security level, EL1 or EL2.
		Implementation with the IVIPT Extension: ^a All Lines that hold the PA that, in the current security state, is mapped to by the combination of all of: <ul style="list-style-type: none"> • The specified VA. • For an instruction executed at EL1, the current ASID. • For an instruction executed in Non-secure EL1, the current VMID^b.
Invalidate All: ICIALLU, ICIALUIS		<ul style="list-style-type: none"> • Can invalidate any unlocked entry in the instruction cache. • Are required to invalidate any entries relevant to the software component that executed it. The Non-secure and Secure descriptions give more information: <p>Non-secure</p> An instruction executed at EL1 must operate on all instruction cache lines that contain entries associated with the current virtual machine, meaning any entry with the current VMID^b. An instruction executed at EL2 must operate on all instruction cache lines that contain entries that can be accessed from Non-secure state. <p>Secure</p> The instruction must invalidate all instruction cache lines.
Branch predictor operations		
Invalidate by VA: BPIMVA	Either	All entries that match the specified VA and the current ASID, and come from the same VA space as the current security state. For an operation performed in Non-secure state, entries are invalidated only if they also match the current VMID ^b and security level, EL1 or EL2.
Invalidate all: BPIALL, BPIALLIS	<ul style="list-style-type: none"> • Can invalidate any unlocked entry in the instruction cache. • Are required to invalidate any entries relevant to the software component that executed it. The Non-secure and Secure descriptions give more information. 	

a. See *IVIPT architecture Extension* on page G3-3646.

b. Dependencies on the VMID apply even when HCR_EL2.VM is set to 0. However, VTTBR_EL2.VMID resets to zero, meaning there is a valid VMID from reset.

For locked entries and entries that might be locked, the behavior of cache maintenance instructions described in *The interaction of cache lockdown with cache maintenance instructions* on page G2-3542 applies.

With an implementation that generates aborts if entries are locked or might be locked in the cache, when the use of lockdown aborts is enabled, these aborts can occur on any cache maintenance instructions.

In an implementation that includes EL2:

- The architecture does not require cache cleaning when switching between virtual machines. Cache invalidation by set/way must not present an opportunity for one virtual machine to corrupt state associated with a second virtual machine. To ensure this requirement is met, Non-secure clean by set/way operations can be upgraded to clean and invalidate by set/way.

- The AArch64 Data Cache Invalidate instructions, **DC IVAC** and **DC ISW**, at EL1 and EL0, and the AArch32 Data Cache Invalidate instructions **DCIMVAC** and **DCISW**, perform a cache clean as well as a cache invalidation if all of the following apply:
 - EL2 is implemented.
 - **HCR.VM** is set.
 - **SCR.NS** is set or EL3 is not implemented.
- When the value of **HCR.FB** is 1, TLB and instruction cache invalidate instructions executed in the Non-secure EL1 Exception level are broadcast across the Inner Shareable domain. When Non-secure EL1 is using AArch32, this applies to the **TLBIMVA**, **TLBIASID**, **TLBIMVAA**, **TLBIMVAL**, **TLBIMVAAL**, and **ICIALLU** instructions. This means the instruction is upgraded to the corresponding Inner Shareable instruction, for example **ICIALLU** is upgraded to **ICIALLUIS**, and **BPIALL** is upgraded to **BPIALLIS**.
- When the value of **HCR.SWIO** is 1, a cache invalidate by set/way instructions executed in the Non-secure EL1 Exception level is upgraded to a clean and invalidate by set/way. When Non-secure EL1 is using AArch64, this means the **DCISW** instruction is upgraded to **DCCISW**.

For more information about the cache maintenance instructions, see [The ARMv8 cache maintenance functionality on page G2-3529](#), [Cache maintenance instructions on page G2-3534](#), and [Chapter G3 The AArch32 Virtual Memory System Architecture](#).

Boundary conditions for cache maintenance instructions

Cache maintenance instructions operate on the caches when the caches are enabled or when they are disabled.

For address-based cache maintenance instructions, the instructions operate on the caches regardless of the memory type and cacheability attributes marked for the memory address in the VMSA translation table entries. This means that the effects of the cache maintenance instructions can apply regardless of:

- Whether the address accessed:
 - Is Normal memory or Device memory.
 - Has the Cacheable attribute or the Non-cacheable attribute.
- Any applicable domain control of the address accessed.
- The access permissions for the address accessed, other than the effect of the stage two write permission on data or unified cache invalidation instructions.

Ordering of cache and branch predictor maintenance instructions

The following rules describe the effect of the memory order model on the cache and branch predictor maintenance instructions:

- All cache and branch predictor maintenance instructions that do not specify an address execute, relative to each other, in program order.

All cache and branch predictor instructions that specify an address:

 - Execute in program order relative to all cache and branch predictor operations that do not specify an address.
 - Execute in program order relative to all cache and branch predictor operations that specify the same address.
 - Can execute in any order relative to cache and branch predictor operations that specify a different address.
- Where a cache maintenance or branch predictor instruction appears in program order before a change to the translation tables, the architecture guarantees that the cache or branch predictor maintenance instruction uses the translations that were visible before the change to the translation tables

- Where a change of the translation tables appears in program order before a cache maintenance or branch predictor instruction, software must execute the sequence outlined in [TLB maintenance operations and the memory order model on page G3-3635](#) before performing the cache or branch predictor maintenance instruction, to ensure that the maintenance operation uses the new translations.
- A DMB instruction causes the effect of all data or unified cache maintenance instructions appearing in program order before the DMB to be visible to all explicit load and store operations appearing in program order after the DMB.

Also, a DMB instruction ensures that the effects of any data or unified cache maintenance operations appearing in program order before the DMB are observable by any observer in the same required shareability domain before any data or unified cache maintenance or explicit memory operations appearing in program order after the DMB are observed by the same observer. Completion of the DMB does not guarantee the visibility of all data to other observers. For example, all data might not be visible to a translation table walk, or to instruction fetches.
- A DSB is required to guarantee the completion of all cache maintenance instruction that appear in program order before the DSB instruction.
- A context synchronization operation is required to guarantee the effects of any branch predictor maintenance operation. This means a context synchronization operation causes the effect of all completed branch predictor maintenance operations appearing in program order before the context synchronization operation to be visible to all instructions after the context synchronization operation.

———— **Note** —————

See [Context synchronization operation](#) in the [Glossary](#) for the definition of this term.

This means that, if a branch instruction appears after an invalidate branch predictor operation and before any context synchronization operation, it is UNPREDICTABLE whether the branch instruction is affected by the invalidate. Software must avoid this ordering of instructions, because it might cause UNPREDICTABLE behavior.

- Any data or unified cache maintenance operation by VA must be executed in program order relative to any explicit load or store on the same PE to an address covered by the VA of the cache instruction if that load or store is to Normal Cacheable memory. The order of memory accesses that result from the cache maintenance instruction, relative to any other memory accesses to Normal Cacheable memory, are subject to the memory ordering rules. For more information, see [Memory ordering on page E2-2350](#).

Any data or unified cache maintenance operation by VA can be executed in any order relative to any explicit load or store on the same PE to an address covered by the VA of the cache operation if that load or store is not to Normal Cacheable memory.
- There is no restriction on the ordering of data or unified cache maintenance operations by VA relative to any explicit load or store on the same PE where the address of the explicit load or store is not covered by the VA of the cache instruction. Where the ordering must be restricted, a DMB instruction must be inserted to enforce ordering.
- There is no restriction on the ordering of a data or unified cache maintenance operation by set/way relative to any explicit load or store on the same PE. Where the ordering must be restricted, a DMB instruction must be inserted to enforce ordering.
- Software must execute a context synchronization operation after the completion of an instruction cache maintenance instruction, to guarantee that the effect of the maintenance instruction is visible to any instruction fetch.

The scope of instruction cache maintenance depends on the type of the instruction cache. For more information see [Instruction caches on page G3-3644](#).

Example G2-1 Cache cleaning operations for self-modifying code

The sequence of cache cleaning operations for a line of self-modifying code on a uniprocessor system is:

```

; Enter this code with <Rx> containing the new 32-bit instruction. Use STRH in the first
; line instead of STR for a 16-bit instruction.
STR    <Rx>, [instruction location]
DCCMVAU [instruction location] ; Clean data cache by MVA to point of unification
DSB    ; Ensure visibility of the data cleaned from the cache
ICIMVAU [instruction location] ; Invalidate instruction cache by MVA to PoU
BPIMVAU [instruction location] ; Invalidate branch predictor by MVA to PoU
DSB    ; Ensure completion of the invalidations
ISB    ; Synchronize fetched instruction stream

```

Performing cache maintenance instructions

To ensure all cache lines in a block of address space are maintained through all levels of cache ARM strongly recommends that software:

- For data or unified cache maintenance, uses the `CTR.DMinLine` value to determine the loop increment size for a loop of data cache maintenance by VA instructions.
- For instruction cache maintenance, uses the `CTR.IMinLine` value to determine the loop increment size for a loop of instruction cache maintenance by VA instructions.

Example code for cache maintenance instructions

The cache maintenance instructions by set/way can be used to clean or invalidate, or both, the entirety of one or more levels of cache attached to a processing element. However, unless all processing elements attached to the caches regard all memory locations as Non-cacheable, it is not possible to prevent locations being allocated into the cache during such a sequence of the cache maintenance instructions.

———— Note ————

In multi-processing environments, the cache maintenance instructions that operate by set/way are not broadcast within the shareability domains, and so allocations can occur from other, unmaintained, locations, in caches in other locations. For this reason, the use of cache maintenance instructions that operate by set/way for the maintenance of large buffers of memory is not recommended in the architectural sequence. The expected usage of the cache maintenance instructions that operate by set/way is associated with the cache maintenance instructions associated with the powerdown and powerup of caches, if this is required by the implementation.

The following example code for cleaning a data or unified cache to the point of coherency illustrates a generic mechanism for cleaning the entire data or unified cache to the point of coherency.

```

MRC p15, 1, R0, c0, c0, 1 ; Read CLIDR into R0
ANDS R3, R0, #0x07000000
MOV R3, R3, LSR #23 ; Cache level value (naturally aligned)
BEQ Finished
MOV R10, #0
Loop1
ADD R2, R10, R10, LSR #1 ; Work out 3 x cachelevel
MOV R1, R0, LSR R2 ; bottom 3 bits are the Cache type for this level
AND R1, R1, #7 ; get those 3 bits alone
CMP R1, #2
BLT Skip ; no cache or only instruction cache at this level
MCR p15, 2, R10, c0, c0, 0 ; write CSELR from R10
ISB ; ISB to sync the change to the CCSIDR
MRC p15, 1, R1, c0, c0, 0 ; read current CCSIDR to R1
AND R2, R1, #7 ; extract the line length field
ADD R2, R2, #4 ; add 4 for the line length offset (log2 16 bytes)
LDR R4, =0x3FF
ANDS R4, R4, R1, LSR #3 ; R4 is the max number on the way size (right aligned)
CLZ R5, R4 ; R5 is the bit position of the way size increment
MOV R9, R4 ; R9 working copy of the max way size (right aligned)
Loop2
LDR R7, =0x0007FFF

```

```
    ANDS R7, R7, R1, LSR #13 ; R7 is the max number of the index size (right aligned)
Loop3
    ORR R11, R10, R9, LSL R5 ; factor in the way number and cache number into R11
    ORR R11, R11, R7, LSL R2 ; factor in the index number
    MCR p15, 0, R11, c7, c10, 2 ; DCCSW, clean by set/way
    SUBS R7, R7, #1 ; decrement the index
    BGE Loop3
    SUBS R9, R9, #1 ; decrement the way number
    BGE Loop2

Skip
    ADD R10, R10, #2 ; increment the cache number
    CMP R3, R10
    BGT Loop1
    DSB
Finished
```

Similar approaches can be used for all cache maintenance instructions.

G2.4.9 Cache lockdown

The concept of an entry locked in a cache is allowed, but not architecturally defined. How lockdown is achieved is IMPLEMENTATION DEFINED and might not be supported by:

- An implementation.
- Some memory attributes.

An unlocked entry in a cache might not remain in that cache. The architecture does not guarantee that an unlocked cache entry remains in the cache or remains incoherent with the rest of memory. Software must not assume that an unlocked item that remains in the cache remains dirty.

A locked entry in a cache is guaranteed to remain in that cache. The architecture does not guarantee that a locked cache entry remains incoherent with the rest of memory, that is, it might not remain dirty.

The interaction of cache lockdown with cache maintenance instructions

The interaction of cache lockdown and cache maintenance instructions is IMPLEMENTATION DEFINED. However, an architecturally-defined cache maintenance instruction on a locked cache line must comply with the following general rules:

- The effect of the following instructions on locked cache entries is IMPLEMENTATION DEFINED:
 - Cache clean by set/way, [DCCSW](#).
 - Cache invalidate by set/way, [DCISW](#).
 - Cache clean and invalidate by set/way, [DCISW](#).
 - Instruction cache invalidate all, [ICIALLU](#) and [ICIALUIS](#).

However, one of the following approaches must be adopted in all these cases:

1. If the instruction specified an invalidation, a locked entry is not invalidated from the cache.
2. If the instruction specified a clean it is IMPLEMENTATION DEFINED whether locked entries are cleaned.
3. If an entry is locked down, or could be locked down, an IMPLEMENTATION DEFINED Data Abort exception is generated, using the fault status code defined for this purpose. See [Data Abort exception on page G1-3483](#).

This permits a usage model for cache invalidate routines to operate on a large range of addresses by performing the required operation on the entire cache, without having to consider whether any cache entries are locked.

The effect of the following instructions is IMPLEMENTATION DEFINED:

- Cache clean by virtual address, [DCCMVAC](#) and [DCCMVAU](#).
- Cache invalidate by virtual address, [DCIMVAC](#).
- Cache clean and invalidate by virtual address, [DCCIMVAC](#).

However, one of the following approaches must be adopted in all these cases:

1. If the instruction specified an invalidation, a locked entry is invalidated from the cache. For the clean and invalidate instructions, the entry must be cleaned before it is invalidated.
2. If the instruction specified an invalidation, a locked entry is not invalidated from the cache. If the instruction specified a clean it is IMPLEMENTATION DEFINED whether locked entries are cleaned.
3. If an entry is locked down, or could be locked down, an IMPLEMENTATION DEFINED Data Abort exception is generated, using the fault status code defined for this purpose. See [DFSR](#) or [HSR](#).

In an implementation that includes EL2, if [HCR.TIDCP](#) is set to 1, any exception relating to lockdown of an entry associated with Non-secure memory is routed to EL2.

———— **Note** —————

An implementation that uses an abort mechanisms for entries that can be locked down but are not actually locked down must:

- Document the IMPLEMENTATION DEFINED instruction sequences that perform the required operations on entries that are not locked down.
- Implement one of the other permitted alternatives for the locked entries.

ARM recommends that, when possible, such IMPLEMENTATION DEFINED instruction sequences use architecturally-defined instructions. This minimizes the number of customized instructions required.

In addition, an implementation that uses an abort to handle cache maintenance instructions for entries that might be locked must provide a mechanism that ensures that no entries are locked in the cache.

The reset setting of the cache must be that no cache entries are locked.

Additional cache functions for the implementation of lockdown

An implementation can add additional cache maintenance functions for the handling of lockdown in the IMPLEMENTATION DEFINED space. See [IMPLEMENTATION DEFINED registers, functional group on page G3-3751](#).

G2.4.10 System level caches

The system level architecture might define further aspects of the software view of caches and the memory model that are not defined by the ARMv8 architecture. These aspects of the system level architecture can affect the requirements for software management of caches and coherency. For example, a system design might introduce additional levels of caching that cannot be managed using the architecturally-defined maintenance instructions. Such caches are referred to as *system caches* and are managed through the use of memory-mapped operations. The ARMv8 architecture does not forbid the presence of system caches that are outside the scope of the architecture, but ARM strongly recommends that such caches are always placed after the point of coherency for all memory locations that might be held in a cache. Placing such system caches after the point of coherency means that coherency management does not require maintenance of these system caches.

ARM also strongly recommends:

- For the maintenance of any such system cache:
 - Physical, rather than virtual, addresses are used for address-based cache maintenance instructions.
 - Any IMPLEMENTATION DEFINED system cache maintenance instruction includes at least the set of maintenance options defined by [Cache maintenance instructions on page G2-3534](#), with the number of levels of system cache operated on by the cache maintenance instructions being IMPLEMENTATION DEFINED.

- Wherever possible, all caches that require maintenance to ensure coherency are included in the caches affected by the architecturally-defined cache maintenance instructions, so that the architecturally-defined software sequences for managing the memory model and coherency are sufficient for managing all caches in the system.

G2.5 ARMv8 CP15 register support for IMPLEMENTATION DEFINED features

The ARMv8 CP15 registers implementation includes the following support for IMPLEMENTATION DEFINED features of the memory system:

- The TCM Type Register, [TCMTR](#), in CP15 c0, must be implemented. The following conditions apply to this register:
 - If no TCMs are implemented, the [TCMTR](#) indicates zero-size TCMs.
 - If bits[31:29] are 0b100, the format of the rest of the register is IMPLEMENTATION DEFINED. This value indicates that the implementation includes TCMs that do not follow the legacy usage model. Other fields in the register might give more information about the TCMs.
- The CP15 c9 encoding space with $\langle CRm \rangle = \{0-2, 5-7\}$ is IMPLEMENTATION DEFINED for all values of $\langle opc2 \rangle$ and $\langle opc1 \rangle$. This space is reserved for branch predictor, cache and TCM functionality, for example maintenance, override behaviors and lockdown.

For more information, see [VMSAv8-32 CP15 c9 register summary on page G3-3719](#).

- In a VMSAv8 implementation, part of the CP15 c10 encoding space is IMPLEMENTATION DEFINED and reserved for TLB functionality, see [TLB lockdown on page G3-3631](#).
- The CP15 c11 encoding space with $\langle CRm \rangle = \{0-8, 15\}$ is IMPLEMENTATION DEFINED for all values of $\langle opc2 \rangle$ and $\langle opc1 \rangle$. This space is reserved for DMA operations to and from the TCMs

For more information, see [VMSAv8-32 CP15 c11 register summary on page G3-3721](#).

G2.6 External aborts

The ARM architecture defines external aborts as errors that occur in the memory system, other than those that are detected by the MMU or Debug hardware. External aborts include parity errors detected by the caches or other parts of the memory system. For example, an uncorrectable parity or ECC failure on a Level 2 Memory structure might generate an external abort.

An external abort is one of:

- Synchronous.
- Precise asynchronous.
- Imprecise asynchronous.

For more information, see [Exception terminology on page G1-3402](#).

The ARM architecture does not provide any method to distinguish between precise asynchronous and imprecise asynchronous aborts.

In AArch32 state, asynchronous aborts are reported using the Data Abort exception.

Synchronous external aborts are reported using the Data Abort exception. See [Handling exceptions that are taken to an Exception level using AArch32 on page G1-3431](#).

VMSAv8-32 permits external aborts on data accesses, translation table walks, and instruction fetches to be either synchronous or asynchronous. The reported fault code identifies whether the external abort is synchronous or asynchronous.

It is IMPLEMENTATION DEFINED which external aborts, if any, are supported.

Normally, external aborts are rare. An imprecise asynchronous external abort is likely to be fatal to the process that is running. ARM recommends that implementations make external aborts precise wherever possible.

The following subsections give more information about possible external aborts:

- [External abort on instruction fetch](#).
- [External abort on data read or write](#).
- [Provision for classification of external aborts on page G2-3547](#).
- [Parity error reporting on page G2-3547](#).

The section [Exception reporting in a VMSAv8-32 implementation on page G3-3659](#) describes the reporting of external aborts.

G2.6.1 External abort on instruction fetch

An external abort on an instruction fetch can be either synchronous or asynchronous. A synchronous external abort on an instruction fetch is taken precisely.

An implementation can report the external abort asynchronously from the instruction that it applies to. In such an implementation these aborts behave essentially as interrupts. The aborts are masked when `CPSR.A` is set to 1, otherwise they are reported using the Data Abort exception.

G2.6.2 External abort on data read or write

Externally-generated errors during a data read or write can be either synchronous or asynchronous.

An implementation can report the external abort asynchronously from the instruction that generated the access. In such an implementation these aborts behave essentially as interrupts. The aborts are masked when `CPSR.A` is set to 1, otherwise they are reported using the Data Abort exception.

G2.6.3 Provision for classification of external aborts

For a synchronous external abort taken to a privileged mode other than Hyp mode, an implementation can use the [DFSR.ExT](#) and [IFSR.ExT](#) bits to provide more information about synchronous external aborts:

- [DFSR.ExT](#) provides an IMPLEMENTATION DEFINED classification of synchronous external aborts on data accesses.
- [IFSR.ExT](#) provides an IMPLEMENTATION DEFINED classification of synchronous external aborts on instruction accesses.

For a synchronous external abort taken to Hyp mode, the [HSR.EA](#), ISS[9] bit, provides an IMPLEMENTATION DEFINED classification of external aborts.

For all aborts other than synchronous external aborts these bits return a value of 0.

G2.6.4 Parity error reporting

The ARM architecture supports the reporting of both synchronous and asynchronous parity errors from the cache systems. It is IMPLEMENTATION DEFINED what parity errors in the cache systems, if any, result in synchronous or asynchronous parity errors.

A fault code is defined for reporting parity errors, see [Exception reporting in a VMSAv8-32 implementation on page G3-3659](#). However when parity error reporting is implemented it is IMPLEMENTATION DEFINED whether a parity error is reported using the assigned fault code, or using another appropriate encoding.

For all purposes other than the fault status encoding, parity errors are treated as external aborts.

G2.7 Memory barrier instructions

[Memory barriers on page E2-2352](#) describes the memory barrier instructions. This section describes the system level controls of those instructions.

G2.7.1 EL2 control of the shareability of data barrier instructions executed at EL0 or EL1

In an implementation that includes EL2 and supports shareability limitations on the data barrier instructions, the [HCR.BSU](#) field can upgrade the required shareability of an instruction that is executed at EL0 or EL1 in Non-secure state. [Table G2-7](#) shows the encoding of this field:

Table G2-7 EL2 control of shareability of barrier instructions executed at EL0 or EL1

HCR.BSU	Minimum shareability of barrier instructions
00	No effect, shareability is as specified by the instruction
01	Inner Shareable
10	Outer Shareable
11	Full system

For an instruction executed at EL0 or EL1 in Non-secure state, [Table G2-8](#) shows how the [HCR.BSU](#) is combined with the shareability specified by the argument of the DMB or DSB instruction to give the scope of the instruction:

Table G2-8 Effect of the HCR_EL2.BSU on barrier instructions executed at Non-secure EL1 or EL1

Shareability specified by the DMB or DSB argument	HCR.BSU	Resultant shareability
Full system	Any	Full system
	00, 01, or 10	Outer Shareable
Outer Shareable	11, Full system	Full system
	00 or 01	Inner Shareable
Inner Shareable	10, Outer Shareable	Outer Shareable
	11, Full system	Full system
Non-shareable	00, No effect	Non-shareable
	01, Inner Shareable	Inner Shareable
	10, Outer Shareable	Outer Shareable
	11, Full system	Full system

G2.8 Pseudocode details of general memory system instructions

This section contains the following pseudocode describing general memory operations:

- [Memory data type definitions.](#)
- [Basic memory access on page G2-3550.](#)
- [Aligned memory access on page G2-3550.](#)
- [Unaligned memory access on page G2-3551.](#)
- [Exclusive monitors operations on page G2-3552.](#)
- [Access permission checking on page G2-3554.](#)
- [Abort exceptions on page G2-3555.](#)
- [Memory barriers on page G2-3556.](#)

G2.8.1 Memory data type definitions

This section describes the memory data type definitions.

The address descriptor type is defined as follows:

```
type AddressDescriptor is (
    FaultRecord    fault,    // fault.type indicates whether the address is valid
    MemoryAttributes memattrs,
    FullAddress    paddress
)
```

The full address type is defined as follows:

```
type FullAddress is (
    bits(48) physicaladdress,
    bit      NS                // '0' = Secure, '1' = Non-secure
)
```

The memory attributes types are defined is as follows:

```
type MemoryAttributes is (
    MemType      type,

    DeviceType   device,    // For Device memory types
    MemAttrHints inner,    // Inner hints and attributes
    MemAttrHints outer,    // Outer hints and attributes

    boolean      shareable,
    boolean      outershareable
)
```

The memory type is defined as follows.

```
enumeration MemType {MemType_Normal, MemType_Device};
```

The Device memory types are defined as follows:

```
enumeration DeviceType {DeviceType_GRE, DeviceType_nGRE, DeviceType_nGnRE, DeviceType_nGnRnE};
```

For Normal memory, the inner and outer attributes are defined is as follows:

```
type MemAttrHints is (
    bits(2) attrs, // The possible encodings for each attributes field are as below
    bits(2) hints, // The possible encodings for the hints are below
    boolean transient
)
```

The cacheability attributes are defined as follows:

```
constant bits(2) MemAttr_NC = '00';    // Non-cacheable
```

```
constant bits(2) MemAttr_WT = '10';    // Write-through
```

```
constant bits(2) MemAttr_WB = '11';    // Write-back
```

The allocation hints are defined as follows:

```
constant bits(2) MemHint_No = '00';    // No allocate
constant bits(2) MemHint_WA = '01';    // Write-allocate, Read-no-allocate
constant bits(2) MemHint_RA = '10';    // Read-allocate, Write-no-allocate
constant bits(2) MemHint_RWA = '11';   // Read-allocate and Write-allocate
```

The access permissions type is defined as follows:

```
type Permissions is (
    bits(3) ap,    // Access permission bits
    bit    xn,    // Execute-never bit
    bit    pxn    // Privileged execute-never bit
)
```

G2.8.2 Basic memory access

The two `_Mem[]` accessors, Non-assignment (memory read) and Assignment (memory write), are the operations that perform single-copy atomic, aligned, little-endian memory accesses of size bytes to or from the underlying physical memory array of bytes.

```
bits(8*size) _Mem[AddressDescriptor desc, integer size, AccType acctype];
_Mem[AddressDescriptor desc, integer size, AccType acctype] = bits(8*size) value;
```

The functions address the array using `desc.address` which supplies:

- A 48-bit physical address.
- A single NS bit to select between Secure and Non-secure parts of the array.

The `AccType` parameter describes the access type, such as normal, exclusive, ordered, and streaming. For a definition of `AccType`, see [Address space on page E2-2334](#).

The actual implemented array of memory might be smaller than the 2^{48} bytes implied. In this case the scheme for aliasing is IMPLEMENTATION DEFINED, or some parts of the address space might give rise to external aborts or a System Error.

The attributes in `memaddrdesc.memattrs` are used by the memory system to determine caching and ordering behaviors as described in [Memory types and attributes on page E2-2357](#), [Memory ordering on page E2-2350](#), and [Atomicity in the ARM architecture on page E2-2346](#).

`PAMax()` returns the IMPLEMENTATION DEFINED size of the physical address.

```
integer PAMax();
```

———— Note ————

In AArch32 a translation regime can never generate more than 40 bits of an address.

G2.8.3 Aligned memory access

The `MemA_with_type[]` function makes an atomic, little-endian accesses of size bytes.

```
// MemA_with_type[] - non-assignment (read) form
// =====
bits(size*8) MemA_with_type[bits(32) address, integer size, AccType acctype, boolean wasaligned]
    assert size IN {1, 2, 4, 8, 16};
    assert address == Align(address, size);

    AddressDescriptor memaddrdesc;
```

```

bits(size*8) value;
iswrite = FALSE;

// MMU or MPU
memaddrdesc = AArch32.TranslateAddress(address, acctype, iswrite, wasaligned, size);

// Check for aborts or debug exceptions
if IsFault(memaddrdesc) then
    AArch32.Abort(address, memaddrdesc.fault);

// Memory array access
value = _Mem[memaddrdesc, size, acctype];
return value;

// MemA_with_type[] - assignment (write) form
// =====

MemA_with_type[bits(32) address, integer size, AccType acctype, boolean wasaligned] = bits(size*8) value
assert size IN {1, 2, 4, 8, 16};
assert address == Align(address, size);

AddressDescriptor memaddrdesc;
iswrite = TRUE;

// MMU or MPU
memaddrdesc = AArch32.TranslateAddress(address, acctype, iswrite, wasaligned, size);

// Check for aborts or debug exceptions
if IsFault(memaddrdesc) then
    AArch32.Abort(address, memaddrdesc.fault);

// Effect on exclusives
if memaddrdesc.memattrs.shareable then
    ClearExclusiveByAddress(memaddrdesc.paddress, ProcessorID(), size);

// Memory array access
_Mem[memaddrdesc, size, acctype] = value;
return;

```

G2.8.4 Unaligned memory access

The MemU_with_type[] function makes an access of the required type. If that access is architecturally defined to be atomic, it synthesizes accesses from multiple calls to MemA_with_type[] or multiple accesses, depending on whether the access is required to be atomic. It also reverses the byte order if the access is big-endian.

```

// MemU_with_type[] - non-assignment (read) form
// =====

bits(size*8) MemU_with_type[bits(32) address, integer size, AccType acctype]
assert size IN {1, 2, 4, 8, 16};
bits(size*8) value;
integer i;
boolean iswrite = FALSE;

aligned = AArch32.CheckAlignment(address, size, acctype, iswrite);

if !aligned then
    assert size > 1;
    value<7:0> = MemA_with_type[address, 1, acctype, aligned];

// For subsequent bytes it is CONSTRAINED UNPREDICTABLE whether an unaligned Device memory
// access will generate an Alignment Fault, as to get this far means the first byte did
// not, so we must be changing to a new translation page.
c = ConstrainUnpredictable();
assert c IN {Constraint_FAULT, Constraint_NONE};
if c == Constraint_NONE then aligned = TRUE;

```

```

        for i = 1 to size-1
            value<8*i+7:8*i> = MemA_with_type[address+i, 1, acctype, aligned];
    else
        value = MemA_with_type[address, size, acctype, aligned];

    if BigEndian() then
        value = BigEndianReverse(value);
    return value;

// MemU_with_type[] - assignment (write) form
// =====

MemU_with_type[bits(32) address, integer size, AccType acctype] = bits(size*8) value
integer i;
boolean iswrite = TRUE;

if BigEndian() then
    value = BigEndianReverse(value);

aligned = AArch32.CheckAlignment(address, size, acctype, iswrite);

if !aligned then
    assert size > 1;
    MemA_with_type[address, 1, acctype, aligned] = value<7:0>;

    // For subsequent bytes it is CONSTRAINED UNPREDICTABLE whether an unaligned Device memory
    // access will generate an Alignment Fault, as to get this far means the first byte did
    // not, so we must be changing to a new translation page.
    c = ConstrainUnpredictable();
    assert c IN {Constraint_FAULT, Constraint_NONE};
    if c == Constraint_NONE then aligned = TRUE;

    for i = 1 to size-1
        MemA_with_type[address+i, 1, acctype, aligned] = value<8*i+7:8*i>;
else
    MemA_with_type[address, size, acctype, aligned] = value;
return;

```

G2.8.5 Exclusive monitors operations

The SetExclusiveMonitors() function sets the exclusive monitors for a Load-Exclusive instruction, for a block of bytes. The size of the blocks is determined by size, at the VA address. The ExclusiveMonitorsPass() function checks whether a Store-Exclusive instruction still has possession of the exclusive monitors and therefore completes successfully.

```

// AArch32.SetExclusiveMonitors()
// =====

// Sets the Exclusive Monitors for the current PE to record the addresses associated
// with the virtual address region of size bytes starting at address.

AArch32.SetExclusiveMonitors(bits(32) address, integer size)

    acctype = AccType_ATOMIC;
    iswrite = FALSE;
    aligned = (address != Align(address, size));

    memaddrdesc = AArch32.TranslateAddress(address, acctype, iswrite, aligned, size);

    // Check for aborts or debug exceptions
    if IsFault(memaddrdesc) then
        return;

    if memaddrdesc.memattrs.shareable then
        MarkExclusiveGlobal(memaddrdesc.paddress, ProcessorID(), size);

    MarkExclusiveLocal(memaddrdesc.paddress, ProcessorID(), size);

```

```
AArch32.MarkExclusiveVA(address, ProcessorID(), size);
```

The ExclusiveMonitorsPass() function checks whether a Store-Exclusive instruction still has possession of the exclusive monitors, by checking whether the exclusive monitors are set to include the location of the memory block specified by size, at the virtual address defined by address. The atomic write that follows after the exclusive monitors have been set must be to the same physical address. It is permitted, but not required, for this function to return FALSE if the virtual address is not the same as that used in the previous call to SetExclusiveMonitors().

```
// AArch32.ExclusiveMonitorsPass()
// =====
```

```
// Return TRUE if the Exclusive Monitors for the current PE include all of the addresses
// associated with the virtual address region of size bytes starting at address.
// The immediately following memory write must be to the same addresses.
```

```
boolean AArch32.ExclusiveMonitorsPass(bits(32) address, integer size)
```

```
// It is IMPLEMENTATION DEFINED whether the detection of memory aborts happens
// before or after the check on the local Exclusive Monitor. As a result a failure
// of the local monitor can occur on some implementations even if the memory
// access would give an memory abort.
```

```
acctype = AccType_ATOMIC;
iswrite = TRUE;
aligned = (address == Align(address, size));
```

```
if !aligned then
    secondstage = FALSE;
    AArch32.Abort(address, AArch32.AlignmentFault(acctype, iswrite, secondstage));
```

```
passed = AArch32.IsExclusiveVA(address, ProcessorID(), size);
if !passed then
    return FALSE;
```

```
memaddrdesc = AArch32.TranslateAddress(address, acctype, iswrite, aligned, size);
```

```
// Check for aborts or debug exceptions
if IsFault(memaddrdesc) then
    AArch32.Abort(address, memaddrdesc.fault);
```

```
passed = IsExclusiveLocal(memaddrdesc.paddress, ProcessorID(), size);
if passed && memaddrdesc.memattrs.shareable then
    passed = IsExclusiveGlobal(memaddrdesc.paddress, ProcessorID(), size);
```

```
if passed then
    ClearExclusiveLocal(ProcessorID());
```

```
return passed;
```

The ExclusiveMonitorsStatus() function returns 0 if the previous atomic write was to the same physical memory locations selected by ExclusiveMonitorsPass() and therefore succeeded. Otherwise the function returns 1, indicating that the address translation delivered a different physical address.

```
bit ExclusiveMonitorsStatus();
```

The MarkExclusiveGlobal() procedure takes as arguments a FullAddress.paddress, the PE identifier processorid and the size of the transfer. The procedure records that the PE processorid has requested exclusive access covering at least size bytes from address paddress. The size of the location marked as exclusive is IMPLEMENTATION DEFINED, up to a limit of 2KB and no smaller than two words, and aligned in the address space to the size of the location. It is UNPREDICTABLE whether this causes any previous request for exclusive access to any other address by the same PE to be cleared.

```
MarkExclusiveGlobal(FullAddress paddress, integer processorid, integer size);
```

The `MarkExclusiveLocal()` procedure takes as arguments a `FullAddr` address, the PE identifier `processorid` and the size of the transfer. The procedure records in a local record that PE `processorid` has requested exclusive access to an address covering at least `size` bytes from address `address`. The size of the location marked as exclusive is IMPLEMENTATION DEFINED, and can at its largest cover the whole of memory but is no smaller than two words, and is aligned in the address space to the size of the location. It is IMPLEMENTATION DEFINED whether this procedure also performs a `MarkExclusiveGlobal()` using the same parameters.

```
MarkExclusiveLocal(FullAddr address, integer processorid, integer size);
```

The `IsExclusiveGlobal()` function takes as arguments a `FullAddr` address, the PE identifier `processorid` and the size of the transfer. The function returns `TRUE` if the PE `processorid` has marked in a global record an address range as exclusive access requested that covers at least `size` bytes from address `address`. It is IMPLEMENTATION DEFINED whether it returns `TRUE` or `FALSE` if a global record has marked a different address as exclusive access requested. If no address is marked in a global record as exclusive access, `IsExclusiveGlobal()` returns `FALSE`.

```
boolean IsExclusiveGlobal(FullAddr address, integer processorid, integer size);
```

The `IsExclusiveLocal()` function takes as arguments a `FullAddr` address, the PE identifier `processorid` and the size of the transfer. The function returns `TRUE` if the PE `processorid` has marked an address range as exclusive access requested that covers at least the `size` bytes from address `address`. It is IMPLEMENTATION DEFINED whether this function returns `TRUE` or `FALSE` if the address marked as exclusive access requested does not cover all of `size` bytes from address `address`. If no address is marked as exclusive access requested, then this function returns `FALSE`. It is IMPLEMENTATION DEFINED whether this result is ANDed with the result of `IsExclusiveGlobal()` with the same parameters.

```
boolean IsExclusiveLocal(FullAddr address, integer processorid, integer size);
```

The `ClearExclusiveByAddress()` procedure takes as arguments a `FullAddr` address, the PE identifier `processorid` and the size of the transfer. The procedure clears the global records of all PEs, other than `processorid`, for which an address region including any of `size` bytes starting from `address` has had a request for an exclusive access. It is IMPLEMENTATION DEFINED whether the equivalent global record of the PE `processorid` is also cleared if any of `size` bytes starting from `address` has had a request for an exclusive access, or if any other address has had a request for an exclusive access.

```
ClearExclusiveByAddress(FullAddr address, integer processorid, integer size);
```

The `ClearExclusiveLocal()` procedure takes as arguments the PE identifier `processorid`. The procedure clears the local record of PE `processorid` for which an address has had a request for an exclusive access. It is IMPLEMENTATION DEFINED whether this operation also clears the global record of PE `processorid` that an address has had a request for an exclusive access.

```
ClearExclusiveLocal(integer processorid);
```

G2.8.6 Access permission checking

The function `CheckPermission()` is used by the architecture to perform access permission checking based on attributes derived from the translation tables or location descriptors.

The interpretation of access permission is shown in [Memory access control on page G3-3609](#).

The pseudocode function for checking access permissions is as follows:

```
// AArch32.CheckPermission()
// =====
// Function used for permission checking from AArch32 stage 1 translations

FaultRecord AArch32.CheckPermission(Permissions perms, bits(32) vaddress, integer level,
                                     bits(4) domain, bit NS, AccType acctype, boolean iswrite)
    assert ELUsingAArch32(TranslationRegime());

    if PSTATE.EL != EL2 then
        wxn = SCTLX.WXN == '1';
        if TTBCR.EAE == '1' || SCTLX.AFE == '1' || perms.ap<0> == '1' then
            priv_r = TRUE;
            priv_w = perms.ap<2> == '0';
```



```

        user_r = perms.ap<1> == '1';
        user_w = perms.ap<2:1> == '01';
    else
        priv_r = perms.ap<2:1> != '00';
        priv_w = perms.ap<2:1> == '01';
        user_r = perms.ap<1> == '1';
        user_w = FALSE;
    uwxn = SCTL.R.UWXN == '1';
    user_x = user_r && perms.xn == '0' && !(user_w && wxn);
    priv_x = (priv_r && perms.xn == '0' && perms.pxn == '0' &&
        !(priv_w && wxn) && !(user_w && uwxn));
    ispriv = PSTATE.EL == EL1 && acctype != AccType_UNPRIV;

    if ispriv then
        (r, w, x) = (priv_r, priv_w, priv_x);
    else
        (r, w, x) = (user_r, user_w, user_x);
    else
        // Access from EL2
        wxn = HSCTLR.WXN == '1';
        r = TRUE;
        w = perms.ap<2> == '0';
        x = perms.xn == '0' && !(w && wxn);

    secure_instr_fetch = SCR_GEN[].SIF; // Restriction on Secure instruction fetch
    if HaveEL(EL3) && IsSecure() && NS == '1' && secure_instr_fetch == '1' then
        x = FALSE;

    if acctype == AccType_IFETCH then
        fail = !x;
    elseif iswrite then
        fail = !w;
    else
        fail = !r;

    if fail then
        secondstage = FALSE;
        s2fs1walk = FALSE;
        ipaddress = bits(40) UNKNOWN;
        return AArch32.PermissionFault(ipaddress, domain, level, acctype, iswrite, secondstage,
            s2fs1walk);
    else
        return AArch32.NoFault();

```

G2.8.7 Abort exceptions

The Abort() function generates a Data Abort exception or a Prefetch Abort exception by calling the TakeDataAbortException() or TakePrefetchAbortException() function.

```

// AArch32.Abort()
// =====
// Abort and Debug exception handling in an AArch32 translation regime.

AArch32.Abort(bits(32) vaddress, FaultRecord fault)

    route_to_monitor = HaveEL(EL3) && SCR_GEN[].EA == '1' && IsExternalAbort(fault);
    route_to_hyp = (AArch32.GeneralExceptionsToHyp() || IsSecondStage(fault) ||
        (HaveEL(EL2) && !IsSecure() && IsDebugException(fault) && HDCR.TDE == '1'));

    if (route_to_monitor && !ELUsingAArch32(EL3)) || (route_to_hyp && !ELUsingAArch32(EL2)) then
        AArch64.Abort(ZeroExtend(vaddress), fault);

    if fault.acctype == AccType_IFETCH then
        AArch32.TakePrefetchAbortException(vaddress, fault);
    else
        AArch32.TakeDataAbortException(vaddress, fault);

```

The FaultRecord type describes a fault. Functions that check for faults return a record of this type appropriate to the type of fault. [Pseudocode details of VMSAv8-32 memory system operations on page G3-3755](#) provides a number of wrappers to generate a FaultRecord.

The NoFault() function returns a null record that indicates no fault. The IsFault() function tests whether a FaultRecord contains a fault.

```

enumeration Fault {Fault_None,
                    Fault_AccessFlag,
                    Fault_Alignment,
                    Fault_Background,
                    Fault_Domain,
                    Fault_Permission,
                    Fault_Translation,
                    Fault_AddressSize,
                    Fault_SyncExternal,
                    Fault_SyncExternalOnWalk,
                    Fault_SyncParity,
                    Fault_SyncParityOnWalk,
                    Fault_AsyncParity,
                    Fault_AsyncExternal,
                    Fault_Debug,
                    Fault_TLBConflict,
                    Fault_Lockdown,
                    Fault_Coproc,
                    Fault_ICacheMaint};

type FaultRecord is (Fault   type,           // Fault Status
                    AccType acctype,        // Type of access that faulted
                    bits(48) ipaddress,     // Intermediate physical address
                    boolean  s2fs1walk,    // Is on a Stage 1 page table walk
                    boolean  write,        // TRUE for a read, FALSE for a write
                    integer  level,        // For translation, access flag and permission faults
                    bit      extflag,      // IMPLEMENTATION DEFINED syndrome for external aborts
                    boolean  secondstage,  // Is a Stage 2 abort
                    bits(4)  domain,      // Domain number, AArch32 only
                    bits(4)  debugmoe)    // Debug method of entry, from AArch32 only

// AArch32.NoFault()
// =====

FaultRecord AArch32.NoFault()

    ipaddress = bits(40) UNKNOWN;
    domain = bits(4) UNKNOWN;
    level = integer UNKNOWN;
    acctype = AccType_NORMAL;
    iswrite = boolean UNKNOWN;
    extflag = bit UNKNOWN;
    debugmoe = bits(4) UNKNOWN;
    secondstage = FALSE;
    s2fs1walk = FALSE;

    return AArch32.CreateFaultRecord(Fault_None, ipaddress, domain, level, acctype, iswrite,
                                     extflag, debugmoe, secondstage, s2fs1walk);

// IsFault()
// =====
// Return true if a fault is associated with an address descriptor

boolean IsFault(AddressDescriptor addrdesc)
    return addrdesc.fault.type != Fault_None;

```

G2.8.8 Memory barriers

The definition for the memory barrier functions is:

```

enumeration MReqDomain {MReqDomain_Nonshareable, MReqDomain_InnerShareable,
                       MReqDomain_OuterShareable, MReqDomain_FullSystem};

```

```
enumeration MBReqTypes    {MBReqTypes_Reads, MBReqTypes_Writes, MBReqTypes_A11};
```

These functions define the required shareability domains and required access types used as arguments for DMB and DSB instructions.

The following procedures perform the memory barriers:

```
DataMemoryBarrier(MBReqDomain domain, MBReqTypes types);
```

```
DataSynchronizationBarrier(MBReqDomain domain, MBReqTypes types);
```

```
InstructionSynchronizationBarrier();
```

Chapter G3

The AArch32 Virtual Memory System Architecture

This chapter describes the ARMv8-A AArch32 Virtual Memory System Architecture (VMSA), that is backwards-compatible with VMSAv7. It includes the following section.

- *Execution privilege, Exception levels, and AArch32 Privilege levels* on page G3-3560.
- *About VMSAv8-32* on page G3-3562.
- *The effects of disabling address translation stages on VMSAv8-32 behavior* on page G3-3569.
- *Translation tables* on page G3-3573.
- *The VMSAv8-32 Short-descriptor translation table format* on page G3-3578.
- *The VMSAv8-32 Long-descriptor translation table format* on page G3-3591.
- *Memory access control* on page G3-3609.
- *Memory region attributes* on page G3-3618.
- *Translation Lookaside Buffers (TLBs)* on page G3-3630.
- *TLB maintenance requirements* on page G3-3633.
- *Caches in VMSAv8-32* on page G3-3644.
- *VMSAv8-32 memory aborts* on page G3-3647.
- *Exception reporting in a VMSAv8-32 implementation* on page G3-3659.
- *Virtual Address to Physical Address translation operations* on page G3-3685.
- *About the System registers for VMSAv8-32* on page G3-3691.
- *Organization of the CP14 registers in VMSAv8-32* on page G3-3713.
- *Organization of the CP15 registers in VMSAv8-32* on page G3-3716.
- *Functional grouping of VMSAv8-32 System registers* on page G3-3735.
- *Pseudocode details of VMSAv8-32 memory system operations* on page G3-3755.

———— **Note** —————

This chapter must be read with [Chapter G2 The AArch32 System Level Memory Model](#).

G3.1 Execution privilege, Exception levels, and AArch32 Privilege levels

In ARMv8, the hierarchy of software execution privilege, within a particular Security state, is defined by the Exception levels, with higher Exception level numbers indicating higher privilege. Table G3-1 shows this hierarchy for each Security state.

Table G3-1 Execution privilege and Exception levels, by Security state

Execution privilege	Secure state	Non-secure state	Typical use
Highest	EL3	- ^a	Secure monitor
-	- ^a	EL2	Hypervisor
-	EL1	EL1	Secure or Non-secure OS
Lowest, Unprivileged	EL0	EL0	Secure or Non-secure application

a. EL2 is never implemented in Secure state, and EL3 is never implemented in Non-secure state.

When executing in AArch32 state, within a given Security state, the current PE state, including the execution privilege, is primarily indicated by the current *PE mode*. In Secure state, how the PE modes map onto the Exception levels depends on whether EL3 is using AArch32 or is using AArch64, and:

- Figure G1-1 on page G1-3408 shows this mapping when EL3 is using AArch32.
- Figure G1-2 on page G1-3415 shows this mapping when EL3 is using AArch64.

Table G3-2 shows this mapping. In interpreting this table:

- Monitor mode is implemented only in Secure state, and only if EL3 is using AArch32.
- Hyp mode is implemented only in Non-secure state, and only if EL2 is using AArch32.
- System, FIQ, IRQ, Supervisor, Abort, and Undefined modes are implemented:
 - In Secure state** If either:
 - EL3 is using AArch32.
 - EL3 is using AArch64 and EL1 is using AArch32.
 - In Non-secure state** If EL1 is using AArch32.
- User mode is implemented if EL0 is using AArch32.

Table G3-2 Mapping of AArch32 PE modes to Exception levels

Exception level	PE modes in the given Security state, and EL3 Execution state		
	Secure state, EL3 using AArch32	Secure state, EL3 using AArch64	Non-secure state
EL3	Monitor, System, FIQ, IRQ, Supervisor, Abort, Undefined	-	-
EL2	-	-	Hyp
EL1	-	System, FIQ, IRQ, Supervisor, Abort, Undefined	System, FIQ, IRQ, Supervisor, Abort, Undefined
EL0	User	User	User

Because AArch32 behavior is described in terms of the PE modes, and transitions between PE modes, the Exception levels are implicit in most of the description of operation in AArch32 state.

However, the *translation regimes* provided by the VMSA cannot be described only in terms of the PE modes. In AArch64 state these regimes are defined by the Exception levels that use them. However, in AArch32 state this would result in descriptions that, for Secure state operation in modes other than User mode, would depend on the Exception level being used by AArch32.

To provide a consistent description of address translation as seen from AArch32 state, the translation regimes are described in terms of the Privilege levels originally defined in the ARMv7 descriptions of AArch32 state. [Table G3-3](#) shows this.

Table G3-3 Mapping of PE modes to AArch32 Privilege levels

Privilege level	Secure state	Non-secure state
PL2	-	Hyp ^a
PL1	Monitor ^b , System, FIQ, IRQ, Supervisor, Abort, Undefined	System, FIQ, IRQ, Supervisor, Abort, Undefined
PL0	User	User

a. Implemented only in Non-secure state, and only if EL2 is using AArch32

b. Implemented only in Secure state, and only if EL3 is using AArch32.

Comparing [Table G3-3](#) with [Table G3-2 on page G3-3560](#) shows that:

In Non-secure state

Each privilege level maps to the corresponding Exception level. For example PL1 maps to EL1.

In Secure state

PL0 maps to EL0.

The mapping of PL1 depends on the Execution state being used by EL3, as follows:

EL3 using AArch64 Secure PL1 maps to Secure EL1. Monitor mode is not implemented.

EL3 using AArch32 Secure PL1 maps to Secure EL3. Monitor mode is implemented as one of the Secure PL1 modes.

G3.2 About VMSAv8-32

Note

- This chapter describes the ARMv8 VMSA for AArch32 state, VMSAv8-32. This is generally equivalent to VMSAv7 for an implementation that includes all of the Security Extensions, the Multiprocessing Extension, the Large Physical Address Extension, and the Virtualization Extensions.
- This chapter describes the control of the VMSA by Exception levels that are using AArch32. [Execution privilege, Exception levels, and AArch32 Privilege levels on page G3-3560](#) summarizes how the AArch32 PE modes map onto the Exception levels.
[Chapter D5 The AArch64 Virtual Memory System Architecture](#) describes the control of the VMSA by exception levels that are using AArch64.
- For details of the VMSA differences in previous versions of the ARM architecture see the *ARM® Architecture Reference Manual, ARMv7-A and ARMv7-R edition*.

The main function of the VMSA is to perform address translation, and access permissions and memory attribute determination and checking, for memory accesses made by the PE. Address translation, and permissions and attribute determination and checking, is performed by a *stage* of address translation.

In VMSAv8-32, the *Memory Management Unit* (MMU) provides a number of stages of address translation. This chapter describes only the stages that are visible from Exception levels that are using AArch32, which are as follows:

For operation in Secure state

A single stage of address translation, for use when executing at PL1 or PL0. This is the *Secure PL1&0 stage 1* address translation stage.

For operation in Non-secure state

- A single stage of address translation for use when executing at PL2. This is the *Non-secure PL2 stage 1* address translation stage.
- Two stages of address translation for use when executing at PL1 or PL0. These are:
 - The *Non-secure PL1&0 stage 1* address translation stage.
 - The *Non-secure PL1&0 stage 2* address translation stage.

The System registers provide independent control of each supported stage of address translation, including a control to disable that stage of translation.

These features mean the VMSAv8-32 can support a hierarchy of software supervision, for example an Operating System and a hypervisor.

Each stage of address translation uses address translations and associated memory properties held in memory mapped tables called *translation tables*.

For information about how the MMU features differ if an implementation does not include all of the Exception levels, see [About address translation for VMSAv8-32 on page G3-3565](#).

The translation tables define the following properties:

Access to the Secure or Non-secure address map

The translation table entries determine whether an access from Secure state accesses the Secure or the Non-secure address map. Any access from Non-secure state accesses the Non-secure address map.

Memory access permission control

This controls whether a program is permitted to access a memory region. For instruction and data access, the possible settings are:

- No access.
- Read-only.

- Write-only. This is possible only in a translation regime with two stages of translation.
- Read/write.

For instruction accesses, additional controls determine whether instructions can be fetched and executed from the memory region.

If a PE attempts an access that is not permitted, a memory fault is signaled to the PE.

Memory region attributes

These describe the properties of a memory region. The top-level attribute, the Memory type, is one of Normal, or a type of Device memory, as follows:

- Both translation table formats support the following Device memory types:
 - Device-nGnRnE
 - Device-nGnRE
- The Long-descriptor translation table format supports, in addition, the following Device memory types:
 - Device-nGRE
 - Device-GRE

———— Note ————

ARMv8 added the Device-nGRE and Device-GRE memory types. Also, in versions of the ARM architecture before ARMv8:

- Device-nGnRnE memory is described as Strongly-ordered memory.
- Device-nGnRE memory is described as Device memory.

Normal memory regions can have additional attributes.

For more information, see [Memory types and attributes on page E2-2357](#).

Address translation mappings

An address translation maps an *input address* to an *output address*.

A stage 1 translation takes the address of an explicit data access or instruction fetch, a *virtual address* (VA), as the input address, and translates it to a different output address:

- If only one stage of translation is provided, this output address is the *physical address* (PA).
- If two stages of address translation are provided, the output address of the stage 1 translation is an *intermediate physical address* (IPA).

———— Note ————

In the ARMv8-32 architecture, a software agent, such as an Operating System, that uses or defines stage 1 memory translations, might be unaware of the distinction between IPA and PA.

A stage 2 translation translates the IPA to a PA.

The possible security states and privilege levels of memory accesses define a set of *translation regimes*. [Figure G3-1](#) shows the VMSAv8-32 translation regimes, and their associated translation stages and the Exception levels from which they are controlled.

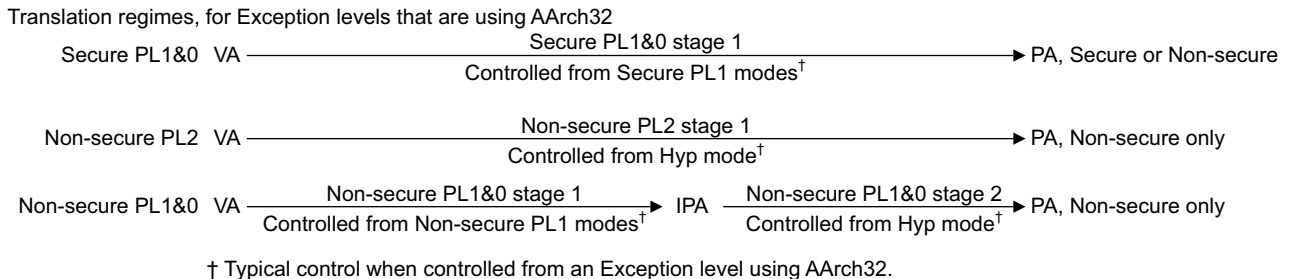

Figure G3-1 VMSAv8-32 translation regimes, and associated control

Note

Conceptually, a translation regime that has only a stage 1 address translation is equivalent to a regime with a fixed, flat stage 2 mapping from IPA to PA.

System registers control VMSAv8-32, including defining the location of the translation tables, and enabling and configuring the MMU, including enabling and disabling the different address translation stages. Also, they report any faults that occur on a memory access. For more information, see [Functional grouping of VMSAv8-32 System registers](#) on page G3-3735.

The following sections give an overview of VMSAv8-32, and of the implementation options for VMSAv8-32:

- [Address types used in a VMSAv8-32 description.](#)
- [Address spaces in VMSAv8-32.](#)
- [About address translation for VMSAv8-32](#) on page G3-3565.

The remainder of the chapter fully describes the VMSA, including the different implementation options, as summarized in [Organization of this chapter](#) on page G3-3567.

G3.2.1 Address types used in a VMSAv8-32 description

A description of VMSAv8-32 refers to the following address types.

Note

These descriptions relate to a VMSAv8-32 description and therefore sometimes differ from the generic definitions given in the Glossary.

Virtual Address (VA)

An address used in an instruction, as a data or instruction address, is a Virtual Address (VA).

An address held in the PC, LR, or SP, is a VA.

The VA map runs from zero to the size of the VA space. For AArch32 state, the maximum VA space is 4GB, giving a maximum VA range of 0x00000000-0xFFFFFFFF.

Intermediate Physical Address (IPA)

In a translation regime that provides two stages of address translation, the IPA is the address after the stage 1 translation, and is the input address for the stage 2 translation.

In a translation regime that provides only one stage of address translation, the IPA is identical to the PA.

A VMSAv8-32 implementation provides only one stage of address translation:

- If the implementation does not include EL2.
- When executing in Secure state.
- When executing in Hyp mode.

Physical Address (PA)

The address of a location in the Secure or Non-secure memory map. That is, an output address from the PE to the memory system.

G3.2.2 Address spaces in VMSAv8-32

For execution in AArch32 state, the ARMv8 architecture supports:

- A VA space of up to 32 bits. The actual width is IMPLEMENTATION DEFINED.
- An IPA space of up to 40 bits. The translation tables and associated System registers define the width of the implemented address space.

Note

AArch32 defines two translation table formats. The *Long-descriptor* format gives access to the full 40-bit IPA or PA space at a granularity of 4KB. The *Short-descriptor* format:

- Gives access to a 32-bit PA space at 4KB granularity.
- Gives access to a 40-bit PA space, but only at 16MB granularity, by the use of Supersections.

If an implementation includes EL3, the address maps are defined independently for Secure and Non-secure operation, providing two independent 40-bit address spaces, where:

- A VA accessed from Non-secure state can only be translated to the Non-secure address map.
- A VA accessed from Secure state can be translated to either the Secure or the Non-secure address map.

G3.2.3 About address translation for VMSAv8-32

Address translation is the process of mapping one address type to another, for example, mapping VAs to IPAs, or mapping VAs to PAs. A *translation table* defines the mapping from one address type to another, and a *Translation table base register* indicates the start of a translation table. Each implemented stage of address translation shown in [Figure G3-1 on page G3-3563](#) requires its own translation tables.

For PL1&0 stage 1 translations, the mapping can be split between two tables, one controlling the lower part of the VA space, and the other controlling the upper part of the VA space. This can be used, for example, so that:

- One table defines the mapping for operating system and I/O addresses, that do not change on a context switch.
- A second table defines the mapping for application-specific addresses, and therefore might require updating on a context switch.

The VMSAv8-32 implementation options determine the supported address translation stages. The following descriptions apply when all implemented Exception levels are using AArch32:

VMSAv8-32 without EL2 or EL3

Supports only a single PL1&0 stage 1 address translation. Translation of this stage of address translation can be split between two sets of translation tables, with base addresses defined by [TTBR0](#) and [TTBR1](#), and controlled by [TTBCR](#).

VMSAv8-32 with EL3 but without EL2

Supports only the Secure PL1&0 stage 1 address translation and the Non-secure PL1&0 stage 1 address translation. In each security state, this stage of translation can be split between two sets of translation tables, with base addresses defined by the Secure and Non-secure copies of [TTBR0](#) and [TTBR1](#), and controlled by the Secure and Non-secure copies of [TTBCR](#).

VMSAv8-32 with EL2 but without EL3

The implementation supports the following stages of address translation:

Non-secure PL2 stage 1 address translation

The [HTTBR](#) defines the base address of the translation table for this stage of address translation, controlled by [HTCR](#).

Non-secure PL1&0 stage 1 address translation

Translation of this stage of address translation can be split between two sets of translation tables, with base addresses defined by the Non-secure copies of [TTBR0](#) and [TTBR1](#) and controlled by the Non-secure instance of [TTBCR](#).

Non-secure PL1&0 stage 2 address translation

The [VTTBR](#) defines the base address of the translation table for this stage of address translation, controlled by [VTCR](#).

VMSAv8-32 with EL2 and EL3

The implementation supports all of the stages of address translation, as follows:

Secure PL1&0 stage 1 address translation

Translation of this stage of address translation can be split between two sets of translation tables, with base addresses defined by the Secure copies of **TTBR0** and **TTBR1**, and controlled by the Secure instance of **TTBCR**.

Non-secure PL2 stage 1 address translation

The **HTTBR** defines the base address of the translation table for this stage of address translation, controlled by **HTCR**.

Non-secure PL1&0 stage 1 address translation

Translation of this stage of address translation can be split between two sets of translation tables, with base addresses defined by the Non-secure copies of **TTBR0** and **TTBR1** and controlled by the Non-secure instance of **TTBCR**.

Non-secure PL1&0 stage 2 address translation

The **VTTBR** defines the base address of the translation table for this stage of address translation, controlled by **VTCT**.

Figure G3-2 shows the translation regimes and stages in a VMSAv8-32 implementation that includes all of the Exception levels, and indicates the PE mode that, typically, defines each set of translation tables, if that stage of address translation is controlled by a Privilege level that is using AArch32:

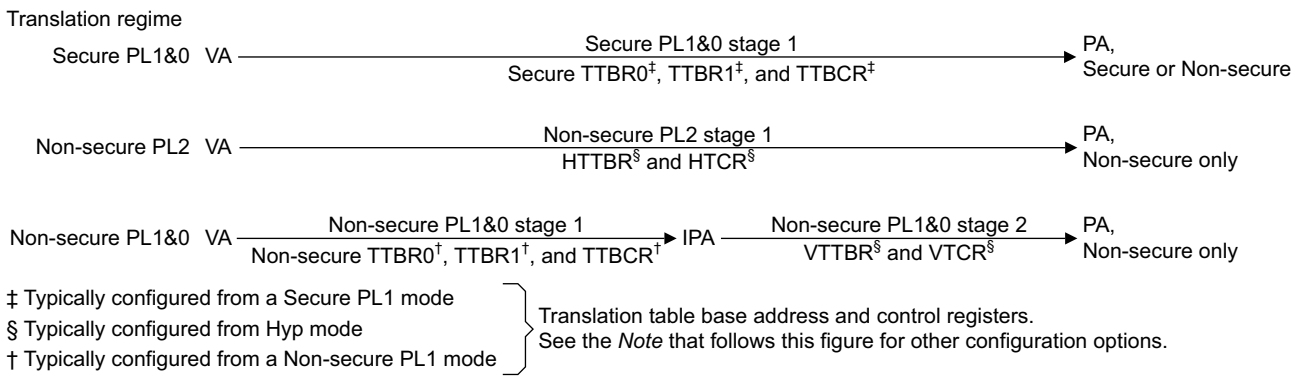

Figure G3-2 VMSAv8-32 address translation summary

Note

The term *Typically configured* is used in Figure G3-2 to indicate the expected software usage. However, stages of address translation used in AArch32 state can also be configured:

- From an Exception level higher than the Exception level of the configuring PE mode shown in Figure G3-2, regardless of whether that Exception level is using AArch32 or is using AArch64, except that a Non-secure Exception level can never configure a stage of address translation that is used in Secure state.
- From an Exception level that is using AArch64 and is higher than the level at which the translation stage is being used. For example, if Non-secure EL0 is the only Non-secure Exception level that is using AArch32, then the Non-secure PL1&0 stage of address translation is configured from Non-secure EL1, that is using AArch64.

In general:

- The translation from VA to PA can require multiple *stages* of address translation, as Figure G3-2 shows.
- A single stage of address translation takes an *input address* and translates it to an *output address*.

A full translation table lookup is called a *translation table walk*. It is performed automatically by hardware, and can have a significant cost in execution time. To support fine granularity of the VA to PA mapping, a single input address to output address translation can require multiple accesses to the translation tables, with each access giving finer granularity. Each access is described as a *level* of address lookup. The final level of the lookup defines:

- The required output address.
- The *attributes* and *access permissions* of the addressed memory.

Translation Lookaside Buffers (TLBs) reduce the average cost of a memory access by caching the results of translation table walks. TLBs behave as caches of the translation table information, and VMSAv8-32 provides TLB maintenance operations for the management of TLB contents.

———— **Note** ————

The ARM architecture permits TLBs to hold any translation table entry that does not directly cause a Translation fault, an Address size fault, or an Access flag fault.

To reduce the software overhead of TLB maintenance, for the PL1&0 translation regimes VMSAv8-32 distinguishes between *Global pages* and *Process-specific pages*. The *Address Space Identifier* (ASID) identifies pages associated with a specific process and provides a mechanism for changing process-specific tables without having to maintain the TLB structures.

If an implementation includes EL2, the *virtual machine identifier* (VMID) identifies the current virtual machine, with its own independent ASID space. The TLB entries include this VMID information, meaning TLBs do not require explicit invalidation when changing from one virtual machine to another, if the virtual machines have different VMIDs. For stage 2 translations, all translations are associated with the current VMID. There is no mechanism to associate a particular stage 2 translation with multiple virtual machines.

G3.2.4 Organization of this chapter

The remainder of this chapter is organized as follows.

The first part of the chapter describes address translation and the associated memory properties held in the translation table entries, in the following sections:

- [The effects of disabling address translation stages on VMSAv8-32 behavior on page G3-3569.](#)
- [Translation tables on page G3-3573.](#)
- [Secure and Non-secure address spaces on page G3-3576.](#)
- [The VMSAv8-32 Short-descriptor translation table format on page G3-3578.](#)
- [The VMSAv8-32 Long-descriptor translation table format on page G3-3591.](#)
- [Memory access control on page G3-3609.](#)
- [Memory region attributes on page G3-3618.](#)
- [Translation Lookaside Buffers \(TLBs\) on page G3-3630.](#)
- [TLB maintenance requirements on page G3-3633.](#)

[Caches in VMSAv8-32 on page G3-3644](#) describes VMSAv8-32-specific cache requirements.

The following sections describe aborts on VMSAv8-32 memory accesses, and how these and other faults are reported:

- [VMSAv8-32 memory aborts on page G3-3647.](#)
- [Exception reporting in a VMSAv8-32 implementation on page G3-3659.](#)

[Virtual Address to Physical Address translation operations on page G3-3685](#) describes these operations, and how they relate to address translation.

A number of sections then describe the System registers for VMSAv8-32. The following sections give general information about the System registers, and the organization of the registers in the two coprocessor encoding spaces, CP14 and CP15, that provide the interface to these registers:

- [About the System registers for VMSAv8-32 on page G3-3691.](#)
- [Organization of the CP14 registers in VMSAv8-32 on page G3-3713.](#)
- [Organization of the CP15 registers in VMSAv8-32 on page G3-3716.](#)

- *Functional grouping of VMSAv8-32 System registers on page G3-3735.*

The following sections then describe each of the functional groups of CP15 registers, including a full description of each register in the group:

- *Identification registers, functional group on page G3-3736.*
- *Virtual memory control registers, functional group on page G3-3737.*
- *Exception and fault handling registers, functional group on page G3-3741.*
- *Other system control registers, functional group on page G3-3737.*
- *Lockdown, DMA, and TCM features, functional group on page G3-3747.*
- *Cache maintenance operations, functional group on page G3-3743.*
- *TLB maintenance operations, functional group on page G3-3744.*
- *Address translation operations, functional group on page G3-3745.*
- *Legacy feature registers, functional group on page G3-3750.*
- *Performance Monitors Extension registers, functional group on page G3-3747.*
- *Security registers, functional group on page G3-3741.*
- *Virtualization registers, functional group on page G3-3738.*
- *IMPLEMENTATION DEFINED registers, functional group on page G3-3751.*

Pseudocode details of VMSAv8-32 memory system operations on page G3-3755 then describes many feature of VMSAv8-32 operation.

G3.3 The effects of disabling address translation stages on VMSAv8-32 behavior

About VMSAv8-32 on page G3-3562 defines the translation regimes and the associated stages of address translation, each of which has its own System registers for control and configuration. VMSAv8-32 includes an enable bit for each stage of address translation, as follows:

- **SCTLR.M**, in the Secure instance of the register, controls Secure PL1&0 stage 1 address translation.
- **SCTLR.M**, in the Non-secure instance of the register, controls Non-secure PL1&0 stage 1 address translation.
- **HCR.VM** controls Non-secure PL1&0 stage 2 address translation.
- **HSCTLR.M** controls Non-secure PL2 stage 1 address translation.

Note

- The descriptions throughout this chapter describe address translation as seen by Exception levels that are using AArch32. However, for the Non-secure PL1&0 translation regime, the stage 2 translation:
 - Is controlled by the **HCR** if EL2 is using AArch32.
 - Is controlled by the **HCR_EL2** if EL2 is using AArch64.For this reason, links to the **HCR** link to a table that disambiguates between the AArch32 **HCR** and the AArch64 **HCR_EL2**.
- If EL2 is using AArch64, then the equivalent of the Non-secure PL2 translation regime is described in *Chapter D5 The AArch64 Virtual Memory System Architecture*, not in this chapter.

The following sections describe the effect on VMSAv8-32 behavior of disabling each stage of translation:

- *VMSAv8-32 behavior when stage 1 address translation is disabled.*
- *VMSAv8-32 behavior when stage 2 address translation is disabled on page G3-3571.*
- *Behavior of instruction fetches when all associated address translations are disabled on page G3-3571.*

Enabling stages of address translation on page G3-3572 gives more information about each stage of address translation, in particular after a reset on an implementation that includes EL3.

G3.3.1 VMSAv8-32 behavior when stage 1 address translation is disabled

When stage 1 address translation is disabled, memory accesses that would otherwise be translated by that stage of address translation are treated as follows:

Non-secure PL1 and PL0 accesses when EL2 is implemented and HCR.DC is set to 1

In an implementation that includes EL2, for an access from a Non-secure PL1 or PL0 mode when **HCR.DC** is set to 1, the stage 1 translation assigns the Normal Non-shareable, Inner Write-Back Write-Allocate, Outer Write-Back Write-Allocate memory attributes.

See also *Effect of the HCR.DC bit on page G3-3570*.

All other accesses

For all other accesses, when a stage 1 address translation is disabled, the assigned attributes depend on whether the access is a data access or an instruction access, as follows:

Data access

The stage 1 translation assigns the Device-nGnRnE memory type.

Note

This means the access is Non-cacheable. Unexpected data cache hit behavior is IMPLEMENTATION DEFINED.

Instruction access

The stage 1 translation assigns Normal memory attribute, with the cacheability and shareability attributes determined by the value of:

- The Secure instance of **SCTLR.I** for the Secure PL1&0 translation regime.
- The Non-secure instance of **SCTLR.I** for the Non-secure PL1&0 translation regime.
- **HSCTLR.I** for the Non-secure PL2 translation regime.

In these cases, the meaning of the I bit is as follows:

When I is set to 0

The stage 1 translation assigns the attributes Outer Shareable, Non-cacheable.

When I is set to 1

The stage 1 translation assigns the attributes Inner Write-Through no Write-Allocate, Outer Write-Through no Write-Allocate Cacheable.

Note

On some implementations, if the **SCTLR.TRE** bit is set to 0 then this behavior can be changed by the remap settings in the memory remap registers. The details of **TEX** remap when **SCTLR.TRE** is set to 0 are IMPLEMENTATION DEFINED, see [SCTLR.TRE](#), [SCTLR.M](#), and [the effect of the TEX remap registers on page G3-3623](#).

For this stage of translation, no memory access permission checks are performed, and therefore no MMU faults relating to this stage of translation can be generated.

Note

Alignment checking is performed, and therefore Alignment faults can occur.

For every access, when stage 1 translation is disabled, the output address of the stage 1 translation is equal to the input address. This is called a flat address mapping. If the implementation supports output addresses of more than 32 bits then the output address bits above bit[31] are zero. For example, for a VA to PA translation on an implementation that supports 40-bit PAs, PA[39:32] is 0x00.

For a Non-secure PL1 or PL0 access, if the PL1&0 stage 2 address translation is enabled, the stage 1 memory attribute assignments and output address can be modified by the stage 2 translation.

See also [Behavior of instruction fetches when all associated address translations are disabled on page G3-3571](#).

Effect of the HCR.DC bit

The **HCR.DC** bit determines the default memory attributes assigned for the first stage of the Non-secure PL1&0 translation regime when that stage of translation is disabled.

When executing in a Non-secure PL1 or PL0 mode with **HCR.DC** set to 1:

- For all purposes other than reading the value of the **SCTLR**, the PE behaves as if the value of the **SCTLR.M** bit is 0. This means Non-secure PL1&0 stage 1 address translation is disabled.
- For all purposes other than reading the value of the **HCR**, the PE behaves as if the value of the **HCR.VM** bit is 1. This means Non-secure PL1&0 stage 2 address translation is enabled.

The effect of **HCR.DC** might be held in TLB entries associated with a particular VMID. Therefore, if software executing at EL2 changes the **HCR.DC** value without also changing the current VMID, it must also invalidate all TLB entries associated with the current VMID. Otherwise, the behavior of Non-secure software executing at EL1 or ELO is UNPREDICTABLE.

Effect of disabling translation on maintenance and address translation operations

Cache maintenance operations act on the target cache whether address translation is enabled or not, and regardless of the values of the memory attributes. However, if a stage of translation is disabled, they use the flat address mapping for that stage, and all mappings are considered global.

TLB invalidate operations act on the target TLB whether address translation is enabled or not.

When the Non-secure PL1&0 stage 1 address translation is disabled, any ATS1C** or ATS12NSO** address translation operation that accesses the Non-secure state translation reflects the effect of the HCR.DC bit. For more information about these operations see [Virtual Address to Physical Address translation operations on page G3-3685](#).

G3.3.2 VMSAv8-32 behavior when stage 2 address translation is disabled

When stage 2 address translation is disabled:

- The IPA output from the stage 1 translation maps flat to the PA
- The memory attributes and permissions from the stage 1 translation apply to the PA.

If the stage 1 address translation and the stage 2 address translation are both disabled, see [Behavior of instruction fetches when all associated address translations are disabled](#).

G3.3.3 Behavior of instruction fetches when all associated address translations are disabled

The information in this section applies to memory accesses:

- From Secure PL1 and PL0 modes, when the Secure PL1&0 stage 1 address translation is disabled
- From Hyp mode, when the Non-secure PL2 stage 1 address translation is disabled
- From Non-secure PL1 and PL0 modes, when all of the following apply:
 - The Non-secure PL1&0 stage 1 address translation is disabled.
 - The Non-secure PL1&0 stage 2 address translation is disabled.
 - HCR.DC is set to 0.

In these cases, a memory location might be accessed as a result of an instruction fetch if one of the following conditions is met:

- The memory location is in the same 4KB block of memory (aligned to 4KB) as an instruction that a simple sequential execution of the program requires to be fetched, or is in the 4KB block of memory immediately following such a block.
- The memory location is in the same 4KB block of memory (aligned to 4KB) from which a simple sequential execution of the program with all associated stages of address translation disabled has previously required an instruction to be fetched, or is in the 4KB block immediately following such a block.

These accesses can be caused by speculative instruction fetches, regardless of whether the prefetched instruction is committed for execution.

———— **Note** —————

To ensure architectural compliance, software must ensure that both of the following apply:

- Instructions that will be executed when address translation is disabled are located in 4KB blocks of the address space that contain only memory that is tolerant to speculative accesses.
- Each 4KB block of the address space that immediately follows a 4KB block that holds instructions that will be executed when address translation is disabled also contains only memory that is tolerant to speculative accesses.

G3.3.4 Enabling stages of address translation

On powerup or reset, only the **SCTLR.M** bit for the Exception level and Security state entered on reset is reset to 0, disabling address translation for the initial state of the PE. All other **SCTLR.M** and **HSCTLR.M** bits that are implemented are UNKNOWN after the reset.

This means, on powerup or reset:

- On an implementation that includes EL3, where EL3 is using AArch32:
 - The PL1&0 stage 1 address translation enable bit, **SCTLR.M**, is Banked, meaning there are separate enables for operation in Secure and Non-secure state.
 - If EL3 is using AArch32, only the Secure instance of the **SCTLR.M** bit resets to 0, disabling the Secure state PL1&0 stage 1 address translation. The reset value of the Non-secure instance of **SCTLR.M** is UNKNOWN.
- On an implementation that includes EL2, where EL2 is using AArch32, the **HSCTLR.M** bit, that controls the Non-secure PL2 stage 1 address translation:
 - If the implementation does not include EL3, resets to 0.
 - Otherwise, is UNKNOWN.
- On an implementation that does not include either EL2 or EL3, there is a single stage of translation. This is controlled by **SCTLR.M**, that resets to 0.

———— **Note** —————

If, for the software that enables or disables a stage of address translation, the input address of a stage 1 translation differs from the output address of that stage 1 translation, and the software is running in translation regime that is affected by that stage of translation, then the requirement to synchronize changes to the system registers means it is uncertain where in the instruction stream the change of the translation takes place. For this reason, ARM strongly recommends that the input address and the output address are identical in this situation.

G3.4 Translation tables

VMSAv8-32 defines two alternative translation table formats:

Short-descriptor format

It uses 32-bit descriptor entries in the translation tables, and provides:

- Up to two levels of address lookup.
- 32-bit input addresses.
- Output addresses of up to 40 bits.
- Support for PAs of more than 32 bits by use of supersections, with 16MB granularity.
- Support for No access, Client, and Manager domains.

Long-descriptor format

It uses 64-bit descriptor entries in the translation tables, and provides:

- Up to three levels of address lookup.
- Input addresses of up to 40 bits, when used for stage 2 translations.
- Output addresses of up to 40 bits.
- 4KB assignment granularity across the entire PA range.
- No support for domains, all memory regions are treated as in a Client domain.
- Fixed 4KB table size, unless truncated by the size of the input address space.

Note

- Translation with a 40-bit input address range requires two concatenated 4KB top-level tables, aligned to 8KB.
- The VMSAv8-64 Long-descriptor translation table format is generally similar to this format, but supports input and output addresses of up to 48 bits, and has an assignment granularity and table size defined by its *translation granule*. This can be 4KB, 16KB, or 64KB. See [The VMSAv8-64 translation table format on page D5-1733](#).

In all implementations, of the possible address translations shown in [Figure G3-2 on page G3-3566](#), for stages of address translation that are using AArch32:

- In a particular Security state, the translation tables for the PL1&0 stage 1 translations can use either translation table format, and the `TTBCR.EAE` bit indicates the current translation table format.
- The translation tables for the Non-secure PL2 stage 1 translations, and for the Non-secure PL1&0 stage 2 translations, must use the Long-descriptor translation table format.

Many aspects of performing a translation table walk depend on the current translation table format. Therefore, the following sections describe the two formats, including how the MMU performs a translation table walk for each format:

- [The VMSAv8-32 Short-descriptor translation table format on page G3-3578](#).
- [The VMSAv8-32 Long-descriptor translation table format on page G3-3591](#).

The following subsections describe aspects of the translation tables and translation table walks, for memory accesses from AArch32 state, that are independent of the translation table format:

- [Translation table walks for memory accesses using VMSAv8-32 translation regimes on page G3-3574](#).
- [Information returned by a translation table lookup on page G3-3574](#).
- [Determining the translation table base address in the VMSAv8-32 translation regimes on page G3-3575](#).
- [Control of translation table walks on a TLB miss on page G3-3576](#).
- [Access to the Secure or Non-secure physical address map on page G3-3576](#).

See also [TLB maintenance requirements on page G3-3633](#).

G3.4.1 Translation table walks for memory accesses using VMSAv8-32 translation regimes

A translation table walk occurs as the result of a TLB miss, and starts with a read of the appropriate starting-level translation table. The result of that read determines whether additional translation table reads are required, for this stage of translation, as described in either:

- [Translation table walks, when using the VMSAv8-32 Short-descriptor translation table format on page G3-3584.](#)
- [Translation table walks, when using the VMSAv8-32 Long-descriptor translation table format on page G3-3603.](#)

———— **Note** —————

When using the Short-descriptor translation table format, the starting level for a translation table walk is always a first-level lookup. However, with the Long-descriptor translation table format, the starting-level can be either a first-level or a second-level lookup.

For the PL1&0 stage 1 translations, [SCTLR.EE](#) determines the endianness of the translation table lookups. [SCTLR](#) is Banked, and therefore the endianness is determined independently for each Security state.

[HSCTLR.EE](#) defines the endianness for the Non-secure PL2 stage 1 and Non-secure PL1&0 stage 2 translations.

———— **Note** —————

Dynamically changing translation table endianness

Because any change to [SCTLR.EE](#) or [HSCTLR.EE](#) requires synchronization before it is visible to subsequent operations, ARM strongly recommends that:

- [SCTLR.EE](#) is changed only when either:
 - Executing in a mode that does not use the translation tables affected by [SCTLR.EE](#).
 - Executing with [SCTLR.M](#) set to 0.
- [HSCTLR.EE](#) is changed only when either:
 - Executing in a mode that does not use the translation tables affected by [HSCTLR.EE](#).
 - Executing with [HSCTLR.M](#) set to 0.

The physical address of the base of the starting-level translation table is determined from the appropriate *Translation table base register* (TTBR), see [Determining the translation table base address in the VMSAv8-32 translation regimes on page G3-3575](#).

For more information, see [TLB maintenance operations and the memory order model on page G3-3635](#).

Translation table walks must access data or unified caches, or data and unified caches, of other agents participating in the coherency protocol, according to the shareability attributes described in the TTBR. These shareability attributes must be consistent with the shareability attributes for the translation tables themselves.

G3.4.2 Information returned by a translation table lookup

When an associated stage of address translation is enabled, a memory access requires one or more translation table lookups. If the required translation table descriptor is not held in a TLB, a translation table walk is performed to obtain the descriptor. A lookup, whether from the TLB or as the result of a translation table walk, returns both:

- An output address that corresponds to the input address for the lookup.
- A set of properties that correspond to that output address.

The returned properties are classified as providing *address map control*, *access controls*, or *region attributes*. This classification determines how the descriptions of the properties are grouped. The classification is based on the following model:

Address map control

Memory accesses from Secure state can access either the Secure or the Non-secure address map, as summarized in [Access to the Secure or Non-secure physical address map on page G3-3576](#).

Memory accesses from Non-secure state can only access the Non-secure address map.

Access controls

Determine whether the PE, in its current state, can access the output address that corresponds to the given input address. If not, a MMU fault is generated and there is no memory access.

Memory access control on page G3-3609 describes the properties in this group.

Attributes Are valid only for an output address that the PE, in its current state, can access. The attributes define aspects of the required behavior of accesses to the target memory region.

Memory region attributes on page G3-3618 describes the properties in this group.

G3.4.3 Determining the translation table base address in the VMSAv8-32 translation regimes

On a TLB miss, the VMSA must perform a translation table walk, and therefore must find the base address of the translation table to use for its lookup. A TTBR holds this address. As [Figure G3-2 on page G3-3566](#) shows:

- For a Non-secure PL2 stage 1 translation, the **HTTBR** holds the required base address. The **HTCR** is the control register for these translations.
- For a Non-secure PL1&0 stage 2 translation, the **VTTBR** holds the required base address. The **VTCT** is the control register for these translations.
- For a PL1&0 stage 1 translation, either **TTBR0** or **TTBR1** holds the required base address. The **TTBCR** is the control register for these translations.

The Non-secure copies of **TTBR0**, **TTBR1**, and **TTBCR**, relate to the Non-secure PL1&0 stage 1 translation. The Secure copies of **TTBR0**, **TTBR1**, and **TTBCR**, relate to the Secure PL1&0 stage 1 translation.

For the PL1&0 translation table walks:

- **TTBR0** can be configured to describe the translation of VAs in the entire address map, or to describe only the translation of VAs in the lower part of the address map.
- If **TTBR0** is configured to describe the translation of VAs in the lower part of the address map, **TTBR1** is configured to describe the translation of VAs in the upper part of the address map.

The contents of the appropriate instance of the **TTBCR** determine whether the address map is separated into two parts, and where the separation occurs. The details of the separation depend on the current translation table format, see:

- *Selecting between TTBR0 and TTBR1, VMSAv8-32 Short-descriptor translation table format* on page G3-3583.
- *Selecting between TTBR0 and TTBR1, VMSAv8-32 Long-descriptor translation table format* on page G3-3598.

[Example G3-1](#) shows a typical use of the two sets of translation tables:

Example G3-1 Example use of TTBR0 and TTBR1

An example of using the two TTBRs for PL1&0 stage 1 address translations is:

TTBR0 Used for process-specific addresses.

Each process maintains a separate first-level translation table. On a context switch:

- **TTBR0** is updated to point to the first-level translation table for the new context.
- **TTBCR** is updated if this change changes the size of the translation table.
- The **CONTEXTIDR** is updated.

TTBCR can be programmed so that all translations use **TTBR0** in a manner compatible with architecture versions before ARMv6.

TTBR1 Used for operating system and I/O addresses, that do not change on a context switch.

G3.4.4 Control of translation table walks on a TLB miss

Two bits in the **TCR** for the translation stage required by a memory access control whether a translation table walk is performed on a TLB miss. These two bits are the:

- PD0 and PD1 bits, on a PE using the Short-descriptor translation table format.
- EPD0 and EPD1 bits, on a PE using the Long-descriptor translation table format.

———— **Note** ————

For the VMSAv8-32 translation regimes, the different bit names are because the bits are in different positions in **TTBCR**, depending on the translation table format.

The effect of these bits is:

{E}PDx == 0 If a TLB miss occurs based on TTBRx, a translation table walk is performed. The current security state determines whether the memory access is Secure or Non-secure.

{E}PDx == 1 If a TLB miss occurs based on TTBRx, a First level Translation fault is returned, and no translation table walk is performed.

G3.4.5 Access to the Secure or Non-secure physical address map

As stated in *Address spaces in VMSAv8-32 on page G3-3564*, a PE can access independent Secure and Non-secure address maps. When the PL1 Exception level is using AArch32, these are defined by the translation tables identified by the Secure **TTBR0** and **TTBR1**. In both translation table formats in the Secure translation tables, the NS bit in a descriptor indicates whether the descriptor refers to the Secure or the Non-secure address map:

NS == 0 Access the Secure physical address space.

NS == 1 Access the Non-secure physical address space.

———— **Note** ————

In the Non-secure translation tables, the corresponding bit is SBZ. Non-secure accesses always access the Non-secure physical address space, regardless of the value of this bit.

The Long-descriptor translation table format extends this control, adding an NSTable bit to the Secure translation tables, as described in *Hierarchical control of Secure or Non-secure memory accesses, Long-descriptor format on page G3-3597*. In the Non-secure translation tables, the corresponding bit is SBZ, and Non-secure accesses ignore the value of this bit.

The following sections describe the address map controls in the two implementations:

- *Control of Secure or Non-secure memory access, VMSAv8-32 Short-descriptor format on page G3-3583.*
- *Control of Secure or Non-secure memory access, VMSAv8-32 Long-descriptor format on page G3-3597.*

The following subsection gives more information.

Secure and Non-secure address spaces

EL3 provides two physical address spaces, a Secure physical address space and a Non-secure physical address space.

As described in *Access to the Secure or Non-secure physical address map*, for the PL1&0 stage 1 translations when controlled from an Exception level using AArch32, the translation table base registers, **TTBR0**, **TTBR1**, and **TTBCR** are Banked between Secure and Non-secure versions, and the Security state of the PE when it performs a memory access selects the corresponding version of the registers. This means there are independent Secure and Non-secure versions of these translation tables, and translation table walks are made to the physical address space corresponding to the security state of the translation tables used.

For a translation table walk caused by a memory access from Non-secure state, all memory accesses are to the Non-secure address space.

For a translation table walk caused by a memory access from Secure state:

- When address translation is using the Long-descriptor translation table format:
 - The first lookup performed must access the Secure address space.
 - If a table descriptor read from the Secure address space has the NSTable bit set to 0, then the next level of lookup is from the Secure address space.
 - If a table descriptor read from the Secure address space has the NSTable bit set to 1, then the next level of lookup, and any subsequent level of lookup, is from the Non-secure address space.
- For more information, see [Control of Secure or Non-secure memory access, VMSAv8-32 Long-descriptor format on page G3-3597](#).
- Otherwise, all memory accesses are to the Secure address space.

Note

- When executing in Non-secure state, additional translations are supported. For memory accesses from AArch32 state these are:
 - Non-secure PL2 stage 1 translation.
 - Non-secure PL1&0 stage 2 translation.These translations can access only the Non-secure address space.
 - A system implementation can alias parts of the Secure physical address space to the Non-secure physical address space in an implementation-specific way. As with any other aliasing of physical memory, the use of aliases in this way can require the use of cache maintenance operations to ensure that changes to memory made using one alias of the physical memory are visible to accesses to the other alias of the physical memory.
-

G3.5 The VMSAv8-32 Short-descriptor translation table format

The Short-descriptor translation table format supports a memory map based on memory sections or pages:

Supersections Consist of 16MB blocks of memory. Support for Supersections is optional, except that an implementation that supports more than 32 bits of Physical Address must also support Supersections to provide access to the entire Physical Address space.

Sections Consist of 1MB blocks of memory.

Large pages Consist of 64KB blocks of memory.

Small pages Consist of 4KB blocks of memory.

Supersections, Sections and Large pages map large regions of memory using only a single TLB entry.

———— **Note** —————

Whether a VMSAv8-32 implementation of the Short-descriptor format translation tables supports supersections is IMPLEMENTATION DEFINED.

When using the Short-descriptor translation table format, two levels of translation tables are held in memory:

First-level table

Holds *first-level descriptors* that contain the base address and

- Translation properties for a Section and Supersection.
- Translation properties and pointers to a second-level table for a Large page or a Small page.

Second-level tables

Hold *second-level descriptors* that contain the base address and translation properties for a Small page or a Large page. With the Short-descriptor format, second-level tables can be referred to as *Page tables*.

A second-level table requires 1KByte of memory.

In the translation tables, in general, a descriptor is one of:

- An invalid or fault entry.
- A page table entry, that points to a next-level translation table.
- A page or section entry, that defines the memory properties for the access.
- A reserved format.

Bits[1:0] of the descriptor give the primary indication of the descriptor type.

[Figure G3-3 on page G3-3579](#) gives a general view of address translation when using the Short-descriptor translation table format.

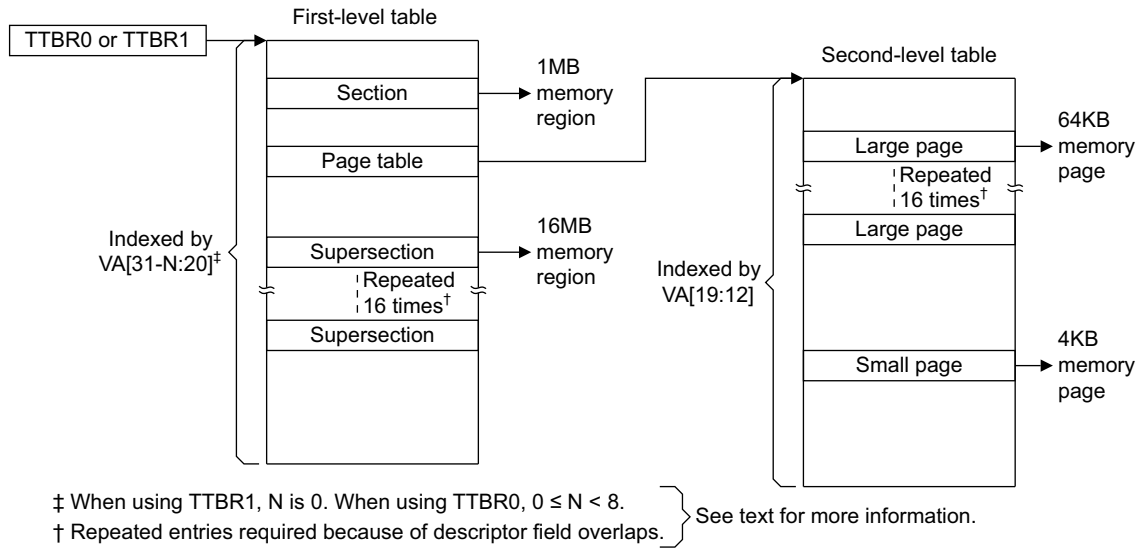

Figure G3-3 General view of address translation using Short-descriptor format translation tables

Additional requirements for Short-descriptor format translation tables on page G3-3582 describes why, when using the Short-descriptor format, Supersection and Large page entries must be repeated 16 times, as shown in *Figure G3-3*.

VMSAv8-32 Short-descriptor translation table format descriptors, Memory attributes in the VMSAv8-32 Short-descriptor translation table format descriptors on page G3-3582, and Control of Secure or Non-secure memory access, VMSAv8-32 Short-descriptor format on page G3-3583 describe the format of the descriptors in the Short-descriptor format translation tables.

The following sections then describe the use of this translation table format:

- *Selecting between TTBR0 and TTBR1, VMSAv8-32 Short-descriptor translation table format on page G3-3583.*
- *Translation table walks, when using the VMSAv8-32 Short-descriptor translation table format on page G3-3584.*

G3.5.1 VMSAv8-32 Short-descriptor translation table format descriptors

The following sections describe the formats of the entries in the Short-descriptor translation tables:

- *Short-descriptor translation table first-level descriptor formats.*
- *Short-descriptor translation table second-level descriptor formats on page G3-3581.*

For more information about second-level translation tables see *Additional requirements for Short-descriptor format translation tables on page G3-3582*.

————— **Note** —————

Previous versions of the *ARM Architecture Reference Manual*, and some other documentation, describes the AP[2] bit in the translation table entries as the APX bit.

Information returned by a translation table lookup on page G3-3574 describes the classification of the non-address fields in the descriptors as address map control, access control, or attribute fields.

Short-descriptor translation table first-level descriptor formats

Each entry in the first-level table describes the mapping of the associated 1MB VA range.

Figure G3-4 on page G3-3580 shows the possible first-level descriptor formats.

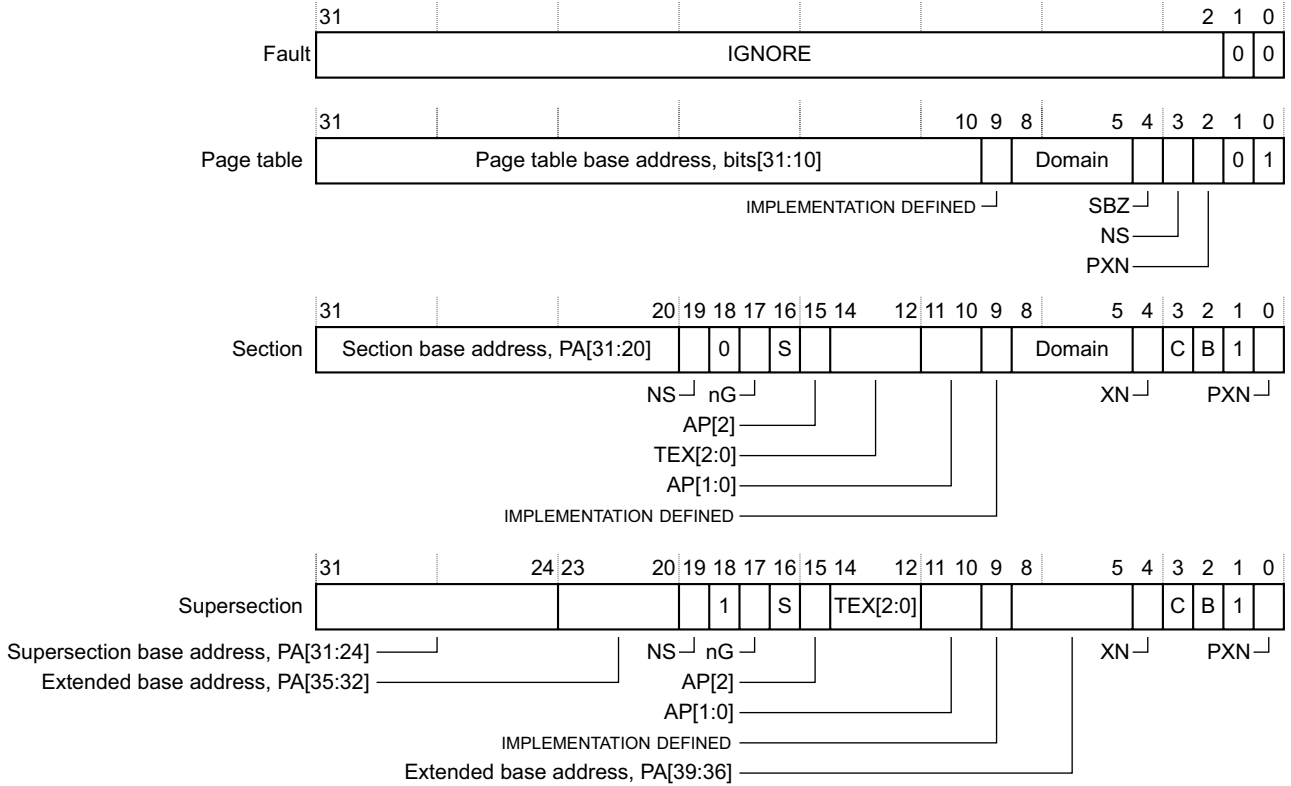

Figure G3-4 Short-descriptor first-level descriptor formats

Descriptor bits[1:0] identify the descriptor type. The encoding of these bits is:

0b00, Invalid or fault entry

The associated VA is unmapped, and any attempt to access it generates a Translation fault.

Software can use bits[31:2] of the descriptor for its own purposes, because the hardware ignores these bits.

0b01, Page table

The descriptor gives the address of a second-level translation table, that specifies the mapping of the associated 1MByte VA range.

0b10, Section or Supersection

The descriptor gives the base address of the Section or Supersection. Bit[18] determines whether the entry describes a Section or a Supersection.

This encoding also defines the PXN bit as 0.

0b11, Section or Supersection, if the implementation supports the PXN attribute

This encoding is identical to 0b10, except that it defines the PXN bit as 1.

Note

A VMSAv8-32 implementation can use the Short-descriptor translation table format for the Secure EL3&0 or Non-secure EL1&0 stage 1 translations, by setting **TTBCR.EAE** to 0.

The address information in the first-level descriptors is:

Page table Bits[31:10] of the descriptor are bits[31:10] of the address of a Page table.

Section Bits[31:20] of the descriptor are bits[31:20] of the address of the Section.

Supersection Bits[31:24] of the descriptor are bits[31:24] of the address of the Supersection.
 Optionally, bits[8:5, 23:20] of the descriptor are bits[39:32] of the extended Supersection address.

For the Non-secure EL1&0 translation tables, the address in the descriptor is the IPA of the Page table, Section, or Supersection. Otherwise, the address is the PA of the Page table, Section, or Supersection.

For descriptions of the other fields in the descriptors, see [Memory attributes in the VMSAv8-32 Short-descriptor translation table format descriptors](#) on page G3-3582.

Short-descriptor translation table second-level descriptor formats

Figure G3-5 shows the possible formats of a second-level descriptor.

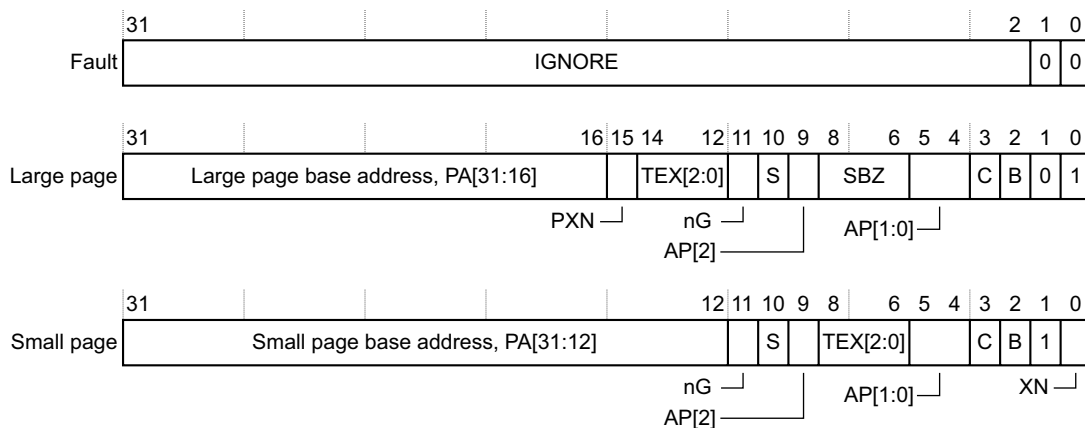

Figure G3-5 Short-descriptor second-level descriptor formats

Descriptor bits[1:0] identify the descriptor type. The encoding of these bits is:

0b00, Invalid or fault entry

The associated VA is unmapped, and attempting to access it generates a Translation fault.

Software can use bits[31:2] of the descriptor for its own purposes, because the hardware ignores these bits.

0b01, Large page

The descriptor gives the base address and properties of the Large page.

0b1x, Small page

The descriptor gives the base address and properties of the Small page.

In this descriptor format, bit[0] of the descriptor is the XN bit.

The address information in the second-level descriptors is:

Large page Bits[31:16] of the descriptor are bits[31:16] of the address of the Large page.

Small page Bits[31:12] of the descriptor are bits[31:12] of the address of the Small page.

For the Non-secure EL1&0 translation tables, the address in the descriptor is the IPA of the Page table, Section, or Supersection. Otherwise, the address is the PA of the Page table, Section, or Supersection.

For descriptions of the other fields in the descriptors, see [Memory attributes in the VMSAv8-32 Short-descriptor translation table format descriptors](#) on page G3-3582.

Additional requirements for Short-descriptor format translation tables

When using Supersection or Large page descriptors in the Short-descriptor translation table format, the input address field that defines the Supersection or Large page descriptor address overlaps the table address field. In each case, the size of the overlap is 4 bits. The following diagrams show these overlaps:

- [Figure G3-8 on page G3-3587](#) for the first-level translation table Supersection entry.
- [Figure G3-10 on page G3-3589](#) for the second-level translation table Large page table entry.

Considering the case of using Large page table descriptors in a second-level translation table, this overlap means that for any specific Large page, the bottom four bits of the second-level translation table entry might take any value from 0b0000 to 0b1111. Therefore, each of these sixteen index values must point to a separate copy of the same descriptor.

This means that each Large page or Supersection descriptor must:

- Occur first on a sixteen-word boundary.
- Be repeated in 16 consecutive memory locations.

G3.5.2 Memory attributes in the VMSAv8-32 Short-descriptor translation table format descriptors

This section describes the descriptor fields other than the descriptor type field and the address field:

TEX[2:0], C, B

Memory region attribute bits, see [Memory region attributes on page G3-3618](#).

These bits are not present in a Page table entry.

XN bit

The Execute-never bit. Determines whether the PE can execute software from the addressed region, see [Execute-never restrictions on instruction fetching on page G3-3612](#).

This bit is not present in a Page table entry.

PXN bit

The Privileged execute-never bit. Determines whether the PE can execute software from the region when executing at PL1, see [Execute-never restrictions on instruction fetching on page G3-3612](#).

———— Note —————

Memory accesses by software executing at EL2 always use the Long-descriptor translation table format.

When this bit is set to 1 in the Page table descriptor, it indicates that all memory pages described in the corresponding page table are Privileged execute-never.

NS bit

Non-secure bit. Specifies whether the translated PA is in the Secure or Non-secure address map, see [Control of Secure or Non-secure memory access, VMSAv8-32 Short-descriptor format on page G3-3583](#).

This bit is not present in second-level descriptors. The value of the NS bit in the first level Page table descriptor applies to all entries in the corresponding second-level translation table.

Domain

Domain field, see [Domains, Short-descriptor format only on page G3-3614](#).

This field is not present in a Supersection entry. Memory described by Supersections is in domain 0.

This bit is not present in second-level descriptors. The value of the Domain field in the first level Page table descriptor applies to all entries in the corresponding second-level translation table.

An IMPLEMENTATION DEFINED bit

This bit is not present in second-level descriptors.

AP[2], AP[1:0]

Access Permissions bits, see [Memory access control on page G3-3609](#).

AP[0] can be configured as the *Access flag*, see [The Access flag on page G3-3615](#).

These bits are not present in a Page table entry.

S bit The Shareable bit. Determines whether the addressed region is Shareable memory, see [Memory region attributes](#) on page G3-3618.

This bit is not present in a Page table entry.

nG bit The not global bit. Determines how the translation is marked in the TLB, see [Global and process-specific translation table entries](#) on page G3-3630.

This bit is not present in a Page table entry.

Bit[18], when bits[1:0] indicate a Section or Supersection descriptor

0 Descriptor is for a Section.

1 Descriptor is for a Supersection.

G3.5.3 Control of Secure or Non-secure memory access, VMSAv8-32 Short-descriptor format

[Access to the Secure or Non-secure physical address map](#) on page G3-3576 describes how the NS bit in the translation table entries:

- For accesses from Secure state, determines whether the access is to Secure or Non-secure memory.
- Is ignored by accesses from Non-secure state.

In the Short-descriptor translation table format, the NS bit is defined only in the first-level translation tables. This means that, in a first-level Page table descriptor, the NS bit defines the physical address space, Secure or Non-secure, for all of the Large pages and Small pages of memory described by that table.

The NS bit of a first-level Page table descriptor has no effect on the physical address space in which that translation table is held. As stated in [Secure and Non-secure address spaces](#) on page G3-3576, the physical address of that translation table is in:

- The Secure address space if the translation table walk is in Secure state.
- The Non-secure address space if the translation table walk is in Non-secure state.

This means the granularity of the Secure and Non-secure memory spaces is 1MB. However, in these memory spaces, table entries can define physical memory regions with a granularity of 4KB.

G3.5.4 Selecting between TTBR0 and TTBR1, VMSAv8-32 Short-descriptor translation table format

As described in [Determining the translation table base address in the VMSAv8-32 translation regimes](#) on page G3-3575, two sets of translation tables can be defined for each of the PL1&0 stage 1 translations, and **TTBR0** and **TTBR1** hold the base addresses for the two sets of tables. When using the Short-descriptor translation table format, the value of **TTBCR.N** indicates the number of most significant bits of the input VA that determine whether **TTBR0** or **TTBR1** holds the required translation table base address, as follows:

- If $N == 0$ then use **TTBR0**. Setting **TTBCR.N** to zero disables use of a second set of translation tables.
- if $N > 0$ then:
 - If bits[31:32-N] of the input VA are all zero then use **TTBR0**.
 - Otherwise use **TTBR1**.

[Table G3-4](#) shows how the value of N determines the lowest address translated using **TTBR1**, and the size of the first-level translation table addressed by **TTBR0**.

Table G3-4 Effect of TTBCR.N on address translation, Short-descriptor format

TTBCR.N	First address translated with TTBR1	TTBR0 table	
		Size	Index range
0b000	TTBR1 not used	16KB	VA[31:20]
0b001	0x80000000	8KB	VA[30:20]
0b010	0x40000000	4KB	VA[29:20]

Table G3-4 Effect of TTBCR.N on address translation, Short-descriptor format (continued)

TTBCR.N	First address translated with TTBR1	TTBR0 table	
		Size	Index range
0b011	0x20000000	2KB	VA[28:20]
0b100	0x10000000	1KB	VA[27:20]
0b101	0x08000000	512 bytes	VA[26:20]
0b110	0x04000000	256 bytes	VA[25:20]
0b111	0x02000000	128 bytes	VA[24:20]

Whenever TTBCR.N is nonzero, the size of the translation table addressed by TTBR1 is 16KB.

Figure G3-6 shows how the value of TTBCR.N controls the boundary between VAs that are translated using TTBR0, and VAs that are translated using TTBR1.

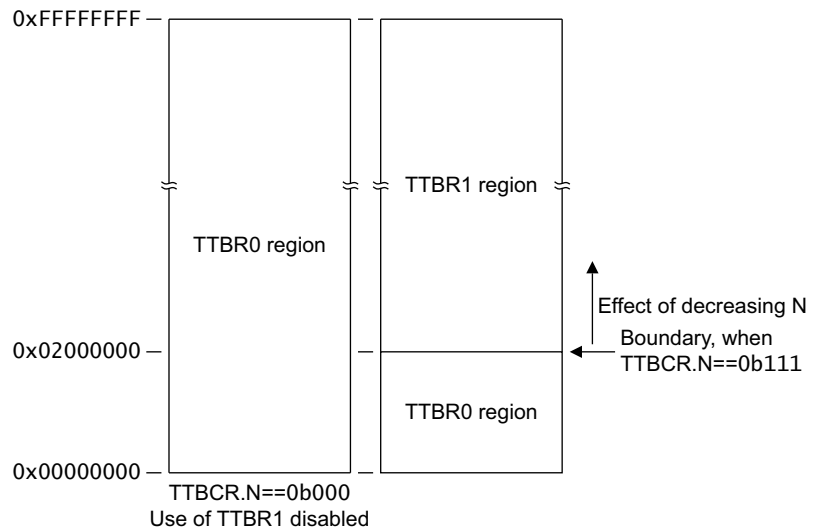

Figure G3-6 How TTBCR.N controls the boundary between the TTBRs, Short-descriptor format

In the selected TTBR, bits RGN, S and IRGN[1:0] define the memory region attributes for the translation table walk.

Translation table walks, when using the VMSAv8-32 Short-descriptor translation table format describes the translation.

G3.5.5 Translation table walks, when using the VMSAv8-32 Short-descriptor translation table format

When using the Short-descriptor translation table format, and a memory access requires a translation table walk:

- A section-mapped access only requires a read of the first-level translation table.
- A page-mapped access also requires a read of the second-level translation table.

Reading a first-level translation table on page G3-3585 describes how either TTBR1 or TTBR0 is used, with the accessed VA, to determine the address of the first-level descriptor.

Reading a first-level translation table on page G3-3585 shows the output address as A[39:0]:

- For a Non-secure PL1&0 stage 1 translation, this is the IPA of the required descriptor. A Non-secure PL1&0 stage 2 translation of this address is performed to obtain the PA of the descriptor.
- Otherwise, this address is the PA of the required descriptor.

The full translation flow for Sections, Supersections, Small pages and Large pages then shows the complete translation flow for each valid memory access.

Reading a first-level translation table

When performing a fetch based on **TTBR0**:

- The address bits taken from **TTBR0** vary between bits[31:14] and bits[31:7].
- The address bits taken from the VA, that is the input address for the translation, vary between bits[31:20] and bits[24:20].

The width of the **TTBR0** and VA fields depend on the value of **TTBCR.N**, as [Figure G3-7](#) shows.

When performing a fetch based on **TTBR1**, Bits **TTBR1**[31:14] are concatenated with bits[31:20] of the VA. This makes the fetch equivalent to that shown in [Figure G3-7](#), with $N=0$.

Note

See [The address and Properties fields shown in the translation flows on page G3-3586](#) for more information about the *Properties* label used in this and other figures.

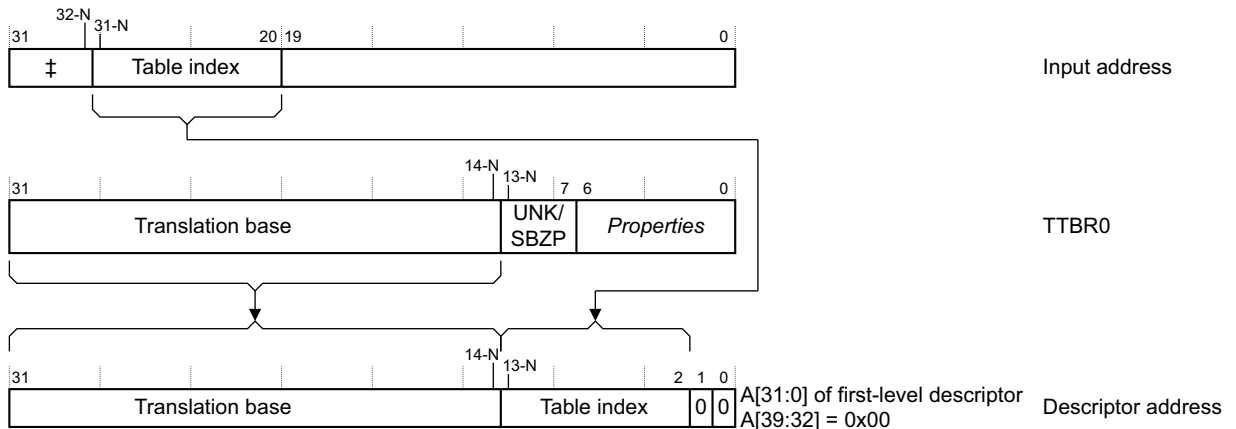

‡ This field is absent if N is 0
 N is the value of **TTBCR.N**
 For details of the *Properties* field, see the register description

Figure G3-7 Accessing first-level translation table based on TTBR0, Short-descriptor format

Regardless of which register is used as the base for the fetch, the resulting output address selects a four-byte translation table entry that is one of:

- A first-level descriptor for a Section or Supersection.
- A *Page table* descriptor that points to a second-level translation table. In this case:
 - A second fetch is performed to retrieve a second-level descriptor.
 - The descriptor also contains some attributes for the access, see [Figure G3-4 on page G3-3580](#).
- A faulting entry.

The full translation flow for Sections, Supersections, Small pages and Large pages

In a translation table walk, only the first lookup uses the translation table base address from the appropriate Translation table base register. Subsequent lookups use a combination of address information from:

- The table descriptor read in the previous lookup.
- The input address.

This section summarizes how each of the memory section and page options is described in the translation tables, and has a subsection summarizing the full translation flow for each of the options.

As described in [VMSEv8-32 Short-descriptor translation table format descriptors](#) on page G3-3579, the four options are:

Supersection A 16MB memory region, see [Translation flow for a Supersection](#).

Section A 1MB memory region, see [Translation flow for a Section](#) on page G3-3587.

Large page A 64KB memory region, described by the combination of:

- A first-level translation table entry that indicates a second-level Page table address.
- A second-level descriptor that indicates a Large page.

See [Translation flow for a Large page](#) on page G3-3588.

Small page A 4KB memory region, described by the combination of:

- A first-level translation table entry that indicates a second-level Page table address.
- A second-level descriptor that indicates a Small page.

See [Translation flow for a Small page](#) on page G3-3590.

The address and Properties fields shown in the translation flows

For the Non-secure PL1&0 stage 1 translation tables:

- Any descriptor address is the IPA of the required descriptor.
- The final output address is the IPA of the Section, Supersection, Large page, or Small page.

In these cases, a PL1&0 stage 2 translation is performed to translate the IPA to the required PA.

Otherwise, the address is the PA of the descriptor, Section, Supersection, Large page, or Small page.

Properties indicates register or translation table fields that return information, other than address information, about the translation or the targeted memory region. For more information see [Information returned by a translation table lookup](#) on page G3-3574, and the description of the register or translation table descriptor.

For translations using the Short-descriptor translation table format, [VMSEv8-32 Short-descriptor translation table format descriptors](#) on page G3-3579 describes the descriptors formats.

Translation flow for a Supersection

[Figure G3-8](#) on page G3-3587 shows the complete translation flow for a Supersection. For more information about the fields shown in this figure see [The address and Properties fields shown in the translation flows](#).

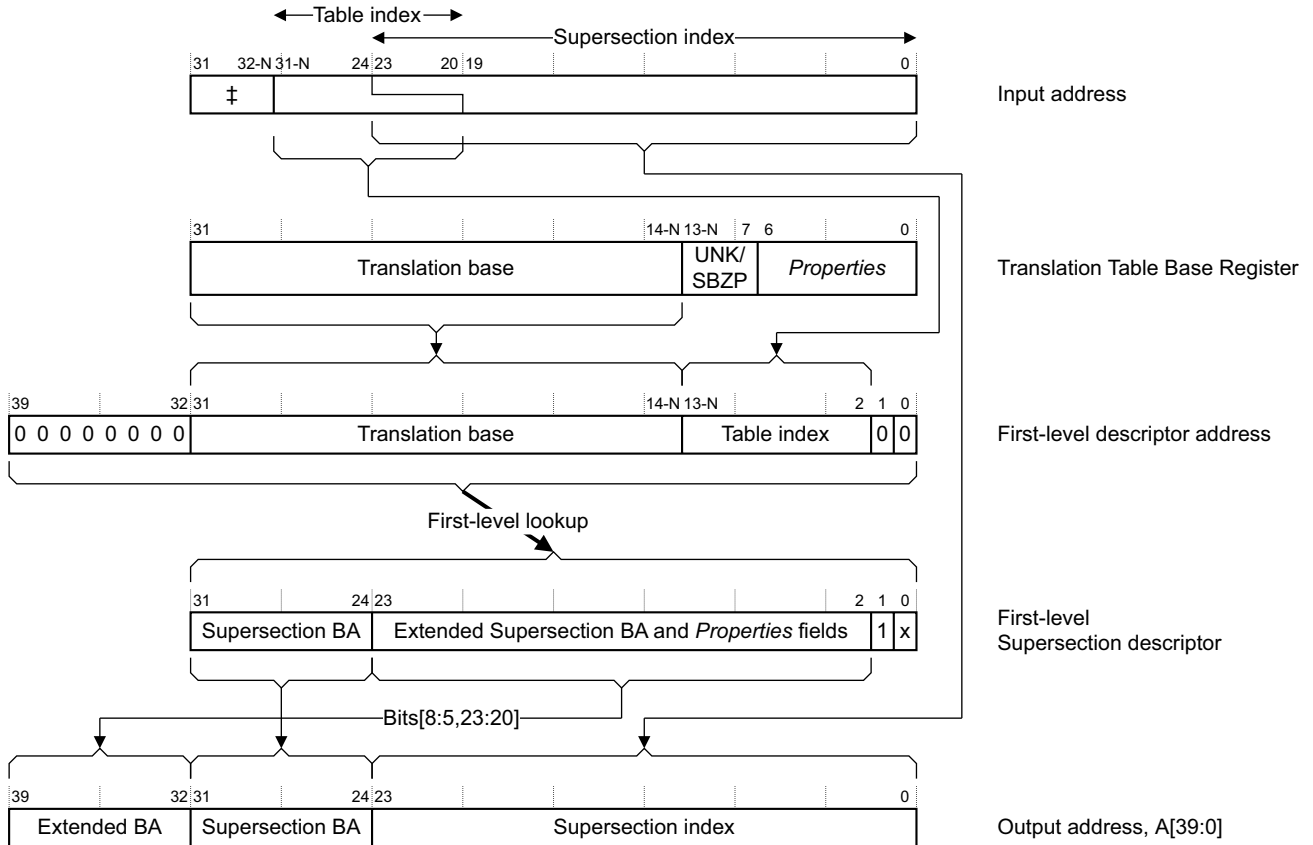

‡ This field is absent if N is 0
 BA = Base address
 For a translation based on TTBR0, N is the value of TTBCR.N
 For a translation based on TTBR1, N is 0
 For details of *Properties* fields, see the register or descriptor description

Figure G3-8 VMSAv8-32 Short-descriptor Supersection address translation

Note

Figure G3-8 shows how, when the input address, the VA, addresses a Supersection, the top four bits of the *Supersection index* bits of the address overlap the bottom four bits of the *Table index* bits. For more information, see [Additional requirements for Short-descriptor format translation tables on page G3-3582](#).

Translation flow for a Section

Figure G3-9 on page G3-3588 shows the complete translation flow for a Section. For more information about the fields shown in this figure see [The address and Properties fields shown in the translation flows on page G3-3586](#).

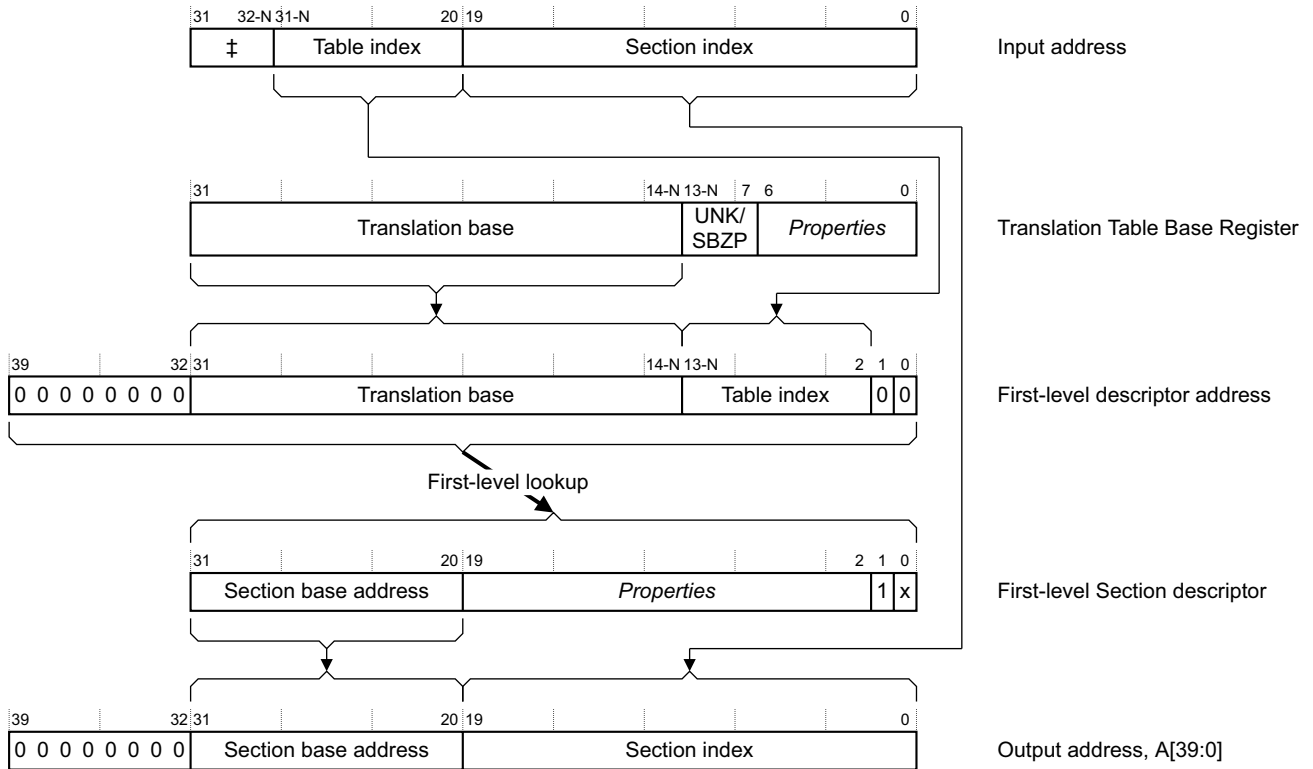

‡ This field is absent if N is 0
 For a translation based on TTBR0, N is the value of TTBCR.N
 For a translation based on TTBR1, N is 0
 For details of *Properties* fields, see the register or descriptor description.

Figure G3-9 VMSAv8-32 Short-descriptor Section address translation

Translation flow for a Large page

Figure G3-10 on page G3-3589 shows the complete translation flow for a Large page. For more information about the fields shown in this figure see *The address and Properties fields shown in the translation flows* on page G3-3586.

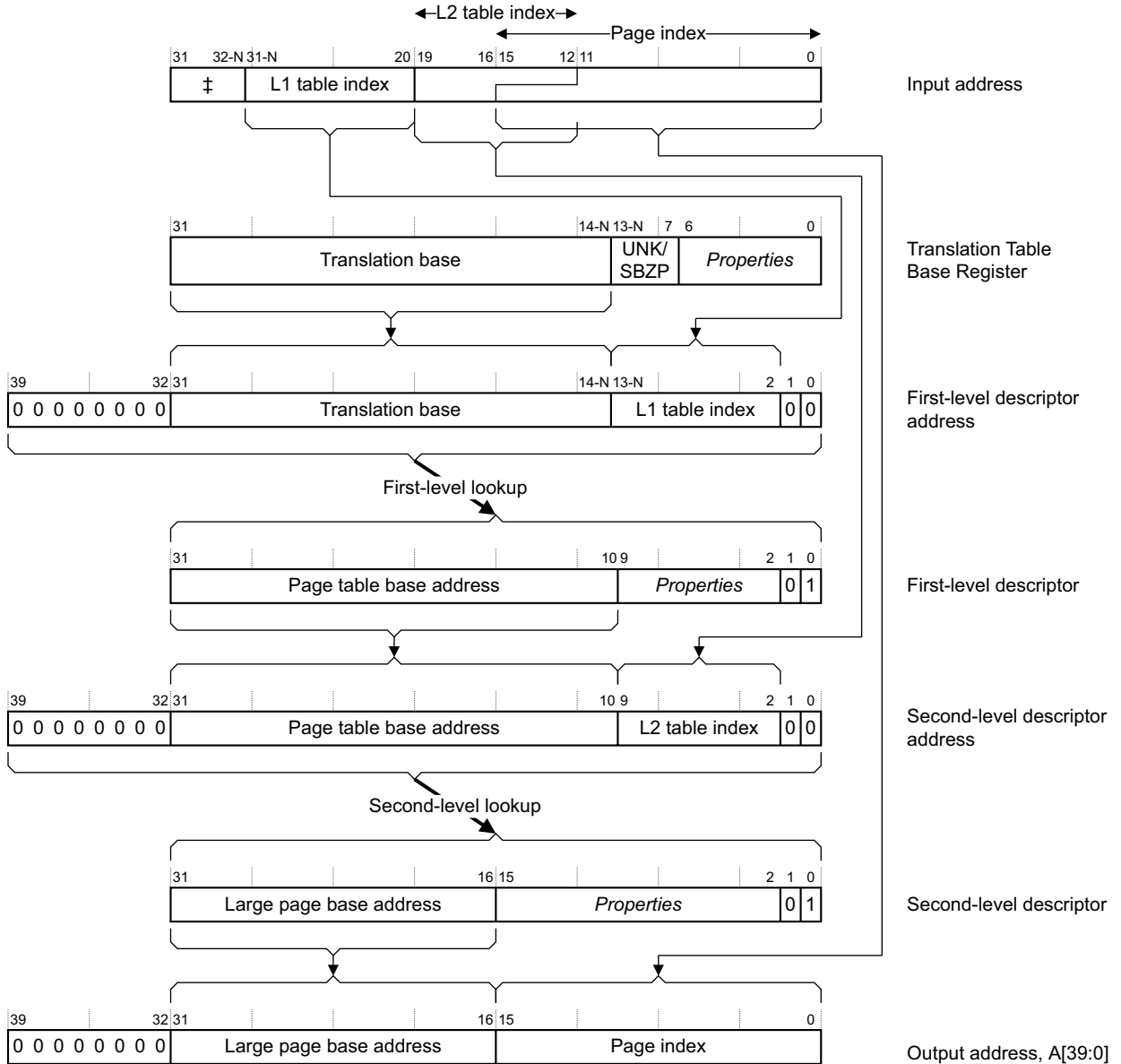

‡ This field is absent if N is 0
 L1 = First-level, L2 = Second-level
 For a translation based on TTBR0, N is the value of TTBCR.N
 For a translation based on TTBR1, N is 0
 For details of *Properties* fields, see the register or descriptor description

Figure G3-10 VMSAv8-32 Short-descriptor Large page address translation

Note

Figure G3-10 shows how, when the input address, the VA, addresses a Large page, the top four bits of the *page index* bits of the address overlap the bottom four bits of the *First-level table index* bits. For more information, see [Additional requirements for Short-descriptor format translation tables on page G3-3582](#).

Translation flow for a Small page

Figure G3-11 on page G3-3590 shows the complete translation flow for a Small page. For more information about the fields shown in this figure see *The address and Properties fields shown in the translation flows* on page G3-3586.

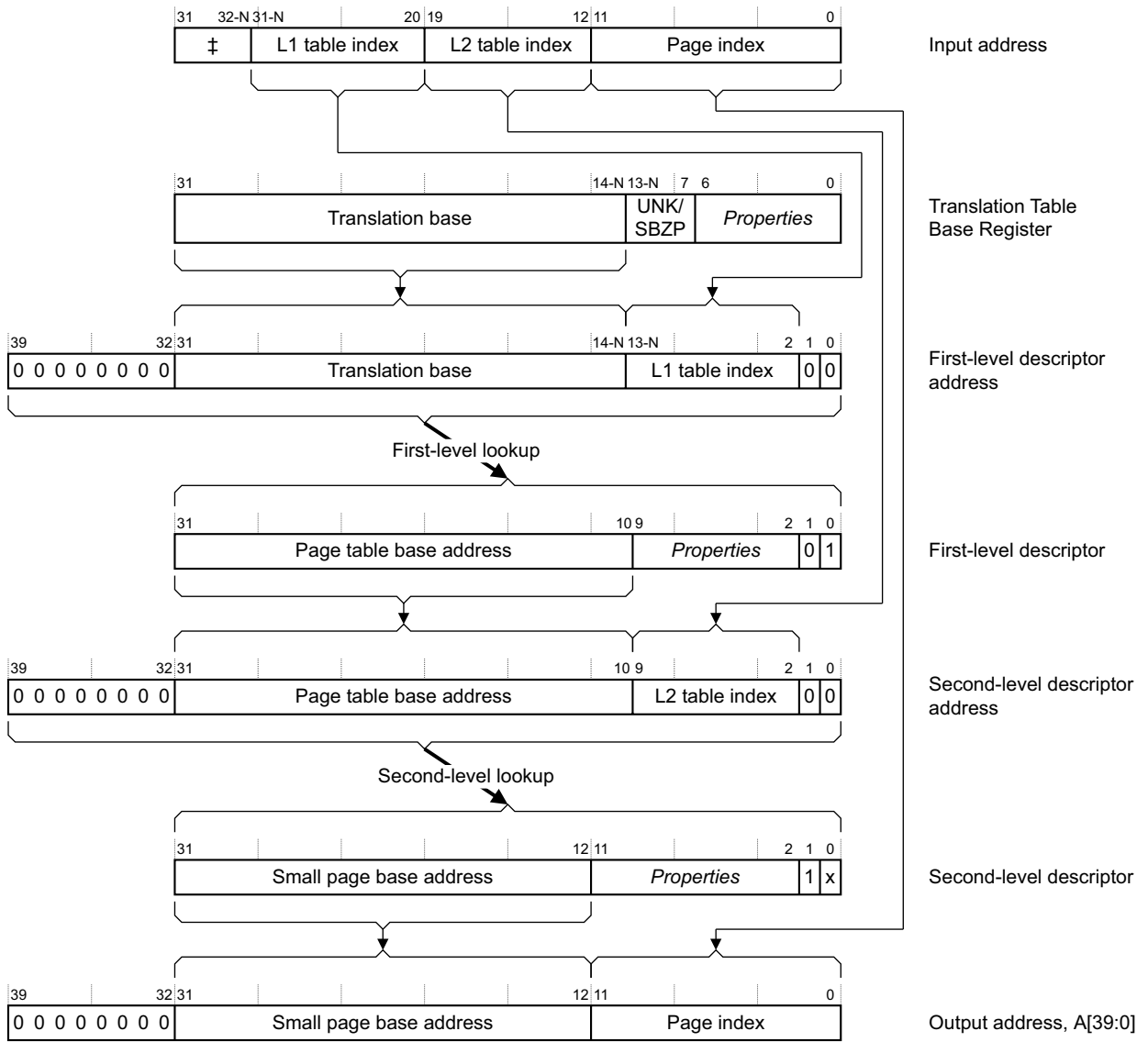

‡ This field is absent if N is 0
 L1 = First-level, L2 = Second-level
 For a translation based on TTBR0, N is the value of TTBCR.N
 For a translation based on TTBR1, N is 0
 For details of *Properties* fields, see the register or descriptor description.

Figure G3-11 VMSAv8-32 Short-descriptor Small page address translation

G3.6 The VMSAv8-32 Long-descriptor translation table format

The VMSAv8-32 Long-descriptor translation table format supports the assignment of memory attributes to memory *Pages*, at a granularity of 4KB, across the complete input address range. It also supports the assignment of memory attributes to *blocks* of memory, where a block can be 2MB or 1GB.

———— **Note** —————

- Although the VMSAv8-32 Long-descriptor format is limited to three levels of address lookup, its design and naming conventions support extension to additional levels, to support a larger input address range.
- Similarly, while the VMSAv8-32 implementation limits the output address range to 40 bits, its design supports extension to a larger output address range.

Figure G3-2 on page G3-3566 shows the different address translation stages. The Long-descriptor translation table format:

- Is used for:
 - The Non-secure PL2 stage 1 translation.
 - The Non-secure PL1&0 stage 2 translation.
- Can be used for the Secure and Non-secure PL1&0 translations.

When used for a stage 1 translation, the translation tables support an input address of up to 32 bits, corresponding to the VA address range of the PE.

When used for a stage 2 translation, the translation tables support an input address range of up to 40 bits, to support the translation from IPA to PA. If the input address for the stage 2 translation is a 32-bit address then this address is zero-extended to 40 bits.

———— **Note** —————

When the Short-descriptor translation table format is used for the Non-secure stage 1 translations, this generates 32-bit IPAs. These are zero-extended to 40 bits to provide the input address for the stage 2 translation.

Overview of VMSAv8-32 address translation using Long-descriptor translation tables summarizes address translation from AArch32 state when using the Long-descriptor format translation tables.

VMSAv8-32 Long-descriptor translation table format descriptors on page G3-3592, *Memory attributes in the VMSAv8-32 Long-descriptor translation table format descriptors* on page G3-3595, and *Control of Secure or Non-secure memory access, VMSAv8-32 Long-descriptor format* on page G3-3597 describe the format of the descriptors in the Long-descriptor format translation tables.

The following sections then describe the use of this translation table format:

- *Selecting between TTBR0 and TTBR1, VMSAv8-32 Long-descriptor translation table format* on page G3-3598.
- *VMSAv8-32 Long-descriptor translation table format address lookup levels* on page G3-3600.
- *Translation table walks, when using the VMSAv8-32 Long-descriptor translation table format* on page G3-3603.

G3.6.1 Overview of VMSAv8-32 address translation using Long-descriptor translation tables

Figure G3-12 on page G3-3592 gives a general view of VMSAv8-32 stage 1 address translation when using the Long-descriptor translation table format.

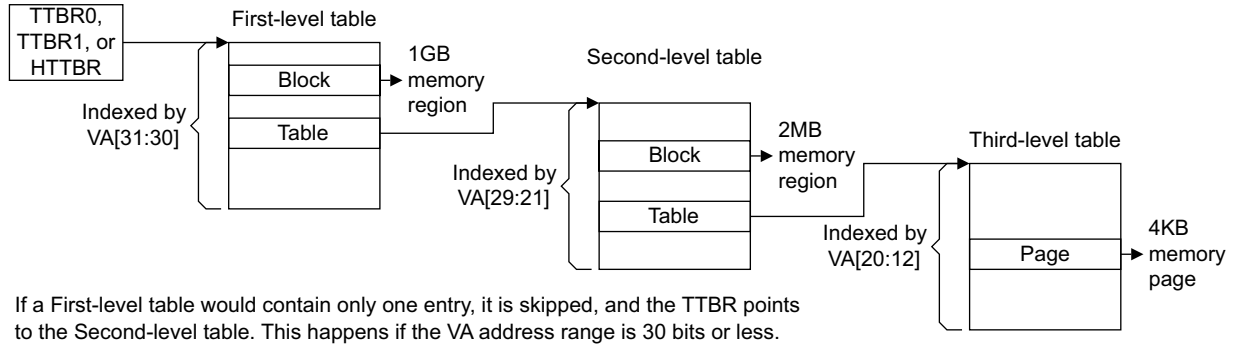
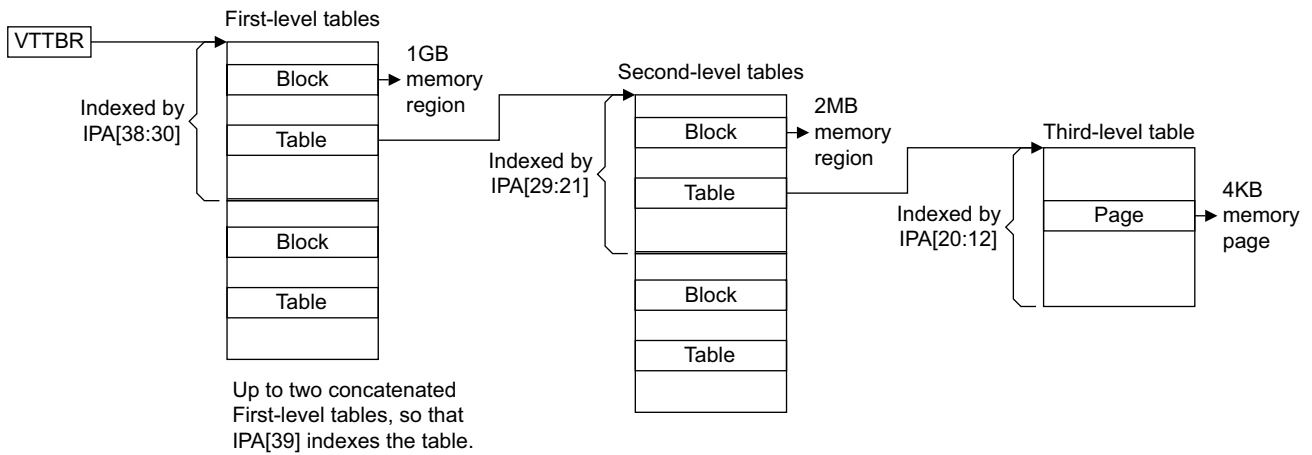

Figure G3-12 General view of VMSAv8-32 stage 1 address translation using Long-descriptor format

Figure G3-13 gives a general view of VMSAv8-32 stage 2 address translation. Stage 2 translation always uses the Long-descriptor translation table format.



If a First-level table would contain 16 entries or fewer, first-level lookup can be omitted. If so, VTTBR points to the start of a block of concatenated Second-level tables. See text for more information.

Figure G3-13 General view of VMSAv8-32 stage 2 address translation, Long-descriptor translation table format

Use of concatenated translation tables for stage 2 translations on page G3-3601 describes how using concatenated Second-level tables means lookup can start at the Second level, as referred to in Figure G3-13.

G3.6.2 VMSAv8-32 Long-descriptor translation table format descriptors

As described in *VMSAv8-32 Long-descriptor translation table format address lookup levels* on page G3-3600, the Long-descriptor translation table format provides up to three levels of address lookup. A translation table walk starts either at the first level or the second level of address lookup.

In general, a descriptor is one of:

- An invalid or fault entry.
- A table entry, that points to the next-level translation table.
- A block entry, that defines the memory properties for the access.
- A reserved format.

Bit[1] of the descriptor indicates the descriptor type, and bit[0] indicates whether the descriptor is valid.

The following sections describe the Long-descriptor translation table descriptor formats:

- *VMSAv8-32 Long-descriptor first-level and second-level descriptor formats* on page G3-3593.
- *VMSAv8-32 Long-descriptor translation table third-level descriptor formats* on page G3-3594.

Information returned by a translation table lookup on page G3-3574 describes the classification of the non-address fields in the descriptors between *address map control*, *access controls*, and *region attributes*.

VMSAv8-32 Long-descriptor first-level and second-level descriptor formats

In the Long-descriptor translation tables, the formats of the first-level and second-level descriptors differ only in the size of the block of memory addressed by the block descriptor. A block entry:

- In a first-level table describes the mapping of the associated 1GB input address range.
- In a second-level table describes the mapping of the associated 2MB input address range.

Figure G3-14 shows the Long-descriptor first-level and second-level descriptor formats:

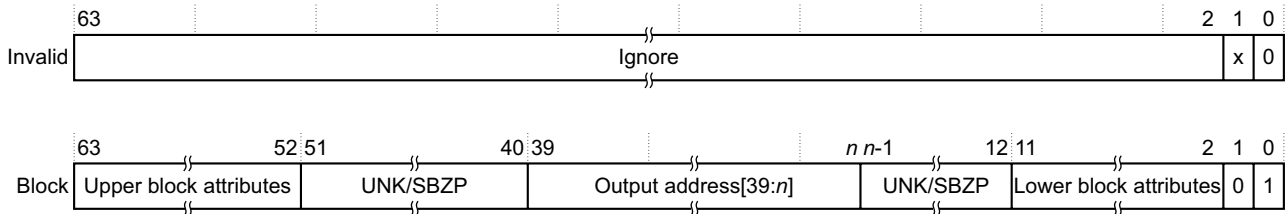

For the first-level descriptor, n is 30. For the second-level descriptor, n is 21.

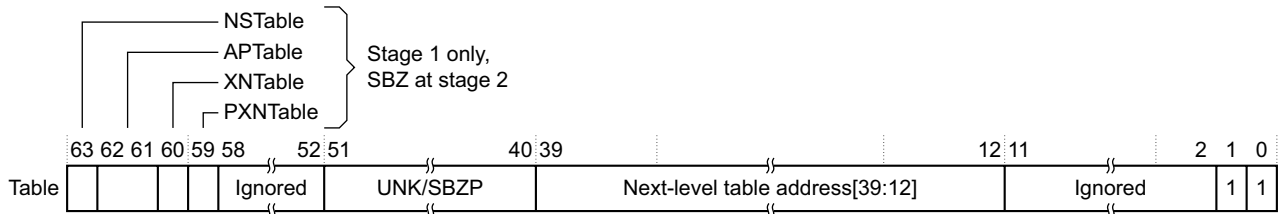

The first-level descriptor returns the address of the second-level table.
 The second-level descriptor returns the address of the third-level table.

Figure G3-14 VMSAv8-32 Long-descriptor first-level and second-level descriptor formats

Descriptor encodings, Long-descriptor first-level and second-level formats

Descriptor bit[0] identifies whether the descriptor is valid, and is 1 for a valid descriptor. If a lookup returns an invalid descriptor, the associated input address is unmapped, and any attempt to access it generates a Translation fault.

Descriptor bit[1] identifies the descriptor type, and is encoded as:

- 0, Block** The descriptor gives the base address of a block of memory, and the attributes for that memory region.
- 1, Table** The descriptor gives the address of the next level of translation table, and for a stage 1 translation, some attributes for that translation.

The other fields in the valid descriptors are:

Block descriptor

Gives the base address and attributes of a block of memory:

- For a first-level Block descriptor, bits[47:30] are bits[47:30] of the output address that specifies a 1GB block of memory.
- For a second-level Block descriptor, bits[47:21] are bits[47:21] of the output address that specifies a 2MB block of memory.

Bits[63:52, 11:2] provide attributes for the target memory block, see [Memory attributes in the VMSAv8-32 Long-descriptor translation table format descriptors on page G3-3595](#). The position and contents of these bits are identical in the second-level block descriptor and in the third-level page descriptor.

Table descriptor

Bits[47:m] are bits[47:m] of the address of the required next-level table. Bits[m-1:0] of the table address are zero:

- For a first-level Table descriptor, this is the address of a second-level table.
- For a second-level Table descriptor, this is the address of a third-level table.

For a stage 1 translation only, bits[63:59] provide attributes for the next-level lookup, see [Memory attributes in the VMSAv8-32 Long-descriptor translation table format descriptors on page G3-3595](#).

If the translation table defines the Non-secure PL1&0 stage 1 translations, then the output address in the descriptor is the IPA of the target block or table. Otherwise, it is the PA of the target block or table.

VMSAv8-32 Long-descriptor translation table third-level descriptor formats

Each entry in a third-level table describes the mapping of the associated 4KB input address range.

Figure G3-15 shows the Long-descriptor third-level descriptor formats.

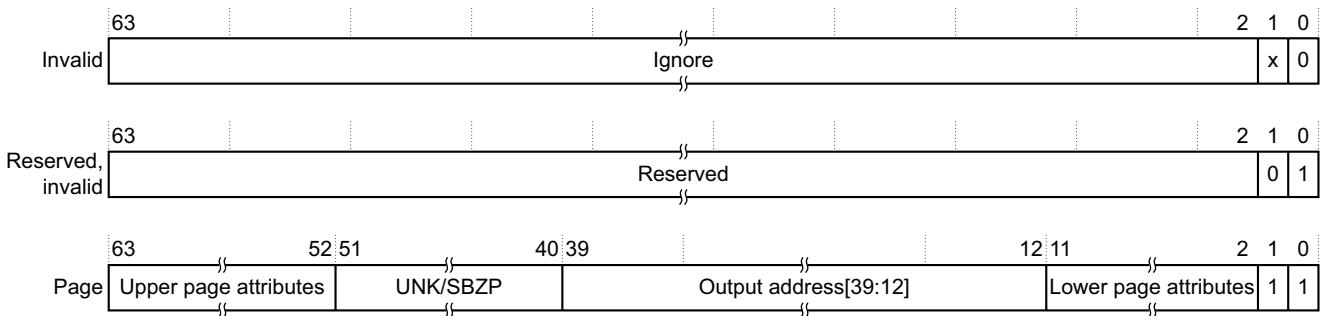

Figure G3-15 VMSAv8-32 Long-descriptor third-level descriptor formats

Descriptor bit[0] identifies whether the descriptor is valid, and is 1 for a valid descriptor. If a lookup returns an invalid descriptor, the associated input address is unmapped, and any attempt to access it generates a Translation fault.

Descriptor bit[1] identifies the descriptor type, and is encoded as:

0, Reserved, invalid

Behaves identically to encodings with bit[0] set to 0.

This encoding must not be used in third-level translation tables.

1, Page Gives the address and attributes of a 4KB page of memory.

At this level, the only valid format is the Page descriptor. The other fields in the Page descriptor are:

Page descriptor

Bits[47:12] are bits[47:12] of the output address for a page of memory.

Bits[63:52, 11:2] provide attributes for the target memory page, see [Memory attributes in the VMSAv8-32 Long-descriptor translation table format descriptors on page G3-3595](#). The position and contents of these bits are identical in the first-level block descriptor and in the second-level block descriptor.

If the translation table defines the Non-secure PL1&0 stage 1 translations, then the output address in the descriptor is the IPA of the target page. Otherwise, it is the PA of the target page.

G3.6.3 Memory attributes in the VMSAv8-32 Long-descriptor translation table format descriptors

The memory attributes in the VMSAv8-32 Long-descriptor translation tables are based on those in the Short-descriptor translation table format, with some extensions. *Memory region attributes* on page G3-3618 describes these attributes. In the Long-descriptor translation table format:

- Table entries for stage 1 translations define attributes for the next level of lookup, see *Next-level attributes in VMSAv8-32 Long-descriptor stage 1 Table descriptors*
- Block and Page entries define memory attributes for the target block or page of memory. Stage 1 and stage 2 translations have some differences in these attributes, see:
 - *Attribute fields in VMSAv8-32 Long-descriptor stage 1 Block and Page descriptors.*
 - *Attribute fields in VMSAv8-32 Long-descriptor stage 2 Block and Page descriptors* on page G3-3596.

Next-level attributes in VMSAv8-32 Long-descriptor stage 1 Table descriptors

In a Table descriptor for a stage 1 translation, bits[63:59] of the descriptor define the following attributes for the next-level translation table access:

- NSTable, bit[63]** For memory accesses from Secure state, specifies the security level for subsequent levels of lookup, see *Hierarchical control of Secure or Non-secure memory accesses, Long-descriptor format* on page G3-3597.
 For memory accesses from Non-secure state, this bit is ignored.
- APTable, bits[62:61]** Access permissions limit for subsequent levels of lookup, see *Hierarchical control of access permissions, Long-descriptor format* on page G3-3610.
 APTable[0] is reserved, SBZ, in the Non-secure PL2 stage 1 translation tables.
- XNTable, bit[60]** XN limit for subsequent levels of lookup, see *Hierarchical control of instruction fetching, Long-descriptor format* on page G3-3613.
- PXNTable, bit[59]** PXN limit for subsequent levels of lookup, see *Hierarchical control of instruction fetching, Long-descriptor format* on page G3-3613.
 This bit is reserved, SBZ, in the Non-secure PL2 stage 1 translation tables.

Attribute fields in VMSAv8-32 Long-descriptor stage 1 Block and Page descriptors

Block and Page descriptors split the memory attributes into an upper block and a lower block. Figure G3-16 shows the memory attribute fields in these blocks, for a stage 1 translation:

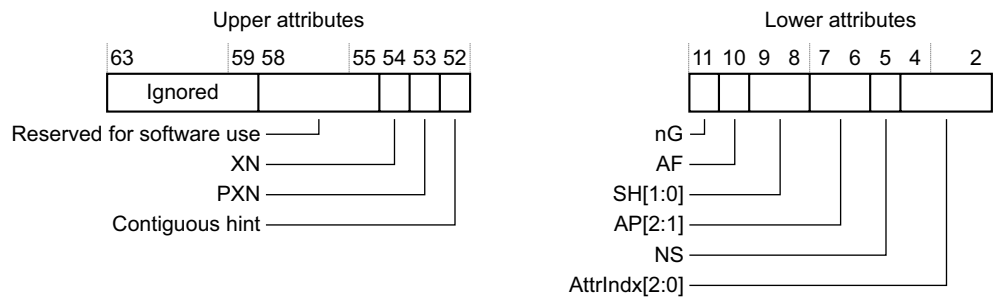

Figure G3-16 VMSAv8-32 memory attribute fields in Long-descriptor stage 1 Block and Page descriptors

For a stage 1 descriptor, the attributes are:

- XN, bit[54]** The Execute-never bit. Determines whether the region is executable, see *Execute-never restrictions on instruction fetching* on page G3-3612.
- PXN, bit[53]** The Privileged execute-never bit. Determines whether the region is executable at EL1, see *Execute-never restrictions on instruction fetching* on page G3-3612.

This bit is reserved, SBZ, in the Non-secure PL2 stage 1 translation tables.

Contiguous, bit[52]

Indicates that 16 adjacent translation table entries point to contiguous memory regions, see [Contiguous bit on page G3-3625](#).

nG, bit[11]

The not global bit. Determines how the translation is marked in the TLB, see [Global and process-specific translation table entries on page G3-3630](#).

This bit is reserved, SBZ, in the Non-secure PL2 stage 1 translation tables.

AF, bit[10]

The Access flag, see [The Access flag on page G3-3615](#).

SH, bits[9:8]

Shareability field, see [Memory region attributes on page G3-3618](#).

AP[2:1], bits[7:6]

Access Permissions bits, see [Memory access control on page G3-3609](#).

———— **Note** ————

For consistency with the Short-descriptor translation table formats, the Long-descriptor format defines AP[2:1] as the Access Permissions bits, and does not define an AP[0] bit.

AP[1] is reserved, SBO, in the Non-secure PL2 stage 1 translation tables.

NS, bit[5]

Non-secure bit. For memory accesses from Secure state, specifies whether the output address is in Secure or Non-secure memory, see [Control of Secure or Non-secure memory access, VMSAv8-32 Long-descriptor format on page G3-3597](#).

For memory accesses from Non-secure state, this bit is ignored.

AttrIndx[2:0], bits[4:2]

Stage 1 memory attributes index field, for the indicated Memory Attribute Indirection Register, see [VMSAv8-32 Long-descriptor format memory region attributes on page G3-3624](#).

In the upper attributes block, the architecture guarantees that hardware does not alter the fields marked as *Ignored* and *Reserved for software use*. For more information see [Other fields in the Long-descriptor translation table format descriptors on page G3-3625](#).

Attribute fields in VMSAv8-32 Long-descriptor stage 2 Block and Page descriptors

Block and Page descriptors split the memory attributes into an upper block and a lower block. [Figure G3-17](#) shows the memory attribute fields in these blocks, for a stage 2 translation:

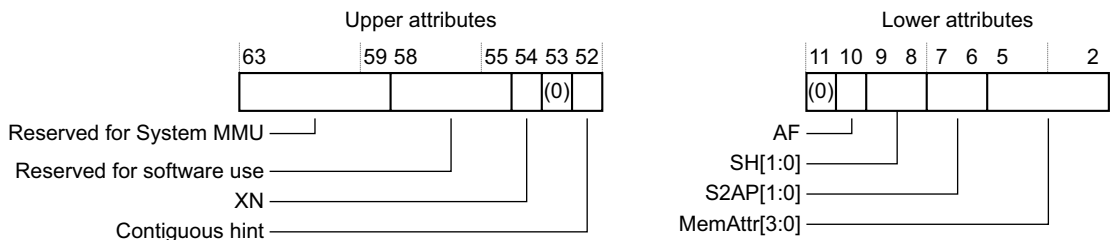

Figure G3-17 VMSAv8-32 memory attribute fields in Long-descriptor stage 2 Block and Page descriptors

For a stage 2 descriptor, the attributes are:

XN, bit[54]

The Execute-never bit. Determines whether the region is executable, see [Execute-never restrictions on instruction fetching on page G3-3612](#).

Contiguous, bit[52]

Indicates that 16 adjacent translation table entries point to contiguous memory regions, see [Contiguous bit on page G3-3625](#).

AF, bit[10] The Access flag, see *The Access flag* on page G3-3615.

SH, bits[9:8] Shareability field, see *EL2 control of Non-secure memory region attributes* on page G3-3625.

S2AP, bits[7:6]

Stage 2 Access Permissions bits, see *Hyp mode control of Non-secure access permissions* on page G3-3616.

———— **Note** —————

In the original VMSAv7-32 Long-descriptor attribute definition, this field was called HAP[2:1], for consistency with the AP[2:1] field in the stage 1 descriptors and despite there being no HAP[0] bit. ARMv8 renames the field for greater clarity.

MemAttr, bits[5:2]

Stage 2 memory attributes, see *EL2 control of Non-secure memory region attributes* on page G3-3625.

In the upper attributes block:

- The field marked as *Reserved for System MMU use* is ignored by the PE. The architecture guarantees that the PE does not alter this field.
- The architecture guarantees that the PE does not alter the fields marked as *Ignored* and *Reserved for software use*.

For more information see *Other fields in the Long-descriptor translation table format descriptors* on page G3-3625.

G3.6.4 Control of Secure or Non-secure memory access, VMSAv8-32 Long-descriptor format

Access to the Secure or Non-secure physical address map on page G3-3576 describes how the NS bit in the translation table entries:

- For accesses from Secure state, determines whether the access is to Secure or Non-secure memory.
- Is ignored by accesses from Non-secure state.

In the Long-descriptor format:

- The NS bit relates only to the memory block or page at the output address defined by the descriptor.
- The descriptors also include an NSTable bit, see *Hierarchical control of Secure or Non-secure memory accesses, Long-descriptor format*.

The NS and NSTable bits are valid only for memory accesses from Secure state. Memory accesses from Non-secure state ignore the values of these bits.

Hierarchical control of Secure or Non-secure memory accesses, Long-descriptor format

For Long-descriptor format table descriptors for stage 1 translations, the descriptor includes an NSTable bit, that indicates whether the table identified in the descriptor is in Secure or Non-secure memory. For accesses from Secure state, the meaning of the NSTable bit is:

NSTable == 0 The defined table address is in the Secure physical address space. In the descriptors in that translation table, NS bits and NSTable bits have their defined meanings.

NSTable == 1 The defined table address is in the Non-secure physical address space. Because this table is fetched from the Non-secure address space, the NS and NSTable bits in the descriptors in this table must be ignored. This means that, for this table:

- The value of the NS bit in any block or page descriptor is ignored. The block or page address is refers to Non-secure memory.

- The value of the NSTable bit in any table descriptor is ignored, and the table address refers to Non-secure memory. When this table is accessed, the NS bit in any block or page descriptor is ignored, and all descriptors in the table refer to Non-secure memory.

In addition, an entry fetched in Secure state is treated as non-global if either:

- NSTable is set to 1.
- The fetch ignores the values of NS and NSTable, because of a higher-level fetch with NSTable set to 1.

That is, these entries must be treated as if nG==1, regardless of the value of the nG bit. For more information about the nG bit, see [Global and process-specific translation table entries on page G3-3630](#).

———— **Note** —————

- When using the Long-descriptor format, table descriptors are defined only for the first level and second level of lookup.
- Stage 2 translations are performed only for operations in Non-secure state, that can access only the Non-secure address space. Therefore, the stage 2 descriptors do not include NS or NSTable bits.

G3.6.5 Selecting between TTBR0 and TTBR1, VMSAv8-32 Long-descriptor translation table format

As described in [Determining the translation table base address in the VMSAv8-32 translation regimes on page G3-3575](#), two sets of translation tables can be defined for each of the PL1&0 stage 1 translations, and **TTBR0** and **TTBR1** hold the base addresses for the two sets of tables. The Long-descriptor translation table format provides more flexibility in defining the boundary between using **TTBR0** and using **TTBR1**. When a PL1&0 stage 1 address translation is enabled, **TTBR0** is always used. If **TTBR1** is also used then:

- **TTBR1** is used for the top part of the input address range.
- **TTBR0** is used for the bottom part of the input address range.

The **TTBCR.T0SZ** and **TTBCR.T1SZ** size fields control the use of **TTBR0** and **TTBR1**, as [Table G3-5](#) shows.

Table G3-5 Use of TTBR0 and TTBR1, Long-descriptor format

TTBCR		Input address range using:	
T0SZ	T1SZ	TTBR0	TTBR1
0b000	0b000	All addresses	Not used
M^a	0b000	Zero to $(2^{(32-M)}-1)$	2^{32-M} to maximum input address
0b000	N^a	Zero to $(2^{32-2^{(32-N)}}-1)$	$2^{32-2^{(32-N)}}$ to maximum input address
M^a	N^a	Zero to $(2^{(32-M)}-1)$	$2^{32-2^{(32-N)}}$ to maximum input address

a. M, N must be greater than 0. The maximum possible value for each of T0SZ and T1SZ is 7.

For stage 1 translations, the input address is always a VA, and the maximum possible VA is $(2^{32}-1)$.

When address translation is using the Long-descriptor translation table format:

- [Figure G3-18 on page G3-3599](#) shows how, when **TTBCR.T1SZ** is zero, the value of **TTBCR.T0SZ** controls the boundary between VAs that are translated using **TTBR0**, and VAs that are translated using **TTBR1**.

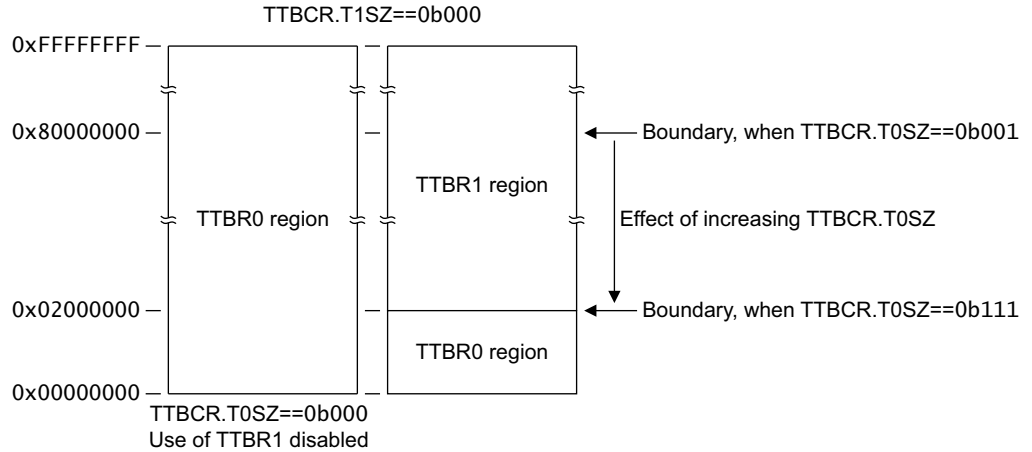

Figure G3-18 Control of TTBR boundary, when TTBCR.T1SZ is zero

- [Figure G3-19](#) shows how, when **TTBCR.T1SZ** is nonzero, the values of **TTBCR.T0SZ** and **TTBCR.T1SZ** control the boundaries between VAs that are translated using **TTBR0**, and VAs that are translated using **TTBR1**.

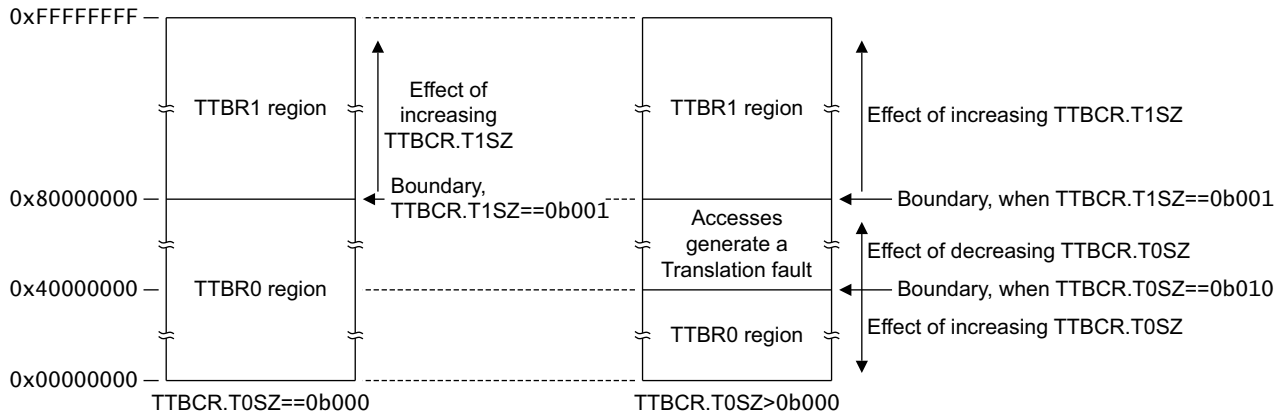

Figure G3-19 Control of TTBR boundaries, when TTBCR.T1SZ is nonzero

When T0SZ and T1SZ are both nonzero:

- If both fields are set to 0b001, the boundary between the two regions is 0x80000000. This is identical to having T0SZ set to 0b000 and T1SZ set to 0b001.
- Otherwise, the **TTBR0** and **TTBR1** regions are non-contiguous. In this case, any attempt to access an address that is in that gap between the **TTBR0** and **TTBR1** regions generates a Translation fault.

When using the Long-descriptor translation table format:

- The **TTBCR** contains fields that define memory region attributes for the translation table walk, for each TTBR. These are the SH0, ORGN0, IRGN0, SH1, ORGN1, and IRGN1 bits.
- **TTBR0** and **TTBR1** each contain an ASID field, and the **TTBCR.A1** field selects which ASID to use.

For this translation table format, [VMSAv8-32 Long-descriptor translation table format address lookup levels](#) on page G3-3600 summarizes the lookup levels, and [Translation table walks, when using the VMSAv8-32 Long-descriptor translation table format](#) on page G3-3603 describes the possible translations.

Possible translation table registers programming errors

In all the descriptions in this subsection, the *size of the input address* supported for a PL1&0 stage 1 translation refers to the size specified by a **TTBCR.TxSZ** field.

Note

For a PL1&0 stage 1 translation, this section has described how the input address range can be split so that the lower addresses are translated by **TTBR0** and the higher addresses are translated by **TTBR1**. In this case, each of input address sizes specified by **TTBCR**.{T0SZ, T1SZ} is smaller than the total address size supported by the stage of translation.

The following are possible errors in the programming of **TTBR0**, **TTBR1**, and **TTBCR**. For the translation of a particular address at a particular stage of translation, either:

- The block size being used to translate the address is larger than the size of the input address supported at a stage of translation used in performing the required translation. This can occur only for the PL1&0 stage 1 translations, and only when either **TTBCR**.T0SZ or **TTBCR**.T1SZ is zero, meaning there is no gap between the address range translated by **TTBR0** and the range translated by **TTBR1**. In this case, this programming error occurs if a block translated from the region that has TxSZ set to zero straddles the boundary between the two address ranges. [Example G3-2](#) shows an example of this mis-programming.
- The address range translated by a set of blocks marked as contiguous, by use of the contiguous bit, is larger than the size of the input address supported at a stage of translation used in performing the required translation.

Example G3-2 Translation table programming error

If **TTBCR**.T0SZ is programmed to 0 and **TTBCR**.T1SZ is programmed to 7, this means:

- **TTBR0** translates addresses in the range 0x00000000-0xFDFFFFFF.
- **TTBR1** translates addresses in the range 0xFE000000-0xFFFFFFFF.

The translation table indicated by **TTBR0** might be programmed with a block entry for a 1GB region starting at 0xC0000000. This covers the address range 0xC0000000-0xFFFFFFFF, that overlaps the **TTBR1** address range. This means this block size is larger than the input address size supported for translations using **TTBR0**, and therefore this is a programming error.

To understand why this must be a programming error, consider a memory access to address 0xFFFF0000. According to the **TTBCR**.{T0SZ, T1SZ} values, this must be translated using **TTBR1**. However, the access matches a TLB entry for the translation, using **TTBR0**, of the block at 0xC0000000. Hardware is not required to detect that the access to 0xFFFF0000 is being translated incorrectly.

In these cases, an implementation might use one of the following approaches:

- Treat such a block, that might be a block within a contiguous set of blocks, as causing a Translation fault, even though the block is valid, and the address accessed within that block is within the size of the input address supported at a stage of translation.
- Treat such a block, that might be a block within a contiguous set of blocks, as not causing a Translation fault, even though the address accessed within that block is outside the size of the input address supported at a stage of translation, provided that both of the following apply:
 - The block is valid.
 - At least one address within the block, or contiguous set of blocks, is within the size of the input address supported at a stage of translation.

G3.6.6 VMSAv8-32 Long-descriptor translation table format address lookup levels

As stated at the start of this section, because the Long-descriptor translation table format is used for the Non-secure PL1&0 stage 2 translations, the format must support input addresses of up to 40 bits.

Table G3-6 summarizes the properties of the different levels of address lookup when using this format.

Table G3-6 Properties of the three levels of address lookup with VMSAv8-32 Long-descriptor translation tables

Level	Input address		Output address ^a		Number of entries
	Size	Address range ^b	Size	Address range	
First	Up to 512GB	Up to Address[38:0]	1GB	Address[39:30]	Up to 512
Second	Up to 1GB	Up to Address[29:0]	2MB	Address[39:21]	Up to 512
Third	2MB	Address[20:0]	4KB	Address[47:12]	512

- a. Output address when an entry addresses a block of memory or a memory page. If an entry addresses the next level of address lookup it specifies Address[39:12] for the next-level translation table.
- b. Input address range for the translation table. See *Use of concatenated first-level translation tables* on page G3-3602 for details of support for additional bits of address at a given level, including possible support of a 40-bit input address range at the first level.

For first-level and second-level tables, reducing the input address range reduces the number of addresses in the table and therefore reduces the table size. The appropriate Translation Table Control Register specifies the input address range.

Stage 1 translations require an input address range of up to 32 bits, corresponding to VA[31:0]. For these translations:

- For a memory access from a mode other than Hyp mode, the Secure or Non-secure **TTBR0** or **TTBR1** holds the translation table base address, and the Secure or Non-secure **TTBCR** is the control register.
- For a memory access from Hyp mode, **HTTBR** holds the translation table base address, and **HTCR** is the control register.

———— **Note** —————

For translations controlled by **TTBR0** and **TTBR1**, if neither Translation Table Base Register has an input address range larger than 1GB, then translation starts at the second level. Together, **TTBR0** and **TTBR1** can still cover the 32-bit VA input address range.

Stage 2 translations require an input address range of up to 40 bits, corresponding to IPA[39:0], and the supported input address size is configurable in the range 25-40 bits. Table G3-6 indicates a requirement for the translation mechanism to support a 39-bit input address range, Address[38:0]. *Use of concatenated translation tables for stage 2 translations* describes how a 40-bit IPA address range is supported. For stage 2 translations:

- **VTTBR** holds the translation table base address, and **VTTCR** is the control register.
- If a supplied input address is larger than the configured input address size, a Translation fault is generated.

Use of concatenated translation tables for stage 2 translations

If a stage 2 translation requires 16 entries or fewer in its top-level translation table, it can instead:

- Require the corresponding number of concatenated translation tables at the next translation level, aligned to the size of the block of concatenated translation tables.
- Start the translation at that next translation level.

———— **Note** —————

Stage 2 translations always use the Long-descriptor translation table format.

Use of this translation scheme is:

- Required when the stage 2 translation supports a 40-bit input address range, see [Use of concatenated first-level translation tables](#).
- Supported for a stage 2 translation with an input address range of 31-34 bits, see [Use of concatenated second-level translation tables](#).

———— **Note** —————

This translation scheme:

- Avoids the overhead of an additional level of translation
- Requires the software that is defining the translation to:
 - Define the concatenated translation tables with the required overall alignment.
 - Program [VTTBR](#) to hold the address of the first of the concatenated translation tables.
 - Program [VTCR](#) to indicate the required input address range and first lookup level.

Use of concatenated first-level translation tables

The Long-descriptor format translation tables provide 9 bits of address resolution at each level of lookup. However, a 40-bit input address range with a translation granularity of 4KB requires a total of 28 bits of address resolution. Therefore, a stage 2 translation that supports a 40-bit input address range requires two concatenated first-level translation tables, together aligned to 8KB, where:

- The table at the address with $PA[12:0] == 0b0_0000_0000_0000$ defines the translations for input addresses with $bit[39] == 0$.
- The table at the address with $PA[12:0] == 0b1_0000_0000_0000$ defines the translations for input addresses with $bit[39] == 1$.
- The 8KB alignment requirement means that both table have the same value for $PA[39:13]$.

Use of concatenated second-level translation tables

A stage 2 translation with an input address range of 31-34 bits can start the translation either:

- With a first-level lookup, accessing a first-level translation table with 2-16 entries.
- With a second-level lookup, accessing a set of concatenated second-level translation tables.

[Table G3-7](#) shows these options, for each of the input address ranges that can use this scheme.

———— **Note** —————

Because these are stage 2 translations, the input address range is an IPA range.

Table G3-7 Possible uses of concatenated translation tables for second-level lookup

Input address range		Lookup starts at first level	Lookup starts at second level	
IPA range	Size	Required first-level entries	Number of concatenated tables	Required alignment ^a
IPA[30:0]	2 ³¹ bytes	2	2	8KB
IPA[31:0]	2 ³² bytes	4	4	16KB
IPA[32:0]	2 ³³ bytes	8	8	32KB
IPA[33:0]	2 ³⁴ bytes	16	16	64KB

a. Required alignment of the set of concatenated second-level tables.

See also [Determining the required first lookup level for stage 2 translations on page G3-3605](#).

G3.6.7 Translation table walks, when using the VMSAv8-32 Long-descriptor translation table format

Figure G3-2 on page G3-3566 shows the possible address translations. The following descriptions of the translations include the registers that control each translation if that translation is controlled from an Exception level that is using AArch32:

Stage 1 translations

For all stage 1 translations:

- The input address range is up to 32 bits, as determined by either:
 - **TTBCR.T0SZ** or **TTBCR.T1SZ**, for a PL1&0 stage 1 translation.
 - **HTCR.T0SZ**, for a PL2 stage 1 translation.
- The output address range is 40 bits.

The stage 1 translations are:

Non-secure PL1&0 stage 1 translation

The stage 1 translation for memory accesses from Non-secure modes other than Hyp mode. This translates a VA to an IPA. For this translation, when Non-secure EL1 is using AArch32:

- Non-secure **TTBR0** or **TTBR1** holds the translation table base address.
- Non-secure **TTBCR** determines which TTBR is used.

Non-secure PL2 stage 1 translation

The stage 1 translation for memory accesses from Hyp mode, translates a VA to a PA. For this translation, when EL2 is using AArch32, **HTTBR** holds the translation table base address.

Secure PL1&0 stage 1 translation

The stage 1 translation for memory accesses from Secure modes, translates a VA to a PA. For this translation, when the Secure PL1 modes are using AArch32:

- Secure **TTBR0** or **TTBR1** holds the translation table base address.
- Secure **TTBCR** determines which TTBR is used.

Stage 2 translation

Non-secure PL1&0 stage 2 translation

The stage 2 translation for memory accesses from Non-secure modes other than Hyp mode, and translates an IPA to a PA. For this translation, when EL2 is using AArch32:

- The input address range is 40 bits, as determined by **VTCR.T0SZ**.
- The output address range depends on the implemented memory system, and is up to 40 bits.
- **VTTBR** holds the translation table base address.
- **VTCR** specifies the required input address range, and whether the first lookup is at the first level or at the second level.

The descriptions of the VMSAv8-32 translation stages state that the maximum output address size is 40 bits. However, the register and Long-descriptor format descriptor fields that hold these addresses are 48 bits wide. If bits[47:40] of an output address are not all zero then the address generates an Address size fault.

The Long-descriptor translation table format provides up to three levels of address lookup, as described in [VMSAv8-32 Long-descriptor translation table format address lookup levels on page G3-3600](#), and the first lookup, in which the MMU reads the translation table base address, is at either the first level or the second level. The following determines the level of the first lookup:

- For a stage 1 translation, the required input address range. For more information see [Determining the required first lookup level for stage 1 translations on page G3-3605](#).

- For a stage 2 translation, the level specified by the **VTCR.SL0** field. For more information see [Determining the required first lookup level for stage 2 translations](#) on page G3-3605.

———— **Note** ————

For a stage 2 translation, the size of the required input address range constrains the **VTCR.SL0** value.

Figure G3-20 shows how the descriptor address for the first lookup for a translation using the Long-descriptor translation table format is determined from the input address and the translation table base register value. This figure shows the lookup for a translation that starts with a first-level lookup, that translates bits[39:30] of the input address, zero extended if necessary.

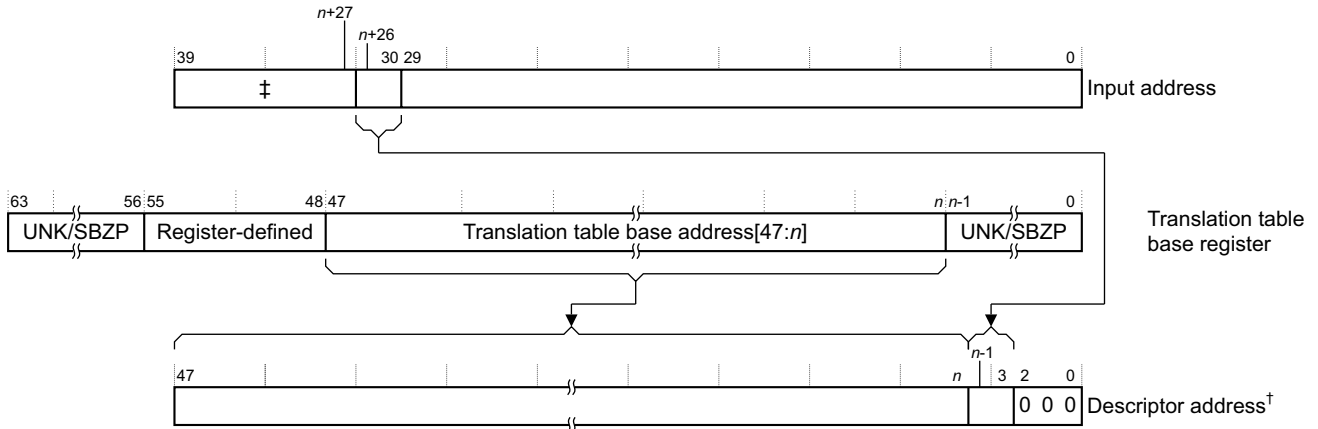

See text for more information about the translation table base register used, and the value of n .

‡ This field is absent if n is 13.

† For a Non-secure PL1&0 stage 1 translation, the IPA of the descriptor. Otherwise, the PA of the descriptor.

Figure G3-20 Long-descriptor first lookup, starting at first level

For a translation that starts with a first-level lookup, as shown in Figure G3-20:

For a stage 1 translation

n is in the range 4-5 and:

- For a memory access from Hyp mode:
 - HTTBR** is the translation table base register.
 - $n=5-(\text{HTCR.TOSZ})$.
- For other accesses:
 - the Secure or Non-secure instance of **TTBR0** or **TTBR1** is the translation table base register.
 - $n=(5-\text{TTBCR.TxSZ})$, where x is 0 when using **TTBR0**, and 1 when using **TTBR1**.

For a stage 2 translation

n is in the range 4-13 and:

- VTTBR** is the translation table base register.
- $n=5-(\text{VTCCR.TOSZ})$.

For a translation that starts with a second-level lookup, the descriptor address is obtained in the same way, except that bits[($n+17$):21] of the input address provide bits[($n-1$):3] of the descriptor address, where:

For a stage 1 translation

n is in the range 7-12. As [Determining the required first lookup level for stage 1 translations](#) on page G3-3605 shows, for a stage 1 translation to start with a second-level lookup, the corresponding TOSZ or TISZ field must be 2 or more. This means:

- For a memory access from Hyp mode, $n=14-\text{HTCR.TOSZ}$.

- For other memory accesses, $n=14-(\text{TTBCR.TxSZ})$, where x is 0 when using **TTBR0**, and 1 when using **TTBR1**.

For a stage 2 translation

n is in the range 7-16. For a stage 2 translation to start with a second-level lookup, **VTCR.SL0** is 0b00, and $n=14-(\text{VTCT.TOSZ})$.

Determining the required first lookup level for stage 1 translations

For a stage 1 translation, the required input address range, indicated by a TOSZ or T1SZ field in a translation table control register, determines the first lookup level. The size of this input address region is $2^{(32-\text{T}x\text{SZ})}$ bytes, and if this size is:

- Less than or equal to 2^{30} bytes, the required start is at the second level, and translation requires two levels of table to map to 4KB pages. This corresponds to a TxSZ value of 2 or more.
- More than 2^{30} bytes, the required start is at the first level, and translation requires three levels of table to map to 4KB pages. This corresponds to a TxSZ value that is less than 2.

For the PL1&0 stage 1 translations, the **TTBCR**:

- Splits the 32-bit VA input address range between **TTBR0** and **TTBR1**, see *Selecting between TTBR0 and TTBR1, VMSAv8-32 Long-descriptor translation table format on page G3-3598*.
- Holds the input address range sizes for **TTBR0** and **TTBR1**, in the **TTBCR.TOSZ** and **TTBCR.T1SZ** fields.

For the PL2 stage 1 translations, **HTCR.TOSZ** indicates the size of the required input address range. For example, if this field is 0b000, it indicates a 32-bit VA input address range, and translation lookup must start at the first level.

Determining the required first lookup level for stage 2 translations

For a PL1&0 stage 2 translation, the output address range from the PL1&0 stage 1 translations determines the required input address range for the stage 2 translation.

VTCR.SL0 indicates the starting level for the lookup. The permitted SL0 values are:

- 0b00 Stage 2 translation lookup must start at the second level.
- 0b01 Stage 2 translation lookup must start at the first level.

In addition, **VTCT.TOSZ** must indicate the required input address range. The size of the input address region is $2^{(32-\text{TOSZ})}$ bytes.

———— **Note** —————

VTCT.TOSZ holds a four-bit signed integer value, meaning it supports values from -8 to 7. This is different from the other translation control registers, where **TnSZ** holds a three-bit unsigned integer, supporting values from 0 to 7.

The programming of **VTCT** must follow the constraints shown in [Table G3-8](#), otherwise behavior is UNPREDICTABLE. The table also shows how the **VTCT.SL0** and **VTCT.TOSZ** values determine the **VTTBR.BADDR** field width.

Table G3-8 Input address range constraints on programming VTCT

VTCT.SL0	VTCT.TOSZ	Input address range, R	First lookup level	BADDR[39:x] width^a
0b00	2 to 7	$R \leq 2^{30}$ bytes	Second	[39:12] to [39:7]
0b00	-2 to 1	$2^{30} < R \leq 2^{34}$ bytes	Second	[39:16] to [39:13]
0b01	-2 to 1		First	[39:7] to [39:4]
0b01	-8 to -3	$2^{34} < R$	First	[39:13] to [39:8]

- a. The first range corresponds to the first TOSZ value, the second range to the second TOSZ value.

Where necessary, the first lookup level provides multiple concatenated translation tables, as described in [Use of concatenated second-level translation tables on page G3-3602](#). This section also gives more information about the alternatives, shown in [Table G3-8 on page G3-3605](#), when R is in the range 2^{31} - 2^{34} .

Full translation flows for VMSAv8-32 Long-descriptor format translation tables

In a translation table walk, only the first lookup uses the translation table base address from the appropriate Translation table base register. Subsequent lookups use a combination of address information from:

- The table descriptor read in the previous lookup.
- The input address.

The following sections describe full Long-descriptor format translation flows, down to an entry for a 4KB page:

- [The address and Properties fields shown in the translation flows on page G3-3586](#).
- [Full translation flow, starting at first-level lookup](#).
- [Full translation flow, starting at second-level lookup on page G3-3608](#).

The address and Properties fields shown in the translation flows

For the Non-secure PL1&0 stage 1 translation:

- Any descriptor address is the IPA of the required descriptor.
- The final output address is the IPA of the block or page.

In these cases, a PL1&0 stage 2 translation is performed to translate the IPA to the required PA.

For all other translations, the final output address is the PA of the block or page, and any descriptor address is the PA of the descriptor.

Properties indicates register or translation table fields that return information, other than address information, about the translation or the targeted memory region. For more information see [Information returned by a translation table lookup on page G3-3574](#), and the description of the register or translation table descriptor.

For translations using the Long-descriptor translation table format, [VMSAv8-32 Long-descriptor translation table format descriptors on page G3-3592](#) describes the descriptors formats.

Full translation flow, starting at first-level lookup

[Figure G3-21 on page G3-3607](#) shows the complete translation flow for a VMSAv8-32 Long-descriptor stage 1 translation table walk that starts with a first-level lookup. For more information about the fields shown in the figure see [The address and Properties fields shown in the translation flows on page G3-3586](#).

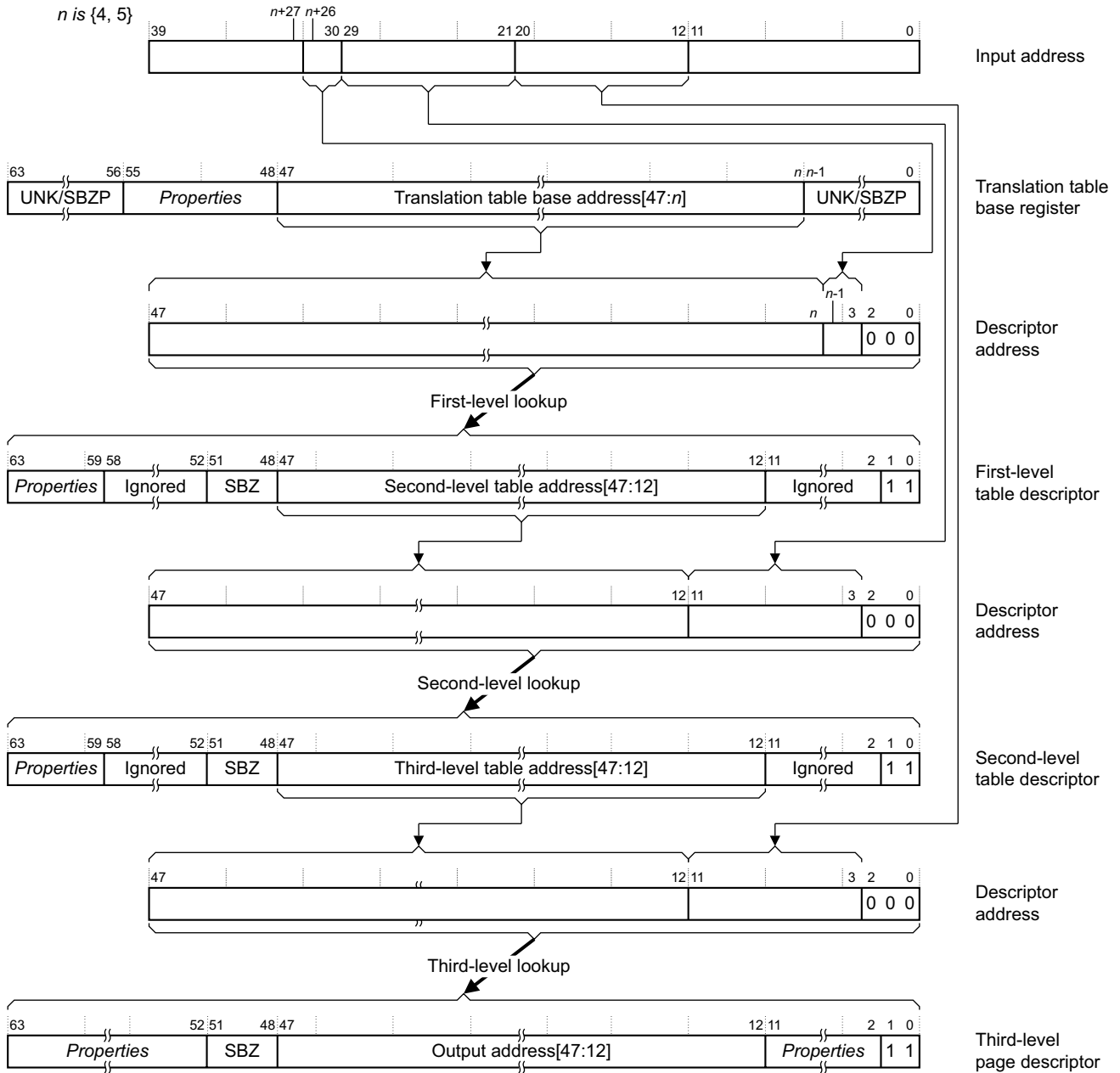

For details of *Properties* fields, see the register or descriptor description.

Figure G3-21 Complete VMSAv8-32 Long-descriptor format stage 1 translation, starting at first level

If the first-level lookup or the second-level lookup returns a block descriptor then the translation table walk completes at that level.

A stage 2 translation that starts at a first-level lookup differs from the translation shown in Figure G3-21 only as follows:

- The possible values of n are 4-13, to support an input address of between 31 and 40 bits.
- A descriptor and output addresses are always PAs.

Full translation flow, starting at second-level lookup

Figure G3-22 shows the complete translation flow for a stage 1 VMSAv8-32 Long-descriptor translation table walk that starts at a second-level lookup. For more information about the fields shown in the figure see *The address and Properties fields shown in the translation flows* on page G3-3586.

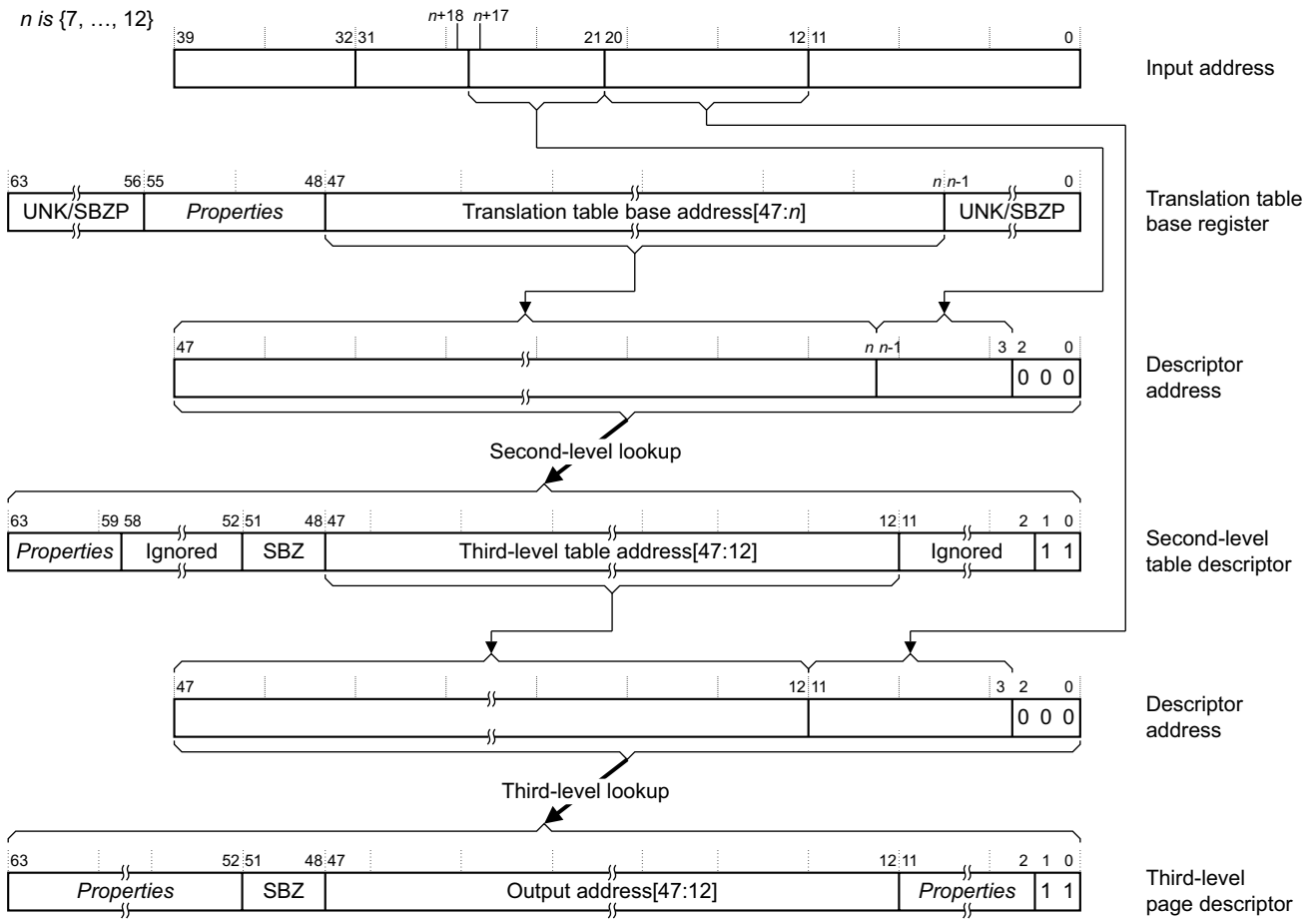

For details of *Properties* fields, see the register or descriptor description.

Figure G3-22 Complete VMSAv8-32 Long-descriptor format stage 1 translation, starting at second level

If the second-level lookup returns a block descriptor then the translation table walk completes at that level.

A stage 2 translation that starts at a second-level lookup differs from the translation shown in Figure G3-22 only as follows:

- The possible values of n are 7-16, to support an input address of up to 34 bits.
- The descriptor and output addresses are always PAs.

G3.7 Memory access control

In addition to an output address, a translation table entry that refers to page or region of memory includes fields that define properties of the target memory region. *Information returned by a translation table lookup on page G3-3574* describes the classification of those fields as address map control, access control, and memory attribute fields. The access control fields, described in this section, determine whether the PE, in its current state, is permitted to perform the required access to the output address given in the translation table descriptor. If a translation stage does not permit the access then a MMU fault is generated for that translation stage, and no memory access is performed.

The following sections describe the memory access controls:

- [Access permissions.](#)
- [Execute-never restrictions on instruction fetching on page G3-3612.](#)
- [Domains, Short-descriptor format only on page G3-3614.](#)
- [The Access flag on page G3-3615.](#)
- [Hyp mode control of Non-secure access permissions on page G3-3616.](#)

G3.7.1 Access permissions

———— Note ————

This section gives a general description of memory access permissions. Software executing at PL1 in Non-secure state can see only the access permissions defined by the Non-secure PL1&0 stage 1 translations. However, software executing at PL2 can modify these permissions, as described in [Hyp mode control of Non-secure access permissions on page G3-3616](#). This modification is invisible to Non-secure software executing at EL1 or EL0.

Access permission bits in a translation table descriptor control access to the corresponding memory region. The details of this control depend on the translation table format, as follows:

Short-descriptor format

This format supports two options for defining the access permissions:

- Three bits, AP[2:0], define the access permissions.
- Two bits, AP[2:1], define the access permissions, and AP[0] can be used as an Access flag.

[SCTLR.AFE](#) selects the access permissions option. Setting this bit to 1, to enable the Access flag, also selects use of AP[2:1] to define access permissions.

ARM deprecates any use of the AP[2:0] scheme for defining access permissions.

Long-descriptor format

AP[2:1] to control the access permissions, and the descriptors provide an AF bit for use as an Access flag. This means VMSAv8-32 behaves as if the value of [SCTLR.AFE](#) is 1, regardless of the value that software has written to this bit.

———— Note ————

When use of the Long-descriptor format is enabled, [SCTLR.AFE](#) is UNK/SBOP.

[The Access flag on page G3-3615](#) describes the Access flag, for both translation table formats.

The XN and PXN bits provide additional access controls for instruction fetches, see [Execute-never restrictions on instruction fetching on page G3-3612](#).

An attempt to perform a memory access that the translation table access permission bits do not permit generates a Permission fault, for the corresponding stage of translation. However, when using the Short-descriptor translation table format, it generates the fault only if the access is to memory in the Client domain, see [Domains, Short-descriptor format only on page G3-3614](#).

———— **Note** —————

For the Non-secure PL1&0 translation regime, memory accesses are subject to two stages of translation. Each stage of translation has its own, independent, fault checking. Fault handling is different for the two stages, see [Exception reporting in a VMSAv8-32 implementation on page G3-3659](#).

The following sections describe the two access permissions models:

- [AP\[2:1\] access permissions model](#).
- [AP\[2:0\] access permissions control, Short-descriptor format only on page G3-3611](#). This section includes some information on access permission control in earlier versions of the ARM VMSA.

AP[2:1] access permissions model

———— **Note** —————

ARM recommends that this model is always used, even where the AP[2:0] model is permitted. Some documentation describes the AP[2:1] model as the *simplified access permissions* model.

This access permissions model is used if the translation is either:

- Using the Long-descriptor translation table format.
- Using Short-descriptor translation table format, and the [SCTLR.AFE](#) bit is set to 1.

In this model:

- One bit, AP[2], selects between read-only and read/write access.
- A second bit, AP[1], selects between Application level (PL0) and System level (PL1) control. For the Non-secure PL2 stage 1 translations, AP[1] is SBO.

This provides four access combinations:

- Read-only at all privilege levels.
- Read/write at all privilege levels.
- Read-only at PL1, no access by software executing at PL0.
- Read/write at PL1, no access by software executing at PL0.

[Table G3-9](#) shows this access control model.

Table G3-9 VMSAv8-32 AP[2:1] access permissions model

AP[2], disable write access	AP[1], enable unprivileged access	Access
0	0 ^a	Read/write, only at PL1
0	1	Read/write, at any privilege level
1	0 ^a	Read-only, only at PL1
1	1	Read-only, at any privilege level

a. Not valid for Non-secure PL2 stage 1 translation tables. AP[1] is SBO in these tables.

Hierarchical control of access permissions, Long-descriptor format

The Long-descriptor translation table format introduces a mechanism that entries at one level of translation table lookup can use to set limits on the permitted entries at subsequent levels of lookup. This applies to the access permissions, and also to the restrictions on instruction fetching described in [Hierarchical control of instruction fetching, Long-descriptor format on page G3-3613](#).

The restrictions apply only to subsequent levels of lookup at the same stage of translation. The APTable[1:0] field restricts the access permissions, as [Table G3-10 on page G3-3611](#) shows.

As stated in the table footnote, for the Non-secure PL2 stage 1 translation tables, APTable[0] is reserved, SBZ.

Table G3-10 Effect of APTable[1:0] on subsequent levels of lookup

APTable[1:0]	Effect
00	No effect on permissions in subsequent levels of lookup.
01 ^a	Access at PL0 not permitted, regardless of permissions in subsequent levels of lookup.
10	Write access not permitted, at any exception level, regardless of permissions in subsequent levels of lookup.
11 ^a	Regardless of permissions in subsequent levels of lookup: <ul style="list-style-type: none"> • Write access not permitted, at any exception level. • Read access not permitted at PL0.

a. Not valid for the Non-secure PL2 stage 1 translation tables. In those tables, APTable[0] is SBZ.

Note

The APTable[1:0] settings are combined with the translation table access permissions in the translation tables descriptors accessed in subsequent levels of lookup. They do not restrict or change the values entered in those descriptors.

The Long-descriptor format provides APTable[1:0] control only for the stage 1 translations. The corresponding bits are SBZ in the stage 2 translation table descriptors.

When APTable[1:0] is not set to 0b00, its effects might be held in one or more TLB entries. Therefore, a change to APTable[1:0] might require coarse-grained invalidation of the TLB to ensure that the effect of the change is visible to subsequent memory transactions.

AP[2:0] access permissions control, Short-descriptor format only

This access permissions model applies when using the Short-descriptor translation tables format, and the SCTLR.AFE bit is set to 0. ARM deprecates any use of this access permissions model.

When SCTLR.AFE is set to 0, ensuring that the AP[0] bit is always set to 1 effectively changes the access model to the simpler model described in *AP[2:1] access permissions model on page G3-3610*.

Table G3-11 shows the full AP[2:0] access permissions model:

Table G3-11 VMSAv8-32 MMU access permissions

AP[2]	AP[1:0]	EL1 and EL2 access	Unprivileged access	Description
0	00	No access	No access	All accesses generate Permission faults
	01	Read/write	No access	Access only at PL1 or higher
	10	Read/write	Read-only	Writes at PL0 generate Permission faults
	11	Read/write	Read/write	Full access
1	00	-	-	Reserved
	01	Read-only	No access	Read-only, only at PL1 or higher
	10	Read-only	Read-only	Read-only at any exception level, deprecated ^a
	11	Read-only	Read-only	Read-only at any exception level ^b

a. From VMSAv7, ARM strongly recommends use of the 0b11 encoding for Read-only at any exception level.

b. This mapping was introduced in VMSAv7, and is reserved in earlier versions of the VMSA.

———— **Note** ————

- VMSAv8-32 supports the full set of access permissions shown in [Table G3-11 on page G3-3611](#) only when `SCTLR.AFE` is set to 0. When `SCTLR.AFE` is set to 1, the only supported access permissions are those described in [AP\[2:1\] access permissions model on page G3-3610](#).
- Some old documentation describes the AP[2] bit in the translation table entries as the APX bit.

G3.7.2 Execute-never restrictions on instruction fetching

Execute-never (XN) controls provide an additional level of control on memory accesses permitted by the access permissions settings. These controls are:

XN, Execute-never

When the XN bit is 1, a Permission fault is generated if the PE attempts to execute an instruction fetched from the corresponding memory region. However, when using the Short-descriptor translation table format, the fault is generated only if the access is to memory in the Client domain, see [Domains, Short-descriptor format only on page G3-3614](#). A PE can execute instructions from a memory region only if the access permissions for its current state permit read access, and the XN bit is set to 0.

PXN, Privileged execute-never

When the PXN bit is 1, a Permission fault is generated if the PE is executing at PL1 and attempts to execute an instruction fetched from the corresponding memory region. As with the XN bit, when using the Short-descriptor translation table format, the fault is generated only if the access is to memory in the Client domain.

In both the Short-descriptor format and the Long-descriptor format translation tables, all descriptors for memory blocks and pages always include an XN bit.

Support for the PXN bit is as follows:

- The Long-descriptor translation table formats always include the PXN bit.
- All implementations must:
 - Support the use of the PXN bit.
 - Use the Short-descriptor translation table formats that include the PXN bit.

In the Non-secure PL2 stage 1 translation tables, the PXN bit is reserved, SBZ.

In addition, additional controls can enforce execute-never restrictions, regardless of the settings in the translation tables, see:

- [Restriction on Secure instruction fetch on page G3-3613](#).
- [Preventing execution from writable locations on page G3-3614](#).

The execute-never controls apply also to speculative instruction fetching. This means a speculative instruction fetch from a memory region that is execute-never at the current level of privilege is prohibited.

The XN control means that, when the stage of address translation is enabled, the PE can fetch, or speculatively fetch, an instruction from a memory location only if all of the following apply:

- If using the Short-descriptor translation table format, the translation table descriptor for the location does not indicate that it is in a No access domain.
- If using the Long-descriptor translation table format, or using the Short descriptor format and the descriptor indicates that the location is in a Client domain, in the descriptor for the location the following apply:
 - XN is set to 0.
 - The access permissions permit a read access from the current PE mode.
- No other Prefetch Abort condition exists.

Note

- The PXN control applies to the PE privilege when it attempts to execute the instruction. In an implementation that fetches instructions speculatively, this might not be the privilege when the instruction was prefetched. Therefore, the architecture does not require the PXN control to prevent instruction fetching.
- Although the XN control applies to speculative fetching, on a speculative instruction fetch from an XN location, no Permission fault is generated unless the PE attempts to execute the instruction fetched from that location. This means that, if a speculative fetch from an XN location is attempted, but there is no attempt to execute the corresponding instruction, a Permission fault is not generated.
- The software that defines a translation table must mark any region of memory that is read-sensitive as XN, to avoid the possibility of a speculative fetch accessing the memory region. For example, it must mark any memory region that corresponds to a read-sensitive peripheral as XN.
- When using the Short-descriptor translation table format, the XN attribute is not checked for domains marked as Manager. Therefore, the system must not include read-sensitive memory in domains marked as Manager, because the XN bit does not prevent speculative fetches from a Manager domain.

When no stage of address translation for the translation regime is enabled, memory regions cannot have XN or PXN attributes assigned. [Behavior of instruction fetches when all associated address translations are disabled on page G3-3571](#) describes how disabling all MMUs affects instruction fetching.

Hierarchical control of instruction fetching, Long-descriptor format

The Long-descriptor translation table format introduces a mechanism that means entries at one level of translation tables lookup can set limits on the permitted entries at subsequent levels of lookup. This applies to the restrictions on instruction fetching, and also to the access permissions described in [Hierarchical control of access permissions, Long-descriptor format on page G3-3610](#).

The restrictions apply only to subsequent levels of lookup at the same stage of translation, and:

- XNTable restricts the XN control:
 - When XNTable is set to 1, the XN bit is treated as 1 in all subsequent levels of lookup, regardless of the actual value of the bit.
 - When XNTable is set to 0 it has no effect.
- PXNTable restricts the PXN control:
 - When PXNTable is set to 1, the PXN bit is treated as 1 in all subsequent levels of lookup, regardless of the actual value of the bit.
 - When PXNTable is set to 0 it has no effect.

Note

The XNTable and PXNTable settings are combined with the XN and PXN bits in the translation table descriptors accessed at subsequent levels of lookup. They do not restrict or change the values entered in those descriptors.

The XNTable and PXNTable controls are provided only in the Long-descriptor translation table format, and only for stage 1 translations. The corresponding bits are SBZ in the stage 2 translation table descriptors.

When XNTable, or PXNTable, is set to 1, its effects might be held in one or more TLB entries. Therefore, a change to XNTable or PXNTable might require coarse-grained invalidation of the TLB to ensure that the effect of the change is visible to subsequent memory transactions.

Restriction on Secure instruction fetch

EL3 provides a Secure instruction fetch bit, [SCR.SIF](#). When this bit is set to 1, any attempt in Secure state to execute an instruction fetched from Non-secure physical memory causes a Permission fault. As with all Permission fault checking, when using the Short-descriptor format translation tables the check applies only to Client domains, see [Access permissions on page G3-3609](#).

ARM expects `SCR.SIF` to be static during normal operation. In particular, whether the TLB holds the effect of the SIF bit is IMPLEMENTATION DEFINED. The generic sequence to ensure visibility of a change to the SIF bit is:

```
Change the SCR.SIF bit
ISB                ; This ensures synchronization of the change
Invalidate entire TLB
DSB                ; This completes the TLB Invalidation
ISB                ; This ensures instruction synchronization
```

Preventing execution from writable locations

The architecture includes control bits that, when the corresponding stage 1 address translation is enabled, force writable memory to be treated as XN, regardless of the setting of the XN bit. When the translation stages are controlled by an Exception level that is using AArch32:

- For PL1&0 stage 1 translations, when `SCTLR.WXN` is set to 1, all regions that are writable at stage 1 of the address translation are treated as XN.
- For Non-secure PL2 stage 1 translations, when `HSCTLR.WXN` is set to 1, all regions that are writable at stage 1 of the address translation are treated as XN.
- For PL1&0 stage 1 translations, when `SCTLR.UWXN` is set to 1, an instruction fetch is treated as accessing a PXN region if it accesses a region that software executing at PL0 can write to.

Note

Setting a WXN or UWXN bit to 1 changes the interpretation of the translation table entry, overriding a zero value of an XN or PXN field. It does not cause any change to the translation table entry.

For any given virtual machine, ARM expects WXN and UWXN to remain static in normal operation. In particular, it is IMPLEMENTATION DEFINED whether TLB entries associated with a particular VMID reflect the effect of the values of these bits. A generic sequence to ensure synchronization of a change to these bits, when that change is made without a corresponding change of VMID, is:

```
Change the WXN or UWXN bit
ISB                ; This ensures synchronization of the change
Invalidate entire TLB of associated entries
DSB                ; This completes the TLB Invalidation
ISB                ; This ensures instruction synchronization
```

As with all Permission fault checking, if the stage 1 translation is using the Short-descriptor translation table format, the permission checks are performed only for Client domains. For more information see [Access permissions on page G3-3609](#).

For more information about address translation see [About address translation for VMSEA8-32 on page G3-3565](#).

G3.7.3 Domains, Short-descriptor format only

A domain is a collection of memory regions. The Short-descriptor translation table format supports 16 domains, and requires the software that defines a translation table to assign each VMSEA8-32 memory region to a domain. When using the Short-descriptor format:

- First-level translation table entries for Page tables and Sections include a domain field.
- Translation table entries for Supersections do not include a domain field. The Short-descriptor format defines Supersections as being in domain 0.
- Second-level translation table entries inherit a domain setting from the parent first-level Page table entry.
- Each TLB entry includes a domain field.

The domain field specifies which of the 16 domains the entry is in, and a two-bit field in the [DACR](#) defines the permitted access for each domain. The possible settings for each domain are:

- No access** Any access using the translation table descriptor generates a Domain fault.
- Clients** On an access using the translation table descriptor, the access permission attributes are checked. Therefore, the access might generate a Permission fault.
- Managers** On an access using the translation table descriptor, the access permission attributes are not checked. Therefore, the access cannot generate a Permission fault.

See [The MMU fault-checking sequence on page G3-3650](#) for more information about how, when using the Short-descriptor translation table format, the Domain attribute affects the checking of the other attributes in the translation table descriptor.

———— **Note** —————

A single program might:

- Be a Client of some domains.
- Be a Manager of some other domains.
- Have no access to the remaining domains.

The Long-descriptor translation table format does not support domains. When a stage of translation is using this format, all memory is treated as being in a Client domain, and the settings in the [DACR](#) are ignored.

G3.7.4 The Access flag

The Access flag indicates when a page or section of memory is accessed for the first time since the Access flag in the corresponding translation table descriptor was set to 0:

- If address translation is using the Short-descriptor translation table format, it must set [SCTLR.AFE](#) to 1 to enable use of the Access flag, see [SCTLR, System Control Register on page G4-4005](#). Setting this bit to 1 redefines the AP[0] bit in the translation table descriptors as an Access flag, and limits the access permissions information in the translation table descriptors to AP[2:1], as described in [AP\[2:1\] access permissions model on page G3-3610](#).
- The Long-descriptor format always supports an Access flag bit in the translation table descriptors, and address translation using this format behaves as if [SCTLR.AFE](#) is set to 1, regardless of the value of that bit.

In ARMv8 the Access flag is managed by software as described in the following subsection.

———— **Note** —————

Previous version of the ARM architecture optionally supported hardware management of the Access flag. ARMv8 obsoletes this option.

Software management of the Access flag

An implementation that requires software to manage the Access flag generates an Access flag fault whenever a translation table entry with the Access flag set to 0 is read into the TLB

———— **Note** —————

When using the Short-descriptor translation table format, Access flag faults are generated only if [SCTLR.AFE](#) is set to 1, to enable use of a translation table descriptor bit as an Access flag.

The Access flag mechanism expects that, when an Access flag fault occurs, software resets the Access flag to 1 in the translation table entry that caused the fault. This prevents the fault occurring the next time that memory location is accessed. Entries with the Access flag set to 0 are never held in the TLB, meaning software does not have to flush the entry from the TLB after setting the flag.

G3.7.5 Hyp mode control of Non-secure access permissions

When EL2 is using AArch32, Non-secure software executing in Hyp mode controls two sets of translation tables, both of which use the Long-descriptor translation table format:

- The translation tables that control the Non-secure PL2 stage 1 translations. These map VAs to PAs, for memory accesses made when executing in Non-secure state in Hyp mode, and are indicated and controlled by the [HTTBR](#) and [HTCR](#).

These translations have similar access controls to other Non-secure stage 1 translations using the Long-descriptor translation table format, as described in:

- [AP\[2:1\] access permissions model on page G3-3610](#).
- [Execute-never restrictions on instruction fetching on page G3-3612](#).

The differences from the Non-secure stage 1 translations are that:

- The APTable[0], PXNTable, and PXN bits are reserved, SBZ.
- AP[1] is reserved, SBO.

- The translation tables that control the Non-secure PL1&0 stage 2 translations. These map the IPAs from the stage 1 translation onto PAs, for memory accesses made when executing in Non-secure state at PL1 or PL0, and are indicated and controlled by the [VTTBR](#) and [VTCR](#).

The descriptors in the virtualization translation tables define a second level of access permissions, that are combined with the permissions defined in the stage 1 translation. This section describes this combining of access permissions.

———— **Note** ————

The second-level access permissions mean a hypervisor can define additional access restrictions to those defined by a Guest OS in the stage 1 translation tables. For a particular access, the actual access permission is the more restrictive of the permissions defined by:

- The Guest OS, in the stage 1 translation tables.
- The hypervisor, in the stage 2 translation tables.

The stage 2 access controls defined from Hyp mode:

- Affect only the Non-secure stage 1 access permissions settings.
- Take no account of whether the accesses are from a Non-secure PL1 mode or a Non-secure PL0 mode.
- Permit software executing in Hyp mode to assign a write-only attribute to a memory region.

The S2AP field in the stage 2 descriptors define the stage 2 access permissions, as [Table G3-12](#) shows:

Table G3-12 Stage 2 control of access permissions

S2AP	Access permission
00	No access permitted
01	Read-only. Writes to the region are not permitted, regardless of the stage 1 permissions.
10	Write-only. Reads from the region are not permitted, regardless of the stage 1 permissions.
11	Read/write. The stage 1 permissions determine the access permissions for the region.

For more information about the S2AP field see [Attribute fields in VMSAv8-32 Long-descriptor stage 2 Block and Page descriptors on page G3-3596](#).

If the stage 2 permissions cause a Permission fault, this is a stage 2 address translation fault. Stage 2 address translation faults are taken to Hyp mode, and reported in the [HSR](#) using an EC code of 0x20 or 0x24. For more information, see [Use of the HSR on page G3-3672](#).

Note

The combination of the EC code and the STATUS value in the [HSR](#) indicate that the fault is a stage 2 address translation fault.

The stage 2 permissions include an XN attribute. If this is set to 1, execution from the region is not permitted, regardless of the value of the XN attribute in the stage 1 translation. If a Permission fault is generated because the stage 2 XN bit is set to 1, this is reported as a stage 2 address translation fault.

[Prioritization of aborts on page G3-3658](#) describes the abort prioritization if both stages of a translation generate a fault.

G3.8 Memory region attributes

In addition to an output address, a translation table entry that refers to a page or region of memory includes fields that define properties of that target memory region. [Information returned by a translation table lookup on page G3-3574](#) describes the classification of those fields as address map control, access control, and memory attribute fields. The memory region attribute fields control the memory type, accesses to the caches, and whether the memory region is Shareable and therefore is coherent.

The following sections describe the assignment of memory region attributes for stage 1 translations:

- [Overview of memory region attributes for stage 1 translations.](#)
- [Short-descriptor format memory region attributes, without TEX remap on page G3-3619.](#)
- [Short-descriptor format memory region attributes, with TEX remap on page G3-3620.](#)
- [VMSAv8-32 Long-descriptor format memory region attributes on page G3-3624.](#)

For an implementation that is operating in Secure state, or in Hyp mode, these assignments define the memory attributes of the accessed region.

For an implementation that is operating in a Non-secure PL1 or PL0 mode, the Non-secure PL1&0 stage 2 translation can modify the memory attributes assigned by the stage 1 translation. [EL2 control of Non-secure memory region attributes on page G3-3625](#) describes these stage 2 assignments.

G3.8.1 Overview of memory region attributes for stage 1 translations

The description of the memory region attributes in a translation descriptor divides into:

Memory type and attributes

These are described either:

- Directly, by bits in the translation table descriptor.
- Indirectly, by registers referenced by bits in the table descriptor. This is described as *remapping* the memory type and attribute description.

The Short-descriptor translation table format can use either of these approaches, selected by the `SCTLR.TRE` bit:

TRE == 0 Remap disabled. The `TEX[2:0]`, `C`, and `B` bits in the translation table descriptor define the memory region attributes. [Short-descriptor format memory region attributes, without TEX remap on page G3-3619](#) describes this encoding.

———— **Note** —————

With the Short-descriptor format, remapping is called *TEX remap*, and the `SCTLR.TRE` bit is the *TEX remap enabled* bit.

The description of the `TRE == 0` encoding includes information about the encoding in previous versions of the architecture.

TRE == 1 Remap enabled. The `TEX[0]`, `C`, and `B` bits in the translation table descriptor are index bits to the remap registers, that define the memory region attributes:

- The Primary Region Remap Register, `PRRR`.
- The Normal Memory Remap Register, `NMRR`.

[Short-descriptor format memory region attributes, with TEX remap on page G3-3620](#) describes this encoding scheme.

This scheme reassigns translation table descriptor bits `TEX[2:1]` for use as bits managed by the operating system.

The Long-descriptor translation table format always uses remapping. This means VMSAv8-32 behaves as if the value of `SCTLR.TRE` is 1, regardless of the value that software has written to this bit.

———— **Note** —————

When use of the Long-descriptor format is enabled, `SCTLR.TRE` is `UNK/SBOP`.

[VMSAv8-32 Long-descriptor format memory region attributes on page G3-3624](#) describes this encoding.

Shareability In the Short-descriptor translation table format, the S bit in the translation table descriptor encodes whether the region is shareable. Enabling TEX remap extends the shareability description. For more information see:

- [Shareability and the S bit, without TEX remap on page G3-3620](#).
- [Shareability and the S bit, with TEX remap on page G3-3622](#).

In the Long-descriptor translation table format, the SH[1:0] field in the translation table descriptor encodes shareability information. For more information see [Shareability, Long-descriptor format on page G3-3624](#).

G3.8.2 Short-descriptor format memory region attributes, without TEX remap

When using the Short-descriptor translation table formats, TEX remap is disabled when `SCTLR.TRE` is set to 0.

———— **Note** —————

- The Short-descriptor format scheme without TEX remap is the scheme used in VMSAv6.
- The B (Bufferable), C (Cacheable), and TEX (Type extension) bit names are inherited from earlier versions of the architecture. These names no longer adequately describe the function of the B, C, and TEX bits.

[Table G3-13](#) shows the C, B, and TEX[2:0] encodings when TEX remap is disabled:

Table G3-13 TEX, C, and B encodings when TRE == 0

TEX[2:0]	C	B	Description	Memory type	Page Shareable
000	0	0	Device-nGnRnE	Device-nGnRnE	Shareable
		1	Shareable Device-nGnRE ^a	Device-nGnRE	Shareable ^a
	1	0	Outer and Inner Write-Through, no Write-Allocate	Normal	S bit ^b
		1	Outer and Inner Write-Back, no Write-Allocate	Normal	S bit ^b
001	0	0	Outer and Inner Non-cacheable	Normal	S bit ^b
		1	Reserved	-	-
	1	0	IMPLEMENTATION DEFINED	IMPLEMENTATION DEFINED	IMPLEMENTATION DEFINED
		1	Outer and Inner Write-Back, Write-Allocate	Normal	S bit ^b
010	0	0	Non-shareable Device-nGnRE ^a	Device-nGnRE	Non-shareable ^a
		1	Reserved	-	-
	1	x	Reserved	-	-
011	x	x	Reserved	-	-
1BB	A	A	Cacheable memory: AA = Inner attribute ^c BB = Outer attribute	Normal	S bit ^b

- Some implementations make no distinction between Shareable Device-nGnRE memory and Non-shareable Device-nGnRE memory, and refer to both memory types as Shareable Device-nGnRE memory.
- For more information, see [Shareability and the S bit, without TEX remap on page G3-3620](#).
- For more information, see [Cacheable memory attributes, without TEX remap on page G3-3620](#).

See [Memory types and attributes on page E2-2357](#) for an explanation of Normal memory, and the types of Device memory, and of the shareability attribute.

Cacheable memory attributes, without TEX remap

When $TEX[2] == 1$, the memory described by the translation table entry is Cacheable, and the rest of the encoding defines the Inner and Outer cache attributes:

- TEX[1:0]** Define the Outer cache attribute.
- C, B** Define the Inner cache attribute.

The translation table entries use the same encoding for the Outer and Inner cache attributes, as [Table G3-14](#) shows.

Table G3-14 Inner and Outer cache attribute encoding

Encoding	Cache attribute
00	Non-cacheable
01	Write-Back, Write-Allocate
10	Write-Through, no Write-Allocate
11	Write-Back, no Write-Allocate

Shareability and the S bit, without TEX remap

The translation table entries also include an S bit. This bit:

- Is ignored if the entry refers to any type of Device memory.
- For Normal memory, determines whether the memory region is Shareable or Non-shareable:
 - S == 0** Normal memory region is Non-shareable.
 - S == 1** Normal memory region is Shareable.

G3.8.3 Short-descriptor format memory region attributes, with TEX remap

When using the Short-descriptor translation table formats, TEX remap is enabled when **SCTLR.TRE** is set to 1. In this configuration:

- The software that defines the translation tables must program the **PRRR** and **NMRR** to define seven possible memory region attributes.
- The **TEX[0]**, **C**, and **B** bits of the translation table descriptors define the memory region attributes, by indexing **PRRR** and **NMRR**.
- Hardware makes no use **TEX[2:1]**, see [The OS managed translation table bits on page G3-3623](#).

When TEX remap is enabled:

- For seven of the eight possible combinations of the **TEX[0]**, **C** and **B** bits, fields in the **PRRR** and **NMRR** define the region attributes, as described in this section.
- The meaning of the eighth combination for the **TEX[0]**, **C** and **B** bits is IMPLEMENTATION DEFINED.
- Four bits in the **PRRR** define whether the region is shareable, as described in [Shareability and the S bit, with TEX remap on page G3-3622](#).

For each of the possible encodings of the TEX[0], C, and B bits in a translation table entry, [Table G3-15](#) shows which fields of the [PRRR](#) and [NMRR](#) registers describe the memory region attributes.

Table G3-15 TEX, C, and B encodings when TRE == 1

Encoding TEX[0]	C	B	Memory type ^a	Cache attributes ^{a, b} :		Outer Shareable attribute ^{a, c}
				Inner cacheability	Outer cacheability	
0	0	0	PRRR [1:0]	NMRR [1:0]	NMRR [17:16]	NOT(PRRR [24])
		1	PRRR [3:2]	NMRR [3:2]	NMRR [19:18]	NOT(PRRR [25])
	1	0	PRRR [5:4]	NMRR [5:4]	NMRR [21:20]	NOT(PRRR [26])
		1	PRRR [7:6]	NMRR [7:6]	NMRR [23:22]	NOT(PRRR [27])
1	0	0	PRRR [9:8]	NMRR [9:8]	NMRR [25:24]	NOT(PRRR [28])
		1	PRRR [11:10]	NMRR [11:10]	NMRR [27:26]	NOT(PRRR [29])
	1	0	IMPLEMENTATION DEFINED			
		1	PRRR [15:14]	NMRR [15:14]	NMRR [31:30]	NOT(PRRR [31])

- For details of the *Memory type* and *Outer Shareable* encodings see [PRRR, Primary Region Remap Register](#) on page G4-3992. For details of the *Cache attributes* encodings see [Table G3-14](#) on page G3-3620.
- Applies only if the memory type for the region is mapped as Normal memory.
- Applies only if the memory type for the region is mapped as Normal or Device-nGnRE memory and the region is Shareable.

The TEX remap registers and the [SCTLR.TRE](#) bit are Banked between the Secure and Non-secure Security states. For more information, see [The effect of EL3 on TEX remap](#) on page G3-3624.

When TEX remap is enabled, the mappings specified by the [PRRR](#) and [NMRR](#) determine the mapping of the TEX[0], C and B bits in the translation tables to memory type and cacheability attributes:

- The primary mapping, indicated by a field in the [PRRR](#) as shown in the *Memory type* column of [Table G3-15](#), takes precedence.
- For any region that the [PRRR](#) maps as Normal memory, the [NMRR](#) determines the Inner cacheability and Outer cacheability attributes.
- If it is supported, the Outer Shareable mapping identifies Shareable memory as either Inner Shareable or Outer Shareable, see [Interpretation of the NOSn fields in the PRRR, with TEX remap](#) on page G3-3622.

The TEX remap registers must be static during normal operation. In particular, when the remap registers are changed:

- It is IMPLEMENTATION DEFINED when the changes take effect.
- It is UNPREDICTABLE whether the TLB caches the effect of the TEX remap on translation tables.

The software sequence to ensure the synchronization of changes to the TEX remap registers is:

- Execute a DSB instruction. This ensures any memory accesses using the old mapping have completed.
- Write the TEX remap registers or [SCTLR.TRE](#) bit.
- Execute an ISB instruction. This ensures synchronization of the register updates.
- Invalidate the entire TLB.
- Execute a DSB instruction. This ensures completion of the entire TLB operation.
- Clean and invalidate all caches. This removes any cached information associated with the old mapping.
- Execute a DSB instruction. This ensures completion of the cache maintenance.
- Execute an ISB instruction. This ensures instruction synchronization.

This extends the standard rules for the synchronization of changes to System registers described in *Synchronization of changes to System registers* on page G3-3706, and provides implementation freedom as to whether or not the effect of the TEX remap is cached.

Shareability and the S bit, with TEX remap

The memory type of a region, as indicated in the *Memory type* column of Table G3-15 on page G3-3621, provides the first level of control of whether the region is shareable:

- If using the Long-descriptor translation table format, if the memory is any type of Device memory then the region is Shareable.
- If using the Short descriptor translation table format then:
 - If the memory is Device-nGnRnE memory then the region is Shareable.
 - Otherwise, the shareability is determined by using the value of the S bit in the translation table descriptor to index bits in the *PRRR*.

Some implementations make no distinction between Shareable Device-nGnRE memory and Non-shareable Device-nGnRE memory, and refer to both memory types as Shareable Device memory.
- If the memory type is Normal then the shareability is determined by using the value of the S bit in the translation table descriptor to index bits in the *PRRR*.

Table G3-16 shows this determination:

Table G3-16 Determining shareability, with TEX remap

Memory type	Remapping when S == 0	Remapping when S == 1
Any type of Device	Shareable	Shareable
Normal	<i>PRRR</i> [18]	<i>PRRR</i> [19]

In the cases where the shareability is remapped, the appropriate bit of the *PRRR* indicates whether the region is Shareable or Non-shareable, as follows:

PRRR[n] == 0 Not shareable.

PRRR[n] == 1 Shareable.

———— **Note** —————

When TEX remap is enabled, a translation table entry with S == 0 can be mapped as Shareable memory.

Interpretation of the NOSn fields in the *PRRR*, with TEX remap

When all of the following apply, the NOSn fields in the *PRRR* distinguish between Inner Shareable and Outer Shareable memory regions:

- The *SCTLR*.TRE bit is set to 1.
- The region is mapped as Normal memory, or the Short-descriptor translation table format is used and the region is mapped as Device-nGnRE memory.
- The Normal memory remapping or Device-nGnRE memory remapping of the S bit value for the entry makes the region Shareable.
- The implementation supports the distinction between Inner Shareable and Outer Shareable.

If the *SCTLR*.TRE bit is set to 0, an implementation can provide an IMPLEMENTATION DEFINED mechanism to interpret the NOSn fields in the *PRRR*, see *SCTLR.TRE*, *SCTLR.M*, and the effect of the TEX remap registers on page G3-3623.

The values of the NOSn fields in the [PRRR](#) have no effect.

The NOSn fields in the [PRRR](#) are RAZ/WI if the implementation does not support the distinction between Inner Shareable and Outer Shareable memory regions.

———— **Note** —————

The meaning of shareability attributes for Device-nGnRE memory is IMPLEMENTATION DEFINED when the Short-descriptor translation table is used, and otherwise has no meaning.

SCTLR.TRE, SCTLR.M, and the effect of the TEX remap registers

When TEX remap is disabled, because the [SCTLR.TRE](#) bit is set to 0:

- The effect of the [PRRR](#) and [NMRR](#) registers can be IMPLEMENTATION DEFINED.
- The interpretation of the fields of the [PRRR](#) and [NMRR](#) registers can differ from the description given earlier in this section.

VMSAv8-32 requires that the effect of these registers is limited to remapping the attributes of memory locations. These registers must not change whether any cache hardware or stages of address translation are enabled. The mechanism by which the TEX remap registers have an effect when the [SCTLR.TRE](#) bit is set to 0 is IMPLEMENTATION DEFINED. The AArch32 architecture requires that from reset, if the IMPLEMENTATION DEFINED mechanism has not been invoked:

- If the EL1&0 stage 1 address translation is enabled and is using the Short-descriptor format translation tables, the architecturally-defined behavior of the TEX[2:0], C, and B bits must apply, without reference to the TEX remap functionality. In other words, memory attribute assignment must comply with the scheme described in *Short-descriptor format memory region attributes, without TEX remap* on page G3-3619.
- If the EL1&0 stage 1 address translation is disabled, then the architecturally-defined behavior of VMSAv8-32 with address translation disabled must apply, without reference to the TEX remap functionality. See *The effects of disabling address translation stages on VMSAv8-32 behavior* on page G3-3569.

Possible mechanisms for enabling the IMPLEMENTATION DEFINED effect of the TEX remap registers when [SCTLR.TRE](#) is set to 0 include:

- A control bit in the [ACTLR](#), or in an IMPLEMENTATION DEFINED System register.
- Changing the behavior when the [PRRR](#) and [NMRR](#) registers are changed from their IMPLEMENTATION DEFINED reset values.

In addition, if the stage of address translation is disabled and the [SCTLR.TRE](#) bit is set to 1, the architecturally-defined behavior of the VMSAv8-32 with the stage of address translation disabled must apply without reference to the TEX remap functionality.

In an implementation that includes EL3, the IMPLEMENTATION DEFINED effect of these registers must only take effect in the Security state of the registers. See also *The effect of EL3 on TEX remap* on page G3-3624.

The OS managed translation table bits

When TEX remap is enabled, the TEX[2:1] bits in the translation table descriptors are available as two bits that can be managed by the operating system. In VMSAv8-32, as long as the [SCTLR.TRE](#) bit is set to 1, the values of the TEX[2:1] bits are ignored by the memory management hardware. Software can write any value to these bits in the translation tables.

The effect of EL3 on TEX remap

In an implementation that includes EL3, the TEX remap registers are Banked between the Secure and Non-secure Security states. The register instances for the current security state apply to all PL1&0 stage 1 translation table lookups in that state. The **SCTLR.TRE** bit is Banked in the Secure and Non-secure copies of the register, and the appropriate version of this bit determines whether TEX remap is applied to translation table lookups in the current security state.

Write accesses to the Secure copies of the TEX remap registers are disabled when the **CP15SDISABLE** input is asserted HIGH, meaning the MCR operations to access these registers are UNDEFINED. For more information, see [The CP15SDISABLE input on page G3-3704](#).

G3.8.4 VMSAv8-32 Long-descriptor format memory region attributes

When a PE is using the VMSAv8-32 Long-descriptor translation table format, the **AttrIdx[2:0]** field in a block or page translation table descriptor for a stage 1 translation indicates the 8-bit field in the appropriate MAIR register, that specifies the attributes for the corresponding memory region, as follows:

- **AttrIdx[2]** indicates the MAIR register to be used:
AttrIdx[2] == 0 Use [MAIR0](#).
AttrIdx[2] == 1 Use [MAIR1](#).
- **AttrIdx[2:0]** indicates the required **Attr** field, **Attr_n**, where $n = \text{AttrIdx}[2:0]$.

Each **AttrIdx** field defines, for the corresponding memory region:

- The memory type, Normal or a type of Device memory.
- For Normal memory:
 - The inner and outer cacheability, Non-cacheable, Write-Through, or Write-Back.
 - For Write-Through Cacheable and Write-Back Cacheable regions, the Read-Allocate and Write-Allocate policy hints, each of which is *Allocate* or *Do not allocate*.

For more information about the **AttrIdx[2:0]** descriptor field, see [Attribute fields in VMSAv8-32 Long-descriptor stage 1 Block and Page descriptors on page G3-3595](#).

Shareability, Long-descriptor format

When a PE is using the Long-descriptor translation table format, the **SH[1:0]** field in a block or page translation table descriptor specifies the Shareability attributes of the corresponding memory region, if the MAIR entry for that region identifies it as Normal memory. [Table G3-17](#) shows the encoding of this field.

Table G3-17 SH[1:0] field encoding for Normal memory, Long-descriptor format

SH[1:0]	Normal memory
00	Non-shareable
01	UNPREDICTABLE
10	Outer Shareable
11	Inner Shareable

See [Combining the shareability attribute on page G3-3629](#) for constraints on the Shareability attributes of a Normal memory region that is Inner Non-cacheable, Outer Non-cacheable.

For any type of Device memory, the value of the **SH[1:0]** field of the translation table descriptor is ignored.

Other fields in the Long-descriptor translation table format descriptors

The following subsections describe the other fields in the translation table block and page descriptors when a PE is using the Long-descriptor translation table format:

- [Contiguous bit](#)
- [Field reserved for software use](#)
- [Ignored fields](#).

Contiguous bit

The Long-descriptor translation table format descriptors contain a Contiguous bit. Setting this bit to 1 indicates that 16 adjacent translation table entries point to a *contiguous output address range*. These 16 entries must be aligned in the translation table so that the top five bits of their input addresses, that index their position in the translation table, are the same. For example, referring to [Figure G3-21 on page G3-3607](#), to use this hint for a block of 16 entries in the third-level translation table, bits[20:16] of the input addresses for the 16 entries must be the same.

The contiguous output address range must be aligned to size of 16 translation table entries at the same translation table level.

Use of this bit means that the TLB can cache a single entry to cover the 16 translation table entries.

This bit acts as a hint. The architecture does not require a PE to cache TLB entries in this way. To avoid TLB coherency issues, any TLB maintenance by address must not assume any optimization of the TLB tables that might result from use of this bit.

———— Note —————

The use of the contiguous bit is similar to the approach used, in the Short-descriptor translation table format, for optimized caching of Large Pages and Supersections in the TLB. However, an important difference in the contiguous bit capability is that TLB maintenance must be performed based on the size of the underlying translation table entries, to avoid TLB coherency issues. That is, any use of the contiguous bit has no effect on the minimum size of entry that must be invalidated from the TLB.

Field reserved for software use

The architecture reserves a 4-bit field in the Block and Page table descriptors for software use. In considering migration from using the Short-descriptor format to the Long-descriptor format, this field is an extension of the Short-descriptor field described in [The OS managed translation table bits on page G3-3623](#).

Ignored fields

For stage 1 translation descriptors, the architecture defines a 4-bit Ignored field in the Block and Page table descriptors, bit[63:59], and guarantees that the PE will not alter the value of this field. For stage 2 translation descriptors, the corresponding field is reserved for use by a System MMU. In a PE that is using the Long-descriptor translator table format, this field is an ignored field and the architecture guarantees that the PE does not update the field.

G3.8.5 EL2 control of Non-secure memory region attributes

Software executing at EL2 controls two sets of translation tables, both of which use the Long-descriptor translation table format. These are:

- The translation tables that control Non-secure PL2 stage 1 translations. These map VAs to PAs, and when EL2 is using AArch32 they are indicated and controlled by the [HTTBR](#) and [HTCR](#).
These translations have exactly the same memory region attribute controls as any other stage 1 translations, as described in [VMSAv8-32 Long-descriptor format memory region attributes on page G3-3624](#).
- The translation tables that control Non-secure PL1&0 stage 2 translations. These map the IPAs from the stage 1 translation onto PAs, and are indicated and when EL2 is using AArch32 they are controlled by the [VTTBR](#) and [VTCR](#).

The descriptors in the virtualization translation tables define a second level of memory region attributes, that are combined with the attributes defined in the stage 1 translation. This section describes this combining of attributes.

[VMSAv8-32 Long-descriptor translation table format descriptors on page G3-3592](#) describes the format of the entries in these tables.

———— **Note** —————

In a virtualization implementation, a hypervisor might usefully:

- Reduce the permitted cacheability of a region.
- Increase the required shareability of a region.

The combining of attributes from stage 1 and stage 2 translations supports both of these options.

In the stage 2 translation table descriptors for memory regions and pages, the MemAttr[3:0] and SH[1:0] fields describe the stage 2 memory region attributes:

- The definition of the stage 2 SH[1:0] field is identical to the same field for a stage 1 translation, see [Shareability, Long-descriptor format on page G3-3624](#).
- MemAttr[3:2] give a top-level definition of the memory type, and of the cacheability of a Normal memory region, as [Table G3-18](#) shows:

Table G3-18 Long-descriptor MemAttr[3:2] encoding, stage 2 translation

MemAttr[3:2]	Memory type	Cacheability
00	Device, of type determined by MemAttr[1:0]	Not applicable
01	Normal	Outer Non-cacheable
10		Outer Write-Through Cacheable
11		Outer Write-Back Cacheable

The encoding of MemAttr[1:0] depends on the Memory type indicated by MemAttr[3:2]:

- When MemAttr[3:2]==0b00, indicating a type of Device memory, [Table G3-19](#) shows the encoding of MemAttr[1:0]:

Table G3-19 MemAttr[1:0] encoding for the types of Device memory

MemAttr[1:0]	Meaning when MemAttr[3:2] == 0b00
00	Region is Device-nGnRnE memory
01	Region is Device-nGnRE memory
10	Region is Device-nGRE memory
11	Region is Device-GRE memory

- When MemAttr[3:2] != 0b00, indicating Normal memory, [Table G3-20](#) shows the encoding of MemAttr[1:0]:

Table G3-20 MemAttr[1:0] encoding for Normal memory

MemAttr[1:0]	Meaning when MemAttr[3:2] != 0b00
00	UNPREDICTABLE
01	Inner Non-cacheable
10	Inner Write-Through Cacheable
11	Inner Write-Back Cacheable

Note

The stage 2 translation does not assign any allocation hints.

The following sections describe how the memory type attributes assigned at stage 2 of the translation are combined with those assigned at stage 1:

- [Combining the memory type attribute.](#)
- [Combining the cacheability attribute on page G3-3628.](#)
- [Combining the shareability attribute on page G3-3629.](#)

Note

The following stage 2 translation table attribute settings leave the stage 1 settings unchanged:

- MemAttr[3:2] == 0b11, Normal memory, Outer Write-Back Cacheable.
- MemAttr[1:0] == 0b11, Inner Write-Back Cacheable.

Combining the memory type attribute

[Table G3-21](#) shows how the stage 1 and stage 2 memory type assignments are combined:

Table G3-21 Combining the stage 1 and stage 2 memory type assignments

Assignment in stage 1	Assignment in stage 2	Resultant type
Device-nGnRnE	Any	Device-nGnRnE
Device-nGnRE	Device-nGnRnE	Device-nGnRnE
	Not Device-nGnRnE	Device-nGnRE
Device-nGRE	Device-nGnRnE	Device-nGnRnE
	Device-nGnRE	Device-nGnRE
	Not (Device-nGnRnE or Device-nGnRE)	Device-nGRE

Table G3-21 Combining the stage 1 and stage 2 memory type assignments (continued)

Assignment in stage 1	Assignment in stage 2	Resultant type
Device-GRE	Device-nGnRnE	Device-nGnRnE
	Device-nGnRE	Device-nGnRE
	Device-nGRE	Device-nGRE
	Device-GRE or Normal	Device-GRE
Normal	Any type of Device	Device type assigned at stage 2
	Normal	Normal

See [Combining the shareability attribute on page G3-3629](#) for information about:

- The shareability of a region for which the resultant type is any Device type.
- The shareability requirements of a region with a resultant type of Normal for which the resultant cacheability, described in [Combining the cacheability attribute](#), is Inner Non-cacheable, Outer Non-cacheable.

The combining of the memory type attribute means a translation table walk for a stage 1 translation can be made to type of Device memory. This is likely to indicate a Guest OS error, and setting the HCR.PTW bit to 1 causes such an access to generate a Translation fault, see [Stage 2 fault on a stage 1 translation table walk on page G3-3654](#).

Combining the cacheability attribute

For a Normal memory region, [Table G3-22](#) shows how the stage 1 and stage 2 cacheability assignments are combined. This combination applies, independently, for the Inner cacheability and Outer cacheability attributes:

Table G3-22 Combining the stage 1 and stage 2 cacheability assignments

Assignment in stage 1	Assignment in stage 2	Resultant cacheability
Non-cacheable	Any	Non-cacheable
Any	Non-cacheable	Non-cacheable
Write-Through Cacheable	Write-Through or Write-Back Cacheable	Write-Through Cacheable
Write-Through or Write-Back Cacheable	Write-Through Cacheable	Write-Through Cacheable
Write-Back Cacheable	Write-Back Cacheable	Write-Back Cacheable

———— **Note** —————

Only Normal memory has a cacheability attribute.

Combining the shareability attribute

A memory region for which the resultant memory type attribute, described in [Combining the memory type attribute on page G3-3627](#), is any type of Device memory, is treated as Outer Shareable, regardless of any shareability assignments at either stage of translation.

For a memory region with a resultant memory type attribute of Normal, [Table G3-23](#) shows how the stage 1 and stage 2 shareability assignments are combined:

Table G3-23 Combining the stage 1 and stage 2 shareability assignments

Assignment in stage 1	Assignment in stage 2	Resultant shareability
Outer Shareable	Any	Outer Shareable
Inner Shareable	Outer Shareable	Outer Shareable
Inner Shareable	Inner Shareable	Inner Shareable
Inner Shareable	Non-shareable	Inner Shareable
Non-shareable	Outer Shareable	Outer Shareable
Non-shareable	Inner Shareable	Inner Shareable
Non-shareable	Non-shareable	Non-shareable

A memory region with a resultant memory type attribute of Normal, and a resultant cacheability attribute of Inner Non-cacheable, Outer Non-cacheable, must have a resultant shareability attribute of Outer Shareable, otherwise shareability is UNPREDICTABLE.

G3.9 Translation Lookaside Buffers (TLBs)

Translation Lookaside Buffers (TLBs) are an implementation technique that caches translations or translation table entries. TLBs avoid the requirement to perform a translation table walk in memory for every memory access. The ARM architecture does not specify the exact form of the TLB structures for any design. In a similar way to the requirements for caches, the architecture only defines certain principles for TLBs:

- The architecture has a concept of an entry locked down in the TLB. The method by which lockdown is achieved is IMPLEMENTATION DEFINED, and an implementation might not support lockdown.
- The architecture does not guarantee that an unlocked TLB entry remains in the TLB.
- The architecture guarantees that a locked TLB entry remains in the TLB. However, a locked TLB entry might be updated by subsequent updates to the translation tables. Therefore, when a change is made to the translation tables, the architecture does not guarantee that a locked TLB entry remains incoherent with an entry in the translation table.
- The architecture guarantees that a translation table entry that generates a Translation fault, an Address size fault, or an Access flag fault is not held in the TLB. However a translation table entry that generates a Domain fault or a Permission fault might be held in the TLB.
- Any translation table entry that does not generate a Translation fault, an Address size fault, or an Access flag fault and is not out of context might be allocated to an enabled TLB at any time. The only translation table entries guaranteed not to be held in the TLB are those that generate a Translation fault, an Address size fault, or an Access flag fault.

———— **Note** —————

An enabled TLB can hold translation table entries that do not generate a Translation fault but point to subsequent tables in the translation table walk. This can be referred to as *intermediate caching* of TLB entries.

- Software can rely on the fact that between disabling and re-enabling a stage of address translation, entries in the TLB relating to that stage of translation have not have been corrupted to give incorrect translations.

The following sections give more information about TLB implementation:

- [Global and process-specific translation table entries](#).
- [TLB matching on page G3-3631](#).
- [TLB behavior at reset on page G3-3631](#).
- [TLB lockdown on page G3-3631](#).
- [TLB conflict aborts on page D5-1807](#).

See also [TLB maintenance requirements on page G3-3633](#).

G3.9.1 Global and process-specific translation table entries

For VMSAv8-32, system software can divide a virtual memory map used by memory accesses at PL1 and PL0 into global and non-global regions, indicated by the nG bit in the translation table descriptors:

nG == 0 The translation is global, meaning the region is available for all processes.

nG == 1 The translation is non-global, or process-specific, meaning it relates to the current ASID, as defined by the [CONTEXTIDR](#).

Each non-global region has an associated *Address Space Identifier* (ASID). These identifiers mean different translation table mappings can co-exist in a caching structure such as a TLB. This means that software can create a new mapping of a non-global memory region without removing previous mappings.

For a symmetric multiprocessor cluster where a single operating system is running on the set of PEs, the architecture requires all ASID values to be assigned uniquely within any single Inner Shareable domain. In other words, each ASID value must have the same meaning to all PEs in the system.

The translation regime used for accesses made at PL2 does not support ASIDs, and all pages are treated as global.

When a PE is using the Long-descriptor translation table format, and is in Secure state, a translation must be treated as non-global, regardless of the value of the nG bit, if NSTable is set to 1 at any level of the translation table walk.

For more information see [Control of Secure or Non-secure memory access, VMSAv8-32 Long-descriptor format on page G3-3597](#).

G3.9.2 TLB matching

A TLB is a hardware caching structure for translation table information. Like other hardware caching structures, it is mostly invisible to software. However, there are some situations where it can become visible. These are associated with coherency problems caused by an update to the translation table that has not been reflected in the TLB. Use of the TLB maintenance operations described in [TLB maintenance requirements on page G3-3633](#) can prevent any TLB incoherency becoming a problem.

A particular case where the presence of the TLB can become visible is if the translation table entries that are in use under a particular ASID and VMID are changed without suitable invalidation of the TLB. This is an issue regardless of whether or not the translation table entries are global. In some cases, the TLB can hold two mappings for the same address, and this might lead to UNPREDICTABLE behavior

G3.9.3 TLB behavior at reset

The architecture does not require a reset to invalidate the TLBs, and recognizes that an implementation might require caches, including TLBs, to maintain context over a system reset. Possible reasons for doing so include power management and debug requirements.

The architectural requirements for TLB behavior at reset are:

- All TLBs are disabled from reset. All stages of address translation that are used from the processor state entered on coming out of reset are disabled from reset, and the contents of the TLBs have no effect on address translation. For more information see [Enabling stages of address translation on page G3-3572](#).
- An implementation can require the use of a specific TLB *invalidation routine*, to invalidate the TLB arrays before they are enabled after a reset. The exact form of this routine is IMPLEMENTATION DEFINED, but if an invalidation routine is required it must be documented clearly as part of the documentation of the device.
ARM recommends that if an invalidation routine is required for this purpose, and the PE resets into AArch32 state, the routine is based on the AArch32 TLB maintenance operations described in [The scope of TLB maintenance operations on page G3-3640](#).
- When TLBs that have not been invalidated by some mechanism since reset are enabled, the state of those TLBs is UNPREDICTABLE.

Similar rules apply:

- To cache behavior, see [Behavior of caches at reset on page G2-3526](#).
- To branch predictor behavior, see [Behavior of the branch predictors at reset on page G2-3534](#).

G3.9.4 TLB lockdown

The ARM architecture recognizes that any TLB lockdown scheme is heavily dependent on the microarchitecture, making it inappropriate to define a common mechanism across all implementations. This means that:

- The architecture does not require TLB lockdown support.
- If TLB lockdown support is implemented, the lockdown mechanism is IMPLEMENTATION DEFINED. However, key properties of the interaction of lockdown with the architecture must be documented as part of the implementation documentation.

This means that:

- The TLB Type Register, **TLBTR**, does not define the lockdown scheme in use.
- In AArch32 state, a region of the CP15 c10 encodings is reserved for IMPLEMENTATION DEFINED TLB functions, such as TLB lockdown functions. The reserved encodings are those with:
 - $\langle CRm \rangle == \{c0, c1, c4, c8\}$.
 - All values of $\langle opc2 \rangle$ and $\langle opc1 \rangle$.

See also *VMSAv8-32 CP15 c10 register summary* on page G3-3720.

An implementation might use some of the CP15 c10 encodings that are reserved for IMPLEMENTATION DEFINED TLB functions to implement additional TLB control functions. These functions might include:

- Unlock all locked TLB entries.
- Preload into a specific level of TLB. This is beyond the scope of the PLI and PLD hint instructions.

The inclusion of EL2 in an implementation does not affect the TLB lockdown requirements. However, in an implementation that includes EL2, exceptions generated by problems related to TLB lockdown, in a Non-secure PL1 mode, can be routed to either:

- Non-secure Abort mode, using the Non-secure Data Abort exception vector.
- Hyp mode, using the Hyp Trap exception vector.

For more information, see *Trapping accesses to lockdown, DMA, and TCM operations* on page G1-3508

G3.9.5 TLB conflict aborts

Fault status encodings for TLB conflict aborts are defined for both the Short-descriptor and Long-descriptor translation table formats, see:

- *PL1 fault reporting with the Short-descriptor translation table format* on page G3-3663
- *PL1 fault reporting with the Long-descriptor translation table format* on page G3-3665.

An implementation can generate a TLB conflict abort if it detects that the address being looked up in the TLB hits multiple entries. This can happen if the TLB has been invalidated inappropriately, for example if TLB invalidation required by this manual has not been performed. If it happens, the resulting behavior is UNPREDICTABLE, but must not permit access to regions of memory with permissions or attributes that mean they cannot be accessed in the current Security state at the current Privilege level.

In some implementations, multiple hits in the TLB can generate a synchronous Data Abort or Prefetch Abort exception. In any case where this is possible it is IMPLEMENTATION DEFINED whether the abort is a stage 1 abort or a stage 2 abort.

———— **Note** —————

A stage 2 abort cannot be generated if the Non-secure PL1&0 stage 2 address translation is disabled.

The priority of the TLB conflict abort is IMPLEMENTATION DEFINED, because it depends on the form of any TLB that can generate the abort.

———— **Note** —————

The TLB conflict abort must have higher priority than any abort that depends on a value held in the TLB.

An implementation can generate TLB conflict aborts on either or both instruction fetches and data accesses.

On a TLB conflict abort, the fault address register returns the address that generated the fault. That is, it returns the address that was being looked up in the TLB.

G3.10 TLB maintenance requirements

[Translation Lookaside Buffers \(TLBs\)](#) on page G3-3630 describes the ARM architectural provision for TLBs. Although the ARM architecture does not specify the form of any TLB structures, it does define the mechanisms by which TLBs can be maintained. The following sections describe the VMSAv8-32 TLB maintenance operations:

- [General TLB maintenance requirements](#).
- [Maintenance requirements on changing System register values](#) on page G3-3636.
- [Atomicity of register changes on changing virtual machine](#) on page G3-3637.
- [Synchronization of changes of ASID and TTBR](#) on page G3-3637.
- [The scope of TLB maintenance operations](#) on page G3-3640.

G3.10.1 General TLB maintenance requirements

TLB maintenance operations provide a mechanism to invalidate entries from a TLB. As stated at the start of [Translation Lookaside Buffers \(TLBs\)](#) on page G3-3630, any translation table entry that does not generate a Translation fault, an Address size fault, or an Access flag fault might be allocated to an enabled TLB at any time. This means that software must perform TLB maintenance between updating translation table entries that apply in a particular context and accessing memory locations whose translation is determined by those entries in that context.

———— **Note** ————

This requirement applies to any translation table entry at any level of the translation tables, including an entry that points to further levels of the tables, provided that the entry in that level of the tables does not cause a Translation fault, an Address size fault, or an Access flag fault.

In addition to any TLB maintenance requirement, when changing the cacheability attributes of an area of memory, software must ensure that any cached copies of affected locations are removed from the caches. For more information see [Cache maintenance requirement created by changing translation table attributes](#) on page G3-3646.

Because a TLB never holds any translation table entry that generates a Translation fault, an Address size fault, or an Access flag fault, a change from a translation table entry that causes a Translation, Address size, or Access flag fault to one that does not fault, does not require any TLB or branch predictor invalidation.

In addition, software must perform TLB maintenance after updating the System registers if the update means that the TLB might hold information that applies to a current translation context, but is no longer valid for that context. [Maintenance requirements on changing System register values](#) on page G3-3636 gives more information about this maintenance requirement.

Each of the translation regimes defined in [Figure G3-1](#) on page G3-3563 is a different context, and:

- For the Non-secure PL1&0 regime, a change in the VMID or ASID value changes the context.
- For the Secure PL1&0 regime, a change in the ASID value changes the context.

For operation in Non-secure PL1 or PL0 modes, a change of `HCR.VM`, unless made at the same time as a change of VMID, requires the invalidation of all TLB entries for the Non-secure PL1&0 translation regime that apply to the current VMID. Otherwise, there is no guarantee that the effect of the change of `HCR.VM` is visible to software executing in the Non-secure PL1 and PL0 modes.

Any TLB operation can affect any other TLB entries that are not locked down.

AArch32 state defines CP15 c8 functions for TLB maintenance operations, and supports the following operations:

- Invalidate all unlocked entries in the TLB.
- Invalidate a single TLB entry, by VA, or VA and ASID for a non-global entry.
- Invalidate all TLB entries that match a specified ASID.
- Invalidate all TLB entries that match a specified VA, regardless of the ASID.
- Operations that apply across multiprocessors in the same Inner Shareable domain.

———— **Note** ————

An address-based TLB maintenance operation that applies to the Inner Shareable domain does so regardless of the Shareability attributes of the address supplied as an argument to the operation.

A TLB maintenance operation that specifies a virtual address that would generate any MMU fault, including a virtual address that is not in the range of virtual addresses that can be translated, does not generate an abort.

EL2 provides additional TLB maintenance operations for use in AArch32 state at PL2, and has some implications for the effect of the other TLB maintenance operations, see [The scope of TLB maintenance operations on page G3-3640](#).

In an implementation that includes EL3, the TLB operations take account of the current Security state, as part of the address translation required for the TLB operation.

Some TLB operations are defined as operating only on instruction TLBs, or only on data TLBs. ARMv8 AArch32 state includes these operations for backwards compatibility. However, more recent TLB operations do not support this distinction. From the introduction of ARMv7, ARM deprecates any use of Instruction TLB operations, or of Data TLB operations, and developers must not rely on this distinction being maintained in future revisions of the ARM architecture.

The ARM architecture does not dictate the form in which the TLB stores translation table entries. However, for TLB invalidate operations, the minimum size of the table entry that is invalidated from the TLB must be at least the size that appears in the translation table entry.

[The scope of TLB maintenance operations on page G3-3640](#) describes the TLB operations.

The interaction of TLB lockdown with TLB maintenance operations

The precise interaction of TLB lockdown with the TLB maintenance operations is IMPLEMENTATION DEFINED. However, the architecturally-defined TLB maintenance operations must comply with these rules:

- The effect on locked entries of a TLB invalidate all unlocked entries operation or a TLB invalidate by VA all ASID operation is IMPLEMENTATION DEFINED. However, these operations must implement one of the following options:
 - Have no effect on entries that are locked down.
 - Generate an IMPLEMENTATION DEFINED Data Abort exception if an entry is locked down, or might be locked down. For an invalidate operation performed in AArch32 state, the CP15 c5 fault status register definitions include a fault code for cache and TLB lockdown faults, see [Table G3-26 on page G3-3664](#) for the codes used with the Short-descriptor translation table formats, or [Table G3-27 on page G3-3665](#) for the codes used with the Long-descriptor translation table formats.
In an implementation that includes EL2, if EL2 is using AArch32 and the value of HCR.TIDCP is 1, any such exceptions taken from a Non-secure PL1 mode are routed to Hyp mode, see [Trapping accesses to lockdown, DMA, and TCM operations on page G1-3508](#).

This permits a usage model for TLB invalidate routines, where the routine invalidates a large range of addresses, without considering whether any entries are locked in the TLB.

- The effect on locked entries of a TLB invalidate by VA operation or a TLB invalidate by ASID match operation is IMPLEMENTATION DEFINED. However, these operations must implement one of the following options:
 - A locked entry is invalidated in the TLB.
 - The operation has no effect on a locked entry in the TLB. In the case of the Invalidate single entry by VA, this means the PE treats the operation as a NOP.
 - The operation generates an IMPLEMENTATION DEFINED Data Abort exception if it operates on an entry that is locked down, or might be locked down. For an invalidate operation performed in AArch32 state, the CP15 c5 fault status register definitions include a fault code for cache and TLB lockdown faults, see [Table G3-26 on page G3-3664](#) and [Table G3-27 on page G3-3665](#).

————— Note —————

Any implementation that uses an abort mechanism for entries that can be locked down but are not actually locked down must:

- Document the IMPLEMENTATION DEFINED instruction sequences that perform the required operations on entries that are not locked down.

- Implement one of the other specified alternatives for the locked entries.

ARM recommends that, when possible, such IMPLEMENTATION DEFINED instruction sequences use the architecturally-defined operations. This minimizes the number of customized operations required.

In addition, an implementation that uses an abort mechanism for handling TLB maintenance operations on entries that can be locked down but are not actually locked down must also provide a mechanism that ensures that no TLB entries are locked.

Similar rules apply to cache lockdown, see [The interaction of cache lockdown with cache maintenance instructions on page G2-3542](#).

The architecture does not guarantee that any unlocked entry in the TLB remains in the TLB. This means that, as a side-effect of a TLB maintenance operation, any unlocked entry in the TLB might be invalidated.

TLB maintenance operations and the memory order model

The following rules describe the relations between the memory order model and the TLB maintenance operations:

- A TLB invalidate operation is complete when all memory accesses using the invalidated TLB entries have been observed by all observers, to the extent that those accesses must be observed. The shareability and cacheability of the accessed memory locations determine the extent to which the accesses must be observed. In addition, once the TLB invalidate operation is complete, no new memory accesses that can be observed by those observers will be performed using the invalidated TLB entries. For a TLB invalidate operation that affects other PEs, the set of memory accesses that have been observed when the TLB maintenance operation is complete must include the memory accesses from those processes that used the invalidated TLB entries.
- A TLB maintenance operation is only guaranteed to be complete after the execution of a DSB instruction.
- An ISB instruction, or a return from an exception, causes the effect of all completed TLB maintenance operations that appear in program order before the ISB or return from exception to be visible to all subsequent instructions, including the instruction fetches for those instructions.
- An exception causes all completed TLB maintenance operations, that appear in the instruction stream before the point where the exception is taken, to be visible to all subsequent instructions, including the instruction fetches for those instructions.
- All TLB maintenance operations are executed in program order relative to each other.
- The execution of a Data or Unified TLB maintenance operation is only guaranteed to be visible to a subsequent explicit load or store operation after both:
 - The execution of a DSB instruction to ensure the completion of the TLB operation.
 - Execution of a subsequent [Context synchronization operation](#).
- The execution of an Instruction or Unified TLB maintenance operation is only guaranteed to be visible to a subsequent instruction fetch after both:
 - The execution of a DSB instruction to ensure the completion of the TLB operation.
 - Execution of a subsequent [Context synchronization operation](#).

The following rules apply when writing translation table entries. They ensure that the updated entries are visible to subsequent accesses and cache maintenance operations.

For TLB maintenance, the translation table walk is treated as a separate observer. This means:

- A write to the translation tables, after it has been cleaned from the cache if appropriate, is only guaranteed to be seen by a translation table walk caused by an explicit load or store after the execution of both a DSB and an ISB.

However, the architecture guarantees that any writes to the translation tables are not seen by any explicit memory access that occurs in program order before the write to the translation tables.

- A write to the translation tables, after it has been cleaned from the cache if appropriate, is only guaranteed to be seen by a translation table walk caused by the instruction fetch of an instruction that follows the write to the translation tables after both a DSB and an ISB.

Therefore, in a uniprocessor system, an example instruction sequence for writing a translation table entry, covering changes to the instruction or data mappings is:

```
STR rx, [Translation table entry] ; write new entry to the translation table
DSB ; ensures visibility of the data cleaned from the D Cache
Invalidate TLB entry by VA (and ASID if non-global) [page address]
Invalidate BTC
DSB ; ensure completion of the Invalidate TLB operation
ISB ; ensure table changes visible to instruction fetch
```

G3.10.2 Maintenance requirements on changing System register values

The TLB contents can be influenced by control bits in a number of System registers. This means the TLB must be invalidated after any changes to these bits, unless the changes are accompanied by a change to the VMID or ASID that defines the context to which the bits apply. The general form of the required invalidation sequence is as follows:

```
; Change control bits in System registers
ISB ; Synchronize changes to the control bits
; Perform TLB invalidation of all entries that might be affected by the changed control bits
```

The System register changes that this applies to are:

- Any change to the [NMRR](#), [PRRR](#), [MAIR0](#), [MAIR1](#), [HMAIR0](#) or [HMAIR1](#) registers.
- Any change to the [SCTLR.AFE](#) bit, see [Changing the Access flag enable](#).
- Any change to any of the [SCTLR](#).{TRE, WXN, UWXN} bits.
- Changing [TTBCR.EAE](#), see [Changing the current Translation table format on page G3-3637](#).
- In an implementation that includes EL3, any change to the [SCR.SIF](#) bit.
- In an implementation that includes EL2:
 - Any change to the [HCR.VM](#) bit.
 - Any change to [HCR.PTW](#) bit, see [Changing HCR.PTW](#).
- When using the Short-descriptor translation table format:
 - Any change to the RGN, IRGN, S, or NOS fields in [TTBR0](#) or [TTBR1](#).
 - Any change to the PD0 or PD1 fields in [TTBCR](#)
- When using the Long-descriptor translation table format:
 - Any change to the T_n SZ, $ORGN_n$, $IRGN_n$, SH_n , or EPD_n fields in the [TTBCR](#), where n is 0 or 1.
 - Any change to the TOSZ, $ORGN_0$, $IRGN_0$, or SH_0 fields in the [HTCR](#).
 - Any change to the TOSZ, $ORGN_0$, $IRGN_0$, or SH_0 fields in the [VTCR](#).

Changing the Access flag enable

In a PE that is using the Short-descriptor translation table format, it is UNPREDICTABLE whether the TLB caches the effect of the [SCTLR.AFE](#) bit on translation tables. This means that, after changing the [SCTLR.AFE](#) bit software must invalidate the TLB before it relies on the effect of the new value of the [SCTLR.AFE](#) bit.

———— Note —————

There is no enable bit for use of the Access flag when using the Long-descriptor translation table format.

Changing HCR.PTW

When EL2 is using AArch32 and the value of the Protected table walk bit, [HCR.PTW](#), is 1, a stage 1 translation table access in the Non-secure PL1&O translation regime, to an address that is mapped to any type of Device memory by its stage 2 translation, generates a stage 2 Permission fault. A TLB associated with a particular VMID

might hold entries that depend on the effect of [HCR.PTW](#). Therefore, if the value of [HCR.PTW](#) is changed without a change to the VMID value, all TLB entries associated with the current VMID must be invalidated before executing software in a Non-secure PL1 or PL0 mode. If this is not done, behavior is UNPREDICTABLE.

Changing the current Translation table format

The effect of changing [TTBCR.EAE](#) when executing in the translation regime affected by [TTBCR.EAE](#) with any stage of address translation for that translation regime enabled is UNPREDICTABLE. When [TTBCR.EAE](#) is changed for a given context, the TLB must be invalidated before resuming execution in that context, otherwise the effect is UNPREDICTABLE.

G3.10.3 Atomicity of register changes on changing virtual machine

From the viewpoint of software executing in a Non-secure PL1 or PL0 mode, when there is a switch from one virtual machine to another, the registers that control or affect address translation must be changed atomically. This applies to the registers for:

- Non-secure PL1&0 stage 1 address translations. This means that all of the following registers must change atomically:
 - [PRRR](#) and [NMRR](#), if using the Short-descriptor translation table format.
 - [MAIR0](#) and [MAIR1](#), if using the Long-descriptor translation table format.
 - [TTBR0](#), [TTBR1](#), [TTBCR](#), [DACR](#), and [CONTEXTIDR](#).
 - The [SCTLR](#).
- Non-secure PL1&0 stage 2 address translations. When EL2 is using AArch32, this means that all of the following registers and register fields must change atomically:
 - [VTBR](#) and [VTCR](#).
 - [HMAIR0](#) and [HMAIR1](#).
 - The [HSCTLR](#).

———— Note ————

Only some bits of [SCTLR](#) affect the stage 1 translation, and only some bits of [HSCTLR](#) affect the stage 2 translation. However, in each case, changing these bits requires a write to the register, and that write must be atomic with the other register updates.

These registers apply to execution in Non-secure PL1&0 modes. However, when updated as part of a switch of virtual machines they are updated by software executing in Hyp mode. This means the registers are *out of context* when they are updated, and no synchronization precautions are required.

———— Note ————

By contrast, a translation table change associated with a change of ASID, made by software executing at PL1, can require changes to registers that are *in context*. [Synchronization of changes of ASID and TTBR](#) describes appropriate precautions for such a change.

Software executing in Hyp mode, or in Secure state, must not use the registers associated with the Non-secure PL1&0 translation regime for speculative memory accesses.

G3.10.4 Synchronization of changes of ASID and TTBR

A common virtual memory management requirement is to change the ASID and Translation Table Base Registers together to associate the new ASID with different translation tables, without any change to the current translation regime. When using the Short-descriptor translation table format, different registers hold the ASID and the translation table base address, meaning these two values cannot be updated atomically. Since a PE can perform a speculative memory access at any time, this lack of atomicity is a problem that software must address. Such a change is complicated by:

- The depth of speculative fetch being IMPLEMENTATION DEFINED.

- The use of branch prediction.

When using the Short-descriptor translation table format, the virtual memory management operations must ensure the synchronization of changes of the ContextID and the translation table registers. For example, some or all of the TLBs, branch predictors, and other caching of ASID and translation information might become corrupt with invalid translations. Synchronization is required to avoid either:

- The old ASID being associated with translation table walks from the new translation tables.
- The new ASID being associated with translation table walks from the old translation tables.

There are a number of possible solutions to this problem, and the most appropriate approach depends on the system. [Example G3-3](#), [Example G3-4](#), and [Example G3-5 on page G3-3639](#) describe three possible approaches.

Note

Another instance of the synchronization problem occurs if a branch is encountered between changing the ASID and performing the synchronization. In this case the value in the branch predictor might be associated with the incorrect ASID. Software can address this possibility using any of these approaches, but instead software might be written in a way that avoids such branches.

Example G3-3 Using a reserved ASID to synchronize ASID and TTBR changes

In this approach, a particular ASID value is reserved for use by the operating system, and is used only for the synchronization of the ASID and Translation Table Base Register. This example uses the value of 0 for this purpose, but any value could be used.

This approach can be used only when the size of the mapping for any given virtual address is the same in the old and new translation tables.

The maintenance software uses the following sequence, that must be executed from memory marked as global:

```
Change ASID to 0
ISB
Change Translation Table Base Register
ISB
Change ASID to new value
```

This approach ensures that any non-global pages fetched at a time when it is uncertain whether the old or new translation tables are being accessed are associated with the unused ASID value of 0. Since the ASID value of 0 is not used for any normal operations these entries cannot cause corruption of execution.

Example G3-4 Using translation tables containing only global mappings when changing the ASID

A second approach involves switching the translation tables to a set of translation tables that only contain global mappings while switching the ASID.

The maintenance software uses the following sequence, that must be executed from memory marked as global:

```
Change Translation Table Base Register to the global-only mappings
ISB
Change ASID to new value
ISB
Change Translation Table Base Register to new value
```

This approach ensures that no non-global pages can be fetched at a time when it is uncertain whether the old or new ASID value will be used.

This approach works without the need for TLB invalidations in systems that have caching of intermediate levels of translation tables, as described in *General TLB maintenance requirements* on page G3-3633, provided that the translation tables containing only global mappings have only level 1 translation table entries of the following kinds:

- Entries that are global.
- Pointers to level 2 tables that hold only global entries, and that are the same level 2 tables that are used for accessing global entries by both:
 - The set of translation tables that were used under the old ASID value.
 - The set of translation tables that will be used with the new ASID value.
- Invalid level 1 entries.

In addition, all sets of translation tables in this example should have the same shareability and cacheability attributes, as held in the `TTBR0.{ORGN, IRGN}` or `TTBR1.{ORGN, IRGN}` fields.

If these rules are not followed, then the implementation might cache level 1 translation table entries that require explicit invalidation.

Example G3-5 Disabling non-global mappings when changing the ASID

In systems where only the translation tables indexed by `TTBR0` hold non-global mappings, maintenance software can use the `TTBCR.PD0` field to disable use of `TTBR0` during the change of ASID. This means the system does not require a set of global-only mappings.

The maintenance software uses the following sequence, that must be executed from a memory region with a translation that is accessed using the base address in the `TTBR1` register, and is marked as global:

```
Set TTBCR.PD0 = 1
ISB
Change ASID to new value
Change Translation Table Base Register to new value
ISB
Set TTBCR.PD0 = 0
```

This approach ensures that no non-global pages can be fetched at a time when it is uncertain whether the old or new ASID value will be used.

When using the Long-descriptor translation table format, `TTBCR.A1` holds the number, 0 or 1, of the TTBR that holds the current ASID. This means the current Translation Table Base Register can also hold the current ASID, and the current translation table base address and ASID can be updated atomically when:

- `TTBR0` is the only Translation Table Base Register being used. `TTBCR.A1` must be set to 0.
- `TTBR0` points to the only translation tables that hold non-global entries, and `TTBCR.A1` is set to 0.
- `TTBR1` points to the only translation tables that hold non-global entries, and `TTBCR.A1` is set to 1.

In these cases, software can update the current translation table base address and ASID atomically, by updating the appropriate TTBR, and does not require a specific routine to ensure synchronization of the change of ASID and base address.

However, in all other cases using the Long-descriptor format, the synchronization requirements are identical to those when using the Short-descriptor formats, and the examples in this section indicate how synchronization might be achieved.

———— Note —————

When using the Long-descriptor translation table format, `CONTEXTIDR.ASID` has no significance for address translation, and is only an extension of the Context ID value.

G3.10.5 The scope of TLB maintenance operations

TLB maintenance operations provide a mechanism for invalidating entries from TLB caching structures, to ensure that changes to the translation tables are reflected correctly in the TLB caching structures. To support TLB maintenance in multiprocessor systems, there are maintenance operations that apply to the TLBs of all PEs in the same Inner Shareable domain.

The architecture permits the caching of any translation table entry that has been returned from memory without a fault and that does not, itself, cause a Translation Fault, an Address size fault, or an Access Flag fault. This means the TLB:

- Cannot hold an entry that, when used for a translation table lookup, causes a Translation fault, an Address size fault, or an Access Flag fault.
- Can hold an entry for a translation table lookup for a translation that causes a Translation Fault, an Address size fault, or an Access Flag fault at a subsequent level of translation table lookup. For example, it can hold an entry for the first level lookup of a translation that causes a Translation fault, an Address size fault, or an Access Flag fault at the second or third level of lookup.

This means that entries cached in the TLB can include:

- Translation table entries that point to a subsequent table to be used in the current stage of translation.
- In an implementation that includes EL2:
 - Stage 2 translation table entries that are used as part of a stage 1 translation table walk.
 - Stage 2 translation table entries for translating the output address of a stage 1 translation.

Such entries might be held in intermediate TLB caching structures that are distinct from the data caches, in that they are not required to be invalidated as the result of writes of the data. The architecture makes no restriction on the form of these intermediate TLB caching structures.

The architecture does not intend to restrict the form of TLB caching structures used for holding translation table entries. In particular for translation regimes that involve two stages of translation, it recognizes that such caching structures might contain:

- At any level of the translation table walk, entries containing information from stage 1 translation table entries.
- In an implementation that includes EL2:
 - At any level of the translation table walk, entries containing information from stage 2 translation table entries.
 - At any level of the translation table walk, entries combining information from both stage 1 and stage 2 translation table entries.

Where a TLB maintenance operation is required to apply to stage 1 entries, then it must apply to any cached entry in the caching structures that includes any stage 1 information that would be used to translate the address being invalidated, including any entry that combines information from both stage 1 and stage 2 translation table entries.

Where a TLB maintenance operation is required to apply to stage 2 entries it must apply to any cached entry in the caching structures that includes any information from stage 2 translation table entries, including any entry that combines information from both stage 1 and stage 2 translation table entries.

[Table G3-24 on page G3-3641](#) summarizes the required effect of the preferred TLB operations, for execution in AArch32 state, that operate only on TLBs on the PE that executes the instruction. Additional TLB operations:

- Apply across all PEs in the same Inner Shareable domain. Each operation shown in the table has an Inner Shareable equivalent, identified by an IS suffix. For example, the Inner Shareable equivalent of [TLBIALL](#) is [TLBIALLIS](#). See also [EL2 upgrading of TLB maintenance operations on page G3-3643](#).
- Can apply to separate Instruction or Data TLBs, as indicated by a footnote to the table. ARM deprecates any use of these operations.

———— **Note** —————

- The architecture permits a TLB invalidation operation to affect any unlocked entry in the TLB. [Table G3-24 on page G3-3641](#) defines only the entries that each operation must invalidate.

- All TLB operations, including those that operate on an VA match, operate regardless of the value of `SCTLR.M`.

When interpreting the table:

- Related operations** Each operation description applies also to any equivalent operation that either:
- Applies to all PEs in the same Inner Shareable domain.
 - Applies only to a data TLB, or only to an instruction TLB.
- So, for example, the `TLBIALL` description applies also to `TLBIALLIS`, `ITLBIALL`, and `DTLBIALL`.
- TLB maintenance operations, functional group* on page G3-3744 lists all of the TLB maintenance operations.
- Matches the VA** Means the VA argument for the operation must match the VA value in the TLB entry.
- Matches the ASID** Means the ASID argument for the operation must match the ASID in use when the TLB entry was assigned.
- Matches the current VMID**
- Means the current VMID must match the VMID in use when the TLB entry was assigned. The dependency on the VMID applies even when the value of `HCR.VM` is 0, including situations where there is no use of virtualization. However, `VTTBR.VMID` resets to zero, meaning there is a valid VMID from reset.
- Execution at PL2** Descriptions of operations at PL2 apply only to implementations that include EL2.
- For the definitions of the translation regimes referred to in the table see *About VMSAv8-32* on page G3-3562.

Table G3-24 Effect of the TLB maintenance operations

Operation	Executed from		Effect, must invalidate any entry that matches all stated conditions
	State	Mode	
<code>TLBIALL</code> ^a	Secure	PL1	All entries for the Secure PL1&0 translation regime. That is, all entries that were allocated in Secure state.
	Non-secure	PL1	All entries for stage 1 of the Non-secure PL1&0 translation regime that match the current VMID.
		Hyp	All entries for stage 1 or stage 2 of the Non-secure PL1&0 translation regime that match the current VMID.
<code>TLBIMVA</code> ^a	Secure	PL1	Any entry for the Secure PL1&0 translation regime that both: <ul style="list-style-type: none"> • Matches the VA argument. • Matches the ASID argument, or is global.
	Non-secure	PL1 or Hyp	Any entry for stage 1 of the Non-secure PL1&0 translation regime for which all of the following apply. The entry: <ul style="list-style-type: none"> • Matches the VA argument. • Matches the ASID argument, or is global. • Matches the current VMID.
<code>TLBIASID</code> ^a	Secure	PL1	Any entry for the Secure PL1&0 translation regime that matches the ASID argument.
	Non-secure	PL1 or Hyp	Any entry for stage 1 of the Non-secure PL1&0 translation regime that both: <ul style="list-style-type: none"> • Is not global and matches the ASID argument. • Matches the current VMID.

Table G3-24 Effect of the TLB maintenance operations (continued)

Operation	Executed from		Effect, must invalidate any entry that matches all stated conditions
	State	Mode	
TLBIMVAA	Secure	PL1	Any entry for the Secure PL1&0 translation regime that matches the VA argument.
	Non-secure	PL1 or Hyp	Any entry for stage 1 of the Non-secure PL1&0 translation regime that both: <ul style="list-style-type: none"> • Matches the VA argument. • Matches the current VMID.
TLBIALLNSNH ^b	Secure	Monitor	All entries for stage 1 or stage 2 of the Non-secure PL1&0 translation regime, regardless of the associated VMID.
	Non-secure	Hyp	
TLBIALLH ^b	Secure	Monitor	All entries for the Non-secure PL2 translation regime. That is, any entry that was allocated in Non-secure state from Hyp mode.
	Non-secure	Hyp	
TLBIMVAL	Secure	PL1	Any entry for stage 1 of the Secure PL1&0 translation regime that is the last level of the translation table walk and matches: <ul style="list-style-type: none"> • The VA argument. • The ASID argument.
	Non-secure	PL1 or Hyp	Any entry for stage 1 of the Non-secure PL1&0 translation regime that is the last level of the translation table walk and matches: <ul style="list-style-type: none"> • The VA argument. • The ASID argument. • The current VMID.
TLBIMVAAL	Secure	PL1	Any entry for stage 1 of the Secure PL1&0 translation regime that is the last level of the translation table walk and matches the VA argument.
	Non-secure	PL1 or Hyp	Any entry for stage 1 of the Non-secure PL1&0 translation regime that is the last level of the translation table walk and matches: <ul style="list-style-type: none"> • The VA argument. • The current VMID.
TLBIMVAH ^b	Secure	Monitor	Any entry for the Non-secure PL2 translation regime that matches the VA argument.
	Non-secure	Hyp	
TLBIMVALH ^b	Secure	Monitor	Any entry for stage 1 of the translation regime that is the last level of the translation table walk and matches the given VA.
	Non-secure	Hyp	
TLBIIPAS2 ^b	Secure	Monitor	Any entry for an EL1&0 stage 2 of the translation regime holding the IPA to PA translations and the current VMID ^c .
	Non-secure	Hyp	Any entry for an EL1&0 stage 2 of the translation regime holding the IPA to PA translations and the current VMID ^d .
TLBIIPAS2L ^b	Secure	Monitor	Any entry for an EL1&0 stage 2 of the translation regime for the last level of translation holding the IPA to PA translations and the current VMID ^c .
	Non-secure	Hyp	Any entry for an EL1&0 stage 2 of the translation regime for the last level of translation holding the IPA to PA translations and the current VMID ^d .

a. The architecture defines variants of these operations that apply only to instruction TLBs, and only to data TLBs. ARM deprecates any use of these variants. For more information, see the referenced description of the operation.

b. Available only in an implementation that includes EL2. See also [EL2 upgrading of TLB maintenance operations on page G3-3643](#).

- c. This operation execute as NOPs when SCR.NS == 0.
- d. This operation is CONSTRAINED UNPREDICTABLE from any AArch32 Secure privileged mode.

EL2 upgrading of TLB maintenance operations

In an implementation that includes EL2, when the value of HCR.FB is 1, the TLB maintenance operations that are not broadcast across the Inner Shareable domain are upgraded to operate across the Inner Shareable domain when performed in a Non-secure PL1 mode. For example, when the value of HCR.FB is 1, a TLBIMVA operation performed in a Non-secure PL1 mode operates as a TLBIMVAIS operation,

G3.11 Caches in VMSAv8-32

The ARM architecture describes the required behavior of an implementation of the architecture. As far as possible it does not restrict the implemented microarchitecture, or the implementation techniques that might achieve the required behavior.

Maintaining this level of abstraction is difficult when describing the relationship between memory address translation and caches, especially regarding the indexing and tagging policy of caches. This section:

- Summarizes the architectural requirements for the interaction between caches and memory translation.
- Gives some information about the likely implementation impact of the required behavior.

The following sections give this information:

- [Data and unified caches](#).
- [Instruction caches](#).

In addition [Cache maintenance requirement created by changing translation table attributes on page G3-3646](#) describes the cache maintenance required after updating the translation tables to change the attributes of an area of memory.

For more information about cache maintenance see:

- [Cache support on page G2-3524](#). This section describes the ARM cache maintenance operations.
- [Cache maintenance operations, functional group on page G3-3743](#). This section summarizes the System register encodings used for these operations when executing in AArch32 state.

G3.11.1 Data and unified caches

For data and unified caches, the use of memory address translation is entirely transparent to any data access that is not UNPREDICTABLE.

This means that the behavior of accesses from the same observer to different VAs, that are translated to the same PA with the same memory attributes, is fully coherent. This means these accesses behave as follows, regardless of which VA is accessed:

- Two writes to the same PA occur in program order.
- A read of a PA returns the value of the last successful write to that PA.
- A write to a PA that occurs, in program order, after a read of that PA, has no effect on the value returned by that read.

The memory system behaves in this way without any requirement to use barrier or cache maintenance operations.

In addition, if cache maintenance is performed on a memory location, the effect of that cache maintenance is visible to all aliases of that physical memory location.

These properties are consistent with implementing all caches that can handle data accesses as *Physically-indexed, physically-tagged* (PIPT) caches.

G3.11.2 Instruction caches

In the ARM architecture, an instruction cache is a cache that is accessed only as a result of an instruction fetch. Therefore, an instruction cache is never written to by any load or store instruction executed by the PE.

The ARM architecture supports three different behaviors for instruction caches. For ease of reference and description these are identified by descriptions of the associated expected implementation, as follows:

- PIPT instruction caches.
- *Virtually-indexed, physically-tagged* (VIPT) instruction caches.
- ASID and VMID tagged *Virtually-indexed, virtually-tagged* (VIVT) instruction caches.

In AArch32 state, the CTR identifies the form of the instruction caches, see [CTR, Cache Type Register on page G4-3815](#).

The following subsections describe the behavior associated with these cache types, including any occasions where explicit cache maintenance is required to make the use of memory address translation transparent to the instruction cache:

- [PIPT instruction caches](#).
- [VIPT instruction caches](#).
- [ASID and VMID tagged VIVT instruction caches](#).

Note

For software to be portable between implementations that might use any of PIPT instruction caches, VIPT instruction caches, or ASID and VMID tagged VIVT instruction caches, the software must invalidate the instruction cache whenever any condition occurs that would require instruction cache maintenance for at least one of the instruction cache types.

PIPT instruction caches

For PIPT instruction caches, the use of memory address translation is entirely transparent to all instruction fetches that are not UNPREDICTABLE.

If cache maintenance is performed on a memory location, the effect of that cache maintenance is visible to all aliases of that physical memory location.

An implementation that provides PIPT instruction caches implements the IVIPT Extension, see [IVIPT architecture Extension on page G3-3646](#).

VIPT instruction caches

For VIPT instruction caches, the use of memory address translation is transparent to all instruction fetches that are not UNPREDICTABLE, except for the effect of memory address translation on instruction cache invalidate by address operations.

Note

Cache invalidation is the only cache maintenance operation that can be performed on an instruction cache.

If instruction cache invalidation by address is performed on a memory location, the effect of that invalidation is visible only to the virtual address supplied with the operation. The effect of the invalidation might not be visible to any other virtual address aliases of that physical memory location.

The only architecturally-guaranteed way to invalidate all aliases of a physical address from a VIPT instruction cache is to invalidate the entire instruction cache.

An implementation that provides VIPT instruction caches implements the IVIPT Extension, see [IVIPT architecture Extension on page G3-3646](#).

ASID and VMID tagged VIVT instruction caches

For ASID and VMID tagged VIVT instruction caches, if the instructions at any virtual address change, for a given translation regime and a given ASID and VMID, as appropriate, then instruction cache maintenance is required to ensure that the change is visible to subsequent execution. This maintenance is required when writing new values to instruction locations. It can also be required as a result of any of the following situations that change the translation of a virtual address to a physical address, if, as a result of the change to the translation, the instructions at the virtual addresses change:

- Enabling or disabling the stage of address translation.
- Writing new mappings to the translation tables.

- In AArch32 state, any change to the [TTBR0](#), [TTBR1](#), or [TTBCR](#) registers, unless accompanied by a change to the ContextID, or a change to the VMID.
- In AArch32 state, changes to the [VTTBR](#) or [VTCR](#) registers, unless accompanied by a change to the VMID.

———— **Note** —————

For ASID and VMID tagged VIVT instruction caches only, invalidation is not required if the changes to the translations are such that the instructions associated with the non-faulting translations of a virtual address, for a given translation regime and a given ASID and VMID, as appropriate, remain unchanged, through the sequence of changes to the translations. Examples of translation changes to which this applies are:

- Changing a valid translation to a translation that generates an MMU fault.
- Changing a translation that generates a MMU fault to a valid translation.

This does not apply for VIPT or PIPT instruction caches.

If instruction cache invalidation by address is performed on a memory location, the effect of that invalidation is visible only to the virtual address supplied with the operation. The effect of the invalidation might not be visible to any other virtual address aliases of that physical memory location.

The only architecturally-guaranteed way to invalidate all aliases of a physical address from an ASID and VMID tagged VIVT instruction cache is to invalidate the entire instruction cache.

IVIPT architecture Extension

An implementation in which the instruction cache exhibits the behaviors described in [PIPT instruction caches on page G3-3645](#), or those described in [VIPT instruction caches on page G3-3645](#), is said to implement the *IVIPT Extension* to the ARM architecture.

The formal definition of the IVIPT Extension to the ARM architecture is that it reduces the instruction cache maintenance requirement to the following condition:

- Instruction cache maintenance is required only after writing new data to a physical address that holds an instruction.

G3.11.3 Cache maintenance requirement created by changing translation table attributes

Any change to the translation tables to change the attributes of an area of memory can require maintenance of the translation tables, as described in [General TLB maintenance requirements on page G3-3633](#). If the change affects the cacheability attributes of the area of memory, including any change between Write-Through and Write-Back attributes, software must ensure that any cached copies of affected locations are removed from the caches, typically by cleaning and invalidating the locations from the levels of cache that might hold copies of the locations affected by the attribute change. Any of the following changes to the inner cacheability or outer cacheability attribute creates this maintenance requirement:

- Write-Back to Write-Through.
- Write-Back to Non-cacheable.
- Write-Through to Non-cacheable.
- Write-Through to Write-Back.

The cache clean and invalidate avoids any possible coherency errors caused by mismatched memory attributes.

Similarly, to avoid possible coherency errors caused by mismatched memory attributes, the following sequence must be followed when changing the shareability attributes of a cacheable memory location:

1. Make the memory location Non-cacheable, Outer Shareable.
2. Clean and invalidate the location from them cache.
3. Change the shareability attributes to the required new values.

G3.12 VMSAv8-32 memory aborts

In a VMSAv8-32 implementation, the following mechanisms cause a PE to take an exception on a failed memory access:

Debug exception	An exception caused by the debug configuration, see Chapter D2 <i>Debug Exceptions and Exception Catch debug event</i> on page H3-4377 .
Alignment fault	An Alignment fault is generated if the address used for a memory access does not have the required alignment for the operation. For more information see Unaligned data access on page E2-2341 and Alignment faults on page G3-3654 .
MMU fault	A MMU fault is a fault generated by the fault checking sequence for the current translation regime.
External abort	Any memory system fault other than a Debug exception, an Alignment fault, or a MMU fault.

Collectively, these mechanisms are called *aborts*. [Chapter D2 *Debug Exceptions*](#) and [Chapter H3 *Halting Debug Events*](#) describe Debug exceptions, and the remainder of this section describes Alignment faults, MMU faults, and External aborts.

The exception generated on a synchronous memory abort:

- On an instruction fetch is called the Prefetch Abort exception.
- On a data access is called the Data Abort exception.

———— Note ————

The Prefetch Abort exception applies to any synchronous memory abort on an instruction fetch. It is not restricted to speculative instruction fetches.

In AArch32 state, asynchronous memory aborts are a type of External abort, and are treated as a special type of Data Abort exception.

The following sections describe the abort mechanisms:

- [Routing of aborts taken to AArch32 state](#).
- [VMSAv8-32 MMU fault terminology on page G3-3650](#).
- [The MMU fault-checking sequence on page G3-3650](#).
- [Alignment faults on page G3-3654](#).
- [MMU faults in AArch32 state on page G3-3655](#).
- [External abort on a translation table walk on page G3-3657](#).
- [Prioritization of aborts on page G3-3658](#).

An access that causes an abort is said to be aborted, and uses the *Fault Address Registers* (FARs) and *Fault Status Registers* (FSRs) to record context information. For more information about the FARs and FSRs, see [Exception reporting in a VMSAv8-32 implementation on page G3-3659](#).

G3.12.1 Routing of aborts taken to AArch32 state

A memory abort is either a Data Abort exception or a Prefetch Abort exception. When executing in AArch32 state, depending on the cause of the abort, and possibly on configuration settings, an abort is taken either:

- To the Exception level of the PE mode from which the abort is taken. In this case the abort is taken to AArch32 state.
- To a higher Exception level. In this case the Exception level to which the abort is taken is either:
 - Using AArch32. In this case, this chapter describes how the abort is handled.
 - Using AArch64. In this case, [Chapter D5 *The AArch64 Virtual Memory System Architecture*](#) describes how the abort is handled.

For an abort taken to an Exception level that is using AArch32, the mode to which a memory abort is taken depends on the reason for the exception, the mode the PE is in when it takes the exception, and configuration settings, as follows:

Memory aborts taken to Monitor mode

If an implementation includes EL3, when the value of `SCR.EA` is 1, all External aborts are taken to EL3, and if EL3 is using AArch32 they are taken to Monitor mode. This applies to aborts taken from Secure modes and from Non-secure modes. For more information see [Asynchronous exception routing controls on page G1-3467](#).

Note

- Although the referenced section mostly describes the routing of asynchronous exceptions, it includes the `SCR.EA` control that applies to both synchronous and asynchronous external aborts.
- The `SCR` is implemented only as part of EL3.

Memory aborts taken to Secure Abort mode

If an implementation includes EL3, when the PE is executing in Secure state, all memory aborts that are not routed to EL3 are taken to Secure Abort mode.

Note

The only memory aborts that can be routed to Monitor mode are External aborts.

Memory aborts taken to Hyp mode

If an implementation includes EL2, when the PE is executing in Non-secure state, the following aborts are taken to EL2. If EL2 is using AArch32 this means they are taken to Hyp mode:

- Alignment faults taken:
 - When the PE is in Hyp mode.
 - When the PE is in a Non-secure PL1 or EPL0 mode and the exception is generated because the Non-secure PL1&0 stage 2 translation identifies the target of an unaligned access as any type of Device memory.
 - When the PE is in Non-secure User mode and `HCR.TGE` is set to 1. For more information see [External abort, when HCR.TGE is set to 1 on page G1-3453](#).
- When the PE is using the Non-secure PL1&0 translation regime:
 - MMU faults from stage 2 translations, for which the stage 1 translation did not cause an MMU fault.
 - Any abort taken during the stage 2 translation of an address accessed in a stage 1 translation table walk that is not routed to Secure Monitor mode, see [Stage 2 fault on a stage 1 translation table walk on page G3-3654](#).
- When the PE is using the Non-secure PL2 translation regime, MMU faults from stage 1 translations.

Note

The Non-secure PL2 translation regime has only one stage of translation.

- External aborts, if `SCR.EA` is set to 0 and any of the following applies:
 - The PE was executing in Hyp mode when it took the exception.
 - The PE was executing in a Non-secure PL0 or PL1 mode when it took the exception, the abort is asynchronous, and `HCR.AMO` is set to 1. For more information see [Asynchronous exception routing controls on page G1-3467](#).
 - The PE was executing in the Non-secure User mode when it took the exception, the abort is synchronous, and `HCR.TGE` is set to 1. For more information see [External abort, when HCR.TGE is set to 1 on page G1-3453](#).

- The abort occurred on a stage 2 translation table walk.
- Debug exceptions, if `HDCR.TDE` is set to 1. For more information, see [Routing Debug exceptions to Hyp mode on page G1-3454](#).

Memory aborts taken to Non-secure Abort mode

In an implementation that does not include EL3, all memory aborts that are taken to an Exception level that is using AArch32 are taken to Abort mode.

Otherwise, when the PE is executing in Non-secure state, the following aborts are taken to Non-secure Abort mode:

- When the PE is in a Non-secure PL1 or PL0 mode, Alignment faults taken for any of the following reasons:
 - `SCTLR.A` is set to 1.
 - An instruction that does not support unaligned accesses is committed for execution, and the instruction accesses an unaligned address.
 - The PL1&0 stage 1 translation identifies the target of an unaligned access as any type of Device memory.

———— Note —————

In an implementation that does not include EL2, this case results in an UNPREDICTABLE memory access, see [Cases where unaligned accesses are UNPREDICTABLE on page E2-2341](#).

If an implementation includes EL2 and the PE is in Non-secure User mode, these exceptions are taken to Abort mode only if the value of `HCR.TGE` is 0.

- When the PE is using the Non-secure PL1&0 translation regime, a stage of address translation faults from stage 1 translations.
- External aborts, if all of the following apply:
 - The abort is not on a stage 2 translation table walk.
 - The PE is not in Hyp mode.
 - The value of `SCR.EA` is 0.
 - The abort is asynchronous, and `HCR.AMO` is set to 0.
 - The abort is synchronous, and `HCR.TGE` is set to 0.
- Virtual Aborts, see [Virtual exceptions when an implementation includes EL2 on page G1-3465](#).
- When the value of `HDCR.TDE` is 0, Debug exceptions. For more information, see [Routing Debug exceptions to Hyp mode on page G1-3454](#).

———— Note —————

If EL0 is using AArch32 and EL1 is using AArch64 then any of these memory aborts taken from User mode are taken to EL1 as described in [Chapter D5 The AArch64 Virtual Memory System Architecture](#).

Memory aborts with IMPLEMENTATION DEFINED behavior

In addition, a PE can generate an abort for an IMPLEMENTATION DEFINED reason associated with lockdown. In an implementation that includes EL2, whether such an abort is taken to Non-secure Abort mode or is taken to EL2 is IMPLEMENTATION DEFINED, and an implementation might include a mechanism to select whether the abort is routed to Non-secure Abort mode or to EL2.

When the PE is in a Non-secure mode other than Hyp mode, if multiple factors cause an Alignment fault, the abort is taken to Non-secure Abort mode if any of the factors require the abort to be taken to Abort mode. For example, if the `SCTLR.A` bit is set to 1, and the access is an unaligned access to an address that the stage 2 translation tables mark as Device-nGnRnE, then the abort is taken to Non-secure Abort mode.

For more information see [Handling exceptions that are taken to an Exception level using AArch32 on page G1-3431](#).

G3.12.2 VMSAv8-32 MMU fault terminology

The ARMv7 Large Physical Address Extension introduced new terminology for faults on a stage of address translation, to provide consistent terminology across all implementations. [Table G3-25](#) shows the terminology used in this manual for a MMU faults, compared with older ARM documentation. The current terms are the same for faults that occur with the Short-descriptor translation table format and with the Long-descriptor format, and also apply to faults in a third-level lookup when using the Long-descriptor translation table format.

Table G3-25 Address translation fault terminology

Current term	Old term	Note
First level Translation fault	Section Translation fault	-
Second level Translation fault	Page Translation fault	-
Third level Translation fault	-	Long-descriptor translation table format only.
First level Access flag fault	Section Access flag fault	-
Second level Access flag fault	Page Access flag fault	-
Third level Access flag fault	-	Long-descriptor translation table format only.
First level Domain fault	Section Domain fault	Short-descriptor translation table format only, except for reporting faults on address translation operations in the 64-bit PAR , see Determining the PAR format on page G3-3688 . Cannot occur at third level.
Second level Domain fault	Page Domain fault	
First level Permission fault	Section Permission fault	-
Second level Permission fault	Page Permission fault	-
Third level Permission fault	-	Long-descriptor translation table format only.

In an implementation that includes EL2, MMU faults are also classified by the translation stage at which the fault is generated. This means that a memory access from a Non-secure PL1 or PL0 mode can generate:

- A stage 1 address translation fault, for example, a stage 1 Translation fault.
- A stage 2 address translation fault, for example, a stage 2 Translation fault.

G3.12.3 The MMU fault-checking sequence

This section describes the MMU checks made for the memory accesses required for instruction fetches and for explicit memory accesses:

- If an instruction fetch faults it generates a Prefetch Abort exception.
- If an data memory access faults it generates a Data Abort exception.

For more information about Prefetch Abort exceptions and Data Abort exceptions see [Handling exceptions that are taken to an Exception level using AArch32 on page G1-3431](#).

In VMSAv8-32, all memory accesses require VA to PA translation. Therefore, when a corresponding stage of address translation is enabled, each access requires a lookup of the translation table descriptor for the accessed VA. For more information, see [Translation tables on page G3-3573](#) and subsequent sections of this chapter. MMU fault checking is performed for each level of translation table lookup. If an implementation includes EL2 and is operating in Non-secure state, MMU fault checking is performed for each stage of address translation.

Note

In an implementation that includes EL2, if a PE is executing in Non-secure state, the operating system or similar Non-secure system software defines the stage 1 translation tables in the IPA address space, and typically is unaware of the stage 2 translation from IPA to PA. However, each Non-secure stage 1 translation table access is subject to stage 2 address translation, and might be faulted at that stage.

The MMU fault checking sequence is largely independent of the translation table format, as the figures in this section show. The differences are:

When using the Short-descriptor format

- There are one or two levels of lookup.
- Lookup always starts at the first level.
- The final level of lookup checks the Domain field of the descriptor and:
 - Faults if there is no access to the Domain.
 - Checks the access permissions only for Client domains.

When using the Long-descriptor format

- There are one, two, or three levels of lookup.
- Lookup starts at either the first level or the second level.
- Domains are not supported. All accesses are treated as Client domain accesses.

The fault-checking sequence shows a translation from an Input address to an Output address. For more information about this terminology, see [About address translation for VMSAv8-32 on page G3-3565](#).

Note

The descriptions in this section do not include the possibility that the attempted address translation generates a TLB conflict abort, as described in [TLB conflict aborts on page G3-3632](#).

[MMU faults in AArch32 state on page G3-3655](#) describes the faults that a MMU fault-checking sequence can report.

[Figure G3-23 on page G3-3652](#) shows the process of fetching a descriptor from the translation table. For the top-level fetch for any translation, the descriptor is fetched only if the input address passes any required alignment check. As the figure shows, in an implementation that includes EL2, if the translation is stage 1 of the Non-secure PL1&0 translation regime, then the descriptor address is in the IPA address space, and is subject to a stage 2 translation to obtain the required PA. This stage 2 translation requires a recursive entry to the fault checking sequence.

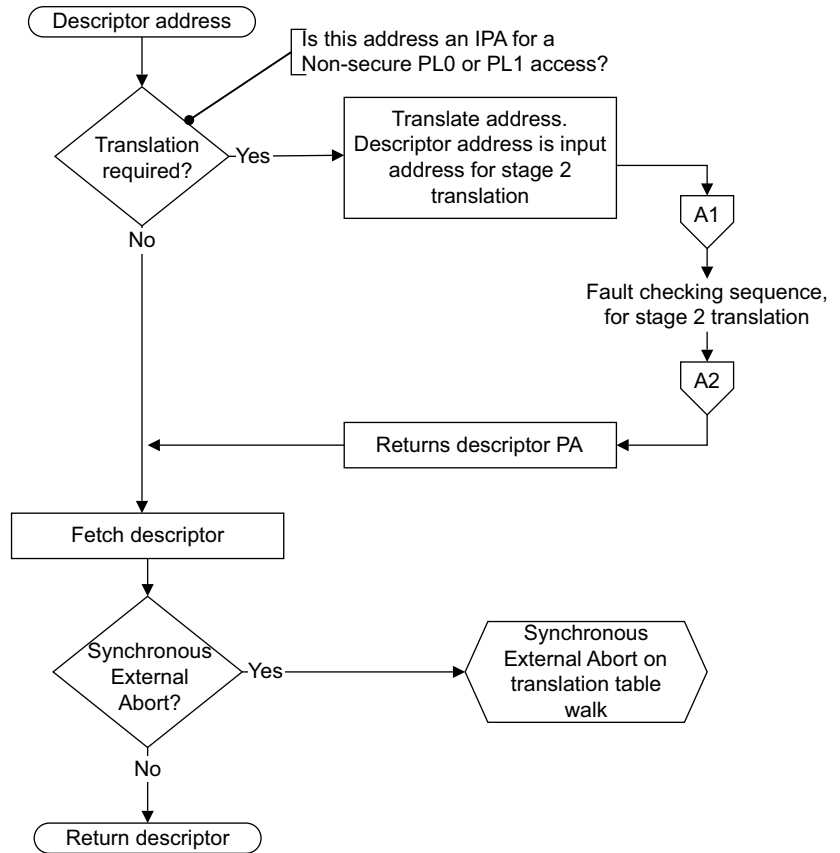

Figure G3-23 Fetching the descriptor in a VMSAv8-32 translation table walk

Figure G3-24 shows the full VMSAv8-32 fault checking sequence, including the alignment check on the initial access.

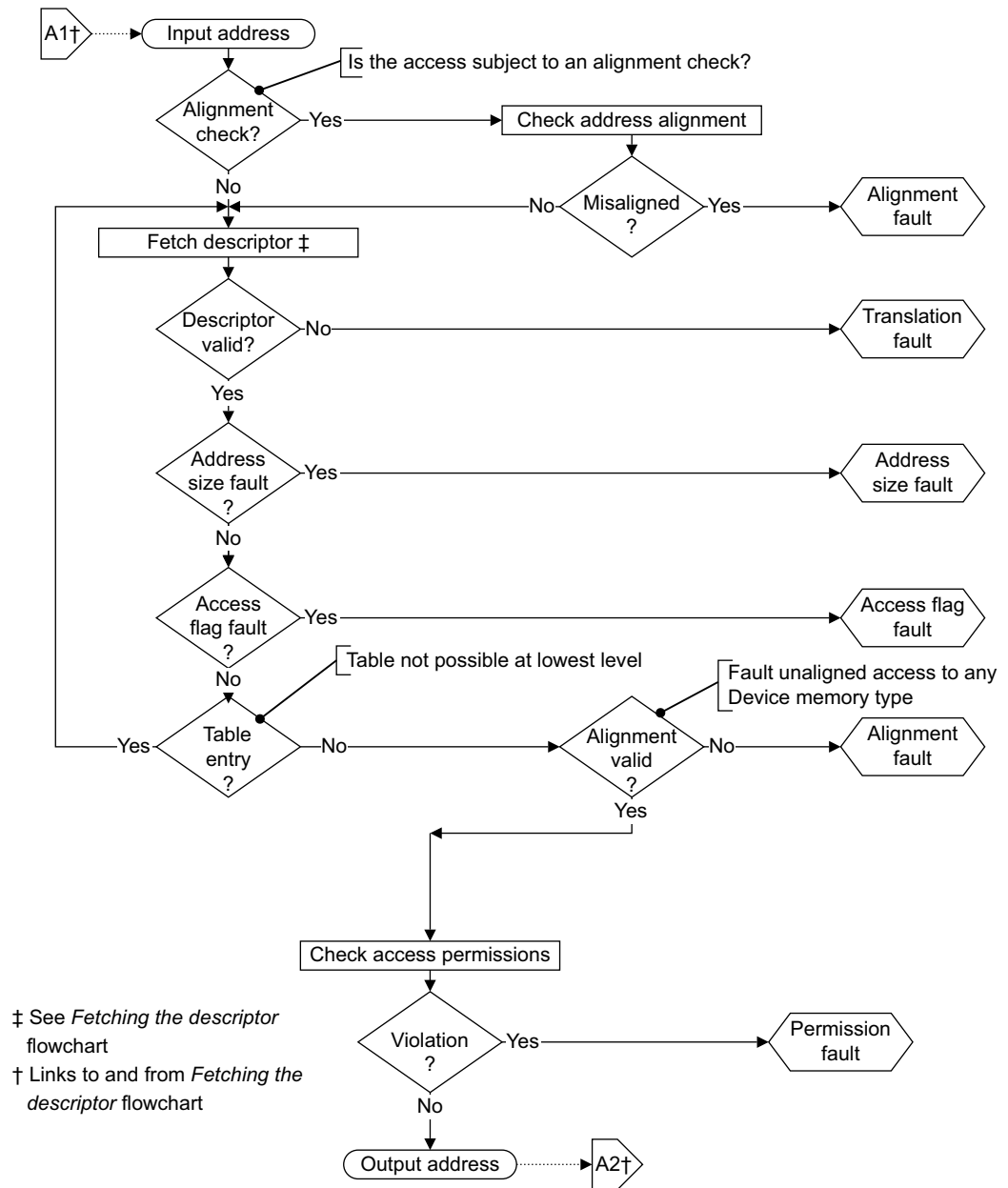

Figure G3-24 VMSAv8-32 fault checking sequence

Stage 2 fault on a stage 1 translation table walk

When an implementation that includes EL2 is operating in a Non-secure PL1 or PL0 mode, any memory access goes through two stages of translation:

- Stage 1, from VA to IPA.
- Stage 2, from IPA to PA.

Note

In a virtualized system that is using AArch32, typically, a Guest OS operating in a Non-secure PL1 mode defines the translation tables and translation table register entries controlling the Non-secure PL1&0 stage 1 translations. A Guest OS has no awareness of the stage 2 address translation, and therefore believes it is specifying translation table addresses in the physical address space. However, it actually specifies these addresses in its IPA space. Therefore, to support virtualization, translation table addresses for the Non-secure PL1&0 stage 1 translations are always defined in the IPA address space.

On performing a translation table walk for the stage 1 translations, the descriptor addresses must be translated from IPA to PA, using a stage 2 translation. This means that a memory access made as part of a stage 1 translation table lookup might generate, on a stage 2 translation:

- A Translation fault, Access flag fault, or Permission fault.
- A synchronous external abort on the memory access.

If **SCR.EA** is set to 1, a synchronous external abort is taken to EL3, and if EL3 is using AArch32 it is taken to Secure Monitor mode. Otherwise, these faults are reported as stage 2 memory aborts. When EL2 is using AArch32, **HSR.ISS[7]** is set to 1, to indicate a stage 2 fault during a stage 1 translation table walk, and the part of the ISS field that might contain details of the instruction is invalid. For more information see [Use of the HSR on page G3-3672](#).

Alternatively, a memory access made as part of a stage 1 translation table lookup might target an area of memory with the any type of Device memory attribute assigned on the stage 2 translation of the address accessed. When the value of the **HCR.PTW** bit is 1, such an access generates a stage 2 Permission fault.

Note

- On most systems, such a mapping to a Device memory type on the stage 2 translation is likely to indicate a Guest OS error, where the stage 1 translation table is corrupted. Therefore, it is appropriate to trap this access to the hypervisor.
-

A TLB might hold entries that depend on the effect of **HCR.PTW**. Therefore, if **HCR.PTW** is changed without changing the current VMID, the TLBs must be invalidated before executing in a Non-secure PL1 or PL0 mode. For more information see [Changing HCR.PTW on page G3-3636](#).

A cache maintenance operation performed from a Non-secure PL1 mode can cause a stage 1 translation table walk that might generate a stage 2 Permission fault, as described in this section. This is an exception to the general rule that a cache maintenance operation cannot generate a Permission fault.

G3.12.4 Alignment faults

The ARM memory architecture requires support for strict alignment checking. This checking is controlled by **SCTLR.A**. In addition, some instructions do not support unaligned accesses, regardless of the value of **SCTLR.A**. [Unaligned data access on page E2-2341](#) defines when Alignment faults are generated, for both values of **SCTLR.A**.

An Alignment fault can occur on an access for which the stage of address translation is disabled.

Any unaligned access to memory region with any Device memory type attribute generates an Alignment fault.

[Routing of aborts taken to AArch32 state on page G3-3647](#) defines the mode to which an Alignment fault is taken.

The prioritization of Alignment faults depends on whether the fault was generated because of an access to a Device memory type, or for another reason. For more information see [Prioritization of aborts on page G3-3658](#).

G3.12.5 MMU faults in AArch32 state

This section describes the faults that might be detected during one of the fault-checking sequences described in *The MMU fault-checking sequence* on page G3-3650. Unless indicated otherwise, information in this section applies to the fault checking sequences for both the Short-descriptor translation table format and the Long-descriptor translation table format.

MMU faults are always synchronous.

When a MMU fault generates an abort for a region of memory, no memory access is made if that region is or could be marked as any type of Device memory.

The following subsections describe the MMU faults that might be detected during a fault checking sequence:

- [Translation fault](#).
- [Address size fault](#).
- [Access flag fault](#) on page G3-3656.
- [Domain fault, Short-descriptor format translation tables](#) only on page G3-3656.
- [Permission fault](#) on page G3-3657.

See also [External abort on a translation table walk](#) on page G3-3657.

Translation fault

A Translation fault can be generated at any level of lookup, and the reported fault code identifies the lookup level. A Translation fault is generated if bits[1:0] of a translation table descriptor identify the descriptor as either a Fault encoding or a reserved encoding. For more information see:

- [VMSAv8-32 Short-descriptor translation table format descriptors](#) on page G3-3579.
- [VMSAv8-32 Long-descriptor translation table format descriptors](#) on page G3-3592.

In addition, a Translation fault is generated if the input address for a translation either does not map on to an address range of a Translation Table Base Register, or the Translation Table Base Register range that it maps on to is disabled. In these cases the fault is reported as a first level Translation fault on the translation stage at which the mapping to a region described by a Translation Table Base Register failed.

The architecture guarantees that any translation table entry that causes a Translation fault is not cached, meaning the TLB never holds such an entry. Therefore, when a Translation fault occurs, the fault handler does not have to perform any TLB maintenance operations to remove the faulting entry.

A data or unified cache maintenance operation by VA can generate a Translation fault. Whether an instruction cache invalidate by VA operation can generate a Translation fault is IMPLEMENTATION DEFINED, because it is IMPLEMENTATION DEFINED whether the operation requires an address translation. If the instruction cache invalidate by VA operation requires an address translation then the operation can generate a Translation fault, otherwise it cannot generate a Translation fault.

Whether branch predictor maintenance operations can generate Translation faults is IMPLEMENTATION DEFINED, because it is IMPLEMENTATION DEFINED whether the operation requires an address translation. If the branch predictor maintenance operation requires an address translation then the operation can generate a Translation fault, otherwise it cannot generate a Translation fault.

Address size fault

An Address size fault can be generated at any level of lookup, and the reported fault code identifies the lookup level.

An Address size fault is generated if one of the following applies:

- The translation table entries or the **TTBR** for the stage of translation have address bits above the most significant bit of the specified PA size as non zero.

Since VMSAv8-32 supports a maximum PA and IPA size of 40 bits, this includes any case where a translation table entry or the **TTBR** holds an address for which A[47:40] is nonzero.

- The specified output address size is larger than the implemented PA.

The architecture guarantees that any translation table entry that causes an Address size fault is not cached, meaning the TLB never holds such an entry. Therefore, when an Address size fault occurs, the fault handler does not have to perform any TLB maintenance operations to remove the faulting entry.

Access flag fault

An Access flag fault can be generated at any level of lookup, and the reported fault code identifies the lookup level. An Access flag fault is generated only if all of the following apply:

- The translation tables support an Access flag bit:
 - The Short-descriptor format supports an Access flag only when `SCTLR.AFE` is set to 1.
 - The Long-descriptor format always supports an Access flag.
- A translation table descriptor with the Access flag bit set to 0 is loaded.

For more information about the Access flag bit see:

- [VMSAv8-32 Short-descriptor translation table format descriptors on page G3-3579](#)
- [VMSAv8-32 Long-descriptor translation table format descriptors on page G3-3592](#).

The architecture guarantees that any translation table entry that causes an Access flag fault is not cached, meaning the TLB never holds such an entry. Therefore, when an Access flag fault occurs, the fault handler does not have to perform any TLB maintenance operations to remove the faulting entry.

Whether any cache maintenance operations by VA can generate Access flag faults is IMPLEMENTATION DEFINED.

Whether branch predictor invalidate by VA operations can generate Access flag faults is IMPLEMENTATION DEFINED.

For more information, see [The Access flag on page G3-3615](#).

Domain fault, Short-descriptor format translation tables only

When using the Short-descriptor translation table format, a Domain fault can be generated at the first level or second level of lookup. The reported fault code identifies the lookup level. The conditions for generating a Domain fault are:

First level When a first-level descriptor fetch returns a valid Section first-level descriptor, the domain field of that descriptor is checked against the `DACR`. A first-level Domain fault is generated if this check fails.

Second level When a second-level descriptor fetch returns a valid second-level descriptor, the domain field of the first-level descriptor that required the second-level fetch is checked against the `DACR`, and a second-level Domain fault is generated if this check fails.

For more information, see [Domains, Short-descriptor format only on page G3-3614](#).

Domain faults cannot occur on cache or branch predictor maintenance operations.

A TLB might hold a translation table entry that cause a Domain fault. Therefore, if the handling of a Domain fault results in an update to the associated translation tables, the software that updates the translation tables must invalidate the appropriate TLB entry, to prevent the stale information in the TLB being used on a subsequent memory access. For more information, see the translation table entry update examples in [TLB maintenance operations and the memory order model on page G3-3635](#).

Any change to the `DACR` must be synchronized by a context synchronization operation. For more information see [Synchronization of changes to System registers on page G3-3706](#).

Permission fault

A Permission fault can be generated at any level of lookup, and the reported fault code identifies the lookup level. See [Access permissions on page G3-3609](#) for information about conditions that cause a Permission fault.

———— Note —————

When using the Short-descriptor translation table format, the translation table descriptors are checked for Permission faults only for accesses to memory regions in Client domains.

A TLB might hold a translation table entry that cause a Permission fault. Therefore, if the handling of a Permission fault results in an update to the associated translation tables, the software that updates the translation tables must invalidate the appropriate TLB entry, to prevent the stale information in the TLB being used on a subsequent memory access. For more information, see the translation table entry update examples in [TLB maintenance operations and the memory order model on page G3-3635](#).

———— Note —————

In an implementation that includes EL2, this maintenance requirement applies to Permission faults in both stage 1 and stage 2 translations.

Cache or branch predictor maintenance operations cannot cause a Permission fault, except that:

- A stage 1 translation table walk performed as part of a cache or branch predictor maintenance operation can generate a stage 2 Permission fault as described in [Stage 2 fault on a stage 1 translation table walk on page G3-3654](#).
- A [DCIMVAC](#) issued in Non-secure state that attempts to update a location for which it does not have stage 2 write access can generate a stage 2 Permission fault, as described in [Data cache maintenance instructions \(DC*\) on page G2-3535](#).

G3.12.6 External abort on a translation table walk

An external abort on a translation table walk can be either synchronous or asynchronous. For more information on external aborts, see [External aborts on page G2-3546](#).

An external abort on a translation table walk is reported:

- If the external abort is synchronous, using:
 - A synchronous Prefetch Abort exception if the translation table walk is for an instruction fetch.
 - A synchronous Data Abort exception if the translation table walk is for a data access.
- If the external abort is asynchronous, using an asynchronous Data Abort exception.

If an implementation reports the error in the translation table walk asynchronously from executing the instruction whose instruction fetch or memory access caused the translation table walk, these aborts behave essentially as interrupts. The aborts are masked when [CPSR.A](#) is set to 1, otherwise they are reported using the Data Abort exception.

Behavior of external aborts on a translation table walk caused by address translation operations

The address translation operations summarized in [Address translation operations, functional group on page G3-3745](#) require translation table walks. An external abort can occur in the translation table walk. The abort generates a Data Abort exception, and can be synchronous or asynchronous. For more information, see [Handling of faults and aborts during an address translation operation on page G3-3688](#).

G3.12.7 Prioritization of aborts

This section describes the abort prioritization that applies to a single memory access from AArch32 state that might generate multiple aborts:

On a single memory access from AArch32 state, the following rules apply:

- If a memory access generates an Alignment fault because **SCTLR.A** is set to 1, or because it is an unaligned access by an instruction that does not support unaligned accesses, then that access cannot generate any of:
 - A MMU fault, on either the stage 1 translation or the stage 2 translation.
 - An external abort.
 - A Watchpoint debug event.An Alignment fault generated by an unaligned access to any type of Device memory is prioritized as an MMU fault. For more information see [Alignment faults caused by accessing Device memory types](#).
- If a memory access generates an MMU fault on its stage 1 translation, and also generates an abort on its stage 2 translation, the fault from the stage 1 translation has priority:
 - If a memory access made as part of a stage 1 translation table walk generates an MMU fault on its stage 2 translation, as described in [Stage 2 fault on a stage 1 translation table walk on page G3-3654](#), the stage 1 translation table walk does not generate an MMU fault on the stage 1 translation.
 - A fault on a particular stage of translation might be a synchronous external abort on a translation table walk made at that stage of translation.
- If a memory access generates an MMU fault on either its stage 1 translation or on its stage 2 translation, then the PE cannot generate a Watchpoint debug event on that access.
- If a memory access generates an MMU fault on either its stage 1 translation or on its stage 2 translation, or generates a synchronous Watchpoint debug event, then the memory access cannot generate an external abort.
- Except as defined in this list, the architecture does not define any prioritization of asynchronous external aborts relative to any other asynchronous aborts.

If a single instruction generates aborts on more than one memory access, the architecture does not define any prioritization between those aborts.

In general, the ARM architecture does not define when asynchronous events are taken, and therefore the prioritization of asynchronous events is IMPLEMENTATION DEFINED.

———— **Note** —————

[Debug state entry and debug event prioritization on page H2-4331](#) describes the relationship between debug events, MMU faults, and external aborts, for synchronous aborts generated by the same memory access.

Alignment faults caused by accessing Device memory types

Any unaligned access to any type of Device memory generates an Alignment fault. When applying the prioritization rules, this fault is prioritized at any MMU fault. The priority of this Alignment fault relative to possible MMU faults is as follows:

- The Alignment fault has lower priority than an Access flag fault.
- If the translation stage that generates the Access flag fault:
 - Can generate Domain faults, the Alignment fault has higher priority than a Domain fault.
 - Cannot generate Domain faults, the Alignment fault has higher priority than a Permission fault.

The MMU fault checking sequence in [Figure G3-24 on page G3-3653](#) shows this prioritization.

G3.13 Exception reporting in a VMSAv8-32 implementation

This section describes exception reporting, in AArch32 state, in a VMSAv8-32 implementation. That is, it describes only the reporting of exceptions that are taken to an Exception level that is using AArch32. EL2 provides an enhanced reporting mechanism for exceptions taken to the Non-secure EL2 mode, Hyp mode. This means that, for VMSAv8-32, the exception reporting depends on the mode to which the exception is taken.

Note

The enhanced reporting mechanism for exceptions that are taken to Hyp mode is generally similar to the reporting of exceptions that are taken to an Exception level that is using AArch64.

About exception reporting introduces the general approach to exception reporting, and the following sections then describe exception reporting at different privilege levels:

- *Reporting exceptions taken to PL1 modes* on page G3-3660.
- *Fault reporting in PL1 modes* on page G3-3663.
- *Summary of register updates on faults taken to PL1 modes* on page G3-3666.
- *Reporting exceptions taken to Hyp mode* on page G3-3668.
- *Use of the HSR* on page G3-3672.
- *Summary of register updates on exceptions taken to Hyp mode* on page G3-3682.

Note

The registers used for exception reporting also report information about debug exceptions. For more information see:

- *Data Abort exceptions, taken to a PL1 mode* on page G3-3661.
 - *Prefetch Abort exceptions, taken to a PL1 mode* on page G3-3662.
 - *Reporting exceptions taken to Hyp mode* on page G3-3668.
-

G3.13.1 About exception reporting

In an implementation that includes EL2 and EL3, exceptions can be taken to:

- Monitor mode, if EL3 is using AArch32.
- Hyp mode, if EL2 is using AArch32.
- A Secure or Non-secure PL1 mode.

Monitor mode is a PL1 mode, but:

- It is accessible only when EL3 is using AArch32.
- It is present only in Secure state.
- When EL3 is using AArch32, System register controls route some exceptions from Non-secure state to Monitor mode. These are the only cases where taking an exception to an Exception level that is using AArch32 changes the Security state of the PE.

Exception reporting in Hyp mode differs significantly from that in the other modes, but in general, exception reporting returns:

- Information about the exception:
 - On taking an exception to Hyp mode, the *Hyp Syndrome Register*, **HSR**, returns syndrome information.
 - On taking an exception to any other mode, a *Fault Status Register* (FSR) returns status information.
- For synchronous exceptions, one or more addresses associated with the exceptions, returned in *Fault Address Registers* (FARs).

In all modes, additional IMPLEMENTATION DEFINED registers can provide additional information about exceptions.

Note

- [PE mode for taking exceptions on page G1-3439](#) describes how the mode to which an exception is taken is determined.
 - EL2 provides:
 - Specific exception types, that can only be taken from Non-secure PL1 and PL0 modes, and are always taken to Hyp mode.
 - Routing controls that can route some exceptions from Non-secure PL1 and PL0 modes to Hyp mode.These exceptions are reported using the same mechanism as the Hyp mode reporting of VMSAv8-32 memory aborts, as described in this section.
-

Memory system faults generate either a Data Abort exception or a Prefetch Abort exception, as summarized in:

- [Reporting exceptions taken to PL1 modes.](#)
- [Memory fault reporting in Hyp mode on page G3-3670.](#)

On an access that might have multiple aborts, the MMU fault checking sequence and the prioritization of aborts determine which abort occurs. For more information, see [The MMU fault-checking sequence on page G3-3650](#) and [Prioritization of aborts on page G3-3658](#).

G3.13.2 Reporting exceptions taken to PL1 modes

The following sections give general information about the reporting of exceptions when they are taken to a Secure or Non-secure PL1 mode:

- [Registers used for reporting exceptions taken to PL1 modes.](#)
- [Data Abort exceptions, taken to a PL1 mode on page G3-3661.](#)
- [Prefetch Abort exceptions, taken to a PL1 mode on page G3-3662.](#)

[Fault reporting in PL1 modes on page G3-3663](#) then describes the fault reporting in these modes, including the encodings used for reporting the faults.

Note

[Execution privilege, Exception levels, and AArch32 Privilege levels on page G3-3560](#) describes how the Secure and Non-secure PL1 modes map onto the Exception levels.

Registers used for reporting exceptions taken to PL1 modes

AArch32 state defines the following registers, and register encodings, for exceptions taken to PL1 modes:

- The **DFSR** holds information about a Data Abort exception.
- The **DFAR** holds the faulting address for some synchronous Data Abort exceptions.
- The **IFSR** holds information about a Prefetch Abort exception.
- The **IFAR** holds the faulting address of a Prefetch Abort exception.

In addition, if implemented, the optional **ADFSR** and **AIFSR** can provide additional fault information, see [Auxiliary Fault Status Registers](#).

Auxiliary Fault Status Registers

AArch32 state defines the following Auxiliary Fault Status Registers:

- The Auxiliary Data Fault Status Register, **ADFSR**.
- The Auxiliary Instruction Fault Status Register, **AIFSR**.

The position of these registers is architecturally-defined, but the content and use of the registers is IMPLEMENTATION DEFINED. An implementation can use these registers to return additional fault status information. An example use of these registers is to return more information for diagnosing parity errors.

An implementation that does not need to report additional fault information must implement these registers as UNK/SBZP. This ensures that an attempt to access these registers from software executing at PL1 does not cause an Undefined Instruction exception.

Data Abort exceptions, taken to a PL1 mode

On taking a Data Abort exception to a PL1 mode:

- If the exception is on an instruction cache or branch predictor maintenance operation by VA, its reporting depends on the current translation table format. For more information about the registers used when reporting the exception, see *Data Abort on an instruction cache maintenance operation by VA*.
- If the exception is generated by a Watchpoint debug event, then its reporting depends on whether the Watchpoint debug event is synchronous or asynchronous, and on the Debug architecture version. For more information, see *Data Abort on a Watchpoint exception on page G3-3662*.

Otherwise:

- The **DFSR** is updated with details of the fault, including the appropriate fault status code.
If the Data Abort exception is synchronous, **DFSR.WnR** is updated to indicate whether the faulted access was a read or a write. However, if the fault is on a cache maintenance operation, or on an address translation operation, **WnR** is set to 1, to indicate a write access fault, and the **CM** bit is set to 1.
DFSR.WnR is UNKNOWN on an asynchronous Data Abort exception.
See the register description for more information about the returned fault information.
- If the Data Abort exception is
 - Synchronous, the **DFAR** is updated with the VA that caused the exception.
 - Asynchronous, the **DFAR** becomes UNKNOWN.

For all Data Abort exceptions, if the implementation includes EL3, the Security state of the PE in the mode to which the Data Abort exception is taken determines whether the Secure or Non-secure **DFSR** and **DFAR** are updated.

Data Abort on an instruction cache maintenance operation by VA

If an instruction cache or branch predictor invalidation by VA operation generates a Data Abort exception that is taken to a PL1 mode, the **DFAR** is updated to hold the faulting VA. However, the reporting of the fault depends on the current translation table format:

Short-descriptor format

It is IMPLEMENTATION DEFINED which of the following is used when reporting the fault:

- The **DFSR** indicates an Instruction cache maintenance operation fault, and the **IFSR** is valid and indicates the cause of the fault, a Translation fault or Access flag fault.
- The **DFSR** indicates the cause of the fault, a Translation fault or Access flag fault. The **IFSR** is UNKNOWN.

In either case:

- **DFSR.WnR** is set to 1.
- **DFSR.CM** is set to 1, to indicate a fault on a cache maintenance operation.

Long-descriptor format

- **DFSR.CM** is set to 1, to indicate a fault on a cache maintenance operation.
- **DFSR.STATUS** indicates the cause of the fault, a Translation or Access flag fault.
- **DFSR.WnR** is set to 1.
- The **IFSR** is UNKNOWN.

Data Abort on a Watchpoint exception

On taking a Data Abort exception caused by a watchpoint:

- **DFSR.FS** is updated to indicate a debug event.
- **DFSR**.{WnR, Domain} are UNKNOWN.
- **DFAR** is set to the address that generated the watchpoint

Note

- **LR_abt** indicates the address of the instruction that triggered the watchpoint.
- In some ARMv7 AArch32 implementations, the **DBGWFAR** is set to the address of the instruction that triggered the watchpoint. In ARMv8 this register is **RES0**.

A watchpointed address can be any byte-aligned address. The address reported in **DFAR** might not be the watchpointed address, and, for a watchpoint due to an operation other than a Data Cache maintenance operation, can be any address between and including:

- The lowest address accessed by the instruction that triggered the watchpoint.
- The highest watchpointed address accessed by that instruction.

If multiple watchpoints are set in this range, there is no guarantee of which watchpoint is generated.

Note

In particular, there is no guarantee of generating the watchpoint with the lowest address in the range.

The address must also be within a naturally-aligned block of memory of an IMPLEMENTATION DEFINED power-of-two size, containing a watchpoint address accessed by that location.

Note

The implementation defined power-of-two size must be no larger than the block size of the AArch64 **DC ZVA** operation.

Prefetch Abort exceptions, taken to a PL1 mode

For a Prefetch Abort exception generated by an instruction fetch, the Prefetch Abort exception is taken synchronously with the instruction that the abort is reported on. This means:

- If the PE attempts to execute the instruction a Prefetch Abort exception is generated.
- If an instruction fetch is issued but the PE does not attempt to execute the prefetched instruction, no Prefetch Abort exception is generated for that instruction. For example, if the execution flow branches round a prefetched instruction, no Prefetch Abort exception is generated.

In addition, debug exceptions caused by a BKPT instruction, Breakpoint, or a Vector catch debug event, generate a Prefetch Abort exception, see [Breakpoint debug events and Vector Catch exception on page H2-4333](#).

On taking a Prefetch Abort exception to a PL1 mode:

- The **IFSR** is updated with details of the fault, including the appropriate fault code. If appropriate, the fault code indicates that the exception was generated by a debug exception.
See the register description for more information about the returned fault information.
- For a Prefetch Abort exception generated by an instruction fetch, the **IFAR** is updated with the VA that caused the exception.
- For a Prefetch Abort exception generated by a debug exception, the **IFAR** is UNKNOWN.

If the implementation includes EL3, the security state of the PE in the mode to which it takes the Prefetch Abort exception determines whether the exception updates the Secure or Non-secure **IFSR** and **IFAR**.

G3.13.3 Fault reporting in PL1 modes

The FSRs provide fault information, including an indication of the fault that occurred. The following subsections describe fault reporting in PL1 modes for each of the translation table formats:

- [PL1 fault reporting with the Short-descriptor translation table format.](#)
- [PL1 fault reporting with the Long-descriptor translation table format on page G3-3665.](#)

[Reserved encodings in the IFSR and DFSR encodings tables on page G3-3666](#) gives some additional information about the encodings for both formats.

[Summary of register updates on faults taken to PL1 modes on page G3-3666](#) shows which registers are updated on each of the reported faults.

[Reporting of External aborts taken from Non-secure state to Monitor mode](#) describes how the fault status register format is determined for those aborts. For all other aborts, the current translation table format determines the format of the fault status registers.

Reporting of External aborts taken from Non-secure state to Monitor mode

When an External abort is taken from Non-secure state to Monitor mode:

- For a Data Abort exception, the Secure [DFSR](#) and [DFAR](#) hold information about the abort.
- For a Prefetch Abort exception, the Secure [IFSR](#) and [IFAR](#) hold information about the abort.
- The abort does not affect the contents of the Non-secure copies of the fault reporting registers.

Normally, the current translation table format determines the format of the [DFSR](#) and [IFSR](#). However, when [SCR.EA](#) is set to 1, to route external aborts to Monitor mode, and an external abort is taken from Non-secure state, this section defines the [DFSR](#) and [IFSR](#) format.

For an External abort taken from Non-secure state to Monitor mode, the [DFSR](#) or [IFSR](#) uses the format associated with the Long-descriptor translation table format, as described in [PL1 fault reporting with the Long-descriptor translation table format on page G3-3665](#), if any of the following applies:

- The Secure [TTBCR.EAE](#) bit is set to 1.
- The External abort is synchronous and either:
 - It is taken from Hyp mode.
 - It is taken from a Non-secure PL1 mode, and the Non-secure [TTBCR.EAE](#) bit is set to 1.

Otherwise, the [DFSR](#) or [IFSR](#) uses the format associated with the Short-descriptor translation table format, as described in [PL1 fault reporting with the Short-descriptor translation table format](#).

PL1 fault reporting with the Short-descriptor translation table format

This subsection describes the fault reporting for a fault taken to a PL1 when address translation is using the Short-descriptor translation table format.

On taking an exception, bit[9] of the FSR is RAZ, or set to 0, if the PE is using this FSR format.

An FSR encodes the fault in a 5-bit FS field, that comprises FSR[10, 3:0]. [Table G3-26 on page G3-3664](#) shows the encoding of that field. [Summary of register updates on faults taken to PL1 modes on page G3-3666](#) shows:

- Whether the corresponding FAR is updated on the fault. That is:
 - For a fault reported in the [IFSR](#), whether the [IFAR](#) holds a valid address.
 - For a fault reported in the [DFSR](#), whether the [DFAR](#) holds a valid address.
- For faults that update [DFSR](#), whether [DFSR.Domain](#) is valid

When reading [Table G3-26 on page G3-3664](#):

- FS values not shown in the table are reserved.

- FS values shown as **DFSR** only are reserved for the **IFSR**.

Table G3-26 FSR encodings when using the Short-description translation table format

FS	Source		Notes
00001	Alignment fault		DFSR only. Fault on first lookup
00100	Fault on instruction cache maintenance		DFSR only
01100 01110	Synchronous external abort on translation table walk	First level Second level	-
11100 11110	Synchronous parity error on translation table walk	First level Second level	-
00101 00111	Translation fault	First level Second level	MMU fault
00011 ^a 00110	Access flag fault	First level Second level	MMU fault
01001 01011	Domain fault	First level Second level	MMU fault
01101 01111	Permission fault	First level Second level	MMU fault
00010	Debug event		See Chapter D3 The Debug Exception Model
01000	Synchronous external abort		-
10000	TLB conflict abort		See TLB conflict aborts on page G3-3632
10100	IMPLEMENTATION DEFINED		Lockdown
11010	IMPLEMENTATION DEFINED		Coprocessor abort
11001	Synchronous parity error on memory access		-
10110	Asynchronous external abort ^b		DFSR only
11000	Asynchronous parity error on memory access ^c		DFSR only

a. Previously, this encoding was a deprecated encoding for Alignment fault. The extensive changes in the memory model in VMSAv8-32 mean there should be no possibility of confusing the new use of this encoding with its previous use

b. Including asynchronous data external abort on translation table walk or instruction fetch.

c. Including asynchronous parity error on translation table walk.

The Domain field in the DFSR

The **DFSR** includes a Domain field. This is inherited from previous versions of the VMSA. The **IFSR** does not include a Domain field. [Summary of register updates on faults taken to PL1 modes on page G3-3666](#) describes when **DFSR.Domain** is valid.

ARM deprecates any use of the Domain field in the **DFSR**. The Long-descriptor translation table format does not support a Domain field, and future versions of the ARM architecture might not support a Domain field in the Short-descriptor translation table format. ARM strongly recommends that new software does not use this field.

For both Data Abort exceptions and Prefetch Abort exceptions, software can find the domain information by performing a translation table read for the faulting address and extracting the Domain field from the translation table entry.

PL1 fault reporting with the Long-descriptor translation table format

This subsection describes the fault reporting for a fault taken to a PL1 mode when address translation is using the Long-descriptor translation table format.

When the PE takes an exception, bit[9] of the FSR is set to 1 if the PE is using this FSR format.

The FSRs encode the fault in a 6-bit STATUS field, that comprises FSR[5:0]. [Table G3-27](#) shows the encoding of that field. In addition:

- For a fault taken to a PL1 mode, [Summary of register updates on faults taken to PL1 modes on page G3-3666](#) shows whether the corresponding FAR is updated on the fault. That is:
 - For a fault reported in the **IFSR**, whether the **IFAR** holds a valid address.
 - For a fault reported in the **DFSR**, whether the **DFAR** holds a valid address.
- For a fault taken to the Hyp mode, [Summary of register updates on exceptions taken to Hyp mode on page G3-3682](#) shows what registers are updated on the fault.

Table G3-27 FSR encodings when using the Long-descriptor translation table format

STATUS ^a	Source	Notes
0001LL	Translation fault. LL bits indicate level ^b .	MMU fault
0010LL	Access flag fault. LL bits indicate level ^b .	MMU fault
0011LL	Permission fault. LL bits indicate level ^b .	MMU fault
010000	Synchronous external abort.	-
011000	Synchronous parity error on memory access.	-
010001	Asynchronous external abort.	DFSR only
011001	Asynchronous parity error on memory access.	DFSR only
0101LL	Synchronous external abort on translation table walk. LL bits indicate level ^b .	-
0111LL	Synchronous parity error on memory access on translation table walk. LL bits indicate level ^b .	-
100001	Alignment fault.	Fault on first lookup
100010	Debug event.	See Chapter D3 The Debug Exception Model
110000	TLB conflict abort.	See TLB conflict aborts on page G3-3632
110100	IMPLEMENTATION DEFINED.	Lockdown, DFSR only
111010	IMPLEMENTATION DEFINED.	Coprocessor abort, DFSR only
1111LL	Domain fault. LL bits indicate level ^b .	MMU fault. 64-bit PAR only, First or second level only. Never used in DFSR , IFSR , or HSR ^c

a. STATUS values not shown in this table are reserved. STATUS values not supported in the **IFSR** or **DFSR** are reserved for the register or registers in which they are not supported.

b. See [The level associated with MMU faults on page G3-3666](#).

c. A Domain fault can be reported using the Long-descriptor STATUS encodings only as a result of a fault on an address translation operation. For more information see [MMU fault on an address translation operation on page G3-3689](#).

The level associated with MMU faults

For MMU faults, [Table G3-28](#) shows how the LL bits in the xFSR.STATUS field encode the lookup level associated with the fault.

Table G3-28 Use of LL bits to encode the lookup level at which the fault occurred

LL bits	Meaning
00	Reserved.
01	First level.
10	Second level.
11	Third level. When xFSR.STATUS indicates a Domain fault, this value is reserved.

The lookup level associated with a fault is:

- For a fault generated on a translation table walk, the lookup level of the walk being performed.
- For a Translation fault, the lookup level of the translation table that gave the fault. If a fault occurs because an stage of address translation is disabled, or because the input address is outside the range specified by the appropriate base address register or registers, the fault is reported as a First level fault.
- For an Access flag fault, the lookup level of the translation table that gave the fault.
- For a Permission fault, including a Permission fault caused by hierarchical permissions, the lookup level of the final level of translation table accessed for the translation. That is, the lookup level of the translation table that returned a Block or Page descriptor.

Reserved encodings in the IFSR and DFSR encodings tables

With both the Short-descriptor and the Long-descriptor FSR format, the fault encodings reserve a single encoding for each of:

- Cache and TLB lockdown faults. The details of these faults and any associated subsidiary registers are IMPLEMENTATION DEFINED.
- Aborts associated with coprocessors. The details of these faults are IMPLEMENTATION DEFINED.

G3.13.4 Summary of register updates on faults taken to PL1 modes

For faults that generate exceptions that are taken to a PL1 mode, [Table G3-29 on page G3-3667](#) shows the registers affected by each fault. In this table:

- Yes indicates that the register is updated.
- UNK indicates that the fault makes the register value UNKNOWN.
- A null entry, -, indicates that the fault does not affect the register.

For faults that update the [DFSR](#) using the Short-descriptor format FSR encodings, [Table G3-30 on page G3-3668](#) shows whether [DFSR.Domain](#) is valid.

Table G3-29 Effect of a fault taken to a PL1 mode on the reporting registers

Fault	IFSR	IFAR	DFSR	DFAR
Faults reported as Prefetch Abort exceptions:				
MMU fault, always synchronous.	Yes	Yes	-	-
Synchronous external abort on translation table walk.	Yes	Yes	-	-
Synchronous parity error on translation table walk.	Yes	Yes	-	-
Synchronous external abort.	Yes	Yes	-	-
Synchronous parity error on memory access.	Yes	Yes	-	-
TLB conflict abort.	Yes	Yes	-	-
Fault reported as Data Abort exception:				
Alignment fault, always synchronous.	-	-	Yes	Yes
MMU fault, always synchronous.	-	-	Yes	Yes
Fault on instruction cache maintenance, when using Long-descriptor translation table format ^a .	UNK	-	Yes	Yes
Fault on instruction cache maintenance, when using Short descriptor translation table format ^b .	<i>either</i>	Yes	-	Yes
	<i>or</i>	UNK	-	Yes
Synchronous external abort on translation table walk.	-	-	Yes	Yes
Synchronous parity error on translation table walk.	-	-	Yes	Yes
Synchronous external abort.	-	-	Yes	Yes
Synchronous parity error on memory access.	-	-	Yes	Yes
Asynchronous external abort.	-	-	Yes	UNK
Asynchronous parity error on memory access.	-	-	Yes	UNK
TLB conflict abort.	-	-	Yes	Yes
Debug exceptions:				
Breakpoint, Software Breakpoint Instruction, or Vector Catch ^c .	Yes	UNK	-	-
Watchpoint ^d .	-	-	Yes	Yes

- When using the Long-descriptor translation table format, there is not a specific fault code for a fault on an instruction cache maintenance operation. For more information see [Data Abort on an instruction cache maintenance operation by VA on page G3-3661](#).
- The two lines of this entry show the alternative ways of reporting the fault when using the Short-descriptor translation table format. It is IMPLEMENTATION DEFINED which methods is used, see [Data Abort on an instruction cache maintenance operation by VA on page G3-3661](#).
- Generates a Prefetch Abort exception.
- Generates a Data Abort exception.

For those faults for which [Table G3-29 on page G3-3667](#) shows that the **DFSR** is updated, if the fault is reported using the Short-descriptor FSR encodings, [Table G3-30](#) shows whether **DFSR.Domain** is valid. In this table, UNK indicates that the fault makes **DFSR.Domain** UNKNOWN.

Table G3-30 Validity of Domain field on faults that update the **DFSR when using the Short-descriptor encodings**

DFSR.FS	Source		DFSR.Domain	Notes
00001	Alignment fault		UNK	-
00100	Fault on instruction cache maintenance operation		UNK	-
01100	Synchronous external abort on translation table walk	First level	UNK	-
01110		Second level	Valid	
11100	Synchronous parity error on translation table walk	First level	UNK	-
11110		Second level	Valid	
00101	Translation fault	First level	UNK	MMU fault
00111		Second level	Valid	
00011 ^a	Access flag fault	First level	UNK	MMU fault
00110		Second level	Valid	
01001	Domain fault	First level	Valid	MMU fault
01011		Second level	Valid	
01101	Permission fault	First level	UNK	MMU fault
01111		Second level	UNK	
01000	Synchronous external abort		UNK	-
10000	TLB conflict abort		UNK	-
11001	Synchronous parity error on memory access		UNK	-
10110	Asynchronous external abort ^b		UNK	-
11000	Asynchronous parity error on memory access ^c		UNK	-
00010	Watchpoint		UNK	

- a. Previously, this encoding was a deprecated encoding for Alignment fault. The extensive changes in the memory model in VMSAv8-32 mean there should be no possibility of confusing the new use of this encoding with its previous use
- b. Including asynchronous data external abort on translation table walk or instruction fetch.
- c. Including asynchronous parity error on translation table walk.

G3.13.5 Reporting exceptions taken to Hyp mode

Hyp mode is the Non-secure EL2 mode. It is entered by taking an exception to Hyp mode.

———— **Note** ————

Software executing in Monitor mode, or at EL3 when EL3 is using AArch64, can perform an exception return to Hyp mode. This means Hyp mode can be entered either by taking an exception, or by a permitted exception return.

When EL2 is using AArch32, the following exceptions are taken to Hyp mode:

- Asynchronous external aborts, IRQ exceptions, and FIQ exceptions, from Non-secure PL0 and PL1 modes, if not routed to Secure Monitor mode, and if configured by the AMO, FMO or IMO bits. For more information see [Asynchronous exception routing controls on page G1-3467](#).

- When [HCR.TGE](#) is set to 1, all exceptions that would be routed to Non-secure PL1 modes. For more information, see [Routing general exceptions to EL2 on page G1-3452](#).
- When [HCR.TDE](#) is set to 1, any debug exception that would otherwise be taken to a Non-secure PL1 mode, see [Routing Debug exceptions to Hyp mode on page G1-3454](#).
- The privilege rules for taking exceptions mean that any exception taken from Hyp mode, if not routed to EL3, must be taken to Hyp mode. This includes a Prefetch Abort exception generated by a Debug exception on a BKPT instruction.

———— **Note** —————

Debug exceptions other than the exception on a BKPT instruction are not permitted in Hyp mode.

- Hypervisor Call exceptions, and Hyp Trap exceptions, are always taken to Hyp mode. These exceptions are supported only as part of EL2. When EL2 is implemented, various operations from Non-secure PL0 and PL1 modes can be *trapped* to Hyp mode, using the Hyp Trap exception. For more information, see [AArch32 control of traps to the hypervisor on page G1-3503](#).

These exceptions include any memory system fault that occurs:

- On a memory access from Hyp mode.
- On memory access from a Non-secure PL0 or PL1 mode:
 - On a stage 2 translation, from IPA to PA.
 - On the stage 2 translation of an address accessed in performing a stage 1 translation table walk.

[Memory fault reporting in Hyp mode on page G3-3670](#) gives more information about these faults.

The following exceptions provide *syndrome* information in the [HSR](#):

- Any synchronous exception taken to Hyp mode.
- Some exceptions taken from Debug state that would be taken to Hyp mode if the PE was not in Debug state, see [Exceptions in Debug state on page H2-4355](#).

———— **Note** —————

- In Debug state, the PE does not change mode on taking an exception.
- As [Exceptions in Debug state on page H2-4355](#) describes, some other exceptions taken from Debug state make the [HSR UNKNOWN](#).

The syndrome information in the [HSR](#) includes the fault status code otherwise provided by the fault status register, and extends the fault reporting compared to that available for an exception taken to a PL1 mode. For more information, see [Use of the HSR on page G3-3672](#).

In addition, for a Debug exception taken to Hyp mode, [DBGDSCRint.MOE](#) or [DBGDTRRNext.MOE](#) shows what caused the Debug exception. This bit is valid regardless of whether the Debug exception was taken from Hyp mode or from another Non-secure mode.

[Registers used for reporting exceptions taken to Hyp mode](#) lists all of the registers used for exception reporting in Hyp mode.

Registers used for reporting exceptions taken to Hyp mode

The following registers are used for reporting exceptions taken to Hyp mode:

- The [HSR](#) holds syndrome information for the exception.
- The [HDFAR](#) holds the VA associated with a Data Abort exception.
- The [HIFAR](#) holds the VA associated with a Prefetch Abort exception.
- The [HPFAR](#) holds bits[39:12] of the IPA associated with a Prefetch Abort exception.

In addition, if implemented, the optional [HADFSR](#) and [HAIFSR](#) can provide additional fault information, see [Hyp Auxiliary Fault Syndrome Registers](#).

Hyp Auxiliary Fault Syndrome Registers

EL2 also defines encodings for the following Hyp Auxiliary Fault Syndrome Registers:

- The Hyp Auxiliary Data Fault Syndrome Register, [HADFSR](#).
- The Hyp Auxiliary Instruction Fault Syndrome Register, [HAIFSR](#).

An implementation can use these registers to return additional fault status information for aborts taken to Hyp mode. They are the Hyp mode equivalents of the registers described in [Auxiliary Fault Status Registers](#) on page G3-3660. An example use of these registers is to return more information for diagnosing parity errors.

The architectural requirements for the [HADFSR](#) and [HAIFSR](#) are:

- The position of these registers is architecturally-defined, but the content and use of the registers is IMPLEMENTATION DEFINED.
- An implementation with no requirement for additional fault reporting can implement these registers as UNK/SBZP, but the architecture does not require it to do so.

Memory fault reporting in Hyp mode

Prefetch Abort and Data Abort exceptions taken to Hyp mode report memory faults. For these aborts, the [HSR](#) contains the following fault status information:

- The [HSR.EC](#) field indicates the type of abort, as [Table G3-31](#) shows.
- The [HSR.ISS](#) field holds more information about the abort. In particular:
 - Bits[5:0] of this field hold the STATUS field for the abort, using the encodings defined in [PL1 fault reporting with the Long-descriptor translation table format](#) on page G3-3665.
 - Other subfields of the ISS give more information about the exception, equivalent to the information returned in the FSR for a memory fault reported at PL1.

See the descriptions of the ISS fields for the memory faults, referenced from the *Syndrome description* column of [Table G3-31](#), for information about the returned fault information.

Table G3-31 HSR.EC encodings for aborts taken to Hyp mode

HSR.EC	Abort	Syndrome description
0x20	Prefetch Abort taken from Non-secure PL0 or PL1 mode	<i>ISS encoding for Prefetch Abort exceptions taken to Hyp mode</i> on page G3-3679
0x21	Prefetch Abort taken from Hyp mode	
0x24	Data Abort taken from Non-secure PL0 or PL1 mode	<i>ISS encoding for Data Abort exceptions taken to Hyp mode</i> on page G3-3680
0x25	Data Abort taken from Hyp mode	

For more information, see [Use of the HSR](#) on page G3-3672.

A Prefetch Abort exception is taken synchronously with the instruction that the abort is reported on. This means:

- If the PE attempts to execute the instruction a Prefetch Abort exception is generated.
- If an instruction fetch is issued but the PE does not attempt to execute the prefetched instruction, no Prefetch Abort exception is generated for that instruction. For example, if the execution flow branches round a prefetched instruction that would abort if the PE attempted to execute it, no Prefetch Abort exception is generated.

Register updates on exception reporting in Hyp mode

The use of the **HSR**, and of the other registers listed in *Registers used for reporting exceptions taken to Hyp mode* on page G3-3669, depends on the cause of the Abort. In reporting these faults, in general:

- If the fault generates a synchronous Data Abort exception, the **HDFAR** holds the associated VA.
 - If the fault generates a Prefetch Abort exception, the **HIFAR** holds the associated VA.
 - In the following cases, the **HPFAR** holds the faulting IPA:
 - A Translation or Access flag fault on a stage 2 translation.
 - A fault on the stage 2 translation of an address accessed in a stage 1 translation table walk.
- In all other cases, the **HPFAR** is UNKNOWN.
- On a Data Abort exception that is taken to Hyp mode, the **HIFAR** is UNKNOWN.
 - On a Prefetch Abort exception that is taken to Hyp mode, the **HDFAR** is UNKNOWN.

In addition, the reporting of particular aborts is as follows:

Abort on the stage 1 translation for a memory access from Hyp mode

The **HDFAR** or **HIFAR** holds the VA that caused the fault. The **STATUS** subfield of **HSR.ISS** indicates the type of fault, Translation, Address size, Access flag, or Permission. The **HPFAR** is UNKNOWN.

Abort on the stage 2 translation for a memory access from a Non-secure PL1 or PL0 mode

This includes aborts on the stage 2 translation of a memory access made as part of a translation table walk for a stage 1 translation. The **HDFAR** or **HIFAR** holds the VA that caused the fault. The **STATUS** subfield of **HSR.ISS** indicates the type of fault, Translation, Address size, Access flag, or Permission.

For any Access flag fault or Translation fault, and also for any Permission fault on the stage 2 translation of a memory access made as part of a translation table walk for a stage 1 translation, the **HPFAR** holds the IPA that caused the fault. Otherwise, the **HPFAR** is UNKNOWN.

Abort caused by a synchronous external abort, or synchronous parity error, and taken to Hyp mode

The **HDFAR** or **HIFAR** holds the VA that caused the fault. The **HPFAR** is UNKNOWN.

Data Abort caused by a Watchpoint exception and routed to Hyp mode because **HDCR.TDE** is set to 1

When **HDCR.TDE** is set to 1, a Watchpoint exception generated in a Non-secure PL1 or PL0 mode, that would otherwise generate a Data Abort exception, is routed to Hyp mode and generates a Hyp Trap exception.

HDFAR is set to the address that generated the watchpoint.

———— Note —————

ELR_hyp indicates the address of the instruction that triggered the watchpoint.

A watchpointed address can be any byte-aligned address. The address reported in **HDFAR** might not be the watchpointed address, and, for a watchpoint due to an operation other than a Data Cache maintenance operation, can be any address between and including:

- The lowest address accessed by the instruction that triggered the watchpoint.
- The highest watchpointed address accessed by that instruction.

If multiple watchpoints are set in this range, there is no guarantee of which watchpoint is generated.

———— Note —————

In particular, there is no guarantee of generating the watchpoint with the lowest address in the range.

The address must also be within a naturally-aligned block of memory of an IMPLEMENTATION DEFINED power-of-two size, containing a watchpoint address accessed by that location.

———— **Note** ————

The IMPLEMENTATION DEFINED power-of-two size must be no larger than the block size of the AArch64 **DC ZVA** operation.

See also *Watchpoint exceptions* on page D2-1606.

In all cases, **HPFAR** is UNKNOWN.

Prefetch Abort caused by a Software Breakpoint Instruction exception and taken to Hyp mode

This abort is generated if a BKPT instruction is executed in Hyp mode. The abort leaves the **HIFAR** and **HPFAR** UNKNOWN.

See also *Breakpoint debug events and Vector Catch exception* on page H2-4333.

Prefetch Abort caused by a Software Breakpoint Instruction, Breakpoint, or Vector Catch exception, and routed to Hyp mode because HDCR.TDE is set to 1

When **HDCR.TDE** is set to 1, a debug exception, generated in a Non-secure PL1 or PL0 mode, that would otherwise generate a Prefetch Abort exception, is routed to Hyp mode and generates a Hyp Trap exception.

The abort leaves the **HIFAR** and **HPFAR** UNKNOWN. This is identical to the reporting of a Prefetch Abort exception caused by a Debug exception on a BKPT instruction that is executed in Hyp mode.

———— **Note** ————

The difference between these two cases is:

- The Debug exception on a BKPT instruction executed in Hyp mode generates a Prefetch Abort exception, taken to Hyp mode, and reported in the **HSR** using EC value 0x21.
- Aborts generated because **HDCR.TDE** is set to 1 generate a Hyp Trap exception, and are reported in the **HSR** using EC value 0x20.

G3.13.6 Use of the HSR

The **HSR** holds syndrome information for any synchronous exception taken to Hyp mode. Compared with the reporting of exceptions taken to PL1 modes, the **HSR**:

- Always provides details of the fault. The **DFSR** and **IFSR** are not used.
- Provides more extensive information, for a wider range of exceptions.

———— **Note** ————

IRQ and FIQ exceptions taken to Hyp mode do not report any syndrome information in the **HSR**.

The general format of the **HSR** is that it comprises:

- A 6-bit exception class field, EC, that indicates the cause of the exception.
- An instruction length bit, IL. When an exception is caused by trapping an instruction to Hyp mode, this bit indicates the length of the trapped instruction, as follows:
0 16-bit instruction trapped.
1 32-bit instruction trapped.

This field is not valid for the following cases:

- When the EC field is 0x00, indicating an exception with an unknown reason.
- Instruction Aborts.
- Data Aborts that do not have ISS information, or for which the ISS is not valid.

In these cases, the IL field is RES1.

- An instruction specific syndrome field, ISS. Architecturally, this field can be defined independently for each defined exception class.

This field is not valid, UNK/SBZP, when the EC field is 0x00, indicating an exception with an unknown reason.

Figure G3-25 shows the format of the HSR, with the subdivision of the ISS field that applies to nonzero EC values with the two most significant bits 0b00.

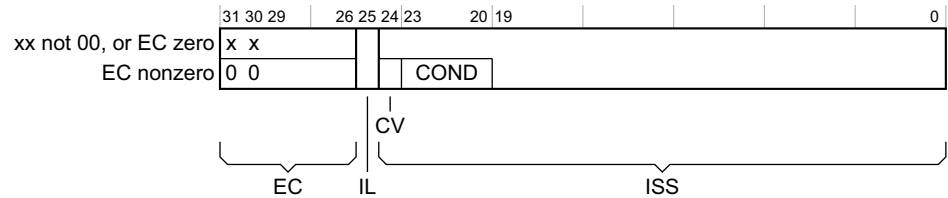

Figure G3-25 Format of the HSR, with subdivision of the ISS field for specified EC encodings

HSR exception classes and associated ISS encodings

Table G3-32 shows the encoding of the HSR exception class field, EC. Values of EC not shown in the table are reserved. The table divides the EC values into three groups, relating to the interpretation of the associated ISS fields. For each EC value, the table references a subsection that gives information about:

- The cause of the exception, for example the configuration required to enable the trap.
- The encoding of the associated ISS.

Table G3-32 HSR.EC field encoding

EC	Exception class	ISS description, or notes
0x00	Unknown reason	<i>Exceptions with an unknown reason on page G3-3674.</i>
Nonzero EC values with HSR[31:30] zero ^a		
0x01	Trapped WFI or WFE instruction	<i>ISS encoding for trapped WFI or WFE instruction on page G3-3675.</i>
0x03	Trapped MCR or MRC access to CP15	<i>ISS encoding for trapped MCR or MRC access on page G3-3675.</i>
0x04	Trapped MCRR or MRRC access to CP15	<i>ISS encoding for trapped MCRR or MRRC access on page G3-3676.</i>
0x05	Trapped MCR or MRC access to CP14	<i>ISS encoding for trapped MCR or MRC access on page G3-3675.</i>
0x06	Trapped LDC or STC access to CP14	<i>ISS encoding for trapped LDC or STC access on page G3-3677.</i>
0x07	HCPTR-trapped access to CP10 or CP11	<i>ISS encoding for HCPTR-trapped access to CP10 or CP11 on page G3-3678.</i> Includes trap on use of Advanced SIMD.
0x08	Trapped MRC or VMRS access to CP10, for ID group traps	<i>ISS encoding for trapped MCR or MRC access on page G3-3675.</i> This trap is not taken if the HCPTR settings trap the access.
0x0C	Trapped MRRC access to CP14	<i>ISS encoding for trapped MCRR or MRRC access on page G3-3676.</i>
0x0E	Illegal exception return to AArch32 state	The ISS is RES0

Table G3-32 HSR.EC field encoding (continued)

EC	Exception class	ISS description, or notes
EC values with HSR[31:30] nonzero		
0x11	Supervisor Call exception routed to Hyp mode	<i>ISS encoding for Hypervisor Call exception, or Supervisor Call exception routed to Hyp mode on page G3-3678.</i>
0x12	Hypervisor Call	
0x13	Trapped SMC instruction	<i>ISS encoding for trapped SMC execution on page G3-3679.</i>
0x20	Prefetch Abort routed to Hyp mode	<i>ISS encoding for Prefetch Abort exceptions taken to Hyp mode on page G3-3679.</i>
0x21	Prefetch Abort taken from Hyp mode	
0x22	PC Alignment Exception.	The ISS is RES0
0x24	Data Abort routed to Hyp mode	<i>ISS encoding for Data Abort exceptions taken to Hyp mode on page G3-3680.</i>
0x25	Data Abort taken from Hyp mode	

a. For more information see *Encoding of ISS[24:20] when HSR[31:30] is 0b00*.

All EC encodings not shown in [Table G3-31 on page G3-3670](#) are reserved by ARM.

Exceptions with an unknown reason

An HSR.EC value of 0x00 indicates an exception with an unknown reason. Any exception not covered by a nonzero EC value defined in [Table G3-32 on page G3-3673](#) returns this value. When HSR.EC returns a value of 0x00, all other fields of HSR are invalid.

Undefined Instruction exception, when HCR.TGE is set to 1 on page G1-3452 describes the configuration settings for a trap that returns an HSR.EC value of 0x00.

Encoding of ISS[24:20] when HSR[31:30] is 0b00

For EC values that are nonzero and have the two most-significant bits 0b00, ISS[24:20] provides the condition code field for the trapped instruction, together with a valid flag for this field. The encoding of this part of the ISS field is:

CV, ISS[24] Condition code valid. Possible values of this bit are:

0	The COND field is not valid.
1	The COND field is valid

COND, ISS[23:20]

The condition code for the trapped instruction. This field is valid only when CV is set to 1.

If CV is set to 0, this field is UNK/SBZP.

When an A32 instruction is trapped, CV is set to 1 and:

- If the instruction is conditional, COND is set to the condition code field value from the instruction.
- If the instruction is unconditional, COND is set to 0xE.

A conditional A32 instruction that is known to pass its condition code check can be presented either:

- With COND set to 0xE, the value for unconditional.
- With the COND value held in the instruction.

When a T32 instruction is trapped, it is IMPLEMENTATION DEFINED whether:

- CV set to 0 and COND is set to an UNKNOWN value
- CV set to 1 and COND is set to the condition code for the condition that applied to the instruction.

When CV is set to 0, software must examine the SPSR.IT field to determine the conditionality of a T32 instruction.

Except for unconditional T32 instructions reported with CV set to 0, a trapped unconditional instruction is reported with CV set to 1 and a COND value of 0x0E, the condition code value for unconditional.

For an implementation that, for both A32 and T32 instructions, takes an exception on a trapped conditional instruction only if the instruction passes its condition code check, these definitions mean that when CV is set to 1 it is IMPLEMENTATION DEFINED whether the COND field is set to 0xE, or to the value of any condition that applied to the instruction.

———— **Note** ————

In some circumstances, it is IMPLEMENTATION DEFINED whether a conditional instruction that fails its condition code check generates an Undefined Instruction exception, see [Conditional execution of undefined instructions on page G1-3478](#).

ISS encoding for trapped WFI or WFE instruction

This is the exception with EC value 0x01. When HSR.EC returns this value, the encoding of the ISS field is:

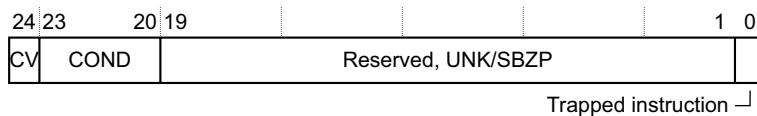

ISS[24:20] See [Encoding of ISS\[24:20\] when HSR\[31:30\] is 0b00 on page G3-3674](#).

ISS[19:1] Reserved, UNK/SBZP.

ISS[0] Indicates the trapped instruction. The possible values of this bit are:

- 0** WFI trapped.
- 1** WFE trapped.

[Trapping use of the WFI and WFE instructions on page G1-3511](#) describes the configuration settings for this trap.

ISS encoding for trapped MCR or MRC access

These are the exceptions with the following EC values:

- 0x03, trapped MRC or MCR access to CP15.
- 0x05, trapped MRC or MCR access to CP14.
- 0x08, trapped MRC or VMRS access to CP10.

When HSR.EC returns one of these values, the encoding of the ISS field is:

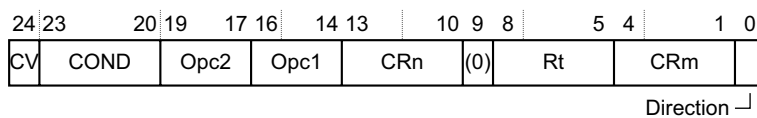

ISS[24:20] See [Encoding of ISS\[24:20\] when HSR\[31:30\] is 0b00 on page G3-3674](#).

ISS[19:17] The Opc2 value from the issued instruction.

ISS[16:14] The Opc1 value from the issued instruction.

ISS[13:10] The CRn value from the issued instruction, the coprocessor primary register value.

ISS[9] Reserved, UNK/SBZP.

ISS[8:5] The Rt value from the issued instruction, the general-purpose register used for the transfer.

ISS[4:1] The CRm value from the issued instruction.

ISS[0] Indicates the direction of the trapped instruction. The possible values of this bit are:

- 0** Write to coprocessor. MCR instruction.
- 1** Read from coprocessor. MRC or VMRS instruction.

The following sections describe configuration settings for traps that are reported using EC value 0x03:

- [Trapping ID mechanisms on page G1-3506](#).

- [Trapping accesses to lockdown, DMA, and TCM operations](#) on page G1-3508.
- [Trapping accesses to cache maintenance operations](#) on page G1-3509.
- [Trapping accesses to TLB maintenance operations](#) on page G1-3509.
- [Trapping accesses to the Auxiliary Control Register](#) on page G1-3509.
- [Trapping accesses to the Performance Monitors Extension](#) on page G1-3510.
- [Trapping CPACR accesses](#) on page G1-3513.
- [Generic trapping of accesses to CP15 system control registers](#) on page G1-3513.

The following sections describe configuration settings for traps that are reported using EC value 0x05:

- [ID group 0, Primary device identification registers](#) on page G1-3507.
- [Trapping accesses to the T32EE configuration registers](#) on page G1-3511.
- [Trapping CP14 accesses to Debug ROM registers](#) on page G1-3514.
- [Trapping CP14 accesses to OS-related debug registers](#) on page G1-3515.
- [Trapping CP14 accesses to debug registers](#) on page G1-3514.
- [Trapping CP14 accesses to trace registers](#) on page G1-3516.

[Trapping ID mechanisms](#) on page G1-3506 describes configuration settings for traps that are reported using EC value 0x08.

ISS encoding for trapped MCRR or MRRC access

These are the exceptions with the following EC values:

- 0x04, trapped MRRC or MCRR access to CP15.
- 0x0C, trapped MRRC access to CP14.

When HSR.EC returns one of these values, the encoding of the ISS field is:

24	23	20	19	16	15	14	13	10	9	8	5	4	1	0
CV	COND	Opc1	(0)	(0)	Rt2	(0)	Rt	CRm	Direction					

ISS[24:20] See [Encoding of ISS\[24:20\] when HSR\[31:30\] is 0b00](#) on page G3-3674.

ISS[19:16] The Opc1 value from the issued instruction.

ISS[15:14] Reserved, UNK/SBZP.

ISS[13:10] The Rt2 value from the issued instruction, one of the general-purpose registers for the transfer.

ISS[9] Reserved, UNK/SBZP.

ISS[8:5] The Rt value from the issued instruction, one of the general-purpose registers for the transfer.

ISS[4:1] The CRm value from the issued instruction, the coprocessor primary register value.

ISS[0] Indicates the direction of the trapped instruction. The possible values of this bit are:

- 0** Write to coprocessor, MCRR instruction.
- 1** Read from coprocessor, MRRC instruction.

The following sections describe configuration settings for traps that are reported using EC value 0x04:

- [Trapping writes to virtual memory control registers](#) on page G1-3513.
- [Generic trapping of accesses to CP15 system control registers](#) on page G1-3513.

The following sections describe configuration settings for traps that are reported using EC value 0x0C:

- [Trapping CP14 accesses to debug registers](#) on page G1-3514.
- [Trapping CP14 accesses to Debug ROM registers](#) on page G1-3514.

ISS encoding for trapped LDC or STC access

This is the exception with EC value 0x06. When HSR.EC returns this value, the encoding of the ISS field is:

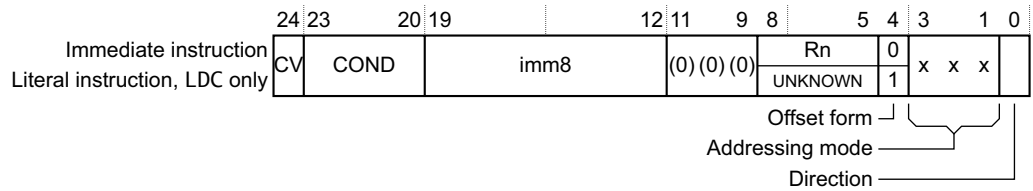

ISS[24:20] See [Encoding of ISS\[24:20\] when HSR\[31:30\] is 0b00](#) on page G3-3674.

ISS[19:12] imm8. The immediate value from the issued instruction.

ISS[11:9] Reserved, UNK/SBZP.

ISS[8:5] Encoding depends on the instruction form indicated by ISS[3]:

ISS[3]==0 Encodes Rn, the general-purpose register that holds the base address. Applies only to immediate instruction forms.

ISS[3]==1 UNKNOWN. Applies only to literal instruction forms, that are available only for LDC instructions

ISS[4] Indicates whether the offset is added or subtracted:

0 Subtract offset.

1 Add offset.

This bit corresponds to the U bit in the instruction encoding.

ISS[3:1] Addressing mode. The permitted values of this field are:

0b000 Immediate unindexed.

0b001 Immediate post-indexed.

0b010 Immediate offset.

0b011 Immediate pre-indexed.

0b100 Literal unindexed.

LDC instruction in A32 instruction set only.

For a trapped STC instruction or a trapped LDC T32 instruction, this encoding is reserved.

0b101 Reserved.

0b110 Literal offset.

LDC instruction only.

For a trapped STC instruction, this encoding is reserved.

0b111 Reserved.

ISS[3] indicates the instruction form, immediate or literal. See the description of ISS[8:5].

ISS[2:1] correspond to the bits {P, W} in the instruction encoding.

ISS[0] Indicates the direction of the trapped instruction. The possible values of this bit are:

0 Write to coprocessor. STC instruction.

1 Read from coprocessor, LDC instruction.

————— **Note** —————

The only architected uses of these instructions to access CP14 are:

- An STC to write to [DBGDTRTXint](#).
- An LDC to read [DBGDTRTXint](#).

[Trapping general CP14 accesses to debug registers on page G1-3515](#) describes the configuration settings for the trap that is reported using EC value 0x06.

ISS encoding for HCPTR-trapped access to CP10 or CP11

This is the exception with EC value 0x07. When HSR.EC returns this value, the encoding of the ISS field is:

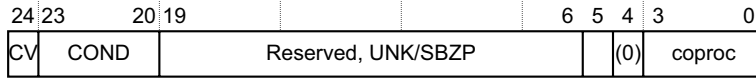

Trapped Advanced SIMD \lrcorner

ISS[24:20] See [Encoding of ISS\[24:20\] when HSR\[31:30\] is 0b00 on page G3-3674](#).

ISS[19:6] Reserved, UNK/SBZP.

ISS[5] Indicates trapped use of the Advanced SIMD functionality. The possible values of this bit are:
0 Exception was not caused by trapped use of Advanced SIMD functionality.
1 Exception was caused by trapped use of Advanced SIMD functionality.

Any use of an Advanced SIMD instruction that is trapped to Hyp mode because of a trap configured in the HCPTR sets this bit to 1.

ISS[4] Reserved, UNK/SBZP.

ISS[3:0] coproc. The number of the coprocessor accessed by the trapped operation, 10 or 11. This field is valid only when ISS[5] returns 0. Otherwise, it is UNK/SBZP.

Any use of a floating-point instruction or access to a register in the Advanced SIMD and floating-point register bank that is trapped to Hyp mode because of a trap configured in the HCPTR sets this field to 0xA.

The following sections describe the configuration settings for the traps that are reported using EC value 0x07:

- [Trapping of Advanced SIMD functionality on page G1-3512](#).
- [General trapping of coprocessor accesses on page G1-3512](#)

ISS encoding for Hypervisor Call exception, or Supervisor Call exception routed to Hyp mode

These are the exceptions with the following EC values:

- 0x11, Supervisor Call exception taken to Hyp mode.
- 0x12, Hypervisor Call exception.

———— **Note** —————

- A Supervisor Call exception is generated by executing an SVC instruction, see [SVC \(previously SWI\) on page F7-2926](#).
- A Hypervisor Call exception is generated by executing an HVC instruction, see [HVC on page F7-3040](#).

When HSR.EC returns one of these values, the encoding of the ISS field is:



ISS[24:16] Reserved, UNK/SBZP.

ISS[15:0] imm16. The value of the immediate field from the issued instruction.

For an SVC instruction:

- If the instruction is unconditional:
 - For the 16-bit T32 instruction, this field is zero-extended from the imm8 field of the instruction.
 - For the A32 instruction, this field is the bottom 16 bits of the imm24 field of the instruction.
- If the instruction is conditional, this field is UNKNOWN.

———— **Note** ————

The HVC instruction is unconditional, and a conditional SVC instruction generates a Supervisor Call exception that is routed to Hyp mode only if it passes its condition code check. Therefore, the syndrome information for these exceptions does not include conditionality information.

[Supervisor Call exception, when HCR.TGE is set to 1 on page G1-3452](#) describes the configuration settings for the trap reported with EC value 0x11.

ISS encoding for trapped SMC execution

This is the exception with EC value 0x13. When HSR.EC returns this value, the ISS field does not return any syndrome information, and the encoding of the ISS field is:

ISS[24:0] Reserved, UNK/SBZP.

———— **Note** ————

SMC instructions cannot be trapped if they fail their condition code check. Therefore, the syndrome information for this exception does not include conditionality information.

[Trapping use of the SMC instruction on page G1-3510](#) describes the configuration settings for this trap, for instructions executed in Non-secure PL1 modes.

ISS encoding for Prefetch Abort exceptions taken to Hyp mode

These are the exceptions with the following EC values:

- 0x20, for a Prefetch Abort exception taken from a mode other than Hyp mode and routed to Hyp mode.
- 0x21, for a Prefetch Abort exception taken from Hyp mode.

When HSR.EC returns one of these values, the encoding of the ISS field is:

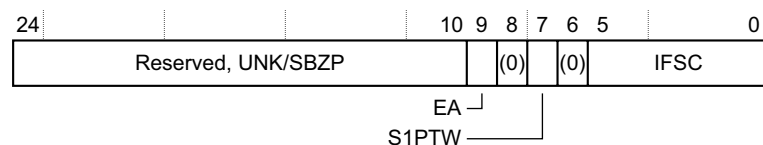

ISS[24:10] Reserved, UNK/SBZP.

ISS[9] EA, External abort type. Can provide an IMPLEMENTATION DEFINED classification of external aborts. If the implementation does not provide any classification of external aborts, this bit is UNK/SBZP.

For any abort other than an External abort this bit returns a value of 0.

———— **Note** ————

This bit is equivalent to the IFSR.ExT bit.

ISS[8] Reserved, UNK/SBZP.

- ISS[7]** S1PTW. For a stage 2 fault, indicates whether the fault was a fault on the stage 2 translation of an address accessed during a stage 1 translation table walk:
- 0** Fault not on a stage 2 translation for a stage 1 translation table walk.
 - 1** Fault on the stage 2 translation of an access for a stage 1 translation table walk.
- For a stage 1 fault, this bit is UNK/SBZP.
- ISS[6]** Reserved, UNK/SBZP.
- ISS[5:0]** IFSC, Instruction fault status code. Indicates the fault that caused the exception, using the fault codes defined for use with the Long-descriptor translation table format, see [PLI fault reporting with the Long-descriptor translation table format on page G3-3665](#).

———— **Note** ————

This field is equivalent to the **IFSR.STATUS** field, and only valid **IFSR.STATUS** values are valid for this field.

—————

The following sections describe cases where Prefetch Abort exceptions can be routed to Hyp mode, generating exceptions that are reported in the **HSR** with EC value 0x20:

- [External abort, when HCR.TGE is set to 1 on page G1-3453](#).
- [Routing Debug exceptions to Hyp mode on page G1-3454](#).

ISS encoding for Data Abort exceptions taken to Hyp mode

These are the exceptions with the following EC values:

- 0x24, for a Data Abort exception taken from a mode other than Hyp mode and routed to Hyp mode.
- 0x25, for a Data Abort exception taken from Hyp mode.

When **HSR.EC** returns one of these values, the encoding of the ISS field is:

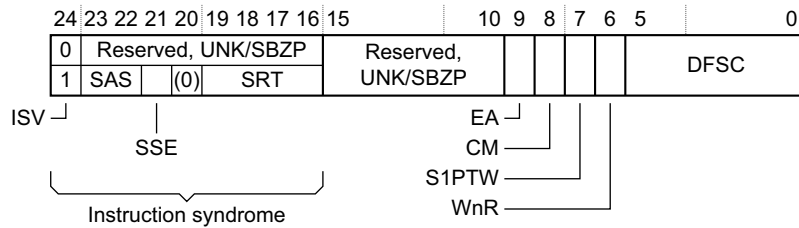

- ISS[24]** Instruction syndrome valid. Indicates whether ISS[24:16] provide a valid instruction syndrome, as part of the returned ISS. The possible values of this bit are:
- 0** No valid instruction syndrome. ISS[23:16] are UNK/SBZP.
 - 1** ISS[24:16] hold a valid instruction syndrome.

This bit is 0 for all faults except for those generated by a stage 2 translation. For Data Abort exceptions generated by a stage 2 translation, this bit is 1 and a valid instruction syndrome is returned only if all of the following are true:

- The instruction that generated the Data Abort exception:
 - Is an LDR, LDRT, LDRSH, LDRSHT, LDRH, LDRHT, LDRSB, LDRSBT, LDRB, LDRBT, STR, STRT, STRH, STRHT, STRB, or STRBT.
 - Is not performing register writeback.
 - Is not using the PC as its destination register.

———— **Note** ————

- For ISS reporting, a stage 2 abort on a stage 1 translation table lookup is treated as a stage 1 Translation fault, and does not return a valid instruction syndrome.
- In the A32 instruction set, LDR*T and STR*T instructions always perform register writeback and therefore never return a valid instruction syndrome.

- A valid instruction syndrome provides information that can help a hypervisor to emulate the instruction efficiently. Instruction syndromes are returned for instructions for which such accelerated emulation is possible.

ISS[23:16], when ISS[24] is 0

Reserved, UNK/SBZP.

ISS[23:16], when ISS[24] is 1

The remainder of the valid instruction syndrome, defined as follows:

ISS[23:22] SAS, Syndrome access size. Indicate the size of the access attempted by the faulted operation. The possible values of this field are:

0b00 Byte.
0b01 Halfword.
0b10 Word.
0b11 Reserved.

ISS[21] SSE, Syndrome sign extend. For a byte or halfword load operation, indicates whether the data item must be sign extended. For these cases, the possible values of this bit are:

0 Sign-extension not required.
1 Data item must be sign-extended.

For all other operations this bit is 0.

ISS[20] Reserved, UNK/SBZP.

ISS[19:16] SRT, Syndrome Register Transfer. The value of the Rt operand of the faulting instruction. This specifies:

- The destination register for a load operation.
- The source register for a store operation.

Note

Normally, software emulating an instruction must consider both the Rt value and the Mode value saved in the [SPSR](#), to determine the physical register to access.

ISS[15:10] Reserved, UNK/SBZP.

ISS[9] EA, External abort type. Can provide an IMPLEMENTATION DEFINED classification of external aborts. If the implementation does not provide any classification of external aborts, this bit is UNK/SBZP.

For any abort other than an External abort this bit returns a value of 0.

Note

This bit is equivalent to the [DFSR.ExT](#) bit.

ISS[8] CM, Cache maintenance. For a synchronous fault, identifies fault that comes from a cache maintenance or address translation operation. For synchronous faults, the possible values of this bit are:

0 Fault not generated by a cache maintenance or address translation operation.
1 Fault generated by a cache maintenance or address translation operation.

For asynchronous faults, this bit is 0.

Note

This bit is equivalent to the [DFSR.CM](#) bit.

ISS[7] S1PTW. For a stage 2 fault, indicates whether the fault was a fault on the stage 2 translation of an address accessed during a stage 1 translation table walk:
0 Fault not on a stage 2 translation for a stage 1 translation table walk.
1 Fault on the stage 2 translation of an access for a stage 1 translation table walk.
For a stage 1 fault, this bit is UNK/SBZP.

ISS[6] WnR. Indicates whether a synchronous abort was caused by a write or a read operation. The possible values of this bit are:
0 Abort caused by a read operation.
1 Abort caused by a write operation.
For synchronous faults on cache maintenance and address translation operations, this bit always returns a value of 1.

———— **Note** —————

ISS[8] is set to 1 to identify a fault on a cache maintenance or address translation operation.

For an asynchronous Data Abort exception this bit is UNKNOWN.

———— **Note** —————

This bit is equivalent to the [DFSR.WnR](#) bit.

ISS[5:0] DFSC, Data fault status code. Indicates the fault that caused the exception, using the fault codes defined for use with the Long-descriptor translation table format, see [PL1 fault reporting with the Long-descriptor translation table format on page G3-3665](#).

———— **Note** —————

This field is equivalent to the [DFSR.STATUS](#) field, and all valid [DFSR.STATUS](#) values are valid for this field.

The following describe cases where Data Abort exceptions can be routed to Hyp mode, generating exceptions that are reported in the [HSR](#) with EC value 0x24:

- [MMU fault, when HCR.TGE is set to 1 on page G1-3453](#).
- [External abort, when HCR.TGE is set to 1 on page G1-3453](#).
- [Routing Debug exceptions to Hyp mode on page G1-3454](#).

G3.13.7 Summary of register updates on exceptions taken to Hyp mode

For memory system faults that generate exceptions that are taken to Hyp mode, [Table G3-33 on page G3-3683](#) shows the registers affected by each fault. In this table:

- Yes indicates that the register is updated.
- UNK indicates that the fault makes the register value UNKNOWN.
- A null entry, -, indicates that the fault does not affect the register.

Table G3-33 Effect of an exception taken to Hyp mode on the reporting registers

Fault	HSR	HIFAR	HDFAR	HPFAR
Faults reported as Prefetch Abort exceptions:				
Address translation fault ^a at stage 1.	Yes	Yes	UNK	UNK
Address translation or Access flag fault ^a at stage 2.	Yes	Yes	UNK	Yes
Address translation fault ^a at stage 2.	Yes	Yes	UNK	UNK
Address translation stage 2 fault ^a on stage 1 translation.	Yes	Yes	UNK	Yes
Synchronous external abort on translation table walk.	Yes	Yes	UNK	UNK
Synchronous parity error on translation table walk.	Yes	Yes	UNK	UNK
Synchronous external abort.	Yes	Yes	UNK	UNK
Synchronous parity error on memory access.	Yes	Yes	UNK	UNK
TLB conflict abort.	Yes	Yes	UNK	UNK
Fault reported as Data Abort exception:				
Alignment fault, always synchronous	Yes	UNK	Yes	UNK
Address translation fault ^a at stage 1.	Yes	UNK	Yes	UNK
Address translation Translation or Access flag fault ^a at stage 2.	Yes	UNK	Yes	Yes
Address translation Permission fault ^a at stage 2.	Yes	UNK	Yes	UNK
Address translation stage 2 fault ^a on stage 1 translation.	Yes	UNK	Yes	Yes
Synchronous external abort on translation table walk.	Yes	UNK	Yes	UNK
Synchronous parity error on translation table walk.	Yes	UNK	Yes	UNK
Synchronous external abort.	Yes	UNK	Yes	UNK
Synchronous parity error on memory access.	Yes	UNK	Yes	UNK
Asynchronous external abort.	Yes	UNK	UNK	UNK
Asynchronous parity error on memory access.	Yes	UNK	UNK	UNK
TLB conflict abort.	Yes	UNK	Yes	UNK
Debug exception:				
Software Breakpoint Instruction ^b , generates a Prefetch Abort exception.	Yes	UNK	-	UNK
Debug exception routed to Hyp mode because HDCR.TDE is set to 1. Generates a Hyp Trap exception.				
Breakpoint Software Breakpoint Instruction or Vector Catch	Yes	UNK	-	UNK
Watchpoint	Yes	-	Yes	UNK

a. For more information see [Classification of MMU faults taken to Hyp mode on page G3-3684](#)

b. All other debug exceptions are not permitted in Hyp mode.

Note

Unlike [Table G3-29 on page G3-3667](#), the Hyp mode fault reporting table does not include an entry for a fault on an instruction cache maintenance operation. That is because, when the fault is taken to Hyp mode, the reporting indicates the cause of the fault, for example a Translation fault, and ISS.CM is set to 1 to indicate that the fault was on a cache maintenance operation, see [ISS encoding for Data Abort exceptions taken to Hyp mode on page G3-3680](#).

Classification of MMU faults taken to Hyp mode

This subsection gives more information about the MMU faults shown in [Table G3-33 on page G3-3683](#).

Note

All MMU faults are synchronous.

The table uses the following descriptions for MMU faults taken to Hyp mode:

Address translation fault at stage 1

This is an address translation fault generated on a stage 1 translation performed in the Non-secure PL2 translation regime.

Address translation fault at stage 2

This is an address translation fault generated on a stage 2 translation performed in the Non-secure PL1&0 translation regime.

As the table shows, for the faults in this group:

- Translation and Access flag faults update the [HPFAR](#)
- Permission faults leave the [HPFAR](#) UNKNOWN.

Address translation stage 2 fault on a stage 1 translation

This is an address translation fault generated on the stage 2 translation of an address accessed in a stage 1 translation table walk performed in the Non-secure PL1&0 translation regime. For more information about these faults see [Stage 2 fault on a stage 1 translation table walk on page G3-3654](#).

[Figure G3-1 on page G3-3563](#) shows the different translation regimes and associated stages of translation.

G3.14 Virtual Address to Physical Address translation operations

The system register space includes operations for *Virtual Address (VA)* to *Physical Address (PA)* translation. [Address translation operations, functional group on page G3-3745](#) summarizes these operations.

When using the Short-descriptor translation table format, all VA to PA translations take account of TEX remap when this is enabled, see [Short-descriptor format memory region attributes, with TEX remap on page G3-3620](#).

A VA to PA translation operation returns the PA in the **PAR**. This is a 64-bit register, that can hold PAs of up to 40 bits.

The following sections give more information about these operations:

- [Naming of the address translation operations, and operation summary.](#)
- [Encoding and availability of the address translation operations on page G3-3687.](#)
- [Determining the PAR format on page G3-3688.](#)
- [Handling of faults and aborts during an address translation operation on page G3-3688.](#)

G3.14.1 Naming of the address translation operations, and operation summary

Some older documentation uses the original names for the Address translation operations that were included in the original ARMv7 documentation. [Table G3-34](#) summarizes the operations that are available in AArch32 state, and relates the old operation names to the current names.

Table G3-34 Naming of address translation operations

Name	Old name	Description
ATS1CPR, ATS1CPW, ATS1CUR, ATS1CUW	V2PCWPR, V2PCWPW, V2PCWUR, V2PCWUW	See Address translation stage 1, current security state on page G3-3686
ATS12NSOPR, ATS12NSOPW, ATS12NSOUR, ATS12NSOUW	V2POWPR, V2POWPW, V2POWUR, V2POWUW	See Address translation stages 1 and 2, Non-secure state only on page G3-3686
ATS1HR, ATS1HW	Not applicable ^a	See Address translation stage 1, Hyp mode on page G3-3686

a. Operations are part of EL2 and have no equivalent in the older descriptions.

In an implementation that does not include EL2, there is no distinction between stage 1 translations and stage 1 and 2 combined translations.

In the *stage 1 current state* and *stages 1 and 2 Non-secure state only* operations, the meanings of the last two letters of the names are:

PR	PL1 mode, read operation.
PW	PL1 mode, write operation.
UR	User mode, read operation.
UW	User mode, write operation.

———— **Note** —————

User mode can be described as an unprivileged mode. It is the only PL0 mode.

In the *stage 1 Hyp mode* operations, the last letter of the operation name is **R** for the read operation and **W** for the write operation.

The following sections describe the use and availability of these operations:

- [Address translation stage 1, current security state on page G3-3686.](#)
- [Address translation stages 1 and 2, Non-secure state only on page G3-3686.](#)
- [Address translation stage 1, Hyp mode on page G3-3686.](#)

[Encoding and availability of the address translation operations on page G3-3687](#) gives the encodings of the operations.

Address translation stage 1, current security state

These are the ATS1Cxx operations. Any VMSAv8-32 implementation supports these operations. They can be executed by any software executing at PL1 or higher, in either Security state.

These instructions perform the address translations of the PL1&0 translation regime.

In an implementation that includes EL2, when executed in Non-secure state, these operations return the IPA that is the output address of the stage 1 translation. [Figure G3-1 on page G3-3563](#) shows the different translation regimes.

———— Note —————

The Non-secure PL1 and PL0 modes have no visibility of the stage 2 address translations, that can be defined only at PL2, and translate IPAs to be PAs.

See [Determining the PAR format on page G3-3688](#) for the format used when returning the result of these operations.

Address translation stages 1 and 2, Non-secure state only

These are the ATS12NSOxx operations. A VMSAv8-32 implementation supports these operations only if it includes EL2. In an implementation that includes EL2, in AArch32 state, they can be executed:

- If the implementation includes EL3, by any software executing in Secure state at PL1.
- If the implementation includes EL2, by software executing in Non-secure state at PL2. This means by software executing in Hyp mode.

In an implementation that does not include EL2, but includes EL3, when EL3 is using AArch32 these instructions are not undefined but each instruction behaves in the same way as the equivalent *ATSIC** instruction.

ARM deprecates use of these operations from any Secure PL1 mode other than Monitor mode.

In Secure state and in Non-secure Hyp mode these operations perform the translations made by the Non-secure PL1&0 translation regime.

These operations always return the PA and final attributes generated by the translation. That is, for an implementation that includes EL2, they return:

- The result of the two stages of address translation for the specified Non-secure input address.
- The memory attributes obtained by the combination of the stage 1 and stage 2 attributes.

———— Note —————

From Hyp mode, the ATS1Cxx and ATS12NSOxx operations both return the results of address translations that would be performed in the Non-secure modes other than Hyp mode. The difference is:

- The ATS1Cxx operations return the Non-secure PL1 view of these operations. That is, they return the IPA output address corresponding to the VA input address.
- The ATS12NSOxx operations return the EL2, or Hyp mode, view of these operations. That is, they return the PA output address corresponding to the VA input address, generated by two stages of translation.

See [Determining the PAR format on page G3-3688](#) for the format used when returning the result of these operations.

Address translation stage 1, Hyp mode

These are the ATS1Hx operations. A VMSAv8-32 implementation supports these operations only if it includes EL2. They can be executed by:

- Software executing in Non-secure state at PL2. This means by software executing in Hyp mode.
- Software executing in Secure state in Monitor mode.

These operations are UNPREDICTABLE if used in a Secure PL1 mode other than Monitor mode.

These operations perform the translations made by the Non-secure EL2 translation regime. The operation takes a VA input address and returns a PA output address.

These operations always return a result in a 64-bit format [PAR](#).

G3.14.2 Encoding and availability of the address translation operations

Software executing at PL0 never has any visibility of the address translation operations, but software executing at PL1 or higher can use the unprivileged address translation operations to find the address translations used for memory accesses by software executing at PL0 and PL1.

———— **Note** ————

For information about translations when the stage of address translation is disabled see [The effects of disabling address translation stages on VMSAv8-32 behavior on page G3-3569](#).

[Table G3-35](#) shows the encodings for the address translation operations, and their availability in different implementations in different PE modes and states.

Table G3-35 Address translation operations in AArch32 state

opc1	CRm	opc2	Name	Type	Description
All VMSAv8-32 implementations, in all modes, at PL1 or higher					
0	c8	0	ATS1CPR	WO	PL1 stage 1 read translation, current state ^a
		1	ATS1CPW	WO	PL1 stage 1 write translation, current state ^a
		2	ATS1CUR	WO	Unprivileged stage 1 read translation, current state ^a
		3	ATS1CUW	WO	Unprivileged stage 1 write translation, current state ^a
Implementations that include EL2, in Non-secure Hyp mode and Secure PL1 modes					
0	c8	4	ATS12NSOPR	WO	Non-secure PL1 stage 1 and 2 read translation ^b
		5	ATS12NSOPW	WO	Non-secure PL1 stage 1 and 2 write translation ^b
		6	ATS12NSOUR	WO	Non-secure unprivileged stage 1 and 2 read translation ^b
		7	ATS12NSOUW	WO	Non-secure unprivileged stage 1 and 2 write translation ^b
Implementations that include EL2, in Non-secure Hyp mode and Secure Monitor mode					
4	c8	0	ATS1HR	WO	Hyp mode stage 1 read translation ^c
		1	ATS1HW	WO	Hyp mode stage 1 write translation ^c

- a. For more information about these operations see [Address translation stage 1, current security state on page G3-3686](#).
- b. For more information about these operations see [Address translation stages 1 and 2, Non-secure state only on page G3-3686](#).
- c. For more information about these operations see [Address translation stage 1, Hyp mode on page G3-3686](#).

The result of an operation is always returned in the [PAR](#). The [PAR](#) is a RW register and:

- In all implementations, the 32-bit format [PAR](#) is accessed using an MCR or MRC instruction with CRn set to c7, CRm set to c4, and opc1 and opc2 both set to 0.
- The 64-bit format [PAR](#) is accessed using an MCRR or MRRC instruction with CRm set to c7, and opc1 set to 0.

Address translation operations that are not available in a particular implementation are reserved and UNPREDICTABLE. For example, in an implementation that does not include EL3, the encodings with `opc2` values of 4-7, and the encodings with an `opc1` value of 4, are reserved and UNPREDICTABLE.

G3.14.3 Determining the PAR format

The `PAR` is a 64-bit register, that supports both 32-bit and 64-bit `PAR` formats. This section describes how the `PAR` format is determined, for returning a result from each of the groups of address translation operations. The returned result might be the translated address, or might indicate a fault on the translation, see *Handling of faults and aborts during an address translation operation*.

ATS1Cxx operations

Address translations for the current state. From modes other than Hyp mode:

- `TTBCR.EAE` determines whether the result is returned using the 32-bit or the 64-bit `PAR` format.
- If the implementation includes EL3, the translation performed is for the current security state and, depending on that state:
 - The Secure or Non-secure `TTBCR.EAE` determines the `PAR` format.
 - The result is returned to the Secure or Non-secure instance of the `PAR`.

Operations from Hyp mode always return a result to the Non-secure `PAR`, using the 64-bit format.

ATS12NSOxx operations

Address translations for the Non-secure PL1 and PL0 modes. These operations return a result using the 64-bit `PAR` format if at least one of the following is true:

- The Non-secure `TTBCR.EAE` bit is set to 1.
- The implementation includes EL2, and the value of `HCR.VM` is 1.

Otherwise, the operation returns a result using the 32-bit `PAR` format.

Operations from a Secure PL1 mode return a result to the Secure `PAR`. Operations from Hyp mode return a result to the Non-secure `PAR`.

ATS1Hx operations

Address translations from Hyp mode. These operations always return a result using the 64-bit `PAR` format.

Operations from Secure Monitor mode return a result to the Secure `PAR`. Operations from Non-secure Hyp mode return a result to the Non-secure `PAR`.

G3.14.4 Handling of faults and aborts during an address translation operation

When a stage of address translation is enabled, any corresponding address translation operation requires a translation table lookup, and this might require a translation table walk. However, the input address for the translation might be a faulting address, either because:

- The translation table entries used for the translation indicate a fault.
- A stage 2 fault or an external abort occurs on the required translation table walk.

VMSAv8-32 memory aborts on page G3-3647 describes the faults that might occur on a translation table walk in AArch32 state.

How the fault is handled, and whether it generates an exception, depends on the cause of the fault, as described in:

- *MMU fault on an address translation operation on page G3-3689*.
- *External abort during an address translation operation on page G3-3689*.
- *Stage 2 fault on a current state address translation operation on page G3-3690*.

MMU fault on an address translation operation

In the following cases, an MMU fault on an address translation is reported in the [PAR](#), and no abort is taken. This applies:

- For a faulting address translation operation executed in Hyp mode, or in a Secure PL1 mode.
- For a faulting address translation operation executed in a Non-secure PL1 mode, for cases where the fault would generate a stage 1 abort if it occurred on the on the equivalent load or store operation.

Using the PAR to report a fault on an address translation operation gives more information about how these faults are reported.

———— Note —————

- The Domain fault encodings shown in [Table G3-27 on page G3-3665](#) are used only for reporting a fault on an address translation operation that uses the 64-bit [PAR](#) format. That is, they are used only in an implementation that includes EL2, and are used for reporting a Domain fault on either:
 - An [ATS1Cxx](#) operation from Hyp mode.
 - An [ATS12NSOxx](#) operation when [HCR.VM](#) is set to 1.These encodings are never used for fault reporting in the [DFSR](#), [IFSR](#), or [HSR](#).
- For an address translation operation executed in a Non-secure PL1 mode, for a fault that would generate a stage 2 abort if it occurred on the equivalent load or store operation, the stage 2 abort is generated as described in [Stage 2 fault on a current state address translation operation on page G3-3690](#).

Using the PAR to report a fault on an address translation operation

For a fault on an address translation operation for which no abort is taken, the [PAR](#) is updated with the following information, to indicate the fault:

- The fault code, that would normally be written to the Fault status register. The code used depends on the current translation table format, as described in either:
 - [PL1 fault reporting with the Short-descriptor translation table format on page G3-3663](#).
 - [PL1 fault reporting with the Long-descriptor translation table format on page G3-3665](#).See also the Note at the start of [Determining the PAR format on page G3-3688](#) about the Domain fault encodings shown in [Table G3-27 on page G3-3665](#).
- A status bit, that indicates that the translation operation failed.

The fault does not update any Fault Address Register.

External abort during an address translation operation

As stated in [External abort on a translation table walk on page G3-3657](#), an external abort on a translation table walk generates a Data Abort exception. The abort can be synchronous or asynchronous, and behaves as follows:

Synchronous external abort on a translation table walk

The fault status and fault address registers of the Security state to which the abort is taken are updated. The fault status register indicates the appropriate external abort on a Translation fault, and the fault address register indicates the input address for the translation.

The [PAR](#) is UNKNOWN.

Asynchronous external abort on a translation table walk

The fault status register of the Security state to which the abort is taken is updated, to indicate the asynchronous external abort. No fault address registers are updated.

The [PAR](#) is UNKNOWN.

Stage 2 fault on a current state address translation operation

If the PE is in a Non-secure PL1 mode and performs one of the ATS1C** operations, then a fault in the stage 2 translation of an address accessed in a stage 1 translation table lookup generates an exception. This is equivalent to the case described in [Stage 2 fault on a stage 1 translation table walk on page G3-3654](#). When this fault occurs on an ATS1C** address translation operation:

- A Hyp Trap exception is taken to Hyp mode.
- The **PAR** is UNKNOWN.
- The **HSR** indicates that:
 - The fault occurred on a translation table walk.
 - The operation that faulted was a cache maintenance operation.
- The **HPFAR** holds the IPA that faulted.
- The **HDFAR** holds the VA that the executing software supplied to the address translation operation.

G3.15 About the System registers for VMSAv8-32

In AArch32 state, the System registers comprise:

- The registers accessed using the System Control Coprocessor interface, CP15.
- Registers accessed using the CP14 coprocessor interface, including:
 - Debug registers.
 - Trace registers.
 - Legacy execution environment registers.

Organization of the CP14 registers in VMSAv8-32 on page G3-3713 summarizes the CP14 registers, and indicates where the CP14 registers are described, either in this manual or in other architecture specifications.

Organization of the CP15 registers in VMSAv8-32 on page G3-3716 summarizes the CP15 registers, and indicates where in this manual the CP15 registers are described.

This section gives general information about the control registers, the CP14 and CP15 interfaces to these registers, and the conventions used in describing these registers.

———— **Note** —————

Many implementations include other interfaces to some functional groups of CP14 and CP15 registers, for example memory-mapped interfaces to the CP14 Debug registers. These are described in the appropriate sections of this manual.

This section is organized as follows:

- *About System register accesses.*
- *General behavior of System registers on page G3-3693.*
- *Classification of System registers on page G3-3696.*
- *Synchronization of changes to System registers on page G3-3706.*
- *Meaning of fixed bit values in register diagrams on page G3-3711.*

G3.15.1 About System register accesses

Most AArch32 System registers are 32 bits wide. *Accessing 32-bit control registers on page G3-3692* describes how these registers are accessed.

A small number of the AArch32 System registers are 64 bits wide. *Accessing 64-bit control registers on page G3-3692* describes how these registers are accessed.

When using the MCR, MRC, MCRR, and MRRC instructions to access these registers, the instruction arguments include:

- A coprocessor identifier, coproc, as a value p0-p15, corresponding to CP0-CP15.
- A coprocessor register, CRn or CRm, as a value c0-c15, to specify a coprocessor register number.
- An opcode, opc1 or opc2, as a value in the range 0-7.

———— **Note** —————

- When accessing CP15, the primary coprocessor register is the top-level indicator of the accessed functionality, and when:
 - Using an MCR or MRC instruction, CRn specifies the primary coprocessor register.
 - Using an MCRR or MRRC instruction, CRm specifies the primary coprocessor register.
- When accessing CP14 using any of these instructions, opc1 is the top-level indicator of the accessed functionality.

Ordering of reads of System registers

Reads of the System registers can occur out of order with respect to earlier instructions executed on the same PE, provided that the data dependencies between the instructions, specified in [Synchronization of changes to System registers on page G3-3706](#), are met.

———— Note —————

In particular, System registers holding self-incrementing counts, for example the Performance Monitors counters or the Generic Timer counter or timers, can be read *early*. This means that, for example, if a memory communication is used to communicate a read of the Generic Timer counter, an ISB must be inserted between the read of the memory location used for this communication and the read of the Generic Timer counter if it is required that the Generic Timer counter returns a count value that is later than the memory communication.

Accessing 32-bit control registers

Software accesses a 32-bit control register using the generic MCR and MRC coprocessor interface, specifying:

- A coprocessor identifier, coproc, identifying a valid coprocessor, CP14 or CP15.
- Two coprocessor registers, CRn and CRm. CRn specifies the primary coprocessor register.
- Two coprocessor-specific opcodes, opc1 and opc2.
- A general-purpose register to hold a 32-bit value to transfer to or from the coprocessor.

CP15 and CP14 provides the control registers. A PE access to a specific 32-bit control register uses:

- p15 to specify CP15, or p14 to specify CP14.
- A unique combination of CRn, opc1, CRm, and opc2, to specify the required control register.
- A general-purpose register for the transferred 32-bit value.

The PE accesses a 32-bit control register using:

- An MCR instruction to write to a control register, see [MCR, MCR2 on page F7-2700](#).
- An MRC instruction to read a control register, see [MCR, MCR2 on page F7-2700](#).

Accessing 64-bit control registers

Software accesses a 64-bit control register using the generic MCRR and MRRC coprocessor interface, specifying:

- A coprocessor identifier, coproc, identifying a valid coprocessor, CP14 or CP15.
- A coprocessor register, CRm. In this case, CRm specifies the primary coprocessor register.
- A single coprocessor-specific opcode, opc1.
- Two general-purpose registers to hold two 32-bit values to transfer to or from the coprocessor.

CP15 and CP14 provide the control registers. A PE access to a specific 64-bit System register uses:

- p15 to specify CP15, or p14 to specify CP14.
- A unique combination of CRm and opc1, to specify the required 64-bit System register.
- Two general-purpose registers, each holding 32 bits of the value to transfer.

Therefore, PE accesses a 64-bit control register using:

- An MCRR instruction to write to a control register, see [MCRR, MCRR2 on page F7-2702](#).
- An MRRC instruction to read a control register, see [MCRR, MCRR2 on page F7-2702](#).

When using a MCRR or MRRC instruction:

- Rt contains the least-significant 32 bits of the transferred value, and Rt2 contains the most-significant 32 bits of that value.
- The access is 64-bit atomic.

Some 64-bit registers also have an MCR and MRC encoding. The MCR and MRC encodings for these registers access the least significant 32 bits of the register. For example, to access the **PAR**, software can:

- Use the following instructions to access all 64 bits of the register:
 MRRC p15, 0, <Rt>, <Rt2>, c7 ; Read 64-bit PAR into Rt (low word) and Rt2 (high word)
 MCRR p15, 0, <Rt>, <Rt2>, c7 ; Write Rt (low word) and Rt2 (high word) to 64-bit PAR
- Use the following instructions to access the least-significant 32 bits of the register:
 MRC p15, 0, <Rt>, c7, c4, 0 ; Read PAR[31:0] into Rt
 MCR p15, 0, <Rt>, c7, c4, 0 ; Write Rt to PAR[31:0]

G3.15.2 General behavior of System registers

Except where indicated, System registers are 32-bits wide. As stated in *About System register accesses on page G3-3691*, there are some 64-bit registers, and these include cases where software can access either a 32-bit view or a 64-bit view of a register. The register summaries, and the individual register descriptions, identify the 64-bit registers and how they can be accessed.

The following sections give information about the general behavior of these registers. Unless otherwise indicated, information applies to both CP14 and CP15 registers:

- *Read-only bits in read/write registers.*
- *UNPREDICTABLE and UNDEFINED behavior for CP14 and CP15 accesses.*
- *Read-only and write-only register encodings on page G3-3695.*
- *Reset behavior of CP14 and CP15 registers on page G3-3695.*

See also *About System register accesses on page G3-3691* and *Meaning of fixed bit values in register diagrams on page G3-3711*.

Read-only bits in read/write registers

Some read/write registers include bits that are read-only. These bits ignore writes.

An example of this is the **SCTLR.NMFI** bit, **SCTLR[27]**.

UNPREDICTABLE and UNDEFINED behavior for CP14 and CP15 accesses

In AArch32 state the following operations are UNDEFINED:

- All CDP, LDC and STC operations to CP14 and CP15, except for the LDC access to **DBGDTRTXint** and the STC access to **DBGDTRTXint** specified in *Table G3-45 on page G3-3714*.
- All MCRR and MRRC operations to CP14 and CP15, except for those explicitly defined as accessing 64-bit CP14 and CP15 registers.
- All CDP2, MCR2, MRC2, MCRR2, MRRC2, LDC2 and STC2 operations to CP14 and CP15.

Unless otherwise indicated in the individual register descriptions:

- Reserved fields in registers are RES0.
- Assigning a reserved value to a field can have an UNPREDICTABLE effect.

The following subsections give more information about UNPREDICTABLE and UNDEFINED behavior for CP14 and CP15 accesses:

- *Accesses to unallocated CP14 and CP15 encodings.*
- *Additional rules for MCR and MRC accesses to CP14 and CP15 registers on page G3-3694.*
- *Effects of EL3 and EL2 on CP15 register accesses on page G3-3694.*

Accesses to unallocated CP14 and CP15 encodings

In ARMv8-A, accesses to unallocated CP14 and CP15 register encodings are UNDEFINED.

Additional rules for MCR and MRC accesses to CP14 and CP15 registers

All MCR operations from the PC are UNPREDICTABLE for all coprocessors, including for CP14 and CP15.

All MRC operations to APSR_nzcv are UNPREDICTABLE for CP14 and CP15, except for the CP14 MRC operation to APSR_nzcv from [DBGDSCRint](#).

For registers and operations that are accessible from a particular Privilege level, any attempt to access those registers from a lower Privilege level is UNDEFINED.

Some individual registers can be made inaccessible by setting configuration bits, possibly including IMPLEMENTATION DEFINED configuration bits, to disable access to the register. The effects of the architecturally-defined configuration bits are defined individually in this manual. Unless explicitly stated otherwise in this manual, setting a configuration bit to disable access to a register results in the register becoming UNDEFINED for MRC and MCR accesses.

See also [Read-only and write-only register encodings on page G3-3695](#).

Effects of EL3 and EL2 on CP15 register accesses

EL2 and EL3 introduce classes of System registers, described in [Classification of System registers on page G3-3696](#). Some of these classes of register are either:

- Accessible only from certain modes or states.
- Accessible from certain modes or states only when configuration settings permit the access.

Accesses to these registers that are not permitted are UNDEFINED, meaning execution of the register access instruction generates an Undefined Instruction exception.

Note

This section applies only to registers that are accessible from some modes and states. That is, it applies only to register access instructions using an encoding that, under some circumstances, would perform a valid register access.

The following register classes restrict access in this way:

Restricted access System registers

This register class is defined in any implementation that includes EL3.

Restricted access registers other than the [NSACR](#) are accessible only from Secure EL3 modes. All other accesses to these registers are UNDEFINED.

The [NSACR](#) is a special case of a Restricted access register and:

- The [NSACR](#) is:
 - Read/write accessible from Secure PL1 modes.
 - Is Read-only accessible from Non-secure PL2 and PL1 modes.
- All other accesses to the [NSACR](#) are UNDEFINED.

For more information, including behavior when EL3 is using AArch64 or is not implemented, see [Restricted access System registers on page G3-3698](#).

Configurable access System registers

This register class is defined in any implementation that includes EL3.

Most Configurable access registers are accessible from Non-secure state only if control bits in the [NSACR](#) permit Non-secure access to the register. Otherwise, a Non-secure access to the register is UNDEFINED.

For other Configurable access registers, control bits in the [NSACR](#) control the behavior of bits or fields in the register when it is accessed from Non-secure state. That is, Non-secure accesses to the register are permitted, but the [NSACR](#) controls how they behave. The only architecturally-defined register of this type is the [CPACR](#).

For more information, see [Configurable access System registers on page G3-3699](#).

EL2-mode System registers

This register class is defined only in an implementation that includes EL2.

EL2-mode registers are accessible only from:

- The Non-secure EL2 mode, Hyp mode.
- Secure Monitor mode when `SCR.NS` is set to 1.

All other accesses to these registers are UNDEFINED.

For more information, see [Banked EL2-mode CP15 read/write registers on page G3-3700](#) and [EL2-mode encodings for shared CP15 registers on page G3-3701](#).

EL2-mode write-only operations

This register class is defined only in an implementation that includes EL2.

EL2-mode write-only operations are accessible only from:

- The Non-secure EL2 mode, Hyp mode.
- Secure Monitor mode, regardless of the value of `SCR.NS`.

Write accesses to these operations are:

- UNPREDICTABLE in Secure EL3 modes other than Monitor mode.
- UNDEFINED in Non-secure modes other than Hyp mode.

For more information, see [Banked EL2-mode CP15 write-only operations on page G3-3702](#).

In addition, in any implementation that includes EL3, if write access to a register is disabled by the `CP15SDISABLE` signal then any MCR access to that register is UNDEFINED.

Read-only and write-only register encodings

Some System registers are *read-only* (RO) or *write-only* (WO). For example:

- Most identification registers are read-only.
- Most encodings that perform an operation, such as a cache maintenance operation, are write-only.

If a particular Privilege level defines a register to be:

- RO, then any attempt to write to that register, at that Privilege level, is UNDEFINED. This means that any access to that register with `L == 0` is UNDEFINED.
- WO, then any attempt to read from that register, at that Privilege level, is UNDEFINED. This means that any access to that register with `L == 1` is UNDEFINED.

For IMPLEMENTATION DEFINED encoding spaces, the treatment of the encodings is IMPLEMENTATION DEFINED.

———— Note —————

- This section applies only to registers that this manual defines as RO or WO. It does not apply to registers for which other access permissions are explicitly defined.
- Although the `FPSID` is a RO register, a write using the `FPSID` encoding is a valid *serializing* operation, see [Floating-point exception traps, serialization, and floating-point exception barriers on page G1-3501](#). Such a write does not access the register.

Reset behavior of CP14 and CP15 registers

After a reset, only a limited subset of the PE state is guaranteed to be set to defined values. Also, for CP14 debug and trace registers, reset requirements must take account of different levels of reset. For more information about the reset behavior of CP14 and CP15 registers, see:

- [Reset and debug on page H8-4463](#), for the Debug CP14 registers.
- the appropriate Trace architecture specification, for the Trace CP14 registers.
- [Reset behavior of CP15 registers on page G3-3696](#).
- [Pseudocode details of resetting CP14 and CP15 registers on page G3-3696](#).

Reset behavior of CP15 registers

On reset, the VMSAv8-32 architecture defines a required reset value for all or part of each of the following CP15 registers:

- The [SCTLR](#), [CPACR](#), [TTBCR](#), and [VBAR](#). If the implementation includes EL3, unless the register description says otherwise, the defined reset values apply only to the Secure instances of these registers, and the reset values of the corresponding bits are UNKNOWN in the Non-secure instances of the registers.
- In an implementation that includes EL3, when EL3 supports AArch32, the [SCR](#) and the [NSACR](#).
- In an implementation that includes EL2, when EL2 supports AArch32, the [VPIDR](#), [VMPIDR](#), [HCR](#), [HDCR](#), [HCPTR](#), [HSTR](#), and [VTTBR](#).
- In an implementation that includes the Performance Monitors Extension, the [PMCR](#), the [PMUSERENR](#), and the instance of [PMXEVTYPER](#) that relates to the cycle counter.
- In an implementation that includes the Generic Timer Extension, the [CNTKCTL](#) and [CNTHCTL](#) registers.

Note

In an implementation that includes EL3, unless this manual explicitly states otherwise, only the Secure instance of a Banked register is reset to the defined value, and software must program the Non-secure instance of the register with the required values. Typically, this programming is part of the PE boot sequence.

For details of the reset values of these registers see the register descriptions. If the description of a register or register field does not include its reset value then the architecture does not require that register or field to reset to a defined value, and software must treat the value as UNKNOWN after a reset.

The values of all other registers at reset are architecturally UNKNOWN. An implementation can assign an IMPLEMENTATION DEFINED reset value to a register whose reset value is architecturally UNKNOWN. After a reset, software must not rely on the value of any read/write register that does not have either an architecturally-defined reset value or an IMPLEMENTATION DEFINED reset value.

Pseudocode details of resetting CP14 and CP15 registers

The `ResetControlRegisters()` pseudocode function resets all CP14 and CP15 registers, and register fields, that have defined reset values, as described in this section.

Note

For CP14 debug and trace registers this function resets registers as defined for the appropriate level of reset.

G3.15.3 Classification of System registers

Features provided by EL3 and EL2 integrate with many features of the architecture. Therefore, the descriptions of the individual System registers include information about how these Exception levels affect the register. This section:

- Summarizes how EL3 and EL2 affect the implementation of the System registers, and the classification of those registers.
- Summarizes how EL3 controls access to the System registers.
- Describes an EL3 signal that can control access to some CP15 registers.

It contains the following subsections:

- [Banked System registers on page G3-3697.](#)
- [Restricted access System registers on page G3-3698.](#)
- [Configurable access System registers on page G3-3699.](#)
- [EL2-mode System registers on page G3-3699.](#)
- [Common System registers on page G3-3702.](#)
- [The CP15SDISABLE input on page G3-3704.](#)

- [Access to registers from Monitor mode on page G3-3704.](#)

———— **Note** —————

EL3 defines the register classifications of Banked, Restricted access, Configurable, and Common. EL2 defines the EL2-mode classification. Some of these classifications can apply to some CP10 and CP11 coprocessor registers, as well as to the CP14 and CP15 System registers.

It is IMPLEMENTATION DEFINED whether each IMPLEMENTATION DEFINED register is Banked, Restricted access, Configurable, EL2-mode, or Common.

Banked System registers

In an implementation that includes EL3, some System registers are Banked. Banked System registers have two copies, one Secure and one Non-secure. The [SCR.NS](#) bit selects the Secure or Non-secure instance of the register. [Table G3-36](#) shows which CP15 registers are Banked in this way, and the permitted access to each register. No CP14 registers are Banked.

Table G3-36 Banked CP15 registers

CRn ^a	Banked register	Permitted accesses ^b
c0	CSSELR , Cache Size Selection Register	Read/write only at EL1 or higher
c1	SCTLR , System Control Register ^c	Read/write only at EL1 or higher
	ACTLR , Auxiliary Control Register ^d	Read/write only at EL1 or higher
c2	TTBR0 , Translation Table Base 0	Read/write only at EL1 or higher
	TTBR1 , Translation Table Base 1	Read/write only at EL1 or higher
	TTBCR , Translation Table Base Control	Read/write only at EL1 or higher
c3	DACR , Domain Access Control Register	Read/write only at EL1 or higher
c5	DFSR , Data Fault Status Register	Read/write only at EL1 or higher
	IFSR , Instruction Fault Status Register	Read/write only at EL1 or higher
	ADFSR , Auxiliary Data Fault Status Register ^d	Read/write only at EL1 or higher
	AIFSR , Auxiliary Instruction Fault Status Register ^d	Read/write only at EL1 or higher
c6	DFAR , Data Fault Address Register	Read/write only at EL1 or higher
	IFAR , Instruction Fault Address Register	Read/write only at EL1 or higher
c7	PAR , Physical Address Register	Read/write only at EL1 or higher
c10	PRRR , Primary Region Remap Register	Read/write only at EL1 or higher
	NMRR , Normal Memory Remap Register	Read/write only at EL1 or higher
c12	VBAR , Vector Base Address Register	Read/write only at EL1 or higher

Table G3-36 Banked CP15 registers (continued)

CRn ^a	Banked register	Permitted accesses ^b
c13	FCSEIDR, FCSE PID Register ^e	Read/write only at EL1 or higher
	CONTEXTIDR, Context ID Register	Read/write only at EL1 or higher
	TPIDRURW, User Read/Write Thread ID	Read/write at all privilege levels, including EL0
	TPIDRURO, User Read-only Thread ID	Read-only at EL0 Read/write at EL1 or higher
	TPIDRPRW, EL1 only Thread ID	Read/write only at EL1 or higher

- a. For accesses to 32-bit registers. More correctly, this is the primary coprocessor register.
- b. Any attempt to execute an access that is not permitted results in an Undefined Instruction exception.
- c. Some bits are common to the Secure and the Non-secure copies of the register, see [SCTLR, System Control Register on page G4-4005](#).
- d. Register is IMPLEMENTATION DEFINED.
- e. Banked only in an implementation that includes the FCSE. The FCSE PID Register is RAZ/WI if the FCSE is not implemented.

A Banked CP15 register can contain a mixture of:

- Fields that are Banked.
- Fields that are read-only in Non-secure PL1 or PL2 modes but read/write in the Secure state.

The System Control Register [SCTLR](#) is an example of a register of that contains this mixture of fields.

The Secure copies of the Banked CP15 registers are sometimes referred to as the Secure Banked CP15 registers. The Non-secure copies of the Banked CP15 registers are sometimes referred to as the Non-secure Banked CP15 registers.

Restricted access System registers

In an implementation that includes EL3, some System registers are present only in the Secure security state. These are called *Restricted access* registers, and their read/write access permissions are:

- In Non-secure state, software cannot modify Restricted access registers.
- For the [NSACR](#), in Non-secure state:
 - Software running at PL1 or higher can read the register.
 - Unprivileged software, meaning software running at PL0, cannot read the register.

This means that Non-secure software running at PL1 or higher can read the access permissions for System registers that have Configurable access.

If EL3 is using AArch64d then any read of the [NSACR](#) from Non-secure EL2 using AArch32, or Non-secure EL1 using AArch32, returns the value 0x00000C00.

If EL3 is not implemented, any read of the [NSACR](#) from Non-secure EL2 using AArch32, or Secure or Non-secure EL1 using AArch32, returns the value 0x00000C00.

- For all other Restricted access registers, Non-secure software cannot read the register.

Table G3-37 shows the Restricted access CP15 registers in an implementation that includes EL3. There are no Restricted access CP14 registers.

Table G3-37 Restricted access CP15 registers

CRn ^a	Register	Permitted accesses ^b
c1	SCR, Secure Configuration	Read/write in Secure PL1 modes
	SDER, Secure Debug Enable	Read/write in Secure PL1 modes
	NSACR, Non-Secure Access Control	Read/write in Secure PL1 modes Read-only in Non-secure PL1 and PL2 modes
c12	MVBAR, Monitor Vector Base Address	Read/write in Secure PL1 modes

a. For accesses to 32-bit registers. More correctly, this is the primary coprocessor register.

b. Any attempt to execute an access that is not permitted results in an Undefined Instruction exception.

Configurable access System registers

Secure software can configure the access to some System registers. These registers are called Configurable access registers, and the control can be:

- A bit in the control register determines whether the register is:
 - Accessible from Secure state only.
 - Accessible from both Secure and Non-secure states.
- A bit in the control register changes the accessibility of a register bit or field. For example, setting a bit in the control register might mean that a R/W field behaves as RAZ/WI when accessed from Non-secure state.

Bits in the NSACR control access.

In an AArch32 implementation that includes EL3:

- There are no Configurable access CP14 registers.
- The only required Configurable access CP15 register is the CPACR, Coprocessor Access Control Register.
- The following registers in the CP10 and CP11 register space are Configurable access:
 - Floating-point Status and Control Register, FPSCR
 - Floating-point Exception register, FPEXC.
 - Floating-point System ID register, FPSID.
 - Media and VFP Feature Register 0, MVFR0.
 - Media and VFP Feature Register 1, MVFR1.

EL2-mode System registers

An implementation that includes EL2, when EL2 is using AArch32 it provides a number of registers for use in the EL2 mode, Hyp mode. As with other System register encodings, some of these register encodings provide write-only operations. When the implementation includes EL3 and EL3 is using AArch32, these registers are also accessible from Monitor mode when the value of SCR.NS is 1.

The following subsections describe the EL2-mode registers:

- [Banked EL2-mode CP15 read/write registers on page G3-3700.](#)
- [EL2-mode encodings for shared CP15 registers on page G3-3701.](#)
- [Banked EL2-mode CP15 write-only operations on page G3-3702.](#)

There are no EL2-mode CP14 registers.

Banked EL2-mode CP15 read/write registers

Architecturally, these are an extension of the Banked registers described in *Banked System registers* on page G3-3697, where:

- The implementation does not implement the Secure instance of the register.
- The Non-secure instance of the register is accessible only at PL2, that is, only from Hyp mode.

Except for accesses to **CNTVOFF** in an implementation that includes EL3 but not EL2, the behavior of accesses to these registers is as follows:

- In Secure state, the registers can be accessed from Monitor mode when **SCR.NS** is set to 1, see *Access to registers from Monitor mode* on page G3-3704.
- The following accesses are UNDEFINED:
 - Accesses from Non-secure PL1 modes.
 - Accesses in Secure state when **SCR.NS** is set to 0.

In an implementation that includes EL3 but not EL2, the behavior of accesses to **CNTVOFF** is as follows:

- Any access from Secure Monitor mode is UNPREDICTABLE, regardless of the value of **SCR.NS**.
- All other accesses are UNDEFINED.

———— Note —————

Except for **CNTVOFF**, the Banked EL2-mode registers are part of EL2, meaning they are implemented only if the implementation includes EL2. However, conceptually, **CNTVOFF** is part of any implementation that includes the Generic Timer Extension, see *Status of the CNTVOFF register* on page D7-1864. This means the behavior of **CNTVOFF** in an implementation that includes the Generic Timer Extension but does not include EL2 is not covered by the general definition of the behavior of the Banked EL2-mode CP15 read/write registers.

Table G3-38 shows the EL2-mode CP15 read/write registers:

Table G3-38 Banked EL2-mode CP15 read/write registers

CRn or CRm ^a	Register	Width	Permitted accesses ^b
c0	VPIDR	32-bit	Read/write. In Non-secure state, accessible only from Hyp mode
	VMPIDR	32-bit	Read/write. In Non-secure state, accessible only from Hyp mode
c1	HSCTLR	32-bit	Read/write. In Non-secure state, accessible only from Hyp mode
	HACTLR	32-bit	Read/write. In Non-secure state, accessible only from Hyp mode
	HCR	32-bit	Read/write. In Non-secure state, accessible only from Hyp mode
	HDCR	32-bit	Read/write. In Non-secure state, accessible only from Hyp mode
	HCPTR	32-bit	Read/write. In Non-secure state, accessible only from Hyp mode
	HSTR	32-bit	Read/write. In Non-secure state, accessible only from Hyp mode
	HACR	32-bit	Read/write. In Non-secure state, accessible only from Hyp mode
c2	HTCR	32-bit	Read/write. In Non-secure state, accessible only from Hyp mode
	VTCR	32-bit	Read/write. In Non-secure state, accessible only from Hyp mode
	HTTBR	64-bit	Read/write. In Non-secure state, accessible only from Hyp mode
	VTTBR	64-bit	Read/write. In Non-secure state, accessible only from Hyp mode

Table G3-38 Banked EL2-mode CP15 read/write registers (continued)

CRn or CRm ^a	Register	Width	Permitted accesses ^b
c5	HADFSR	32-bit	Read/write. In Non-secure state, accessible only from Hyp mode
	HAIFSR	32-bit	Read/write. In Non-secure state, accessible only from Hyp mode
	HSR	32-bit	Read/write. In Non-secure state, accessible only from Hyp mode
c6	HPFAR	32-bit	Read/write. In Non-secure state, accessible only from Hyp mode
c10	HMAIRO	32-bit	Read/write. In Non-secure state, accessible only from Hyp mode
	HMAIR1	32-bit	Read/write. In Non-secure state, accessible only from Hyp mode
	HAMAIRO	32-bit	Read/write. In Non-secure state, accessible only from Hyp mode
	HAMAIR1	32-bit	Read/write. In Non-secure state, accessible only from Hyp mode
c12	HVBAR	32-bit	Read/write. In Non-secure state, accessible only from Hyp mode
c13	HTPIDR	32-bit	Read/write. In Non-secure state, accessible only from Hyp mode
c14	CNTVOFF^c	64-bit	Read/write. In Non-secure state, accessible only from Hyp mode

- a. CRn for accesses to 32-bit registers, CRm for accesses to 64-bit registers. More correctly, this is the primary coprocessor register.
b. Any attempt to execute an access that is not permitted results in an Undefined Instruction exception.
c. Implemented only in an implementation that includes the Generic Timer Extension. See, also, the Note earlier in this section.

EL2-mode encodings for shared CP15 registers

Some Hyp mode registers share the Secure instance of an existing Banked register. In this case the implementation includes an encoding for the register that is accessible only in Hyp mode, or in Monitor mode when [SCR.NS](#) is set to 1.

For these registers, the following accesses are UNDEFINED:

- Accesses from Non-secure PL1 modes.
- Accesses in Secure state when [SCR.NS](#) is set to 0.

[Table G3-39](#) lists the EL2-mode encodings for shared registers.

Table G3-39 EL2-mode CP15 register encodings for shared registers

CRn ^a	Register	Permitted accesses ^b	Shared register
c6	HDFAR	Read/write. In Non-secure state, accessible only from Hyp mode ^c	Secure DFAR
c6	HIFAR	Read/write. In Non-secure state, accessible only from Hyp mode ^c	Secure IFAR

- a. For accesses to 32-bit registers. More correctly, this is the primary coprocessor register.
b. Any attempt to execute an access that is not permitted results in an Undefined Instruction exception.
c. Also accessible from Monitor mode when [SCR.NS](#) set to 1.

In Monitor mode, the Secure copies of these registers can be accessed either:

- Using the [DFAR](#) or [IFAR](#) encoding with [SCR.NS](#) set to 0.
- Using the [HDFAR](#) or [HIFAR](#) encoding with [SCR.NS](#) set to 1.

However, between accessing a register using one alias and accessing the register using the other alias, a *Context synchronization operation* is required to ensure the ordering of the accesses.

Banked EL2-mode CP15 write-only operations

Architecturally, these encodings are an extension of the Banked register encodings described in *Banked System registers* on page G3-3697, where:

- The implementation does not implement the operation in Secure state.
- In Non-secure state, the operation is accessible only at EL2, that is, only from Hyp mode.

In Secure state:

- These operations can be accessed from Monitor mode regardless of the value of SCR.NS, see *Access to registers from Monitor mode* on page G3-3704.
- Accesses to these operations are UNPREDICTABLE if executed in a Secure mode other than Monitor mode.

Accesses to these operations are UNDEFINED if accessed from a Non-secure PL1 mode.

Table G3-40 shows the EL2-mode CP15 write-only operations:

Table G3-40 Banked EL2-mode CP15 write-only operations

CRn	Register	Width	Permitted accesses ^a
c8	ATS1HR	32-bit	Write-only. In Non-secure state, accessible only from Hyp mode
	ATS1HW	32-bit	Write-only. In Non-secure state, accessible only from Hyp mode
	TLBIALLHIS	32-bit	Write-only. In Non-secure state, accessible only from Hyp mode
	TLBIMVAHIS	32-bit	Write-only. In Non-secure state, accessible only from Hyp mode
	TLBIALLNSNHIS	32-bit	Write-only. In Non-secure state, accessible only from Hyp mode
	TLBIALLH	32-bit	Write-only. In Non-secure state, accessible only from Hyp mode
	TLBIMVAH	32-bit	Write-only. In Non-secure state, accessible only from Hyp mode
	TLBIALLNSNH	32-bit	Write-only. In Non-secure state, accessible only from Hyp mode

a. This section describes the behavior of write accesses that are not permitted. See also *Read-only and write-only register encodings* on page G3-3695.

For more information about these operations, see *Address translation stage 1, Hyp mode* on page G3-3686.

Common System registers

Some System registers and operations are common to the Secure and Non-secure Security states. These are described as the *Common access* registers, or simply as the *Common* registers. These registers include:

- Read-only registers that hold configuration information.
- Register encodings used for various memory system operations, rather than to access registers.
- The *ISR*.
- All CP14 registers.

Table G3-41 shows the Common CP15 System registers. These registers are not affected by whether EL3 is implemented.

Table G3-41 Common CP15 registers

CRn ^a	Register	Permitted accesses ^b
c0	MIDR , Main ID Register	Read-only, only at EL1 or higher
	CTR , Cache Type Register	Read-only, only at EL1 or higher
	TCMTR , TCM Type Register ^c	Read-only, only at EL1 or higher
	TLBTR , TLB Type Register ^c	Read-only, only at EL1 or higher
	MPIDR , Multiprocessor Affinity Register	Read-only, only at EL1 or higher
	REVIDR , Revision ID	Read-only, only at EL1 or higher
c0	ID_PFRx , Processor Feature Registers	Read-only, only at EL1 or higher
	ID_DFR0 , Debug Feature Register 0	Read-only, only at EL1 or higher
	ID_AFR0 , Auxiliary Feature Register 0	Read-only, only at EL1 or higher
	ID_MMFRx , Memory Model Feature Registers	Read-only, only at EL1 or higher
	ID_ISARx , Instruction Set Attribute Registers	Read-only, only at EL1 or higher
	CCSIDR , Cache Size ID Register	Read-only, only at EL1 or higher
	CLIDR , Cache Level ID Register	Read-only, only at EL1 or higher
	AIDR , Auxiliary ID Register ^c	Read-only, only at EL1 or higher
c7	Cache maintenance operations	See Cache maintenance operations, functional group on page G3-3743
	Address translation operations	See Address translation operations, functional group on page G3-3745
	Data barrier operations	Write-only at all privilege levels, including EL0
c8	TLB maintenance operations	Write-only, only at EL1 or higher
c9	Performance monitors	See Access permissions on page D6-1851
c12	ISR , Interrupt Status Register	Read-only, only at EL1 or higher

- For accesses to 32-bit registers. More correctly, this is the primary coprocessor register.
- Any attempt to execute an access that is not permitted results in an Undefined Instruction exception.
- Register or operation details are IMPLEMENTATION DEFINED.

Secure CP15 registers

The Secure CP15 registers comprise:

- The Secure copies of the Banked CP15 registers.
- The Restricted access CP15 registers.
- The Configurable access CP15 registers that are configured to be accessible only from Secure state.

In an implementation that includes EL3, the Non-secure CP15 registers are the CP15 registers other than the Secure CP15 registers.

The CP15SDISABLE input

EL3 provides an input signal, **CP15SDISABLE**, that disables write access to some of the Secure registers when asserted HIGH.

———— Note ————

The interaction between **CP15SDISABLE** and any IMPLEMENTATION DEFINED register is IMPLEMENTATION DEFINED.

Table G3-42 shows the registers and operations affected.

Table G3-42 Secure registers affected by CP15SDISABLE

CRn	Register name	Affected operation
c1	SCTLR , System Control Register	MCR p15, 0, <Rt>, c1, c0, 0
c2	TTBR0 , Translation Table Base Register 0	MCR p15, 0, <Rt>, c2, c0, 0
	TTBCR , Translation Table Base Control Register	MCR p15, 0, <Rt>, c2, c0, 2
c3	DACR , Domain Access Control Register	MCR p15, 0, <Rt>, c3, c0, 0
c10	PRRR , Primary Region Remap Register	MCR p15, 0, <Rt>, c10, c2, 0
	NMRR , Normal Memory Remap Register	MCR p15, 0, <Rt>, c10, c2, 1
c12	VBAR , Vector Base Address Register	MCR p15, 0, <Rt>, c12, c0, 0
	MVBAR , Monitor Vector Base Address Register	MCR p15, 0, <Rt>, c12, c0, 1

On a reset by the external system, the **CP15SDISABLE** input signal must be taken LOW. This permits the Reset code to set up the configuration of EL3 features. When the input is asserted HIGH, any attempt to write to the Secure registers shown in Table G3-42 results in an Undefined Instruction exception.

The **CP15SDISABLE** input does not affect reading Secure registers, or reading or writing Non-secure registers. It is IMPLEMENTATION DEFINED how the input is changed and when changes to this input are reflected in the PE, and an implementation might not provide any mechanism for driving the **CP15SDISABLE** input HIGH. However, in an implementation in which the **CP15SDISABLE** input can be driven HIGH, changes in the state of **CP15SDISABLE** must be reflected as quickly as possible. Any change must occur before completion of a Instruction Synchronization Barrier operation, issued after the change, is visible to the PE with respect to instruction execution boundaries. Software must perform a Instruction Synchronization Barrier operation meeting the above conditions to ensure all subsequent instructions are affected by the change to **CP15SDISABLE**.

Use of **CP15SDISABLE** means key Secure features that are accessible only at PL1 can be locked in a known good state. This provides an additional level of overall system security. ARM expects control of **CP15SDISABLE** to reside in the system, in a block dedicated to security.

Access to registers from Monitor mode

When the PE is in Monitor mode, the PE is in Secure state regardless of the value of the **SCR.NS** bit. In Monitor mode, the **SCR.NS** bit determines whether valid uses of the MRC, MCR, MRRC and MCRR instructions access the Secure Banked CP15 registers or the Non-secure Banked CP15 registers. That is, when:

NS == 0 Common, Restricted access, and Secure Banked registers are accessed by CP15 MRC, MCR, MRRC and MCRR instructions.

If the implementation includes EL2, the registers listed in *Banked EL2-mode CP15 read/write registers on page G3-3700* and *EL2-mode encodings for shared CP15 registers on page G3-3701* are not accessible, and any attempt to access them generates an Undefined Instruction exception.

Note

The operations listed in [Banked EL2-mode CP15 write-only operations on page G3-3702](#) are accessible in Monitor mode regardless of the value of `SCR.NS`.

CP15 operations use the Security state to determine all resources used, that is, all CP15-based operations are performed in Secure state.

NS == 1 Common, Restricted access and Non-secure Banked registers are accessed by CP15 MRC, MCR, MRRC and MCRR instructions.

If the implementation includes EL2, all the registers and operations listed in the subsections of [EL2-mode System registers on page G3-3699](#) are accessible, using the MRC, MCR, MRRC, or MCRR instructions required to access them from Hyp mode.

CP15 operations use the Security state to determine all resources used, that is, all CP15-based operations are performed in Secure state.

The Security state determines whether the Secure or Non-secure Banked registers determine the control state.

Note

Where the contents of a register select the value accessed by an MRC or MCR access to a different register, then the register that is used for selection is being used as control state. For example, `CSSELR` selects the current `CCSIDR`, and therefore `CSSELR` is used as control state. Therefore, in Monitor mode:

- `SCR.NS` determines whether the Secure or Non-secure `CSSELR` is accessible.
- Because the PE is in Secure state, the Secure `CSSELR` selects the current `CCSIDR`.

G3.15.4 Synchronization of changes to System registers

In this section, *this PE* means the PE on which accesses are being synchronized.

———— **Note** —————

See [Definitions of direct and indirect reads and writes and their side-effects on page G3-3709](#) for definitions of the terms *direct write*, *direct read*, *indirect write*, and *indirect read*.

A *direct write* to a System register might become visible at any point after the change to the register, but without a *Context synchronization operation* there is no guarantee that the change becomes visible.

Any direct write to a System register is guaranteed not to affect any instruction that appears, in program order, before the instruction that performed the direct write, and any direct write to a System register must be synchronized before any instruction that appears after the direct write, in program order, can rely on the effect of that write. The only exceptions to this are:

- All direct writes to the same register, using the same encoding, are guaranteed to occur in program order.
- All direct writes to a register are guaranteed to occur in program order relative to all direct reads of the same register using the same encoding.
- If an instruction that appears in program order before the direct write performs a memory access, such as a memory-mapped register access, that causes an indirect read or write to a register, that memory access is subject to the ARM ordering model. In this case, if permitted by the ARM ordering model, the instruction that appears in program order before the direct write can be affected by the direct write.

These rules mean that an instruction that writes to one of the address translation operations described in [Virtual Address to Physical Address translation operations on page G3-3685](#) must be explicitly synchronized to guarantee that the result of the address translation operation is visible in the **PAR**.

———— **Note** —————

In this case, the direct write to the encoding of the address translation operation causes an *indirect write* to the **PAR**. Without a *Context synchronization operation* after the direct write there is no guarantee that the indirect write to the **PAR** is visible.

Conceptually, the explicit synchronization occurs as the first step of any *Context synchronization operation*. This means that if the operation uses state that had been changed but not synchronized before the operation occurred, the operation is guaranteed to use the state as if it had been synchronized.

———— **Note** —————

This explicit synchronization is applied as the first step of the execution of any instruction that causes the synchronization operation. This means it does not synchronize any effect of system registers that might affect the fetch and decode of the instructions that cause the operation, such as breakpoints or changes to translation tables.

Except for the register reads listed in [Registers with some architectural guarantee of ordering or observability on page G3-3708](#), if no context synchronization operation is performed, direct reads of System registers can occur in any order.

[Table G3-43 on page G3-3707](#) shows the synchronization requirement between two reads or writes that access the same System register. In the column headings, *First* and *Second* refer to:

- Program order, for any read or write caused by the execution of an instruction by this PE, other than a read or write caused by a memory access made by that instruction.
- The order of arrival of asynchronous reads or writes made by this PE relative to the execution of instructions by this PE.

In addition:

- For indirect reads or writes caused by an external agent, such as a debugger, the mechanism that determines the order of the reads or writes is defined by that external agent. The external agent can provide mechanisms that ensure that any read or write it makes arrives at the PE. These indirect reads and writes are asynchronous to software execution on the PE.
- For indirect reads or writes caused by memory-mapped reads or writes made by this PE, the ordering of the memory accesses is subject to the memory order model, including the effect of the memory type of the accessed memory address. This applies, for example, if this PE reads or writes one of its registers in a memory-mapped register interface.

The mechanism for ensuring completion of these memory accesses, including ensuring the arrival of the asynchronous read or write at the PE, is defined by the system.

———— **Note** —————

Such accesses are likely to be given the a Device memory attribute, but requiring this is outside the scope of the architecture.

- For indirect reads or writes caused by autonomous asynchronous events that count, for example events caused by the passage of time, the events are ordered so that:
 - Counts progress monotonically.
 - The events arrive at the PE in finite time and without undue delay.

Table G3-43 Synchronization requirements for updates to System registers

First read or write	Second read or write	Context synchronization operation required
Direct read	Direct read	No
	Direct write	No
	Indirect read	No ^a
	Indirect write	No ^a , but see text in this section for exceptions
Direct write	Direct read	No
	Direct write	No
	Indirect read	Yes ^a
	Indirect write	No, but see text in this section for exceptions
Indirect read	Direct read	No
	Direct write	No
	Indirect read	No
	Indirect write	No
Indirect write	Direct read	Yes, but see text in this section for exceptions
	Direct write	No, but see text in this section for exceptions
	Indirect read	Yes, but see text in this section for exceptions
	Indirect write	No, but see text in this section for exceptions

a. Although no synchronization is required between a Direct write and a Direct read, or between a Direct read and an Indirect write, this does not imply that a Direct read causes synchronization of a previous Direct write. This means that the sequence Direct write followed by Direct read followed by Indirect read, with no intervening context synchronization, does not guarantee that the Indirect read observes the result of the Direct write.

If the indirect write is to a register that *Registers with some architectural guarantee of ordering or observability* shows as having some guarantee of the visibility of an indirect writes, synchronization might not be required.

If a direct read or a direct write to a register is followed by an indirect write to that register that is caused by an external agent, or by an autonomous asynchronous event, or as a result of a memory-mapped write, then synchronization is required to guarantee the ordering of the indirect write relative to the direct read or direct write.

If an indirect write caused by a direct write is followed by an indirect write caused by an external agent, or by an autonomous asynchronous event, or as a result of a memory-mapped write, then synchronization is required to guarantee the ordering of the two indirect writes.

If a direct read causes an indirect write, synchronization is required to guarantee that the indirect write is visible to subsequent direct or indirect reads or writes. This synchronization must be performed after the direct read, before any subsequent direct or indirect read or write.

If a direct write causes an indirect write, synchronization is required to guarantee that the indirect write is visible to subsequent direct or indirect reads or writes. This synchronization must be performed after the direct write, before any subsequent direct or indirect read or write.

———— **Note** —————

Where a register has more than one encoding, a direct write to the register using a particular encoding is not an indirect write to the same register with a different encoding.

Where an indirect write is caused by the action of an external agent, such as a debugger, or by a memory-mapped read or write by the PE, then an indirect write by that agent to a register using a particular access mechanism, followed by an indirect read by that agent to the same register using the same access mechanism and address does not need synchronization.

For information about the additional synchronization requirements for memory-mapped registers, see [Synchronization requirements for system registers on page D8-1866](#).

To guarantee the visibility of changes to some registers, additional operations might be required before the context synchronization operation. For such a register, the definition of the register identifies these additional requirements.

In this manual, unless the context indicates otherwise:

- *Accessing* a System register refers to a direct read or write of the register.
- *Using* a System register refers to an indirect read or write of the register.

Registers with some architectural guarantee of ordering or observability

For the registers for which [Table G3-44](#) shows that the ordering of direct reads is guaranteed, multiple direct reads of a single register, using the same encoding, occur in program order without any explicit ordering.

For the registers for which [Table G3-44](#) shows that some observability of indirect writes is guaranteed, an indirect write to the register caused by an external agent, an autonomous asynchronous event, or as a result of a memory-mapped write, is both:

- Observable to direct reads of the register, in finite time, without explicit synchronization.
- Observable to subsequent indirect reads of the register without explicit synchronization.

These two sets of registers are similar, as [Table G3-44](#) shows:

Table G3-44 Registers with a guarantee of ordering or observability, VMSAv8-32

Register	Ordering of direct reads	Observability of indirect writes	Notes
ISR	Guaranteed	Guaranteed	Interrupt Status Register
DBGCLAIMCLR	-	Guaranteed	Debug claim registers
DBGCLAIMSET	Guaranteed	Guaranteed	

Table G3-44 Registers with a guarantee of ordering or observability, VMSAv8-32 (continued)

Register	Ordering of direct reads	Observability of indirect writes	Notes
DBGDTRRX	Guaranteed	Guaranteed	Debug Communication Channel registers
DBGDTRTX	Guaranteed	Guaranteed	
CNTPCT	Guaranteed	Guaranteed	Generic Timer Extension registers, if the implementation includes the extension
CNTP_TVAL	Guaranteed	Guaranteed	
CNTVCT	Guaranteed	Guaranteed	
CNTV_TVAL	Guaranteed	Guaranteed	
CNTHP_TVAL	Guaranteed	Guaranteed	
PMCCNTR	Guaranteed	Guaranteed	Performance Monitors Extension registers, if the implementation includes the extension
PMXEVNTR	Guaranteed	Guaranteed	
PMOVSSET	Guaranteed	Guaranteed	

For the specified registers, the observability requirement is more demanding than the observability requirements for other registers. However, the possibility that direct reads can occur *early*, in the absence of context synchronization, described in [Ordering of reads of System registers on page G3-3692](#), still applies to these registers.

In Debug state, additional synchronization requirements can apply to the registers shown in [Table G3-44 on page G3-3708](#). For more information, see [Synchronization of DCC and ITR accesses on page H4-4398](#).

Definitions of direct and indirect reads and writes and their side-effects

Direct and indirect reads and writes are defined as follows:

Direct read Is a read of a register, using an MRC, MRC2, MRRC, MRRC2, LDC, or LDC2 instruction, that the architecture permits for the current PE state.

If a direct read of a register has a side-effect of changing the value of a register, the effect of a direct read on that register is defined to be an *indirect write*, and has the synchronization requirements of an indirect write. This means the indirect write is guaranteed to have occurred, and to be visible to subsequent direct or indirect reads and writes only if synchronization is performed after the direct read.

———— **Note** ————

The indirect write described here can affect either the register written to by the direct write, or some other register. The synchronization requirement is the same in both cases.

Direct write Is a write to a register, using an MCR, MCR2, MCRR, MCRR2, STC, or STC2 instruction, that the architecture permits for the current PE state.

In the following cases, the side-effect of the direct write is defined to be an indirect write of the affected register, and has the synchronization requirements of an indirect write:

- If the direct write has a side-effect of changing the value of a register other than the register accessed by the direct write.
- If the direct write has a side-effect of changing the value of the register accessed by the direct write, so that the value in that register might not be the value that the direct write wrote to the register.

In both cases, this means that the indirect write is not guaranteed to be visible to subsequent direct or indirect reads and writes unless synchronization is performed after the direct write.

Note

- As an example of a direct write to a register having an effect that is an indirect write of that register, writing 1 to a [PMCNTENCLR.Px](#) bit is also an indirect write, because if the Px bit had the value 1 before the direct write, the side-effect of the write changes the value of that bit to 0.
 - The indirect write described here can affect either the register written to by the direct write, or some other register. The synchronization requirement is the same in both cases. For example, writing 1 to a [PMCNTENCLR.Px](#) bit that is set to 1 also changes the corresponding [PMCNTENSET.Px](#) bit from 1 to 0. This means that the direct write to the [PMCNTENCLR](#) defines indirect writes to both itself and to the [PMCNTENSET](#).
-

Indirect read Is a use of the register by an instruction to establish the operating conditions for the instruction. Examples of operating conditions that might be determined by an indirect read are the translation table base address, or whether a cache is enabled.

Indirect reads include situations where the value of one register determines what value is returned by a second register. This means that any read of the second register is an indirect read of the register that determines what value is returned.

Indirect reads also include:

- Reads of the System registers by external agents, such as debuggers, as described in [Debug registers on page G4-4101](#).
- Memory-mapped reads of the System registers made by the PE on which the System registers are implemented.

Where an indirect read of a register has a side-effect of changing the value of a register, that change is defined to be an indirect write, and has the synchronization requirements of an indirect write.

Indirect write Is an update to the value of a register as a consequence of either:

- An exception, operation, or execution of an instruction that is not a direct write to that register.
- The asynchronous operation of some external agent.

This can include:

- The passage of time, as seen in counters or timers, including performance counters.
- The assertion of an interrupt.
- A write from an external agent, such as a debugger.

However, for some registers, the architecture gives some guarantee of visibility without any explicit synchronization, see [Registers with some architectural guarantee of ordering or observability on page G3-3708](#).

Note

Taking an exception is a context-synchronizing operation. Therefore, any indirect write performed as part of an exception entry does not require additional synchronization. This includes the indirect writes to the registers that report the exception, as described in [Exception reporting in a VMSAv8-32 implementation on page G3-3659](#).

G3.15.5 Meaning of fixed bit values in register diagrams

In register diagrams, fixed bits are indicated by one of following:

0 In any implementation:

- The bit must read as 0.
- Writes to the bit must be ignored.
- Software:
 - Can rely on the bit reading as 0.
 - Must use an SBZP policy to write to the bit.

(0) In AArch32 state there are a small number of cases where a bit is (0) in some contexts, and has a different defined behavior in other contexts. The meaning of (0) is modified for these bits. For a read/write register, this means:

If a register bit is (0) for all uses of the register

- The bit must read as 0.
- Writes to the bit must be ignored.
- Software:
 - Must not rely on the bit reading as 0.
 - Must use an SBZP policy to write to the bit.

If a register bit is (0) only for some uses of the register, when that bit is described as (0)

- A read of the bit must return the value last successfully written to the bit, regardless of the use of the register when the bit was written.
If the bit has not been successfully written since reset, then the read of the bit returns the reset value if there is one, or otherwise returns an UNKNOWN value.
- A write to the bit must update a storage location associated with the bit.
- While the use of the register is such that the bit is described as (0), or as RES0, the value of the bit must have no effect on the operation of the PE, other than determining the value read back from that bit.
- Software:
 - Must not rely on the bit reading as 0.
 - Must use an SBZP policy to write to the bit.

———— **Note** —————

This definition applies only to bits that are defined as (0), or as RES0, for one use of a register, and are defined differently for another use of the register.

Fields that are more than one bit wide are sometimes described as RES0, instead of having each bit marked as (0).

In a read-only register, (0) or RES0 indicates that the bit reads as 0, but software must treat the bit as UNK.

In a write-only register, (0) indicates that software must treat the bit as SBZ.

1 In any implementation:

- The bit must read as 1.
- Writes to the bit must be ignored.
- Software:
 - Can rely on the bit reading as 1.
 - Must use an SBOP policy to write to the bit.

- (1) In AArch32 state there are a small number of cases where a bit is (1) in some contexts, and has a different defined behavior in other contexts. The meaning of (1) is modified for these bits. For a read/write register, this means:

If a register bit is (1) for all uses of the register

- The bit must read as 1.
- Writes to the bit must be ignored.
- Software:
 - Must not rely on the bit reading as 1.
 - Must use an SBOP policy to write to the bit.

If a register bit is (1) only for some uses of the register, when that bit is described as (1)

- A read of the bit must return the value last successfully written to the bit, regardless of the use of the register when the bit was written.
If the bit has not been successfully written since reset, then the read of the bit returns the reset value if there is one, or otherwise returns an UNKNOWN value.
- A write to the bit must update a storage location associated with the bit.
- While the use of the register is such that the bit is described as (1), or as RES1, the value of the bit must have no effect on the operation of the PE, other than determining the value read back from that bit.
- Software:
 - Must not rely on the bit reading as 1.
 - Must use an SBOP policy to write to the bit.

———— **Note** —————

This definition applies only to bits that are defined as (1), or as RES1, for one use of a register, and are defined differently for another use of the register.

Fields that are more than one bit wide are sometimes described as RES1, instead of having each bit marked as (1).

In a read-only register, (1) indicates that the bit reads as 1, but software must treat the bit as UNK.

In a write-only register, (1) indicates that software must treat the bit as SBO.

G3.16 Organization of the CP14 registers in VMSAv8-32

The CP14 registers provide a number of distinct control functions, covering:

- Debug.
- Trace.
- Execution environment control, for the T32EE execution environment, if supported, and identification of the trivial Jazelle implementation.

Because these functions are so distinct, the descriptions of these registers are distributed, as follows:

- In this manual [Debug registers on page G4-4101](#) describes the Debug registers.
- The following ARM trace architecture specifications describe the Trace registers:
 - [Embedded Trace Macrocell Architecture Specification](#).
 - [CoreSight Program Flow Trace Architecture Specification](#).

This section summarizes the allocation of the CP14 registers between these different functions, and the CP14 register encodings that are reserved.

The CP14 register encodings are classified by the {CRn, opc1, CRm, opc2} values required to access them using an MCR or an MRC instruction. The opc1 value determines the primary allocation of these registers, as follows:

- opc1==0** Debug registers.
- opc1==1** Trace registers.
- opc1==6** T32EE registers. Support for T32EE is OPTIONAL and deprecated.
- opc1==7** Jazelle registers. Jazelle registers are implemented as required for a trivial Jazelle implementation.

Other opc1 values

Reserved.

———— Note —————

Primary allocation of CP14 register function by opc1 value differs from the allocation of CP15 registers, where primary allocation is by CRn value.

For the Debug registers, considering accesses using MCR or MRC instructions:

- Register encodings with CRn values 8-15 are unallocated.
- For registers with CRn values 0-7, the {CRn, opc2, CRm} values used for accessing the registers map onto a set of register numbers, as defined in [Table G3-45 on page G3-3714](#). These register numbers define the order of the registers in:
 - The memory-mapped interfaces to the registers.
 - The top-level register summary in [Debug registers on page G4-4101](#).

———— Note —————

Some Debug registers are not visible in some of the Debug register interfaces. For more information see [Chapter H8 About the External Debug Registers](#).

The ARM trace architectures use the same mapping of {CRn, opc2, CRm} values to register numbers for the Trace registers. The associated opc1 value determines whether a particular CP14 register number refers to the Trace register or the Debug register.

G3.16.1 CP14 interface instruction arguments

Table G3-45 shows the instruction arguments required for accesses to each register than can be visible in the CP14 interface.

Table G3-45 Mapping of CP14 MCR and MRC instruction arguments to registers

CRn	op1	CRm	opc2	Name	Width	Description
c0	0	c0	0	DBGDIDR	32-bit	Debug ID, or UNALLOCATED ^a
c0	3	c1	0	DBGDSCRint	32-bit	Debug Communication Channel Status
c0	0	c2	0	DBGDCCINT	32-bit	Debug Communication Channel Interrupt Enable
c0	0	c5	0	DBGDTRRXint	32-bit	Full duplex, receive, 32-bit, Data Transfer
c0	0	c5	0	DBGDTRTXint	32-bit	Full duplex, transmit, 32-bit, Data Transfer
c0	0	c6	0	-	32-bit	Legacy DBGWFAR , RES0
c0	0	c7	0	DBGVCR	32-bit	Vector Catch
c0	0	c0	2	DBGDTRRXext	32-bit	OS Lock Data Transfer
c0	0	c2	2	DBGDSCRext	32-bit	Monitor Debug System Control
c0	0	c3	2	DBGDTRTXext	32-bit	OS Lock Data Transfer
c0	0	c6	2	DBGOSECCR	32-bit	OS Lock Exception Catch Control
c0	0	c0-15 ^b	4	DBGBVR<n>	32-bit	Breakpoint Value or UNALLOCATED
c0	0	c0-15 ^b	5	DBGBCR<n>	32-bit	Breakpoint Control or UNALLOCATED
c0	0	c0-15 ^b	6	DBGWVR<n>	32-bit	Watchpoint Value or UNALLOCATED
c0	0	c0-15 ^b	7	DBGWCR<n>	32-bit	Watchpoint Control or UNALLOCATED
c1	0	c0	0	DBGDRAR	32-bit or 64-bit	Debug ROM Address
		c1 ^c			32-bit	
c1	0	c0-15 ^b	1	DBGBXVR<n>	32-bit	Breakpoint Value
c1	0	c0	4	DBGOSLAR	32-bit	OS Lock Access
c1	0	c1	4	DBGOSLSR	32-bit	OS Lock Status
c1	0	c3	4	DBGOSDLR	32-bit	OS Double Lock
c1	0	c4	4	DBGPRCR	32-bit	Debug Power Control
c2	0	c0	0	DBGDSAR	32-bit	Debug Self Address or UNALLOCATED ^a
		c2				
c4	0	c0-15	0-3	-		IMPLEMENTATION DEFINED
c7	0	c8	6	DBGCLAIMSET	32-bit	Claim Tag Set
c7	0	c9	6	DBGCLAIMCLR	32-bit	Claim Tag Clear
c7	0	c14	6	DBGAUTHSTATUS	32-bit	Authentication Status

Table G3-45 Mapping of CP14 MCR and MRC instruction arguments to registers (continued)

CRn	op1	CRm	opc2	Name	Width	Description
c7	0	c0	7	DBGDEVID2	32-bit	Debug Device ID
c7	0	c1	7	DBGDEVID1	32-bit	
c7	0	c2	7	DBGDEVID	32-bit	
co-15	1	c0-c15	0-7	-	32-bit	Reserved for OPTIONAL Trace extension
All other encodings					32-bit	UNALLOCATED

- a. If EL1 is using AArch32 is not implemented this register is optional. See the register description for details.
- b. Not implemented breakpoint and watchpoint register access instructions are UNALLOCATED. If EL2 is not implemented or breakpoint *n* is not context-aware, [DBGBXVR<n>](#) is unallocated. CRm encodes *n*, the breakpoint or watchpoint number.
- c. MRRC instruction in AArch32 state. That is, MRRC p<14>,0,<Rt>,<Rt1>,<CRm>. There is no AArch64 state equivalent.

G3.17 Organization of the CP15 registers in VMSAv8-32

Previous documentation has described the CP15 registers in order of their primary coprocessor register number. More precisely, the ordered set of values {CRn, opc1, CRm, opc2} determined the register order. As the number of System registers has increased this ordering has become less appropriate. Also, it applies only to 32-bit registers, since 64-bit registers are identified only by {CRm, opc1}, making it difficult to include 32-bit and 64-bit versions of a single register in a common ordering scheme.

This document now:

- Groups the CP15 registers by functional group. For more information about this grouping in VMSAv8-32, including a summary of each functional group, see [Functional grouping of VMSAv8-32 System registers on page G3-3735](#).
- Describes all of the System registers for VMSAv8-32, including the CP15 registers, in [Chapter G4 AArch32 System Register Descriptions](#).

This section gives additional information about the organization of the CP15 registers in VMSAv8-32, as follows:

Register ordering by {CRn, opc1, CRm, opc2}

See:

- [CP15 32-bit register summary by coprocessor register number, CRn on page G3-3717](#).
- [Full list of VMSAv8-32 CP15 registers, by coprocessor register number on page G3-3722](#).

———— Note —————

The ordered listing of CP15 registers by the {CRn, opc1, CRm, opc2} encoding of the 32-bit registers is most likely to be useful to those implementing AArch32 state, and to those validating such implementations. However, otherwise, the grouping of registers by function is more logical.

Views of the registers, that depend on the current state of the PE

See [Views of the CP15 registers on page G3-3732](#).

———— Note —————

The different register views are particularly significant in implementations that include EL2.

In addition, the indexes in [Appendix J Registers Index](#) include all of the CP15 registers.

G3.17.1 CP15 32-bit register summary by coprocessor register number, CRn

Figure G3-26 summarizes the grouping of CP15 registers by primary coprocessor register number for a VMSAv8-32 implementation.

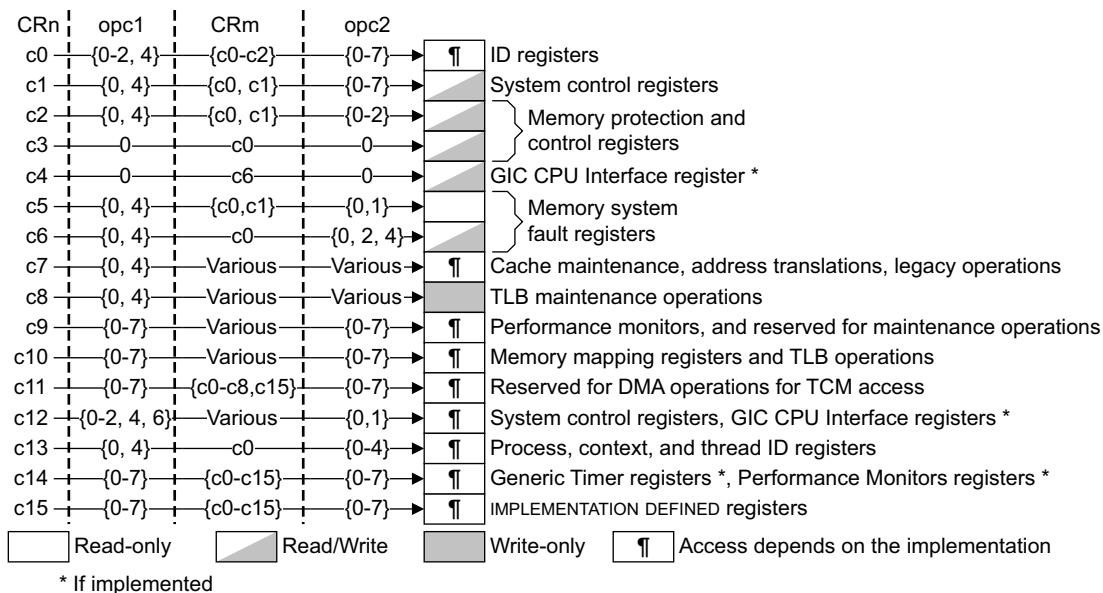

Figure G3-26 CP15 32-bit register grouping by primary coprocessor register, CRn

Note

- Figure G3-26 gives only an overview of the assigned encodings for 32-registers for each of the CP15 primary registers c0-c15. See the description of each primary register for the definition of the assigned and unassigned encodings for that register, including any dependencies on the implemented Exception levels.
- 64-bit registers in the CP15 encoding space use the same primary coprocessor register model, but in the 64-bit register read and write instructions, MRRR and MCRR, CRm identifies the primary coprocessor register.

The following sections give the register assignments for each of the CP15 primary registers, c0-c15:

- [VMSAv8-32 CP15 c0 register summary.](#)
- [VMSAv8-32 CP15 c1 register summary on page G3-3718.](#)
- [VMSAv8-32 CP15 c2 and c3 register summary on page G3-3718](#)
- [VMSAv8-32 CP15 c4 register summary on page G3-3718.](#)
- [VMSAv8-32 CP15 c5 and c6 register summary on page G3-3719.](#)
- [VMSAv8-32 CP15 c7 register summary on page G3-3719.](#)
- [VMSAv8-32 CP15 c8 register summary on page G3-3719.](#)
- [VMSAv8-32 CP15 c9 register summary on page G3-3719.](#)
- [VMSAv8-32 CP15 c10 register summary on page G3-3720.](#)
- [VMSAv8-32 CP15 c11 register summary on page G3-3721.](#)
- [VMSAv8-32 CP15 c12 register summary on page G3-3721.](#)
- [VMSAv8-32 CP15 c13 register summary on page G3-3721.](#)
- [VMSAv8-32 CP15 c14 register summary on page G3-3722.](#)
- [VMSAv8-32 CP15 c15 register summary on page G3-3722.](#)

VMSAv8-32 CP15 c0 register summary

The CP15 c0 registers provide device and feature identification. That is, they provide the register functional group described in *Identification registers, functional group on page G3-3736*.

Table G3-46 on page G3-3723 shows all of the architecturally required CP15 c0 registers. CP15 c0 register encodings not shown in the table, and encodings that are part of an unimplemented Exception level:

- If they have an `opc1` value of zero, are `RES0`.
- Otherwise, are `UNPREDICTABLE`, see [Accesses to unallocated CP14 and CP15 encodings on page G3-3693](#).

Note

Some of these registers were previously described as being part of the CPUID identification scheme, see [The CPUID identification scheme on page G3-3737](#).

VMSAv8-32 CP15 c1 register summary

The CP15 c1 registers provide system control, including security and virtualization control. That is, they provide registers from the functional groups described in the following sections:

- [Other system control registers, functional group on page G3-3737](#).
- [Virtualization registers, functional group on page G3-3738](#).
- [Security registers, functional group on page G3-3741](#).

Table G3-46 on page G3-3723 shows all of the architecturally required CP15 c1 registers. CP15 c1 register encodings not shown in the table, and encodings that are part of an unimplemented Exception level are `UNPREDICTABLE`, see [Accesses to unallocated CP14 and CP15 encodings on page G3-3693](#).

VMSAv8-32 CP15 c2 and c3 register summary

The CP15 c2 and c3 registers provide memory system control. That is, they provide registers from the functional group described in the section [Virtual memory control registers, functional group on page G3-3737](#).

Table G3-46 on page G3-3723 shows all of the architecturally required CP15 c2 and c3 registers. CP15 c2 and c3 32-bit register encodings not shown in the table, and encodings that are part of an unimplemented Exception level are `UNPREDICTABLE`, see [Accesses to unallocated CP14 and CP15 encodings on page G3-3693](#).

Note

All 64-bit CP15 register encodings not shown in [Table G3-46 on page G3-3723](#) are `UNDEFINED`.

VMSAv8-32 CP15 c4 register summary

In an implementation that includes the System register interface to the Generic Interrupt Control CPU interface, the CP15 c4 registers provide a register for this interface. That is, they provide a register from the functional group described in the section [Generic Interrupt Controller CPU interface registers, functional group on page G3-3749](#).

Table G3-46 on page G3-3723 shows all of the architecturally required CP15 c4 registers. CP15 c4 32-bit register encodings not shown in the table are:

- `UNPREDICTABLE` if the implementation includes the System register interface to the Generic Interrupt Control CPU interface. See [Accesses to unallocated CP14 and CP15 encodings on page G3-3693](#).
- Otherwise, `UNDEFINED`.

VMSAv8-32 CP15 c5 and c6 register summary

The CP15 c5 and c6 registers provide exception and fault handling. That is, they provide registers from the functional group described in the section *Exception and fault handling registers, functional group* on page G3-3741.

Table G3-46 on page G3-3723 shows all of the architecturally required CP15 c5 and c6 registers. CP15 c5 and c6 32-bit register encodings not shown in the table, and encodings that are part of an unimplemented Exception level are UNPREDICTABLE, see *Accesses to unallocated CP14 and CP15 encodings* on page G3-3693.

VMSAv8-32 CP15 c7 register summary

The CP15 c7 registers provide system operations for cache maintenance, address translation, and some legacy operations. That is, they provide registers from the functional groups described in the following sections:

- *Cache maintenance operations, functional group* on page G3-3743.
- *Address translation operations, functional group* on page G3-3745.
- *Legacy feature registers, functional group* on page G3-3750.

Table G3-46 on page G3-3723 shows all of the architecturally required CP15 c7 registers. CP15 c7 32-bit register encodings not shown in the table, and encodings that are part of an unimplemented Exception level are UNPREDICTABLE, see *Accesses to unallocated CP14 and CP15 encodings* on page G3-3693.

———— Note ————

All 64-bit CP15 register encodings not shown in Table G3-46 on page G3-3723 are UNDEFINED.

VMSAv8-32 CP15 c8 register summary

The CP15 c8 registers provide operations for TLB maintenance. That is, they provide registers from the functional groups described in *TLB maintenance operations, functional group* on page G3-3744.

Table G3-46 on page G3-3723 shows all of the architecturally required CP15 c8 registers. CP15 c8 32-bit register encodings not shown in the table, and encodings that are part of an unimplemented Exception level are UNPREDICTABLE, see *Accesses to unallocated CP14 and CP15 encodings* on page G3-3693.

VMSAv8-32 CP15 c9 register summary

The CP15 c9 registers provide:

- Registers for the OPTIONAL Performance Monitors Extension. That is, they provide registers from the functional group described in *Performance Monitors Extension registers, functional group* on page G3-3747.
- Reserved encodings for IMPLEMENTATION DEFINED memory system functions, in particular:
 - Cache control, including lockdown.
 - TCM control, including lockdown.
 - Branch predictor control.

———— Note ————

The reserved encodings permit implementations that are compatible with previous versions of the ARM architecture, in particular with the ARMv6 requirements.

- Reserved encodings for additional IMPLEMENTATION DEFINED performance monitors.

Figure G3-27 shows the VMSAv8-32 allocation of CP15 c9 register encodings.

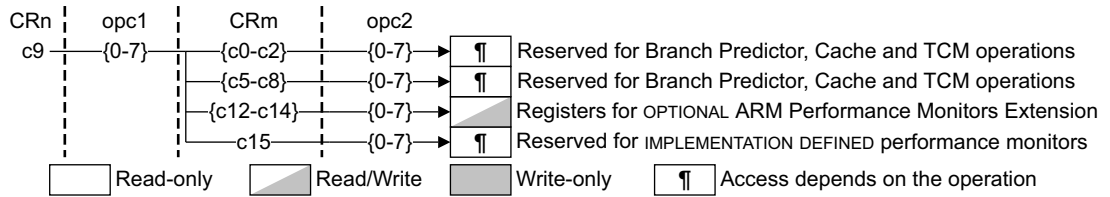

Figure G3-27 VMSAv8-32 CP15 c9 32-bit register encodings

Table G3-46 on page G3-3723 shows all of the architecturally required CP15 c9 registers. Unimplemented CP15 c9 32-bit register encodings, including encodings that are part of an unimplemented Exception level, are UNPREDICTABLE, see *Accesses to unallocated CP14 and CP15 encodings* on page G3-3693.

VMSAv8-32 CP15 c10 register summary

The CP15 c10 registers provide:

- Virtual memory control registers. That is, they provide registers from the functional group described in *Virtual memory control registers, functional group* on page G3-3737.
- Reserved encodings for IMPLEMENTATION DEFINED TLB control functions, including lockdown.

Figure G3-28 shows the VMSAv8-32 allocation of CP15 c10 registers and reserved encodings.

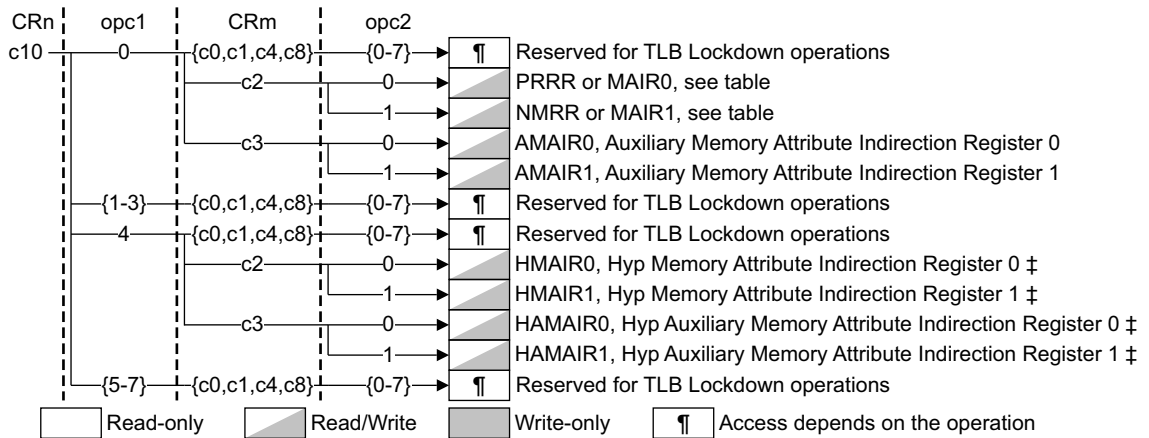

‡ Implemented only as part of EL2

When using Short-descriptor translation table format	When using Long-descriptor translation table format
PRRR, Primary Region Remap Register	MAIR0, Memory Attribute Indirection Register 0
NMRR, Normal Memory Remap Register	MAIR1, Memory Attribute Indirection Register 1

Figure G3-28 VMSAv8-32 CP15 c10 32-bit register encodings

Table G3-46 on page G3-3723 shows all of the architecturally required CP15 c10 registers. Unimplemented CP15 c10 32-bit register encodings, including encodings that are part of an unimplemented Exception level, are UNPREDICTABLE, see *Accesses to unallocated CP14 and CP15 encodings* on page G3-3693.

VMSAv8-32 CP15 c11 register summary

The CP15 c11 registers provide some reserved encodings for IMPLEMENTATION DEFINED DMA operations to and from TCM. Figure G3-29 shows these reserved encodings:

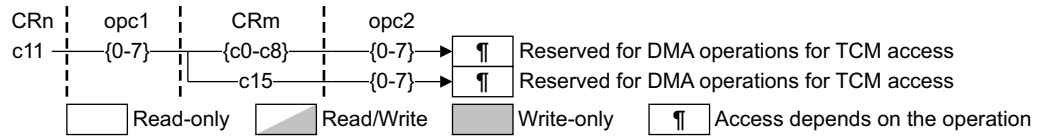

Figure G3-29 VMSAv8-32 reserved CP15 c11 encodings

CP15 c11 encodings not shown in Figure G3-29 are UNPREDICTABLE, see [Accesses to unallocated CP14 and CP15 encodings on page G3-3693](#).

VMSAv8-32 CP15 c12 register summary

The CP15 c12 registers provide registers from the functional groups described in the following sections:

- [Exception and fault handling registers, functional group on page G3-3741](#).
- [Virtualization registers, functional group on page G3-3738](#).
- [Security registers, functional group on page G3-3741](#).
- [Reset management registers, functional group on page G3-3742](#).
- [Generic Interrupt Controller CPU interface registers, functional group on page G3-3749](#).

Table G3-46 on page G3-3723 shows all of the architecturally required CP15 c12 registers. CP15 c12 32-bit register encodings not shown in the table, and encodings that are part of an unimplemented Exception level are UNPREDICTABLE, see [Accesses to unallocated CP14 and CP15 encodings on page G3-3693](#).

———— **Note** —————

- Some CP15 c12 registers are in more than one functional group.
- All 64-bit CP15 register encodings not shown in Table G3-46 on page G3-3723 are UNDEFINED.

VMSAv8-32 CP15 c13 register summary

The CP15 c13 registers provide:

- An FCSE Process ID Register, that indicates that ARMv8 implementations do not include the FCSE.
- A Context ID Register.
- Software Thread ID Registers.

These registers are from the functional groups described in the following sections:

- [Virtual memory control registers, functional group on page G3-3737](#).
- [Virtualization registers, functional group on page G3-3738](#).
- [Thread and process ID registers, functional group on page G3-3743](#).
- [Legacy feature registers, functional group on page G3-3750](#).

———— **Note** —————

Some CP15 c12 registers are in more than one functional group.

Figure G3-30 shows these registers:

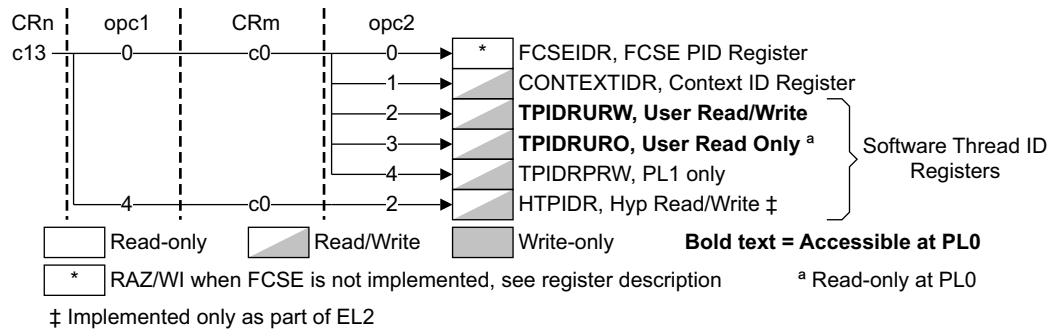

Figure G3-30 CP15 c13 registers in VMSAv8-32

Table G3-46 on page G3-3723 shows all of the architecturally required CP15 c13 registers. CP15 c13 32-bit register encodings not shown in the table, and encodings that are part of an unimplemented Exception level are UNPREDICTABLE, see [Accesses to unallocated CP14 and CP15 encodings on page G3-3693](#).

VMSAv8-32 CP15 c14 register summary

The CP15 c14 registers provide Performance Monitors Extension and Generic Timer Extension registers. That is, they provide registers from the functional group described in the following sections:

- [Performance Monitors Extension registers, functional group on page G3-3747](#).
- [Generic Timer Extension registers, functional group on page G3-3749](#)

Table G3-46 on page G3-3723 shows all of the architecturally required CP15 c14 registers. CP15 c14 32-bit register encodings not shown in the table, and encodings that are part of an unimplemented Exception level are UNPREDICTABLE, see [Accesses to unallocated CP14 and CP15 encodings on page G3-3693](#).

From issue C.a of this manual, CP15 c14 is reserved for the System registers of the OPTIONAL Generic Timer Extension. For more information, see [Chapter D7 The Generic Timer](#). On an implementation that does not include the Generic Timer, c14 is an unallocated CP15 primary register, see [UNPREDICTABLE and UNDEFINED behavior for CP14 and CP15 accesses on page G3-3693](#).

Note

- Some CP15 c14 registers are also in the Virtualization group, see [Virtualization registers, functional group on page G3-3738](#).
- All 64-bit CP15 register encodings not shown in [Table G3-46 on page G3-3723](#) are UNDEFINED.

VMSAv8-32 CP15 c15 register summary

The CP15 c15 registers are reserved for IMPLEMENTATION DEFINED purposes. The architecture does not impose any restrictions on the use of these encodings. For more information, see [IMPLEMENTATION DEFINED registers, functional group on page G3-3751](#).

G3.17.2 Full list of VMSAv8-32 CP15 registers, by coprocessor register number

Table G3-46 on page G3-3723 shows the CP15 registers in VMSAv8-32, in the order of the {CRn, opc1, CRm, opc2} values used in MCR or MRC accesses to the 32-bit registers:

- For MCR or MRC accesses to the 32-bit registers, CRn identifies the CP15 primary register used for the access.
- For MRRR or MRRC accesses to the 64-bit registers, CRm identifies the CP15 primary register used for the access. [Table G3-46 on page G3-3723](#) lists the 64-bit registers with the 32-bit registers accessed using the same CP15 primary register number.

Table G3-46 Summary of VMSAv8-32 CP15 register descriptions, in coprocessor register number order

CRn	opc1	CRm	opc2	Name	Width	Description		
c0	0	c0	0	MIDR	32-bit	Main ID Register		
			1	CTR	32-bit	Cache Type Register		
			2	TCMTR	32-bit	TCM Type Register		
			3	TLBTR	32-bit	TLB Type Register		
			4, 6 ^a , 7	MIDR	32-bit	Aliases of Main ID Register		
			5	MPIDR	32-bit	Multiprocessor Affinity Register		
			6 ^a	REVIDR	32-bit	Revision ID Register		
c0	0	c1	0	ID_PFR0	32-bit	Processor Feature Register 0		
			1	ID_PFR1	32-bit	Processor Feature Register 1		
			2	ID_DFR0	32-bit	Debug Feature Register 0		
			3	ID_AFR0	32-bit	Auxiliary Feature Register 0		
			4	ID_MMFR0	32-bit	Memory Model Feature Register 0		
			5	ID_MMFR1	32-bit	Memory Model Feature Register 1		
			6	ID_MMFR2	32-bit	Memory Model Feature Register 2		
	7	ID_MMFR3	32-bit	Memory Model Feature Register 3				
	1	c0	c2	0	ID_ISAR0	32-bit	Instruction Set Attribute Register 0	
				1	ID_ISAR1	32-bit	Instruction Set Attribute Register 1	
				2	ID_ISAR2	32-bit	Instruction Set Attribute Register 2	
				3	ID_ISAR3	32-bit	Instruction Set Attribute Register 3	
				4	ID_ISAR4	32-bit	Instruction Set Attribute Register 4	
			5	ID_ISAR5	32-bit	Instruction Set Attribute Register 5		
			1	c0		0	CCSIDR	32-bit
1						CLIDR	32-bit	Cache Level ID Register
7	AIDR	32-bit				Auxiliary ID Register, IMPLEMENTATION DEFINED		
c0	2	c0	0	CSSELR	32-bit	Cache Size Selection Register		
	4	c0	0	VPIDR ^b	32-bit	Virtualization Processor ID Register		
			5	VMPIDR ^b	32-bit	Virtualization Multiprocessor ID Register		

Table G3-46 Summary of VMSAv8-32 CP15 register descriptions, in coprocessor register number order (continued)

CRn	opc1	CRm	opc2	Name	Width	Description	
c1	0	c0	0	SCTLR	32-bit	System Control Register	
			1	ACTLR	32-bit	Auxiliary Control Register, IMPLEMENTATION DEFINED	
			2	CPACR	32-bit	Coprocessor Access Control Register	
	c1	0	0	SCR ^c	32-bit	Secure Configuration Register	
			1	SDER ^c	32-bit	Secure Debug Enable Register	
			2	NSACR ^c	32-bit	Non-Secure Access Control Register	
	c3	1	SDCR ^d	32-bit	Secure Debug Configuration Register		
c1	4	c0	0	HSCTLR ^b	32-bit	Hyp System Control Register	
			1	HACTLR ^b	32-bit	Hyp Auxiliary Control Register	
	c1	0	0	HCR ^b	32-bit	Hyp Configuration Register	
			1	HDCR ^b	32-bit	Hyp Debug Configuration Register	
			2	HCPTR ^b	32-bit	Hyp Coprocessor Trap Register	
			3	HSTR ^b	32-bit	Hyp System Trap Register	
			4	HCR2 ^{b, d}	32-bit	Hyp Configuration Register 2	
			7	HACR ^b	32-bit	Hyp Auxiliary Configuration Register	
c2	0	c0	0	TTBR0	32-bit	Translation Table Base Register 0	
-	0	c2	-	TTBR0	64-bit		
c2	0	c0	1	TTBR1	32-bit	Translation Table Base Register 1	
-	1	c2	-	TTBR1	64-bit		
c2	0	c0	2	TTBCR	32-bit	Translation Table Base Control Register	
			4	HTCR ^b	32-bit	Hyp Translation Control Register	
		c1	2	VTCR ^b	32-bit	Virtualization Translation Control Register	
-	4	c2	-	HTTBR ^b	64-bit	Hyp Translation Table Base Register	
-	6	c2	-	VTTBR ^b	64-bit	Virtualization Translation Table Base Register	
c3	0	c0	1	DACR	32-bit	Domain Access Control Register	
c4	0	c6	0	ICC_PMR ^e	32-bit	Interrupt Controller Interrupt Priority Mask Register	
			3	c5	0	DSPSR ^d	32-bit
				1	DLR ^d	32-bit	Debug Link Register ^f

Table G3-46 Summary of VMSAv8-32 CP15 register descriptions, in coprocessor register number order (continued)

CRn	opc1	CRm	opc2	Name	Width	Description
c5	0	c0	0	DFSR	32-bit	Data Fault Status Register
			1	IFSR	32-bit	Instruction Fault Status Register
		c1	0	ADFSR	32-bit	Auxiliary Data Fault Status Register
			1	AIFSR	32-bit	Auxiliary Instruction Fault Status Register
c5	4	c1	0	HADFSR ^b	32-bit	Hyp Auxiliary Data Fault Syndrome Register
			1	HAIFSR	32-bit	Hyp Auxiliary Instruction Fault Syndrome Register
		c2	0	HSR ^b	32-bit	Hyp Syndrome Register
c6	0	c0	0	DFAR	32-bit	Data Fault Address Register
			2	IFAR	32-bit	Instruction Fault Address Register
	4	c0	0	HDFAR ^b	32-bit	Hyp Data Fault Address Register
			2	HIFAR ^b	32-bit	Hyp Instruction Fault Address Register
			4	HPFAR ^b	32-bit	Hyp IPA Fault Address Register
c7	0	c1	0	ICIALLUIS	32-bit	See <i>Cache maintenance operations, functional group on page G3-3743</i>
			6	BPIALLIS	32-bit	
			c4	0	PAR	32-bit
	0	c7	-	PAR	64-bit	
c7	0	c5	0	ICIALLU	32-bit	See <i>Cache maintenance operations, functional group on page G3-3743</i>
			1	ICIMVAU	32-bit	
			4	CP15ISB	32-bit	See <i>Memory barriers on page E2-2352</i>
			6	BPIALL	32-bit	See <i>Cache maintenance operations, functional group on page G3-3743</i>
			7	BPIMVA	32-bit	
		c6	1	DCIMVAC	32-bit	See <i>Cache maintenance operations, functional group on page G3-3743</i>
			2	DCISW	32-bit	
c7	0	c8	0	ATS1CPR	32-bit	See <i>Virtual Address to Physical Address translation operations on page G3-3685</i>
			1	ATS1CPW	32-bit	
			2	ATS1CUR	32-bit	
			3	ATS1CUW	32-bit	
			4	ATS12NSOPR ^c	32-bit	
			5	ATS12NSOPW ^c	32-bit	
			6	ATS12NSOUR ^c	32-bit	
			7	ATS12NSOUW ^c	32-bit	

Table G3-46 Summary of VMSAv8-32 CP15 register descriptions, in coprocessor register number order (continued)

CRn	opc1	CRm	opc2	Name	Width	Description		
c7	0	c10	1	DCCMVAC	32-bit	See <i>Cache maintenance operations, functional group</i> on page G3-3743		
			2	DCCSW	32-bit			
			4	CP15DSB	32-bit	See <i>Memory barriers</i> on page E2-2352		
			5	CP15DMB	32-bit			
c7	0	c11	1	DCCMVAU	32-bit	See <i>Cache maintenance operations, functional group</i> on page G3-3743		
			c14	1	DCCIMVAC	32-bit	See <i>Cache maintenance operations, functional group</i> on page G3-3743	
		2		DCCISW	32-bit			
		4	c8	0	ATS1HR ^b	32-bit	See <i>Virtual Address to Physical Address translation operations</i> on page G3-3685	
				1	ATS1HW ^b	32-bit		
		c8	0	c3	0	TLBIALLIS	32-bit	See <i>The scope of TLB maintenance operations</i> on page G3-3640
1	TLBIMVAIS				32-bit			
2	TLBIASIDIS				32-bit			
3	TLBIMVAAIS				32-bit			
5	TLBIMVALIS ^d				32-bit			
7	TLBIMVAALIS ^d				32-bit			
c5	0				ITLBIALL	32-bit	See <i>The scope of TLB maintenance operations</i> on page G3-3640	
	1			ITLBIMVA	32-bit			
	2			ITLBIASID	32-bit			
c6	0			DTLBIALL	32-bit	See <i>The scope of TLB maintenance operations</i> on page G3-3640		
	1			DTLBIMVA	32-bit			
	2			DTLBIASID	32-bit			
c7	0			c7	0	TLBIALL	32-bit	See <i>The scope of TLB maintenance operations</i> on page G3-3640
					1	TLBIMVA	32-bit	
					2	TLBIASID	32-bit	
					3	TLBIMVAA	32-bit	
		5	TLBIMVAL ^d		32-bit			
		7	TLBIMVAAL ^d		32-bit			
c8	4	c0	1	TLBIIPAS2IS ^d	32-bit	See <i>The scope of TLB maintenance operations</i> on page G3-3640		
			5	TLBIIPAS2LIS ^d	32-bit			

Table G3-46 Summary of VMSAv8-32 CP15 register descriptions, in coprocessor register number order (continued)

CRn	opc1	CRm	opc2	Name	Width	Description	
c8	4	c3	0	TLBIALLHIS^b	32-bit	See <i>The scope of TLB maintenance operations on page G3-3640</i>	
			1	TLBIMVAHIS^b	32-bit		
			4	TLBIALLNSNHIS^b	32-bit		
			5	TLBIMVALHIS^d	32-bit		
c8	4	c4	1	TLBIIPAS2^d	32-bit	See <i>The scope of TLB maintenance operations on page G3-3640</i>	
			5	TLBIIPAS2L^d	32-bit		
	c7	0	c7	0	TLBIALLH^b	32-bit	See <i>The scope of TLB maintenance operations on page G3-3640</i>
				1	TLBIMVAH^b	32-bit	
				4	TLBIALLNSNH^b	32-bit	
				5	TLBIMVALH^d	32-bit	
	c9	0	c12	0	PMCR	32-bit	Performance Monitors Control Register
				1	PMCNTENSET	32-bit	Performance Monitors Count Enable Set register
2				PMCNTENCLR	32-bit	Performance Monitors Count Enable Clear register	
3				PMOVSR	32-bit	Performance Monitors Overflow Flag Status Register	
4				PMSWINC	32-bit	Performance Monitors Software Increment register	
5				PMSELR	32-bit	Performance Monitors Event Counter Selection Register	
6				PMCEID0	32-bit	Performance Monitors Common Event Identification register 0	
7				PMCEID1	32-bit	Performance Monitors Common Event Identification register 1	
c9	0	c13	0	PMCCNTR	32-bit	Performance Monitors Cycle Count Register	
			1	PMXEVTYPER	32-bit	Performance Monitors Event Type Select Register	
			2	PMXEVCNTR	32-bit	Performance Monitors Event Count Register	
c9	0	c14	0	PMUSERENR	32-bit	Performance Monitors User Enable Register	
			1	PMINTENSET	32-bit	Performance Monitors Interrupt Enable Set register	
			2	PMINTENCLR	32-bit	Performance Monitors Interrupt Enable Clear register	
			3	PMOVSSSET^b	32-bit	Performance Monitors Overflow Flag Status Set register	
c10	0	c2	0	PRRR^g	32-bit	Primary Region Remap Register	
				MAIR0^g	32-bit	Memory Attribute Indirection Register 0	
			1	NMRR^g	32-bit	Normal Memory Remap Register	
				MAIR1^g	32-bit	Memory Attribute Indirection Register 1	

Table G3-46 Summary of VMSAv8-32 CP15 register descriptions, in coprocessor register number order (continued)

CRn	opc1	CRm	opc2	Name	Width	Description	
c10	0	c3	0	AMAIRO	32-bit	Auxiliary Memory Attribute Indirection Register 0	
			1	AMAIR1	32-bit	Auxiliary Memory Attribute Indirection Register 1	
	4	c2	0	HMAIRO^b	32-bit	Hyp Memory Attribute Indirection Register 0	
			1	HMAIR1^b	32-bit	Hyp Memory Attribute Indirection Register 1	
		c3	0	HAMAIRO^b	32-bit	Hyp Auxiliary Memory Attribute Indirection Register 0	
			1	HAMAIR1^b	32-bit	Hyp Auxiliary Memory Attribute Indirection Register 1	
c11	0-7	c0-c8	0-7	-	32-bit	See VMSAv8-32 CP15 c11 register summary on page G3-3721	
		c15	c15	-	32-bit		
-	0	c12	-	ICC_SGI1R^e	64-bit	Interrupt Controller SGI group 1 Register	
c12	0	c0	0	VBAR	32-bit	Vector Base Address Register	
			1	MVBAR^c	32-bit	Monitor Vector Base Address Register	
				JRVBAR	32-bit	Reset Vector Base Address Register	
			2	RMR (at EL1)^h	32-bit	Reset Management Register, at EL1	
				RMR (at EL3)^h	32-bit	Reset Management Register, at EL3	
		c1	0	ISR^c	32-bit	Interrupt Status Register	
		c8	0	ICC_IAR0^e	32-bit	Interrupt Controller Interrupt Acknowledge Register 0	
			1	ICC_EOIR0^e	32-bit	Interrupt Controller End Of Interrupt Register 0	
			2	ICC_HPIR0^e	32-bit	Interrupt Controller Highest Priority Pending Interrupt Register 0	
			3	ICC_BPR0^e	32-bit	Interrupt Controller Binary Point Register 0	
			4	ICC_AP0R0^e	32-bit	Interrupt Controller Active Priorities Register (0,0)	
			5	ICC_AP0R1^e	32-bit	Interrupt Controller Active Priorities Register (0,1)	
			6	ICC_AP0R2^e	32-bit	Interrupt Controller Active Priorities Register (0,2)	
			7	ICC_AP0R3^e	32-bit	Interrupt Controller Active Priorities Register (0,3)	
		c12	0	c9	0	ICC_APIR0^e	32-bit
1	ICC_APIR1^e				32-bit	Interrupt Controller Active Priorities Register (1,1)	
2	ICC_APIR2^e				32-bit	Interrupt Controller Active Priorities Register (1,2)	
3	ICC_APIR3^e				32-bit	Interrupt Controller Active Priorities Register (1,3)	
c11	1		c11	1	ICC_DIR^e	32-bit	Interrupt Controller Deactivate Interrupt Register
				3	ICC_RPR^e	32-bit	Interrupt Controller Running Priority Register

Table G3-46 Summary of VMSAv8-32 CP15 register descriptions, in coprocessor register number order (continued)

CRn	opc1	CRm	opc2	Name	Width	Description	
c12	0	c12	0	ICC_IAR1 ^e	32-bit	Interrupt Controller Interrupt Acknowledge Register 1	
			1	ICC_EOIR1 ^e	32-bit	Interrupt Controller End Of Interrupt Register 1	
			2	ICC_HPPIR1 ^e	32-bit	Interrupt Controller Highest Priority Pending Interrupt Register 1	
			3	ICC_BPR1 ^e	32-bit	Interrupt Controller Binary Point Register 1	
			4	ICC_CTLR ^e	32-bit	Interrupt Controller Control Register	
			5	ICC_SRE ^e	32-bit	Interrupt Controller System Register Enable Register	
			6	ICC_IGRPEN0 ^e	32-bit	Interrupt Controller Interrupt Group 0 Enable Register	
			7	ICC_IGRPEN1 ^e	32-bit	Interrupt Controller Interrupt Group 1 Enable Register	
		c13	0	ICC_SEIEN ^e	32-bit	Interrupt Controller System Error Interrupt Enable register	
-	1	c12	-	ICC_ASGI1R ^e	64 bit	Interrupt Controller Alias SGI group 1 Register	
-	2	c12	-	ICC_SGI0R ^e	64 bit	Interrupt Controller SGI group 0 Register	
c12	4	c0	0	HVBAR ^{b, c}	32-bit	Hyp Vector Base Address Register	
			2	HRMR ^h	32-bit	Hyp Reset Management Register	
			c8	0	ICH_AP0R0 ^e	32-bit	Interrupt Controller Hyp Active Priorities Register (0,0)
				1	ICH_AP0R1 ^e	32-bit	Interrupt Controller Hyp Active Priorities Register (0,1)
				2	ICH_AP0R2 ^e	32-bit	Interrupt Controller Hyp Active Priorities Register (0,2)
				3	ICH_AP0R3 ^e	32-bit	Interrupt Controller Hyp Active Priorities Register (0,3)
			c9	0	ICH_AP1R0 ^e	32-bit	Interrupt Controller Hyp Active Priorities Register (1,0)
				1	ICH_AP1R1 ^e	32-bit	Interrupt Controller Hyp Active Priorities Register (1,1)
				2	ICH_AP1R2 ^e	32-bit	Interrupt Controller Hyp Active Priorities Register (1,2)
				3	ICH_AP1R3 ^e	32-bit	Interrupt Controller Hyp Active Priorities Register (1,3)
				4	ICH_VSEIR ^e	32-bit	Interrupt Controller Virtual System Error Interrupt Register
				5	ICC_HSRE ^e	32-bit	Interrupt Controller Hyp System Register Enable register
	c12	4	c11	0	ICH_HCR ^e	32-bit	Interrupt Controller Hyp Control Register
				1	ICH_VTR ^e	32-bit	Interrupt Controller VGIC Type Register
2				ICH_MISR ^e	32-bit	Interrupt Controller Maintenance Interrupt State Register	
3				ICH_EISR ^e	32-bit	Interrupt Controller End of Interrupt Status Register	
5				ICH_ELSR ^e	32-bit	Interrupt Controller Empty List Register Status Register	
7				ICH_VMCR ^e	32-bit	Interrupt Controller Virtual Machine Control Register	

Table G3-46 Summary of VMSAv8-32 CP15 register descriptions, in coprocessor register number order (continued)

CRn	opc1	CRm	opc2	Name	Width	Description	
c12	4	c12	0-7	ICH_LR<n> , for n==0 to 7 ^e	32-bit	Interrupt Controller List Registers 0 to 7	
		c13	0-7	ICH_LR<n> , for n==8 to 15 ^e	32-bit	Interrupt Controller List Registers 8 to 15	
		c14	0-7	ICH_LRC<n> , for n==0 to 7 ^e	32-bit	Interrupt Controller List Registers 0 to 7, continuation	
		c15	0-7	ICH_LRC<n> , for n==8 to 15 ^e	32-bit	Interrupt Controller List Registers 8 to 15, continuation	
6	c12	4		ICC_MCTLR ^e	32-bit	Interrupt Controller Monitor Control Register	
		5		ICC_MSRE ^e	32-bit	Interrupt Controller Monitor System Register Enable register	
		7		ICC_MGRPEN1 ^e	32-bit	Interrupt Controller Monitor Interrupt Group 1 Enable register	
c13	0	c0	0	FCSEIDR	32-bit	FCSE Process ID Register	
			1	CONTEXTIDR	32-bit	Context ID Register	
			2	TPIDRURW	32-bit	User Read/Write Thread ID Register	
			3	TPIDRURO	32-bit	User Read-Only Thread ID Register	
			4	TPIDRPRW	32-bit	EL1 only Thread ID Register	
4	c0	2	HTPIDR ^b	32-bit	Hyp Software Thread ID Register		
-	0	c14	-	CNTPCT ⁱ	64-bit	Physical Count register	
c14	0	c0	0	CNTFRQ ⁱ	32-bit	Counter Frequency register	
c14	0	c1	0	CNTKCTL ⁱ	32-bit	Timer EL1 Control register	
			c2	0	CNTP_TVAL ⁱ	32-bit	EL1 Physical TimerValue register
		c3	1	CNTP_CTL ⁱ	32-bit	EL1 Physical Timer Control register	
			c3	0	CNTV_TVAL ⁱ	32-bit	Virtual TimerValue register
				1	CNTV_CTL ⁱ	32-bit	Virtual Timer Control register
c14	0	c8	0-7	PMEVCNTR<n> , for n==0 to 7 ^d	32-bit	Performance Monitors Event Count Registers, 0-7	
			c9	0-7	PMEVCNTR<n> , for n==8 to 15 ^d	32-bit	Performance Monitors Event Count Registers, 8-15
		c10	0-7	PMEVCNTR<n> , for n==16 to 23 ^d	32-bit	Performance Monitors Event Count Registers, 16-23	
		c11	0-6	PMEVCNTR<n> , for n==24 to 30 ^d	32-bit	Performance Monitors Event Count Registers, 24-30	
		c12	0-7	PMEVTYPER<n> , for n==0 to 7 ^d	32-bit	Performance Monitors Event Type Registers, 0-7	

Table G3-46 Summary of VMSAv8-32 CP15 register descriptions, in coprocessor register number order (continued)

CRn	opc1	CRm	opc2	Name	Width	Description
c14	0	c13	0-7	PMEVTYPER<n> , for n==8 to 15 ^d	32-bit	Performance Monitors Event Type Registers, 8-15
		c14	0-7	PMEVTYPER<n> , for n==16 to 23 ^d	32-bit	Performance Monitors Event Type Registers, 16-23
		c15	0-6	PMEVTYPER<n> , for n==17 to 30 ^d	32-bit	Performance Monitors Event Type Registers, 24-30
		c15	7	PMCCFILTR ^d	32-bit	Performance Monitors Cycle Count Filter Register
-	1	c14	-	CNTVCT ⁱ	64-bit	Virtual Count register
			2	CNTP_CVAL ⁱ	64-bit	EL1 Physical Timer CompareValue register
			3	CNTV_CVAL ⁱ	64-bit	Virtual Timer CompareValue register
			4	CNTVOFF ^j	64-bit	Virtual Offset register
c14	4	c1	0	CNTHCTL	32-bit	Timer EL2 Control register
		c2	0	CNTHP_TVAL	32-bit	EL2 Physical TimerValue register
			1	CNTHP_CTL	32-bit	EL2 Physical Timer Control register
-	6	c14	-	CNTHP_CVAL	64-bit	EL2 Physical Timer CompareValue register
c15	0-7	c0-c15	0-7	-	32-bit	See IMPLEMENTATION DEFINED registers, functional group on page G3-3751

- a. [REVIDR](#) is an optional register. If it is not implemented, the encoding with opc2 set to 6 is an alias of [MIDR](#).
- b. Implemented only as part of EL2, when EL2 is using AArch32. Otherwise, encoding is unallocated and UNPREDICTABLE, see [Accesses to unallocated CP14 and CP15 encodings on page G3-3693](#).
- c. Implemented only as part of the EL3, when EL3 is using AArch32. Otherwise, as described in [Accesses to unallocated CP14 and CP15 encodings on page G3-3693](#), encoding is unallocated and:
 - UNDEFINED, for the registers accessed using CRn set to c12.
 - UNPREDICTABLE, for the register accessed using CRn values other than c12.
- d. Introduced in ARMv8.
- e. Introduced in ARMv8. Implemented only if the implementation includes the System registers interface to the Generic Interrupt Controller CPU interface.
- f. This register is only accessible in Debug state.
- g. When an implementation is using the Long descriptor translation table format these encodings access the [MAIR0](#) and [MAIR1](#) registers. Otherwise, they access the [PRRR](#) and [NMRR](#).
- h. Introduced in ARMv8. Only one of [RMR \(at EL1\)](#), [HRMR](#), and [RMR \(at EL3\)](#) is implemented, corresponding to the highest implemented Exception level, and the register is implemented only if that Exception level is using AArch32.
- i. Implemented only as part of the Generic Timers Extension. Otherwise, encoding is unallocated and UNDEFINED, see [Accesses to unallocated CP14 and CP15 encodings on page G3-3693](#).
- j. Implemented as RW only as part of the Generic Timers Extension on an implementation that includes EL2 and when EL2 is using AArch32. For more information see [Status of the CNTVOFF register on page D7-1864](#).

G3.17.3 Views of the CP15 registers

The following sections summarize the different software views of the CP15 registers, for VMSAv8-32:

- [EL0 views of the CP15 registers.](#)
- [EL1 views of the CP15 registers on page G3-3733.](#)
- [Non-secure EL2 view of the CP15 registers on page G3-3734.](#)

EL0 views of the CP15 registers

Software executing at EL0, unprivileged, can access only a small subset of the CP15 registers, as [Table G3-47](#) shows. This table excludes possible EL0 access to CP15 registers that are part of the following OPTIONAL extensions to the architecture:

- The Performance Monitors Extension, see [Possible EL0 access to the Performance Monitors Extension CP15 registers.](#)
- The Generic Timer Extension, see [Possible EL0 access to the Generic Timer Extension CP15 registers on page G3-3733.](#)

Table G3-47 CP15 registers accessible from EL0

Name	Access	Description	Note
CP15ISB	WO	Memory barriers on page E2-2352	ARM deprecates use of these operations
CP15DSB	WO		
CP15DMB	WO		
TPIDRURW	RW	TPIDRURW, Thread Pointer / ID Register, Unprivileged Read-Write on page G4-4078	-
TPIDRURO	RO	TPIDRURO, Thread Pointer / ID Register, Unprivileged Read-Only on page G4-4077	RW at EL1

Possible EL0 access to the Performance Monitors Extension CP15 registers

In a VMSAv8-32 implementation that includes the Performance Monitors Extension, when using CP15 to access the Performance Monitors registers:

- The [PMUSERENR](#) is RO from EL0.
- When:
 - The value of [PMUSERENR.EN](#) is 1, [PMCNTENSET](#), [PMCNTENCLR](#), [PMOVSr](#), [PMSWINC](#), [PMSELR](#), [PMCEID0](#), [PMCEID1](#), [PMCCNTR](#), [PMXEVTPER](#), [PMXVCNTR](#), [PMUSERENR](#), [PMOVSSET](#), [PMEVCNTR<n>](#), [PMEVTPER<n>](#), and [PMCCFILTR](#).are accessible by reads and writes from EL0.
 - The value of [PMUSERENR.ER](#) is 1, [PMXVCNTR](#) and [PMEVCNTR<n>](#).are accessible by reads and from EL0, and [PMSELR](#) is accessible by reads and writes from EL0.
 - The value of [PMUSERENR.CR](#) is 1, [PMCCNTR](#) is accessible by reads from EL0.
 - The value of [PMUSERENR.SW](#) is 1, [PMSWINC](#) is accessible by writes from EL0.

In general, when the value of a [PMUSERENR](#).{EN, ER, CR, SW} bit is 1, the enabled registers have the same access permissions from EL0 as they do from EL1.

For more information, see:

- [Traps to EL1 of EL0 accesses to Performance Monitors registers on page D1-1473.](#)
- [Chapter D6 The Performance Monitors Extension](#), in particular [Access permissions on page D6-1851.](#)

Possible EL0 access to the Generic Timer Extension CP15 registers

In a VMSAv8-32 implementation that includes the Generic Timer Extension, when using CP15 to access the Generic Timer registers:

- If `CNTKCTL.PLOPCTEN` is set to 1, then if the physical counter register `CNTPCT` is accessible from EL1 it is also accessible from EL0. For more information see [Accessing the physical counter on page D7-1858](#).
- If `CNTKCTL.PLOPVTEN` is set to 1, the virtual counter register `CNTVCT` is accessible from EL0. For more information, see [Accessing the virtual counter on page D7-1859](#).
- If at least one of `CNTKCTL.{PLOPCTEN, PLOPVTEN}` is set to 1, the `CNTFRQ` register is RO from EL0.
- If:
 - `CNTKCTL.PLOPTEN` is set to 1, the physical timer registers `CNTP_CTL`, `CNTP_CVAL`, and `CNTP_TVAL` are accessible from EL0.
 - `CNTKCTL.PLOVTEN` is set to 1, the virtual timer registers `CNTV_CTL`, `CNTV_CVAL`, and `CNTV_TVAL`, are accessible from EL0.

For more information, see [Accessing the timer registers on page D7-1861](#).

EL1 views of the CP15 registers

Software executing at EL1 can access all CP15 registers, with the following exceptions:

Non-secure EL1 software

EL3 restricts or prevents access to some registers by Non-secure EL1 software. In particular:

- The Restricted access CP15 registers are either not accessible to Non-secure EL1 software, or are read-only to Non-secure EL1 software, see [Restricted access System registers on page G3-3698](#)
- Configuration settings determine whether Non-secure EL1 software can access the Configurable access CP15 registers, see [Configurable access System registers on page G3-3699](#).

The individual register descriptions identify these access restrictions.

In an implementation that includes EL2, Non-secure EL1 software has no visibility of the EL2-mode registers summarized in [Banked EL2-mode CP15 read/write registers on page G3-3700](#). The individual register descriptions identify these registers as EL2-mode registers.

Secure EL1 software

In general, Secure EL1 software has access to all CP15 registers. However:

- The `CP15SDISABLE` signal disables write access to a number of Secure registers, see [The CP15SDISABLE input on page G3-3704](#).
- To access the EL2-mode registers, Secure EL1 software must move into Monitor mode, and set `SCR.NS` to 1.
[Banked EL2-mode CP15 read/write registers on page G3-3700](#) summarizes these registers.

The individual register descriptions identify:

- The registers affected by the `CP15SDISABLE` signal.
- The EL2-mode registers.

Non-secure EL2 view of the CP15 registers

Non-secure software executing at EL2 can access:

- The registers that are accessible to Non-secure software executing at EL1, as defined in [EL1 views of the CP15 registers on page G3-3733](#). Access permissions for these registers are identical to those for Non-secure software executing at EL1.
- The EL2-mode registers summarized in [Banked EL2-mode CP15 read/write registers on page G3-3700](#), and described in [Virtualization registers, functional group on page G3-3738](#).

G3.18 Functional grouping of VMSAv8-32 System registers

This section describes how the System registers in an VMSAv8-32 implementation divide into functional groups.

General system control registers on page G4-3773 describes each of these registers.

———— Note ————

- [Table G3-46 on page G3-3723](#) lists all of the VMSAv8-32 CP15 registers, ordered by:
 1. The CP15 primary register used when accessing the register. This is the CRn value for an access to a 32-bit register, or the CRm value for an access to a 64-bit register.
 2. The opc1 value used when accessing the register.
 3. For 32-bit registers, the {CRm, opc2} values used when accessing the register.
- The functional groups defined in this section mainly consist of the VMSAv8-32 registers, but include some additional System registers.
- Some registers belong to more than one functional group.

For other related information see:

- [The conceptual coprocessor interface and system control on page G1-3492](#) for general information about the System Control Coprocessor, CP15 and the register access instructions MRC and MCR
- [About the System registers for VMSAv8-32 on page G3-3691](#) for general information about the CP15 registers for VMSAv8-32, including:
 - Their organization, both by CP15 primary registers c0 to c15, and by function.
 - Their general behavior.
 - The effect of not implementing some Exception levels on the registers.
 - Different views of the registers, that depend on the state of the PE.
 - Conventions used in describing the registers.

The remainder of this chapter, and [General system control registers on page G4-3773](#), assumes you are familiar with [About the System registers for VMSAv8-32 on page G3-3691](#), and uses conventions and other information from that section without any explanation.

Each of the following sections summarizes a functional group of VMSAv8-32 System registers:

- [Identification registers, functional group on page G3-3736.](#)
- [Other system control registers, functional group on page G3-3737.](#)
- [Virtual memory control registers, functional group on page G3-3737.](#)
- [Virtualization registers, functional group on page G3-3738.](#)
- [Security registers, functional group on page G3-3741.](#)
- [Exception and fault handling registers, functional group on page G3-3741.](#)
- [Reset management registers, functional group on page G3-3742.](#)
- [Thread and process ID registers, functional group on page G3-3743.](#)
- [Cache maintenance operations, functional group on page G3-3743.](#)
- [TLB maintenance operations, functional group on page G3-3744.](#)
- [Address translation operations, functional group on page G3-3745.](#)
- [Lockdown, DMA, and TCM features, functional group on page G3-3747.](#)
- [Performance Monitors Extension registers, functional group on page G3-3747.](#)
- [Generic Timer Extension registers, functional group on page G3-3749.](#)
- [Generic Interrupt Controller CPU interface registers, functional group on page G3-3749.](#)
- [Legacy feature registers, functional group on page G3-3750.](#)
- [IMPLEMENTATION DEFINED registers, functional group on page G3-3751.](#)
- [Floating-point registers, functional group on page G3-3752.](#)
- [Debug registers, functional group on page G3-3752.](#)

G3.18.1 Identification registers, functional group

Table G3-48 shows the VMSAv8-32 CP15 registers in the Identification registers functional group.

Table G3-48 Identification registers, VMSAv8-32

Name	CRn	opc1	CRm	opc2	Width	Type	Description
AIDR	c0	1	c0	7	32-bit	RO	Auxiliary ID Register, IMPLEMENTATION DEFINED
CCSIDR	c0	1	c0	0	32-bit	RO	Cache Size ID Registers
CLIDR	c0	1	c0	1	32-bit	RO	Cache Level ID Register
CSSELR	c0	2	c0	0	32-bit	RW	Cache Size Selection Register
CTR	c0	0	c0	1	32-bit	RO	Cache Type Register
ID_AFR0	c0	0	c1	3	32-bit	RO	Auxiliary Feature Register 0 ^a
ID_DFR0	c0	0	c1	2	32-bit	RO	Debug Feature Register 0 ^a
ID_ISAR0	c0	0	c2	0	32-bit	RO	Instruction Set Attribute Register 0 ^a
ID_ISAR1	c0	0	c2	1	32-bit	RO	Instruction Set Attribute Register 1 ^a
ID_ISAR2	c0	0	c2	2	32-bit	RO	Instruction Set Attribute Register 2 ^a
ID_ISAR3	c0	0	c2	3	32-bit	RO	Instruction Set Attribute Register 3 ^a
ID_ISAR4	c0	0	c2	4	32-bit	RO	Instruction Set Attribute Register 4 ^a
ID_ISAR5	c0	0	c2	5	32-bit	RO	Instruction Set Attribute Register 5 ^a
ID_MMFR0	c0	0	c1	4	32-bit	RO	Memory Model Feature Register 0 ^a
ID_MMFR1	c0	0	c1	5	32-bit	RO	Memory Model Feature Register 1 ^a
ID_MMFR2	c0	0	c1	6	32-bit	RO	Memory Model Feature Register 2 ^a
ID_MMFR3	c0	0	c1	7	32-bit	RO	Memory Model Feature Register 3 ^a
ID_PFR0	c0	0	c1	0	32-bit	RO	Processor Feature Register 0 ^a
ID_PFR1	c0	0	c1	1	32-bit	RO	Processor Feature Register 1 ^a
MIDR	c0	0	c0	0	32-bit	RO	Main ID Register
MPIDR	c0	0	c0	5	32-bit	RO	Multiprocessor Affinity Register
REVIDR	c0	0	c0	6	32-bit	RO	Revision ID Register
TCMTR	c0	0	c0	2	32-bit	RO	TCM Type Register
TLBTR	c0	0	c0	3	32-bit	RO	TLB Type Register
VMPIDR	c0	4	c0	5	32-bit	RW	Virtualization Multiprocessor ID Register
VPIDR	c0	4	c0	5	32-bit	RW	Virtualization Processor ID Register

a. CPUID register, see *The CPUID identification scheme* on page G3-3737.

The other registers in this group are the [FPSID](#), [MVFR0](#), [MVFR1](#), and [MVFR2](#).

The [JIDR](#) holds legacy identification information.

The CPUID identification scheme

The ID_* registers were originally called the CPUID identification scheme registers. A footnote to [Table G3-48](#) on [page G3-3736](#) identifies these registers. However, functionally, there is no value in separating these registers from the slightly larger Identification registers functional group.

G3.18.2 Other system control registers, functional group

[Table G3-49](#) shows the VMSAv8-32 CP15 registers in the Other System registers functional group.

Table G3-49 Other System registers, VMSAv8-32

Name	CRn	opc1	CRm	opc2	Width	Type	Description
ACTLR	c1	0	c0	1	32-bit	RW	Auxiliary Control Register, IMPLEMENTATION DEFINED
CPACR	c1	0	c0	2	32-bit	RW	Coprocessor Access Control Register
HACTLR	c1	4	c0	0	32-bit	RW	Hyp Auxiliary System Control Register, IMPLEMENTATION DEFINED
HSCTLR	c1	4	c0	0	32-bit	RW	Hyp System Control Register
SCTLR	c1	0	c0	0	32-bit	RW	System Control Register

The following sections summarize the System registers added by the corresponding Exception levels:

- [Security registers, functional group on page G3-3741.](#)
- [Virtualization registers, functional group on page G3-3738.](#)

G3.18.3 Virtual memory control registers, functional group

[Table G3-50](#) shows the VMSAv8-32 CP15 registers in the Virtual memory control registers functional group.

Table G3-50 Virtual memory control registers

Name	CRn	opc1	CRm	opc2	Width	Type	Description
AMAIRO	c10	0	c3	0	32-bit	RW	Auxiliary Memory Attribute Indirection Register 0, IMPLEMENTATION DEFINED
AMAIR1	c10	0	c3	1	32-bit	RW	Auxiliary Memory Attribute Indirection Register 1, IMPLEMENTATION DEFINED
CONTEXTIDR	c13	0	c0	1	32-bit	RW	Context ID Register
DACR	c3	0	c0	0	32-bit	RW	Domain Access Control Register
HAMAIRO	c10	4	c3	0	32-bit	RW	Hyp Auxiliary Memory Attribute Indirection Register 0
HAMAIR1	c10	4	c3	1	32-bit	RW	Hyp Auxiliary Memory Attribute Indirection Register 1
HMAIRO	c10	4	c2	0	32-bit	RW	Hyp Memory Attribute Indirection Register 0
HMAIR1	c10	4	c2	1	32-bit	RW	Hyp Memory Attribute Indirection Register 1
HTCR	c2	4	c0	2	32-bit	RW	Hyp Translation Control Register
HTTBR	-	4	c2	-	64-bit	RW	Hyp Translation Table Base Register
MAIRO	c10	0	c2	0	32-bit	RW	Memory Attribute Indirection Register 0
MAIR1	c10	0	c2	1	32-bit	RW	Memory Attribute Indirection Register 1

Table G3-50 Virtual memory control registers (continued)

Name	CRn	opc1	CRm	opc2	Width	Type	Description
NMRR	c10	0	c2	1	32-bit	RW	Normal Memory Remap Register
PRRR	c10	0	c2	0	32-bit	RW	Primary Region Remap Register
SCTLR	c1	0	c0	0	32-bit	RW	System Control Register
TTBCR	c2	0	c0	2	32-bit	RW	Translation Table Base Control Register
TTBR0	c2	0	c0	0	32-bit	RW	Translation Table Base Register 0
TTBR0	-	0	c2	-	64-bit	RW	Translation Table Base Register 0
TTBR1	c2	0	c0	1	32-bit	RW	Translation Table Base Register 1
TTBR1	-	1	c2	-	64-bit	RW	Translation Table Base Register 1
VTCSR	c2	4	c1	2	32-bit	RW	Virtualization Translation Control Register
VTTBR	-	6	c2	-	64-bit	RW	Virtualization Translation Table Base Register

The IMPLEMENTATION DEFINED [ACTLR](#) might provide additional virtual memory control.

G3.18.4 Virtualization registers, functional group

[Table G3-51](#) shows the VMSAv8-32 CP15 registers in the Virtualization registers functional group, excluding the CP15 operations in this group.

Table G3-51 Virtualization registers, excluding CP15 operations

Name	CRn	opc1	CRm	opc2	Width	Type	Description
CNTHCTL	c14	4	c1	0	32-bit	RW	Counter-timer Hyp Control register
CNTHP_CTL	c14	4	c2	1	32-bit	RW	Counter-timer Hyp Physical Timer Control register
CNTHP_CVAL	-	6	c14	-	64-bit	RW	Counter-timer Hyp Physical Compare Value register
CNTHP_TVAL	c14	4	c2	0	32-bit	RW	Counter-timer Hyp Physical Timer Timer Value register
CNTVOFF	-	4	c14	-	64-bit	RW	Counter-timer Virtual Offset register
HACR	c1	4	c1	7	32-bit	RW	Hyp Auxiliary Configuration Register
HACTLR	c1	4	c0	1	32-bit	RW	Hyp Auxiliary Control Register, IMPLEMENTATION DEFINED
HADFSR	c5	4	c1	0	32-bit	RW	Hyp Auxiliary Data Fault Status Register, IMPLEMENTATION DEFINED
HAIFSR	c5	4	c1	1	32-bit	RW	Hyp Auxiliary Instruction Fault Status Register, IMPLEMENTATION DEFINED
HAMAIR0	c10	4	c3	0	32-bit	RW	Hyp Auxiliary Memory Attribute Indirection Register 0, IMPLEMENTATION DEFINED
HAMAIR1	c10	4	c3	1	32-bit	RW	Hyp Auxiliary Memory Attribute Indirection Register 1, IMPLEMENTATION DEFINED
HCPTR	c1	4	c1	2	32-bit	RW	Hyp Coprocessor Trap Register

Table G3-51 Virtualization registers, excluding CP15 operations (continued)

Name	CRn	opc1	CRm	opc2	Width	Type	Description
HCR	c1	4	c1	0	32-bit	RW	Hyp Configuration Register
HCR2	c1	4	c1	4	32-bit	RW	Hyp Configuration Register 2
HDCR	c1	4	c1	1	32-bit	RW	Hyp Debug Configuration Register
HDFAR	c6	4	c0	0	32-bit	RW	Hyp Data Fault Address Register
HIFAR	c6	4	c0	2	32-bit	RW	Hyp Instruction Fault Address Register
HMAIRO	c10	4	c2	0	32-bit	RW	Hyp Memory Attribute Indirection Register 0
HMAIR1	c10	4	c2	1	32-bit	RW	Hyp Memory Attribute Indirection Register 1
HPFAR	c6	4	c0	4	32-bit	RW	Hyp IPA Fault Address Register
HRMR	c12	4	c0	2	32-bit	RW	Hyp Reset Management Register
HSCTLR	c1	4	c0	0	32-bit	RW	Hyp System Control Register
HSR	c5	4	c2	0	32-bit	RW	Hyp Syndrome Register
HSTR	c1	4	c1	3	32-bit	RW	Hyp System Trap Register
HTCR	c2	4	c0	2	32-bit	RW	Hyp Translation Control Register
HTPIDR	c13	4	c0	2	32-bit	RW	Hyp Thread and Process ID Register
HTTBR	-	4	c2	-	64-bit	RW	Hyp Translation Table Base Register
HVBAR	c12	4	c0	0	32-bit	RW	Hyp Vector Base Address Register
ICC_HSRE	c12	4	c9	5	32-bit	RW	Interrupt Controller Hyp System Register Enable register
ICH_AP0R0	c12	4	c8	0	32-bit	RW	Interrupt Controller Hyp Active Priorities Register (0,0)
ICH_AP0R1	c12	4	c8	1	32-bit	RW	Interrupt Controller Hyp Active Priorities Register (0,1)
ICH_AP0R2	c12	4	c8	2	32-bit	RW	Interrupt Controller Hyp Active Priorities Register (0,2)
ICH_AP0R3	c12	4	c8	3	32-bit	RW	Interrupt Controller Hyp Active Priorities Register (0,3)
ICH_APIR0	c12	4	c9	0	32-bit	RW	Interrupt Controller Hyp Active Priorities Register (1,0)
ICH_APIR1	c12	4	c9	1	32-bit	RW	Interrupt Controller Hyp Active Priorities Register (1,1)
ICH_APIR2	c12	4	c9	2	32-bit	RW	Interrupt Controller Hyp Active Priorities Register (1,2)
ICH_APIR3	c12	4	c9	3	32-bit	RW	Interrupt Controller Hyp Active Priorities Register (1,3)
ICH_EISR	c12	4	c11	3	32-bit	RO	Interrupt Controller End of Interrupt Status Register
ICH_ELSR	c12	4	c11	5	32-bit	RO	Interrupt Controller Empty List Register Status Register
ICH_HCR	c12	4	c11	0	32-bit	RW	Interrupt Controller Hyp Control Register
ICH_LR<n>, n==0-7	c12	4	c12	0-7	32-bit	RW	Interrupt Controller List Registers, 0-7
ICH_LR<n>, n==8-15	c12	4	c13	0-7	32-bit	RW	Interrupt Controller List Registers, 8-15

Table G3-51 Virtualization registers, excluding CP15 operations (continued)

Name	CRn	opc1	CRm	opc2	Width	Type	Description
ICH_LRC<n> , n==0-7	c12	4	c14	0-7	32-bit	RW	Interrupt Controller List Registers Continuation, 0-7
ICH_LRC<n> , n==8-15	c12	4	c15	0-7	32-bit	RW	Interrupt Controller List Registers Continuation, 8-15
ICH_MISR	c12	4	c11	2	32-bit	RO	Interrupt Controller Maintenance Interrupt State Register
ICH_VMCR	c12	4	c11	7	32-bit	RW	Interrupt Controller Virtual Machine Control Register
ICH_VSEIR	c12	4	c9	4	32-bit	RW	Interrupt Controller Virtual System Error Interrupt Register
ICH_VTR	c12	4	c11	1	32-bit	RO	Interrupt Controller VGIC Type Register
VMPIDR	c0	4	c0	5	32-bit	RW	Virtualization Multiprocessor ID Register
VPIDR	c0	4	c0	0	32-bit	RW	Virtualization Processor ID Register
VTCR	c2	4	c1	2	32-bit	RW	Virtualization Translation Control Register
VTBR	-	6	c2	-	64-bit	RW	Virtualization Translation Table Base Register

Table G3-52 shows the Hyp mode CP15 operations, that are part of this functional group. See also [Table G3-51](#) on page G3-3738.

Table G3-52 Hyp mode CP15 operations

Name	CRn	opc1	CRm	opc2	Width	Type	Description
ATS1HR	c7	4	c8	0	32-bit	WO	Address Translate Stage 1 Hyp mode Read
ATS1HW	c7	4	c8	1	32-bit	WO	Address Translate Stage 1 Hyp mode Write
TLBIALLH ^a	c8	4	c7	0	32-bit	WO	Invalidate entire Hyp unified TLB
TLBIALLHIS ^a	c8	4	c3	0	32-bit	WO	Invalidate entire Hyp unified TLB
TLBIALLNSNH ^a	c8	4	c7	4	32-bit	WO	Invalidate entire Non-secure Non-Hyp unified TLB
TLBIALLNSNHIS ^a	c8	4	c3	4	32-bit	WO	Invalidate entire Non-secure Non-Hyp unified TLB
TLBIIPAS2 ^a	c8	4	c4	1	32-bit	WO	TLB Invalidate entry by IPA, Stage 2
TLBIIPAS2IS ^a	c8	4	c0	1	32-bit	WO	TLB Invalidate entry by IPA, Stage 2, Inner Shareable
TLBIIPAS2L ^a	c8	4	c4	5	32-bit	WO	TLB Invalidate entry by IPA, Stage 2, Last level
TLBIIPAS2LIS ^a	c8	4	c0	5	32-bit	WO	TLB Invalidate entry by IPA, Stage 2, Last level, Inner Shareable
TLBIMVAH ^a	c8	4	c7	1	32-bit	WO	Invalidate Hyp unified TLB by VA

Table G3-52 Hyp mode CP15 operations (continued)

Name	CRn	opc1	CRm	opc2	Width	Type	Description
TLBIMVAHIS^a	c8	4	c3	1	32-bit	WO	Invalidate Hyp unified TLB by VA
TLBIMVALH^a	c8	4	c7	5	32-bit	WO	TLB Invalidate entry by MVA, Last level, Hyp mode
TLBIMVALHIS^a	c8	4	c3	5	32-bit	WO	TLB Invalidate entry by MVA, Last level, Hyp mode, Inner Shareable

a. These links are to a summary of the operation, and [The scope of TLB maintenance operations on page G3-3640](#) describes the operation.

All the encodings shown in [Table G3-51 on page G3-3738](#) and [Table G3-52 on page G3-3740](#) are unallocated and UNPREDICTABLE on an implementation that does not include EL2, see [Accesses to unallocated CP14 and CP15 encodings on page G3-3693](#).

G3.18.5 Security registers, functional group

[Table G3-53](#) shows the VMSAv8-32 CP15 registers in the Security registers functional group.

Table G3-53 Security registers

Name	CRn	opc1	CRm	opc2	Width	Type	Description
ICC_MCTLR	c12	6	c12	4	32-bit	RW	Interrupt Controller Monitor Control Register
ICC_MGRPEN1	c12	6	c12	7	32-bit	RW	Interrupt Controller Monitor Interrupt Group 1 Enable register
ICC_MSRE	c12	6	c12	5	32-bit	RW	Interrupt Controller Monitor System Register Enable register
MVBAR	c12	0	c0	1	32-bit	RW	Monitor Vector Base Address Register
NSACR	c1	0	c1	2	32-bit	RW	Non-Secure Access Control Register
RMR (at EL3)	c12	0	c0	2	32-bit	RW	Reset Management Register
SCR	c1	0	c1	0	32-bit	RW	Secure Configuration Register
SDER	c1	0	c1	1	32-bit	RW	Secure Debug Enable Register

All the encodings shown in [Table G3-53](#) are unallocated and UNPREDICTABLE on an implementation that does not include EL3, see [Accesses to unallocated CP14 and CP15 encodings on page G3-3693](#).

G3.18.6 Exception and fault handling registers, functional group

[Table G3-54](#) shows the VMSAv8-32 CP15 registers in the Exception and fault handling registers functional group.

Table G3-54 Exception and fault handling registers

Name	CRn	opc1	CRm	opc2	Width	Type	Description
ADFSR	c5	0	c1	0	32-bit	RW	Auxiliary Data Fault Status Register, IMPLEMENTATION DEFINED
AIFSR	c5	0	c1	1	32-bit	RW	Auxiliary Instruction Fault Status Register, IMPLEMENTATION DEFINED
DFAR	c6	0	c0	0	32-bit	RW	Data Fault Address Register

Table G3-54 Exception and fault handling registers (continued)

Name	CRn	opc1	CRm	opc2	Width	Type	Description
DFSR	c5	0	c0	0	32-bit	RW	Data Fault Status Register
HADFSR	c5	4	c1	0	32-bit	RW	Hyp Auxiliary Data Fault Status Register, IMPLEMENTATION DEFINED
HAIFSR	c5	4	c1	1	32-bit	RW	Hyp Auxiliary Instruction Fault Status Register, IMPLEMENTATION DEFINED
HDFAR	c6	4	c0	0	32-bit	RW	Hyp Data Fault Address Register
HIFAR	c6	4	c0	2	32-bit	RW	Hyp Instruction Fault Address Register
HPFAR	c6	4	c0	4	32-bit	RW	Hyp IPA Fault Address Register
HSR	c5	4	c2	0	32-bit	RW	Hyp Syndrome Register
HVBAR	c12	4	c0	1	32-bit	RW	Hyp Vector Base Address Register
IFAR	c6	0	c0	2	32-bit	RW	Instruction Fault Address Register
IFSR	c5	0	c0	1	32-bit	RW	Instruction Fault Status Register
ISR	c12	0	c1	0	32-bit	RO	Interrupt Status Register
MVBAR	c12	0	c0	1	32-bit	RW	Monitor Vector Base Address Register
RVBAR	c12	0	c0	1	32-bit	RW	Reset Vector Base Address Register
VBAR	c12	0	c0	0	32-bit	RW	Vector Base Address Register

The PE returns fault information using the fault status registers and the fault address registers. For details of how these registers are used see [Exception reporting in a VMSAv8-32 implementation on page G3-3659](#).

———— **Note** —————

These registers also report information about debug exceptions. For more information see:

- [Data Abort exceptions, taken to a PL1 mode on page G3-3661](#).
- [Prefetch Abort exceptions, taken to a PL1 mode on page G3-3662](#).
- [Reporting exceptions taken to Hyp mode on page G3-3668](#).

G3.18.7 Reset management registers, functional group

[Table G3-55](#) shows the VMSAv8-32 CP15 registers in the Reset management registers functional group.

Table G3-55 Reset management registers

Name	CRn	opc1	CRm	opc2	Width	Type	Description
HRMR	c12	4	c0	2	32-bit	RW	Hyp Reset Management Register
RMR (at EL1)	c12	0	c0	2	32-bit	RW	Reset Management Register, EL1
RMR (at EL3)	c12	0	c0	2	32-bit	RW	Reset Management Register, EL3
RVBAR	c12	0	c0	1	32-bit	RW	Reset Vector Base Address Register

G3.18.8 Thread and process ID registers, functional group

Table G3-56 shows the VMSAv8-32 Thread and process ID registers.

Table G3-56 VMSAv8-32 Thread and process ID registers

Name	CRn	opc1	CRm	opc2	Width	Type ^a	Description
HTPIDR ^b	c13	4	c0	2	32-bit	RW	Hyp Software Thread ID Register
TPIDRPRW	c13	0	c0	4	32-bit	RW	PL1 Software Thread ID Register
TPIDRURO	c13	0	c0	3	32-bit	RW, PL0	PL0 Read-Only Software Thread ID Register
TPIDRURW	c13	0	c0	2	32-bit	RW, PL0	PL0 Read/Write Software Thread ID Register

- a. PL0 in a Type description indicates that the encoding is accessible by software executing at PL0. See the register description for more information.
- b. Implemented only as part of EL2. Otherwise, encoding is unallocated and UNPREDICTABLE, see [Accesses to unallocated CP14 and CP15 encodings](#) on page G3-3693.

G3.18.9 Cache maintenance operations, functional group

Table G3-57 shows the VMSAv8-32 Cache and branch predictor maintenance operations functional group.

Table G3-57 Cache and branch predictor maintenance operations

Name	CRn	opc1	CRm	opc2	Width	Type	Description	Limits ^a
BPIALL ^b	c7	0	c5	6	32-bit	WO	Branch predictor invalidate all	-
BPIALLIS ^b	c7	0	c1	6	32-bit	WO	Branch predictor invalidate all	IS
BPIMVA ^b	c7	0	c5	7	32-bit	WO	Branch predictor invalidate by VA	-
DCCIMVAC ^b	c7	0	c14	1	32-bit	WO	Data cache clean and invalidate by VA	PoC
DCCISW ^b	c7	0	c14	2	32-bit	WO	Data cache clean and invalidate by set/way	-
DCCMVAC ^b	c7	0	c10	1	32-bit	WO	Data cache clean by VA	PoC
DCCMVAU ^b	c7	0	c11	1	32-bit	WO	Data cache clean by VA	PoU
DCCSW ^b	c7	0	c10	2	32-bit	WO	Data cache clean by set/way	-
DCIMVAC ^b	c7	0	c6	1	32-bit	WO	Data cache invalidate by VA	PoC
DCISW ^b	c7	0	c6	2	32-bit	WO	Data cache invalidate by set/way	-
ICIALLU ^b	c7	0	c5	0	32-bit	WO	Instruction cache invalidate all	PoU
ICIALUIS ^b	c7	0	c1	0	32-bit	WO	Instruction cache invalidate all	PoU, IS
ICIMVAU ^b	c7	0	c5	1	32-bit	WO	Instruction cache invalidate by VA	PoU

- a. PoU = to Point of Unification, PoC = to Point of Coherence, IS = Inner Shareable.
- b. The links in this column are to a summary of the operation, see [Cache maintenance instructions](#) on page G2-3534.

G3.18.10 TLB maintenance operations, functional group

Table G3-58 shows the VMSAv8-32 TLB maintenance operations functional group. *The scope of TLB maintenance operations on page G3-3640 describes the operations.*

Table G3-58 TLB maintenance operations

Name ^a	CRn	opc1	CRm	opc2	Width	Type	Description	Limits ^b
DTLBIALL^c	c8	0	c6	0	32-bit	WO	Invalidate entire data TLB	-
DTLBIASID^c	c8	0	c6	2	32-bit	WO	Invalidate data TLB by ASID	-
DTLBIMVA^c	c8	0	c6	1	32-bit	WO	Invalidate data TLB entry by VA	-
ITLBIALL^c	c8	0	c5	0	32-bit	WO	Invalidate entire instruction TLB	-
ITLBIASID^c	c8	0	c5	2	32-bit	WO	Invalidate instruction TLB by ASID	-
ITLBIMVA^c	c8	0	c5	1	32-bit	WO	Invalidate instruction TLB by VA	-
TLBIALL^d	c8	0	c7	0	32-bit	WO	Invalidate entire unified TLB	-
TLBIALLH	c8	4	c7	0	32-bit	WO	Invalidate entire Hyp unified TLB	-
TLBIALLHIS	c8	4	c3	0	32-bit	WO	Invalidate entire Hyp unified TLB	IS
TLBIALLIS	c8	0	c3	0	32-bit	WO	Invalidate entire unified TLB	IS
TLBIALLNSNH	c8	4	c7	4	32-bit	WO	Invalidate entire Non-secure Non-Hyp unified TLB	-
TLBIALLNSNHIS	c8	4	c3	4	32-bit	WO	Invalidate entire Non-secure Non-Hyp unified TLB	IS
TLBIASID	c8	0	c7	2	32-bit	WO	Invalidate unified TLB by ASID	-
TLBIASIDIS	c8	0	c3	2	32-bit	WO	Invalidate unified TLB by ASID	IS
TLBIIPAS2	c8	4	c4	1	32-bit	WO	TLB Invalidate entry by IPA, Stage 2	-
TLBIIPAS2IS	c8	4	c0	1	32-bit	WO	TLB Invalidate entry by IPA, Stage 2, Inner Shareable	IS
TLBIIPAS2L	c8	4	c4	5	32-bit	WO	TLB Invalidate entry by IPA, Stage 2, Last level	-
TLBIIPAS2LIS	c8	4	c0	5	32-bit	WO	TLB Invalidate entry by IPA, Stage 2, Last level, Inner Shareable	IS
TLBIMVAA	c8	0	c7	3	32-bit	WO	Invalidate unified TLB by VA, all ASID	-
TLBIMVAAIS	c8	0	c3	3	32-bit	WO	Invalidate unified TLB by VA, all ASID	IS
TLBIMVAAL	c8	0	c7	7	32-bit	WO	TLB Invalidate entry by MVA, All ASID, Last level	-
TLBIMVAALIS	c8	0	c3	7	32-bit	WO	TLB Invalidate entry by MVA, All ASID, Last level, Inner Shareable	IS
TLBIMVA	c8	0	c7	1	32-bit	WO	Invalidate unified TLB by VA	-
TLBIMVAH	c8	4	c7	1	32-bit	WO	Invalidate Hyp unified TLB by VA	-

Table G3-58 TLB maintenance operations (continued)

Name ^a	CRn	opc1	CRm	opc2	Width	Type	Description	Limits ^b
TLBIMVAHIS	c8	4	c3	1	32-bit	WO	Invalidate Hyp unified TLB by VA	IS
TLBIMVAIS	c8	0	c3	1	32-bit	WO	Invalidate unified TLB by VA	IS
TLBIMVAL	c8	0	c7	5	32-bit	WO	TLB Invalidate entry by MVA, Last level	-
TLBIMVALH	c8	4	c7	5	32-bit	WO	TLB Invalidate entry by MVA, Last level, Hyp mode	-
TLBIMVALHIS	c8	4	c3	5	32-bit	WO	TLB Invalidate entry by MVA, Last level, Hyp mode, Inner Shareable	IS
TLBIMVALIS	c8	0	c3	5	32-bit	WO	TLB Invalidate entry by MVA, Last level	IS

- a. These links are to a summary of the operation, and [The scope of TLB maintenance operations on page G3-3640](#) describes the operation.
b. IS = Inner Shareable.
c. Deprecated. ARM deprecates use of operations that operate only on an Instruction TLB, or only on a Data TLB.
d. The mnemonics for the operations with CRm==c7, opc2=={0, 1, 2} were previously UTLBIALL, UTLBIMVA and UTLBIMASID.

G3.18.11 Address translation operations, functional group

[Table G3-59](#) shows the VMSAv8-32 Address translation operations functional group.

Table G3-59 Address translation operations

Name	CRn	opc1	CRm	opc2	Width	Type	Description
ATS12NSOPR ^{a, c}	c7	0	c8	4	32-bit	WO	Stages 1 and 2 Non-secure only EL1 read
ATS12NSOPW ^{a, c}	c7	0	c8	5	32-bit	WO	Stages 1 and 2 Non-secure only EL1 write
ATS12NSOUR ^{a, c}	c7	0	c8	6	32-bit	WO	Stages 1 and 2 Non-secure only unprivileged read
ATS12NSOUW ^{a, c}	c7	0	c8	7	32-bit	WO	Stages 1 and 2 Non-secure only unprivileged write
ATS1CPR ^c	c7	0	c8	0	32-bit	WO	Stage 1 Current state EL1 read
ATS1CPW ^c	c7	0	c8	1	32-bit	WO	Stage 1 Current state EL1 write
ATS1CUR ^c	c7	0	c8	2	32-bit	WO	Stage 1 Current state unprivileged read
ATS1CUW ^c	c7	0	c8	3	32-bit	WO	Stage 1 Current state unprivileged write
ATS1HR ^{b, c}	c7	4	c8	0	32-bit	WO	Stage 1 Hyp mode read
ATS1HW ^{b, c}	c7	4	c8	1	32-bit	WO	Stage 1 Hyp mode write
PAR	c7	0	c4	0	32-bit	RW	Physical Address Register
	-	0	c7	-	64-bit	RW	

- a. Implemented only as part of EL3. Otherwise, encoding is unallocated and UNPREDICTABLE, see [Accesses to unallocated CP14 and CP15 encodings on page G3-3693](#).
b. Implemented only as part of EL2. Otherwise, encoding is unallocated and UNPREDICTABLE, see [Accesses to unallocated CP14 and CP15 encodings on page G3-3693](#).
c. These links are to a summary of the operation.

Virtual Address to Physical Address translation operations on page G3-3685 describes these operations.

G3.18.12 Lockdown, DMA, and TCM features, functional group

Table G3-60 shows the VMSAv8-32 reserved encodings for the Lockdown, DMA, and TCM features registers functional group.

Table G3-60 Lockdown, DMA, and TCM features, VMSAv8-32

Name	CRn	opc1	CRm	Width	opc2	Type	Description
IMPLEMENTATION DEFINED	c9	0-7	c0-c2	32-bit	0-7	a	VMSAv8-32 CP15 c9 register summary on page G3-3719
			c5-c8	32-bit	0-7	a	
	c10	0	c0-c1	32-bit	0-7	a	VMSAv8-32 CP15 c10 register summary on page G3-3720
			c4	32-bit	0-7	a	
			c8	32-bit	0-7	a	
	c11	0-7	c0-c8	32-bit	0-7	a	VMSAv8-32 CP15 c11 register summary on page G3-3721
			c15	32-bit	0-7	a	

a. Access depends on the register or operation, and is IMPLEMENTATION DEFINED.

G3.18.13 Performance Monitors Extension registers, functional group

Table G3-61 shows the VMSAv8-32 Performance Monitors Extension registers functional group. See also [IMPLEMENTATION DEFINED performance monitors on page G3-3748](#).

Table G3-61 Performance Monitors Extension registers

Name	CRn	opc1	CRm	opc2	Width	Description
PMCCFILTR	c14	0	c15	7	32-bit	Performance Monitors Cycle Count Filter Register
PMCCNTR	c9	0	c13	0	32-bit	Performance Monitors Cycle Count Register
PMCEID0	c9	0	c12	6	32-bit	Performance Monitors Common Event Identification register 0
PMCEID1	c9	0	c12	7	32-bit	Performance Monitors Common Event Identification register 1
PMCNTENCLR	c9	0	c12	2	32-bit	Performance Monitors Count Enable Clear register
PMCNTENSET	c9	0	c12	1	32-bit	Performance Monitors Count Enable Set register
PMCR	c9	0	c12	0	32-bit	Performance Monitors Control Register
PMEVCNTR<n> , for n==0 to 7	c14	0	c8	0-7	32-bit	Performance Monitors Event Count Registers, 0-7
PMEVCNTR<n> , for n== 16 to 23	c14	0	c10	0-7	32-bit	Performance Monitors Event Count Registers, 16-23
PMEVCNTR<n> , for n==24 to 30	c14	0	c11	0-6	32-bit	Performance Monitors Event Count Registers, 24-30
PMEVCNTR<n> , for n==8 to 15	c14	0	c9	0-7	32-bit	Performance Monitors Event Count Registers, 8-15
PMEVTPER<n> , for n==0 to 7	c14	0	c12	0-7	32-bit	Performance Monitors Event Type Registers, 0-7

Table G3-61 Performance Monitors Extension registers (continued)

Name	CRn	opc1	CRm	opc2	Width	Description
PMEVTYPER<n> , for n== 16 to 23	c14	0	c14	0-7	32-bit	Performance Monitors Event Type Registers, 16-23
PMEVTYPER<n> , for n== 17 to 30	c14	0	c15	0-6	32-bit	Performance Monitors Event Type Registers, 24-30
PMEVTYPER<n> , for n==8 to 15	c14	0	c13	0-7	32-bit	Performance Monitors Event Type Registers, 8-15
PMINTENCLR	c9	0	c14	2	32-bit	Performance Monitors Interrupt Enable Clear register
PMINTENSET	c9	0	c14	1	32-bit	Performance Monitors Interrupt Enable Set register
PMOVSRR	c9	0	c12	3	32-bit	Performance Monitors Overflow Flag Status Register
PMOVSSET	c9	0	c14	3	32-bit	Performance Monitors Overflow Flag Status Set register
PMSCLR	c9	0	c12	5	32-bit	Performance Monitors Event Counter Selection Register
PMSWINC	c9	0	c12	4	32-bit	Performance Monitors Software Increment register
PMUSERENR	c9	0	c14	0	32-bit	Performance Monitors User Enable Register
PMXEVCNTR	c9	0	c13	2	32-bit	Performance Monitors Event Count Register
PMXEVTYPER	c9	0	c13	1	32-bit	Performance Monitors Event Type Select Register

IMPLEMENTATION DEFINED performance monitors

VMSAv8-32 reserves some additional CP15c9 encodings for optional additional IMPLEMENTATION DEFINED performance monitors. [Table G3-62](#) shows the allocation of CP15 c9 encodings:

Table G3-62 Performance Monitors register encoding allocations in CP15 c9

CRn	opc1	CRm	opc2	Name	Width	Type	Description
c9	0-7	c12-c14	0-7	Performance Monitors Extension registers, see Table G3-61 on page G3-3747	32-bit	RW or RO ^a	<i>IMPLEMENTATION DEFINED performance monitors</i>
		c15	0-7	IMPLEMENTATION DEFINED			

a. The table referenced in the *Name* entry shows the type of each of the OPTIONAL Performance Monitors Extension registers.

b. Access depends on the register or operation, and is IMPLEMENTATION DEFINED.

G3.18.14 Generic Timer Extension registers, functional group

AArch32 state reserves CP15 primary coprocessor register c14 for access to the Generic Timer Extension registers. For more information about these registers see *About the Generic Timer registers* on page D7-1864. Table G3-63 shows the VMSAv8-32 CP15 registers in the Generic Timer registers functional group.

Table G3-63 Generic Timer Extension registers

Name	CRn	opc1	CRm	opc2	Width	Type ^a	Description
CNTFRQ	c14	0	c0	0	32-bit	RW	Counter Frequency register
CNTHCTL	c14	4	c1	0	32-bit	RW	Timer EL2 Control register
CNTHP_CTL	c14	4	c2	1	32-bit	RW	EL2 Physical Timer Control register
CNTHP_CVAL	-	6	c14	-	64-bit	RW	EL2 Physical Timer CompareValue register
CNTHP_TVAL	c14	4	c2	0	32-bit	RW	EL2 Physical TimerValue register
CNTKCTL	c14	0	c1	0	32-bit	RW	Timer EL1 Control register
CNTP_CTL	c14	0	c2	1	32-bit	RW	EL1 Physical Timer Control register
CNTP_CVAL	-	2	c14	-	64-bit	RW	EL1 Physical Timer CompareValue register
CNTP_TVAL	c14	0	c2	0	32-bit	RW	EL1 Physical TimerValue register
CNTPCT	-	0	c14	-	64-bit	RW	Physical Count register
CNTV_CTL	c14	0	c3	1	32-bit	RW	Virtual Timer Control register
CNTV_CVAL	-	3	c14	-	64-bit	RW	Virtual Timer CompareValue register
CNTV_TVAL	c14	0	c3	0	32-bit	RW	Virtual TimerValue register
CNTVCT	-	1	c14	-	64-bit	RO	Virtual Count register
CNTVOFF^b	-	4	c14	-	64-bit	RW	Virtual Offset register

- a. See the register descriptions for more information. Accessibility can depend on configuration settings as well as on the current Exception level.
- b. Implemented as RW only as part of the Generic Timers Extension on an implementation that includes EL2 and when EL2 is using AArch32. For more information see *Status of the CNTVOFF register* on page D7-1864.

G3.18.15 Generic Interrupt Controller CPU interface registers, functional group

Table G3-64 shows the VMSAv8-32 CP15 registers in the Generic Interrupt Controller CPU interface registers functional group.

Table G3-64 Generic Interrupt Controller CPU interface registers

Name	CRn	opc1	CRm	opc2	Width	Type	Description
ICC_HSRE	c12	4	c9	5	32-bit	RW	Interrupt Controller Hyp System Register Enable register
ICH_AP0R0	c12	4	c8	0	32-bit	RW	Interrupt Controller Hyp Active Priorities Register (0,0)
ICH_AP0R1	c12	4	c8	1	32-bit	RW	Interrupt Controller Hyp Active Priorities Register (0,1)
ICH_AP0R2	c12	4	c8	2	32-bit	RW	Interrupt Controller Hyp Active Priorities Register (0,2)
ICH_AP0R3	c12	4	c8	3	32-bit	RW	Interrupt Controller Hyp Active Priorities Register (0,3)
ICH_APIR0	c12	4	c9	0	32-bit	RW	Interrupt Controller Hyp Active Priorities Register (1,0)

Table G3-64 Generic Interrupt Controller CPU interface registers (continued)

Name	CRn	opc1	CRm	opc2	Width	Type	Description
ICH_APIR1	c12	4	c9	1	32-bit	RW	Interrupt Controller Hyp Active Priorities Register (1,1)
ICH_APIR2	c12	4	c9	2	32-bit	RW	Interrupt Controller Hyp Active Priorities Register (1,2)
ICH_APIR3	c12	4	c9	3	32-bit	RW	Interrupt Controller Hyp Active Priorities Register (1,3)
ICH_EISR	c12	4	c11	3	32-bit	RO	Interrupt Controller End of Interrupt Status Register
ICH_ELSR	c12	4	c11	5	32-bit	RO	Interrupt Controller Empty List Register Status Register
ICH_HCR	c12	4	c11	0	32-bit	RW	Interrupt Controller Hyp Control Register
ICH_LR<n>, n==0-7	c12	4	c12	0-7	32-bit	RW	Interrupt Controller List Registers, 0-7
ICH_LR<n>, n==8-15	c12	4	c13	0-7	32-bit	RW	Interrupt Controller List Registers, 8-15
ICH_LRC<n>, n==0-7	c12	4	c14	0-7	32-bit	RW	Interrupt Controller List Registers Continuation, 0-7
ICH_LRC<n>, n==8-15	c12	4	c15	0-7	32-bit	RW	Interrupt Controller List Registers Continuation, 8-15
ICH_MISR	c12	4	c11	2	32-bit	RO	Interrupt Controller Maintenance Interrupt State Register
ICH_VMCR	c12	4	c11	7	32-bit	RW	Interrupt Controller Virtual Machine Control Register
ICH_VSEIR	c12	4	c9	4	32-bit	RW	Interrupt Controller Virtual System Error Interrupt Register
ICH_VTR	c12	4	c11	1	32-bit	RO	Interrupt Controller VGIC Type Register

G3.18.16 Legacy feature registers, functional group

Table G3-65 shows the VMSAv8-32 CP15 Legacy features registers.

Table G3-65 CP15 Legacy features registers

Name	CRn	opc1	CRm	opc2	Width	Type ^a	Description
CP15DMB	c7	0	c10	5	32-bit	WO, PL0	Memory barriers on page E2-2352
CP15DSB	c7	0	c10	4	32-bit	WO, PL0	
CP15ISB	c7	0	c5	4	32-bit	WO, PL0	
FCSEIDR	c13	0	c0	0	32-bit	^b	FCSE Process ID Register

- PL0 in a Type description indicates that the encoding is accessible by software executing at PL0. See the register description for more information.
- In ARMv8, the PE does not implement the [FCSEIDR](#), and therefore the register is RO. See the register description for more information.

Table G3-66 shows the VMSAv8-32 CP14 Legacy features registers.

Table G3-66 CP14 Legacy features registers

Name	CRn	opc1	CRm	opc2	Width	Type	Description
JIDR	c0	7	c0	0	32-bit	RO	Jazelle ID Register
JMCR	c2	7	c0	0	32-bit	RW	Jazelle Main Configuration Register
JOSCR	c1	7	c0	0	32-bit	RW	Jazelle OS Control Register
TEECR ^a	c0	6	c0	0	32-bit	RW	T32EE Configuration Register
TEEHBR ^a	c1	6	c0	0	32-bit	RW	T32EE Handler Base Register

a. Implemented only if the implementation includes support for T32EE state. This support is deprecated and OPTIONAL. When T32EE state is not supported, these encodings are reserved and UNDEFINED.

G3.18.17 IMPLEMENTATION DEFINED registers, functional group

AArch32 state reserves CP15 c15 for IMPLEMENTATION DEFINED purposes, and does not impose any restrictions on the use of the CP15 c15 encodings. The documentation of the ARM implementation must describe fully any registers implemented in CP15 c15. Normally, for processor implementations by ARM, this information is included in the *Technical Reference Manual* for the processor.

Typically, an implementation uses CP15 c15 to provide test features, and any required configuration options that are not covered by this manual.

In addition, VMSAv8-32 defines some encodings for IMPLEMENTATION DEFINED registers. Table G3-67 shows these registers.

Table G3-67 IMPLEMENTATION DEFINED registers with architecturally-defined encodings

Name	CRn	opc1	CRm	opc2	Width	Type	Description
ACTLR	c1	0	c0	1	32-bit	RW	Auxiliary Control Register
ADFSR	c5	0	c1	0	32-bit	RW	Auxiliary Data Fault Status Register
AIDR	c0	1	c0	7	32-bit	RO	Auxiliary ID Register
AIFSR	c5	0	c1	1	32-bit	RW	Auxiliary Instruction Fault Status Register
AMAIRO	c10	0	c3	0	32-bit	RW	Auxiliary Memory Attribute Indirection Register 0
AMAIR1	c10	0	c3	1	32-bit	RW	Auxiliary Memory Attribute Indirection Register 1
HACTLR	c1	4	c0	0	32-bit	RW	Hyp Auxiliary System Control Register
HADFSR	c5	4	c1	0	32-bit	RW	Hyp Auxiliary Data Fault Status Register
HAIFSR	c5	4	c1	1	32-bit	RW	Hyp Auxiliary Instruction Fault Status Register
HAMAIRO	c10	4	c3	0	32-bit	RW	Hyp Auxiliary Memory Attribute Indirection Register 0
HAMAIR1	c10	4	c3	1	32-bit	RW	Hyp Auxiliary Memory Attribute Indirection Register 1

See also *IMPLEMENTATION DEFINED performance monitors* on page G3-3748.

G3.18.18 Floating-point registers, functional group

Table G3-68 shows the VMSAv8-32 Floating-point registers. These registers are accessed using MRS and MSR instructions, see the register descriptions for more information.

Table G3-68 Floating-point registers

Name	Width	Type	Description
FPEXC	32-bit	RW	Floating-Point Exception Control register
FPSCR	32-bit	RW	Floating-Point Status and Control Register
FPSID	32-bit	RO	Floating-Point System ID register
MVFR0	32-bit	RO	Media and VFP Feature Register 0
MVFR1	32-bit	RO	Media and VFP Feature Register 1
MVFR2	32-bit	RO	Media and VFP Feature Register 2

G3.18.19 Debug registers, functional group

In AArch32 state, most Debug registers that are accessible through the System registers interface use CP14 encodings, and are accessed with an `opc1` value of 0. Table G3-69 shows these registers.

Table G3-69 System register CP14 encodings of Debug registers

Name	CRn	opc2	CRm	Width	Type	Description	Number ^a
DBGAUTHSTATUS	c7	6	c14	32-bit	RO	Authentication Status	1006
DBGBCR<n>	c0	5	c0-c15	32-bit	RW	Breakpoint Control	80-95
DBGBVR<n>	c0	4	c0-c15	32-bit	RW	Breakpoint Value	64-79
DBGBXVR<n>	c1	1	c0-c15	32-bit	RW	Breakpoint Extended Value	144-159
DBGCLAIMCLR	c7	6	c9	32-bit	RW	Claim Tag Clear	1001
DBGCLAIMSET	c7	6	c8	32-bit	RW	Claim Tag Set	1000
DBGDCCINT	c0	0	c2	32-bit	RW	Debug Communications Channel Interrupt Enable Register	2
DBGDEVID	c7	7	c2	32-bit	RO	Device ID 0	1010
DBGDEVID1	c7	7	c1	32-bit	RO	Device ID 1	1009
DBGDEVID2	c7	7	c0	32-bit	RO	Contents reserved, RAZ	1008
DBGDIDR	c0	0	c0	32-bit	RO	Debug ID	0
DBGDRAR	-	-	c1	64-bit	RO	Debug ROM Address	128
	c1	0	c0	32-bit			
DBGDSAR	-	-	c2	64-bit	RO	Debug Self Address Offset	256
	c2	0	c0	32-bit			
DBGDSCRExt	c0	2	c2	32-bit	RW	Debug Status and Control external	34
DBGDSCRint	c0	0	c1	32-bit	RO	Debug Status and Control internal	1

Table G3-69 System register CP14 encodings of Debug registers (continued)

Name	CRn	opc2	CRm	Width	Type	Description	Number ^a
DBGDTRRExt	c0	2	c0	32-bit	RW	Host to Target Data Transfer external	32
DBGDTRRInt	c0	0	c5	32-bit	RO	Host to Target Data Transfer internal	5
DBGDTRTExt	c0	2	c3	32-bit	RW	Target to Host Data Transfer external	35
DBGDTRTInt	c0	0	c5	32-bit	WO	Target to Host Data Transfer internal	5
DBGOSDLR	c1	4	c3	32-bit	RW	OS Double Lock	195
DBGOSECCR	c0	2	c6	32-bit	RW	OS Lock Exception Catch Control Register	38
DBGOSLAR	c1	4	c0	32-bit	WO	OS Lock Access	192
DBGOSLSR	c1	4	c1	32-bit	RO	OS Lock Status	193
DBGPRCR	c1	4	c4	32-bit	RW	Device Powerdown and Reset Control	196
DBGVCR	c0	0	c7	32-bit	RW	Vector Catch	7
DBGWCR<n>	c0	7	c0-c15	32-bit	RW	Watchpoint Control	112-127
DBGWFAR	c0	0	c6	32-bit	RW	Watchpoint Fault Address	6
DBGWVR<n>	c0	6	c0-c15	32-bit	RW	Watchpoint Value	96-111
-	c4	0-3	c0-c15	32-bit	IMP DEF	IMPLEMENTATION DEFINED	512-575
-	c7	2-3	c0-c15	32-bit	IMP DEF	Integration registers	928-959
		4	c0	32-bit	IMP DEF		960

a. See [Debug CP14 System register numbers](#) on page G3-3754.

In AArch32 state, some Debug registers that are accessible through the System registers interface use CP15 encodings. [Table G3-70](#) shows these registers.

Table G3-70 System register CP15 encodings of Debug registers

Name	CRn	opc1	CRm	opc2	Width	Type	Description
DLR	c4	3	c5	1	32-bit	RW	Debug Link Register
DPSR	c4	3	c5	0	32-bit	RW	Debug Saved Program Status Register
HDCR	c1	4	c1	1	32-bit	RW	Hyp Debug Control Register
SDCR	c1	0	c3	1	32-bit	RW	Secure Debug Configuration Register
SDER	c1	0	c1	1	32-bit	RW	Secure Debug Enable Register

Debug CP14 System register numbers

In AArch32 state, each debug register that is accessible using a System registers CP14 encoding can be assigned a register number, determined by the {CRn, opc2, CRm} values used to access the register. If the register is also accessible in a memory-mapped interface, then its offset in that interface is (4*(register_number)). [Figure G3-31](#) shows this mapping from {CRn, opc2, CRm} values to the debug register number.

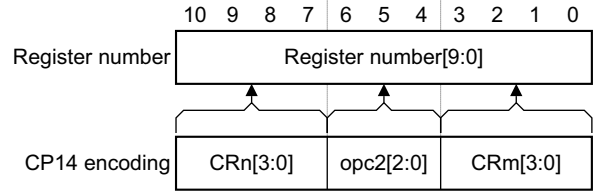

Figure G3-31 Mapping from CP14 encoding to debug register number

———— **Note** —————

The CP14 debug register encodings only use CRn values c0-c7, meaning bit[10] of the register number is 0.

[Example G3-6](#) shows this encoding for debug register 195, [DBGOSDLR](#).

Example G3-6 CP14 encoding of debug register 195

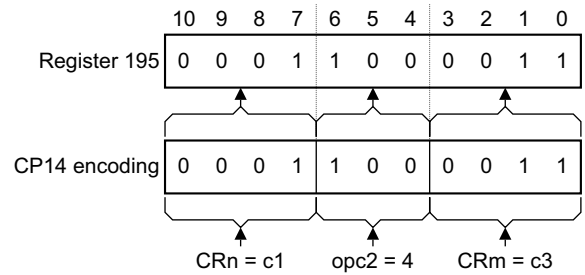

G3.19 Pseudocode details of VMSAv8-32 memory system operations

This section contains pseudocode describing VMSAv8-32 memory operations. The following subsections describe the pseudocode functions:

- [Alignment fault](#).
- [Address translation](#).
- [Domain checking on page G3-3757](#).
- [TLB operations on page G3-3757](#).
- [Translation table walk on page G3-3757](#).
- [Reporting syndrome information on page G3-3768](#).
- [Calling the hypervisor on page G3-3769](#).
- [Memory access decode when TEX remap is enabled on page G3-3769](#).

See also the pseudocode for general memory system operations in [Pseudocode details of general memory system instructions on page G2-3549](#).

G3.19.1 Alignment fault

The `AlignmentFault()` pseudocode function describes the generation of an Alignment fault Data Abort exception:

```
// AArch32.AlignmentFault()
// =====

FaultRecord AArch32.AlignmentFault(AccType acctype, boolean iswrite, boolean secondstage)

    ipaddress = bits(40) UNKNOWN;
    domain = bits(4) UNKNOWN;
    level = integer UNKNOWN;
    extflag = bit UNKNOWN;
    debugmoe = bits(4) UNKNOWN;
    s2fslwalk = boolean UNKNOWN;

    return AArch32.CreateFaultRecord(Fault_Alignment, ipaddress, domain, level, acctype, iswrite,
                                     extflag, debugmoe, secondstage, s2fslwalk);
```

See also [Abort exceptions on page G2-3555](#).

G3.19.2 Address translation

The `TranslateAddress()` pseudocode function describes a VMSAv8-32 address translation. This function calls either:

- The function described in [Address translation when the stage 1 address translation is disabled on page G3-3756](#).
- One of the functions described in [Translation table walk on page G3-3757](#).

```
// AArch32.TranslateAddress()
// =====
// Main entry point for translating an address

AddressDescriptor AArch32.TranslateAddress(bits(32) vaddress, AccType acctype, boolean iswrite,
                                           boolean wasaligned, integer size)

    if PSTATE.EL == EL0 && !ELUsingAArch32(EL1) then
        return AArch64.TranslateAddress(ZeroExtend(vaddress, 64), acctype, iswrite, wasaligned,
                                         size);

    result = AArch32.FullTranslate(vaddress, acctype, iswrite, wasaligned, size);

    if !(acctype IN {AccType_PTW, AccType_IC, AccType_AT}) && !IsFault(result) then
        result.fault = AArch32.CheckDebug(vaddress, acctype, iswrite, size);

    return result;
```

[Stage 2 translation table walk on page G3-3765](#) describes the CheckPermissionS2() and CombineS1S2Desc() pseudocode functions.

Address translation when the stage 1 address translation is disabled

The TranslateAddressS10ff() pseudocode function describes the address translation performed when the stage 1 address translation is disabled.

```
// AArch32.TranslateAddressS10ff()
// =====
// Called for stage 1 translations when translation is disabled to supply a default translation.
// Note that there are additional constraints on instruction prefetching that are not described in
// this pseudocode.
```

```
TLBRecord AArch32.TranslateAddressS10ff(bits(32) vaddress, AccType acctype, boolean iswrite)
    assert ELUsingAArch32(TranslationRegime());
```

```
    TLBRecord result;
```

```
    if HaveEL(EL2) && !IsSecure() && PSTATE.EL != EL2 && HCR.DC == '1' then
        // Use default cacheable settings
        result.addrdesc.memattrs.type = MemType_Normal;
        result.addrdesc.memattrs.device = DeviceType_UNKNOWN;
        result.addrdesc.memattrs.inner.attrs = MemAttr_WB;           // Write-back
        result.addrdesc.memattrs.inner.hints = MemHint_RWA;
        result.addrdesc.memattrs.shareable = FALSE;
        result.addrdesc.memattrs.outershareable = FALSE;
        if HCR.VM != '1' then UNPREDICTABLE;
```

```
    elsif acctype != AccType_IFETCH then
        // Treat data as Device
        result.addrdesc.memattrs.type = MemType_Device;
        result.addrdesc.memattrs.device = DeviceType_nGnRnE;
        result.addrdesc.memattrs.inner = MemAttrHints_UNKNOWN;
        result.addrdesc.memattrs.shareable = TRUE;
        result.addrdesc.memattrs.outershareable = TRUE;
    else
        // Instruction cacheability controlled by SCTL/HSCTL.I
        if PSTATE.EL == EL2 then
            cacheable = HSCTL.I == '1';
        else
            cacheable = SCTL.I == '1';
        result.addrdesc.memattrs.type = MemType_Normal;
        result.addrdesc.memattrs.device = DeviceType_UNKNOWN;
        if cacheable then
            result.addrdesc.memattrs.inner.attrs = MemAttr_WT;
            result.addrdesc.memattrs.inner.hints = MemHint_RA;
        else
            result.addrdesc.memattrs.inner.attrs = MemAttr_NC;
            result.addrdesc.memattrs.inner.hints = MemHint_No;
        result.addrdesc.memattrs.shareable = TRUE;
        result.addrdesc.memattrs.outershareable = TRUE;
```

```
    result.addrdesc.memattrs.outer = result.addrdesc.memattrs.inner;
```

```
    result.perms.ap = bits(3) UNKNOWN;
    result.perms.xn = '0';
    result.perms.pxn = '0';
```

```
    result.nG = bit UNKNOWN;
    result.contiguous = boolean UNKNOWN;
    result.domain = bits(4) UNKNOWN;
    result.level = integer UNKNOWN;
    result.blocksize = integer UNKNOWN;
    result.addrdesc.paddress.physicaladdress = ZeroExtend(vaddress);
    result.addrdesc.paddress.NS = if IsSecure() then '0' else '1';
    result.addrdesc.fault = AArch32.NoFault();
```

```
return result;
```

G3.19.3 Domain checking

The CheckDomain() pseudocode function describes domain checking:

```
// AArch32.CheckDomain()
// =====

(boolean, FaultRecord) AArch32.CheckDomain(bits(4) domain, bits(32) vaddress, integer level,
                                           AccType acctype, boolean iswrite)

    index = 2 * UInt(domain);
    attrfield = DACR<index+1:index>;

    if attrfield == '10' then // Reserved, maps to an allocated value
        // Reserved value maps to an allocated value
        (-, attrfield) = ConstrainUnpredictableBits();

    if attrfield == '00' then
        fault = AArch32.DomainFault(domain, level, acctype, iswrite);
    else
        fault = AArch32.NoFault();

    permissioncheck = (attrfield == '01');

    return (permissioncheck, fault);
```

G3.19.4 TLB operations

The TLBRecord() type represents the contents of a TLB entry:

```
type TLBRecord is (
    Permissions perms,
    bit nG, // '0' = Global, '1' = not Global
    bits(4) domain, // AArch32 only
    boolean contiguous, // Contiguous bit from page table
    integer level, // In AArch32 Short-descriptor format, indicates Section/Page
    integer blocksize, // Describes size of memory translated in KBytes
    AddressDescriptor addrdesc
)
```

G3.19.5 Translation table walk

Because of the complexity of a translation table walk, the following sections describe the different cases:

- [Translation table walk using the Short-descriptor translation table format for stage 1.](#)
- [Translation table walk using the Long-descriptor translation table format for stage 1 on page G3-3761.](#)
- [Stage 2 translation table walk on page G3-3765.](#)

Translation table walk using the Short-descriptor translation table format for stage 1

The TranslationTableWalkSD() pseudocode function describes the translation table walk when the stage 1 translation tables use the Short-descriptor format. It calls the function described in [Stage 2 translation table walk on page G3-3765](#) if necessary:

```
// AArch32.TranslationTableWalkSD()
// =====
// Returns a result of a translation table walk using the Short-descriptor format
//
// Implementations might cache information from memory in any number of non-coherent TLB
// caching structures, and so avoid memory accesses that have been expressed in this
// pseudocode. The use of such TLBs is not expressed in this pseudocode.

TLBRecord AArch32.TranslationTableWalkSD(bits(32) vaddress, AccType acctype, boolean iswrite,
```

```

integer size)
assert ELUsingAArch32(TranslationRegime());

// This is only called when the MMU is enabled
TLBRecord      result;
AddressDescriptor l1descaddr;
AddressDescriptor l2descaddr;
bits(40)        physicaladdress;

// Variables for Abort functions
ipaddress = bits(40) UNKNOWN;
secondstage = FALSE;
s2fs1walk = FALSE;

// Default setting of the domain
domain = bits(4) UNKNOWN;

// Determine correct Translation Table Base Register to use.
bits(64) ttbr;
n = UInt(TTBCR.N);
if n == 0 || IsZero(vaddress<31:(32-n)>) then
    ttbr = TTBR0;
    disabled = (TTBCR.PD0 == '1');
else
    ttbr = TTBR1;
    disabled = (TTBCR.PD1 == '1');
    n = 0; // TTBR1 translation always works like N=0 TTBR0 translation

// Check this Translation Table Base Register is not disabled.
if disabled then
    level = 1;
    result.addrdesc.fault = AArch32.TranslationFault(ipaddress, domain, level, acctype, iswrite,
                                                    secondstage, s2fs1walk);

    return result;

// Obtain First level descriptor.
l1descaddr.paddress.physicaladdress = ZeroExtend(ttbr<31:14-n>;vaddress<31-n:20>:'00');
l1descaddr.paddress.NS = if IsSecure() then '0' else '1';
IRGN = ttbr<0>;ttbr<6>; // TTBR.IRGN
RGN = ttbr<4:3>; // TTBR.RGN
SH = ttbr<1>;ttbr<5>; // TTBR.S:TTBR.NOS
l1descaddr.memattrs = WalkAttrDecode(SH, RGN, IRGN);

if !HaveEL(EL2) || IsSecure() then
    // if only 1 stage of translation
    l1descaddr2 = l1descaddr;
else
    l1descaddr2 = AArch32.SecondStageWalk(l1descaddr, vaddress, acctype, 4);

l1desc = _Mem[l1descaddr2, 4, AccType_PTW];
if SCTL.R.EE == '1' then
    l1desc = BigEndianReverse(l1desc);

// Process First level descriptor.
case l1desc<1:0> of
    when '00' // Fault, Reserved
        level = 1;
        result.addrdesc.fault = AArch32.TranslationFault(ipaddress, domain, level, acctype,
                                                    iswrite, secondstage, s2fs1walk);

        return result;

    when '01' // Large page or Small page
        domain = l1desc<8:5>;
        level = 2;
        pxn = l1desc<2>;
        NS = l1desc<3>;

// Obtain Second level descriptor.

```

```

l2descaddr.address.physicaladdress = ZeroExtend(l1desc<31:10>:vaddress<19:12>:'00');
l2descaddr.address.NS = if IsSecure() then '0' else '1';
l2descaddr.memattrs = l1descaddr.memattrs;

if !HaveEL(EL2) || IsSecure() then
  // if only 1 stage of translation
  l2descaddr2 = l2descaddr;
else
  l2descaddr2 = AArch32.SecondStageWalk(l2descaddr, vaddress, acctype, 4);
l2desc = _Mem[l2descaddr2, 4, AccType_PTW];
if SCTL.R.EE == '1' then
  l2desc = BigEndianReverse(l2desc);

// Process Second level descriptor.
if l2desc<1:0> == '00' then
  result.addrdesc.fault = AArch32.TranslationFault(ipaddress, domain, level, acctype,
                                                    iswrite, secondstage, s2fs1walk);

  return result;

nG = l2desc<11>;
S = l2desc<10>;
ap = l2desc<9,5:4>;

if SCTL.R.AFE == '1' && l2desc<4> == '0' then
  // Hardware access to the Access Flag is not supported in ARMv8
  result.addrdesc.fault = AArch32.AccessFlagFault(ipaddress, domain, level, acctype,
                                                    iswrite, secondstage, s2fs1walk);

  return result;

if l2desc<1> == '0' then // Large page
  xn = l2desc<15>;
  tex = l2desc<14:12>;
  c = l2desc<3>;
  b = l2desc<2>;
  blocksize = 64;
  physicaladdress = ZeroExtend(l2desc<31:16>:vaddress<15:0>);
else // Small page
  tex = l2desc<8:6>;
  c = l2desc<3>;
  b = l2desc<2>;
  xn = l2desc<0>;
  blocksize = 4;
  physicaladdress = ZeroExtend(l2desc<31:12>:vaddress<11:0>);

when '1x' // Section or Supersection
  NS = l1desc<19>;
  nG = l1desc<17>;
  S = l1desc<16>;
  ap = l1desc<15,11:10>;
  tex = l1desc<14:12>;
  xn = l1desc<4>;
  c = l1desc<3>;
  b = l1desc<2>;
  pxn = l1desc<0>;
  level = 1;

if SCTL.R.AFE == '1' && l1desc<10> == '0' then
  // Hardware management of the Access Flag is not supported in ARMv8
  result.addrdesc.fault = AArch32.AccessFlagFault(ipaddress, domain, level, acctype,
                                                    iswrite, secondstage, s2fs1walk);

  return result;

if l1desc<18> == '0' then // Section
  domain = l1desc<8:5>;
  blocksize = 1024;
  physicaladdress = ZeroExtend(l1desc<31:20>:vaddress<19:0>);
else // Supersection
  domain = '0000';

```

```

        blocksize = 16384;
        physicaladdress = 11desc<8:5>:11desc<23:20>:11desc<31:24>:vaddress<23:0>;

// Decode the TEX, C, B and S bits to produce the TLBRecord's memory attributes
if SCTL.R.TRE == '0' then
    if RemapRegsHaveResetValues() then
        result.addrdesc.memattrs = AArch32.DefaultTEXDecode(tex, c, b, S, acctype);
    else
        result.addrdesc.memattrs = MemoryAttributes IMPLEMENTATION_DEFINED;
else
    if SCTL.R.M == '0' then
        result.addrdesc.memattrs = AArch32.DefaultTEXDecode(tex, c, b, S, acctype);
    else
        result.addrdesc.memattrs = AArch32.RemappedTEXDecode(tex, c, b, S, acctype);

// Set the rest of the TLBRecord, try to add it to the TLB, and return it.
result.perms.ap = ap;
result.perms.xn = xn;
result.perms.pxn = pxn;
result.nG = nG;
result.domain = domain;
result.level = level;
result.blocksize = blocksize;
result.addrdesc.paddress.physicaladdress = ZeroExtend(physicaladdress);
result.addrdesc.paddress.NS = if IsSecure() then NS else '1';
result.addrdesc.fault = AArch32.NoFault();

return result;

```

The ShortConvertAttrHints() pseudocode function converts the Normal memory cacheability attribute, from the translation table base register or the translation table TEX field, into the separate cacheability attribute and cache allocation hint defined in a Long-descriptor translation table descriptor:

```

// ShortConvertAttrHints()
// =====
// Converts the short attribute fields for Normal memory as used in the TTBR and
// TEX fields to orthogonal attributes and hints

MemAttrHints ShortConvertAttrHints(bits(2) RGN, AccType acctype)

MemAttrHints result;

if CacheDisabled(acctype) then // Force Non-cacheable
    result.attrs = MemAttr_NC;
    result.hints = MemHint_No;
else
    case RGN of
        when '00' // Non-cacheable (no allocate)
            result.attrs = MemAttr_NC;
            result.hints = MemHint_No;
        when '01' // Write-back, Read and Write allocate
            result.attrs = MemAttr_WB;
            result.hints = MemHint_RWA;
        when '10' // Write-through, Read allocate
            result.attrs = MemAttr_WT;
            result.hints = MemHint_RA;
        when '11' // Write-back, Read allocate
            result.attrs = MemAttr_WB;
            result.hints = MemHint_RA;

    result.transient = FALSE;

return result;

```

Translation table walk using the Long-descriptor translation table format for stage 1

The TranslationTableWalkLD() pseudocode function describes the translation table walk when the stage 1 translation tables use the Long-descriptor format. It calls the function described in [Stage 2 translation table walk on page G3-3765](#) if necessary:

```
// AArch32.TranslationTableWalkLD()
// =====
// Returns a result of a translation table walk using the Long-descriptor format
//
// Implementations might cache information from memory in any number of non-coherent TLB
// caching structures, and so avoid memory accesses that have been expressed in this
// pseudocode. The use of such TLBs is not expressed in this pseudocode.

TLBRecord AArch32.TranslationTableWalkLD(bits(40) ipaddress, bits(32) vaddress,
                                         AccType acctype, boolean iswrite, boolean secondstage,
                                         boolean s2fs1walk, integer size)

    if !secondstage then
        assert ELUsingAArch32(TranslationRegime());
    else
        assert HaveEL(EL2) && !IsSecure() && ELUsingAArch32(EL2) && PSTATE.EL != EL2;

    TLBRecord result;
    AddressDescriptor descaddr;

    domain = bits(4) UNKNOWN;
    baseaddress = Zeros(40);
    basefound = FALSE;
    bits(64) base;

    descaddr.memattrs.type = MemType_Normal;

    // Determine parameters for the page table walk:
    // grainsize = Log2(Size of Table) - in AArch32 this is a constant
    // stride = Log2(Address per level) - in AArch32 this is a constant
    constant integer grainsize = 12;           // 4KB pages
    constant integer stride = grainsize - 3;
    // tablesize = Log2(Address Size)
    // level = level to start walk from
    // This means that the number of levels after start level = 3-level

    if !secondstage then
        // First stage translation
        bits(40) inputaddr = ZeroExtend(vaddress);
        if PSTATE.EL == EL2 then
            tablesize = 32 - UInt(HTCR.T0SZ);
            basefound = tablesize == 32 || IsZero(inputaddr<31:tablesize>);
            base = TTBR0_EL2;
            descaddr.memattrs = WalkAttrDecode(HTCR.SH0, HTCR.ORGNO, HTCR.IRGNO);
            reversedescriptors = HSCTLR.EE == '1';
            lookupsecure = FALSE;
            singlepriv = TRUE;
        else
            tablesize = 32 - UInt(TTBCR.T0SZ);
            if tablesize == 32 || IsZero(inputaddr<31:tablesize>) then
                basefound = TTBCR.EPD0 == '0';
                base = TTBR0_EL1;
                descaddr.memattrs = WalkAttrDecode(TTBCR.SH0, TTBCR.ORGNO, TTBCR.IRGNO);
            else
                tablesize = 32 - UInt(TTBCR.T1SZ);
                basefound = (tablesize == 32 || IsOnes(inputaddr<31:tablesize>)) && TTBCR.EPD1 == '0';
                base = TTBR1_EL1;
                descaddr.memattrs = WalkAttrDecode(TTBCR.SH1, TTBCR.ORGNO, TTBCR.IRGNO);
                reversedescriptors = SCTL.R.EE == '1';
                lookupsecure = IsSecure();
                singlepriv = FALSE;

        if tablesize > (grainsize + 2*stride) then
```

```

        level = 1;
    else
        level = 2;
else
    // Second stage translation
    bits(40) inputaddr = ipaddress;
    lookupsecure = FALSE;
    singlepriv = TRUE;
    tablesize = 32 - SInt(VTCR.T0SZ);

    base = VTTBR;
    basefound = tablesize == 40 || IsZero(inputaddr<39:tablesize>);
    descaddr.memattrs = WalkAttrDecode(VTCR.IRGN0, VTCR.ORGNO, VTCR.SH0);
    reversedescriptors = HSCTLR.EE == '1';

    level = 2 - UInt(VTCR.SL0);
    if level <= 0 then basefound = FALSE;

    // Check for Translation Table of fewer than 2 entries or more than 16*(2^grainsize/8)
    // entries
    // Number entries in start table level =
    // (Address Size)/((Address per level)^Num of levels after start + Size of Table)
    if ((tablesize > stride*(3-level) + 2*grainsize + 1) ||
        (tablesize < stride*(3-level) + grainsize + 1)) then
        basefound = FALSE;

if !basefound then
    result.addrdesc.fault = AArch32.TranslationFault(ipaddress, domain, 0, acctype, iswrite,
                                                    secondstage, s2fslwalk);

    return result;

if !IsZero(base<47:40>) then
    result.addrdesc.fault = AArch32.AddressSizeFault(ipaddress, domain, 0, acctype, iswrite,
                                                    secondstage, s2fslwalk);

    return result;

// Bottom bound of the Base address is:
// log2(8 bytes per entry)+log2(num of entries in start table level)
// Number of entries in start table level =
// (Address Size)/((Address per level)^Num of levels after start level + Size of Table)

baselowerbound = 3 + tablesize - stride*(3-level) - grainsize;
baseaddress = base<39:baselowerbound>:Zeros(baselowerbound);

ns_table = if lookupsecure then '0' else '1';
ap_table = if singlepriv then '10' else '11';
xn_table = '0';
pxn_table = '0';

addrselecttop = tablesize - 1;

repeat
    addrselectbottom = (3-level)*stride + grainsize;

    bits(40) index = ZeroExtend(inputaddr<addrselecttop:addrselectbottom>:'000');
    descaddr.paddress.physicaladdress = ZeroExtend(baseaddress OR index);
    descaddr.paddress.NS = ns_table;

    // If there are two stages of translation, then the first stage table walk addresses
    // are themselves subject to translation
    if !HaveEL(EL2) || secondstage || IsSecure() || PSTATE.EL == EL2 then
        descaddr2 = descaddr;
    else
        descaddr2 = AArch32.SecondStageWalk(descaddr, vaddress, acctype, 8);
    desc = _Mem[descaddr2, 8, AccType_PTW];
    if reversedescriptors then
        desc = BigEndianReverse(desc);

```



```

// Process descriptor
case desc<1:0> of
  when 'x0'
    // Fault or reserved
    result.addrdesc.fault = AArch32.TranslationFault(ipaddress, domain,
                                                    level, acctype, iswrite,
                                                    secondstage, s2fs1walk);

    return result;

  when '01'
    if level == 3 then
      // Invalid at level 3
      result.addrdesc.fault = AArch32.TranslationFault(ipaddress, domain,
                                                    level, acctype, iswrite,
                                                    secondstage, s2fs1walk);

      return result;
    else
      // Block
      blocktranslate = TRUE;

  when '11'
    if level != 3 then
      // Table
      if !IsZero(desc<47:40>) then
        result.addrdesc.fault = AArch32.AddressSizeFault(ipaddress, domain,
                                                    level, acctype,
                                                    iswrite, secondstage,
                                                    s2fs1walk);

        return result;

      baseaddress = desc<39:grainsize>:Zeros(grainsize);

      if !secondstage then
        // Unpack the upper and lower table attributes
        // pxn_table and ap_table[0] apply only in EL0&1 translation regimes
        ns_table = ns_table AND desc<63>;
        ap_table<1> = ap_table<1> AND desc<62>;
        xn_table = xn_table OR desc<60>;
        if !singlepriv then
          ap_table<0> = ap_table<0> AND desc<61>;
          pxn_table = pxn_table OR desc<59>;

        level = level + 1;
        addrselecttop = addrselectbottom - 1;
        blocktranslate = FALSE;
      else
        // Page
        blocktranslate = TRUE;
until blocktranslate;

if !IsZero(desc<47:40>) then
  result.addrdesc.fault = AArch32.AddressSizeFault(ipaddress, domain, level, acctype,
                                                    iswrite, secondstage, s2fs1walk);

  return result;

physicaladdress = desc<39:addrselectbottom>:inputaddr<addrselectbottom-1:0>;

// Check the access flag
if desc<10> == '0' then
  result.addrdesc.fault = AArch32.AccessFlagFault(ipaddress, domain, level,
                                                    acctype, iswrite,
                                                    secondstage, s2fs1walk);

  return result;

// Unpack the upper and lower block attributes
xn = desc<54>;
pxn = desc<53>;
contiguousbit = desc<52>;
nG = desc<11>;
sh = desc<9:8>;
ap = desc<7:6>:'1';
memattr = desc<5:2>;
// AttrIndx and NS bit in stage 1

```

```

result.domain = bits(4) UNKNOWN;           // Domains not used
result.level = level;
result.blocksize = 2^(((3-level)*stride + grainsize));

// Stage 1 translation regimes also inherit attributes from the tables
if !secondstage then
    result.perms.xn      = xn OR xn_table;
    result.perms.ap<2>  = ap<2> OR ap_table<1>;

// PXN, nG and AP[1] apply only in EL0&1 stage 1 translation regimes
if !singlepriv then
    result.perms.ap<1> = ap<1> OR NOT(ap_table<0>);
    result.perms.pxn  = pxn OR pxn_table;
    // Pages from Non-secure tables are marked Global in Secure EL0&1
    if IsSecure() then
        result.nG = nG OR ns_table;
    else
        result.nG = nG;
else
    result.perms.ap<1> = '1';
    result.perms.pxn  = '0';
    result.nG         = '0';
result.perms.ap<0>  = '1';
result.addrdesc.memattrs = AArch32.S1AttrDecode(sh, memattr<2:0>, acctype);
result.addrdesc.paddress.NS = if lookupsecure then (memattr<3> OR ns_table) else '1';
else
    result.perms.ap<2:1> = ap<2:1>;
    result.perms.ap<0>  = '1';
    result.perms.xn      = xn;
    result.perms.pxn    = '0';
    result.nG           = '0';
    result.addrdesc.memattrs = S2AttrDecode(sh, memattr, acctype);
    result.addrdesc.paddress.NS = '1';

result.addrdesc.paddress.physicaladdress = ZeroExtend(physicaladdress);
result.addrdesc.fault = AArch32.NoFault();
result.contiguous = contiguousbit == '1';

return result;

```

This function calls the `ConvertAttrHints()` pseudocode function that is defined in [Translation table walk using the Short-descriptor translation table format for stage 1 on page G3-3757](#).

The `S1AttrDecode()` pseudocode function uses the `MAIR0` and `MAIR1` registers to decode the `Attr[2:0]` value from a stage 1 translation table descriptor:

```

// AArch32.S1AttrDecode()
// =====
// Converts the Stage 1 attribute fields, using the MAIR, to orthogonal
// attributes and hints.

MemoryAttributes AArch32.S1AttrDecode(bits(2) SH, bits(3) attr, AccType acctype)

MemoryAttributes memattrs;

if PSTATE.EL == EL2 then
    mair = HMAIR1:HMAIR0;
else
    mair = MAIR1:MAIR0;
index = 8 * UInt(attr);
attrfield = mair<index+7:index>;

if ((attrfield<7:4> != '0000' && attrfield<3:0> == '0000') ||
    (attrfield<7:4> == '0000' && !(attrfield<3:0> IN {'000x', '1x00'}))) then
    // Reserved, maps to an allocated value
    (-, attrfield) = ConstrainUnpredictableBits();

```

```

if attrfield<7:4> == '0000' then           // Device
    memattrs.type = MemType_Device;
    memattrs.inner = MemAttrHints UNKNOWN;
    memattrs.outer = MemAttrHints UNKNOWN;
    memattrs.shareable = TRUE;
    memattrs.outershareable = TRUE;
    case attrfield<3:0> of
        when '0000' memattrs.device = DeviceType_nGnRnE;
        when '0001' memattrs.device = DeviceType_nGnRE;
        when '1000' memattrs.device = DeviceType_nGRE;
        when '1100' memattrs.device = DeviceType_GRE;
        otherwise Unreachable();          // Reserved, handled above

elseif attrfield<3:0> != '0000' then      // Normal
    memattrs.type = MemType_Normal;
    memattrs.outer = LongConvertAttrHints(attrfield<7:4>, acctype);
    memattrs.inner = LongConvertAttrHints(attrfield<3:0>, acctype);
    memattrs.device = DeviceType UNKNOWN;
    memattrs.shareable = SH<1> == '1';
    memattrs.outershareable = SH == '10';

else
    Unreachable();                        // Reserved, handled above

return memattrs;

```

The S2AttrDecode() pseudocode function decodes the Attr[3:0] value from a stage 2 translation table descriptor:

```

// S2AttrDecode()
// =====
// Converts the Stage 2 attribute fields into orthogonal attributes and hints

```

MemoryAttributes S2AttrDecode(bits(2) SH, bits(4) attr, AccType acctype)

```

MemoryAttributes memattrs;

if attr<3:2> == '00' then                 // Device
    memattrs.type = MemType_Device;
    memattrs.inner = MemAttrHints UNKNOWN;
    memattrs.outer = MemAttrHints UNKNOWN;
    case attr<1:0> of
        when '00' memattrs.device = DeviceType_nGnRnE;
        when '01' memattrs.device = DeviceType_nGnRE;
        when '10' memattrs.device = DeviceType_nGRE;
        when '11' memattrs.device = DeviceType_GRE;
    memattrs.shareable = TRUE;
    memattrs.outershareable = TRUE;

elseif attr<1:0> != '00' then            // Normal
    memattrs.type = MemType_Normal;
    memattrs.device = DeviceType UNKNOWN;
    memattrs.outer = S2ConvertAttrHints(attr<3:2>, acctype);
    memattrs.inner = S2ConvertAttrHints(attr<1:0>, acctype);
    memattrs.shareable = SH<1> == '1';
    memattrs.outershareable = SH == '10';

else
    memattrs = MemoryAttributes UNKNOWN; // Reserved

return memattrs;

```

Stage 2 translation table walk

The SecondStageTranslate() pseudocode function describes the stage 2 translation table walk. Stage 2 translations tables always use the Long-descriptor format.

```

// AArch32.SecondStageTranslate()
// =====
// This function is called to perform a stage 2 translation walk.

AddressDescriptor AArch32.SecondStageTranslate(AddressDescriptor S1, bits(32) vaddress,
                                              AccType acctype, boolean iswrite, boolean wasaligned,
                                              boolean s2fs1walk, integer size)
assert HaveEL(EL2) && !IsSecure() && PSTATE.EL != EL2;
assert IsZero(S1.paddress.physicaladdress<47:40>);

if !ELUsingAArch32(EL2) then
    return AArch64.SecondStageTranslate(S1, ZeroExtend(vaddress, 64), acctype, iswrite,
                                        wasaligned, s2fs1walk, size);

s2_enabled = HCR.VM == '1';
secondstage = TRUE;

if s2_enabled then // Second stage enabled
    ipaddress = S1.paddress.physicaladdress<39:0>;
    S2 = AArch32.TranslationTableWalkLD(ipaddress, vaddress, acctype, iswrite, secondstage,
                                        s2fs1walk, size);

    // Check for unaligned data accesses to Device memory
    if (!wasaligned && !IsFault(S2.addrdesc) && S2.addrdesc.memattrs.type == MemType_Device &&
        acctype != AccType_IFETCH) then
        S2.addrdesc.fault = AArch32.AlignmentFault(acctype, iswrite, secondstage);

    if !IsFault(S2.addrdesc) then
        S2.addrdesc.fault = AArch32.CheckS2Permission(S2.perms, vaddress, ipaddress, S2.level,
                                                    acctype, iswrite, s2fs1walk);

    // Check for instruction fetches from Device memory not marked as execute-never. As there
    // has not been a Permission Fault then the memory is not marked execute-never.
    if (!IsFault(S2.addrdesc) && S2.addrdesc.memattrs.type == MemType_Device &&
        acctype == AccType_IFETCH) then
        domain = bits(4) UNKNOWN;
        S2.addrdesc = AArch32.InstructionDevice(S2.addrdesc, vaddress, ipaddress, S2.level,
                                                domain, acctype, iswrite,
                                                secondstage, s2fs1walk);

    // Check for protected table walk
    if (s2fs1walk && !IsFault(S2.addrdesc) && HCR.PTW == '1' &&
        S2.addrdesc.memattrs.type == MemType_Device) then
        domain = bits(4) UNKNOWN;
        S2.addrdesc.fault = AArch32.PermissionFault(ipaddress, domain, S2.level, acctype,
                                                    iswrite, secondstage, s2fs1walk);

    result = CombineS1S2Desc(S1, S2.addrdesc);
else
    result = S1;

return result;

```

The CheckPermission() pseudocode function checks the access permissions for the stage 1 translation.

```

// AArch32.CheckPermission()
// =====
// Function used for permission checking from AArch32 stage 1 translations

FaultRecord AArch32.CheckPermission(Permissions perms, bits(32) vaddress, integer level,
                                    bits(4) domain, bit NS, AccType acctype, boolean iswrite)
assert ELUsingAArch32(TranslationRegime());

if PSTATE.EL != EL2 then
    wxn = SCTLX.WXN == '1';
    if TTBCR.EAE == '1' || SCTLX.AFE == '1' || perms.ap<0> == '1' then
        priv_r = TRUE;
        priv_w = perms.ap<2> == '0';
        user_r = perms.ap<1> == '1';

```

```

        user_w = perms.ap<2:1> == '01';
    else
        priv_r = perms.ap<2:1> != '00';
        priv_w = perms.ap<2:1> == '01';
        user_r = perms.ap<1> == '1';
        user_w = FALSE;
    uwxn = SCTL.R.UWXN == '1';
    user_x = user_r && perms.xn == '0' && !(user_w && wxn);
    priv_x = (priv_r && perms.xn == '0' && perms.pxn == '0' &&
        !(priv_w && wxn) && !(user_w && uwxn));
    ispriv = PSTATE.EL == EL1 && acctype != AccType_UNPRIV;

    if ispriv then
        (r, w, x) = (priv_r, priv_w, priv_x);
    else
        (r, w, x) = (user_r, user_w, user_x);
else
    // Access from EL2
    wxn = HSCTLR.WXN == '1';
    r = TRUE;
    w = perms.ap<2> == '0';
    x = perms.xn == '0' && !(w && wxn);

    secure_instr_fetch = SCR_GEN[].SIF; // Restriction on Secure instruction fetch
    if HaveEL(EL3) && IsSecure() && NS == '1' && secure_instr_fetch == '1' then
        x = FALSE;

    if acctype == AccType_IFETCH then
        fail = !x;
    elseif iswrite then
        fail = !w;
    else
        fail = !r;

    if fail then
        secondstage = FALSE;
        s2fs1walk = FALSE;
        ipaddress = bits(40) UNKNOWN;
        return AArch32.PermissionFault(ipaddress, domain, level, acctype, iswrite, secondstage,
            s2fs1walk);
    else
        return AArch32.NoFault();

```

The CheckS2Permission() pseudocode function checks the access permissions for the stage 2 translation.

```

// AArch32.CheckS2Permission()
// =====
// Function used for permission checking from AArch32 stage 2 translations

FaultRecord AArch32.CheckS2Permission(Permissions perms, bits(32) vaddress, bits(40) ipaddress,
    integer level, AccType acctype, boolean iswrite,
    boolean s2fs1walk)
    assert HaveEL(EL2) && !IsSecure() && ELUsingAArch32(EL2) && PSTATE.EL != EL2;

    r = perms.ap<1> == '0';
    w = perms.ap<2> == '0';
    x = r && perms.xn == '0';

    // Stage 1 walk is checked as a read, regardless of the original type
    if acctype == AccType_IFETCH && !s2fs1walk then
        fail = !x;
    elseif iswrite && !s2fs1walk then
        fail = !w;
    else
        fail = !r;

    if fail then
        domain = bits(4) UNKNOWN;

```

```
        secondstage = TRUE;
        return AArch32.PermissionFault(ipaddress, domain, level, acctype, iswrite, secondstage,
                                       s2fs1walk);
    else
        return AArch32.NoFault();
```

The CombineS1S2Desc() pseudocode function combines the stage 1 and stage 2 access permissions:

```
// CombineS1S2Desc()
// =====
// Combines the address descriptors from stage 1 and stage 2

AddressDescriptor CombineS1S2Desc(AddressDescriptor s1desc, AddressDescriptor s2desc)

    AddressDescriptor result;

    result.paddress = s2desc.paddress;

    if IsFault(s1desc) || IsFault(s2desc) then
        result = if IsFault(s1desc) then s1desc else s2desc;
    elseif s2desc.memattrs.type == MemType_Device || s1desc.memattrs.type == MemType_Device then
        result.memattrs.type = MemType_Device;
        if s1desc.memattrs.type == MemType_Normal then
            result.memattrs.device = s2desc.memattrs.device;
        elseif s2desc.memattrs.type == MemType_Normal then
            result.memattrs.device = s1desc.memattrs.device;
        else
            // Both Device
            result.memattrs.device = CombineS1S2Device(s1desc.memattrs.device,
                                                    s2desc.memattrs.device);

        result.memattrs.inner = MemAttrHints UNKNOWN;
        result.memattrs.outer = MemAttrHints UNKNOWN;
        result.memattrs.shareable = TRUE;
        result.memattrs.outershareable = TRUE;
    else
        // Both Normal
        result.memattrs.type = MemType_Normal;
        result.memattrs.device = DeviceType UNKNOWN;
        result.memattrs.inner = CombineS1S2AttrHints(s1desc.memattrs.inner, s2desc.memattrs.inner);
        result.memattrs.outer = CombineS1S2AttrHints(s1desc.memattrs.outer, s2desc.memattrs.outer);
        if (result.memattrs.inner.attrs == MemAttr_NC &&
            result.memattrs.outer.attrs == MemAttr_NC) then
            // something Non-cacheable at each level is Outer Shareable
            result.memattrs.shareable = TRUE;
            result.memattrs.outershareable = TRUE;
        else
            result.memattrs.shareable = (s1desc.memattrs.shareable || s2desc.memattrs.shareable);
            result.memattrs.outershareable = (s1desc.memattrs.outershareable ||
                                             s2desc.memattrs.outershareable);

    return result;
```

G3.19.6 Reporting syndrome information

The ReportHypEntry() pseudocode function writes a syndrome value to the [HSR](#):

```
// AArch32.ReportHypEntry()
// =====
// Report syndrome information to Hyp mode registers.

AArch32.ReportHypEntry(ExceptionRecord exception)

    Exception type = exception.type;

    (ec,il) = AArch32.ExceptionClass(type);
    iss = exception.syndrome;

    // IL is not valid for Data Abort exceptions without valid instruction syndrome information
    if ec IN {0x24,0x25} && iss<24> == '0' then
        il = '1';
```

```

HSR = ec<5:0>:i1:iss;

if type IN {Exception_InstructionAbort, Exception_PCAlignmet} then
    HIFAR = exception.vaddress<31:0>;
    HDFAR = bits(32) UNKNOWN;
elseif type == Exception_DataAbort then
    HIFAR = bits(32) UNKNOWN;
    HDFAR = exception.vaddress<31:0>;

if exception.ipavalid then
    HPFAR<31:4> = exception.ipaddress<39:12>;

return;

```

G3.19.7 Calling the hypervisor

The CallHypervisor() pseudocode function generates an HVC exception. Valid execution of the HVC instruction calls this function.

```

// AArch32.CallHypervisor()
// =====
// Performs a HVC call

AArch32.CallHypervisor(bits(16) immediate)

if !ELUsingAArch32(EL2) then
    AArch64.CallHypervisor(immediate);

AArch32.TakeHVCException(immediate);

```

G3.19.8 Memory access decode when TEX remap is enabled

When using the Short-descriptor translation table format, the function RemappedTEXDecode() decodes the texcb and S attributes derived from the translation tables when TEX remap is enabled. *Short-descriptor format memory region attributes, with TEX remap* on page G3-3620 shows the interpretation of the arguments.

```

// AArch32.RemappedTEXDecode()
// =====

MemoryAttributes AArch32.RemappedTEXDecode(bits(3) TEX, bit C, bit B, bit S, AccType acctype)

MemoryAttributes memattr;

region = UInt(TEX<0>:C:B); // TEX<2:1> are ignored in this mapping scheme
if region == 6 then
    memattr = MemoryAttributes IMPLEMENTATION_DEFINED;
else
    base = 2 * region;
    attrfield = PRRR<base+1:base>;

    if attrfield == '11' then // Reserved, maps to allocated value
        (-, attrfield) = ConstrainUnpredictableBits();

    case attrfield of
        when '00' // Device-nGnRnE
            memattr.type = MemType_Device;
            memattr.device = DeviceType_nGnRnE;
            memattr.shareable = TRUE;
            memattr.outershareable = TRUE;
        when '01' // Device-nGnRE
            memattr.type = MemType_Device;
            memattr.device = DeviceType_nGnRE;
            memattr.shareable = TRUE;
            memattr.outershareable = TRUE;
        when '10'

```

```
    memattrs.type = MemType_Normal;
    memattrs.inner = ShortConvertAttrHints(NMRR<base+1:base>, acctype);
    memattrs.outer = ShortConvertAttrHints(NMRR<base+17:base+16>, acctype);
    s_bit = if S == '0' then PRRR.NS0 else PRRR.NS1;
    memattrs.shareable = (s_bit == '1');
    memattrs.outershareable = (s_bit == '1' && PRRR<region+24> == '0');
when '11'
    Unreachable();

// transient bits are not supported in this format
memattrs.inner.transient = FALSE;
memattrs.outer.transient = FALSE;

if memattrs.type == MemType_Device then
    memattrs.inner = MemAttrHints UNKNOWN;
    memattrs.outer = MemAttrHints UNKNOWN;
else
    memattrs.device = DeviceType UNKNOWN;

return memattrs;
```

Chapter G4

AArch32 System Register Descriptions

This chapter describes each of the AArch32 System registers.

It contains the following sections:

- *About the AArch32 System registers* on page G4-3772.
- *General system control registers* on page G4-3773.
- *Debug registers* on page G4-4101.
- *Performance Monitors registers* on page G4-4170.
- *Generic Timer registers* on page G4-4208.
- *Generic Interrupt Controller CPU interface registers* on page G4-4230.

G4.1 About the AArch32 System registers

The following sections describe the AArch32 system registers:

- [General system control registers](#) on page G4-3773.
- [Debug registers](#) on page G4-4101.
- [Performance Monitors registers](#) on page G4-4170.
- [Generic Timer registers](#) on page G4-4208.
- [Generic Timer registers](#) on page G4-4208.

For general information about these registers see:

- [About the System registers for VMSAv8-32](#) on page G3-3691.
- [Organization of the CP14 registers in VMSAv8-32](#) on page G3-3713.
- [Organization of the CP15 registers in VMSAv8-32](#) on page G3-3716.
- [Functional grouping of VMSAv8-32 System registers](#) on page G3-3735.

G4.2 General system control registers

This section describe the system registers in AArch32 state that are not part of one of the other functional groups.

G4.2.1 ACTLR, Auxiliary Control Register

The ACTLR characteristics are:

Purpose

Provides IMPLEMENTATION DEFINED configuration and control options.

This register is part of:

- the Other system control registers functional group
- the IMPLEMENTATION DEFINED functional group.

Usage constraints

This register is accessible as shown below:

When accessed as ACTLR(S):

EL0 (NS)	EL0 (S)	EL1 (NS)	EL1 (S)	EL2	EL3 (SCR.NS=1)	EL3 (SCR.NS=0)
-	-	-	RW	-	-	RW

When accessed as ACTLR(NS):

EL0 (NS)	EL0 (S)	EL1 (NS)	EL1 (S)	EL2	EL3 (SCR.NS=1)	EL3 (SCR.NS=0)
-	-	RW	-	RW	RW	-

Configurations

ACTLR(NS) is architecturally mapped to AArch64 register [ACTLR_EL1](#).

ACTLR(S) can be mapped to AArch64 register [ACTLR_EL3](#), but this is not architecturally mandated.

If EL3 is using AArch32, there are separate Secure and Non-secure instances of this register.

Some bits might define global configuration settings, and be common to the Secure and Non-secure copies of the register.

Attributes

ACTLR is a 32-bit register.

The ACTLR bit assignments are:



Accessing the ACTLR:

To access the ACTLR:

MRC p15,0,<Rt>,c1,c0,1 ; Read ACTLR into Rt

MCR p15,0,<Rt>,c1,c0,1 ; Write Rt to ACTLR

Register access is encoded as follows:

coproc	opc1	CRn	CRm	opc2
1111	000	0001	0000	001

G4.2.2 ADFSR, Auxiliary Data Fault Status Register

The ADFSR characteristics are:

Purpose

Provides additional IMPLEMENTATION DEFINED fault status information for Data Abort exceptions taken to EL1 modes.

This register is part of:

- the Exception and fault handling registers functional group
- the IMPLEMENTATION DEFINED functional group.

Usage constraints

This register is accessible as shown below:

When accessed as ADFSR(S):

EL0 (NS)	EL0 (S)	EL1 (NS)	EL1 (S)	EL2	EL3 (SCR.NS=1)	EL3 (SCR.NS=0)
-	-	-	RW	-	-	RW

When accessed as ADFSR(NS):

EL0 (NS)	EL0 (S)	EL1 (NS)	EL1 (S)	EL2	EL3 (SCR.NS=1)	EL3 (SCR.NS=0)
-	-	RW	-	RW	RW	-

Configurations

ADFSR(NS) is architecturally mapped to AArch64 register [AFSR0_EL1](#).

ADFSR(S) can be mapped to AArch64 register [AFSR0_EL3](#), but this is not architecturally mandated.

If EL3 is using AArch32, there are separate Secure and Non-secure instances of this register.

If EL3 is implemented and is using AArch32, this register also provides fault status information for Data Abort exceptions taken to EL3 modes.

Attributes

ADFSR is a 32-bit register.

The ADFSR bit assignments are:



Accessing the ADFSR:

To access the ADFSR:

MRC p15,0,<Rt>,c5,c1,0 ; Read ADFSR into Rt
MCR p15,0,<Rt>,c5,c1,0 ; Write Rt to ADFSR

Register access is encoded as follows:

coproc	opc1	CRn	CRm	opc2
1111	000	0101	0001	000

G4.2.3 AIDR, Auxiliary ID Register

The AIDR characteristics are:

Purpose

Provides IMPLEMENTATION DEFINED identification information.

This register is part of:

- the Identification registers functional group
- the IMPLEMENTATION DEFINED functional group.

Usage constraints

This register is accessible as shown below:

EL0 (NS)	EL0 (S)	EL1 (NS)	EL1 (S)	EL2	EL3 (SCR.NS=1)	EL3 (SCR.NS=0)
-	-	RO	RO	RO	RO	RO

The value of this register must be used in conjunction with the value of [MIDR](#).

Configurations

AIDR is architecturally mapped to AArch64 register [AIDR_EL1](#).

There is one instance of this register that is used in both Secure and Non-secure states.

Attributes

AIDR is a 32-bit register.

The AIDR bit assignments are:



Accessing the AIDR:

To access the AIDR:

MRC p15,1,<Rt>,c0,c0,7 ; Read AIDR into Rt

Register access is encoded as follows:

coproc	opc1	CRn	CRm	opc2
1111	001	0000	0000	111

G4.2.4 AIFSR, Auxiliary Instruction Fault Status Register

The AIFSR characteristics are:

Purpose

Provides additional IMPLEMENTATION DEFINED fault status information for Prefetch Abort exceptions taken to EL1 modes.

This register is part of:

- the Exception and fault handling registers functional group
- the IMPLEMENTATION DEFINED functional group.

Usage constraints

This register is accessible as shown below:

When accessed as AIFSR(S):

EL0 (NS)	EL0 (S)	EL1 (NS)	EL1 (S)	EL2	EL3 (SCR.NS=1)	EL3 (SCR.NS=0)
-	-	-	RW	-	-	RW

When accessed as AIFSR(NS):

EL0 (NS)	EL0 (S)	EL1 (NS)	EL1 (S)	EL2	EL3 (SCR.NS=1)	EL3 (SCR.NS=0)
-	-	RW	-	RW	RW	-

Configurations

AIFSR(NS) is architecturally mapped to AArch64 register [AFSR1_EL1](#).

AIFSR(S) can be mapped to AArch64 register [AFSR1_EL3](#), but this is not architecturally mandated.

If EL3 is using AArch32, there are separate Secure and Non-secure instances of this register.

If EL3 is implemented and is using AArch32, this register also provides fault status information for Data Abort exceptions taken to EL3 modes.

Attributes

AIFSR is a 32-bit register.

The AIFSR bit assignments are:



Accessing the AIFSR:

To access the AIFSR:

MRC p15,0,<Rt>,c5,c1,1 ; Read AIFSR into Rt
 MCR p15,0,<Rt>,c5,c1,1 ; Write Rt to AIFSR

Register access is encoded as follows:

coproc	opc1	CRn	CRm	opc2
1111	000	0101	0001	001

G4.2.5 AMAIR0, Auxiliary Memory Attribute Indirection Register 0

The AMAIR0 characteristics are:

Purpose

When using the Long-descriptor format translation tables for stage 1 translations, provides IMPLEMENTATION DEFINED memory attributes for the memory regions specified by MAIR0.

This register is part of:

- the Virtual memory control registers functional group
- the IMPLEMENTATION DEFINED functional group.

Usage constraints

This register is accessible as shown below:

When accessed as AMAIR0(S):

EL0 (NS)	EL0 (S)	EL1 (NS)	EL1 (S)	EL2	EL3 (SCR.NS=1)	EL3 (SCR.NS=0)
-	-	-	RW	-	-	RW

When accessed as AMAIR0(NS):

EL0 (NS)	EL0 (S)	EL1 (NS)	EL1 (S)	EL2	EL3 (SCR.NS=1)	EL3 (SCR.NS=0)
-	-	RW	-	RW	RW	-

If an implementation does not provide any IMPLEMENTATION DEFINED memory attributes, this register is RES0. Otherwise, it is only valid when using the Long-descriptor translation table format.

If EL3 is implemented and is using AArch32:

- The Secure copy of the register gives the value for memory accesses from Secure state.
- The Non-secure copy of the register gives the value for memory accesses from Non-secure states other than Hyp mode.

Any IMPLEMENTATION DEFINED memory attributes are additional qualifiers for the memory locations and must not change the architected behavior specified by MAIR0 and MAIR1.

In a typical implementation, AMAIR0 and AMAIR1 split into eight one-byte fields, corresponding to the MAIRn.Attr<n> fields, but the architecture does not require them to do so.

Configurations

AMAIRO(NS) is architecturally mapped to AArch64 register AMAIR_EL1[31:0].

AMAIRO(S) can be mapped to AArch64 register AMAIR_EL3[31:0], but this is not architecturally mandated.

If EL3 is using AArch32, there are separate Secure and Non-secure instances of this register.

Write access to the Secure copy of AMAIR0 is disabled when the CP15SDISABLE signal is asserted HIGH.

Attributes

AMAIRO is a 32-bit register.

The AMAIR0 bit assignments are:



Accessing the AMAIR0:

To access the AMAIR0:

MRC p15,0,<Rt>,c10,c3,0 ; Read AMAIR0 into Rt
MCR p15,0,<Rt>,c10,c3,0 ; Write Rt to AMAIR0

Register access is encoded as follows:

coproc	opc1	CRn	CRm	opc2
1111	000	1010	0011	000

G4.2.6 AMAIR1, Auxiliary Memory Attribute Indirection Register 1

The AMAIR1 characteristics are:

Purpose

When using the Long-descriptor format translation tables for stage 1 translations, provides IMPLEMENTATION DEFINED memory attributes for the memory regions specified by MAIR1.

This register is part of:

- the Virtual memory control registers functional group
- the IMPLEMENTATION DEFINED functional group.

Usage constraints

This register is accessible as shown below:

When accessed as AMAIR1(S):

EL0 (NS)	EL0 (S)	EL1 (NS)	EL1 (S)	EL2	EL3 (SCR.NS=1)	EL3 (SCR.NS=0)
-	-	-	RW	-	-	RW

When accessed as AMAIR1(NS):

EL0 (NS)	EL0 (S)	EL1 (NS)	EL1 (S)	EL2	EL3 (SCR.NS=1)	EL3 (SCR.NS=0)
-	-	RW	-	RW	RW	-

If an implementation does not provide any IMPLEMENTATION DEFINED memory attributes, this register is RES0. Otherwise, it is only valid when using the Long-descriptor translation table format.

If EL3 is implemented and is using AArch32:

- The Secure copy of the register gives the value for memory accesses from Secure state.
- The Non-secure copy of the register gives the value for memory accesses from Non-secure states other than Hyp mode.

Any IMPLEMENTATION DEFINED memory attributes are additional qualifiers for the memory locations and must not change the architected behavior specified by MAIR0 and MAIR1.

In a typical implementation, AMAIR0 and AMAIR1 split into eight one-byte fields, corresponding to the MAIRn.Attr<n> fields, but the architecture does not require them to do so.

Configurations

AMAIR1(NS) is architecturally mapped to AArch64 register AMAIR_EL1[63:32].

AMAIR1(S) can be mapped to AArch64 register AMAIR_EL3[63:32], but this is not architecturally mandated.

If EL3 is using AArch32, there are separate Secure and Non-secure instances of this register.

Write access to the Secure copy of AMAIR1 is disabled when the CP15SDISABLE signal is asserted HIGH.

Attributes

AMAIR1 is a 32-bit register.

The AMAIR1 bit assignments are:



Accessing the AMAIR1:

To access the AMAIR1:

MRC p15,0,<Rt>,c10,c3,1 ; Read AMAIR1 into Rt
MCR p15,0,<Rt>,c10,c3,1 ; Write Rt to AMAIR1

Register access is encoded as follows:

coproc	opc1	CRn	CRm	opc2
1111	000	1010	0011	001

G4.2.7 APSR, Application Program Status Register

The APSR characteristics are:

Purpose

Hold program status and control information.

This register is part of the Process state registers functional group.

Usage constraints

The APSR can be read using the MRS instruction and written using the MSR (immediate) or MSR (register) instructions. For more information see [MRS on page F7-2720](#), [MSR \(immediate\) on page F7-2722](#), and [MSR \(register\) on page F7-2724](#).

Configurations

There is one instance of this register that is used in both Secure and Non-secure states.

Attributes

APSR is a 32-bit register.

The APSR bit assignments are:

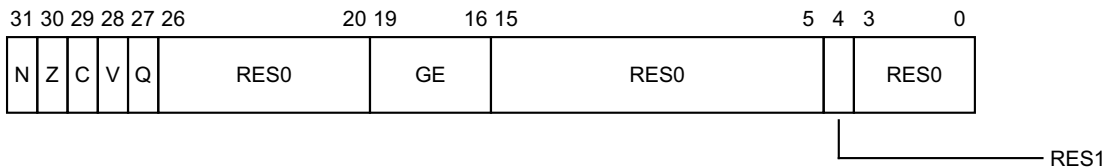

N, bit [31]

Negative condition flag. Set to bit[31] of the result of the last flag-setting instruction. If the result is regarded as a two's complement signed integer, then the processor sets N to 1 if the result was negative, and sets N to 0 if it was positive or zero.

Z, bit [30]

Zero condition flag. Set to 1 if the result of the last flag-setting instruction was zero, and to 0 otherwise. A result of zero often indicates an equal result from a comparison.

C, bit [29]

Carry condition flag. Set to 1 if the last flag-setting instruction resulted in a carry condition, for example an unsigned overflow on an addition.

V, bit [28]

Overflow condition flag. Set to 1 if the last flag-setting instruction resulted in an overflow condition, for example a signed overflow on an addition.

Q, bit [27]

Cumulative saturation bit. Set to 1 to indicate that overflow or saturation occurred in some instructions.

Bits [26:20]

Reserved, RES0.

GE, bits [19:16]

Greater than or Equal flags, for parallel addition and subtraction.

Bits [15:5]

Reserved, RES0.

Bit [4]

Reserved, RES1.

Bits [3:0]

Reserved, RES0.

G4.2.8 ATS12NSOPR, Address Translate Stages 1 and 2 Non-secure Only PL1 Read

The ATS12NSOPR characteristics are:

Purpose

Performs stage 1 and 2 address translations as defined for EL1 and the current security state, with permissions as if reading from the given virtual address.

This register is part of the Address translation operations functional group.

Usage constraints

This operation can be performed at the exception levels shown below:

EL0 (NS)	EL0 (S)	EL1 (NS)	EL1 (S)	EL2	EL3 (SCR.NS=1)	EL3 (SCR.NS=0)
-	-	-	WO	WO	WO	WO

If EL3 is implemented and is using AArch64, any execution of ATS12NSOPR in Secure EL1 state in AArch32 is trapped as an exception to EL3.

Configurations

There are no configuration notes.

Attributes

ATS12NSOPR is a 32-bit system operation.

The ATS12NSOPR input value bit assignments are:

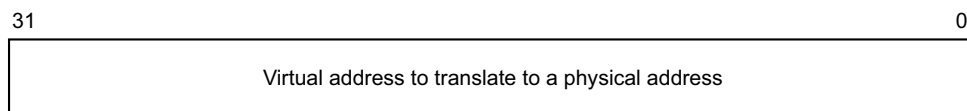

Bits [31:0]

Virtual address to translate to a physical address. The resulting physical address can be read from the [PAR](#).

Performing the ATS12NSOPR operation:

To perform the ATS12NSOPR operation:

MCR p15,0,<Rt>,c7,c8,4 ; ATS12NSOPR operation

The operation is encoded as follows:

coproc	opc1	CRn	CRm	opc2
1111	000	0111	1000	100

G4.2.9 ATS12NSOPW, Address Translate Stages 1 and 2 Non-secure Only PL1 Write

The ATS12NSOPW characteristics are:

Purpose

Performs stage 1 and 2 address translations as defined for EL1 and the current security state, with permissions as if writing to the given virtual address.

This register is part of the Address translation operations functional group.

Usage constraints

This operation can be performed at the exception levels shown below:

EL0 (NS)	EL0 (S)	EL1 (NS)	EL1 (S)	EL2	EL3 (SCR.NS=1)	EL3 (SCR.NS=0)
-	-	-	WO	WO	WO	WO

If EL3 is implemented and is using AArch64, any execution of ATS12NSOPW in Secure EL1 state in AArch32 is trapped as an exception to EL3.

Configurations

There are no configuration notes.

Attributes

ATS12NSOPW is a 32-bit system operation.

The ATS12NSOPW input value bit assignments are:

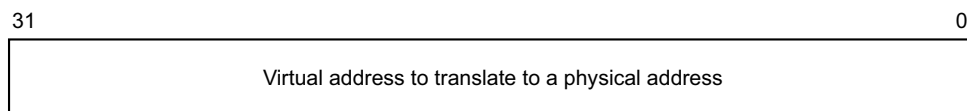

Bits [31:0]

Virtual address to translate to a physical address. The resulting physical address can be read from the [PAR](#).

Performing the ATS12NSOPW operation:

To perform the ATS12NSOPW operation:

MCR p15,0,<Rt>,c7,c8,5 ; ATS12NSOPW operation

The operation is encoded as follows:

coproc	opc1	CRn	CRm	opc2
1111	000	0111	1000	101

G4.2.10 ATS12NSOUR, Address Translate Stages 1 and 2 Non-secure Only Unprivileged Read

The ATS12NSOUR characteristics are:

Purpose

Performs stage 1 and 2 address translations as defined for EL0 and the current security state, with permissions as if reading from the given virtual address.

This register is part of the Address translation operations functional group.

Usage constraints

This operation can be performed at the exception levels shown below:

EL0 (NS)	EL0 (S)	EL1 (NS)	EL1 (S)	EL2	EL3 (SCR.NS=1)	EL3 (SCR.NS=0)
-	-	-	WO	WO	WO	WO

If EL3 is implemented and is using AArch64, any execution of ATS12NSOUR in Secure EL1 state in AArch32 is trapped as an exception to EL3.

Configurations

There are no configuration notes.

Attributes

ATS12NSOUR is a 32-bit system operation.

The ATS12NSOUR input value bit assignments are:

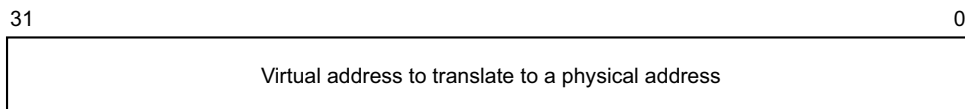

Bits [31:0]

Virtual address to translate to a physical address. The resulting physical address can be read from the [PAR](#).

Performing the ATS12NSOUR operation:

To perform the ATS12NSOUR operation:

MCR p15,0,<Rt>,c7,c8,6 ; ATS12NSOUR operation

The operation is encoded as follows:

coproc	opc1	CRn	CRm	opc2
1111	000	0111	1000	110

G4.2.11 ATS12NSOUW, Address Translate Stages 1 and 2 Non-secure Only Unprivileged Write

The ATS12NSOUW characteristics are:

Purpose

Performs stage 1 and 2 address translations as defined for EL0 and the current security state, with permissions as if writing to the given virtual address.

This register is part of the Address translation operations functional group.

Usage constraints

This operation can be performed at the exception levels shown below:

EL0 (NS)	EL0 (S)	EL1 (NS)	EL1 (S)	EL2	EL3 (SCR.NS=1)	EL3 (SCR.NS=0)
-	-	-	WO	WO	WO	WO

If EL3 is implemented and is using AArch64, any execution of ATS12NSOUW in Secure EL1 state in AArch32 is trapped as an exception to EL3.

Configurations

There are no configuration notes.

Attributes

ATS12NSOUW is a 32-bit system operation.

The ATS12NSOUW input value bit assignments are:

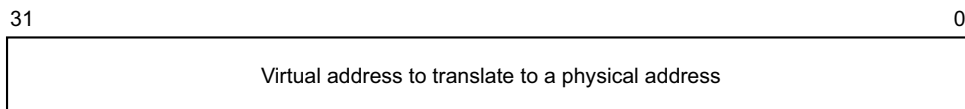

Bits [31:0]

Virtual address to translate to a physical address. The resulting physical address can be read from the [PAR](#).

Performing the ATS12NSOUW operation:

To perform the ATS12NSOUW operation:

MCR p15,0,<Rt>,c7,c8,7 ; ATS12NSOUW operation

The operation is encoded as follows:

coproc	opc1	CRn	CRm	opc2
1111	000	0111	1000	111

G4.2.12 ATS1CPR, Address Translate Stage 1 Current state PL1 Read

The ATS1CPR characteristics are:

Purpose

Performs stage 1 address translation as defined for EL1 and the current security state, with permissions as if reading from the given virtual address.

This register is part of the Address translation operations functional group.

Usage constraints

This operation can be performed at the exception levels shown below:

EL0 (NS)	EL0 (S)	EL1 (NS)	EL1 (S)	EL2	EL3 (SCR.NS=1)	EL3 (SCR.NS=0)
-	-	WO	WO	WO	WO	WO

Configurations

There are no configuration notes.

Attributes

ATS1CPR is a 32-bit system operation.

The ATS1CPR input value bit assignments are:

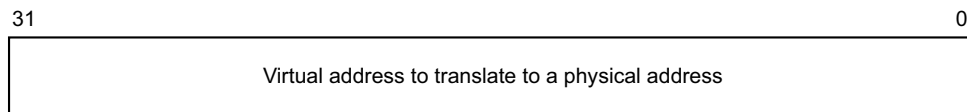

Bits [31:0]

Virtual address to translate to a physical address. The resulting physical address can be read from the [PAR](#).

Performing the ATS1CPR operation:

To perform the ATS1CPR operation:

MCR p15,0,<Rt>,c7,c8,0 ; ATS1CPR operation

The operation is encoded as follows:

coproc	opc1	CRn	CRm	opc2
1111	000	0111	1000	000

G4.2.13 ATS1CPW, Address Translate Stage 1 Current state PL1 Write

The ATS1CPW characteristics are:

Purpose

Performs stage 1 address translation as defined for EL1 and the current security state, with permissions as if writing to the given virtual address.

This register is part of the Address translation operations functional group.

Usage constraints

This operation can be performed at the exception levels shown below:

EL0 (NS)	EL0 (S)	EL1 (NS)	EL1 (S)	EL2	EL3 (SCR.NS=1)	EL3 (SCR.NS=0)
-	-	WO	WO	WO	WO	WO

Configurations

There are no configuration notes.

Attributes

ATS1CPW is a 32-bit system operation.

The ATS1CPW input value bit assignments are:

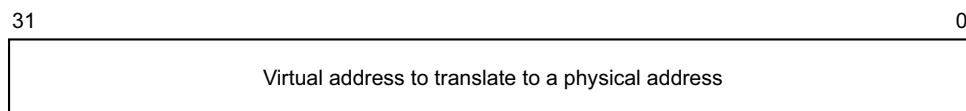

Bits [31:0]

Virtual address to translate to a physical address. The resulting physical address can be read from the [PAR](#).

Performing the ATS1CPW operation:

To perform the ATS1CPW operation:

MCR p15,0,<Rt>,c7,c8,1 ; ATS1CPW operation

The operation is encoded as follows:

coproc	opc1	CRn	CRm	opc2
1111	000	0111	1000	001

G4.2.14 ATS1CUR, Address Translate Stage 1 Current state Unprivileged Read

The ATS1CUR characteristics are:

Purpose

Performs stage 1 address translation as defined for EL0 and the current security state, with permissions as if reading from the given virtual address.

This register is part of the Address translation operations functional group.

Usage constraints

This operation can be performed at the exception levels shown below:

EL0 (NS)	EL0 (S)	EL1 (NS)	EL1 (S)	EL2	EL3 (SCR.NS=1)	EL3 (SCR.NS=0)
-	-	WO	WO	WO	WO	WO

Configurations

There are no configuration notes.

Attributes

ATS1CUR is a 32-bit system operation.

The ATS1CUR input value bit assignments are:

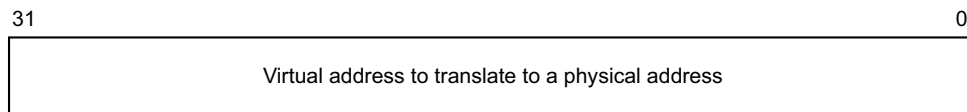

Bits [31:0]

Virtual address to translate to a physical address. The resulting physical address can be read from the [PAR](#).

Performing the ATS1CUR operation:

To perform the ATS1CUR operation:

MCR p15,0,<Rt>,c7,c8,2 ; ATS1CUR operation

The operation is encoded as follows:

coproc	opc1	CRn	CRm	opc2
1111	000	0111	1000	010

G4.2.15 ATS1CUW, Address Translate Stage 1 Current state Unprivileged Write

The ATS1CUW characteristics are:

Purpose

Performs stage 1 address translation as defined for EL0 and the current security state, with permissions as if writing to the given virtual address.

This register is part of the Address translation operations functional group.

Usage constraints

This operation can be performed at the exception levels shown below:

EL0 (NS)	EL0 (S)	EL1 (NS)	EL1 (S)	EL2	EL3 (SCR.NS=1)	EL3 (SCR.NS=0)
-	-	WO	WO	WO	WO	WO

Configurations

There are no configuration notes.

Attributes

ATS1CUW is a 32-bit system operation.

The ATS1CUW input value bit assignments are:

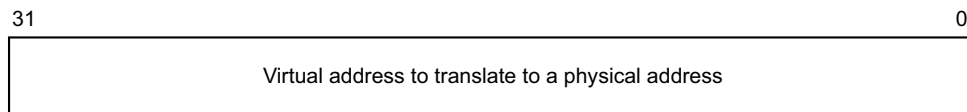

Bits [31:0]

Virtual address to translate to a physical address. The resulting physical address can be read from the [PAR](#).

Performing the ATS1CUW operation:

To perform the ATS1CUW operation:

MCR p15,0,<Rt>,c7,c8,3 ; ATS1CUW operation

The operation is encoded as follows:

coproc	opc1	CRn	CRm	opc2
1111	000	0111	1000	011

G4.2.16 ATS1HR, Address Translate Stage 1 Hyp mode Read

The ATS1HR characteristics are:

Purpose

Performs stage 1 address translation as defined for EL2 and the current security state, with permissions as if reading from the given virtual address.

This register is part of:

- the Address translation operations functional group
- the Virtualization registers functional group.

Usage constraints

This operation can be performed at the exception levels shown below:

EL0 (NS)	EL0 (S)	EL1 (NS)	EL1 (S)	EL2	EL3 (SCR.NS=1)	EL3 (SCR.NS=0, Mon)	EL3 (SCR.NS=0, !Mon)
-	-	-	-	WO	WO	WO	UNPREDICTABLE

Configurations

There are no configuration notes.

Attributes

ATS1HR is a 32-bit system operation.

The ATS1HR input value bit assignments are:

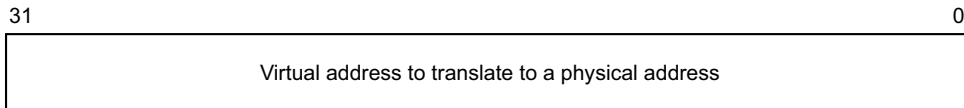

Bits [31:0]

Virtual address to translate to a physical address. The resulting physical address can be read from the [PAR](#).

Performing the ATS1HR operation:

To perform the ATS1HR operation:

```
MCR p15,4,<Rt>,c7,c8,0 ; ATS1HR operation
```

The operation is encoded as follows:

coproc	opc1	CRn	CRm	opc2
1111	100	0111	1000	000

G4.2.17 ATS1HW, Address Translate Stage 1 Hyp mode Write

The ATS1HW characteristics are:

Purpose

Performs stage 1 address translation as defined for EL2 and the current security state, with permissions as if writing to the given virtual address.

This register is part of:

- the Address translation operations functional group
- the Virtualization registers functional group.

Usage constraints

This operation can be performed at the exception levels shown below:

EL0 (NS)	EL0 (S)	EL1 (NS)	EL1 (S)	EL2	EL3 (SCR.NS=1)	EL3 (SCR.NS=0, Mon)	EL3 (SCR.NS=0, !Mon)
-	-	-	-	WO	WO	WO	UNPREDICTABLE

Configurations

There are no configuration notes.

Attributes

ATS1HW is a 32-bit system operation.

The ATS1HW input value bit assignments are:

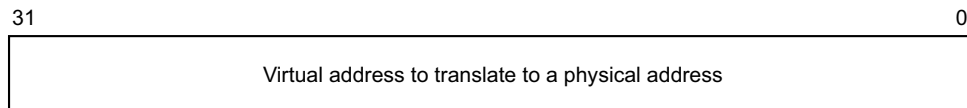

Bits [31:0]

Virtual address to translate to a physical address. The resulting physical address can be read from the [PAR](#).

Performing the ATS1HW operation:

To perform the ATS1HW operation:

MCR p15,4,<Rt>,c7,c8,1 ; ATS1HW operation

The operation is encoded as follows:

coproc	opc1	CRn	CRm	opc2
1111	100	0111	1000	001

G4.2.18 BPIALL, Branch Predictor Invalidate All

The BPIALL characteristics are:

Purpose

Invalidate all entries from branch predictors.

This register is part of the Cache maintenance operations functional group.

Usage constraints

This operation can be performed at the exception levels shown below:

EL0 (NS)	EL0 (S)	EL1 (NS)	EL1 (S)	EL2	EL3 (SCR.NS=1)	EL3 (SCR.NS=0)
-	-	WO	WO	WO	WO	WO

Configurations

There are no configuration notes.

Attributes

BPIALL is a 32-bit system operation.

The BPIALL operation ignores the value in the register specified by the instruction used to perform this operation. Software does not have to write a value to the register before issuing this instruction.

Performing the BPIALL operation:

To perform the BPIALL operation:

MCR p15,0,<Rt>,c7,c5,6 ; BPIALL operation, ignoring the value in Rt

The operation is encoded as follows:

coproc	opc1	CRn	CRm	opc2
1111	000	0111	0101	110

G4.2.19 BPIALLIS, Branch Predictor Invalidate All, Inner Shareable

The BPIALLIS characteristics are:

Purpose

Invalidate all entries from branch predictors Inner Shareable.

This register is part of the Cache maintenance operations functional group.

Usage constraints

This operation can be performed at the exception levels shown below:

EL0 (NS)	EL0 (S)	EL1 (NS)	EL1 (S)	EL2	EL3 (SCR.NS=1)	EL3 (SCR.NS=0)
-	-	WO	WO	WO	WO	WO

Configurations

There are no configuration notes.

Attributes

BPIALLIS is a 32-bit system operation.

The BPIALLIS operation ignores the value in the register specified by the instruction used to perform this operation. Software does not have to write a value to the register before issuing this instruction.

Performing the BPIALLIS operation:

To perform the BPIALLIS operation:

MCR p15,0,<Rt>,c7,c1,6 ; BPIALLIS operation, ignoring the value in Rt

The operation is encoded as follows:

coproc	opc1	CRn	CRm	opc2
1111	000	0111	0001	110

G4.2.20 BPIMVA, Branch Predictor Invalidate VA

The BPIMVA characteristics are:

Purpose

Invalidate virtual address from branch predictors.

This register is part of the Cache maintenance operations functional group.

Usage constraints

This operation can be performed at the exception levels shown below:

EL0 (NS)	EL0 (S)	EL1 (NS)	EL1 (S)	EL2	EL3 (SCR.NS=1)	EL3 (SCR.NS=0)
-	-	WO	WO	WO	WO	WO

Configurations

There are no configuration notes.

Attributes

BPIMVA is a 32-bit system operation.

The BPIMVA input value bit assignments are:

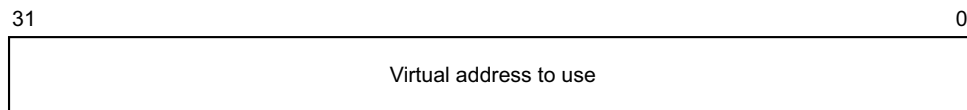

Bits [31:0]

Virtual address to use.

Performing the BPIMVA operation:

To perform the BPIMVA operation:

MCR p15,0,<Rt>,c7,c5,7 ; BPIMVA operation

The operation is encoded as follows:

coproc	opc1	CRn	CRm	opc2
1111	000	0111	0101	111

G4.2.21 CCSIDR, Current Cache Size ID Register

The CCSIDR characteristics are:

Purpose

Provides information about the architecture of the currently selected cache.
This register is part of the Identification registers functional group.

Usage constraints

This register is accessible as shown below:

EL0 (NS)	EL0 (S)	EL1 (NS)	EL1 (S)	EL2	EL3 (SCR.NS=1)	EL3 (SCR.NS=0)
-	-	RO	RO	RO	RO	RO

If [CSSELR](#) indicates a cache that is not implemented, then on a read of the CCSIDR the behavior is CONSTRAINED UNPREDICTABLE, and can be one of the following:

- The CCSIDR read is treated as NOP.
- The CCSIDR read is UNDEFINED.
- The CCSIDR read returns an UNKNOWN value.

Configurations

CCSIDR is architecturally mapped to AArch64 register [CCSIDR_EL1](#).

There is one instance of this register that is used in both Secure and Non-secure states.

The implementation includes one CCSIDR for each cache that it can access. [CSSELR](#) and the security state select which Cache Size ID Register is accessible.

Attributes

CCSIDR is a 32-bit register.

The CCSIDR bit assignments are:

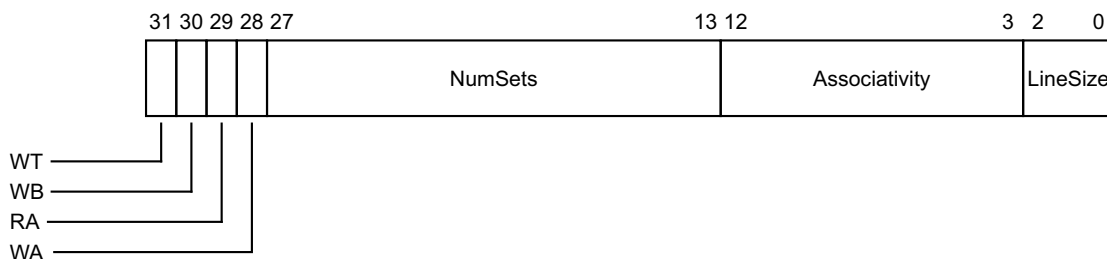

WT, bit [31]

Indicates whether the selected cache level supports write-through. Permitted values are:

- 0 Write-through not supported.
- 1 Write-through supported.

WB, bit [30]

Indicates whether the selected cache level supports write-back. Permitted values are:

- 0 Write-back not supported.
- 1 Write-back supported.

RA, bit [29]

Indicates whether the selected cache level supports read-allocation. Permitted values are:

- 0 Read-allocation not supported.
- 1 Read-allocation supported.

WA, bit [28]

Indicates whether the selected cache level supports write-allocation. Permitted values are:

- 0 Write-allocation not supported.
- 1 Write-allocation supported.

NumSets, bits [27:13]

(Number of sets in cache) - 1, therefore a value of 0 indicates 1 set in the cache. The number of sets does not have to be a power of 2.

Associativity, bits [12:3]

(Associativity of cache) - 1, therefore a value of 0 indicates an associativity of 1. The associativity does not have to be a power of 2.

LineSize, bits [2:0]

($\text{Log}_2(\text{Number of bytes in cache line})$) - 4. For example:

For a line length of 16 bytes: $\text{Log}_2(16) = 4$, LineSize entry = 0. This is the minimum line length.

For a line length of 32 bytes: $\text{Log}_2(32) = 5$, LineSize entry = 1.

Accessing the CCSIDR:

To access the CCSIDR:

MRC p15,1,<Rt>,c0,c0,0 ; Read CCSIDR into Rt

Register access is encoded as follows:

coproc	opc1	CRn	CRm	opc2
1111	001	0000	0000	000

G4.2.22 CLIDR, Cache Level ID Register

The CLIDR characteristics are:

Purpose

Identifies the type of cache, or caches, implemented at each level, up to a maximum of seven levels. Also identifies the Level of Coherency and Level of Unification for the cache hierarchy.

This register is part of the Identification registers functional group.

Usage constraints

This register is accessible as shown below:

EL0 (NS)	EL0 (S)	EL1 (NS)	EL1 (S)	EL2	EL3 (SCR.NS=1)	EL3 (SCR.NS=0)
-	-	RO	RO	RO	RO	RO

Configurations

CLIDR is architecturally mapped to AArch64 register [CLIDR_EL1](#).

There is one instance of this register that is used in both Secure and Non-secure states.

Attributes

CLIDR is a 32-bit register.

The CLIDR bit assignments are:

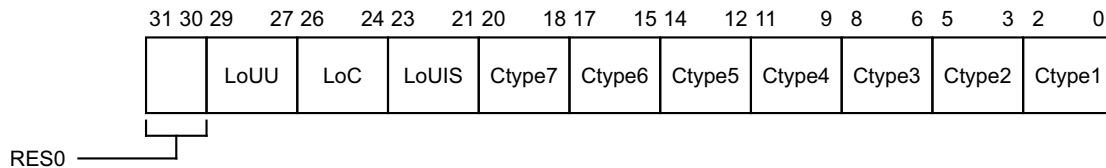

Bits [31:30]

Reserved, RES0.

LoUU, bits [29:27]

Level of Unification Uniprocessor for the cache hierarchy.

LoC, bits [26:24]

Level of Coherency for the cache hierarchy.

LoUIS, bits [23:21]

Level of Unification Inner Shareable for the cache hierarchy.

Ctype<n>, bits [3(n-1)+2:3(n-1)], for n = 1 to 7

Cache Type fields. Indicate the type of cache implemented at each level, from Level 1 up to a maximum of seven levels of cache hierarchy. Possible values of each field are:

- 000 No cache.
- 001 Instruction cache only.
- 010 Data cache only.
- 011 Separate instruction and data caches.
- 100 Unified cache.

All other values are reserved.

If software reads the Cache Type fields from Ctype1 upwards, once it has seen a value of 0b000, no caches exist at further-out levels of the hierarchy. So, for example, if Ctype3 is the first Cache Type field with a value of 0b000, the values of Ctype4 to Ctype7 must be ignored.

Accessing the CLIDR:

To access the CLIDR:

MRC p15,1,<Rt>,c0,c0,1 ; Read CLIDR into Rt

Register access is encoded as follows:

coproc	opc1	CRn	CRm	opc2
1111	001	0000	0000	001

G4.2.23 CONTEXTIDR, Context ID Register

The CONTEXTIDR characteristics are:

Purpose

Identifies the current Process Identifier and, when using the Short-descriptor translation table format, the Address Space Identifier.

This register is part of the Virtual memory control registers functional group.

Usage constraints

This register is accessible as shown below:

When accessed as CONTEXTIDR(S):

EL0 (NS)	EL0 (S)	EL1 (NS)	EL1 (S)	EL2	EL3 (SCR.NS=1)	EL3 (SCR.NS=0)
-	-	-	RW	-	-	RW

When accessed as CONTEXTIDR(NS):

EL0 (NS)	EL0 (S)	EL1 (NS)	EL1 (S)	EL2	EL3 (SCR.NS=1)	EL3 (SCR.NS=0)
-	-	RW	-	RW	RW	-

The value of the whole of this register is called the Context ID and is used by:

- The debug logic, for Linked and Unlinked Context ID matching.
- The trace logic, to identify the current process.

Configurations

CONTEXTIDR(NS) is architecturally mapped to AArch64 register [CONTEXTIDR_EL1](#).

If EL3 is using AArch32, there are separate Secure and Non-secure instances of this register.

The register format depends on whether address translation is using the Long-descriptor or the Short-descriptor translation table format.

Attributes

CONTEXTIDR is a 32-bit register.

The CONTEXTIDR bit assignments are:

When TTBCR.EAE==0:

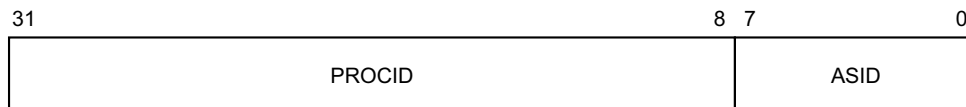

PROCID, bits [31:8]

Process Identifier. This field must be programmed with a unique value that identifies the current process.

ASID, bits [7:0]

Address Space Identifier. This field is programmed with the value of the current ASID.

When TTBCR.EAE==1:

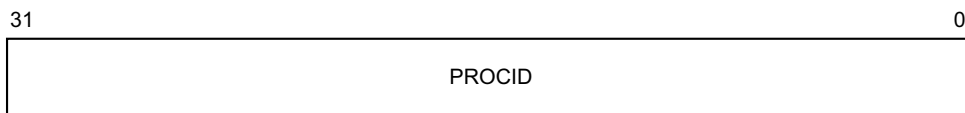

PROCID, bits [31:0]

Process Identifier. This field must be programmed with a unique value that identifies the current process.

Accessing the CONTEXTIDR:

To access the CONTEXTIDR:

MRC p15,0,<Rt>,c13,c0,1 ; Read CONTEXTIDR into Rt
MCR p15,0,<Rt>,c13,c0,1 ; Write Rt to CONTEXTIDR

Register access is encoded as follows:

coproc	opc1	CRn	CRm	opc2
1111	000	1101	0000	001

G4.2.24 CP15DMB, CP15 Data Memory Barrier operation

The CP15DMB characteristics are:

Purpose

Performs a Data Memory Barrier.

This register is part of the Legacy feature registers functional group.

Usage constraints

This operation can be performed at the exception levels shown below:

EL0 (NS)	EL0 (S)	EL1 (NS)	EL1 (S)	EL2	EL3 (SCR.NS=1)	EL3 (SCR.NS=0)
WO	WO	WO	WO	WO	WO	WO

If `SCTLR.CP15BEN` is set to 0, this operation is disabled and its encoding is UNDEFINED.

ARM deprecates any use of this operation, and strongly recommends that software use the DMB instruction instead.

Configurations

There are no configuration notes.

Attributes

CP15DMB is a 32-bit system operation.

The CP15DMB operation ignores the value in the register specified by the instruction used to perform this operation. Software does not have to write a value to the register before issuing this instruction.

Performing the CP15DMB operation:

To perform the CP15DMB operation:

`MCR p15,0,<Rt>,c7,c10,5 ; CP15DMB operation, ignoring the value in Rt`

The operation is encoded as follows:

coproc	opc1	CRn	CRm	opc2
1111	000	0111	1010	101

G4.2.25 CP15DSB, CP15 Data Synchronization Barrier operation

The CP15DSB characteristics are:

Purpose

Performs a Data Synchronization Barrier.

This register is part of the Legacy feature registers functional group.

Usage constraints

This operation can be performed at the exception levels shown below:

EL0 (NS)	EL0 (S)	EL1 (NS)	EL1 (S)	EL2	EL3 (SCR.NS=1)	EL3 (SCR.NS=0)
WO	WO	WO	WO	WO	WO	WO

If `SCTLR.CP15BEN` is set to 0, this operation is disabled and its encoding is UNDEFINED.

ARM deprecates any use of this operation, and strongly recommends that software use the DSB instruction instead.

Configurations

There are no configuration notes.

Attributes

CP15DSB is a 32-bit system operation.

The CP15DSB operation ignores the value in the register specified by the instruction used to perform this operation. Software does not have to write a value to the register before issuing this instruction.

Performing the CP15DSB operation:

To perform the CP15DSB operation:

`MCR p15,0,<Rt>,c7,c10,4 ; CP15DSB operation, ignoring the value in Rt`

The operation is encoded as follows:

coproc	opc1	CRn	CRm	opc2
1111	000	0111	1010	100

G4.2.26 CP15ISB, CP15 Instruction Synchronization Barrier operation

The CP15ISB characteristics are:

Purpose

Performs an Instruction Synchronization Barrier.

This register is part of the Legacy feature registers functional group.

Usage constraints

This operation can be performed at the exception levels shown below:

EL0 (NS)	EL0 (S)	EL1 (NS)	EL1 (S)	EL2	EL3 (SCR.NS=1)	EL3 (SCR.NS=0)
WO	WO	WO	WO	WO	WO	WO

If [SCTLR.CP15BEN](#) is set to 0, this operation is disabled and its encoding is UNDEFINED.

ARM deprecates any use of this operation, and strongly recommends that software use the ISB instruction instead.

Configurations

There are no configuration notes.

Attributes

CP15ISB is a 32-bit system operation.

The CP15ISB operation ignores the value in the register specified by the instruction used to perform this operation. Software does not have to write a value to the register before issuing this instruction.

Performing the CP15ISB operation:

To perform the CP15ISB operation:

MCR p15,0,<Rt>,c7,c5,4 ; CP15ISB operation, ignoring the value in Rt

The operation is encoded as follows:

coproc	opc1	CRn	CRm	opc2
1111	000	0111	0101	100

G4.2.27 CPACR, Architectural Feature Access Control Register

The CPACR characteristics are:

Purpose

Controls access to Trace, Floating-point, and Advanced SIMD functionality.
 This register is part of the Other system control registers functional group.

Usage constraints

This register is accessible as shown below:

EL0 (NS)	EL0 (S)	EL1 (NS)	EL1 (S)	EL2	EL3 (SCR.NS=1)	EL3 (SCR.NS=0)
-	-	RW	RW	RW	RW	RW

In an implementation that includes EL2, the CPACR has no effect on instructions executed at EL2.

Configurations

CPACR is architecturally mapped to AArch64 register [CPACR_EL1](#).

There is one instance of this register that is used in both Secure and Non-secure states.

Bits in the [NSACR](#) control Non-secure access to the CPACR fields. See the field descriptions for more information.

Attributes

CPACR is a 32-bit register.

The CPACR bit assignments are:

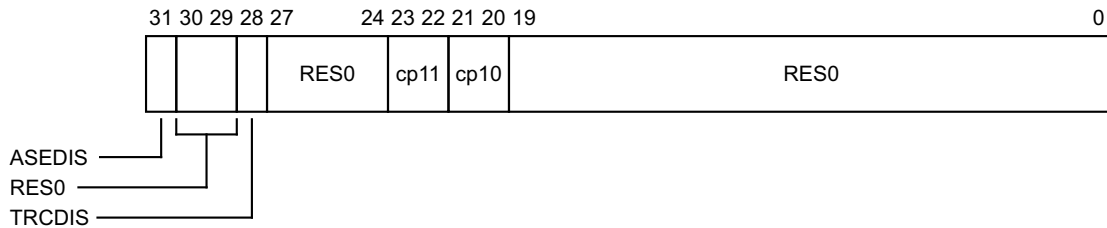

ASEDIS, bit [31]

Disable Advanced SIMD functionality:

- 0 Does not cause any instructions to be UNDEFINED.
- 1 All instruction encodings that are part of Advanced SIMD, but that are not VFPv3 or VFPv4 instructions, are UNDEFINED.

In Non-secure state, if [NSACR.NSASEDIS](#) is set to 1, this bit is RES1.

Resets to 0.

Bits [30:29]

Reserved, RES0.

TRCDIS, bit [28]

Disable CP14 access to trace registers:

- 0 Does not cause any instructions to be UNDEFINED.
- 1 Any MRC or MCR instruction with coproc set to 0b1110 and opc1 set to 0b001 is UNDEFINED.

In Non-secure state, if **NSACR.NSTRCDIS** is set to 1, this bit is RES1.

Reset value is architecturally UNKNOWN.

Bits [27:24]

Reserved, RES0.

cp<n>, bits [2n+1:2n], for n = 10 to 11

Defines the access rights for coprocessors 10 and 11, which control the Floating-point and Advanced SIMD features. Possible values of the fields are:

- 00 Access denied. Any attempt to access Floating-point and Advanced SIMD registers or instructions generates an Undefined Instruction exception.
- 01 Access at EL1 only. Any attempt to access Floating-point and Advanced SIMD registers or instructions from software executing at EL0 generates an Undefined Instruction exception.
- 11 Full access.

The value 0b10 is reserved.

In Non-secure state, if **NSACR.cp<n>** is set to 0, this bit is RES0.

The Floating-point and Advanced SIMD features controlled by these fields are:

- VFP floating-point instructions.
- Advanced SIMD instructions (both integer and floating-point).
- Advanced SIMD and Floating-point registers D0-D31 and their views as S0-S31 and Q0-Q15.
- **FPSCR**, **FPSID**, **MVFR0**, **MVFR1**, **MVFR2**, **FPEXC** system registers.

If the cp11 and cp10 fields are set to different values, the behavior is **CONSTRAINED UNPREDICTABLE**, and is the same as if both fields were set to the value of cp10, in all respects other than the value read back by explicitly reading cp11.

Other coprocessors are not supported in ARMv8, so bits[27:24] and bits[19:0] are RES0.

Resets to 0.

Bits [19:0]

Reserved, RES0.

Accessing the CPACR:

To access the CPACR:

MRC p15,0,<Rt>,c1,c0,2 ; Read CPACR into Rt

MCR p15,0,<Rt>,c1,c0,2 ; Write Rt to CPACR

Register access is encoded as follows:

coproc	opc1	CRn	CRm	opc2
1111	000	0001	0000	010

G4.2.28 CPSR, Current Program Status Register

The CPSR characteristics are:

Purpose

Holds processor status and control information.

This register is part of the Process state registers functional group.

Usage constraints

The CPSR can be read using the MRS instruction and written using the MSR (immediate) or MSR (register) instructions. For more information see [MRS on page F7-2720](#), [MSR \(immediate\) on page F7-2722](#), and [MSR \(register\) on page F7-2724](#).

Configurations

There is one instance of this register that is used in both Secure and Non-secure states.

Attributes

CPSR is a 32-bit register.

The CPSR bit assignments are:

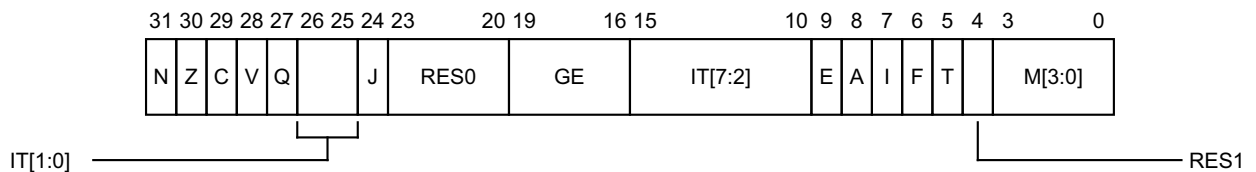

N, bit [31]

Negative condition flag. Set to bit[31] of the result of the last flag-setting instruction. If the result is regarded as a two's complement signed integer, then the processor sets N to 1 if the result was negative, and sets N to 0 if it was positive or zero.

Z, bit [30]

Zero condition flag. Set to 1 if the result of the last flag-setting instruction was zero, and to 0 otherwise. A result of zero often indicates an equal result from a comparison.

C, bit [29]

Carry condition flag. Set to 1 if the last flag-setting instruction resulted in a carry condition, for example an unsigned overflow on an addition.

V, bit [28]

Overflow condition flag. Set to 1 if the last flag-setting instruction resulted in an overflow condition, for example a signed overflow on an addition.

Q, bit [27]

Cumulative saturation bit. Set to 1 to indicate that overflow or saturation occurred in some instructions.

IT[1:0], bits [26:25]

If-Then execution state bits for the T32 IT (If-Then) instruction. See IT[7:2] for explanation of this field.

Bits [23:20]

Reserved, RES0.

GE, bits [19:16]

Greater than or Equal flags, for parallel addition and subtraction.

IT[7:2], bits [15:10]

If-Then execution state bits for the T32 IT (If-Then) instruction. This field must be interpreted in two parts.

- IT[7:5] holds the base condition for the IT block. The base condition is the top 3 bits of the condition code specified by the first condition field of the IT instruction.
- IT[4:0] encodes the size of the IT block, which is the number of instructions that are to be conditionally executed, by the position of the least significant 1 in this field. It also encodes the value of the least significant bit of the condition code for each instruction in the block.

The IT field is 0b00000000 when no IT block is active.

E, bit [9]

Endianness execution state bit. Controls the load and store endianness for data accesses:

- 0 Little-endian operation
- 1 Big-endian operation.

Instruction fetches ignore this bit.

When the reset value of the SCTL.R.EE bit is defined by a configuration input signal, that value also applies to the CPSR.E bit on reset, and therefore applies to software execution from reset.

If an implementation does not provide Big-endian support, this bit is RES0. If it does not provide Little-endian support, this bit is RES1.

If an implementation provides Big-endian support but only at EL0, this bit is RES0 for an exception return to any exception level other than EL0.

Likewise, if it provides Little-endian support only at EL0, this bit is RES1 for an exception return to any exception level other than EL0.

A, bit [8]

Asynchronous data abort mask bit. The possible values of this bit are:

- 0 Exception not masked.
- 1 Exception masked.

I, bit [7]

IRQ mask bit. The possible values of this bit are:

- 0 Exception not masked.
- 1 Exception masked.

F, bit [6]

FIQ mask bit. The possible values of this bit are:

- 0 Exception not masked.
- 1 Exception masked.

Bit [4]

Reserved, RES1.

M[3:0], bits [3:0]

Current processor mode. Possible values are:

M[3:0]	Mode
0b0000	User
0b0001	FIQ
0b0010	IRQ
0b0011	Supervisor
0b0110	Monitor
0b0111	Abort
0b1010	Hyp
0b1011	Undefined
0b1111	System

Other values are reserved.

G4.2.29 CSSELR, Cache Size Selection Register

The CSSELR characteristics are:

Purpose

Selects the current Cache Size ID Register, [CCSIDR](#), by specifying the required cache level and the cache type (either instruction or data cache).

This register is part of the Identification registers functional group.

Usage constraints

This register is accessible as shown below:

When accessed as CSSELR(S):

EL0 (NS)	EL0 (S)	EL1 (NS)	EL1 (S)	EL2	EL3 (SCR.NS=1)	EL3 (SCR.NS=0)
-	-	-	RW	-	-	RW

When accessed as CSSELR(NS):

EL0 (NS)	EL0 (S)	EL1 (NS)	EL1 (S)	EL2	EL3 (SCR.NS=1)	EL3 (SCR.NS=0)
-	-	RW	-	RW	RW	-

If the CSSELR level field is programmed to a cache level that is not implemented, then a read of CSSELR is CONstrained UNPREDICTABLE, and returns an UNKNOWN value in CSSELR.Level.

Configurations

CSSELR(NS) is architecturally mapped to AArch64 register [CSSELR_EL1](#).

If EL3 is using AArch32, there are separate Secure and Non-secure instances of this register.

Attributes

CSSELR is a 32-bit register.

The CSSELR bit assignments are:

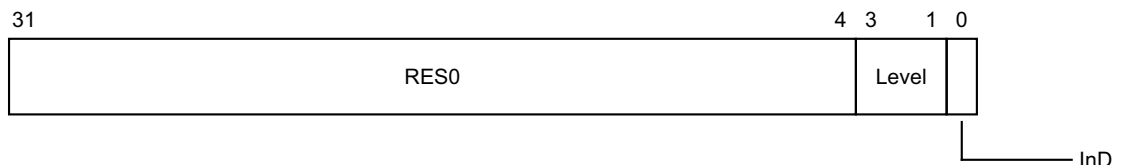

Bits [31:4]

Reserved, RES0.

Level, bits [3:1]

Cache level of required cache. Permitted values are from 0b000, indicating Level 1 cache, to 0b110 indicating Level 7 cache.

InD, bit [0]

Instruction not Data bit. Permitted values are:

- 0 Data or unified cache.
- 1 Instruction cache.

Accessing the CSSELR:

To access the CSSELR:

MRC p15,2,<Rt>,c0,c0,0 ; Read CSSELR into Rt
MCR p15,2,<Rt>,c0,c0,0 ; Write Rt to CSSELR

Register access is encoded as follows:

coproc	opc1	CRn	CRm	opc2
1111	010	0000	0000	000

G4.2.30 CTR, Cache Type Register

The CTR characteristics are:

Purpose

Provides information about the architecture of the caches.

This register is part of the Identification registers functional group.

Usage constraints

This register is accessible as shown below:

EL0 (NS)	EL0 (S)	EL1 (NS)	EL1 (S)	EL2	EL3 (SCR.NS=1)	EL3 (SCR.NS=0)
-	-	RO	RO	RO	RO	RO

Configurations

CTR is architecturally mapped to AArch64 register [CTR_ELO](#).

There is one instance of this register that is used in both Secure and Non-secure states.

Attributes

CTR is a 32-bit register.

The CTR bit assignments are:

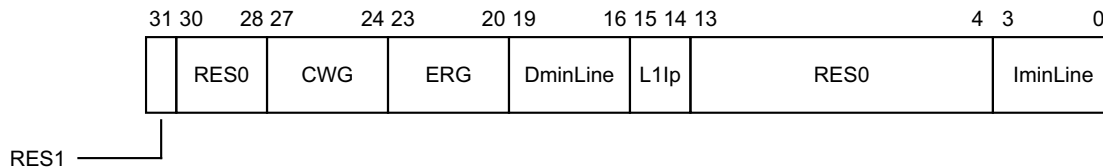

Bit [31]

Reserved, RES1.

Bits [30:28]

Reserved, RES0.

CWG, bits [27:24]

Cache Writeback Granule. \log_2 of the number of words of the maximum size of memory that can be overwritten as a result of the eviction of a cache entry that has had a memory location in it modified.

A value of `0b0000` indicates that this register does not provide Cache Writeback Granule information and either:

- The architectural maximum of 512 words (2Kbytes) must be assumed.
- The Cache Writeback Granule can be determined from maximum cache line size encoded in the Cache Size ID Registers.

Values greater than `0b1001` are reserved.

ERG, bits [23:20]

Exclusives Reservation Granule. \log_2 of the number of words of the maximum size of the reservation granule that has been implemented for the Load-Exclusive and Store-Exclusive instructions.

A value of `0b0000` indicates that this register does not provide Exclusives Reservation Granule information and the architectural maximum of 512 words (2Kbytes) must be assumed.

Values greater than 0b1001 are reserved.

DminLine, bits [19:16]

Log₂ of the number of words in the smallest cache line of all the data caches and unified caches that are controlled by the processor.

L1Ip, bits [15:14]

Level 1 instruction cache policy. Indicates the indexing and tagging policy for the L1 instruction cache. Possible values of this field are:

- 01 ASID-tagged Virtual Index, Virtual Tag (AIVIVT)
- 10 Virtual Index, Physical Tag (VIPT)
- 11 Physical Index, Physical Tag (PIPT)

Other values are reserved.

Bits [13:4]

Reserved, RES0.

IminLine, bits [3:0]

Log₂ of the number of words in the smallest cache line of all the instruction caches that are controlled by the processor.

Accessing the CTR:

To access the CTR:

MRC p15,0,<Rt>,c0,c0,1 ; Read CTR into Rt

Register access is encoded as follows:

coproc	opc1	CRn	CRm	opc2
1111	000	0000	0000	001

G4.2.31 DACR, Domain Access Control Register

The DACR characteristics are:

Purpose

Defines the access permission for each of the sixteen memory domains.
This register is part of the Virtual memory control registers functional group.

Usage constraints

This register is accessible as shown below:

When accessed as DACR(S):

EL0 (NS)	EL0 (S)	EL1 (NS)	EL1 (S)	EL2	EL3 (SCR.NS=1)	EL3 (SCR.NS=0)
-	-	-	RW	-	-	RW

When accessed as DACR(NS):

EL0 (NS)	EL0 (S)	EL1 (NS)	EL1 (S)	EL2	EL3 (SCR.NS=1)	EL3 (SCR.NS=0)
-	-	RW	-	RW	RW	-

Configurations

DACR(NS) is architecturally mapped to AArch64 register [DACR32_EL2](#).

If EL3 is using AArch32, there are separate Secure and Non-secure instances of this register.

DACR has write access to the Secure copy of the register disabled when the CP15SDISABLE signal is asserted HIGH.

In an implementation that includes the Large Physical Address Extension, this register has no function when [TTBCR.EAE](#) is set to 1, to select the Long-descriptor translation table format.

Attributes

DACR is a 32-bit register.

The DACR bit assignments are:

31	30	29	28	27	26	25	24	23	22	21	20	19	18	17	16	15	14	13	12	11	10	9	8	7	6	5	4	3	2	1	0
D15	D14	D13	D12	D11	D10	D9	D8	D7	D6	D5	D4	D3	D2	D1	D0																

D<n>, bits [2n+1:2n], for n = 0 to 15

Domain n access permission, where n = 0 to 15. Permitted values are:

- 00 No access. Any access to the domain generates a Domain fault.
- 01 Client. Accesses are checked against the permission bits in the translation tables.
- 11 Manager. Accesses are not checked against the permission bits in the translation tables.

The value 0b10 is reserved.

Accessing the DACR:

To access the DACR:

MRC p15,0,<Rt>,c3,c0,0 ; Read DACR into Rt
MCR p15,0,<Rt>,c3,c0,0 ; Write Rt to DACR

Register access is encoded as follows:

coproc	opc1	CRn	CRm	opc2
1111	000	0011	0000	000

G4.2.32 DCCIMVAC, Data Cache line Clean and Invalidate by VA to PoC

The DCCIMVAC characteristics are:

Purpose

Clean and Invalidate data or unified cache line by virtual address to PoC.

This register is part of the Cache maintenance operations functional group.

Usage constraints

This operation can be performed at the exception levels shown below:

EL0 (NS)	EL0 (S)	EL1 (NS)	EL1 (S)	EL2	EL3 (SCR.NS=1)	EL3 (SCR.NS=0)
-	-	WO	WO	WO	WO	WO

Configurations

DCCIMVAC performs the same function as AArch64 operation [DC CIVAC](#).

Attributes

DCCIMVAC is a 32-bit system operation.

The DCCIMVAC input value bit assignments are:

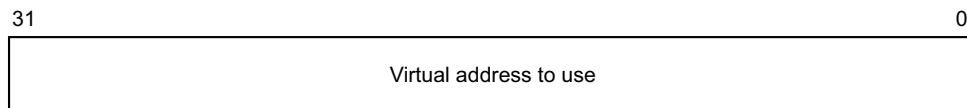

Bits [31:0]

Virtual address to use.

Performing the DCCIMVAC operation:

To perform the DCCIMVAC operation:

MCR p15,0,<Rt>,c7,c14,1 ; DCCIMVAC operation

The operation is encoded as follows:

coproc	opc1	CRn	CRm	opc2
1111	000	0111	1110	001

G4.2.33 DCCISW, Data Cache line Clean and Invalidate by Set/Way

The DCCISW characteristics are:

Purpose

Clean and Invalidate data or unified cache line by set/way.

This register is part of the Cache maintenance operations functional group.

Usage constraints

This operation can be performed at the exception levels shown below:

EL0 (NS)	EL0 (S)	EL1 (NS)	EL1 (S)	EL2	EL3 (SCR.NS=1)	EL3 (SCR.NS=0)
-	-	WO	WO	WO	WO	WO

Configurations

DCCISW performs the same function as AArch64 operation [DC C1SW](#).

Attributes

DCCISW is a 32-bit system operation.

The DCCISW input value bit assignments are:

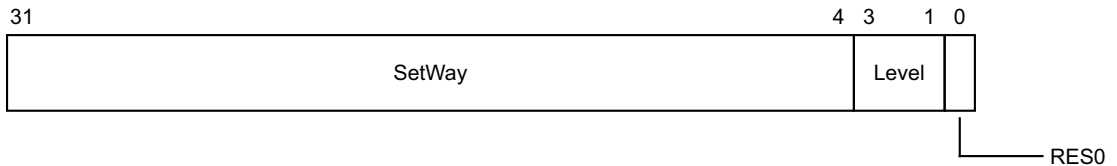

SetWay, bits [31:4]

Contains two fields:

- Way, bits[31:32-A], the number of the way to operate on.
- Set, bits[B-1:L], the number of the set to operate on.

Bits[L-1:4] are RES0.

$$A = \text{Log}_2(\text{ASSOCIATIVITY}), L = \text{Log}_2(\text{LINELEN}), B = (L + S), S = \text{Log}_2(\text{NSETS}).$$

ASSOCIATIVITY, LINELEN (line length, in bytes), and NSETS (number of sets) have their usual meanings and are the values for the cache level being operated on. The values of A and S are rounded up to the next integer.

Level, bits [3:1]

Cache level to operate on, minus 1. For example, this field is 0 for operations on L1 cache, or 1 for operations on L2 cache.

Bit [0]

Reserved, RES0.

Performing the DCCISW operation:

To perform the DCCISW operation:

```
MCR p15,0,<Rt>,c7,c14,2 ; DCCISW operation
```

The operation is encoded as follows:

coproc	opc1	CRn	CRm	opc2
1111	000	0111	1110	010

G4.2.34 DCCMVAC, Data Cache line Clean by VA to PoC

The DCCMVAC characteristics are:

Purpose

Clean data or unified cache line by virtual address to PoC.

This register is part of the Cache maintenance operations functional group.

Usage constraints

This operation can be performed at the exception levels shown below:

EL0 (NS)	EL0 (S)	EL1 (NS)	EL1 (S)	EL2	EL3 (SCR.NS=1)	EL3 (SCR.NS=0)
-	-	WO	WO	WO	WO	WO

Configurations

DCCMVAC performs the same function as AArch64 operation [DC CVAC](#).

Attributes

DCCMVAC is a 32-bit system operation.

The DCCMVAC input value bit assignments are:

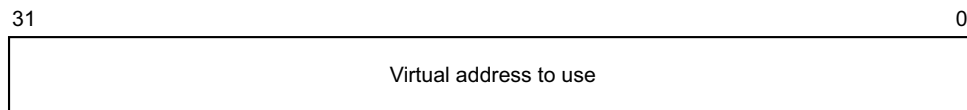

Bits [31:0]

Virtual address to use.

Performing the DCCMVAC operation:

To perform the DCCMVAC operation:

MCR p15,0,<Rt>,c7,c10,1 ; DCCMVAC operation

The operation is encoded as follows:

coproc	opc1	CRn	CRm	opc2
1111	000	0111	1010	001

G4.2.35 DCCMVAU, Data Cache line Clean by VA to PoU

The DCCMVAU characteristics are:

Purpose

Clean data or unified cache line by virtual address to PoU.

This register is part of the Cache maintenance operations functional group.

Usage constraints

This operation can be performed at the exception levels shown below:

EL0 (NS)	EL0 (S)	EL1 (NS)	EL1 (S)	EL2	EL3 (SCR.NS=1)	EL3 (SCR.NS=0)
-	-	WO	WO	WO	WO	WO

Configurations

DCCMVAU performs the same function as AArch64 operation [DC CVAU](#).

Attributes

DCCMVAU is a 32-bit system operation.

The DCCMVAU input value bit assignments are:

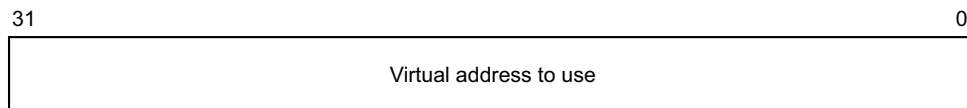

Bits [31:0]

Virtual address to use.

Performing the DCCMVAU operation:

To perform the DCCMVAU operation:

MCR p15,0,<Rt>,c7,c11,1 ; DCCMVAU operation

The operation is encoded as follows:

coproc	opc1	CRn	CRm	opc2
1111	000	0111	1011	001

G4.2.36 DCCSW, Data Cache line Clean by Set/Way

The DCCSW characteristics are:

Purpose

Clean data or unified cache line by set/way.

This register is part of the Cache maintenance operations functional group.

Usage constraints

This operation can be performed at the exception levels shown below:

EL0 (NS)	EL0 (S)	EL1 (NS)	EL1 (S)	EL2	EL3 (SCR.NS=1)	EL3 (SCR.NS=0)
-	-	WO	WO	WO	WO	WO

Configurations

DCCSW performs the same function as AArch64 operation [DC CSW](#).

Attributes

DCCSW is a 32-bit system operation.

The DCCSW input value bit assignments are:

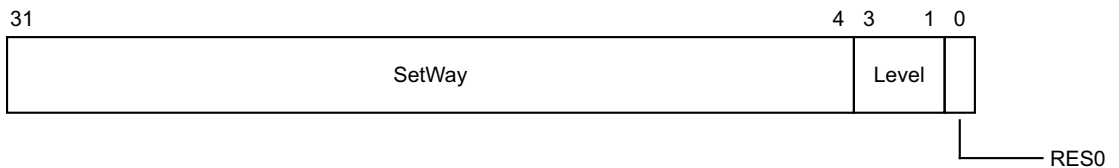

SetWay, bits [31:4]

Contains two fields:

- Way, bits[31:32-A], the number of the way to operate on.
- Set, bits[B-1:L], the number of the set to operate on.

Bits[L-1:4] are RES0.

$$A = \text{Log}_2(\text{ASSOCIATIVITY}), L = \text{Log}_2(\text{LINELEN}), B = (L + S), S = \text{Log}_2(\text{NSETS}).$$

ASSOCIATIVITY, LINELEN (line length, in bytes), and NSETS (number of sets) have their usual meanings and are the values for the cache level being operated on. The values of A and S are rounded up to the next integer.

Level, bits [3:1]

Cache level to operate on, minus 1. For example, this field is 0 for operations on L1 cache, or 1 for operations on L2 cache.

Bit [0]

Reserved, RES0.

Performing the DCCSW operation:

To perform the DCCSW operation:

MCR p15,0,<Rt>,c7,c10,2 ; DCCSW operation

The operation is encoded as follows:

coproc	opc1	CRn	CRm	opc2
1111	000	0111	1010	010

G4.2.37 DCIMVAC, Data Cache line Invalidate by VA to PoC

The DCIMVAC characteristics are:

Purpose

Invalidate data or unified cache line by virtual address to PoC.

This register is part of the Cache maintenance operations functional group.

Usage constraints

This operation can be performed at the exception levels shown below:

EL0 (NS)	EL0 (S)	EL1 (NS)	EL1 (S)	EL2	EL3 (SCR.NS=1)	EL3 (SCR.NS=0)
-	-	WO	WO	WO	WO	WO

At EL1, this operation must be performed as [DCCIMVAC](#) if all of the following apply:

- EL2 is implemented.
- [HCR.VM](#) is set to 1.
- [SCR.NS](#) is set to 1 or EL3 is not implemented.

Configurations

DCIMVAC performs the same function as AArch64 operation [DC IVAC](#).

Attributes

DCIMVAC is a 32-bit system operation.

The DCIMVAC input value bit assignments are:

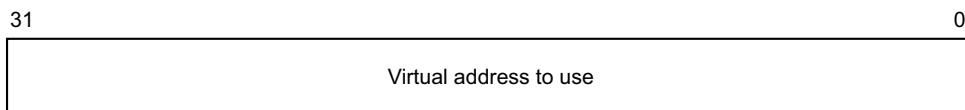

Bits [31:0]

Virtual address to use.

Performing the DCIMVAC operation:

To perform the DCIMVAC operation:

MCR p15,0,<Rt>,c7,c6,1 ; DCIMVAC operation

The operation is encoded as follows:

coproc	opc1	CRn	CRm	opc2
1111	000	0111	0110	001

G4.2.38 DCISW, Data Cache line Invalidate by Set/Way

The DCISW characteristics are:

Purpose

Invalidate data or unified cache line by set/way.

This register is part of the Cache maintenance operations functional group.

Usage constraints

This operation can be performed at the exception levels shown below:

EL0 (NS)	EL0 (S)	EL1 (NS)	EL1 (S)	EL2	EL3 (SCR.NS=1)	EL3 (SCR.NS=0)
-	-	WO	WO	WO	WO	WO

At EL1, this operation must be performed as [DCCISW](#) if all of the following apply:

- EL2 is implemented
- [HCR.VM](#) is set to 1
- [SCR.NS](#) is set to 1 or EL3 is not implemented.

Configurations

DCISW performs the same function as AArch64 operation [DC ISW](#).

Attributes

DCISW is a 32-bit system operation.

The DCISW input value bit assignments are:

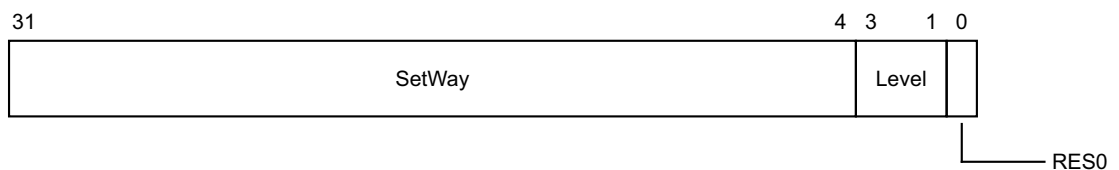

SetWay, bits [31:4]

Contains two fields:

- Way, bits[31:32-A], the number of the way to operate on.
- Set, bits[B-1:L], the number of the set to operate on.

Bits[L-1:4] are RES0.

$A = \text{Log}_2(\text{ASSOCIATIVITY})$, $L = \text{Log}_2(\text{LINELEN})$, $B = (L + S)$, $S = \text{Log}_2(\text{NSETS})$.

ASSOCIATIVITY, LINELEN (line length, in bytes), and NSETS (number of sets) have their usual meanings and are the values for the cache level being operated on. The values of A and S are rounded up to the next integer.

Level, bits [3:1]

Cache level to operate on, minus 1. For example, this field is 0 for operations on L1 cache, or 1 for operations on L2 cache.

Bit [0]

Reserved, RES0.

Performing the DCISW operation:

To perform the DCISW operation:

MCR p15,0,<Rt>,c7,c6,2 ; DCISW operation

The operation is encoded as follows:

coproc	opc1	CRn	CRm	opc2
1111	000	0111	0110	010

G4.2.39 DFAR, Data Fault Address Register

The DFAR characteristics are:

Purpose

Holds the virtual address of the faulting address that caused a synchronous Data Abort exception.
This register is part of the Exception and fault handling registers functional group.

Usage constraints

This register is accessible as shown below:

When accessed as DFAR(S):

EL0 (NS)	EL0 (S)	EL1 (NS)	EL1 (S)	EL2	EL3 (SCR.NS=1)	EL3 (SCR.NS=0)
-	-	-	RW	-	-	RW

When accessed as DFAR(NS):

EL0 (NS)	EL0 (S)	EL1 (NS)	EL1 (S)	EL2	EL3 (SCR.NS=1)	EL3 (SCR.NS=0)
-	-	RW	-	RW	RW	-

Configurations

DFAR(NS) is architecturally mapped to AArch64 register [FAR_EL1](#)[31:0].

DFAR(S) is architecturally mapped to AArch32 register [HDFAR](#) when EL2 is implemented.

DFAR(S) is architecturally mapped to AArch64 register [FAR_EL2](#)[31:0] when EL2 is implemented.

DFAR(S) can be mapped to AArch64 register [FAR_EL3](#)[31:0] when EL2 is not implemented, but this is not architecturally mandated.

If EL3 is using AArch32, there are separate Secure and Non-secure instances of this register.

Attributes

DFAR is a 32-bit register.

The DFAR bit assignments are:

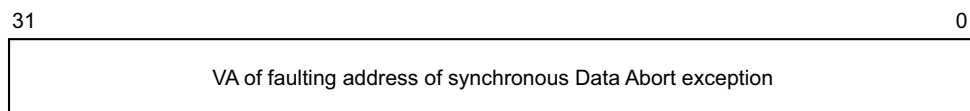

Bits [31:0]

VA of faulting address of synchronous Data Abort exception.

Accessing the DFAR:

To access the DFAR:

MRC p15,0,<Rt>,c6,c0,0 ; Read DFAR into Rt

MCR p15,0,<Rt>,c6,c0,0 ; Write Rt to DFAR

Register access is encoded as follows:

coproc	opc1	CRn	CRm	opc2
1111	000	0110	0000	000

G4.2.40 DFSR, Data Fault Status Register

The DFSR characteristics are:

Purpose

Holds status information about the last data fault.

This register is part of the Exception and fault handling registers functional group.

Usage constraints

This register is accessible as shown below:

When accessed as DFSR(S):

EL0 (NS)	EL0 (S)	EL1 (NS)	EL1 (S)	EL2	EL3 (SCR.NS=1)	EL3 (SCR.NS=0)
-	-	-	RW	-	-	RW

When accessed as DFSR(NS):

EL0 (NS)	EL0 (S)	EL1 (NS)	EL1 (S)	EL2	EL3 (SCR.NS=1)	EL3 (SCR.NS=0)
-	-	RW	-	RW	RW	-

Configurations

DFSR(NS) is architecturally mapped to AArch64 register [ESR_EL1](#).

DFSR(S) can be mapped to AArch64 register [ESR_EL3](#), but this is not architecturally mandated.

If EL3 is using AArch32, there are separate Secure and Non-secure instances of this register.

The Large Physical Address Extension adds an alternative format for the register. If an implementation includes the Large Physical Address Extension then the current translation table format determines which format of the register is used.

Attributes

DFSR is a 32-bit register.

The DFSR bit assignments are:

When TTBCR.EAE==0:

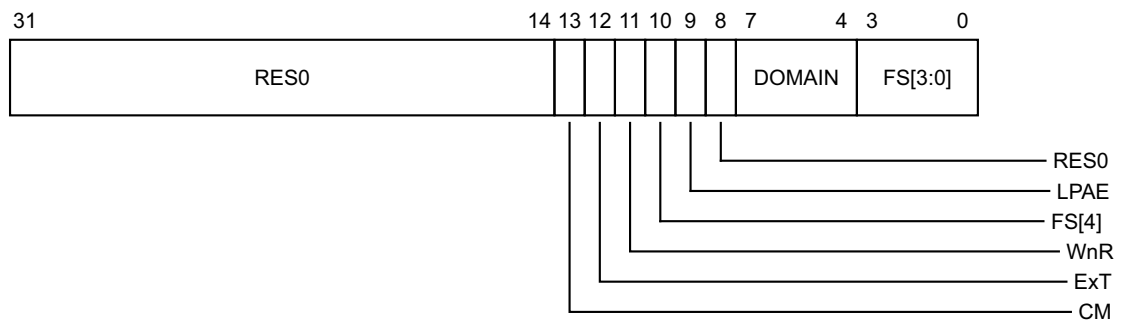

Bits [31:14]

Reserved, RES0.

CM, bit [13]

Cache maintenance fault. For synchronous faults, this bit indicates whether a cache maintenance operation generated the fault. The possible values of this bit are:

- 0 Abort not caused by a cache maintenance operation.
- 1 Abort caused by a cache maintenance operation.

On an asynchronous fault, this bit is UNKNOWN.

Ext, bit [12]

External abort type. This bit can be used to provide an IMPLEMENTATION DEFINED classification of external aborts.

For aborts other than external aborts this bit always returns 0.

WnR, bit [11]

Write not Read bit. Indicates whether the abort was caused by a write or read access. The possible values of this bit are:

- 0 Abort caused by a read access.
- 1 Abort caused by a write access.

For faults on CP15 cache maintenance operations, including the VA to PA translation operations, this bit always returns a value of 1.

FS[4], bit [10]

See below for description of the FS field.

LPAAE, bit [9]

On taking a Data Abort exception, this bit is set as follows:

- 0 Using the Short-descriptor translation table formats.
- 1 Using the Long-descriptor translation table formats.

Hardware does not interpret this bit to determine the behavior of the memory system, and therefore software can set this bit to 0 or 1 without affecting operation.

Bit [8]

Reserved, RES0.

DOMAIN, bits [7:4]

Domain of the fault address. Use of this field is deprecated.

FS[3:0], bits [3:0]

Fault status bits. Possible values of this field are:

- 0001 Alignment fault
- 0010 Debug event
- 0011 Access flag fault, first level
- 0100 Fault on instruction cache maintenance
- 0101 Translation fault, first level
- 0110 Access flag fault, second level
- 0111 Translation fault, second level
- 1000 Synchronous external abort
- 1001 Domain fault, first level
- 1011 Domain fault, second level
- 1100 Synchronous external abort on translation table walk, first level
- 1101 Permission fault, first level

- 1110 Synchronous external abort on translation table walk, second level
 - 1111 Permission fault, second level
 - 10000 TLB conflict abort
 - 10100 IMPLEMENTATION DEFINED fault (Lockdown fault)
 - 10101 IMPLEMENTATION DEFINED fault (Unsupported Exclusive access fault)
 - 10110 Asynchronous external abort
 - 11000 Asynchronous parity error on memory access
 - 11001 Synchronous parity error on memory access
 - 11100 Synchronous parity error on translation table walk, first level
 - 11110 Synchronous parity error on translation table walk, second level
- All other values are reserved.

When TTBCR.EAE==1:

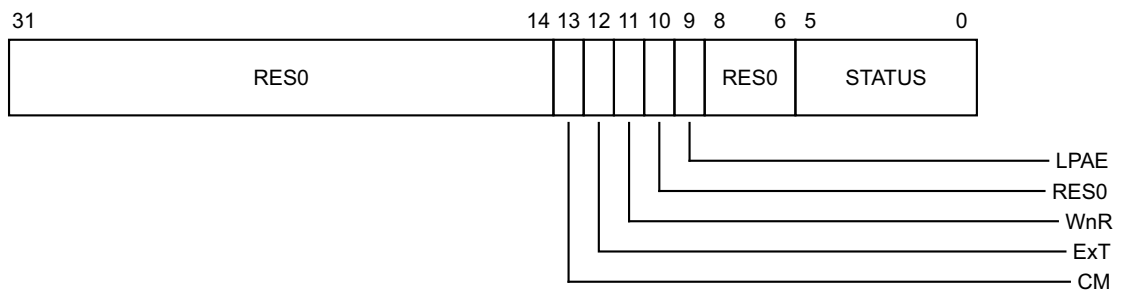

Bits [31:14]

Reserved, RES0.

CM, bit [13]

Cache maintenance fault. For synchronous faults, this bit indicates whether a cache maintenance operation generated the fault. The possible values of this bit are:

- 0 Abort not caused by a cache maintenance operation.
- 1 Abort caused by a cache maintenance operation.

On an asynchronous fault, this bit is UNKNOWN.

ExT, bit [12]

External abort type. This bit can be used to provide an IMPLEMENTATION DEFINED classification of external aborts.

For aborts other than external aborts this bit always returns 0.

WnR, bit [11]

Write not Read bit. Indicates whether the abort was caused by a write or read access. The possible values of this bit are:

- 0 Abort caused by a read access.
- 1 Abort caused by a write access.

For faults on CP15 cache maintenance operations, including the VA to PA translation operations, this bit always returns a value of 1.

Bit [10]

Reserved, RES0.

LPAE, bit [9]

On taking a Data Abort exception, this bit is set as follows:

- 0 Using the Short-descriptor translation table formats.
- 1 Using the Long-descriptor translation table formats.

Hardware does not interpret this bit to determine the behavior of the memory system, and therefore software can set this bit to 0 or 1 without affecting operation.

Bits [8:6]

Reserved, RES0.

STATUS, bits [5:0]

Fault status bits. Possible values of this field are:

000000	Address size fault in TTBR0 or TTBR1
000101	Translation fault, first level
000110	Translation fault, second level
000111	Translation fault, third level
001001	Access flag fault, first level
001010	Access flag fault, second level
001011	Access flag fault, third level
001101	Permission fault, first level
001110	Permission fault, second level
001111	Permission fault, third level
010000	Synchronous external abort
010001	Asynchronous external abort
010101	Synchronous external abort on translation table walk, first level
010110	Synchronous external abort on translation table walk, second level
010111	Synchronous external abort on translation table walk, third level
011000	Synchronous parity error on memory access
011001	Asynchronous parity error on memory access
011101	Synchronous parity error on memory access on translation table walk, first level
011110	Synchronous parity error on memory access on translation table walk, second level
011111	Synchronous parity error on memory access on translation table walk, third level
100001	Alignment fault
100010	Debug event
110000	TLB conflict abort
110100	IMPLEMENTATION DEFINED fault (Lockdown fault)
110101	IMPLEMENTATION DEFINED fault (Unsupported Exclusive access fault)

All other values are reserved.

The lookup level associated with a fault is:

- For a fault generated on a translation table walk, the lookup level of the walk being performed.
- For a Translation fault, the lookup level of the translation table that gave the fault. If a fault occurs because an MMU is disabled, or because the input address is outside the range specified by the appropriate base address register or registers, the fault is reported as a First level fault.
- For an Access flag fault, the lookup level of the translation table that gave the fault.

- For a Permission fault, including a Permission fault caused by hierarchical permissions, the lookup level of the final level of translation table accessed for the translation. That is, the lookup level of the translation table that returned a Block or Page descriptor.

Accessing the DFSR:

To access the DFSR:

MRC p15,0,<Rt>,c5,c0,0 ; Read DFSR into Rt

MCR p15,0,<Rt>,c5,c0,0 ; Write Rt to DFSR

Register access is encoded as follows:

coproc	opc1	CRn	CRm	opc2
1111	000	0101	0000	000

G4.2.41 DTLBIALL, Data TLB Invalidate All entries

The DTLBIALL characteristics are:

Purpose

Invalidate all EL1&0 regime stage 1 and 2 data TLB entries for the current VMID.
 This register is part of the TLB maintenance operations functional group.

Usage constraints

This operation can be performed at the exception levels shown below:

EL0 (NS)	EL0 (S)	EL1 (NS)	EL1 (S)	EL2	EL3 (SCR.NS=1)	EL3 (SCR.NS=0)
-	-	WO	WO	WO	WO	WO

If this operation is executed at Secure EL1 in AArch32 when EL3 is using AArch64, it only affects TLB entries related to the Secure EL1 translation regime.

Configurations

There are no configuration notes.

Attributes

DTLBIALL is a 32-bit system operation.

The DTLBIALL operation ignores the value in the register specified by the instruction used to perform this operation. Software does not have to write a value to the register before issuing this instruction.

Performing the DTLBIALL operation:

To perform the DTLBIALL operation:

MCR p15,0,<Rt>,c8,c6,0 ; DTLBIALL operation, ignoring the value in Rt

The operation is encoded as follows:

coproc	opc1	CRn	CRm	opc2
1111	000	1000	0110	000

G4.2.42 DTLBIASID, Data TLB Invalidate by ASID match

The DTLBIASID characteristics are:

Purpose

Invalidate EL1&0 regime stage 1 data TLB entries for the given ASID and the current VMID.
This register is part of the TLB maintenance operations functional group.

Usage constraints

This operation can be performed at the exception levels shown below:

EL0 (NS)	EL0 (S)	EL1 (NS)	EL1 (S)	EL2	EL3 (SCR.NS=1)	EL3 (SCR.NS=0)
-	-	WO	WO	WO	WO	WO

If this operation is executed at Secure EL1 in AArch32 when EL3 is using AArch64, it only affects TLB entries related to the Secure EL1 translation regime.

Configurations

There are no configuration notes.

Attributes

DTLBIASID is a 32-bit system operation.

The DTLBIASID input value bit assignments are:

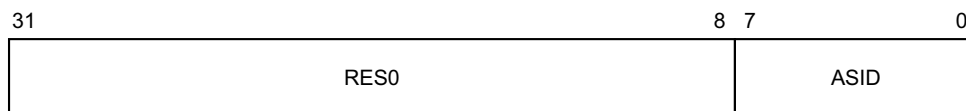

Bits [31:8]

Reserved, RES0.

ASID, bits [7:0]

ASID value to match. Any TLB entries for non-global pages that match the ASID values will be affected by this operation.

Performing the DTLBIASID operation:

To perform the DTLBIASID operation:

MCR p15,0,<Rt>,c8,c6,2 ; DTLBIASID operation

The operation is encoded as follows:

coproc	opc1	CRn	CRm	opc2
1111	000	1000	0110	010

G4.2.43 DTLBIMVA, Data TLB Invalidate entry by VA

The DTLBIMVA characteristics are:

Purpose

Invalidate EL1&0 regime stage 1 and 2 data TLB entries for the given VA and ASID and the current VMID.

This register is part of the TLB maintenance operations functional group.

Usage constraints

This operation can be performed at the exception levels shown below:

EL0 (NS)	EL0 (S)	EL1 (NS)	EL1 (S)	EL2	EL3 (SCR.NS=1)	EL3 (SCR.NS=0)
-	-	WO	WO	WO	WO	WO

If this operation is executed at Secure EL1 in AArch32 when EL3 is using AArch64, it only affects TLB entries related to the Secure EL1 translation regime.

Configurations

There are no configuration notes.

Attributes

DTLBIMVA is a 32-bit system operation.

The DTLBIMVA input value bit assignments are:

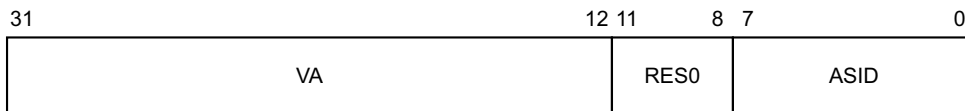

VA, bits [31:12]

Virtual address to match. Any TLB entries that match the ASID value and VA value will be affected by this operation.

Bits [11:8]

Reserved, RES0.

ASID, bits [7:0]

ASID value to match. Any TLB entries that match the ASID value and VA value will be affected by this operation.

Global TLB entries that match the VA value will be affected by this operation, regardless of the value of the ASID field.

Performing the DTLBIMVA operation:

To perform the DTLBIMVA operation:

MCR p15,0,<Rt>,c8,c6,1 ; DTLBIMVA operation

The operation is encoded as follows:

coproc	opc1	CRn	CRm	opc2
1111	000	1000	0110	001

G4.2.44 ELR_hyp, Exception Link Register (Hyp mode)

The ELR_hyp characteristics are:

Purpose

When taking an exception to Hyp mode, holds the address to return to.
This register is part of the Special purpose registers functional group.

Usage constraints

This register is accessible as shown below:

EL0 (NS)	EL0 (S)	EL1 (NS)	EL1 (S)	EL2	EL3 (SCR.NS=1)	EL3 (SCR.NS=0)
-	-	-	-	RW	RW	RW

Configurations

ELR_hyp is architecturally mapped to AArch64 register [ELR_EL2](#).

Attributes

ELR_hyp is a 32-bit register.

The ELR_hyp bit assignments are:

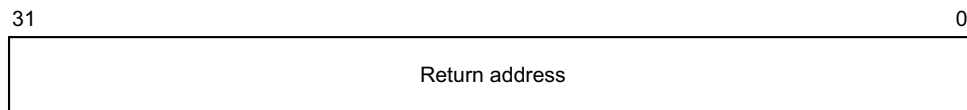

Bits [31:0]

Return address.

Accessing the ELR_hyp:

To access the ELR_hyp:

MRS <Rd>, ELR_hyp ; Read ELR_hyp into Rd
MSR ELR_hyp, <Rd> ; Write Rd to ELR_hyp

Register access is encoded as follows:

m	m1	R
1	1110	0

G4.2.45 FCSEIDR, FCSE Process ID register

The FCSEIDR characteristics are:

Purpose

Identifies whether the Fast Context Switch Extension (FCSE) is implemented, and if it is, also identifies the current Process ID for the FCSE.

This register is part of the Legacy feature registers functional group.

Usage constraints

This register is accessible as shown below:

When accessed as FCSEIDR(S):

EL0 (NS)	EL0 (S)	EL1 (NS)	EL1 (S)	EL2	EL3 (SCR.NS=1)	EL3 (SCR.NS=0)
-	-	-	RW	-	-	RW

When accessed as FCSEIDR(NS):

EL0 (NS)	EL0 (S)	EL1 (NS)	EL1 (S)	EL2	EL3 (SCR.NS=1)	EL3 (SCR.NS=0)
-	-	RW	-	RW	RW	-

In ARMv8, the FCSE is not implemented, so this register is RAZ/WI. Software can access this register to determine that the implementation does not include the FCSE.

Configurations

If EL3 is using AArch32, there are separate Secure and Non-secure instances of this register.

Attributes

FCSEIDR is a 32-bit register.

The FCSEIDR bit assignments are:

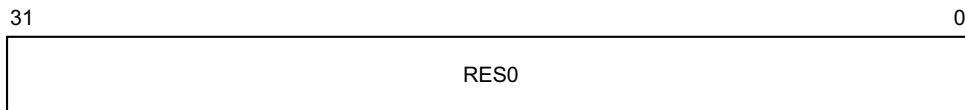

Bits [31:0]

Reserved, RES0.

Accessing the FCSEIDR:

To access the FCSEIDR:

```
MRC p15,0,<Rt>,c13,c0,0 ; Read FCSEIDR into Rt
MCR p15,0,<Rt>,c13,c0,0 ; Write Rt to FCSEIDR
```

Register access is encoded as follows:

coproc	opc1	CRn	CRm	opc2
1111	000	1101	0000	000

G4.2.46 FPEXC, Floating-Point Exception Control register

The FPEXC characteristics are:

Purpose

Provides a global enable for the Advanced SIMD and Floating-point (VFP) extensions, and indicates how the state of these extensions is recorded.

This register is part of the Floating-point registers functional group.

Usage constraints

This register is accessible as shown below:

EL0 (NS)	EL0 (S)	EL1 (NS)	EL1 (S)	EL2	EL3 (SCR.NS=1)	EL3 (SCR.NS=0)
-	-	Config-RW	RW	Config-RW	Config-RW	RW

Access to this register depends on the values of [CPACR](#).{cp10,cp11}, [NSACR](#).{cp10,cp11}, and [HCPTR](#).{TCP10,TCP11}.

Configurations

FPEXC is architecturally mapped to AArch64 register [FPEXC32_EL2](#).

There is one instance of this register that is used in both Secure and Non-secure states.

Implemented only if the implementation includes one or both of the Floating-point Extension or the Advanced SIMD Extension.

Attributes

FPEXC is a 32-bit register.

The FPEXC bit assignments are:

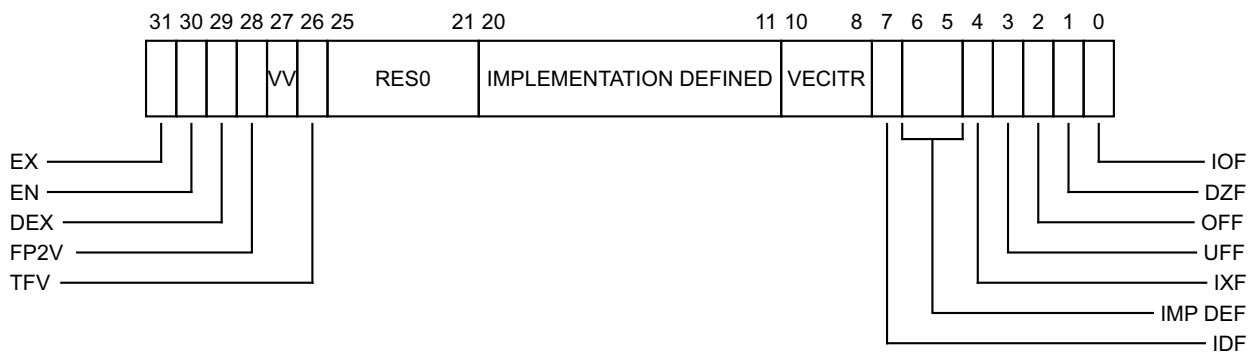

EX, bit [31]

Exception bit. A status bit that specifies how much information must be saved to record the state of the Advanced SIMD and VFP system:

- 0 The only significant state is the contents of the registers D0 - D31, [FPSCR](#), and [FPEXC](#). A context switch can be performed by saving and restoring the values of these registers.
- 1 There is additional state that must be handled by any context switch system.

In ARMv8, this bit must be RES0.

EN, bit [30]

Enable bit. A global enable for the Advanced SIMD and VFP extensions:

- 0 The Advanced SIMD and VFP extensions are disabled.

1 The Advanced SIMD and VFP extensions are enabled and operate normally.
This bit is made obsolete by the features in the CPACR when executing in AArch64.
When executing in EL0 using AArch32 with EL1 using AArch64, the behavior is as if the FPEXC.EN bit is set.
Resets to 0.

DEX, bit [29]

Defined synchronous instruction exception bit.
When a floating-point synchronous exception has occurred, if the exception was caused by an allocated floating-point instruction that is not implemented in hardware then it is IMPLEMENTATION DEFINED whether DEX is set to 0 or 1.
Otherwise, the meaning of this bit is:

0 A synchronous exception occurred when processing an unallocated floating-point or Advanced SIMD instruction.

1 A synchronous exception occurred on an allocated floating-point instruction that encountered an exceptional condition.

The exception-handling routine must clear DEX to 0.
In an implementation that does not require synchronous exception handling this bit is RES0.
Reset value is architecturally UNKNOWN.

FP2V, bit [28]

FPINST2 instruction valid bit. In ARMv8, this field is always RES0.

VV, bit [27]

VECITR valid bit. In ARMv8, this field is always RES0.

TFV, bit [26]

Trapped Fault Valid bit. Indicates whether FPEXC bits[7, 4:0] indicate trapped exceptions, or have an IMPLEMENTATION DEFINED meaning:

0 FPEXC bits[7, 4:0] have an IMPLEMENTATION DEFINED meaning

1 FPEXC bits[7, 4:0] indicate the presence of trapped exceptions that have occurred at the time of the exception. All trapped exceptions that occurred at the time of the exception have their bits set.

This bit has a fixed value and ignores writes.

Bits [25:21]

Reserved, RES0.

VECITR, bits [10:8]

Vector iteration count. In ARMv8, this field is always RES1.

IDE, bit [7]

Input Denormal trapped exception bit, or IMPLEMENTATION DEFINED. The meaning of this bit depends on the value of FPEXC.TFV.
If FPEXC.TFV is 0, this bit is IMPLEMENTATION DEFINED and can contain IMPLEMENTATION DEFINED information about the cause of an exception.
If FPEXC.TFV is 1, this bit is the Input Denormal trapped exception bit, and indicates whether an Input Denormal exception occurred while FPSCR.IDE was 1:

0 Input denormal exception has not occurred.

1 Input denormal exception has occurred.

Input Denormal exceptions can occur only when FPSCR.FZ is 1.
In both cases this bit must be cleared to 0 by the exception-handling routine.

Reset value is architecturally UNKNOWN.

IXF, bit [4]

Inexact trapped exception bit, or IMPLEMENTATION DEFINED. The meaning of this bit depends on the value of FPEXC.TFV.

If FPEXC.TFV is 0, this bit is IMPLEMENTATION DEFINED and can contain IMPLEMENTATION DEFINED information about the cause of an exception.

If FPEXC.TFV is 1, this bit is the Inexact trapped exception bit, and indicates whether an Inexact exception occurred while FPSCR.IXE was 1:

In this case, the meaning of this bit is:

0 Inexact exception has not occurred.

1 Inexact exception has occurred.

In both cases this bit must be cleared to 0 by the exception-handling routine.

Reset value is architecturally UNKNOWN.

UFF, bit [3]

Underflow trapped exception bit, or IMPLEMENTATION DEFINED. The meaning of this bit depends on the value of FPEXC.TFV.

If FPEXC.TFV is 0, this bit is IMPLEMENTATION DEFINED and can contain IMPLEMENTATION DEFINED information about the cause of an exception.

If FPEXC.TFV is 1, this bit is the Underflow trapped exception bit, and indicates whether an Underflow exception occurred while FPSCR.UFE was 1:

0 Underflow exception has not occurred.

1 Underflow exception has occurred.

Underflow trapped exceptions can occur only when FPSCR.FZ is 0.

In both cases this bit must be cleared to 0 by the exception-handling routine.

Reset value is architecturally UNKNOWN.

OFF, bit [2]

Overflow trapped exception bit, or IMPLEMENTATION DEFINED. The meaning of this bit depends on the value of FPEXC.TFV.

If FPEXC.TFV is 0, this bit is IMPLEMENTATION DEFINED and can contain IMPLEMENTATION DEFINED information about the cause of an exception.

If FPEXC.TFV is 1, this bit is the Overflow trapped exception bit, and indicates whether an Overflow exception occurred while FPSCR.OFE was 1:

0 Overflow exception has not occurred.

1 Overflow exception has occurred.

In both cases this bit must be cleared to 0 by the exception-handling routine.

Reset value is architecturally UNKNOWN.

DZF, bit [1]

Divide-by-zero trapped exception bit, or IMPLEMENTATION DEFINED. The meaning of this bit depends on the value of FPEXC.TFV.

If FPEXC.TFV is 0, this bit is IMPLEMENTATION DEFINED and can contain IMPLEMENTATION DEFINED information about the cause of an exception.

If FPEXC.TFV is 1, this bit is the Divide-by-zero trapped exception bit, and indicates whether a Divide-by-zero exception occurred while FPSCR.DZE was 1:

0 Divide-by-zero exception has not occurred.

1 Divide-by-zero exception has occurred.

In both cases this bit must be cleared to 0 by the exception-handling routine.

Reset value is architecturally UNKNOWN.

IOF, bit [0]

Invalid Operation trapped exception bit, or IMPLEMENTATION DEFINED. The meaning of this bit depends on the value of FPEXC.TFV.

If FPEXC.TFV is 0, this bit is IMPLEMENTATION DEFINED and can contain IMPLEMENTATION DEFINED information about the cause of an exception.

If FPEXC.TFV is 1, this bit is the Invalid Operation trapped exception bit, and indicates whether an Invalid Operation exception occurred while FPSCR.IOE was 1:

0 Invalid Operation exception has not occurred.

1 Invalid Operation exception has occurred.

In both cases this bit must be cleared to 0 by the exception-handling routine.

Reset value is architecturally UNKNOWN.

Accessing the FPEXC:

To access the FPEXC:

VMRS <Rt>, FPEXC ; Read FPEXC into Rt

VMSR FPEXC, <Rt> ; Write Rt to FPEXC

Register access is encoded as follows:

spec_reg

1000

G4.2.47 FPSCR, Floating-Point Status and Control Register

The FPSCR characteristics are:

Purpose

Provides floating-point system status information and control.

This register is part of:

- the Special purpose registers functional group
- the Floating-point registers functional group.

Usage constraints

This register is accessible as shown below:

EL0 (NS)	EL0 (S)	EL1 (NS)	EL1 (S)	EL2	EL3 (SCR.NS=1)	EL3 (SCR.NS=0)
Config-RW	RW	Config-RW	RW	Config-RW	Config-RW	RW

Access to this register depends on the values of [CPACR](#).{cp10,cp11}, [NSACR](#).{cp10,cp11}, [HCPTR](#).{TCP10,TCP11}, and [FPEXC](#).EN.

Configurations

There is one instance of this register that is used in both Secure and Non-secure states.

The named fields in this register map to the equivalent fields in the AArch64 [FPCR](#) and [FPSR](#).

It is IMPLEMENTATION DEFINED whether the Len and Stride fields can be programmed to non-zero values, which will cause some AArch32 floating-point instruction encodings to be UNDEFINED, or whether these fields are RAZ.

Attributes

FPSCR is a 32-bit register.

The FPSCR bit assignments are:

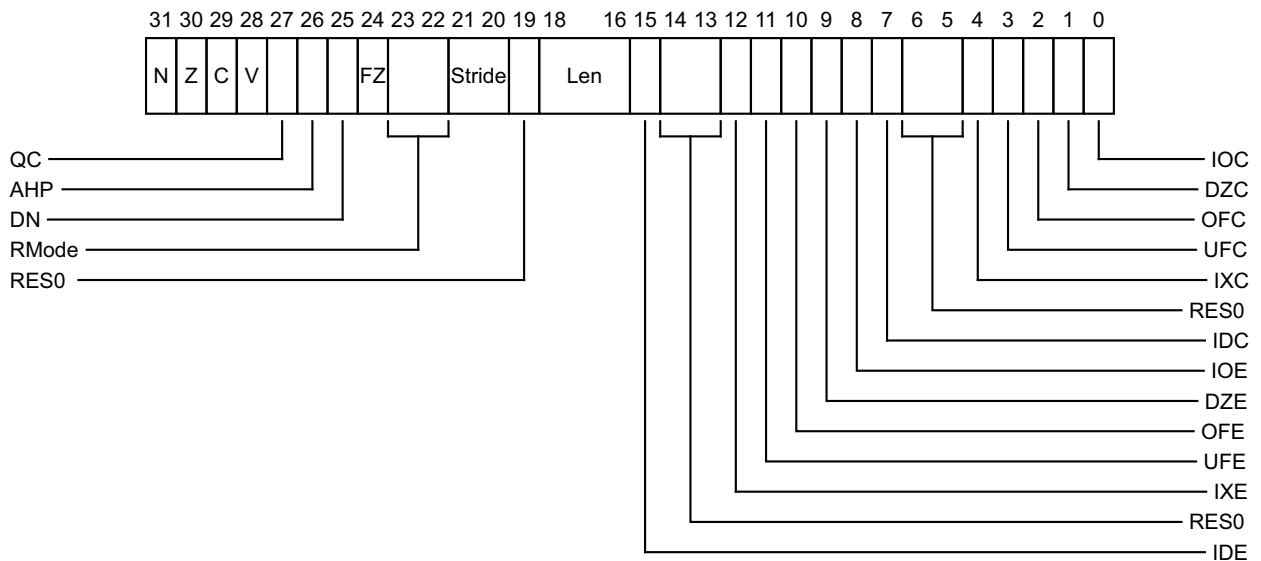

N, bit [31]

Negative condition flag. This is updated by floating-point comparison operations.

Z, bit [30]

Zero condition flag. This is updated by floating-point comparison operations.

C, bit [29]

Carry condition flag. This is updated by floating-point comparison operations.

V, bit [28]

Overflow condition flag. This is updated by floating-point comparison operations.

QC, bit [27]

Cumulative saturation bit, Advanced SIMD only. This bit is set to 1 to indicate that an Advanced SIMD integer operation has saturated since 0 was last written to this bit.

AHP, bit [26]

Alternative half-precision control bit:

- 0 IEEE half-precision format selected.
- 1 Alternative half-precision format selected.

DN, bit [25]

Default NaN mode control bit:

- 0 NaN operands propagate through to the output of a floating-point operation.
- 1 Any operation involving one or more NaNs returns the Default NaN.

The value of this bit only controls scalar floating-point arithmetic. Advanced SIMD arithmetic always uses the Default NaN setting, regardless of the value of the DN bit.

FZ, bit [24]

Flush-to-zero mode control bit:

- 0 Flush-to-zero mode disabled. Behavior of the floating-point system is fully compliant with the IEEE 754 standard.
- 1 Flush-to-zero mode enabled.

The value of this bit only controls scalar floating-point arithmetic. Advanced SIMD arithmetic always uses the Flush-to-zero setting, regardless of the value of the FZ bit.

RMode, bits [23:22]

Rounding Mode control field. The encoding of this field is:

- 00 Round to Nearest (RN) mode
- 01 Round towards Plus Infinity (RP) mode
- 10 Round towards Minus Infinity (RM) mode
- 11 Round towards Zero (RZ) mode.

The specified rounding mode is used by almost all scalar floating-point instructions. Advanced SIMD arithmetic always uses the Round to Nearest setting, regardless of the value of the RMode bits.

Stride, bits [21:20]

It is IMPLEMENTATION DEFINED whether this field is RW or RAZ.

If this field is RW and is set to a value other than zero, some floating-point instruction encodings are UNDEFINED. The instruction pseudocode identifies these instructions.

ARM strongly recommends that software never sets this field to a value other than zero.

The value of this field is ignored when processing Advanced SIMD instructions.

Bit [19]

Reserved, RES0.

Len, bits [18:16]

It is IMPLEMENTATION DEFINED whether this field is RW or RAZ.

If this field is RW and is set to a value other than zero, some floating-point instruction encodings are UNDEFINED. The instruction pseudocode identifies these instructions.

ARM strongly recommends that software never sets this field to a value other than zero.

The value of this field is ignored when processing Advanced SIMD instructions.

IDE, bit [15]

Input Denormal exception trap enable. Possible values are:

- 0 Untrapped exception handling selected. If the floating-point exception occurs then the IDC bit is set to 1.
- 1 Trapped exception handling selected. If the floating-point exception occurs, the PE does not update the IDC bit. The trap handling software can decide whether to set the IDC bit to 1.

This bit is RW only if the implementation supports the trapping of floating-point exceptions. In an implementation that does not support floating-point exception trapping, this bit is RES0.

When this bit is RW, it applies only to floating-point operations. Advanced SIMD operations always use untrapped floating-point exception handling in AArch32 state.

Bits [14:13]

Reserved, RES0.

IXE, bit [12]

Inexact exception trap enable. Possible values are:

- 0 Untrapped exception handling selected. If the floating-point exception occurs then the IXC bit is set to 1.
- 1 Trapped exception handling selected. If the floating-point exception occurs, the PE does not update the IXC bit. The trap handling software can decide whether to set the IXC bit to 1.

This bit is RW only if the implementation supports the trapping of floating-point exceptions. In an implementation that does not support floating-point exception trapping, this bit is RES0.

When this bit is RW, it applies only to floating-point operations. Advanced SIMD operations always use untrapped floating-point exception handling in AArch32 state.

UFE, bit [11]

Underflow exception trap enable. Possible values are:

- 0 Untrapped exception handling selected. If the floating-point exception occurs then the UFC bit is set to 1.
- 1 Trapped exception handling selected. If the floating-point exception occurs, the PE does not update the UFC bit. The trap handling software can decide whether to set the UFC bit to 1.

This bit is RW only if the implementation supports the trapping of floating-point exceptions. In an implementation that does not support floating-point exception trapping, this bit is RES0.

When this bit is RW, it applies only to floating-point operations. Advanced SIMD operations always use untrapped floating-point exception handling in AArch32 state.

OFE, bit [10]

Overflow exception trap enable. Possible values are:

- 0 Untrapped exception handling selected. If the floating-point exception occurs then the OFC bit is set to 1.

- 1 Trapped exception handling selected. If the floating-point exception occurs, the PE does not update the OFC bit. The trap handling software can decide whether to set the OFC bit to 1.

This bit is RW only if the implementation supports the trapping of floating-point exceptions. In an implementation that does not support floating-point exception trapping, this bit is RES0.

When this bit is RW, it applies only to floating-point operations. Advanced SIMD operations always use untrapped floating-point exception handling in AArch32 state.

DZE, bit [9]

Division by Zero exception trap enable. Possible values are:

- 0 Untrapped exception handling selected. If the floating-point exception occurs then the DZC bit is set to 1.
- 1 Trapped exception handling selected. If the floating-point exception occurs, the PE does not update the DZC bit. The trap handling software can decide whether to set the DZC bit to 1.

This bit is RW only if the implementation supports the trapping of floating-point exceptions. In an implementation that does not support floating-point exception trapping, this bit is RES0.

When this bit is RW, it applies only to floating-point operations. Advanced SIMD operations always use untrapped floating-point exception handling in AArch32 state.

IOE, bit [8]

Invalid Operation exception trap enable. Possible values are:

- 0 Untrapped exception handling selected. If the floating-point exception occurs then the IOC bit is set to 1.
- 1 Trapped exception handling selected. If the floating-point exception occurs, the PE does not update the IOC bit. The trap handling software can decide whether to set the IOC bit to 1.

This bit is RW only if the implementation supports the trapping of floating-point exceptions. In an implementation that does not support floating-point exception trapping, this bit is RES0.

When this bit is RW, it applies only to floating-point operations. Advanced SIMD operations always use untrapped floating-point exception handling in AArch32 state.

IDC, bit [7]

Input Denormal cumulative exception bit. This bit is set to 1 to indicate that the Input Denormal exception has occurred since 0 was last written to this bit.

How VFP instructions update this bit depends on the value of the IDE bit.

Advanced SIMD instructions set this bit if the Input Denormal exception occurs in one or more of the floating-point calculations performed by the instruction, regardless of the value of the IDE bit.

Bits [6:5]

Reserved, RES0.

IXC, bit [4]

Inexact cumulative exception bit. This bit is set to 1 to indicate that the Inexact exception has occurred since 0 was last written to this bit.

How VFP instructions update this bit depends on the value of the IXE bit.

Advanced SIMD instructions set this bit if the Inexact exception occurs in one or more of the floating-point calculations performed by the instruction, regardless of the value of the IXE bit.

UFC, bit [3]

Underflow cumulative exception bit. This bit is set to 1 to indicate that the Underflow exception has occurred since 0 was last written to this bit.

How VFP instructions update this bit depends on the value of the UFE bit.

Advanced SIMD instructions set this bit if the Underflow exception occurs in one or more of the floating-point calculations performed by the instruction, regardless of the value of the UFE bit.

OFC, bit [2]

Overflow cumulative exception bit. This bit is set to 1 to indicate that the Overflow exception has occurred since 0 was last written to this bit.

How VFP instructions update this bit depends on the value of the OFE bit.

Advanced SIMD instructions set this bit if the Overflow exception occurs in one or more of the floating-point calculations performed by the instruction, regardless of the value of the OFE bit.

DZC, bit [1]

Division by Zero cumulative exception bit. This bit is set to 1 to indicate that the Division by Zero exception has occurred since 0 was last written to this bit.

How VFP instructions update this bit depends on the value of the DZE bit.

Advanced SIMD instructions set this bit if the Division by Zero exception occurs in one or more of the floating-point calculations performed by the instruction, regardless of the value of the DZE bit.

IOC, bit [0]

Invalid Operation cumulative exception bit. This bit is set to 1 to indicate that the Invalid Operation exception has occurred since 0 was last written to this bit.

How VFP instructions update this bit depends on the value of the IOE bit.

Advanced SIMD instructions set this bit if the Invalid Operation exception occurs in one or more of the floating-point calculations performed by the instruction, regardless of the value of the IOE bit.

Accessing the FPSCR:

To access the FPSCR:

VMRS <Rt>, FPSCR ; Read FPSCR into Rt
VMSR FPSCR, <Rt> ; Write Rt to FPSCR

Register access is encoded as follows:

spec_reg

0001

G4.2.48 FPSID, Floating-Point System ID register

The FPSID characteristics are:

Purpose

Provides top-level information about the floating-point implementation.

This register is part of:

- the Floating-point registers functional group
- the Identification registers functional group.

Usage constraints

This register is accessible as shown below:

EL0 (NS)	EL0 (S)	EL1 (NS)	EL1 (S)	EL2	EL3 (SCR.NS=1)	EL3 (SCR.NS=0)
-	-	Config-RO	RO	Config-RO	Config-RO	RO

Access to this register depends on the values of [CPACR](#).{cp10,cp11}, [NSACR](#).{cp10,cp11}, and [HCPTR](#).{TCP10,TCP11}.

This register largely duplicates information held in the [MIDR](#). ARM deprecates use of it.

Configurations

There is one instance of this register that is used in both Secure and Non-secure states.

FPSID can be implemented in a system that provides only software emulation of the ARM floating-point instructions, and must be implemented if the implementation includes one or both of the Floating-point Extension or the Advanced SIMD Extension.

Attributes

FPSID is a 32-bit register.

The FPSID bit assignments are:

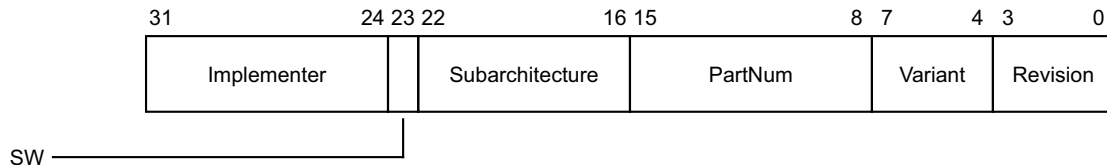

Implementer, bits [31:24]

Implementer codes are the same as those used for the [MIDR](#).

For an implementation by ARM this field is 0x41, the ASCII code for A.

SW, bit [23]

Software bit. This bit indicates whether a system provides only software emulation of the floating-point instructions that are provided by the Floating-point extension:

- 0 The system includes hardware support for the floating-point instructions provided by the Floating-point extension.
- 1 The system provides only software emulation of the floating-point instructions provided by the Floating-point extension.

Subarchitecture, bits [22:16]

Subarchitecture version number. For an implementation by ARM, permitted values are:

- 0000000 VFPv1 architecture with an IMPLEMENTATION DEFINED subarchitecture. Not permitted in an ARMv7 implementation.
- 0000001 VFPv2 architecture with Common VFP subarchitecture v1. Not permitted in an ARMv7 implementation.
- 0000010 VFPv3 architecture, or later, with Common VFP subarchitecture v2. The VFP architecture version is indicated by the [MVFR0](#) and [MVFR1](#) registers.
- 0000011 VFPv3 architecture, or later, with Null subarchitecture. The entire floating-point implementation is in hardware, and no software support code is required. The VFP architecture version is indicated by the [MVFR0](#) and [MVFR1](#) registers. This value can be used only by an implementation that does not support the trap enable bits in the [FPSCR](#).
- 0000100 VFPv3 architecture, or later, with Common VFP subarchitecture v3. The VFP architecture version is indicated by the [MVFR0](#) and [MVFR1](#) registers.

For a subarchitecture designed by ARM the most significant bit of this field, register bit[22], is 0. Values with a most significant bit of 0 that are not listed here are reserved.

When the subarchitecture designer is not ARM, the most significant bit of this field, register bit[22], must be 1. Each implementer must maintain its own list of subarchitectures it has designed, starting at subarchitecture version number 0x40.

PartNum, bits [15:8]

An IMPLEMENTATION DEFINED part number for the floating-point implementation, assigned by the implementer.

Variant, bits [7:4]

An IMPLEMENTATION DEFINED variant number. Typically, this field distinguishes between different production variants of a single product.

Revision, bits [3:0]

An IMPLEMENTATION DEFINED revision number for the floating-point implementation.

Accessing the FPSID:

To access the FPSID:

VMRS <Rt>, FPSID ; Read FPSID into Rt

Register access is encoded as follows:

spec_reg

0000

G4.2.49 HACR, Hyp Auxiliary Configuration Register

The HACR characteristics are:

Purpose

Controls trapping to Hyp mode of IMPLEMENTATION DEFINED or IMPLEMENTATION SPECIFIC aspects of Non-secure EL1 or EL0 operation.

This register is part of the Virtualization registers functional group.

Usage constraints

This register is accessible as shown below:

EL0 (NS)	EL0 (S)	EL1 (NS)	EL1 (S)	EL2	EL3 (SCR.NS=1)	EL3 (SCR.NS=0)
-	-	-	-	RW	RW	-

Configurations

HACR is architecturally mapped to AArch64 register [HACR_EL2](#).

If EL2 is not implemented, this register is RES0 from EL3.

Attributes

HACR is a 32-bit register.

The HACR bit assignments are:



Accessing the HACR:

To access the HACR:

MRC p15,4,<Rt>,c1,c1,7 ; Read HACR into Rt

MCR p15,4,<Rt>,c1,c1,7 ; Write Rt to HACR

Register access is encoded as follows:

coproc	opc1	CRn	CRm	opc2
1111	100	0001	0001	111

G4.2.50 HACTLR, Hyp Auxiliary Control Register

The HACTLR characteristics are:

Purpose

Controls IMPLEMENTATION DEFINED features of Hyp mode operation.

This register is part of:

- the Virtualization registers functional group
- the Other system control registers functional group
- the IMPLEMENTATION DEFINED functional group.

Usage constraints

This register is accessible as shown below:

EL0 (NS)	EL0 (S)	EL1 (NS)	EL1 (S)	EL2	EL3 (SCR.NS=1)	EL3 (SCR.NS=0)
-	-	-	-	RW	RW	-

Configurations

HACTLR is architecturally mapped to AArch64 register [ACTLR_EL2](#).

If EL2 is not implemented, this register is RES0 from EL3.

Attributes

HACTLR is a 32-bit register.

The HACTLR bit assignments are:



Accessing the HACTLR:

To access the HACTLR:

MRC p15,4,<Rt>,c1,c0,1 ; Read HACTLR into Rt
MCR p15,4,<Rt>,c1,c0,1 ; Write Rt to HACTLR

Register access is encoded as follows:

coproc	opc1	CRn	CRm	opc2
1111	100	0001	0000	001

G4.2.51 HADFSR, Hyp Auxiliary Data Fault Status Register

The HADFSR characteristics are:

Purpose

Provides additional IMPLEMENTATION DEFINED syndrome information for Data Abort exceptions taken to Hyp mode.

This register is part of:

- the Virtualization registers functional group
- the Exception and fault handling registers functional group
- the IMPLEMENTATION DEFINED functional group.

Usage constraints

This register is accessible as shown below:

EL0 (NS)	EL0 (S)	EL1 (NS)	EL1 (S)	EL2	EL3 (SCR.NS=1)	EL3 (SCR.NS=0)
-	-	-	-	RW	RW	-

Configurations

HADFSR is architecturally mapped to AArch64 register [AFSR0_EL2](#).

This is an optional register. An implementation that does not require this register can implement it as RES0.

If EL2 is not implemented, this register is RES0 from EL3.

Attributes

HADFSR is a 32-bit register.

The HADFSR bit assignments are:



Accessing the HADFSR:

To access the HADFSR:

```
MRC p15,4,<Rt>,c5,c1,0 ; Read HADFSR into Rt
MCR p15,4,<Rt>,c5,c1,0 ; Write Rt to HADFSR
```

Register access is encoded as follows:

coproc	opc1	CRn	CRm	opc2
1111	100	0101	0001	000

G4.2.52 HAIFSR, Hyp Auxiliary Instruction Fault Status Register

The HAIFSR characteristics are:

Purpose

Provides additional IMPLEMENTATION DEFINED syndrome information for Prefetch Abort exceptions taken to Hyp mode.

This register is part of:

- the Virtualization registers functional group
- the Exception and fault handling registers functional group
- the IMPLEMENTATION DEFINED functional group.

Usage constraints

This register is accessible as shown below:

EL0 (NS)	EL0 (S)	EL1 (NS)	EL1 (S)	EL2	EL3 (SCR.NS=1)	EL3 (SCR.NS=0)
-	-	-	-	RW	RW	-

Configurations

HAIFSR is architecturally mapped to AArch64 register [AFSR1_EL2](#).

This is an optional register. An implementation that does not require this register can implement it as RES0.

If EL2 is not implemented, this register is RES0 from EL3.

Attributes

HAIFSR is a 32-bit register.

The HAIFSR bit assignments are:



Accessing the HAIFSR:

To access the HAIFSR:

MRC p15,4,<Rt>,c5,c1,1 ; Read HAIFSR into Rt
MCR p15,4,<Rt>,c5,c1,1 ; Write Rt to HAIFSR

Register access is encoded as follows:

coproc	opc1	CRn	CRm	opc2
1111	100	0101	0001	001

G4.2.53 HMAIRO, Hyp Auxiliary Memory Attribute Indirection Register 0

The HMAIRO characteristics are:

Purpose

Provides IMPLEMENTATION DEFINED memory attributes for the memory attribute encodings defined by HMAIRO. These IMPLEMENTATION DEFINED attributes can only provide additional qualifiers for the memory attribute encodings, and cannot change the memory attributes defined in HMAIRO.

This register is part of:

- the Virtualization registers functional group
- the Virtual memory control registers functional group
- the IMPLEMENTATION DEFINED functional group.

Usage constraints

This register is accessible as shown below:

EL0 (NS)	EL0 (S)	EL1 (NS)	EL1 (S)	EL2	EL3 (SCR.NS=1)	EL3 (SCR.NS=0)
-	-	-	-	RW	RW	-

If an implementation does not provide any IMPLEMENTATION DEFINED memory attributes, this register is RES0.

Configurations

HMAIRO is architecturally mapped to AArch64 register AMAIR_EL2[31:0].

If EL2 is not implemented, this register is RES0 from EL3.

Attributes

HMAIRO is a 32-bit register.

The HMAIRO bit assignments are:



Accessing the HMAIRO:

To access the HMAIRO:

```
MRC p15,4,<Rt>,c10,c3,0 ; Read HMAIRO into Rt
MCR p15,4,<Rt>,c10,c3,0 ; Write Rt to HMAIRO
```

Register access is encoded as follows:

coproc	opc1	CRn	CRm	opc2
1111	100	1010	0011	000

G4.2.54 HMAIR1, Hyp Auxiliary Memory Attribute Indirection Register 1

The HMAIR1 characteristics are:

Purpose

Provides IMPLEMENTATION DEFINED memory attributes for the memory attribute encodings defined by [HMAIR1](#). These IMPLEMENTATION DEFINED attributes can only provide additional qualifiers for the memory attribute encodings, and cannot change the memory attributes defined in [HMAIR1](#).

This register is part of:

- the Virtualization registers functional group
- the Virtual memory control registers functional group
- the IMPLEMENTATION DEFINED functional group.

Usage constraints

This register is accessible as shown below:

EL0 (NS)	EL0 (S)	EL1 (NS)	EL1 (S)	EL2	EL3 (SCR.NS=1)	EL3 (SCR.NS=0)
-	-	-	-	RW	RW	-

If an implementation does not provide any IMPLEMENTATION DEFINED memory attributes, this register is RES0.

Configurations

HMAIR1 is architecturally mapped to AArch64 register [AMAIR_EL2](#)[63:32].

If EL2 is not implemented, this register is RES0 from EL3.

Attributes

HMAIR1 is a 32-bit register.

The HMAIR1 bit assignments are:

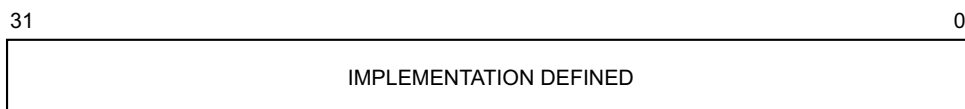

Accessing the HMAIR1:

To access the HMAIR1:

MRC p15,4,<Rt>,c10,c3,1 ; Read HMAIR1 into Rt

MCR p15,4,<Rt>,c10,c3,1 ; Write Rt to HMAIR1

Register access is encoded as follows:

coproc	opc1	CRn	CRm	opc2
1111	100	1010	0011	001

G4.2.55 HCPTR, Hyp Architectural Feature Trap Register

The HCPTR characteristics are:

Purpose

Controls trapping to Hyp mode of Non-secure access, at EL1 or lower, to Trace, Floating Point, and Advanced SIMD functionality. Also controls access from Hyp mode to this functionality.

This register is part of the Virtualization registers functional group.

Usage constraints

This register is accessible as shown below:

EL0 (NS)	EL0 (S)	EL1 (NS)	EL1 (S)	EL2	EL3 (SCR.NS=1)	EL3 (SCR.NS=0)
-	-	-	-	RW	RW	-

If a bit in the [NSACR](#) prohibits a Non-secure access, then the corresponding bit in the HCPTR behaves as RAO/WI for Non-secure accesses. See the bit descriptions for more information.

Configurations

HCPTR is architecturally mapped to AArch64 register [CPTR_EL2](#).

If EL2 is not implemented, this register is RES0 from EL3.

Attributes

HCPTR is a 32-bit register.

The HCPTR bit assignments are:

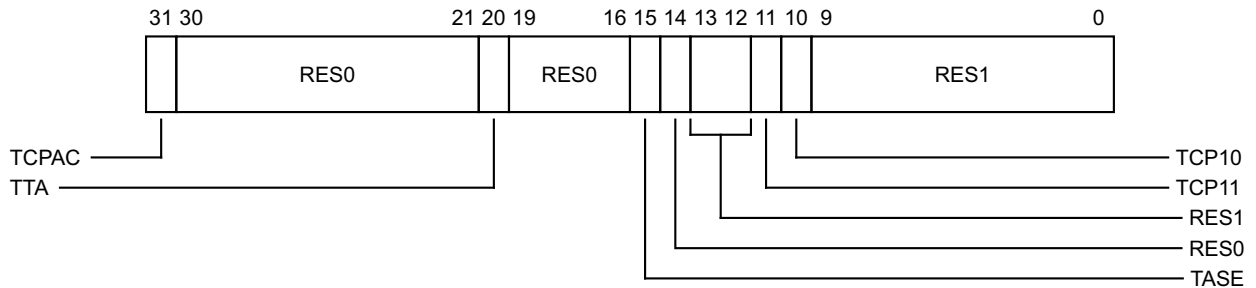

TCPAC, bit [31]

Trap [CPACR](#) accesses. The possible values of this bit are:

- 0 Has no effect on [CPACR](#) accesses.
- 1 Trap valid Non-secure EL1 [CPACR](#) accesses to Hyp mode.

Resets to 0.

Bits [30:21]

Reserved, RES0.

TTA, bit [20]

Trap Trace Access. The possible values of this bit are:

- 0 Has no effect on accesses to CP14 Trace registers.
- 1 Trap valid Non-secure EL0 and EL1 accesses to CP14 Trace registers to Hyp mode. Valid Hyp mode accesses to CP14 Trace registers generate an Undefined Instruction exception, taken in Hyp mode.

In an implementation that does not include Trace functionality, or does not include a CP14 interface to the Trace registers, it is IMPLEMENTATION DEFINED whether this bit:

- Is RAO/WI.
- Is RAZ/WI.
- Can be written from Hyp mode, and from Secure Monitor mode when `SCR.NS` is set to 1.

Resets to 0.

Bits [19:16]

Reserved, RES0.

TASE, bit [15]

Trap Advanced SIMD Extension use. The possible values of this bit are:

- | | |
|---|--|
| 0 | If the <code>NSACR</code> settings permit Non-secure use of the Advanced SIMD functionality then Hyp mode can access that functionality, regardless of any settings in the CPACR. This bit value has no effect on the possible use of the Advanced SIMD functionality from Non-secure EL1 and EL0 modes. |
| 1 | Trap valid Non-secure accesses to Advanced SIMD functionality to Hyp mode. Valid Hyp mode accesses to Advanced SIMD functionality generate an Undefined Instruction exception, taken in Hyp mode. |

Resets to 0.

Bit [14]

Reserved, RES0.

Bits [13:12]

Reserved, RES1.

TCP<n>, bit [n], for n = 10 to 11

Trap coprocessor n (CP<n>). The possible values of each of these bits are:

- | | |
|---|---|
| 0 | If <code>NSACR.cp<n></code> is set to 1, then Hyp mode can access CP<n>, regardless of the value of <code>CPACR.cp<n></code> . This bit value has no effect on possible use of CP<n> from Non-secure EL1 and EL0 modes. |
| 1 | Trap valid Non-secure accesses to CP<n> to Hyp mode. |

When TCP<n> is set to 1, any otherwise-valid access to CP<n> from:

- A Non-secure EL1 or EL0 mode is trapped to Hyp mode.
- Hyp mode generates an Undefined Instruction exception, taken in Hyp mode.

In an implementation that includes the Floating Point extension, the extension is controlled by coprocessors 10 and 11. If bits 11 and 10 are set to different values, the behavior is the same as if both bits were set to the value of bit 10, in all respects other than the value read back by explicitly reading bit 11.

Other coprocessors are not supported in ARMv8, so bits[13:12] and bits[9:0] are RES1.

Resets to 0.

Bits [9:0]

Reserved, RES1.

Accessing the HCPTR:

To access the HCPTR:

```
MRC p15,4,<Rt>,c1,c1,2 ; Read HCPTR into Rt
MCR p15,4,<Rt>,c1,c1,2 ; Write Rt to HCPTR
```

Register access is encoded as follows:

coproc	opc1	CRn	CRm	opc2
1111	100	0001	0001	010

G4.2.56 HCR, Hyp Configuration Register

The HCR characteristics are:

Purpose

Provides configuration controls for virtualization, including defining whether various Non-secure operations are trapped to Hyp mode.

This register is part of the Virtualization registers functional group.

Usage constraints

This register is accessible as shown below:

EL0 (NS)	EL0 (S)	EL1 (NS)	EL1 (S)	EL2	EL3 (SCR.NS=1)	EL3 (SCR.NS=0)
-	-	-	-	RW	RW	-

Configurations

HCR is architecturally mapped to AArch64 register [HCR_EL2](#)[31:0].

If EL2 is not implemented, this register is RES0 from EL3.

Attributes

HCR is a 32-bit register.

The HCR bit assignments are:

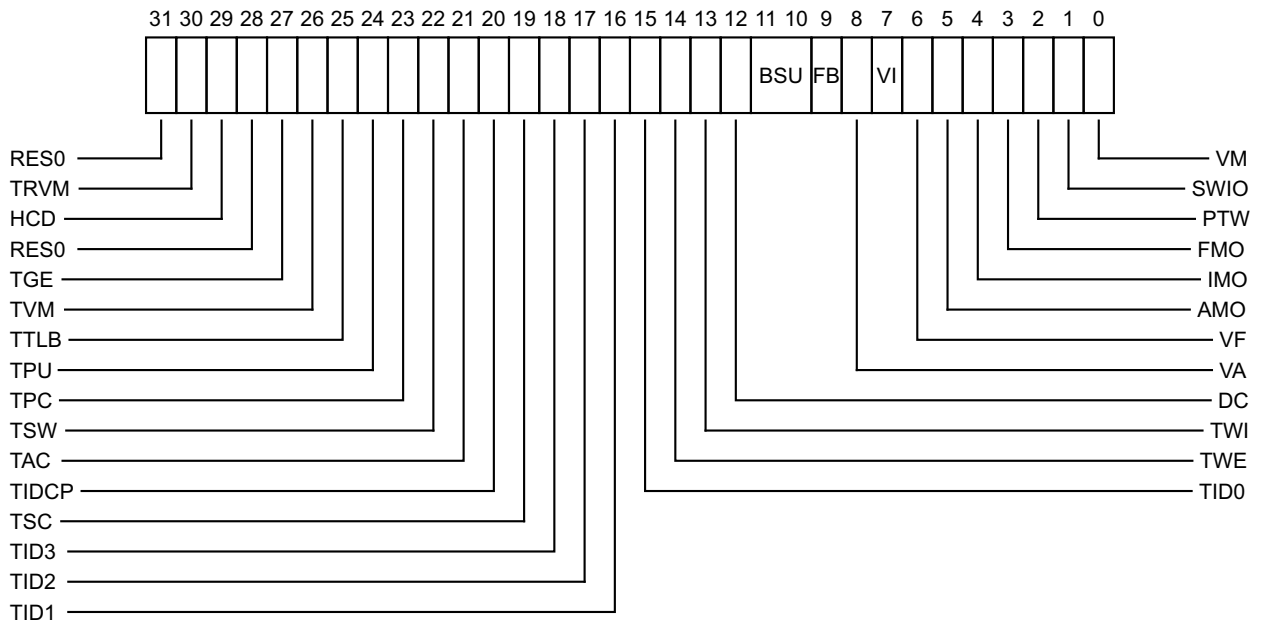

Bit [31]

Reserved, RES0.

TRVM, bit [30]

Trap Read of Virtual Memory controls. When this bit is set to 1, this causes Reads to the EL1 virtual memory control registers from EL1 to be trapped to EL2. This covers the following registers:

[SCTLR](#), [TTBR0](#), [TTBR1](#), [TTBCR](#), [DACR](#), [DFSR](#), [IFSR](#), [DFAR](#), [IFAR](#), [ADFSR](#), [AIFSR](#), [PRRR/MAIR0](#), [NMRR/MAIR1](#), [AMAIR0](#), [AMAIR1](#), [CONTEXTIDR](#).

Resets to 0.

HCD, bit [29]

Hypervisor Call Disable, if EL3 is not implemented:

- 0 HVC instruction is enabled at EL1 or EL2.
- 1 HVC instruction is UNDEFINED at all exception levels.

If EL3 is implemented, this bit is RES0.

Resets to 0.

Bit [28]

Reserved, RES0.

TGE, bit [27]

Trap General Exceptions. If this bit is set to 1, and [SCR.NS](#) is set to 1, then:

- All exceptions that would be routed to EL1 are routed to EL2.
- The [SCTLR.M](#) bit is treated as being 0 regardless of its actual state other than for the purpose of reading the bit.
- The [HCR.FMO](#), [IMO](#), and [AMO](#) bits are treated as being 1 regardless of their actual state other than for the purpose of reading the bits.
- All virtual interrupts are disabled.
- Any implementation defined mechanisms for signalling virtual interrupts are disabled.
- An exception return to EL1 is treated as an illegal exception return.

Additionally, if [HCR.TGE](#) == 1, the [HDCR](#).{[TDRA](#),[TDOSA](#),[TDA](#)} bits are ignored and the processor behaves as if they are set to 1, other than for the value read back from [HDCR](#).

Resets to 0.

TVM, bit [26]

Trap Virtual Memory controls. When this bit is set to 1, this causes Writes to the EL1 virtual memory control registers from EL1 to be trapped to EL2. This covers the following registers:

[SCTLR](#), [TTBR0](#), [TTBR1](#), [TTBCR](#), [DACR](#), [DFSR](#), [IFSR](#), [DFAR](#), [IFAR](#), [ADFSR](#), [AIFSR](#), [PRRR/MAIR0](#), [NMRR/MAIR1](#), [AMAIRO](#), [AMAIR1](#), [CONTEXTIDR](#).

Resets to 0.

TTLB, bit [25]

Trap TLB maintenance instructions. When this bit is set to 1, this causes TLB maintenance instructions executed from EL1 which are not UNDEFINED to be trapped to EL2. This covers the following instructions:

[TLBIALLIS](#), [TLBIMVAIS](#), [TLBIASIDIS](#), [TLBIMVAAIS](#), [TLBIALL](#), [TLBIMVA](#), [TLBIASID](#), [DTLBIALL](#), [DTLBIMVA](#), [DTLBIASID](#), [ITLBIALL](#), [ITLBIMVA](#), [ITLBIASID](#), [TLBIMVAA](#), [TLBIMVALIS](#), [TLBIMVAALIS](#), [TLBIMVAL](#), [TLBIMVAAL](#).

Resets to 0.

TPU, bit [24]

Trap Cache maintenance instructions to Point of Unification. When this bit is set to 1, this causes Cache maintenance instructions to the point of unification executed from EL1 or EL0 which are not UNDEFINED to be trapped to EL2. This covers the following instructions:

[ICIMVAU](#), [ICIALLU](#), [ICIALLUIS](#), [DCCMVAU](#).

Resets to 0.

TPC, bit [23]

Trap Data/Unified Cache maintenance operations to Point of Coherency. When this bit is set to 1, this causes Data or Unified Cache maintenance instructions by address to the point of coherency executed from EL1 or EL0 which are not UNDEFINED to be trapped to EL2. This covers the following instructions:

[DCIMVAC](#), [DCCIMVAC](#), [DCCMVAC](#).

Resets to 0.

TSW, bit [22]

Trap Data/Unified Cache maintenance operations by Set/Way. When this bit is set to 1, this causes Data or Unified Cache maintenance instructions by set/way executed from EL1 which are not UNDEFINED to be trapped to EL2. This covers the following instructions:

[DCISW](#), [DCCSW](#), [DCCISW](#).

Resets to 0.

TAC, bit [21]

Trap [ACTLR](#) accesses. When this bit is set to 1, any valid Non-secure access to the [ACTLR](#) is trapped to Hyp mode.

Resets to 0.

TIDCP, bit [20]

Trap Implementation Dependent functionality. When this bit is set to 1, this causes accesses to the following instruction set space executed from EL1 to be trapped to EL2.

AArch32: MCR and MRC instructions as follows:

- All CP15, CRn==9, Opcode1 = {0-7}, CRm == {c0-c2, c5-c8}, opcode2 == {0-7}.
- All CP15, CRn==10, Opcode1 =={0-7}, CRm == {c0, c1, c4, c8}, opcode2 == {0-7}.
- All CP15, CRn==11, Opcode1=={0-7}, CRm == {c0-c8, c15}, opcode2 == {0-7}.

It is IMPLEMENTATION DEFINED whether any of this functionality accessed from EL0 is trapped to EL2 when the HCR.TIDCP bit is set. If it is not trapped to EL2, it results in an Undefined exception taken to EL1.

Resets to 0.

TSC, bit [19]

Trap SMC instruction. When this bit is set to 1, any attempt from a Non-secure EL1 mode to execute an SMC instruction, that passes its condition check if it is conditional, is trapped to Hyp mode.

Resets to 0.

TID3, bit [18]

Trap ID Group 3. When this bit is set to 1, this causes reads to the following registers executed from EL1 to be trapped to EL2:

[ID_PFR0](#), [ID_PFR1](#), [ID_DFR0](#), [ID_AFR0](#), [ID_MMFR0](#), [ID_MMFR1](#), [ID_MMFR2](#), [ID_MMFR3](#), [ID_ISAR0](#), [ID_ISAR1](#), [ID_ISAR2](#), [ID_ISAR3](#), [ID_ISAR4](#), [ID_ISAR5](#), [MVFR0](#), [MVFR1](#), [MVFR2](#). Also MRC to any of the following encodings:

- CP15, CRn == 0, Opc1 == 0, CRm == {3-7}, Opc2 == {0,1}.
- CP15, CRn == 0, Opc1 == 0, CRm == 3, Opc2 == 2.
- CP15, CRn == 0, Opc1 == 0, CRm == 5, Opc2 == {4,5}.

Resets to 0.

TID2, bit [17]

Trap ID Group 2. When this bit is set to 1, this causes reads (or writes to [CSSELR/CSSELR_EL1](#)) to the following registers executed from EL1 or EL0 if not UNDEFINED to be trapped to EL2:

[CTR](#), [CCSIDR](#), [CLIDR](#), [CSSELR](#).

Resets to 0.

TID1, bit [16]

Trap ID Group 1. When this bit is set to 1, this causes reads to the following registers executed from EL1 to be trapped to EL2:

[TCMTR](#), [TLBTR](#), [AIDR](#), [REVIDR](#).

Resets to 0.

TID0, bit [15]

Trap ID Group 0. When this bit is set to 1, this causes reads to the following registers executed from EL1 or EL0 if not UNDEFINED to be trapped to EL2:

[FPSID](#), [JIDR](#).

Resets to 0.

TWE, bit [14]

Trap WFE. When this bit is set to 1, this causes execution of the WFE instruction from EL1 or EL0 to be trapped to EL2 if the instruction would otherwise cause suspension of execution (i.e. if the event register is not set).

Conditional WFE instructions that fail their condition are not trapped if this bit is set to 1.

Resets to 0.

TWI, bit [13]

Trap WFI. When this bit is set to 1, this causes execution of the WFI instruction from EL1 or EL0 to be trapped to EL2 if the instruction would otherwise cause suspension of execution (i.e. if there is not a pending WFI wakeup event).

Conditional WFI instructions that fail their condition are not trapped if this bit is set to 1.

Resets to 0.

DC, bit [12]

Default cacheable. When this bit is set to 1, and the Non-secure EL1 and EL0 stage 1 MMU is disabled, the memory type and attributes determined by the stage 1 translation is Normal, Non-shareable, Inner Write-Back Write-Allocate, Outer Write-Back Write-Allocate.

When this bit is 0 and the stage 1 MMU is disabled, the default memory attribute for Data accesses is Device-nGnRnE.

This bit is permitted to be cached in a TLB.

Resets to 0.

BSU, bits [11:10]

Barrier Shareability upgrade. The value in this field determines the minimum shareability domain that is applied to any barrier executed from EL1 or EL0:

00	No effect
01	Inner Shareable
10	Outer Shareable
11	Full system

This value is combined with the specified level of the barrier held in its instruction, using the same principles as combining the shareability attributes from two stages of address translation.

Resets to 0.

FB, bit [9]

Force broadcast. When this bit is set to 1, this causes the following instructions to be broadcast within the Inner Shareable domain when executed from Non-secure EL1:

[BPIALL](#), [TLBIALL](#), [TLBIMVA](#), [TLBIASID](#), [DTLBIALL](#), [DTLBIMVA](#), [DTLBIASID](#),
[ITLBIALL](#), [ITLBIMVA](#), [ITLBIASID](#), [TLBIMVAA](#), [ICIALLU](#), [TLBIMVAL](#), [TLBIMVAAL](#).

Resets to 0.

VA, bit [8]

Virtual Asynchronous Abort exception. When the AMO bit is set to 1, setting this bit to 1 generates a virtual Asynchronous Abort exception to the Guest OS, when the processor is executing in Non-secure state at EL0 or EL1.

The Guest OS cannot distinguish the virtual exception from the corresponding physical exception.

Resets to 0.

VI, bit [7]

Virtual IRQ exception. When the IMO bit is set to 1, setting this bit to 1 generates a virtual IRQ exception to the Guest OS, when the processor is executing in Non-secure state at EL0 or EL1.

The Guest OS cannot distinguish the virtual exception from the corresponding physical exception.

Resets to 0.

VF, bit [6]

Virtual FIQ exception. When the FMO bit is set to 1, setting this bit to 1 generates a virtual FIQ exception to the Guest OS, when the processor is executing in Non-secure state at EL0 or EL1.

The Guest OS cannot distinguish the virtual exception from the corresponding physical exception.

Resets to 0.

AMO, bit [5]

Asynchronous Abort Mask Override. When this bit is set to 1, it overrides the effect of CPSR.A, and enables virtual exception signalling by the VA bit.

Resets to 0.

IMO, bit [4]

IRQ Mask Override. When this bit is set to 1, it overrides the effect of CPSR.I, and enables virtual exception signalling by the VI bit.

Resets to 0.

FMO, bit [3]

FIQ Mask Override. When this bit is set to 1, it overrides the effect of CPSR.F, and enables virtual exception signalling by the VF bit.

Resets to 0.

PTW, bit [2]

Protected Table Walk. When this bit is set to 1, if the stage 2 translation of a translation table access made as part of a stage 1 translation table walk at EL0 or EL1 maps that translation table access to Strongly-ordered or Device memory, the access is faulted as a stage 2 Permission fault.

This bit is permitted to be cached in a TLB.

Resets to 0.

SWIO, bit [1]

Set/Way Invalidation Override. When this bit is set to 1, this causes EL1 execution of the data cache invalidate by set/way instruction to be treated as data cache clean and invalidate by set/way. That is, [DCISW](#) is executed as [DCCISW](#).

As a result of changes to the behavior of [DCISW](#), this bit is redundant in v8-A. It is permissible that an implementation makes this bit RES1.

Resets to 0.

VM, bit [0]

Virtualization MMU enable for EL1 and EL0 stage 2 address translation. Possible values of this bit are:

- 0 EL1 and EL0 stage 2 address translation disabled.
- 1 EL1 and EL0 stage 2 address translation enabled.

This bit is permitted to be cached in a TLB.

If the HCR.DC bit is set to 1, then the behavior of the processor when executing in a Non-secure mode other than Hyp mode is consistent with HCR.VM being 1, regardless of the actual value of HCR.VM, other than the value returned by an explicit read of HCR.VM.

Resets to 0.

Accessing the HCR:

To access the HCR:

MRC p15,4,<Rt>,c1,c1,0 ; Read HCR into Rt
MCR p15,4,<Rt>,c1,c1,0 ; Write Rt to HCR

Register access is encoded as follows:

coproc	opc1	CRn	CRm	opc2
1111	100	0001	0001	000

G4.2.57 HCR2, Hyp Configuration Register 2

The HCR2 characteristics are:

Purpose

Provides additional configuration controls for virtualization.

This register is part of the Virtualization registers functional group.

Usage constraints

This register is accessible as shown below:

EL0 (NS)	EL0 (S)	EL1 (NS)	EL1 (S)	EL2	EL3 (SCR.NS=1)	EL3 (SCR.NS=0)
-	-	-	-	RW	RW	-

Configurations

HCR2 is architecturally mapped to AArch64 register [HCR_EL2](#)[63:32].

If EL2 is not implemented, this register is RES0 from EL3.

Attributes

HCR2 is a 32-bit register.

The HCR2 bit assignments are:

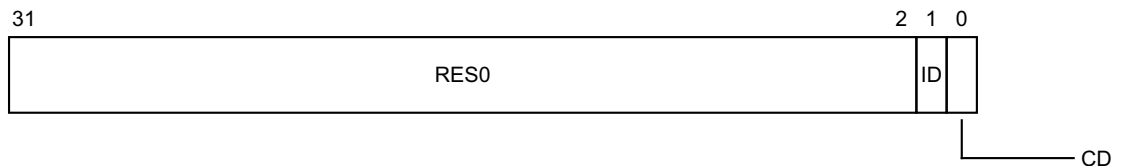

Bits [31:2]

Reserved, RES0.

ID, bit [1]

Stage 2 Instruction cache disable. When HCR.VM==1, this forces all stage 2 translations for instruction accesses to Normal memory to be Non-cacheable for the EL1&0 translation regime.

0 No effect on the stage 2 of the EL1&0 translation regime for instruction accesses.

1 Forces all stage 2 translations for instruction accesses to Normal memory to be Non-cacheable for the EL1&0 translation regime.

This bit has no effect on the EL2 or EL3 translation regimes.

CD, bit [0]

Stage 2 Data cache disable. When HCR.VM==1, this forces all stage 2 translations for data accesses and translation table walks to Normal memory to be Non-cacheable for the EL1&0 translation regime.

0 No effect on the stage 2 of the EL1&0 translation regime for data accesses and translation table walks.

1 Forces all stage 2 translations for data accesses and translation table walks to Normal memory to be Non-cacheable for the EL1&0 translation regime.

This bit has no effect on the EL2 or EL3 translation regimes.

Accessing the HCR2:

To access the HCR2:

MRC p15,4,<Rt>,c1,c1,4 ; Read HCR2 into Rt
MCR p15,4,<Rt>,c1,c1,4 ; Write Rt to HCR2

Register access is encoded as follows:

coproc	opc1	CRn	CRm	opc2
1111	100	0001	0001	100

G4.2.58 HDFAR, Hyp Data Fault Address Register

The HDFAR characteristics are:

Purpose

Holds the virtual address of the faulting address that caused a synchronous Data Abort exception that is taken to Hyp mode.

This register is part of:

- the Virtualization registers functional group
- the Exception and fault handling registers functional group.

Usage constraints

This register is accessible as shown below:

EL0 (NS)	EL0 (S)	EL1 (NS)	EL1 (S)	EL2	EL3 (SCR.NS=1)	EL3 (SCR.NS=0)
-	-	-	-	RW	RW	-

Any execution in a Non-secure PL1 mode, or in Secure state, makes the HDFAR UNKNOWN.

Configurations

HDFAR is architecturally mapped to AArch64 register [FAR_EL2](#)[31:0].

HDFAR is architecturally mapped to AArch32 register [DFAR](#) (S) when EL2 is implemented.

If EL2 is not implemented, this register is RES0 from EL3.

Attributes

HDFAR is a 32-bit register.

The HDFAR bit assignments are:

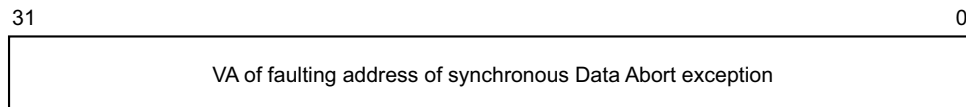

Bits [31:0]

VA of faulting address of synchronous Data Abort exception.

Accessing the HDFAR:

To access the HDFAR:

MRC p15,4,<Rt>,c6,c0,0 ; Read HDFAR into Rt

MCR p15,4,<Rt>,c6,c0,0 ; Write Rt to HDFAR

Register access is encoded as follows:

coproc	opc1	CRn	CRm	opc2
1111	100	0110	0000	000

G4.2.59 HIFAR, Hyp Instruction Fault Address Register

The HIFAR characteristics are:

Purpose

Holds the virtual address of the faulting address that caused a synchronous Prefetch Abort exception that is taken to Hyp mode.

This register is part of:

- the Virtualization registers functional group
- the Exception and fault handling registers functional group.

Usage constraints

This register is accessible as shown below:

EL0 (NS)	EL0 (S)	EL1 (NS)	EL1 (S)	EL2	EL3 (SCR.NS=1)	EL3 (SCR.NS=0)
-	-	-	-	RW	RW	-

Any execution in a Non-secure PL1 mode, or in Secure state, makes the HIFAR UNKNOWN.

Configurations

HIFAR is architecturally mapped to AArch64 register [FAR_EL2](#)[63:32].

HIFAR is architecturally mapped to AArch32 register [IFAR](#) (S) when EL2 is implemented.

If EL2 is not implemented, this register is RES0 from EL3.

Attributes

HIFAR is a 32-bit register.

The HIFAR bit assignments are:

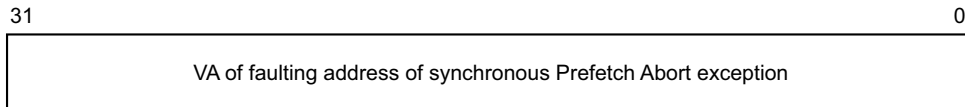

Bits [31:0]

VA of faulting address of synchronous Prefetch Abort exception.

Accessing the HIFAR:

To access the HIFAR:

MRC p15,4,<Rt>,c6,c0,2 ; Read HIFAR into Rt

MCR p15,4,<Rt>,c6,c0,2 ; Write Rt to HIFAR

Register access is encoded as follows:

coproc	opc1	CRn	CRm	opc2
1111	100	0110	0000	010

G4.2.60 HMAIR0, Hyp Memory Attribute Indirection Register 0

The HMAIR0 characteristics are:

Purpose

Along with [HMAIR1](#), provides the memory attribute encodings corresponding to the possible AttrIdx values in a Long-descriptor format translation table entry for stage 1 translations for memory accesses from Hyp mode.

This register is part of:

- the Virtualization registers functional group
- the Virtual memory control registers functional group.

Usage constraints

This register is accessible as shown below:

EL0 (NS)	EL0 (S)	EL1 (NS)	EL1 (S)	EL2	EL3 (SCR.NS=1)	EL3 (SCR.NS=0)
-	-	-	-	RW	RW	-

AttrIdx[2], from the translation table descriptor, selects the appropriate HMAIR: setting AttrIdx[2] to 0 selects HMAIR0.

Configurations

HMAIR0 is architecturally mapped to AArch64 register [MAIR_EL2](#)[31:0].

If EL2 is not implemented, this register is RES0 from EL3.

Attributes

HMAIR0 is a 32-bit register.

The HMAIR0 bit assignments are:

When TTBCR.EAE==1:

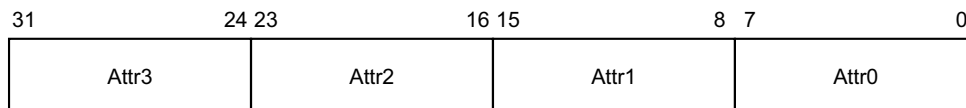

Attr<n>, bits [8n+7:8n], for n = 0 to 3

The memory attribute encoding for an AttrIdx[2:0] entry in a Long descriptor format translation table entry, where:

- AttrIdx[2:0] gives the value of <n> in Attr<n>.
- AttrIdx[2] defines which MAIR to access. Attr7 to Attr4 are in MAIR1, and Attr3 to Attr0 are in MAIR0.

Bits [7:4] are encoded as follows:

Attr<n>[7:4]	Meaning
0000	Device memory. See encoding of Attr<n>[3:0] for the type of Device memory.
00RW, RW not 00	Normal Memory, Outer Write-through transient
0100	Normal Memory, Outer Non-Cacheable

Attr<n>[7:4]	Meaning
01RW, RW not 00	Normal Memory, Outer Write-back transient
10RW	Normal Memory, Outer Write-through non-transient
11RW	Normal Memory, Outer Write-back non-transient

R = Outer Read Allocate Policy, W = Outer Write Allocate Policy.
The meaning of bits [3:0] depends on the value of bits [7:4]:

Attr<n>[3:0]	Meaning when Attr<n>[7:4] is 0000	Meaning when Attr<n>[7:4] is not 0000
0000	Device-nGnRnE memory	UNPREDICTABLE
00RW, RW not 00	UNPREDICTABLE	Normal Memory, Inner Write-through transient
0100	Device-nGnRE memory	Normal memory, Inner Non-Cacheable
01RW, RW not 00	UNPREDICTABLE	Normal Memory, Inner Write-back transient
1000	Device-nGRE memory	Normal Memory, Inner Write-through non-transient (RW=00)
10RW, RW not 00	UNPREDICTABLE	Normal Memory, Inner Write-through non-transient
1100	Device-GRE memory	Normal Memory, Inner Write-back non-transient (RW=00)
11RW, RW not 00	UNPREDICTABLE	Normal Memory, Inner Write-back non-transient

R = Inner Read Allocate Policy, W = Inner Write Allocate Policy.

ARMv7's Strongly-ordered and Device memory types have been renamed to Device-nGnRnE and Device-nGnRE in ARMv8.

The R and W bits in some Attr<n> fields have the following meanings:

R or W	Meaning
0	Do not allocate
1	Allocate

Accessing the HMAIRO:

To access the HMAIRO:

MRC p15,4,<Rt>,c10,c2,0 ; Read HMAIRO into Rt
MCR p15,4,<Rt>,c10,c2,0 ; Write Rt to HMAIRO

Register access is encoded as follows:

coproc	opc1	CRn	CRm	opc2
1111	100	1010	0010	000

G4.2.61 HMAIR1, Hyp Memory Attribute Indirection Register 1

The HMAIR1 characteristics are:

Purpose

Along with [HMAIR0](#), provides the memory attribute encodings corresponding to the possible AttrIdx values in a Long-descriptor format translation table entry for stage 1 translations for memory accesses from Hyp mode.

This register is part of:

- the Virtualization registers functional group
- the Virtual memory control registers functional group.

Usage constraints

This register is accessible as shown below:

EL0 (NS)	EL0 (S)	EL1 (NS)	EL1 (S)	EL2	EL3 (SCR.NS=1)	EL3 (SCR.NS=0)
-	-	-	-	RW	RW	-

AttrIdx[2], from the translation table descriptor, selects the appropriate HMAIR: setting AttrIdx[2] to 1 selects HMAIR1.

Configurations

HMAIR1 is architecturally mapped to AArch64 register [MAIR_EL2](#)[63:32].

If EL2 is not implemented, this register is RES0 from EL3.

Attributes

HMAIR1 is a 32-bit register.

The HMAIR1 bit assignments are:

When TTBCR.EAE==1:

31	24 23	16 15	8 7	0
Attr7	Attr6	Attr5	Attr4	

Attr<n>, bits [8(n-4)+7:8(n-4)], for n = 4 to 7

The memory attribute encoding for an AttrIdx[2:0] entry in a Long descriptor format translation table entry, where:

- AttrIdx[2:0] gives the value of <n> in Attr<n>.
- AttrIdx[2] defines which MAIR to access. Attr7 to Attr4 are in MAIR1, and Attr3 to Attr0 are in MAIR0.

Bits [7:4] are encoded as follows:

Attr<n>[7:4]	Meaning
0000	Device memory. See encoding of Attr<n>[3:0] for the type of Device memory.
00RW, RW not 00	Normal Memory, Outer Write-through transient
0100	Normal Memory, Outer Non-Cacheable

Attr<n>[7:4]	Meaning
01RW, RW not 00	Normal Memory, Outer Write-back transient
10RW	Normal Memory, Outer Write-through non-transient
11RW	Normal Memory, Outer Write-back non-transient

R = Outer Read Allocate Policy, W = Outer Write Allocate Policy.
The meaning of bits [3:0] depends on the value of bits [7:4]:

Attr<n>[3:0]	Meaning when Attr<n>[7:4] is 0000	Meaning when Attr<n>[7:4] is not 0000
0000	Device-nGnRnE memory	UNPREDICTABLE
00RW, RW not 00	UNPREDICTABLE	Normal Memory, Inner Write-through transient
0100	Device-nGnRE memory	Normal memory, Inner Non-Cacheable
01RW, RW not 00	UNPREDICTABLE	Normal Memory, Inner Write-back transient
1000	Device-nGRE memory	Normal Memory, Inner Write-through non-transient (RW=00)
10RW, RW not 00	UNPREDICTABLE	Normal Memory, Inner Write-through non-transient
1100	Device-GRE memory	Normal Memory, Inner Write-back non-transient (RW=00)
11RW, RW not 00	UNPREDICTABLE	Normal Memory, Inner Write-back non-transient

R = Inner Read Allocate Policy, W = Inner Write Allocate Policy.

ARMv7's Strongly-ordered and Device memory types have been renamed to Device-nGnRnE and Device-nGnRE in ARMv8.

The R and W bits in some Attr<n> fields have the following meanings:

R or W	Meaning
0	Do not allocate
1	Allocate

Accessing the HMAIR1:

To access the HMAIR1:

MRC p15,4,<Rt>,c10,c2,1 ; Read HMAIR1 into Rt
MCR p15,4,<Rt>,c10,c2,1 ; Write Rt to HMAIR1

Register access is encoded as follows:

coproc	opc1	CRn	CRm	opc2
1111	100	1010	0010	001

G4.2.62 HPFAR, Hyp IPA Fault Address Register

The HPFAR characteristics are:

Purpose

Holds the faulting IPA for some aborts on a stage 2 translation taken to Hyp mode.

This register is part of:

- the Exception and fault handling registers functional group
- the Virtualization registers functional group.

Usage constraints

This register is accessible as shown below:

EL0 (NS)	EL0 (S)	EL1 (NS)	EL1 (S)	EL2	EL3 (SCR.NS=1)	EL3 (SCR.NS=0)
-	-	-	-	RW	RW	-

Execution in any Non-secure mode other than Hyp mode makes this register UNKNOWN.

Configurations

HPFAR is architecturally mapped to AArch64 register [HPFAR_EL2](#)[31:0].

If EL2 is not implemented, this register is RES0 from EL3.

Attributes

HPFAR is a 32-bit register.

The HPFAR bit assignments are:

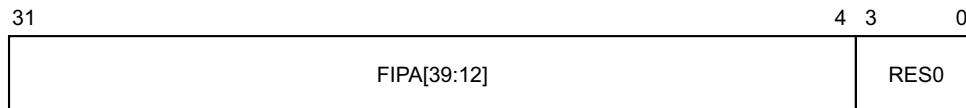

FIPA[39:12], bits [31:4]

Bits [39:12] of the faulting intermediate physical address.

Bits [3:0]

Reserved, RES0.

Accessing the HPFAR:

To access the HPFAR:

MRC p15,4,<Rt>,c6,c0,4 ; Read HPFAR into Rt

MCR p15,4,<Rt>,c6,c0,4 ; Write Rt to HPFAR

Register access is encoded as follows:

coproc	opc1	CRn	CRm	opc2
1111	100	0110	0000	100

G4.2.63 HRMR, Hyp Reset Management Register

The HRMR characteristics are:

Purpose

If EL2 is the highest exception level implemented, and is capable of using both AArch32 and AArch64, controls the execution state that the processor boots into and allows request of a Warm reset.

This register is part of:

- the Virtualization registers functional group
- the Reset management registers functional group.

Usage constraints

This register is accessible as shown below:

EL0	EL1	EL2
-	-	RW

Configurations

HRMR is architecturally mapped to AArch64 register [RMR_EL2](#).

Only implemented if the highest exception level implemented is EL2 and supports AArch32 and AArch64.

If EL2 is not the highest one implemented, then this register is not implemented and its encoding is UNDEFINED.

Attributes

HRMR is a 32-bit register when EL2 implemented, EL3 not implemented.

The HRMR bit assignments are:

When EL2 implemented, EL3 not implemented:

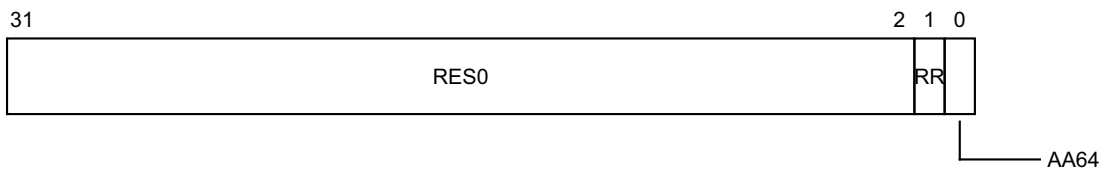

Bits [31:2]

Reserved, RES0.

RR, bit [1]

When set to 1 this bit requests a Warm reset. The bit is strictly a request.

On Warm reset, the field resets to 0.

AA64, bit [0]

Determines which execution state the processor boots into after a Warm reset:

- 0 AArch32.
- 1 AArch64.

The reset vector address on reset takes a choice between two IMP DEF values, depending on the value in the AA64 bit. This ensures that even with reprogramming of the AA64 bit, it is not possible to change the reset vector to go to a different location.

On Cold reset, the field resets to 0.

Accessing the HRMR:

To access the HRMR when EL2 implemented, EL3 not implemented:

MRC p15,4,<Rt>,c12,c0,2 ; Read HRMR into Rt
MCR p15,4,<Rt>,c12,c0,2 ; Write Rt to HRMR

Register access is encoded as follows:

coproc	opc1	CRn	CRm	opc2
1111	100	1100	0000	010

G4.2.64 HSCTLR, Hyp System Control Register

The HSCTLR characteristics are:

Purpose

Provides top level control of the system operation in Hyp mode. This register provides Hyp mode control of features controlled by the Banked SCTLR bits, and shows the values of the non-Banked SCTLR bits.

This register is part of:

- the Virtualization registers functional group
- the Other system control registers functional group.

Usage constraints

This register is accessible as shown below:

EL0 (NS)	EL0 (S)	EL1 (NS)	EL1 (S)	EL2	EL3 (SCR.NS=1)	EL3 (SCR.NS=0)
-	-	-	-	RW	RW	-

Configurations

HSCTLR is architecturally mapped to AArch64 register [SCTLR_EL2](#).

If EL2 is not implemented, this register is RES0 from EL3.

Attributes

HSCTLR is a 32-bit register.

The HSCTLR bit assignments are:

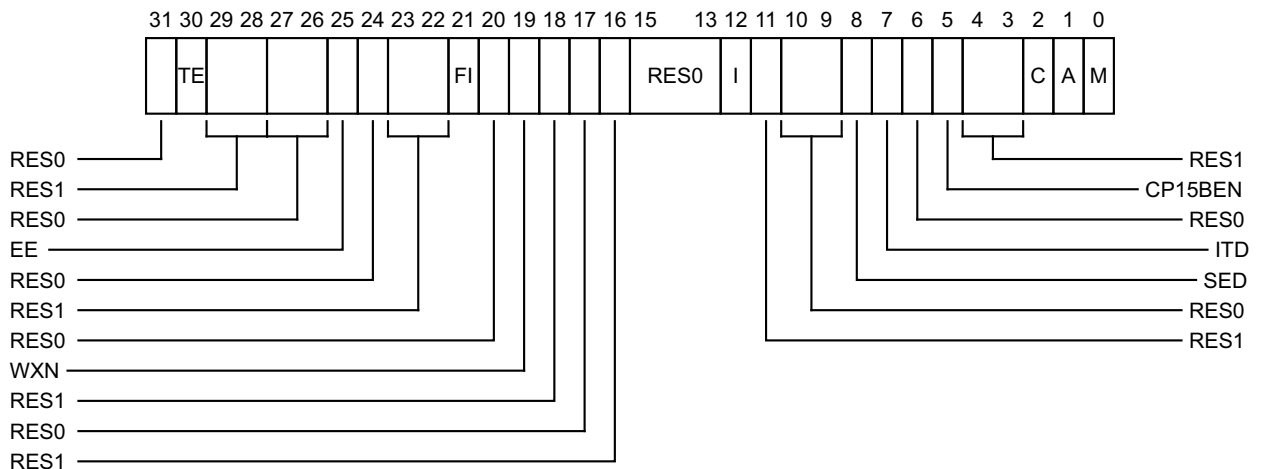

Bit [31]

Reserved, RES0.

TE, bit [30]

Thumb Exception Enable. This bit controls whether exceptions are taken in A32 or T32 state:

- 0 Exceptions, including reset, taken in A32 state.
- 1 Exceptions, including reset, taken in T32 state.

Reset value is architecturally UNKNOWN.

Bits [29:28]

Reserved, RES1.

Bits [27:26]

Reserved, RES0.

EE, bit [25]

Exception Endianness. The value of this bit defines the value of the CPSR.E bit on entry to an exception vector, including reset. This value also indicates the endianness of the translation table data for translation table lookups. The possible values of this bit are:

0 Little-endian.

1 Big-endian.

If an implementation does not provide Big-endian support, this bit is RES0. If it does not provide Little-endian support, this bit is RES1.

If this register is at the highest exception level implemented, field resets to an IMPLEMENTATION DEFINED value. Otherwise, its reset value is UNKNOWN.

Bit [24]

Reserved, RES0.

Bits [23:22]

Reserved, RES1.

FI, bit [21]

Fast interrupts configuration enable. This bit can be used to reduce interrupt latency in an implementation by disabling IMPLEMENTATION DEFINED performance features. The possible values of this bit are:

0 All performance features enabled.

1 Low interrupt latency configuration. Some performance features disabled.

Reset value is architecturally UNKNOWN.

Bit [20]

Reserved, RES0.

WXN, bit [19]

Write permission implies XN (Execute Never). This bit can be used to require all memory regions with write permission to be treated as XN. The possible values of this bit are:

0 Regions with write permission are not forced to XN.

1 Regions with write permission are forced to XN.

The WXN bit is permitted to be cached in a TLB.

Reset value is architecturally UNKNOWN.

Bit [18]

Reserved, RES1.

Bit [17]

Reserved, RES0.

Bit [16]

Reserved, RES1.

Bits [15:13]

Reserved, RES0.

I, bit [12]

Instruction cache enable. This is an enable bit for instruction caches at EL2:

- | | |
|---|---|
| 0 | Instruction caches disabled at EL2. If HSCTLR.M is set to 0, instruction accesses from stage 1 of the EL2 translation regime are to Normal memory, Outer Shareable, Inner Non-cacheable, Outer Non-cacheable. |
| 1 | Instruction caches enabled at EL2. If HSCTLR.M is set to 0, instruction accesses from stage 1 of the EL2 translation regime are to Normal memory, Outer Shareable, Inner Write-Through, Outer Write-Through. |

When this bit is 0, all EL2 Normal memory instruction accesses are Non-cacheable.

If this register is at the highest exception level implemented, field resets to 0. Otherwise, its reset value is UNKNOWN.

Bit [11]

Reserved, RES1.

Bits [10:9]

Reserved, RES0.

SED, bit [8]

SETEND Disable. The possible values of this bit are:

- | | |
|---|--|
| 0 | The SETEND instruction is available. |
| 1 | The SETEND instruction is UNALLOCATED. |

If an implementation does not support mixed endian operation at EL2, this bit is RES1.

Reset value is architecturally UNKNOWN.

ITD, bit [7]

IT Disable. The possible values of this bit are:

- | | |
|---|---|
| 0 | The IT instruction functionality is available. |
| 1 | It is IMPLEMENTATION DEFINED whether the IT instruction is treated as either: <ul style="list-style-type: none">• A 16-bit instruction, which can only be followed by another 16-bit instruction.• The first half of a 32-bit instruction. |

An implementation might vary dynamically as to whether IT is treated as a 16-bit instruction or the first half of a 32-bit instruction.

All encodings of the IT instruction with hw1[3:0]!=1000 are UNDEFINED and treated as unallocated.

All encodings of the subsequent instruction with the following values for hw1 are UNDEFINED (and treated as unallocated):

11xxxxxxxxxxxx
All 32-bit instructions, B(2), B(1), Undefined, SVC, Load/Store multiple

1x11xxxxxxxxxxxx
Miscellaneous 16-bit instructions

1x100xxxxxxxxxxxx
ADD Rd, PC, #imm

01001xxxxxxxxxxxx
LDR Rd, [PC, #imm]

0100x1xxx1111xxx
ADD(4),CMP(3), MOV, BX pc, BLX pc

010001xx1xxxx111
ADD(4),CMP(3), MOV (Note: this pattern also covers UNPREDICTABLE cases with BLX Rn)

Contrary to the standard treatment of conditional UNDEFINED instructions in the ARM architecture, in this case these instructions are always treated as UNDEFINED, regardless of whether the instruction would pass or fail its condition codes as a result of being in an IT block.

Reset value is architecturally UNKNOWN.

Bit [6]

Reserved, RES0.

CP15BEN, bit [5]

CP15 barrier enable. If implemented, this is an enable bit for the CP15 DMB, DSB, and ISB barrier operations at EL2:

0 CP15 barrier operations disabled at EL2. Their encodings are UNDEFINED.

1 CP15 barrier operations enabled at EL2.

If an implementation does not support the CP15 barrier operations, this bit is RES0.

Reset value is architecturally UNKNOWN.

Bits [4:3]

Reserved, RES1.

C, bit [2]

Cache enable. This is an enable bit for data and unified caches at EL2:

0 Data and unified caches disabled at EL2.

1 Data and unified caches enabled at EL2.

When this bit is 0, all EL2 Normal memory data accesses and all accesses to the EL2 translation tables are Non-cacheable.

If this register is at the highest exception level implemented, field resets to 0. Otherwise, its reset value is UNKNOWN.

A, bit [1]

Alignment check enable. This is the enable bit for Alignment fault checking:

0 Alignment fault checking disabled.

Instructions that load or store one or more registers, other than load/store exclusive and load-acquire/store-release, do not check that the address being accessed is aligned to the size of the data element(s) being accessed.

1 Alignment fault checking enabled.

All instructions that load or store one or more registers have an alignment check that the address being accessed is aligned to the size of the data element(s) being accessed. If this check fails it causes an Alignment fault, which is taken as a Data Abort exception.

Load/store exclusive and load-acquire/store-release instructions have an alignment check regardless of the value of the A bit.

If this register is at the highest exception level implemented, field resets to 0. Otherwise, its reset value is UNKNOWN.

M, bit [0]

MMU enable for EL2 stage 1 address translation. Possible values of this bit are:

0 EL2 stage 1 address translation disabled.

1 EL2 stage 1 address translation enabled.

If this register is at the highest exception level implemented, field resets to 0. Otherwise, its reset value is UNKNOWN.

Accessing the HSCTLR:

To access the HSCTLR:

MRC p15,4,<Rt>,c1,c0,0 ; Read HSCTLR into Rt
MCR p15,4,<Rt>,c1,c0,0 ; Write Rt to HSCTLR

Register access is encoded as follows:

coproc	opc1	CRn	CRm	opc2
1111	100	0001	0000	000

G4.2.65 HSR, Hyp Syndrome Register

The HSR characteristics are:

Purpose

Holds syndrome information for an exception taken to Hyp mode.

This register is part of:

- the Virtualization registers functional group
- the Exception and fault handling registers functional group.

Usage constraints

This register is accessible as shown below:

EL0 (NS)	EL0 (S)	EL1 (NS)	EL1 (S)	EL2	EL3 (SCR.NS=1)	EL3 (SCR.NS=0)
-	-	-	-	RW	RW	-

Execution in any Non-secure mode other than Hyp mode makes this register UNKNOWN.

When an UNPREDICTABLE instruction is treated as UNDEFINED, and the exception is taken to EL2, the value of HSR is UNKNOWN. The value written to HSR must be consistent with a value that could be created as a result of an exception from the same exception level that generated the exception as a result of a situation that is not UNPREDICTABLE at that exception level, in order to avoid the possibility of a privilege violation.

Configurations

HSR is architecturally mapped to AArch64 register [ESR_EL2](#).

If EL2 is not implemented, this register is RES0 from EL3.

Attributes

HSR is a 32-bit register.

The HSR bit assignments are:

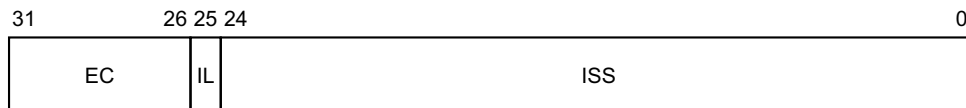

EC, bits [31:26]

Exception Class. Indicates the reason for the exception that this register holds information about.

Possible values of this field are:

- | | |
|--------|---|
| 000000 | Unknown reason. |
| 000001 | Trapped WFI or WFE instruction.
Conditional WFE and WFI instructions that fail their condition code check do not cause an exception. |
| 000011 | Trapped MCR or MRC access to CP15. |
| 000100 | Trapped MCRR or MRRC access to CP15. |
| 000101 | Trapped MCR or MRC access to CP14. |
| 000110 | Trapped LDC or STC access to CP14. |
| 000111 | HCPTR-trapped access to CP10 or CP11. |
| 001000 | Trapped MRC or VMRS access to CP10, for ID group traps. |
| 001100 | Trapped MRRC or MCRR access to CP14. |

001111	Illegal exception return to AArch32 state.
010001	SVC taken to Hyp mode.
010010	HVC executed.
010011	Trapped SMC instruction.
100000	Prefetch Abort routed to Hyp mode.
100001	Prefetch Abort taken from Hyp mode.
100010	PC Alignment Exception.
100100	Data Abort routed to Hyp mode.
100101	Data Abort taken from Hyp mode.

Other values are reserved.

IL, bit [25]

Instruction Length. Indicates the size of the instruction that has been trapped to this exception level. Possible values of this bit are:

0	16-bit instruction trapped.				
1	32-bit instruction trapped. This value also applies to the following exceptions: <ul style="list-style-type: none">• An SError interrupt.• An Instruction Abort exception.• A Misaligned PC exception.• A Misaligned Stack Pointer exception.• A Data Abort for which the value of the ISV bit is 0.• An Illegal Execution State exception.• Any debug exception except for Software Breakpoint Instruction exceptions. For Software Breakpoint Instruction exceptions, this bit has its standard meaning:<table><tr><td>0</td><td>16-bit T32 BKPT instruction.</td></tr><tr><td>1</td><td>32-bit A32 BKPT instruction.</td></tr></table>• An exception reported using EC value 0b000000.	0	16-bit T32 BKPT instruction.	1	32-bit A32 BKPT instruction.
0	16-bit T32 BKPT instruction.				
1	32-bit A32 BKPT instruction.				

ISS, bits [24:0]

Instruction Specific Syndrome. Architecturally, this field can be defined independently for each defined Exception class. However, in practice, some ISS encodings are used for more than one Exception class.

Typically, an ISS encoding has a number of subfields. When an ISS subfield holds a register number, the value returned in that field is the AArch64 view of the register number, even if the reported exception was taken from AArch32 state. If the register number is AArch32 register R15, then:

- If the instruction that generated the exception was not UNPREDICTABLE, the field takes the value 0b11111.
- If the instruction that generated the exception was UNPREDICTABLE, the field takes an UNKNOWN value that must be either:
 - The AArch64 view of the register number of a register that might have been used at the Exception level from which the exception was taken.
 - The value 0b11111.

When the EC field is 0b000000, indicating an exception with an unknown reason, the ISS field is not valid, RES0.

Exceptions with an unknown reason:

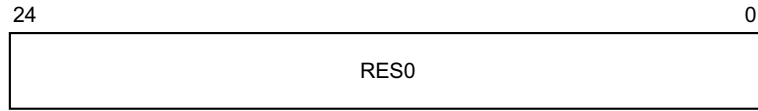

Bits [24:0]

Reserved, RES0.

Exception from a WFI or WFE instruction:

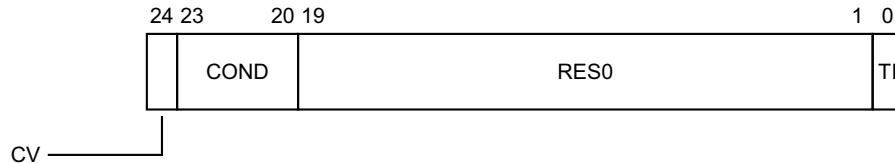

CV, bit [24]

Condition code valid. Possible values of this bit are:

- 0 The COND field is not valid.
- 1 The COND field is valid.

When an A32 instruction is trapped, CV is set to 1.

When a T32 instruction is trapped, it is IMPLEMENTATION DEFINED whether:

- CV is set to 0 and COND is set to an UNKNOWN value. Software must examine the SPSR.IT field to determine the condition of a T32 instruction.
- CV is set to 1 and COND is set to the condition code for the condition that applied to the instruction.

COND, bits [23:20]

The condition code for the trapped instruction.

When an A32 instruction is trapped:

- If the instruction is conditional, COND is set to the condition code field value from the instruction.
- If the instruction is unconditional, COND is set to 0xE.

A conditional A32 instruction that is known to pass its condition code check can be presented either:

- With COND set to 0xE, the value for unconditional.
- With the COND value held in the instruction.

When a T32 instruction is trapped, it is IMPLEMENTATION DEFINED whether:

- CV is set to 0 and COND is set to an UNKNOWN value. Software must examine the SPSR.IT field to determine the condition of a T32 instruction.
- CV is set to 1 and COND is set to the condition code for the condition that applied to the instruction.

For an implementation that, for both A32 and T32 instructions, takes an exception on a trapped conditional instruction only if the instruction passes its condition code check, these definitions mean that when CV is set to 1 it is IMPLEMENTATION DEFINED whether the COND field is set to 0xE, or to the value of any condition that applied to the instruction.

Bits [19:1]

Reserved, RES0.

TI, bit [0]

Trapped instruction. Possible values of this bit are:

- 0 WFI trapped.
- 1 WFE trapped.

Exception from an MCR or MRC access:

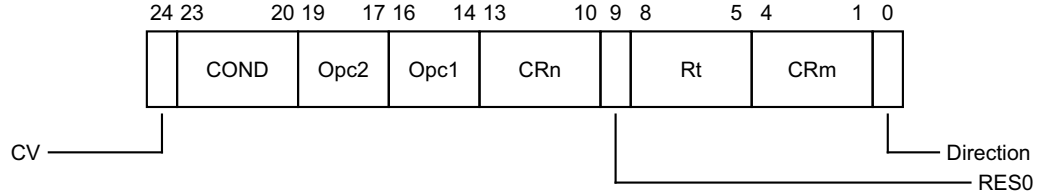

CV, bit [24]

Condition code valid. Possible values of this bit are:

- 0 The COND field is not valid.
- 1 The COND field is valid.

When an A32 instruction is trapped, CV is set to 1.

When a T32 instruction is trapped, it is IMPLEMENTATION DEFINED whether:

- CV is set to 0 and COND is set to an UNKNOWN value. Software must examine the SPSR.IT field to determine the condition of a T32 instruction.
- CV is set to 1 and COND is set to the condition code for the condition that applied to the instruction.

COND, bits [23:20]

The condition code for the trapped instruction.

When an A32 instruction is trapped:

- If the instruction is conditional, COND is set to the condition code field value from the instruction.
- If the instruction is unconditional, COND is set to 0xE.

A conditional A32 instruction that is known to pass its condition code check can be presented either:

- With COND set to 0xE, the value for unconditional.
- With the COND value held in the instruction.

When a T32 instruction is trapped, it is IMPLEMENTATION DEFINED whether:

- CV is set to 0 and COND is set to an UNKNOWN value. Software must examine the SPSR.IT field to determine the condition of a T32 instruction.
- CV is set to 1 and COND is set to the condition code for the condition that applied to the instruction.

For an implementation that, for both A32 and T32 instructions, takes an exception on a trapped conditional instruction only if the instruction passes its condition code check, these definitions mean that when CV is set to 1 it is IMPLEMENTATION DEFINED whether the COND field is set to 0xE, or to the value of any condition that applied to the instruction.

Opc2, bits [19:17]

The Opc2 value from the issued instruction.

Opc1, bits [16:14]

The Opc1 value from the issued instruction.

CRn, bits [13:10]

The CRn value from the issued instruction, the coprocessor primary register value.

Bit [9]

Reserved, RES0.

Rt, bits [8:5]

The Rt value from the issued instruction, the general purpose register used for the transfer.

CRm, bits [4:1]

The CRm value from the issued instruction.

Direction, bit [0]

Indicates the direction of the trapped instruction. The possible values of this bit are:

- 0 Write to coprocessor. MCR instruction.
- 1 Read from coprocessor. MRC or VMRS instruction.

Exception from an MCRR or MRRC access:

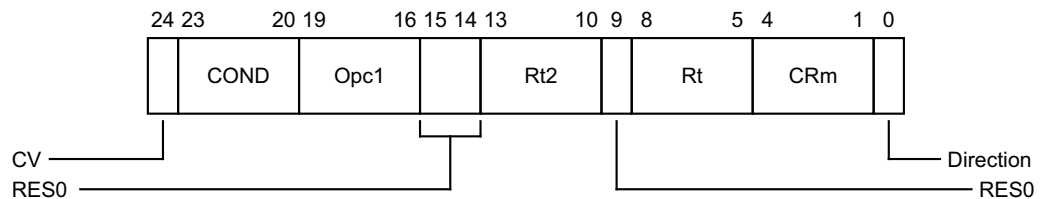

CV, bit [24]

Condition code valid. Possible values of this bit are:

- 0 The COND field is not valid.
- 1 The COND field is valid.

When an A32 instruction is trapped, CV is set to 1.

When a T32 instruction is trapped, it is IMPLEMENTATION DEFINED whether:

- CV is set to 0 and COND is set to an UNKNOWN value. Software must examine the SPSR.IT field to determine the condition of a T32 instruction.
- CV is set to 1 and COND is set to the condition code for the condition that applied to the instruction.

COND, bits [23:20]

The condition code for the trapped instruction.

When an A32 instruction is trapped:

- If the instruction is conditional, COND is set to the condition code field value from the instruction.
- If the instruction is unconditional, COND is set to 0xE.

A conditional A32 instruction that is known to pass its condition code check can be presented either:

- With COND set to 0xE, the value for unconditional.
- With the COND value held in the instruction.

When a T32 instruction is trapped, it is IMPLEMENTATION DEFINED whether:

- CV is set to 0 and COND is set to an UNKNOWN value. Software must examine the SPSR.IT field to determine the condition of a T32 instruction.
- CV is set to 1 and COND is set to the condition code for the condition that applied to the instruction.

For an implementation that, for both A32 and T32 instructions, takes an exception on a trapped conditional instruction only if the instruction passes its condition code check, these definitions mean that when CV is set to 1 it is IMPLEMENTATION DEFINED whether the COND field is set to 0xE, or to the value of any condition that applied to the instruction.

Opc1, bits [19:16]

The Opc1 value from the issued instruction.

Bits [15:14]

Reserved, RES0.

Rt2, bits [13:10]

The Rt2 value from the issued instruction, the second general purpose register used for the transfer.

Bit [9]

Reserved, RES0.

Rt, bits [8:5]

The Rt value from the issued instruction, the general purpose register used for the transfer.

CRm, bits [4:1]

The CRm value from the issued instruction.

Direction, bit [0]

Indicates the direction of the trapped instruction. The possible values of this bit are:

- 0 Write to coprocessor. MCRR instruction.
- 1 Read from coprocessor. MRRC instruction.

Exception from an LDC or STC access to CP14:

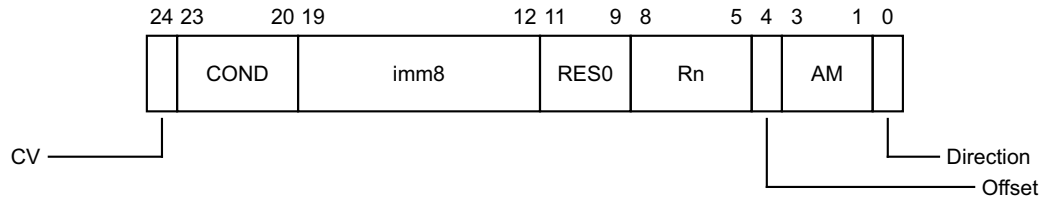

CV, bit [24]

Condition code valid. Possible values of this bit are:

- 0 The COND field is not valid.
- 1 The COND field is valid.

When an A32 instruction is trapped, CV is set to 1.

When a T32 instruction is trapped, it is IMPLEMENTATION DEFINED whether:

- CV is set to 0 and COND is set to an UNKNOWN value. Software must examine the SPSR.IT field to determine the condition of a T32 instruction.
- CV is set to 1 and COND is set to the condition code for the condition that applied to the instruction.

COND, bits [23:20]

The condition code for the trapped instruction.

When an A32 instruction is trapped:

- If the instruction is conditional, COND is set to the condition code field value from the instruction.
- If the instruction is unconditional, COND is set to 0xE.

A conditional A32 instruction that is known to pass its condition code check can be presented either:

- With COND set to 0xE, the value for unconditional.
- With the COND value held in the instruction.

When a T32 instruction is trapped, it is IMPLEMENTATION DEFINED whether:

- CV is set to 0 and COND is set to an UNKNOWN value. Software must examine the SPSR.IT field to determine the condition of a T32 instruction.
- CV is set to 1 and COND is set to the condition code for the condition that applied to the instruction.

For an implementation that, for both A32 and T32 instructions, takes an exception on a trapped conditional instruction only if the instruction passes its condition code check, these definitions mean that when CV is set to 1 it is IMPLEMENTATION DEFINED whether the COND field is set to 0xE, or to the value of any condition that applied to the instruction.

imm8, bits [19:12]

The immediate value from the issued instruction.

Bits [11:9]

Reserved, RES0.

Rn, bits [8:5]

The Rn value from the issued instruction. Valid only when the Direction field is 0, indicating a trapped STC instruction.

When the Direction field is 1, indicating a trapped LDC instruction, this field is RES0.

Offset, bit [4]

Indicates whether the offset is added or subtracted:

- 0 Subtract offset.
- 1 Add offset.

This bit corresponds to the U bit in the instruction encoding.

AM, bits [3:1]

Addressing mode. The permitted values of this field are:

- 000 Immediate unindexed.
- 001 Immediate post-indexed.
- 010 Immediate offset.
- 011 Immediate pre-indexed.
- 100 Literal unindexed.
A32 instruction set only.
For a trapped LDC or STC T32 instruction, this encoding is reserved.
- 110 Literal offset.
For the STC instruction, valid only in the A32 instruction set.
For a trapped STC T32 instruction, this encoding is reserved.

The values 0b101 and 0b111 are reserved.

Bit [2] in this subfield indicates the instruction form, immediate or literal.

Bits [1:0] in this subfield correspond to the bits {P, W} in the instruction encoding.

Direction, bit [0]

Indicates the direction of the trapped instruction. The possible values of this bit are:

- 0 Write to coprocessor. STC instruction.
- 1 Read from coprocessor. LDC instruction.

Exception from an access to SIMD or floating-point registers:

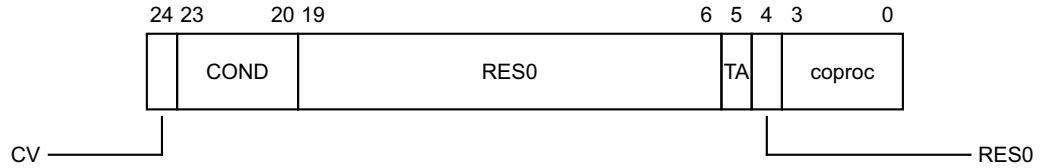

CV, bit [24]

Condition code valid. Possible values of this bit are:

- 0 The COND field is not valid.
- 1 The COND field is valid.

When an A32 instruction is trapped, CV is set to 1.

When a T32 instruction is trapped, it is IMPLEMENTATION DEFINED whether:

- CV is set to 0 and COND is set to an UNKNOWN value. Software must examine the SPSR.IT field to determine the condition of a T32 instruction.
- CV is set to 1 and COND is set to the condition code for the condition that applied to the instruction.

COND, bits [23:20]

The condition code for the trapped instruction.

When an A32 instruction is trapped:

- If the instruction is conditional, COND is set to the condition code field value from the instruction.
- If the instruction is unconditional, COND is set to 0xE.

A conditional A32 instruction that is known to pass its condition code check can be presented either:

- With COND set to 0xE, the value for unconditional.
- With the COND value held in the instruction.

When a T32 instruction is trapped, it is IMPLEMENTATION DEFINED whether:

- CV is set to 0 and COND is set to an UNKNOWN value. Software must examine the SPSR.IT field to determine the condition of a T32 instruction.
- CV is set to 1 and COND is set to the condition code for the condition that applied to the instruction.

For an implementation that, for both A32 and T32 instructions, takes an exception on a trapped conditional instruction only if the instruction passes its condition code check, these definitions mean that when CV is set to 1 it is IMPLEMENTATION DEFINED whether the COND field is set to 0xE, or to the value of any condition that applied to the instruction.

Bits [19:6]

Reserved, RES0.

TA, bit [5]

Indicates trapped use of the Advanced SIMD extension. The possible values of this bit are:

- 0 Exception was not caused by trapped use of the Advanced SIMD extension.
- 1 Exception was caused by trapped use of the Advanced SIMD extension.

Any use of an Advanced SIMD instruction that is trapped to Hyp mode because of a trap configured in the **HCPTR** sets this bit to 1.

Bit [4]

Reserved, RES0.

coproc, bits [3:0]

The number of the coprocessor accessed by the trapped operation, 0-13.

Exception from HVC or SVC instruction execution:

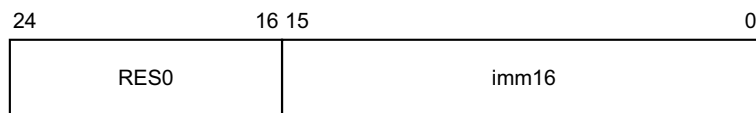

Bits [24:16]

Reserved, RES0.

imm16, bits [15:0]

The value of the immediate field from the HVC or SVC instruction.

For an HVC instruction this is the value of the imm16 field of the issued instruction.

For an SVC instruction:

- If the instruction is unconditional, then:
 - For the 16-bit T32 instruction, this field is zero-extended from the imm8 field of the instruction.
 - For the A32 instruction, this field is the bottom 16 bits of the imm24 field of the instruction.
- If the instruction is conditional, this field is UNKNOWN.

The HVC instruction is unconditional, and a conditional SVC instruction generates a Supervisor Call exception that is routed to Hyp mode only if it passes its condition code check. Therefore, the syndrome information for these exceptions does not include conditionality information.

Exception from SMC instruction execution in AArch32 state:

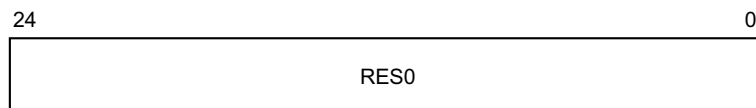

Bits [24:0]

Reserved, RES0.

Exception from an Instruction abort:

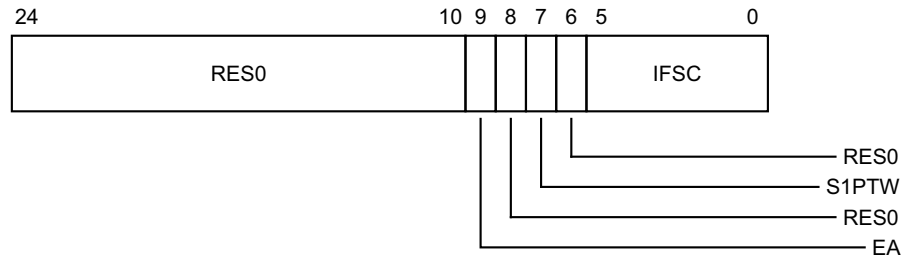

Bits [24:10]

Reserved, RES0.

EA, bit [9]

External abort type. This bit can be provide an IMPLEMENTATION DEFINED classification of external aborts.

For any abort other than an External abort this bit returns a value of 0.

Bit [8]

Reserved, RES0.

S1PTW, bit [7]

For a stage 2 fault, indicates whether the fault was a fault on the stage 2 translation of an address accessed during a stage 1 translation table walk:

0 Fault not on a stage 2 translation for a stage 1 translation table walk.

1 Fault on the stage 2 translation of an access for a stage 1 translation table walk.

For a stage 1 fault, this bit is RES0.

Bit [6]

Reserved, RES0.

IFSC, bits [5:0]

Instruction Fault Status Code. Possible values of this field are:

000000	Address size fault, zeroth level of translation or translation table base register
000001	Address size fault, first level
000010	Address size fault, second level
000011	Address size fault, third level
000100	Translation fault, zeroth level
000101	Translation fault, first level
000110	Translation fault, second level
000111	Translation fault, third level
001001	Access flag fault, first level
001010	Access flag fault, second level
001011	Access flag fault, third level
001101	Permission fault, first level
001110	Permission fault, second level
001111	Permission fault, third level
010000	Synchronous external abort
011000	Synchronous parity error on memory access

010100	Synchronous external abort on translation table walk, zeroth level
010101	Synchronous external abort on translation table walk, first level
010110	Synchronous external abort on translation table walk, second level
010111	Synchronous external abort on translation table walk, third level
011100	Synchronous parity error on memory access on translation table walk, zeroth level
011101	Synchronous parity error on memory access on translation table walk, first level
011110	Synchronous parity error on memory access on translation table walk, second level
011111	Synchronous parity error on memory access on translation table walk, third level
100001	Alignment fault
100010	Debug event
110000	TLB conflict abort
110100	IMPLEMENTATION DEFINED fault (Lockdown fault)

All other values are reserved.

The lookup level associated with a fault is:

- For a fault generated on a translation table walk, the lookup level of the walk being performed.
- For a Translation fault, the lookup level of the translation table that gave the fault. If a fault occurs because a stage of address translation is disabled, or because the input address is outside the range specified by the appropriate base address register or registers, the fault is reported as a level 1 fault.
- For an Access flag fault, the lookup level of the translation table that gave the fault.
- For a Permission fault, including a Permission fault caused by hierarchical permissions, the lookup level of the final level of translation table accessed for the translation. That is, the lookup level of the translation table that returned a Block or Page descriptor.

Exception from an Instruction set state, PC alignment, or SP alignment fault:

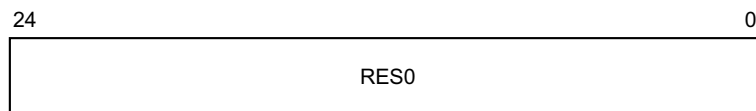

Bits [24:0]

Reserved, RES0.

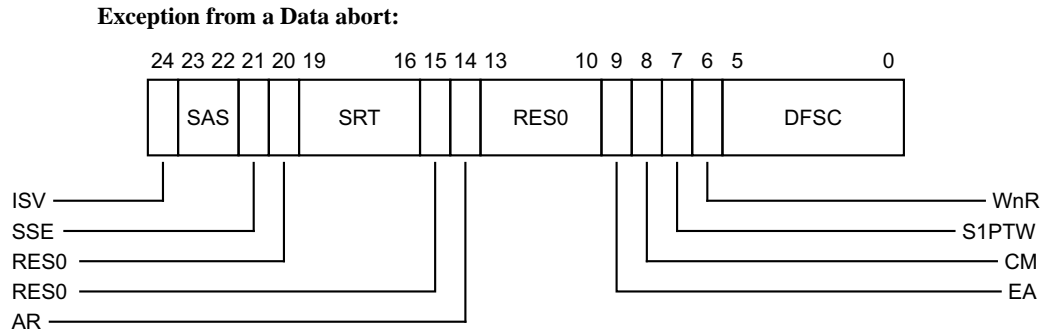

ISV, bit [24]

Instruction syndrome valid. Indicates whether the rest of the syndrome information in this register is valid.

- 0 No valid instruction syndrome. ISS[23:16] are RES0.
- 1 ISS[24:16] hold a valid instruction syndrome.

This bit is 0 for all faults except those generated by a stage 2 translation. For Data Abort exceptions generated by a stage 2 translation, this bit is 1 and a valid instruction syndrome is returned, only if all of the following are true:

- The instruction that generated the Data Abort exception:
 - Is an LDR, LDA, LDRT, LDRSH, LDRSHT, LDRH, LDAH, LDRHT, LDRSB, LDRSBT, LDRB, LDAB, LDRBT, STR, STL, STRT, STRH, STLH, STRHT, STRB, STLB, or STRBT instruction.
 - Is not performing register writeback.
 - Is not using the PC as its source or destination register.

For ISS reporting, a stage 2 abort on a stage 1 translation table lookup is treated as a stage 1 Translation fault, and does not return a valid instruction syndrome.

It is IMPLEMENTATION DEFINED whether ISV is set to 1 or 0 on a synchronous external abort on stage 2 translation table walks.

In the A32 instruction set, LDR*T and STR*T instructions always perform register writeback and therefore never return a valid instruction syndrome.

SAS, bits [23:22]

Syndrome Access Size. Indicates the size of the access attempted by the faulting operation.

- 00 Byte
- 01 Halfword
- 10 Word
- 11 Doubleword

SSE, bit [21]

Syndrome Sign Extend. For a byte, halfword, or word load operation, indicates whether the data item must be sign extended. For these cases, the possible values of this bit are:

- 0 Sign-extension not required.
- 1 Data item must be sign-extended.

For all other operations this bit is 0.

Bit [20]

Reserved, RES0.

SRT, bits [19:16]

Syndrome Register transfer. The register number of the Rt operand of the faulting instruction.

Bit [15]

Reserved, RES0.

AR, bit [14]

Acquire/Release. Possible values of this bit are:

- 0 Instruction did not have acquire/release semantics.
- 1 Instruction did have acquire/release semantics.

Bits [13:10]

Reserved, RES0.

EA, bit [9]

External abort type. This bit can be provide an IMPLEMENTATION DEFINED classification of external aborts.

For any abort other than an External abort this bit returns a value of 0.

CM, bit [8]

Cache maintenance. For a synchronous fault, identifies fault that comes from a cache maintenance or address translation operation. For synchronous faults, the possible values of this bit are:

- 0 Fault not generated by a cache maintenance or address translation operation.
- 1 Fault generated by a cache maintenance or address translation operation.

For asynchronous faults, this bit is 0.

S1PTW, bit [7]

For a stage 2 fault, indicates whether the fault was a fault on the stage 2 translation of an address accessed during a stage 1 translation table walk:

- 0 Fault not on a stage 2 translation for a stage 1 translation table walk.
- 1 Fault on the stage 2 translation of an access for a stage 1 translation table walk.

For a stage 1 fault, this bit is RES0.

WnR, bit [6]

Write not Read. Indicates whether a synchronous abort was caused by a write or a read operation. The possible values of this bit are:

- 0 Abort caused by a read operation.
- 1 Abort caused by a write operation.

For faults on cache maintenance and address translation operations, this bit always returns a value of 1.

DFSC, bits [5:0]

Data Fault Status Code. Possible values of this field are:

- 000000 Address size fault, zeroth level of translation or translation table base register
- 000001 Address size fault, first level
- 000010 Address size fault, second level
- 000011 Address size fault, third level
- 000100 Translation fault, zeroth level
- 000101 Translation fault, first level
- 000110 Translation fault, second level

000111	Translation fault, third level
001001	Access flag fault, first level
001010	Access flag fault, second level
001011	Access flag fault, third level
001101	Permission fault, first level
001110	Permission fault, second level
001111	Permission fault, third level
010000	Synchronous external abort
011000	Synchronous parity error on memory access
010001	Asynchronous external abort
011001	Asynchronous parity error on memory access
010100	Synchronous external abort on translation table walk, zeroth level
010101	Synchronous external abort on translation table walk, first level
010110	Synchronous external abort on translation table walk, second level
010111	Synchronous external abort on translation table walk, third level
011100	Synchronous parity error on memory access on translation table walk, zeroth level
011101	Synchronous parity error on memory access on translation table walk, first level
011110	Synchronous parity error on memory access on translation table walk, second level
011111	Synchronous parity error on memory access on translation table walk, third level
100001	Alignment fault
100010	Debug event
110000	TLB conflict abort
110100	IMPLEMENTATION DEFINED fault (Lockdown fault)
110101	IMPLEMENTATION DEFINED fault (Unsupported Exclusive access fault)
111101	Section Domain Fault, used only for faults reported in the PAR_EL1
111110	Page Domain Fault, used only for faults reported in the PAR_EL1

All other values are reserved.

The lookup level associated with a fault is:

- For a fault generated on a translation table walk, the lookup level of the walk being performed.
- For a Translation fault, the lookup level of the translation table that gave the fault. If a fault occurs because a stage of address translation is disabled, or because the input address is outside the range specified by the appropriate base address register or registers, the fault is reported as a level 1 fault.
- For an Access flag fault, the lookup level of the translation table that gave the fault.

- For a Permission fault, including a Permission fault caused by hierarchical permissions, the lookup level of the final level of translation table accessed for the translation. That is, the lookup level of the translation table that returned a Block or Page descriptor.

Accessing the HSR:

To access the HSR:

MRC p15,4,<Rt>,c5,c2,0 ; Read HSR into Rt
MCR p15,4,<Rt>,c5,c2,0 ; Write Rt to HSR

Register access is encoded as follows:

coproc	opc1	CRn	CRm	opc2
1111	100	0101	0010	000

G4.2.66 HSTR, Hyp System Trap Register

The HSTR characteristics are:

Purpose

Controls trapping to Hyp mode of Non-secure accesses, at EL1 or lower, of use of T32EE or the CP15 primary coprocessor registers, {c0-c3,c5-c13,c15}.

This register is part of the Virtualization registers functional group.

Usage constraints

This register is accessible as shown below:

EL0 (NS)	EL0 (S)	EL1 (NS)	EL1 (S)	EL2	EL3 (SCR.NS=1)	EL3 (SCR.NS=0)
-	-	-	-	RW	RW	-

Configurations

HSTR is architecturally mapped to AArch64 register [HSTR_EL2](#).

If EL2 is not implemented, this register is RES0 from EL3.

Attributes

HSTR is a 32-bit register.

The HSTR bit assignments are:

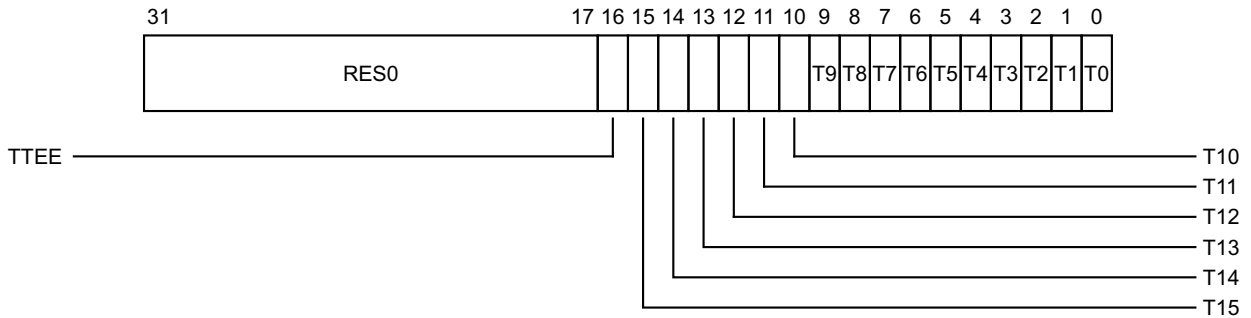

Bits [31:17]

Reserved, RES0.

TTEE, bit [16]

Trap T32EE. The possible values of this bit are:

- 0 Has no effect on accesses to the T32EE configuration registers.
- 1 Trap valid Non-secure accesses to T32EE configuration registers to Hyp mode.

When this bit is set to 1, any valid Non-secure access to the T32EE configuration registers is trapped to Hyp mode.

If T32EE is not implemented, then this bit is RES0.

Resets to 0.

T<n>, bit [n], for n = 0 to 15

Trap coprocessor primary register. For each field T<n>, the possible values of this bit are:

- 0 Has no effect on Non-secure accesses to CP15 coprocessor registers.
- 1 Trap valid Non-secure accesses to coprocessor primary register c<n> to Hyp mode.

When T<n> is set to 1, any valid Non-secure access to CP15 primary coprocessor register c<n> is trapped to Hyp mode. For example, when T7 is set to 1:

- Any valid Non-secure 32-bit CP15 accesses, using MRC or MCR instructions with CRn==c7, are trapped to Hyp mode.
- Any valid Non-secure 64-bit CP15 accesses, using MRRC or MCRR instructions with CRm==c7, are trapped to Hyp mode.

Fields T14 and T4 are RES0.

Resets to 0.

Accessing the HSTR:

To access the HSTR:

MRC p15,4,<Rt>,c1,c1,3 ; Read HSTR into Rt
MCR p15,4,<Rt>,c1,c1,3 ; Write Rt to HSTR

Register access is encoded as follows:

coproc	opc1	CRn	CRm	opc2
1111	100	0001	0001	011

G4.2.67 HTCR, Hyp Translation Control Register

The HTCR characteristics are:

Purpose

Controls translation table walks required for the stage 1 translation of memory accesses from Hyp mode, and holds cacheability and shareability information for the accesses.

This register is part of:

- the Virtualization registers functional group
- the Virtual memory control registers functional group.

Usage constraints

This register is accessible as shown below:

EL0 (NS)	EL0 (S)	EL1 (NS)	EL1 (S)	EL2	EL3 (SCR.NS=1)	EL3 (SCR.NS=0)
-	-	-	-	RW	RW	-

Used in conjunction with [HTTBR](#), that defines the translation table base address for the translations.

Configurations

HTCR is architecturally mapped to AArch64 register [TCR_EL2](#).

If EL2 is not implemented, this register is RES0 from EL3.

Attributes

HTCR is a 32-bit register.

The HTCR bit assignments are:

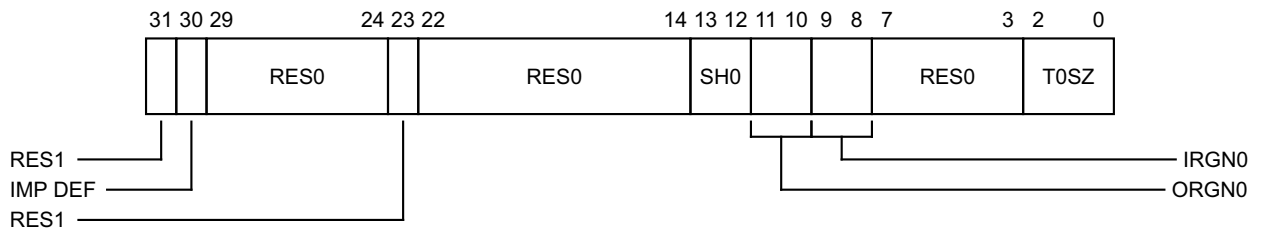

Bit [31]

Reserved, RES1.

Bits [29:24]

Reserved, RES0.

Bit [23]

Reserved, RES1.

Bits [22:14]

Reserved, RES0.

SH0, bits [13:12]

Shareability attribute for memory associated with translation table walks using [TTBR0](#).

- 00 Non-shareable
- 10 Outer Shareable

11 Inner Shareable

Other values are reserved.

ORGN0, bits [11:10]

Outer cacheability attribute for memory associated with translation table walks using [TTBR0](#).

00 Normal memory, Outer Non-cacheable

01 Normal memory, Outer Write-Back Write-Allocate Cacheable

10 Normal memory, Outer Write-Through Cacheable

11 Normal memory, Outer Write-Back no Write-Allocate Cacheable

IRGN0, bits [9:8]

Inner cacheability attribute for memory associated with translation table walks using [TTBR0](#).

00 Normal memory, Inner Non-cacheable

01 Normal memory, Inner Write-Back Write-Allocate Cacheable

10 Normal memory, Inner Write-Through Cacheable

11 Normal memory, Inner Write-Back no Write-Allocate Cacheable

Bits [7:3]

Reserved, RES0.

T0SZ, bits [2:0]

The size offset of the memory region addressed by [TTBR0](#). The region size is $2^{32-T0SZ}$ bytes.

Accessing the HTCR:

To access the HTCR:

MRC p15,4,<Rt>,c2,c0,2 ; Read HTCR into Rt

MCR p15,4,<Rt>,c2,c0,2 ; Write Rt to HTCR

Register access is encoded as follows:

coproc	opc1	CRn	CRm	opc2
1111	100	0010	0000	010

G4.2.68 HTPIDR, Hyp Thread Pointer / ID Register

The HTPIDR characteristics are:

Purpose

Provides a location where software running in Hyp mode can store thread identifying information that is not visible to Non-secure software executing at EL0 or EL1, for hypervisor management purposes.

This register is part of:

- the Virtualization registers functional group
- the Thread and process ID registers functional group.

Usage constraints

This register is accessible as shown below:

EL0 (NS)	EL0 (S)	EL1 (NS)	EL1 (S)	EL2	EL3 (SCR.NS=1)	EL3 (SCR.NS=0)
-	-	-	-	RW	RW	-

Processor hardware never updates this register.

Configurations

HTPIDR is architecturally mapped to AArch64 register [TPIDR_EL2](#)[31:0].

If EL2 is not implemented, this register is RES0 from EL3.

Attributes

HTPIDR is a 32-bit register.

The HTPIDR bit assignments are:

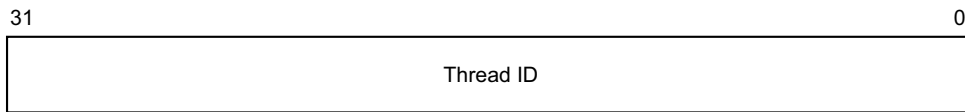

Bits [31:0]

Thread ID. Thread identifying information stored by software running at this exception level.

Accessing the HTPIDR:

To access the HTPIDR:

MRC p15,4,<Rt>,c13,c0,2 ; Read HTPIDR into Rt
 MCR p15,4,<Rt>,c13,c0,2 ; Write Rt to HTPIDR

Register access is encoded as follows:

coproc	opc1	CRn	CRm	opc2
1111	100	1101	0000	010

G4.2.69 HTTBR, Hyp Translation Table Base Register

The HTTBR characteristics are:

Purpose

Holds the base address of the translation table for the stage 1 translation of memory accesses from Hyp mode.

This register is part of:

- the Virtualization registers functional group
- the Virtual memory control registers functional group.

Usage constraints

This register is accessible as shown below:

EL0 (NS)	EL0 (S)	EL1 (NS)	EL1 (S)	EL2	EL3 (SCR.NS=1)	EL3 (SCR.NS=0)
-	-	-	-	RW	RW	-

Used in conjunction with the [HTCR](#).

Configurations

HTTBR is architecturally mapped to AArch64 register [TTBR0_EL2](#).

If EL2 is not implemented, this register is RES0 from EL3.

Attributes

HTTBR is a 64-bit register.

The HTTBR bit assignments are:

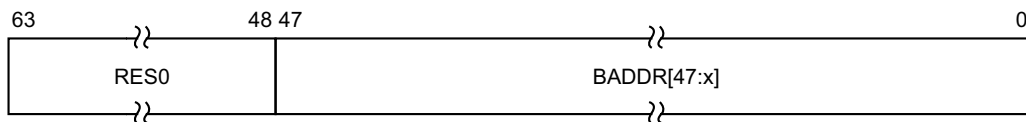

Bits [63:48]

Reserved, RES0.

BADDR[47:x], bits [47:0]

Translation table base address, bits[47:x]. Bits [x-1:0] are RES0.

x is based on the value of [HTCR.TOSZ](#), and is calculated as follows:

- If [HTCR.TOSZ](#) is 0 or 1, $x = 5 - \text{HTCR.TOSZ}$.
- If [HTCR.TOSZ](#) is greater than 1, $x = 14 - \text{HTCR.TOSZ}$.

The value of x determines the required alignment of the translation table, which must be aligned to 2^x bytes.

If bits [x-1:3] are not all zero, this is a misaligned Translation Table Base Address. Its effects are CONstrained UNPREDICTABLE, and can be one of the following:

- Bits [x-1:3] are treated as if all the bits are zero. The value read back from those bits might be the value written or might be zero.
- The calculation of an address for a translation table walk using this register can be corrupted in those bits that are non-zero.

Accessing the HTTBR:

To access the HTTBR:

MRRC p15,4,<Rt>,<Rt2>,c2 ; Read 64-bit HTTBR into Rt (low word) and Rt2 (high word)
MCRR p15,4,<Rt>,<Rt2>,c2 ; Write Rt (low word) and Rt2 (high word) to 64-bit HTTBR

Register access is encoded as follows:

coproc	opc1	CRm
1111	0100	0010

G4.2.70 HVBAR, Hyp Vector Base Address Register

The HVBAR characteristics are:

Purpose

Holds the exception base address for any exception that is taken to Hyp mode.

This register is part of:

- the Virtualization registers functional group
- the Exception and fault handling registers functional group.

Usage constraints

This register is accessible as shown below:

EL0 (NS)	EL0 (S)	EL1 (NS)	EL1 (S)	EL2	EL3 (SCR.NS=1)	EL3 (SCR.NS=0)
-	-	-	-	RW	RW	-

Configurations

HVBAR is architecturally mapped to AArch64 register [VBAR_EL2](#)[31:0].

If EL2 is not implemented, this register is RES0 from EL3.

Attributes

HVBAR is a 32-bit register.

The HVBAR bit assignments are:



Bits [31:5]

Vector Base Address. Bits[31:5] of the base address of the exception vectors for exceptions taken in this exception level. Bits[4:0] of an exception vector are the exception offset.

Bits [4:0]

Reserved, RES0.

Accessing the HVBAR:

To access the HVBAR:

MRC p15,4,<Rt>,c12,c0,0 ; Read HVBAR into Rt

MCR p15,4,<Rt>,c12,c0,0 ; Write Rt to HVBAR

Register access is encoded as follows:

coproc	opc1	CRn	CRm	opc2
1111	100	1100	0000	000

G4.2.71 ICIALLU, Instruction Cache Invalidate All to PoU

The ICIALLU characteristics are:

Purpose

Invalidate all instruction caches to PoU. If branch predictors are architecturally visible, also flush branch predictors.

This register is part of the Cache maintenance operations functional group.

Usage constraints

This operation can be performed at the exception levels shown below:

EL0 (NS)	EL0 (S)	EL1 (NS)	EL1 (S)	EL2	EL3 (SCR.NS=1)	EL3 (SCR.NS=0)
-	-	WO	WO	WO	WO	WO

Configurations

ICIALLU performs the same function as AArch64 operation [IC IALLU](#).

Attributes

ICIALLU is a 32-bit system operation.

The ICIALLU operation ignores the value in the register specified by the instruction used to perform this operation. Software does not have to write a value to the register before issuing this instruction.

Performing the ICIALLU operation:

To perform the ICIALLU operation:

MCR p15,0,<Rt>,c7,c5,0 ; ICIALLU operation, ignoring the value in Rt

The operation is encoded as follows:

coproc	opc1	CRn	CRm	opc2
1111	000	0111	0101	000

G4.2.72 ICIALLUIS, Instruction Cache Invalidate All to PoU, Inner Shareable

The ICIALLUIS characteristics are:

Purpose

Invalidate all instruction caches Inner Shareable to PoU. If branch predictors are architecturally visible, also flush branch predictors.

This register is part of the Cache maintenance operations functional group.

Usage constraints

This operation can be performed at the exception levels shown below:

EL0 (NS)	EL0 (S)	EL1 (NS)	EL1 (S)	EL2	EL3 (SCR.NS=1)	EL3 (SCR.NS=0)
-	-	WO	WO	WO	WO	WO

Configurations

ICIALLUIS performs the same function as AArch64 operation [IC IALLUIS](#).

Attributes

ICIALLUIS is a 32-bit system operation.

The ICIALLUIS operation ignores the value in the register specified by the instruction used to perform this operation. Software does not have to write a value to the register before issuing this instruction.

Performing the ICIALLUIS operation:

To perform the ICIALLUIS operation:

MCR p15,0,<Rt>,c7,c1,0 ; ICIALLUIS operation, ignoring the value in Rt

The operation is encoded as follows:

coproc	opc1	CRn	CRm	opc2
1111	000	0111	0001	000

G4.2.73 ICIMVAU, Instruction Cache line Invalidate by VA to PoU

The ICIMVAU characteristics are:

Purpose

Invalidate instruction cache line by virtual address to PoU.

This register is part of the Cache maintenance operations functional group.

Usage constraints

This operation can be performed at the exception levels shown below:

EL0 (NS)	EL0 (S)	EL1 (NS)	EL1 (S)	EL2	EL3 (SCR.NS=1)	EL3 (SCR.NS=0)
-	-	WO	WO	WO	WO	WO

Configurations

ICIMVAU performs the same function as AArch64 operation [IC IVAU](#).

Attributes

ICIMVAU is a 32-bit system operation.

The ICIMVAU input value bit assignments are:

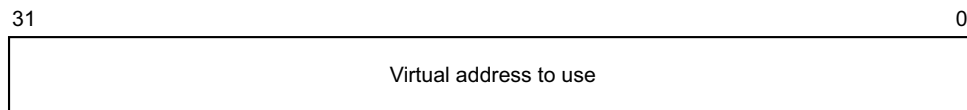

Bits [31:0]

Virtual address to use.

Performing the ICIMVAU operation:

To perform the ICIMVAU operation:

MCR p15,0,<Rt>,c7,c5,1 ; ICIMVAU operation

The operation is encoded as follows:

coproc	opc1	CRn	CRm	opc2
1111	000	0111	0101	001

G4.2.74 ID_AFR0, Auxiliary Feature Register 0

The ID_AFR0 characteristics are:

Purpose

Provides information about the IMPLEMENTATION DEFINED features of the processor in AArch32.
This register is part of the Identification registers functional group.

Usage constraints

This register is accessible as shown below:

EL0 (NS)	EL0 (S)	EL1 (NS)	EL1 (S)	EL2	EL3 (SCR.NS=1)	EL3 (SCR.NS=0)
-	-	RO	RO	RO	RO	RO

Must be interpreted with the Main ID Register, [MIDR](#).

Configurations

ID_AFR0 is architecturally mapped to AArch64 register [ID_AFR0_EL1](#).

There is one instance of this register that is used in both Secure and Non-secure states.

Attributes

ID_AFR0 is a 32-bit register.

The ID_AFR0 bit assignments are:

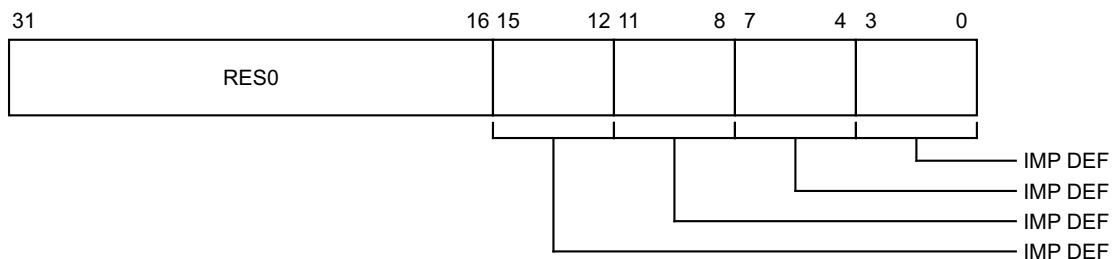

Bits [31:16]

Reserved, RES0.

Accessing the ID_AFR0:

To access the ID_AFR0:

MRC p15,0,<Rt>,c0,c1,3 ; Read ID_AFR0 into Rt

Register access is encoded as follows:

coproc	opc1	CRn	CRm	opc2
1111	000	0000	0001	011

G4.2.75 ID_DFR0, Debug Feature Register 0

The ID_DFR0 characteristics are:

Purpose

Provides top level information about the debug system in AArch32.
 This register is part of the Identification registers functional group.

Usage constraints

This register is accessible as shown below:

EL0 (NS)	EL0 (S)	EL1 (NS)	EL1 (S)	EL2	EL3 (SCR.NS=1)	EL3 (SCR.NS=0)
-	-	RO	RO	RO	RO	RO

Must be interpreted with the Main ID Register, [MIDR](#).

Configurations

ID_DFR0 is architecturally mapped to AArch64 register [ID_DFR0_EL1](#).
 There is one instance of this register that is used in both Secure and Non-secure states.

Attributes

ID_DFR0 is a 32-bit register.

The ID_DFR0 bit assignments are:

31	28 27	24 23	20 19	16 15	12 11	8 7	4 3	0
RES0	PerfMon	MProfDbg	MMapTrc	CopTrc	MMapDbg	CopSDBG	CopDbg	

Bits [31:28]

Reserved, RES0.

PerfMon, bits [27:24]

Performance Monitors. Support for coprocessor-based ARM Performance Monitors Extension, for A and R profile processors. Possible values are:

- 0000 Performance Monitors Extension system registers not implemented.
- 0001 Support for Performance Monitors Extension version 1 (PMUv1) system registers. Not permitted in v8-A.
- 0010 Support for Performance Monitors Extension version 2 (PMUv2) system registers. Not permitted in v8-A.
- 0011 Support for Performance Monitors Extension version 3 (PMUv3) system registers.
- 1111 IMPLEMENTATION DEFINED form of Performance Monitors system registers supported. PMUv3 not supported.

All other values are reserved.

In v7, the value 0b0000 can mean that PMUv1 is implemented. PMUv1 is not permitted in a v8-A implementation.

MProfDbg, bits [23:20]

M Profile Debug. Support for memory-mapped debug model for M profile processors. Permitted values are:

- 0000 Not supported.

0001 Support for M profile Debug architecture, with memory-mapped access.
All other values are reserved. For v8-A, this field is 0b0000.

MMapTrc, bits [19:16]

Memory Mapped Trace. Support for memory-mapped trace model. Permitted values are:

0000 Not supported.
0001 Support for ARM trace architecture, with memory-mapped access.
All other values are reserved.

In the Trace registers, the ETMIDR gives more information about the implementation.

CopTrc, bits [15:12]

Coprocessor Trace. Support for coprocessor-based trace model. Permitted values are:

0000 Not supported.
0001 Support for ARM trace architecture, with CP14 access.
All other values are reserved.

In the Trace registers, the ETMIDR gives more information about the implementation.

MMapDbg, bits [11:8]

Memory Mapped Debug. Support for v7 memory-mapped debug model, for A and R profile processors.

In v8-A this field is RES0. The optional memory map defined by v8-A is not compatible with v7-A.

CopSDBG, bits [7:4]

Coprocessor Secure Debug. Support for coprocessor-based Secure debug model, for an A profile processor that includes the Security Extensions.

If EL3 is not implemented and the processor is Non-secure, this field is RES0. Otherwise, this field reads the same as bits [3:0].

CopDbg, bits [3:0]

Coprocessor Debug. Support for coprocessor based debug model, for A and R profile processors. Permitted values are:

0000 Not supported.
0010 Support for v6 Debug architecture, with CP14 access.
0011 Support for v6.1 Debug architecture, with CP14 access.
0100 Support for v7 Debug architecture, with CP14 access.
0101 Support for v7.1 Debug architecture, with CP14 access.
0110 Support for v8-A debug architecture, with CP14 access. This is the value that this field has in v8-A.

All other values are reserved.

Accessing the ID_DFR0:

To access the ID_DFR0:

MRC p15,0,<Rt>,c0,c1,2 ; Read ID_DFR0 into Rt

Register access is encoded as follows:

coproc	opc1	CRn	CRm	opc2
1111	000	0000	0001	010

G4.2.76 ID_ISAR0, Instruction Set Attribute Register 0

The ID_ISAR0 characteristics are:

Purpose

Provides information about the instruction sets implemented by the processor in AArch32.
 This register is part of the Identification registers functional group.

Usage constraints

This register is accessible as shown below:

EL0 (NS)	EL0 (S)	EL1 (NS)	EL1 (S)	EL2	EL3 (SCR.NS=1)	EL3 (SCR.NS=0)
-	-	RO	RO	RO	RO	RO

Must be interpreted with [ID_ISAR1](#), [ID_ISAR2](#), [ID_ISAR3](#), [ID_ISAR4](#), and [ID_ISAR5](#).

Configurations

ID_ISAR0 is architecturally mapped to AArch64 register [ID_ISAR0_EL1](#).
 There is one instance of this register that is used in both Secure and Non-secure states.

Attributes

ID_ISAR0 is a 32-bit register.

The ID_ISAR0 bit assignments are:

31	28 27	24 23	20 19	16 15	12 11	8 7	4 3	0
RES0	Divide	Debug	Coproc	CmpBranch	BitField	BitCount	Swap	

Bits [31:28]

Reserved, RES0.

Divide, bits [27:24]

Indicates the implemented Divide instructions. Permitted values are:

- 0000 None implemented.
 - 0001 Adds SDIV and UDIV in the T32 instruction set.
 - 0010 As for 0b0001, and adds SDIV and UDIV in the A32 instruction set.
- All other values are reserved.

Debug, bits [23:20]

Indicates the implemented Debug instructions. Permitted values are:

- 0000 None implemented.
 - 0001 Adds BKPT.
- All other values are reserved.

Coproc, bits [19:16]

Indicates the implemented Coprocessor instructions. Permitted values are:

- 0000 None implemented, except for instructions separately attributed by the architecture, including CP15, CP14, and Advanced SIMD and VFP.
- 0001 Adds generic CDP, LDC, MCR, MRC, and STC.
- 0010 As for 0b0001, and adds generic CDP2, LDC2, MCR2, MRC2, and STC2.

0011 As for 0b0010, and adds generic MCRR and MRRC.
 0100 As for 0b0011, and adds generic MCRR2 and MRRC2.
 All other values are reserved.

CmpBranch, bits [15:12]

Indicates the implemented combined Compare and Branch instructions in the T32 instruction set.
 Permitted values are:
 0000 None implemented.
 0001 Adds CBNZ and CBZ.
 All other values are reserved.

BitField, bits [11:8]

Indicates the implemented BitField instructions. Permitted values are:
 0000 None implemented.
 0001 Adds BFC, BFI, SBFX, and UBFX.
 All other values are reserved.

BitCount, bits [7:4]

Indicates the implemented Bit Counting instructions. Permitted values are:
 0000 None implemented.
 0001 Adds CLZ.
 All other values are reserved.

Swap, bits [3:0]

Indicates the implemented Swap instructions in the A32 instruction set. Permitted values are:
 0000 None implemented.
 0001 Adds SWP and SWPB.
 All other values are reserved.
 In v8-A this field is 0b0000. The SWP and SWPB instructions are not supported in v8-A.

Accessing the ID_ISAR0:

To access the ID_ISAR0:

MRC p15,0,<Rt>,c0,c2,0 ; Read ID_ISAR0 into Rt

Register access is encoded as follows:

coproc	opc1	CRn	CRm	opc2
1111	000	0000	0010	000

G4.2.77 ID_ISAR1, Instruction Set Attribute Register 1

The ID_ISAR1 characteristics are:

Purpose

Provides information about the instruction sets implemented by the processor in AArch32.
 This register is part of the Identification registers functional group.

Usage constraints

This register is accessible as shown below:

EL0 (NS)	EL0 (S)	EL1 (NS)	EL1 (S)	EL2	EL3 (SCR.NS=1)	EL3 (SCR.NS=0)
-	-	RO	RO	RO	RO	RO

Must be interpreted with [ID_ISAR0](#), [ID_ISAR2](#), [ID_ISAR3](#), [ID_ISAR4](#), and [ID_ISAR5](#).

Configurations

ID_ISAR1 is architecturally mapped to AArch64 register [ID_ISAR1_EL1](#).
 There is one instance of this register that is used in both Secure and Non-secure states.

Attributes

ID_ISAR1 is a 32-bit register.

The ID_ISAR1 bit assignments are:

31	28 27	24 23	20 19	16 15	12 11	8 7	4 3	0
Jazelle	Interwork	Immediate	IfThen	Extend	Except_AR	Except	Endian	

Jazelle, bits [31:28]

Indicates the implemented Jazelle extension instructions. Permitted values are:

- 0000 No support for Jazelle.
- 0001 Adds the BXJ instruction, and the J bit in the PSR. This setting might indicate a trivial implementation of the Jazelle extension.

All other values are reserved.

Interwork, bits [27:24]

Indicates the implemented Interworking instructions. Permitted values are:

- 0000 None implemented.
- 0001 Adds the BX instruction, and the T bit in the PSR.
- 0010 As for 0b0001, and adds the BLX instruction. PC loads have BX-like behavior.
- 0011 As for 0b0010, and guarantees that data-processing instructions in the A32 instruction set with the PC as the destination and the S bit clear have BX-like behavior.

All other values are reserved.

Immediate, bits [23:20]

Indicates the implemented data-processing instructions with long immediates. Permitted values are:

- 0000 None implemented.
- 0001 Adds:
 - The MOVT instruction.

- The MOV instruction encodings with zero-extended 16-bit immediates.
- The T32 ADD and SUB instruction encodings with zero-extended 12-bit immediates, and the other ADD, ADR, and SUB encodings cross-referenced by the pseudocode for those encodings.

All other values are reserved.

IfThen, bits [19:16]

Indicates the implemented If-Then instructions in the T32 instruction set. Permitted values are:

- 0000 None implemented.
- 0001 Adds the IT instructions, and the IT bits in the PSRs.

All other values are reserved.

Extend, bits [15:12]

Indicates the implemented Extend instructions. Permitted values are:

- 0000 No scalar sign-extend or zero-extend instructions are implemented, where scalar instructions means non-Advanced SIMD instructions.
- 0001 Adds the SXTB, SXTH, UXTB, and UXTH instructions.
- 0010 As for 0b0001, and adds the SXTB16, SXTAB, SXTAB16, SXTAH, UXTB16, UXTAB, UXTAB16, and UXTAH instructions.

All other values are reserved.

Except_AR, bits [11:8]

Indicates the implemented A and R profile exception-handling instructions. Permitted values are:

- 0000 None implemented.
- 0001 Adds the SRS and RFE instructions, and the A and R profile forms of the CPS instruction.

All other values are reserved.

Except, bits [7:4]

Indicates the implemented exception-handling instructions in the ARM instruction set. Permitted values are:

- 0000 Not implemented. This indicates that the User bank and Exception return forms of the LDM and STM instructions are not implemented.
- 0001 Adds the LDM (exception return), LDM (user registers), and STM (user registers) instruction versions.

All other values are reserved.

Endian, bits [3:0]

Indicates the implemented Endian instructions. Permitted values are:

- 0000 None implemented.
- 0001 Adds the SETEND instruction, and the E bit in the PSRs.

All other values are reserved.

Accessing the ID_ISAR1:

To access the ID_ISAR1:

MRC p15,0,<Rt>,c0,c2,1 ; Read ID_ISAR1 into Rt

Register access is encoded as follows:

coproc	opc1	CRn	CRm	opc2
1111	000	0000	0010	001

G4.2.78 ID_ISAR2, Instruction Set Attribute Register 2

The ID_ISAR2 characteristics are:

Purpose

Provides information about the instruction sets implemented by the processor in AArch32.
This register is part of the Identification registers functional group.

Usage constraints

This register is accessible as shown below:

EL0 (NS)	EL0 (S)	EL1 (NS)	EL1 (S)	EL2	EL3 (SCR.NS=1)	EL3 (SCR.NS=0)
-	-	RO	RO	RO	RO	RO

Must be interpreted with [ID_ISAR0](#), [ID_ISAR1](#), [ID_ISAR3](#), [ID_ISAR4](#), and [ID_ISAR5](#).

Configurations

ID_ISAR2 is architecturally mapped to AArch64 register [ID_ISAR2_EL1](#).

There is one instance of this register that is used in both Secure and Non-secure states.

Attributes

ID_ISAR2 is a 32-bit register.

The ID_ISAR2 bit assignments are:

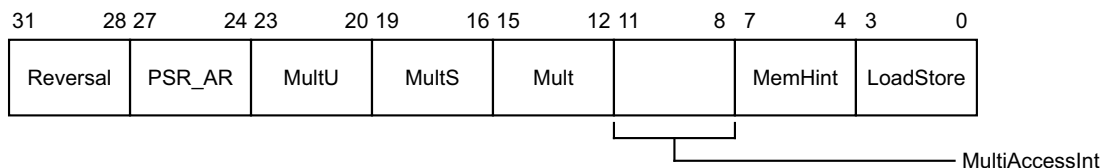

Reversal, bits [31:28]

Indicates the implemented Reversal instructions. Permitted values are:

- 0000 None implemented.
- 0001 Adds the REV, REV16, and REVSH instructions.
- 0010 As for 0b0001, and adds the RBIT instruction.

All other values are reserved.

PSR_AR, bits [27:24]

Indicates the implemented A and R profile instructions to manipulate the PSR. Permitted values are:

- 0000 None implemented.
- 0001 Adds the MRS and MSR instructions, and the exception return forms of data-processing instructions.

All other values are reserved.

The exception return forms of the data-processing instructions are:

- In the A32 instruction set, data-processing instructions with the PC as the destination and the S bit set. These instructions might be affected by the WithShifts attribute.
- In the T32 instruction set, the SUBS PC,LR,#N instruction.

MultU, bits [23:20]

Indicates the implemented advanced unsigned Multiply instructions. Permitted values are:

- 0000 None implemented.
 - 0001 Adds the UMULL and UMLAL instructions.
 - 0010 As for 0b0001, and adds the UMAAL instruction.
- All other values are reserved.

MultS, bits [19:16]

Indicates the implemented advanced signed Multiply instructions. Permitted values are:

- 0000 None implemented.
 - 0001 Adds the SMULL and SMLAL instructions.
 - 0010 As for 0b0001, and adds the SMLABB, SMLABT, SMLALBB, SMLALBT, SMLALTB, SMLALTT, SMLATB, SMLATT, SMLAWB, SMLAWT, SMULBB, SMULBT, SMULTB, SMULTT, SMULWB, and SMULWT instructions. Also adds the Q bit in the PSRs.
 - 0011 As for 0b0010, and adds the SMLAD, SMLADX, SMLALD, SMLALDX, SMLS D, SMLS DX, SMLS LD, SMLS LD X, SMMLA, SMMLAR, SMMLS, SMMLSR, SMMUL, SMMULR, SMUAD, SMUADX, SMUSD, and SMUSD X instructions.
- All other values are reserved.

Mult, bits [15:12]

Indicates the implemented additional Multiply instructions. Permitted values are:

- 0000 No additional instructions implemented. This means only MUL is implemented.
 - 0001 Adds the MLA instruction.
 - 0010 As for 0b0001, and adds the MLS instruction.
- All other values are reserved.

MultiAccessInt, bits [11:8]

Indicates the support for interruptible multi-access instructions. Permitted values are:

- 0000 No support. This means the LDM and STM instructions are not interruptible.
 - 0001 LDM and STM instructions are restartable.
 - 0010 LDM and STM instructions are continuable.
- All other values are reserved.

MemHint, bits [7:4]

Indicates the implemented Memory Hint instructions. Permitted values are:

- 0000 None implemented.
 - 0001 Adds the PLD instruction.
 - 0010 Adds the PLD instruction. (0b0001 and 0b0010 have identical effects.)
 - 0011 As for 0b0001 (or 0b0010), and adds the PLI instruction.
 - 0100 As for 0b0011, and adds the PLDW instruction.
- All other values are reserved.

LoadStore, bits [3:0]

Indicates the implemented additional load/store instructions. Permitted values are:

- 0000 No additional load/store instructions implemented.
- 0001 Adds the LDRD and STRD instructions.

0010 As for 0b0001, and adds the Load Acquire (LDAB, LDAH, LDA, LDAEXB, LDAEXH, LDAEX, LDAEXD) and Store Release (STLB, STLH, STL, STLEXB, STLEXH, STLEX, STLEXD) instructions.

All other values are reserved.

Accessing the ID_ISAR2:

To access the ID_ISAR2:

MRC p15,0,<Rt>,c0,c2,2 ; Read ID_ISAR2 into Rt

Register access is encoded as follows:

coproc	opc1	CRn	CRm	opc2
1111	000	0000	0010	010

G4.2.79 ID_ISAR3, Instruction Set Attribute Register 3

The ID_ISAR3 characteristics are:

Purpose

Provides information about the instruction sets implemented by the processor in AArch32.
 This register is part of the Identification registers functional group.

Usage constraints

This register is accessible as shown below:

EL0 (NS)	EL0 (S)	EL1 (NS)	EL1 (S)	EL2	EL3 (SCR.NS=1)	EL3 (SCR.NS=0)
-	-	RO	RO	RO	RO	RO

Must be interpreted with [ID_ISAR0](#), [ID_ISAR1](#), [ID_ISAR2](#), [ID_ISAR4](#), and [ID_ISAR5](#).

Configurations

ID_ISAR3 is architecturally mapped to AArch64 register [ID_ISAR3_EL1](#).
 There is one instance of this register that is used in both Secure and Non-secure states.

Attributes

ID_ISAR3 is a 32-bit register.

The ID_ISAR3 bit assignments are:

31	28 27	24 23	20 19	16 15	12 11	8 7	4 3	0
T32EE	TrueNOP	ThumbCopy	TabBranch	SynchPrim	SVC	SIMD	Saturate	

T32EE, bits [31:28]

Indicates the implemented TT32EE instructions. Permitted values are:

- 0000 None implemented.
- 0001 Adds the ENTERX and LEAVEX instructions, and modifies the load behavior to include null checking.

All other values are reserved.

This field can only have a value other than 0b0000 when the ID_PFR0.State3 field has a value of 0b0001.

TrueNOP, bits [27:24]

Indicates the implemented True NOP instructions. Permitted values are:

- 0000 None implemented. This means there are no NOP instructions that do not have any register dependencies.
- 0001 Adds true NOP instructions in both the T32 and A32 instruction sets. This also permits additional NOP-compatible hints.

All other values are reserved.

ThumbCopy, bits [23:20]

Indicates the support for T32 non flag-setting MOV instructions. Permitted values are:

- 0000 Not supported. This means that in the T32 instruction set, encoding T1 of the MOV (register) instruction does not support a copy from a low register to a low register.

0001 Adds support for T32 instruction set encoding T1 of the MOV (register) instruction, copying from a low register to a low register.

All other values are reserved.

TabBranch, bits [19:16]

Indicates the implemented Table Branch instructions in the T32 instruction set. Permitted values are:

0000 None implemented.

0001 Adds the TBB and TBH instructions.

All other values are reserved.

SynchPrim, bits [15:12]

Used in conjunction with ID_ISAR4.SynchPrim_frac to indicate the implemented Synchronization Primitive instructions. Permitted values are:

0000 If SynchPrim_frac == 0b0000, no Synchronization Primitives implemented.

0001 If SynchPrim_frac == 0b0000, adds the LDREX and STREX instructions.

If SynchPrim_frac == 0b0011, also adds the CLREX, LDREXB, STREXB, and STREXH instructions.

0010 If SynchPrim_frac == 0b0000, as for [0b0001, 0b0011] and also adds the LDREXD and STREXD instructions.

All other combinations of SynchPrim and SynchPrim_frac are reserved.

SVC, bits [11:8]

Indicates the implemented SVC instructions. Permitted values are:

0000 Not implemented.

0001 Adds the SVC instruction.

All other values are reserved.

SIMD, bits [7:4]

Indicates the implemented SIMD instructions. Permitted values are:

0000 None implemented.

0001 Adds the SSAT and USAT instructions, and the Q bit in the PSRs.

0011 As for 0b0001, and adds the PKHBT, PKHTB, QADD16, QADD8, QASX, QSUB16, QSUB8, QSAX, SADD16, SADD8, SASX, SEL, SHADD16, SHADD8, SHASX, SHSUB16, SHSUB8, SHSAX, SSAT16, SSUB16, SSUB8, SSAX, SXTAB16, SXTB16, UADD16, UADD8, UASX, UHADD16, UHADD8, UHASX, UHSUB16, UHSUB8, UHSAX, UQADD16, UQADD8, UQASX, UQSUB16, UQSUB8, UQSAX, USAD8, USADA8, USAT16, USUB16, USUB8, USAX, UXTAB16, and UXTB16 instructions. Also adds support for the GE[3:0] bits in the PSRs.

All other values are reserved.

The SIMD field relates only to implemented instructions that perform SIMD operations on the general-purpose registers. **MVFR0** and **MVFR1** give information about the SIMD instructions implemented by the optional Advanced SIMD Extension.

Saturate, bits [3:0]

Indicates the implemented Saturate instructions. Permitted values are:

0000 None implemented. This means no non-Advanced SIMD saturate instructions are implemented.

0001 Adds the QADD, QDADD, QDSUB, and QSUB instructions, and the Q bit in the PSRs.

All other values are reserved.

Accessing the ID_ISAR3:

To access the ID_ISAR3:

MRC p15,0,<Rt>,c0,c2,3 ; Read ID_ISAR3 into Rt

Register access is encoded as follows:

coproc	opc1	CRn	CRm	opc2
1111	000	0000	0010	011

G4.2.80 ID_ISAR4, Instruction Set Attribute Register 4

The ID_ISAR4 characteristics are:

Purpose

Provides information about the instruction sets implemented by the processor in AArch32.
This register is part of the Identification registers functional group.

Usage constraints

This register is accessible as shown below:

EL0 (NS)	EL0 (S)	EL1 (NS)	EL1 (S)	EL2	EL3 (SCR.NS=1)	EL3 (SCR.NS=0)
-	-	RO	RO	RO	RO	RO

Must be interpreted with [ID_ISAR0](#), [ID_ISAR1](#), [ID_ISAR2](#), [ID_ISAR3](#), and [ID_ISAR5](#).

Configurations

ID_ISAR4 is architecturally mapped to AArch64 register [ID_ISAR4_EL1](#).
There is one instance of this register that is used in both Secure and Non-secure states.

Attributes

ID_ISAR4 is a 32-bit register.

The ID_ISAR4 bit assignments are:

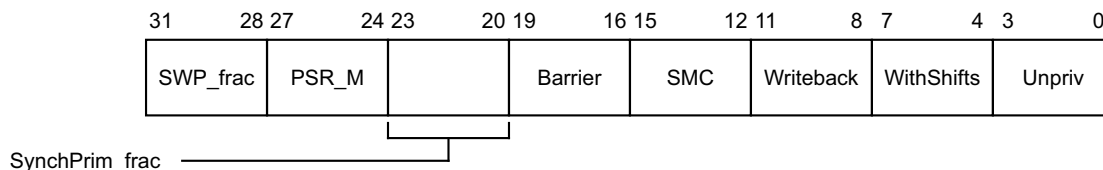

SWP_frac, bits [31:28]

Indicates support for the memory system locking the bus for SWP or SWPB instructions. Permitted values are:

- 0000 SWP or SWPB instructions not implemented.
- 0001 SWP or SWPB implemented but only in a uniprocessor context. SWP and SWPB do not guarantee whether memory accesses from other masters can come between the load memory access and the store memory access of the SWP or SWPB.

All other values are reserved. This field is valid only if the [ID_ISAR0.Swap_instrs](#) field is 0b0000.
In v8-A this field is 0b0000. The SWP and SWPB instructions are not supported in v8-A.

PSR_M, bits [27:24]

Indicates the implemented M profile instructions to modify the PSRs. Permitted values are:

- 0000 None implemented.
- 0001 Adds the M profile forms of the CPS, MRS, and MSR instructions.

All other values are reserved.

SynchPrim_frac, bits [23:20]

Used in conjunction with ID_ISAR3.SynchPrim to indicate the implemented Synchronization Primitive instructions. Possible values are:

- 0000 If SynchPrim == 0b0000, no Synchronization Primitives implemented. If SynchPrim == 0b0001, adds the LDREX and STREX instructions. If SynchPrim == 0b0010, also adds the CLREX, LDREXB, LDREXH, STREXB, STREXH, LDREXD, and STREXD instructions.
- 0011 If SynchPrim == 0b0001, adds the LDREX, STREX, CLREX, LDREXB, LDREXH, STREXB, and STREXH instructions.

All other combinations of SynchPrim and SynchPrim_frac are reserved.

Barrier, bits [19:16]

Indicates the implemented Barrier instructions in the A32 and T32 instruction sets. Permitted values are:

- 0000 None implemented. Barrier operations are provided only as CP15 operations.
- 0001 Adds the DMB, DSB, and ISB barrier instructions.

All other values are reserved.

SMC, bits [15:12]

Indicates the implemented SMC instructions. Permitted values are:

- 0000 None implemented.
- 0001 Adds the SMC instruction.

All other values are reserved.

Writeback, bits [11:8]

Indicates the support for Writeback addressing modes. Permitted values are:

- 0000 Basic support. Only the LDM, STM, PUSH, POP, SRS, and RFE instructions support writeback addressing modes. These instructions support all of their writeback addressing modes.
- 0001 Adds support for all of the writeback addressing modes defined in ARMv7.

All other values are reserved.

WithShifts, bits [7:4]

Indicates the support for instructions with shifts. Permitted values are:

- 0000 Nonzero shifts supported only in MOV and shift instructions.
- 0001 Adds support for shifts of loads and stores over the range LSL 0-3.
- 0011 As for 0b0001, and adds support for other constant shift options, both on load/store and other instructions.
- 0100 As for 0b0011, and adds support for register-controlled shift options.

All other values are reserved.

Unpriv, bits [3:0]

Indicates the implemented unprivileged instructions. Permitted values are:

- 0000 None implemented. No T variant instructions are implemented.
- 0001 Adds the LDRBT, LDRT, STRBT, and STRT instructions.
- 0010 As for 0b0001, and adds the LDRHT, LDRSBT, LDRSHT, and STRHT instructions.

All other values are reserved.

Accessing the ID_ISAR4:

To access the ID_ISAR4:

MRC p15,0,<Rt>,c0,c2,4 ; Read ID_ISAR4 into Rt

Register access is encoded as follows:

coproc	opc1	CRn	CRm	opc2
1111	000	0000	0010	100

G4.2.81 ID_ISAR5, Instruction Set Attribute Register 5

The ID_ISAR5 characteristics are:

Purpose

Provides information about the instruction sets implemented by the processor in AArch32.
 This register is part of the Identification registers functional group.

Usage constraints

This register is accessible as shown below:

EL0 (NS)	EL0 (S)	EL1 (NS)	EL1 (S)	EL2	EL3 (SCR.NS=1)	EL3 (SCR.NS=0)
-	-	RO	RO	RO	RO	RO

Must be interpreted with ID_ISAR0, ID_ISAR1, ID_ISAR2, ID_ISAR3, and ID_ISAR4.

Configurations

ID_ISAR5 is architecturally mapped to AArch64 register ID_ISAR5_EL1.
 There is one instance of this register that is used in both Secure and Non-secure states.

Attributes

ID_ISAR5 is a 32-bit register.

The ID_ISAR5 bit assignments are:

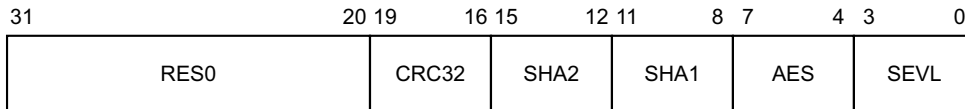

Bits [31:20]

Reserved, RES0.

CRC32, bits [19:16]

Indicates whether CRC32 instructions are implemented in AArch32.

0000 No CRC32 instructions implemented.

0001 CRC32B, CRC32H, CRC32W, CRC32CB, CRC32CH, and CRC32CW instructions implemented.

All other values are reserved.

This field must have the same value as ID_AA64ISAR0_EL1.CRC32. The architecture requires that if CRC32 is supported in one Execution state, it must be supported in both Execution states.

SHA2, bits [15:12]

Indicates whether SHA2 instructions are implemented in AArch32.

0000 No SHA2 instructions implemented.

0001 SHA256H, SHA256H2, SHA256SU0, and SHA256SU1 implemented.

All other values are reserved.

SHA1, bits [11:8]

Indicates whether SHA1 instructions are implemented in AArch32.

0000 No SHA1 instructions implemented.

0001 SHA1C, SHA1P, SHA1M, SHA1H, SHA1SU0, and SHA1SU1 implemented.

All other values are reserved.

AES, bits [7:4]

Indicates whether AES instructions are implemented in AArch32.

- 0000 No AES instructions implemented.
 - 0001 AESE, AESD, AESMC, and AESIMC implemented.
 - 0010 As for 0b0001, plus PMULL/PMULL2 instructions operating on 64-bit data quantities.
- All other values are reserved.

SEVL, bits [3:0]

Indicates whether the SEVL instruction is implemented in AArch32.

- 0000 SEVL is implemented as a NOP.
- 0001 SEVL is implemented as Send Event Local.

Accessing the ID_ISAR5:

To access the ID_ISAR5:

MRC p15,0,<Rt>,c0,c2,5 ; Read ID_ISAR5 into Rt

Register access is encoded as follows:

coproc	opc1	CRn	CRm	opc2
1111	000	0000	0010	101

G4.2.82 ID_MMFR0, Memory Model Feature Register 0

The ID_MMFR0 characteristics are:

Purpose

Provides information about the implemented memory model and memory management support in AArch32.

This register is part of the Identification registers functional group.

Usage constraints

This register is accessible as shown below:

EL0 (NS)	EL0 (S)	EL1 (NS)	EL1 (S)	EL2	EL3 (SCR.NS=1)	EL3 (SCR.NS=0)
-	-	RO	RO	RO	RO	RO

Must be interpreted with [ID_MMFR1](#), [ID_MMFR2](#), and [ID_MMFR3](#).

Configurations

ID_MMFR0 is architecturally mapped to AArch64 register [ID_MMFR0_EL1](#).

There is one instance of this register that is used in both Secure and Non-secure states.

Attributes

ID_MMFR0 is a 32-bit register.

The ID_MMFR0 bit assignments are:

31	28 27	24 23	20 19	16 15	12 11	8 7	4 3	0
InnerShr	FCSE	AuxReg	TCM	ShareLvl	OuterShr	PMSA	VMSA	

InnerShr, bits [31:28]

Innermost Shareability. Indicates the innermost shareability domain implemented. Permitted values are:

- 0000 Implemented as Non-cacheable.
- 0001 Implemented with hardware coherency support.
- 1111 Shareability ignored.

All other values are reserved.

This field is valid only if the implementation distinguishes between Inner Shareable and Outer Shareable, by implementing two levels of shareability, as indicated by the value of the Shareability levels field, bits[15:12].

When the Shareability level field is zero, this field is UNK.

FCSE, bits [27:24]

Indicates whether the implementation includes the FCSE. Permitted values are:

- 0000 Not supported.
- 0001 Support for FCSE.

All other values are reserved.

The value of 0b0001 is only permitted when the VMSA field has a value greater than 0b0010.

AuxReg, bits [23:20]

Auxiliary Registers. Indicates support for Auxiliary registers. Permitted values are:

- 0000 None supported.
- 0001 Support for Auxiliary Control Register only.
- 0010 Support for Auxiliary Fault Status Registers (AIFSR and ADFSR) and Auxiliary Control Register.

All other values are reserved.

TCM, bits [19:16]

Indicates support for TCMs and associated DMAs. Permitted values are:

- 0000 Not supported.
- 0001 Support is IMPLEMENTATION DEFINED. ARMv7 requires this setting.
- 0010 Support for TCM only, ARMv6 implementation.
- 0011 Support for TCM and DMA, ARMv6 implementation.

All other values are reserved.

An ARMv7 implementation might include an ARMv6 model for TCM support. However, in ARMv7 this is an IMPLEMENTATION DEFINED option, and therefore it must be represented by the 0b0001 encoding in this field.

ShareLvl, bits [15:12]

Shareability Levels. Indicates the number of shareability levels implemented. Permitted values are:

- 0000 One level of shareability implemented.
- 0001 Two levels of shareability implemented.

All other values are reserved.

OuterShr, bits [11:8]

Outermost Shareability. Indicates the outermost shareability domain implemented. Permitted values are:

- 0000 Implemented as Non-cacheable.
- 0001 Implemented with hardware coherency support.
- 1111 Shareability ignored.

All other values are reserved.

PMSA, bits [7:4]

Indicates support for a PMSA. Permitted values are:

- 0000 Not supported.
- 0001 Support for IMPLEMENTATION DEFINED PMSA.
- 0010 Support for PMSAv6, with a Cache Type Register implemented.
- 0011 Support for PMSAv7, with support for memory subsections. ARMv7-R profile.

All other values are reserved.

When the PMSA field is set to a value other than 0b0000 the VMSA field must be set to 0b0000.

VMSA, bits [3:0]

Indicates support for a VMSA. Permitted values are:

- 0000 Not supported.
- 0001 Support for IMPLEMENTATION DEFINED VMSA.
- 0010 Support for VMSAv6, with Cache and TLB Type Registers implemented.
- 0011 Support for VMSAv7, with support for remapping and the Access flag. ARMv7-A profile.

0100 As for 0b0011, and adds support for the PXN bit in the Short-descriptor translation table format descriptors.

0101 As for 0b0100, and adds support for the Long-descriptor translation table format.

All other values are reserved.

When the VMVA field is set to a value other than 0b0000 the PMSA field must be set to 0b0000.

Accessing the ID_MMFR0:

To access the ID_MMFR0:

MRC p15,0,<Rt>,c0,c1,4 ; Read ID_MMFR0 into Rt

Register access is encoded as follows:

coproc	opc1	CRn	CRm	opc2
1111	000	0000	0001	100

G4.2.83 ID_MMFR1, Memory Model Feature Register 1

The ID_MMFR1 characteristics are:

Purpose

Provides information about the implemented memory model and memory management support in AArch32.

This register is part of the Identification registers functional group.

Usage constraints

This register is accessible as shown below:

EL0 (NS)	EL0 (S)	EL1 (NS)	EL1 (S)	EL2	EL3 (SCR.NS=1)	EL3 (SCR.NS=0)
-	-	RO	RO	RO	RO	RO

Must be interpreted with [ID_MMFR0](#), [ID_MMFR2](#), and [ID_MMFR3](#).

Configurations

ID_MMFR1 is architecturally mapped to AArch64 register [ID_MMFR1_EL1](#).

There is one instance of this register that is used in both Secure and Non-secure states.

Attributes

ID_MMFR1 is a 32-bit register.

The ID_MMFR1 bit assignments are:

31	28	27	24	23	20	19	16	15	12	11	8	7	4	3	0
BPred	L1TstCln		L1Uni		L1Hvd		L1UniSW		L1HvdSW		L1UniVA		L1HvdVA		

BPred, bits [31:28]

Branch Predictor. Indicates branch predictor management requirements. Permitted values are:

- 0000 No branch predictor, or no MMU present. Implies a fixed MPU configuration.
- 0001 Branch predictor requires flushing on:
 - Enabling or disabling the MMU.
 - Writing new data to instruction locations.
 - Writing new mappings to the translation tables.
 - Any change to the [TTBR0](#), [TTBR1](#), or [TTBCR](#) registers.
 - Changes of FCSE ProcessID or ContextID.
- 0010 Branch predictor requires flushing on:
 - Enabling or disabling the MMU.
 - Writing new data to instruction locations.
 - Writing new mappings to the translation tables.
 - Any change to the [TTBR0](#), [TTBR1](#), or [TTBCR](#) registers without a corresponding change to the FCSE ProcessID or ContextID.
- 0011 Branch predictor requires flushing only on writing new data to instruction locations.
- 0100 For execution correctness, branch predictor requires no flushing at any time.

All other values are reserved.

The branch predictor is described in some documentation as the Branch Target Buffer.

L1TstCln, bits [27:24]

Level 1 cache Test and Clean. Indicates the supported Level 1 data cache test and clean operations, for Harvard or unified cache implementations. Permitted values are:

- 0000 None supported. This is the required setting for ARMv7.
- 0001 Supported Level 1 data cache test and clean operations are:
 - Test and clean data cache.
- 0010 As for 0b0001, and adds:
 - Test, clean, and invalidate data cache.

All other values are reserved.

L1Uni, bits [23:20]

Level 1 Unified cache. Indicates the supported entire Level 1 cache maintenance operations, for a unified cache implementation. Permitted values are:

- 0000 None supported. This is the required setting for ARMv7, because ARMv7 requires a hierarchical cache implementation.
- 0001 Supported entire Level 1 cache operations are:
 - Invalidate cache, including branch predictor if appropriate.
 - Invalidate branch predictor, if appropriate.
- 0010 As for 0b0001, and adds:
 - Clean cache, using a recursive model that uses the cache dirty status bit.
 - Clean and invalidate cache, using a recursive model that uses the cache dirty status bit.

All other values are reserved.

If this field is set to a value other than 0b0000 then the L1 Harvard cache field, bits[19:16], must be set to 0b0000.

L1Hvd, bits [19:16]

Level 1 Harvard cache. Indicates the supported entire Level 1 cache maintenance operations, for a Harvard cache implementation. Permitted values are:

- 0000 None supported. This is the required setting for ARMv7, because ARMv7 requires a hierarchical cache implementation.
- 0001 Supported entire Level 1 cache operations are:
 - Invalidate instruction cache, including branch predictor if appropriate.
 - Invalidate branch predictor, if appropriate.
- 0010 As for 0b0001, and adds:
 - Invalidate data cache.
 - Invalidate data cache and instruction cache, including branch predictor if appropriate.
- 0011 As for 0b0010, and adds:
 - Clean data cache, using a recursive model that uses the cache dirty status bit.
 - Clean and invalidate data cache, using a recursive model that uses the cache dirty status bit.

All other values are reserved.

If this field is set to a value other than 0b0000 then the L1 unified cache field, bits[23:20], must be set to 0b0000.

L1UniSW, bits [15:12]

Level 1 Unified cache by Set/Way. Indicates the supported Level 1 cache line maintenance operations by set/way, for a unified cache implementation. Permitted values are:

- 0000 None supported. This is the required setting for ARMv7, because ARMv7 requires a hierarchical cache implementation.
- 0001 Supported Level 1 unified cache line maintenance operations by set/way are:
 - Clean cache line by set/way.
- 0010 As for 0b0001, and adds:
 - Clean and invalidate cache line by set/way.
- 0011 As for 0b0010, and adds:
 - Invalidate cache line by set/way.

All other values are reserved.

If this field is set to a value other than 0b0000 then the L1 Harvard cache s/w field, bits[11:8], must be set to 0b0000.

L1HvdSW, bits [11:8]

Level 1 Harvard cache by Set/Way. Indicates the supported Level 1 cache line maintenance operations by set/way, for a Harvard cache implementation. Permitted values are:

- 0000 None supported. This is the required setting for ARMv7, because ARMv7 requires a hierarchical cache implementation.
- 0001 Supported Level 1 Harvard cache line maintenance operations by set/way are:
 - Clean data cache line by set/way.
 - Clean and invalidate data cache line by set/way.
- 0010 As for 0b0001, and adds:
 - Invalidate data cache line by set/way.
- 0011 As for 0b0010, and adds:
 - Invalidate instruction cache line by set/way.

All other values are reserved.

If this field is set to a value other than 0b0000 then the L1 unified cache s/w field, bits[15:12], must be set to 0b0000.

L1UniVA, bits [7:4]

Level 1 Unified cache by Virtual Address. Indicates the supported Level 1 cache line maintenance operations by VA, for a unified cache implementation. Permitted values are:

- 0000 None supported. This is the required setting for ARMv7, because ARMv7 requires a hierarchical cache implementation.
- 0001 Supported Level 1 unified cache line maintenance operations by VA are:
 - Clean cache line by VA.
 - Invalidate cache line by VA.
 - Clean and invalidate cache line by VA.
- 0010 As for 0b0001, and adds:
 - Invalidate branch predictor by VA, if branch predictor is implemented.

All other values are reserved.

If this field is set to a value other than 0b0000 then the L1 Harvard cache VA field, bits[3:0], must be set to 0b0000.

L1HvdVA, bits [3:0]

Level 1 Harvard cache by Virtual Address. Indicates the supported Level 1 cache line maintenance operations by VA, for a Harvard cache implementation. Permitted values are:

- 0000 None supported. This is the required setting for ARMv7, because ARMv7 requires a hierarchical cache implementation.
- 0001 Supported Level 1 Harvard cache line maintenance operations by VA are:
 - Clean data cache line by VA.
 - Invalidate data cache line by VA.
 - Clean and invalidate data cache line by VA.
 - Clean instruction cache line by VA.
- 0010 As for 0b0001, and adds:
 - Invalidate branch predictor by VA, if branch predictor is implemented.

All other values are reserved.

If this field is set to a value other than 0b0000 then the L1 unified cache VA field, bits[7:4], must be set to 0b0000.

Accessing the ID_MMFR1:

To access the ID_MMFR1:

MRC p15,0,<Rt>,c0,c1,5 ; Read ID_MMFR1 into Rt

Register access is encoded as follows:

coproc	opc1	CRn	CRm	opc2
1111	000	0000	0001	101

G4.2.84 ID_MMFR2, Memory Model Feature Register 2

The ID_MMFR2 characteristics are:

Purpose

Provides information about the implemented memory model and memory management support in AArch32.

This register is part of the Identification registers functional group.

Usage constraints

This register is accessible as shown below:

EL0 (NS)	EL0 (S)	EL1 (NS)	EL1 (S)	EL2	EL3 (SCR.NS=1)	EL3 (SCR.NS=0)
-	-	RO	RO	RO	RO	RO

Must be interpreted with [ID_MMFR0](#), [ID_MMFR1](#), and [ID_MMFR3](#).

Configurations

ID_MMFR2 is architecturally mapped to AArch64 register [ID_MMFR2_EL1](#).

There is one instance of this register that is used in both Secure and Non-secure states.

Attributes

ID_MMFR2 is a 32-bit register.

The ID_MMFR2 bit assignments are:

31	28 27	24 23	20 19	16 15	12 11	8 7	4 3	0
HWAccFlg	WFIStall	MemBarr	UniTLB	HvdTLB	L1HvdRng	L1HvdBG	L1HvdFG	

HWAccFlg, bits [31:28]

Hardware Access Flag. Indicates support for a Hardware Access flag, as part of the VMSAv7 implementation. Permitted values are:

0000 Not supported.

0001 Support for VMSAv7 Access flag, updated in hardware.

All other values are reserved.

On an ARMv7-R implementation this field must be 0b0000.

WFIStall, bits [27:24]

Wait For Interrupt Stall. Indicates the support for Wait For Interrupt (WFI) stalling. Permitted values are:

0000 Not supported.

0001 Support for WFI stalling.

All other values are reserved.

MemBarr, bits [23:20]

Memory Barrier. Indicates the supported CP15 memory barrier operations:

0000 None supported.

0001 Supported CP15 Memory barrier operations are:

- Data Synchronization Barrier (DSB), which in previous versions of the ARM architecture was named Data Write Barrier (DWB).

- 0010 As for 0b0001, and adds:
- Instruction Synchronization Barrier (ISB), which in previous versions of the ARM architecture was called Prefetch Flush.
 - Data Memory Barrier (DMB).

All other values are reserved.

From ARMv7, ARM deprecates the use of these operations. ID_ISAR4.Barrier_instrs indicates the level of support for the preferred barrier instructions.

UniTLB, bits [19:16]

Unified TLB. Indicates the supported TLB maintenance operations, for a unified TLB implementation. Permitted values are:

- 0000 Not supported.
- 0001 Supported unified TLB maintenance operations are:
- Invalidate all entries in the TLB.
 - Invalidate TLB entry by VA.
- 0010 As for 0b0001, and adds:
- Invalidate TLB entries by ASID match.
- 0011 As for 0b0010, and adds:
- Invalidate instruction TLB and data TLB entries by VA All ASID. This is a shared unified TLB operation.
- 0100 As for 0b0011, and adds:
- Invalidate Hyp mode unified TLB entry by VA.
 - Invalidate entire Non-secure EL1&0 unified TLB.
 - Invalidate entire Hyp mode unified TLB.
- 0101 As for 0b0100, and adds the following operations: [TLBIMVALIS](#), [TLBIMVAALIS](#), [TLBIMVALHIS](#), [TLBIMVAL](#), [TLBIMVAAL](#), [TLBIMVALH](#).
- 0110 As for 0b0101, and adds the following operations: [TLBIIPAS2IS](#), [TLBIIPAS2LIS](#), [TLBIIPAS2](#), [TLBIIPAS2L](#).

All other values are reserved.

If this field is set to a value other than 0b0000 then the Harvard TLB field, bits[15:12], must be set to 0b0000.

HvdTLB, bits [15:12]

Harvard TLB. Indicates the supported TLB maintenance operations, for a Harvard TLB implementation. Permitted values are:

- 0000 Not supported.
- 0001 Supported Harvard TLB maintenance operations are:
- Invalidate all entries in the ITLB and the DTLB. This is a shared unified TLB operation.
 - Invalidate all ITLB entries.
 - Invalidate all DTLB entries.
 - Invalidate ITLB entry by VA.
 - Invalidate DTLB entry by VA.
- 0010 As for 0b0001, and adds:
- Invalidate ITLB and DTLB entries by ASID match. This is a shared unified TLB operation.
 - Invalidate ITLB entries by ASID match.
 - Invalidate DTLB entries by ASID match.

All other values are reserved.

If this field is set to a value other than 0b0000 then the Unified TLB field, bits[19:16], must be set to 0b0000.

L1HvdRng, bits [11:8]

Level 1 Harvard cache Range. Indicates the supported Level 1 cache maintenance range operations, for a Harvard cache implementation. Permitted values are:

0000 Not supported.

0001 Supported Level 1 Harvard cache maintenance range operations are:

- Invalidate data cache range by VA.
- Invalidate instruction cache range by VA.
- Clean data cache range by VA.
- Clean and invalidate data cache range by VA.

All other values are reserved.

L1HvdBG, bits [7:4]

Level 1 Harvard cache Background fetch. Indicates the supported Level 1 cache background fetch operations, for a Harvard cache implementation. When supported, background fetch operations are non-blocking operations. Permitted values are:

0000 Not supported.

0001 Supported Level 1 Harvard cache background fetch operations are:

- Fetch instruction cache range by VA.
- Fetch data cache range by VA.

All other values are reserved.

L1HvdFG, bits [3:0]

Level 1 Harvard cache Foreground fetch. Indicates the supported Level 1 cache foreground fetch operations, for a Harvard cache implementation. When supported, foreground fetch operations are blocking operations. Permitted values are:

0000 Not supported.

0001 Supported Level 1 Harvard cache foreground fetch operations are:

- Fetch instruction cache range by VA.
- Fetch data cache range by VA.

All other values are reserved.

Accessing the ID_MMFR2:

To access the ID_MMFR2:

MRC p15,0,<Rt>,c0,c1,6 ; Read ID_MMFR2 into Rt

Register access is encoded as follows:

coproc	opc1	CRn	CRm	opc2
1111	000	0000	0001	110

G4.2.85 ID_MMFR3, Memory Model Feature Register 3

The ID_MMFR3 characteristics are:

Purpose

Provides information about the implemented memory model and memory management support in AArch32.

This register is part of the Identification registers functional group.

Usage constraints

This register is accessible as shown below:

EL0 (NS)	EL0 (S)	EL1 (NS)	EL1 (S)	EL2	EL3 (SCR.NS=1)	EL3 (SCR.NS=0)
-	-	RO	RO	RO	RO	RO

Must be interpreted with ID_MMFR0, ID_MMFR1, and ID_MMFR2.

Configurations

ID_MMFR3 is architecturally mapped to AArch64 register ID_MMFR3_EL1.

There is one instance of this register that is used in both Secure and Non-secure states.

Attributes

ID_MMFR3 is a 32-bit register.

The ID_MMFR3 bit assignments are:

31	28 27	24 23	20 19	16 15	12 11	8 7	4 3	0
Supersec	CMemSz	CohWalk	RES0	MaintBcst	BPMaint	CMaintSW	CMaintVA	

Supersec, bits [31:28]

Supersections. On a VMSA implementation, indicates whether Supersections are supported.

Permitted values are:

0000 Supersections supported.

1111 Supersections not supported.

All other values are reserved.

The sense of this identification is reversed from the normal usage in the CPUID mechanism, with the value of zero indicating that the feature is supported.

CMemSz, bits [27:24]

Cached Memory Size. Indicates the physical memory size supported by the processor caches.

Permitted values are:

0000 4GBbyte, corresponding to a 32-bit physical address range.

0001 64GBbyte, corresponding to a 36-bit physical address range.

0010 1TBbyte or more, corresponding to a 40-bit or larger physical address range.

All other values are reserved.

CohWalk, bits [23:20]

Coherent Walk. Indicates whether Translation table updates require a clean to the point of unification. Permitted values are:

- 0000 Updates to the translation tables require a clean to the point of unification to ensure visibility by subsequent translation table walks.
- 0001 Updates to the translation tables do not require a clean to the point of unification to ensure visibility by subsequent translation table walks.

All other values are reserved.

Bits [19:16]

Reserved, RES0.

MaintBcst, bits [15:12]

Maintenance Broadcast. Indicates whether Cache, TLB, and branch predictor operations are broadcast. Permitted values are:

- 0000 Cache, TLB, and branch predictor operations only affect local structures.
- 0001 Cache and branch predictor operations affect structures according to shareability and defined behavior of instructions. TLB operations only affect local structures.
- 0010 Cache, TLB, and branch predictor operations affect structures according to shareability and defined behavior of instructions.

All other values are reserved.

BPMaint, bits [11:8]

Branch Predictor Maintenance. Indicates the supported branch predictor maintenance operations in an implementation with hierarchical cache maintenance operations. Permitted values are:

- 0000 None supported.
- 0001 Supported branch predictor maintenance operations are:
 - Invalidate all branch predictors.
- 0010 As for 0b0001, and adds:
 - Invalidate branch predictors by VA.

All other values are reserved.

CMaintSW, bits [7:4]

Cache Maintenance by Set/Way. Indicates the supported cache maintenance operations by set/way, in an implementation with hierarchical caches. Permitted values are:

- 0000 None supported.
- 0001 Supported hierarchical cache maintenance operations by set/way are:
 - Invalidate data cache by set/way.
 - Clean data cache by set/way.
 - Clean and invalidate data cache by set/way.

All other values are reserved.

In a unified cache implementation, the data cache operations apply to the unified caches.

CMaintVA, bits [3:0]

Cache Maintenance by Virtual Address. Indicates the supported cache maintenance operations by VA, in an implementation with hierarchical caches. Permitted values are:

- 0000 None supported.
- 0001 Supported hierarchical cache maintenance operations by VA are:
 - Invalidate data cache by VA.
 - Clean data cache by VA.

- Clean and invalidate data cache by VA.
- Invalidate instruction cache by VA.
- Invalidate all instruction cache entries.

All other values are reserved.

In a unified cache implementation, the data cache operations apply to the unified caches, and the instruction cache operations are not implemented.

Accessing the ID_MMFR3:

To access the ID_MMFR3:

MRC p15,0,<Rt>,c0,c1,7 ; Read ID_MMFR3 into Rt

Register access is encoded as follows:

coproc	opc1	CRn	CRm	opc2
1111	000	0000	0001	111

G4.2.86 ID_PFR0, Processor Feature Register 0

The ID_PFR0 characteristics are:

Purpose

Gives top-level information about the instruction sets supported by the processor in AArch32.
This register is part of the Identification registers functional group.

Usage constraints

This register is accessible as shown below:

EL0 (NS)	EL0 (S)	EL1 (NS)	EL1 (S)	EL2	EL3 (SCR.NS=1)	EL3 (SCR.NS=0)
-	-	RO	RO	RO	RO	RO

Must be interpreted with [ID_PFR1](#).

Configurations

ID_PFR0 is architecturally mapped to AArch64 register [ID_PFR0_EL1](#).
There is one instance of this register that is used in both Secure and Non-secure states.

Attributes

ID_PFR0 is a 32-bit register.

The ID_PFR0 bit assignments are:

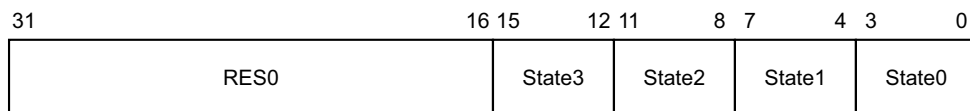

Bits [31:16]

Reserved, RES0.

State3, bits [15:12]

T32EE instruction set support. Permitted values are:

0000 Not implemented.
0001 T32EE instruction set implemented.

All other values are reserved.

The value of 0b0001 is only permitted when State1 == 0b0011.

State2, bits [11:8]

Jazelle extension support. Permitted values are:

0000 Not implemented.
0001 Jazelle extension implemented, without clearing of [JOSCR.CV](#) on exception entry.
0010 Jazelle extension implemented, with clearing of [JOSCR.CV](#) on exception entry.

All other values are reserved.

State1, bits [7:4]

T32 instruction set support. Permitted values are:

0000 T32 instruction set not implemented.

- 0001 T32 encodings before the introduction of Thumb-2 technology implemented:
- All instructions are 16-bit.
 - A BL or BLX is a pair of 16-bit instructions.
 - 32-bit instructions other than BL and BLX cannot be encoded.
- 0011 T32 encodings after the introduction of Thumb-2 technology implemented, for all 16-bit and 32-bit T32 basic instructions.
- All other values are reserved.

State0, bits [3:0]

- A32 instruction set support. Permitted values are:
- 0000 A32 instruction set not implemented.
- 0001 A32 instruction set implemented.
- All other values are reserved.

Accessing the ID_PFR0:

To access the ID_PFR0:

MRC p15,0,<Rt>,c0,c1,0 ; Read ID_PFR0 into Rt

Register access is encoded as follows:

coproc	opc1	CRn	CRm	opc2
1111	000	0000	0001	000

G4.2.87 ID_PFR1, Processor Feature Register 1

The ID_PFR1 characteristics are:

Purpose

Gives information about the programmers' model and extensions support in AArch32.
This register is part of the Identification registers functional group.

Usage constraints

This register is accessible as shown below:

EL0 (NS)	EL0 (S)	EL1 (NS)	EL1 (S)	EL2	EL3 (SCR.NS=1)	EL3 (SCR.NS=0)
-	-	RO	RO	RO	RO	RO

Must be interpreted with [ID_PFR0](#).

Configurations

ID_PFR1 is architecturally mapped to AArch64 register [ID_PFR1_EL1](#).
There is one instance of this register that is used in both Secure and Non-secure states.

Attributes

ID_PFR1 is a 32-bit register.

The ID_PFR1 bit assignments are:

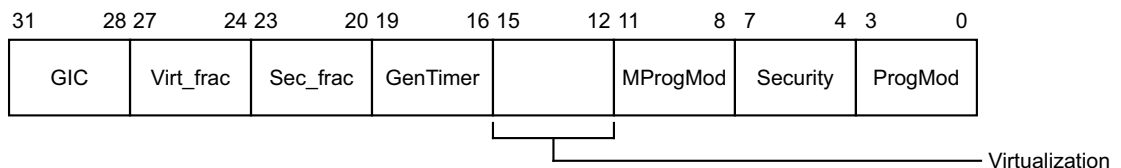

GIC, bits [31:28]

GIC CP15 interface. Permitted values are:

- 0000 No GIC CP15 registers are supported.
- 0001 GICv3 CP15 registers are supported.

All other values are reserved.

Virt_frac, bits [27:24]

Virtualization fractional field. When the Virtualization field is 0b0000, determines the support for features from the ARMv7 Virtualization Extensions. Permitted values are:

- 0000 No features from the ARMv7 Virtualization Extensions are implemented.
- 0001 The [SCR.SIF](#) bit is implemented. The modifications to the [SCR.AW](#) and [SCR.FW](#) bits are part of the control of whether the [CPSR.A](#) and [CPSR.F](#) bits mask the corresponding aborts. The [MSR](#) (Banked register) and [MRS](#) (Banked register) instructions are implemented.

This value is permitted only when ID_PFR1.Security is not 0b0000.

All other values are reserved.

This field is only valid when ID_PFR1[15:12] == 0, otherwise it holds the value 0b0000.

Sec_frac, bits [23:20]

Security fractional field. When the Security field is 0b0000, determines the support for features from the ARMv7 Security Extensions. Permitted values are:

- 0000 No features from the ARMv7 Security Extensions are implemented.
- 0001 The implementation includes the VBAR, and the TCR.PD0 and TCR.PD1 bits.
- 0010 As for 0b0001, plus the ability to access Secure or Non-secure physical memory is supported.

All other values are reserved.

This field is only valid when ID_PFR1[7:4] == 0, otherwise it holds the value 0b0000.

GenTimer, bits [19:16]

Generic Timer Extension support. Permitted values are:

- 0000 Not implemented.
- 0001 Generic Timer Extension implemented.

All other values are reserved.

Virtualization, bits [15:12]

Virtualization support. Permitted values are:

- 0000 EL2 not implemented.
- 0001 EL2 implemented.

All other values are reserved.

A value of 0b0001 implies implementation of the HVC, ERET, MRS (banked register), and MSR (banked register) instructions. The ID_ISARs do not identify whether these instructions are implemented.

MProgMod, bits [11:8]

M profile programmers' model support. Permitted values are:

- 0000 Not supported.
- 0010 Support for two-stack programmers' model.

All other values are reserved.

Security, bits [7:4]

Security support. Permitted values are:

- 0000 EL3 not implemented.
- 0001 EL3 implemented.
This includes support for Monitor mode and the SMC instruction.
- 0010 As for 0b0001, and adds the ability to set the NSACR.RFR bit. Not permitted in v8-A as the NSACR.RFR bit is RES0.

All other values are reserved.

ProgMod, bits [3:0]

Support for the standard programmers' model for ARMv4 and later. Model must support User, FIQ, IRQ, Supervisor, Abort, Undefined, and System modes. Permitted values are:

- 0000 Not supported.
- 0001 Supported.

All other values are reserved.

Accessing the ID_PFR1:

To access the ID_PFR1:

MRC p15,0,<Rt>,c0,c1,1 ; Read ID_PFR1 into Rt

Register access is encoded as follows:

coproc	opc1	CRn	CRm	opc2
1111	000	0000	0001	001

G4.2.88 IFAR, Instruction Fault Address Register

The IFAR characteristics are:

Purpose

Holds the virtual address of the faulting address that caused a synchronous Prefetch Abort exception.

This register is part of the Exception and fault handling registers functional group.

Usage constraints

This register is accessible as shown below:

When accessed as IFAR(S):

EL0 (NS)	EL0 (S)	EL1 (NS)	EL1 (S)	EL2	EL3 (SCR.NS=1)	EL3 (SCR.NS=0)
-	-	-	RW	-	-	RW

When accessed as IFAR(NS):

EL0 (NS)	EL0 (S)	EL1 (NS)	EL1 (S)	EL2	EL3 (SCR.NS=1)	EL3 (SCR.NS=0)
-	-	RW	-	RW	RW	-

Configurations

IFAR(NS) is architecturally mapped to AArch64 register [FAR_EL1](#)[63:32].

IFAR(S) is architecturally mapped to AArch32 register [HIFAR](#) when EL2 is implemented.

IFAR(S) is architecturally mapped to AArch64 register [FAR_EL2](#)[63:32] when EL2 is implemented.

IFAR(S) can be mapped to AArch64 register [FAR_EL3](#)[63:32] when EL2 is not implemented, but this is not architecturally mandated.

If EL3 is using AArch32, there are separate Secure and Non-secure instances of this register.

Attributes

IFAR is a 32-bit register.

The IFAR bit assignments are:

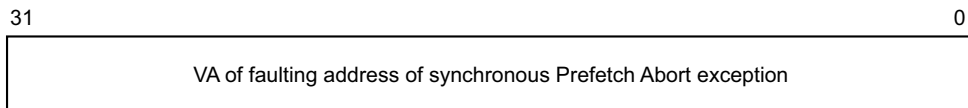

Bits [31:0]

VA of faulting address of synchronous Prefetch Abort exception.

Accessing the IFAR:

To access the IFAR:

MRC p15,0,<Rt>,c6,c0,2 ; Read IFAR into Rt
 MCR p15,0,<Rt>,c6,c0,2 ; Write Rt to IFAR

Register access is encoded as follows:

coproc	opc1	CRn	CRm	opc2
1111	000	0110	0000	010

G4.2.89 IFSR, Instruction Fault Status Register

The IFSR characteristics are:

Purpose

Holds status information about the last instruction fault.

This register is part of the Exception and fault handling registers functional group.

Usage constraints

This register is accessible as shown below:

When accessed as IFSR(S):

EL0 (NS)	EL0 (S)	EL1 (NS)	EL1 (S)	EL2	EL3 (SCR.NS=1)	EL3 (SCR.NS=0)
-	-	-	RW	-	-	RW

When accessed as IFSR(NS):

EL0 (NS)	EL0 (S)	EL1 (NS)	EL1 (S)	EL2	EL3 (SCR.NS=1)	EL3 (SCR.NS=0)
-	-	RW	-	RW	RW	-

Configurations

IFSR(NS) is architecturally mapped to AArch64 register [IFSR32_EL2](#).

If EL3 is using AArch32, there are separate Secure and Non-secure instances of this register.

The Large Physical Address Extension adds an alternative format for the register. If an implementation includes the Large Physical Address Extension then the current translation table format determines which format of the register is used.

Attributes

IFSR is a 32-bit register.

The IFSR bit assignments are:

When TTBCR.EAE==0:

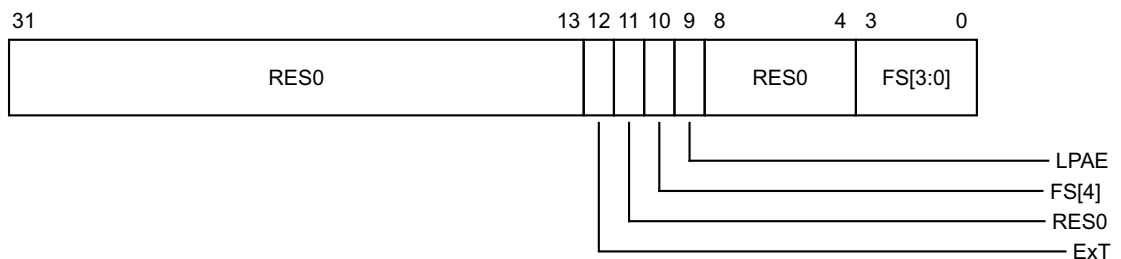

Bits [31:13]

Reserved, RES0.

ExT, bit [12]

External abort type. This bit can be used to provide an IMPLEMENTATION DEFINED classification of external aborts.

For aborts other than external aborts this bit always returns 0.

Bit [11]

Reserved, RES0.

FS[4], bit [10]

See below for description of the FS field.

LPAAE, bit [9]

On taking a Data Abort exception, this bit is set as follows:

- 0 Using the Short-descriptor translation table formats.
- 1 Using the Long-descriptor translation table formats.

Hardware does not interpret this bit to determine the behavior of the memory system, and therefore software can set this bit to 0 or 1 without affecting operation.

Bits [8:4]

Reserved, RES0.

FS[3:0], bits [3:0]

Fault status bits. Possible values of this field are:

- 0010 Debug event
- 0011 Access flag fault, first level
- 0101 Translation fault, first level
- 0110 Access flag fault, second level
- 0111 Translation fault, second level
- 1000 Synchronous external abort
- 1001 Domain fault, first level
- 1011 Domain fault, second level
- 1100 Synchronous external abort on translation table walk, first level
- 1101 Permission fault, first level
- 1110 Synchronous external abort on translation table walk, second level
- 1111 Permission fault, second level
- 10000 TLB conflict abort
- 10100 IMPLEMENTATION DEFINED fault (Lockdown fault)
- 11001 Synchronous parity error on memory access
- 11100 Synchronous parity error on translation table walk, first level
- 11110 Synchronous parity error on translation table walk, second level

All other values are reserved.

When TTBCR.EAE==1:

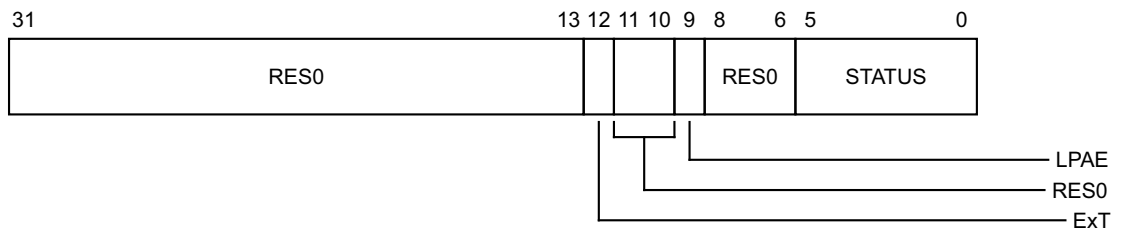

Bits [31:13]

Reserved, RES0.

ExT, bit [12]

External abort type. This bit can be used to provide an IMPLEMENTATION DEFINED classification of external aborts.

For aborts other than external aborts this bit always returns 0.

Bits [11:10]

Reserved, RES0.

LPAE, bit [9]

On taking a Data Abort exception, this bit is set as follows:

0 Using the Short-descriptor translation table formats.

1 Using the Long-descriptor translation table formats.

Hardware does not interpret this bit to determine the behavior of the memory system, and therefore software can set this bit to 0 or 1 without affecting operation.

Bits [8:6]

Reserved, RES0.

STATUS, bits [5:0]

Fault status bits. Possible values of this field are:

000000 Address size fault in [TTBR0](#) or [TTBR1](#)

000101 Translation fault, first level

000110 Translation fault, second level

000111 Translation fault, third level

001001 Access flag fault, first level

001010 Access flag fault, second level

001011 Access flag fault, third level

001101 Permission fault, first level

001110 Permission fault, second level

001111 Permission fault, third level

010000 Synchronous external abort

010101 Synchronous external abort on translation table walk, first level

010110 Synchronous external abort on translation table walk, second level

010111 Synchronous external abort on translation table walk, third level

011000 Synchronous parity error on memory access

011101 Synchronous parity error on memory access on translation table walk, first level

011110 Synchronous parity error on memory access on translation table walk, second level

011111 Synchronous parity error on memory access on translation table walk, third level

100001 Alignment fault

100010 Debug event

110000 TLB conflict abort

110100 IMPLEMENTATION DEFINED fault (Lockdown fault)

All other values are reserved.

The lookup level associated with a fault is:

- For a fault generated on a translation table walk, the lookup level of the walk being performed.
- For a Translation fault, the lookup level of the translation table that gave the fault. If a fault occurs because an MMU is disabled, or because the input address is outside the range specified by the appropriate base address register or registers, the fault is reported as a First level fault.
- For an Access flag fault, the lookup level of the translation table that gave the fault.
- For a Permission fault, including a Permission fault caused by hierarchical permissions, the lookup level of the final level of translation table accessed for the translation. That is, the lookup level of the translation table that returned a Block or Page descriptor.

Accessing the IFSR:

To access the IFSR:

MRC p15,0,<Rt>,c5,c0,1 ; Read IFSR into Rt
 MCR p15,0,<Rt>,c5,c0,1 ; Write Rt to IFSR

Register access is encoded as follows:

coproc	opc1	CRn	CRm	opc2
1111	000	0101	0000	001

G4.2.90 ISR, Interrupt Status Register

The ISR characteristics are:

Purpose

Shows whether an IRQ, FIQ, or external abort is pending. If EL2 is implemented, an indicated pending abort might be a physical abort or a virtual abort.

This register is part of the Exception and fault handling registers functional group.

Usage constraints

This register is accessible as shown below:

EL0 (NS)	EL0 (S)	EL1 (NS)	EL1 (S)	EL2	EL3 (SCR.NS=1)	EL3 (SCR.NS=0)
-	-	RO	RO	RO	RO	RO

Configurations

ISR is architecturally mapped to AArch64 register [ISR_EL1](#).

There is one instance of this register that is used in both Secure and Non-secure states.

Attributes

ISR is a 32-bit register.

The ISR bit assignments are:

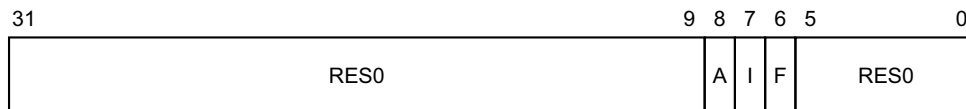

Bits [31:9]

Reserved, RES0.

A, bit [8]

External abort pending bit:

0 No pending external abort.

1 An external abort is pending.

I, bit [7]

IRQ pending bit. Indicates whether an IRQ interrupt is pending:

0 No pending IRQ.

1 An IRQ interrupt is pending.

F, bit [6]

FIQ pending bit. Indicates whether an FIQ interrupt is pending.

0 No pending FIQ.

1 An FIQ interrupt is pending.

Bits [5:0]

Reserved, RES0.

Accessing the ISR:

To access the ISR:

MRC p15,0,<Rt>,c12,c1,0 ; Read ISR into Rt

Register access is encoded as follows:

coproc	opc1	CRn	CRm	opc2
1111	000	1100	0001	000

G4.2.91 ITLBIALL, Instruction TLB Invalidate All entries

The ITLBIALL characteristics are:

Purpose

Invalidate all EL1&0 regime stage 1 and 2 instruction TLB entries for the current VMID.
 This register is part of the TLB maintenance operations functional group.

Usage constraints

This operation can be performed at the exception levels shown below:

EL0 (NS)	EL0 (S)	EL1 (NS)	EL1 (S)	EL2	EL3 (SCR.NS=1)	EL3 (SCR.NS=0)
-	-	WO	WO	WO	WO	WO

If this operation is executed at Secure EL1 in AArch32 when EL3 is using AArch64, it only affects TLB entries related to the Secure EL1 translation regime.

Configurations

There are no configuration notes.

Attributes

ITLBIALL is a 32-bit system operation.

The ITLBIALL operation ignores the value in the register specified by the instruction used to perform this operation. Software does not have to write a value to the register before issuing this instruction.

Performing the ITLBIALL operation:

To perform the ITLBIALL operation:

MCR p15,0,<Rt>,c8,c5,0 ; ITLBIALL operation, ignoring the value in Rt

The operation is encoded as follows:

coproc	opc1	CRn	CRm	opc2
1111	000	1000	0101	000

G4.2.92 ITLBIASID, Instruction TLB Invalidate by ASID match

The ITLBIASID characteristics are:

Purpose

Invalidate EL1&0 regime stage 1 instruction TLB entries for the given ASID and the current VMID.
This register is part of the TLB maintenance operations functional group.

Usage constraints

This operation can be performed at the exception levels shown below:

EL0 (NS)	EL0 (S)	EL1 (NS)	EL1 (S)	EL2	EL3 (SCR.NS=1)	EL3 (SCR.NS=0)
-	-	WO	WO	WO	WO	WO

If this operation is executed at Secure EL1 in AArch32 when EL3 is using AArch64, it only affects TLB entries related to the Secure EL1 translation regime.

Configurations

There are no configuration notes.

Attributes

ITLBIASID is a 32-bit system operation.

The ITLBIASID input value bit assignments are:

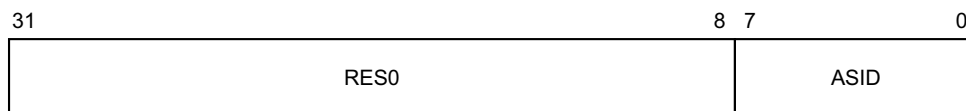

Bits [31:8]

Reserved, RES0.

ASID, bits [7:0]

ASID value to match. Any TLB entries for non-global pages that match the ASID values will be affected by this operation.

Performing the ITLBIASID operation:

To perform the ITLBIASID operation:

MCR p15,0,<Rt>,c8,c5,2 ; ITLBIASID operation

The operation is encoded as follows:

coproc	opc1	CRn	CRm	opc2
1111	000	1000	0101	010

G4.2.93 ITLBIMVA, Instruction TLB Invalidate entry by VA

The ITLBIMVA characteristics are:

Purpose

Invalidate EL1&0 regime stage 1 and 2 instruction TLB entries for the given VA and ASID and the current VMID.

This register is part of the TLB maintenance operations functional group.

Usage constraints

This operation can be performed at the exception levels shown below:

EL0 (NS)	EL0 (S)	EL1 (NS)	EL1 (S)	EL2	EL3 (SCR.NS=1)	EL3 (SCR.NS=0)
-	-	WO	WO	WO	WO	WO

If this operation is executed at Secure EL1 in AArch32 when EL3 is using AArch64, it only affects TLB entries related to the Secure EL1 translation regime.

Configurations

There are no configuration notes.

Attributes

ITLBIMVA is a 32-bit system operation.

The ITLBIMVA input value bit assignments are:

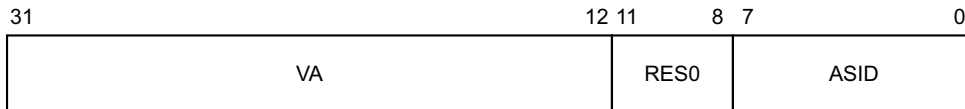

VA, bits [31:12]

Virtual address to match. Any TLB entries that match the ASID value and VA value will be affected by this operation.

Bits [11:8]

Reserved, RES0.

ASID, bits [7:0]

ASID value to match. Any TLB entries that match the ASID value and VA value will be affected by this operation.

Global TLB entries that match the VA value will be affected by this operation, regardless of the value of the ASID field.

Performing the ITLBIMVA operation:

To perform the ITLBIMVA operation:

MCR p15,0,<Rt>,c8,c5,1 ; ITLBIMVA operation

The operation is encoded as follows:

coproc	opc1	CRn	CRm	opc2
1111	000	1000	0101	001

G4.2.94 JIDR, Jazelle ID Register

The JIDR characteristics are:

Purpose

A Jazelle register, which identifies the Jazelle architecture and subarchitecture version.
This register is part of the Legacy feature registers functional group.

Usage constraints

This register is accessible as shown below:

EL0 (NS)	EL0 (S)	EL1 (NS)	EL1 (S)	EL2	EL3 (SCR.NS=1)	EL3 (SCR.NS=0)
RO	RO	RO	RO	RO	RO	RO

Configurations

There is one instance of this register that is used in both Secure and Non-secure states.
Implemented as RES0 in v8, which only contains a trivial implementation of the Jazelle Extension.

Attributes

JIDR is a 32-bit register.

The JIDR bit assignments are:

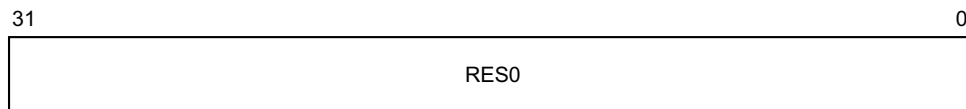

Bits [31:0]

Reserved, RES0.

Accessing the JIDR:

To access the JIDR:

MRC p14,7,<Rt>,c0,c0,0 ; Read JIDR into Rt

Register access is encoded as follows:

coproc	opc1	CRn	CRm	opc2
1110	111	0000	0000	000

G4.2.95 JMCR, Jazelle Main Configuration Register

The JMCR characteristics are:

Purpose

A Jazelle register, which provides control of the Jazelle extension.

This register is part of the Legacy feature registers functional group.

Usage constraints

This register is accessible as shown below:

EL0 (NS)	EL0 (S)	EL1 (NS)	EL1 (S)	EL2	EL3 (SCR.NS=1)	EL3 (SCR.NS=0)
-	-	RW	RW	RW	RW	RW

Configurations

There is one instance of this register that is used in both Secure and Non-secure states.

Implemented as RES0 in v8, which only contains a trivial implementation of the Jazelle Extension.

Attributes

JMCR is a 32-bit register.

The JMCR bit assignments are:

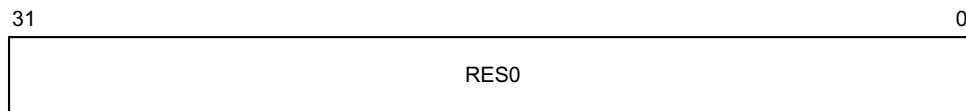

Bits [31:0]

Reserved, RES0.

Accessing the JMCR:

To access the JMCR:

MRC p14,7,<Rt>,c2,c0,0 ; Read JMCR into Rt

MCR p14,7,<Rt>,c2,c0,0 ; Write Rt to JMCR

Register access is encoded as follows:

coproc	opc1	CRn	CRm	opc2
1110	111	0010	0000	000

G4.2.96 JOSCR, Jazelle OS Control Register

The JOSCR characteristics are:

Purpose

A Jazelle register, which provides operating system control of the use of the Jazelle extension by processes and threads.

This register is part of the Legacy feature registers functional group.

Usage constraints

This register is accessible as shown below:

EL0 (NS)	EL0 (S)	EL1 (NS)	EL1 (S)	EL2	EL3 (SCR.NS=1)	EL3 (SCR.NS=0)
-	-	RW	RW	RW	RW	RW

Configurations

There is one instance of this register that is used in both Secure and Non-secure states.

Implemented as RES0 in v8, which only contains a trivial implementation of the Jazelle Extension.

Attributes

JOSCR is a 32-bit register.

The JOSCR bit assignments are:

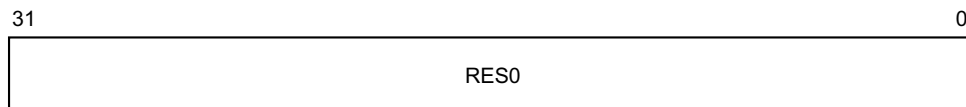

Bits [31:0]

Reserved, RES0.

Accessing the JOSCR:

To access the JOSCR:

MRC p14,7,<Rt>,c1,c0,0 ; Read JOSCR into Rt

MCR p14,7,<Rt>,c1,c0,0 ; Write Rt to JOSCR

Register access is encoded as follows:

coproc	opc1	CRn	CRm	opc2
1110	111	0001	0000	000

G4.2.97 MAIRO, Memory Attribute Indirection Register 0

The MAIRO characteristics are:

Purpose

Along with MAIR1, provides the memory attribute encodings corresponding to the possible AttrIdx values in a Long-descriptor format translation table entry for stage 1 translations.

This register is part of the Virtual memory control registers functional group.

Usage constraints

This register is accessible as shown below:

When accessed as MAIRO(S):

EL0 (NS)	EL0 (S)	EL1 (NS)	EL1 (S)	EL2	EL3 (SCR.NS=1)	EL3 (SCR.NS=0)
-	-	-	RW	-	-	RW

When accessed as MAIRO(NS):

EL0 (NS)	EL0 (S)	EL1 (NS)	EL1 (S)	EL2	EL3 (SCR.NS=1)	EL3 (SCR.NS=0)
-	-	RW	-	RW	RW	-

Only accessible when using the Long-descriptor translation table format.

AttrIdx[2], from the translation table descriptor, selects the appropriate MAIR: setting AttrIdx[2] to 0 selects MAIRO.

In an implementation that includes EL3:

- The Secure copy of the register gives the value for memory accesses from Secure state.
- The Non-secure copy of the register gives the value for memory accesses from Non-secure states other than Hyp mode.

Configurations

MAIRO(NS) is architecturally mapped to AArch64 register MAIR_EL1[31:0] when TTBCR.EAE==1.

MAIRO(S) can be mapped to AArch64 register MAIR_EL3[31:0] when TTBCR.EAE==1, but this is not architecturally mandated.

If EL3 is using AArch32, there are separate Secure and Non-secure instances of this register.

MAIRO has write access to the Secure copy of the register disabled when the CP15SDISABLE signal is asserted HIGH.

Attributes

MAIRO is a 32-bit register when TTBCR.EAE==1.

The MAIRO bit assignments are:

When TTBCR.EAE==1:

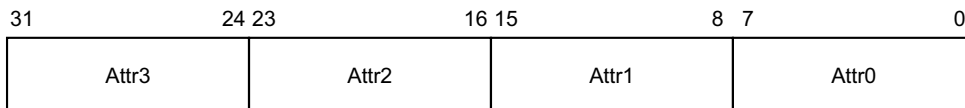

Attr<n>, bits [8n+7:8n], for n = 0 to 3

The memory attribute encoding for an AttrIdx[2:0] entry in a Long descriptor format translation table entry, where:

- AttrIdx[2:0] gives the value of <n> in Attr<n>.
- AttrIdx[2] defines which MAIR to access. Attr7 to Attr4 are in MAIR1, and Attr3 to Attr0 are in MAIR0.

Bits [7:4] are encoded as follows:

Attr<n>[7:4]	Meaning
0000	Device memory. See encoding of Attr<n>[3:0] for the type of Device memory.
00RW, RW not 00	Normal Memory, Outer Write-through transient
0100	Normal Memory, Outer Non-Cacheable
01RW, RW not 00	Normal Memory, Outer Write-back transient
10RW	Normal Memory, Outer Write-through non-transient
11RW	Normal Memory, Outer Write-back non-transient

R = Outer Read Allocate Policy, W = Outer Write Allocate Policy.

The meaning of bits [3:0] depends on the value of bits [7:4]:

Attr<n>[3:0]	Meaning when Attr<n>[7:4] is 0000	Meaning when Attr<n>[7:4] is not 0000
0000	Device-nGnRnE memory	UNPREDICTABLE
00RW, RW not 00	UNPREDICTABLE	Normal Memory, Inner Write-through transient
0100	Device-nGnRE memory	Normal memory, Inner Non-Cacheable
01RW, RW not 00	UNPREDICTABLE	Normal Memory, Inner Write-back transient
1000	Device-nGRE memory	Normal Memory, Inner Write-through non-transient (RW=00)
10RW, RW not 00	UNPREDICTABLE	Normal Memory, Inner Write-through non-transient
1100	Device-GRE memory	Normal Memory, Inner Write-back non-transient (RW=00)
11RW, RW not 00	UNPREDICTABLE	Normal Memory, Inner Write-back non-transient

R = Inner Read Allocate Policy, W = Inner Write Allocate Policy.

ARMv7's Strongly-ordered and Device memory types have been renamed to Device-nGnRnE and Device-nGnRE in ARMv8.

The R and W bits in some Attr<n> fields have the following meanings:

R or W	Meaning
0	Do not allocate
1	Allocate

Accessing the MAIR0:

To access the MAIR0 when TTBCR.EAE==1:

MRC p15,0,<Rt>,c10,c2,0 ; Read MAIR0 into Rt
MCR p15,0,<Rt>,c10,c2,0 ; Write Rt to MAIR0

Register access is encoded as follows:

coproc	opc1	CRn	CRm	opc2
1111	000	1010	0010	000

G4.2.98 MAIR1, Memory Attribute Indirection Register 1

The MAIR1 characteristics are:

Purpose

Along with [MAIR0](#), provides the memory attribute encodings corresponding to the possible AttrIndx values in a Long-descriptor format translation table entry for stage 1 translations.

This register is part of the Virtual memory control registers functional group.

Usage constraints

This register is accessible as shown below:

When accessed as MAIR1(S):

EL0 (NS)	EL0 (S)	EL1 (NS)	EL1 (S)	EL2	EL3 (SCR.NS=1)	EL3 (SCR.NS=0)
-	-	-	RW	-	-	RW

When accessed as MAIR1(NS):

EL0 (NS)	EL0 (S)	EL1 (NS)	EL1 (S)	EL2	EL3 (SCR.NS=1)	EL3 (SCR.NS=0)
-	-	RW	-	RW	RW	-

Only accessible when using the Long-descriptor translation table format.

AttrIndx[2], from the translation table descriptor, selects the appropriate MAIR: setting AttrIndx[2] to 1 selects MAIR1.

In an implementation that includes EL3:

- The Secure copy of the register gives the value for memory accesses from Secure state.
- The Non-secure copy of the register gives the value for memory accesses from Non-secure states other than Hyp mode.

Configurations

MAIR1(NS) is architecturally mapped to AArch64 register [MAIR_EL1](#)[63:32] when TTBCR.EAE==1.

MAIR1(S) can be mapped to AArch64 register [MAIR_EL3](#)[63:32] when TTBCR.EAE==1, but this is not architecturally mandated.

If EL3 is using AArch32, there are separate Secure and Non-secure instances of this register.

MAIR1 has write access to the Secure copy of the register disabled when the CP15SDISABLE signal is asserted HIGH.

Attributes

MAIR1 is a 32-bit register when TTBCR.EAE==1.

The MAIR1 bit assignments are:

When TTBCR.EAE==1:

31	24 23	16 15	8 7	0
Attr7	Attr6	Attr5	Attr4	

Attr<n>, bits [8(n-4)+7:8(n-4)], for n = 4 to 7

The memory attribute encoding for an AttrIdx[2:0] entry in a Long descriptor format translation table entry, where:

- AttrIdx[2:0] gives the value of <n> in Attr<n>.
- AttrIdx[2] defines which MAIR to access. Attr7 to Attr4 are in MAIR1, and Attr3 to Attr0 are in MAIR0.

Bits [7:4] are encoded as follows:

Attr<n>[7:4]	Meaning
0000	Device memory. See encoding of Attr<n>[3:0] for the type of Device memory.
00RW, RW not 00	Normal Memory, Outer Write-through transient
0100	Normal Memory, Outer Non-Cacheable
01RW, RW not 00	Normal Memory, Outer Write-back transient
10RW	Normal Memory, Outer Write-through non-transient
11RW	Normal Memory, Outer Write-back non-transient

R = Outer Read Allocate Policy, W = Outer Write Allocate Policy.

The meaning of bits [3:0] depends on the value of bits [7:4]:

Attr<n>[3:0]	Meaning when Attr<n>[7:4] is 0000	Meaning when Attr<n>[7:4] is not 0000
0000	Device-nGnRnE memory	UNPREDICTABLE
00RW, RW not 00	UNPREDICTABLE	Normal Memory, Inner Write-through transient
0100	Device-nGnRE memory	Normal memory, Inner Non-Cacheable
01RW, RW not 00	UNPREDICTABLE	Normal Memory, Inner Write-back transient
1000	Device-nGRE memory	Normal Memory, Inner Write-through non-transient (RW=00)
10RW, RW not 00	UNPREDICTABLE	Normal Memory, Inner Write-through non-transient
1100	Device-GRE memory	Normal Memory, Inner Write-back non-transient (RW=00)
11RW, RW not 00	UNPREDICTABLE	Normal Memory, Inner Write-back non-transient

R = Inner Read Allocate Policy, W = Inner Write Allocate Policy.

ARMv7's Strongly-ordered and Device memory types have been renamed to Device-nGnRnE and Device-nGnRE in ARMv8.

The R and W bits in some Attr<n> fields have the following meanings:

R or W	Meaning
0	Do not allocate
1	Allocate

Accessing the MAIR1:

To access the MAIR1 when TTBCR.EAE==1:

MRC p15,0,<Rt>,c10,c2,1 ; Read MAIR1 into Rt
MCR p15,0,<Rt>,c10,c2,1 ; Write Rt to MAIR1

Register access is encoded as follows:

coproc	opc1	CRn	CRm	opc2
1111	000	1010	0010	001

G4.2.99 MIDR, Main ID Register

The MIDR characteristics are:

Purpose

Provides identification information for the processor, including an implementer code for the device and a device ID number.

This register is part of the Identification registers functional group.

Usage constraints

This register is accessible as shown below:

EL0 (NS)	EL0 (S)	EL1 (NS)	EL1 (S)	EL2	EL3 (SCR.NS=1)	EL3 (SCR.NS=0)
-	-	RO	RO	RO	RO	RO

Configurations

MIDR is architecturally mapped to AArch64 register [MIDR_EL1](#).

MIDR is architecturally mapped to external register [MIDR_EL1](#).

There is one instance of this register that is used in both Secure and Non-secure states.

Some fields of the MIDR are IMPLEMENTATION DEFINED. For details of the values of these fields for a particular ARMv8 implementation, and any implementation-specific significance of these values, see the product documentation.

Attributes

MIDR is a 32-bit register.

The MIDR bit assignments are:

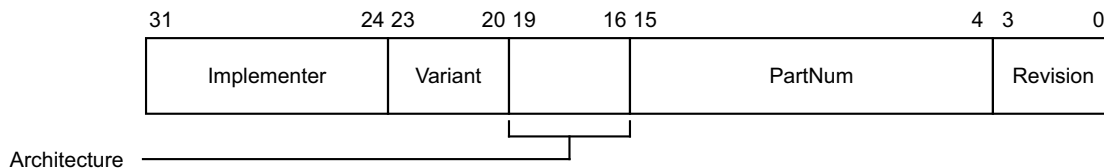

Implementer, bits [31:24]

The Implementer code. This field must hold an implementer code that has been assigned by ARM. Assigned codes include the following:

Hex representation	ASCII representation	Implementer
0x41	A	ARM Limited
0x42	B	Broadcom Corporation
0x43	C	Cavium Inc.
0x44	D	Digital Equipment Corporation
0x49	I	Infineon Technologies AG
0x4D	M	Motorola or Freescale Semiconductor Inc.
0x4E	N	NVIDIA Corporation

Hex representation	ASCII representation	Implementer
0x50	P	Applied Micro Circuits Corporation
0x51	Q	Qualcomm Inc.
0x56	V	Marvell International Ltd.
0x69	i	Intel Corporation

ARM can assign codes that are not published in this manual. All values not assigned by ARM are reserved and must not be used.

Variant, bits [23:20]

An IMPLEMENTATION DEFINED variant number. Typically, this field is used to distinguish between different product variants, or major revisions of a product.

Architecture, bits [19:16]

The permitted values of this field are:

0001	ARMv4
0010	ARMv4T
0011	ARMv5 (obsolete)
0100	ARMv5T
0101	ARMv5TE
0110	ARMv5TEJ
0111	ARMv6
1111	Defined by CPUID scheme

All other values are reserved.

PartNum, bits [15:4]

An IMPLEMENTATION DEFINED primary part number for the device.

On processors implemented by ARM, if the top four bits of the primary part number are 0x0 or 0x7, the variant and architecture are encoded differently.

Revision, bits [3:0]

An IMPLEMENTATION DEFINED revision number for the device.

Accessing the MIDR:

To access the MIDR:

MRC p15,0,<Rt>,c0,c0,0 ; Read MIDR into Rt

Register access is encoded as follows:

coproc	opc1	CRn	CRm	opc2
1111	000	0000	0000	000

G4.2.100 MPIDR, Multiprocessor Affinity Register

The MPIDR characteristics are:

Purpose

In a multiprocessor system, provides an additional processor identification mechanism for scheduling purposes, and indicates whether the implementation includes the Multiprocessing Extensions.

This register is part of the Identification registers functional group.

Usage constraints

This register is accessible as shown below:

EL0 (NS)	EL0 (S)	EL1 (NS)	EL1 (S)	EL2	EL3 (SCR.NS=1)	EL3 (SCR.NS=0)
-	-	RO	RO	RO	RO	RO

Configurations

MPIDR is architecturally mapped to AArch64 register [MPIDR_EL1](#).

There is one instance of this register that is used in both Secure and Non-secure states.

In a uniprocessor system ARM recommends that this register returns a value of 0.

Attributes

MPIDR is a 32-bit register.

The MPIDR bit assignments are:



M, bit [31]

Indicates whether this implementation includes the Multiprocessing Extensions. The possible values of this bit are:

- 0 This implementation does not include the Multiprocessing Extensions.
- 1 This implementation includes the Multiprocessing Extensions.

In v8-A this bit is RES1.

U, bit [30]

Indicates a Uniprocessor system, as distinct from processor 0 in a multiprocessor system. The possible values of this bit are:

- 0 Processor is part of a multiprocessor system.
- 1 Processor is part of a uniprocessor system.

Bits [29:25]

Reserved, RES0.

MT, bit [24]

Indicates whether the lowest level of affinity consists of logical processors that are implemented using a multi-threading type approach. The possible values of this bit are:

- 0 Performance of processors at the lowest affinity level is largely independent.
- 1 Performance of processors at the lowest affinity level is very interdependent.

Aff2, bits [23:16]

Affinity level 2. The least significant affinity level field, for this processor in the system.

Aff1, bits [15:8]

Affinity level 1. The intermediate affinity level field, for this processor in the system.

Aff0, bits [7:0]

Affinity level 0. The most significant affinity level field, for this processor in the system.

Accessing the MPIDR:

To access the MPIDR:

MRC p15,0,<Rt>,c0,c0,5 ; Read MPIDR into Rt

Register access is encoded as follows:

coproc	opc1	CRn	CRm	opc2
1111	000	0000	0000	101

G4.2.101 MVBAR, Monitor Vector Base Address Register

The MVBAR characteristics are:

Purpose

Holds the exception base address for any exception that is taken to Monitor mode.

This register is part of:

- the Exception and fault handling registers functional group
- the Security registers functional group.

Usage constraints

This register is accessible as shown below:

EL0 (NS)	EL0 (S)	EL1 (NS)	EL1 (S)	EL2	EL3 (SCR.NS=1)	EL3 (SCR.NS=0)
-	-	-	RW	-	RW	RW

Secure software must program the MVBAR with the required initial value as part of the processor boot sequence.

If EL3 is implemented and is using AArch64, any read or write to MVBAR in Secure EL1 state in AArch32 is trapped as an exception to EL3.

Configurations

There is one instance of this register that is used in both Secure and Non-secure states.

The reset value of MVBAR, when resetting into EL3 using AArch32, is an IMPLEMENTATION DEFINED choice between the following:

- Either:
 - MVBAR[31:5] is an IMPLEMENTATION DEFINED value, which might be UNKNOWN.
 - MVBAR[4:1] is RES0.
 - MVBAR[0] is 0.
- Or:
 - MVBAR[31:1] is an IMPLEMENTATION DEFINED value being the AArch32 reset address, bits[31:1].
 - MVBAR[0] is 1.

The reset value of MVBAR[0] can be used to distinguish between these two approaches.

Attributes

MVBAR is a 32-bit register.

The MVBAR bit assignments are:



Bits [31:5]

Vector Base Address. Bits[31:5] of the base address of the exception vectors for exceptions taken in this exception level. Bits[4:0] of an exception vector are the exception offset.

Bits [4:0]

Reserved, RES0.

Accessing the MVBAR:

To access the MVBAR:

MRC p15,0,<Rt>,c12,c0,1 ; Read MVBAR into Rt
MCR p15,0,<Rt>,c12,c0,1 ; Write Rt to MVBAR

Register access is encoded as follows:

coproc	opc1	CRn	CRm	opc2
1111	000	1100	0000	001

G4.2.102 MVFR0, Media and VFP Feature Register 0

The MVFR0 characteristics are:

Purpose

Describes the features provided by the Advanced SIMD and Floating-point extensions.

This register is part of:

- the Floating-point registers functional group
- the Identification registers functional group.

Usage constraints

This register is accessible as shown below:

EL0 (NS)	EL0 (S)	EL1 (NS)	EL1 (S)	EL2	EL3 (SCR.NS=1)	EL3 (SCR.NS=0)
-	-	Config-RO	RO	Config-RO	Config-RO	RO

Access to this register depends on the values of [CPACR](#).{cp10,cp11}, [NSACR](#).{cp10,cp11}, and [HCPTR](#).{TCP10,TCP11}.

Must be interpreted with [MVFR1](#) and [MVFR2](#).

Configurations

MVFR0 is architecturally mapped to AArch64 register [MVFR0_EL1](#).

There is one instance of this register that is used in both Secure and Non-secure states.

Implemented only if the implementation includes one or both of the Floating-point Extension or the Advanced SIMD Extension.

Attributes

MVFR0 is a 32-bit register.

The MVFR0 bit assignments are:

31	28 27	24 23	20 19	16 15	12 11	8 7	4 3	0
FPRound	FPSHVec	FPSqrt	FPDivide	FPTrap	FPDP	FPSP	SIMDReg	

FPRound, bits [31:28]

Floating-Point Rounding modes. Indicates the rounding modes supported by the VFP floating-point hardware. Permitted values are:

0000 Only Round to Nearest mode supported, except that Round towards Zero mode is supported for VCVT instructions that always use that rounding mode regardless of the [FPSCR](#) setting.

0001 All rounding modes supported.

All other values are reserved.

FPSHVec, bits [27:24]

Short Vectors. Indicates the hardware support for VFP short vectors. Permitted values are:

0000 Not supported.

0001 Short vector operation supported.

All other values are reserved.

FPSqrt, bits [23:20]

Square Root. Indicates the hardware support for VFP square root operations. Permitted values are:

0000 Not supported in hardware.

0001 Supported.

All other values are reserved.

The VSQRT.F32 instruction also requires the single-precision VFP attribute, and the VSQRT.F64 instruction also requires the double-precision VFP attribute.

FPDivide, bits [19:16]

Indicates the hardware support for VFP divide operations. Permitted values are:

0000 Not supported in hardware.

0001 Supported.

All other values are reserved.

The VDIV.F32 instruction also requires the single-precision VFP attribute, and the VDIV.F64 instruction also requires the double-precision VFP attribute.

FPTrap, bits [15:12]

Floating Point Exception Trapping. Indicates whether the VFP hardware implementation supports exception trapping. Permitted values are:

0000 Not supported. This is the value for VFPv3 and VFPv4.

0001 Supported by the hardware. This is the value for VFPv3U, VFP4U, and for VFPv2. When exception trapping is supported, support code is needed to handle the trapped exceptions.

All other values are reserved.

A value of 0b0001 does not indicate that trapped exception handling is available. Because trapped exception handling requires support code, only the support code can provide this information.

FPDP, bits [11:8]

Double Precision. Indicates the hardware support for VFP double-precision operations. Permitted values are:

0000 Not supported in hardware.

0001 Supported, VFPv2.

0010 Supported, VFPv3 or VFPv4. VFPv3 adds an instruction to load a double-precision floating-point constant, and conversions between double-precision and fixed-point values.

All other values are reserved.

A value of 0b0001 or 0b0010 indicates support for all VFP double-precision instructions in the supported version of VFP, except that, in addition to this field being nonzero:

- VSQRT.F64 is only available if the Square root field is 0b0001.
- VDIV.F64 is only available if the Divide field is 0b0001.
- Conversion between double-precision and single-precision is only available if the single-precision field is nonzero.

FPSP, bits [7:4]

Single Precision. Indicates the hardware support for VFP single-precision operations. Permitted values are:

0000 Not supported in hardware.

0001 Supported, VFPv2.

0010 Supported, VFPv3 or VFPv4. VFPv3 adds an instruction to load a single-precision floating-point constant, and conversions between single-precision and fixed-point values.

All other values are reserved.

A value of 0b0001 or 0b0010 indicates support for all VFP single-precision instructions in the supported version of VFP, except that, in addition to this field being nonzero:

- VSQRT.F32 is only available if the Square root field is 0b0001.
- VDIV.F32 is only available if the Divide field is 0b0001.
- Conversion between double-precision and single-precision is only available if the double-precision field is nonzero.

SIMDReg, bits [3:0]

Advanced SIMD registers. Indicates support for the Advanced SIMD register bank. Permitted values are:

0000 Not supported.
0001 Supported, 16 x 64-bit registers.
0010 Supported, 32 x 64-bit registers.

All other values are reserved.

If this field is nonzero:

- All VFP LDC, STC, MCR, and MRC instructions are supported.
- If the CPUID registers show that the MCRR and MRRC instructions are supported then the corresponding VFP instructions are supported.

Accessing the MVFR0:

To access the MVFR0:

VMRS <Rt>, MVFR0 ; Read MVFR0 into Rt

Register access is encoded as follows:

spec_reg

0111

G4.2.103 MVFR1, Media and VFP Feature Register 1

The MVFR1 characteristics are:

Purpose

Describes the features provided by the Advanced SIMD and Floating-point extensions.

This register is part of:

- the Floating-point registers functional group
- the Identification registers functional group.

Usage constraints

This register is accessible as shown below:

EL0 (NS)	EL0 (S)	EL1 (NS)	EL1 (S)	EL2	EL3 (SCR.NS=1)	EL3 (SCR.NS=0)
-	-	Config-RO	RO	Config-RO	Config-RO	RO

Access to this register depends on the values of [CPACR](#).{cp10,cp11}, [NSACR](#).{cp10,cp11}, and [HCPTR](#).{TCP10,TCP11}.

Must be interpreted with [MVFR0](#) and [MVFR2](#).

Configurations

MVFR1 is architecturally mapped to AArch64 register [MVFR1_EL1](#).

There is one instance of this register that is used in both Secure and Non-secure states.

Implemented only if the implementation includes one or both of the Floating-point Extension or the Advanced SIMD Extension.

Attributes

MVFR1 is a 32-bit register.

The MVFR1 bit assignments are:

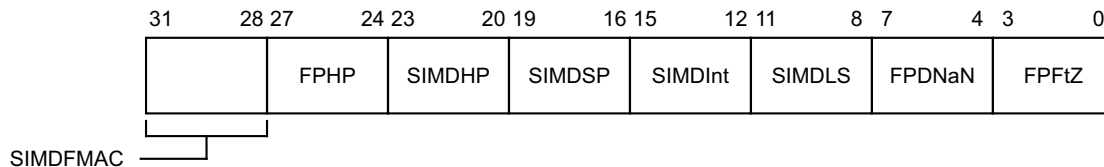

SIMDFMAC, bits [31:28]

Advanced SIMD Fused Multiply-Accumulate. Indicates whether any implemented VFP or Advanced SIMD extension implements the fused multiply accumulate instructions. Permitted values are:

0000 Not implemented.

0001 Implemented.

All other values are reserved.

If an implementation includes both the VFP extension and the Advanced SIMD extension, both extensions must provide the same level of support for these instructions.

FPHP, bits [27:24]

Floating Point Half Precision. Indicates whether the VFP extension implements half-precision floating-point conversion instructions. Permitted values are:

0000 Not implemented.

- 0001 Instructions to convert between half-precision and single-precision implemented.
- 0010 As for 0b0001, and also instructions to convert between half-precision and double-precision implemented.

All other values are reserved.

SIMDHP, bits [23:20]

Advanced SIMD Half Precision. Indicates whether the Advanced SIMD extension implements half-precision floating-point conversion instructions. Permitted values are:

- 0000 Not implemented.
- 0001 Implemented. This value is permitted only if the AdvSIMD SPFP field is 0b0001.

All other values are reserved.

SIMDSP, bits [19:16]

Advanced SIMD Single Precision. Indicates whether the Advanced SIMD extension implements single-precision floating-point instructions. Permitted values are:

- 0000 Not implemented.
- 0001 Implemented. This value is permitted only if the AdvSIMD integer field is 0b0001.

All other values are reserved.

SIMDInt, bits [15:12]

Advanced SIMD Integer. Indicates whether the Advanced SIMD extension implements integer instructions. Permitted values are:

- 0000 Not implemented.
- 0001 Implemented.

All other values are reserved.

SIMDLS, bits [11:8]

Advanced SIMD Load/Store. Indicates whether the Advanced SIMD extension implements load/store instructions. Permitted values are:

- 0000 Not implemented.
- 0001 Implemented.

All other values are reserved.

FPDNaN, bits [7:4]

Default NaN mode. Indicates whether the VFP hardware implementation supports only the Default NaN mode. Permitted values are:

- 0000 Hardware supports only the Default NaN mode. If a VFP subarchitecture is implemented its support code might include support for propagation of NaN values.
- 0001 Hardware supports propagation of NaN values.

All other values are reserved.

FPFtZ, bits [3:0]

Flush to Zero mode. Indicates whether the VFP hardware implementation supports only the Flush-to-Zero mode of operation. Permitted values are:

- 0000 Hardware supports only the Flush-to-Zero mode of operation. If a VFP subarchitecture is implemented its support code might include support for full denormalized number arithmetic.
- 0001 Hardware supports full denormalized number arithmetic.

All other values are reserved.

Accessing the MVFR1:

To access the MVFR1:

VMRS <Rt>, MVFR1 ; Read MVFR1 into Rt

Register access is encoded as follows:

spec_reg
0110

G4.2.104 MVFR2, Media and VFP Feature Register 2

The MVFR2 characteristics are:

Purpose

Describes the features provided by the Advanced SIMD and Floating-point extensions.

This register is part of:

- the Floating-point registers functional group
- the Identification registers functional group.

Usage constraints

This register is accessible as shown below:

EL0 (NS)	EL0 (S)	EL1 (NS)	EL1 (S)	EL2	EL3 (SCR.NS=1)	EL3 (SCR.NS=0)
-	-	Config-RO	RO	Config-RO	Config-RO	RO

Access to this register depends on the values of [CPACR](#).{cp10,cp11}, [NSACR](#).{cp10,cp11}, and [HCPTR](#).{TCP10,TCP11}.

Must be interpreted with [MVFR0](#) and [MVFR1](#).

Configurations

MVFR2 is architecturally mapped to AArch64 register [MVFR2_EL1](#).

There is one instance of this register that is used in both Secure and Non-secure states.

Implemented only if the implementation includes one or both of the Floating-point Extension or the Advanced SIMD Extension.

Attributes

MVFR2 is a 32-bit register.

The MVFR2 bit assignments are:

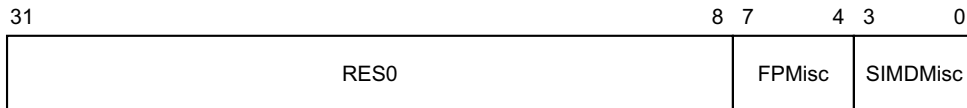

Bits [31:8]

Reserved, RES0.

FPMisc, bits [7:4]

Indicates support for miscellaneous VFP features.

0000 No support for miscellaneous features.

0001 Support for Floating-point selection.

0010 As 0b0001, and Floating-point Conversion to Integer with Directed Rounding modes.

0011 As 0b0010, and Floating-point Round to Integral Floating-point.

0100 As 0b0011, and Floating-point MaxNum and MinNum.

All other values are reserved.

SIMDMisc, bits [3:0]

Indicates support for miscellaneous Advanced SIMD features.

0000 No support for miscellaneous features.

- 0001 Floating-point Conversion to Integer with Directed Rounding modes.
 - 0010 As 0b0001, and Floating-point Round to Integral Floating-point.
 - 0011 As 0b0010, and Floating-point MaxNum and MinNum.
- All other values are reserved.

Accessing the MVFR2:

To access the MVFR2:

VMRS <Rt>, MVFR2 ; Read MVFR2 into Rt

Register access is encoded as follows:

spec_reg
0101

G4.2.105 NMRR, Normal Memory Remap Register

The NMRR characteristics are:

Purpose

Provides additional mapping controls for memory regions that are mapped as Normal memory by their entry in the [PRRR](#).

This register is part of the Virtual memory control registers functional group.

Usage constraints

This register is accessible as shown below:

When accessed as NMRR(S):

EL0 (NS)	EL0 (S)	EL1 (NS)	EL1 (S)	EL2	EL3 (SCR.NS=1)	EL3 (SCR.NS=0)
-	-	-	RW	-	-	RW

When accessed as NMRR(NS):

EL0 (NS)	EL0 (S)	EL1 (NS)	EL1 (S)	EL2	EL3 (SCR.NS=1)	EL3 (SCR.NS=0)
-	-	RW	-	RW	RW	-

Used in conjunction with the [PRRR](#).

Only accessible when using the Short-descriptor translation table format.

Configurations

NMRR(NS) is architecturally mapped to AArch64 register [MAIR_EL1](#)[63:32] when TTBCR.EAE==0.

NMRR(S) can be mapped to AArch64 register [MAIR_EL3](#)[63:32] when TTBCR.EAE==0, but this is not architecturally mandated.

If EL3 is using AArch32, there are separate Secure and Non-secure instances of this register.

NMRR has write access to the Secure copy of the register disabled when the CP15SDISABLE signal is asserted HIGH.

Attributes

NMRR is a 32-bit register when TTBCR.EAE==0.

The NMRR bit assignments are:

When TTBCR.EAE==0:

31	30	29	28	27	26	25	24	23	22	21	20	19	18	17	16	15	14	13	12	11	10	9	8	7	6	5	4	3	2	1	0
OR7	OR6	OR5	OR4	OR3	OR2	OR1	OR0	IR7	IR6	IR5	IR4	IR3	IR2	IR1	IR0																

OR<n>, bits [2n+17:2n+16], for n = 0 to 7

Outer Cacheable property mapping for memory attributes n, if the region is mapped as Normal memory by the PRRR.TR<n> entry. n is the value of the TEX[0], C, and B bits concatenated. The possible values of this field are:

- 00 Region is Non-cacheable.
- 01 Region is Write-Back, Write-Allocate.

- 10 Region is Write-Through, no Write-Allocate.
- 11 Region is Write-Back, no Write-Allocate.

The meaning of the field with $n = 6$ is IMPLEMENTATION DEFINED and might differ from the meaning given here. This is because the meaning of the attribute combination {TEX[0] = 1, C = 1, B = 0} is IMPLEMENTATION DEFINED.

IR<n>, bits [2n+1:2n], for n = 0 to 7

Inner Cacheable property mapping for memory attributes n, if the region is mapped as Normal memory by the PRRR.TR<n> entry. n is the value of the TEX[0], C, and B bits concatenated. The possible values of this field are:

- 00 Region is Non-cacheable.
- 01 Region is Write-Back, Write-Allocate.
- 10 Region is Write-Through, no Write-Allocate.
- 11 Region is Write-Back, no Write-Allocate.

The meaning of the field with $n = 6$ is IMPLEMENTATION DEFINED and might differ from the meaning given here. This is because the meaning of the attribute combination {TEX[0] = 1, C = 1, B = 0} is IMPLEMENTATION DEFINED.

Accessing the NMRR:

To access the NMRR when TTBCR.EAE==0:

MRC p15,0,<Rt>,c10,c2,1 ; Read NMRR into Rt
 MCR p15,0,<Rt>,c10,c2,1 ; Write Rt to NMRR

Register access is encoded as follows:

coproc	opc1	CRn	CRm	opc2
1111	000	1010	0010	001

G4.2.106 NSACR, Non-Secure Access Control Register

The NSACR characteristics are:

Purpose

Defines the Non-secure access permissions to coprocessors CP0 to CP13, and can include additional IMPLEMENTATION DEFINED bits that define Non-secure access permissions for IMPLEMENTATION DEFINED functionality.

This register is part of the Security registers functional group.

Usage constraints

This register is accessible as shown below:

EL0 (NS)	EL0 (S)	EL1 (NS)	EL1 (S)	EL2	EL3 (SCR.NS=1)	EL3 (SCR.NS=0)
-	-	RO	RW	RO	RW	RW

If EL3 is implemented and is using AArch64, any read or write to NSACR in Secure EL1 state in AArch32 is trapped as an exception to EL3.

Configurations

There is one instance of this register that is used in both Secure and Non-secure states.

When EL3 is using AArch64, then any reads of the NSACR from Non-secure EL2 using AArch32 or Non-secure EL1 using AArch32 will return a fixed value of 0x00000C00.

If EL3 is not implemented, then any reads of the NSACR from Non-secure EL2 using AArch32 or Secure or Non-secure EL1 using AArch32 will return a fixed value of 0x00000C00.

In AArch64, the NSACR functionality is replaced by the behavior in [CPTR_EL3](#).

Attributes

NSACR is a 32-bit register.

The NSACR bit assignments are:

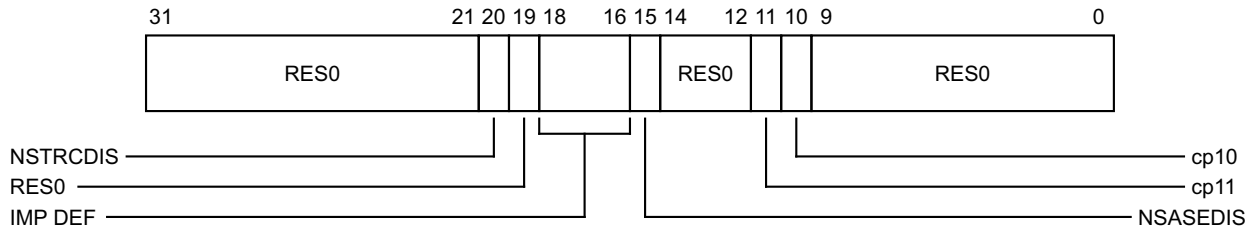

Bits [31:21]

Reserved, RES0.

NSTRCDIS, bit [20]

Disable Non-secure access to CP14 trace registers. The implementation of this bit must correspond to the implementation of the [CPACR.TRCDIS](#) bit:

If [CPACR.TRCDIS](#) is RES0 then this bit is RES0.

If [CPACR.TRCDIS](#) is RW then this bit is RW and its possible values are:

- 0 This bit has no effect on the ability to write to [CPACR.TRCDIS](#).
- 1 When executing in Non-secure state, [CPACR.TRCDIS](#) is RES1.

Bit [19]

Reserved, RES0.

NSASEDIS, bit [15]

Disable Non-secure Advanced SIMD functionality. The implementation of this bit must correspond to the implementation of the CPACR.ASEDIS bit.

If CPACR.ASEDIS is not RW then this bit is RES0.

If CPACR.ASEDIS is RW then this bit is RW and its possible values are:

- 0 This bit has no effect on the ability to write to CPACR.ASEDIS.
- 1 When executing in Non-secure state, CPACR.ASEDIS is RES1.

Bits [14:12]

Reserved, RES0.

cp<n>, bit [n], for n = 10 to 11

Enable Non-secure access to coprocessors 10 and 11, which control the Floating-point and Advanced SIMD features. Possible values of the fields are:

- 0 Coprocessor <n> can be accessed only from Secure state. Any attempt to access coprocessor <n> in Non-secure state results in an Undefined Instruction exception. If the processor is in Non-secure state, the corresponding bits in the CPACR ignore writes and read as 0b00, access denied.
- 1 Coprocessor <n> can be accessed from any security state.

If Non-secure access to a coprocessor is enabled, the CPACR must be checked to determine the level of access that is permitted.

The Floating-point and Advanced SIMD features controlled by these fields are:

- VFP floating-point instructions.
- Advanced SIMD instructions (both integer and floating-point).
- Advanced SIMD and Floating-point registers D0-D31 and their views as S0-S31 and Q0-Q15.
- FPSCR, FPSID, MVFR0, MVFR1, MVFR2, FPEXC system registers.

If the cp11 and cp10 fields are set to different values, the behavior is CONSTRAINED UNPREDICTABLE, and is the same as if both fields were set to the value of cp10, in all respects other than the value read back by explicitly reading cp11.

Other coprocessors are not supported in ARMv8, so bits[13:12] and bits[9:0] are RES0.

Bits [9:0]

Reserved, RES0.

Accessing the NSACR:

To access the NSACR:

MRC p15,0,<Rt>,c1,c1,2 ; Read NSACR into Rt
MCR p15,0,<Rt>,c1,c1,2 ; Write Rt to NSACR

Register access is encoded as follows:

coproc	opc1	CRn	CRm	opc2
1111	000	0001	0001	010

G4.2.107 PAR, Physical Address Register

The PAR characteristics are:

Purpose

Receives the PA from any address translation operation.

This register is part of the Address translation operations functional group.

Usage constraints

This register is accessible as shown below:

When accessed as PAR(S):

EL0 (NS)	EL0 (S)	EL1 (NS)	EL1 (S)	EL2	EL3 (SCR.NS=1)	EL3 (SCR.NS=0)
-	-	-	RW	-	-	RW

When accessed as PAR(NS):

EL0 (NS)	EL0 (S)	EL1 (NS)	EL1 (S)	EL2	EL3 (SCR.NS=1)	EL3 (SCR.NS=0)
-	-	RW	-	RW	RW	-

An implementation that does not support a cacheability attribute can report its corresponding behavior instead of the actual value in the translation table entry.

Configurations

PAR(NS) is architecturally mapped to AArch64 register [PAR_EL1](#).

If EL3 is using AArch32, there are separate Secure and Non-secure instances of this register.

If the implementation includes the Large Physical Address Extension, the PAR is extended to be a 64-bit register and:

- The 64-bit PAR is used:
 - When using the Long-descriptor translation table format.
 - In an implementation that includes EL2, for the result of an ATSI Cxx operation performed from Hyp mode.
- The 32-bit PAR is used when using the Short-descriptor translation table format. In this case, PAR[63:32] is RES0.

Otherwise, the PAR is a 32-bit register.

Attributes

PAR is a 32-bit register when TTBCR.EAE==0 and a 64-bit register when TTBCR.EAE==1.

The PAR bit assignments are:

For all register layouts:

F, bit [0]

Indicates whether the conversion completed successfully.

0 VA to PA conversion completed successfully.

1 VA to PA conversion aborted.

When TTBCR.EAE==0, PAR.F==0:

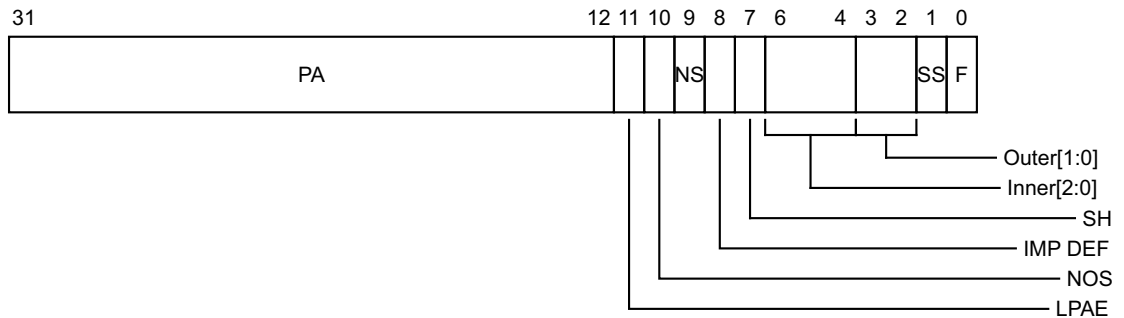

PA, bits [31:12]

Physical Address. The physical address corresponding to the supplied virtual address. This field returns address bits[31:12].

LPAE, bit [11]

When updating the PAR with the result of a translation operation, this bit is set as follows:

- 0 Indicates use of the Short-descriptor translation table formats. This indicates that the PAR returns a 32-bit value.
- 1 Indicates use of the Long-descriptor translation table formats. This indicates that the PAR returns a 64-bit value.

Hardware does not interpret this bit to determine the behavior of the memory system, and therefore software can set this bit to 0 or 1 without affecting operation.

NOS, bit [10]

Not Outer Shareable attribute for the region. Indicates whether Shareable physical memory is Outer Shareable:

- 0 Memory is Outer Shareable.
- 1 Memory is not Outer Shareable.

NS, bit [9]

Non-secure. The NS attribute for a translation table entry read from Secure state.

This bit is UNKNOWN for a translation table entry read from Non-secure state.

SH, bit [7]

Shareable attribute for the region. Indicates whether the physical memory is Shareable:

- 0 Memory is Non-shareable.
- 1 Memory is Shareable.

Inner[2:0], bits [6:4]

Inner memory attributes for the region. Permitted values are:

- 000 Non-cacheable.
- 001 Strongly-ordered.
- 011 Device.
- 101 Write-Back, Write-Allocate.
- 110 Write-Through.
- 111 Write-Back, no Write-Allocate.

The values 0b010 and 0b100 are reserved.

An implementation that does not support all of the defined attributes can return the behavior that the cache supports, instead of the value in the translation table entry.

Outer[1:0], bits [3:2]

Outer memory attributes for the region. Permitted values are:

- 00 Non-cacheable.
- 01 Write-Back, Write-Allocate.
- 10 Write-Through, no Write-Allocate.
- 11 Write-Back, no Write-Allocate.

An implementation that does not support all of the defined attributes can return the behavior that the cache supports, instead of the value in the translation table entry.

SS, bit [1]

Supersection. Used to indicate if the result is a Supersection:

- 0 Page is not a Supersection. That is, PAR[31:12] contains PA[31:12], regardless of the page size.
- 1 Page is part of a Supersection:
 - PAR[31:24] contains PA[31:24].
 - PAR[23:16] contains PA[39:32].
 - PAR[15:12] contains 0b0000.

If an implementation supports less than 40 bits of physical address, the bits in the PAR field that correspond to physical address bits that are not implemented are UNKNOWN.

F, bit [0]

Indicates whether the conversion completed successfully.

- 0 VA to PA conversion completed successfully.

When TTBCR.EAE==0, PAR.F==1:

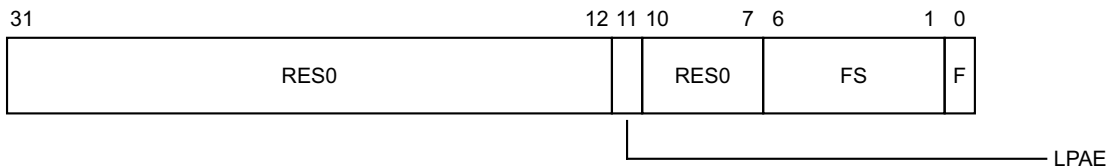

Bits [31:12]

Reserved, RES0.

LPAE, bit [11]

When updating the PAR with the result of a translation operation, this bit is set as follows:

- 0 Indicates use of the Short-descriptor translation table formats. This indicates that the PAR returns a 32-bit value.
- 1 Indicates use of the Long-descriptor translation table formats. This indicates that the PAR returns a 64-bit value.

Hardware does not interpret this bit to determine the behavior of the memory system, and therefore software can set this bit to 0 or 1 without affecting operation.

Bits [10:7]

Reserved, RES0.

FS, bits [6:1]

Fault status bits. Bits [12,10,3:0] from the **DFSR**, indicating the source of the abort.

F, bit [0]

Indicates whether the conversion completed successfully.

1 VA to PA conversion aborted.

When TTBCR.EAE==1, PAR.F==0:

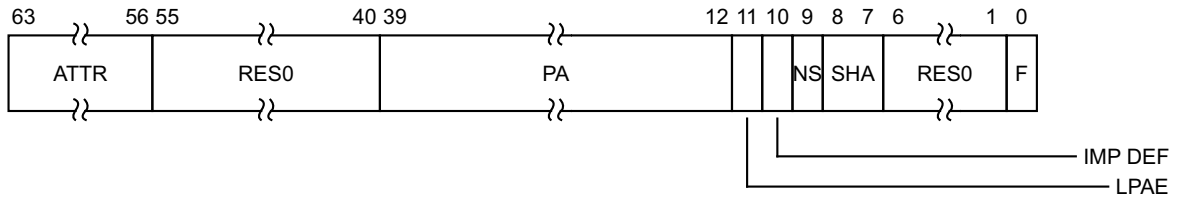

ATTR, bits [63:56]

Memory attributes for the returned PA, as indicated by the translation table entry. This field uses the same encoding as the Attr<7:0> fields in **MAIRO** and **MAIR1**.

Bits [55:40]

Reserved, RES0.

PA, bits [39:12]

Physical Address. The physical address corresponding to the supplied virtual address. This field returns address bits[39:12].

LPAE, bit [11]

When updating the PAR with the result of a translation operation, this bit is set as follows:

- 0 Indicates use of the Short-descriptor translation table formats. This indicates that the PAR returns a 32-bit value.
- 1 Indicates use of the Long-descriptor translation table formats. This indicates that the PAR returns a 64-bit value.

Hardware does not interpret this bit to determine the behavior of the memory system, and therefore software can set this bit to 0 or 1 without affecting operation.

NS, bit [9]

Non-secure. The NS attribute for a translation table entry read from Secure state.

This bit is UNKNOWN for a translation table entry read from Non-secure state.

SHA, bits [8:7]

Shareability attribute, from the translation table entry for the returned PA. Permitted values are:

- 00 Non-shareable.
- 10 Outer Shareable.
- 11 Inner Shareable.

The value 0b01 is reserved.

Note: this takes the value 0b10 for:

- Any type of Device memory.
- Normal memory with both Inner Non-cacheable and Outer Non-cacheable attributes.

Bits [6:1]

Reserved, RES0.

F, bit [0]

Indicates whether the conversion completed successfully.
 0 VA to PA conversion completed successfully.

When TTBCR.EAE==1, PAR.F==1:

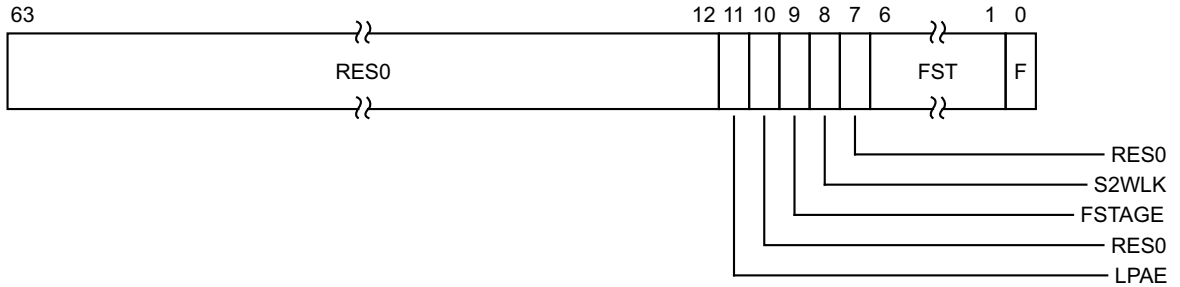

Bits [63:12]

Reserved, RES0.

LPAE, bit [11]

When updating the PAR with the result of a translation operation, this bit is set as follows:

- 0 Indicates use of the Short-descriptor translation table formats. This indicates that the PAR returns a 32-bit value.
- 1 Indicates use of the Long-descriptor translation table formats. This indicates that the PAR returns a 64-bit value.

Hardware does not interpret this bit to determine the behavior of the memory system, and therefore software can set this bit to 0 or 1 without affecting operation.

Bit [10]

Reserved, RES0.

FSTAGE, bit [9]

Indicates the translation stage at which the translation aborted:

- 0 Translation aborted because of a fault in the stage 1 translation.
- 1 Translation aborted because of a fault in the stage 2 translation.

S2WLK, bit [8]

If this bit is set to 1, it indicates the translation aborted because of a stage 2 fault during a stage 1 translation table walk.

Bit [7]

Reserved, RES0.

FST, bits [6:1]

Fault status field. Values are as in the [DFSR.STATUS](#) and [IFSR.STATUS](#) fields (when using the Long-descriptor translation table format).

F, bit [0]

Indicates whether the conversion completed successfully.
 1 VA to PA conversion aborted.

Accessing the PAR:

To access the PAR when TTBCR.EAE==0:

MRC p15,0,<Rt>,c7,c4,0 ; Read PAR into Rt
MCR p15,0,<Rt>,c7,c4,0 ; Write Rt to PAR

Register access is encoded as follows:

coproc	opc1	CRn	CRm	opc2
1111	000	0111	0100	000

To access the PAR when TTBCR.EAE==1:

MRRC p15,0,<Rt>,<Rt2>,c7 ; Read 64-bit PAR into Rt (low word) and Rt2 (high word)
MCRR p15,0,<Rt>,<Rt2>,c7 ; Write Rt (low word) and Rt2 (high word) to 64-bit PAR

Register access is encoded as follows:

coproc	opc1	CRm
1111	0000	0111

G4.2.108 PRRR, Primary Region Remap Register

The PRRR characteristics are:

Purpose

Controls the top level mapping of the TEX[0], C, and B memory region attributes.
 This register is part of the Virtual memory control registers functional group.

Usage constraints

This register is accessible as shown below:

When accessed as PRRR(S):

EL0 (NS)	EL0 (S)	EL1 (NS)	EL1 (S)	EL2	EL3 (SCR.NS=1)	EL3 (SCR.NS=0)
-	-	-	RW	-	-	RW

When accessed as PRRR(NS):

EL0 (NS)	EL0 (S)	EL1 (NS)	EL1 (S)	EL2	EL3 (SCR.NS=1)	EL3 (SCR.NS=0)
-	-	RW	-	RW	RW	-

Only accessible when using the Short-descriptor translation table format.

Configurations

PRRR(NS) is architecturally mapped to AArch64 register [MAIR_EL1](#)[31:0] when TTBCR.EAE==0.

PRRR(S) can be mapped to AArch64 register [MAIR_EL3](#)[31:0] when TTBCR.EAE==0, but this is not architecturally mandated.

If EL3 is using AArch32, there are separate Secure and Non-secure instances of this register.

PRRR has write access to the Secure copy of the register disabled when the CP15SDISABLE signal is asserted HIGH.

Attributes

PRRR is a 32-bit register when TTBCR.EAE==0.

The PRRR bit assignments are:

When TTBCR.EAE==0:

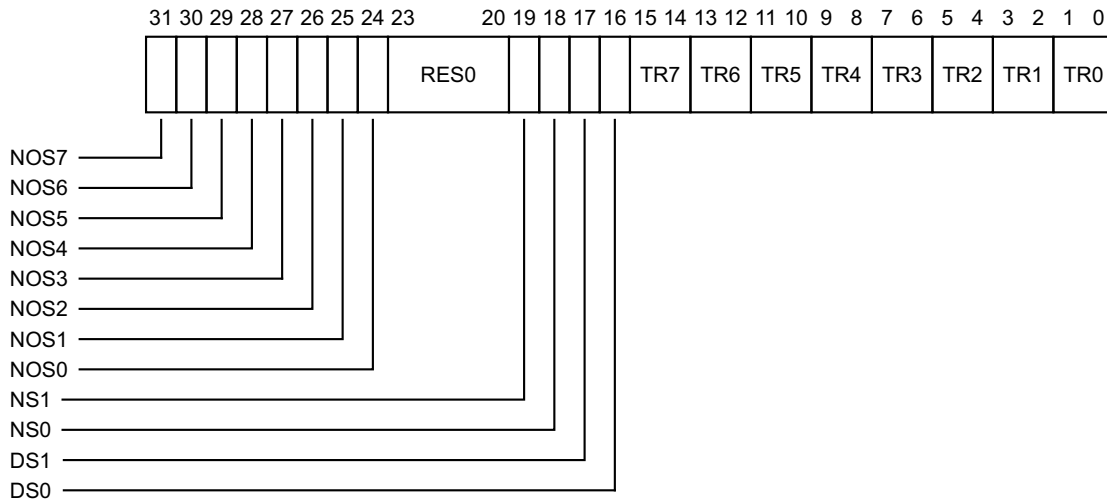

NOS<n>, bit [n+24], for n = 0 to 7

NOS<n> is the Outer Shareable property mapping for memory attributes n, if the region is mapped as Normal or Device memory that is Shareable. n is the value of the TEX[0], C, and B bits concatenated. The possible values of each NOS<n> bit are:

- 0 Memory region is Outer Shareable.
- 1 Memory region is Inner Shareable.

The value of this bit is ignored if the region is Normal or Device memory that is not Shareable.

The meaning of the field with n = 6 is IMPLEMENTATION DEFINED and might differ from the meaning given here. This is because the meaning of the attribute combination {TEX[0] = 1, C = 1, B = 0} is IMPLEMENTATION DEFINED.

If the implementation does not distinguish between Inner Shareable and Outer Shareable then these bits are reserved and are RES0.

Bits [23:20]

Reserved, RES0.

NS1, bit [19]

Mapping of S = 1 attribute for Normal memory. This bit gives the mapped Shareable attribute for a region of memory that:

- Is mapped as Normal memory.
- Has the S bit set to 1.

The possible values of this bit are:

- 0 Region is not Shareable.
- 1 Region is Shareable.

NS0, bit [18]

Mapping of S = 0 attribute for Normal memory. This bit gives the mapped Shareable attribute for a region of memory that:

- Is mapped as Normal memory.
- Has the S bit set to 0.

The possible values of this bit are:

- 0 Region is not Shareable.

1 Region is Shareable.

DS1, bit [17]

Mapping of S = 1 attribute for Device memory. This bit gives the mapped Shareable attribute for a region of memory that:

- Is mapped as Device memory.
- Has the S bit set to 1.

The possible values of this bit are:

0 Region is not Shareable.
 1 Region is Shareable.

DS0, bit [16]

Mapping of S = 0 attribute for Device memory. This bit gives the mapped Shareable attribute for a region of memory that:

- Is mapped as Device memory.
- Has the S bit set to 0.

The possible values of this bit are:

0 Region is not Shareable.
 1 Region is Shareable.

TR<n>, bits [2n+1:2n], for n = 0 to 7

TR<n> is the primary TEX mapping for memory attributes n, and defines the mapped memory type for a region with attributes n. n is the value of the TEX[0], C, and B bits concatenated. The possible values of this field are:

00 Device-nGnRnE memory
 01 Device-nGnRE memory
 10 Normal memory

The value 0b11 is reserved.

The meaning of the field with n = 6 is IMPLEMENTATION DEFINED and might differ from the meaning given here. This is because the meaning of the attribute combination {TEX[0] = 1, C = 1, B = 0} is IMPLEMENTATION DEFINED.

Accessing the PRRR:

To access the PRRR when TTBCR.EAE==0:

MRC p15,0,<Rt>,c10,c2,0 ; Read PRRR into Rt
 MCR p15,0,<Rt>,c10,c2,0 ; Write Rt to PRRR

Register access is encoded as follows:

coproc	opc1	CRn	CRm	opc2
1111	000	1010	0010	000

G4.2.109 REVIDR, Revision ID Register

The REVIDR characteristics are:

Purpose

Provides implementation-specific minor revision information that can only be interpreted in conjunction with the Main ID Register.

This register is part of the Identification registers functional group.

Usage constraints

This register is accessible as shown below:

EL0 (NS)	EL0 (S)	EL1 (NS)	EL1 (S)	EL2	EL3 (SCR.NS=1)	EL3 (SCR.NS=0)
-	-	RO	RO	RO	RO	RO

Configurations

REVIDR is architecturally mapped to AArch64 register [REVIDR_EL1](#).

There is one instance of this register that is used in both Secure and Non-secure states.

An optional register. When REVIDR is not implemented, its encoding is an alias of the [MIDR](#).

Attributes

REVIDR is a 32-bit register.

The REVIDR bit assignments are:



Accessing the REVIDR:

To access the REVIDR:

MRC p15,0,<Rt>,c0,c0,6 ; Read REVIDR into Rt

Register access is encoded as follows:

coproc	opc1	CRn	CRm	opc2
1111	000	0000	0000	110

G4.2.110 RMR (at EL1), Reset Management Register

The RMR (at EL1) characteristics are:

Purpose

If this register's exception level is the highest exception level implemented, and is capable of using both AArch32 and AArch64, controls the execution state that the processor boots into and allows request of a Warm reset.

This register is part of the Reset management registers functional group.

Usage constraints

This register is accessible as shown below:

EL0	EL1
-	RW

If EL3 is implemented, the AArch32 view of the RMR register is subject to CP15SDISABLE, which prevents writing to this register when the CP15SDISABLE signal is asserted.

Configurations

RMR (at EL1) is architecturally mapped to AArch64 register [RMR_EL1](#).

There is one instance of this register that is used in both Secure and Non-secure states.

Only implemented if this register's exception level is the highest exception level implemented, and is capable of using both AArch32 and AArch64.

If this exception level is not the highest one implemented, then this register is not implemented and its encoding is UNDEFINED.

Attributes

RMR (at EL1) is a 32-bit register when EL2 and EL3 not implemented.

The RMR (at EL1) bit assignments are:

When EL2 and EL3 not implemented:

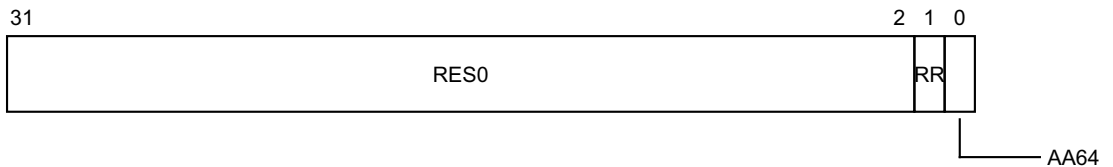

Bits [31:2]

Reserved, RES0.

RR, bit [1]

When set to 1 this bit requests a Warm reset. The bit is strictly a request.

On Warm reset, the field resets to 0.

AA64, bit [0]

Determines which execution state the processor boots into after a Warm reset:

0 AArch32.

1 AArch64.

The reset vector address on reset takes a choice between two IMP DEF values, depending on the value in the AA64 bit. This ensures that even with reprogramming of the AA64 bit, it is not possible to change the reset vector to go to a different location.

On Cold reset, the field resets to 0.

Accessing the RMR (at EL1):

To access the RMR (at EL1) when EL2 and EL3 not implemented:

MRC p15,0,<Rt>,c12,c0,2 ; Read RMR into Rt
 MCR p15,0,<Rt>,c12,c0,2 ; Write Rt to RMR

Register access is encoded as follows:

coproc	opc1	CRn	CRm	opc2
1111	000	1100	0000	010

G4.2.111 RMR (at EL3), Reset Management Register

The RMR (at EL3) characteristics are:

Purpose

If this register's exception level is the highest exception level implemented, and is capable of using both AArch32 and AArch64, controls the execution state that the processor boots into and allows request of a Warm reset.

This register is part of the Reset management registers functional group.

Usage constraints

This register is accessible as shown below:

EL0 (NS)	EL0 (S)	EL1 (NS)	EL1 (S)	EL2	EL3 (SCR.NS=1)	EL3 (SCR.NS=0)
-	-	-	-	-	RW	RW

If EL3 is implemented, the AArch32 view of the RMR register is subject to CP15SSDISABLE, which prevents writing to this register when the CP15SSDISABLE signal is asserted.

Configurations

RMR (at EL3) is architecturally mapped to AArch64 register [RMR_EL3](#).

There is one instance of this register that is used in both Secure and Non-secure states.

Only implemented if this register's exception level is the highest exception level implemented, and is capable of using both AArch32 and AArch64.

If this exception level is not the highest one implemented, then this register is not implemented and its encoding is UNDEFINED.

Attributes

RMR (at EL3) is a 32-bit register when EL3 implemented.

The RMR (at EL3) bit assignments are:

When EL3 implemented:

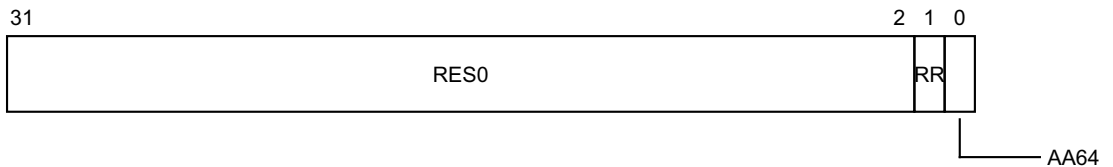

Bits [31:2]

Reserved, RES0.

RR, bit [1]

When set to 1 this bit requests a Warm reset. The bit is strictly a request.

On Warm reset, the field resets to 0.

AA64, bit [0]

Determines which execution state the processor boots into after a Warm reset:

0 AArch32.

1 AArch64.

The reset vector address on reset takes a choice between two IMP DEF values, depending on the value in the AA64 bit. This ensures that even with reprogramming of the AA64 bit, it is not possible to change the reset vector to go to a different location.

On Cold reset, the field resets to 0.

Accessing the RMR (at EL3):

To access the RMR (at EL3) when EL3 implemented:

MRC p15,0,<Rt>,c12,c0,2 ; Read RMR into Rt
MCR p15,0,<Rt>,c12,c0,2 ; Write Rt to RMR

Register access is encoded as follows:

coproc	opc1	CRn	CRm	opc2
1111	000	1100	0000	010

G4.2.112 RVBAR, Reset Vector Base Address Register

The RVBAR characteristics are:

Purpose

If EL3 is not implemented, contains the IMPLEMENTATION DEFINED address that execution starts from after reset when executing in AArch32 state.

This register is part of the Reset management registers functional group.

Usage constraints

This register is accessible as shown below:

EL0	EL1	EL2
-	Config-RO	Config-RO

This register can only be read at the highest exception level implemented. It is UNDEFINED at all other exception levels.

Configurations

There is one instance of this register that is used in both Secure and Non-secure states.

This register is only implemented if the highest exception level implemented is not EL3 and can use AArch32. In such an implementation, whether this register is implemented is implementation defined. If RVBAR is not implemented its encoding is UNDEFINED.

Attributes

RVBAR is a 32-bit register.

The RVBAR bit assignments are:

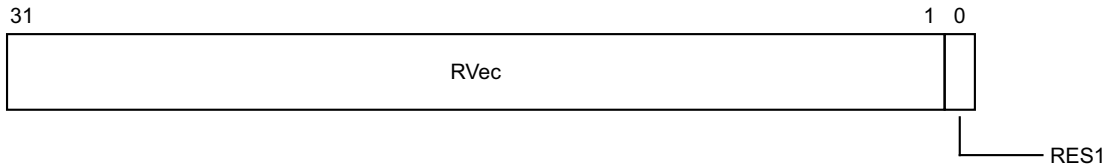

RVec, bits [31:1]

Bits [31:1] of the IMPLEMENTATION DEFINED AArch32 reset address.

Bit [0]

Reserved, RES1.

Accessing the RVBAR:

To access the RVBAR:

MRC p15,0,<Rt>,c12,c0,1 ; Read RVBAR into Rt

Register access is encoded as follows:

coproc	opc1	CRn	CRm	opc2
1111	000	1100	0000	001

G4.2.113 SCR, Secure Configuration Register

The SCR characteristics are:

Purpose

Defines the configuration of the current security state. It specifies:

- The security state, either Secure or Non-secure.
- What mode the processor branches to if an IRQ, FIQ, or External Abort occurs.
- Whether the CPSR.F or CPSR.A bits can be modified when SCR.NS==1.

This register is part of the Security registers functional group.

Usage constraints

This register is accessible as shown below:

EL0 (NS)	EL0 (S)	EL1 (NS)	EL1 (S)	EL2	EL3 (SCR.NS=1)	EL3 (SCR.NS=0)
-	-	-	RW	-	RW	RW

If EL3 is implemented and is using AArch64, any read or write to SCR in Secure EL1 state in AArch32 is trapped as an exception to EL3.

Configurations

SCR can be mapped to AArch64 register [SCR_EL3](#), but this is not architecturally mandated.

This register is only accessible in Secure state.

Attributes

SCR is a 32-bit register.

The SCR bit assignments are:

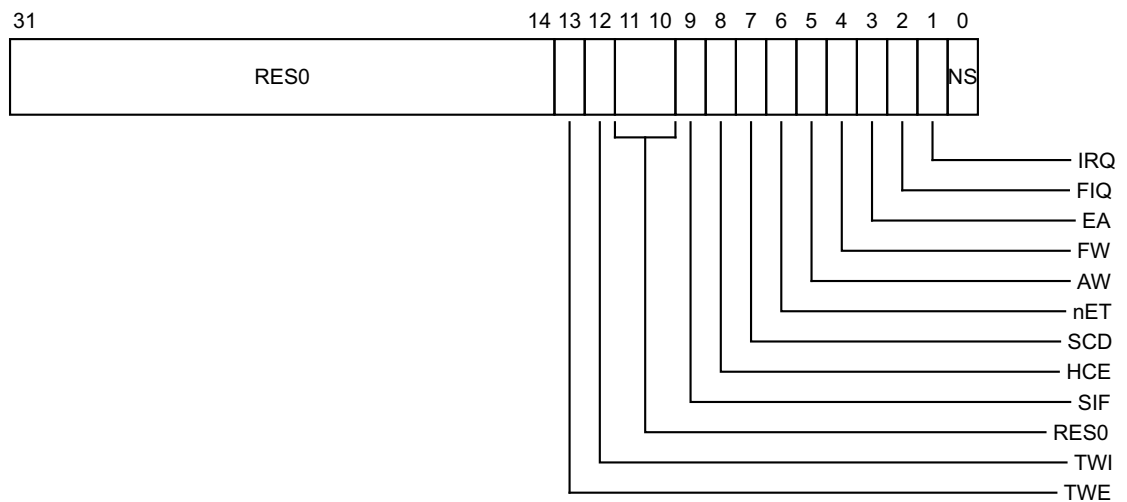

Bits [31:14]

Reserved, RES0.

TWE, bit [13]

Trap WFE. The possible values of this bit are:

- 0 WFE instructions are not trapped.

- 1 WFE instructions executed in any mode other than Monitor mode are trapped to Monitor mode as UNDEFINED if the instruction would otherwise cause suspension of execution, i.e. if the event register is not set, there is not a pending WFE wakeup event, and the instruction does not cause another exception.

Conditional WFE instructions that fail their condition do not cause an exception by this mechanism.
Resets to 0.

TWI, bit [12]

Trap WFI. The possible values of this bit are:

- 0 WFI instructions are not trapped.
- 1 WFI instructions executed in any mode other than Monitor mode are trapped to Monitor mode as UNDEFINED if the instruction would otherwise cause suspension of execution.

Conditional WFI instructions that fail their condition do not cause an exception by this mechanism.
Resets to 0.

Bits [11:10]

Reserved, RES0.

SIF, bit [9]

Secure instruction fetch. When the processor is in Secure state, this bit disables instruction fetch from Non-secure memory. The possible values for this bit are:

- 0 Secure state instruction fetches from Non-secure memory are permitted.
- 1 Secure state instruction fetches from Non-secure memory are not permitted.

This bit is permitted to be cached in a TLB.
Resets to 0.

HCE, bit [8]

Hypervisor Call enable. This bit enables use of the HVC instruction from Non-secure EL1 modes. The possible values of this bit are:

- 0 HVC instruction is UNDEFINED in Non-secure EL1 modes, and either UNDEFINED or a NOP in Hyp mode, depending on the implementation.
- 1 HVC instruction is enabled in Non-secure EL1 modes, and performs a Hypervisor Call. If EL3 is implemented but EL2 is not implemented, this bit is RES0.

Resets to 0.

SCD, bit [7]

Secure Monitor Call disable. Makes the SMC instruction UNDEFINED in Non-secure state. The possible values of this bit are:

- 0 SMC executes normally in Non-secure state, performing a Secure Monitor Call.
- 1 SMC instruction is either UNDEFINED or a NOP in Non-secure state, depending on the implementation.

A trap of the SMC instruction to Hyp mode takes priority over the value of this bit.
Resets to 0.

nET, bit [6]

Not Early Termination. This bit disables early termination. The possible values of this bit are:

- 0 Early termination permitted. Execution time of data operations can depend on the data values.
- 1 Disable early termination. The number of cycles required for data operations is forced to be independent of the data values.

This IMPLEMENTATION DEFINED mechanism can disable data dependent timing optimizations from multiplies and data operations. It can provide system support against information leakage that might be exploited by timing correlation types of attack.

Resets to 0.

AW, bit [5]

When the value of SCR.EA is 1 and the value of HCR.AMO is 0, this bit controls whether CPSR.A masks an external abort taken from Non-secure state, and the possible values of this bit are:

0 External aborts taken from Non-secure state are not masked by CPSR.A, and are taken to EL3.

External aborts taken from Secure state are masked by CPSR.A.

1 External aborts taken from either security state are masked by CPSR.A. When CPSR.A is 0, the abort is taken to EL3.

When SCR.EA is 0 or HCR.AMO is 1, this bit has no effect.

Resets to 0.

FW, bit [4]

When the value of SCR.FIQ is 1 and the value of HCR.FMO is 0, this bit controls whether CPSR.F masks an FIQ interrupt taken from Non-secure state, and the possible values of this bit are:

0 An FIQ taken from Non-secure state is not masked by CPSR.F, and is taken to EL3.

An FIQ taken from Secure state is masked by CPSR.F.

1 An FIQ taken from either security state is masked by CPSR.F. When CPSR.F is 0, the FIQ is taken to EL3.

When SCR.FIQ is 0 or HCR.FMO is 1, this bit has no effect.

Resets to 0.

EA, bit [3]

External Abort handler. This bit controls which mode takes external aborts. The possible values of this bit are:

0 External aborts taken in Abort mode.

1 External aborts taken in Monitor mode.

Resets to 0.

FIQ, bit [2]

FIQ handler. This bit controls which mode takes FIQ exceptions. The possible values of this bit are:

0 FIQs taken in FIQ mode.

1 FIQs taken in Monitor mode.

Resets to 0.

IRQ, bit [1]

IRQ handler. This bit controls which mode takes IRQ exceptions. The possible values of this bit are:

0 IRQs taken in IRQ mode.

1 IRQs taken in Monitor mode.

Resets to 0.

NS, bit [0]

Non-secure bit. Except when the processor is in Monitor mode, this bit determines the security state of the processor:

0 Processor is in Secure state.

1 Processor is in Non-secure state.

If the **HCR.TGE** bit is set, an attempt to change from a Secure Kernel mode to a Non-secure Kernel mode by changing the **SCR.NS** bit from 0 to 1 will result in the **SCR.NS** bit remaining as 0.
Resets to 0.

Accessing the SCR:

To access the SCR:

MRC p15,0,<Rt>,c1,c1,0 ; Read SCR into Rt
MCR p15,0,<Rt>,c1,c1,0 ; Write Rt to SCR

Register access is encoded as follows:

coproc	opc1	CRn	CRm	opc2
1111	000	0001	0001	000

G4.2.114 SCTLR, System Control Register

The SCTLR characteristics are:

Purpose

Provides the top level control of the system, including its memory system.
This register is part of the Other system control registers functional group.

Usage constraints

This register is accessible as shown below:

When accessed as SCTLR(S):

EL0 (NS)	EL0 (S)	EL1 (NS)	EL1 (S)	EL2	EL3 (SCR.NS=1)	EL3 (SCR.NS=0)
-	-	-	RW	-	-	RW

When accessed as SCTLR(NS):

EL0 (NS)	EL0 (S)	EL1 (NS)	EL1 (S)	EL2	EL3 (SCR.NS=1)	EL3 (SCR.NS=0)
-	-	RW	-	RW	RW	-

Some bits in the register are read-only. These bits relate to non-configurable features of an implementation, and are provided for compatibility with previous versions of the architecture.

Configurations

SCTLR(NS) is architecturally mapped to AArch64 register [SCTLR_EL1](#).

SCTLR(S) can be mapped to AArch64 register [SCTLR_EL3](#), but this is not architecturally mandated.

If EL3 is using AArch32, there are separate Secure and Non-secure instances of this register.

SCTLR has write access to the Secure copy of the register disabled when the CP15SDISABLE signal is asserted HIGH.

Attributes

SCTLR is a 32-bit register.

The SCTLR bit assignments are:

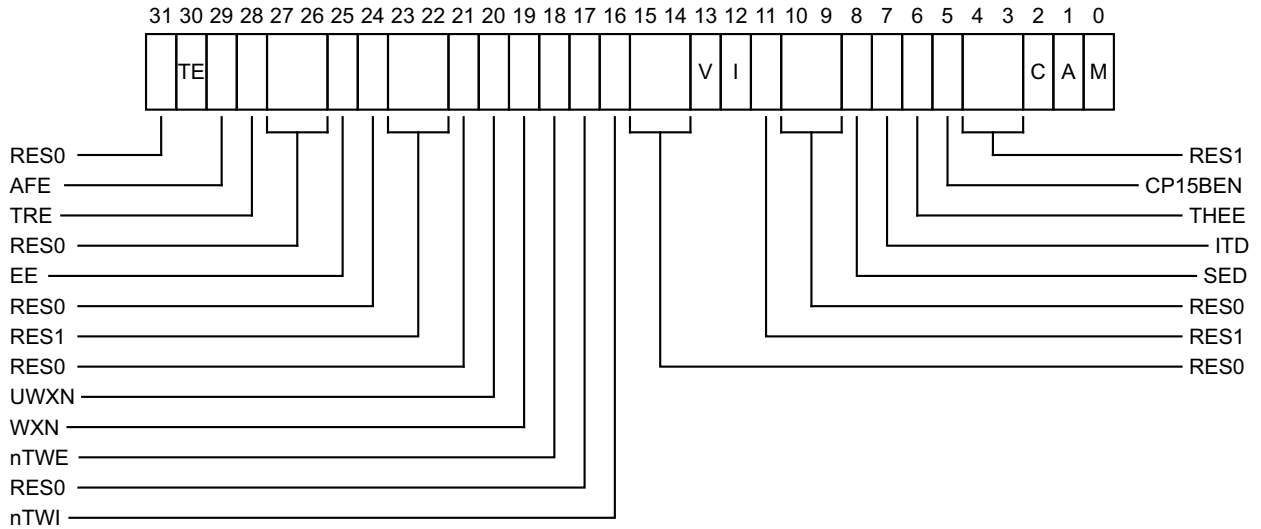

Bit [31]

Reserved, RES0.

TE, bit [30]

Thumb Exception Enable. This bit controls whether exceptions are taken in A32 or T32 state:

- 0 Exceptions, including reset, taken in A32 state.
- 1 Exceptions, including reset, taken in T32 state.

For the Secure copy of this register, the field resets to a value that is configurable by either input signal or pin setting.

For the Non-secure copy of this register, the field reset value is architecturally UNKNOWN.

AFE, bit [29]

Access Flag Enable. When using the Short-descriptor translation table format, this bit enables use of the AP[0] bit in the translation descriptors as the Access flag, and restricts access permissions in the translation descriptors to the simplified model. The possible values of this bit are:

- 0 In the translation table descriptors, AP[0] is an access permissions bit. The full range of access permissions is supported. No Access flag is implemented.
- 1 In the translation table descriptors, AP[0] is the Access flag. Only the simplified model for access permissions is supported.

When using the Long-descriptor translation table format, the VMSA behaves as if this bit is set to 1, regardless of the value of this bit.

The AFE bit is permitted to be cached in a TLB.

For the Secure copy of this register, the field resets to 0.

For the Non-secure copy of this register, the field reset value is architecturally UNKNOWN.

TRE, bit [28]

TEX remap enable. This bit enables remapping of the TEX[2:1] bits for use as two translation table bits that can be managed by the operating system. Enabling this remapping also changes the scheme used to describe the memory region attributes in the VMSA. The possible values of this bit are:

- 0 TEX remap disabled. TEX[2:0] are used, with the C and B bits, to describe the memory region attributes.

1 TEX remap enabled. TEX[2:1] are reassigned for use as bits managed by the operating system. The TEX[0], C, and B bits are used to describe the memory region attributes, with the MMU remap registers.

The TRE bit is permitted to be cached in a TLB.

For the Secure copy of this register, the field resets to 0.

For the Non-secure copy of this register, the field reset value is architecturally UNKNOWN.

Bits [27:26]

Reserved, RES0.

EE, bit [25]

Exception Endianness. The value of this bit defines the value of the CPSR.E bit on entry to an exception vector, including reset. This value also indicates the endianness of the translation table data for translation table lookups. The possible values of this bit are:

0 Little-endian.

1 Big-endian.

If an implementation does not provide Big-endian support, this bit is RES0. If it does not provide Little-endian support, this bit is RES1.

For the Secure copy of this register, the field resets to a value that is configurable by either input signal or pin setting.

For the Non-secure copy of this register, the field reset value is architecturally UNKNOWN.

Bit [24]

Reserved, RES0.

Bits [23:22]

Reserved, RES1.

Bit [21]

Reserved, RES0.

UWXN, bit [20]

Unprivileged write permission implies EL1 XN (Execute Never). This bit can be used to require all memory regions with unprivileged write permissions to be treated as XN for accesses from software executing at EL1. The possible values of this bit are:

0 Regions with unprivileged write permission are not forced to XN.

1 Regions with unprivileged write permission are forced to XN for accesses from software executing at EL1.

The UWXN bit is permitted to be cached in a TLB.

For the Secure copy of this register, the field resets to 0.

For the Non-secure copy of this register, the field resets to 0.

WXN, bit [19]

Write permission implies XN (Execute Never). This bit can be used to require all memory regions with write permission to be treated as XN. The possible values of this bit are:

0 Regions with write permission are not forced to XN.

1 Regions with write permission are forced to XN.

The WXN bit is permitted to be cached in a TLB.

For the Secure copy of this register, the field resets to 0.

For the Non-secure copy of this register, the field resets to 0.

nTWE, bit [18]

Not trap WFE. Possible values of this bit are:

- 0 If a WFE instruction executed at EL0 would cause execution to be suspended, such as if the event register is not set and there is not a pending WFE wakeup event, it is treated as UNDEFINED.
- 1 WFE instructions are executed as normal.

Conditional WFE instructions that fail their condition do not cause an exception if this bit is 0.

For the Secure copy of this register, the field resets to 1.

For the Non-secure copy of this register, the field resets to 1.

Bit [17]

Reserved, RES0.

nTWI, bit [16]

Not trap WFI. Possible values of this bit are:

- 0 If a WFI instruction executed at EL0 would cause execution to be suspended, such as if there is not a pending WFI wakeup event, it is treated as UNDEFINED.
- 1 WFI instructions are executed as normal.

Conditional WFI instructions that fail their condition do not cause an exception if this bit is 0.

For the Secure copy of this register, the field resets to 1.

For the Non-secure copy of this register, the field resets to 1.

Bits [15:14]

Reserved, RES0.

V, bit [13]

Vectors bit. This bit selects the base address of the exception vectors:

- 0 Normal exception vectors, base address 0x00000000. In an implementation that includes EL3, this base address can be re-mapped.
- 1 High exception vectors (Hivecs), base address 0xFFFF0000. This base address is never remapped.

For the Secure copy of this register, the field resets to a value that is configurable by either input signal or pin setting.

For the Non-secure copy of this register, the field reset value is architecturally UNKNOWN.

I, bit [12]

Instruction cache enable. This is a global enable bit for instruction caches:

- 0 Instruction caches disabled. If SCTL.R.M is set to 0, instruction accesses from stage 1 of the EL1&0 translation regime are to Normal memory, Outer Shareable, Inner Non-cacheable, Outer Non-cacheable.
- 1 Instruction caches enabled. If SCTL.R.M is set to 0, instruction accesses from stage 1 of the EL1&0 translation regime are to Normal memory, Outer Shareable, Inner Write-Through, Outer Write-Through.

When this bit is 0, all Normal memory instruction accesses are Non-cacheable.

If the HCR.DC bit is set to 1, then the Non-secure stage 1 EL1&0 translation regime is Cacheable regardless of the value of this bit.

For the Secure copy of this register, the field if this register is at the highest exception level implemented, field resets to 0. Otherwise, its reset value is UNKNOWN.

For the Non-secure copy of this register, the field reset value is architecturally UNKNOWN.

Bit [11]

Reserved, RES1.

Bits [10:9]

Reserved, RES0.

SED, bit [8]

SETEND Disable. The possible values of this bit are:

- 0 The SETEND instruction is available.
- 1 The SETEND instruction is UNALLOCATED.

If an implementation does not support mixed endian operation, this bit is RES1.

For the Secure copy of this register, the field resets to 0.

For the Non-secure copy of this register, the field resets to 1.

ITD, bit [7]

IT Disable. The possible values of this bit are:

- 0 The IT instruction functionality is available.
- 1 It is IMPLEMENTATION DEFINED whether the IT instruction is treated as either:
 - A 16-bit instruction, which can only be followed by another 16-bit instruction.
 - The first half of a 32-bit instruction.

An implementation might vary dynamically as to whether IT is treated as a 16-bit instruction or the first half of a 32-bit instruction.

All encodings of the IT instruction with hw1[3:0]! = 1000 are UNDEFINED and treated as unallocated.

All encodings of the subsequent instruction with the following values for hw1 are UNDEFINED (and treated as unallocated):

11xxxxxxxxxxxx

All 32-bit instructions, B(2), B(1), Undefined, SVC, Load/Store multiple

1x11xxxxxxxxxxxx

Miscellaneous 16-bit instructions

1x100xxxxxxxxxxx

ADD Rd, PC, #imm

01001xxxxxxxxxxx

LDR Rd, [PC, #imm]

0100x1xxx1111xxx

ADD(4),CMP(3), MOV, BX pc, BLX pc

010001xx1xxx111

ADD(4),CMP(3), MOV (Note: this pattern also covers UNPREDICTABLE cases with BLX Rn)

Contrary to the standard treatment of conditional UNDEFINED instructions in the ARM architecture, in this case these instructions are always treated as UNDEFINED, regardless of whether the instruction would pass or fail its condition codes as a result of being in an IT block.

For the Secure copy of this register, the field resets to 0.

For the Non-secure copy of this register, the field resets to 0.

THEE, bit [6]

T32EE enable. The possible values of this bit are:

- 0 T32EE is disabled.
- 1 T32EE is enabled.

If T32EE is not implemented, this bit is RES0.

For the Secure copy of this register, the field resets to 1 if T32EE is implemented. Otherwise, its reset value is UNKNOWN.

For the Non-secure copy of this register, the field resets to 1 if T32EE is implemented. Otherwise, its reset value is UNKNOWN.

CP15BEN, bit [5]

CP15 barrier enable. If implemented, this is an enable bit for the CP15 DMB, DSB, and ISB barrier operations at EL0 and EL1:

0 CP15 barrier operations disabled at EL0 and EL1. Their encodings are UNDEFINED.

1 CP15 barrier operations enabled at EL0 and EL1.

If an implementation does not support the CP15 barrier operations, this bit is RES0.

For the Secure copy of this register, the field resets to 1.

For the Non-secure copy of this register, the field resets to 1.

Bits [4:3]

Reserved, RES1.

C, bit [2]

Cache enable. This is a global enable bit for data and unified caches:

0 Data and unified caches disabled.

1 Data and unified caches enabled.

When this bit is 0, all Normal memory data accesses and all accesses to the EL1&0 stage 1 translation tables are Non-cacheable.

If the HCR.DC bit is set to 1, then the Non-secure stage 1 EL1&0 translation regime is Cacheable regardless of the value of the SCTLR.C bit.

For the Secure copy of this register, the field resets to 0.

For the Non-secure copy of this register, the field reset value is architecturally UNKNOWN.

A, bit [1]

Alignment check enable. This is the enable bit for Alignment fault checking:

0 Alignment fault checking disabled.

Instructions that load or store one or more registers, other than load/store exclusive and load-acquire/store-release, do not check that the address being accessed is aligned to the size of the data element(s) being accessed.

1 Alignment fault checking enabled.

All instructions that load or store one or more registers have an alignment check that the address being accessed is aligned to the size of the data element(s) being accessed. If this check fails it causes an Alignment fault, which is taken as a Data Abort exception.

Load/store exclusive and load-acquire/store-release instructions have an alignment check regardless of the value of the A bit.

For the Secure copy of this register, the field resets to 0.

For the Non-secure copy of this register, the field reset value is architecturally UNKNOWN.

M, bit [0]

MMU enable for EL1 and EL0 stage 1 address translation. Possible values of this bit are:

0 EL1 and EL0 stage 1 address translation disabled.

1 EL1 and EL0 stage 1 address translation enabled.

If the HCR.DC bit is set to 1, then the behavior of the processor when executing in a Non-secure mode other than Hyp mode is consistent with SCTLR.M being 0, regardless of the actual value of SCTLR.M, other than the value returned by an explicit read of SCTLR.M.

For the Secure copy of this register, the field resets to 0.

For the Non-secure copy of this register, the field reset value is architecturally UNKNOWN.

Accessing the SCTLR:

To access the SCTLR:

MRC p15,0,<Rt>,c1,c0,0 ; Read SCTLR into Rt

MCR p15,0,<Rt>,c1,c0,0 ; Write Rt to SCTLR

Register access is encoded as follows:

coproc	opc1	CRn	CRm	opc2
1111	000	0001	0000	000

G4.2.115 SPSR, Saved Program Status Register

The SPSR characteristics are:

Purpose

Holds the saved processor state for the current mode.

Usage constraints

The SPSR can be read using the MRS instruction and written using the MSR (immediate) or MSR (register) instructions. For more information see [MRS on page F7-2720](#), [MSR \(immediate\) on page F7-2722](#), and [MSR \(register\) on page F7-2724](#).

Configurations

There is one instance of this register that is used in both Secure and Non-secure states.

Attributes

SPSR is a 32-bit register.

The SPSR bit assignments are:

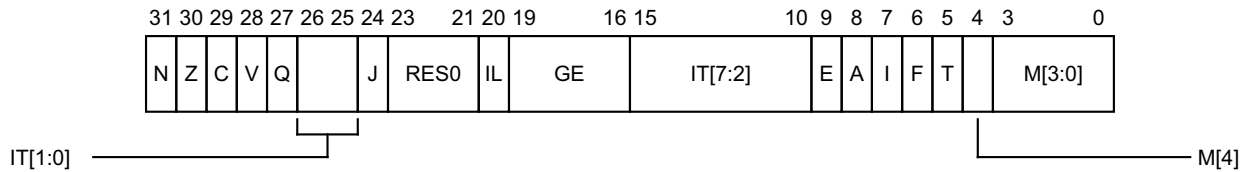

N, bit [31]

Set to the value of [CPSR.N](#) on taking an exception to the current mode, and copied to [CPSR.N](#) on executing an exception return operation in the current mode.

Z, bit [30]

Set to the value of [CPSR.Z](#) on taking an exception to the current mode, and copied to [CPSR.Z](#) on executing an exception return operation in the current mode.

C, bit [29]

Set to the value of [CPSR.C](#) on taking an exception to the current mode, and copied to [CPSR.C](#) on executing an exception return operation in the current mode.

V, bit [28]

Set to the value of [CPSR.V](#) on taking an exception to the current mode, and copied to [CPSR.V](#) on executing an exception return operation in the current mode.

Q, bit [27]

Set to the value of [CPSR.Q](#) on taking an exception to the current mode, and copied to [CPSR.Q](#) on executing an exception return operation in the current mode.

IT[1:0], bits [26:25]

If-Then execution state bits for the T32 IT (If-Then) instruction. See [IT\[7:2\]](#) for explanation of this field.

J, bit [24]

Jazelle bit. Along with the T bit, determines the AArch32 instruction set state that the exception was taken from. Possible values of this bit are:

- 0 Processor in A32 state if T is 0, or T32 state if T is 1.
- 1 Processor in an invalid state (Jazelle state before ARMv8) if T is 0, or T32EE state if T is 1.

Since the Jazelle state is obsolete in ARMv8, J==1 and T==0 is an invalid combination, and attempting to perform an exception return with those values is an illegal exception return.

If T32EE is not implemented, this bit is RES0, so the possible values of the T bit signify either A32 or T32 state.

Bits [23:21]

Reserved, RES0.

IL, bit [20]

Illegal Execution State bit. Shows the value of PSTATE.IL immediately before the exception was taken.

GE, bits [19:16]

Greater than or Equal flags, for parallel addition and subtraction.

IT[7:2], bits [15:10]

If-Then execution state bits for the T32 IT (If-Then) instruction. This field must be interpreted in two parts.

- IT[7:5] holds the base condition for the IT block. The base condition is the top 3 bits of the condition code specified by the first condition field of the IT instruction.
- IT[4:0] encodes the size of the IT block, which is the number of instructions that are to be conditionally executed, by the position of the least significant 1 in this field. It also encodes the value of the least significant bit of the condition code for each instruction in the block.

The IT field is 0b00000000 when no IT block is active.

E, bit [9]

Endianness execution state bit. Controls the load and store endianness for data accesses:

- 0 Little-endian operation
- 1 Big-endian operation.

Instruction fetches ignore this bit.

When the reset value of the SCTL.R.EE bit is defined by a configuration input signal, that value also applies to the CPSR.E bit on reset, and therefore applies to software execution from reset.

If an implementation does not provide Big-endian support, this bit is RES0. If it does not provide Little-endian support, this bit is RES1.

If an implementation provides Big-endian support but only at EL0, this bit is RES0 for an exception return to any exception level other than EL0.

Likewise, if it provides Little-endian support only at EL0, this bit is RES1 for an exception return to any exception level other than EL0.

A, bit [8]

Asynchronous data abort mask bit. The possible values of this bit are:

- 0 Exception not masked.
- 1 Exception masked.

I, bit [7]

IRQ mask bit. The possible values of this bit are:

- 0 Exception not masked.
- 1 Exception masked.

F, bit [6]

FIQ mask bit. The possible values of this bit are:

- 0 Exception not masked.
- 1 Exception masked.

T, bit [5]

Thumb execution state bit. Along with the J bit, determines the AArch32 instruction set state that the exception was taken from. Possible values of this bit are:

- 0 Processor in A32 state if J is 0, or an invalid state (Jazelle state before ARMv8) if J is 1.
- 1 Processor in T32 state if J is 0, or T32EE state if J is 1.

Since the Jazelle state is obsolete in ARMv8, J==1 and T==0 is an invalid combination, and attempting to perform an exception return with those values is an illegal exception return.

If T32EE is not implemented, the J bit is RES0, so the possible values of this bit signify either A32 or T32 state.

M[4], bit [4]

Register width that the exception was taken from. Possible values of this bit are:

- 1 Exception taken from AArch32.

M[3:0], bits [3:0]

Mode that an exception was taken from. For exceptions taken from AArch32, the possible values are:

M[3:0]	Mode
0b0000	User
0b0001	FIQ
0b0010	IRQ
0b0011	Supervisor
0b0110	Monitor
0b0111	Abort
0b1010	Hyp
0b1011	Undefined
0b1111	System

Other values are reserved.

G4.2.116 SPSR_abt, Saved Program Status Register (Abort mode)

The SPSR_abt characteristics are:

Purpose

Holds the saved processor state when an exception is taken to Abort mode.

This register is part of the Special purpose registers functional group.

Usage constraints

This register is accessible as shown below:

EL0 (NS)	EL0 (S)	EL1 (NS, IABT)	EL1 (S, IABT)	EL2	EL3 (SCR.NS=1)	EL3 (SCR.NS=0)
-	-	RW	RW	RW	RW	RW

This register is only accessible at EL1 in modes other than Abort mode. In Abort mode, it is accessible as the current SPSR.

Configurations

SPSR_abt is architecturally mapped to AArch64 register [SPSR_abt](#).

There is one instance of this register that is used in both Secure and Non-secure states.

Attributes

SPSR_abt is a 32-bit register.

The SPSR_abt bit assignments are:

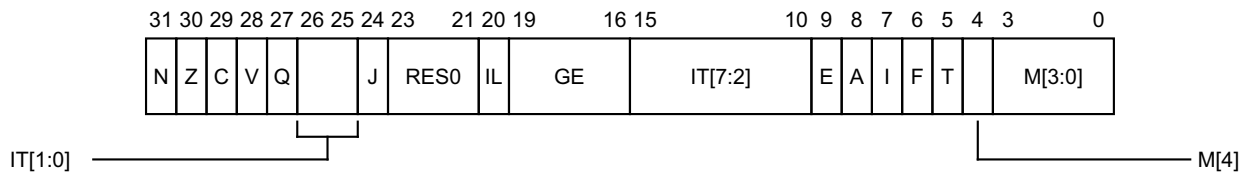

N, bit [31]

Set to the value of [CPSR.N](#) on taking an exception to Abort mode, and copied to [CPSR.N](#) on executing an exception return operation in Abort mode.

Z, bit [30]

Set to the value of [CPSR.Z](#) on taking an exception to Abort mode, and copied to [CPSR.Z](#) on executing an exception return operation in Abort mode.

C, bit [29]

Set to the value of [CPSR.C](#) on taking an exception to Abort mode, and copied to [CPSR.C](#) on executing an exception return operation in Abort mode.

V, bit [28]

Set to the value of [CPSR.V](#) on taking an exception to Abort mode, and copied to [CPSR.V](#) on executing an exception return operation in Abort mode.

Q, bit [27]

Set to the value of [CPSR.Q](#) on taking an exception to Abort mode, and copied to [CPSR.Q](#) on executing an exception return operation in Abort mode.

IT[1:0], bits [26:25]

If-Then execution state bits for the T32 IT (If-Then) instruction. See IT[7:2] for explanation of this field.

J, bit [24]

Jazelle bit. Along with the T bit, determines the AArch32 instruction set state that the exception was taken from. Possible values of this bit are:

- 0 Processor in A32 state if T is 0, or T32 state if T is 1.
- 1 Processor in an invalid state (Jazelle state before ARMv8) if T is 0, or T32EE state if T is 1.

Since the Jazelle state is obsolete in ARMv8, J==1 and T==0 is an invalid combination, and attempting to perform an exception return with those values is an illegal exception return.

If T32EE is not implemented, this bit is RES0, so the possible values of the T bit signify either A32 or T32 state.

Bits [23:21]

Reserved, RES0.

IL, bit [20]

Illegal Execution State bit. Shows the value of PSTATE.IL immediately before the exception was taken.

GE, bits [19:16]

Greater than or Equal flags, for parallel addition and subtraction.

IT[7:2], bits [15:10]

If-Then execution state bits for the T32 IT (If-Then) instruction. This field must be interpreted in two parts.

- IT[7:5] holds the base condition for the IT block. The base condition is the top 3 bits of the condition code specified by the first condition field of the IT instruction.
- IT[4:0] encodes the size of the IT block, which is the number of instructions that are to be conditionally executed, by the position of the least significant 1 in this field. It also encodes the value of the least significant bit of the condition code for each instruction in the block.

The IT field is 0b00000000 when no IT block is active.

E, bit [9]

Endianness execution state bit. Controls the load and store endianness for data accesses:

- 0 Little-endian operation
- 1 Big-endian operation.

Instruction fetches ignore this bit.

When the reset value of the SCTL.R.EE bit is defined by a configuration input signal, that value also applies to the CPSR.E bit on reset, and therefore applies to software execution from reset.

If an implementation does not provide Big-endian support, this bit is RES0. If it does not provide Little-endian support, this bit is RES1.

If an implementation provides Big-endian support but only at EL0, this bit is RES0 for an exception return to any exception level other than EL0.

Likewise, if it provides Little-endian support only at EL0, this bit is RES1 for an exception return to any exception level other than EL0.

A, bit [8]

Asynchronous data abort mask bit. The possible values of this bit are:

- 0 Exception not masked.
- 1 Exception masked.

I, bit [7]

IRQ mask bit. The possible values of this bit are:

- 0 Exception not masked.
- 1 Exception masked.

F, bit [6]

FIQ mask bit. The possible values of this bit are:

- 0 Exception not masked.
- 1 Exception masked.

T, bit [5]

Thumb execution state bit. Along with the J bit, determines the AArch32 instruction set state that the exception was taken from. Possible values of this bit are:

- 0 Processor in A32 state if J is 0, or an invalid state (Jazelle state before ARMv8) if J is 1.
- 1 Processor in T32 state if J is 0, or T32EE state if J is 1.

Since the Jazelle state is obsolete in ARMv8, J==1 and T==0 is an invalid combination, and attempting to perform an exception return with those values is an illegal exception return.

If T32EE is not implemented, the J bit is RES0, so the possible values of this bit signify either A32 or T32 state.

M[4], bit [4]

Register width that the exception was taken from. Possible values of this bit are:

- 1 Exception taken from AArch32.

M[3:0], bits [3:0]

Mode that an exception was taken from. For exceptions taken from AArch32, the possible values are:

M[3:0]	Mode
0b0000	User
0b0001	FIQ
0b0010	IRQ
0b0011	Supervisor
0b0110	Monitor (only valid in Secure state, if EL3 is implemented and can use AArch32)
0b0111	Abort
0b1011	Undefined
0b1111	System

Other values are reserved.

Accessing the SPSR_abt:

To access the SPSR_abt:

MRS <Rd>, SPSR_abt ; Read SPSR_abt into Rd
MSR SPSR_abt, <Rd> ; Write Rd to SPSR_abt

Register access is encoded as follows:

m	m1	R
1	0100	1

G4.2.117 SPSR_fiq, Saved Program Status Register (FIQ mode)

The SPSR_fiq characteristics are:

Purpose

Holds the saved processor state when an exception is taken to FIQ mode.
This register is part of the Special purpose registers functional group.

Usage constraints

This register is accessible as shown below:

EL0 (NS)	EL0 (S)	EL1 (NS, !FIQ)	EL1 (S, !FIQ)	EL2	EL3 (SCR.NS=1)	EL3 (SCR.NS=0)
-	-	RW	RW	RW	RW	RW

This register is only accessible at EL1 in modes other than FIQ mode. In FIQ mode, it is accessible as the current SPSR.

Configurations

SPSR_fiq is architecturally mapped to AArch64 register [SPSR_fiq](#).
There is one instance of this register that is used in both Secure and Non-secure states.

Attributes

SPSR_fiq is a 32-bit register.

The SPSR_fiq bit assignments are:

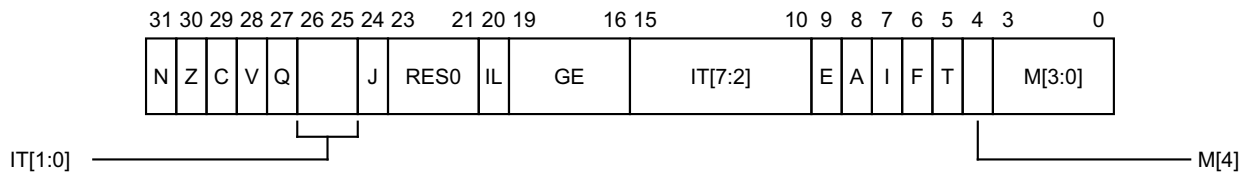

N, bit [31]

Set to the value of [CPSR.N](#) on taking an exception to FIQ mode, and copied to [CPSR.N](#) on executing an exception return operation in FIQ mode.

Z, bit [30]

Set to the value of [CPSR.Z](#) on taking an exception to FIQ mode, and copied to [CPSR.Z](#) on executing an exception return operation in FIQ mode.

C, bit [29]

Set to the value of [CPSR.C](#) on taking an exception to FIQ mode, and copied to [CPSR.C](#) on executing an exception return operation in FIQ mode.

V, bit [28]

Set to the value of [CPSR.V](#) on taking an exception to FIQ mode, and copied to [CPSR.V](#) on executing an exception return operation in FIQ mode.

Q, bit [27]

Set to the value of [CPSR.Q](#) on taking an exception to FIQ mode, and copied to [CPSR.Q](#) on executing an exception return operation in FIQ mode.

IT[1:0], bits [26:25]

If-Then execution state bits for the T32 IT (If-Then) instruction. See IT[7:2] for explanation of this field.

J, bit [24]

Jazelle bit. Along with the T bit, determines the AArch32 instruction set state that the exception was taken from. Possible values of this bit are:

- | | |
|---|---|
| 0 | Processor in A32 state if T is 0, or T32 state if T is 1. |
| 1 | Processor in an invalid state (Jazelle state before ARMv8) if T is 0, or T32EE state if T is 1. |

Since the Jazelle state is obsolete in ARMv8, J==1 and T==0 is an invalid combination, and attempting to perform an exception return with those values is an illegal exception return.

If T32EE is not implemented, this bit is RES0, so the possible values of the T bit signify either A32 or T32 state.

Bits [23:21]

Reserved, RES0.

IL, bit [20]

Illegal Execution State bit. Shows the value of PSTATE.IL immediately before the exception was taken.

GE, bits [19:16]

Greater than or Equal flags, for parallel addition and subtraction.

IT[7:2], bits [15:10]

If-Then execution state bits for the T32 IT (If-Then) instruction. This field must be interpreted in two parts.

- IT[7:5] holds the base condition for the IT block. The base condition is the top 3 bits of the condition code specified by the first condition field of the IT instruction.
- IT[4:0] encodes the size of the IT block, which is the number of instructions that are to be conditionally executed, by the position of the least significant 1 in this field. It also encodes the value of the least significant bit of the condition code for each instruction in the block.

The IT field is 0b00000000 when no IT block is active.

E, bit [9]

Endianness execution state bit. Controls the load and store endianness for data accesses:

- | | |
|---|-------------------------|
| 0 | Little-endian operation |
| 1 | Big-endian operation. |

Instruction fetches ignore this bit.

When the reset value of the SCTL.R.EE bit is defined by a configuration input signal, that value also applies to the CPSR.E bit on reset, and therefore applies to software execution from reset.

If an implementation does not provide Big-endian support, this bit is RES0. If it does not provide Little-endian support, this bit is RES1.

If an implementation provides Big-endian support but only at EL0, this bit is RES0 for an exception return to any exception level other than EL0.

Likewise, if it provides Little-endian support only at EL0, this bit is RES1 for an exception return to any exception level other than EL0.

A, bit [8]

Asynchronous data abort mask bit. The possible values of this bit are:

- | | |
|---|-----------------------|
| 0 | Exception not masked. |
| 1 | Exception masked. |

I, bit [7]

IRQ mask bit. The possible values of this bit are:

- 0 Exception not masked.
- 1 Exception masked.

F, bit [6]

FIQ mask bit. The possible values of this bit are:

- 0 Exception not masked.
- 1 Exception masked.

T, bit [5]

Thumb execution state bit. Along with the J bit, determines the AArch32 instruction set state that the exception was taken from. Possible values of this bit are:

- 0 Processor in A32 state if J is 0, or an invalid state (Jazelle state before ARMv8) if J is 1.
- 1 Processor in T32 state if J is 0, or T32EE state if J is 1.

Since the Jazelle state is obsolete in ARMv8, J==1 and T==0 is an invalid combination, and attempting to perform an exception return with those values is an illegal exception return.

If T32EE is not implemented, the J bit is RES0, so the possible values of this bit signify either A32 or T32 state.

M[4], bit [4]

Register width that the exception was taken from. Possible values of this bit are:

- 1 Exception taken from AArch32.

M[3:0], bits [3:0]

Mode that an exception was taken from. For exceptions taken from AArch32, the possible values are:

M[3:0]	Mode
0b0000	User
0b0001	FIQ
0b0010	IRQ
0b0011	Supervisor
0b0110	Monitor (only valid in Secure state, if EL3 is implemented and can use AArch32)
0b0111	Abort
0b1011	Undefined
0b1111	System

Other values are reserved.

Accessing the SPSR_fiq:

To access the SPSR_fiq:

MRS <Rd>, SPSR_fiq ; Read SPSR_fiq into Rd
MSR SPSR_fiq, <Rd> ; Write Rd to SPSR_fiq

Register access is encoded as follows:

m	m1	R
0	1110	1

G4.2.118 SPSR_hyp, Saved Program Status Register (Hyp mode)

The SPSR_hyp characteristics are:

Purpose

Holds the saved processor state when an exception is taken to Hyp mode.
This register is part of the Special purpose registers functional group.

Usage constraints

This register is accessible as shown below:

EL0 (NS)	EL0 (S)	EL1 (NS)	EL1 (S)	EL2	EL3 (SCR.NS=1)	EL3 (SCR.NS=0)
-	-	-	-	-	RW	RW

Configurations

SPSR_hyp is architecturally mapped to AArch64 register [SPSR_EL2](#).
There is one instance of this register that is used in both Secure and Non-secure states.

Attributes

SPSR_hyp is a 32-bit register.

The SPSR_hyp bit assignments are:

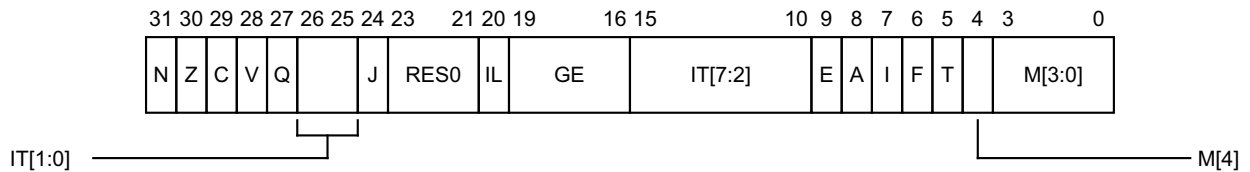

N, bit [31]

Set to the value of [CPSR.N](#) on taking an exception to Hyp mode, and copied to [CPSR.N](#) on executing an exception return operation in Hyp mode.

Z, bit [30]

Set to the value of [CPSR.Z](#) on taking an exception to Hyp mode, and copied to [CPSR.Z](#) on executing an exception return operation in Hyp mode.

C, bit [29]

Set to the value of [CPSR.C](#) on taking an exception to Hyp mode, and copied to [CPSR.C](#) on executing an exception return operation in Hyp mode.

V, bit [28]

Set to the value of [CPSR.V](#) on taking an exception to Hyp mode, and copied to [CPSR.V](#) on executing an exception return operation in Hyp mode.

Q, bit [27]

Set to the value of [CPSR.Q](#) on taking an exception to Hyp mode, and copied to [CPSR.Q](#) on executing an exception return operation in Hyp mode.

IT[1:0], bits [26:25]

If-Then execution state bits for the T32 IT (If-Then) instruction. See [IT\[7:2\]](#) for explanation of this field.

J, bit [24]

Jazelle bit. Along with the T bit, determines the AArch32 instruction set state that the exception was taken from. Possible values of this bit are:

- 0 Processor in A32 state if T is 0, or T32 state if T is 1.
- 1 Processor in an invalid state (Jazelle state before ARMv8) if T is 0, or T32EE state if T is 1.

Since the Jazelle state is obsolete in ARMv8, J==1 and T==0 is an invalid combination, and attempting to perform an exception return with those values is an illegal exception return.

If T32EE is not implemented, this bit is RES0, so the possible values of the T bit signify either A32 or T32 state.

Bits [23:21]

Reserved, RES0.

IL, bit [20]

Illegal Execution State bit. Shows the value of PSTATE.IL immediately before the exception was taken.

GE, bits [19:16]

Greater than or Equal flags, for parallel addition and subtraction.

IT[7:2], bits [15:10]

If-Then execution state bits for the T32 IT (If-Then) instruction. This field must be interpreted in two parts.

- IT[7:5] holds the base condition for the IT block. The base condition is the top 3 bits of the condition code specified by the first condition field of the IT instruction.
- IT[4:0] encodes the size of the IT block, which is the number of instructions that are to be conditionally executed, by the position of the least significant 1 in this field. It also encodes the value of the least significant bit of the condition code for each instruction in the block.

The IT field is 0b00000000 when no IT block is active.

E, bit [9]

Endianness execution state bit. Controls the load and store endianness for data accesses:

- 0 Little-endian operation
- 1 Big-endian operation.

Instruction fetches ignore this bit.

When the reset value of the SCTL.R.EE bit is defined by a configuration input signal, that value also applies to the CPSR.E bit on reset, and therefore applies to software execution from reset.

If an implementation does not provide Big-endian support, this bit is RES0. If it does not provide Little-endian support, this bit is RES1.

If an implementation provides Big-endian support but only at EL0, this bit is RES0 for an exception return to any exception level other than EL0.

Likewise, if it provides Little-endian support only at EL0, this bit is RES1 for an exception return to any exception level other than EL0.

A, bit [8]

Asynchronous data abort mask bit. The possible values of this bit are:

- 0 Exception not masked.
- 1 Exception masked.

I, bit [7]

IRQ mask bit. The possible values of this bit are:

- 0 Exception not masked.
- 1 Exception masked.

F, bit [6]

FIQ mask bit. The possible values of this bit are:

- 0 Exception not masked.
- 1 Exception masked.

T, bit [5]

Thumb execution state bit. Along with the J bit, determines the AArch32 instruction set state that the exception was taken from. Possible values of this bit are:

- 0 Processor in A32 state if J is 0, or an invalid state (Jazelle state before ARMv8) if J is 1.
- 1 Processor in T32 state if J is 0, or T32EE state if J is 1.

Since the Jazelle state is obsolete in ARMv8, J==1 and T==0 is an invalid combination, and attempting to perform an exception return with those values is an illegal exception return.

If T32EE is not implemented, the J bit is RES0, so the possible values of this bit signify either A32 or T32 state.

M[4], bit [4]

Register width that the exception was taken from. Possible values of this bit are:

- 1 Exception taken from AArch32.

M[3:0], bits [3:0]

Mode that an exception was taken from. For exceptions taken from AArch32, the possible values are:

M[3:0]	Mode
0b0000	User
0b0001	FIQ
0b0010	IRQ
0b0011	Supervisor
0b0111	Abort
0b1010	Hyp
0b1011	Undefined
0b1111	System

Other values are reserved.

Accessing the SPSR_hyp:

To access the SPSR_hyp:

MRS <Rd>, SPSR_hyp ; Read SPSR_hyp into Rd
MSR SPSR_hyp, <Rd> ; Write Rd to SPSR_hyp

Register access is encoded as follows:

m	m1	R
1	1110	1

G4.2.119 SPSR_irq, Saved Program Status Register (IRQ mode)

The SPSR_irq characteristics are:

Purpose

Holds the saved processor state when an exception is taken to IRQ mode.
This register is part of the Special purpose registers functional group.

Usage constraints

This register is accessible as shown below:

EL0 (NS)	EL0 (S)	EL1 (NS, !IRQ)	EL1 (S, !IRQ)	EL2	EL3 (SCR.NS=1)	EL3 (SCR.NS=0)
-	-	RW	RW	RW	RW	RW

This register is only accessible at EL1 in modes other than IRQ mode. In IRQ mode, it is accessible as the current SPSR.

Configurations

SPSR_irq is architecturally mapped to AArch64 register [SPSR_irq](#).
There is one instance of this register that is used in both Secure and Non-secure states.

Attributes

SPSR_irq is a 32-bit register.

The SPSR_irq bit assignments are:

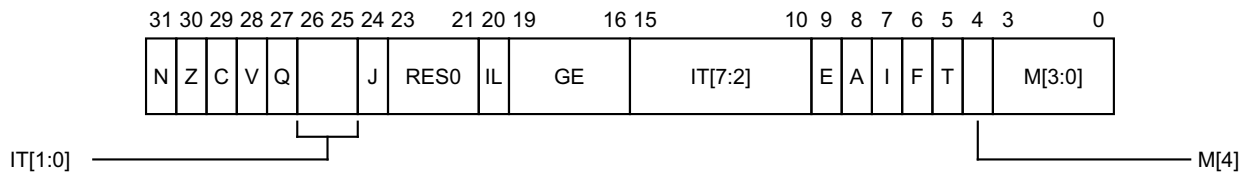

N, bit [31]

Set to the value of [CPSR.N](#) on taking an exception to IRQ mode, and copied to [CPSR.N](#) on executing an exception return operation in IRQ mode.

Z, bit [30]

Set to the value of [CPSR.Z](#) on taking an exception to IRQ mode, and copied to [CPSR.Z](#) on executing an exception return operation in IRQ mode.

C, bit [29]

Set to the value of [CPSR.C](#) on taking an exception to IRQ mode, and copied to [CPSR.C](#) on executing an exception return operation in IRQ mode.

V, bit [28]

Set to the value of [CPSR.V](#) on taking an exception to IRQ mode, and copied to [CPSR.V](#) on executing an exception return operation in IRQ mode.

Q, bit [27]

Set to the value of [CPSR.Q](#) on taking an exception to IRQ mode, and copied to [CPSR.Q](#) on executing an exception return operation in IRQ mode.

IT[1:0], bits [26:25]

If-Then execution state bits for the T32 IT (If-Then) instruction. See IT[7:2] for explanation of this field.

J, bit [24]

Jazelle bit. Along with the T bit, determines the AArch32 instruction set state that the exception was taken from. Possible values of this bit are:

- | | |
|---|---|
| 0 | Processor in A32 state if T is 0, or T32 state if T is 1. |
| 1 | Processor in an invalid state (Jazelle state before ARMv8) if T is 0, or T32EE state if T is 1. |

Since the Jazelle state is obsolete in ARMv8, J==1 and T==0 is an invalid combination, and attempting to perform an exception return with those values is an illegal exception return.

If T32EE is not implemented, this bit is RES0, so the possible values of the T bit signify either A32 or T32 state.

Bits [23:21]

Reserved, RES0.

IL, bit [20]

Illegal Execution State bit. Shows the value of PSTATE.IL immediately before the exception was taken.

GE, bits [19:16]

Greater than or Equal flags, for parallel addition and subtraction.

IT[7:2], bits [15:10]

If-Then execution state bits for the T32 IT (If-Then) instruction. This field must be interpreted in two parts.

- IT[7:5] holds the base condition for the IT block. The base condition is the top 3 bits of the condition code specified by the first condition field of the IT instruction.
- IT[4:0] encodes the size of the IT block, which is the number of instructions that are to be conditionally executed, by the position of the least significant 1 in this field. It also encodes the value of the least significant bit of the condition code for each instruction in the block.

The IT field is 0b00000000 when no IT block is active.

E, bit [9]

Endianness execution state bit. Controls the load and store endianness for data accesses:

- | | |
|---|-------------------------|
| 0 | Little-endian operation |
| 1 | Big-endian operation. |

Instruction fetches ignore this bit.

When the reset value of the SCTL.R.EE bit is defined by a configuration input signal, that value also applies to the CPSR.E bit on reset, and therefore applies to software execution from reset.

If an implementation does not provide Big-endian support, this bit is RES0. If it does not provide Little-endian support, this bit is RES1.

If an implementation provides Big-endian support but only at EL0, this bit is RES0 for an exception return to any exception level other than EL0.

Likewise, if it provides Little-endian support only at EL0, this bit is RES1 for an exception return to any exception level other than EL0.

A, bit [8]

Asynchronous data abort mask bit. The possible values of this bit are:

- | | |
|---|-----------------------|
| 0 | Exception not masked. |
| 1 | Exception masked. |

I, bit [7]

IRQ mask bit. The possible values of this bit are:

- 0 Exception not masked.
- 1 Exception masked.

F, bit [6]

FIQ mask bit. The possible values of this bit are:

- 0 Exception not masked.
- 1 Exception masked.

T, bit [5]

Thumb execution state bit. Along with the J bit, determines the AArch32 instruction set state that the exception was taken from. Possible values of this bit are:

- 0 Processor in A32 state if J is 0, or an invalid state (Jazelle state before ARMv8) if J is 1.
- 1 Processor in T32 state if J is 0, or T32EE state if J is 1.

Since the Jazelle state is obsolete in ARMv8, J==1 and T==0 is an invalid combination, and attempting to perform an exception return with those values is an illegal exception return.

If T32EE is not implemented, the J bit is RES0, so the possible values of this bit signify either A32 or T32 state.

M[4], bit [4]

Register width that the exception was taken from. Possible values of this bit are:

- 1 Exception taken from AArch32.

M[3:0], bits [3:0]

Mode that an exception was taken from. For exceptions taken from AArch32, the possible values are:

M[3:0]	Mode
0b0000	User
0b0001	FIQ
0b0010	IRQ
0b0011	Supervisor
0b0110	Monitor (only valid in Secure state, if EL3 is implemented and can use AArch32)
0b0111	Abort
0b1011	Undefined
0b1111	System

Other values are reserved.

Accessing the SPSR_irq:

To access the SPSR_irq:

MRS <Rd>, SPSR_irq ; Read SPSR_irq into Rd
MSR SPSR_irq, <Rd> ; Write Rd to SPSR_irq

Register access is encoded as follows:

m	m1	R
1	0000	1

G4.2.120 SPSR_mon, Saved Program Status Register (Monitor mode)

The SPSR_mon characteristics are:

Purpose

Holds the saved processor state when an exception is taken to Monitor mode.
This register is part of the Special purpose registers functional group.

Usage constraints

This register is accessible as shown below:

EL0 (NS)	EL0 (S)	EL1 (NS)	EL1 (S)	EL2	EL3 (SCR.NS=1)	EL3 (SCR.NS=0)
-	-	-	RW	-	-	-

Configurations

SPSR_mon can be mapped to AArch64 register [SPSR_EL3](#), but this is not architecturally mandated.

There is one instance of this register that is used in both Secure and Non-secure states.

Attributes

SPSR_mon is a 32-bit register.

The SPSR_mon bit assignments are:

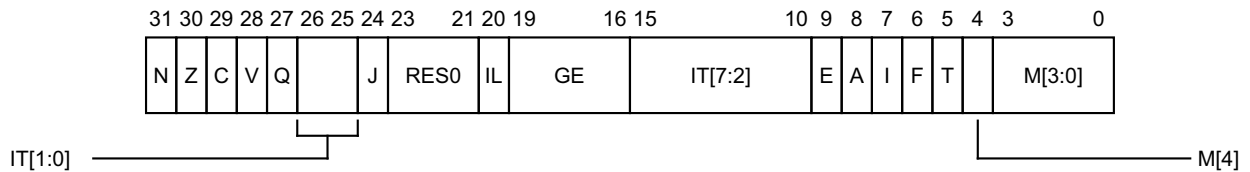

N, bit [31]

Set to the value of [CPSR.N](#) on taking an exception to Monitor mode, and copied to [CPSR.N](#) on executing an exception return operation in Monitor mode.

Z, bit [30]

Set to the value of [CPSR.Z](#) on taking an exception to Monitor mode, and copied to [CPSR.Z](#) on executing an exception return operation in Monitor mode.

C, bit [29]

Set to the value of [CPSR.C](#) on taking an exception to Monitor mode, and copied to [CPSR.C](#) on executing an exception return operation in Monitor mode.

V, bit [28]

Set to the value of [CPSR.V](#) on taking an exception to Monitor mode, and copied to [CPSR.V](#) on executing an exception return operation in Monitor mode.

Q, bit [27]

Set to the value of [CPSR.Q](#) on taking an exception to Monitor mode, and copied to [CPSR.Q](#) on executing an exception return operation in Monitor mode.

IT[1:0], bits [26:25]

If-Then execution state bits for the T32 IT (If-Then) instruction. See IT[7:2] for explanation of this field.

J, bit [24]

Jazelle bit. Along with the T bit, determines the AArch32 instruction set state that the exception was taken from. Possible values of this bit are:

- 0 Processor in A32 state if T is 0, or T32 state if T is 1.
- 1 Processor in an invalid state (Jazelle state before ARMv8) if T is 0, or T32EE state if T is 1.

Since the Jazelle state is obsolete in ARMv8, J==1 and T==0 is an invalid combination, and attempting to perform an exception return with those values is an illegal exception return.

If T32EE is not implemented, this bit is RES0, so the possible values of the T bit signify either A32 or T32 state.

Bits [23:21]

Reserved, RES0.

IL, bit [20]

Illegal Execution State bit. Shows the value of PSTATE.IL immediately before the exception was taken.

GE, bits [19:16]

Greater than or Equal flags, for parallel addition and subtraction.

IT[7:2], bits [15:10]

If-Then execution state bits for the T32 IT (If-Then) instruction. This field must be interpreted in two parts.

- IT[7:5] holds the base condition for the IT block. The base condition is the top 3 bits of the condition code specified by the first condition field of the IT instruction.
- IT[4:0] encodes the size of the IT block, which is the number of instructions that are to be conditionally executed, by the position of the least significant 1 in this field. It also encodes the value of the least significant bit of the condition code for each instruction in the block.

The IT field is 0b00000000 when no IT block is active.

E, bit [9]

Endianness execution state bit. Controls the load and store endianness for data accesses:

- 0 Little-endian operation
- 1 Big-endian operation.

Instruction fetches ignore this bit.

When the reset value of the SCTL.R.EE bit is defined by a configuration input signal, that value also applies to the CPSR.E bit on reset, and therefore applies to software execution from reset.

If an implementation does not provide Big-endian support, this bit is RES0. If it does not provide Little-endian support, this bit is RES1.

If an implementation provides Big-endian support but only at EL0, this bit is RES0 for an exception return to any exception level other than EL0.

Likewise, if it provides Little-endian support only at EL0, this bit is RES1 for an exception return to any exception level other than EL0.

A, bit [8]

Asynchronous data abort mask bit. The possible values of this bit are:

- 0 Exception not masked.
- 1 Exception masked.

I, bit [7]

IRQ mask bit. The possible values of this bit are:

- 0 Exception not masked.
- 1 Exception masked.

F, bit [6]

FIQ mask bit. The possible values of this bit are:

- 0 Exception not masked.
- 1 Exception masked.

T, bit [5]

Thumb execution state bit. Along with the J bit, determines the AArch32 instruction set state that the exception was taken from. Possible values of this bit are:

- 0 Processor in A32 state if J is 0, or an invalid state (Jazelle state before ARMv8) if J is 1.
- 1 Processor in T32 state if J is 0, or T32EE state if J is 1.

Since the Jazelle state is obsolete in ARMv8, J==1 and T==0 is an invalid combination, and attempting to perform an exception return with those values is an illegal exception return.

If T32EE is not implemented, the J bit is RES0, so the possible values of this bit signify either A32 or T32 state.

M[4], bit [4]

Register width that the exception was taken from. Possible values of this bit are:

- 1 Exception taken from AArch32.

M[3:0], bits [3:0]

Mode that an exception was taken from. For exceptions taken from AArch32, the possible values are:

M[3:0]	Mode
0b0000	User
0b0001	FIQ
0b0010	IRQ
0b0011	Supervisor
0b0110	Monitor (only valid in Secure state, if EL3 is implemented and can use AArch32)
0b0111	Abort
0b1010	Hyp
0b1011	Undefined
0b1111	System

Other values are reserved.

Accessing the SPSR_mon:

To access the SPSR_mon:

MRS <Rd>, SPSR_mon ; Read SPSR_mon into Rd
MSR SPSR_mon, <Rd> ; Write Rd to SPSR_mon

Register access is encoded as follows:

m	m1	R
1	1100	1

G4.2.121 SPSR_svc, Saved Program Status Register (Sup. Call mode)

The SPSR_svc characteristics are:

Purpose

Holds the saved processor state when an exception is taken to Supervisor mode.
This register is part of the Special purpose registers functional group.

Usage constraints

This register is accessible as shown below:

EL0 (NS)	EL0 (S)	EL1 (NS, ISVC)	EL1 (S, ISVC)	EL2	EL3 (SCR.NS=1)	EL3 (SCR.NS=0)
-	-	RW	RW	RW	RW	RW

This register is only accessible at EL1 in modes other than Supervisor mode. In Supervisor mode, it is accessible as the current SPSR.

Configurations

SPSR_svc is architecturally mapped to AArch64 register [SPSR_EL1](#).
There is one instance of this register that is used in both Secure and Non-secure states.

Attributes

SPSR_svc is a 32-bit register.

The SPSR_svc bit assignments are:

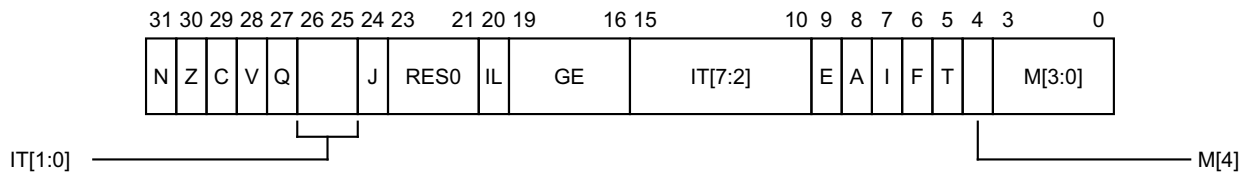

N, bit [31]

Set to the value of [CPSR.N](#) on taking an exception to Supervisor mode, and copied to [CPSR.N](#) on executing an exception return operation in Supervisor mode.

Z, bit [30]

Set to the value of [CPSR.Z](#) on taking an exception to Supervisor mode, and copied to [CPSR.Z](#) on executing an exception return operation in Supervisor mode.

C, bit [29]

Set to the value of [CPSR.C](#) on taking an exception to Supervisor mode, and copied to [CPSR.C](#) on executing an exception return operation in Supervisor mode.

V, bit [28]

Set to the value of [CPSR.V](#) on taking an exception to Supervisor mode, and copied to [CPSR.V](#) on executing an exception return operation in Supervisor mode.

Q, bit [27]

Set to the value of [CPSR.Q](#) on taking an exception to Supervisor mode, and copied to [CPSR.Q](#) on executing an exception return operation in Supervisor mode.

IT[1:0], bits [26:25]

If-Then execution state bits for the T32 IT (If-Then) instruction. See IT[7:2] for explanation of this field.

J, bit [24]

Jazelle bit. Along with the T bit, determines the AArch32 instruction set state that the exception was taken from. Possible values of this bit are:

- 0 Processor in A32 state if T is 0, or T32 state if T is 1.
- 1 Processor in an invalid state (Jazelle state before ARMv8) if T is 0, or T32EE state if T is 1.

Since the Jazelle state is obsolete in ARMv8, J==1 and T==0 is an invalid combination, and attempting to perform an exception return with those values is an illegal exception return.

If T32EE is not implemented, this bit is RES0, so the possible values of the T bit signify either A32 or T32 state.

Bits [23:21]

Reserved, RES0.

IL, bit [20]

Illegal Execution State bit. Shows the value of PSTATE.IL immediately before the exception was taken.

GE, bits [19:16]

Greater than or Equal flags, for parallel addition and subtraction.

IT[7:2], bits [15:10]

If-Then execution state bits for the T32 IT (If-Then) instruction. This field must be interpreted in two parts.

- IT[7:5] holds the base condition for the IT block. The base condition is the top 3 bits of the condition code specified by the first condition field of the IT instruction.
- IT[4:0] encodes the size of the IT block, which is the number of instructions that are to be conditionally executed, by the position of the least significant 1 in this field. It also encodes the value of the least significant bit of the condition code for each instruction in the block.

The IT field is 0b00000000 when no IT block is active.

E, bit [9]

Endianness execution state bit. Controls the load and store endianness for data accesses:

- 0 Little-endian operation
- 1 Big-endian operation.

Instruction fetches ignore this bit.

When the reset value of the SCTL.R.EE bit is defined by a configuration input signal, that value also applies to the CPSR.E bit on reset, and therefore applies to software execution from reset.

If an implementation does not provide Big-endian support, this bit is RES0. If it does not provide Little-endian support, this bit is RES1.

If an implementation provides Big-endian support but only at EL0, this bit is RES0 for an exception return to any exception level other than EL0.

Likewise, if it provides Little-endian support only at EL0, this bit is RES1 for an exception return to any exception level other than EL0.

A, bit [8]

Asynchronous data abort mask bit. The possible values of this bit are:

- 0 Exception not masked.
- 1 Exception masked.

I, bit [7]

IRQ mask bit. The possible values of this bit are:

- 0 Exception not masked.
- 1 Exception masked.

F, bit [6]

FIQ mask bit. The possible values of this bit are:

- 0 Exception not masked.
- 1 Exception masked.

T, bit [5]

Thumb execution state bit. Along with the J bit, determines the AArch32 instruction set state that the exception was taken from. Possible values of this bit are:

- 0 Processor in A32 state if J is 0, or an invalid state (Jazelle state before ARMv8) if J is 1.
- 1 Processor in T32 state if J is 0, or T32EE state if J is 1.

Since the Jazelle state is obsolete in ARMv8, J==1 and T==0 is an invalid combination, and attempting to perform an exception return with those values is an illegal exception return.

If T32EE is not implemented, the J bit is RES0, so the possible values of this bit signify either A32 or T32 state.

M[4], bit [4]

Register width that the exception was taken from. Possible values of this bit are:

- 1 Exception taken from AArch32.

M[3:0], bits [3:0]

Mode that an exception was taken from. For exceptions taken from AArch32, the possible values are:

M[3:0]	Mode
0b0000	User
0b0001	FIQ
0b0010	IRQ
0b0011	Supervisor
0b0110	Monitor (only valid in Secure state, if EL3 is implemented and can use AArch32)
0b0111	Abort
0b1011	Undefined
0b1111	System

Other values are reserved.

Accessing the SPSR_svc:

To access the SPSR_svc:

MRS <Rd>, SPSR_svc ; Read SPSR_svc into Rd
MSR SPSR_svc, <Rd> ; Write Rd to SPSR_svc

Register access is encoded as follows:

m	m1	R
1	0010	1

G4.2.122 SPSR_und, Saved Program Status Register (Undefined mode)

The SPSR_und characteristics are:

Purpose

Holds the saved processor state when an exception is taken to Undefined mode.
This register is part of the Special purpose registers functional group.

Usage constraints

This register is accessible as shown below:

EL0 (NS)	EL0 (S)	EL1 (NS, !UND)	EL1 (S, !UND)	EL2	EL3 (SCR.NS=1)	EL3 (SCR.NS=0)
-	-	RW	RW	RW	RW	RW

This register is only accessible at EL1 in modes other than Undefined mode. In Undefined mode, it is accessible as the current SPSR.

Configurations

SPSR_und is architecturally mapped to AArch64 register [SPSR_und](#).
There is one instance of this register that is used in both Secure and Non-secure states.

Attributes

SPSR_und is a 32-bit register.

The SPSR_und bit assignments are:

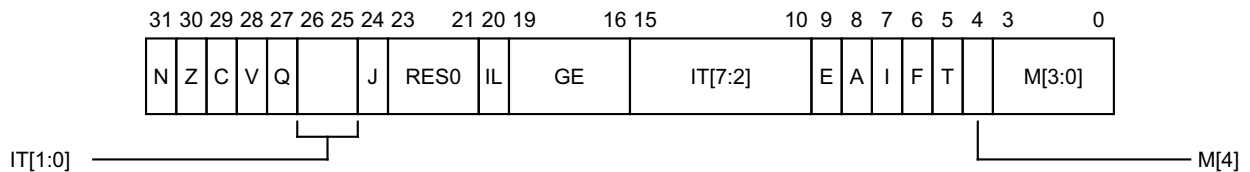

N, bit [31]

Set to the value of [CPSR.N](#) on taking an exception to Undefined mode, and copied to [CPSR.N](#) on executing an exception return operation in Undefined mode.

Z, bit [30]

Set to the value of [CPSR.Z](#) on taking an exception to Undefined mode, and copied to [CPSR.Z](#) on executing an exception return operation in Undefined mode.

C, bit [29]

Set to the value of [CPSR.C](#) on taking an exception to Undefined mode, and copied to [CPSR.C](#) on executing an exception return operation in Undefined mode.

V, bit [28]

Set to the value of [CPSR.V](#) on taking an exception to Undefined mode, and copied to [CPSR.V](#) on executing an exception return operation in Undefined mode.

Q, bit [27]

Set to the value of [CPSR.Q](#) on taking an exception to Undefined mode, and copied to [CPSR.Q](#) on executing an exception return operation in Undefined mode.

IT[1:0], bits [26:25]

If-Then execution state bits for the T32 IT (If-Then) instruction. See IT[7:2] for explanation of this field.

J, bit [24]

Jazelle bit. Along with the T bit, determines the AArch32 instruction set state that the exception was taken from. Possible values of this bit are:

- 0 Processor in A32 state if T is 0, or T32 state if T is 1.
- 1 Processor in an invalid state (Jazelle state before ARMv8) if T is 0, or T32EE state if T is 1.

Since the Jazelle state is obsolete in ARMv8, J==1 and T==0 is an invalid combination, and attempting to perform an exception return with those values is an illegal exception return.

If T32EE is not implemented, this bit is RES0, so the possible values of the T bit signify either A32 or T32 state.

Bits [23:21]

Reserved, RES0.

IL, bit [20]

Illegal Execution State bit. Shows the value of PSTATE.IL immediately before the exception was taken.

GE, bits [19:16]

Greater than or Equal flags, for parallel addition and subtraction.

IT[7:2], bits [15:10]

If-Then execution state bits for the T32 IT (If-Then) instruction. This field must be interpreted in two parts.

- IT[7:5] holds the base condition for the IT block. The base condition is the top 3 bits of the condition code specified by the first condition field of the IT instruction.
- IT[4:0] encodes the size of the IT block, which is the number of instructions that are to be conditionally executed, by the position of the least significant 1 in this field. It also encodes the value of the least significant bit of the condition code for each instruction in the block.

The IT field is 0b00000000 when no IT block is active.

E, bit [9]

Endianness execution state bit. Controls the load and store endianness for data accesses:

- 0 Little-endian operation
- 1 Big-endian operation.

Instruction fetches ignore this bit.

When the reset value of the SCTL.R.EE bit is defined by a configuration input signal, that value also applies to the CPSR.E bit on reset, and therefore applies to software execution from reset.

If an implementation does not provide Big-endian support, this bit is RES0. If it does not provide Little-endian support, this bit is RES1.

If an implementation provides Big-endian support but only at EL0, this bit is RES0 for an exception return to any exception level other than EL0.

Likewise, if it provides Little-endian support only at EL0, this bit is RES1 for an exception return to any exception level other than EL0.

A, bit [8]

Asynchronous data abort mask bit. The possible values of this bit are:

- 0 Exception not masked.
- 1 Exception masked.

I, bit [7]

IRQ mask bit. The possible values of this bit are:

- 0 Exception not masked.
- 1 Exception masked.

F, bit [6]

FIQ mask bit. The possible values of this bit are:

- 0 Exception not masked.
- 1 Exception masked.

T, bit [5]

Thumb execution state bit. Along with the J bit, determines the AArch32 instruction set state that the exception was taken from. Possible values of this bit are:

- 0 Processor in A32 state if J is 0, or an invalid state (Jazelle state before ARMv8) if J is 1.
- 1 Processor in T32 state if J is 0, or T32EE state if J is 1.

Since the Jazelle state is obsolete in ARMv8, J==1 and T==0 is an invalid combination, and attempting to perform an exception return with those values is an illegal exception return.

If T32EE is not implemented, the J bit is RES0, so the possible values of this bit signify either A32 or T32 state.

M[4], bit [4]

Register width that the exception was taken from. Possible values of this bit are:

- 1 Exception taken from AArch32.

M[3:0], bits [3:0]

Mode that an exception was taken from. For exceptions taken from AArch32, the possible values are:

M[3:0]	Mode
0b0000	User
0b0001	FIQ
0b0010	IRQ
0b0011	Supervisor
0b0110	Monitor (only valid in Secure state, if EL3 is implemented and can use AArch32)
0b0111	Abort
0b1011	Undefined
0b1111	System

Other values are reserved.

Accessing the SPSR_und:

To access the SPSR_und:

MRS <Rd>, SPSR_und ; Read SPSR_und into Rd
MSR SPSR_und, <Rd> ; Write Rd to SPSR_und

Register access is encoded as follows:

m	m1	R
1	0110	1

G4.2.123 TCMTR, TCM Type Register

The TCMTR characteristics are:

Purpose

Provides information about the implementation of the TCM.

This register is part of the Identification registers functional group.

Usage constraints

This register is accessible as shown below:

EL0 (NS)	EL0 (S)	EL1 (NS)	EL1 (S)	EL2	EL3 (SCR.NS=1)	EL3 (SCR.NS=0)
-	-	RO	RO	RO	RO	RO

Configurations

There is one instance of this register that is used in both Secure and Non-secure states.

Attributes

TCMTR is a 32-bit register.

The TCMTR bit assignments are:

For all register layouts:

Format, bits [31:29]

Indicates the implemented TCMTR format. The possible values of this are:

000 ARMv6 format, or no TCMs implemented.

100 ARMv7 format.

Other values are reserved.

When TCMTR.Format==0b000:

31	29 28	19 18	16 15	3 2	0
Format	UNKNOWN	RES0	UNKNOWN	RES0	RES0

Format, bits [31:29]

Indicates the implemented TCMTR format. The possible values of this are:

000 ARMv6 format, or no TCMs implemented.

Other values are reserved.

Bits [18:16]

Reserved, RES0.

Bits [2:0]

Reserved, RES0.

When TCMTR.Format==0b100:

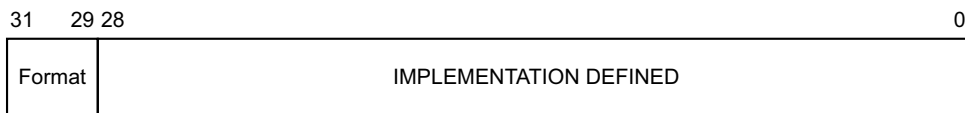

Format, bits [31:29]

Indicates the implemented TCMTR format. The possible values of this are:

100 ARMv7 format.

Other values are reserved.

Accessing the TCMTR:

To access the TCMTR:

MRC p15,0,<Rt>,c0,c0,2 ; Read TCMTR into Rt

Register access is encoded as follows:

coproc	opc1	CRn	CRm	opc2
1111	000	0000	0000	010

G4.2.124 TEECR, T32EE Configuration Register

The TEECR characteristics are:

Purpose

A T32EE register. Controls unprivileged access to the [TEEHBR](#).

This register is part of the Legacy feature registers functional group.

Usage constraints

This register is accessible as shown below:

EL0 (NS)	EL0 (S)	EL1 (NS)	EL1 (S)	EL2	EL3 (SCR.NS=1)	EL3 (SCR.NS=0)
-	-	RW	RW	RW	RW	RW

Configurations

TEECR is architecturally mapped to AArch64 register [TEECR32_EL1](#).

There is one instance of this register that is used in both Secure and Non-secure states.

This register is implemented in any system that implements T32EE.

It is optional in ARMv8, and is UNDEFINED when T32EE is not implemented, or when SCTLR.THEE is 0.

Attributes

TEECR is a 32-bit register.

The TEECR bit assignments are:

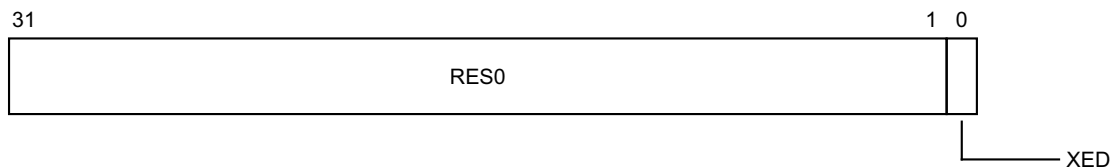

Bits [31:1]

Reserved, RES0.

XED, bit [0]

Execution Environment Disable bit. Control unprivileged access to [TEEHBR](#):

0 Unprivileged access permitted.

1 Unprivileged access disabled.

The effects of a write to this register on T32EE configuration are only guaranteed to be visible to subsequent instructions after the execution of a context synchronization operation. However, a read of this register always returns the value most recently written to the register.

Resets to 0.

Accessing the TEECR:

To access the TEECR:

```
MRC p14,6,<Rt>,c0,c0,0 ; Read TEECR into Rt
MCR p14,6,<Rt>,c0,c0,0 ; Write Rt to TEECR
```

Register access is encoded as follows:

coproc	opc1	CRn	CRm	opc2
1110	110	0000	0000	000

G4.2.125 TEEHBR, T32EE Handler Base Register

The TEEHBR characteristics are:

Purpose

A T32EE register. Holds the base address for T32EE handlers.

This register is part of the Legacy feature registers functional group.

Usage constraints

This register is accessible as shown below:

EL0 (NS)	EL0 (S)	EL1 (NS)	EL1 (S)	EL2	EL3 (SCR.NS=1)	EL3 (SCR.NS=0)
-	-	RW	RW	RW	RW	RW

Configurations

TEEHBR is architecturally mapped to AArch64 register [TEEHBR32_EL1](#).

There is one instance of this register that is used in both Secure and Non-secure states.

Implemented in any system that implements T32EE.

This register is optional in ARMv8, and is UNDEFINED when not implemented, or when disabled by [SCTLR.THEE](#).

Attributes

TEEHBR is a 32-bit register.

The TEEHBR bit assignments are:

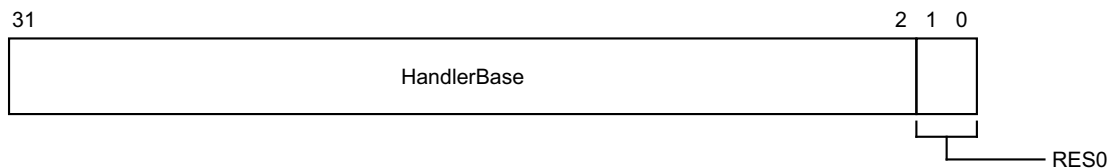

HandlerBase, bits [31:2]

The address of the T32EE Handler_00 implementation. This is the address of the first of the T32EE handlers.

Bits [1:0]

Reserved, RES0.

Accessing the TEEHBR:

To access the TEEHBR:

MRC p14,6,<Rt>,c1,c0,0 ; Read TEEHBR into Rt
MCR p14,6,<Rt>,c1,c0,0 ; Write Rt to TEEHBR

Register access is encoded as follows:

coproc	opc1	CRn	CRm	opc2
1110	110	0001	0000	000

G4.2.126 TLBIALL, TLB Invalidate All entries

The TLBIALL characteristics are:

Purpose

Invalidate all EL1&0 regime stage 1 and 2 TLB entries for the current VMID.
 This register is part of the TLB maintenance operations functional group.

Usage constraints

This operation can be performed at the exception levels shown below:

EL0 (NS)	EL0 (S)	EL1 (NS)	EL1 (S)	EL2	EL3 (SCR.NS=1)	EL3 (SCR.NS=0)
-	-	WO	WO	WO	WO	WO

If this operation is executed at Secure EL1 in AArch32 when EL3 is using AArch64, it only affects TLB entries related to the Secure EL1 translation regime.

Configurations

There are no configuration notes.

Attributes

TLBIALL is a 32-bit system operation.

The TLBIALL operation ignores the value in the register specified by the instruction used to perform this operation. Software does not have to write a value to the register before issuing this instruction.

Performing the TLBIALL operation:

To perform the TLBIALL operation:

MCR p15,0,<Rt>,c8,c7,0 ; TLBIALL operation, ignoring the value in Rt

The operation is encoded as follows:

coproc	opc1	CRn	CRm	opc2
1111	000	1000	0111	000

G4.2.127 TLBIALLH, TLB Invalidate All entries, Hyp mode

The TLBIALLH characteristics are:

Purpose

Invalidate all EL2 regime stage 1 TLB entries.

This register is part of:

- the TLB maintenance operations functional group
- the Virtualization registers functional group.

Usage constraints

This operation can be performed at the exception levels shown below:

EL0 (NS)	EL0 (S)	EL1 (NS)	EL1 (S)	EL2	EL3 (SCR.NS=1)	EL3 (SCR.NS=0, Mon)	EL3 (SCR.NS=0, !Mon)
-	-	-	-	WO	WO	WO	UNPREDICTABLE

If this operation is executed at Secure EL3 not in Monitor mode, the result is **CONSTRAINED UNPREDICTABLE** and may be one of the following:

- The operation is **UNDEFINED**.
- The operation is treated as a **NOP**.
- The operation is executed as if it had been executed in Monitor mode.

Configurations

There are no configuration notes.

Attributes

TLBIALLH is a 32-bit system operation.

The TLBIALLH operation ignores the value in the register specified by the instruction used to perform this operation. Software does not have to write a value to the register before issuing this instruction.

Performing the TLBIALLH operation:

To perform the TLBIALLH operation:

MCR p15,4,<Rt>,c8,c7,0 ; TLBIALLH operation, ignoring the value in Rt

The operation is encoded as follows:

coproc	opc1	CRn	CRm	opc2
1111	100	1000	0111	000

G4.2.128 TLBIALLHIS, TLB Invalidate All entries, Hyp mode, Inner Shareable

The TLBIALLHIS characteristics are:

Purpose

Invalidate all EL2 regime stage 1 TLB entries on all PEs in the same Inner Shareable domain.

This register is part of:

- the TLB maintenance operations functional group
- the Virtualization registers functional group.

Usage constraints

This operation can be performed at the exception levels shown below:

EL0 (NS)	EL0 (S)	EL1 (NS)	EL1 (S)	EL2	EL3 (SCR.NS=1)	EL3 (SCR.NS=0, Mon)	EL3 (SCR.NS=0, !Mon)
-	-	-	-	WO	WO	WO	UNPREDICTABLE

If this operation is executed at Secure EL3 not in Monitor mode, the result is **CONSTRAINED UNPREDICTABLE** and may be one of the following:

- The operation is **UNDEFINED**.
- The operation is treated as a **NOP**.
- The operation is executed as if it had been executed in Monitor mode.

Configurations

There are no configuration notes.

Attributes

TLBIALLHIS is a 32-bit system operation.

The TLBIALLHIS operation ignores the value in the register specified by the instruction used to perform this operation. Software does not have to write a value to the register before issuing this instruction.

Performing the TLBIALLHIS operation:

To perform the TLBIALLHIS operation:

MCR p15,4,<Rt>,c8,c3,0 ; TLBIALLHIS operation, ignoring the value in Rt

The operation is encoded as follows:

coproc	opc1	CRn	CRm	opc2
1111	100	1000	0011	000

G4.2.129 TLBIALLIS, TLB Invalidate All entries, Inner Shareable

The TLBIALLIS characteristics are:

Purpose

Invalidate all EL1&0 regime stage 1 and 2 TLB entries for the current VMID on all PEs in the same Inner Shareable domain.

This register is part of the TLB maintenance operations functional group.

Usage constraints

This operation can be performed at the exception levels shown below:

EL0 (NS)	EL0 (S)	EL1 (NS)	EL1 (S)	EL2	EL3 (SCR.NS=1)	EL3 (SCR.NS=0)
-	-	WO	WO	WO	WO	WO

If this operation is executed at Secure EL1 in AArch32 when EL3 is using AArch64, it only affects TLB entries related to the Secure EL1 translation regime.

Configurations

There are no configuration notes.

Attributes

TLBIALLIS is a 32-bit system operation.

The TLBIALLIS operation ignores the value in the register specified by the instruction used to perform this operation. Software does not have to write a value to the register before issuing this instruction.

Performing the TLBIALLIS operation:

To perform the TLBIALLIS operation:

MCR p15,0,<Rt>,c8,c3,0 ; TLBIALLIS operation, ignoring the value in Rt

The operation is encoded as follows:

coproc	opc1	CRn	CRm	opc2
1111	000	1000	0011	000

G4.2.130 TLBIALLNSNH, TLB Invalidate All entries, Non-Secure Non-Hyp

The TLBIALLNSNH characteristics are:

Purpose

Invalidate all Non-secure EL1&0 regime stage 1 and 2 TLB entries.
 This register is part of the TLB maintenance operations functional group.

Usage constraints

This operation can be performed at the exception levels shown below:

EL0 (NS)	EL0 (S)	EL1 (NS)	EL1 (S)	EL2	EL3 (SCR.NS=1)	EL3 (SCR.NS=0, Mon)	EL3 (SCR.NS=0, !Mon)
-	-	-	-	WO	WO	WO	UNPREDICTABLE

If this operation is executed at Secure EL3 not in Monitor mode, the result is CONstrained UNPREDICTABLE and may be one of the following:

- The operation is UNDEFINED.
- The operation is treated as a NOP.
- The operation is executed as if it had been executed in Monitor mode.

Configurations

There are no configuration notes.

Attributes

TLBIALLNSNH is a 32-bit system operation.

The TLBIALLNSNH operation ignores the value in the register specified by the instruction used to perform this operation. Software does not have to write a value to the register before issuing this instruction.

Performing the TLBIALLNSNH operation:

To perform the TLBIALLNSNH operation:

MCR p15,4,<Rt>,c8,c7,4 ; TLBIALLNSNH operation, ignoring the value in Rt

The operation is encoded as follows:

coproc	opc1	CRn	CRm	opc2
1111	100	1000	0111	100

G4.2.131 TLBIALLNSNHIS, TLB Invalidate All entries, Non-Secure Non-Hyp, Inner Shareable

The TLBIALLNSNHIS characteristics are:

Purpose

Invalidate all Non-secure EL1&0 regime stage 1 and 2 TLB entries on all PEs in the same Inner Shareable domain.

This register is part of the TLB maintenance operations functional group.

Usage constraints

This operation can be performed at the exception levels shown below:

EL0 (NS)	EL0 (S)	EL1 (NS)	EL1 (S)	EL2	EL3 (SCR.NS=1)	EL3 (SCR.NS=0, Mon)	EL3 (SCR.NS=0, !Mon)
-	-	-	-	WO	WO	WO	UNPREDICTABLE

If this operation is executed at Secure EL3 not in Monitor mode, the result is CONstrained UNPREDICTABLE and may be one of the following:

- The operation is UNDEFINED.
- The operation is treated as a NOP.
- The operation is executed as if it had been executed in Monitor mode.

Configurations

There are no configuration notes.

Attributes

TLBIALLNSNHIS is a 32-bit system operation.

The TLBIALLNSNHIS operation ignores the value in the register specified by the instruction used to perform this operation. Software does not have to write a value to the register before issuing this instruction.

Performing the TLBIALLNSNHIS operation:

To perform the TLBIALLNSNHIS operation:

MCR p15,4,<Rt>,c8,c3,4 ; TLBIALLNSNHIS operation, ignoring the value in Rt

The operation is encoded as follows:

coproc	opc1	CRn	CRm	opc2
1111	100	1000	0011	100

G4.2.132 TLBIASID, TLB Invalidate entry by ASID match

The TLBIASID characteristics are:

Purpose

Invalidate EL1&0 regime stage 1 TLB entries for the given ASID and the current VMID.
 This register is part of the TLB maintenance operations functional group.

Usage constraints

This operation can be performed at the exception levels shown below:

EL0 (NS)	EL0 (S)	EL1 (NS)	EL1 (S)	EL2	EL3 (SCR.NS=1)	EL3 (SCR.NS=0)
-	-	WO	WO	WO	WO	WO

If this operation is executed at Secure EL1 in AArch32 when EL3 is using AArch64, it only affects TLB entries related to the Secure EL1 translation regime.

Configurations

There are no configuration notes.

Attributes

TLBIASID is a 32-bit system operation.

The TLBIASID input value bit assignments are:

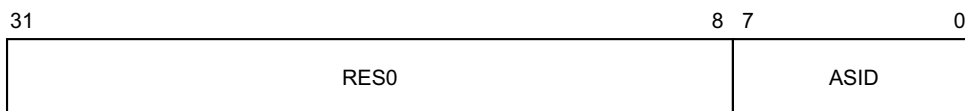

Bits [31:8]

Reserved, RES0.

ASID, bits [7:0]

ASID value to match. Any TLB entries for non-global pages that match the ASID values will be affected by this operation.

Performing the TLBIASID operation:

To perform the TLBIASID operation:

MCR p15,0,<Rt>,c8,c7,2 ; TLBIASID operation

The operation is encoded as follows:

coproc	opc1	CRn	CRm	opc2
1111	000	1000	0111	010

G4.2.133 TLBIASIDIS, TLB Invalidate entry by ASID match, Inner Shareable

The TLBIASIDIS characteristics are:

Purpose

Invalidate EL1&0 regime stage 1 TLB entries for the given ASID and the current VMID on all PEs in the same Inner Shareable domain.

This register is part of the TLB maintenance operations functional group.

Usage constraints

This operation can be performed at the exception levels shown below:

EL0 (NS)	EL0 (S)	EL1 (NS)	EL1 (S)	EL2	EL3 (SCR.NS=1)	EL3 (SCR.NS=0)
-	-	WO	WO	WO	WO	WO

If this operation is executed at Secure EL1 in AArch32 when EL3 is using AArch64, it only affects TLB entries related to the Secure EL1 translation regime.

Configurations

There are no configuration notes.

Attributes

TLBIASIDIS is a 32-bit system operation.

The TLBIASIDIS input value bit assignments are:

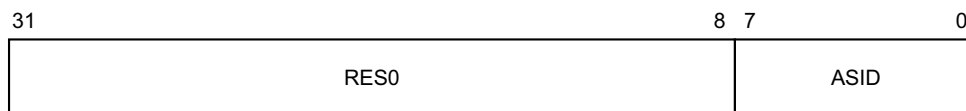

Bits [31:8]

Reserved, RES0.

ASID, bits [7:0]

ASID value to match. Any TLB entries for non-global pages that match the ASID values will be affected by this operation.

Performing the TLBIASIDIS operation:

To perform the TLBIASIDIS operation:

MCR p15,0,<Rt>,c8,c3,2 ; TLBIASIDIS operation

The operation is encoded as follows:

coproc	opc1	CRn	CRm	opc2
1111	000	1000	0011	010

G4.2.134 TLBIIPAS2, TLB Invalidate entry by Intermediate Physical Address, Stage 2

The TLBIIPAS2 characteristics are:

Purpose

Invalidate EL1&0 regime stage 2 TLB entries for the given IPA and the current VMID.

This register is part of:

- the TLB maintenance operations functional group
- the Virtualization registers functional group.

Usage constraints

This operation can be performed at the exception levels shown below:

EL0 (NS)	EL0 (S)	EL1 (NS)	EL1 (S)	EL2	EL3 (SCR.NS=1)	EL3 (SCR.NS=0)
-	-	-	-	WO	WO	WO

This instruction is a NOP when executed in Monitor mode with SCR.NS==0, and is UNPREDICTABLE when executed in any AArch32 Secure privileged mode other than Monitor mode.

This instruction must apply to structures that contain only stage 2 translation information, but does not need to apply to structures that contain combined stage 1 and stage 2 translation information.

Configurations

This operation is not implemented in architecture versions before ARMv8.

Attributes

TLBIIPAS2 is a 32-bit system operation.

The TLBIIPAS2 input value bit assignments are:

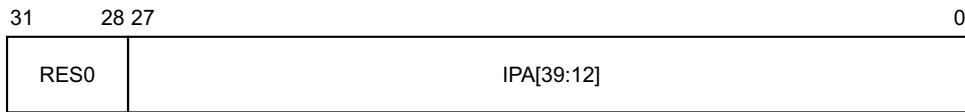

Bits [31:28]

Reserved, RES0.

IPA[39:12], bits [27:0]

Bits[39:12] of the intermediate physical address to match.

Performing the TLBIIPAS2 operation:

To perform the TLBIIPAS2 operation:

MCR p15,4,<Rt>,c8,c4,1 ; TLBIIPAS2 operation

The operation is encoded as follows:

coproc	opc1	CRn	CRm	opc2
1111	100	1000	0100	001

G4.2.135 TLBIIPAS2IS, TLB Invalidate entry by Intermediate Physical Address, Stage 2, Inner Shareable

The TLBIIPAS2IS characteristics are:

Purpose

Invalidate EL1&0 regime stage 2 TLB entries for the given IPA and the current VMID on all PEs in the same Inner Shareable domain.

This register is part of:

- the TLB maintenance operations functional group
- the Virtualization registers functional group.

Usage constraints

This operation can be performed at the exception levels shown below:

EL0 (NS)	EL0 (S)	EL1 (NS)	EL1 (S)	EL2	EL3 (SCR.NS=1)	EL3 (SCR.NS=0)
-	-	-	-	WO	WO	WO

This instruction is a NOP when executed in Monitor mode with SCR.NS==0, and is UNPREDICTABLE when executed in any AArch32 Secure privileged mode other than Monitor mode.

This instruction must apply to structures that contain only stage 2 translation information, but does not need to apply to structures that contain combined stage 1 and stage 2 translation information.

Configurations

This operation is not implemented in architecture versions before ARMv8.

Attributes

TLBIIPAS2IS is a 32-bit system operation.

The TLBIIPAS2IS input value bit assignments are:

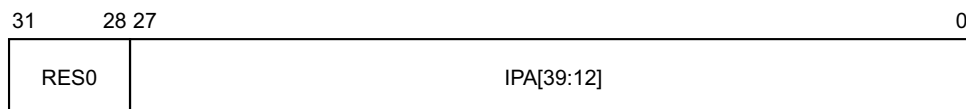

Bits [31:28]

Reserved, RES0.

IPA[39:12], bits [27:0]

Bits[39:12] of the intermediate physical address to match.

Performing the TLBIIPAS2IS operation:

To perform the TLBIIPAS2IS operation:

MCR p15,4,<Rt>,c8,c0,1 ; TLBIIPAS2IS operation

The operation is encoded as follows:

coproc	opc1	CRn	CRm	opc2
1111	100	1000	0000	001

G4.2.136 TLBIIPAS2L, TLB Invalidate entry by Intermediate Physical Address, Stage 2, Last level

The TLBIIPAS2L characteristics are:

Purpose

Invalidate EL1&0 regime stage 2 TLB entries for the last level of translation, the given IPA, and the current VMID.

This register is part of:

- the TLB maintenance operations functional group
- the Virtualization registers functional group.

Usage constraints

This operation can be performed at the exception levels shown below:

EL0 (NS)	EL0 (S)	EL1 (NS)	EL1 (S)	EL2	EL3 (SCR.NS=1)	EL3 (SCR.NS=0)
-	-	-	-	WO	WO	WO

This instruction is a NOP when executed in Monitor mode with SCR.NS==0, and is UNPREDICTABLE when executed in any AArch32 Secure privileged mode other than Monitor mode.

This instruction must apply to structures that contain only stage 2 translation information, but does not need to apply to structures that contain combined stage 1 and stage 2 translation information.

Configurations

This operation is not implemented in architecture versions before ARMv8.

Attributes

TLBIIPAS2L is a 32-bit system operation.

The TLBIIPAS2L input value bit assignments are:

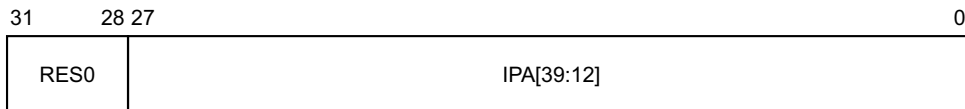

Bits [31:28]

Reserved, RES0.

IPA[39:12], bits [27:0]

Bits[39:12] of the intermediate physical address to match.

Performing the TLBIIPAS2L operation:

To perform the TLBIIPAS2L operation:

MCR p15,4,<Rt>,c8,c4,5 ; TLBIIPAS2L operation

The operation is encoded as follows:

coproc	opc1	CRn	CRm	opc2
1111	100	1000	0100	101

G4.2.137 TLBIIPAS2LIS, TLB Invalidate entry by Intermediate Physical Address, Stage 2, Last level, Inner Shareable

The TLBIIPAS2LIS characteristics are:

Purpose

Invalidate EL1&0 regime stage 2 TLB entries for the last level of translation, the given IPA, and the current VMID, on all PEs in the same Inner Shareable domain.

This register is part of:

- the TLB maintenance operations functional group
- the Virtualization registers functional group.

Usage constraints

This operation can be performed at the exception levels shown below:

EL0 (NS)	EL0 (S)	EL1 (NS)	EL1 (S)	EL2	EL3 (SCR.NS=1)	EL3 (SCR.NS=0)
-	-	-	-	WO	WO	WO

This instruction is a NOP when executed in Monitor mode with SCR.NS==0, and is UNPREDICTABLE when executed in any AArch32 Secure privileged mode other than Monitor mode.

This instruction must apply to structures that contain only stage 2 translation information, but does not need to apply to structures that contain combined stage 1 and stage 2 translation information.

Configurations

This operation is not implemented in architecture versions before ARMv8.

Attributes

TLBIIPAS2LIS is a 32-bit system operation.

The TLBIIPAS2LIS input value bit assignments are:

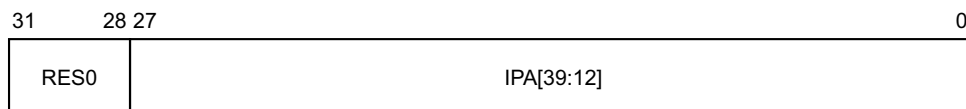

Bits [31:28]

Reserved, RES0.

IPA[39:12], bits [27:0]

Bits[39:12] of the intermediate physical address to match.

Performing the TLBIIPAS2LIS operation:

To perform the TLBIIPAS2LIS operation:

MCR p15,4,<Rt>,c8,c0,5 ; TLBIIPAS2LIS operation

The operation is encoded as follows:

coproc	opc1	CRn	CRm	opc2
1111	100	1000	0000	101

G4.2.138 TLBIMVA, TLB Invalidate entry by VA

The TLBIMVA characteristics are:

Purpose

Invalidate EL1&0 regime stage 1 and 2 TLB entries for the given VA and ASID and the current VMID.

This register is part of the TLB maintenance operations functional group.

Usage constraints

This operation can be performed at the exception levels shown below:

EL0 (NS)	EL0 (S)	EL1 (NS)	EL1 (S)	EL2	EL3 (SCR.NS=1)	EL3 (SCR.NS=0)
-	-	WO	WO	WO	WO	WO

If this operation is executed at Secure EL1 in AArch32 when EL3 is using AArch64, it only affects TLB entries related to the Secure EL1 translation regime.

Configurations

There are no configuration notes.

Attributes

TLBIMVA is a 32-bit system operation.

The TLBIMVA input value bit assignments are:

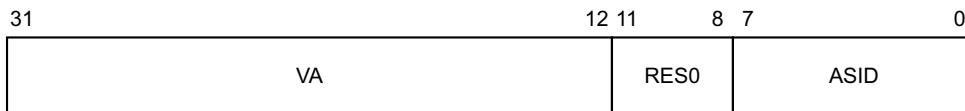

VA, bits [31:12]

Virtual address to match. Any TLB entries that match the ASID value and VA value will be affected by this operation.

Bits [11:8]

Reserved, RES0.

ASID, bits [7:0]

ASID value to match. Any TLB entries that match the ASID value and VA value will be affected by this operation.

Global TLB entries that match the VA value will be affected by this operation, regardless of the value of the ASID field.

Performing the TLBIMVA operation:

To perform the TLBIMVA operation:

MCR p15,0,<Rt>,c8,c7,1 ; TLBIMVA operation

The operation is encoded as follows:

coproc	opc1	CRn	CRm	opc2
1111	000	1000	0111	001

G4.2.139 TLBIMVAA, TLB Invalidate entry by VA, All ASID

The TLBIMVAA characteristics are:

Purpose

Invalidate EL1&0 regime stage 1 TLB entries for the given VA and the current VMID.
This register is part of the TLB maintenance operations functional group.

Usage constraints

This operation can be performed at the exception levels shown below:

EL0 (NS)	EL0 (S)	EL1 (NS)	EL1 (S)	EL2	EL3 (SCR.NS=1)	EL3 (SCR.NS=0)
-	-	WO	WO	WO	WO	WO

If this operation is executed at Secure EL1 in AArch32 when EL3 is using AArch64, it only affects TLB entries related to the Secure EL1 translation regime.

Configurations

There are no configuration notes.

Attributes

TLBIMVAA is a 32-bit system operation.

The TLBIMVAA input value bit assignments are:

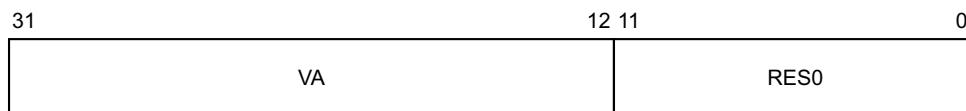

VA, bits [31:12]

Virtual address to match. Any unlocked TLB entries that match the VA will be affected by this operation, regardless of the ASID.

Bits [11:0]

Reserved, RES0.

Performing the TLBIMVAA operation:

To perform the TLBIMVAA operation:

MCR p15,0,<Rt>,c8,c7,3 ; TLBIMVAA operation

The operation is encoded as follows:

coproc	opc1	CRn	CRm	opc2
1111	000	1000	0111	011

G4.2.140 TLBIMVAAIS, TLB Invalidate entry by VA, All ASID, Inner Shareable

The TLBIMVAAIS characteristics are:

Purpose

Invalidate EL1&0 regime stage 1 TLB entries for the given VA and the current VMID on all PEs in the same Inner Shareable domain.

This register is part of the TLB maintenance operations functional group.

Usage constraints

This operation can be performed at the exception levels shown below:

EL0 (NS)	EL0 (S)	EL1 (NS)	EL1 (S)	EL2	EL3 (SCR.NS=1)	EL3 (SCR.NS=0)
-	-	WO	WO	WO	WO	WO

If this operation is executed at Secure EL1 in AArch32 when EL3 is using AArch64, it only affects TLB entries related to the Secure EL1 translation regime.

Configurations

There are no configuration notes.

Attributes

TLBIMVAAIS is a 32-bit system operation.

The TLBIMVAAIS input value bit assignments are:

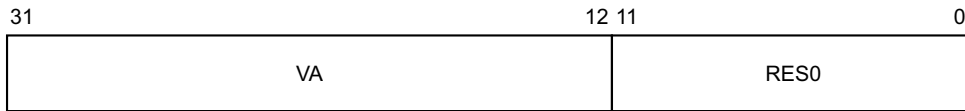

VA, bits [31:12]

Virtual address to match. Any unlocked TLB entries that match the VA will be affected by this operation, regardless of the ASID.

Bits [11:0]

Reserved, RES0.

Performing the TLBIMVAAIS operation:

To perform the TLBIMVAAIS operation:

MCR p15,0,<Rt>,c8,c3,3 ; TLBIMVAAIS operation

The operation is encoded as follows:

coproc	opc1	CRn	CRm	opc2
1111	000	1000	0011	011

G4.2.141 TLBIMVAAL, TLB Invalidate entry by VA, All ASID, Last level

The TLBIMVAAL characteristics are:

Purpose

Invalidate EL1&0 regime stage 1 TLB entries for the last level of translation table walk, the given VA, and the current VMID.

This register is part of the TLB maintenance operations functional group.

Usage constraints

This operation can be performed at the exception levels shown below:

EL0 (NS)	EL0 (S)	EL1 (NS)	EL1 (S)	EL2	EL3 (SCR.NS=1)	EL3 (SCR.NS=0)
-	-	WO	WO	WO	WO	WO

If this operation is executed at Secure EL1 in AArch32 when EL3 is using AArch64, it only affects TLB entries related to the Secure EL1 translation regime.

Configurations

This operation is not implemented in architecture versions before ARMv8.

Attributes

TLBIMVAAL is a 32-bit system operation.

The TLBIMVAAL input value bit assignments are:

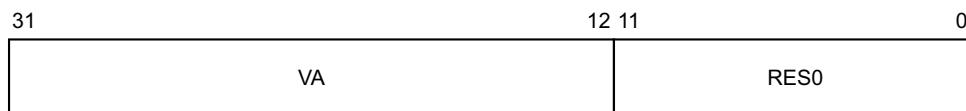

VA, bits [31:12]

Virtual address to match. Any unlocked TLB entries that match the VA will be affected by this operation, regardless of the ASID.

Bits [11:0]

Reserved, RES0.

Performing the TLBIMVAAL operation:

To perform the TLBIMVAAL operation:

MCR p15,0,<Rt>,c8,c7,7 ; TLBIMVAAL operation

The operation is encoded as follows:

coproc	opc1	CRn	CRm	opc2
1111	000	1000	0111	111

G4.2.142 TLBIMVAALIS, TLB Invalidate entry by VA, All ASID, Last level, Inner Shareable

The TLBIMVAALIS characteristics are:

Purpose

Invalidate EL1&0 regime stage 1 TLB entries for the last level of translation table walk, the given VA, and the current VMID, on all PEs in the same Inner Shareable domain.

This register is part of the TLB maintenance operations functional group.

Usage constraints

This operation can be performed at the exception levels shown below:

EL0 (NS)	EL0 (S)	EL1 (NS)	EL1 (S)	EL2	EL3 (SCR.NS=1)	EL3 (SCR.NS=0)
-	-	WO	WO	WO	WO	WO

If this operation is executed at Secure EL1 in AArch32 when EL3 is using AArch64, it only affects TLB entries related to the Secure EL1 translation regime.

Configurations

This operation is not implemented in architecture versions before ARMv8.

Attributes

TLBIMVAALIS is a 32-bit system operation.

The TLBIMVAALIS input value bit assignments are:

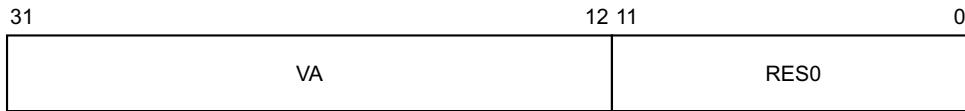

VA, bits [31:12]

Virtual address to match. Any unlocked TLB entries that match the VA will be affected by this operation, regardless of the ASID.

Bits [11:0]

Reserved, RES0.

Performing the TLBIMVAALIS operation:

To perform the TLBIMVAALIS operation:

MCR p15,0,<Rt>,c8,c3,7 ; TLBIMVAALIS operation

The operation is encoded as follows:

coproc	opc1	CRn	CRm	opc2
1111	000	1000	0011	111

G4.2.143 TLBIMVAH, TLB Invalidate entry by VA, Hyp mode

The TLBIMVAH characteristics are:

Purpose

Invalidate EL2 regime stage 1 TLB entries for the given VA.

This register is part of:

- the TLB maintenance operations functional group
- the Virtualization registers functional group.

Usage constraints

This operation can be performed at the exception levels shown below:

EL0 (NS)	EL0 (S)	EL1 (NS)	EL1 (S)	EL2	EL3 (SCR.NS=1)	EL3 (SCR.NS=0, Mon)	EL3 (SCR.NS=0, !Mon)
-	-	-	-	WO	WO	WO	UNPREDICTABLE

If this operation is executed at Secure EL3 not in Monitor mode, the result is CONstrained UNPREDICTABLE and may be one of the following:

- The operation is UNDEFINED.
- The operation is treated as a NOP.
- The operation is executed as if it had been executed in Monitor mode.

Configurations

There are no configuration notes.

Attributes

TLBIMVAH is a 32-bit system operation.

The TLBIMVAH input value bit assignments are:

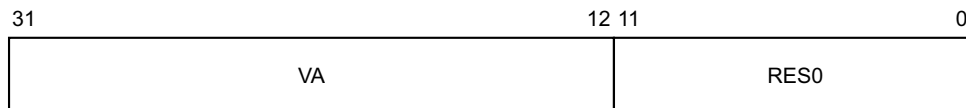

VA, bits [31:12]

Virtual address to match. Any TLB entries that match the ASID value and VA value will be affected by this operation.

Bits [11:0]

Reserved, RES0.

Performing the TLBIMVAH operation:

To perform the TLBIMVAH operation:

MCR p15,4,<Rt>,c8,c7,1 ; TLBIMVAH operation

The operation is encoded as follows:

coproc	opc1	CRn	CRm	opc2
1111	100	1000	0111	001

G4.2.144 TLBIMVAHIS, TLB Invalidate entry by VA, Hyp mode, Inner Shareable

The TLBIMVAHIS characteristics are:

Purpose

Invalidate EL2 regime stage 1 TLB entries for the given VA on all PEs in the same Inner Shareable domain.

This register is part of:

- the TLB maintenance operations functional group
- the Virtualization registers functional group.

Usage constraints

This operation can be performed at the exception levels shown below:

EL0 (NS)	EL0 (S)	EL1 (NS)	EL1 (S)	EL2	EL3 (SCR.NS=1)	EL3 (SCR.NS=0, Mon)	EL3 (SCR.NS=0, !Mon)
-	-	-	-	WO	WO	WO	UNPREDICTABLE

If this operation is executed at Secure EL3 not in Monitor mode, the result is CONstrained UNPREDICTABLE and may be one of the following:

- The operation is UNDEFINED.
- The operation is treated as a NOP.
- The operation is executed as if it had been executed in Monitor mode.

Configurations

There are no configuration notes.

Attributes

TLBIMVAHIS is a 32-bit system operation.

The TLBIMVAHIS input value bit assignments are:

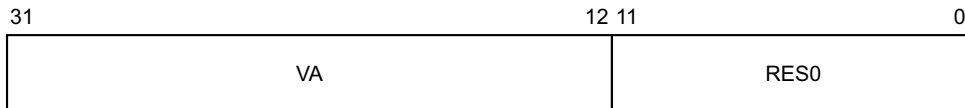

VA, bits [31:12]

Virtual address to match. Any TLB entries that match the ASID value and VA value will be affected by this operation.

Bits [11:0]

Reserved, RES0.

Performing the TLBIMVAHIS operation:

To perform the TLBIMVAHIS operation:

MCR p15,4,<Rt>,c8,c3,1 ; TLBIMVAHIS operation

The operation is encoded as follows:

coproc	opc1	CRn	CRm	opc2
1111	100	1000	0011	001

G4.2.145 TLBIMVAIS, TLB Invalidate entry by VA, Inner Shareable

The TLBIMVAIS characteristics are:

Purpose

Invalidate EL1&0 regime stage 1 and 2 TLB entries for the given VA and ASID, and the current VMID, on all PEs in the same Inner Shareable domain.

This register is part of the TLB maintenance operations functional group.

Usage constraints

This operation can be performed at the exception levels shown below:

EL0 (NS)	EL0 (S)	EL1 (NS)	EL1 (S)	EL2	EL3 (SCR.NS=1)	EL3 (SCR.NS=0)
-	-	WO	WO	WO	WO	WO

If this operation is executed at Secure EL1 in AArch32 when EL3 is using AArch64, it only affects TLB entries related to the Secure EL1 translation regime.

Configurations

There are no configuration notes.

Attributes

TLBIMVAIS is a 32-bit system operation.

The TLBIMVAIS input value bit assignments are:

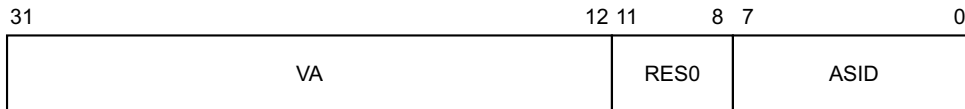

VA, bits [31:12]

Virtual address to match. Any TLB entries that match the ASID value and VA value will be affected by this operation.

Bits [11:8]

Reserved, RES0.

ASID, bits [7:0]

ASID value to match. Any TLB entries that match the ASID value and VA value will be affected by this operation.

Global TLB entries that match the VA value will be affected by this operation, regardless of the value of the ASID field.

Performing the TLBIMVAIS operation:

To perform the TLBIMVAIS operation:

MCR p15,0,<Rt>,c8,c3,1 ; TLBIMVAIS operation

The operation is encoded as follows:

coproc	opc1	CRn	CRm	opc2
1111	000	1000	0011	001

G4.2.146 TLBIMVAL, TLB Invalidate entry by VA, Last level

The TLBIMVAL characteristics are:

Purpose

Invalidate EL1&0 regime stage 1 and 2 TLB entries for the last level of translation table walk, the given VA and ASID, and the current VMID.

This register is part of the TLB maintenance operations functional group.

Usage constraints

This operation can be performed at the exception levels shown below:

EL0 (NS)	EL0 (S)	EL1 (NS)	EL1 (S)	EL2	EL3 (SCR.NS=1)	EL3 (SCR.NS=0)
-	-	WO	WO	WO	WO	WO

If this operation is executed at Secure EL1 in AArch32 when EL3 is using AArch64, it only affects TLB entries related to the Secure EL1 translation regime.

Configurations

This operation is not implemented in architecture versions before ARMv8.

Attributes

TLBIMVAL is a 32-bit system operation.

The TLBIMVAL input value bit assignments are:

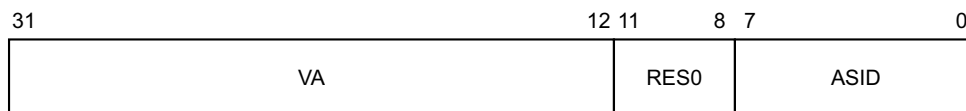

VA, bits [31:12]

Virtual address to match. Any TLB entries that match the ASID value and VA value will be affected by this operation.

Bits [11:8]

Reserved, RES0.

ASID, bits [7:0]

ASID value to match. Any TLB entries that match the ASID value and VA value will be affected by this operation.

Global TLB entries that match the VA value will be affected by this operation, regardless of the value of the ASID field.

Performing the TLBIMVAL operation:

To perform the TLBIMVAL operation:

MCR p15,0,<Rt>,c8,c7,5 ; TLBIMVAL operation

The operation is encoded as follows:

coproc	opc1	CRn	CRm	opc2
1111	000	1000	0111	101

G4.2.147 TLBIMVALH, TLB Invalidate entry by VA, Last level, Hyp mode

The TLBIMVALH characteristics are:

Purpose

Invalidate EL2 regime stage 1 TLB entries for the last level of translation table walk and the given VA.

This register is part of:

- the TLB maintenance operations functional group
- the Virtualization registers functional group.

Usage constraints

This operation can be performed at the exception levels shown below:

EL0 (NS)	EL0 (S)	EL1 (NS)	EL1 (S)	EL2	EL3 (SCR.NS=1)	EL3 (SCR.NS=0, Mon)	EL3 (SCR.NS=0, !Mon)
-	-	-	-	WO	WO	WO	UNPREDICTABLE

If this operation is executed at Secure EL3 not in Monitor mode, the result is CONstrained UNPREDICTABLE and may be one of the following:

- The operation is UNDEFINED.
- The operation is treated as a NOP.
- The operation is executed as if it had been executed in Monitor mode.

Configurations

This operation is not implemented in architecture versions before ARMv8.

Attributes

TLBIMVALH is a 32-bit system operation.

The TLBIMVALH input value bit assignments are:

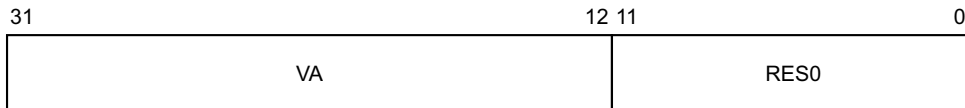

VA, bits [31:12]

Virtual address to match. Any TLB entries that match the ASID value and VA value will be affected by this operation.

Bits [11:0]

Reserved, RES0.

Performing the TLBIMVALH operation:

To perform the TLBIMVALH operation:

MCR p15,4,<Rt>,c8,c7,5 ; TLBIMVALH operation

The operation is encoded as follows:

coproc	opc1	CRn	CRm	opc2
1111	100	1000	0111	101

G4.2.148 TLBIMVALHIS, TLB Invalidate entry by VA, Last level, Hyp mode, Inner Shareable

The TLBIMVALHIS characteristics are:

Purpose

Invalidate EL2 regime stage 1 TLB entries for the last level of translation table walk and the given VA on all PEs in the same Inner Shareable domain.

This register is part of:

- the TLB maintenance operations functional group
- the Virtualization registers functional group.

Usage constraints

This operation can be performed at the exception levels shown below:

EL0 (NS)	EL0 (S)	EL1 (NS)	EL1 (S)	EL2	EL3 (SCR.NS=1)	EL3 (SCR.NS=0, Mon)	EL3 (SCR.NS=0, !Mon)
-	-	-	-	WO	WO	WO	UNPREDICTABLE

If this operation is executed at Secure EL3 not in Monitor mode, the result is CONstrained UNPREDICTABLE and may be one of the following:

- The operation is UNDEFINED.
- The operation is treated as a NOP.
- The operation is executed as if it had been executed in Monitor mode.

Configurations

This operation is not implemented in architecture versions before ARMv8.

Attributes

TLBIMVALHIS is a 32-bit system operation.

The TLBIMVALHIS input value bit assignments are:

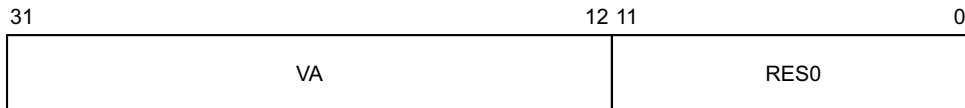

VA, bits [31:12]

Virtual address to match. Any TLB entries that match the ASID value and VA value will be affected by this operation.

Bits [11:0]

Reserved, RES0.

Performing the TLBIMVALHIS operation:

To perform the TLBIMVALHIS operation:

MCR p15,4,<Rt>,c8,c3,5 ; TLBIMVALHIS operation

The operation is encoded as follows:

coproc	opc1	CRn	CRm	opc2
1111	100	1000	0011	101

G4.2.149 TLBIMVALIS, TLB Invalidate entry by VA, Last level, Inner Shareable

The TLBIMVALIS characteristics are:

Purpose

Invalidate EL1&0 regime stage 1 and 2 TLB entries for the last level of translation table walk, the given VA and ASID, and the current VMID, on all PEs in the same Inner Shareable domain.

This register is part of the TLB maintenance operations functional group.

Usage constraints

This operation can be performed at the exception levels shown below:

EL0 (NS)	EL0 (S)	EL1 (NS)	EL1 (S)	EL2	EL3 (SCR.NS=1)	EL3 (SCR.NS=0)
-	-	WO	WO	WO	WO	WO

If this operation is executed at Secure EL1 in AArch32 when EL3 is using AArch64, it only affects TLB entries related to the Secure EL1 translation regime.

Configurations

This operation is not implemented in architecture versions before ARMv8.

Attributes

TLBIMVALIS is a 32-bit system operation.

The TLBIMVALIS input value bit assignments are:

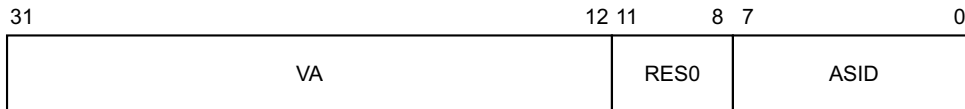

VA, bits [31:12]

Virtual address to match. Any TLB entries that match the ASID value and VA value will be affected by this operation.

Bits [11:8]

Reserved, RES0.

ASID, bits [7:0]

ASID value to match. Any TLB entries that match the ASID value and VA value will be affected by this operation.

Global TLB entries that match the VA value will be affected by this operation, regardless of the value of the ASID field.

Performing the TLBIMVALIS operation:

To perform the TLBIMVALIS operation:

MCR p15,0,<Rt>,c8,c3,5 ; TLBIMVALIS operation

The operation is encoded as follows:

coproc	opc1	CRn	CRm	opc2
1111	000	1000	0011	101

G4.2.150 TLBTR, TLB Type Register

The TLBTR characteristics are:

Purpose

Provides information about the TLB implementation. The register must define whether the implementation provides separate instruction and data TLBs, or a unified TLB. Normally, the IMPLEMENTATION DEFINED information in this register includes the number of lockable entries in the TLB.

This register is part of the Identification registers functional group.

Usage constraints

This register is accessible as shown below:

EL0 (NS)	EL0 (S)	EL1 (NS)	EL1 (S)	EL2	EL3 (SCR.NS=1)	EL3 (SCR.NS=0)
-	-	RO	RO	RO	RO	RO

Configurations

There is one instance of this register that is used in both Secure and Non-secure states.

Attributes

TLBTR is a 32-bit register.

The TLBTR bit assignments are:



nU, bit [0]

Not Unified TLB. Indicates whether the implementation has a unified TLB:

- 0 Unified TLB.
- 1 Separate Instruction and Data TLBs.

Accessing the TLBTR:

To access the TLBTR:

MRC p15,0,<Rt>,c0,c0,3 ; Read TLBTR into Rt

Register access is encoded as follows:

coproc	opc1	CRn	CRm	opc2
1111	000	0000	0000	011

G4.2.151 TPIDRPRW, Thread Pointer / ID Register, Privileged Read-Write

The TPIDRPRW characteristics are:

Purpose

Provides a location where software executing at EL1 or higher can store thread identifying information that is not visible to software executing at EL0, for OS management purposes.

This register is part of the Thread and process ID registers functional group.

Usage constraints

This register is accessible as shown below:

When accessed as TPIDRPRW(S):

EL0 (NS)	EL0 (S)	EL1 (NS)	EL1 (S)	EL2	EL3 (SCR.NS=1)	EL3 (SCR.NS=0)
-	-	-	RW	-	-	RW

When accessed as TPIDRPRW(NS):

EL0 (NS)	EL0 (S)	EL1 (NS)	EL1 (S)	EL2	EL3 (SCR.NS=1)	EL3 (SCR.NS=0)
-	-	RW	-	RW	RW	-

Processor hardware never updates this register.

Configurations

TPIDRPRW(NS) is architecturally mapped to AArch64 register [TPIDR_EL1](#)[31:0].

If EL3 is using AArch32, there are separate Secure and Non-secure instances of this register.

Attributes

TPIDRPRW is a 32-bit register.

The TPIDRPRW bit assignments are:

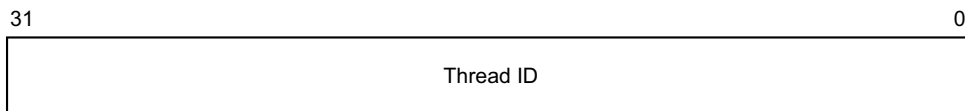

Bits [31:0]

Thread ID. Thread identifying information stored by software running at this exception level.

Accessing the TPIDRPRW:

To access the TPIDRPRW:

MRC p15,0,<Rt>,c13,c0,4 ; Read TPIDRPRW into Rt
 MCR p15,0,<Rt>,c13,c0,4 ; Write Rt to TPIDRPRW

Register access is encoded as follows:

coproc	opc1	CRn	CRm	opc2
1111	000	1101	0000	100

G4.2.152 TPIDRURO, Thread Pointer / ID Register, Unprivileged Read-Only

The TPIDRURO characteristics are:

Purpose

Provides a location where software executing at EL1 or higher can store thread identifying information that is visible to software executing at EL0, for OS management purposes.

This register is part of the Thread and process ID registers functional group.

Usage constraints

This register is accessible as shown below:

When accessed as TPIDRURO(S):

EL0 (NS)	EL0 (S)	EL1 (NS)	EL1 (S)	EL2	EL3 (SCR.NS=1)	EL3 (SCR.NS=0)
-	RO	-	RW	-	-	RW

When accessed as TPIDRURO(NS):

EL0 (NS)	EL0 (S)	EL1 (NS)	EL1 (S)	EL2	EL3 (SCR.NS=1)	EL3 (SCR.NS=0)
RO	-	RW	-	RW	RW	-

Processor hardware never updates this register.

Configurations

TPIDRURO(NS) is architecturally mapped to AArch64 register [TPIDRRO_EL0](#)[31:0].

If EL3 is using AArch32, there are separate Secure and Non-secure instances of this register.

Attributes

TPIDRURO is a 32-bit register.

The TPIDRURO bit assignments are:

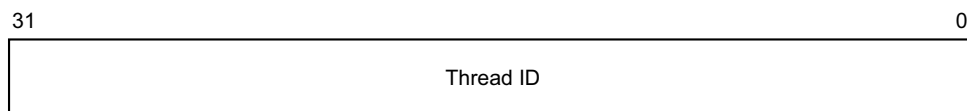

Bits [31:0]

Thread ID. Thread identifying information stored by software running at this exception level.

Accessing the TPIDRURO:

To access the TPIDRURO:

MRC p15,0,<Rt>,c13,c0,3 ; Read TPIDRURO into Rt
MCR p15,0,<Rt>,c13,c0,3 ; Write Rt to TPIDRURO

Register access is encoded as follows:

coproc	opc1	CRn	CRm	opc2
1111	000	1101	0000	011

G4.2.153 TPIDRURW, Thread Pointer / ID Register, Unprivileged Read-Write

The TPIDRURW characteristics are:

Purpose

Provides a location where software executing at EL0 can store thread identifying information, for OS management purposes.

This register is part of the Thread and process ID registers functional group.

Usage constraints

This register is accessible as shown below:

When accessed as TPIDRURW(S):

EL0 (NS)	EL0 (S)	EL1 (NS)	EL1 (S)	EL2	EL3 (SCR.NS=1)	EL3 (SCR.NS=0)
-	RW	-	RW	-	-	RW

When accessed as TPIDRURW(NS):

EL0 (NS)	EL0 (S)	EL1 (NS)	EL1 (S)	EL2	EL3 (SCR.NS=1)	EL3 (SCR.NS=0)
RW	-	RW	-	RW	RW	-

Processor hardware never updates this register.

Configurations

TPIDRURW(NS) is architecturally mapped to AArch64 register [TPIDR_EL0](#)[31:0].

If EL3 is using AArch32, there are separate Secure and Non-secure instances of this register.

Attributes

TPIDRURW is a 32-bit register.

The TPIDRURW bit assignments are:

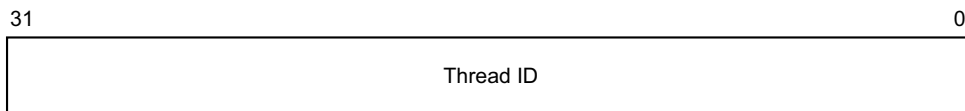

Bits [31:0]

Thread ID. Thread identifying information stored by software running at this exception level.

Accessing the TPIDRURW:

To access the TPIDRURW:

```
MRC p15,0,<Rt>,c13,c0,2 ; Read TPIDRURW into Rt
MCR p15,0,<Rt>,c13,c0,2 ; Write Rt to TPIDRURW
```

Register access is encoded as follows:

coproc	opc1	CRn	CRm	opc2
1111	000	1101	0000	010

G4.2.154 TTBCR, Translation Table Base Control Register

The TTBCR characteristics are:

Purpose

Determines which of the Translation Table Base Registers defined the base address for a translation table walk required for the stage 1 translation of a memory access from any mode other than Hyp mode. Also controls the translation table format and, when using the Long-descriptor translation table format, holds cacheability and shareability information.

This register is part of the Virtual memory control registers functional group.

Usage constraints

This register is accessible as shown below:

When accessed as TTBCR(S):

EL0 (NS)	EL0 (S)	EL1 (NS)	EL1 (S)	EL2	EL3 (SCR.NS=1)	EL3 (SCR.NS=0)
-	-	-	RW	-	-	RW

When accessed as TTBCR(NS):

EL0 (NS)	EL0 (S)	EL1 (NS)	EL1 (S)	EL2	EL3 (SCR.NS=1)	EL3 (SCR.NS=0)
-	-	RW	-	RW	RW	-

Configurations

TTBCR(NS) is architecturally mapped to AArch64 register [TCR_EL1](#)[31:0].

TTBCR(S) can be mapped to AArch64 register [TCR_EL3](#)[31:0], but this is not architecturally mandated.

If EL3 is using AArch32, there are separate Secure and Non-secure instances of this register.

The Large Physical Address Extension adds an alternative format for the register. If an implementation includes the Large Physical Address Extension then the current translation table format determines which format of the register is used.

TTBCR has write access to the Secure copy of the register disabled when the CP15SDISABLE signal is asserted HIGH.

Attributes

TTBCR is a 32-bit register.

The TTBCR bit assignments are:

For all register layouts:

EAE, bit [31]

Extended Address Enable. The meanings of the possible values of this bit are:

- 0 Use the 32-bit translation system, with the Short-descriptor translation table format.
- 1 Use the 40-bit translation system, with the Long-descriptor translation table format.

When TTBCR.EAE==0:

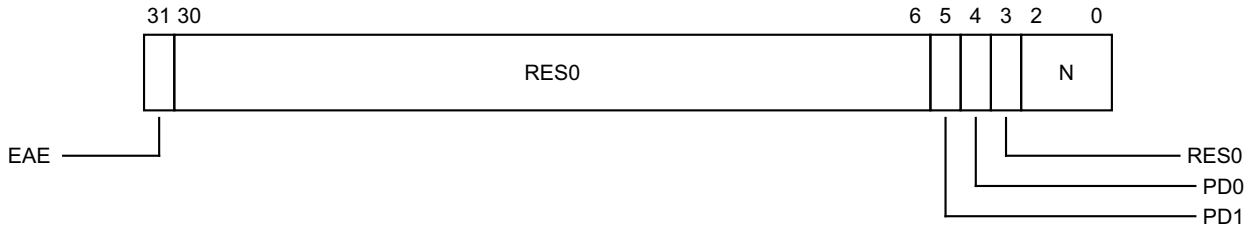

EAE, bit [31]

Extended Address Enable. The meanings of the possible values of this bit are:

0 Use the 32-bit translation system, with the Short-descriptor translation table format.

Resets to 0.

Bits [30:6]

Reserved, RES0.

PD1, bit [5]

Translation table walk disable for translations using [TTBR1](#). This bit controls whether a translation table walk is performed on a TLB miss, for an address that is translated using [TTBR1](#). The encoding of this bit is:

0 Perform translation table walks using [TTBR1](#).

1 A TLB miss on an address that is translated using [TTBR1](#) generates a Translation fault. No translation table walk is performed.

Resets to 0.

PD0, bit [4]

Translation table walk disable for translations using [TTBR0](#). This bit controls whether a translation table walk is performed on a TLB miss for an address that is translated using [TTBR0](#). The encoding of this bit is:

0 Perform translation table walks using [TTBR0](#).

1 A TLB miss on an address that is translated using [TTBR0](#) generates a Translation fault. No translation table walk is performed.

Resets to 0.

Bit [3]

Reserved, RES0.

N, bits [2:0]

Indicate the width of the base address held in [TTBR0](#). In [TTBR0](#), the base address field is bits[31:14-N]. The value of N also determines:

- Whether [TTBR0](#) or [TTBR1](#) is used as the base address for translation table walks.
- The size of the translation table pointed to by [TTBR0](#).

N can take any value from 0 to 7, that is, from 0b000 to 0b111.

When N has its reset value of 0, the translation table base is compatible with ARMv5 and ARMv6.

Resets to 0.

When TTBCR.EAE==1:

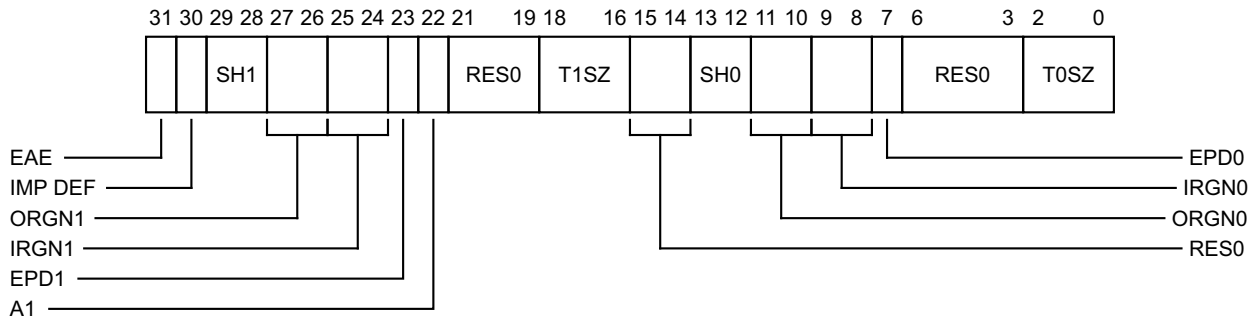

EAE, bit [31]

Extended Address Enable. The meanings of the possible values of this bit are:

- 1 Use the 40-bit translation system, with the Long-descriptor translation table format.

Resets to 0.

SH1, bits [29:28]

Shareability attribute for memory associated with translation table walks using [TTBR1](#).

- 00 Non-shareable
- 10 Outer Shareable
- 11 Inner Shareable

Other values are reserved.

Resets to 0.

ORGN1, bits [27:26]

Outer cacheability attribute for memory associated with translation table walks using [TTBR1](#).

- 00 Normal memory, Outer Non-cacheable
- 01 Normal memory, Outer Write-Back Write-Allocate Cacheable
- 10 Normal memory, Outer Write-Through Cacheable
- 11 Normal memory, Outer Write-Back no Write-Allocate Cacheable

Resets to 0.

IRGN1, bits [25:24]

Inner cacheability attribute for memory associated with translation table walks using [TTBR1](#).

- 00 Normal memory, Inner Non-cacheable
- 01 Normal memory, Inner Write-Back Write-Allocate Cacheable
- 10 Normal memory, Inner Write-Through Cacheable
- 11 Normal memory, Inner Write-Back no Write-Allocate Cacheable

Resets to 0.

EPD1, bit [23]

Translation table walk disable for translations using [TTBR1](#). This bit controls whether a translation table walk is performed on a TLB miss, for an address that is translated using [TTBR1](#). The encoding of this bit is:

- 0 Perform translation table walks using [TTBR1](#).
- 1 A TLB miss on an address that is translated using [TTBR1](#) generates a Translation fault. No translation table walk is performed.

Resets to 0.

A1, bit [22]

Selects whether [TTBR0](#) or [TTBR1](#) defines the ASID. The encoding of this bit is:

0 [TTBR0](#).ASID defines the ASID.

1 [TTBR1](#).ASID defines the ASID.

Resets to 0.

Bits [21:19]

Reserved, RES0.

T1SZ, bits [18:16]

The size offset of the memory region addressed by [TTBR1](#). The region size is $2^{32-T1SZ}$ bytes.

Resets to 0.

Bits [15:14]

Reserved, RES0.

SH0, bits [13:12]

Shareability attribute for memory associated with translation table walks using [TTBR0](#).

00 Non-shareable

10 Outer Shareable

11 Inner Shareable

Other values are reserved.

Resets to 0.

ORGN0, bits [11:10]

Outer cacheability attribute for memory associated with translation table walks using [TTBR0](#).

00 Normal memory, Outer Non-cacheable

01 Normal memory, Outer Write-Back Write-Allocate Cacheable

10 Normal memory, Outer Write-Through Cacheable

11 Normal memory, Outer Write-Back no Write-Allocate Cacheable

Resets to 0.

IRGN0, bits [9:8]

Inner cacheability attribute for memory associated with translation table walks using [TTBR0](#).

00 Normal memory, Inner Non-cacheable

01 Normal memory, Inner Write-Back Write-Allocate Cacheable

10 Normal memory, Inner Write-Through Cacheable

11 Normal memory, Inner Write-Back no Write-Allocate Cacheable

Resets to 0.

EPD0, bit [7]

Translation table walk disable for translations using [TTBR0](#). This bit controls whether a translation table walk is performed on a TLB miss, for an address that is translated using [TTBR0](#). The encoding of this bit is:

0 Perform translation table walks using [TTBR0](#).

1 A TLB miss on an address that is translated using [TTBR0](#) generates a Translation fault. No translation table walk is performed.

Resets to 0.

Bits [6:3]

Reserved, RES0.

T0SZ, bits [2:0]

The size offset of the memory region addressed by [TTBR0](#). The region size is $2^{32-T0SZ}$ bytes.

Resets to 0.

Accessing the TTBCR:

To access the TTBCR:

MRC p15,0,<Rt>,c2,c0,2 ; Read TTBCR into Rt

MCR p15,0,<Rt>,c2,c0,2 ; Write Rt to TTBCR

Register access is encoded as follows:

coproc	opc1	CRn	CRm	opc2
1111	000	0010	0000	010

G4.2.155 TTBR0, Translation Table Base Register 0

The TTBR0 characteristics are:

Purpose

Holds the base address of translation table 0, and information about the memory it occupies. This is one of the translation tables for the stage 1 translation of memory accesses from modes other than Hyp mode.

This register is part of the Virtual memory control registers functional group.

Usage constraints

This register is accessible as shown below:

When accessed as TTBR0(S):

EL0 (NS)	EL0 (S)	EL1 (NS)	EL1 (S)	EL2	EL3 (SCR.NS=1)	EL3 (SCR.NS=0)
-	-	-	RW	-	-	RW

When accessed as TTBR0(NS):

EL0 (NS)	EL0 (S)	EL1 (NS)	EL1 (S)	EL2	EL3 (SCR.NS=1)	EL3 (SCR.NS=0)
-	-	RW	-	RW	RW	-

Used in conjunction with the [TTBCR](#). When the 64-bit TTBR0 format is used, cacheability and shareability information is held in the [TTBCR](#), not in TTBR0.

Configurations

TTBR0(NS) is architecturally mapped to AArch64 register [TTBR0_EL1](#).

TTBR0(S) can be mapped to AArch64 register [TTBR0_EL3](#), but this is not architecturally mandated.

If EL3 is using AArch32, there are separate Secure and Non-secure instances of this register.

The Large Physical Address Extension extends TTBR0 to a 64-bit register. In an implementation that includes the Large Physical Address Extension, TTBCR.EAE determines which TTBR0 format is used:

EAE==0 32-bit format is used. TTBR0[63:32] are ignored.

EAE==1 64-bit format is used.

TTBR0 has write access to the Secure copy of the register disabled when the CP15SDISABLE signal is asserted HIGH.

Attributes

TTBR0 is a 32-bit register when TTBCR.EAE==0 and a 64-bit register when TTBCR.EAE==1.

The TTBR0 bit assignments are:

When TTBCR.EAE==0:

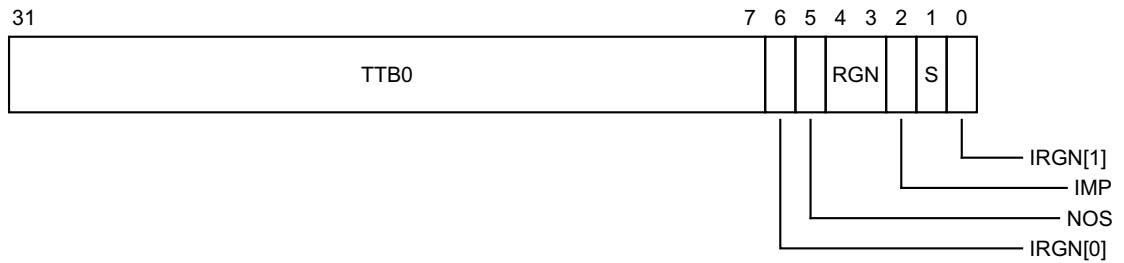

TTB0, bits [31:7]

Translation table base 0 address, bits[31:x], where x is 14-(TTBCR.N). Bits [x-1:7] are RES0.

The value of x determines the required alignment of the translation table, which must be aligned to 2^x bytes.

If bits [x-1:7] are not all zero, this is a misaligned Translation Table Base Address. Its effects are CONSTRAINED UNPREDICTABLE, and can be one of the following:

- Bits [x-1:7] are treated as if all the bits are zero. The value read back from those bits might be the value written or might be zero.
- The calculation of an address for a translation table walk using this register can be corrupted in those bits that are non-zero.

IRGN[0], bit [6]

See IRGN[1] below for description of the IRGN field.

NOS, bit [5]

Not Outer Shareable bit. Indicates the Outer Shareable attribute for the memory associated with a translation table walk that has the Shareable attribute, indicated by `TTBR0.S == 1`:

- 0 Outer Shareable
- 1 Inner Shareable.

This bit is ignored when `TTBR0.S == 0`.

RGN, bits [4:3]

Region bits. Indicates the Outer cacheability attributes for the memory associated with the translation table walks:

- 00 Normal memory, Outer Non-cacheable.
- 01 Normal memory, Outer Write-Back Write-Allocate Cacheable.
- 10 Normal memory, Outer Write-Through Cacheable.
- 11 Normal memory, Outer Write-Back no Write-Allocate Cacheable.

IMP, bit [2]

The effect of this bit is IMPLEMENTATION DEFINED. If the translation table implementation does not include any IMPLEMENTATION DEFINED features this bit is UNK/SBZP.

S, bit [1]

Shareable bit. Indicates the Shareable attribute for the memory associated with the translation table walks:

- 0 Non-shareable
- 1 Shareable.

IRGN[1], bit [0]

Inner region bits. Indicates the Inner Cacheability attributes for the memory associated with the translation table walks. The possible values of IRGN[1:0] are:

- 00 Normal memory, Inner Non-cacheable.
- 01 Normal memory, Inner Write-Back Write-Allocate Cacheable.
- 10 Normal memory, Inner Write-Through Cacheable.
- 11 Normal memory, Inner Write-Back no Write-Allocate Cacheable.

The encoding of the IRGN bits is counter-intuitive, with register bit[6] being IRGN[0] and register bit[0] being IRGN[1]. This encoding is chosen to give a consistent encoding of memory region types and to ensure that software written for ARMv7 or later without the Multiprocessing Extensions can run unmodified on an implementation that includes the Multiprocessing Extensions.

When TTBCR.EAE==1:

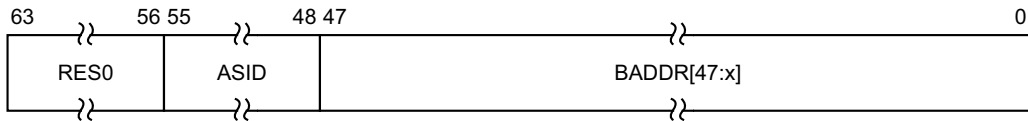

Bits [63:56]

Reserved, RES0.

ASID, bits [55:48]

An ASID for the translation table base address. The [TTBCR.A1](#) field selects either TTBR0.ASID or TTBR1.ASID.

BADDR[47:x], bits [47:0]

Translation table base address, bits[47:x]. Bits [x-1:0] are RES0.

x is based on the value of [TTBCR.TOSZ](#), and is calculated as follows:

- If [TTBCR.TOSZ](#) is 0 or 1, $x = 5 - \text{TTBCR.TOSZ}$.
- If [TTBCR.TOSZ](#) is greater than 1, $x = 14 - \text{TTBCR.TOSZ}$.

The value of x determines the required alignment of the translation table, which must be aligned to 2^x bytes.

If bits [x-1:3] are not all zero, this is a misaligned Translation Table Base Address. Its effects are CONSTRAINED UNPREDICTABLE, and can be one of the following:

- Bits [x-1:3] are treated as if all the bits are zero. The value read back from those bits might be the value written or might be zero.
- The calculation of an address for a translation table walk using this register can be corrupted in those bits that are non-zero.

Accessing the TTBR0:

To access the TTBR0 when TTBCR.EAE==0:

```
MRC p15,0,<Rt>,c2,c0,0 ; Read TTBR0 into Rt
MCR p15,0,<Rt>,c2,c0,0 ; Write Rt to TTBR0
```

Register access is encoded as follows:

coproc	opc1	CRn	CRm	opc2
1111	000	0010	0000	000

To access the TTBR0 when TTBCR.EAE==1:

MRRC p15,0,<Rt>,<Rt2>,c2 ; Read 64-bit TTBR0 into Rt (low word) and Rt2 (high word)
MCRR p15,0,<Rt>,<Rt2>,c2 ; Write Rt (low word) and Rt2 (high word) to 64-bit TTBR0

Register access is encoded as follows:

coproc	opc1	CRm
1111	0000	0010

G4.2.156 TTBR1, Translation Table Base Register 1

The TTBR1 characteristics are:

Purpose

Holds the base address of translation table 1, and information about the memory it occupies. This is one of the translation tables for the stage 1 translation of memory accesses from modes other than Hyp mode.

This register is part of the Virtual memory control registers functional group.

Usage constraints

This register is accessible as shown below:

When accessed as TTBR1(S):

EL0 (NS)	EL0 (S)	EL1 (NS)	EL1 (S)	EL2	EL3 (SCR.NS=1)	EL3 (SCR.NS=0)
-	-	-	RW	-	-	RW

When accessed as TTBR1(NS):

EL0 (NS)	EL0 (S)	EL1 (NS)	EL1 (S)	EL2	EL3 (SCR.NS=1)	EL3 (SCR.NS=0)
-	-	RW	-	RW	RW	-

Used in conjunction with the [TTBCR](#). When the 64-bit TTBR1 format is used, cacheability and shareability information is held in the [TTBCR](#), not in TTBR1.

Configurations

TTBR1(NS) is architecturally mapped to AArch64 register [TTBR1_EL1](#).

If EL3 is using AArch32, there are separate Secure and Non-secure instances of this register.

The Large Physical Address Extension extends TTBR1 to a 64-bit register. In an implementation that includes the Large Physical Address Extension, TTBCR.EAE determines which TTBR1 format is used:

- EAE==0 32-bit format is used. TTBR1[63:32] are ignored.
- EAE==1 64-bit format is used.

Attributes

TTBR1 is a 32-bit register when TTBCR.EAE==0 and a 64-bit register when TTBCR.EAE==1.

The TTBR1 bit assignments are:

When TTBCR.EAE==0:

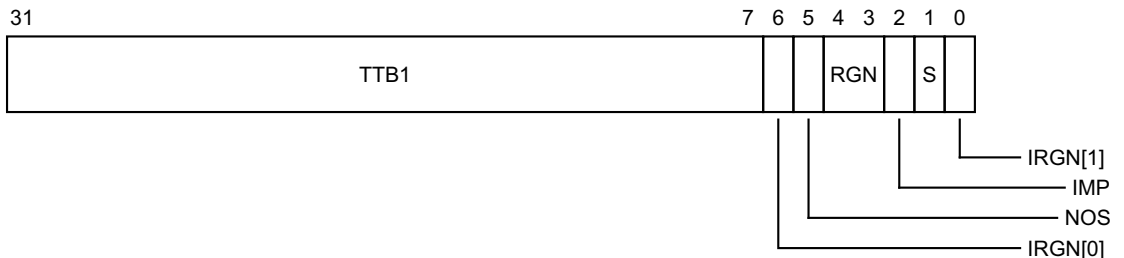

TTB1, bits [31:7]

Translation table base 1 address, bits[31:x], where x is 14-(TTBCR.N). Bits [x-1:7] are RES0.

The translation table must be aligned on a 16KByte boundary.

If bits [x-1:7] are not all zero, this is a misaligned Translation Table Base Address. Its effects are CONSTRAINED UNPREDICTABLE, and can be one of the following:

- Bits [x-1:7] are treated as if all the bits are zero. The value read back from those bits might be the value written or might be zero.
- The calculation of an address for a translation table walk using this register can be corrupted in those bits that are non-zero.

IRGN[0], bit [6]

See IRGN[1] below for description of the IRGN field.

NOS, bit [5]

Not Outer Shareable bit. Indicates the Outer Shareable attribute for the memory associated with a translation table walk that has the Shareable attribute, indicated by `TTBR0.S == 1`:

0	Outer Shareable
1	Inner Shareable.

This bit is ignored when `TTBR0.S == 0`.

RGN, bits [4:3]

Region bits. Indicates the Outer cacheability attributes for the memory associated with the translation table walks:

00	Normal memory, Outer Non-cacheable.
01	Normal memory, Outer Write-Back Write-Allocate Cacheable.
10	Normal memory, Outer Write-Through Cacheable.
11	Normal memory, Outer Write-Back no Write-Allocate Cacheable.

IMP, bit [2]

The effect of this bit is IMPLEMENTATION DEFINED. If the translation table implementation does not include any IMPLEMENTATION DEFINED features this bit is UNK/SBZP.

S, bit [1]

Shareable bit. Indicates the Shareable attribute for the memory associated with the translation table walks:

0	Non-shareable
1	Shareable.

IRGN[1], bit [0]

Inner region bits. Indicates the Inner Cacheability attributes for the memory associated with the translation table walks. The possible values of IRGN[1:0] are:

00	Normal memory, Inner Non-cacheable.
01	Normal memory, Inner Write-Back Write-Allocate Cacheable.
10	Normal memory, Inner Write-Through Cacheable.
11	Normal memory, Inner Write-Back no Write-Allocate Cacheable.

The encoding of the IRGN bits is counter-intuitive, with register bit[6] being IRGN[0] and register bit[0] being IRGN[1]. This encoding is chosen to give a consistent encoding of memory region types and to ensure that software written for ARMv7 or later without the Multiprocessing Extensions can run unmodified on an implementation that includes the Multiprocessing Extensions.

When TTBCR.EAE==1:

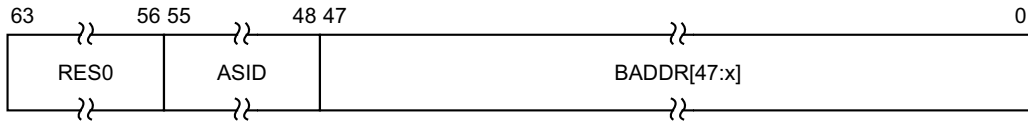

Bits [63:56]

Reserved, RES0.

ASID, bits [55:48]

An ASID for the translation table base address. The [TTBCR.A1](#) field selects either TTBR0.ASID or TTBR1.ASID.

BADDR[47:x], bits [47:0]

Translation table base address, bits[47:x]. Bits [x-1:0] are RES0.

x is based on the value of [TTBCR.T1SZ](#), and is calculated as follows:

- If [TTBCR.T1SZ](#) is 0 or 1, $x = 5 - \text{TTBCR.T1SZ}$.
- If [TTBCR.T1SZ](#) is greater than 1, $x = 14 - \text{TTBCR.T1SZ}$.

The value of x determines the required alignment of the translation table, which must be aligned to 2^x bytes.

If bits [x-1:3] are not all zero, this is a misaligned Translation Table Base Address. Its effects are CONSTRAINED UNPREDICTABLE, and can be one of the following:

- Bits [x-1:3] are treated as if all the bits are zero. The value read back from those bits might be the value written or might be zero.
- The calculation of an address for a translation table walk using this register can be corrupted in those bits that are non-zero.

Accessing the TTBR1:

To access the TTBR1 when [TTBCR.EAE](#)==0:

MRC p15,0,<Rt>,c2,c0,1 ; Read TTBR1 into Rt
 MCR p15,0,<Rt>,c2,c0,1 ; Write Rt to TTBR1

Register access is encoded as follows:

coproc	opc1	CRn	CRm	opc2
1111	000	0010	0000	001

To access the TTBR1 when [TTBCR.EAE](#)==1:

MRRC p15,1,<Rt>,<Rt2>,c2 ; Read 64-bit TTBR1 into Rt (low word) and Rt2 (high word)
 MCRR p15,1,<Rt>,<Rt2>,c2 ; Write Rt (low word) and Rt2 (high word) to 64-bit TTBR1

Register access is encoded as follows:

coproc	opc1	CRm
1111	0001	0010

G4.2.157 VBAR, Vector Base Address Register

The VBAR characteristics are:

Purpose

When high exception vectors are not selected, holds the exception base address for exceptions that are not taken to Monitor mode or to Hyp mode.

This register is part of the Exception and fault handling registers functional group.

Usage constraints

This register is accessible as shown below:

When accessed as VBAR(S):

EL0 (NS)	EL0 (S)	EL1 (NS)	EL1 (S)	EL2	EL3 (SCR.NS=1)	EL3 (SCR.NS=0)
-	-	-	RW	-	-	RW

When accessed as VBAR(NS):

EL0 (NS)	EL0 (S)	EL1 (NS)	EL1 (S)	EL2	EL3 (SCR.NS=1)	EL3 (SCR.NS=0)
-	-	RW	-	RW	RW	-

Software must program the Non-secure copy of the register with the required initial value as part of the processor boot sequence.

Configurations

VBAR(NS) is architecturally mapped to AArch64 register [VBAR_EL1](#)[31:0].

VBAR(S) can be mapped to AArch64 register [VBAR_EL3](#)[31:0], but this is not architecturally mandated.

If EL3 is using AArch32, there are separate Secure and Non-secure instances of this register.

VBAR has write access to the Secure copy of the register disabled when the CP15SDISABLE signal is asserted HIGH.

Attributes

VBAR is a 32-bit register.

The VBAR bit assignments are:

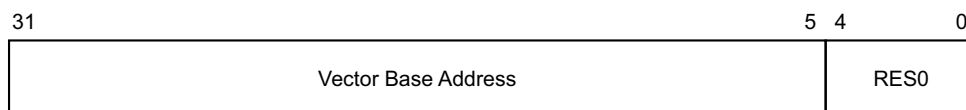

Bits [31:5]

Vector Base Address. Bits[31:5] of the base address of the exception vectors for exceptions taken in this exception level. Bits[4:0] of an exception vector are the exception offset.

For the Secure copy of this register, the field resets to 0.

For the Non-secure copy of this register, the field reset value is architecturally UNKNOWN.

Bits [4:0]

Reserved, RES0.

Accessing the VBAR:

To access the VBAR:

MRC p15,0,<Rt>,c12,c0,0 ; Read VBAR into Rt
MCR p15,0,<Rt>,c12,c0,0 ; Write Rt to VBAR

Register access is encoded as follows:

coproc	opc1	CRn	CRm	opc2
1111	000	1100	0000	000

G4.2.158 VMPIDR, Virtualization Multiprocessor ID Register

The VMPIDR characteristics are:

Purpose

Holds the value of the Virtualization Multiprocessor ID. This is the value returned by Non-secure EL1 reads of [MPIDR](#).

This register is part of:

- the Identification registers functional group
- the Virtualization registers functional group.

Usage constraints

This register is accessible as shown below:

EL0 (NS)	EL0 (S)	EL1 (NS)	EL1 (S)	EL2	EL3 (SCR.NS=1)	EL3 (SCR.NS=0)
-	-	-	-	RW	RW	-

Configurations

VMPIDR is architecturally mapped to AArch64 register [VMPIDR_EL2](#)[31:0].

If EL2 is not implemented, this register is RES0 from EL3.

Attributes

VMPIDR is a 32-bit register.

The VMPIDR bit assignments are:

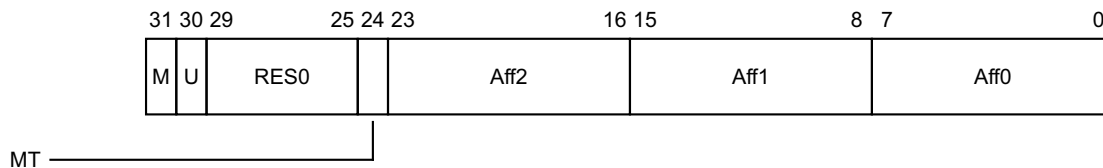

M, bit [31]

Indicates whether this implementation includes the Multiprocessing Extensions. The possible values of this bit are:

- 0 This implementation does not include the Multiprocessing Extensions.
- 1 This implementation includes the Multiprocessing Extensions.

In v8-A this bit is RES1.

U, bit [30]

Indicates a Uniprocessor system, as distinct from processor 0 in a multiprocessor system. The possible values of this bit are:

- 0 Processor is part of a multiprocessor system.
- 1 Processor is part of a uniprocessor system.

Resets to an IMPLEMENTATION DEFINED value.

Bits [29:25]

Reserved, RES0.

MT, bit [24]

Indicates whether the lowest level of affinity consists of logical processors that are implemented using a multi-threading type approach. The possible values of this bit are:

- 0 Performance of processors at the lowest affinity level is largely independent.
- 1 Performance of processors at the lowest affinity level is very interdependent.

Resets to an IMPLEMENTATION DEFINED value.

Aff2, bits [23:16]

Affinity level 2. The least significant affinity level field, for this processor in the system.

Resets to an IMPLEMENTATION DEFINED value.

Aff1, bits [15:8]

Affinity level 1. The intermediate affinity level field, for this processor in the system.

Resets to an IMPLEMENTATION DEFINED value.

Aff0, bits [7:0]

Affinity level 0. The most significant affinity level field, for this processor in the system.

Resets to an IMPLEMENTATION DEFINED value.

Accessing the VMPIDR:

To access the VMPIDR:

MRC p15,4,<Rt>,c0,c0,5 ; Read VMPIDR into Rt
MCR p15,4,<Rt>,c0,c0,5 ; Write Rt to VMPIDR

Register access is encoded as follows:

coproc	opc1	CRn	CRm	opc2
1111	100	0000	0000	101

G4.2.159 VPIDR, Virtualization Processor ID Register

The VPIDR characteristics are:

Purpose

Holds the value of the Virtualization Processor ID. This is the value returned by Non-secure EL1 reads of [MIDR](#).

This register is part of:

- the Virtualization registers functional group
- the Identification registers functional group.

Usage constraints

This register is accessible as shown below:

EL0 (NS)	EL0 (S)	EL1 (NS)	EL1 (S)	EL2	EL3 (SCR.NS=1)	EL3 (SCR.NS=0)
-	-	-	-	RW	RW	-

Configurations

VPIDR is architecturally mapped to AArch64 register [VPIDR_EL2](#).

If EL2 is not implemented, this register is RES0 from EL3.

Attributes

VPIDR is a 32-bit register.

The VPIDR bit assignments are:

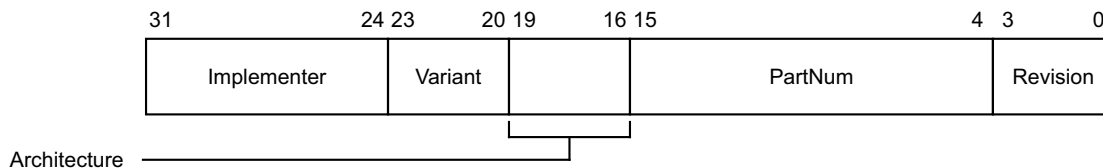

Implementer, bits [31:24]

The Implementer code. This field must hold an implementer code that has been assigned by ARM. Assigned codes include the following:

Hex representation	ASCII representation	Implementer
0x41	A	ARM Limited
0x42	B	Broadcom Corporation
0x43	C	Cavium Inc.
0x44	D	Digital Equipment Corporation
0x49	I	Infineon Technologies AG
0x4D	M	Motorola or Freescale Semiconductor Inc.
0x4E	N	NVIDIA Corporation
0x50	P	Applied Micro Circuits Corporation

Hex representation	ASCII representation	Implementer
0x51	Q	Qualcomm Inc.
0x56	V	Marvell International Ltd.
0x69	i	Intel Corporation

ARM can assign codes that are not published in this manual. All values not assigned by ARM are reserved and must not be used.

Resets to the value of the equivalent field in MIDR.

Variant, bits [23:20]

An IMPLEMENTATION DEFINED variant number. Typically, this field is used to distinguish between different product variants, or major revisions of a product.

Resets to the value of the equivalent field in MIDR.

Architecture, bits [19:16]

The permitted values of this field are:

0001	ARMv4
0010	ARMv4T
0011	ARMv5 (obsolete)
0100	ARMv5T
0101	ARMv5TE
0110	ARMv5TEJ
0111	ARMv6
1111	Defined by CPUID scheme

All other values are reserved.

Resets to the value of the equivalent field in MIDR.

PartNum, bits [15:4]

An IMPLEMENTATION DEFINED primary part number for the device.

On processors implemented by ARM, if the top four bits of the primary part number are 0x0 or 0x7, the variant and architecture are encoded differently.

Resets to the value of the equivalent field in MIDR.

Revision, bits [3:0]

An IMPLEMENTATION DEFINED revision number for the device.

Resets to the value of the equivalent field in MIDR.

Accessing the VPIDR:

To access the VPIDR:

MRC p15,4,<Rt>,c0,c0,0 ; Read VPIDR into Rt
 MCR p15,4,<Rt>,c0,c0,0 ; Write Rt to VPIDR

Register access is encoded as follows:

coproc	opc1	CRn	CRm	opc2
1111	100	0000	0000	000

G4.2.160 VTCR, Virtualization Translation Control Register

The VTCR characteristics are:

Purpose

Controls the translation table walks required for the stage 2 translation of memory accesses from Non-secure modes other than Hyp mode, and holds cacheability and shareability information for the accesses.

This register is part of:

- the Virtualization registers functional group
- the Virtual memory control registers functional group.

Usage constraints

This register is accessible as shown below:

EL0 (NS)	EL0 (S)	EL1 (NS)	EL1 (S)	EL2	EL3 (SCR.NS=1)	EL3 (SCR.NS=0)
-	-	-	-	RW	RW	-

Used in conjunction with [VTTBR](#), that defines the translation table base address for the translations.

Configurations

VTCR is architecturally mapped to AArch64 register [VTCR_EL2](#).

If EL2 is not implemented, this register is RES0 from EL3.

Attributes

VTCR is a 32-bit register.

The VTCR bit assignments are:

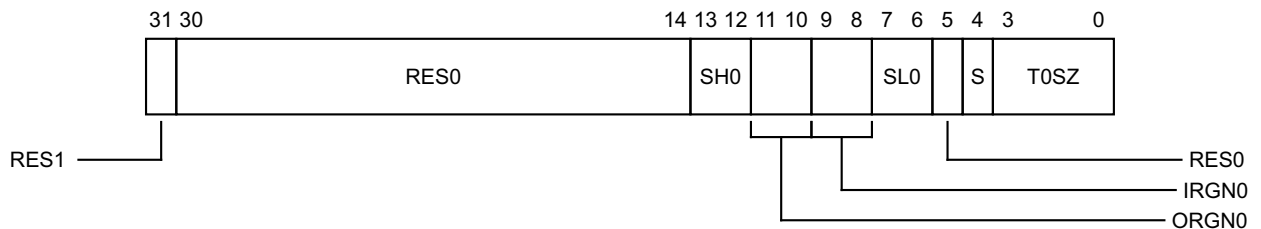

Bit [31]

Reserved, RES1.

Bits [30:14]

Reserved, RES0.

SH0, bits [13:12]

Shareability attribute for memory associated with translation table walks using [TTBR0](#).

- 00 Non-shareable
- 10 Outer Shareable
- 11 Inner Shareable

Other values are reserved.

ORGN0, bits [11:10]

Outer cacheability attribute for memory associated with translation table walks using [TTBR0](#).

- 00 Normal memory, Outer Non-cacheable
- 01 Normal memory, Outer Write-Back Write-Allocate Cacheable
- 10 Normal memory, Outer Write-Through Cacheable
- 11 Normal memory, Outer Write-Back no Write-Allocate Cacheable

IRGN0, bits [9:8]

Inner cacheability attribute for memory associated with translation table walks using [TTBR0](#).

- 00 Normal memory, Inner Non-cacheable
- 01 Normal memory, Inner Write-Back Write-Allocate Cacheable
- 10 Normal memory, Inner Write-Through Cacheable
- 11 Normal memory, Inner Write-Back no Write-Allocate Cacheable

SL0, bits [7:6]

Starting level for translation table walks using [VTTBR](#).

- 00 Start at second level
- 01 Start at first level

Other values are reserved.

If the stage 2 input address size, as programmed in [VTCR.T0SZ](#), is out of range with respect to the starting level at the time of a translation walk that uses the stage 2 translation, then a second stage level 1 translation fault is generated.

Bit [5]

Reserved, RES0.

S, bit [4]

Sign extension bit. This bit must be programmed to the value of [T0SZ\[3\]](#). If it is not, then the stage 2 [T0SZ](#) value is treated as an UNKNOWN value within the legal range that can be programmed.

T0SZ, bits [3:0]

The size offset of the memory region addressed by [TTBR0](#). The region size is $2^{32-T0SZ}$ bytes.

Accessing the VTCR:

To access the VTCR:

MRC p15,4,<Rt>,c2,c1,2 ; Read VTCR into Rt
MCR p15,4,<Rt>,c2,c1,2 ; Write Rt to VTCR

Register access is encoded as follows:

coproc	opc1	CRn	CRm	opc2
1111	100	0010	0001	010

G4.2.161 VTTBR, Virtualization Translation Table Base Register

The VTTBR characteristics are:

Purpose

Holds the base address of the translation table for the stage 2 translation of memory accesses from Non-secure modes other than Hyp mode.

This register is part of:

- the Virtualization registers functional group
- the Virtual memory control registers functional group.

Usage constraints

This register is accessible as shown below:

EL0 (NS)	EL0 (S)	EL1 (NS)	EL1 (S)	EL2	EL3 (SCR.NS=1)	EL3 (SCR.NS=0)
-	-	-	-	RW	RW	-

Used in conjunction with the [VTCR](#).

Configurations

VTTBR is architecturally mapped to AArch64 register [VTTBR_EL2](#).

If EL2 is not implemented, this register is RES0 from EL3.

Attributes

VTTBR is a 64-bit register.

The VTTBR bit assignments are:

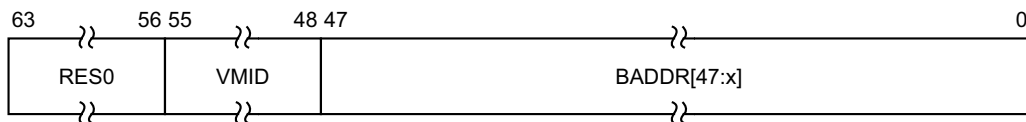

Bits [63:56]

Reserved, RES0.

VMID, bits [55:48]

The VMID for the translation table.

Resets to 0.

BADDR[47:x], bits [47:0]

Translation table base address, bits[47:x]. Bits [x-1:0] are RES0.

x is based on the value of [VTCR.T0SZ](#), and is calculated as follows:

- If [VTCR.T0SZ](#) is 0 or 1, $x = 5 - \text{VTCR.T0SZ}$.
- If [VTCR.T0SZ](#) is greater than 1, $x = 14 - \text{VTCR.T0SZ}$.

The value of x determines the required alignment of the translation table, which must be aligned to 2^x bytes.

If bits [x-1:3] are not all zero, this is a misaligned Translation Table Base Address. Its effects are CONSTRAINED UNPREDICTABLE, and can be one of the following:

- Bits [x-1:3] are treated as if all the bits are zero. The value read back from those bits might be the value written or might be zero.

- The calculation of an address for a translation table walk using this register can be corrupted in those bits that are non-zero.

Reset value is architecturally UNKNOWN.

Accessing the VTTBR:

To access the VTTBR:

MRRC p15,6,<Rt>,<Rt2>,c2 ; Read 64-bit VTTBR into Rt (low word) and Rt2 (high word)

MCRR p15,6,<Rt>,<Rt2>,c2 ; Write Rt (low word) and Rt2 (high word) to 64-bit VTTBR

Register access is encoded as follows:

coproc	opc1	CRm
1111	0110	0010

G4.3 Debug registers

This section describes the Debug registers in AArch32 state.

G4.3.1 DBGAUTHSTATUS, Debug Authentication Status register

The DBGAUTHSTATUS characteristics are:

Purpose

Provides information about the state of the IMPLEMENTATION DEFINED authentication interface for debug.

This register is part of the Debug registers functional group.

Usage constraints

This register is accessible as shown below:

EL0 (NS)	EL0 (S)	EL1 (NS)	EL1 (S)	EL2	EL3 (SCR.NS=1)	EL3 (SCR.NS=0)
-	-	RO	RO	RO	RO	RO

Configurations

DBGAUTHSTATUS is architecturally mapped to AArch64 register [DBGAUTHSTATUS_EL1](#).

DBGAUTHSTATUS is architecturally mapped to external register [DBGAUTHSTATUS_EL1](#).

There is one instance of this register that is used in both Secure and Non-secure states.

This register is required in all implementations.

Attributes

DBGAUTHSTATUS is a 32-bit register.

The DBGAUTHSTATUS bit assignments are:

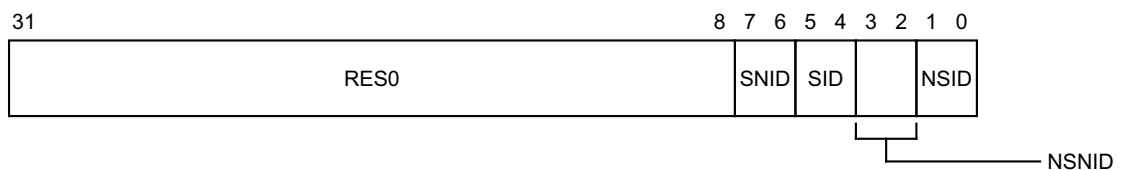

Bits [31:8]

Reserved, RES0.

SNID, bits [7:6]

Secure non-invasive debug. Possible values of this field are:

- 00 Not implemented. EL3 is not implemented and the processor is Non-secure.
- 10 Implemented and disabled. `ExternalSecureNoninvasiveDebugEnabled() == FALSE`.
- 11 Implemented and enabled. `ExternalSecureNoninvasiveDebugEnabled() == TRUE`.

Other values are reserved.

SID, bits [5:4]

Secure invasive debug. Possible values of this field are:

- 00 Not implemented. EL3 is not implemented and the processor is Non-secure.
 - 10 Implemented and disabled. ExternalSecureInvasiveDebugEnabled() == FALSE.
 - 11 Implemented and enabled. ExternalSecureInvasiveDebugEnabled() == TRUE.
- Other values are reserved.

NSNID, bits [3:2]

Non-secure non-invasive debug. Possible values of this field are:

- 00 Not implemented. EL3 is not implemented and the processor is Secure.
 - 10 Implemented and disabled. ExternalNoninvasiveDebugEnabled() == FALSE.
 - 11 Implemented and enabled. ExternalNoninvasiveDebugEnabled() == TRUE.
- Other values are reserved.

NSID, bits [1:0]

Non-secure invasive debug. Possible values of this field are:

- 00 Not implemented. EL3 is not implemented and the processor is Secure.
 - 10 Implemented and disabled. ExternalInvasiveDebugEnabled() == FALSE.
 - 11 Implemented and enabled. ExternalInvasiveDebugEnabled() == TRUE.
- Other values are reserved.

Accessing the DBGAUTHSTATUS:

To access the DBGAUTHSTATUS:

MRC p14,0,<Rt>,c7,c14,6 ; Read DBGAUTHSTATUS into Rt

Register access is encoded as follows:

coproc	opc1	CRn	CRm	opc2
1110	000	0111	1110	110

G4.3.2 DBGBCR<n>, Debug Breakpoint Control Registers, n = 0 - 15

The DBGBCR<n> characteristics are:

Purpose

Holds control information for a breakpoint. Forms breakpoint n together with value register [DBGBVR<n>](#), where n is 0 to 15. If EL2 is implemented and this breakpoint supports Context matching, [DBGBVR<n>](#) can be associated with a Breakpoint Extended Value Register [DBGBXVR<n>](#) for VMID matching.

This register is part of the Debug registers functional group.

Usage constraints

This register is accessible as shown below:

EL0 (NS)	EL0 (S)	EL1 (NS)	EL1 (S)	EL2	EL3 (SCR.NS=1)	EL3 (SCR.NS=0)
-	-	RW	RW	RW	RW	RW

When the E field is zero, all the other fields in the register are ignored.

Configurations

DBGBCR<n> is architecturally mapped to AArch64 register [DBGBCR<n>_EL1](#).

DBGBCR<n> is architecturally mapped to external register [DBGBCR<n>_EL1](#).

There is one instance of this register that is used in both Secure and Non-secure states.

Attributes

DBGBCR<n> is a 32-bit register.

The DBGBCR<n> bit assignments are:

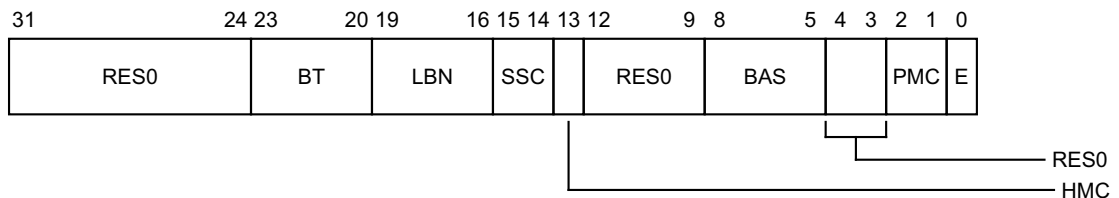

Bits [31:24]

Reserved, RES0.

BT, bits [23:20]

Breakpoint Type. Possible values are:

- 0000 Unlinked instruction address match.
- 0001 Linked instruction address match.
- 0010 Unlinked context ID match.
- 0011 Linked context ID match
- 0100 Unlinked instruction address mismatch.
- 0101 Linked instruction address mismatch.
- 1000 Unlinked VMID match.
- 1001 Linked VMID match.
- 1010 Unlinked VMID and context ID match.

1011 Linked VMID and context ID match.

The field breaks down as follows:

- BT[3:1]: Base type.
 - 000 Match address. **DBGBVR<n>** is the address of an instruction.
 - 010 Mismatch address. Behaves as type 0b000 if in an AArch64 translation, or if Halting debug-mode is enabled and halting is allowed. Otherwise, **DBGBVR<n>** is the address of an instruction to be stepped.
 - 001 Match context ID. **DBGBVR<n>** is a context ID.
 - 100 Match VMID. **DBGBXVR<n>**[7:0] is a VMID.
 - 101 Match VMID and context ID. **DBGBVR<n>** is a context ID, and **DBGBXVR<n>**[7:0] is a VMID.
- BT[0]: Enable linking.

If the breakpoint is not context-aware, BT[3] and BT[1] are RES0. If EL2 is not implemented, BT[3] is RES0. If EL1 using AArch32 is not implemented, BT[2] is RES0.

The values 011x and 11xx are reserved, but must behave as if the breakpoint is disabled. Software must not rely on this property as the behavior of reserved values might change in a future revision of the architecture.

On Cold reset, the field reset value is architecturally UNKNOWN.

LBN, bits [19:16]

Linked breakpoint number. For Linked address matching breakpoints, this specifies the index of the Context-matching breakpoint linked to.

On Cold reset, the field reset value is architecturally UNKNOWN.

SSC, bits [15:14]

Security state control. Determines the security states under which a breakpoint debug event for breakpoint n is generated. This field must be interpreted along with the HMC and PMC fields.

On Cold reset, the field reset value is architecturally UNKNOWN.

HMC, bit [13]

Higher mode control. Determines the debug perspective for deciding when a breakpoint debug event for breakpoint n is generated. This field must be interpreted along with the SSC and PMC fields.

On Cold reset, the field reset value is architecturally UNKNOWN.

Bits [12:9]

Reserved, RES0.

BAS, bits [8:5]

Byte address select. Defines which half-words an address-matching breakpoint matches, regardless of the instruction set and execution state. In an AArch64-only implementation, this field is reserved, RES1. Otherwise:

- BAS[2] and BAS[0] are read/write.
- BAS[3] and BAS[1] are read-only copies of BAS[2] and BAS[0] respectively.

The values 0b0011 and 0b1100 are only supported if AArch32 is supported at any exception level.

The permitted values depend on the breakpoint type.

For Address match breakpoints:

BAS	Match instruction at	Constraint for debuggers
0b0011	DBGBVR<n>	Use for T32 and T32EE instructions.
0b1100	DBGBVR<n>+2	Use for T32 and T32EE instructions.
0b1111	DBGBVR<n>	Use for A32 instructions.

0b0000 is reserved and must behave as if the breakpoint is disabled or map to a permitted value.

For Address mismatch breakpoints in an AArch32 stage 1 translation regime:

BAS	Step instruction at	Constraint for debuggers
0b0000	-	Use for a match anywhere breakpoint.
0b0011	DBGBVR<n>	Use for stepping T32 and T32EE instructions.
0b1100	DBGBVR<n>+2	Use for stepping T32 and T32EE instructions.
0b1111	DBGBVR<n>	Use for stepping A32 instructions.

For Context matching breakpoints, this field is RES1 and ignored.

On Cold reset, the field reset value is architecturally UNKNOWN.

Bits [4:3]

Reserved, RES0.

PMC, bits [2:1]

Privilege mode control. Determines the exception level or levels at which a breakpoint debug event for breakpoint n is generated. This field must be interpreted along with the SSC and HMC fields.

On Cold reset, the field reset value is architecturally UNKNOWN.

E, bit [0]

Enable breakpoint DBGBVR<n>. Possible values are:

- 0 Breakpoint disabled.
- 1 Breakpoint enabled.

On Cold reset, the field reset value is architecturally UNKNOWN.

Accessing the DBGBCR<n>:

To access the DBGBCR<n>:

MRC p14,0,<Rt>,c0,<CRm>,5 ; Read DBGBCR<n> into Rt, where n is in the range 0 to 15
MCR p14,0,<Rt>,c0,<CRm>,5 ; Write Rt to DBGBCR<n>, where n is in the range 0 to 15

Register access is encoded as follows:

coproc	opc1	CRn	CRm	opc2
1110	000	0000	n<3:0>	101

G4.3.3 DBGBVR<n>, Debug Breakpoint Value Registers, n = 0 - 15

The DBGBVR<n> characteristics are:

Purpose

Holds a value for use in breakpoint matching, either the virtual address of an instruction or a context ID. Forms breakpoint n together with control register [DBGBCR<n>](#), where n is 0 to 15. If EL2 is implemented and this breakpoint supports Context matching, DBGBVR<n> can be associated with a Breakpoint Extended Value Register [DBGBXVR<n>](#) for VMID matching.

This register is part of the Debug registers functional group.

Usage constraints

This register is accessible as shown below:

EL0 (NS)	EL0 (S)	EL1 (NS)	EL1 (S)	EL2	EL3 (SCR.NS=1)	EL3 (SCR.NS=0)
-	-	RW	RW	RW	RW	RW

Some breakpoints might not support Context ID comparison. For more information, see the description of the [DBGDIDR.CTX_CMPs](#) field.

Configurations

DBGBVR<n> is architecturally mapped to AArch64 register [DBGBVR<n>_EL1](#)[31:0].

DBGBVR<n> is architecturally mapped to external register [DBGBVR<n>_EL1](#)[31:0].

There is one instance of this register that is used in both Secure and Non-secure states.

Attributes

DBGBVR<n> is a 32-bit register.

The DBGBVR<n> bit assignments are:

When [DBGBCR<n>.BT==0b0x0x](#):

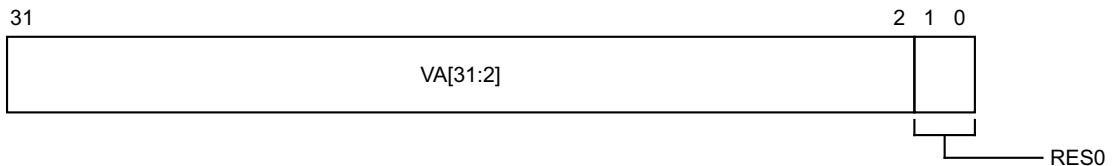

VA[31:2], bits [31:2]

Bits[31:2] of the address value for comparison.

On Cold reset, the field reset value is architecturally UNKNOWN.

Bits [1:0]

Reserved, RES0.

When [DBGBCR<n>.BT==0b1x0x](#):

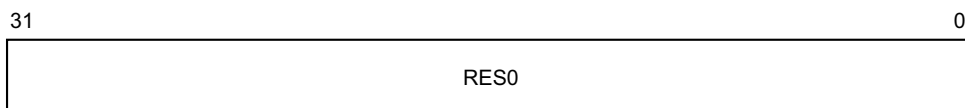

Bits [31:0]

Reserved, RES0.

When $DBGBCR\langle n \rangle.BT == 0xxx1x$:

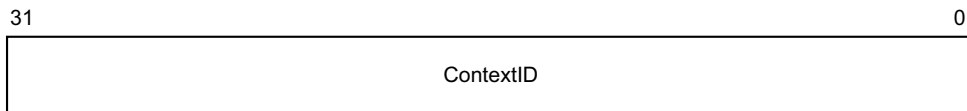

ContextID, bits [31:0]

Context ID value for comparison.

On Cold reset, the field reset value is architecturally UNKNOWN.

Accessing the $DBGBVR\langle n \rangle$:

To access the $DBGBVR\langle n \rangle$:

MRC p14,0,<Rt>,c0,<CRm>,4 ; Read $DBGBVR\langle n \rangle$ into Rt, where n is in the range 0 to 15

MCR p14,0,<Rt>,c0,<CRm>,4 ; Write Rt to $DBGBVR\langle n \rangle$, where n is in the range 0 to 15

Register access is encoded as follows:

coproc	opc1	CRn	CRm	opc2
1110	000	0000	n<3:0>	100

G4.3.4 DBGBXVR<n>, Debug Breakpoint Extended Value Registers, n = 0 - 15

The DBGBXVR<n> characteristics are:

Purpose

Holds a value for use in breakpoint matching, to support VMID matching. Used in conjunction with a control register **DBGBCR<n>** and a value register **DBGBVR<n>**, where n is 0 to 15. Used if EL2 is implemented and breakpoint n supports Context matching.

This register is part of the Debug registers functional group.

Usage constraints

This register is accessible as shown below:

EL0 (NS)	EL0 (S)	EL1 (NS)	EL1 (S)	EL2	EL3 (SCR.NS=1)	EL3 (SCR.NS=0)
-	-	RW	RW	RW	RW	RW

Configurations

DBGBXVR<n> is architecturally mapped to AArch64 register **DBGBVR<n>_EL1**[63:32].

DBGBXVR<n> is architecturally mapped to external register **DBGBVR<n>_EL1**[63:32].

There is one instance of this register that is used in both Secure and Non-secure states.

Attributes

DBGBXVR<n> is a 32-bit register.

The DBGBXVR<n> bit assignments are:

When DBGBCR<n>.BT==0b0xxx:

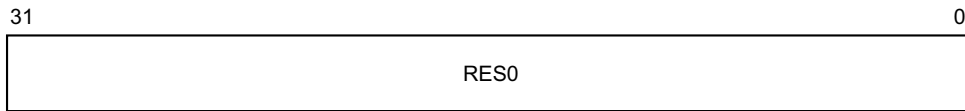

Bits [31:0]

Reserved, RES0.

When DBGBCR<n>.BT==0b1xxx and EL2 implemented:

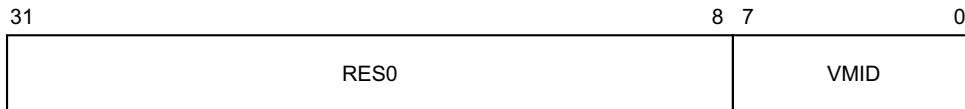

Bits [31:8]

Reserved, RES0.

VMID, bits [7:0]

VMID value for comparison.

On Cold reset, the field reset value is architecturally UNKNOWN.

Accessing the DBGXVR<n>:

To access the DBGXVR<n>:

MRC p14,0,<Rt>,c1,<CRm>,1 ; Read DBGXVR<n> into Rt, where n is in the range 0 to 15
MCR p14,0,<Rt>,c1,<CRm>,1 ; Write Rt to DBGXVR<n>, where n is in the range 0 to 15

Register access is encoded as follows:

coproc	opc1	CRn	CRm	opc2
1110	000	0001	n<3:0>	001

G4.3.5 DBGCLAIMCLR, Debug Claim Tag Clear register

The DBGCLAIMCLR characteristics are:

Purpose

Used by software to read the values of the CLAIM bits, and to clear these bits to 0.
This register is part of the Debug registers functional group.

Usage constraints

This register is accessible as shown below:

EL0 (NS)	EL0 (S)	EL1 (NS)	EL1 (S)	EL2	EL3 (SCR.NS=1)	EL3 (SCR.NS=0)
-	-	RW	RW	RW	RW	RW

The architecture does not define any functionality for the CLAIM bits.
Used in conjunction with the [DBGCLAIMSET](#) register.

Configurations

DBGCLAIMCLR is architecturally mapped to AArch64 register [DBGCLAIMCLR_EL1](#).
DBGCLAIMCLR is architecturally mapped to external register [DBGCLAIMCLR_EL1](#).
There is one instance of this register that is used in both Secure and Non-secure states.
This register is required in all implementations. An implementation must include 8 CLAIM tag bits.

Attributes

DBGCLAIMCLR is a 32-bit register.

The DBGCLAIMCLR bit assignments are:

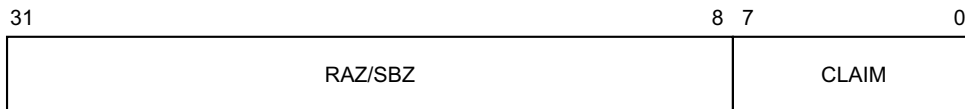

Bits [31:8]

Reserved, RAZ/SBZ. Software can rely on these bits reading as zero, and must use a should-be-zero policy on writes. Implementations must ignore writes.

CLAIM, bits [7:0]

Claim clear bits. Reading this field returns the current value of the CLAIM bits.
Writing a 1 to one of these bits clears the corresponding CLAIM bit to 0. This is an indirect write to the CLAIM bits.
A single write operation can clear multiple bits to 0. Writing 0 to one of these bits has no effect.
On Cold reset, the field resets to 0.

Accessing the DBGCLAIMCLR:

To access the DBGCLAIMCLR:

MRC p14,0,<Rt>,c7,c9,6 ; Read DBGCLAIMCLR into Rt
MCR p14,0,<Rt>,c7,c9,6 ; Write Rt to DBGCLAIMCLR

Register access is encoded as follows:

coproc	opc1	CRn	CRm	opc2
1110	000	0111	1001	110

G4.3.6 DBGCLAIMSET, Debug Claim Tag Set register

The DBGCLAIMSET characteristics are:

Purpose

Used by software to set CLAIM bits to 1.
This register is part of the Debug registers functional group.

Usage constraints

This register is accessible as shown below:

EL0 (NS)	EL0 (S)	EL1 (NS)	EL1 (S)	EL2	EL3 (SCR.NS=1)	EL3 (SCR.NS=0)
-	-	RW	RW	RW	RW	RW

The architecture does not define any functionality for the CLAIM bits.
Used in conjunction with the [DBGCLAIMCLR](#) register.

Configurations

DBGCLAIMSET is architecturally mapped to AArch64 register [DBGCLAIMSET_EL1](#).
DBGCLAIMSET is architecturally mapped to external register [DBGCLAIMSET_EL1](#).
There is one instance of this register that is used in both Secure and Non-secure states.
This register is required in all implementations. An implementation must include 8 CLAIM tag bits.

Attributes

DBGCLAIMSET is a 32-bit register.

The DBGCLAIMSET bit assignments are:

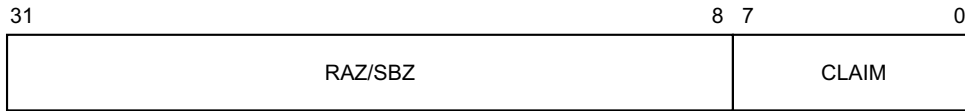

Bits [31:8]

Reserved, RAZ/SBZ. Software can rely on these bits reading as zero, and must use a should-be-zero policy on writes. Implementations must ignore writes.

CLAIM, bits [7:0]

Claim set bits. RAO.
Writing a 1 to one of these bits sets the corresponding CLAIM bit to 1. This is an indirect write to the CLAIM bits.
A single write operation can set multiple bits to 1. Writing 0 to one of these bits has no effect.

Accessing the DBGCLAIMSET:

To access the DBGCLAIMSET:

```
MRC p14,0,<Rt>,c7,c8,6 ; Read DBGCLAIMSET into Rt
MCR p14,0,<Rt>,c7,c8,6 ; Write Rt to DBGCLAIMSET
```

Register access is encoded as follows:

coproc	opc1	CRn	CRm	opc2
1110	000	0111	1000	110

G4.3.7 DBGDCCINT, DCC Interrupt Enable Register

The DBGDCCINT characteristics are:

Purpose

Enables interrupt requests to be signaled based on the DCC status flags.
 This register is part of the Debug registers functional group.

Usage constraints

This register is accessible as shown below:

EL0 (NS)	EL0 (S)	EL1 (NS)	EL1 (S)	EL2	EL3 (SCR.NS=1)	EL3 (SCR.NS=0)
-	-	RW	RW	RW	RW	RW

Configurations

DBGDCCINT is architecturally mapped to AArch64 register [MDCCINT_EL1](#).
 There is one instance of this register that is used in both Secure and Non-secure states.

Attributes

DBGDCCINT is a 32-bit register.

The DBGDCCINT bit assignments are:

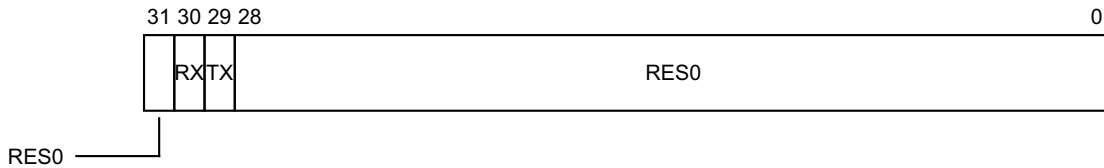

Bit [31]

Reserved, RES0.

RX, bit [30]

DCC interrupt request enable control for DTRRX. Enables a common COMMIRQ interrupt request to be signaled based on the DCC status flags.

- 0 No interrupt request generated by DTRRX.
- 1 Interrupt request will be generated on RXfull == 1.

If legacy COMMRX and COMMTX signals are implemented, then these are not affected by the value of this bit.

On Warm reset, the field resets to 0.

TX, bit [29]

DCC interrupt request enable control for DTRTX. Enables a common COMMIRQ interrupt request to be signaled based on the DCC status flags.

- 0 No interrupt request generated by DTRTX.
- 1 Interrupt request will be generated on TXfull == 0.

If legacy COMMRX and COMMTX signals are implemented, then these are not affected by the value of this bit.

On Warm reset, the field resets to 0.

Bits [28:0]

Reserved, RES0.

Accessing the DBGDCCINT:

To access the DBGDCCINT:

MRC p14,0,<Rt>,c0,c2,0 ; Read DBGDCCINT into Rt
MCR p14,0,<Rt>,c0,c2,0 ; Write Rt to DBGDCCINT

Register access is encoded as follows:

coproc	opc1	CRn	CRm	opc2
1110	000	0000	0010	000

G4.3.8 DBGDEVID, Debug Device ID register 0

The DBGDEVID characteristics are:

Purpose

Adds to the information given by the [DBGDIDR](#) by describing other features of the debug implementation.

This register is part of the Debug registers functional group.

Usage constraints

This register is accessible as shown below:

EL0 (NS)	EL0 (S)	EL1 (NS)	EL1 (S)	EL2	EL3 (SCR.NS=1)	EL3 (SCR.NS=0)
-	-	RO	RO	RO	RO	RO

Configurations

There is one instance of this register that is used in both Secure and Non-secure states.

This register is required in all implementations.

Attributes

DBGDEVID is a 32-bit register.

The DBGDEVID bit assignments are:

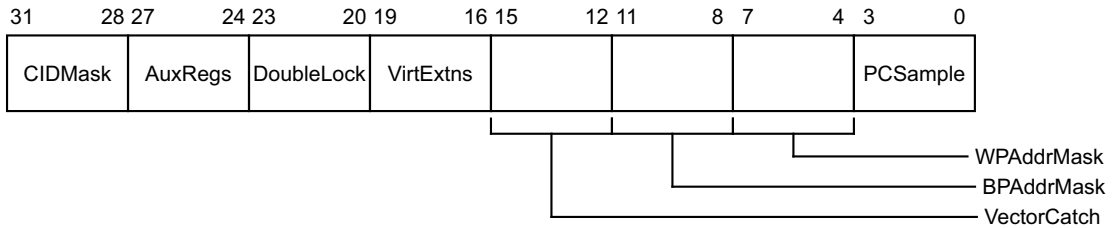

CIDMask, bits [31:28]

Indicates the level of support for the Context ID matching breakpoint masking capability. Permitted values of this field are:

0000 Context ID masking is not implemented.

0001 Context ID masking is implemented.

All other values are reserved. The value of this for v8-A is 0b0000.

AuxRegs, bits [27:24]

Indicates support for Auxiliary registers. Permitted values for this field are:

0000 None supported.

0001 Support for External Debug Auxiliary Control Register, [EDACR](#).

All other values are reserved.

DoubleLock, bits [23:20]

Indicates the presence of the [DBGOSDLR](#), OS Double Lock Register. Permitted values of this field are:

0000 The [DBGOSDLR](#) is not present.

0001 The [DBGOSDLR](#) is present.

All other values are reserved. The value of this for v8-A is 0b0001.

VirtExtns, bits [19:16]

Indicates whether EL2 is implemented. Permitted values of this field are:

- 0000 EL2 is not implemented.
 - 0001 EL2 is implemented.
- All other values are reserved.

VectorCatch, bits [15:12]

Defines the form of Vector catch debug event implemented. Permitted values of this field are:

- 0000 Address matching vector catch debug event implemented.
 - 0001 Exception matching vector catch debug event implemented.
- All other values are reserved.

BPAddrMask, bits [11:8]

Indicates the level of support for the IVA matching breakpoint masking capability. Permitted values of this field are:

- 0000 Breakpoint address matching may be implemented. If not implemented, [DBGBCR<n>](#)[28:24] is RAZ/WI.
 - 0001 Breakpoint address matching is implemented.
 - 1111 Breakpoint address matching is not implemented. [DBGBCR<n>](#)[28:24] is RES0.
- All other values are reserved. The value of this for v8-A is 0b1111.

WPAddrMask, bits [7:4]

Indicates the level of support for the data VA matching watchpoint masking capability. Permitted values of this field are:

- 0000 Watchpoint address matching may be implemented. If not implemented, [DBGWCR<n>.MASK](#) (Address mask) is RAZ/WI.
- 0001 Watchpoint address matching is implemented.
- 1111 Watchpoint address matching is not implemented. [DBGWCR<n>.MASK](#) (Address mask) is RES0.

All other values are reserved. The value of this for v8-A is 0b0001.

PCSample, bits [3:0]

Indicates the level of Sample-based profiling support using external debug registers 40 through 43. Permitted values of this field in v8-A are:

- 0000 Architecture-defined form of Sample-based profiling not implemented.
- 0010 [EDPCSR](#) and [EDCIDSR](#) are implemented (only permitted if EL3 and EL2 are not implemented).
- 0011 [EDPCSR](#), [EDCIDSR](#), and [EDVIDSR](#) are implemented.

All other values are reserved.

Accessing the DBGDEVID:

To access the DBGDEVID:

MRC p14,0,<Rt>,c7,c2,7 ; Read DBGDEVID into Rt

Register access is encoded as follows:

coproc	opc1	CRn	CRm	opc2
1110	000	0111	0010	111

G4.3.9 DBGDEVID1, Debug Device ID register 1

The DBGDEVID1 characteristics are:

Purpose

Adds to the information given by the [DBGDIDR](#) by describing other features of the debug implementation.

This register is part of the Debug registers functional group.

Usage constraints

This register is accessible as shown below:

EL0 (NS)	EL0 (S)	EL1 (NS)	EL1 (S)	EL2	EL3 (SCR.NS=1)	EL3 (SCR.NS=0)
-	-	RO	RO	RO	RO	RO

Configurations

There is one instance of this register that is used in both Secure and Non-secure states.

This register is required in all implementations.

Attributes

DBGDEVID1 is a 32-bit register.

The DBGDEVID1 bit assignments are:

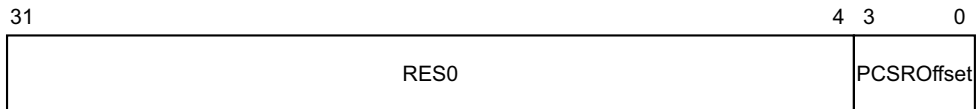

Bits [31:4]

Reserved, RES0.

PCSROffset, bits [3:0]

This field indicates the offset applied to PC samples returned by reads of [EDPCSR](#). Permitted values of this field in v8-A are:

0000 [EDPCSR](#) not implemented.

In v7-A, this field being 0b0000 can also mean that [EDPCSR](#) is implemented and that values returned by reads have an offset applied and indicate the instruction set state. This is not a permitted implementation for v8-A.

0010 [EDPCSR](#) implemented, and samples have no offset applied and do not sample the instruction set state in AArch32 state.

Accessing the DBGDEVID1:

To access the DBGDEVID1:

MRC p14,0,<Rt>,c7,c1,7 ; Read DBGDEVID1 into Rt

Register access is encoded as follows:

coproc	opc1	CRn	CRm	opc2
1110	000	0111	0001	111

G4.3.10 DBGDEVID2, Debug Device ID register 2

The DBGDEVID2 characteristics are:

Purpose

Reserved for future descriptions of features of the debug implementation.
This register is part of the Debug registers functional group.

Usage constraints

This register is accessible as shown below:

EL0 (NS)	EL0 (S)	EL1 (NS)	EL1 (S)	EL2	EL3 (SCR.NS=1)	EL3 (SCR.NS=0)
-	-	RO	RO	RO	RO	RO

Configurations

There is one instance of this register that is used in both Secure and Non-secure states.

Attributes

DBGDEVID2 is a 32-bit register.

The DBGDEVID2 bit assignments are:

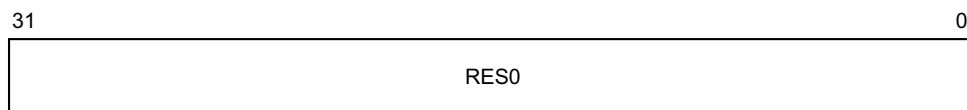

Bits [31:0]

Reserved, RES0.

Accessing the DBGDEVID2:

To access the DBGDEVID2:

MRC p14,0,<Rt>,c7,c0,7 ; Read DBGDEVID2 into Rt

Register access is encoded as follows:

coproc	opc1	CRn	CRm	opc2
1110	000	0111	0000	111

G4.3.11 DBGDIDR, Debug ID Register

The DBGDIDR characteristics are:

Purpose

Specifies which version of the Debug architecture is implemented, and some features of the debug implementation.

This register is part of the Debug registers functional group.

Usage constraints

This register is accessible as shown below:

EL0 (NS)	EL0 (S)	EL1 (NS)	EL1 (S)	EL2	EL3 (SCR.NS=1)	EL3 (SCR.NS=0)
Config-RO	Config-RO	RO	RO	RO	RO	RO

This register is accessible at EL0 if [DBGDSCRext.UDCCdis](#) is set to 0. When it is set to 1, EL0 access to this register is trapped to EL1.

Configurations

There is one instance of this register that is used in both Secure and Non-secure states.

This register is required in all implementations.

If external debug over powerdown is implemented, this register can be implemented in either or both power domains.

Attributes

DBGDIDR is a 32-bit register.

The DBGDIDR bit assignments are:

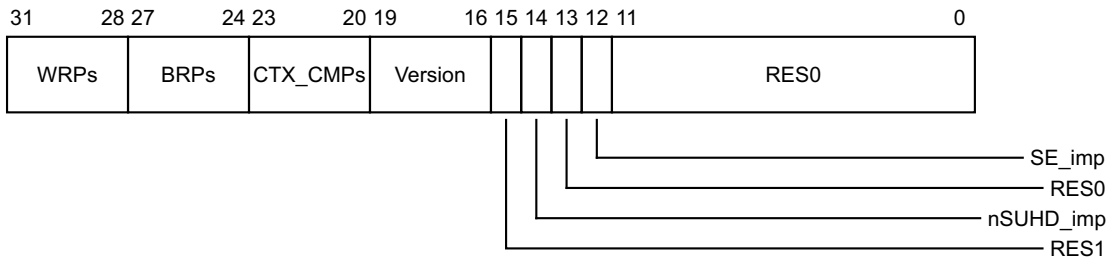

WRPs, bits [31:28]

The number of watchpoints implemented, minus 1.

Permitted values of this field are from 0b0001 for 2 implemented watchpoints, to 0b1111 for 16 implemented watchpoints.

The value of 0b0000 is reserved.

If AArch64 is implemented, this field has the same value as [ID_AA64DFR0_EL1.WRPs](#).

BRPs, bits [27:24]

The number of breakpoints implemented, minus 1.

Permitted values of this field are from 0b0001 for 2 implemented breakpoint, to 0b1111 for 16 implemented breakpoints.

The value of 0b0000 is reserved.

If AArch64 is implemented, this field has the same value as [ID_AA64DFR0_EL1.BRPs](#).

CTX_CMPs, bits [23:20]

The number of breakpoints that can be used for Context matching, minus 1.

Permitted values of this field are from 0b0000 for 1 Context matching breakpoint, to 0b1111 for 16 Context matching breakpoints.

The Context matching breakpoints must be the highest addressed breakpoints. For example, if six breakpoints are implemented and two are Context matching breakpoints, they must be breakpoints 4 and 5.

If AArch64 is implemented, this field has the same value as [ID_AA64DFR0_EL1.CTX_CMPs](#).

Version, bits [19:16]

The Debug architecture version. The permitted values of this field are:

- 0001 ARMv6, v6 Debug architecture
- 0010 ARMv6, v6.1 Debug architecture
- 0011 ARMv7, v7 Debug architecture, with baseline CP14 registers implemented
- 0100 ARMv7, v7 Debug architecture, with all CP14 registers implemented
- 0101 ARMv7, v7.1 Debug architecture.
- 0110 ARMv8, v8 Debug architecture.

All other values are reserved.

Bit [15]

Reserved, RES1.

nSUHD_imp, bit [14]

In v7-A, was Secure User Halting Debug not implemented.

The value of this bit must match the value of the SE_imp bit.

Bit [13]

Reserved, RES0.

SE_imp, bit [12]

EL3 implemented. The meanings of the values of this bit are:

- 0 EL3 not implemented.
- 1 EL3 implemented.

The value of this bit must match the value of the nSUHD_imp bit.

Bits [11:0]

Reserved, RES0.

Accessing the DBGDIDR:

To access the DBGDIDR:

MRC p14,0,<Rt>,c0,c0,0 ; Read DBGDIDR into Rt

Register access is encoded as follows:

coproc	opc1	CRn	CRm	opc2
1110	000	0000	0000	000

G4.3.12 DBGDRAR, Debug ROM Address Register

The DBGDRAR characteristics are:

Purpose

Defines the base physical address of a memory-mapped debug component, usually a ROM table that locates and describes the memory-mapped debug components in the system. However, if this processor is the only memory-mapped debug component in the system, or the only memory mapped-debug component visible to this processor, this register defines the base physical address of this processor's debug registers.

This register is part of the Debug registers functional group.

Usage constraints

This register is accessible as shown below:

EL0 (NS)	EL0 (S)	EL1 (NS)	EL1 (S)	EL2	EL3 (SCR.NS=1)	EL3 (SCR.NS=0)
Config-RO	Config-RO	RO	RO	RO	RO	RO

This register is accessible at EL0 if `DBGDSCRext.UDCCdis` is set to 0. When it is set to 1, EL0 access to this register is trapped to EL1.

Configurations

DBGDRAR is architecturally mapped to AArch64 register `MDRAR_EL1`.

There is one instance of this register that is used in both Secure and Non-secure states.

This register is required in all implementations.

If no memory-mapped debug components are implemented, `DBGDRAR.Valid` is RES0.

DBGDRAR is accessible either as a 64-bit register (using MRRC) or a 32-bit register (using MRC).

Attributes

DBGDRAR is a 32-bit register when accessing the 32-bit version and a 64-bit register when accessing the 64-bit version.

The DBGDRAR bit assignments are:

When accessing the 32-bit version:

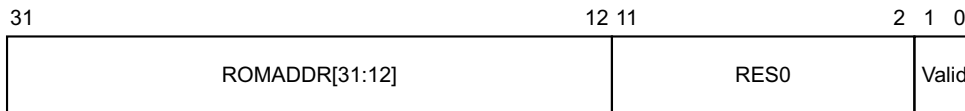

ROMADDR[31:12], bits [31:12]

Bits[31:12] of the ROM table physical address. Bits [11:0] of the address are zero.

Bits [11:2]

Reserved, RES0.

Valid, bits [1:0]

This field indicates whether the ROM Table address is valid. The permitted values of this field are:

- 00 ROM Table address is not valid
- 11 ROM Table address is valid.

Other values are reserved.

When accessing the 64-bit version:

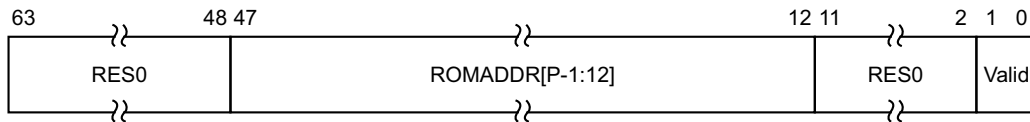

Bits [63:48]

Reserved, RES0.

ROMADDR[P-1:12], bits [47:12]

Bits[P-1:12] of the ROM table physical address, where P is the physical address size in bits (up to 48 bits) as stored in [ID_AA64MMFR0_EL1](#). If P is less than 48, bits[47:P] of this register are RES0.

Bits [11:0] of the ROM table physical address are zero.

If EL3 is implemented, ROMADDR is an address in Non-secure memory. Whether the ROM table is also accessible in Secure memory is IMPLEMENTATION DEFINED.

ARM recommends that bits [P-1:32] are zero in systems that support AArch32 at the highest exception level.

Bits [11:2]

Reserved, RES0.

Valid, bits [1:0]

This field indicates whether the ROM Table address is valid. The permitted values of this field are:

00 ROM Table address is not valid

11 ROM Table address is valid.

Other values are reserved.

Accessing the DBGDRAR:

To access the DBGDRAR when accessing the 32-bit version:

MRC p14,0,<Rt>,c1,c0,0 ; Read DBGDRAR into Rt

Register access is encoded as follows:

coproc	opc1	CRn	CRm	opc2
1110	000	0001	0000	000

To access the DBGDRAR when accessing the 64-bit version:

MRRC p14,0,<Rt>,<Rt2>,c1 ; Read 64-bit DBGDRAR into Rt (low word) and Rt2 (high word)

Register access is encoded as follows:

coproc	opc1	CRm
1110	0000	0001

G4.3.13 DBGDSAR, Debug Self Address Register

The DBGDSAR characteristics are:

Purpose

Previously defined the offset from the base address defined in [DBGDRAR](#) of the physical base address of the debug registers for the processor. Is now deprecated and RAZ.

This register is part of the Debug registers functional group.

Usage constraints

This register is accessible as shown below:

EL0 (NS)	EL0 (S)	EL1 (NS)	EL1 (S)	EL2	EL3 (SCR.NS=1)	EL3 (SCR.NS=0)
Config-RO	Config-RO	RO	RO	RO	RO	RO

This register is accessible at EL0 if [DBGDSCRExt.UDCCdis](#) is set to 0. When it is set to 1, EL0 access to this register is trapped to EL1.

Configurations

There is one instance of this register that is used in both Secure and Non-secure states.

Attributes

DBGDSAR is a 32-bit register when accessing the 32-bit version and a 64-bit register when accessing the 64-bit version.

The DBGDSAR bit assignments are:

When accessing the 32-bit version:

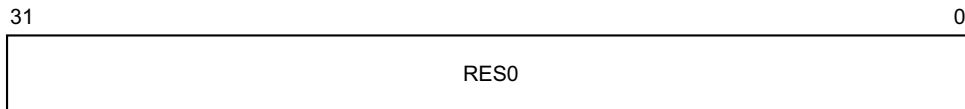

Bits [31:0]

Reserved, RES0.

When accessing the 64-bit version:

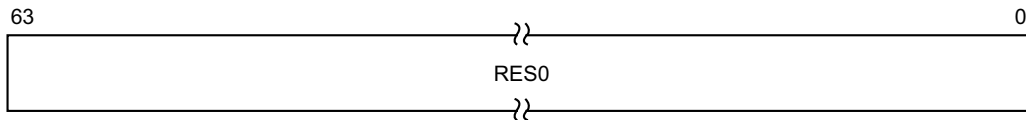

Bits [63:0]

Reserved, RES0.

Accessing the DBGDSAR:

To access the DBGDSAR when accessing the 32-bit version:

```
MRC p14,0,<Rt>,c2,c0,0 ; Read DBGDSAR into Rt
```

Register access is encoded as follows:

coproc	opc1	CRn	CRm	opc2
1110	000	0010	0000	000

To access the DBGDSAR when accessing the 64-bit version:

MRRC p14,0,<Rt>,<Rt2>,c2 ; Read 64-bit DBGDSAR into Rt (low word) and Rt2 (high word)

Register access is encoded as follows:

coproc	opc1	CRm
1110	0000	0010

G4.3.14 DBGDSCRext, Debug Status and Control Register, External View

The DBGDSCRext characteristics are:

Purpose

Main control register for the debug implementation.
 This register is part of the Debug registers functional group.

Usage constraints

This register is accessible as shown below:

EL0 (NS)	EL0 (S)	EL1 (NS)	EL1 (S)	EL2	EL3 (SCR.NS=1)	EL3 (SCR.NS=0)
-	-	RW	RW	RW	RW	RW

Configurations

DBGDSCRext is architecturally mapped to AArch64 register [MDSCR_EL1](#).
 There is one instance of this register that is used in both Secure and Non-secure states.
 This register is required in all implementations.

Attributes

DBGDSCRext is a 32-bit register.

The DBGDSCRext bit assignments are:

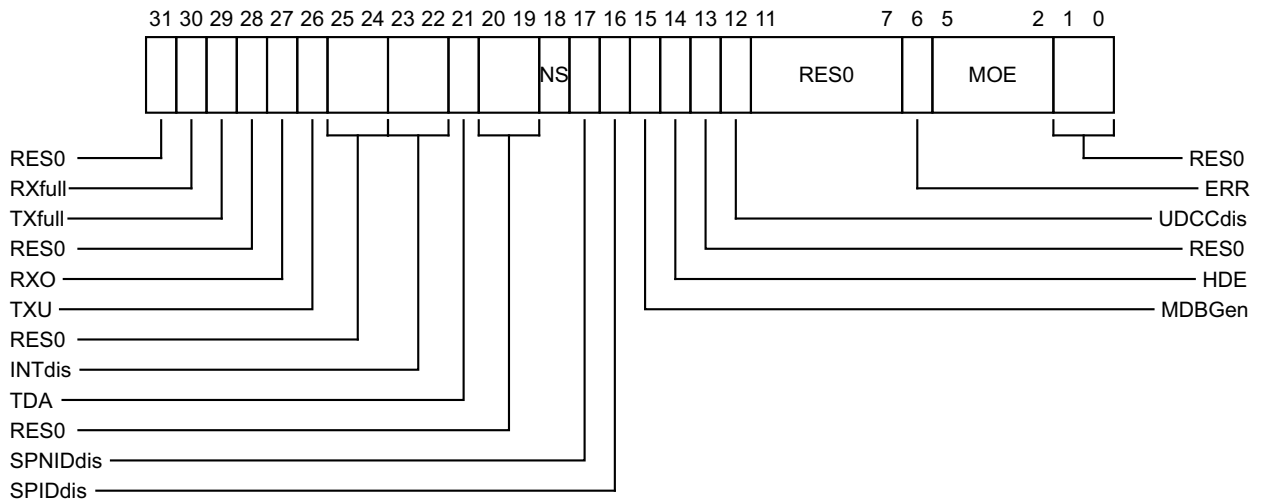

Bit [31]

Reserved, RES0.

RXfull, bit [30]

DTRRX full. Used for save/restore of [EDSCR.RXfull](#).
 When [DBGOSLSR.OSLK](#) == 0 (the OS lock is unlocked), this bit is RO.
 When [DBGOSLSR.OSLK](#) == 1 (the OS lock is locked), this bit is RW.
 ARM deprecates use of this bit other than for save/restore. Use [DBGDSCRint](#) to access the DTRRX full status.

TXfull, bit [29]

DTRTX full. Used for save/restore of [EDSCR.TXfull](#).

When [DBGOSLSR.OSLK](#) == 0 (the OS lock is unlocked), this bit is RO.

When [DBGOSLSR.OSLK](#) == 1 (the OS lock is locked), this bit is RW.

ARM deprecates use of this bit other than for save/restore. Use [DBGDSCRint](#) to access the DTRTX full status.

Bit [28]

Reserved, RES0.

RXO, bit [27]

Used for save/restore of [EDSCR.RXO](#).

When [DBGOSLSR.OSLK](#) == 0 (the OS lock is unlocked), this bit is RO. Software must treat it as UNKNOWN and use an SBZP policy for writes.

When [DBGOSLSR.OSLK](#) == 1 (the OS lock is locked), this bit is RW.

TXU, bit [26]

Used for save/restore of [EDSCR.TXU](#).

When [DBGOSLSR.OSLK](#) == 0 (the OS lock is unlocked), this bit is RO. Software must treat it as UNKNOWN and use an SBZP policy for writes.

When [DBGOSLSR.OSLK](#) == 1 (the OS lock is locked), this bit is RW.

Bits [25:24]

Reserved, RES0.

INTdis, bits [23:22]

Used for save/restore of [EDSCR.INTdis](#).

When [DBGOSLSR.OSLK](#) == 0 (the OS lock is unlocked), this field is RO. Software must treat it as UNKNOWN and use an SBZP policy for writes.

When [DBGOSLSR.OSLK](#) == 1 (the OS lock is locked), this field is RW.

TDA, bit [21]

Used for save/restore of [EDSCR.TDA](#).

When [DBGOSLSR.OSLK](#) == 0 (the OS lock is unlocked), this bit is RO. Software must treat it as UNKNOWN and use an SBZP policy for writes.

When [DBGOSLSR.OSLK](#) == 1 (the OS lock is locked), this bit is RW.

Bits [20:19]

Reserved, RES0.

NS, bit [18]

Non-secure status. Returns the inverse of `IsSecure()`. This bit is RO.

ARM deprecates use of this field.

On Warm reset, the field reset value is architecturally UNKNOWN.

SPNIDdis, bit [17]

Secure privileged profiling disabled status bit. This bit is RO and reflects the value of `ProfilingProhibited(TRUE,EL1)`. Permitted values are:

0 Profiling allowed in Secure privileged modes.

1 Profiling prohibited in Secure privileged modes.

ARM deprecates use of this field.

On Warm reset, the field reset value is architecturally UNKNOWN.

SPIDdis, bit [16]

Secure privileged AArch32 invasive self-hosted debug disabled status bit. This bit is RO and returns the inverse of DebugSPD32(). Permitted values are:

- 0 Self-hosted debug enabled in Secure privileged AArch32 modes.
- 1 Self-hosted debug disabled in Secure privileged AArch32 modes.

ARM deprecates use of this field.

On Warm reset, the field reset value is architecturally UNKNOWN.

MDBGGen, bit [15]

Monitor debug events enable. Enable Breakpoint, Watchpoint, and Vector catch debug exceptions.

- 0 Breakpoint, Watchpoint, and Vector catch debug exceptions disabled.
- 1 Breakpoint, Watchpoint, and Vector catch debug exceptions enabled.

On Warm reset, the field resets to 0.

HDE, bit [14]

Used for save/restore of [EDSCR.HDE](#).

When [DBGOSLSR.OSLK](#) == 0 (the OS lock is unlocked), this bit is RO. Software must treat it as UNKNOWN and use an SBZP policy for writes.

When [DBGOSLSR.OSLK](#) == 1 (the OS lock is locked), this bit is RW.

On Warm reset, the field reset value is architecturally UNKNOWN.

Bit [13]

Reserved, RES0.

UDCCdis, bit [12]

User mode access to Debug Communications Channel disable. When set, then any EL0 access to [DBGDIDR](#), [DBGDRAR](#), [DBGDSAR](#), [DBGDSCRint](#), [DBGDTRTXint](#), or [DBGDTRRXint](#) is trapped to EL1.

On Warm reset, the field resets to 0.

Bits [11:7]

Reserved, RES0.

ERR, bit [6]

Used for save/restore of [EDSCR.ERR](#).

When [DBGOSLSR.OSLK](#) == 0 (the OS lock is unlocked), this bit is RO. Software must treat it as UNKNOWN and use an SBZP policy for writes.

When [DBGOSLSR.OSLK](#) == 1 (the OS lock is locked), this bit is RW.

On Warm reset, the field reset value is architecturally UNKNOWN.

MOE, bits [5:2]

Method of Entry for debug exception. When a debug exception is taken to an exception level using AArch32, this field is set to indicate the event that caused the exception:

- 0001 Breakpoint
- 0011 Software breakpoint (BKPT) instruction
- 0101 Vector catch
- 1010 Watchpoint

On Warm reset, the field reset value is architecturally UNKNOWN.

Bits [1:0]

Reserved, RES0.

Accessing the DBGDSCRExt:

To access the DBGDSCRExt:

MRC p14,0,<Rt>,c0,c2,2 ; Read DBGDSCRExt into Rt
MCR p14,0,<Rt>,c0,c2,2 ; Write Rt to DBGDSCRExt

Register access is encoded as follows:

coproc	opc1	CRn	CRm	opc2
1110	000	0000	0010	010

G4.3.15 DBGDSCRint, Debug Status and Control Register, Internal View

The DBGDSCRint characteristics are:

Purpose

Main control register for the debug implementation. This is an internal, read-only view.
This register is part of the Debug registers functional group.

Usage constraints

This register is accessible as shown below:

EL0 (NS)	EL0 (S)	EL1 (NS)	EL1 (S)	EL2	EL3 (SCR.NS=1)	EL3 (SCR.NS=0)
Config-RO	Config-RO	RO	RO	RO	RO	RO

This register can be read at EL0 when `DBGDSCRext.UDCCdis` is set to 0. When it is set to 1, EL0 access to this register is trapped to EL1.

Configurations

DBGDSCRint is architecturally mapped to AArch64 register `MDCCSR_EL0`.

There is one instance of this register that is used in both Secure and Non-secure states.

This register is required in all implementations.

`DBGDSCRint.{NS, SPNIDdis, SPIDdis, MDBGen, UDCCdis, MOE}` are UNKNOWN when the register is accessed at EL0. However, although these values are not accessible at EL0 by instructions that are neither UNPREDICTABLE nor return UNKNOWN values, it is permissible for an implementation to return the values of `DBGDSCRext.{NS, SPNIDdis, SPIDdis, MDBGen, UDCCdis, MOE}` for these fields at EL0.

It is also permissible for an implementation to return the same values as defined for a read of DBGDSCRint at EL1 or above. (This is the case even if the implementation does not support AArch32 at EL1 or above.)

Attributes

DBGDSCRint is a 32-bit register.

The DBGDSCRint bit assignments are:

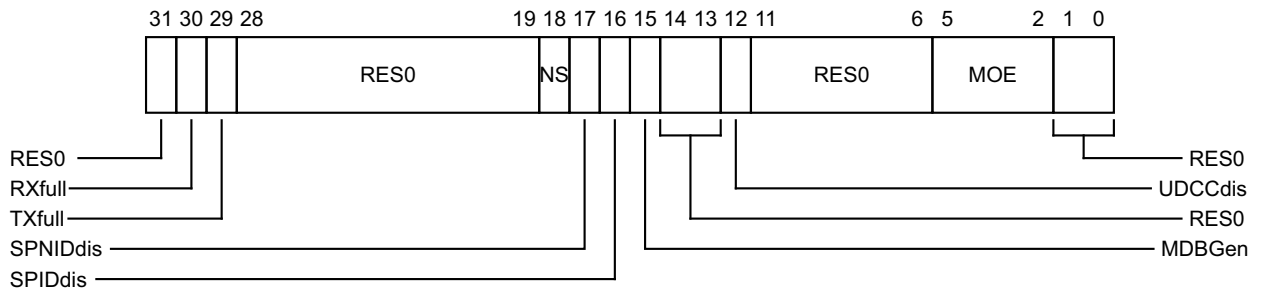

Bit [31]

Reserved, RES0.

RXfull, bit [30]

DTRRX full. Read-only view of the equivalent bit in the [EDSCR](#).

TXfull, bit [29]

DTRTX full. Read-only view of the equivalent bit in the [EDSCR](#).

Bits [28:19]

Reserved, RES0.

NS, bit [18]

Non-secure status.

Read-only view of the equivalent bit in the [DBGDSCRExt](#). ARM deprecates use of this field.

SPNIDdis, bit [17]

Secure privileged non-invasive debug disable.

Read-only view of the equivalent bit in the [DBGDSCRExt](#). ARM deprecates use of this field.

SPIDdis, bit [16]

Secure privileged invasive debug disable.

Read-only view of the equivalent bit in the [DBGDSCRExt](#). ARM deprecates use of this field.

MDBGGen, bit [15]

Monitor debug events enable.

Read-only view of the equivalent bit in the [DBGDSCRExt](#).

Bits [14:13]

Reserved, RES0.

UDCCdis, bit [12]

User mode access to Debug Communications Channel disable.

Read-only view of the equivalent bit in the [DBGDSCRExt](#). ARM deprecates use of this field.

Bits [11:6]

Reserved, RES0.

MOE, bits [5:2]

Method of Entry for debug exception. When a debug exception is taken to an exception level using AArch32, this field is set to indicate the event that caused the exception:

- 0001 Breakpoint
- 0011 Software breakpoint (BKPT) instruction
- 0101 Vector catch
- 1010 Watchpoint

Read-only view of the equivalent bit in the [DBGDSCRExt](#).

Bits [1:0]

Reserved, RES0.

Accessing the DBGDSCRint:

To access the DBGDSCRint:

MRC p14,0,<Rt>,c0,c1,0 ; Read DBGDSCRint into Rt, where Rt can be R0-R14 or APSR_nzcv. The last form writes bits[31:28] of the transferred value to the N, Z, C and V condition flags and is specified by setting the RT field of the encoding to 0b1111.

Register access is encoded as follows:

coproc	opc1	CRn	CRm	opc2
1110	000	0000	0001	000

G4.3.16 DBGDTRRXext, Debug Data Transfer Register, Receive, External View

The DBGDTRRXext characteristics are:

Purpose

Used for save/restore of [DBGDTRRXint](#). It is a component of the Debug Communications Channel. This register is part of the Debug registers functional group.

Usage constraints

This register is accessible as shown below:

EL0 (NS)	EL0 (S)	EL1 (NS)	EL1 (S)	EL2	EL3 (SCR.NS=1)	EL3 (SCR.NS=0)
-	-	RW	RW	RW	RW	RW

ARM deprecates reads and writes of DBGDTRRXext through the CP14 interface when the OS lock is unlocked.

If [EDSCR.ITE](#) == 0 when the processor exits Debug state on receiving a Restart request trigger event, the behavior of any operation issued by a DTR access in memory access mode that has not completed execution is CONSTRAINED UNPREDICTABLE, and must do one of the following:

- It must complete execution in Debug state before the processor executes the restart sequence.
- It must complete execution in Non-debug state before the processor executes the restart sequence.
- It must be abandoned. This means that the instruction does not execute. Any registers or memory accessed by the instruction are left in an UNKNOWN state.

Configurations

DBGDTRRXext is architecturally mapped to AArch64 register [OSDTRRX_EL1](#).

There is one instance of this register that is used in both Secure and Non-secure states. This register is required in all implementations.

Attributes

DBGDTRRXext is a 32-bit register.

The DBGDTRRXext bit assignments are:

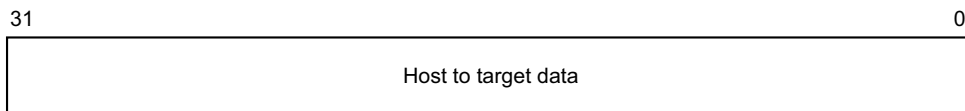

Bits [31:0]

Host to target data. One word of data for transfer from the debug host to the debug target.

For the full behavior of the Debug Communications Channel, see section 9 (The Debug Communications Channel and Instruction Transfer Register) in document PRD03-PRDC-010486.

On Cold reset, the field reset value is architecturally UNKNOWN.

Accessing the DBGDTRRXext:

To access the DBGDTRRXext:

```
MRC p14,0,<Rt>,c0,c0,2 ; Read DBGDTRRXext into Rt
MCR p14,0,<Rt>,c0,c0,2 ; Write Rt to DBGDTRRXext
```

Register access is encoded as follows:

coproc	opc1	CRn	CRm	opc2
1110	000	0000	0000	010

G4.3.17 DBGDTRRXint, Debug Data Transfer Register, Receive, Internal View

The DBGDTRRXint characteristics are:

Purpose

Transfers data from an external host to the ARM processor. For example, it is used by a debugger transferring commands and data to a debug target. It is a component of the Debug Communications Channel.

This register is part of the Debug registers functional group.

Usage constraints

This register is accessible as shown below:

EL0 (NS)	EL0 (S)	EL1 (NS)	EL1 (S)	EL2	EL3 (SCR.NS=1)	EL3 (SCR.NS=0)
Config-RO	Config-RO	RO	RO	RO	RO	RO

This register can be read at EL0 when [DBGDSCRint.UDCCdis](#) is set to 0. When it is set to 1, EL0 access to this register is trapped to EL1.

If [EDSCR.ITE](#) == 0 when the processor exits Debug state on receiving a Restart request trigger event, the behavior of any operation issued by a DTR access in memory access mode that has not completed execution is CONstrained UNPREDICTABLE, and must do one of the following:

- It must complete execution in Debug state before the processor executes the restart sequence.
- It must complete execution in Non-debug state before the processor executes the restart sequence.
- It must be abandoned. This means that the instruction does not execute. Any registers or memory accessed by the instruction are left in an UNKNOWN state.

Configurations

DBGDTRRXint is architecturally mapped to AArch64 register [DBGDTRRX_EL0](#).

DBGDTRRXint is architecturally mapped to external register [DBGDTRRX_EL0](#).

There is one instance of this register that is used in both Secure and Non-secure states.

This register is required in all implementations.

Attributes

DBGDTRRXint is a 32-bit register.

The DBGDTRRXint bit assignments are:

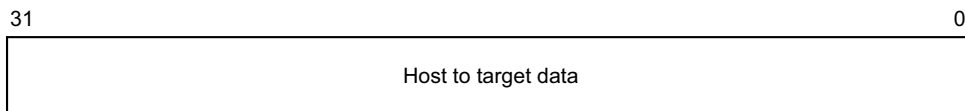

Bits [31:0]

Host to target data. One word of data for transfer from the debug host to the debug target.

For the full behavior of the Debug Communications Channel, see section 9 (The Debug Communications Channel and Instruction Transfer Register) in document PRD03-PRDC-010486.

On Cold reset, the field reset value is architecturally UNKNOWN.

Accessing the DBGDTRRXint:

To access the DBGDTRRXint:

MRC p14,0,<Rt>,c0,c5,0 ; Read DBGDTRRXint into Rt

Register access is encoded as follows:

coproc	opc1	CRn	CRm	opc2
1110	000	0000	0101	000

G4.3.18 DBGDTRTXext, Debug Data Transfer Register, Transmit, External View

The DBGDTRTXext characteristics are:

Purpose

Used for save/restore of [DBGDTRTXint](#). It is a component of the Debug Communication Channel. This register is part of the Debug registers functional group.

Usage constraints

This register is accessible as shown below:

EL0 (NS)	EL0 (S)	EL1 (NS)	EL1 (S)	EL2	EL3 (SCR.NS=1)	EL3 (SCR.NS=0)
-	-	RW	RW	RW	RW	RW

ARM deprecates reads and writes of DBGDTRTXext through the CP14 interface when the OS Lock is unlocked.

If [EDSCR.ITE](#) == 0 when the processor exits Debug state on receiving a Restart request trigger event, the behavior of any operation issued by a DTR access in memory access mode that has not completed execution is CONstrained UNPREDICTABLE, and must do one of the following:

- It must complete execution in Debug state before the processor executes the restart sequence.
- It must complete execution in Non-debug state before the processor executes the restart sequence.
- It must be abandoned. This means that the instruction does not execute. Any registers or memory accessed by the instruction are left in an UNKNOWN state.

Configurations

DBGDTRTXext is architecturally mapped to AArch64 register [OSDTRTX_EL1](#).

There is one instance of this register that is used in both Secure and Non-secure states. This register is required in all implementations.

Attributes

DBGDTRTXext is a 32-bit register.

The DBGDTRTXext bit assignments are:

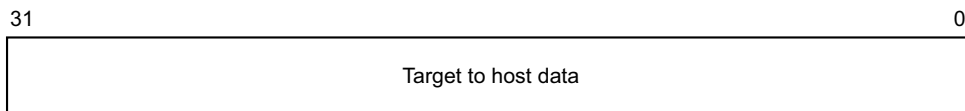

Bits [31:0]

Target to host data. One word of data for transfer from the debug target to the debug host.

For the full behavior of the Debug Communications Channel, see section 9 (The Debug Communications Channel and Instruction Transfer Register) in document PRD03-PRDC-010486.

On Cold reset, the field reset value is architecturally UNKNOWN.

Accessing the DBGDTRTXext:

To access the DBGDTRTXext:

```
MRC p14,0,<Rt>,c0,c3,2 ; Read DBGDTRTXext into Rt
MCR p14,0,<Rt>,c0,c3,2 ; Write Rt to DBGDTRTXext
```

Register access is encoded as follows:

coproc	opc1	CRn	CRm	opc2
1110	000	0000	0011	010

G4.3.19 DBGDTRTXint, Debug Data Transfer Register, Transmit, Internal View

The DBGDTRTXint characteristics are:

Purpose

Transfers data from the ARM processor to an external host. For example, it is used by a debug target to transfer data to the debugger. It is a component of the Debug Communication Channel.

This register is part of the Debug registers functional group.

Usage constraints

This register is accessible as shown below:

EL0 (NS)	EL0 (S)	EL1 (NS)	EL1 (S)	EL2	EL3 (SCR.NS=1)	EL3 (SCR.NS=0)
Config-WO	Config-WO	WO	WO	WO	WO	WO

This register can be written at EL0 when [DBGDSCRint.UDCCdis](#) is set to 0. When it is set to 1, EL0 access to this register is trapped to EL1.

If [EDSCR.ITE](#) == 0 when the processor exits Debug state on receiving a Restart request trigger event, the behavior of any operation issued by a DTR access in memory access mode that has not completed execution is CONstrained UNPREDICTABLE, and must do one of the following:

- It must complete execution in Debug state before the processor executes the restart sequence.
- It must complete execution in Non-debug state before the processor executes the restart sequence.
- It must be abandoned. This means that the instruction does not execute. Any registers or memory accessed by the instruction are left in an UNKNOWN state.

Configurations

DBGDTRTXint is architecturally mapped to AArch64 register [DBGDTRTX_EL0](#).

DBGDTRTXint is architecturally mapped to external register [DBGDTRTX_EL0](#).

There is one instance of this register that is used in both Secure and Non-secure states.

This register is required in all implementations.

Attributes

DBGDTRTXint is a 32-bit register.

The DBGDTRTXint bit assignments are:

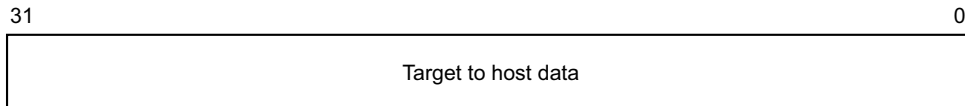

Bits [31:0]

Target to host data. One word of data for transfer from the debug target to the debug host.

For the full behavior of the Debug Communications Channel, see section 9 (The Debug Communications Channel and Instruction Transfer Register) in document PRD03-PRDC-010486.

On Cold reset, the field reset value is architecturally UNKNOWN.

Accessing the DBGDTRTXint:

To access the DBGDTRTXint:

```
MCR p14,0,<Rt>,c0,c5,0 ; Write Rt to DBGDTRTXint
```

Register access is encoded as follows:

coproc	opc1	CRn	CRm	opc2
1110	000	0000	0101	000

G4.3.20 DBGOSDLR, Debug OS Double Lock Register

The DBGOSDLR characteristics are:

Purpose

Locks out the external debug interface.

This register is part of the Debug registers functional group.

Usage constraints

This register is accessible as shown below:

EL0 (NS)	EL0 (S)	EL1 (NS)	EL1 (S)	EL2	EL3 (SCR.NS=1)	EL3 (SCR.NS=0)
-	-	RW	RW	RW	RW	RW

Configurations

DBGOSDLR is architecturally mapped to AArch64 register [OSDLR_EL1](#).

There is one instance of this register that is used in both Secure and Non-secure states.

Attributes

DBGOSDLR is a 32-bit register.

The DBGOSDLR bit assignments are:

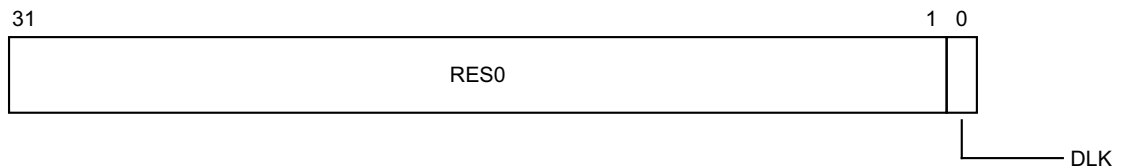

Bits [31:1]

Reserved, RES0.

DLK, bit [0]

OS Double Lock control bit. Possible values are:

0 OS Double Lock unlocked.

1 OS Double Lock locked, if [DBGPRCR.CORENPDRQ](#) (Core no power-down request) bit is set to 0 and the processor is in Non-debug state.

On Warm reset, the field resets to 0.

Accessing the DBGOSDLR:

To access the DBGOSDLR:

MRC p14,0,<Rt>,c1,c3,4 ; Read DBGOSDLR into Rt

MCR p14,0,<Rt>,c1,c3,4 ; Write Rt to DBGOSDLR

Register access is encoded as follows:

coproc	opc1	CRn	CRm	opc2
1110	000	0001	0011	100

G4.3.21 DBGOSECCR, Debug OS Lock Exception Catch Control Register

The DBGOSECCR characteristics are:

Purpose

Provides a mechanism for an operating system to access the contents of [EDECCCR](#) that are otherwise invisible to software, so it can save/restore the contents of [EDECCCR](#) over powerdown on behalf of the external debugger.

This register is part of the Debug registers functional group.

Usage constraints

This register is accessible as shown below:

EL0 (NS)	EL0 (S)	EL1 (NS)	EL1 (S)	EL2	EL3 (SCR.NS=1)	EL3 (SCR.NS=0)
-	-	RW	RW	RW	RW	RW

Configurations

DBGOSECCR is architecturally mapped to AArch64 register [OSECCR_EL1](#).

DBGOSECCR is architecturally mapped to external register [EDECCCR](#).

There is one instance of this register that is used in both Secure and Non-secure states.

Attributes

DBGOSECCR is a 32-bit register.

The DBGOSECCR bit assignments are:

When `OSLSR.OSLK==1`:



EDECCCR, bits [31:0]

Used for save/restore to [EDECCCR](#) over powerdown.

Accessing the DBGOSECCR:

To access the DBGOSECCR:

MRC p14,0,<Rt>,c0,c6,2 ; Read DBGOSECCR into Rt

MCR p14,0,<Rt>,c0,c6,2 ; Write Rt to DBGOSECCR

Register access is encoded as follows:

coproc	opc1	CRn	CRm	opc2
1110	000	0000	0110	010

G4.3.22 DBGOSLAR, Debug OS Lock Access Register

The DBGOSLAR characteristics are:

Purpose

Provides a lock for the debug registers. The OS lock also disables some Software debug events.
 This register is part of the Debug registers functional group.

Usage constraints

This register is accessible as shown below:

EL0 (NS)	EL0 (S)	EL1 (NS)	EL1 (S)	EL2	EL3 (SCR.NS=1)	EL3 (SCR.NS=0)
-	-	WO	WO	WO	WO	WO

Configurations

DBGOSLAR is architecturally mapped to AArch64 register [OSLAR_EL1](#).
 DBGOSLAR is architecturally mapped to external register [OSLAR_EL1](#).
 There is one instance of this register that is used in both Secure and Non-secure states.

Attributes

DBGOSLAR is a 32-bit register.

The DBGOSLAR bit assignments are:

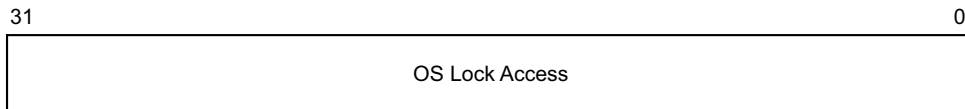

Bits [31:0]

OS Lock Access. Writing the value 0xC5ACCE55 to the DBGOSLAR sets the OS lock to 1. Writing any other value sets the OS lock to 0.
 Use [DBGOSLSR.OSLK](#) to check the current status of the lock.

Accessing the DBGOSLAR:

To access the DBGOSLAR:

```
MCR p14,0,<Rt>,c1,c0,4 ; Write Rt to DBGOSLAR
```

Register access is encoded as follows:

coproc	opc1	CRn	CRm	opc2
1110	000	0001	0000	100

G4.3.23 DBGOSLSR, Debug OS Lock Status Register

The DBGOSLSR characteristics are:

Purpose

Provides status information for the OS lock.

This register is part of the Debug registers functional group.

Usage constraints

This register is accessible as shown below:

EL0 (NS)	EL0 (S)	EL1 (NS)	EL1 (S)	EL2	EL3 (SCR.NS=1)	EL3 (SCR.NS=0)
-	-	RO	RO	RO	RO	RO

Configurations

DBGOSLSR is architecturally mapped to AArch64 register [OSLSR_EL1](#).

There is one instance of this register that is used in both Secure and Non-secure states.

The OS lock status is also visible in the external debug interface through EDPRSR.

Attributes

DBGOSLSR is a 32-bit register.

The DBGOSLSR bit assignments are:

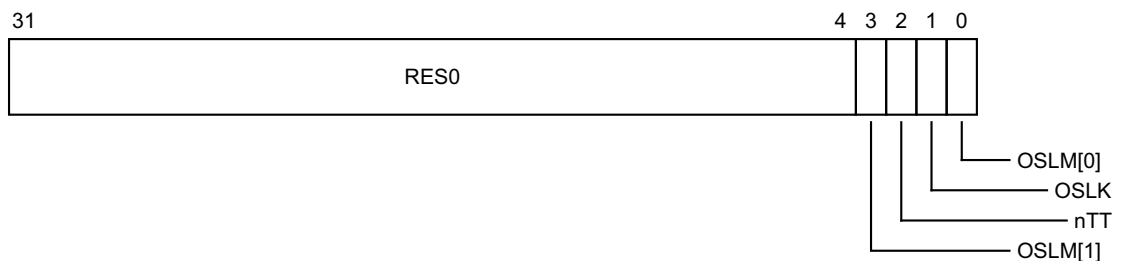

Bits [31:4]

Reserved, RES0.

OSLM[1], bit [3]

See below for description of the OSLM field.

nTT, bit [2]

Not 32-bit access. This bit is always RAZ. It indicates that a 32-bit access is needed to write the key to the OS Lock Access Register.

OSLK, bit [1]

OS Lock Status. The possible values are:

0 OS lock unlocked.

1 OS lock locked.

The OS Lock is locked and unlocked by writing to the OS Lock Access Register.

On Cold reset, the field resets to 1.

OSLM[0], bit [0]

OS lock model implemented. Identifies the form of OS save and restore mechanism implemented.
In v8-A these bits are as follows:
10 OS lock implemented. DBGOSSRR not implemented.
All other values are reserved.

Accessing the DBGOSLSR:

To access the DBGOSLSR:

MRC p14,0,<Rt>,c1,c1,4 ; Read DBGOSLSR into Rt

Register access is encoded as follows:

coproc	opc1	CRn	CRm	opc2
1110	000	0001	0001	100

G4.3.24 DBGPRCR, Debug Power Control Register

The DBGPRCR characteristics are:

Purpose

Controls behavior of processor on power-down request.
This register is part of the Debug registers functional group.

Usage constraints

This register is accessible as shown below:

EL0 (NS)	EL0 (S)	EL1 (NS)	EL1 (S)	EL2	EL3 (SCR.NS=1)	EL3 (SCR.NS=0)
-	-	RW	RW	RW	RW	RW

Configurations

DBGPRCR is architecturally mapped to AArch64 register [DBGPRCR_EL1](#).

There is one instance of this register that is used in both Secure and Non-secure states.

This register is required in all implementations.

Bit [0] of this register is mapped to [EDPRCR.CORENPDRQ](#), bit [0] of the external view of this register. The other bits in these registers are not mapped to each other.

Attributes

DBGPRCR is a 32-bit register.

The DBGPRCR bit assignments are:

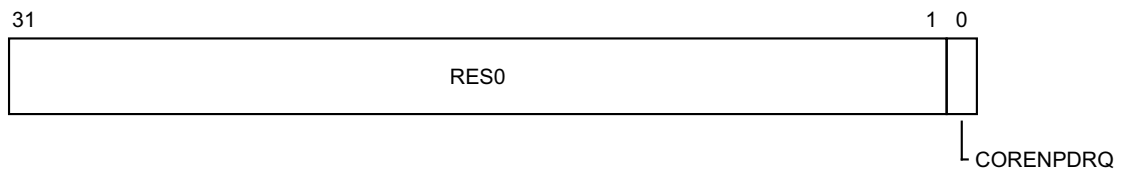

Bits [31:1]

Reserved, RES0.

CORENPDRQ, bit [0]

Core no powerdown request. Requests emulation of powerdown. Possible values of this bit are:

0 On a powerdown request, the system powers down the Core power domain.

1 On a powerdown request, the system emulates powerdown of the Core power domain.
In this emulation mode the Core power domain is not actually powered down.

On Cold reset, the field resets to the value of [EDPRCR.COREPURQ](#).

Accessing the DBGPRCR:

To access the DBGPRCR:

MRC p14,0,<Rt>,c1,c4,4 ; Read DBGPRCR into Rt
MCR p14,0,<Rt>,c1,c4,4 ; Write Rt to DBGPRCR

Register access is encoded as follows:

coproc	opc1	CRn	CRm	opc2
1110	000	0001	0100	100

G4.3.25 DBGVCR, Debug Vector Catch Register

The DBGVCR characteristics are:

Purpose

Controls Vector catch debug events.

This register is part of the Debug registers functional group.

Usage constraints

This register is accessible as shown below:

EL0 (NS)	EL0 (S)	EL1 (NS)	EL1 (S)	EL2	EL3 (SCR.NS=1)	EL3 (SCR.NS=0)
-	-	RW	RW	RW	RW	RW

Configurations

DBGVCR is architecturally mapped to AArch64 register [DBGVCR32_EL2](#).

There is one instance of this register that is used in both Secure and Non-secure states.

This register is required in all implementations.

Attributes

DBGVCR is a 32-bit register.

The DBGVCR bit assignments are:

When EL3 implemented and using AArch32:

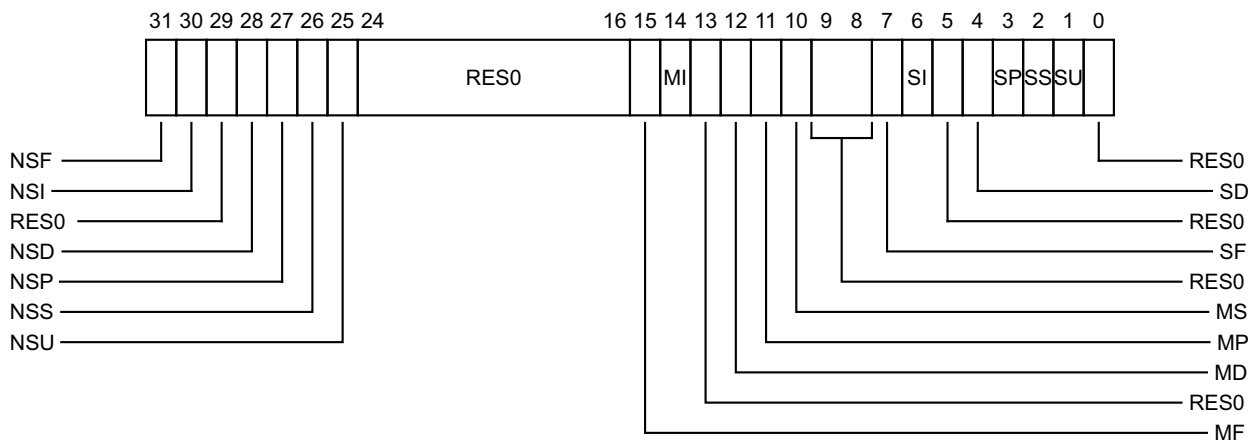

NSF, bit [31]

FIQ vector catch enable in Non-secure state.

The exception vector offset is $0x1C$.

On Warm reset, the field reset value is architecturally UNKNOWN.

NSI, bit [30]

IRQ vector catch enable in Non-secure state.

The exception vector offset is $0x18$.

On Warm reset, the field reset value is architecturally UNKNOWN.

Bit [29]

Reserved, RES0.

NSD, bit [28]

Data Abort vector catch enable in Non-secure state.

The exception vector offset is $0x10$.

On Warm reset, the field reset value is architecturally UNKNOWN.

NSP, bit [27]

Prefetch Abort vector catch enable in Non-secure state.

The exception vector offset is $0x0C$.

On Warm reset, the field reset value is architecturally UNKNOWN.

NSS, bit [26]

Supervisor Call (SVC) vector catch enable in Non-secure state.

The exception vector offset is $0x08$.

On Warm reset, the field reset value is architecturally UNKNOWN.

NSU, bit [25]

Undefined Instruction vector catch enable in Non-secure state.

The exception vector offset is $0x04$.

On Warm reset, the field reset value is architecturally UNKNOWN.

Bits [24:16]

Reserved, RES0.

MF, bit [15]

FIQ vector catch enable in Monitor mode.

The exception vector offset is $0x1C$.

On Warm reset, the field reset value is architecturally UNKNOWN.

MI, bit [14]

IRQ vector catch enable in Monitor mode.

The exception vector offset is $0x18$.

On Warm reset, the field reset value is architecturally UNKNOWN.

Bit [13]

Reserved, RES0.

MD, bit [12]

Data Abort vector catch enable in Monitor mode.

The exception vector offset is $0x10$.

On Warm reset, the field reset value is architecturally UNKNOWN.

MP, bit [11]

Prefetch Abort vector catch enable in Monitor mode.

The exception vector offset is $0x0C$.

On Warm reset, the field reset value is architecturally UNKNOWN.

MS, bit [10]

Secure Monitor Call (SMC) vector catch enable in Monitor mode.

The exception vector offset is $0x08$.

On Warm reset, the field reset value is architecturally UNKNOWN.

Bits [9:8]

Reserved, RES0.

SF, bit [7]

FIQ vector catch enable in Secure state.

The exception vector offset is $0x1C$.

On Warm reset, the field reset value is architecturally UNKNOWN.

SI, bit [6]

IRQ vector catch enable in Secure state.

The exception vector offset is $0x18$.

On Warm reset, the field reset value is architecturally UNKNOWN.

Bit [5]

Reserved, RES0.

SD, bit [4]

Data Abort vector catch enable in Secure state.

The exception vector offset is $0x10$.

On Warm reset, the field reset value is architecturally UNKNOWN.

SP, bit [3]

Prefetch Abort vector catch enable in Secure state.

The exception vector offset is $0x0C$.

On Warm reset, the field reset value is architecturally UNKNOWN.

SS, bit [2]

Supervisor Call (SVC) vector catch enable in Secure state.

The exception vector offset is $0x08$.

On Warm reset, the field reset value is architecturally UNKNOWN.

SU, bit [1]

Undefined Instruction vector catch enable in Secure state.

The exception vector offset is $0x04$.

On Warm reset, the field reset value is architecturally UNKNOWN.

Bit [0]

Reserved, RES0.

When EL3 implemented and using AArch64:

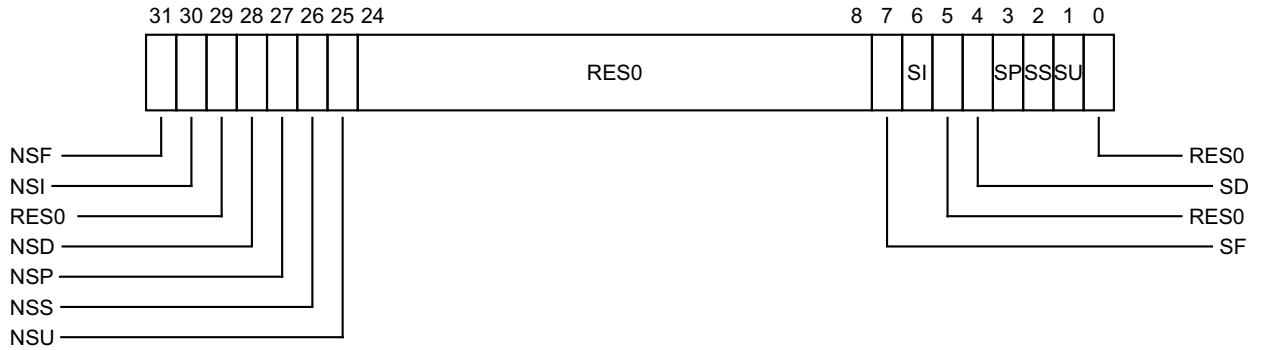

NSF, bit [31]

FIQ vector catch enable in Non-secure state.
 The exception vector offset is 0x1C.
 On Warm reset, the field reset value is architecturally UNKNOWN.

NSI, bit [30]

IRQ vector catch enable in Non-secure state.
 The exception vector offset is 0x18.
 On Warm reset, the field reset value is architecturally UNKNOWN.

Bit [29]

Reserved, RES0.

NSD, bit [28]

Data Abort vector catch enable in Non-secure state.
 The exception vector offset is 0x10.
 On Warm reset, the field reset value is architecturally UNKNOWN.

NSP, bit [27]

Prefetch Abort vector catch enable in Non-secure state.
 The exception vector offset is 0x0C.
 On Warm reset, the field reset value is architecturally UNKNOWN.

NSS, bit [26]

Supervisor Call (SVC) vector catch enable in Non-secure state.
 The exception vector offset is 0x08.
 On Warm reset, the field reset value is architecturally UNKNOWN.

NSU, bit [25]

Undefined Instruction vector catch enable in Non-secure state.
 The exception vector offset is 0x04.
 On Warm reset, the field reset value is architecturally UNKNOWN.

Bits [24:8]

Reserved, RES0.

SF, bit [7]

FIQ vector catch enable in Secure state.
The exception vector offset is 0x1C.
On Warm reset, the field reset value is architecturally UNKNOWN.

SI, bit [6]

IRQ vector catch enable in Secure state.
The exception vector offset is 0x18.
On Warm reset, the field reset value is architecturally UNKNOWN.

Bit [5]

Reserved, RES0.

SD, bit [4]

Data Abort vector catch enable in Secure state.
The exception vector offset is 0x10.
On Warm reset, the field reset value is architecturally UNKNOWN.

SP, bit [3]

Prefetch Abort vector catch enable in Secure state.
The exception vector offset is 0x0C.
On Warm reset, the field reset value is architecturally UNKNOWN.

SS, bit [2]

Supervisor Call (SVC) vector catch enable in Secure state.
The exception vector offset is 0x08.
On Warm reset, the field reset value is architecturally UNKNOWN.

SU, bit [1]

Undefined Instruction vector catch enable in Secure state.
The exception vector offset is 0x04.
On Warm reset, the field reset value is architecturally UNKNOWN.

Bit [0]

Reserved, RES0.

When EL3 not implemented:

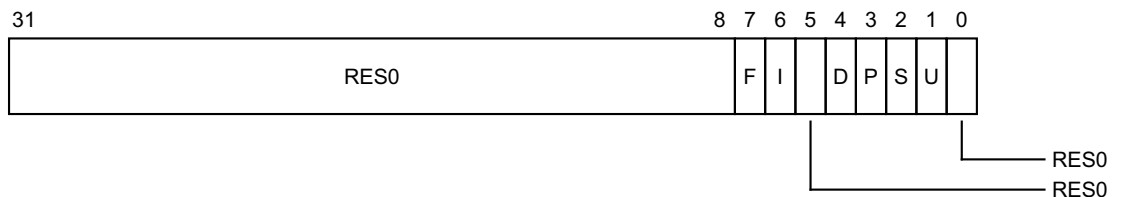

Bits [31:8]

Reserved, RES0.

F, bit [7]

FIQ vector catch enable.

The exception vector offset is 0x1C.
On Warm reset, the field reset value is architecturally UNKNOWN.

I, bit [6]

IRQ vector catch enable.
The exception vector offset is 0x18.
On Warm reset, the field reset value is architecturally UNKNOWN.

Bit [5]

Reserved, RES0.

D, bit [4]

Data Abort vector catch enable.
The exception vector offset is 0x10.
On Warm reset, the field reset value is architecturally UNKNOWN.

P, bit [3]

Prefetch Abort vector catch enable.
The exception vector offset 0x0C.
On Warm reset, the field reset value is architecturally UNKNOWN.

S, bit [2]

Supervisor Call (SVC) vector catch enable.
The exception vector offset is 0x08.
On Warm reset, the field reset value is architecturally UNKNOWN.

U, bit [1]

Undefined Instruction vector catch enable.
The exception vector offset is 0x04.
On Warm reset, the field reset value is architecturally UNKNOWN.

Bit [0]

Reserved, RES0.

Accessing the DBGVCR:

To access the DBGVCR:

MRC p14,0,<Rt>,c0,c7,0 ; Read DBGVCR into Rt
MCR p14,0,<Rt>,c0,c7,0 ; Write Rt to DBGVCR

Register access is encoded as follows:

coproc	opc1	CRn	CRm	opc2
1110	000	0000	0111	000

G4.3.26 DBGWCR<n>, Debug Watchpoint Control Registers, n = 0 - 15

The DBGWCR<n> characteristics are:

Purpose

Holds control information for a watchpoint. Forms watchpoint n together with value register [DBGWVR<n>](#), where n is 0 to 15.

This register is part of the Debug registers functional group.

Usage constraints

This register is accessible as shown below:

EL0 (NS)	EL0 (S)	EL1 (NS)	EL1 (S)	EL2	EL3 (SCR.NS=1)	EL3 (SCR.NS=0)
-	-	RW	RW	RW	RW	RW

When the E field is zero, all the other fields in the register are ignored.

Configurations

DBGWCR<n> is architecturally mapped to AArch64 register [DBGWCR<n>_EL1](#).

DBGWCR<n> is architecturally mapped to external register [DBGWCR<n>_EL1](#).

There is one instance of this register that is used in both Secure and Non-secure states.

Attributes

DBGWCR<n> is a 32-bit register.

The DBGWCR<n> bit assignments are:

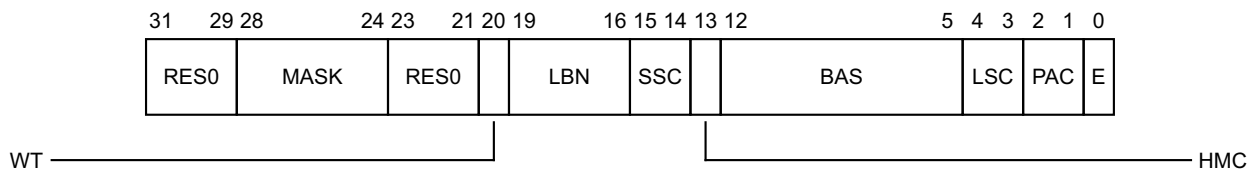

Bits [31:29]

Reserved, RES0.

MASK, bits [28:24]

Address mask. Only objects up to 2GB can be watched using a single mask.

00000 No mask.

00001 Reserved.

00010 Reserved.

Other values mask the corresponding number of address bits, from 0b00011 masking 3 address bits (0x00000007 mask for address) to 0b11111 masking 31 address bits (0x7FFFFFFF mask for address).

On Cold reset, the field reset value is architecturally UNKNOWN.

Bits [23:21]

Reserved, RES0.

WT, bit [20]

Watchpoint type. Possible values are:

0 Unlinked data address match.

1 Linked data address match.
On Cold reset, the field reset value is architecturally UNKNOWN.

LBN, bits [19:16]

Linked breakpoint number. For Linked data address watchpoints, this specifies the index of the Context-matching breakpoint linked to.
On Cold reset, the field reset value is architecturally UNKNOWN.

SSC, bits [15:14]

Security state control. Determines the security states under which a watchpoint debug event for watchpoint n is generated. This field must be interpreted along with the HMC and PAC fields.
On Cold reset, the field reset value is architecturally UNKNOWN.

HMC, bit [13]

Higher mode control. Determines the debug perspective for deciding when a watchpoint debug event for watchpoint n is generated. This field must be interpreted along with the SSC and PAC fields.
On Cold reset, the field reset value is architecturally UNKNOWN.

BAS, bits [12:5]

Byte address select. Each bit of this field selects whether a byte from within the word or double-word addressed by [DBGWVR<n>](#) is being watched.

BAS	Description
xxxxxxx1	Match byte at DBGWVR<n>
xxxxxx1x	Match byte at DBGWVR<n>+1
xxxxx1xx	Match byte at DBGWVR<n>+2
xxxx1xxx	Match byte at DBGWVR<n>+3

In cases where [DBGWVR<n>](#) addresses a double-word:

BAS	Description, if DBGWVR<n> [2] == 0
xxx1xxxx	Match byte at DBGWVR<n>+4
xx1xxxxx	Match byte at DBGWVR<n>+5
x1xxxxxx	Match byte at DBGWVR<n>+6
1xxxxxxx	Match byte at DBGWVR<n>+7

If [DBGWVR<n>](#)[2] == 1, only BAS[3:0] is used. ARM deprecates setting [DBGWVR<n>](#) == 1.
The valid values for BAS are 0b000000, or a binary number all of whose set bits are contiguous. All other values are reserved and must not be used by software.

If BAS is zero, no bytes are watched by this watchpoint.

Ignored if E is 0.

On Cold reset, the field reset value is architecturally UNKNOWN.

LSC, bits [4:3]

Load/store control. This field enables watchpoint matching on the type of access being made. Possible values of this field are:

- 01 Match instructions that load from a watchpointed address.
- 10 Match instructions that store to a watchpointed address.
- 11 Match instructions that load from or store to a watchpointed address.

All other values are reserved, but must behave as if the watchpoint is disabled. Software must not rely on this property as the behavior of reserved values might change in a future revision of the architecture.

Ignored if E is 0.

On Cold reset, the field reset value is architecturally UNKNOWN.

PAC, bits [2:1]

Privilege of access control. Determines the exception level or levels at which a watchpoint debug event for watchpoint n is generated. This field must be interpreted along with the SSC and HMC fields.

On Cold reset, the field reset value is architecturally UNKNOWN.

E, bit [0]

Enable watchpoint n. Possible values are:

- 0 Watchpoint disabled.
- 1 Watchpoint enabled.

On Cold reset, the field reset value is architecturally UNKNOWN.

Accessing the DBGWCR<n>:

To access the DBGWCR<n>:

MRC p14,0,<Rt>,c0,<CRm>,7 ; Read DBGWCR<n> into Rt, where n is in the range 0 to 15
MCR p14,0,<Rt>,c0,<CRm>,7 ; Write Rt to DBGWCR<n>, where n is in the range 0 to 15

Register access is encoded as follows:

coproc	opc1	CRn	CRm	opc2
1110	000	0000	n<3:0>	111

G4.3.27 DBGWFAR, Debug Watchpoint Fault Address Register

The DBGWFAR characteristics are:

Purpose

Previously returned information about the address of the instruction that accessed a watchpointed address. Is now deprecated and RAZ.

This register is part of the Debug registers functional group.

Usage constraints

This register is accessible as shown below:

EL0 (NS)	EL0 (S)	EL1 (NS)	EL1 (S)	EL2	EL3 (SCR.NS=1)	EL3 (SCR.NS=0)
-	-	RW	RW	RW	RW	RW

Configurations

There is one instance of this register that is used in both Secure and Non-secure states.

Attributes

DBGWFAR is a 32-bit register.

The DBGWFAR bit assignments are:

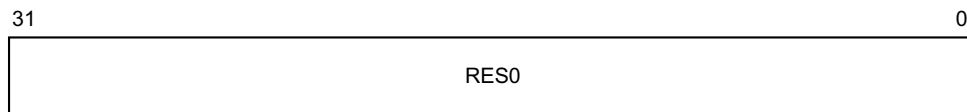

Bits [31:0]

Reserved, RES0.

Accessing the DBGWFAR:

To access the DBGWFAR:

MRC p14,0,<Rt>,c0,c6,0 ; Read DBGWFAR into Rt
MCR p14,0,<Rt>,c0,c6,0 ; Write Rt to DBGWFAR

Register access is encoded as follows:

coproc	opc1	CRn	CRm	opc2
1110	000	0000	0110	000

G4.3.28 DBGWVR<n>, Debug Watchpoint Value Registers, n = 0 - 15

The DBGWVR<n> characteristics are:

Purpose

Holds a data address value for use in watchpoint matching. Forms watchpoint n together with control register [DBGWCR<n>](#), where n is 0 to 15.

This register is part of the Debug registers functional group.

Usage constraints

This register is accessible as shown below:

EL0 (NS)	EL0 (S)	EL1 (NS)	EL1 (S)	EL2	EL3 (SCR.NS=1)	EL3 (SCR.NS=0)
-	-	RW	RW	RW	RW	RW

Configurations

DBGWVR<n> is architecturally mapped to AArch64 register [DBGWVR<n>_EL1](#)[31:0].

DBGWVR<n> is architecturally mapped to external register [DBGWVR<n>_EL1](#)[31:0].

There is one instance of this register that is used in both Secure and Non-secure states.

Attributes

DBGWVR<n> is a 32-bit register.

The DBGWVR<n> bit assignments are:

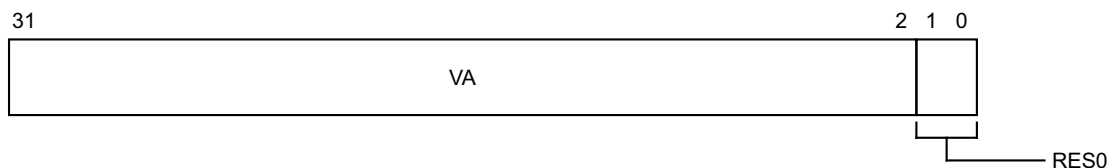

VA, bits [31:2]

Bits[31:2] of the address value for comparison.

ARM deprecates setting [DBGWVR<n>](#)[2] == 1.

On Cold reset, the field reset value is architecturally UNKNOWN.

Bits [1:0]

Reserved, RES0.

Accessing the DBGWVR<n>:

To access the DBGWVR<n>:

MRC p14,0,<Rt>,c0,<CRm>,6 ; Read DBGWVR<n> into Rt, where n is in the range 0 to 15

MCR p14,0,<Rt>,c0,<CRm>,6 ; Write Rt to DBGWVR<n>, where n is in the range 0 to 15

Register access is encoded as follows:

coproc	opc1	CRn	CRm	opc2
1110	000	0000	n<3:0>	110

G4.3.29 DLR, Debug Link Register

The DLR characteristics are:

Purpose

In Debug state, holds the address to restart from.

This register is part of:

- the Debug registers functional group
- the Special purpose registers functional group.

Usage constraints

This register is accessible as shown below:

EL0 (NS)	EL0 (S)	EL1 (NS)	EL1 (S)	EL2	EL3 (SCR.NS=1)	EL3 (SCR.NS=0)
RW	RW	RW	RW	RW	RW	RW

Access to this register is from Debug state only. During normal execution this register is UNALLOCATED.

Configurations

DLR is architecturally mapped to AArch64 register [DLR_EL0](#)[31:0].

There is one instance of this register that is used in both Secure and Non-secure states.

Attributes

DLR is a 32-bit register.

The DLR bit assignments are:

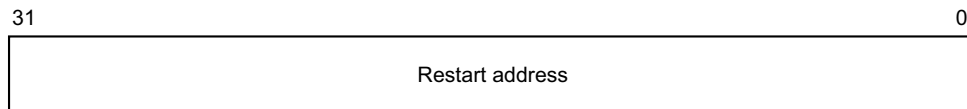

Bits [31:0]

Restart address.

Accessing the DLR:

To access the DLR:

MRC p15,3,<Rt>,c4,c5,1 ; Read DLR into Rt

MCR p15,3,<Rt>,c4,c5,1 ; Write Rt to DLR

Register access is encoded as follows:

coproc	opc1	CRn	CRm	opc2
1111	011	0100	0101	001

G4.3.30 DSPSR, Debug Saved Program Status Register

The DSPSR characteristics are:

Purpose

Holds the saved processor state on entry to Debug state.

This register is part of:

- the Debug registers functional group
- the Special purpose registers functional group.

Usage constraints

This register is accessible as shown below:

EL0 (NS)	EL0 (S)	EL1 (NS)	EL1 (S)	EL2	EL3 (SCR.NS=1)	EL3 (SCR.NS=0)
RW	RW	RW	RW	RW	RW	RW

Access to this register is from Debug state only. During normal execution this register is UNALLOCATED.

Configurations

DSPSR is architecturally mapped to AArch64 register [DSPSR_EL0](#).

There is one instance of this register that is used in both Secure and Non-secure states.

Attributes

DSPSR is a 32-bit register.

The DSPSR bit assignments are:

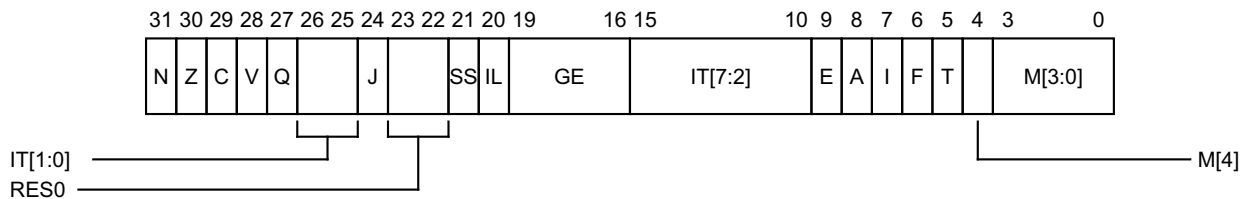

N, bit [31]

Set to the value of [CPSR.N](#) on entering Debug state, and copied to [CPSR.N](#) on exiting Debug state.

Z, bit [30]

Set to the value of [CPSR.Z](#) on entering Debug state, and copied to [CPSR.Z](#) on exiting Debug state.

C, bit [29]

Set to the value of [CPSR.C](#) on entering Debug state, and copied to [CPSR.C](#) on exiting Debug state.

V, bit [28]

Set to the value of [CPSR.V](#) on entering Debug state, and copied to [CPSR.V](#) on exiting Debug state.

Q, bit [27]

Set to the value of [CPSR.Q](#) on entering Debug state, and copied to [CPSR.Q](#) on exiting Debug state.

IT[1:0], bits [26:25]

If-Then execution state bits for the T32 IT (If-Then) instruction. See IT[7:2] for explanation of this field.

J, bit [24]

Jazelle bit. Along with the T bit, determines the AArch32 instruction set state that the Debug state entry was taken from. Possible values of this bit are:

- 0 Processor in A32 state if T is 0, or T32 state if T is 1.
- 1 Processor in an invalid state (Jazelle state before ARMv8) if T is 0, or T32EE state if T is 1.

Since the Jazelle state is obsolete in ARMv8, J==1 and T==0 is an invalid combination, and attempting to exit Debug state with those values is an illegal exception return.

If T32EE is not implemented, this bit is RES0, so the possible values of the T bit signify either A32 or T32 state.

Bits [23:22]

Reserved, RES0.

SS, bit [21]

Software step. Indicates whether software step was enabled when Debug state was entered.

IL, bit [20]

Illegal Execution State bit. Shows the value of PSTATE.IL immediately before Debug state was entered.

GE, bits [19:16]

Greater than or Equal flags, for parallel addition and subtraction.

IT[7:2], bits [15:10]

If-Then execution state bits for the T32 IT (If-Then) instruction. This field must be interpreted in two parts.

- IT[7:5] holds the base condition for the IT block. The base condition is the top 3 bits of the condition code specified by the first condition field of the IT instruction.
- IT[4:0] encodes the size of the IT block, which is the number of instructions that are to be conditionally executed, by the position of the least significant 1 in this field. It also encodes the value of the least significant bit of the condition code for each instruction in the block.

The IT field is 0b00000000 when no IT block is active.

E, bit [9]

Endianness execution state bit. Controls the load and store endianness for data accesses:

- 0 Little-endian operation
- 1 Big-endian operation.

Instruction fetches ignore this bit.

When the reset value of the SCTL.R.EE bit is defined by a configuration input signal, that value also applies to the CPSR.E bit on reset, and therefore applies to software execution from reset.

If an implementation does not provide Big-endian support, this bit is RES0. If it does not provide Little-endian support, this bit is RES1.

If an implementation provides Big-endian support but only at EL0, this bit is RES0 for an exception return to any exception level other than EL0.

Likewise, if it provides Little-endian support only at EL0, this bit is RES1 for an exception return to any exception level other than EL0.

A, bit [8]

Asynchronous data abort mask bit. The possible values of this bit are:

- 0 Exception not masked.
- 1 Exception masked.

I, bit [7]

IRQ mask bit. The possible values of this bit are:

- 0 Exception not masked.
- 1 Exception masked.

F, bit [6]

FIQ mask bit. The possible values of this bit are:

- 0 Exception not masked.
- 1 Exception masked.

T, bit [5]

Thumb execution state bit. Along with the J bit, determines the AArch32 instruction set state that the Debug state entry was taken from. Possible values of this bit are:

- 0 Processor in A32 state if J is 0, or an invalid state (Jazelle state before ARMv8) if J is 1.
- 1 Processor in T32 state if J is 0, or T32EE state if J is 1.

Since the Jazelle state is obsolete in ARMv8, J==1 and T==0 is an invalid combination, and attempting to exit Debug state with those values is an illegal exception return.

If T32EE is not implemented, the J bit is RES0, so the possible values of this bit signify either A32 or T32 state.

M[4], bit [4]

Register width that the exception was taken from. Possible values of this bit are:

- 1 Exception taken from AArch32.

M[3:0], bits [3:0]

Mode that an exception was taken from. For exceptions taken from AArch32, the possible values are:

M[3:0]	Mode
0b0000	User
0b0001	FIQ
0b0010	IRQ
0b0011	Supervisor
0b0110	Monitor (only valid in Secure state, if EL3 is implemented and can use AArch32)
0b0111	Abort
0b1010	Hyp
0b1011	Undefined
0b1111	System

Other values are reserved.

Accessing the DSPSR:

To access the DSPSR:

MRC p15,3,<Rt>,c4,c5,0 ; Read DSPSR into Rt

MCR p15,3,<Rt>,c4,c5,0 ; Write Rt to DSPSR

Register access is encoded as follows:

coproc	opc1	CRn	CRm	opc2
1111	011	0100	0101	000

G4.3.31 HDCR, Hyp Debug Control Register

The HDCR characteristics are:

Purpose

Controls the trapping to Hyp mode of Non-secure accesses, at EL1 or lower, to functions provided by the debug and trace architectures and the Performance Monitors extension.

This register is part of:

- the Debug registers functional group
- the Virtualization registers functional group.

Usage constraints

This register is accessible as shown below:

EL0 (NS)	EL0 (S)	EL1 (NS)	EL1 (S)	EL2	EL3 (SCR.NS=1)	EL3 (SCR.NS=0)
-	-	-	-	RW	RW	-

Configurations

HDCR is architecturally mapped to AArch64 register [MDCR_EL2](#).

If EL2 is not implemented, this register is RES0 from EL3.

Attributes

HDCR is a 32-bit register.

The HDCR bit assignments are:

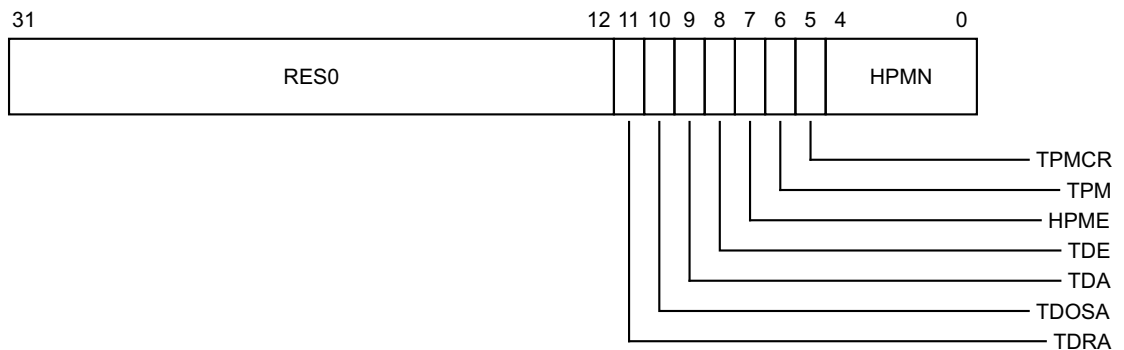

Bits [31:12]

Reserved, RES0.

TDRA, bit [11]

Trap debug ROM address register access. The possible values of this bit are:

- 0 Has no effect on accesses to debug ROM address registers from EL1 and EL0.
- 1 Trap valid Non-secure EL1 and EL0 access to debug ROM address registers to Hyp mode.

When this bit is set to 1, any valid Non-secure access to the [DBGDRAR](#) or [DBGDSAR](#) is trapped to Hyp mode.

If [HCR.TGE](#) == 1 or [HDCR.TDE](#) == 1, the behavior is CONstrained UNPREDICTABLE, and this bit is ignored and treated as though it is 1 other than for the value read back from HDCR.

On Warm reset, the field resets to 0.

TDOSA, bit [10]

Trap debug OS-related register access. The possible values of this bit are:

- 0 Has no effect on accesses to CP14 debug registers.
- 1 Trap valid Non-secure accesses to CP14 OS-related debug registers to Hyp mode.

When this bit is set to 1, any valid Non-secure CP14 access to [DBGOSLAR](#), [DBGOSLSR](#), [DBGOSDLR](#), or [DBGPRCR](#) is trapped to Hyp mode.

If [HCR.TGE](#) == 1 or [HDCR.TDE](#) == 1, then this bit is ignored and treated as though it is 1 other than for the value read back from [HDCR](#).

On Warm reset, the field resets to 0.

TDA, bit [9]

Trap debug access. The possible values of this bit are:

- 0 Has no effect on accesses to CP14 Debug registers.
- 1 Trap valid Non-secure accesses to CP14 Debug registers to Hyp mode.

When this bit is set to 1, any valid access to the CP14 Debug registers, other than the registers trapped by the [TDRA](#) and [TDOSA](#) bits, is trapped to Hyp mode.

If [HCR.TGE](#) == 1 or [HDCR.TDE](#) == 1, then this bit is ignored and treated as though it is 1 other than for the value read back from [HDCR](#).

On Warm reset, the field resets to 0.

TDE, bit [8]

Trap Debug exceptions. The possible values of this bit are:

- 0 Has no effect on Debug exceptions.
- 1 Route Non-secure Debug exceptions to Hyp mode.

When this bit is set to 1, any Debug exception taken in Non-secure state is routed to Hyp mode.

If [HCR.TGE](#) == 1, then this bit is ignored and treated as though it is 1 other than for the value read back from [HDCR](#).

On Warm reset, the field resets to 0.

HPME, bit [7]

Hypervisor Performance Monitors Enable. The possible values of this bit are:

- 0 Hyp mode Performance Monitors disabled.
- 1 Hyp mode Performance Monitors enabled.

When this bit is set to 1, the Performance Monitors counters that are reserved for use from Hyp mode or Secure state are enabled. For more information see the description of the [HPMN](#) field.

If the Performance Monitors extension is not implemented, this field is RES0.

On Warm reset, the field reset value is architecturally UNKNOWN.

TPM, bit [6]

Trap Performance Monitors accesses. The possible values of this bit are:

- 0 Has no effect on Performance Monitors accesses.
- 1 Trap valid Non-secure Performance Monitors accesses to Hyp mode.

If the Performance Monitors extension is not implemented, this field is RES0.

On Warm reset, the field resets to 0.

TPMCR, bit [5]

Trap [PMCR](#) accesses. The possible values of this bit are:

- 0 Has no effect on [PMCR](#) accesses.
- 1 Trap valid Non-secure [PMCR](#) accesses to Hyp mode.

If the Performance Monitors extension is not implemented, this field is RES0.

On Warm reset, the field resets to 0.

HPMN, bits [4:0]

Defines the number of Performance Monitors counters that are accessible from Non-secure EL1 modes, and from Non-secure EL0 modes if unprivileged access is enabled.

If the Performance Monitors extension is not implemented, this field is RES0.

In Non-secure state, HPMN divides the Performance Monitors counters as follows. If software is accessing Performance Monitors counter n then, in Non-secure state:

- If n is in the range $0 \leq n < \text{HPMN}$, the counter is accessible from EL1 and EL2, and from EL0 if unprivileged access to the counters is enabled. **PMCR.E** enables the operation of counters in this range.
- If n is in the range $\text{HPMN} \leq n < \text{PMCR.N}$, the counter is accessible only from EL2. **HDCR.HPME** enables the operation of counters in this range.

If this field is set to 0, or to a value larger than **PMCR.N**, then the behavior in Non-secure EL0 and EL1 is CONstrained UNPREDICTABLE, and one of the following must happen:

- The number of counters accessible is an UNKNOWN non-zero value less than **PMCR.N**.
- There is no access to any counters.

For reads of **HDCR.HPMN** by EL2 or higher, if this field is set to 0 or to a value larger than **PMCR.N**, the processor must return a CONstrained UNPREDICTABLE value being one of:

- **PMCR.N**.
- The value that was written to **HDCR.HPMN**.
- (The value that was written to **HDCR.HPMN**) modulo 2^h , where h is the smallest number of bits required for a value in the range 0 to **PMCR.N**.

On Warm reset, the field resets to an IMPLEMENTATION DEFINED value.

Accessing the HDCR:

To access the HDCR:

MRC p15,4,<Rt>,c1,c1,1 ; Read HDCR into Rt

MCR p15,4,<Rt>,c1,c1,1 ; Write Rt to HDCR

Register access is encoded as follows:

coproc	opc1	CRn	CRm	opc2
1111	100	0001	0001	001

G4.3.32 SDCR, Secure Debug Configuration Register

The SDCR characteristics are:

Purpose

Controls debug and performance monitors functionality in Secure state.

This register is part of:

- the Debug registers functional group
- the Security registers functional group.

Usage constraints

This register is accessible as shown below:

EL0 (NS)	EL0 (S)	EL1 (NS)	EL1 (S)	EL2	EL3 (SCR.NS=1)	EL3 (SCR.NS=0)
-	-	-	RW	-	RW	RW

If EL3 is implemented and is using AArch64, any read or write to SDCR in Secure EL1 state in AArch32 is trapped as an exception to EL3.

Configurations

SDCR can be mapped to AArch64 register [MDCR_EL3](#), but this is not architecturally mandated.

This register is only accessible in Secure state.

Attributes

SDCR is a 32-bit register.

The SDCR bit assignments are:

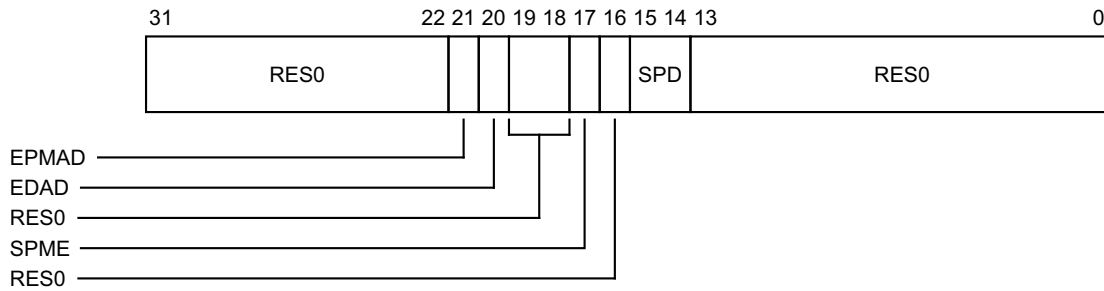

Bits [31:22]

Reserved, RES0.

EPMAD, bit [21]

External debugger access to Performance Monitors registers disabled. This disables access to these registers by an external debugger:

- 0 Access to Performance Monitors registers from external debugger is permitted.
- 1 Access to Performance Monitors registers from external debugger is disabled, unless overridden by authentication interface.

On Warm reset, the field resets to 0.

EDAD, bit [20]

External debugger access to breakpoint and watchpoint registers disabled. This disables access to these registers by an external debugger:

- 0 Access to breakpoint and watchpoint registers from external debugger is permitted.
- 1 Access to breakpoint and watchpoint registers from external debugger is disabled, unless overridden by authentication interface.

On Warm reset, the field resets to 0.

Bits [19:18]

Reserved, RES0.

SPME, bit [17]

Secure performance monitors enable. This allows event counting in Secure state:

- 0 Event counting prohibited in Secure state, unless overridden by the authentication interface.
- 1 Event counting allowed in Secure state.

On Warm reset, the field resets to 0.

Bit [16]

Reserved, RES0.

SPD, bits [15:14]

AArch32 secure privileged debug. Enables or disables debug exceptions from Secure state, other than Software breakpoint instructions. Valid values for this field are:

- 00 Legacy mode. Debug exceptions from Secure EL1 are enabled by the authentication interface.
- 10 Secure privileged debug disabled. Debug exceptions from Secure EL1 are disabled.
- 11 Secure privileged debug enabled. Debug exceptions from Secure EL1 are enabled.

Other values are reserved.

If debug exceptions from Secure EL1 are enabled, then debug exceptions from Secure EL0 are also enabled.

Otherwise, debug exceptions from Secure EL0 are enabled only if `SDER32_EL3.SUIDEN == 1`.

Ignored in Non-secure state. Debug exceptions from Software breakpoint instruction debug events are always enabled.

On Warm reset, the field resets to 0.

Bits [13:0]

Reserved, RES0.

Accessing the SDCR:

To access the SDCR:

MRC p15,0,<Rt>,c1,c3,1 ; Read SDCR into Rt

MCR p15,0,<Rt>,c1,c3,1 ; Write Rt to SDCR

Register access is encoded as follows:

coproc	opc1	CRn	CRm	opc2
1111	000	0001	0011	001

G4.3.33 SDER, Secure Debug Enable Register

The SDER characteristics are:

Purpose

Controls invasive and non-invasive debug in the Secure EL0 mode.

This register is part of:

- the Debug registers functional group
- the Security registers functional group.

Usage constraints

This register is accessible as shown below:

EL0 (NS)	EL0 (S)	EL1 (NS)	EL1 (S)	EL2	EL3 (SCR.NS=1)	EL3 (SCR.NS=0)
-	-	-	RW	-	RW	RW

Configurations

SDER is architecturally mapped to AArch64 register [SDER32_EL3](#).

This register is only accessible in Secure state.

If EL3 is not implemented and EL1 supports AArch32, SDER is implemented only if the processor is Secure.

Attributes

SDER is a 32-bit register.

The SDER bit assignments are:

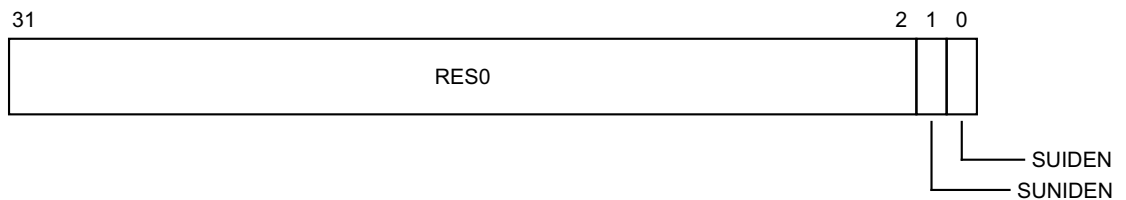

Bits [31:2]

Reserved, RES0.

SUNIDEN, bit [1]

Secure User Non-Invasive Debug Enable:

- 0 Non-invasive debug not permitted in Secure EL0 mode.
- 1 Non-invasive debug permitted in Secure EL0 mode.

On Warm reset, the field resets to 0.

SUIDEN, bit [0]

Secure User Invasive Debug Enable:

- 0 Invasive debug not permitted in Secure EL0 mode.
- 1 Invasive debug permitted in Secure EL0 mode.

On Warm reset, the field resets to 0.

Accessing the SDER:

To access the SDER:

MRC p15,0,<Rt>,c1,c1,1 ; Read SDER into Rt
MCR p15,0,<Rt>,c1,c1,1 ; Write Rt to SDER

Register access is encoded as follows:

coproc	opc1	CRn	CRm	opc2
1111	000	0001	0001	001

G4.4 Performance Monitors registers

This section describes the Performance Monitors registers in AArch32 state.

G4.4.1 PMCCFILTR, Performance Monitors Cycle Count Filter Register

The PMCCFILTR characteristics are:

Purpose

Determines the modes in which the Cycle Counter, [PMCCNTR](#), increments.
 This register is part of the Performance Monitors registers functional group.

Usage constraints

This register is accessible as shown below:

EL0 (NS)	EL0 (S)	EL1 (NS)	EL1 (S)	EL2	EL3 (SCR.NS=1)	EL3 (SCR.NS=0)
Config-RW	Config-RW	RW	RW	RW	RW	RW

This register is accessible at EL0 when [PMUSERENR.EN](#) is set to 1.

PMCCFILTR can also be accessed by using [PMXEVTYPER](#) with [PMSELR.SEL](#) set to 0b11111.

Configurations

PMCCFILTR is architecturally mapped to AArch64 register [PMCCFILTR_EL0](#).

PMCCFILTR is architecturally mapped to external register [PMCCFILTR_EL0](#).

There is one instance of this register that is used in both Secure and Non-secure states.

Attributes

PMCCFILTR is a 32-bit register.

The PMCCFILTR bit assignments are:

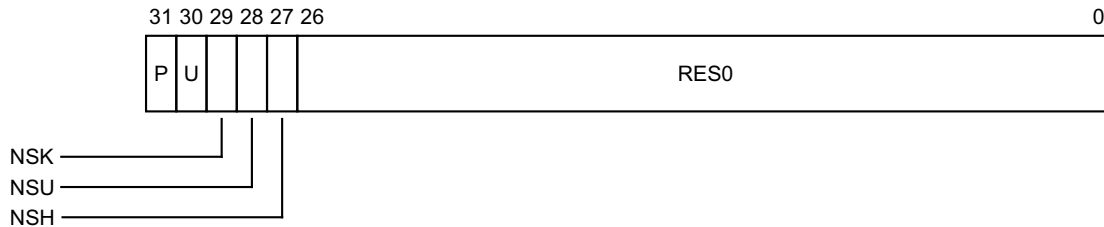

P, bit [31]

EL1 modes filtering bit. Controls counting in EL1. If EL3 is implemented, then counting in Non-secure EL1 is further controlled by the NSK bit. The possible values of this bit are:

- 0 Count cycles in EL1.
- 1 Do not count cycles in EL1.

On Warm reset, the field resets to 0.

U, bit [30]

ELO filtering bit. Controls counting in EL0. If EL3 is implemented, then counting in Non-secure EL0 is further controlled by the NSU bit. The possible values of this bit are:

- 0 Count cycles in EL0.
- 1 Do not count cycles in EL0.

On Warm reset, the field resets to 0.

NSK, bit [29]

Non-secure kernel modes filtering bit. Controls counting in Non-secure EL1. If EL3 is not implemented, this bit is RES0.

If the value of this bit is equal to the value of P, cycles in Non-secure EL1 are counted.

Otherwise, cycles in Non-secure EL1 are not counted.

On Warm reset, the field resets to 0.

NSU, bit [28]

Non-secure user modes filtering bit. Controls counting in Non-secure EL0. If EL3 is not implemented, this bit is RES0.

If the value of this bit is equal to the value of U, cycles in Non-secure EL0 are counted.

Otherwise, cycles in Non-secure EL0 are not counted.

On Warm reset, the field resets to 0.

NSH, bit [27]

Non-secure Hyp modes filtering bit. Controls counting in Non-secure EL2. If EL2 is not implemented, this bit is RES0.

- 0 Do not count cycles in EL2.
- 1 Count cycles in EL2.

On Warm reset, the field resets to 0.

Bits [26:0]

Reserved, RES0.

Accessing the PMCCFILTR:

To access the PMCCFILTR:

MRC p15,0,<Rt>,c14,c15,7 ; Read PMCCFILTR into Rt
 MCR p15,0,<Rt>,c14,c15,7 ; Write Rt to PMCCFILTR

Register access is encoded as follows:

coproc	opc1	CRn	CRm	opc2
1111	000	1110	1111	111

G4.4.2 PMCCNTR, Performance Monitors Cycle Count Register

The PMCCNTR characteristics are:

Purpose

Holds the value of the processor Cycle Counter, CCNT, that counts processor clock cycles.
 This register is part of the Performance Monitors registers functional group.

Usage constraints

This register is accessible as shown below:

EL0 (NS)	EL0 (S)	EL1 (NS)	EL1 (S)	EL2	EL3 (SCR.NS=1)	EL3 (SCR.NS=0)
Config-RW	Config-RW	RW	RW	RW	RW	RW

This register is accessible at EL0 when [PMUSERENR.EN](#) or [PMUSERENR.CR](#) is set to 1.

The [PMCR.{LC, D}](#) bits configure whether PMCCNTR increments every clock cycle, or once every 64 clock cycles.

[PMCCFILTR](#) determines the modes and states in which the PMCCNTR can increment.

Configurations

PMCCNTR is architecturally mapped to AArch64 register [PMCCNTR_ELO](#) when accessing as a 64-bit register.

PMCCNTR is architecturally mapped to external register [PMCCNTR_ELO](#).

PMCCNTR is architecturally mapped to AArch64 register [PMCCNTR_ELO\[31:0\]](#).

There is one instance of this register that is used in both Secure and Non-secure states.

All counters are subject to any changes in clock frequency, including clock stopping caused by the WFI and WFE instructions. This means that it is **CONSTRAINED UNPREDICTABLE** whether or not PMCCNTR continues to increment when clocks are stopped by WFI and WFE instructions.

Attributes

PMCCNTR is a 32-bit register when accessing as a 32-bit register and a 64-bit register when accessing as a 64-bit register.

The PMCCNTR bit assignments are:

When accessing as a 32-bit register:

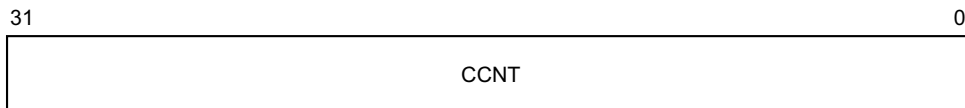

CCNT, bits [31:0]

Cycle count. Depending on the values of [PMCR.{LC,D}](#), this field increments in one of the following ways:

- Every processor clock cycle.
- Every 64th processor clock cycle.

This field can be reset to zero by writing 1 to [PMCR.C](#).

On Warm reset, the field reset value is architecturally UNKNOWN.

When accessing as a 64-bit register:

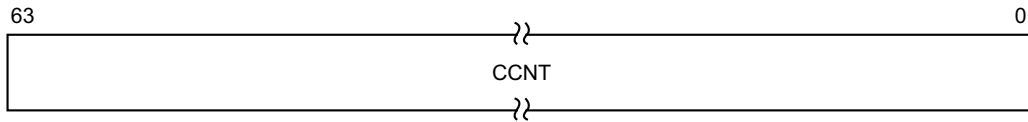

CCNT, bits [63:0]

Cycle count. Depending on the values of **PMCR**.{LC,D}, this field increments in one of the following ways:

- Every processor clock cycle.
- Every 64th processor clock cycle.

This field can be reset to zero by writing 1 to **PMCR.C**.

On Warm reset, the field reset value is architecturally UNKNOWN.

Accessing the PMCCNTR:

To access the PMCCNTR when accessing as a 32-bit register:

MRC p15,0,<Rt>,c9,c13,0 ; Read PMCCNTR into Rt
 MCR p15,0,<Rt>,c9,c13,0 ; Write Rt to PMCCNTR

Register access is encoded as follows:

coproc	opc1	CRn	CRm	opc2
1111	000	1001	1101	000

To access the PMCCNTR when accessing as a 64-bit register:

MRRC p15,0,<Rt>,<Rt2>,c9 ; Read 64-bit PMCCNTR into Rt (low word) and Rt2 (high word)
 MCRR p15,0,<Rt>,<Rt2>,c9 ; Write Rt (low word) and Rt2 (high word) to 64-bit PMCCNTR

Register access is encoded as follows:

coproc	opc1	CRm
1111	0000	1001

G4.4.3 PMCEID0, Performance Monitors Common Event Identification register 0

The PMCEID0 characteristics are:

Purpose

Defines which common architectural and common microarchitectural feature events are implemented. If a particular bit is set to 1, then the event for that bit is implemented.

This register is part of the Performance Monitors registers functional group.

Usage constraints

This register is accessible as shown below:

EL0 (NS)	EL0 (S)	EL1 (NS)	EL1 (S)	EL2	EL3 (SCR.NS=1)	EL3 (SCR.NS=0)
Config-RO	Config-RO	RO	RO	RO	RO	RO

This register is accessible at EL0 when [PMUSERENR.EN](#) is set to 1.

Configurations

PMCEID0 is architecturally mapped to AArch64 register [PMCEID0_EL0](#).

PMCEID0 is architecturally mapped to external register [PMCEID0_EL0](#).

There is one instance of this register that is used in both Secure and Non-secure states.

Attributes

PMCEID0 is a 32-bit register.

The PMCEID0 bit assignments are:

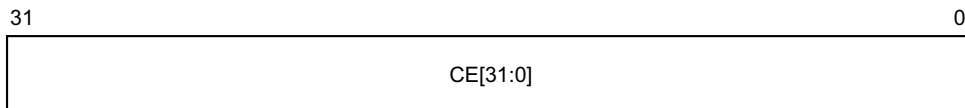

CE[31:0], bits [31:0]

Common architectural and microarchitectural feature events that can be counted by the PMU event counters.

For each bit described in the following table, the event is implemented if the bit is set to 1, or not implemented if the bit is set to 0.

Bit	Event number	Event mnemonic
31	0x01F	L1D_CACHE_ALLOCATE
30	0x01E	CHAIN
29	0x01D	BUS_CYCLES
28	0x01C	TTBR_WRITE_RETIRED
27	0x01B	INST_SPEC
26	0x01A	MEMORY_ERROR
25	0x019	BUS_ACCESS
24	0x018	L2D_CACHE_WB

Bit	Event number	Event mnemonic
23	0x017	L2D_CACHE_REFILL
22	0x016	L2D_CACHE
21	0x015	L1D_CACHE_WB
20	0x014	L1I_CACHE
19	0x013	MEM_ACCESS
18	0x012	BR_PRED
17	0x011	CPU_CYCLES
16	0x010	BR_MIS_PRED
15	0x00F	UNALIGNED_LDST_RETIRED
14	0x00E	BR_RETURN_RETIRED
13	0x00D	BR_IMMED_RETIRED
12	0x00C	PC_WRITE_RETIRED
11	0x00B	CID_WRITE_RETIRED
10	0x00A	EXC_RETURN
9	0x009	EXC_TAKEN
8	0x008	INST_RETIRED
7	0x007	ST_RETIRED
6	0x006	LD_RETIRED
5	0x005	L1D_TLB_REFILL
4	0x004	L1D_CACHE
3	0x003	L1D_CACHE_REFILL
2	0x002	L1I_TLB_REFILL
1	0x001	L1I_CACHE_REFILL
0	0x000	SW_INCR

Accessing the PMCEID0:

To access the PMCEID0:

MRC p15,0,<Rt>,c9,c12,6 ; Read PMCEID0 into Rt

Register access is encoded as follows:

coproc	opc1	CRn	CRm	opc2
1111	000	1001	1100	110

G4.4.4 PMCEID1, Performance Monitors Common Event Identification register 1

The PMCEID1 characteristics are:

Purpose

Reserved for future indication of which common architectural and common microarchitectural feature events are implemented.

This register is part of the Performance Monitors registers functional group.

Usage constraints

This register is accessible as shown below:

EL0 (NS)	EL0 (S)	EL1 (NS)	EL1 (S)	EL2	EL3 (SCR.NS=1)	EL3 (SCR.NS=0)
Config-RO	Config-RO	RO	RO	RO	RO	RO

This register is accessible at EL0 when [PMUSERENR.EN](#) is set to 1.

Configurations

PMCEID1 is architecturally mapped to AArch64 register [PMCEID1_EL0](#).

PMCEID1 is architecturally mapped to external register [PMCEID1_EL0](#).

There is one instance of this register that is used in both Secure and Non-secure states.

Attributes

PMCEID1 is a 32-bit register.

The PMCEID1 bit assignments are:

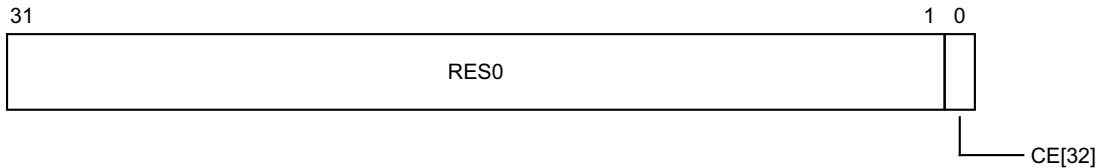

Bits [31:1]

Reserved, RES0.

CE[32], bit [0]

Common architectural and microarchitectural feature events that can be counted by the PMU event counters.

For the bit described in the following table, the event is implemented if the bit is set to 1, or not implemented if the bit is set to 0.

Bit	Event number	Event mnemonic
0	0x020	L2D_CACHE_ALLOCATE

Accessing the PMCEID1:

To access the PMCEID1:

MRC p15,0,<Rt>,c9,c12,7 ; Read PMCEID1 into Rt

Register access is encoded as follows:

coproc	opc1	CRn	CRm	opc2
1111	000	1001	1100	111

G4.4.5 PMCNTENCLR, Performance Monitors Count Enable Clear register

The PMCNTENCLR characteristics are:

Purpose

Disables the Cycle Count Register, [PMCCNTR](#), and any implemented event counters [PMEVCNTR<x>](#). Reading this register shows which counters are enabled.

This register is part of the Performance Monitors registers functional group.

Usage constraints

This register is accessible as shown below:

EL0 (NS)	EL0 (S)	EL1 (NS)	EL1 (S)	EL2	EL3 (SCR.NS=1)	EL3 (SCR.NS=0)
Config-RW	Config-RW	RW	RW	RW	RW	RW

This register is accessible at EL0 when [PMUSERENR.EN](#) is set to 1.

If EL2 is implemented, in Non-secure EL1 and EL0 modes, the value of [HDCR.HPMN](#) can change the behavior of accesses to PMCNTENCLR. See the description of the Px bit.

PMCNTENCLR is used in conjunction with the [PMCNTENSET](#) register.

Configurations

PMCNTENCLR is architecturally mapped to AArch64 register [PMCNTENCLR_EL0](#).

PMCNTENCLR is architecturally mapped to external register [PMCNTENCLR_EL0](#).

There is one instance of this register that is used in both Secure and Non-secure states.

Attributes

PMCNTENCLR is a 32-bit register.

The PMCNTENCLR bit assignments are:

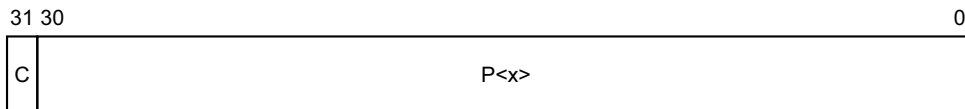

C, bit [31]

[PMCCNTR](#) disable bit. Disables the cycle counter register. Possible values are:

- 0 When read, means the cycle counter is disabled. When written, has no effect.
- 1 When read, means the cycle counter is enabled. When written, disables the cycle counter.

On Warm reset, the field reset value is architecturally UNKNOWN.

P<x>, bit [x] for x = 0 to (N - 1)

Event counter disable bit for [PMEVCNTR<x>](#).

When EL2 is implemented, in Non-secure EL1 and EL0, N is the value in [HDCR.HPMN](#). Otherwise, N is the value in [PMCR.N](#).

Bits [30:N] are RAZ/WI.

Possible values of each bit are:

- 0 When read, means that [PMEVCNTR<x>](#) is disabled. When written, has no effect.
- 1 When read, means that [PMEVCNTR<x>](#) is enabled. When written, disables [PMEVCNTR<x>](#).

On Warm reset, the field reset value is architecturally UNKNOWN.

Accessing the PMCNTENCLR:

To access the PMCNTENCLR:

MRC p15,0,<Rt>,c9,c12,2 ; Read PMCNTENCLR into Rt

MCR p15,0,<Rt>,c9,c12,2 ; Write Rt to PMCNTENCLR

Register access is encoded as follows:

coproc	opc1	CRn	CRm	opc2
1111	000	1001	1100	010

G4.4.6 PMCNTENSET, Performance Monitors Count Enable Set register

The PMCNTENSET characteristics are:

Purpose

Enables the Cycle Count Register, [PMCCNTR](#), and any implemented event counters [PMEVCNTR<x>](#). Reading this register shows which counters are enabled.

This register is part of the Performance Monitors registers functional group.

Usage constraints

This register is accessible as shown below:

EL0 (NS)	EL0 (S)	EL1 (NS)	EL1 (S)	EL2	EL3 (SCR.NS=1)	EL3 (SCR.NS=0)
Config-RW	Config-RW	RW	RW	RW	RW	RW

This register is accessible at EL0 when [PMUSERENR.EN](#) is set to 1.

If EL2 is implemented, in Non-secure EL1 and EL0 modes, the value of [HDCR.HPMN](#) can change the behavior of accesses to PMCNTENSET. See the description of the Px bit.

PMCNTENSET is used in conjunction with the [PMCNTENCLR](#) register.

Configurations

PMCNTENSET is architecturally mapped to AArch64 register [PMCNTENSET_ELO](#).

PMCNTENSET is architecturally mapped to external register [PMCNTENSET_ELO](#).

There is one instance of this register that is used in both Secure and Non-secure states.

Attributes

PMCNTENSET is a 32-bit register.

The PMCNTENSET bit assignments are:

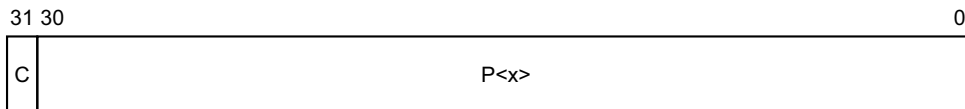

C, bit [31]

[PMCCNTR](#) enable bit. Enables the cycle counter register. Possible values are:

- 0 When read, means the cycle counter is disabled. When written, has no effect.
- 1 When read, means the cycle counter is enabled. When written, enables the cycle counter.

On Warm reset, the field reset value is architecturally UNKNOWN.

P<x>, bit [x] for x = 0 to (N - 1)

Event counter enable bit for [PMEVCNTR<x>](#).

When EL2 is implemented, in Non-secure EL1 and EL0, N is the value in [HDCR.HPMN](#). Otherwise, N is the value in [PMCR.N](#).

Bits [30:N] are RAZ/WI.

Possible values of each bit are:

- 0 When read, means that [PMEVCNTR<x>](#) is disabled. When written, has no effect.
- 1 When read, means that [PMEVCNTR<x>](#) event counter is enabled. When written, enables [PMEVCNTR<x>](#).

On Warm reset, the field reset value is architecturally UNKNOWN.

Accessing the PMCNTENSET:

To access the PMCNTENSET:

MRC p15,0,<Rt>,c9,c12,1 ; Read PMCNTENSET into Rt

MCR p15,0,<Rt>,c9,c12,1 ; Write Rt to PMCNTENSET

Register access is encoded as follows:

coproc	opc1	CRn	CRm	opc2
1111	000	1001	1100	001

G4.4.7 PMCR, Performance Monitors Control Register

The PMCR characteristics are:

Purpose

Provides details of the Performance Monitors implementation, including the number of counters implemented, and configures and controls the counters.

This register is part of the Performance Monitors registers functional group.

Usage constraints

This register is accessible as shown below:

EL0 (NS)	EL0 (S)	EL1 (NS)	EL1 (S)	EL2	EL3 (SCR.NS=1)	EL3 (SCR.NS=0)
Config-RW	Config-RW	RW	RW	RW	RW	RW

This register is accessible at EL0 when [PMUSERENR.EN](#) is set to 1.

Configurations

PMCR is architecturally mapped to AArch64 register [PMCR_EL0](#).

PMCR is architecturally mapped to external register [PMCR_EL0](#).

There is one instance of this register that is used in both Secure and Non-secure states.

Attributes

PMCR is a 32-bit register.

The PMCR bit assignments are:

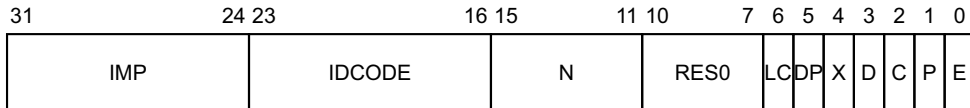

IMP, bits [31:24]

Implementer code. This field is RO with an IMPLEMENTATION DEFINED value.

The implementer codes are allocated by ARM. Values have the same interpretation as bits [31:24] of the [MIDR](#).

IDCODE, bits [23:16]

Identification code. This field is RO with an IMPLEMENTATION DEFINED value.

Each implementer must maintain a list of identification codes that is specific to the implementer. A specific implementation is identified by the combination of the implementer code and the identification code.

N, bits [15:11]

Number of event counters. This field is RO with an IMPLEMENTATION DEFINED value that indicates the number of counters implemented.

The value of this field is the number of counters implemented, from 0b000000 for no counters to 0b11111 for 31 counters.

An implementation can implement only the Cycle Count Register, [PMCCNTR](#). This is indicated by a value of 0b000000 for the N field.

Bits [10:7]

Reserved, RES0.

LC, bit [6]

Long cycle counter enable. Determines which **PMCCNTR** bit generates an overflow recorded by **PMOVSr**[31].

0 Cycle counter overflow on increment that changes **PMCCNTR**[31] from 1 to 0.

1 Cycle counter overflow on increment that changes **PMCCNTR**[63] from 1 to 0.

ARM deprecates use of **PMCR.LC** = 0.

On Warm reset, the field reset value is architecturally UNKNOWN.

DP, bit [5]

Disable cycle counter when event counting is prohibited. The possible values of this bit are:

0 **PMCCNTR**, if enabled, counts when event counting is prohibited.

1 **PMCCNTR** does not count when event counting is prohibited.

Event counting is prohibited when `ProfilingProhibited(IsSecure(),PSTATE.EL) == TRUE`.

This bit is RW.

On Warm reset, the field resets to 0.

X, bit [4]

Enable export of events in an IMPLEMENTATION DEFINED event stream. The possible values of this bit are:

0 Do not export events.

1 Export events where not prohibited.

This bit is used to permit events to be exported to another debug device, such as an OPTIONAL trace extension, over an event bus. If the implementation does not include such an event bus, this bit is RAZ/WI.

This bit does not affect the generation of Performance Monitors overflow interrupt requests or signaling to a cross-trigger interface (CTI) that can be implemented as signals exported from the processor.

If the implementation does not include an exported event stream, this bit is RAZ/WI. Otherwise this bit is RW.

On Warm reset, the field resets to 0.

D, bit [3]

Clock divider. The possible values of this bit are:

0 When enabled, **PMCCNTR** counts every clock cycle.

1 When enabled, **PMCCNTR** counts once every 64 clock cycles.

This bit is RW.

If **PMCR.LC** == 1, this bit is ignored and the cycle counter counts every clock cycle.

ARM deprecates use of **PMCR.D** = 1.

On Warm reset, the field resets to 0.

C, bit [2]

Cycle counter reset. This bit is WO. The effects of writing to this bit are:

0 No action.

1 Reset **PMCCNTR** to zero.

This bit is always RAZ.

Resetting **PMCCNTR** does not clear the **PMCCNTR** overflow bit to 0.

On Warm reset, the field reset value is architecturally UNKNOWN.

P, bit [1]

Event counter reset. This bit is WO. The effects of writing to this bit are:

0 No action.

1 Reset all event counters accessible in the current EL, not including [PMCCNTR](#), to zero.

This bit is always RAZ.

In Non-secure EL0 and EL1, if EL2 is implemented, a write of 1 to this bit does not reset event counters that [HDCR](#).HPMN reserves for EL2 use.

In EL2 and EL3, a write of 1 to this bit resets all the event counters.

Resetting the event counters does not clear any overflow bits to 0.

On Warm reset, the field reset value is architecturally UNKNOWN.

E, bit [0]

Enable. The possible values of this bit are:

0 All counters, including [PMCCNTR](#), are disabled.

1 All counters are enabled by [PMCNTENSET](#).

This bit is RW.

In Non-secure EL0 and EL1, if EL2 is implemented, this bit does not affect the operation of event counters that [HDCR](#).HPMN reserves for EL2 use.

On Warm reset, the field resets to 0.

Accessing the PMCR:

To access the PMCR:

MCR p15,0,<Rt>,c9,c12,0 ; Read PMCR into Rt

MCR p15,0,<Rt>,c9,c12,0 ; Write Rt to PMCR

Register access is encoded as follows:

coproc	opc1	CRn	CRm	opc2
1111	000	1001	1100	000

G4.4.8 PMEVCNTR<n>, Performance Monitors Event Count Registers, n = 0 - 30

The PMEVCNTR<n> characteristics are:

Purpose

Holds event counter n, which counts events, where n is 0 to 30.

This register is part of the Performance Monitors registers functional group.

Usage constraints

This register is accessible as shown below:

EL0 (NS)	EL0 (S)	EL1 (NS)	EL1 (S)	EL2	EL3 (SCR.NS=1)	EL3 (SCR.NS=0)
Config-RW	Config-RW	RW	RW	RW	RW	RW

This register can be read at EL0 when **PMUSERENR**.EN or **PMUSERENR**.ER is set to 1, and can be written at EL0 when **PMUSERENR**.ER is set to 1.

PMEVCNTR<n> can also be accessed by using **PMXVCNTR** with **PMSELR**.SEL set to n.

If <n> is greater than the number of counters available in the current Exception level and state, reads and writes of PMEVCNTR<n> are CONstrained UNPREDICTABLE, and must behave as one of the following:

- UNALLOCATED.
- RAZ/WI.
- No-op.

Configurations

PMEVCNTR<n> is architecturally mapped to AArch64 register **PMEVCNTR<n>_EL0**.

PMEVCNTR<n> is architecturally mapped to external register **PMEVCNTR<n>_EL0**.

There is one instance of this register that is used in both Secure and Non-secure states.

Attributes

PMEVCNTR<n> is a 32-bit register.

The PMEVCNTR<n> bit assignments are:

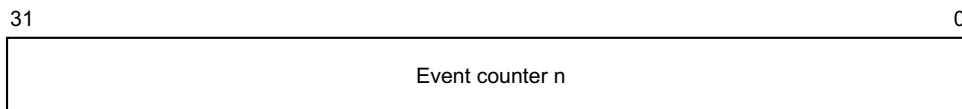

Bits [31:0]

Event counter n. Value of event counter n, where n is the number of this register and is a number from 0 to 30.

On Warm reset, the field reset value is architecturally UNKNOWN.

Accessing the PMEVCNTR<n>:

To access the PMEVCNTR<n>:

MRC p15,0,<Rt>,c14,<CRm>,<opc2> ; Read PMEVCNTR<n> into Rt, where n is in the range 0 to 30
MCR p15,0,<Rt>,c14,<CRm>,<opc2> ; Write Rt to PMEVCNTR<n>, where n is in the range 0 to 30

Register access is encoded as follows:

coproc	opc1	CRn	CRm	opc2
1111	000	1110	10:n<4:3>	n<2:0>

G4.4.9 PMEVTYPER<n>, Performance Monitors Event Type Registers, n = 0 - 30

The PMEVTYPER<n> characteristics are:

Purpose

Configures event counter n, where n is 0 to 30.

This register is part of the Performance Monitors registers functional group.

Usage constraints

This register is accessible as shown below:

EL0 (NS)	EL0 (S)	EL1 (NS)	EL1 (S)	EL2	EL3 (SCR.NS=1)	EL3 (SCR.NS=0)
Config-RW	Config-RW	RW	RW	RW	RW	RW

This register is accessible at EL0 when [PMUSERENR.EN](#) is set to 1.

PMEVTYPER<n> can also be accessed by using [PMXEVTYPER](#) with [PMSELR.SEL](#) set to n.

If <n> is greater than the number of counters available in the current Exception level and state, reads and writes of PMEVTYPER<n> are CONstrained UNPREDICTABLE, and must behave as one of the following:

- UNALLOCATED.
- RAZ/WI.
- No-op.

Configurations

PMEVTYPER<n> is architecturally mapped to AArch64 register [PMEVTYPER<n>_EL0](#).

PMEVTYPER<n> is architecturally mapped to external register [PMEVTYPER<n>_EL0](#).

There is one instance of this register that is used in both Secure and Non-secure states.

Attributes

PMEVTYPER<n> is a 32-bit register.

The PMEVTYPER<n> bit assignments are:

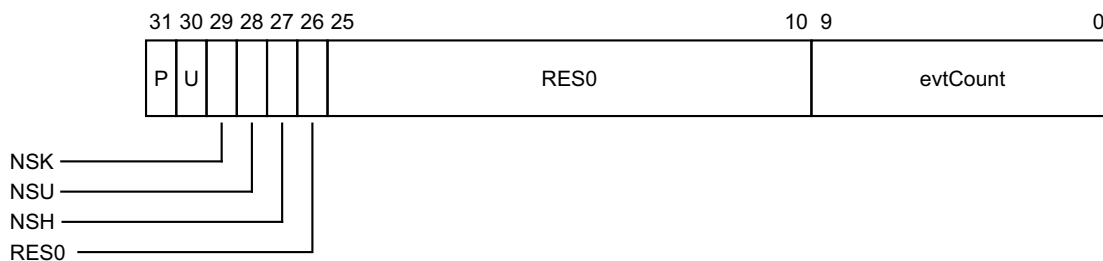

P, bit [31]

EL1 modes filtering bit. Controls counting in EL1. If EL3 is implemented, then counting in Non-secure EL1 is further controlled by the NSK bit. The possible values of this bit are:

- 0 Count events in EL1.
- 1 Do not count events in EL1.

On Warm reset, the field reset value is architecturally UNKNOWN.

U, bit [30]

EL0 filtering bit. Controls counting in EL0. If EL3 is implemented, then counting in Non-secure EL0 is further controlled by the NSU bit. The possible values of this bit are:

- 0 Count events in EL0.
- 1 Do not count events in EL0.

On Warm reset, the field reset value is architecturally UNKNOWN.

NSK, bit [29]

Non-secure kernel modes filtering bit. Controls counting in Non-secure EL1. If EL3 is not implemented, this bit is RES0.

If the value of this bit is equal to the value of P, events in Non-secure EL1 are counted.

Otherwise, events in Non-secure EL1 are not counted.

On Warm reset, the field reset value is architecturally UNKNOWN.

NSU, bit [28]

Non-secure user modes filtering bit. Controls counting in Non-secure EL0. If EL3 is not implemented, this bit is RES0.

If the value of this bit is equal to the value of U, events in Non-secure EL0 are counted.

Otherwise, events in Non-secure EL0 are not counted.

On Warm reset, the field reset value is architecturally UNKNOWN.

NSH, bit [27]

Non-secure Hyp modes filtering bit. Controls counting in Non-secure EL2. If EL2 is not implemented, this bit is RES0.

- 0 Do not count events in EL2.
- 1 Count events in EL2.

On Warm reset, the field reset value is architecturally UNKNOWN.

Bit [26]

Reserved, RES0.

Bits [25:10]

Reserved, RES0.

evtCount, bits [9:0]

Event to count. The event number of the event that is counted by event counter `PMEVCNTR<n>`. Software must program this field with an event defined by the processor or a common event defined by the architecture.

If evtCount is programmed to an event that is reserved or not implemented, the behavior depends on the event type.

For common architectural and microarchitectural events:

- No events are counted.
- The value read back on evtCount is the value written.

For IMPLEMENTATION DEFINED events:

- It is UNPREDICTABLE what event, if any, is counted. UNPREDICTABLE in this case means the event must not expose privileged information.
- The value read back on evtCount is an UNKNOWN value with the same effect.

ARM recommends that the behavior across a family of implementations is defined such that if a given implementation does not include an event from a set of common IMPLEMENTATION DEFINED events, then no event is counted and the value read back on evtCount is the value written.

On Warm reset, the field reset value is architecturally UNKNOWN.

Accessing the PMEVTYPER<n>:

To access the PMEVTYPER<n>:

MRC p15,0,<Rt>,c14,<CRm>,<opc2> ; Read PMEVTYPER<n> into Rt, where n is in the range 0 to 30
MCR p15,0,<Rt>,c14,<CRm>,<opc2> ; Write Rt to PMEVTYPER<n>, where n is in the range 0 to 30

Register access is encoded as follows:

coproc	opc1	CRn	CRm	opc2
1111	000	1110	11:n<4:3>	n<2:0>

G4.4.10 PMINTENCLR, Performance Monitors Interrupt Enable Clear register

The PMINTENCLR characteristics are:

Purpose

Disables the generation of interrupt requests on overflows from the Cycle Count Register, [PMCCNTR](#), and the event counters [PMEVCNTR<n>](#). Reading the register shows which overflow interrupt requests are enabled.

This register is part of the Performance Monitors registers functional group.

Usage constraints

This register is accessible as shown below:

EL0 (NS)	EL0 (S)	EL1 (NS)	EL1 (S)	EL2	EL3 (SCR.NS=1)	EL3 (SCR.NS=0)
-	-	RW	RW	RW	RW	RW

If EL2 is implemented, in Non-secure EL1 and EL0 modes, the value of [HDCR.HPMN](#) can change the behavior of accesses to PMINTENCLR. See the description of the P<x> bit.

PMINTENCLR is used in conjunction with the [PMINTENSET](#) register.

Configurations

PMINTENCLR is architecturally mapped to AArch64 register [PMINTENCLR_EL1](#).

PMINTENCLR is architecturally mapped to external register [PMINTENCLR_EL1](#).

There is one instance of this register that is used in both Secure and Non-secure states.

Attributes

PMINTENCLR is a 32-bit register.

The PMINTENCLR bit assignments are:

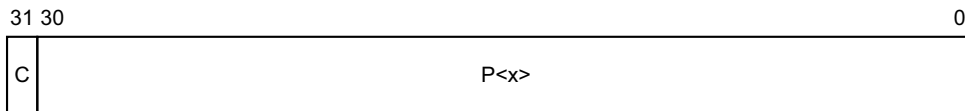

C, bit [31]

[PMCCNTR](#) overflow interrupt request disable bit. Possible values are:

- 0 When read, means the cycle counter overflow interrupt request is disabled. When written, has no effect.
- 1 When read, means the cycle counter overflow interrupt request is enabled. When written, disables the cycle count overflow interrupt request.

On Warm reset, the field reset value is architecturally UNKNOWN.

P<x>, bit [x] for x = 0 to (N - 1)

Event counter overflow interrupt request disable bit for [PMEVCNTR<x>](#).

When EL2 is implemented, in Non-secure EL1 and EL0, N is the value in [HDCR.HPMN](#).

Otherwise, N is the value in [PMCR.N](#).

Bits [30:N] are RAZ/WI.

Possible values are:

- 0 When read, means that the [PMEVCNTR<x>](#) event counter interrupt request is disabled. When written, has no effect.

- 1 When read, means that the PMEVCNTR<x> event counter interrupt request is enabled.
 When written, disables the PMEVCNTR<x> interrupt request.
- On Warm reset, the field reset value is architecturally UNKNOWN.

Accessing the PMINTENCLR:

To access the PMINTENCLR:

MRC p15,0,<Rt>,c9,c14,2 ; Read PMINTENCLR into Rt
MCR p15,0,<Rt>,c9,c14,2 ; Write Rt to PMINTENCLR

Register access is encoded as follows:

coproc	opc1	CRn	CRm	opc2
1111	000	1001	1110	010

G4.4.11 PMINTENSET, Performance Monitors Interrupt Enable Set register

The PMINTENSET characteristics are:

Purpose

Enables the generation of interrupt requests on overflows from the Cycle Count Register, [PMCCNTR](#), and the event counters [PMEVCNTR<n>](#). Reading the register shows which overflow interrupt requests are enabled.

This register is part of the Performance Monitors registers functional group.

Usage constraints

This register is accessible as shown below:

EL0 (NS)	EL0 (S)	EL1 (NS)	EL1 (S)	EL2	EL3 (SCR.NS=1)	EL3 (SCR.NS=0)
-	-	RW	RW	RW	RW	RW

If EL2 is implemented, in Non-secure EL1 and EL0 modes, the value of [HDCR.HPMN](#) can change the behavior of accesses to PMINTENSET. See the description of the P<x> bit.

PMINTENSET is used in conjunction with the [PMINTENCLR](#) register.

Configurations

PMINTENSET is architecturally mapped to AArch64 register [PMINTENSET_EL1](#).

PMINTENSET is architecturally mapped to external register [PMINTENSET_EL1](#).

There is one instance of this register that is used in both Secure and Non-secure states.

Attributes

PMINTENSET is a 32-bit register.

The PMINTENSET bit assignments are:

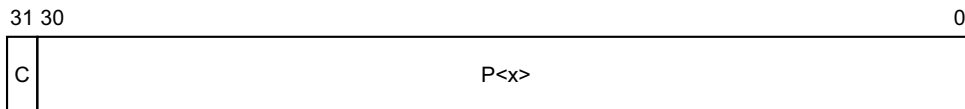

C, bit [31]

[PMCCNTR](#) overflow interrupt request enable bit. Possible values are:

- 0 When read, means the cycle counter overflow interrupt request is disabled. When written, has no effect.
- 1 When read, means the cycle counter overflow interrupt request is enabled. When written, enables the cycle count overflow interrupt request.

On Warm reset, the field reset value is architecturally UNKNOWN.

P<x>, bit [x] for x = 0 to (N - 1)

Event counter overflow interrupt request enable bit for [PMEVCNTR<x>](#).

When EL2 is implemented, in Non-secure EL1 and EL0, N is the value in [HDCR.HPMN](#).

Otherwise, N is the value in [PMCR.N](#).

Bits [30:N] are RAZ/WI.

Possible values are:

- 0 When read, means that the [PMEVCNTR<x>](#) event counter interrupt request is disabled. When written, has no effect.

- 1 When read, means that the PMEVCNTR<x> event counter interrupt request is enabled.
 When written, enables the PMEVCNTR<x> interrupt request.
- On Warm reset, the field reset value is architecturally UNKNOWN.

Accessing the PMINTENSET:

To access the PMINTENSET:

MRC p15,0,<Rt>,c9,c14,1 ; Read PMINTENSET into Rt
MCR p15,0,<Rt>,c9,c14,1 ; Write Rt to PMINTENSET

Register access is encoded as follows:

coproc	opc1	CRn	CRm	opc2
1111	000	1001	1110	001

G4.4.12 PMOVSR, Performance Monitors Overflow Flag Status Register

The PMOVSR characteristics are:

Purpose

Contains the state of the overflow bit for the Cycle Count Register, [PMCCNTR](#), and each of the implemented event counters [PMEVCNTR<x>](#). Writing to this register clears these bits.

This register is part of the Performance Monitors registers functional group.

Usage constraints

This register is accessible as shown below:

EL0 (NS)	EL0 (S)	EL1 (NS)	EL1 (S)	EL2	EL3 (SCR.NS=1)	EL3 (SCR.NS=0)
Config-RW	Config-RW	RW	RW	RW	RW	RW

This register is accessible at EL0 when [PMUSERENR.EN](#) is set to 1.

If EL2 is implemented, in Non-secure EL1 and EL0 modes, the value of [HDCR.HPMN](#) can change the behavior of accesses to PMOVSR. See the description of the Px bit.

Configurations

PMOVSR is architecturally mapped to AArch64 register [PMOVSCLR_EL0](#).

PMOVSR is architecturally mapped to external register [PMOVSCLR_EL0](#).

There is one instance of this register that is used in both Secure and Non-secure states.

Attributes

PMOVSR is a 32-bit register.

The PMOVSR bit assignments are:

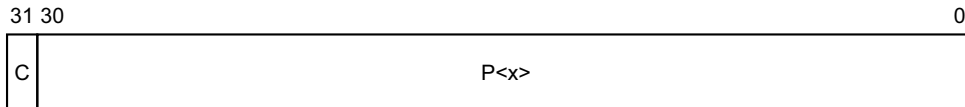

C, bit [31]

[PMCCNTR](#) overflow bit. Possible values are:

- 0 When read, means the cycle counter has not overflowed. When written, has no effect.
- 1 When read, means the cycle counter has overflowed. When written, clears the overflow bit to 0.

[PMCR.LC](#) is used to control from which bit of [PMCCNTR](#) (bit 31 or bit 63) an overflow is detected. On Warm reset, the field reset value is architecturally UNKNOWN.

P<x>, bit [x] for x = 0 to (N - 1)

Event counter overflow clear bit for [PMEVCNTR<x>](#).

When EL2 is implemented, in Non-secure EL1 and EL0, N is the value in [HDCR.HPMN](#). Otherwise, N is the value in [PMCR.N](#).

Bits [30:N] are RAZ/WI.

Possible values of each bit are:

- 0 When read, means that [PMEVCNTR<x>](#) has not overflowed. When written, has no effect.

- 1 When read, means that PMEVCNTR<x> has overflowed. When written, clears the PMEVCNTR<x> overflow bit to 0.

On Warm reset, the field reset value is architecturally UNKNOWN.

Accessing the PMOVSr:

To access the PMOVSr:

MRC p15,0,<Rt>,c9,c12,3 ; Read PMOVSr into Rt
MCR p15,0,<Rt>,c9,c12,3 ; Write Rt to PMOVSr

Register access is encoded as follows:

coproc	opc1	CRn	CRm	opc2
1111	000	1001	1100	011

G4.4.13 PMOVSSET, Performance Monitors Overflow Flag Status Set register

The PMOVSSET characteristics are:

Purpose

Sets the state of the overflow bit for the Cycle Count Register, [PMCCNTR](#), and each of the implemented event counters [PMEVCNTR<x>](#).

This register is part of the Performance Monitors registers functional group.

Usage constraints

This register is accessible as shown below:

EL0 (NS)	EL0 (S)	EL1 (NS)	EL1 (S)	EL2	EL3 (SCR.NS=1)	EL3 (SCR.NS=0)
Config-RW	Config-RW	RW	RW	RW	RW	RW

This register is accessible at EL0 when [PMUSERENR.EN](#) is set to 1.

If EL2 is implemented, in Non-secure EL1 and EL0 modes, the value of [HDCR.HPMN](#) can change the behavior of accesses to PMOVSSET. See the description of the Px bit.

Configurations

PMOVSSET is architecturally mapped to AArch64 register [PMOVSSET_EL0](#).

PMOVSSET is architecturally mapped to external register [PMOVSSET_EL0](#).

There is one instance of this register that is used in both Secure and Non-secure states.

Attributes

PMOVSSET is a 32-bit register.

The PMOVSSET bit assignments are:

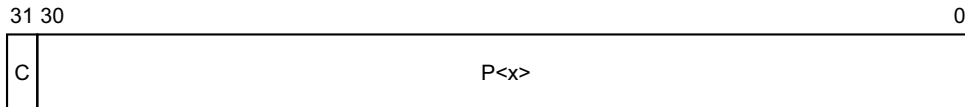

C, bit [31]

[PMCCNTR](#) overflow bit. Possible values are:

- 0 When read, means the cycle counter has not overflowed. When written, has no effect.
- 1 When read, means the cycle counter has overflowed. When written, sets the overflow bit to 1.

On Warm reset, the field reset value is architecturally UNKNOWN.

P<x>, bit [x] for x = 0 to (N - 1)

Event counter overflow set bit for [PMEVCNTR<x>](#).

When EL2 is implemented, in Non-secure EL1 and EL0, N is the value in [HDCR.HPMN](#).

Otherwise, N is the value in [PMCR.N](#).

Bits [30:N] are RAZ/WI.

Possible values are:

- 0 When read, means that [PMEVCNTR<x>](#) has not overflowed. When written, has no effect.
- 1 When read, means that [PMEVCNTR<x>](#) has overflowed. When written, sets the [PMEVCNTR<x>](#) overflow bit to 1.

On Warm reset, the field reset value is architecturally UNKNOWN.

Accessing the PMOVSSET:

To access the PMOVSSET:

MRC p15,0,<Rt>,c9,c14,3 ; Read PMOVSSET into Rt
MCR p15,0,<Rt>,c9,c14,3 ; Write Rt to PMOVSSET

Register access is encoded as follows:

coproc	opc1	CRn	CRm	opc2
1111	000	1001	1110	011

G4.4.14 PMSELR, Performance Monitors Event Counter Selection Register

The PMSELR characteristics are:

Purpose

Selects the current event counter `PMEVCNTR<x>` or the cycle counter, `CCNT`.
 This register is part of the Performance Monitors registers functional group.

Usage constraints

This register is accessible as shown below:

EL0 (NS)	EL0 (S)	EL1 (NS)	EL1 (S)	EL2	EL3 (SCR.NS=1)	EL3 (SCR.NS=0)
Config-RW	Config-RW	RW	RW	RW	RW	RW

This register is accessible at EL0 when `PMUSERENR.EN` or `PMUSERENR.ER` is set to 1.

PMSELR is used in conjunction with `PMXEVTYPER` to determine the event that increments a selected event counter, and the modes and states in which the selected counter increments.

It is also used in conjunction with `PMXEVCNTR`, to determine the value of a selected event counter.

Configurations

PMSELR is architecturally mapped to AArch64 register `PMSELR_ELO`.

There is one instance of this register that is used in both Secure and Non-secure states.

Attributes

PMSELR is a 32-bit register.

The PMSELR bit assignments are:

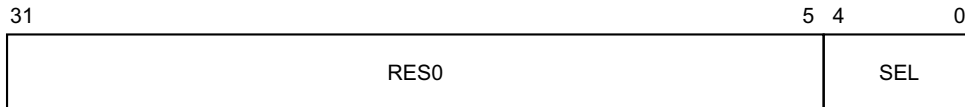

Bits [31:5]

Reserved, RES0.

SEL, bits [4:0]

Selects event counter, `PMEVCNTR<x>`, where `x` is the value held in this field. This value identifies which event counter is accessed when a subsequent access to `PMXEVTYPER` or `PMXEVCNTR` occurs.

This field can take any value from 0 (`0b00000`) to `(PMCR.N)-1`, or 31 (`0b11111`).

When `PMSELR.SEL` is `0b11111` it selects the cycle counter and:

- A read of the `PMXEVTYPER` returns the value of `PMCCFILTR`.
- A write of the `PMXEVTYPER` writes to `PMCCFILTR`.
- A read or write of `PMXEVCNTR` has CONstrained UNpredictable effects, that can be one of the following:
 - Access to `PMXEVCNTR` is UNDEFINED.
 - Access to `PMXEVCNTR` behaves as a NOP.
 - Access to `PMXEVCNTR` behaves as if the register is RAZ/WI.

— Access to **PMXEVNTR** behaves as if the **PMSELR.SEL** field contains an UNKNOWN value.

If this field is set to a value greater than or equal to the number of implemented counters, but not equal to 31, the results of access to **PMXEVTYPER** or **PMXEVNTR** are CONSTRAINED UNPREDICTABLE, and can be one of the following:

- Access to **PMXEVTYPER** or **PMXEVNTR** is UNDEFINED.
- Access to **PMXEVTYPER** or **PMXEVNTR** behaves as a NOP.
- Access to **PMXEVTYPER** or **PMXEVNTR** behaves as if the register is RAZ/WI.
- Access to **PMXEVTYPER** or **PMXEVNTR** behaves as if the **PMSELR.SEL** field contains an UNKNOWN value.
- Access to **PMXEVTYPER** or **PMXEVNTR** behaves as if the **PMSELR.SEL** field contains 0b11111.

On Warm reset, the field reset value is architecturally UNKNOWN.

Accessing the PMSELR:

To access the PMSELR:

MRC p15,0,<Rt>,c9,c12,5 ; Read PMSELR into Rt
 MCR p15,0,<Rt>,c9,c12,5 ; Write Rt to PMSELR

Register access is encoded as follows:

coproc	opc1	CRn	CRm	opc2
1111	000	1001	1100	101

G4.4.15 PMSWINC, Performance Monitors Software Increment register

The PMSWINC characteristics are:

Purpose

Increments a counter that is configured to count the Software increment event, event 0x00.
 This register is part of the Performance Monitors registers functional group.

Usage constraints

This register is accessible as shown below:

EL0 (NS)	EL0 (S)	EL1 (NS)	EL1 (S)	EL2	EL3 (SCR.NS=1)	EL3 (SCR.NS=0)
Config-WO	Config-WO	WO	WO	WO	WO	WO

This register is accessible at EL0 when [PMUSERENR.EN](#) or [PMUSERENR.SW](#) is set to 1.
 If EL2 is implemented, in Non-secure EL1 and EL0 modes, the value of [HDCR.HPMN](#) can change the behavior of accesses to PMSWINC. See the description of the Px bit.

Configurations

PMSWINC is architecturally mapped to AArch64 register [PMSWINC_EL0](#).
 PMSWINC is architecturally mapped to external register [PMSWINC_EL0](#).
 There is one instance of this register that is used in both Secure and Non-secure states.

Attributes

PMSWINC is a 32-bit register.

The PMSWINC bit assignments are:

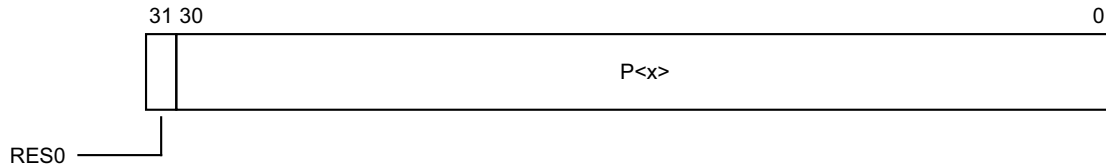

Bit [31]

Reserved, RES0.

P<x>, bit [x] for x = 0 to (N - 1)

Event counter software increment bit for [PMEVCNTR<x>](#).
 When EL2 is implemented, in Non-secure EL1 and EL0, N is the value in [HDCR.HPMN](#).
 Otherwise, N is the value in [PMCR.N](#).
 Bits [30:N] are RAZ/WI.
 The effects of writing to this bit are:

- 0 No action. The write to this bit is ignored.
- 1 If [PMEVCNTR<x>](#) is enabled and configured to count the software increment event, increments [PMEVCNTR<x>](#) by 1. If [PMEVCNTR<x>](#) is disabled, or not configured to count the software increment event, the write to this bit is ignored.

Accessing the PMSWINC:

To access the PMSWINC:

MCR p15,0,<Rt>,c9,c12,4 ; Write Rt to PMSWINC

Register access is encoded as follows:

coproc	opc1	CRn	CRm	opc2
1111	000	1001	1100	100

G4.4.16 PMUSERENR, Performance Monitors User Enable Register

The PMUSERENR characteristics are:

Purpose

Enables or disables User mode access to the Performance Monitors.
 This register is part of the Performance Monitors registers functional group.

Usage constraints

This register is accessible as shown below:

EL0 (NS)	EL0 (S)	EL1 (NS)	EL1 (S)	EL2	EL3 (SCR.NS=1)	EL3 (SCR.NS=0)
RO	RO	RW	RW	RW	RW	RW

Configurations

PMUSERENR is architecturally mapped to AArch64 register [PMUSERENR_EL0](#).
 There is one instance of this register that is used in both Secure and Non-secure states.

Attributes

PMUSERENR is a 32-bit register.

The PMUSERENR bit assignments are:

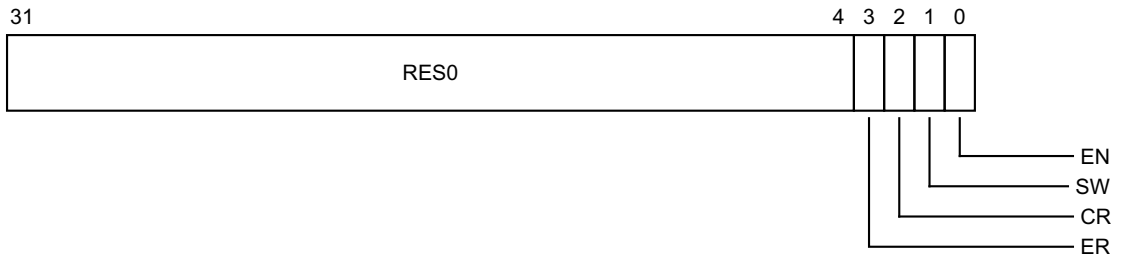

Bits [31:4]

Reserved, RES0.

ER, bit [3]

Event counter read enable. The possible values of this bit are:

- 0 EL0 read access to [PMXVCNTR](#) / [PMEVCNTR<n>](#) and read/write access to [PMSELR](#) disabled if PMUSERENR.EN is also 0.
- 1 EL0 read access to [PMXVCNTR](#) / [PMEVCNTR<n>](#) and read/write access to [PMSELR](#) enabled.

On Warm reset, the field resets to 0.

CR, bit [2]

Cycle counter read enable. The possible values of this bit are:

- 0 EL0 read access to [PMCCNTR](#) disabled if PMUSERENR.EN is also 0.
- 1 EL0 read access to [PMCCNTR](#) enabled.

On Warm reset, the field resets to 0.

SW, bit [1]

Software Increment write enable. The possible values of this bit are:

- 0 ELO write access to [PMSWINC](#) disabled if PMUSERENR.EN is also 0.
- 1 ELO write access to [PMSWINC](#) enabled.

On Warm reset, the field resets to 0.

EN, bit [0]

ELO access enable bit. The possible values of this bit are:

- 0 ELO access to the Performance Monitors disabled.
- 1 ELO access to the Performance Monitors enabled. Can access all PMU registers at ELO, except for writes to PMUSERENR and reads/writes of [PMINTENSET](#) and [PMINTENCLR](#).

On Warm reset, the field resets to 0.

Accessing the PMUSERENR:

To access the PMUSERENR:

MRC p15,0,<Rt>,c9,c14,0 ; Read PMUSERENR into Rt
 MCR p15,0,<Rt>,c9,c14,0 ; Write Rt to PMUSERENR

Register access is encoded as follows:

coproc	opc1	CRn	CRm	opc2
1111	000	1001	1110	000

G4.4.17 PMXEVNTR, Performance Monitors Selected Event Count Register

The PMXEVNTR characteristics are:

Purpose

Reads or writes the value of the selected event counter, PMXEVNTR<x>. PMSELR.SEL determines which event counter is selected.

This register is part of the Performance Monitors registers functional group.

Usage constraints

This register is accessible as shown below:

EL0 (NS)	EL0 (S)	EL1 (NS)	EL1 (S)	EL2	EL3 (SCR.NS=1)	EL3 (SCR.NS=0)
Config-RW	Config-RW	RW	RW	RW	RW	RW

This register can be read at EL0 when PMUSERENR.EN or PMUSERENR.ER is set to 1, and can be written at EL0 when PMUSERENR.ER is set to 1.

If PMSELR.SEL selects a counter that is not accessible then reads and writes of PMXEVNTR are CONSTRAINED UNPREDICTABLE, and must behave as one of the following:

- UNALLOCATED.
- RAZ/WI.
- No-op.
- As if PMSELR.SEL has an UNKNOWN value less than the number of counters accessible at the current exception level and security state.
- As if PMSELR.SEL is 31.
- If the counter is implemented but not accessible at the current exception level and security state, generate a System Register Trap or CP14 Register Trap exception taken to EL2.

This applies:

- If PMSELR.SEL is larger than the number of implemented counters.
- In an implementation that includes EL2, in Non-secure EL1 and EL0 modes, if PMSELR.SEL >= HDCR.HPMN.

Configurations

PMXEVNTR is architecturally mapped to AArch64 register PMXEVNTR_ELO.

There is one instance of this register that is used in both Secure and Non-secure states.

Attributes

PMXEVNTR is a 32-bit register.

The PMXEVNTR bit assignments are:



PMXEVNTR<x>, bits [31:0]

Value of the selected event counter, PMXEVNTR<x>, where x is the value stored in PMSELR.SEL.

Accessing the PMXEVNTR:

To access the PMXEVNTR:

MRC p15,0,<Rt>,c9,c13,2 ; Read PMXEVNTR into Rt
MCR p15,0,<Rt>,c9,c13,2 ; Write Rt to PMXEVNTR

Register access is encoded as follows:

coproc	opc1	CRn	CRm	opc2
1111	000	1001	1101	010

G4.4.18 PMXEVTYPER, Performance Monitors Selected Event Type Register

The PMXEVTYPER characteristics are:

Purpose

When [PMSELR.SEL](#) selects an event counter, this accesses a [PMEVTYPER<n>](#) register. When [PMSELR.SEL](#) selects the cycle counter, this accesses [PMCCFILTR](#).

This register is part of the Performance Monitors registers functional group.

Usage constraints

This register is accessible as shown below:

EL0 (NS)	EL0 (S)	EL1 (NS)	EL1 (S)	EL2	EL3 (SCR.NS=1)	EL3 (SCR.NS=0)
Config-RW	Config-RW	RW	RW	RW	RW	RW

This register is accessible at EL0 when [PMUSERENR.EN](#) is set to 1.

If [PMSELR.SEL](#) selects a counter that is not accessible then reads and writes of PMXEVTYPER are CONstrained UNPREDICTABLE, and must behave as one of the following:

- UNALLOCATED.
- RAZ/WI.
- No-op.
- As if [PMSELR.SEL](#) has an UNKNOWN value less than the number of counters accessible at the current exception level and security state.
- As if [PMSELR.SEL](#) is 31.
- If the counter is implemented but not accessible at the current exception level and security state, generate a System Register Trap or CP14 Register Trap exception taken to EL2.

This applies:

- If [PMSELR.SEL](#) is larger than the number of implemented counters.
- In an implementation that includes EL2, in Non-secure EL1 and EL0 modes, if [PMSELR.SEL](#) >= [HDCR.HPMN](#).

Configurations

PMXEVTYPER is architecturally mapped to AArch64 register [PMXEVTYPER_EL0](#).

There is one instance of this register that is used in both Secure and Non-secure states.

Attributes

PMXEVTYPER is a 32-bit register.

The PMXEVTYPER bit assignments are:

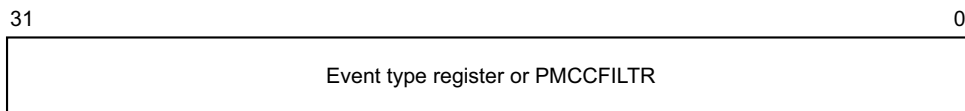

Bits [31:0]

Event type register or [PMCCFILTR](#).

When [PMSELR.SEL](#) == 31, this register accesses [PMCCFILTR](#).

Otherwise, this register accesses [PMEVTYPER<n>](#) where n is the value in [PMSELR.SEL](#).

Accessing the PMXEVTYPYPER:

To access the PMXEVTYPYPER:

MRC p15,0,<Rt>,c9,c13,1 ; Read PMXEVTYPYPER into Rt
MCR p15,0,<Rt>,c9,c13,1 ; Write Rt to PMXEVTYPYPER

Register access is encoded as follows:

coproc	opc1	CRn	CRm	opc2
1111	000	1001	1101	001

G4.5 Generic Timer registers

This section describes the Generic Timer registers in AArch32 state.

G4.5.1 CNTFRQ, Counter-timer Frequency register

The CNTFRQ characteristics are:

Purpose

Holds the clock frequency of the system counter.

This register is part of the Generic Timer registers functional group.

Usage constraints

This register is accessible as shown below:

EL0 (NS)	EL0 (S)	EL1 (NS)	EL1 (S)	EL2	EL3 (SCR.NS=1)	EL3 (SCR.NS=0)
Config-RO	Config-RO	RO	RO	RO	RO	RW

Can only be written at the highest exception level implemented. For example, if EL3 is the highest implemented exception level, CNTFRQ can only be written at EL3.

If EL3 is using AArch64, write access to CNTFRQ in AArch32 at Secure EL1 is UNDEFINED.

This register is accessible and read-only at EL0 when [CNTKCTL.EL0PCTEN](#) or [CNTKCTL.EL0VCTEN](#) is set to 1.

Configurations

CNTFRQ is architecturally mapped to AArch64 register [CNTFRQ_EL0](#).

CNTFRQ is architecturally mapped to external register [CNTFRQ](#).

There is one instance of this register that is used in both Secure and Non-secure states.

Attributes

CNTFRQ is a 32-bit register.

The CNTFRQ bit assignments are:

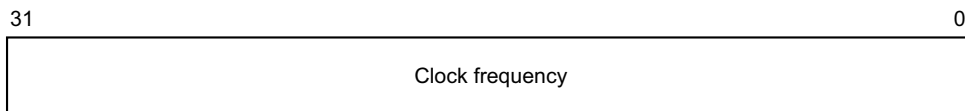

Bits [31:0]

Clock frequency. Indicates the system counter clock frequency, in Hz.

Accessing the CNTFRQ:

To access the CNTFRQ:

MRC p15,0,<Rt>,c14,c0,0 ; Read CNTFRQ into Rt

MCR p15,0,<Rt>,c14,c0,0 ; Write Rt to CNTFRQ

Register access is encoded as follows:

coproc	opc1	CRn	CRm	opc2
1111	000	1110	0000	000

G4.5.2 CNTHCTL, Counter-timer Hyp Control register

The CNTHCTL characteristics are:

Purpose

Controls the generation of an event stream from the physical counter, and access from Non-secure EL1 modes to the physical counter and the Non-secure EL1 physical timer.

This register is part of:

- the Generic Timer registers functional group
- the Virtualization registers functional group.

Usage constraints

This register is accessible as shown below:

EL0 (NS)	EL0 (S)	EL1 (NS)	EL1 (S)	EL2	EL3 (SCR.NS=1)	EL3 (SCR.NS=0)
-	-	-	-	RW	RW	-

Configurations

CNTHCTL is architecturally mapped to AArch64 register [CNTHCTL_EL2](#).

If EL2 is not implemented, this register is RES0 from EL3.

Attributes

CNTHCTL is a 32-bit register.

The CNTHCTL bit assignments are:

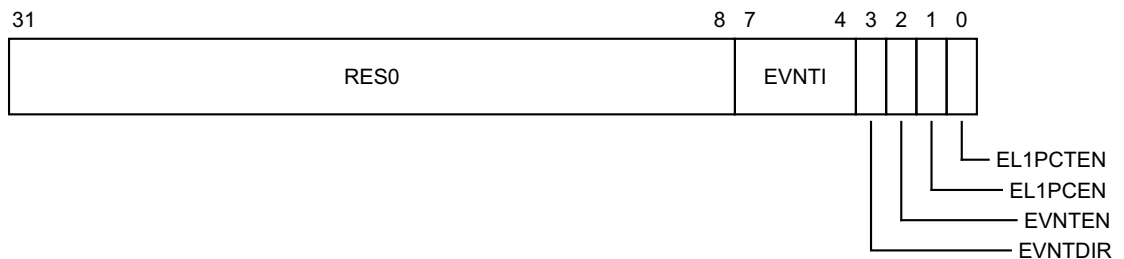

Bits [31:8]

Reserved, RES0.

EVNTI, bits [7:4]

Selects which bit (0 to 15) of the corresponding counter register ([CNTPCT](#) or [CNTVCT](#)) is the trigger for the event stream generated from that counter, when that stream is enabled.

Reset value is architecturally UNKNOWN.

EVNTDIR, bit [3]

Controls which transition of the counter register ([CNTPCT](#) or [CNTVCT](#)) trigger bit, defined by EVNTI, generates an event when the event stream is enabled:

- 0 A 0 to 1 transition of the trigger bit triggers an event.
- 1 A 1 to 0 transition of the trigger bit triggers an event.

Reset value is architecturally UNKNOWN.

EVNTEN, bit [2]

Enables the generation of an event stream from the corresponding counter:

- 0 Disables the event stream.
- 1 Enables the event stream.

Resets to 0.

EL1PCEN, bit [1]

Controls whether the Non-secure copies of the physical timer registers are accessible from Non-secure EL1 and EL0 modes:

- 0 The Non-secure [CNTP_CVAL](#), [CNTP_TVAL](#), and [CNTP_CTL](#) registers are not accessible from Non-secure EL1 and EL0 modes.
- 1 The Non-secure [CNTP_CVAL](#), [CNTP_TVAL](#), and [CNTP_CTL](#) registers are accessible from Non-secure EL1 and EL0 modes.

If EL3 is implemented and EL2 is not implemented, this bit is treated as if it is 1 for all purposes other than reading the register.

Resets to 1.

EL1PCTEN, bit [0]

Controls whether the physical counter, [CNTPCT](#), is accessible from Non-secure EL1 and EL0 modes:

- 0 The [CNTPCT](#) register is not accessible from Non-secure EL1 and EL0 modes.
- 1 The [CNTPCT](#) register is accessible from Non-secure EL1 and EL0 modes.

If EL3 is implemented and EL2 is not implemented, this bit is treated as if it is 1 for all purposes other than reading the register.

Resets to 1.

Accessing the CNTHCTL:

To access the CNTHCTL:

MRC p15,4,<Rt>,c14,c1,0 ; Read CNTHCTL into Rt
MCR p15,4,<Rt>,c14,c1,0 ; Write Rt to CNTHCTL

Register access is encoded as follows:

coproc	opc1	CRn	CRm	opc2
1111	100	1110	0001	000

G4.5.3 CNTHP_CTL, Counter-timer Hyp Physical Timer Control register

The CNTHP_CTL characteristics are:

Purpose

Control register for the Hyp mode physical timer.

This register is part of the Generic Timer registers functional group.

Usage constraints

This register is accessible as shown below:

EL0 (NS)	EL0 (S)	EL1 (NS)	EL1 (S)	EL2	EL3 (SCR.NS=1)	EL3 (SCR.NS=0)
-	-	-	-	RW	RW	-

Configurations

CNTHP_CTL is architecturally mapped to AArch64 register [CNTHP_CTL_EL2](#).

If EL2 is not implemented, this register is RES0 from EL3.

Attributes

CNTHP_CTL is a 32-bit register.

The CNTHP_CTL bit assignments are:

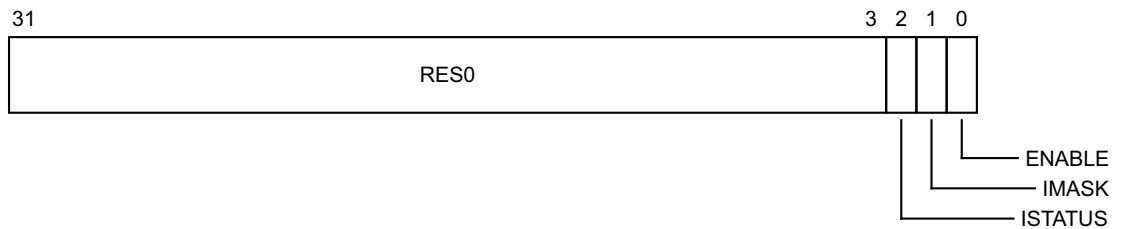

Bits [31:3]

Reserved, RES0.

ISTATUS, bit [2]

The status of the timer interrupt. This bit is read-only. Permitted values are:

0 Interrupt not asserted.

1 Interrupt asserted.

A register write that sets IMASK to 1 latches this bit to reflect the status of the interrupt immediately before that write.

Reset value is architecturally UNKNOWN.

IMASK, bit [1]

Timer interrupt mask bit. Permitted values are:

0 Timer interrupt is not masked.

1 Timer interrupt is masked.

Reset value is architecturally UNKNOWN.

ENABLE, bit [0]

Enables the timer. Permitted values are:

0 Timer disabled.

1 Timer enabled.

Disabling the timer masks the timer interrupt, but the timer value continues to count down.

Resets to 0.

Accessing the CNTHP_CTL:

To access the CNTHP_CTL:

MRC p15,4,<Rt>,c14,c2,1 ; Read CNTHP_CTL into Rt

MCR p15,4,<Rt>,c14,c2,1 ; Write Rt to CNTHP_CTL

Register access is encoded as follows:

coproc	opc1	CRn	CRm	opc2
1111	100	1110	0010	001

G4.5.4 CNTHP_CVAL, Counter-timer Hyp Physical CompareValue register

The CNTHP_CVAL characteristics are:

Purpose

Holds the compare value for the Hyp mode physical timer.

This register is part of:

- the Generic Timer registers functional group
- the Virtualization registers functional group.

Usage constraints

This register is accessible as shown below:

EL0 (NS)	EL0 (S)	EL1 (NS)	EL1 (S)	EL2	EL3 (SCR.NS=1)	EL3 (SCR.NS=0)
-	-	-	-	RW	RW	-

Configurations

CNTHP_CVAL is architecturally mapped to AArch64 register [CNTHP_CVAL_EL2](#).

If EL2 is not implemented, this register is RES0 from EL3.

Attributes

CNTHP_CVAL is a 64-bit register.

The CNTHP_CVAL bit assignments are:

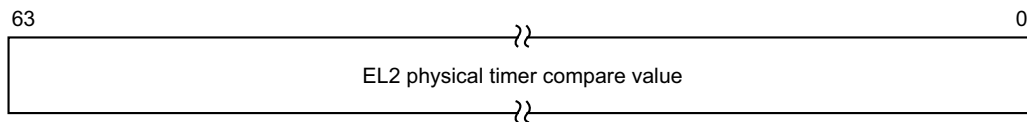

Bits [63:0]

EL2 physical timer compare value.

Accessing the CNTHP_CVAL:

To access the CNTHP_CVAL:

MRRC p15,6,<Rt>,<Rt2>,c14 ; Read 64-bit CNTHP_CVAL into Rt (low word) and Rt2 (high word)

MCRW p15,6,<Rt>,<Rt2>,c14 ; Write Rt (low word) and Rt2 (high word) to 64-bit CNTHP_CVAL

Register access is encoded as follows:

coproc	opc1	CRm
1111	0110	1110

G4.5.5 CNTHP_TVAL, Counter-timer Hyp Physical Timer TimerValue register

The CNTHP_TVAL characteristics are:

Purpose

Holds the timer value for the Hyp mode physical timer.

This register is part of:

- the Generic Timer registers functional group
- the Virtualization registers functional group.

Usage constraints

This register is accessible as shown below:

EL0 (NS)	EL0 (S)	EL1 (NS)	EL1 (S)	EL2	EL3 (SCR.NS=1)	EL3 (SCR.NS=0)
-	-	-	-	RW	RW	-

Configurations

CNTHP_TVAL is architecturally mapped to AArch64 register [CNTHP_TVAL_EL2](#).

If EL2 is not implemented, this register is RES0 from EL3.

Attributes

CNTHP_TVAL is a 32-bit register.

The CNTHP_TVAL bit assignments are:

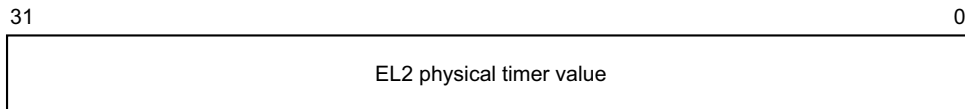

Bits [31:0]

EL2 physical timer value.

Accessing the CNTHP_TVAL:

To access the CNTHP_TVAL:

MRC p15,4,<Rt>,c14,c2,0 ; Read CNTHP_TVAL into Rt

MCR p15,4,<Rt>,c14,c2,0 ; Write Rt to CNTHP_TVAL

Register access is encoded as follows:

coproc	opc1	CRn	CRm	opc2
1111	100	1110	0010	000

G4.5.6 CNTKCTL, Counter-timer Kernel Control register

The CNTKCTL characteristics are:

Purpose

Controls the generation of an event stream from the virtual counter, and access from EL0 modes to the physical counter, virtual counter, EL1 physical timers, and the virtual timer.

This register is part of the Generic Timer registers functional group.

Usage constraints

This register is accessible as shown below:

EL0 (NS)	EL0 (S)	EL1 (NS)	EL1 (S)	EL2	EL3 (SCR.NS=1)	EL3 (SCR.NS=0)
-	-	RW	RW	RW	RW	RW

Configurations

CNTKCTL is architecturally mapped to AArch64 register [CNTKCTL_EL1](#).

There is one instance of this register that is used in both Secure and Non-secure states.

Attributes

CNTKCTL is a 32-bit register.

The CNTKCTL bit assignments are:

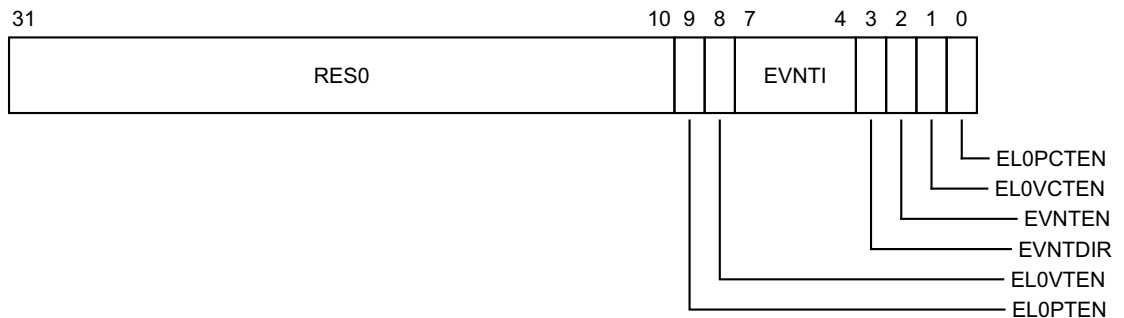

Bits [31:10]

Reserved, RES0.

ELOPTEN, bit [9]

Controls whether the physical timer registers are accessible from EL0 modes:

0 The [CNTP_CVAL](#), [CNTP_CTL](#), and [CNTP_TVAL](#) registers are not accessible from EL0.

1 The [CNTP_CVAL](#), [CNTP_CTL](#), and [CNTP_TVAL](#) registers are accessible from EL0.

Resets to 0.

EL0VTEN, bit [8]

Controls whether the virtual timer registers are accessible from EL0 modes:

0 The [CNTV_CVAL](#), [CNTV_CTL](#), and [CNTV_TVAL](#) registers are not accessible from EL0.

1 The [CNTV_CVAL](#), [CNTV_CTL](#), and [CNTV_TVAL](#) registers are accessible from EL0.

Resets to 0.

EVNTI, bits [7:4]

Selects which bit (0 to 15) of the corresponding counter register ([CNTPCT](#) or [CNTVCT](#)) is the trigger for the event stream generated from that counter, when that stream is enabled.

Reset value is architecturally UNKNOWN.

EVNTDIR, bit [3]

Controls which transition of the counter register ([CNTPCT](#) or [CNTVCT](#)) trigger bit, defined by EVNTI, generates an event when the event stream is enabled:

0 A 0 to 1 transition of the trigger bit triggers an event.

1 A 1 to 0 transition of the trigger bit triggers an event.

Reset value is architecturally UNKNOWN.

EVNTEN, bit [2]

Enables the generation of an event stream from the corresponding counter:

0 Disables the event stream.

1 Enables the event stream.

Resets to 0.

EL0VCTEN, bit [1]

Controls whether the virtual counter, [CNTVCT](#), and the frequency register [CNTFRQ](#), are accessible from EL0 modes:

0 [CNTVCT](#) is not accessible from EL0. If [EL0PCTEN](#) is set to 0, [CNTFRQ](#) is not accessible from EL0.

1 [CNTVCT](#) and [CNTFRQ](#) are accessible from EL0.

Resets to 0.

EL0PCTEN, bit [0]

Controls whether the physical counter, [CNTPCT](#), and the frequency register [CNTFRQ](#), are accessible from EL0 modes:

0 [CNTPCT](#) is not accessible from EL0 modes. If [EL0VCTEN](#) is set to 0, [CNTFRQ](#) is not accessible from EL0.

1 [CNTPCT](#) and [CNTFRQ](#) are accessible from EL0.

Resets to 0.

Accessing the CNTKCTL:

To access the CNTKCTL:

MRC p15,0,<Rt>,c14,c1,0 ; Read CNTKCTL into Rt

MCR p15,0,<Rt>,c14,c1,0 ; Write Rt to CNTKCTL

Register access is encoded as follows:

coproc	opc1	CRn	CRm	opc2
1111	000	1110	0001	000

G4.5.7 CNTP_CTL, Counter-timer Physical Timer Control register

The CNTP_CTL characteristics are:

Purpose

Control register for the EL1 physical timer.

This register is part of the Generic Timer registers functional group.

Usage constraints

This register is accessible as shown below:

When accessed as CNTP_CTL(S):

EL0 (NS)	EL0 (S)	EL1 (NS)	EL1 (S)	EL2	EL3 (SCR.NS=1)	EL3 (SCR.NS=0)
-	Config-RW	-	RW	-	-	RW

When accessed as CNTP_CTL(NS):

EL0 (NS)	EL0 (S)	EL1 (NS)	EL1 (S)	EL2	EL3 (SCR.NS=1)	EL3 (SCR.NS=0)
Config-RW	-	Config-RW	-	RW	RW	-

This register is accessible at EL0 when [CNTKCTL.ELOPTEN](#) is set to 1.

If EL2 is implemented, this register is accessible at Non-secure EL1 and EL0 when [CNTHCTL.ELIPCEN](#) is set to 1.

Configurations

CNTP_CTL(NS) is architecturally mapped to AArch64 register [CNTP_CTL_EL0](#).

CNTP_CTL is architecturally mapped to external register [CNTP_CTL](#).

If EL3 is using AArch32, there are separate Secure and Non-secure instances of this register.

Attributes

CNTP_CTL is a 32-bit register.

The CNTP_CTL bit assignments are:

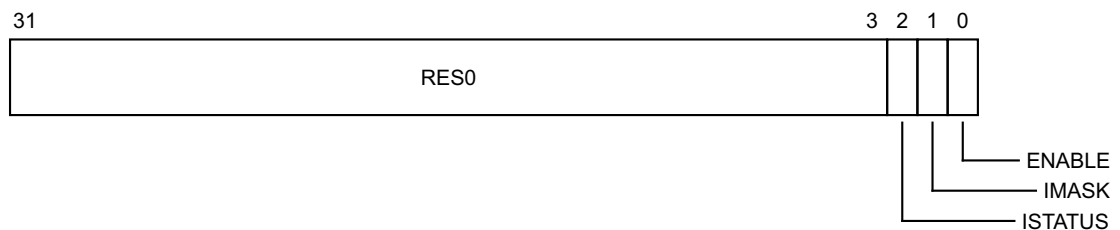

Bits [31:3]

Reserved, RES0.

ISTATUS, bit [2]

The status of the timer interrupt. This bit is read-only. Permitted values are:

- 0 Interrupt not asserted.
- 1 Interrupt asserted.

A register write that sets IMASK to 1 latches this bit to reflect the status of the interrupt immediately before that write.

Reset value is architecturally UNKNOWN.

IMASK, bit [1]

Timer interrupt mask bit. Permitted values are:

- 0 Timer interrupt is not masked.
- 1 Timer interrupt is masked.

Reset value is architecturally UNKNOWN.

ENABLE, bit [0]

Enables the timer. Permitted values are:

- 0 Timer disabled.
- 1 Timer enabled.

Disabling the timer masks the timer interrupt, but the timer value continues to count down.

Resets to 0.

Accessing the CNTP_CTL:

To access the CNTP_CTL:

MRC p15,0,<Rt>,c14,c2,1 ; Read CNTP_CTL into Rt
MCR p15,0,<Rt>,c14,c2,1 ; Write Rt to CNTP_CTL

Register access is encoded as follows:

coproc	opc1	CRn	CRm	opc2
1111	000	1110	0010	001

G4.5.8 CNTP_CVAL, Counter-timer Physical Timer CompareValue register

The CNTP_CVAL characteristics are:

Purpose

Holds the compare value for the EL1 physical timer.

This register is part of the Generic Timer registers functional group.

Usage constraints

This register is accessible as shown below:

When accessed as CNTP_CVAL(S):

EL0 (NS)	EL0 (S)	EL1 (NS)	EL1 (S)	EL2	EL3 (SCR.NS=1)	EL3 (SCR.NS=0)
-	Config-RW	-	RW	-	-	RW

When accessed as CNTP_CVAL(NS):

EL0 (NS)	EL0 (S)	EL1 (NS)	EL1 (S)	EL2	EL3 (SCR.NS=1)	EL3 (SCR.NS=0)
Config-RW	-	Config-RW	-	RW	RW	-

This register is accessible at EL0 when [CNTKCTL.EL0PTEN](#) is set to 1.

If EL2 is implemented, this register is accessible at Non-secure EL1 and EL0 when [CNTHCTL.EL1PCEN](#) is set to 1.

Configurations

CNTP_CVAL(NS) is architecturally mapped to AArch64 register [CNTP_CVAL_EL0](#).

CNTP_CVAL is architecturally mapped to external register [CNTP_CVAL](#).

If EL3 is using AArch32, there are separate Secure and Non-secure instances of this register.

Attributes

CNTP_CVAL is a 64-bit register.

The CNTP_CVAL bit assignments are:

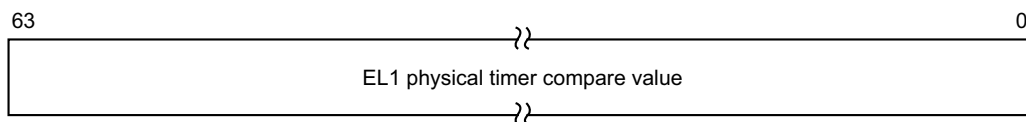

Bits [63:0]

EL1 physical timer compare value.

Accessing the CNTP_CVAL:

To access the CNTP_CVAL:

MRRC p15,2,<Rt>,<Rt2>,c14 ; Read 64-bit CNTP_CVAL into Rt (low word) and Rt2 (high word)
MCRR p15,2,<Rt>,<Rt2>,c14 ; Write Rt (low word) and Rt2 (high word) to 64-bit CNTP_CVAL

Register access is encoded as follows:

coproc	opc1	CRm
1111	0010	1110

G4.5.9 CNTP_TVAL, Counter-timer Physical Timer TimerValue register

The CNTP_TVAL characteristics are:

Purpose

Holds the timer value for the EL1 physical timer. This provides a 32-bit downcounter.
This register is part of the Generic Timer registers functional group.

Usage constraints

This register is accessible as shown below:

When accessed as CNTP_TVAL(S):

EL0 (NS)	EL0 (S)	EL1 (NS)	EL1 (S)	EL2	EL3 (SCR.NS=1)	EL3 (SCR.NS=0)
-	Config-RW	-	RW	-	-	RW

When accessed as CNTP_TVAL(NS):

EL0 (NS)	EL0 (S)	EL1 (NS)	EL1 (S)	EL2	EL3 (SCR.NS=1)	EL3 (SCR.NS=0)
Config-RW	-	Config-RW	-	RW	RW	-

This register is accessible at EL0 when [CNTKCTL.ELOPTEN](#) is set to 1.

If EL2 is implemented, this register is accessible at Non-secure EL1 and EL0 when [CNTHCTL.ELIPCEN](#) is set to 1.

Configurations

CNTP_TVAL(NS) is architecturally mapped to AArch64 register [CNTP_TVAL_ELO](#).

CNTP_TVAL is architecturally mapped to external register [CNTP_TVAL](#).

If EL3 is using AArch32, there are separate Secure and Non-secure instances of this register.

Attributes

CNTP_TVAL is a 32-bit register.

The CNTP_TVAL bit assignments are:

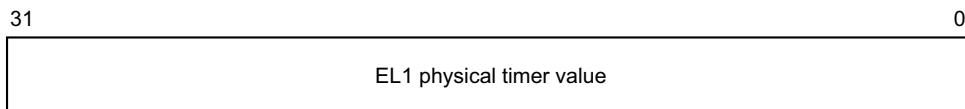

Bits [31:0]

EL1 physical timer value.

Accessing the CNTP_TVAL:

To access the CNTP_TVAL:

MRC p15,0,<Rt>,c14,c2,0 ; Read CNTP_TVAL into Rt
MCR p15,0,<Rt>,c14,c2,0 ; Write Rt to CNTP_TVAL

Register access is encoded as follows:

coproc	opc1	CRn	CRm	opc2
1111	000	1110	0010	000

G4.5.10 CNTPCT, Counter-timer Physical Count register

The CNTPCT characteristics are:

Purpose

Holds the 64-bit physical count value.

This register is part of the Generic Timer registers functional group.

Usage constraints

This register is accessible as shown below:

EL0 (NS)	EL0 (S)	EL1 (NS)	EL1 (S)	EL2	EL3 (SCR.NS=1)	EL3 (SCR.NS=0)
Config-RO	Config-RO	Config-RO	RO	RO	RO	RO

This register is accessible at EL0 when [CNTKCTL.EL0PCTEN](#) is set to 1.

If EL2 is implemented, this register is accessible at Non-secure EL1 and EL0 when [CNTHCTL.EL1PCTEN](#) is set to 1.

Configurations

CNTPCT is architecturally mapped to AArch64 register [CNTPCT_EL0](#).

CNTPCT is architecturally mapped to external register [CNTPCT](#).

There is one instance of this register that is used in both Secure and Non-secure states.

Attributes

CNTPCT is a 64-bit register.

The CNTPCT bit assignments are:

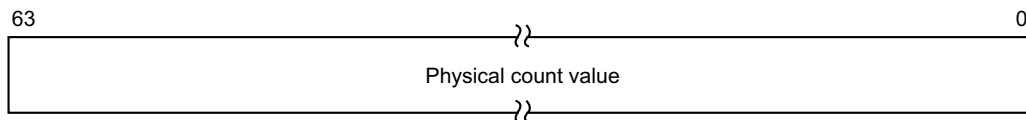

Bits [63:0]

Physical count value.

Accessing the CNTPCT:

To access the CNTPCT:

MRRC p15,0,<Rt>,<Rt2>,c14 ; Read 64-bit CNTPCT into Rt (low word) and Rt2 (high word)

Register access is encoded as follows:

coproc	opc1	CRm
1111	0000	1110

G4.5.11 CNTV_CTL, Counter-timer Virtual Timer Control register

The CNTV_CTL characteristics are:

Purpose

Control register for the virtual timer.

This register is part of the Generic Timer registers functional group.

Usage constraints

This register is accessible as shown below:

EL0 (NS)	EL0 (S)	EL1 (NS)	EL1 (S)	EL2	EL3 (SCR.NS=1)	EL3 (SCR.NS=0)
Config-RW	Config-RW	RW	RW	RW	RW	RW

This register is accessible at EL0 when [CNTKCTL.EL0VTEN](#) is set to 1.

Configurations

CNTV_CTL is architecturally mapped to AArch64 register [CNTV_CTL_EL0](#).

CNTV_CTL is architecturally mapped to external register [CNTV_CTL](#).

There is one instance of this register that is used in both Secure and Non-secure states.

Attributes

CNTV_CTL is a 32-bit register.

The CNTV_CTL bit assignments are:

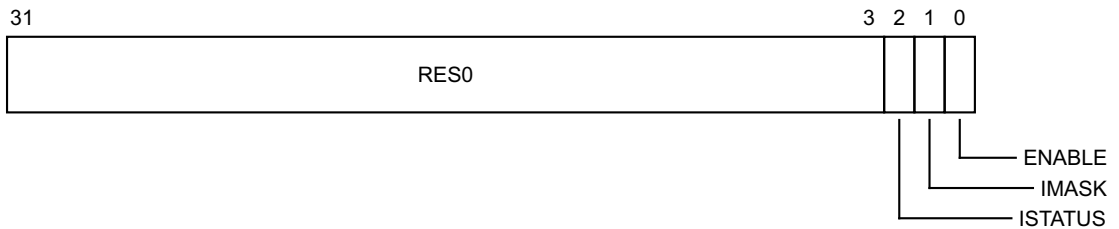

Bits [31:3]

Reserved, RES0.

ISTATUS, bit [2]

The status of the timer interrupt. This bit is read-only. Permitted values are:

- 0 Interrupt not asserted.
- 1 Interrupt asserted.

A register write that sets IMASK to 1 latches this bit to reflect the status of the interrupt immediately before that write.

Reset value is architecturally UNKNOWN.

IMASK, bit [1]

Timer interrupt mask bit. Permitted values are:

- 0 Timer interrupt is not masked.
- 1 Timer interrupt is masked.

Reset value is architecturally UNKNOWN.

ENABLE, bit [0]

Enables the timer. Permitted values are:

0 Timer disabled.

1 Timer enabled.

Disabling the timer masks the timer interrupt, but the timer value continues to count down.

Resets to 0.

Accessing the CNTV_CTL:

To access the CNTV_CTL:

MRC p15,0,<Rt>,c14,c3,1 ; Read CNTV_CTL into Rt

MCR p15,0,<Rt>,c14,c3,1 ; Write Rt to CNTV_CTL

Register access is encoded as follows:

coproc	opc1	CRn	CRm	opc2
1111	000	1110	0011	001

G4.5.12 CNTV_CVAL, Counter-timer Virtual Timer CompareValue register

The CNTV_CVAL characteristics are:

Purpose

Holds the compare value for the virtual timer.
 This register is part of the Generic Timer registers functional group.

Usage constraints

This register is accessible as shown below:

EL0 (NS)	EL0 (S)	EL1 (NS)	EL1 (S)	EL2	EL3 (SCR.NS=1)	EL3 (SCR.NS=0)
Config-RW	Config-RW	RW	RW	RW	RW	RW

This register is accessible at EL0 when CNTKCTL.EL0VTEN is set to 1.

Configurations

CNTV_CVAL is architecturally mapped to AArch64 register CNTV_CVAL_EL0.
 CNTV_CVAL is architecturally mapped to external register CNTV_CVAL.
 There is one instance of this register that is used in both Secure and Non-secure states.

Attributes

CNTV_CVAL is a 64-bit register.

The CNTV_CVAL bit assignments are:

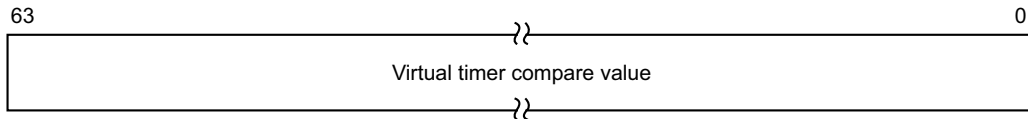

Bits [63:0]

Virtual timer compare value.

Accessing the CNTV_CVAL:

To access the CNTV_CVAL:

MRRC p15,3,<Rt>,<Rt2>,c14 ; Read 64-bit CNTV_CVAL into Rt (low word) and Rt2 (high word)
 MCRR p15,3,<Rt>,<Rt2>,c14 ; Write Rt (low word) and Rt2 (high word) to 64-bit CNTV_CVAL

Register access is encoded as follows:

coproc	opc1	CRm
1111	0011	1110

G4.5.13 CNTV_TVAL, Counter-timer Virtual Timer TimerValue register

The CNTV_TVAL characteristics are:

Purpose

Holds the timer value for the virtual timer.

This register is part of the Generic Timer registers functional group.

Usage constraints

This register is accessible as shown below:

EL0 (NS)	EL0 (S)	EL1 (NS)	EL1 (S)	EL2	EL3 (SCR.NS=1)	EL3 (SCR.NS=0)
Config-RW	Config-RW	RW	RW	RW	RW	RW

This register is accessible at EL0 when [CNTKCTL.EL0VTEN](#) is set to 1.

Configurations

CNTV_TVAL is architecturally mapped to AArch64 register [CNTV_TVAL_EL0](#).

CNTV_TVAL is architecturally mapped to external register [CNTV_TVAL](#).

There is one instance of this register that is used in both Secure and Non-secure states.

Attributes

CNTV_TVAL is a 32-bit register.

The CNTV_TVAL bit assignments are:

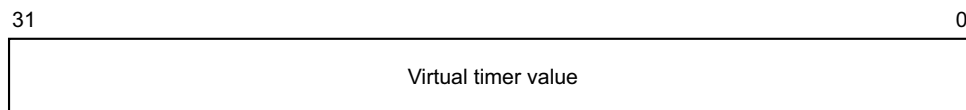

Bits [31:0]

Virtual timer value.

Accessing the CNTV_TVAL:

To access the CNTV_TVAL:

MRC p15,0,<Rt>,c14,c3,0 ; Read CNTV_TVAL into Rt

MCR p15,0,<Rt>,c14,c3,0 ; Write Rt to CNTV_TVAL

Register access is encoded as follows:

coproc	opc1	CRn	CRm	opc2
1111	000	1110	0011	000

G4.5.14 CNTVCT, Counter-timer Virtual Count register

The CNTVCT characteristics are:

Purpose

Holds the 64-bit virtual count value.

This register is part of the Generic Timer registers functional group.

Usage constraints

This register is accessible as shown below:

EL0 (NS)	EL0 (S)	EL1 (NS)	EL1 (S)	EL2	EL3 (SCR.NS=1)	EL3 (SCR.NS=0)
Config-RO	Config-RO	RO	RO	RO	RO	RO

This register is accessible at EL0 when CNTKCTL.EL0VCTEN is set to 1.

Configurations

CNTVCT is architecturally mapped to AArch64 register CNTVCT_EL0.

CNTVCT is architecturally mapped to external register CNTVCT.

There is one instance of this register that is used in both Secure and Non-secure states.

The virtual count value is equal to the physical count value visible in CNTPCT minus the virtual offset visible in CNTVOFF.

When EL2 is not implemented, CNTVOFF is RES0, and the value of this register is the same as the value of CNTPCT.

Attributes

CNTVCT is a 64-bit register.

The CNTVCT bit assignments are:

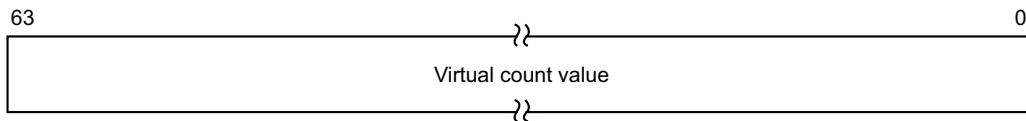

Bits [63:0]

Virtual count value.

Accessing the CNTVCT:

To access the CNTVCT:

MRRC p15,1,<Rt>,<Rt2>,c14 ; Read 64-bit CNTVCT into Rt (low word) and Rt2 (high word)

Register access is encoded as follows:

coproc	opc1	CRm
1111	0001	1110

G4.5.15 CNTVOFF, Counter-timer Virtual Offset register

The CNTVOFF characteristics are:

Purpose

Holds the 64-bit virtual offset.

This register is part of:

- the Generic Timer registers functional group
- the Virtualization registers functional group.

Usage constraints

This register is accessible as shown below:

EL0 (NS)	EL0 (S)	EL1 (NS)	EL1 (S)	EL2	EL3 (SCR.NS=1)	EL3 (SCR.NS=0)
-	-	-	-	RW	RW	-

Configurations

CNTVOFF is architecturally mapped to AArch64 register [CNTVOFF_EL2](#).

CNTVOFF is architecturally mapped to external register [CNTVOFF](#).

CNTVOFF is architecturally mapped to external register [CNTVOFF<n>](#).

If EL2 is not implemented, this register is RES0 from EL3.

Attributes

CNTVOFF is a 64-bit register.

The CNTVOFF bit assignments are:

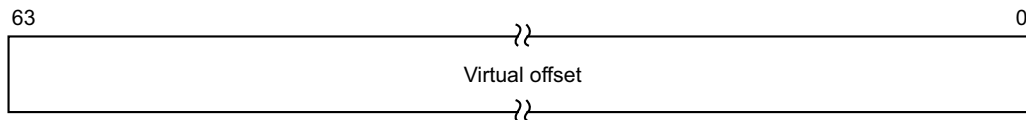

Bits [63:0]

Virtual offset.

Accessing the CNTVOFF:

To access the CNTVOFF:

MRRC p15,4,<Rt>,<Rt2>,c14 ; Read 64-bit CNTVOFF into Rt (low word) and Rt2 (high word)

MCRW p15,4,<Rt>,<Rt2>,c14 ; Write Rt (low word) and Rt2 (high word) to 64-bit CNTVOFF

Register access is encoded as follows:

coproc	opc1	CRm
1111	0100	1110

G4.6 Generic Interrupt Controller CPU interface registers

This section describes the GIC CPU interface registers in AArch32 state.

G4.6.1 ICC_AP0R0, Interrupt Controller Active Priorities Register (0,0)

The ICC_AP0R0 characteristics are:

Purpose

Provides information about the active priorities for the current interrupt regime.

This register is part of the GIC registers functional group.

Usage constraints

This register is accessible as shown below:

EL0 (NS)	EL0 (S)	EL1 (NS)	EL1 (S)	EL2	EL3 (SCR.NS=1)	EL3 (SCR.NS=0)
-	-	RW	RW	RW	RW	RW

In implementations supporting fewer than 8 bits of priority, some of these registers correspond to unimplemented priority levels. Access to such registers will generate an Undefined exception.

Configurations

ICC_AP0R0 is architecturally mapped to AArch64 register [ICC_AP0R0_EL1](#).

There is one instance of this register that is used in both Secure and Non-secure states.

Attributes

ICC_AP0R0 is a 32-bit register.

The ICC_AP0R0 bit assignments are:

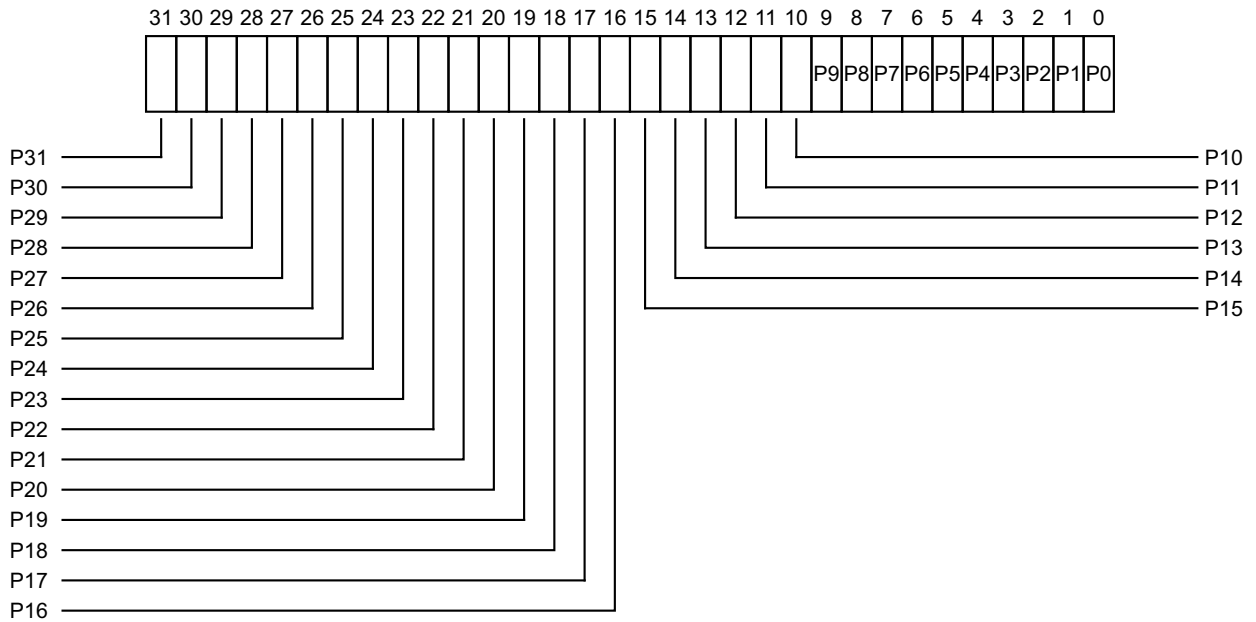

P<n>, bit [n], for n = 0 to 31

Provides information about priority M, according to the following relationship:

Bit P<n> corresponds to priority (M divided by 2^U) minus 1, where U is the number of unimplemented bits of priority and is equal to (7 - ICC_CTLR_EL1.PRIbits).

For example, in a system with ICC_CTLR_EL1.PRIbits == 0b100:

- There are 5 bits of implemented priority.
- This means there are 3 bits of unimplemented priority, which are always at the least significant end (bits [2:0] are RES0).
- Valid priorities are 8, 16, 24, 32, and so on. Dividing these by 2^3 gives 1, 2, 3, 4, and so on.
- Subtracting 1 from each gives bits 0, 1, 2, 3, and so on that provide information about those priorities.

Accesses to these registers from an interrupt regime give a view of the active priorities that is appropriate for that interrupt regime, to allow save and restore of the appropriate state.

Interrupt regime and the number of security states supported by the Distributor affect the view as follows. Unless otherwise stated, when a bit is successfully set to one, this clears any other active priorities corresponding to that bit.

Exception level	AP0Rn access
(Secure) EL3	Permitted. Accesses Group 0 Secure active priorities.
Secure EL1	Permitted. Accesses Group 0 Secure active priorities.
Non-secure EL1 access for a Virtual interrupt	ICH_AP0Rn_EL2
Non-secure EL1 or EL2 when GIC Distributor supports two Security states	Permitted. Accesses Group 0 Secure active priorities.
Non-secure EL1 or EL2 when GIC Distributor supports one Security state	Permitted. Accesses Group 0 active priorities.

A Virtual interrupt in this case means that the interrupt group associated with the register has been virtualized.

Accessing the ICC_AP0R0:

To access the ICC_AP0R0:

MRC p15,0,<Rt>,c12,c8,4 ; Read ICC_AP0R0 into Rt
MCR p15,0,<Rt>,c12,c8,4 ; Write Rt to ICC_AP0R0

Register access is encoded as follows:

coproc	opc1	CRn	CRm	opc2
1111	000	1100	1000	100

G4.6.2 ICC_AP0R1, Interrupt Controller Active Priorities Register (0,1)

The ICC_AP0R1 characteristics are:

Purpose

Provides information about the active priorities for the current interrupt regime.
 This register is part of the GIC registers functional group.

Usage constraints

This register is accessible as shown below:

EL0 (NS)	EL0 (S)	EL1 (NS)	EL1 (S)	EL2	EL3 (SCR.NS=1)	EL3 (SCR.NS=0)
-	-	RW	RW	RW	RW	RW

In implementations supporting fewer than 8 bits of priority, some of these registers correspond to unimplemented priority levels. Access to such registers will generate an Undefined exception.

Configurations

ICC_AP0R1 is architecturally mapped to AArch64 register [ICC_AP0R1_EL1](#).
 There is one instance of this register that is used in both Secure and Non-secure states.

Attributes

ICC_AP0R1 is a 32-bit register.

The ICC_AP0R1 bit assignments are:

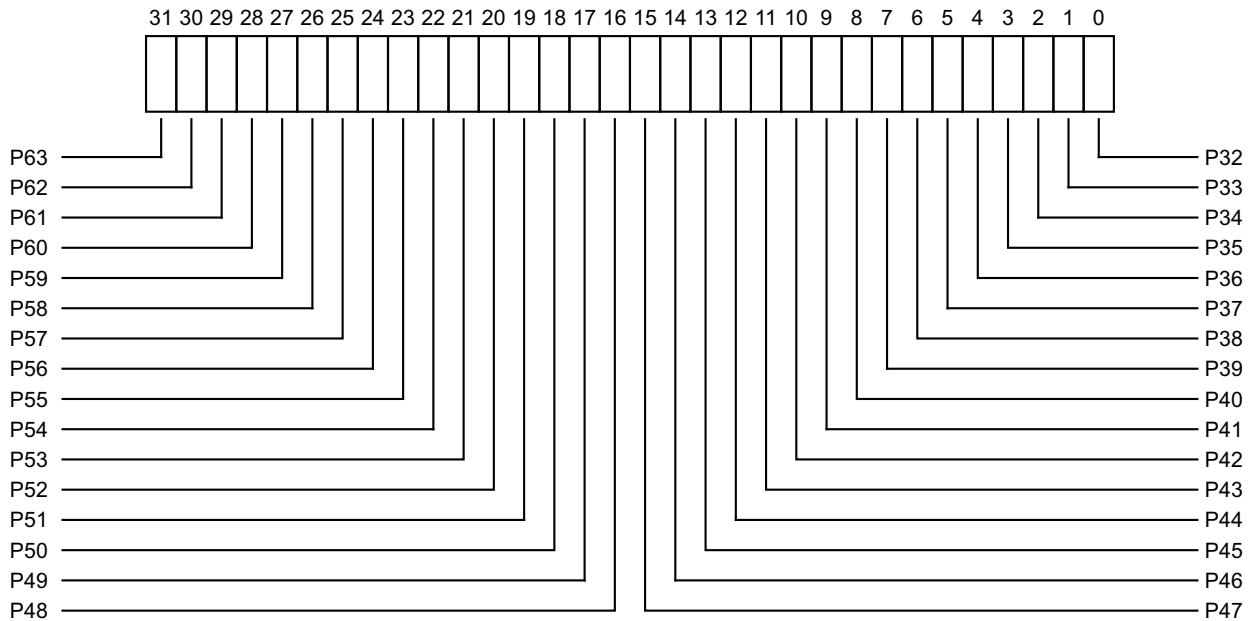

P<n>, bit [(n-32)], for n = 32 to 63

Provides information about priority M, according to the following relationship:

Bit P<n> corresponds to priority (M divided by 2^U) minus 1, where U is the number of unimplemented bits of priority and is equal to $(7 - \text{ICC_CTLR_EL1.PRIbits})$.

For example, in a system with $\text{ICC_CTLR_EL1.PRIbits} == 0b100$:

- There are 5 bits of implemented priority.

- This means there are 3 bits of unimplemented priority, which are always at the least significant end (bits [2:0] are RES0).
- Valid priorities are 8, 16, 24, 32, and so on. Dividing these by 2^3 gives 1, 2, 3, 4, and so on.
- Subtracting 1 from each gives bits 0, 1, 2, 3, and so on that provide information about those priorities.

Accesses to these registers from an interrupt regime give a view of the active priorities that is appropriate for that interrupt regime, to allow save and restore of the appropriate state.

Interrupt regime and the number of security states supported by the Distributor affect the view as follows. Unless otherwise stated, when a bit is successfully set to one, this clears any other active priorities corresponding to that bit.

Exception level	AP0Rn access
(Secure) EL3	Permitted. Accesses Group 0 Secure active priorities.
Secure EL1	Permitted. Accesses Group 0 Secure active priorities.
Non-secure EL1 access for a Virtual interrupt	ICH_AP0Rn_EL2
Non-secure EL1 or EL2 when GIC Distributor supports two Security states	Permitted. Accesses Group 0 Secure active priorities.
Non-secure EL1 or EL2 when GIC Distributor supports one Security state	Permitted. Accesses Group 0 active priorities.

A Virtual interrupt in this case means that the interrupt group associated with the register has been virtualized.

Accessing the ICC_AP0R1:

To access the ICC_AP0R1:

MRC p15,0,<Rt>,c12,c8,5 ; Read ICC_AP0R1 into Rt
MCR p15,0,<Rt>,c12,c8,5 ; Write Rt to ICC_AP0R1

Register access is encoded as follows:

coproc	opc1	CRn	CRm	opc2
1111	000	1100	1000	101

G4.6.3 ICC_AP0R2, Interrupt Controller Active Priorities Register (0,2)

The ICC_AP0R2 characteristics are:

Purpose

Provides information about the active priorities for the current interrupt regime.
 This register is part of the GIC registers functional group.

Usage constraints

This register is accessible as shown below:

EL0 (NS)	EL0 (S)	EL1 (NS)	EL1 (S)	EL2	EL3 (SCR.NS=1)	EL3 (SCR.NS=0)
-	-	RW	RW	RW	RW	RW

In implementations supporting fewer than 8 bits of priority, some of these registers correspond to unimplemented priority levels. Access to such registers will generate an Undefined exception.

Configurations

ICC_AP0R2 is architecturally mapped to AArch64 register [ICC_AP0R2_EL1](#).
 There is one instance of this register that is used in both Secure and Non-secure states.

Attributes

ICC_AP0R2 is a 32-bit register.

The ICC_AP0R2 bit assignments are:

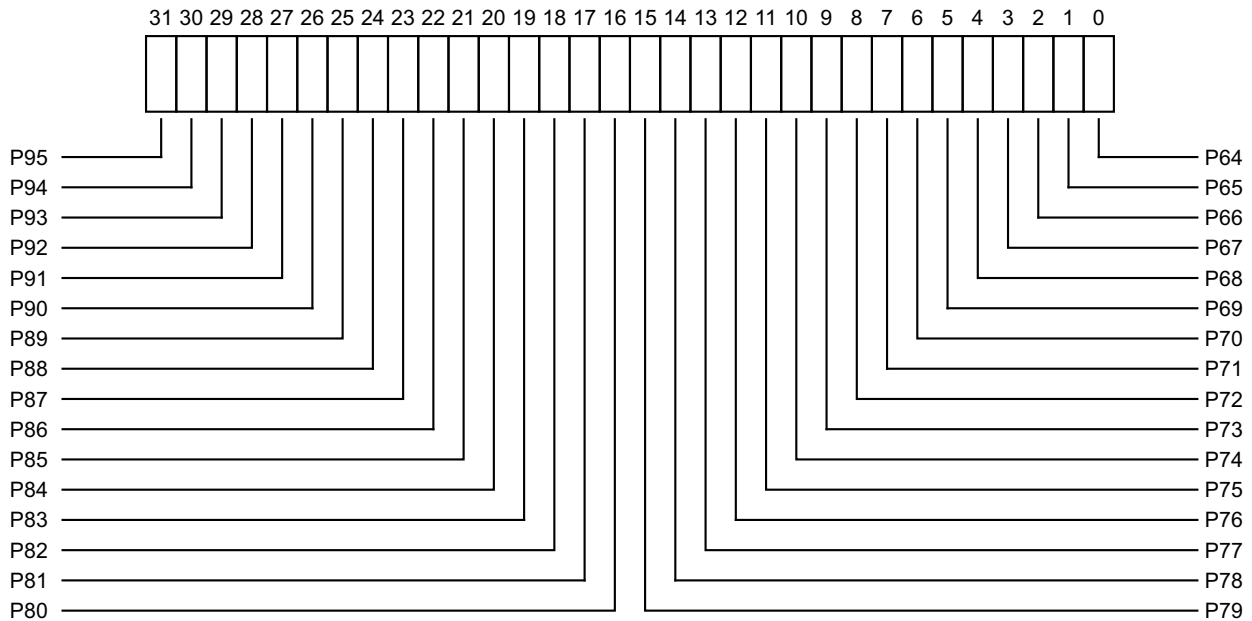

P<n>, bit [(n-64)], for n = 64 to 95

Provides information about priority M, according to the following relationship:
 Bit P<n> corresponds to priority (M divided by 2^U) minus 1, where U is the number of unimplemented bits of priority and is equal to (7 - ICC_CTLR_EL1.PRIbits).

For example, in a system with ICC_CTLR_EL1.PRIbits == 0b100:

- There are 5 bits of implemented priority.

- This means there are 3 bits of unimplemented priority, which are always at the least significant end (bits [2:0] are RES0).
- Valid priorities are 8, 16, 24, 32, and so on. Dividing these by 2^3 gives 1, 2, 3, 4, and so on.
- Subtracting 1 from each gives bits 0, 1, 2, 3, and so on that provide information about those priorities.

Accesses to these registers from an interrupt regime give a view of the active priorities that is appropriate for that interrupt regime, to allow save and restore of the appropriate state.

Interrupt regime and the number of security states supported by the Distributor affect the view as follows. Unless otherwise stated, when a bit is successfully set to one, this clears any other active priorities corresponding to that bit.

Exception level	AP0Rn access
(Secure) EL3	Permitted. Accesses Group 0 Secure active priorities.
Secure EL1	Permitted. Accesses Group 0 Secure active priorities.
Non-secure EL1 access for a Virtual interrupt	ICH_AP0Rn_EL2
Non-secure EL1 or EL2 when GIC Distributor supports two Security states	Permitted. Accesses Group 0 Secure active priorities.
Non-secure EL1 or EL2 when GIC Distributor supports one Security state	Permitted. Accesses Group 0 active priorities.

A Virtual interrupt in this case means that the interrupt group associated with the register has been virtualized.

Accessing the ICC_AP0R2:

To access the ICC_AP0R2:

MRC p15,0,<Rt>,c12,c8,6 ; Read ICC_AP0R2 into Rt
MCR p15,0,<Rt>,c12,c8,6 ; Write Rt to ICC_AP0R2

Register access is encoded as follows:

coproc	opc1	CRn	CRm	opc2
1111	000	1100	1000	110

G4.6.4 ICC_AP0R3, Interrupt Controller Active Priorities Register (0,3)

The ICC_AP0R3 characteristics are:

Purpose

Provides information about the active priorities for the current interrupt regime.
 This register is part of the GIC registers functional group.

Usage constraints

This register is accessible as shown below:

EL0 (NS)	EL0 (S)	EL1 (NS)	EL1 (S)	EL2	EL3 (SCR.NS=1)	EL3 (SCR.NS=0)
-	-	RW	RW	RW	RW	RW

In implementations supporting fewer than 8 bits of priority, some of these registers correspond to unimplemented priority levels. Access to such registers will generate an Undefined exception.

Configurations

ICC_AP0R3 is architecturally mapped to AArch64 register [ICC_AP0R3_EL1](#).
 There is one instance of this register that is used in both Secure and Non-secure states.

Attributes

ICC_AP0R3 is a 32-bit register.

The ICC_AP0R3 bit assignments are:

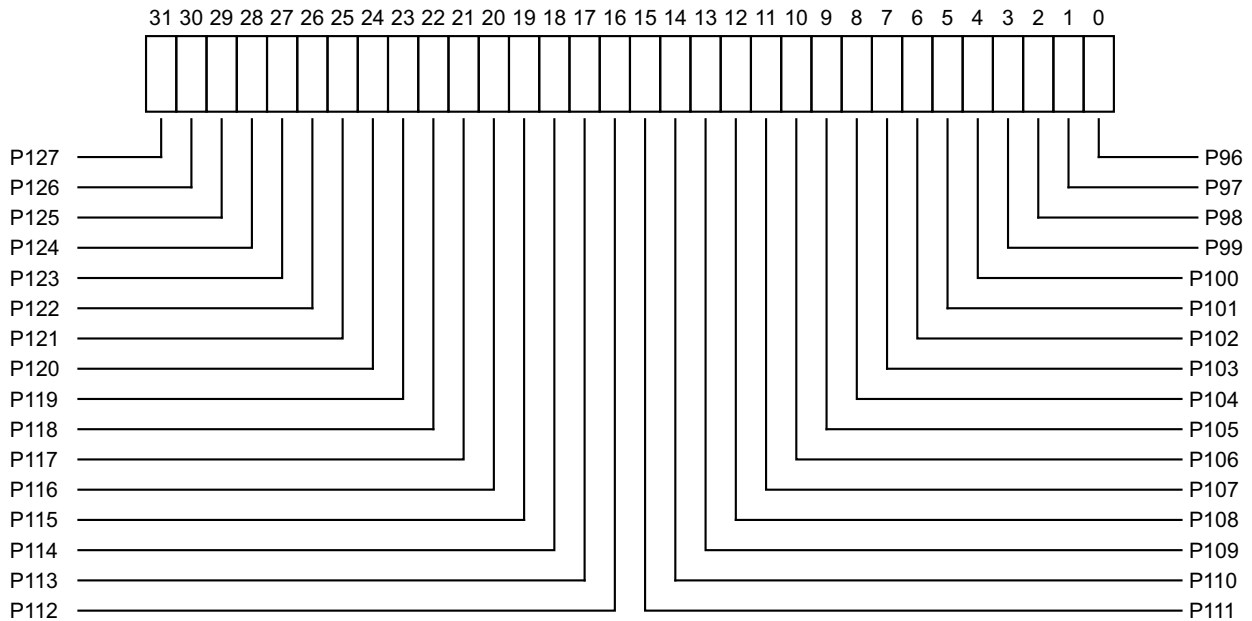

P<n>, bit [(n-96)], for n = 96 to 127

Provides information about priority M, according to the following relationship:
 Bit P<n> corresponds to priority (M divided by 2^U) minus 1, where U is the number of unimplemented bits of priority and is equal to (7 - ICC_CTLR_EL1.PRIbits).

For example, in a system with ICC_CTLR_EL1.PRIbits == 0b100:

- There are 5 bits of implemented priority.

- This means there are 3 bits of unimplemented priority, which are always at the least significant end (bits [2:0] are RES0).
- Valid priorities are 8, 16, 24, 32, and so on. Dividing these by 2^3 gives 1, 2, 3, 4, and so on.
- Subtracting 1 from each gives bits 0, 1, 2, 3, and so on that provide information about those priorities.

Accesses to these registers from an interrupt regime give a view of the active priorities that is appropriate for that interrupt regime, to allow save and restore of the appropriate state.

Interrupt regime and the number of security states supported by the Distributor affect the view as follows. Unless otherwise stated, when a bit is successfully set to one, this clears any other active priorities corresponding to that bit.

Exception level	AP0Rn access
(Secure) EL3	Permitted. Accesses Group 0 Secure active priorities.
Secure EL1	Permitted. Accesses Group 0 Secure active priorities.
Non-secure EL1 access for a Virtual interrupt	ICH_AP0Rn_EL2
Non-secure EL1 or EL2 when GIC Distributor supports two Security states	Permitted. Accesses Group 0 Secure active priorities.
Non-secure EL1 or EL2 when GIC Distributor supports one Security state	Permitted. Accesses Group 0 active priorities.

A Virtual interrupt in this case means that the interrupt group associated with the register has been virtualized.

Accessing the ICC_AP0R3:

To access the ICC_AP0R3:

MRC p15,0,<Rt>,c12,c8,7 ; Read ICC_AP0R3 into Rt
MCR p15,0,<Rt>,c12,c8,7 ; Write Rt to ICC_AP0R3

Register access is encoded as follows:

coproc	opc1	CRn	CRm	opc2
1111	000	1100	1000	111

G4.6.5 ICC_AP1R0, Interrupt Controller Active Priorities Register (1,0)

The ICC_AP1R0 characteristics are:

Purpose

Provides information about the active priorities for the current interrupt regime.
 This register is part of the GIC registers functional group.

Usage constraints

This register is accessible as shown below:

EL0 (NS)	EL0 (S)	EL1 (NS)	EL1 (S)	EL2	EL3 (SCR.NS=1)	EL3 (SCR.NS=0)
-	-	RW	RW	RW	RW	RW

In implementations supporting fewer than 8 bits of priority, some of these registers correspond to unimplemented priority levels. Access to such registers will generate an Undefined exception.

Configurations

ICC_AP1R0 is architecturally mapped to AArch64 register [ICC_AP1R0_EL1](#).
 There is one instance of this register that is used in both Secure and Non-secure states.

Attributes

ICC_AP1R0 is a 32-bit register.

The ICC_AP1R0 bit assignments are:

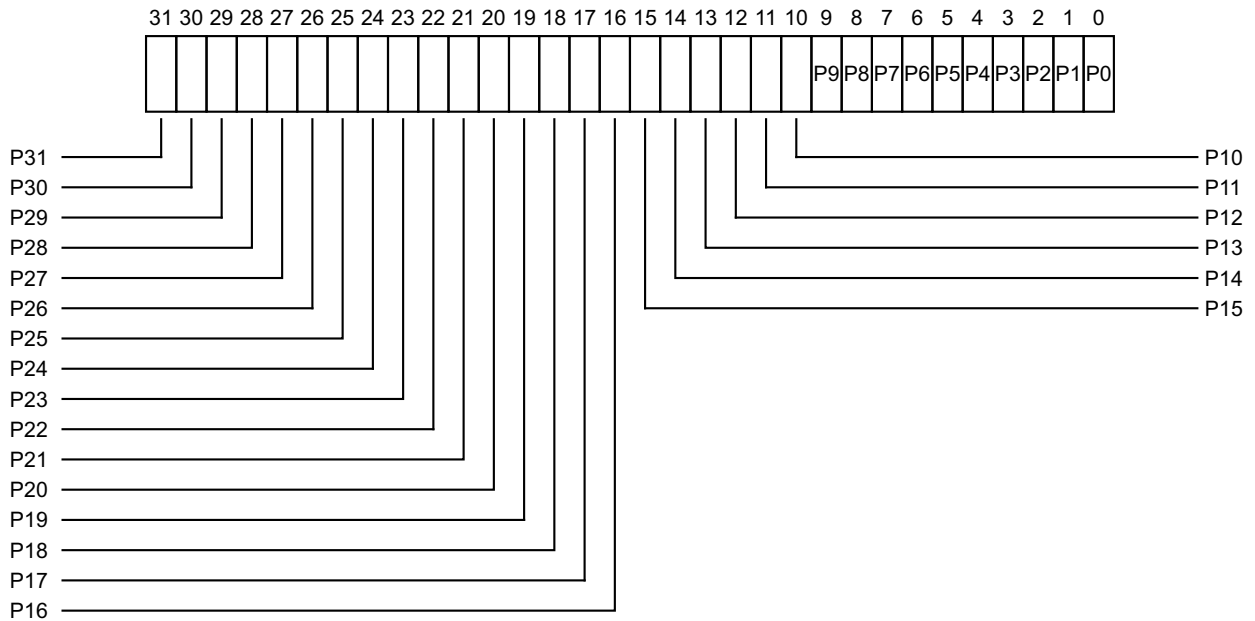

P<n>, bit [n], for n = 0 to 31

Provides information about priority M, according to the following relationship:
 Bit P<n> corresponds to priority (M divided by 2^U) minus 1, where U is the number of unimplemented bits of priority and is equal to (7 - ICC_CTLR_EL1.PRIBits).

For example, in a system with ICC_CTLR_EL1.PRIBits == 0b100:

- There are 5 bits of implemented priority.

- This means there are 3 bits of unimplemented priority, which are always at the least significant end (bits [2:0] are RES0).
- Valid priorities are 8, 16, 24, 32, and so on. Dividing these by 2^3 gives 1, 2, 3, 4, and so on.
- Subtracting 1 from each gives bits 0, 1, 2, 3, and so on that provide information about those priorities.

Accesses to these registers from an interrupt regime give a view of the active priorities that is appropriate for that interrupt regime, to allow save and restore of the appropriate state.

Interrupt regime and the number of security states supported by the Distributor affect the view as follows. Unless otherwise stated, when a bit is successfully set to one, this clears any other active priorities corresponding to that bit.

Current exception level and security state	AP1Rn access
(Secure) EL3	Permitted. When SCR_EL3.NS is 0, accesses Group 1 Secure active priorities. When SCR_EL3.NS is 1, accesses Group 1 Non-secure active priorities (unshifted). When a bit is written, the bit is only updated if the corresponding Group 0 and Group 1 Secure active priority is zero.
Secure EL1	Permitted. Accesses Group 1 Secure active priorities (unshifted). When a bit is written, the bit is only updated if the corresponding Group 0 Secure active priority is zero.
Non-secure EL1 access for a Virtual interrupt	ICH_AP1Rn_EL2
Non-secure EL1 or EL2 when GIC Distributor supports two Security states	Permitted. Accesses Group 1 Non-secure active priorities (shifted). When a bit is written, the bit is only updated if the corresponding Group 0 and Group 1 Secure active priority is zero.
Non-secure EL1 or EL2 when GIC Distributor supports one Security state	Permitted. Accesses Group 1 Non-secure active priorities (unshifted). When a bit is written, the bit is only updated if the Group 0 active priority is zero.

A Virtual interrupt in this case means that the interrupt group associated with the register has been virtualized.

Accessing the ICC_AP1R0:

To access the ICC_AP1R0:

MRC p15,0,<Rt>,c12,c9,0 ; Read ICC_AP1R0 into Rt
MCR p15,0,<Rt>,c12,c9,0 ; Write Rt to ICC_AP1R0

Register access is encoded as follows:

coproc	opc1	CRn	CRm	opc2
1111	000	1100	1001	000

G4.6.6 ICC_AP1R1, Interrupt Controller Active Priorities Register (1,1)

The ICC_AP1R1 characteristics are:

Purpose

Provides information about the active priorities for the current interrupt regime.
 This register is part of the GIC registers functional group.

Usage constraints

This register is accessible as shown below:

EL0 (NS)	EL0 (S)	EL1 (NS)	EL1 (S)	EL2	EL3 (SCR.NS=1)	EL3 (SCR.NS=0)
-	-	RW	RW	RW	RW	RW

In implementations supporting fewer than 8 bits of priority, some of these registers correspond to unimplemented priority levels. Access to such registers will generate an Undefined exception.

Configurations

ICC_AP1R1 is architecturally mapped to AArch64 register [ICC_AP1R1_EL1](#).
 There is one instance of this register that is used in both Secure and Non-secure states.

Attributes

ICC_AP1R1 is a 32-bit register.

The ICC_AP1R1 bit assignments are:

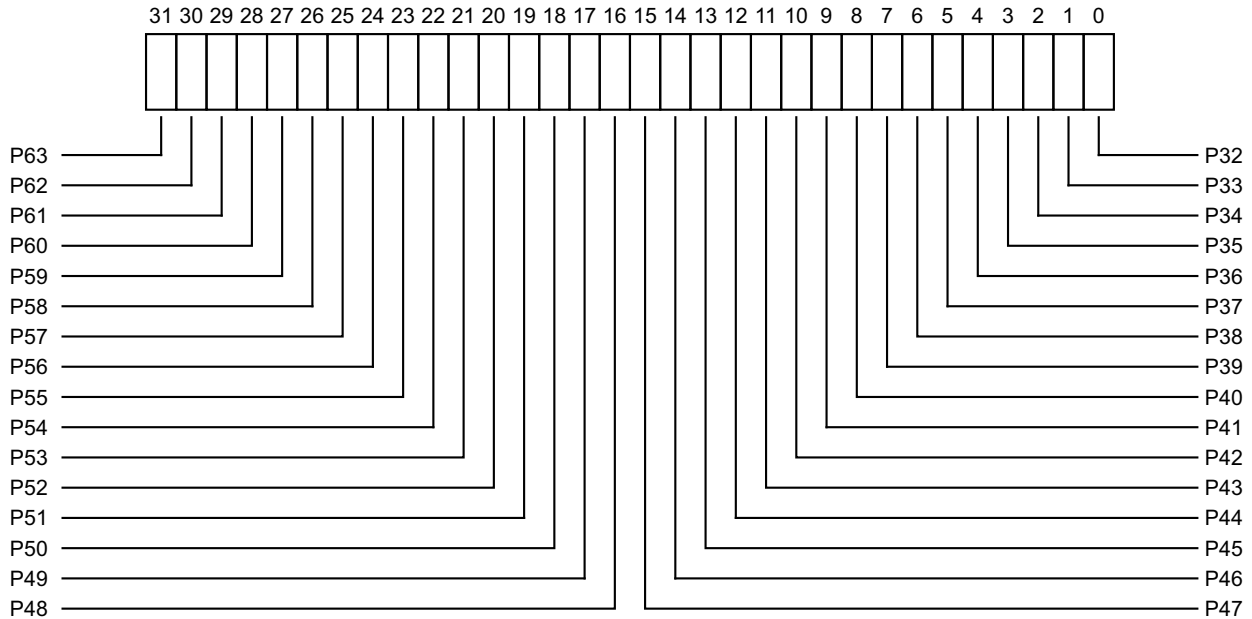

P<n>, bit [(n-32)], for n = 32 to 63

Provides information about priority M, according to the following relationship:
 Bit P<n> corresponds to priority (M divided by 2^U) minus 1, where U is the number of unimplemented bits of priority and is equal to (7 - ICC_CTLR_EL1.PRIbits).

For example, in a system with ICC_CTLR_EL1.PRIbits == 0b100:

- There are 5 bits of implemented priority.

- This means there are 3 bits of unimplemented priority, which are always at the least significant end (bits [2:0] are RES0).
- Valid priorities are 8, 16, 24, 32, and so on. Dividing these by 2^3 gives 1, 2, 3, 4, and so on.
- Subtracting 1 from each gives bits 0, 1, 2, 3, and so on that provide information about those priorities.

Accesses to these registers from an interrupt regime give a view of the active priorities that is appropriate for that interrupt regime, to allow save and restore of the appropriate state.

Interrupt regime and the number of security states supported by the Distributor affect the view as follows. Unless otherwise stated, when a bit is successfully set to one, this clears any other active priorities corresponding to that bit.

Current exception level and security state	AP1Rn access
(Secure) EL3	Permitted. When SCR_EL3.NS is 0, accesses Group 1 Secure active priorities. When SCR_EL3.NS is 1, accesses Group 1 Non-secure active priorities (unshifted). When a bit is written, the bit is only updated if the corresponding Group 0 and Group 1 Secure active priority is zero.
Secure EL1	Permitted. Accesses Group 1 Secure active priorities (unshifted). When a bit is written, the bit is only updated if the corresponding Group 0 Secure active priority is zero.
Non-secure EL1 access for a Virtual interrupt	ICH_AP1Rn_EL2
Non-secure EL1 or EL2 when GIC Distributor supports two Security states	Permitted. Accesses Group 1 Non-secure active priorities (shifted). When a bit is written, the bit is only updated if the corresponding Group 0 and Group 1 Secure active priority is zero.
Non-secure EL1 or EL2 when GIC Distributor supports one Security state	Permitted. Accesses Group 1 Non-secure active priorities (unshifted). When a bit is written, the bit is only updated if the Group 0 active priority is zero.

A Virtual interrupt in this case means that the interrupt group associated with the register has been virtualized.

Accessing the ICC_AP1R1:

To access the ICC_AP1R1:

MRC p15,0,<Rt>,c12,c9,1 ; Read ICC_AP1R1 into Rt
MCR p15,0,<Rt>,c12,c9,1 ; Write Rt to ICC_AP1R1

Register access is encoded as follows:

coproc	opc1	CRn	CRm	opc2
1111	000	1100	1001	001

G4.6.7 ICC_AP1R2, Interrupt Controller Active Priorities Register (1,2)

The ICC_AP1R2 characteristics are:

Purpose

Provides information about the active priorities for the current interrupt regime.
 This register is part of the GIC registers functional group.

Usage constraints

This register is accessible as shown below:

EL0 (NS)	EL0 (S)	EL1 (NS)	EL1 (S)	EL2	EL3 (SCR.NS=1)	EL3 (SCR.NS=0)
-	-	RW	RW	RW	RW	RW

In implementations supporting fewer than 8 bits of priority, some of these registers correspond to unimplemented priority levels. Access to such registers will generate an Undefined exception.

Configurations

ICC_AP1R2 is architecturally mapped to AArch64 register [ICC_AP1R2_EL1](#).
 There is one instance of this register that is used in both Secure and Non-secure states.

Attributes

ICC_AP1R2 is a 32-bit register.

The ICC_AP1R2 bit assignments are:

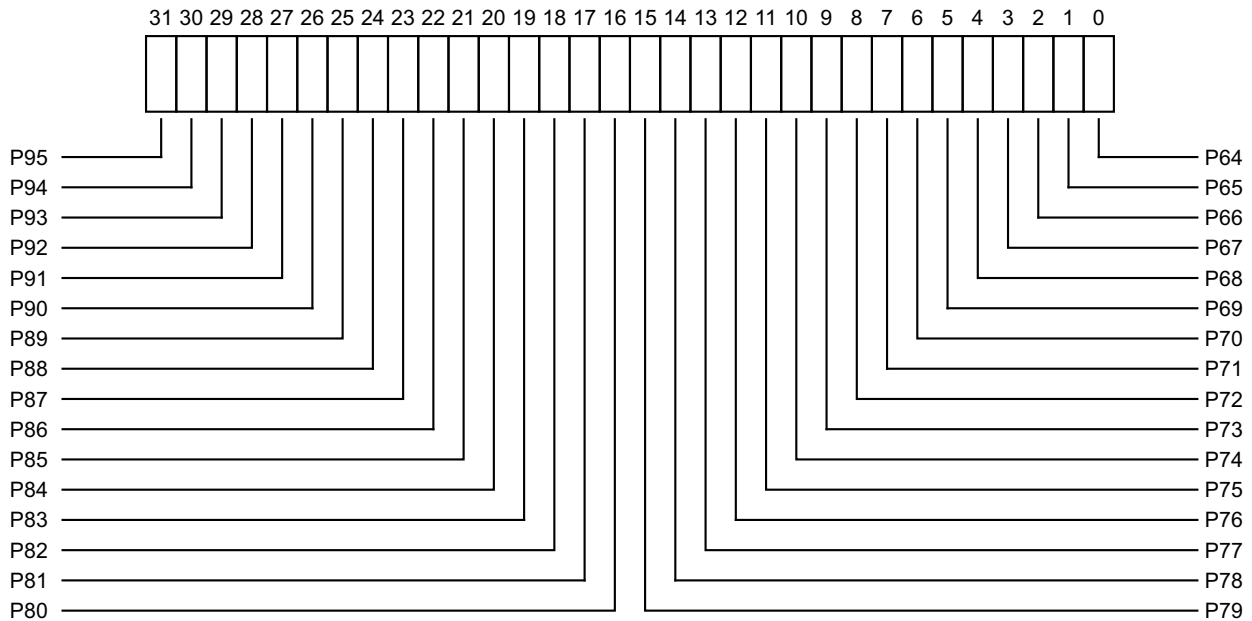

P<n>, bit [(n-64)], for n = 64 to 95

Provides information about priority M, according to the following relationship:
 Bit P<n> corresponds to priority (M divided by 2^U) minus 1, where U is the number of unimplemented bits of priority and is equal to (7 - ICC_CTLR_EL1.PRIbits).
 For example, in a system with ICC_CTLR_EL1.PRIbits == 0b100:

- There are 5 bits of implemented priority.

- This means there are 3 bits of unimplemented priority, which are always at the least significant end (bits [2:0] are RES0).
- Valid priorities are 8, 16, 24, 32, and so on. Dividing these by 2^3 gives 1, 2, 3, 4, and so on.
- Subtracting 1 from each gives bits 0, 1, 2, 3, and so on that provide information about those priorities.

Accesses to these registers from an interrupt regime give a view of the active priorities that is appropriate for that interrupt regime, to allow save and restore of the appropriate state.

Interrupt regime and the number of security states supported by the Distributor affect the view as follows. Unless otherwise stated, when a bit is successfully set to one, this clears any other active priorities corresponding to that bit.

Current exception level and security state	AP1Rn access
(Secure) EL3	Permitted. When SCR_EL3.NS is 0, accesses Group 1 Secure active priorities. When SCR_EL3.NS is 1, accesses Group 1 Non-secure active priorities (unshifted). When a bit is written, the bit is only updated if the corresponding Group 0 and Group 1 Secure active priority is zero.
Secure EL1	Permitted. Accesses Group 1 Secure active priorities (unshifted). When a bit is written, the bit is only updated if the corresponding Group 0 Secure active priority is zero.
Non-secure EL1 access for a Virtual interrupt	ICH_AP1Rn_EL2
Non-secure EL1 or EL2 when GIC Distributor supports two Security states	Permitted. Accesses Group 1 Non-secure active priorities (shifted). When a bit is written, the bit is only updated if the corresponding Group 0 and Group 1 Secure active priority is zero.
Non-secure EL1 or EL2 when GIC Distributor supports one Security state	Permitted. Accesses Group 1 Non-secure active priorities (unshifted). When a bit is written, the bit is only updated if the Group 0 active priority is zero.

A Virtual interrupt in this case means that the interrupt group associated with the register has been virtualized.

Accessing the ICC_AP1R2:

To access the ICC_AP1R2:

MRC p15,0,<Rt>,c12,c9,2 ; Read ICC_AP1R2 into Rt
MCR p15,0,<Rt>,c12,c9,2 ; Write Rt to ICC_AP1R2

Register access is encoded as follows:

coproc	opc1	CRn	CRm	opc2
1111	000	1100	1001	010

G4.6.8 ICC_AP1R3, Interrupt Controller Active Priorities Register (1,3)

The ICC_AP1R3 characteristics are:

Purpose

Provides information about the active priorities for the current interrupt regime.
 This register is part of the GIC registers functional group.

Usage constraints

This register is accessible as shown below:

EL0 (NS)	EL0 (S)	EL1 (NS)	EL1 (S)	EL2	EL3 (SCR.NS=1)	EL3 (SCR.NS=0)
-	-	RW	RW	RW	RW	RW

In implementations supporting fewer than 8 bits of priority, some of these registers correspond to unimplemented priority levels. Access to such registers will generate an Undefined exception.

Configurations

ICC_AP1R3 is architecturally mapped to AArch64 register [ICC_AP1R3_EL1](#).
 There is one instance of this register that is used in both Secure and Non-secure states.

Attributes

ICC_AP1R3 is a 32-bit register.

The ICC_AP1R3 bit assignments are:

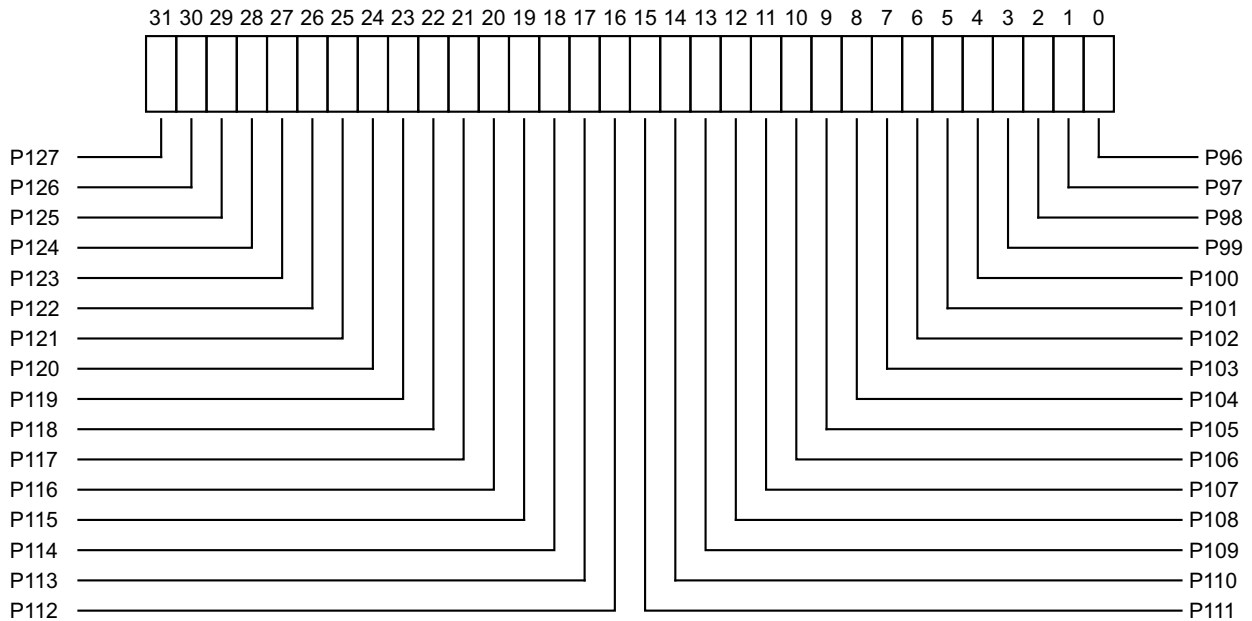

P<n>, bit [(n-96)], for n = 96 to 127

Provides information about priority M, according to the following relationship:
 Bit P<n> corresponds to priority (M divided by 2^U) minus 1, where U is the number of unimplemented bits of priority and is equal to (7 - ICC_CTLR_EL1.PRIbits).

For example, in a system with ICC_CTLR_EL1.PRIbits == 0b100:

- There are 5 bits of implemented priority.

- This means there are 3 bits of unimplemented priority, which are always at the least significant end (bits [2:0] are RES0).
- Valid priorities are 8, 16, 24, 32, and so on. Dividing these by 2^3 gives 1, 2, 3, 4, and so on.
- Subtracting 1 from each gives bits 0, 1, 2, 3, and so on that provide information about those priorities.

Accesses to these registers from an interrupt regime give a view of the active priorities that is appropriate for that interrupt regime, to allow save and restore of the appropriate state.

Interrupt regime and the number of security states supported by the Distributor affect the view as follows. Unless otherwise stated, when a bit is successfully set to one, this clears any other active priorities corresponding to that bit.

Current exception level and security state	AP1Rn access
(Secure) EL3	Permitted. When SCR_EL3.NS is 0, accesses Group 1 Secure active priorities. When SCR_EL3.NS is 1, accesses Group 1 Non-secure active priorities (unshifted). When a bit is written, the bit is only updated if the corresponding Group 0 and Group 1 Secure active priority is zero.
Secure EL1	Permitted. Accesses Group 1 Secure active priorities (unshifted). When a bit is written, the bit is only updated if the corresponding Group 0 Secure active priority is zero.
Non-secure EL1 access for a Virtual interrupt	ICH_AP1Rn_EL2
Non-secure EL1 or EL2 when GIC Distributor supports two Security states	Permitted. Accesses Group 1 Non-secure active priorities (shifted). When a bit is written, the bit is only updated if the corresponding Group 0 and Group 1 Secure active priority is zero.
Non-secure EL1 or EL2 when GIC Distributor supports one Security state	Permitted. Accesses Group 1 Non-secure active priorities (unshifted). When a bit is written, the bit is only updated if the Group 0 active priority is zero.

A Virtual interrupt in this case means that the interrupt group associated with the register has been virtualized.

Accessing the ICC_AP1R3:

To access the ICC_AP1R3:

MRC p15,0,<Rt>,c12,c9,3 ; Read ICC_AP1R3 into Rt
MCR p15,0,<Rt>,c12,c9,3 ; Write Rt to ICC_AP1R3

Register access is encoded as follows:

coproc	opc1	CRn	CRm	opc2
1111	000	1100	1001	011

G4.6.9 ICC_ASGI1R, Interrupt Controller Alias Software Generated Interrupt group 1 Register

The ICC_ASGI1R characteristics are:

Purpose

Provides software the ability to generate group 1 SGIs for the other security state.
 This register is part of the GIC registers functional group.

Usage constraints

This register is accessible as shown below:
 When accessed as ICC_ASGI1R(S):

EL0 (NS)	EL0 (S)	EL1 (NS)	EL1 (S)	EL2	EL3 (SCR.NS=1)	EL3 (SCR.NS=0)
-	-	-	WO	-	-	WO

When accessed as ICC_ASGI1R(NS):

EL0 (NS)	EL0 (S)	EL1 (NS)	EL1 (S)	EL2	EL3 (SCR.NS=1)	EL3 (SCR.NS=0)
-	-	WO	-	WO	WO	-

Configurations

ICC_ASGI1R(S) is architecturally mapped to AArch64 register [ICC_ASGI1R_EL1 \(S\)](#).
 ICC_ASGI1R(NS) is architecturally mapped to AArch64 register [ICC_ASGI1R_EL1 \(NS\)](#).
 If EL3 is using AArch32, there are separate Secure and Non-secure instances of this register.

Attributes

ICC_ASGI1R is a 64-bit register.

The ICC_ASGI1R bit assignments are:

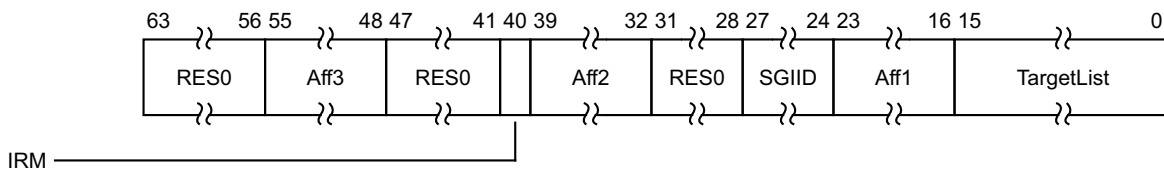

Bits [63:56]

Reserved, RES0.

Aff3, bits [55:48]

The affinity 3 value of the affinity path of the cluster for which SGI interrupts will be generated.

Bits [47:41]

Reserved, RES0.

IRM, bit [40]

Interrupt Routing Mode. Determines how the generated interrupts should be distributed to processors. Possible values are:

- 0 Interrupts routed to the processors specified by a.b.c.{target list}. In this routing, a, b, and c are the values of fields Aff3, Aff2, and Aff1 respectively.

1 Interrupts routed to all processors in the system, excluding "self".

Aff2, bits [39:32]

The affinity 2 value of the affinity path of the cluster for which SGI interrupts will be generated.

Bits [31:28]

Reserved, RES0.

SGIID, bits [27:24]

SGI Interrupt ID.

Aff1, bits [23:16]

The affinity 1 value of the affinity path of the cluster for which SGI interrupts will be generated.

TargetList, bits [15:0]

Target List. The set of processors for which SGI interrupts will be generated. Each bit corresponds to the processor within a cluster with an Affinity 0 value equal to the bit number.

If a bit is 1 and the bit does not correspond to a valid target processor, the bit must be ignored by the Distributor. In such cases, a Distributor may optionally generate an SGI.

This restricts distribution of SGIs to the first 16 processors of an affinity 1 cluster.

Accessing the ICC_ASGI1R:

To access the ICC_ASGI1R:

MCRR p15,1,<Rt>,<Rt2>,c12 ; Write Rt (low word) and Rt2 (high word) to 64-bit ICC_ASGI1R

Register access is encoded as follows:

coproc	opc1	CRm
1111	0001	1100

G4.6.10 ICC_BPR0, Interrupt Controller Binary Point Register 0

The ICC_BPR0 characteristics are:

Purpose

Defines the point at which the priority value fields split into two parts, the group priority field and the subpriority field. The group priority field is used to determine interrupt preemption.

This register is part of the GIC registers functional group.

Usage constraints

This register is accessible as shown below:

When accessed as ICC_BPR0(S):

EL0 (NS)	EL0 (S)	EL1 (NS)	EL1 (S)	EL2	EL3 (SCR.NS=1)	EL3 (SCR.NS=0)
-	-	-	RW	-	-	RW

When accessed as ICC_BPR0(NS):

EL0 (NS)	EL0 (S)	EL1 (NS)	EL1 (S)	EL2	EL3 (SCR.NS=1)	EL3 (SCR.NS=0)
-	-	RW	-	RW	RW	-

In Secure state, this register is the binary point register for Group 0 interrupts. In Non-secure state, this is the BPR for Group 1 interrupts.

The minimum binary point value is IMPLEMENTATION DEFINED in the range:

- 0-3 if the implementation supports one security state, and for the Secure copy of the register if the implementation supports two security states.
- 1-4 for the Non-secure copy of the register.

An attempt to program the binary point field to a value less than the minimum value sets the field to the minimum value. On a reset, the binary point field is set to the minimum supported value.

Configurations

ICC_BPR0(S) is architecturally mapped to AArch64 register [ICC_BPR0_EL1 \(S\)](#).

ICC_BPR0(NS) is architecturally mapped to AArch64 register [ICC_BPR0_EL1 \(NS\)](#).

If EL3 is using AArch32, there are separate Secure and Non-secure instances of this register.

Attributes

ICC_BPR0 is a 32-bit register.

The ICC_BPR0 bit assignments are:

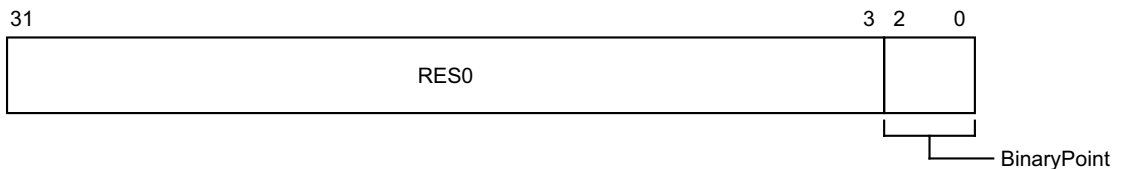

Bits [31:3]

Reserved, RES0.

BinaryPoint, bits [2:0]

The value of this field controls how the 8-bit interrupt priority field is split into a group priority field, used to determine interrupt preemption, and a subpriority field. This is done as follows:

Binary point value	Group priority field	Subpriority field	Field with binary point
0	[7:1]	[0]	ggggggg.s
1	[7:2]	[1:0]	ggggg.ss
2	[7:3]	[2:0]	ggggg.sss
3	[7:4]	[3:0]	gggg.ssss
4	[7:5]	[4:0]	ggg.sssss
5	[7:6]	[5:0]	gg.ssssss
6	[7]	[6:0]	g.ssssss
7	No preemption	[7:0]	.sssssss

Accessing the ICC_BPR0:

To access the ICC_BPR0:

MRC p15,0,<Rt>,c12,c8,3 ; Read ICC_BPR0 into Rt
MCR p15,0,<Rt>,c12,c8,3 ; Write Rt to ICC_BPR0

Register access is encoded as follows:

coproc	opc1	CRn	CRm	opc2
1111	000	1100	1000	011

G4.6.11 ICC_BPR1, Interrupt Controller Binary Point Register 1

The ICC_BPR1 characteristics are:

Purpose

Defines the point at which the priority value fields split into two parts, the group priority field and the subpriority field. The group priority field is used to determine Group 1 interrupt preemption.

This register is part of the GIC registers functional group.

Usage constraints

This register is accessible as shown below:

EL0 (NS)	EL0 (S)	EL1 (NS)	EL1 (S)	EL2	EL3 (SCR.NS=1)	EL3 (SCR.NS=0)
-	-	RW	RW	RW	RW	RW

This register is an alias of the Non-secure view of [ICC_BPR0](#), and a Secure access to this register is identical to a Non-secure access to [ICC_BPR0](#).

The minimum binary point value is IMPLEMENTATION DEFINED in the range 1-4.

An attempt to program the binary point field to a value less than the minimum value sets the field to the minimum value. On a reset, the binary point field is set to the minimum supported value.

Configurations

ICC_BPR1 is architecturally mapped to AArch64 register [ICC_BPR1_EL1](#).

There is one instance of this register that is used in both Secure and Non-secure states.

Attributes

ICC_BPR1 is a 32-bit register.

The ICC_BPR1 bit assignments are:

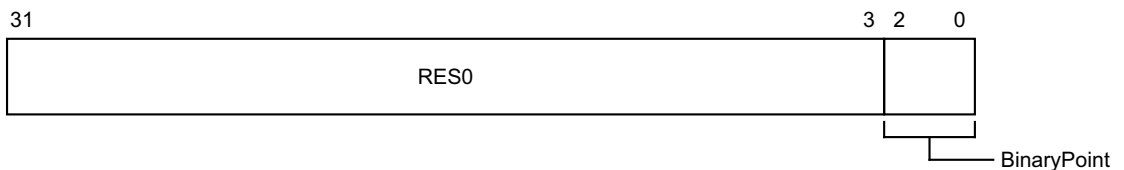

Bits [31:3]

Reserved, RES0.

BinaryPoint, bits [2:0]

The value of this field controls how the 8-bit interrupt priority field is split into a group priority field, used to determine interrupt preemption, and a subpriority field. This is done as follows:

Binary point value	Group priority field	Subpriority field	Field with binary point
0	[7:1]	[0]	ggggggg.s
1	[7:2]	[1:0]	gggggg.ss
2	[7:3]	[2:0]	ggggg.sss
3	[7:4]	[3:0]	gggg.ssss

Binary point value	Group priority field	Subpriority field	Field with binary point
4	[7:5]	[4:0]	ggg.sssss
5	[7:6]	[5:0]	gg.ssssss
6	[7]	[6:0]	g.sssssss
7	No preemption	[7:0]	.ssssssss

Accessing the ICC_BPR1:

To access the ICC_BPR1:

MRC p15,0,<Rt>,c12,c12,3 ; Read ICC_BPR1 into Rt
MCR p15,0,<Rt>,c12,c12,3 ; Write Rt to ICC_BPR1

Register access is encoded as follows:

coproc	opc1	CRn	CRm	opc2
1111	000	1100	1100	011

G4.6.12 ICC_CTLR, Interrupt Controller Control Register

The ICC_CTLR characteristics are:

Purpose

Controls aspects of the behavior of the GIC CPU interface and provides information about the features implemented.

This register is part of the GIC registers functional group.

Usage constraints

This register is accessible as shown below:

When accessed as ICC_CTLR(S):

EL0 (NS)	EL0 (S)	EL1 (NS)	EL1 (S)	EL2	EL3 (SCR.NS=1)	EL3 (SCR.NS=0)
-	-	-	RW	-	-	RW

When accessed as ICC_CTLR(NS):

EL0 (NS)	EL0 (S)	EL1 (NS)	EL1 (S)	EL2	EL3 (SCR.NS=1)	EL3 (SCR.NS=0)
-	-	RW	-	RW	RW	-

Configurations

ICC_CTLR(S) is architecturally mapped to AArch64 register [ICC_CTLR_EL1 \(S\)](#).

ICC_CTLR(NS) is architecturally mapped to AArch64 register [ICC_CTLR_EL1 \(NS\)](#).

If EL3 is using AArch32, there are separate Secure and Non-secure instances of this register.

Attributes

ICC_CTLR is a 32-bit register.

The ICC_CTLR bit assignments are:

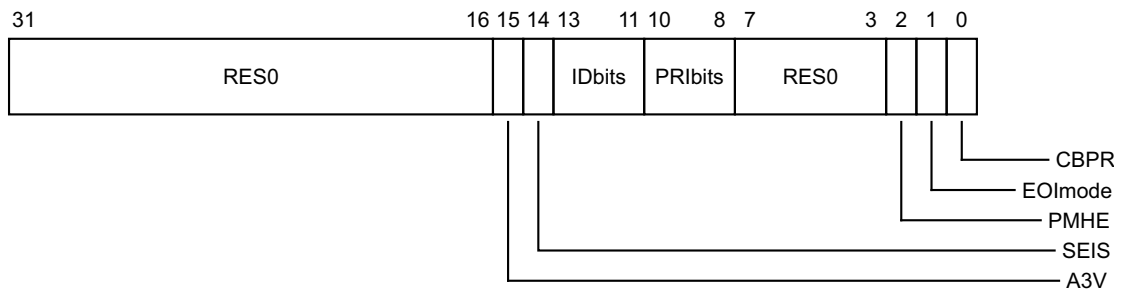

Bits [31:16]

Reserved, RES0.

A3V, bit [15]

Affinity 3 Valid. Read-only. Possible values are:

- 0 The CPU interface logic only supports zero values of Affinity 3 in SGI generation system registers.
- 1 The CPU interface logic supports non-zero values of Affinity 3 in SGI generation system registers.

Virtual accesses return the value from ICH_VTR.A3V.

SEIS, bit [14]

SEI Support. Read-only. Indicates whether the CPU interface supports local generation of SEIs:

- 0 The CPU interface logic does not support local generation of SEIs by the CPU interface.
- 1 The CPU interface logic supports local generation of SEIs by the CPU interface.

Virtual accesses return the value from ICH_VTR.SEIS.

IDbits, bits [13:11]

The number of physical interrupt identifier bits supported:

- 000 16 bits.
- 001 24 bits.

All other values are reserved.

Virtual accesses return the value from ICH_VTR.IDbits.

Reset value is architecturally UNKNOWN.

PRIBits, bits [10:8]

The number of priority bits implemented, minus one. Read-only.

Virtual accesses return the value from ICH_VTR.PRIBits.

Bits [7:3]

Reserved, RES0.

PMHE, bit [2]

Priority Mask Hint Enable.

If EL3 is present and GICD_CTLR.DS == 0, this bit is a read-only alias of ICC_MCTLR.PMHE.

If EL3 is present and GICD_CTLR.DS == 1, this bit is writeable at EL1 and EL2.

Resets to 0.

EOImode, bit [1]

Alias of ICC_MCTLR.EOImode_EL1{S,NS} as appropriate to the current security state.

Virtual accesses modify ICH_VMCR.VEOIM.

Reset value is architecturally UNKNOWN.

CBPR, bit [0]

Common Binary Point Register.

If EL3 is present and GICD_CTLR.DS == 0, this bit is a read-only alias of ICC_MCTLR.CBPR_EL1{S,NS} as appropriate.

If EL3 is not present, this field resets to zero.

If EL3 is present and GICD_CTLR.DS == 1, this bit is writeable at EL1 and EL2.

Virtual accesses modify ICH_VMCR.VCBPR. An access is virtual when accessed at non-secure EL1 and either of FIQ or IRQ has been virtualized. That is, when (SCR.NS == '1' && (HCR.FMO == '1' || HCR.IMO == '1')).

Accessing the ICC_CTLR:

To access the ICC_CTLR:

MRC p15,0,<Rt>,c12,c12,4 ; Read ICC_CTLR into Rt
MCR p15,0,<Rt>,c12,c12,4 ; Write Rt to ICC_CTLR

Register access is encoded as follows:

coproc	opc1	CRn	CRm	opc2
1111	000	1100	1100	100

G4.6.13 ICC_DIR, Interrupt Controller Deactivate Interrupt Register

The ICC_DIR characteristics are:

Purpose

When interrupt priority drop is separated from interrupt deactivation, a write to this register deactivates the specified interrupt.

This register is part of the GIC registers functional group.

Usage constraints

This register is accessible as shown below:

EL0 (NS)	EL0 (S)	EL1 (NS)	EL1 (S)	EL2	EL3 (SCR.NS=1)	EL3 (SCR.NS=0)
-	-	WO	WO	WO	WO	WO

Configurations

ICC_DIR is architecturally mapped to AArch64 register [ICC_DIR_EL1](#).

There is one instance of this register that is used in both Secure and Non-secure states.

Attributes

ICC_DIR is a 32-bit register.

The ICC_DIR bit assignments are:

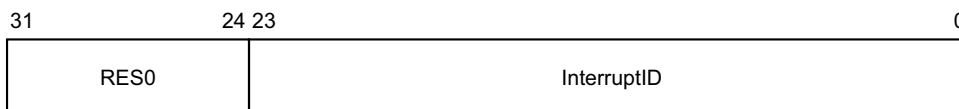

Bits [31:24]

Reserved, RES0.

InterruptID, bits [23:0]

The interrupt ID.

This field has either 16 or 24 bits implemented. The number of implemented bits can be found in [ICC_CTLR_EL1.IDbits](#) and [ICC_CTLR_EL3.IDbits](#). If only 16 bits are implemented, bits [23:16] of this register are RES0.

Accessing the ICC_DIR:

To access the ICC_DIR:

MCR p15,0,<Rt>,c12,c11,1 ; Write Rt to ICC_DIR

Register access is encoded as follows:

coproc	opc1	CRn	CRm	opc2
1111	000	1100	1011	001

G4.6.14 ICC_EOIR0, Interrupt Controller End Of Interrupt Register 0

The ICC_EOIR0 characteristics are:

Purpose

A processor writes to this register to inform the CPU interface that it has completed the processing of the specified interrupt.

This register is part of the GIC registers functional group.

Usage constraints

This register is accessible as shown below:

When accessed as ICC_EOIR0(S):

EL0 (NS)	EL0 (S)	EL1 (NS)	EL1 (S)	EL2	EL3 (SCR.NS=1)	EL3 (SCR.NS=0)
-	-	-	WO	-	-	WO

When accessed as ICC_EOIR0(NS):

EL0 (NS)	EL0 (S)	EL1 (NS)	EL1 (S)	EL2	EL3 (SCR.NS=1)	EL3 (SCR.NS=0)
-	-	WO	-	WO	WO	-

A write to this register must correspond to the most recent valid read from an Interrupt Acknowledge Register. A valid read is a read that returns a valid interrupt ID, that is not a spurious interrupt ID.

Configurations

ICC_EOIR0(S) is architecturally mapped to AArch64 register [ICC_EOIR0_EL1 \(S\)](#).

ICC_EOIR0(NS) is architecturally mapped to AArch64 register [ICC_EOIR0_EL1 \(NS\)](#).

If EL3 is using AArch32, there are separate Secure and Non-secure instances of this register.

In Secure state, this register is the end of interrupt register for Group 0 interrupts. In Non-secure state, this is the EOIR for Group 1 interrupts.

Attributes

ICC_EOIR0 is a 32-bit register.

The ICC_EOIR0 bit assignments are:

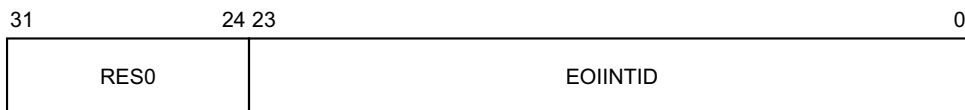

Bits [31:24]

Reserved, RES0.

EOIINTID, bits [23:0]

The InterruptID value from the corresponding GICC_IAR access.

This field has either 16 or 24 bits implemented. The number of implemented bits can be found in [ICC_CTLR_EL1.IDbits](#) and [ICC_CTLR_EL3.IDbits](#). If only 16 bits are implemented, bits [23:16] of this register are RES0.

Accessing the ICC_EOIR0:

To access the ICC_EOIR0:

MCR p15,0,<Rt>,c12,c8,1 ; Write Rt to ICC_EOIR0

Register access is encoded as follows:

coproc	opc1	CRn	CRm	opc2
1111	000	1100	1000	001

G4.6.15 ICC_EOIR1, Interrupt Controller End Of Interrupt Register 1

The ICC_EOIR1 characteristics are:

Purpose

A processor writes to this register to inform the CPU interface that it has completed the processing of the specified Group 1 interrupt.

This register is part of the GIC registers functional group.

Usage constraints

This register is accessible as shown below:

EL0 (NS)	EL0 (S)	EL1 (NS)	EL1 (S)	EL2	EL3 (SCR.NS=1)	EL3 (SCR.NS=0)
-	-	WO	WO	WO	WO	WO

A write to this register must correspond to the most recent valid read from an Interrupt Acknowledge Register. A valid read is a read that returns a valid interrupt ID, that is not a spurious interrupt ID.

Configurations

ICC_EOIR1 is architecturally mapped to AArch64 register [ICC_EOIR1_EL1](#).

There is one instance of this register that is used in both Secure and Non-secure states.

This register is an alias of the Non-secure view of [ICC_EOIRO](#), and a Secure access to this register is identical to a Non-secure access to [ICC_EOIRO](#).

Attributes

ICC_EOIR1 is a 32-bit register.

The ICC_EOIR1 bit assignments are:

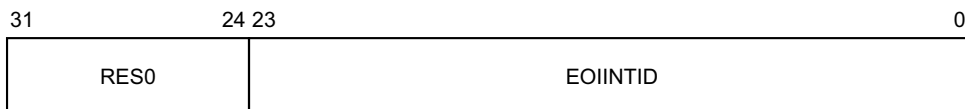

Bits [31:24]

Reserved, RES0.

EOIINTID, bits [23:0]

The InterruptID value from the corresponding GICC_IAR access.

This field has either 16 or 24 bits implemented. The number of implemented bits can be found in [ICC_CTLR_EL1.IDbits](#) and [ICC_CTLR_EL3.IDbits](#). If only 16 bits are implemented, bits [23:16] of this register are RES0.

Accessing the ICC_EOIR1:

To access the ICC_EOIR1:

MCR p15,0,<Rt>,c12,c12,1 ; Write Rt to ICC_EOIR1

Register access is encoded as follows:

coproc	opc1	CRn	CRm	opc2
1111	000	1100	1100	001

G4.6.16 ICC_HPPIR0, Interrupt Controller Highest Priority Pending Interrupt Register 0

The ICC_HPPIR0 characteristics are:

Purpose

Indicates the Interrupt ID, and processor ID if appropriate, of the highest priority pending interrupt on the CPU interface.

This register is part of the GIC registers functional group.

Usage constraints

This register is accessible as shown below:

When accessed as ICC_HPPIR0(S):

EL0 (NS)	EL0 (S)	EL1 (NS)	EL1 (S)	EL2	EL3 (SCR.NS=1)	EL3 (SCR.NS=0)
-	-	-	RO	-	-	RO

When accessed as ICC_HPPIR0(NS):

EL0 (NS)	EL0 (S)	EL1 (NS)	EL1 (S)	EL2	EL3 (SCR.NS=1)	EL3 (SCR.NS=0)
-	-	RO	-	RO	RO	-

Configurations

ICC_HPPIR0(S) is architecturally mapped to AArch64 register [ICC_HPPIR0_EL1 \(S\)](#).

ICC_HPPIR0(NS) is architecturally mapped to AArch64 register [ICC_HPPIR0_EL1 \(NS\)](#).

If EL3 is using AArch32, there are separate Secure and Non-secure instances of this register.

In Secure state, this register is the highest priority pending interrupt register for Group 0 interrupts.

In Non-secure state, this is the HPPIR for Group 1 interrupts.

Attributes

ICC_HPPIR0 is a 32-bit register.

The ICC_HPPIR0 bit assignments are:

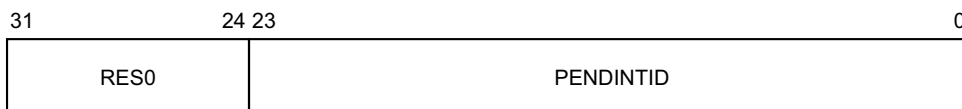

Bits [31:24]

Reserved, RES0.

PENDINTID, bits [23:0]

The interrupt ID of the highest priority pending interrupt.

This field has either 16 or 24 bits implemented. The number of implemented bits can be found in [ICC_CTLR_EL1.IDbits](#) and [ICC_CTLR_EL3.IDbits](#). If only 16 bits are implemented, bits [23:16] of this register are RES0.

Accessing the ICC_HPPIR0:

To access the ICC_HPPIR0:

MRC p15,0,<Rt>,c12,c8,2 ; Read ICC_HPPIR0 into Rt

Register access is encoded as follows:

coproc	opc1	CRn	CRm	opc2
1111	000	1100	1000	010

G4.6.17 ICC_HPPIR1, Interrupt Controller Highest Priority Pending Interrupt Register 1

The ICC_HPPIR1 characteristics are:

Purpose

If the highest priority pending interrupt on the CPU interface is a Group 1 interrupt, returns the interrupt ID of that interrupt. Otherwise, returns a spurious interrupt ID of 1023.

This register is part of the GIC registers functional group.

Usage constraints

This register is accessible as shown below:

EL0 (NS)	EL0 (S)	EL1 (NS)	EL1 (S)	EL2	EL3 (SCR.NS=1)	EL3 (SCR.NS=0)
-	-	RO	RO	RO	RO	RO

Configurations

ICC_HPPIR1 is architecturally mapped to AArch64 register [ICC_HPPIR1_EL1](#).

There is one instance of this register that is used in both Secure and Non-secure states.

This register is an alias of the Non-secure view of [ICC_HPPIR0](#), and a Secure access to this register is identical to a Non-secure access to [ICC_HPPIR0](#).

Attributes

ICC_HPPIR1 is a 32-bit register.

The ICC_HPPIR1 bit assignments are:

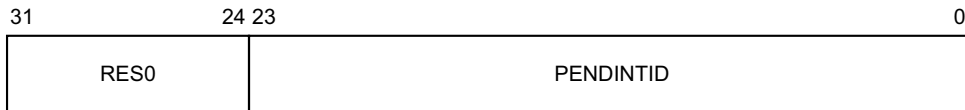

Bits [31:24]

Reserved, RES0.

PENDINTID, bits [23:0]

The interrupt ID of the highest priority pending interrupt.

This field has either 16 or 24 bits implemented. The number of implemented bits can be found in [ICC_CTLR_EL1.IDbits](#) and [ICC_CTLR_EL3.IDbits](#). If only 16 bits are implemented, bits [23:16] of this register are RES0.

Accessing the ICC_HPPIR1:

To access the ICC_HPPIR1:

MRC p15,0,<Rt>,c12,c12,2 ; Read ICC_HPPIR1 into Rt

Register access is encoded as follows:

coproc	opc1	CRn	CRm	opc2
1111	000	1100	1100	010

G4.6.18 ICC_HSRE, Interrupt Controller Hyp System Register Enable register

The ICC_HSRE characteristics are:

Purpose

Controls whether the system register interface or the memory mapped interface to the GIC CPU interface is used for EL2.

This register is part of:

- the GIC registers functional group
- the Virtualization registers functional group.

Usage constraints

This register is accessible as shown below:

EL0 (NS)	EL0 (S)	EL1 (NS)	EL1 (S)	EL2	EL3 (SCR.NS=1)	EL3 (SCR.NS=0)
-	-	-	-	RW	RW	RW

If EL3 is present and ICC_MSRE.Enable is 0, EL2 accesses to this register will trap to EL3.

Configurations

ICC_HSRE is architecturally mapped to AArch64 register [ICC_SRE_EL2](#).

Attributes

ICC_HSRE is a 32-bit register.

The ICC_HSRE bit assignments are:

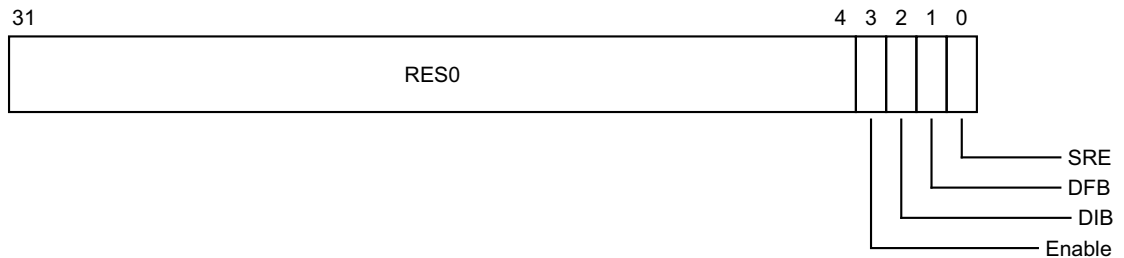

Bits [31:4]

Reserved, RES0.

Enable, bit [3]

Enable. Enables lower exception level access to ICC_SRE_EL1.

0 Non-secure EL1 accesses to ICC_SRE_EL1 trap to EL2.

1 Non-secure EL1 accesses to ICC_SRE_EL1 are permitted if EL3 is not present or ICC_SRE_EL3.Enable is 1, otherwise Non-secure EL1 accesses to ICC_SRE_EL1 trap to EL3.

Resets to 0.

DIB, bit [2]

Disable IRQ bypass.

If EL3 is present and GICD_CTLR.DS is 0, this field is a read-only alias of ICC_MSRE.DIB.

Resets to 0.

DFB, bit [1]

Disable FIQ bypass.

If EL3 is present and GICD_CTLR.DS is 0, this field is a read-only alias of ICC_MSRE.DFB.

Resets to 0.

SRE, bit [0]

System Register Enable.

0 The memory mapped interface must be used. Access at EL2 to any ICH_* system register, or any EL1 or EL2 ICC_* register other than ICC_SRE or ICC_HSRE, results in an Undefined exception.

1 The system register interface to the ICH_* registers and the EL1 and EL2 ICC_* registers is enabled for EL2.

0 The memory mapped interface must be used. Access at EL2 to any ICH_* system register, or any EL1 or EL2 ICC_* register other than ICC_SRE_EL1 or ICC_SRE_EL2, results in an Undefined exception.

1 The system register interface to the ICH_* registers and the EL1 and EL2 ICC_* registers is enabled for EL2.

System Register Enable.

Resets to 0.

Accessing the ICC_HSRE:

To access the ICC_HSRE:

MRC p15,4,<Rt>,c12,c9,5 ; Read ICC_HSRE into Rt

MCR p15,4,<Rt>,c12,c9,5 ; Write Rt to ICC_HSRE

Register access is encoded as follows:

coproc	opc1	CRn	CRm	opc2
1111	100	1100	1001	101

G4.6.19 ICC_IAR0, Interrupt Controller Interrupt Acknowledge Register 0

The ICC_IAR0 characteristics are:

Purpose

The processor reads this register to obtain the interrupt ID of the signaled interrupt. This read acts as an acknowledge for the interrupt.

This register is part of the GIC registers functional group.

Usage constraints

This register is accessible as shown below:

When accessed as ICC_IAR0(S):

EL0 (NS)	EL0 (S)	EL1 (NS)	EL1 (S)	EL2	EL3 (SCR.NS=1)	EL3 (SCR.NS=0)
-	-	-	RO	-	-	RO

When accessed as ICC_IAR0(NS):

EL0 (NS)	EL0 (S)	EL1 (NS)	EL1 (S)	EL2	EL3 (SCR.NS=1)	EL3 (SCR.NS=0)
-	-	RO	-	RO	RO	-

Configurations

ICC_IAR0(S) is architecturally mapped to AArch64 register [ICC_IAR0_EL1 \(S\)](#).

ICC_IAR0(NS) is architecturally mapped to AArch64 register [ICC_IAR0_EL1 \(NS\)](#).

If EL3 is using AArch32, there are separate Secure and Non-secure instances of this register.

In Secure state, this register is the interrupt acknowledge register for Group 0 interrupts. In Non-secure state, this is the IAR for Group 1 interrupts.

Attributes

ICC_IAR0 is a 32-bit register.

The ICC_IAR0 bit assignments are:

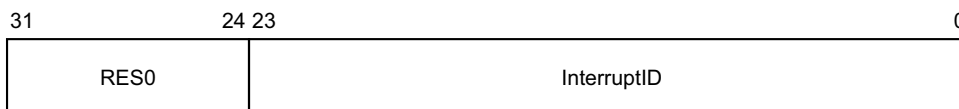

Bits [31:24]

Reserved, RES0.

InterruptID, bits [23:0]

The ID of the signaled interrupt. IDs 1020 to 1023 are reserved and convey additional information such as spurious interrupts.

This field has either 16 or 24 bits implemented. The number of implemented bits can be found in [ICC_CTLR_EL1.IDbits](#) and [ICC_CTLR_EL3.IDbits](#). If only 16 bits are implemented, bits [23:16] of this register are RES0.

Accessing the ICC_IAR0:

To access the ICC_IAR0:

MRC p15,0,<Rt>,c12,c8,0 ; Read ICC_IAR0 into Rt

Register access is encoded as follows:

coproc	opc1	CRn	CRm	opc2
1111	000	1100	1000	000

G4.6.20 ICC_IAR1, Interrupt Controller Interrupt Acknowledge Register 1

The ICC_IAR1 characteristics are:

Purpose

The processor reads this register to obtain the interrupt ID of the signaled Group 1 interrupt. This read acts as an acknowledge for the interrupt.

This register is part of the GIC registers functional group.

Usage constraints

This register is accessible as shown below:

EL0 (NS)	EL0 (S)	EL1 (NS)	EL1 (S)	EL2	EL3 (SCR.NS=1)	EL3 (SCR.NS=0)
-	-	RO	RO	RO	RO	RO

Configurations

ICC_IAR1 is architecturally mapped to AArch64 register [ICC_IAR1_EL1](#).

There is one instance of this register that is used in both Secure and Non-secure states.

This register is an alias of the Non-secure view of [ICC_IAR0](#), and a Secure access to this register is identical to a Non-secure access to [ICC_IAR0](#).

Attributes

ICC_IAR1 is a 32-bit register.

The ICC_IAR1 bit assignments are:

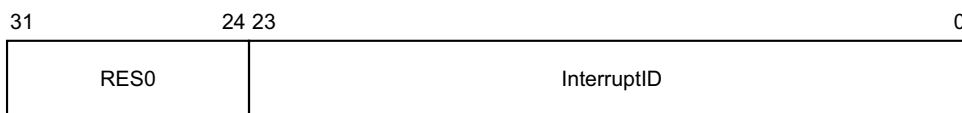

Bits [31:24]

Reserved, RES0.

InterruptID, bits [23:0]

The ID of the signaled interrupt. IDs 1020 to 1023 are reserved and convey additional information such as spurious interrupts.

This field has either 16 or 24 bits implemented. The number of implemented bits can be found in [ICC_CTLR_EL1.IDbits](#) and [ICC_CTLR_EL3.IDbits](#). If only 16 bits are implemented, bits [23:16] of this register are RES0.

Accessing the ICC_IAR1:

To access the ICC_IAR1:

MRC p15,0,<Rt>,c12,c12,0 ; Read ICC_IAR1 into Rt

Register access is encoded as follows:

coproc	opc1	CRn	CRm	opc2
1111	000	1100	1100	000

G4.6.21 ICC_IGRPEN0, Interrupt Controller Interrupt Group 0 Enable register

The ICC_IGRPEN0 characteristics are:

Purpose

Controls whether Group 0 interrupts are enabled or not.
 This register is part of the GIC registers functional group.

Usage constraints

This register is accessible as shown below:
 When accessed as ICC_IGRPEN0(S):

EL0 (NS)	EL0 (S)	EL1 (NS)	EL1 (S)	EL2	EL3 (SCR.NS=1)	EL3 (SCR.NS=0)
-	-	-	RW	-	-	RW

When accessed as ICC_IGRPEN0(NS):

EL0 (NS)	EL0 (S)	EL1 (NS)	EL1 (S)	EL2	EL3 (SCR.NS=1)	EL3 (SCR.NS=0)
-	-	RW	-	RW	RW	-

The lowest exception level at which this register may be accessed is governed by the exception level to which FIQ is routed. This routing depends on SCR.FIQ, SCR.NS and HCR.FMO.

If an interrupt is pending within the CPU interface when Enable becomes 0, the interrupt must be released to allow the Distributor to forward the interrupt to a different processor.

Configurations

ICC_IGRPEN0(S) is architecturally mapped to AArch64 register [ICC_IGRPEN0_EL1 \(S\)](#).
 ICC_IGRPEN0(NS) is architecturally mapped to AArch64 register [ICC_IGRPEN0_EL1 \(NS\)](#).
 If EL3 is using AArch32, there are separate Secure and Non-secure instances of this register.

Attributes

ICC_IGRPEN0 is a 32-bit register.

The ICC_IGRPEN0 bit assignments are:

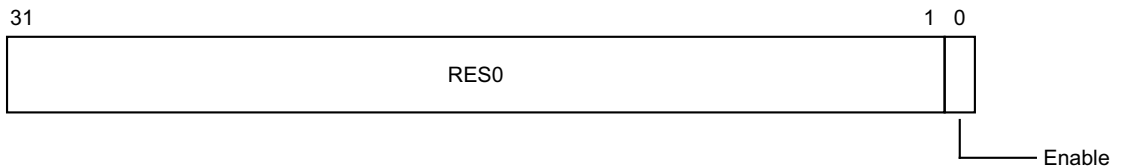

Bits [31:1]

Reserved, RES0.

Accessing the ICC_IGRPEN0:

To access the ICC_IGRPEN0:

```
MRC p15,0,<Rt>,c12,c12,6 ; Read ICC_IGRPEN0 into Rt
MCR p15,0,<Rt>,c12,c12,6 ; Write Rt to ICC_IGRPEN0
```

Register access is encoded as follows:

coproc	opc1	CRn	CRm	opc2
1111	000	1100	1100	110

G4.6.22 ICC_IGRPEN1, Interrupt Controller Interrupt Group 1 Enable register

The ICC_IGRPEN1 characteristics are:

Purpose

Controls whether Group 1 interrupts are enabled for the current security state.
 This register is part of the GIC registers functional group.

Usage constraints

This register is accessible as shown below:

EL0 (NS)	EL0 (S)	EL1 (NS)	EL1 (S)	EL2	EL3 (SCR.NS=1)	EL3 (SCR.NS=0)
-	-	RW	RW	RW	RW	RW

The lowest exception level at which this register may be accessed is governed by the exception level to which FIQ is routed. This routing depends on SCR.FIQ, SCR.NS and HCR.FMO.

If an interrupt is pending within the CPU interface when Enable becomes 0, the interrupt must be released to allow the Distributor to forward the interrupt to a different processor.

Configurations

ICC_IGRPEN1 is architecturally mapped to AArch64 register [ICC_IGRPEN1_EL1](#).

There is one instance of this register that is used in both Secure and Non-secure states.

Attributes

ICC_IGRPEN1 is a 32-bit register.

The ICC_IGRPEN1 bit assignments are:

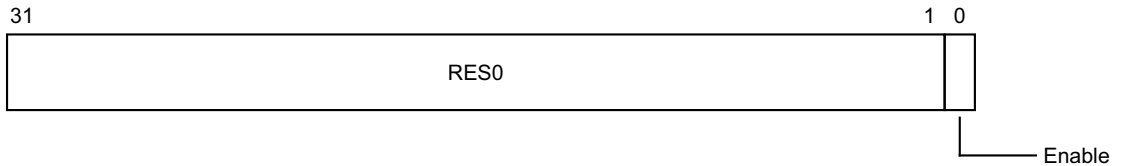

Bits [31:1]

Reserved, RES0.

Accessing the ICC_IGRPEN1:

To access the ICC_IGRPEN1:

```
MRC p15,0,<Rt>,c12,c12,7 ; Read ICC_IGRPEN1 into Rt
MCR p15,0,<Rt>,c12,c12,7 ; Write Rt to ICC_IGRPEN1
```

Register access is encoded as follows:

coproc	opc1	CRn	CRm	opc2
1111	000	1100	1100	111

G4.6.23 ICC_MCTLR, Interrupt Controller Monitor Control Register

The ICC_MCTLR characteristics are:

Purpose

Controls aspects of the behavior of the GIC CPU interface and provides information about the features implemented.

This register is part of:

- the GIC registers functional group
- the Security registers functional group.

Usage constraints

This register is accessible as shown below:

EL0 (NS)	EL0 (S)	EL1 (NS)	EL1 (S)	EL2	EL3 (SCR.NS=1)	EL3 (SCR.NS=0)
-	-	-	-	-	RW	RW

Configurations

ICC_MCTLR is architecturally mapped to AArch64 register [ICC_CTLR_EL3](#).

There is one instance of this register that is used in both Secure and Non-secure states.

Attributes

ICC_MCTLR is a 32-bit register.

The ICC_MCTLR bit assignments are:

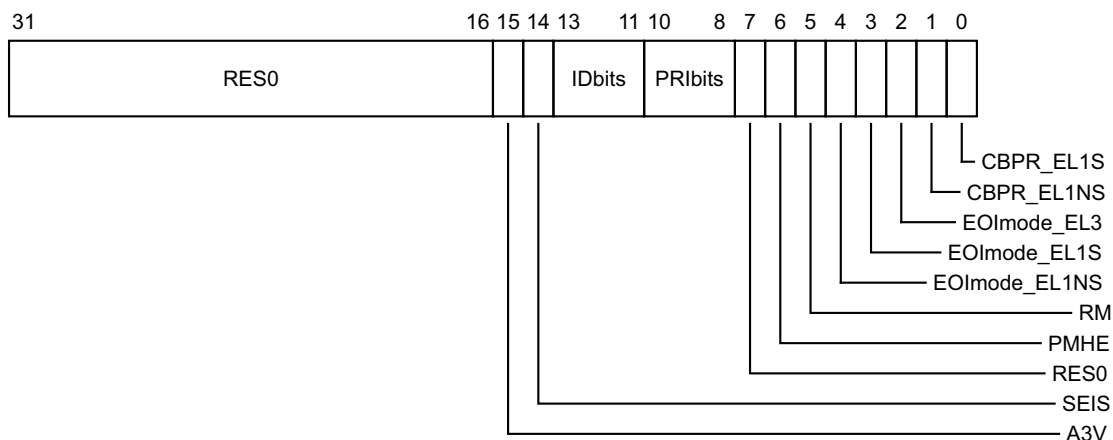

Bits [31:16]

Reserved, RES0.

A3V, bit [15]

Affinity 3 Valid. Read-only. Possible values are:

- 0 The CPU interface logic only supports zero values of Affinity 3 in SGI generation system registers.
- 1 The CPU interface logic supports non-zero values of Affinity 3 in SGI generation system registers.

Virtual accesses return the value from ICH_VTR.A3V.

SEIS, bit [14]

SEI Support. Read-only. Indicates whether the CPU interface supports generation of SEIs:

- 0 The CPU interface logic does not support generation of SEIs.
- 1 The CPU interface logic supports generation of SEIs.

Virtual accesses return the value from ICH_VTR.SEIS.

IDbits, bits [13:11]

The number of physical interrupt identifier bits supported:

- 000 16 bits.
- 001 24 bits.

All other values are reserved.

Reset value is architecturally UNKNOWN.

PRBits, bits [10:8]

The number of priority bits implemented, minus one. Read-only.

Bit [7]

Reserved, RES0.

PMHE, bit [6]

Priority Mask Hint Enable.

When set, enables use of the PMR as a hint for interrupt distribution.

Resets to 0.

RM, bit [5]

Routing Modifier. This bit is used to modify the behaviour of [ICC_IAR0](#) and [ICC_IAR1](#) such that systems with legacy secure software may be supported correctly.

- 0 Reading [ICC_IAR0](#) and [ICC_IAR1](#) at EL3 acknowledges interrupts normally.
- 1 Reading [ICC_IAR0](#) and [ICC_IAR1](#) at EL3 returns special values:
 - Reading [ICC_IAR0](#) at EL3 returns ID 1020, indicating the interrupt should be handled at Secure EL1.
 - Reading [ICC_IAR1](#) at EL3 returns ID 1021, indicating the interrupt should be handled at Non-secure EL1 or EL2.

Reset value is architecturally UNKNOWN.

EOImode_EL1NS, bit [4]

EOI mode for interrupts handled at non-secure EL1 and EL2.

Reset value is architecturally UNKNOWN.

EOImode_EL1S, bit [3]

EOI mode for interrupts handled at secure EL1.

Reset value is architecturally UNKNOWN.

EOImode_EL3, bit [2]

EOI mode for interrupts handled at EL3.

Reset value is architecturally UNKNOWN.

CBPR_EL1NS, bit [1]

When set, non-secure accesses to [GICC_BPR](#) and [ICC_BPR1](#) access the state of [ICC_BPR0](#). [ICC_BPR0](#) is used to determine the preemption group for Non-secure Group 1 interrupts.

Reset value is architecturally UNKNOWN.

CBPR_EL1S, bit [0]

When set, secure EL1 accesses to [ICC_BPR1](#) access the state of [ICC_BPR0](#). [ICC_BPR0](#) is used to determine the preemption group for Secure Group 1 interrupts.

Reset value is architecturally UNKNOWN.

Accessing the ICC_MCTLR:

To access the ICC_MCTLR:

MRC p15,6,<Rt>,c12,c12,4 ; Read ICC_MCTLR into Rt

MCR p15,6,<Rt>,c12,c12,4 ; Write Rt to ICC_MCTLR

Register access is encoded as follows:

coproc	opc1	CRn	CRm	opc2
1111	110	1100	1100	100

G4.6.24 ICC_MGRPEN1, Interrupt Controller Monitor Interrupt Group 1 Enable register

The ICC_MGRPEN1 characteristics are:

Purpose

Controls whether Group 1 interrupts are enabled or not.
 This register is part of the GIC registers functional group.

Usage constraints

This register is accessible as shown below:

EL0 (NS)	EL0 (S)	EL1 (NS)	EL1 (S)	EL2	EL3 (SCR.NS=1)	EL3 (SCR.NS=0)
-	-	-	-	-	RW	RW

If an interrupt is pending within the CPU interface when an Enable bit becomes 0, the interrupt must be released to allow the Distributor to forward the interrupt to a different processor.

Configurations

ICC_MGRPEN1 is architecturally mapped to AArch64 register [ICC_IGRPEN1_EL3](#).
 There is one instance of this register that is used in both Secure and Non-secure states.

Attributes

ICC_MGRPEN1 is a 32-bit register.

The ICC_MGRPEN1 bit assignments are:

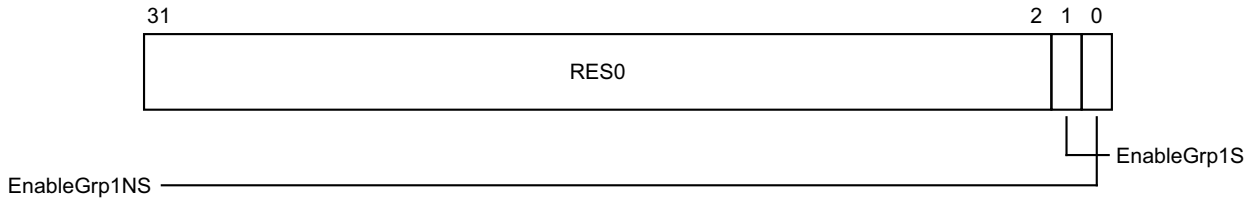

Bits [31:2]

Reserved, RES0.

EnableGrp1S, bit [1]

Enables Group 1 interrupts for the Secure state.
 0 Group 1 interrupts are disabled for the Secure state.
 1 Group 1 interrupts are enabled for the Secure state.
 Resets to 0.

EnableGrp1NS, bit [0]

Enables Group 1 interrupts for the Non-secure state.
 0 Group 1 interrupts are disabled for the Non-secure state.
 1 Group 1 interrupts are enabled for the Non-secure state.
 Resets to 0.

Accessing the ICC_MGRPEN1:

To access the ICC_MGRPEN1:

MRC p15,6,<Rt>,c12,c12,7 ; Read ICC_MGRPEN1 into Rt
MCR p15,6,<Rt>,c12,c12,7 ; Write Rt to ICC_MGRPEN1

Register access is encoded as follows:

coproc	opc1	CRn	CRm	opc2
1111	110	1100	1100	111

G4.6.25 ICC_MSRE, Interrupt Controller Monitor System Register Enable register

The ICC_MSRE characteristics are:

Purpose

Controls whether the system register interface or the memory mapped interface to the GIC CPU interface is used for EL2.

This register is part of:

- the GIC registers functional group
- the Security registers functional group.

Usage constraints

This register is accessible as shown below:

EL0 (NS)	EL0 (S)	EL1 (NS)	EL1 (S)	EL2	EL3 (SCR.NS=1)	EL3 (SCR.NS=0)
-	-	-	-	-	RW	RW

Configurations

ICC_MSRE is architecturally mapped to AArch64 register [ICC_SRE_EL3](#).

There is one instance of this register that is used in both Secure and Non-secure states.

Attributes

ICC_MSRE is a 32-bit register.

The ICC_MSRE bit assignments are:

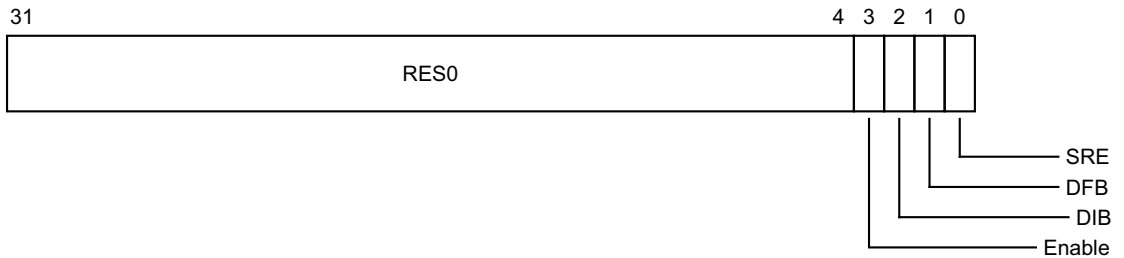

Bits [31:4]

Reserved, RES0.

Enable, bit [3]

Enable. Enables lower exception level access to ICC_SRE_EL1 and ICC_SRE_EL2.

0 EL1 and EL2 accesses to ICC_SRE_EL1 or ICC_SRE_EL2 trap to EL3.

1 EL2 accesses to ICC_SRE_EL2 are permitted. If the Enable bit of ICC_SRE_EL2 is 1, then EL1 accesses to ICC_SRE_EL1 are also permitted.

Resets to 0.

DIB, bit [2]

Disable IRQ bypass.

Resets to 0.

DFB, bit [1]

Disable FIQ bypass.

Resets to 0.

SRE, bit [0]

System Register Enable.

- 0 The memory mapped interface must be used. Access at EL3 to any ICH_* system register, or any EL1, EL2, or EL3 ICC_* register other than ICC_SRE, ICC_HSRE, or ICC_MSRE, results in an Undefined exception.
- 1 The system register interface to the ICH_* registers and the EL1, EL2, and EL3 ICC_* registers is enabled for EL3.

Resets to 0.

Accessing the ICC_MSRE:

To access the ICC_MSRE:

MRC p15,6,<Rt>,c12,c12,5 ; Read ICC_MSRE into Rt
MCR p15,6,<Rt>,c12,c12,5 ; Write Rt to ICC_MSRE

Register access is encoded as follows:

coproc	opc1	CRn	CRm	opc2
1111	110	1100	1100	101

G4.6.26 ICC_PMR, Interrupt Controller Interrupt Priority Mask Register

The ICC_PMR characteristics are:

Purpose

Provides an interrupt priority filter. Only interrupts with higher priority than the value in this register are signaled to the processor.

This register is part of the GIC registers functional group.

Usage constraints

This register is accessible as shown below:

EL0 (NS)	EL0 (S)	EL1 (NS)	EL1 (S)	EL2	EL3 (SCR.NS=1)	EL3 (SCR.NS=0)
-	-	RW	RW	RW	RW	RW

Configurations

ICC_PMR is architecturally mapped to AArch64 register [ICC_PMR_EL1](#).

There is one instance of this register that is used in both Secure and Non-secure states.

Attributes

ICC_PMR is a 32-bit register.

The ICC_PMR bit assignments are:

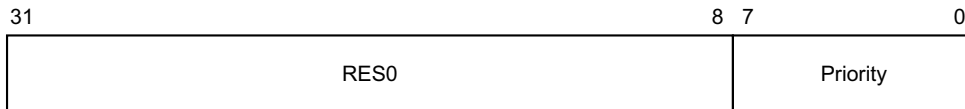

Bits [31:8]

Reserved, RES0.

Priority, bits [7:0]

The priority mask level for the CPU interface. If the priority of an interrupt is higher than the value indicated by this field, the interface signals the interrupt to the processor.

If the GIC supports fewer than 256 priority levels then some bits are RAZ/WI, as follows:

128 supported levels Bit [0] = 0.

64 supported levels Bits [1:0] = 0b00.

32 supported levels Bits [2:0] = 0b000.

16 supported levels Bits [3:0] = 0b0000.

The possible priority field values are as follows:

Implemented priority bits	Possible priority field values	Number of priority levels
[7:0]	0x00-0xFF (0-255), all values	256
[7:1]	0x00-0xFE (0-254), even values only	128

Implemented priority bits	Possible priority field values	Number of priority levels
[7:2]	0x00-0xFC (0-252), in steps of 4	64
[7:3]	0x00-0xF8 (0-248), in steps of 8	32
[7:4]	0x00-0xF0 (0-240), in steps of 16	16

Accessing the ICC_PMR:

To access the ICC_PMR:

MRC p15,0,<Rt>,c4,c6,0 ; Read ICC_PMR into Rt
MCR p15,0,<Rt>,c4,c6,0 ; Write Rt to ICC_PMR

Register access is encoded as follows:

coproc	opc1	CRn	CRm	opc2
1111	000	0100	0110	000

G4.6.27 ICC_RPR, Interrupt Controller Running Priority Register

The ICC_RPR characteristics are:

Purpose

Indicates the Running priority of the CPU interface.
 This register is part of the GIC registers functional group.

Usage constraints

This register is accessible as shown below:

EL0 (NS)	EL0 (S)	EL1 (NS)	EL1 (S)	EL2	EL3 (SCR.NS=1)	EL3 (SCR.NS=0)
-	-	RO	RO	RO	RO	RO

If there is no active interrupt on the CPU interface, the value returned is the Idle priority.
 Software cannot determine the number of implemented priority bits from a read of this register.

Configurations

ICC_RPR is architecturally mapped to AArch64 register [ICC_RPR_EL1](#).
 There is one instance of this register that is used in both Secure and Non-secure states.

Attributes

ICC_RPR is a 32-bit register.

The ICC_RPR bit assignments are:

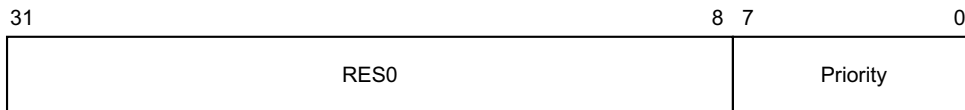

Bits [31:8]

Reserved, RES0.

Priority, bits [7:0]

The current running priority on the CPU interface. This is the priority of the current active interrupt.

Accessing the ICC_RPR:

To access the ICC_RPR:

MRC p15,0,<Rt>,c12,c11,3 ; Read ICC_RPR into Rt

Register access is encoded as follows:

coproc	opc1	CRn	CRm	opc2
1111	000	1100	1011	011

G4.6.28 ICC_SEIEN, Interrupt Controller System Error Interrupt Enable register

The ICC_SEIEN characteristics are:

Purpose

Controls whether System Error Interrupts generated by bus message are enabled.
This register is part of the GIC registers functional group.

Usage constraints

This register is accessible as shown below:

EL0 (NS)	EL0 (S)	EL1 (NS)	EL1 (S)	EL2	EL3 (SCR.NS=1)	EL3 (SCR.NS=0)
-	-	RW	RW	RW	RW	RW

The lowest exception level at which this register may be accessed is governed by the exception level to which SError is routed. This routing depends on SCR.EA, SCR.NS and HCR.AMO.

Internally generated SEIs and pin-generated SEIs might still be generated.

Configurations

ICC_SEIEN is architecturally mapped to AArch64 register [ICC_SEIEN_EL1](#).

There is one instance of this register that is used in both Secure and Non-secure states.

Attributes

ICC_SEIEN is a 32-bit register.

The ICC_SEIEN bit assignments are:



Accessing the ICC_SEIEN:

To access the ICC_SEIEN:

MRC p15,0,<Rt>,c12,c13,0 ; Read ICC_SEIEN into Rt
MCR p15,0,<Rt>,c12,c13,0 ; Write Rt to ICC_SEIEN

Register access is encoded as follows:

coproc	opc1	CRn	CRm	opc2
1111	000	1100	1101	000

G4.6.29 ICC_SGI0R, Interrupt Controller Software Generated Interrupt group 0 Register

The ICC_SGI0R characteristics are:

Purpose

Provides software the ability to generate secure group 0 SGIs, including from the Non-secure state when permitted by GICR_NSACR.

This register is part of the GIC registers functional group.

Usage constraints

This register is accessible as shown below:

EL0 (NS)	EL0 (S)	EL1 (NS)	EL1 (S)	EL2	EL3 (SCR.NS=1)	EL3 (SCR.NS=0)
-	-	WO	WO	WO	WO	WO

Configurations

ICC_SGI0R is architecturally mapped to AArch64 register [ICC_SGI0R_EL1](#).

There is one instance of this register that is used in both Secure and Non-secure states.

Attributes

ICC_SGI0R is a 64-bit register.

The ICC_SGI0R bit assignments are:

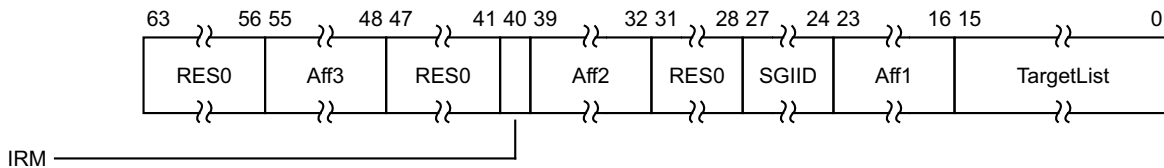

Bits [63:56]

Reserved, RES0.

Aff3, bits [55:48]

The affinity 3 value of the affinity path of the cluster for which SGI interrupts will be generated.

Bits [47:41]

Reserved, RES0.

IRM, bit [40]

Interrupt Routing Mode. Determines how the generated interrupts should be distributed to processors. Possible values are:

- 0 Interrupts routed to the processors specified by a.b.c.{target list}. In this routing, a, b, and c are the values of fields Aff3, Aff2, and Aff1 respectively.
- 1 Interrupts routed to all processors in the system, excluding "self".

Aff2, bits [39:32]

The affinity 2 value of the affinity path of the cluster for which SGI interrupts will be generated.

Bits [31:28]

Reserved, RES0.

SGIID, bits [27:24]

SIGI Interrupt ID.

Aff1, bits [23:16]

The affinity 1 value of the affinity path of the cluster for which SIGI interrupts will be generated.

TargetList, bits [15:0]

Target List. The set of processors for which SIGI interrupts will be generated. Each bit corresponds to the processor within a cluster with an Affinity 0 value equal to the bit number.

If a bit is 1 and the bit does not correspond to a valid target processor, the bit must be ignored by the Distributor. In such cases, a Distributor may optionally generate an SIGI.

This restricts distribution of SIGIs to the first 16 processors of an affinity 1 cluster.

Accessing the ICC_SGI0R:

To access the ICC_SGI0R:

MCRR p15,2,<Rt>,<Rt2>,c12 ; Write Rt (low word) and Rt2 (high word) to 64-bit ICC_SGI0R

Register access is encoded as follows:

coproc	opc1	CRm
1111	0010	1100

G4.6.30 ICC_SGI1R, Interrupt Controller Software Generated Interrupt group 1 Register

The ICC_SGI1R characteristics are:

Purpose

Provides software the ability to generate group 1 SGIs for the current security state.
 This register is part of the GIC registers functional group.

Usage constraints

This register is accessible as shown below:
 When accessed as ICC_SGI1R(S):

EL0 (NS)	EL0 (S)	EL1 (NS)	EL1 (S)	EL2	EL3 (SCR.NS=1)	EL3 (SCR.NS=0)
-	-	-	WO	-	-	WO

When accessed as ICC_SGI1R(NS):

EL0 (NS)	EL0 (S)	EL1 (NS)	EL1 (S)	EL2	EL3 (SCR.NS=1)	EL3 (SCR.NS=0)
-	-	WO	-	WO	WO	-

Configurations

ICC_SGI1R(S) is architecturally mapped to AArch64 register [ICC_SGI1R_EL1 \(S\)](#).
 ICC_SGI1R(NS) is architecturally mapped to AArch64 register [ICC_SGI1R_EL1 \(NS\)](#).
 If EL3 is using AArch32, there are separate Secure and Non-secure instances of this register.

Attributes

ICC_SGI1R is a 64-bit register.

The ICC_SGI1R bit assignments are:

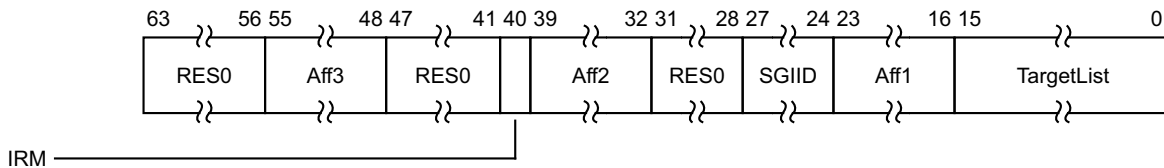

Bits [63:56]

Reserved, RES0.

Aff3, bits [55:48]

The affinity 3 value of the affinity path of the cluster for which SGI interrupts will be generated.

Bits [47:41]

Reserved, RES0.

IRM, bit [40]

Interrupt Routing Mode. Determines how the generated interrupts should be distributed to processors. Possible values are:

- 0 Interrupts routed to the processors specified by a.b.c.{target list}. In this routing, a, b, and c are the values of fields Aff3, Aff2, and Aff1 respectively.
- 1 Interrupts routed to all processors in the system, excluding "self".

Aff2, bits [39:32]

The affinity 2 value of the affinity path of the cluster for which SGI interrupts will be generated.

Bits [31:28]

Reserved, RES0.

SGIID, bits [27:24]

SGI Interrupt ID.

Aff1, bits [23:16]

The affinity 1 value of the affinity path of the cluster for which SGI interrupts will be generated.

TargetList, bits [15:0]

Target List. The set of processors for which SGI interrupts will be generated. Each bit corresponds to the processor within a cluster with an Affinity 0 value equal to the bit number.

If a bit is 1 and the bit does not correspond to a valid target processor, the bit must be ignored by the Distributor. In such cases, a Distributor may optionally generate an SGI.

This restricts distribution of SGIs to the first 16 processors of an affinity 1 cluster.

Accessing the ICC_SGI1R:

To access the ICC_SGI1R:

MCRR p15,0,<Rt>,<Rt2>,c12 ; Write Rt (low word) and Rt2 (high word) to 64-bit ICC_SGI1R

Register access is encoded as follows:

coproc	opc1	CRm
1111	0000	1100

G4.6.31 ICC_SRE, Interrupt Controller System Register Enable register

The ICC_SRE characteristics are:

Purpose

Controls whether the system register interface or the memory mapped interface to the GIC CPU interface is used for EL0 and EL1.

This register is part of the GIC registers functional group.

Usage constraints

This register is accessible as shown below:

When accessed as ICC_SRE(S):

EL0 (NS)	EL0 (S)	EL1 (NS)	EL1 (S)	EL2	EL3 (SCR.NS=1)	EL3 (SCR.NS=0)
-	-	-	RW	-	-	RW

When accessed as ICC_SRE(NS):

EL0 (NS)	EL0 (S)	EL1 (NS)	EL1 (S)	EL2	EL3 (SCR.NS=1)	EL3 (SCR.NS=0)
-	-	RW	-	RW	RW	-

Configurations

ICC_SRE(S) is architecturally mapped to AArch64 register [ICC_SRE_EL1 \(S\)](#).

ICC_SRE(NS) is architecturally mapped to AArch64 register [ICC_SRE_EL1 \(NS\)](#).

If EL3 is using AArch32, there are separate Secure and Non-secure instances of this register.

Attributes

ICC_SRE is a 32-bit register.

The ICC_SRE bit assignments are:

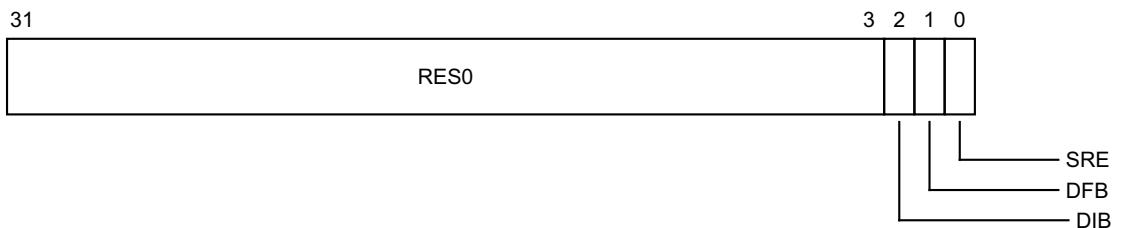

Bits [31:3]

Reserved, RES0.

DIB, bit [2]

Disable IRQ bypass.

If EL3 is present, this field is a read-only alias of ICC_MSRE.DIB.

If EL3 is not present and EL2 is present, this field is a read-only alias of ICC_HSRE.DIB.

Resets to 0.

DFB, bit [1]

Disable FIQ bypass.

If EL3 is present, this field is a read-only alias of ICC_MSRE.DFB.

If EL3 is not present and EL2 is present, this field is a read-only alias of ICC_HSRE.DFB.

Resets to 0.

SRE, bit [0]

System Register Enable.

0 The memory mapped interface must be used. Access at EL1 to any ICC_* system register other than ICC_SRE results in an Undefined exception.

1 The system register interface for the current security state is enabled.

Virtual accesses modify ICH_VMCR.VSRE.

Resets to 0.

Accessing the ICC_SRE:

To access the ICC_SRE:

MRC p15,0,<Rt>,c12,c12,5 ; Read ICC_SRE into Rt

MCR p15,0,<Rt>,c12,c12,5 ; Write Rt to ICC_SRE

Register access is encoded as follows:

coproc	opc1	CRn	CRm	opc2
1111	000	1100	1100	101

G4.6.32 ICH_AP0R0, Interrupt Controller Hyp Active Priorities Register (0,0)

The ICH_AP0R0 characteristics are:

Purpose

Provides information about the active priorities for the current EL2 interrupt regime.

This register is part of:

- the GIC registers functional group
- the Virtualization registers functional group.

Usage constraints

This register is accessible as shown below:

EL0 (NS)	EL0 (S)	EL1 (NS)	EL1 (S)	EL2	EL3 (SCR.NS=1)	EL3 (SCR.NS=0)
-	-	-	-	RW	RW	-

In implementations supporting fewer than 8 bits of priority, some of these registers correspond to unimplemented priority levels. Access to such registers will generate an Undefined exception.

Configurations

ICH_AP0R0 is architecturally mapped to AArch64 register [ICH_AP0R0_EL2](#).

Attributes

ICH_AP0R0 is a 32-bit register.

The ICH_AP0R0 bit assignments are:

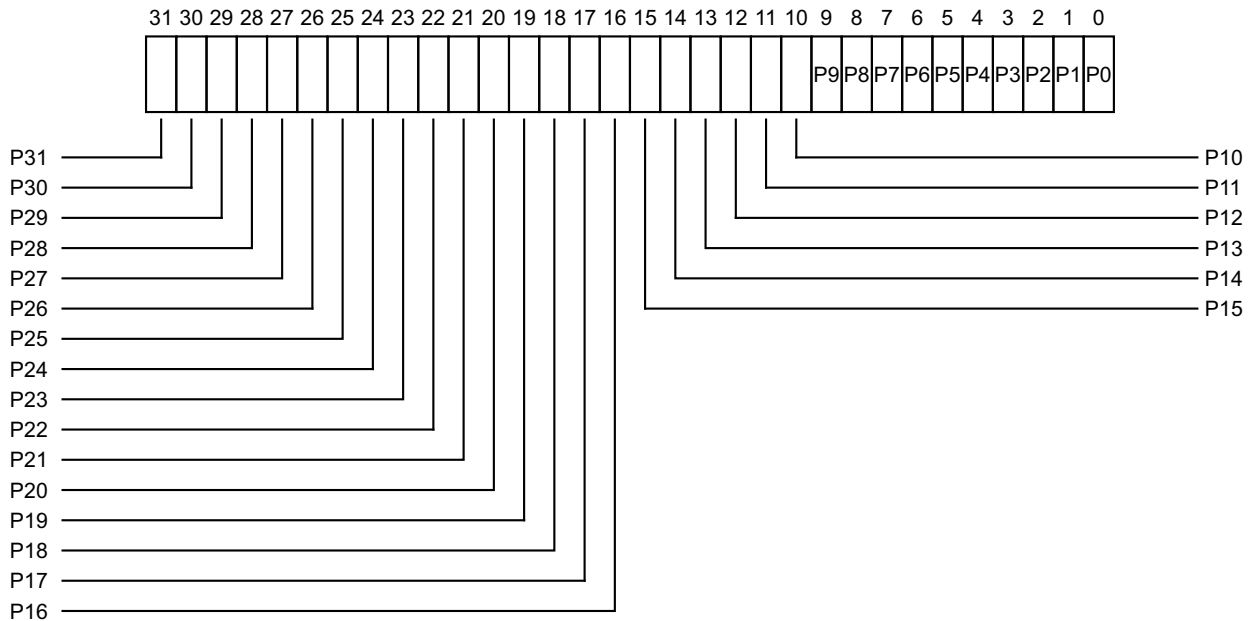

P<n>, bit [n], for n = 0 to 31

Provides information about priority M, according to the following relationship:

Bit P<n> corresponds to priority (M divided by 2^U) minus 1, where U is the number of unimplemented bits of priority and is equal to (7 - ICC_CTLR_EL1.PRIbits).

For example, in a system with ICC_CTLR_EL1.PRIbits == 0b100:

- There are 5 bits of implemented priority.
- This means there are 3 bits of unimplemented priority, which are always at the least significant end (bits [2:0] are RES0).
- Valid priorities are 8, 16, 24, 32, and so on. Dividing these by 2³ gives 1, 2, 3, 4, and so on.
- Subtracting 1 from each gives bits 0, 1, 2, 3, and so on that provide information about those priorities.

Accesses to these registers from an interrupt regime give a view of the active priorities that is appropriate for that interrupt regime, to allow save and restore of the appropriate state.

Interrupt regime and the number of security states supported by the Distributor affect the view as follows. Unless otherwise stated, when a bit is successfully set to one, this clears any other active priorities corresponding to that bit.

Exception level	AP0Rn access
(Secure) EL3	Permitted. Accesses Group 0 Secure active priorities.
Secure EL1	Permitted. Accesses Group 0 Secure active priorities.
Non-secure EL1 access for a Virtual interrupt	ICH_AP0Rn_EL2
Non-secure EL1 or EL2 when GIC Distributor supports two Security states	Permitted. Accesses Group 0 Secure active priorities.
Non-secure EL1 or EL2 when GIC Distributor supports one Security state	Permitted. Accesses Group 0 active priorities.

A Virtual interrupt in this case means that the interrupt group associated with the register has been virtualized.

Accessing the ICH_AP0R0:

To access the ICH_AP0R0:

MRC p15,4,<Rt>,c12,c8,0 ; Read ICH_AP0R0 into Rt
MCR p15,4,<Rt>,c12,c8,0 ; Write Rt to ICH_AP0R0

Register access is encoded as follows:

coproc	opc1	CRn	CRm	opc2
1111	100	1100	1000	000

G4.6.33 ICH_AP0R1, Interrupt Controller Hyp Active Priorities Register (0,1)

The ICH_AP0R1 characteristics are:

Purpose

Provides information about the active priorities for the current EL2 interrupt regime.

This register is part of:

- the GIC registers functional group
- the Virtualization registers functional group.

Usage constraints

This register is accessible as shown below:

EL0 (NS)	EL0 (S)	EL1 (NS)	EL1 (S)	EL2	EL3 (SCR.NS=1)	EL3 (SCR.NS=0)
-	-	-	-	RW	RW	-

In implementations supporting fewer than 8 bits of priority, some of these registers correspond to unimplemented priority levels. Access to such registers will generate an Undefined exception.

Configurations

ICH_AP0R1 is architecturally mapped to AArch64 register [ICH_AP0R1_EL2](#).

Attributes

ICH_AP0R1 is a 32-bit register.

The ICH_AP0R1 bit assignments are:

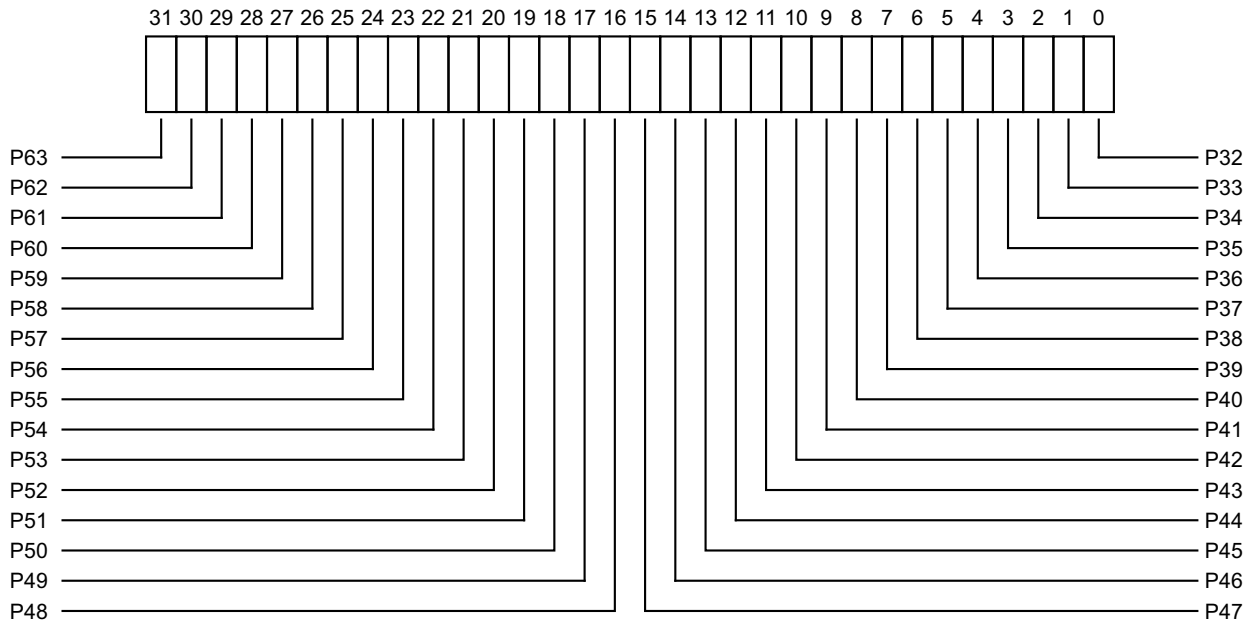

P<n>, bit [(n-32)], for n = 32 to 63

Provides information about priority M, according to the following relationship:

Bit P<n> corresponds to priority (M divided by 2^U) minus 1, where U is the number of unimplemented bits of priority and is equal to (7 - ICC_CTLR_EL1.PRIbits).

For example, in a system with `ICC_CTLR_EL1.PRIbits == 0b100`:

- There are 5 bits of implemented priority.
- This means there are 3 bits of unimplemented priority, which are always at the least significant end (bits [2:0] are RES0).
- Valid priorities are 8, 16, 24, 32, and so on. Dividing these by 2^3 gives 1, 2, 3, 4, and so on.
- Subtracting 1 from each gives bits 0, 1, 2, 3, and so on that provide information about those priorities.

Accesses to these registers from an interrupt regime give a view of the active priorities that is appropriate for that interrupt regime, to allow save and restore of the appropriate state.

Interrupt regime and the number of security states supported by the Distributor affect the view as follows. Unless otherwise stated, when a bit is successfully set to one, this clears any other active priorities corresponding to that bit.

Exception level	AP0Rn access
(Secure) EL3	Permitted. Accesses Group 0 Secure active priorities.
Secure EL1	Permitted. Accesses Group 0 Secure active priorities.
Non-secure EL1 access for a Virtual interrupt	ICH_AP0Rn_EL2
Non-secure EL1 or EL2 when GIC Distributor supports two Security states	Permitted. Accesses Group 0 Secure active priorities.
Non-secure EL1 or EL2 when GIC Distributor supports one Security state	Permitted. Accesses Group 0 active priorities.

A Virtual interrupt in this case means that the interrupt group associated with the register has been virtualized.

Accessing the ICH_AP0R1:

To access the ICH_AP0R1:

MRC p15,4,<Rt>,c12,c8,1 ; Read ICH_AP0R1 into Rt
MCR p15,4,<Rt>,c12,c8,1 ; Write Rt to ICH_AP0R1

Register access is encoded as follows:

coproc	opc1	CRn	CRm	opc2
1111	100	1100	1000	001

G4.6.34 ICH_AP0R2, Interrupt Controller Hyp Active Priorities Register (0,2)

The ICH_AP0R2 characteristics are:

Purpose

Provides information about the active priorities for the current EL2 interrupt regime.

This register is part of:

- the GIC registers functional group
- the Virtualization registers functional group.

Usage constraints

This register is accessible as shown below:

EL0 (NS)	EL0 (S)	EL1 (NS)	EL1 (S)	EL2	EL3 (SCR.NS=1)	EL3 (SCR.NS=0)
-	-	-	-	RW	RW	-

In implementations supporting fewer than 8 bits of priority, some of these registers correspond to unimplemented priority levels. Access to such registers will generate an Undefined exception.

Configurations

ICH_AP0R2 is architecturally mapped to AArch64 register [ICH_AP0R2_EL2](#).

Attributes

ICH_AP0R2 is a 32-bit register.

The ICH_AP0R2 bit assignments are:

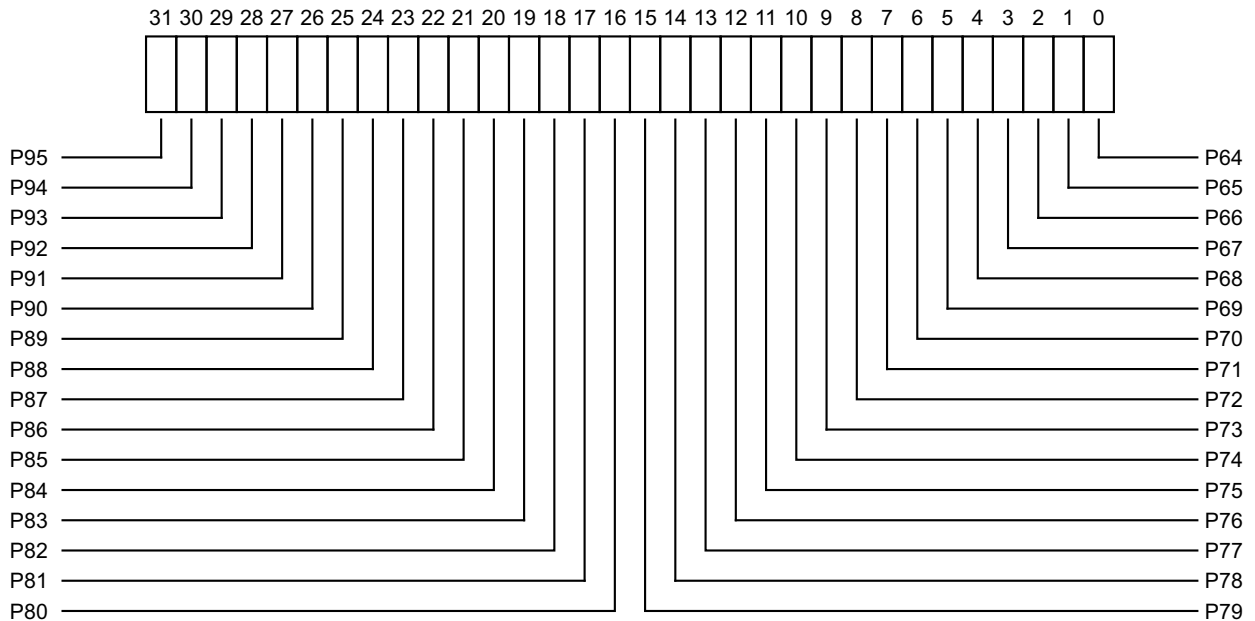

P<n>, bit [(n-64)], for n = 64 to 95

Provides information about priority M, according to the following relationship:

Bit P<n> corresponds to priority (M divided by 2^U) minus 1, where U is the number of unimplemented bits of priority and is equal to (7 - ICC_CTLR_EL1.PRIbits).

For example, in a system with ICC_CTLR_EL1.PRIbits == 0b100:

- There are 5 bits of implemented priority.
- This means there are 3 bits of unimplemented priority, which are always at the least significant end (bits [2:0] are RES0).
- Valid priorities are 8, 16, 24, 32, and so on. Dividing these by 2^3 gives 1, 2, 3, 4, and so on.
- Subtracting 1 from each gives bits 0, 1, 2, 3, and so on that provide information about those priorities.

Accesses to these registers from an interrupt regime give a view of the active priorities that is appropriate for that interrupt regime, to allow save and restore of the appropriate state.

Interrupt regime and the number of security states supported by the Distributor affect the view as follows. Unless otherwise stated, when a bit is successfully set to one, this clears any other active priorities corresponding to that bit.

Exception level	AP0Rn access
(Secure) EL3	Permitted. Accesses Group 0 Secure active priorities.
Secure EL1	Permitted. Accesses Group 0 Secure active priorities.
Non-secure EL1 access for a Virtual interrupt	ICH_AP0Rn_EL2
Non-secure EL1 or EL2 when GIC Distributor supports two Security states	Permitted. Accesses Group 0 Secure active priorities.
Non-secure EL1 or EL2 when GIC Distributor supports one Security state	Permitted. Accesses Group 0 active priorities.

A Virtual interrupt in this case means that the interrupt group associated with the register has been virtualized.

Accessing the ICH_AP0R2:

To access the ICH_AP0R2:

MRC p15,4,<Rt>,c12,c8,2 ; Read ICH_AP0R2 into Rt
MCR p15,4,<Rt>,c12,c8,2 ; Write Rt to ICH_AP0R2

Register access is encoded as follows:

coproc	opc1	CRn	CRm	opc2
1111	100	1100	1000	010

G4.6.35 ICH_AP0R3, Interrupt Controller Hyp Active Priorities Register (0,3)

The ICH_AP0R3 characteristics are:

Purpose

Provides information about the active priorities for the current EL2 interrupt regime.

This register is part of:

- the GIC registers functional group
- the Virtualization registers functional group.

Usage constraints

This register is accessible as shown below:

EL0 (NS)	EL0 (S)	EL1 (NS)	EL1 (S)	EL2	EL3 (SCR.NS=1)	EL3 (SCR.NS=0)
-	-	-	-	RW	RW	-

In implementations supporting fewer than 8 bits of priority, some of these registers correspond to unimplemented priority levels. Access to such registers will generate an Undefined exception.

Configurations

ICH_AP0R3 is architecturally mapped to AArch64 register [ICH_AP0R3_EL2](#).

Attributes

ICH_AP0R3 is a 32-bit register.

The ICH_AP0R3 bit assignments are:

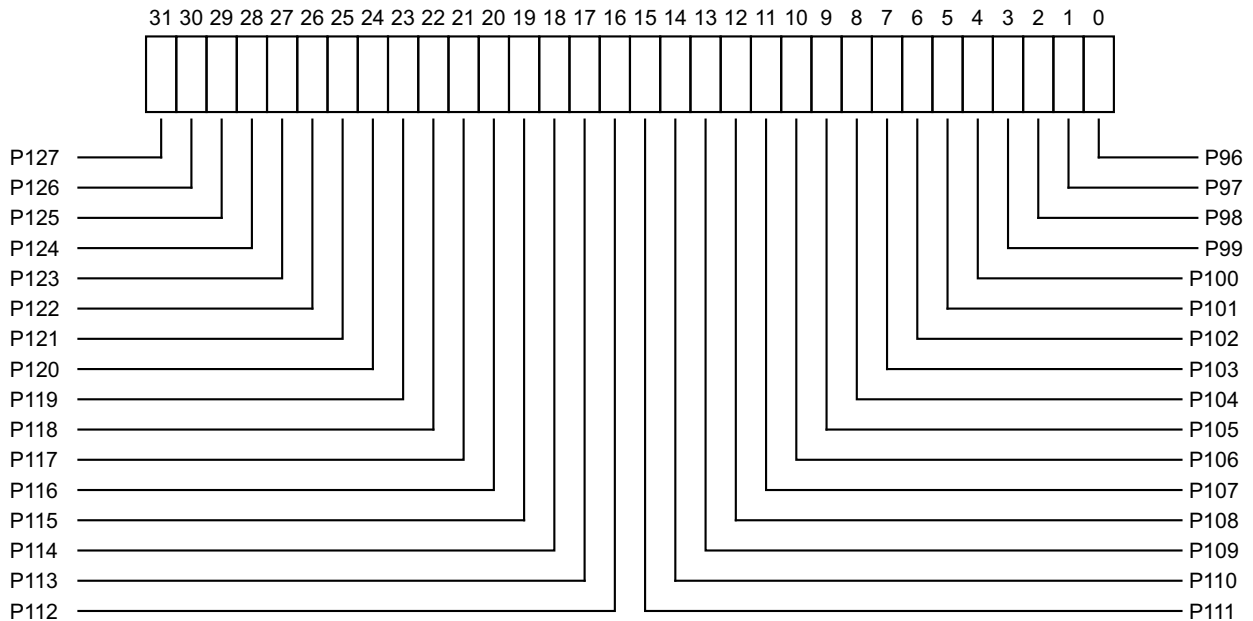

P<n>, bit [(n-96)], for n = 96 to 127

Provides information about priority M, according to the following relationship:

Bit P<n> corresponds to priority (M divided by 2^U) minus 1, where U is the number of unimplemented bits of priority and is equal to (7 - ICC_CTLR_EL1.PRIbits).

For example, in a system with `ICC_CTLR_EL1.PRIbits == 0b100`:

- There are 5 bits of implemented priority.
- This means there are 3 bits of unimplemented priority, which are always at the least significant end (bits [2:0] are RES0).
- Valid priorities are 8, 16, 24, 32, and so on. Dividing these by 2^3 gives 1, 2, 3, 4, and so on.
- Subtracting 1 from each gives bits 0, 1, 2, 3, and so on that provide information about those priorities.

Accesses to these registers from an interrupt regime give a view of the active priorities that is appropriate for that interrupt regime, to allow save and restore of the appropriate state.

Interrupt regime and the number of security states supported by the Distributor affect the view as follows. Unless otherwise stated, when a bit is successfully set to one, this clears any other active priorities corresponding to that bit.

Exception level	AP0Rn access
(Secure) EL3	Permitted. Accesses Group 0 Secure active priorities.
Secure EL1	Permitted. Accesses Group 0 Secure active priorities.
Non-secure EL1 access for a Virtual interrupt	ICH_AP0Rn_EL2
Non-secure EL1 or EL2 when GIC Distributor supports two Security states	Permitted. Accesses Group 0 Secure active priorities.
Non-secure EL1 or EL2 when GIC Distributor supports one Security state	Permitted. Accesses Group 0 active priorities.

A Virtual interrupt in this case means that the interrupt group associated with the register has been virtualized.

Accessing the ICH_AP0R3:

To access the ICH_AP0R3:

MRC p15,4,<Rt>,c12,c8,3 ; Read ICH_AP0R3 into Rt
MCR p15,4,<Rt>,c12,c8,3 ; Write Rt to ICH_AP0R3

Register access is encoded as follows:

coproc	opc1	CRn	CRm	opc2
1111	100	1100	1000	011

G4.6.36 ICH_AP1R0, Interrupt Controller Hyp Active Priorities Register (1,0)

The ICH_AP1R0 characteristics are:

Purpose

Provides information about the active priorities for the current EL2 interrupt regime.

This register is part of:

- the GIC registers functional group
- the Virtualization registers functional group.

Usage constraints

This register is accessible as shown below:

EL0 (NS)	EL0 (S)	EL1 (NS)	EL1 (S)	EL2	EL3 (SCR.NS=1)	EL3 (SCR.NS=0)
-	-	-	-	RW	RW	-

In implementations supporting fewer than 8 bits of priority, some of these registers correspond to unimplemented priority levels. Access to such registers will generate an Undefined exception.

Configurations

ICH_AP1R0 is architecturally mapped to AArch64 register [ICH_AP1R0_EL2](#).

Attributes

ICH_AP1R0 is a 32-bit register.

The ICH_AP1R0 bit assignments are:

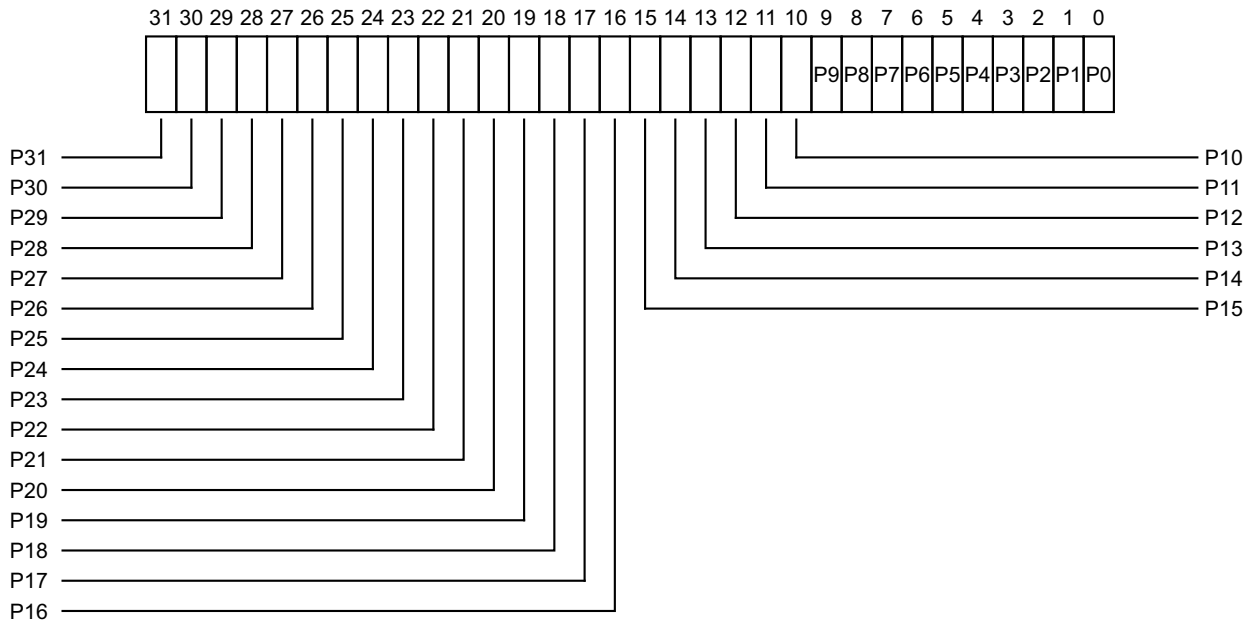

P<n>, bit [n], for n = 0 to 31

Provides information about priority M, according to the following relationship:

Bit P<n> corresponds to priority (M divided by 2^U) minus 1, where U is the number of unimplemented bits of priority and is equal to (7 - ICC_CTLR_EL1.PRIbits).

For example, in a system with ICC_CTLR_EL1.PRIbits == 0b100:

- There are 5 bits of implemented priority.
- This means there are 3 bits of unimplemented priority, which are always at the least significant end (bits [2:0] are RES0).
- Valid priorities are 8, 16, 24, 32, and so on. Dividing these by 2^3 gives 1, 2, 3, 4, and so on.
- Subtracting 1 from each gives bits 0, 1, 2, 3, and so on that provide information about those priorities.

Accesses to these registers from an interrupt regime give a view of the active priorities that is appropriate for that interrupt regime, to allow save and restore of the appropriate state.

Interrupt regime and the number of security states supported by the Distributor affect the view as follows. Unless otherwise stated, when a bit is successfully set to one, this clears any other active priorities corresponding to that bit.

Current exception level and security state	AP1Rn access
(Secure) EL3	Permitted. When SCR_EL3.NS is 0, accesses Group 1 Secure active priorities. When SCR_EL3.NS is 1, accesses Group 1 Non-secure active priorities (unshifted). When a bit is written, the bit is only updated if the corresponding Group 0 and Group 1 Secure active priority is zero.
Secure EL1	Permitted. Accesses Group 1 Secure active priorities (unshifted). When a bit is written, the bit is only updated if the corresponding Group 0 Secure active priority is zero.
Non-secure EL1 access for a Virtual interrupt	ICH_AP1Rn_EL2
Non-secure EL1 or EL2 when GIC Distributor supports two Security states	Permitted. Accesses Group 1 Non-secure active priorities (shifted). When a bit is written, the bit is only updated if the corresponding Group 0 and Group 1 Secure active priority is zero.
Non-secure EL1 or EL2 when GIC Distributor supports one Security state	Permitted. Accesses Group 1 Non-secure active priorities (unshifted). When a bit is written, the bit is only updated if the Group 0 active priority is zero.

A Virtual interrupt in this case means that the interrupt group associated with the register has been virtualized.

Accessing the ICH_AP1R0:

To access the ICH_AP1R0:

MRC p15,4,<Rt>,c12,c9,0 ; Read ICH_AP1R0 into Rt
MCR p15,4,<Rt>,c12,c9,0 ; Write Rt to ICH_AP1R0

Register access is encoded as follows:

coproc	opc1	CRn	CRm	opc2
1111	100	1100	1001	000

G4.6.37 ICH_AP1R1, Interrupt Controller Hyp Active Priorities Register (1,1)

The ICH_AP1R1 characteristics are:

Purpose

Provides information about the active priorities for the current EL2 interrupt regime.

This register is part of:

- the GIC registers functional group
- the Virtualization registers functional group.

Usage constraints

This register is accessible as shown below:

EL0 (NS)	EL0 (S)	EL1 (NS)	EL1 (S)	EL2	EL3 (SCR.NS=1)	EL3 (SCR.NS=0)
-	-	-	-	RW	RW	-

In implementations supporting fewer than 8 bits of priority, some of these registers correspond to unimplemented priority levels. Access to such registers will generate an Undefined exception.

Configurations

ICH_AP1R1 is architecturally mapped to AArch64 register [ICH_AP1R1_EL2](#).

Attributes

ICH_AP1R1 is a 32-bit register.

The ICH_AP1R1 bit assignments are:

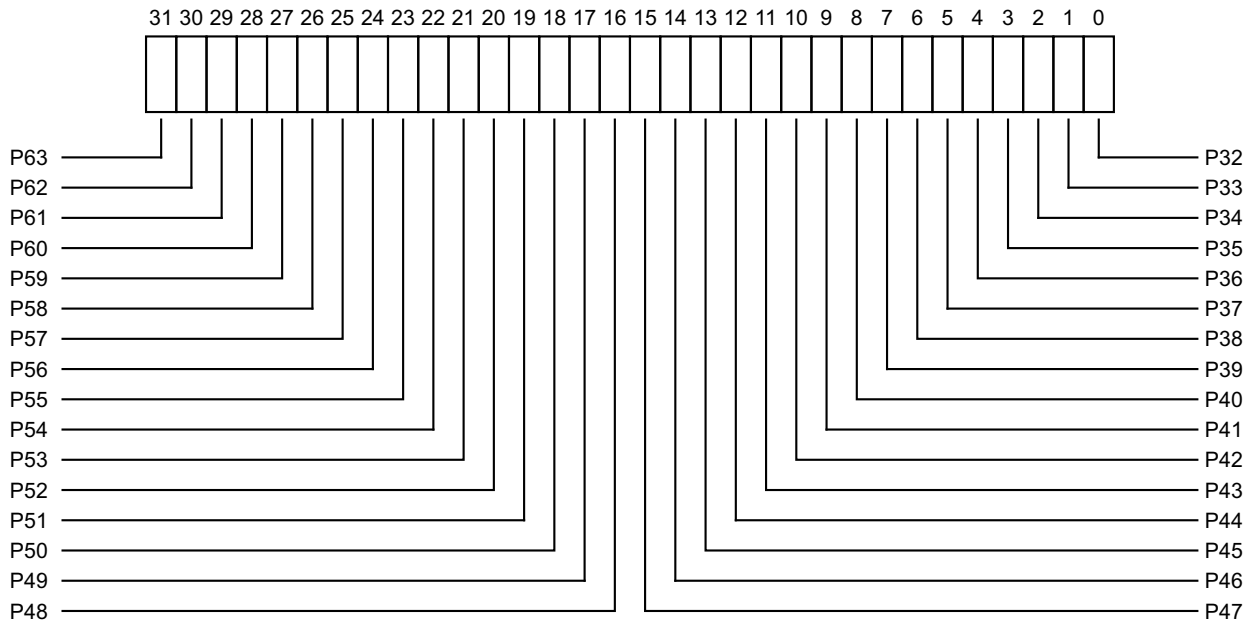

P<n>, bit [(n-32)], for n = 32 to 63

Provides information about priority M, according to the following relationship:

Bit P<n> corresponds to priority (M divided by 2^U) minus 1, where U is the number of unimplemented bits of priority and is equal to (7 - ICC_CTLR_EL1.PRIbits).

For example, in a system with ICC_CTLR_EL1.PRIbits == 0b100:

- There are 5 bits of implemented priority.
- This means there are 3 bits of unimplemented priority, which are always at the least significant end (bits [2:0] are RES0).
- Valid priorities are 8, 16, 24, 32, and so on. Dividing these by 2^3 gives 1, 2, 3, 4, and so on.
- Subtracting 1 from each gives bits 0, 1, 2, 3, and so on that provide information about those priorities.

Accesses to these registers from an interrupt regime give a view of the active priorities that is appropriate for that interrupt regime, to allow save and restore of the appropriate state.

Interrupt regime and the number of security states supported by the Distributor affect the view as follows. Unless otherwise stated, when a bit is successfully set to one, this clears any other active priorities corresponding to that bit.

Current exception level and security state	AP1Rn access
(Secure) EL3	Permitted. When SCR_EL3.NS is 0, accesses Group 1 Secure active priorities. When SCR_EL3.NS is 1, accesses Group 1 Non-secure active priorities (unshifted). When a bit is written, the bit is only updated if the corresponding Group 0 and Group 1 Secure active priority is zero.
Secure EL1	Permitted. Accesses Group 1 Secure active priorities (unshifted). When a bit is written, the bit is only updated if the corresponding Group 0 Secure active priority is zero.
Non-secure EL1 access for a Virtual interrupt	ICH_AP1Rn_EL2
Non-secure EL1 or EL2 when GIC Distributor supports two Security states	Permitted. Accesses Group 1 Non-secure active priorities (shifted). When a bit is written, the bit is only updated if the corresponding Group 0 and Group 1 Secure active priority is zero.
Non-secure EL1 or EL2 when GIC Distributor supports one Security state	Permitted. Accesses Group 1 Non-secure active priorities (unshifted). When a bit is written, the bit is only updated if the Group 0 active priority is zero.

A Virtual interrupt in this case means that the interrupt group associated with the register has been virtualized.

Accessing the ICH_AP1R1:

To access the ICH_AP1R1:

MRC p15,4,<Rt>,c12,c9,1 ; Read ICH_AP1R1 into Rt
MCR p15,4,<Rt>,c12,c9,1 ; Write Rt to ICH_AP1R1

Register access is encoded as follows:

coproc	opc1	CRn	CRm	opc2
1111	100	1100	1001	001

G4.6.38 ICH_AP1R2, Interrupt Controller Hyp Active Priorities Register (1,2)

The ICH_AP1R2 characteristics are:

Purpose

Provides information about the active priorities for the current EL2 interrupt regime.

This register is part of:

- the GIC registers functional group
- the Virtualization registers functional group.

Usage constraints

This register is accessible as shown below:

EL0 (NS)	EL0 (S)	EL1 (NS)	EL1 (S)	EL2	EL3 (SCR.NS=1)	EL3 (SCR.NS=0)
-	-	-	-	RW	RW	-

In implementations supporting fewer than 8 bits of priority, some of these registers correspond to unimplemented priority levels. Access to such registers will generate an Undefined exception.

Configurations

ICH_AP1R2 is architecturally mapped to AArch64 register [ICH_AP1R2_EL2](#).

Attributes

ICH_AP1R2 is a 32-bit register.

The ICH_AP1R2 bit assignments are:

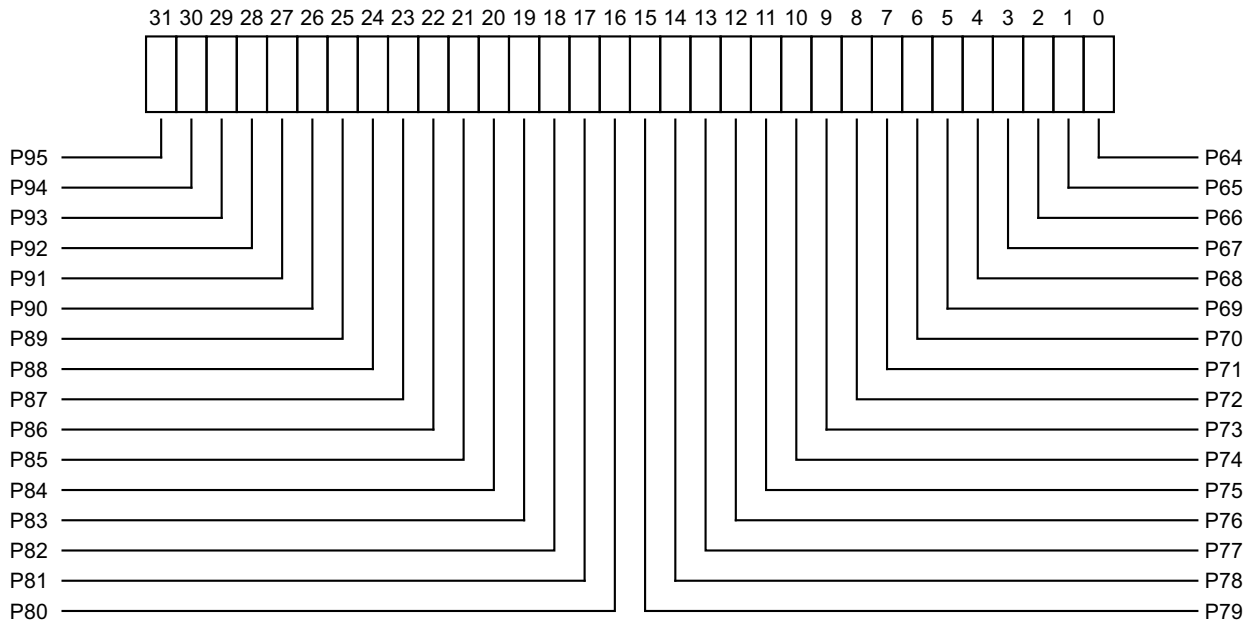

P<n>, bit [(n-64)], for n = 64 to 95

Provides information about priority M, according to the following relationship:

Bit P<n> corresponds to priority (M divided by 2^U) minus 1, where U is the number of unimplemented bits of priority and is equal to (7 - ICC_CTLR_EL1.PRIbits).

For example, in a system with ICC_CTLR_EL1.PRIbits == 0b100:

- There are 5 bits of implemented priority.
- This means there are 3 bits of unimplemented priority, which are always at the least significant end (bits [2:0] are RES0).
- Valid priorities are 8, 16, 24, 32, and so on. Dividing these by 2^3 gives 1, 2, 3, 4, and so on.
- Subtracting 1 from each gives bits 0, 1, 2, 3, and so on that provide information about those priorities.

Accesses to these registers from an interrupt regime give a view of the active priorities that is appropriate for that interrupt regime, to allow save and restore of the appropriate state.

Interrupt regime and the number of security states supported by the Distributor affect the view as follows. Unless otherwise stated, when a bit is successfully set to one, this clears any other active priorities corresponding to that bit.

Current exception level and security state	AP1Rn access
(Secure) EL3	Permitted. When SCR_EL3.NS is 0, accesses Group 1 Secure active priorities. When SCR_EL3.NS is 1, accesses Group 1 Non-secure active priorities (unshifted). When a bit is written, the bit is only updated if the corresponding Group 0 and Group 1 Secure active priority is zero.
Secure EL1	Permitted. Accesses Group 1 Secure active priorities (unshifted). When a bit is written, the bit is only updated if the corresponding Group 0 Secure active priority is zero.
Non-secure EL1 access for a Virtual interrupt	ICH_AP1Rn_EL2
Non-secure EL1 or EL2 when GIC Distributor supports two Security states	Permitted. Accesses Group 1 Non-secure active priorities (shifted). When a bit is written, the bit is only updated if the corresponding Group 0 and Group 1 Secure active priority is zero.
Non-secure EL1 or EL2 when GIC Distributor supports one Security state	Permitted. Accesses Group 1 Non-secure active priorities (unshifted). When a bit is written, the bit is only updated if the Group 0 active priority is zero.

A Virtual interrupt in this case means that the interrupt group associated with the register has been virtualized.

Accessing the ICH_AP1R2:

To access the ICH_AP1R2:

MRC p15,4,<Rt>,c12,c9,2 ; Read ICH_AP1R2 into Rt
MCR p15,4,<Rt>,c12,c9,2 ; Write Rt to ICH_AP1R2

Register access is encoded as follows:

coproc	opc1	CRn	CRm	opc2
1111	100	1100	1001	010

G4.6.39 ICH_AP1R3, Interrupt Controller Hyp Active Priorities Register (1,3)

The ICH_AP1R3 characteristics are:

Purpose

Provides information about the active priorities for the current EL2 interrupt regime.

This register is part of:

- the GIC registers functional group
- the Virtualization registers functional group.

Usage constraints

This register is accessible as shown below:

EL0 (NS)	EL0 (S)	EL1 (NS)	EL1 (S)	EL2	EL3 (SCR.NS=1)	EL3 (SCR.NS=0)
-	-	-	-	RW	RW	-

In implementations supporting fewer than 8 bits of priority, some of these registers correspond to unimplemented priority levels. Access to such registers will generate an Undefined exception.

Configurations

ICH_AP1R3 is architecturally mapped to AArch64 register [ICH_AP1R3_EL2](#).

Attributes

ICH_AP1R3 is a 32-bit register.

The ICH_AP1R3 bit assignments are:

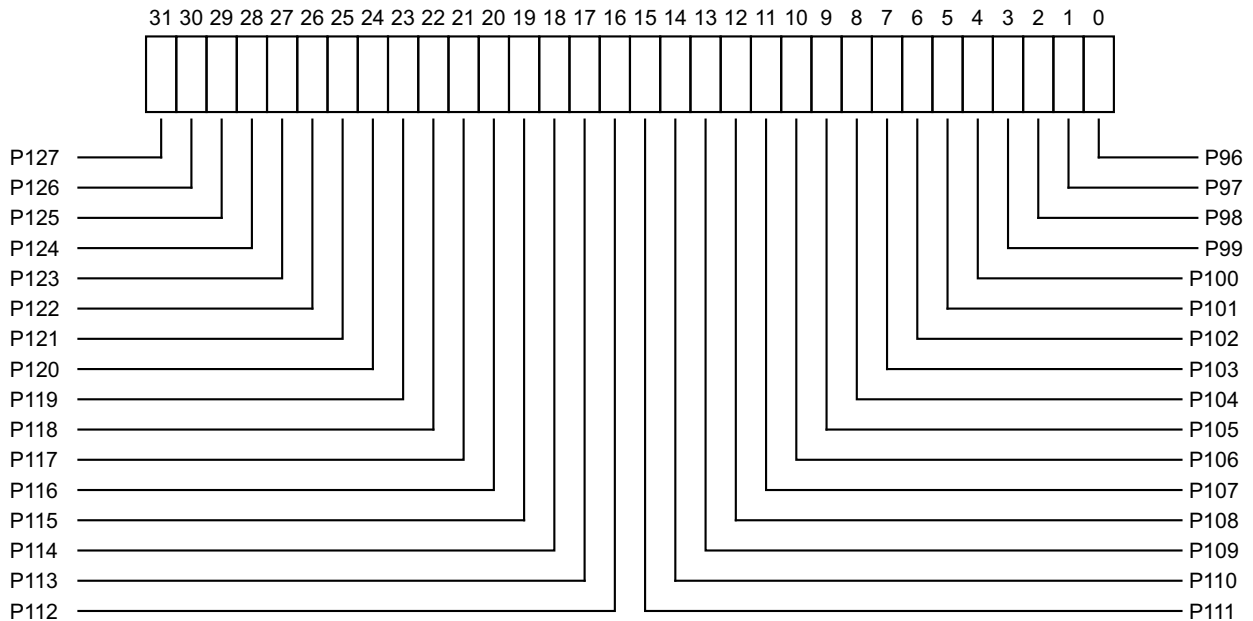

P<n>, bit [(n-96)], for n = 96 to 127

Provides information about priority M, according to the following relationship:

Bit P<n> corresponds to priority (M divided by 2^U) minus 1, where U is the number of unimplemented bits of priority and is equal to (7 - ICC_CTLR_EL1.PRIbits).

For example, in a system with ICC_CTLR_EL1.PRIbits == 0b100:

- There are 5 bits of implemented priority.
- This means there are 3 bits of unimplemented priority, which are always at the least significant end (bits [2:0] are RES0).
- Valid priorities are 8, 16, 24, 32, and so on. Dividing these by 2^3 gives 1, 2, 3, 4, and so on.
- Subtracting 1 from each gives bits 0, 1, 2, 3, and so on that provide information about those priorities.

Accesses to these registers from an interrupt regime give a view of the active priorities that is appropriate for that interrupt regime, to allow save and restore of the appropriate state.

Interrupt regime and the number of security states supported by the Distributor affect the view as follows. Unless otherwise stated, when a bit is successfully set to one, this clears any other active priorities corresponding to that bit.

Current exception level and security state	AP1Rn access
(Secure) EL3	Permitted. When SCR_EL3.NS is 0, accesses Group 1 Secure active priorities. When SCR_EL3.NS is 1, accesses Group 1 Non-secure active priorities (unshifted). When a bit is written, the bit is only updated if the corresponding Group 0 and Group 1 Secure active priority is zero.
Secure EL1	Permitted. Accesses Group 1 Secure active priorities (unshifted). When a bit is written, the bit is only updated if the corresponding Group 0 Secure active priority is zero.
Non-secure EL1 access for a Virtual interrupt	ICH_AP1Rn_EL2
Non-secure EL1 or EL2 when GIC Distributor supports two Security states	Permitted. Accesses Group 1 Non-secure active priorities (shifted). When a bit is written, the bit is only updated if the corresponding Group 0 and Group 1 Secure active priority is zero.
Non-secure EL1 or EL2 when GIC Distributor supports one Security state	Permitted. Accesses Group 1 Non-secure active priorities (unshifted). When a bit is written, the bit is only updated if the Group 0 active priority is zero.

A Virtual interrupt in this case means that the interrupt group associated with the register has been virtualized.

Accessing the ICH_AP1R3:

To access the ICH_AP1R3:

MRC p15,4,<Rt>,c12,c9,3 ; Read ICH_AP1R3 into Rt
MCR p15,4,<Rt>,c12,c9,3 ; Write Rt to ICH_AP1R3

Register access is encoded as follows:

coproc	opc1	CRn	CRm	opc2
1111	100	1100	1001	011

G4.6.40 ICH_EISR, Interrupt Controller End of Interrupt Status Register

The ICH_EISR characteristics are:

Purpose

When a maintenance interrupt is received, this register helps determine which List registers have outstanding EOI interrupts that require servicing.

This register is part of:

- the GIC registers functional group
- the Virtualization registers functional group.

Usage constraints

This register is accessible as shown below:

EL0 (NS)	EL0 (S)	EL1 (NS)	EL1 (S)	EL2	EL3 (SCR.NS=1)	EL3 (SCR.NS=0)
-	-	-	-	RO	RO	-

Configurations

ICH_EISR is architecturally mapped to AArch64 register [ICH_EISR_EL2](#).

Attributes

ICH_EISR is a 32-bit register.

The ICH_EISR bit assignments are:

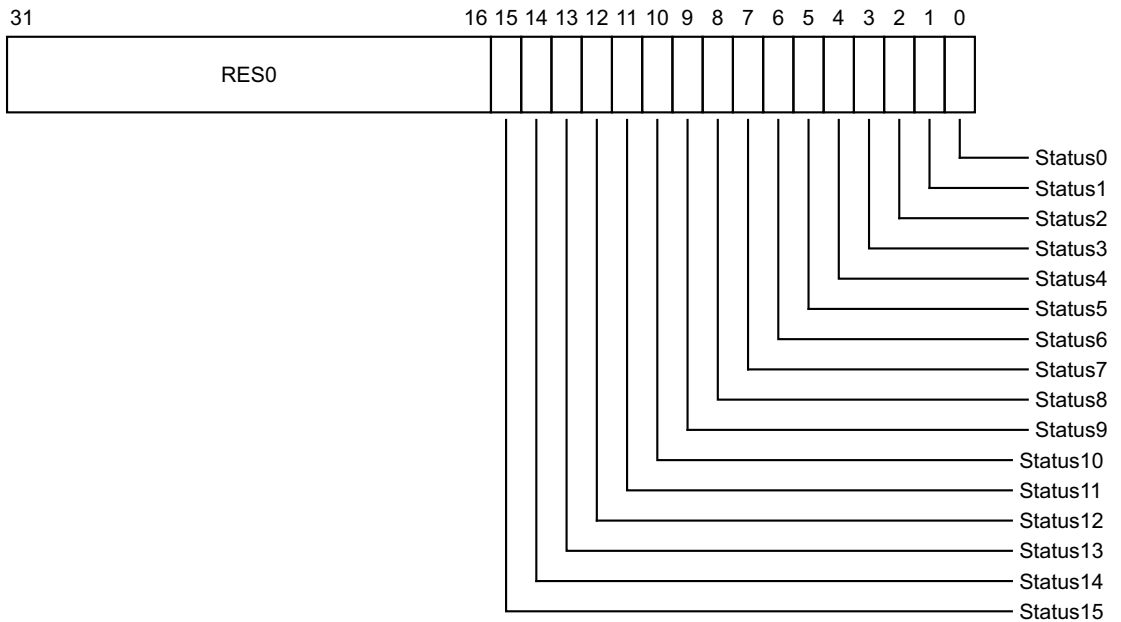

Bits [31:16]

Reserved, RES0.

Status<n>, bit [n], for n = 0 to 15

EOI status bit for List register <n>:

- 0 List register <n>, ICH_LR<n>_EL2, does not have an EOI.
- 1 List register <n>, ICH_LR<n>_EL2, has an EOI.

For any ICH_LR<n>_EL2, the corresponding status bit is set to 1 if ICH_LR<n>_EL2.State is 0b00 and ICH_LR<n>_EL2.HW is 0 and ICH_LR<n>_EL2.EOI is 1.

Accessing the ICH_EISR:

To access the ICH_EISR:

MRC p15,4,<Rt>,c12,c11,3 ; Read ICH_EISR into Rt

Register access is encoded as follows:

coproc	opc1	CRn	CRm	opc2
1111	100	1100	1011	011

G4.6.41 ICH_ELSR, Interrupt Controller Empty List Register Status Register

The ICH_ELSR characteristics are:

Purpose

This register can be used to locate a usable List register when the hypervisor is delivering an interrupt to a Guest OS.

This register is part of:

- the GIC registers functional group
- the Virtualization registers functional group.

Usage constraints

This register is accessible as shown below:

EL0 (NS)	EL0 (S)	EL1 (NS)	EL1 (S)	EL2	EL3 (SCR.NS=1)	EL3 (SCR.NS=0)
-	-	-	-	RO	RO	-

Configurations

ICH_ELSR is architecturally mapped to AArch64 register [ICH_ELSR_EL2](#).

Attributes

ICH_ELSR is a 32-bit register.

The ICH_ELSR bit assignments are:

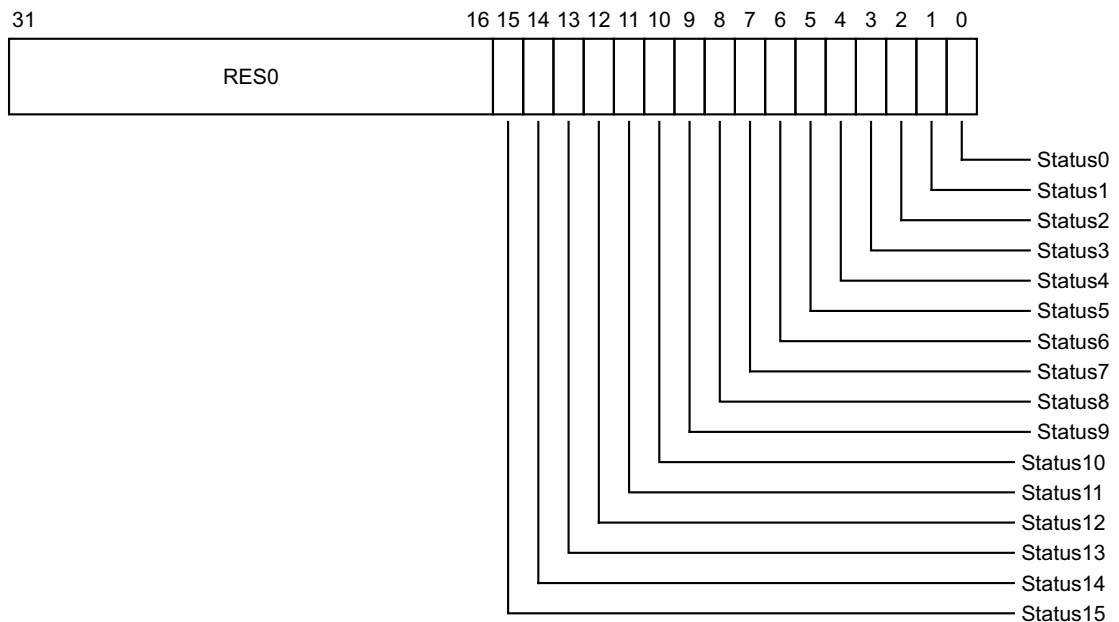

Bits [31:16]

Reserved, RES0.

Status<n>, bit [n], for n = 0 to 15

Status bit for List register <n>, ICH_LR<n>_EL2:

- 0 List register ICH_LR<n>_EL2, if implemented, contains a valid interrupt. Using this List register can result in overwriting a valid interrupt.

- 1 List register ICH_LR<n>_EL2 does not contain a valid interrupt. The List register is empty and can be used without overwriting a valid interrupt or losing an EOI maintenance interrupt.

For any ICH_LR<n>_EL2, the corresponding status bit is set to 1 if ICH_LR<n>_EL2.State is 0b00 and either ICH_LR<n>_EL2.HW is 1 or ICH_LR<n>_EL2.EOI is 0.

Accessing the ICH_ELSR:

To access the ICH_ELSR:

MRC p15,4,<Rt>,c12,c11,5 ; Read ICH_ELSR into Rt

Register access is encoded as follows:

coproc	opc1	CRn	CRm	opc2
1111	100	1100	1011	101

G4.6.42 ICH_HCR, Interrupt Controller Hyp Control Register

The ICH_HCR characteristics are:

Purpose

Controls the environment for guest operating systems.

This register is part of:

- the GIC registers functional group
- the Virtualization registers functional group.

Usage constraints

This register is accessible as shown below:

EL0 (NS)	EL0 (S)	EL1 (NS)	EL1 (S)	EL2	EL3 (SCR.NS=1)	EL3 (SCR.NS=0)
-	-	-	-	RW	RW	-

Configurations

ICH_HCR is architecturally mapped to AArch64 register [ICH_HCR_EL2](#).

Attributes

ICH_HCR is a 32-bit register.

The ICH_HCR bit assignments are:

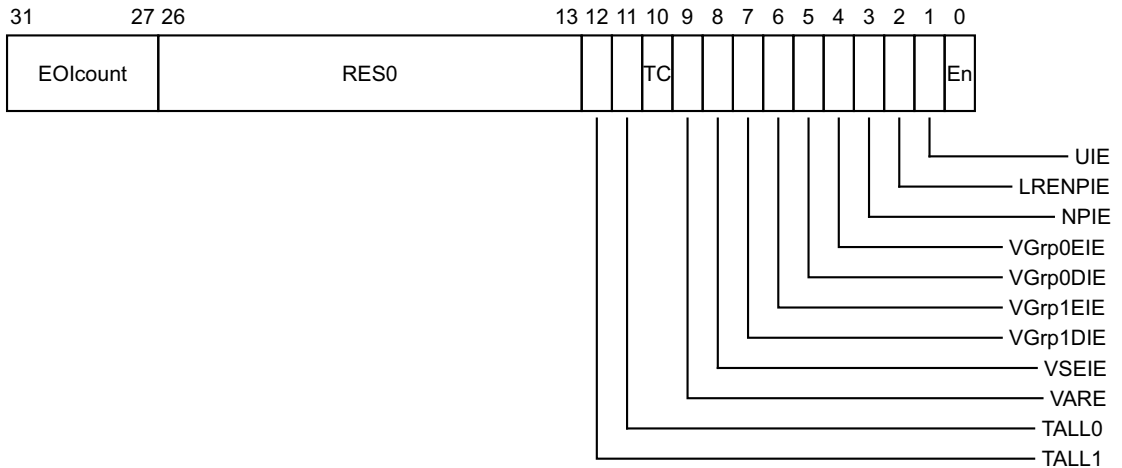

EOIcount, bits [31:27]

Counts the number of EOIs received that do not have a corresponding entry in the List registers. The virtual CPU interface increments this field automatically when a matching EOI is received.

EOIs that do not clear a bit in one of the Active Priorities registers ICH_ApMn do not cause an increment.

Although not possible under correct operation, if an EOI occurs when the value of this field is 31, this field wraps to 0.

The maintenance interrupt is asserted whenever this field is non-zero and the LRENPIE bit is set to 1.

Bits [26:13]

Reserved, RES0.

TALL1, bit [12]

Trap all Non-secure EL1 accesses to ICC_* system registers for group 1 interrupts to EL2.

- 0 Non-Secure EL1 accesses to ICC_* registers for group 1 interrupts proceed as normal.
- 1 Any Non-secure EL1 accesses to ICC_* registers for group 1 interrupts trap to EL2.

TALL0, bit [11]

Trap all Non-secure EL1 accesses to ICC_* system registers for group 0 interrupts to EL2.

- 0 Non-Secure EL1 accesses to ICC_* registers for group 0 interrupts proceed as normal.
- 1 Any Non-secure EL1 accesses to ICC_* registers for group 0 interrupts trap to EL2.

TC, bit [10]

Trap all Non-secure EL1 accesses to system registers that are common to group 0 and group 1 to EL2.

- 0 Non-secure EL1 accesses to common registers proceed as normal.
- 1 Any Non-secure EL1 accesses to common registers trap to EL2.

This affects [ICC_DIR](#), [ICC_PMR](#), and [ICC_RPR](#).

VARE, bit [9]

Virtual ARE.

- 0 The guest operating system does not use affinity routing and expects a Source CPU ID for SGIs.
- 1 The guest operating system uses affinity routing.

When VARE is 0, the guest operating system does not support LPIs and software must ensure that no LPIs are presented to the guest either using the List registers or from the Distributor.

VSEIE, bit [8]

Virtual SEI Enable. Enables the signaling of a maintenance interrupt when performing a virtual access to a system register and a condition that would result in an (optional) SEI for a physical access is detected.

- 0 VSEIE maintenance interrupt is disabled.
- 1 VSEIE maintenance interrupt is enabled.

VGrp1DIE, bit [7]

VM Disable Group 1 Interrupt Enable. Enables the signaling of a maintenance interrupt while signaling of Group 1 interrupts from the virtual CPU interface to the connected virtual machine is disabled:

- 0 Maintenance interrupt disabled.
- 1 Maintenance interrupt signaled while GICV_CTLR.EnableGrp1 is set to 0.

VGrp1EIE, bit [6]

VM Enable Group 1 Interrupt Enable. Enables the signaling of a maintenance interrupt while signaling of Group 1 interrupts from the virtual CPU interface to the connected virtual machine is enabled:

- 0 Maintenance interrupt disabled.
- 1 Maintenance interrupt signaled while GICV_CTLR.EnableGrp1 is set to 1.

VGrp0DIE, bit [5]

VM Disable Group 0 Interrupt Enable. Enables the signaling of a maintenance interrupt while signaling of Group 0 interrupts from the virtual CPU interface to the connected virtual machine is disabled:

- 0 Maintenance interrupt disabled.
- 1 Maintenance interrupt signaled while GICV_CTLR.EnableGrp0 is set to 0.

VGrp0EIE, bit [4]

VM Enable Group 0 Interrupt Enable. Enables the signaling of a maintenance interrupt while signaling of Group 0 interrupts from the virtual CPU interface to the connected virtual machine is enabled:

- 0 Maintenance interrupt disabled.
- 1 Maintenance interrupt signaled while GICV_CTLR.EnableGrp0 is set to 1.

NPIE, bit [3]

No Pending Interrupt Enable. Enables the signaling of a maintenance interrupt while no pending interrupts are present in the List registers:

- 0 Maintenance interrupt disabled.
- 1 Maintenance interrupt signaled while the List registers contain no interrupts in the pending state.

LRENPIE, bit [2]

List Register Entry Not Present Interrupt Enable. Enables the signaling of a maintenance interrupt while the virtual CPU interface does not have a corresponding valid List register entry for an EOI request:

- 0 Maintenance interrupt disabled.
- 1 A maintenance interrupt is asserted while the EOICount field is not 0.

UIE, bit [1]

Underflow Interrupt Enable. Enables the signaling of a maintenance interrupt when the List registers are empty, or hold only one valid entry:

- 0 Maintenance interrupt disabled.
- 1 A maintenance interrupt is asserted if none, or only one, of the List register entries is marked as a valid interrupt.

En, bit [0]

Enable. Global enable bit for the virtual CPU interface:

- 0 Virtual CPU interface operation disabled.
- 1 Virtual CPU interface operation enabled.

When this field is set to 0:

- The virtual CPU interface does not signal any maintenance interrupts.
- The virtual CPU interface does not signal any virtual interrupts.
- A read of GICV_IAR or GICV_AIAR returns a spurious interrupt ID.

Accessing the ICH_HCR:

To access the ICH_HCR:

```
MRC p15,4,<Rt>,c12,c11,0 ; Read ICH_HCR into Rt
MCR p15,4,<Rt>,c12,c11,0 ; Write Rt to ICH_HCR
```

Register access is encoded as follows:

coproc	opc1	CRn	CRm	opc2
1111	100	1100	1011	000

G4.6.43 ICH_LRC<n>, Interrupt Controller List Registers, n = 0 - 15

The ICH_LRC<n> characteristics are:

Purpose

Provides interrupt context information for the virtual CPU interface.

This register is part of:

- the GIC registers functional group
- the Virtualization registers functional group.

Usage constraints

This register is accessible as shown below:

EL0 (NS)	EL0 (S)	EL1 (NS)	EL1 (S)	EL2	EL3 (SCR.NS=1)	EL3 (SCR.NS=0)
-	-	-	-	RW	RW	-

ICH_LR<n> and ICH_LRC<n> may be updated independently.

Configurations

ICH_LRC<n> is architecturally mapped to AArch64 register ICH_LR<n>_EL2[63:32].

Attributes

ICH_LRC<n> is a 32-bit register.

The ICH_LRC<n> bit assignments are:

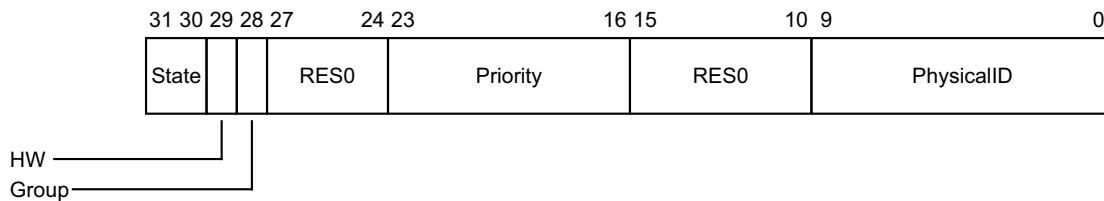

State, bits [31:30]

The state of the interrupt:

- 00 Invalid
- 01 Pending
- 10 Active
- 11 Pending and active.

The GIC updates these state bits as virtual interrupts proceed through the interrupt life cycle. Entries in the invalid state are ignored, except for the purpose of generating virtual maintenance interrupts.

For hardware interrupts, the pending and active state is held in the physical Distributor rather than the virtual CPU interface. A hypervisor must only use the pending and active state for software originated interrupts, which are typically associated with virtual devices, or SGIs.

HW, bit [29]

Indicates whether this virtual interrupt is a hardware interrupt, meaning that it corresponds to a physical interrupt. Deactivation of the virtual interrupt also causes the deactivation of the physical interrupt with the ID that the PhysicalID field indicates.

- 0 The interrupt is triggered entirely in software. No notification is sent to the Distributor when the virtual interrupt is deactivated.

- 1 The interrupt is a hardware interrupt. A deactivate interrupt request is sent to the Distributor when the virtual interrupt is deactivated, using the PhysicalID field from this register to indicate the physical interrupt ID.
 If GICV_CTLR.EOI mode is 0, this request corresponds to a write to the GICV_EOIR or GICV_AEOIR, otherwise it corresponds to a write to the GICV_DIR.

Bits [27:24]

Reserved, RES0.

Priority, bits [23:16]

The priority of this interrupt.

It is IMPLEMENTATION DEFINED how many bits of priority are implemented, though at least five bits must be implemented. Unimplemented bits are RES0 and start from bit [48] up to bit [50]. The number of implemented bits can be discovered from ICH_VTR_EL2.PRIBits, and determines how many GICH_APR<n> registers exist.

Bits [15:10]

Reserved, RES0.

PhysicalID, bits [9:0]

Physical ID, for hardware interrupts.

When HW is 0 (i.e. there is no corresponding physical interrupt), some of these bits have a special meaning:

Bit [39] EOI. When this bit is 1, a maintenance interrupt is asserted to signal EOI when the interrupt state is invalid, which typically occurs when the interrupt is deactivated.

Bits [38:32]Reserved, RES0.

It is IMPLEMENTATION DEFINED how many bits are implemented, though at least 16 bits must be implemented. Unimplemented bits are RES0. The number of implemented bits can be discovered from ICH_VTR_EL2.IDbits.

Accessing the ICH_LRC<n>:

To access the ICH_LRC<n>:

MRC p15,4,<Rt>,c12,<CRm>,<opc2> ; Read ICH_LRC<n> into Rt, where n is in the range 0 to 15

MCR p15,4,<Rt>,c12,<CRm>,<opc2> ; Write Rt to ICH_LRC<n>, where n is in the range 0 to 15

Register access is encoded as follows:

coproc	opc1	CRn	CRm	opc2
1111	100	1100	111:n<3:3>	n<2:0>

G4.6.44 ICH_LR<n>, Interrupt Controller List Registers, n = 0 - 15

The ICH_LR<n> characteristics are:

Purpose

Provides interrupt context information for the virtual CPU interface.

This register is part of:

- the GIC registers functional group
- the Virtualization registers functional group.

Usage constraints

This register is accessible as shown below:

EL0 (NS)	EL0 (S)	EL1 (NS)	EL1 (S)	EL2	EL3 (SCR.NS=1)	EL3 (SCR.NS=0)
-	-	-	-	RW	RW	-

ICH_LR<n> and ICH_LRC<n> may be updated independently.

Configurations

ICH_LR<n> is architecturally mapped to AArch64 register ICH_LR<n>_EL2[31:0].

Attributes

ICH_LR<n> is a 32-bit register.

The ICH_LR<n> bit assignments are:

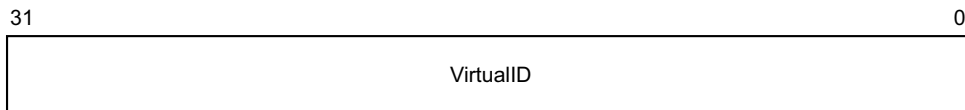

VirtualID, bits [31:0]

Virtual ID of the interrupt.

When VARE is zero, software must ensure the correct Source CPU ID is provided in bits [12:10].

Software must ensure there is only a single valid entry for a given VirtualID.

It is IMPLEMENTATION DEFINED how many bits are implemented, though at least 16 bits must be implemented. Unimplemented bits are RES0. The number of implemented bits can be discovered from ICH_VTR_EL2.IDbits.

Accessing the ICH_LR<n>:

To access the ICH_LR<n>:

MRC p15,4,<Rt>,c12,<CRm>,<opc2> ; Read ICH_LR<n> into Rt, where n is in the range 0 to 15

MCR p15,4,<Rt>,c12,<CRm>,<opc2> ; Write Rt to ICH_LR<n>, where n is in the range 0 to 15

Register access is encoded as follows:

coproc	opc1	CRn	CRm	opc2
1111	100	1100	110:n<3:3>	n<2:0>

G4.6.45 ICH_MISR, Interrupt Controller Maintenance Interrupt State Register

The ICH_MISR characteristics are:

Purpose

Indicates which maintenance interrupts are asserted.

This register is part of:

- the GIC registers functional group
- the Virtualization registers functional group.

Usage constraints

This register is accessible as shown below:

EL0 (NS)	EL0 (S)	EL1 (NS)	EL1 (S)	EL2	EL3 (SCR.NS=1)	EL3 (SCR.NS=0)
-	-	-	-	RO	RO	-

Configurations

ICH_MISR is architecturally mapped to AArch64 register [ICH_MISR_EL2](#).

Attributes

ICH_MISR is a 32-bit register.

The ICH_MISR bit assignments are:

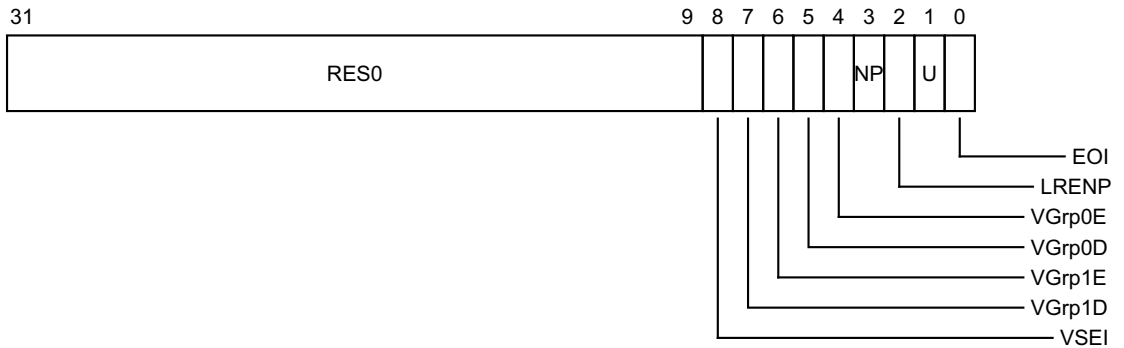

Bits [31:9]

Reserved, RES0.

VSEI, bit [8]

Virtual SEI. Set to 1 when a condition that would result in generation of an SEI is detected during a virtual access to an ICC_* system register.

VGrp1D, bit [7]

Disabled Group 1 maintenance interrupt.

Asserted whenever ICH_HCR_EL2.VGrp1DIE is 1 and ICH_VMCR_EL2.VMGrp1En is 0.

VGrp1E, bit [6]

Enabled Group 1 maintenance interrupt.

Asserted whenever ICH_HCR_EL2.VGrp1EIE is 1 and ICH_VMCR_EL2.VMGrp1En is 1.

VGrp0D, bit [5]

Disabled Group 0 maintenance interrupt.

Asserted whenever ICH_HCR_EL2.VGrp0DIE is 1 and ICH_VMCR_EL2.VMGrp0En is 0.

VGrp0E, bit [4]

Enabled Group 0 maintenance interrupt.

Asserted whenever ICH_HCR_EL2.VGrp0EIE is 1 and ICH_VMCR_EL2.VMGrp0En is 1.

NP, bit [3]

No Pending maintenance interrupt.

Asserted whenever ICH_HCR_EL2.NPIE is 1 and no List register is in pending state.

LRENP, bit [2]

List Register Entry Not Present maintenance interrupt.

Asserted whenever ICH_HCR_EL2.LRENPIE is 1 and ICH_HCR_EL2.EOIcount is non-zero.

U, bit [1]

Underflow maintenance interrupt.

Asserted whenever ICH_HCR_EL2.UIE is 1 and if none, or only one, of the List register entries are marked as a valid interrupt, that is, if the corresponding ICH_LR<n>_EL2.State bits do not equal 0x0.

EOI, bit [0]

EOI maintenance interrupt.

Asserted whenever at least one List register is asserting an EOI interrupt. That is, when at least one bit in ICH_EISR0_EL1 or ICH_EISR1_EL1 is 1.

Accessing the ICH_MISR:

To access the ICH_MISR:

MRC p15,4,<Rt>,c12,c11,2 ; Read ICH_MISR into Rt

Register access is encoded as follows:

coproc	opc1	CRn	CRm	opc2
1111	100	1100	1011	010

G4.6.46 ICH_VMCR, Interrupt Controller Virtual Machine Control Register

The ICH_VMCR characteristics are:

Purpose

Enables the hypervisor to save and restore the virtual machine view of the GIC state.

This register is part of:

- the GIC registers functional group
- the Virtualization registers functional group.

Usage constraints

This register is accessible as shown below:

EL0 (NS)	EL0 (S)	EL1 (NS)	EL1 (S)	EL2	EL3 (SCR.NS=1)	EL3 (SCR.NS=0)
-	-	-	-	RW	RW	-

When EL2 is using system register access, EL1 using either system register or memory-mapped access must be supported.

Configurations

ICH_VMCR is architecturally mapped to AArch64 register [ICH_VMCR_EL2](#).

Attributes

ICH_VMCR is a 32-bit register.

The ICH_VMCR bit assignments are:

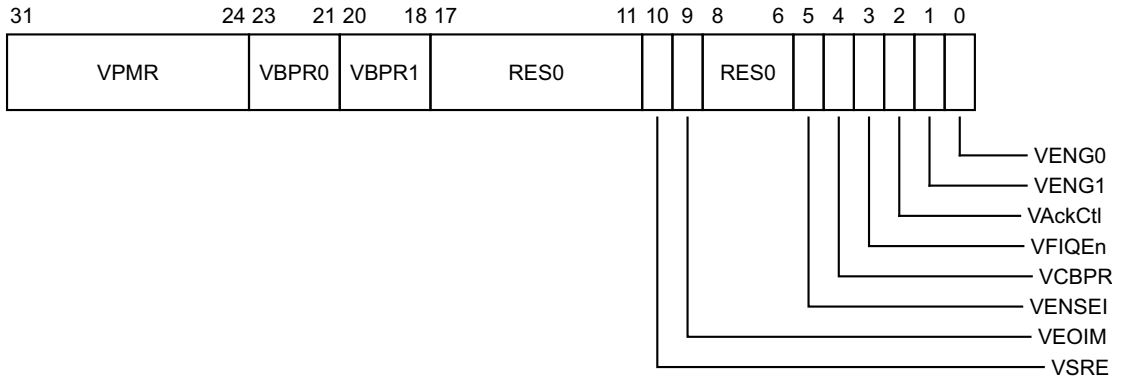

VPMR, bits [31:24]

Virtual Priority Mask.

Visible to the guest OS as ICC_PMR_EL1 / GICV_PMR.

VBPR0, bits [23:21]

Virtual BPR0.

Visible to the guest OS as ICC_BPR0_EL1 / GICV_BPR.

VBPR1, bits [20:18]

Virtual BPR1.

Visible to the guest OS as ICC_BPR1_EL1 / GICV_ABPR.

Bits [17:11]

Reserved, RES0.

VSRE, bit [10]

Virtual SRE.

Visible to the guest OS as ICC_SRE_EL1.SRE.

If EL2 is not configured to use system registers, this bit is treated as if it is 0.

VEOIM, bit [9]

Virtual EOImode.

Visible to the guest OS as ICC_CTLR_EL1.EOImode / GICV_CTLR.EOImode.

Bits [8:6]

Reserved, RES0.

VENSEL, bit [5]

This bit is IMPLEMENTATION DEFINED.

If an implementation does not have functionality associated with this bit, ARM recommends that the bit is RES0.

VCBPR, bit [4]

Virtual CBPR.

Visible to the guest OS as ICC_CTLR_EL1.CBPR / GICV_CTLR.CBPR.

VFIQEn, bit [3]

Virtual FIQ enable.

Visible to the guest OS as GICV_CTLR.FIQEn.

VAckCtl, bit [2]

Virtual AckCtl.

Visible to the guest OS as GICV_CTLR.AckCtl.

VENG1, bit [1]

Virtual group 1 interrupt enable.

Visible to the guest OS as ICC_IGRPEN1_EL1.Enable / GICV_CTLR.EnableGrp1.

VENG0, bit [0]

Virtual group 0 interrupt enable.

Visible to the guest OS as ICC_IGRPEN0_EL1.Enable / GICV_CTLR.EnableGrp0.

Accessing the ICH_VMCR:

To access the ICH_VMCR:

MRC p15,4,<Rt>,c12,c11,7 ; Read ICH_VMCR into Rt

MCR p15,4,<Rt>,c12,c11,7 ; Write Rt to ICH_VMCR

Register access is encoded as follows:

coproc	opc1	CRn	CRm	opc2
1111	100	1100	1011	111

G4.6.47 ICH_VSEIR, Interrupt Controller Virtual System Error Interrupt Register

The ICH_VSEIR characteristics are:

Purpose

Allows the hypervisor to inject a virtual SEI.

This register is part of:

- the GIC registers functional group
- the Virtualization registers functional group.

Usage constraints

This register is accessible as shown below:

EL0 (NS)	EL0 (S)	EL1 (NS)	EL1 (S)	EL2	EL3 (SCR.NS=1)	EL3 (SCR.NS=0)
-	-	-	-	RW	RW	-

Configurations

ICH_VSEIR is architecturally mapped to AArch64 register [ICH_VSEIR_EL2](#).

Attributes

ICH_VSEIR is a 32-bit register.

The ICH_VSEIR bit assignments are:



Accessing the ICH_VSEIR:

To access the ICH_VSEIR:

```
MRC p15,4,<Rt>,c12,c9,4 ; Read ICH_VSEIR into Rt
MCR p15,4,<Rt>,c12,c9,4 ; Write Rt to ICH_VSEIR
```

Register access is encoded as follows:

coproc	opc1	CRn	CRm	opc2
1111	100	1100	1001	100

G4.6.48 ICH_VTR, Interrupt Controller VGIC Type Register

The ICH_VTR characteristics are:

Purpose

Describes the number of implemented virtual priority bits and List registers.

This register is part of:

- the GIC registers functional group
- the Virtualization registers functional group.

Usage constraints

This register is accessible as shown below:

EL0 (NS)	EL0 (S)	EL1 (NS)	EL1 (S)	EL2	EL3 (SCR.NS=1)	EL3 (SCR.NS=0)
-	-	-	-	RO	RO	-

Configurations

ICH_VTR is architecturally mapped to AArch64 register [ICH_VTR_EL2](#).

Attributes

ICH_VTR is a 32-bit register.

The ICH_VTR bit assignments are:

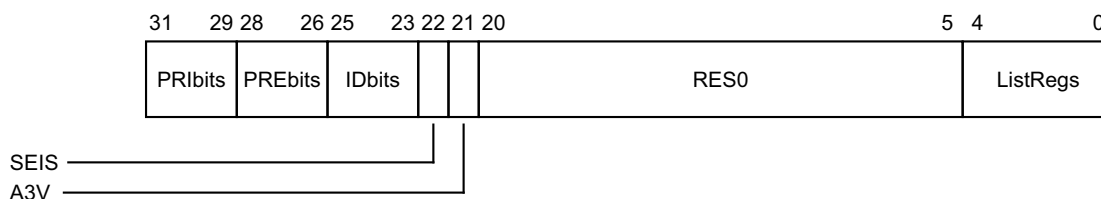

PRBits, bits [31:29]

The number of virtual priority bits implemented, minus one.

PREbits, bits [28:26]

The number of virtual preemption bits implemented, minus one.

IDbits, bits [25:23]

The number of virtual interrupt identifier bits supported:

000 16 bits.

001 24 bits.

All other values are reserved.

SEIS, bit [22]

SEI Support. Indicates whether the virtual CPU interface supports generation of SEIs:

0 The virtual CPU interface logic does not support generation of SEIs.

1 The virtual CPU interface logic supports generation of SEIs.

Virtual system errors may still be generated by writing to ICH_VSEIR_EL2 regardless of the value of this field.

A3V, bit [21]

Affinity 3 Valid. Possible values are:

- 0 The virtual CPU interface logic only supports zero values of Affinity 3 in SGI generation system registers.
- 1 The virtual CPU interface logic supports non-zero values of Affinity 3 in SGI generation system registers.

Bits [20:5]

Reserved, RES0.

ListRegs, bits [4:0]

The number of implemented List registers, minus one. For example, a value of 0b01111 indicates that the maximum of 16 List registers are implemented.

Accessing the ICH_VTR:

To access the ICH_VTR:

MRC p15,4,<Rt>,c12,c11,1 ; Read ICH_VTR into Rt

Register access is encoded as follows:

coproc	opc1	CRn	CRm	opc2
1111	100	1100	1011	001

Part H

External Debug

Chapter H1

Introduction to External Debug

This chapter introduces the external debug components of ARMv8. It contains the following sections:

- [Introduction to external debug](#) on page H1-4324.
- [External debug](#) on page H1-4325.

———— **Note** —————

For information about self-hosted debug, see [Chapter D2 Debug Exceptions](#) and [Chapter D3 The Debug Exception Model](#).

H1.1 Introduction to external debug

ARMv8 supports both:

Self-hosted debug

The PE itself hosts a debugger. That is, developers developing software to run on the PE use debugger software running on the same PE.

External debug

The debugger is external to the PE. The debugging might be either on-chip, for example in a second PE, or off-chip, for example a JTAG debugger. External debug is particularly useful for:

- Hardware bring-up. That is, debugging during development when a system is first powered up and not all of the software functionality is available.
- PEs that are deeply embedded inside systems.

To support external debug, the ARM architecture defines required features that are called *external debug features*.

Note

When the description of external debug in this part of the manual describes a debugger as controlling external debug this might be a second on-chip PE or a processor in an off-chip device such as a JTAG debugger.

H1.2 External debug

The following halting debug events are available in ARMv8:

- [Halting Step debug event on page H3-4366](#):
 - The debugger can use this resource to make the PE step through code one line at a time.
- [Halt Instruction debug event on page H3-4376](#):
 - This might occur when software executes the Halting software breakpoint instruction, HLT.
- [Exception Catch debug event on page H3-4377](#):
 - This can be programmed to occur on all entries to a given Exception level.
- [External Debug Request debug event on page H3-4380](#):
 - An embedded cross-trigger can signal this debug event.
- [OS Unlock Catch debug event on page H3-4381](#):
 - This might occur when the state of the OS Lock changes from locked to unlocked.
- [Reset Catch debug event on page H3-4382](#):
 - This might occur when the PE exits reset state.
- [Software Access debug event on page H3-4383](#):
 - This can be programmed to occur when software tries to access the Breakpoint Value registers, the Breakpoint Control registers, the Watchpoint value registers, or the Watchpoint Control registers. It caused a trap to Debug state.

Halting debug events allow an external debugger to halt the PE. Breakpoints and watchpoints can also halt the PE. The PE then enters Debug state. When the PE is in Debug state:

- It stops executing instructions from the location indicated by the program counter, and is instead controlled through the external debug interface.
- The *Instruction Transfer Register*, ITR, passes instructions to the PE to execute in Debug state:
 - The ITR contains a single register, EDITR, and associated flow-control flags.
- The *Debug Communications Channel*, DCC, passes data between the PE and the debugger:
 - The DCC includes the data transfer registers, DTRRX and DTRTX, and associated flow-control flags.
 - Although the DCC is an essential part of Debug state operation, it can also be used in Non-debug state.
- The PE cannot service any interrupts in Debug state.

[Chapter H2 Debug State](#) describes Debug state in more detail.

Chapter H2

Debug State

This chapter describes Debug state. It contains the following sections:

- [About Debug state on page H2-4328.](#)
- [Halting the PE on debug events on page H2-4329.](#)
- [Entering Debug state on page H2-4337.](#)
- [Behavior in Debug state on page H2-4341.](#)
- [Exiting Debug state on page H2-4361.](#)

———— **Note** —————

[Table J-1 on page AppxJ-5088](#) disambiguates the general register references used in this chapter.

H2.1 About Debug state

In external debug, debug events allow an external debugger to halt the PE. The PE then enters Debug state. When the PE is in Debug state:

- It stops executing instructions from the location indicated by the program counter, and is instead controlled through the external debug interface.
- The *Instruction Transfer Register*, ITR, passes instructions to the PE to execute in Debug state.
- The *Debug Communications Channel*, DCC, passes data between the PE and the debugger.

The PE cannot service any interrupts in Debug state.

H2.2 Halting the PE on debug events

For details of debug events see [Introduction to Halting debug events on page H3-4364](#) and [Breakpoint and Watchpoint debug events on page H2-4330](#).

On a debug event, the PE must do one of the following:

- Enter Debug state.
- Pend the debug event.
- Generate a debug exception.
- Ignore the debug event.

This behavior depends on both:

- Whether halting is allowed by the current state of the debug authentication interface. See [Halting allowed and halting prohibited](#).
- The type of debug event and the programming of the debug control registers.
 - See [Halting debug events](#) for all Halting debug events.
 - See [Breakpoint and Watchpoint debug events on page H2-4330](#) for Breakpoint and Watchpoint debug events.

See also [Other debug exceptions on page H2-4331](#).

This means that behavior can be UNPREDICTABLE if the conditions change. See [Synchronization and Halting debug events on page H3-4384](#).

[Summary of debug events and possible outcomes on page H3-4364](#) summarizes the possible outcomes of each type of debug event.

H2.2.1 Halting allowed and halting prohibited

Halting can be either allowed or prohibited:

- Halting is always prohibited in Debug state.
- Halting is always prohibited when `DoubleLockStatus() == TRUE`.
 - This means that OS Double Lock is locked, that is `EDPRSR.DLK == 1`.
- Halting is also controlled by the IMPLEMENTATION DEFINED authentication interface, and is prohibited when either:
 - The PE is in Non-secure state and `ExternalInvasiveDebugEnabled() == FALSE`.
 - The PE is in Secure state and `ExternalSecureInvasiveDebugEnabled() == FALSE`.

———— **Note** ————

See [Appendix B Recommended External Debug Interface](#) for more information on these functions.

- Otherwise, halting is allowed.

See [Pseudocode details of Halting on debug events on page H2-4335](#).

H2.2.2 Halting debug events

When a Halting debug event is generated, it causes entry to Debug state if both:

- Halting is allowed. See [Halting allowed and halting prohibited](#).
- The Halting debug event is either:
 - A Halt Instruction debug event and Halting debug-mode is enabled. This means that `EDSCR.HDE == 1`.
 - Not a Halt Instruction debug event.

———— **Note** —————

- An Halt Instruction debug event is the only Halting debug event that relies on `EDSCR.HDE == 1`. This is to prevent malicious code from causing an entry Debug state. `EDSCR.HDE == 0` on a Cold reset.
- Halting on Breakpoint and Watchpoint Software debug events is also controlled by `EDSCR.HDE`. See [Breakpoint and Watchpoint debug events](#).
- `EDSCR.HDE` can be written by software when the OS Lock is locked. Privileged code can use `SDCR.TDOSA` and `HDCR.TDOSA` to trap writes to these registers.

If a Halting debug event does not generate entry to Debug state because the conditions listed in this section do not hold, then:

- If the Halting debug event is a Halt Instruction debug event, it generates an Undefined Instruction exception.
- If the Halting debug event is an Exception Catch debug event or a Software Access debug event, it is ignored.
- In all other cases the Halting debug event is pended, meaning that:
 - The pending Halting debug event is recorded in `EDESR`.
 - The pending Halting debug event is taken when halting is allowed. See [Pending Halting debug events on page H3-4384](#).

Pending Halting debug events are discarded by a Cold reset. The debugger can also force a pending event to be dropped by writing to `EDESR`. [Summary of actions from debug events on page H2-4334](#) summarizes the possible outcome for each type of Debug event.

———— **Note** —————

Halting debug events never generate Debug exceptions.

H2.2.3 Breakpoint and Watchpoint debug events

A breakpoint or watchpoint generates an entry to Debug state if all of the following conditions hold:

- Halting debug-mode is enabled, that is `EDSCR.HDE == 1`.
- Halting is allowed. See [Halting allowed and halting prohibited on page H2-4329](#).
- The OS Lock is unlocked, that is `OSLSR.OSLK == 0`.

The Address Mismatch breakpoint type is reserved when all of these conditions are met. See [Legacy debug exceptions on page D2-1564](#).

`MDSCR_EL1.MDE` or `DBGDSCRext.MDBGen` is ignored when determining whether to enter Debug state. A breakpoint or watchpoint that generates entry to Debug state is a Breakpoint or Watchpoint debug event and does not generate a debug exception.

A breakpoint or watchpoint that does not generate an entry to Debug state either:

- Generates a Breakpoint or Watchpoint exception.
- Is ignored.

———— **Note** —————

`EDSCR.HDE` is ignored when determining whether to generate a debug exception. The debug exception is suppressed only if the PE enters Debug state. This means that the use of Halting-debug mode in Non-secure state does not affect the Exception model in Secure state.

See [Chapter D2 Debug Exceptions](#) and the Note in [Other debug exceptions on page H2-4331](#).

H2.2.4 Other debug exceptions

The following events never generate entry to Debug state:

- Software Breakpoint Instruction exceptions.
- Software Step exceptions.
- Vector Catch exceptions. See also [Legacy debug exceptions on page D2-1564](#).

The behavior of these events is unchanged when Halting debug mode is enabled, that is when `EDSCR.HDE == 1`. This means that these events can do one of the following:

- They can generate a debug exception.
- They can be ignored.

For additional information, see [Chapter D2 Debug Exceptions](#).

H2.2.5 Debug state entry and debug event prioritization

The architecture does not define when asynchronous Halting debug events are taken, and therefore the prioritization of asynchronous debug events is IMPLEMENTATION DEFINED.

Synchronous Halting debug events do have a priority order.

The following are synchronous Halting debug events:

- Halting Step debug event.
- Halt Instruction debug event.
- Exception Catch debug event.
- Software Access debug event.
- Reset Catch debug event.

Each of these synchronous Halting debug events is treated as a synchronous exception generated by an instruction, or by the taking of an exception or reset. That is, the synchronous Halting debug event must be taken before any subsequent instructions are executed. Reset Catch debug events must be taken before the PE executes the instruction at the reset vector.

———— **Note** —————

Reset Catch and Exception Catch debug events can also be generated asynchronously, because they can result from an asynchronous exception. However, if halting is allowed after the asynchronous exception has been processed, the Reset Catch or Exception Catch debug event is taken synchronously.

The Halting Step debug event is generated by the instruction after the stepped instruction. Therefore, if the stepped instruction generates any other synchronous exceptions or debug events, these are taken first.

OS Unlock Catch debug events are always pended and taken asynchronously.

Halting Step debug events and Reset Catch debug events might be pended and taken asynchronously at a later time.

The following list shows how the events are prioritized, with -2.0 being the highest priority.

———— **Note** —————

The priority numbering is the same as the numbering for synchronous exception priorities listed in [Synchronous exception types, routing and priorities on page D1-1450](#). The Debug events in this section with a negative priority are a higher priority than any synchronous exception. The debug events with fractional priorities have a priority between two or more exceptions.

The priority for synchronous debug events is as follows:

- 2 Reset Catch debug event. See [Reset Catch debug event on page H3-4382](#).
 This debug event has a higher priority than the synchronous exceptions listed in [Synchronous exception types, routing and priorities on page D1-1450](#).

- 1 Exception Catch debug event. See [Exception Catch debug event on page H3-4377](#).
This debug event can be assigned one of two priorities. When it has a priority of -1, it has a higher priority than the synchronous exceptions listed in the Exception model. See [Exception Catch debug event on page H3-4377](#).
- 0 Halting Step debug event. See [Halting Step debug event on page H3-4366](#).
This debug event has a higher priority than the synchronous exceptions listed in the Exception model.
- 1 Software Step debug event. See [Software Step exceptions on page D2-1634](#).
- 1.5 Exception Catch debug event. See [Exception Catch debug event on page H3-4377](#).
This debug event can be assigned one of two priorities, -1 or 1.5. See [Exception Catch debug event on page H3-4377](#).
- 2 - 3 These events are not debug events.
- 4 Breakpoint exception or debug event or Address Matching Vector Catch exception. See [Breakpoint exceptions on page D2-1569](#) and [Vector Catch exceptions on page D2-1627](#).
These two debug events have the same priority.
- 5 - 13 These events are not debug events.
- 14 Halt Instruction debug event. See [Halt Instruction debug event on page H3-4376](#).
- 15 - 19 These events are not debug events.
- 19.5 Software Access debug event. See [Software Access debug event on page H3-4383](#).
- 20 - 21 These events are not debug events.
- 22 Watchpoint exception or debug event. See [Watchpoint exceptions on page D2-1606](#).

For Reset Catch debug events and Halting Step debug events the priorities listed in this section only apply when halting is allowed at the time the event is generated. This means that the event is taken synchronously and not pending.

The prioritization of asynchronous Halting debug events, including pending Halting debug events taken asynchronously, is IMPLEMENTATION DEFINED. See [Taking Halting debug events asynchronously on page H3-4385](#).

For more information on the prioritization of exceptions see [Synchronous exception types, routing and priorities on page D1-1450](#).

Debug state entry and Software Step

When Software Step is active, a debug event that causes entry to Debug state behaves like an exception taken to an Exception level above the debug target Exception level. That is:

- If the instruction that is stepped generates a synchronous debug event that causes entry to Debug state, or an asynchronous debug event is taken before the step completes, the PE enters Debug state with **DSPSR.SS** set to 1.
- A pending Halting debug event or an asynchronous debug event can be taken after the step has completed. In this case the PE enters Debug state with **DSPSR.SS** set to 0.

In addition:

- If the instruction that is stepped generates an exception trapped by an Exception Catch debug event, the PE enters Debug state at the exception vector with **DSPSR.SS** set to 0. This is because **PSTATE.SS** is set to 0 by taking the exception.

- If the PE is reset, `PSTATE.SS` is reset to 0. If the following debug events are enabled, the PE enters Debug state with `DSPSR.SS` set to 0:
 - Reset Catch debug events at the reset Exception level.
 - Exception Catch debug events at the reset Exception level.
 - Halting Step debug events.
- If Halting Step is also active, then Halting Step and Software Step operate in parallel and can both become active-pending. In this case Halting step has a higher priority than Software step. This means that the PE enters Debug state and `DSPSR.SS` is set to 0.

Breakpoint debug events and Vector Catch exception

An Address Matching Vector Catch exception has the same priority as a Breakpoint debug event. See [Synchronous exception prioritization on page D1-1451](#).

The prioritization of these events is unchanged even if the breakpoint generates entry to Debug state instead of a Breakpoint exception. This means that if a single instruction generates both an Address Matching Vector Catch exception and a Breakpoint debug event, there is a CONstrained UNpredictable choice of:

- The PE entering Debug state due to the Breakpoint debug event.
- A Vector Catch exception.

This only applies if all of the following are true:

- Halting debug-mode is enabled.
- Halting is allowed.
- The OS Lock is unlocked.

An Exception Trapping Vector Catch exception must be generated immediately following the exception that generated it. This means that it does not appear in the priority table.

H2.2.6 Forcing entry to Debug state

Entry to Debug state is normally precise, meaning that the PE cannot enter Debug state if it can neither complete nor abandon all currently executing instructions and leave the PE in a precise state.

A debugger can write a value of 1 to `EDRCR.CBRRQ` to allow imprecise entry to Debug state. An External Debug Request debug event must be pending before writing 1 to this bit. Support for this feature is OPTIONAL and it is IMPLEMENTATION DEFINED when it is effective at forcing entry to Debug state.

The PE ignores writes to this bit if either:

- External debugging is not enabled, meaning `ExternalInvasiveDebugEnabled() == FALSE`.
- Secure external debugging is not enabled, meaning `ExternalSecureInvasiveDebugEnabled() == FALSE`, and either:
 - EL3 is not implemented and the PE is Secure.
 - EL3 is implemented.

[Example H2-1](#) shows how entry to Debug state can be forced.

Example H2-1 Forcing entry to Debug state

The debugger pends an External Debug Request debug event through the CTI to halt a program that has stopped responding. However, the memory system is not responding and a memory access instruction cannot complete. This means that Debug state cannot be entered precisely. The debugger writes a value of 1 to `EDRCR.CBRRQ`. The PE cancels all outstanding memory accesses and enters Debug state. As some instructions might not have completed correctly, entry to Debug state is imprecise.

When Debug state is entered imprecisely, all memory access instructions executed through the ITR have UNPREDICTABLE behavior. The value of all registers is UNKNOWN, but might be useful for diagnostic purposes.

H2.2.7 Summary of actions from debug events

Table H2-2 on page H2-4347 shows the Software and Halting debug events. In Table H2-2 on page H2-4347 the columns have the following meaning:

Debug event type

This means the type of debug event where:

Other software means one of:

- [Software Step exceptions on page D2-1634](#).
- [Software Breakpoint Instruction exceptions on page D2-1566](#).
- [Vector Catch exceptions on page D2-1627](#).

Other Halting means one of the following:

- [Halting Step debug event on page H3-4366](#).
- [External Debug Request debug event on page H3-4380](#).
- [Reset Catch debug event on page H3-4382](#).
- [OS Unlock Catch debug event on page H3-4381](#).

Other debug events are referred to explicitly.

Authentication

This means halting is allowed by the IMPLEMENTATION DEFINED external authentication interface. It is the result of one of the following pseudocode functions:

In Secure state

ExternalSecureInvasiveDebugEnabled().

In Non-secure state

ExternalInvasiveDebugEnabled().

DLK This is the value EDPRSR.DLK. It indicates whether the OS Double Lock is locked, DoubleLockStatus() == TRUE.

OSLK This is the value of EDSCR.OSLK. It indicates whether the OS Lock is locked.

HDE This is the value of EDSCR.HDE. It indicates whether Halting debug-mode is enabled.

The letter X in Table H2-1 indicates that the value can be either 0 or 1.

Table H2-1 Debug authentication for external debug

Debug event type	Authentication	DLK	OSLK	HDE	Behavior
Other software	X	X	X	X	Handled by the Exception model

Table H2-1 Debug authentication for external debug (continued)

Debug event type	Authentication	DLK	OSLK	HDE	Behavior
Breakpoint or Watchpoint debug event	X	1	X	X	Handled by the Exception model (ignored)
	X	0	1	X	Handled by the Exception model (ignored)
	FALSE	0	0	X	Handled by the Exception model
	TRUE	0	0	0	Handled by the Exception model
	TRUE	0	0	1	Entry to Debug state
Halt Instruction debug event	FALSE	X	X	X	UNALLOCATED
	TRUE	1	X	X	UNALLOCATED
	TRUE	0	X	0	UNALLOCATED
	TRUE	0	X	1	Entry to Debug state
Exception Catch debug event	FALSE	X	X	X	Ignored
	TRUE	1	X	X	Ignored
	TRUE	0	X	X	Entry to Debug state
Software Access debug event	FALSE	X	X	X	Ignored
	TRUE	1	X	X	Ignored
	TRUE	0	1	X	Ignored
	TRUE	0	0	X	Entry to Debug state
Other Halting	FALSE	X	X	X	Ignored
	TRUE	1	X	X	Debug event is pended
	TRUE	0	X	X	Entry to Debug state

H2.2.8 Pseudocode details of Halting on debug events

The following pseudocode outlines the Halting(), Restarting(), HaltOnBreakpointOrWatchpoint(), and HaltingAllowed() functions.

```
// Halting()
// =====

boolean HaltingAllowed()
    return !(EDSCR.STATUS IN {'000001', '000010'});           // Halting

// Restarting()
// =====

boolean Restarting()
    return EDSCR.STATUS == '000001';                          // Restarting
```

```
// HaltOnBreakpointOrWatchpoint()
// =====
// Returns TRUE if the Breakpoint and Watchpoint debug events should be considered for Debug
// state entry, FALSE if they should be considered for a debug exception.

boolean HaltOnBreakpointOrWatchpoint()
    return HaltingAllowed() && EDSCR.HDE == '1' && OSLSR_EL1.OSLK == '0';

// HaltingAllowed()
// =====
// Returns TRUE if halting is currently allowed, FALSE if halting is prohibited.

boolean HaltingAllowed()
    if Halted() || DoubleLockStatus() then
        return FALSE;
    elsif IsSecure() then
        return ExternalSecureInvasiveDebugEnabled();
    else
        return ExternalInvasiveDebugEnabled();
```

H2.3 Entering Debug state

On entry to Debug state the preferred restart address and **PSTATE** are saved in **DLR** and **DSPSR**. The PE remains in the mode and security state from which it entered Debug state.

If **EDRCR.CBRRQ** has a value of 0, entry to Debug state is precise. If **EDRCR.CBRRQ** has a value of 1 imprecise entry to Debug state is permitted.

If a Watchpoint debug event causes an entry to Debug state, the address of the access that generated the Watchpoint debug event is recorded in **EDWAR**.

Other than the effect on **PSTATE** and **EDSCR**, entry to Debug state is not a *Context synchronization operation*. The effects of entry to Debug state on **PSTATE** and **EDSCR** are synchronized.

H2.3.1 Entering Debug state from AArch32 state

When entering Debug state from AArch32 state, the PE remains in AArch32 state. In AArch32 Debug state the PE executes T32 instructions, regardless of the values of **PSTATE**.{J,T} before entering Debug state.

To allow the debugger to determine the state of the PE, the current execution state for all four Exception levels can be read from **EDSCR.RW**.

The current endianness state, **PSTATE.E**, is unchanged on entry to Debug state.

———— **Note** —————

- If EL1 is using AArch32 state, the current endianness state can differ from that indicated by **SCTLR.EE**.
- If EL2 is using AArch32 state, the current endianness state can differ from that indicated by **HSCTLR.EE**.
- On entry to Debug state from AArch32 state, **PSTATE.SS** is copied to **DSPSR.SS**, even though the PE remains in AArch32 state.

See also *Effect of entering Debug state on PSTATE* on page H2-4338.

H2.3.2 Effect of entering Debug state on DLR and DSPSR

DLR is set to the preferred restart address for the debug event, and depends on the event type. The value of **PSTATE** is saved in **DSPSR**. For entry to Debug state from AArch32 state, the values saved in **DSPSR.IT**, bits[7:0], are always correct for the preferred return address.

For synchronous Halting debug events, the preferred restart address is the address of the instruction that generated the debug event.

For asynchronous Halting debug events, including pending Halting debug events taken asynchronously, the preferred restart address is the address of the first instruction that must be executed on exit from Debug state.

This means that:

- For Breakpoint and Watchpoint debug events, the preferred restart address is the same as the preferred return address for a debug exception. See *Preferred return addresses* on page D3-1667.
- For Halt Instruction debug events **DLR** is set to the address of the HLT instruction and **DSPSR.IT** is correct for the HLT instruction.
- For Software Access debug events, **DLR** is set to the address of the accessing instruction and **DSPSR.IT** is correct for this instruction.
- For Halting Step debug events taken synchronously, **DLR** and **DSPSR** are set as the ELR and SPSR would be set for a Software Step exception. This is usually the address of, and **PSTATE** for, the instruction after the one that was stepped.

- For Exception Catch debug events, **DLR** is set to the address of the exception vector the PE would have started fetching from. This is UNKNOWN if the VBAR for the Exception level has never been initialized. **DSPSR** records the value of **PSTATE** after taking the exception. The exception catch occurs after **ELR_ELx** and **SPSR_ELx** are set, and the debugger can use these registers to determine where in the application program the exception occurred.
- Reset Catch debug events taken synchronously behave like Exception Catch debug events.
- For pending Halting debug events and External Debug Request debug events, **DLR** is set to the address of the first instruction that must be executed on exit from Debug state and **DSPSR.IT** is correct for this instruction. See *Pending Halting debug events on page H3-4384*.

Normally **DLR** is aligned according to the instruction set state indicated in **DSPSR**. However, a debug event might be taken at a point where the PC is not aligned.

H2.3.3 Effect of entering Debug state on system registers, the Event register, and exclusive monitors

Entering Debug state has no effect on system registers other than **DLR** and **DSPSR**. In particular, ESRs, FARs, and FSRs are not updated on entering Debug state. **SCR** is unchanged, even when entering Debug state from EL3.

Entering Debug state has no architecturally-defined effect on the Event Register and exclusive monitors.

———— Note ————

Entry to Debug state might set the Event Register or clear the exclusive monitors, or both. However, this is not a requirement, and debuggers must not rely on any implementation specific behavior.

Unless otherwise described in this reference manual, instructions executed in Debug state have their architecturally-defined effects on the system registers, Event register, and exclusive monitors.

H2.3.4 Effect of entering Debug state on PSTATE

The effect of an entry to Debug state on **PSTATE** is described in *Entering Debug state on page H2-4337* and *Entering Debug state from AArch32 state on page H2-4337*.

PSTATE.{E, M, nRW, EL, SP} are unchanged on entry to Debug state.

PSTATE.IL is cleared to 0 on entry to Debug state, after being saved in **DSPSR_ELO**.

The other **PSTATE** fields are ignored and not observable in Debug state:

- **PSTATE**.{N, Z, C, V, Q, GE} are unchanged.
- **PSTATE**.{IT, J, T, SS, D, A, I, F} are set to UNKNOWN values, after being saved in **DSPSR_ELO**.

For more information see *Process state (PSTATE) in Debug state on page H2-4341*.

H2.3.5 Pseudocode details for entering Debug state

The following pseudocode shows the definition of the DebugHalt() function.

```
constant bits(6) DebugHalt_Breakpoint      = '000111';
constant bits(6) DebugHalt_EDBGRQ         = '010011';
constant bits(6) DebugHalt_Step_Normal    = '011011';
constant bits(6) DebugHalt_Step_Exclusive = '011111';
constant bits(6) DebugHalt_OSUnlockCatch  = '100011';
constant bits(6) DebugHalt_ResetCatch     = '100111';
constant bits(6) DebugHalt_Watchpoint     = '101011';
constant bits(6) DebugHalt_HaltInstruction = '101111';
```



```
constant bits(6) DebugHalt_SoftwareAccess = '110011';
constant bits(6) DebugHalt_ExceptionCatch = '110111';
constant bits(6) DebugHalt_Step_NoSyndrome = '111011';
```

The pseudocode for the UpdateEDSCRFIELDS() function is as follows:

```
// UpdateEDSCRFIELDS()
// =====
// Update EDSCR processor state fields

UpdateEDSCRFIELDS()

    // This might be invoked at any time, but updates are explicitly visible only following a
    // context synchronization operation and after entry to Debug state.
    // This function illustrates how EDSCR.RW is constructed.

    if !Halted() then
        EDSCR.EL = '00';
        EDSCR.NS = bit UNKNOWN;
        EDSCR.RW = '1111';
    else
        EDSCR.EL = PSTATE.EL;
        EDSCR.NS = if IsSecure() then '0' else '1';
        EDSCR.RW<3> = (if HighestELUsingAArch32() then '0' else '1');
        EDSCR.RW<2> = EDSCR.RW<3> AND (if !HaveEL(EL3) then '1' else SCR_GEN[].RW);
        EDSCR.RW<1> = EDSCR.RW<2> AND (if !CurrentStateHasEL2() then '1' else HCR_EL2.RW);
        EDSCR.RW<0> = EDSCR.RW<1> AND (if PSTATE.EL != EL0 || !UsingAArch32() then '1' else '0');

    return;
```

The pseudocode for the Halt() function is as follows:

```
// Halt()
// =====

Halt(bits(6) reason)

    CTI_SignalEvent(CrossTriggerIn_CrossHalt); // Trigger other cores to halt

    // Save debug entry state in DLR_EL0 and DSPSR_EL0 (see text). Note: no offset on DLR_EL0.
    // Preferred return address is always the address of instruction that generated the debug event.
    // For a Halting Step debug event this is the address of the next instruction.
    // For an Exception Catch debug event this is the target address inside the target EL.
    DLR_EL0 = ThisInstrAddr();
    DSPSR_EL0 = GetSPSRFromPSTATE();

    DSPSR_EL0.SS = PSTATE.SS; // Always save PSTATE.SS

    // Set up EDSCR bits
    EDSCR.ITE = '1'; EDSCR.ITO = '0';
    if IsSecure() then
        EDSCR.SDD = '0'; // If entered in Secure state, allow debug
    elseif HaveEL(EL3) then
        EDSCR.SDD = (if ExternalSecureInvasiveDebugEnabled() then '0' else '1');
    else
        assert EDSCR.SDD == '1'; // Otherwise EDSCR.SDD is RES1
    EDSCR.MA = '0';

    // ERR is not explicitly cleared. An RX0 or TXU error may be pending.
    // PSTATE.{IT,J,T,SS,D,A,I,F} are not observable and ignored in Debug state, so it does not
    // matter what they are set to on entry to Debug state. The processor treats them as if they
    // have specific fixed values. This code sets them to UNKNOWN values to illustrate this.
```

```
if UsingAArch32() then // entering from AArch32 state
    PSTATE.<IT,J,T,SS,A,I,F> = bits(14) UNKNOWN;
else
    PSTATE.<SS,D,A,I,F> = bits(5) UNKNOWN;

// However, a possible implementation is to explicitly set them to values consistent with the
// behavior in Debug state, but this is not required. Such an implementation is shown in the
// following comments. See Effect of entering Debug state on PSTATE.
// if UsingAArch32() then // entering from AArch32 state
//     PSTATE.<J,T> = '01'; // Force execution of T32 instructions
//     PSTATE.IT = Zeros(8); // Force IT bits ignored
//     PSTATE.<A,I,F> = '111'; // Mask asynchronous exceptions
// else
//     PSTATE.<D,A,I,F> = '1111'; // Mask asynchronous exceptions
//     PSTATE.SS = '0';

// PSTATE.IL is cleared on entry to Debug state.
PSTATE.IL = '0';

// PSTATE.{E,M,nRW,EL,SP} and PSTATE.{N,Z,C,V,Q,GE} are unchanged.

StopInstructionPrefetchAndEnableITR();
EDSCR.STATUS = reason; // Signal entered Debug state
UpdateEDSCRFields(); // Update EDSCR processor state flags.

return;
```

H2.4 Behavior in Debug state

Instructions are executed in Debug state from the Instruction Transfer Register, ITR. The debugger controls which instructions are executed in Debug state by writing the instructions to the External Debug Instruction Transfer register, [EDITR](#). The execution state of the PE determines which instruction set is executed:

- If the PE is in AArch64 state it executes A64 instructions.
- If the PE is in AArch32 state it executes T32 instructions.

The PE does not execute A32 instructions in Debug state.

Some instructions are available only in Debug state. See [Debug state instructions on page H2-4344](#). In Non-debug state these instructions are UNALLOCATED.

H2.4.1 Process state (PSTATE) in Debug state

[PSTATE](#).{N, Z, C, V, Q, GE, IT, J, T, SS, D, A, I, F} are all ignored in Debug state:

- There are no conditional instruction in Debug state.
- In AArch32 state, the PE only executes T32 instructions and [PSTATE.IT](#) is ignored.
- Asynchronous exceptions and debug events are ignored.
- Software step is inactive.

Note

[Halt\(\)](#) and [DRPSInstruction\(\)](#) set these fields to UNKNOWN, but the pseudocode provides comments that show how an implementation can set them to fixed values on entry to Debug state and on changing Exception level within Debug state. See [Pseudocode details for entering Debug state on page H2-4338](#).

Instructions executed in Debug state indirectly read [PSTATE](#).{IL, E, M, nRW, EL, SP} as they would in Non-debug state.

H2.4.2 Executing instructions in Debug state

The instructions executed in Debug state must be either A64 instructions or T32 instructions, depending on the current execution state.

In Debug state, an instruction does one of the following:

- It is UNALLOCATED.
- It behaves as defined in [Debug state instructions on page H2-4344](#).
- It behaves as defined for Non-debug state.

The only A64 and T32 instructions with modified behavior in Debug state are:

- The hint instructions WFE and WFI, which do not cause a suspension of execution.
- The T32 ERET instruction, which is decoded as DRPS.

Note

- This chapter is not the instruction set specification. In case of any encoding discrepancies, [Chapter C3 A64 Instruction Set Encoding](#), [Chapter F3 T32 Base Instruction Set Encoding](#), and [Chapter D1 The AArch64 System Level Programmers' Model](#), are authoritative.
- If [EDSCR.SDD](#) == 1 then an instruction executed in Non-secure state cannot cause entry into Secure state. See [Security in Debug state on page H2-4349](#).

All T32 instructions are treated as unconditional, regardless of [PSTATE.IT](#). See [Process state \(PSTATE\) in Debug state](#).

Instructions that are UNALLOCATED in Debug state

The instruction classes in this section are UNALLOCATED in Debug state. The behavior of UNALLOCATED instructions in Debug state is described in *Exceptions in Debug state* on page H2-4355.

The A64 instruction classes that are UNALLOCATED are listed here.

Data Processing Immediate:

- All [PC-rel. addressing](#) instructions.
- The following [Add/subtract \(immediate\)](#) instructions:
 - Flag-setting only.
- All [Logical \(immediate\)](#) instructions.
- All [Bitfield](#) instructions.
- All [Extract](#) instructions.

Branches, Exception Generating and System:

- All [Unconditional branch \(immediate\)](#) instructions.
- All [Compare & branch \(immediate\)](#) instructions.
- All [Test & branch \(immediate\)](#) instructions.
- All [Conditional branch \(immediate\)](#) instructions.
- All [Exception generation](#) instructions, except:
 - [DCPS](#), see *Debug state instructions, DCPS, DRPS, MRS, MSR* on page H2-4351.
- The following [System](#) instructions:
 - MSR (set PSTATE field, immediate).
 - MSR | MRS SPSEL, register.
 - MSR | MRS DAIF, register.
 - MSR | MRS NZCV, register.
 - MRS CurrentEL, register
- All [Unconditional branch \(register\)](#) instructions, except:
 - [DRPS](#).

Loads and Stores:

- All [Load register \(literal\)](#) instructions.
- All [Load/store no-allocate pair \(offset\)](#) instructions.
- All [Load/store register pair \(post-indexed\)](#) instructions.
- All [Load/store register pair \(offset\)](#) instructions.
- All [Load/store register pair \(pre-indexed\)](#) instructions.
- The following [Load/store register \(unscaled immediate\)](#) instructions:
 - SIMD and FP only.
- The following [Load/store register \(immediate post-indexed\)](#) instructions:
 - SIMD and FP only.
- The following [Load/store register \(immediate pre-indexed\)](#) instructions:
 - SIMD and FP only.
- All [Load/store register \(register offset\)](#) instructions.
- All [Load/store register \(unsigned immediate\)](#) instructions.
- All [AdvSIMD load/store multiple structures](#) instructions.
- All [AdvSIMD load/store multiple structures \(post-indexed\)](#) instructions.
- All [AdvSIMD load/store single structure](#) instructions.
- All [AdvSIMD load/store single structure \(post-indexed\)](#) instructions.

Data Processing Register:

- All [Logical \(shifted register\)](#) instructions.
- All [Add/subtract \(shifted register\)](#) instructions.
- All [Add/subtract \(extended register\)](#) instructions.

- All [Add/subtract \(with carry\)](#) instructions.
- All [Conditional compare \(register\)](#) instructions.
- All [Conditional compare \(immediate\)](#) instructions.
- All [Conditional select](#) instructions.
- All [Data-processing \(3 source\)](#) instructions.
- All [Data-processing \(2 source\)](#) instructions.
- All [Data-processing \(1 source\)](#) instructions.

SIMD Data Processing:

- All [AdvSIMD three same](#) instructions.
- All [AdvSIMD three different](#) instructions.
- All [AdvSIMD two-reg misc](#) instructions.
- All [AdvSIMD across lanes](#) instructions.
- All [AdvSIMD vector x indexed element](#) instructions.
- All [AdvSIMD shift by immediate](#) instructions.
- All [AdvSIMD modified immediate](#) instructions.
- All [AdvSIMD TBL/TBX](#) instructions.
- All [AdvSIMD ZIP/UZP/TRN](#) instructions.
- All [AdvSIMD EXT](#) instructions.
- All [Crypto AES](#) instructions.
- All [Floating-point<->fixed-point conversions](#) instructions.
- All [Floating-point conditional compare](#) instructions.
- All [Floating-point conditional select](#) instructions.
- All [Floating-point immediate](#) instructions.
- All [Floating-point compare](#) instructions.
- All [Floating-point data-processing \(1 source\)](#) instructions.
- All [Floating-point data-processing \(2 source\)](#) instructions.
- All [Floating-point data-processing \(3 source\)](#) instructions.
- All [AdvSIMD scalar three same](#) instructions.
- All [AdvSIMD scalar three different](#) instructions.
- All [AdvSIMD scalar two-reg misc](#) instructions.
- All [AdvSIMD scalar pairwise](#) instructions.
- All [AdvSIMD scalar copy](#) instructions.
- All [AdvSIMD scalar x indexed element](#) instructions.
- All [AdvSIMD scalar shift by immediate](#) instructions.
- All [Crypto three-reg SHA](#) instructions.
- All [Crypto two-reg SHA](#) instructions.

The UNALLOCATED T32 instruction classes are:

- All [16-bit Thumb instruction encodings](#).
- All [Data-processing \(modified immediate\)](#) instructions.
- All [Data-processing \(plain binary immediate\)](#) instructions except:
 - [Move Wide \(16-bit\)](#).
 - [Move Top \(16-bit\)](#).
- The following [Branches and miscellaneous control](#) instructions:
 - [Conditional branch](#).
 - [Move to Special register, Application level](#).
 - [Move to Special register, System level, except MSR SPSR \(register\)](#).
 - [CPS from Change Processor State, and hints](#).
 - [ENTERX from Miscellaneous control](#).
 - [LEAVEX from Miscellaneous control](#).
 - [Branch and Exchange Jazelle](#).

- Exception Return. This excludes ERET, which is decoded as DRPS.
- Move from Special register, Application level.
- Move from Special register, System level, except MRS SPSR (register).
- Hypervisor Call.
- Secure Monitor Call.
- Branch.
- Permanently UNDEFINED.
- Branch with Link and Exchange.
- Branch with Link.
- All [Load/store multiple](#) instructions.
- The following [Load/store dual](#), [load/store exclusive](#), [table branch](#) instructions:
 - All load/store with $Rn(hw1[3:0]) == 0b1111$.
 - Table Branch Byte.
 - Table Branch Halfword.
- The following [Load word](#), [Load halfword](#), [memory hints](#), and [Load byte](#), [memory hints](#) instructions:
 - Preload data.
 - Preload data with intent to Write.
 - Preload instruction.
 - All Load single data items with either $Rt(hw2[15:12]) == 0b1111$ or $Rn(hw1[3:0]) == 0b1111$.
- All [Data-processing \(shifted register\)](#) instructions.
- All [Data-processing \(register\)](#) instructions.
- All [Parallel addition and subtraction, signed](#) instructions.
- All [Parallel addition and subtraction, unsigned](#) instructions.
- All [Miscellaneous operations](#) instructions.
- All [Multiply, multiply accumulate, and absolute difference](#) instructions.
- All [Long multiply, long multiply accumulate, and divide](#) instructions.
- The following [Coprocessor](#), [Advanced SIMD](#), and [Floating-point](#) instructions:
 - Load Coprocessor (immediate).
 - Load Coprocessor (literal).
 - Store Coprocessor.
 - Coprocessor data operations.
- All [Advanced SIMD data-processing](#) instructions.
- All [Floating-point data-processing](#) instructions.
- All [Extension register load/store](#) instructions.
- All [Advanced SIMD element or structure load/store](#) instructions.

Note

The Move to Special Register and Move From Special Register classes in this list refer only to those MSR and MRS instructions listed under [Branches and miscellaneous control](#) instructions. For MRS and MSR instructions in the Move To Banked Register, Move From Banked Register, Move To Special Register and Move From Special Register classes see [Instructions that are unchanged in Debug state on page H2-4345](#).

Debug state instructions

The A64 and T32 instructions that are defined in [Debug state instructions](#), [DCPS](#), [DRPS](#), [MRS](#), [MSR](#) on [page H2-4351](#) are allowed in Debug state but are UNALLOCATED in Non-debug state:

- DCPS. See [DCPS on page H2-4351](#).

Note

DCPS can be UNALLOCATED in certain conditions in Debug state. See [DCPS on page H2-4351](#).

- DRPS. See [DRPS on page H2-4353](#).

- System instructions for accessing [DLR](#) and [DSPSR](#).

Instructions with modified behavior in Debug state

In Debug state the hint instructions are allowed, but:

- NOP, YIELD, WFI, and WFE must execute as NOPs. This means that WFE and WFI never cause a suspension of execution in Debug state and are never trapped.
- ERET is decoded as DRPS.

Instructions that are unchanged in Debug state

The remaining instruction classes are allowed in Debug state if they are allowed at the current Exception level and security state in Non-debug state.

The A64 instruction classes that are allowed in Debug state are listed here.

Data Processing Immediate:

- The following [Add/subtract \(immediate\)](#) instructions:
 - All non flag-setting instructions.
- All [Move wide \(immediate\)](#) instructions.

Branches, Exception Generating and System:

- All [System](#) instructions, except:
 - MSR, set PSTATE field, immediate.
 - MSR | MRS SPSe1, register.
 - MSR | MRS DAI, register.
 - MSR | MRS NZCV, register.
 - MRS CurrentEL, register.
 - Hints, see [Instructions with modified behavior in Debug state](#).

Loads and Stores:

- All [Load/store exclusive](#) instructions.
- All [Load/store register \(unscaled immediate\)](#) instructions except:
 - SIMD and FP instructions.
- All [Load/store register \(immediate post-indexed\)](#) instructions except:
 - SIMD and FP instructions.
- All [Load/store register \(unprivileged\)](#) instructions.
- All [Load/store register \(immediate pre-indexed\)](#) instructions, except:
 - SIMD and FP instructions.

SIMD Data Processing:

- [AdvSIMD copy](#), all.
- [Floating-point<->integer conversions](#), all.

In T32 the allowed instruction classes in Debug state are:

- The following [Data-processing \(plain binary immediate\)](#) instructions:
 - Move Wide (16-bit).
 - Move Top (16-bit).
- The following [Branches and miscellaneous control](#) instructions
 - Move to Banked or Special register.
 - MSR SPSR (register) from Move to Special Register, System level.
 - All hint instructions in [Change Processor State, and hints](#).

———— **Note** ————

See [Instructions with modified behavior in Debug state on page H2-4345](#) for further details.

- All miscellaneous control instructions except ENTERX and LEAVEX.
- ERET from Exception return. This is decoded as DRPS.
- Move from Banked or Special register.
- MRS SPSR register from Move from Special register, System level.
- The following [Load/store dual](#), [load/store exclusive](#), [table branch](#) instructions:
 - All Load/Store with Rn(hw1[3:0]) != 0b1111.
- The following [Load word](#), [Load halfword](#), [memory hints](#), [Load byte](#), [memory hints](#) instructions:
 - All load single data item with both Rt(hw2[15:12]) != 0b1111 and Rn(hw1[3:0]) != 0b1111.
- All [Store single data item](#) instructions.
- The following [Coprocessor](#), [Advanced SIMD](#), and [Floating-point instructions](#):
 - Move to Coprocessor from two general-purpose registers.
 - Move to two general-purpose registers from Coprocessor.
 - Move to Coprocessor from general-purpose register.
 - Move to general-purpose register from Coprocessor.
- All [8, 16, and 32-bit transfer between ARM core and extension registers](#).
- All [64-bit transfers between ARM core and extension registers](#).

UNPREDICTABLE instructions in Debug state

The list of [Instructions that are unchanged in Debug state on page H2-4345](#) includes instructions that are UNPREDICTABLE in both Debug state and Non-debug state. This includes some T32 instructions that specify R15 as a destination register or a source register, such as:

```
MOV.W R15, #<uimm16>  
LDREX R15, [Rn]
```

[Appendix A Architectural Constraints on UNPREDICTABLE behaviors](#) describes the CONSTRAINED UNPREDICTABLE behavior for these instructions. In Debug state, these CONSTRAINED UNPREDICTABLE choices are further restricted:

- Instructions that specify R15 as a destination register are not permitted to branch. There is no concept of a branch operation in Debug state:
 - Instructions that specify R15 as a destination register are permitted to set [DLR](#) to an UNKNOWN value.
- Instructions that specify R15 as a source operand cannot use the PC + offset. There is no architecturally-defined PC in Debug state.

All other options, for example treating the instruction as a NOP, are permitted in Debug state.

H2.4.3 Debug state UNALLOCATED decode tables

Table H2-2 shows how the System Register instructions are modified in Debug state when using AArch64. All other System Register instructions are unchanged.

Table H2-2 System Register instructions decode in Debug state in AArch64 state

op0	CRn	CRm	op2	op1	Description	Instruction in Debug state	
0	c2	-	-	3	Architectural Hint Instruction	Allowed, but see <i>Instructions with modified behavior in Debug state on page H2-4345</i>	
				5	0	MSR SPSe1, #imm	UNALLOCATED
				6	3	MSR DAIFSet, #imm	UNALLOCATED
				7	3	MSR DAIFClr, #imm	UNALLOCATED
3	c4	c2	0	0	MSR MRS SPSe1	UNALLOCATED	
				0	3	MSR MRS NZCV	UNALLOCATED
				1	3	MSR MRS DAIF	UNALLOCATED
				2	0	MRS CurrentEL	UNALLOCATED
			c5	0	3	MSR MRS DSPSR_EL0	Allowed ^a
				1	3	MSR MRS DLR_EL0	Allowed ^a

a. These instructions are UNALLOCATED in Non-debug state.

Table H2-3 shows how the System Register instructions are modified in Debug state when using AArch32. All other System Register instructions are unchanged.

Table H2-3 System Register instructions decode in Debug state in AArch32 state

coproc	CRn	CRm	opc2	opc1	Description	Instruction in Debug state
15	-	c5	0	3	The MCR and MRC instructions that access DSPSR	Allowed ^a
			1	3	The MCR and MRC instructions that access DLR	Allowed ^a

a. These instructions are UNALLOCATED in Non-debug state.

H2.4.4 Instructions that debuggers might use in Debug state

Executing instructions in Debug state on page H2-4341 lists the instructions that implementations must provide in Debug state. However, ARM strongly recommends that debuggers use only the instructions shown in [Table H2-4](#).

Table H2-4 Instructions that debug tools must use in Debug state

A64 Instruction Set	T32 Instruction Set
Instructions that move the data in system registers to or from a general-purpose register, including DBGDTRRX, DBGDTRTX, DBGDTR, DLR, and DSPSR ^a	
MRS <system_reg> ^b	MRC <coproc>, <opc1>, <Rt>, <CRn>, <CRm>{,<opc2>}
MSR <system_reg> ^b	MCR <coproc>, <opc1>, <Rt>, <CRn>, <CRm>{,<opc2>}
-	VMRS <vfp_system_reg>
-	VMSR <vfp_system_reg>
MRS <special_reg> ^b	MRS <banked_reg>_<mode>
MSR <special_reg> ^b	MSR <banked_reg>_<mode>
Debug state instructions	
DCPS1, DCPS2, DCPS3	DCPS
DRPS	ERET (decoded as DRPS)
[Instructions that move floating-point data between a SIMD and floating-point register and a general-purpose register	
FMOV (general-purpose register to or from a single-precision SIMD and floating-point register)	VMOV (between general-purpose register and a single-precision register)
FMOV (general-purpose register to or from a double-precision SIMD and floating-point register)	VMOV (between two general-purpose registers and a doubleword extension register)
FMOV (general-purpose register to or from a SIMD element)	-
Instructions that move SIMD data between a SIMD and floating-point register and a general-purpose register	
INS (from a general-purpose register to a SIMD element)	VMOV (general-purpose register to scalar)
UMOV (from a SIMD element to general-purpose register)	VMOV (scalar to general-purpose register)
-	VMOV (between two general-purpose registers and a doubleword extension register)
Barrier instructions	
ISB	ISB
DSB	DSB
DMB	DMB
Memory access instructions at various access sizes ^c	
LDR, LDRB, LDRH (immediate, not literal)	LDRB, LDRH (immediate, not literal)
STR, STRB, STRH (immediate)	STRB, STRH (immediate)
-	LDRD (immediate, not literal)
-	STRD (immediate)

Table H2-4 Instructions that debug tools must use in Debug state (continued)

A64 Instruction Set	T32 Instruction Set
Load-Exclusive/Store-Exclusive and Load-Acquire/Store-Release operations with the same addressing modes as memory access ^d	
LDXR, LDXRB, LDXRH	LDREX, LDREXB, LDREXH
LDAR, LDARB, LDARH	LDA, LDAB, LDAH
LDAXR, LDAXRB, LDAXRH	LDAEX, LDAEXB, LDAEXH
STXR, STXRB, STXRH	STREX, STREXB, STREXH
STLR, STLRB, STLRH	STL, STLB, STLH
STLXR, STLXRB, STLXRH	STLEX, STLEXB, STLEXH
LDXP	LDREXD
LDAXP	LDAEXD
STXP	STREXD
STLXP	STLEXD
CLREX	CLREX
Move to register	
MOVZ (immediate)	MOVW (immediate)
MOVN (immediate)	MOVT (immediate)
MOVK (immediate)	-
MOV (between general-purpose register and SP)	-
Cache and TLB maintenance and address translation operations	
SEV, SEVL	SEV.W
IC	ICIALLU, ICIALLUIS, ICIMVAU
DC	DCCIMVAC, DCCISW, DCCMVAC, DCCMVAU, DCCSW, DCIMVAC, DCISW
TLBI	TLBIALL, TLBIALLIS, TLBIASID, TLBIASIDIS, TLBIMVAA, TLBIMVAAIS, TLBIMVA, TLBIMVAIS
AT	ATS12NSOPR, ATS12NSOPW, ATS12NSOUR, ATS12NSOUW, ATS1CPR, ATS1CPW, ATS1CUR, ATS1CUW, ATS1HR, ATS1HW

- These instructions cannot access banked registers in the current mode.
- Other than NZCV, DAIF, SPSEL, and CurrentEL.
- This includes write-back addressing modes [`<Rn>, #imm`] ! or [`<Rn>`], #imm, immediate offsets only, and general-purpose register only. It includes both 32-bit and 64-bit general-purpose registers in AArch64.
- This includes both 32-bit and 64-bit general-purpose registers in AArch64.

H2.4.5 Security in Debug state

If EL3 is implemented or the PE is Secure, security in Debug state is governed by the Secure debug disabled flag, [EDSCR.SDD](#).

On entry to Debug state

If entering in Secure state, `EDSCR.SDD` is set to 0. Otherwise `EDSCR.SDD` is set to the inverse of `ExternalSecureInvasiveDebugEnabled()`. That is:

- If `ExternalSecureInvasiveDebugEnabled() == TRUE`, `EDSCR.SDD` is set to 0.
- If `ExternalSecureInvasiveDebugEnabled() == FALSE`, `EDSCR.SDD` is set to 1.

Note

Normally, if `ExternalSecureInvasiveDebugEnabled() == FALSE` then halting is prohibited and it is not possible to enter Debug state from Secure state. However, because changes to the authentication signals require a *Context synchronization operation* to guarantee their effect, there is a period during which the PE might halt even though the authentication signals prohibit halting.

In Debug state

The value of `EDSCR.SDD` does not change, even if `ExternalSecureInvasiveDebugEnabled()` changes.

Note

- `DBGAUTHSTATUS_EL1`.{SNID, SID, NSNID, NSID} are not frozen in Debug state.
 - If `EDSCR.SDD` set to 1 in Debug state, then there is no means no enter Secure state from Non-secure state. In this case it is impossible for the PE to be in Secure state. This is a general principle of behavior in Debug state.
-

In Non-debug state

`EDSCR.SDD` returns the inverse of `ExternalSecureInvasiveDebugEnabled()`. If the authentication signals that control `ExternalSecureInvasiveDebugEnabled()` change, a *Context synchronization operation* is required to guarantee their effect.

Note

- In Non-debug state, `EDSCR.SDD` is unaffected by the Security state of the PE.
 - A *Context synchronization operation* is also required to guarantee that changes in the authentication signals are visible in `DBGAUTHSTATUS_EL1`.{SNID, SID, NSNID, NSID}.
-

If EL3 is not implemented and the PE is Non-secure, `EDSCR.SDD` is RES1.

H2.4.6 Privilege in Debug state

The only additional privileges offered to Debug state are:

- The privilege to execute *Debug state instructions, DCPS, DRPS, MRS, MSR* on page H2-4351.
- The privilege to execute DTR access instructions regardless of the Exception level and traps.

In Non-debug state, the Debug state instructions are UNALLOCATED, except for the T32 DRPS instruction. The T32 DRPS instruction uses the encoding of the Non-debug T32 ERET instruction.

In Debug state, the Debug state instructions can be executed at any Exception level. However, there are some cases where the instructions are UNALLOCATED. For more information, see *Debug state instructions, DCPS, DRPS, MRS, MSR* on page H2-4351. These instructions generate an Undefined Instruction exception when they are UNALLOCATED. If this Undefined Instruction exception is taken to an Exception level using AArch64, it is reported using `ESR_ELx.EC`, with the code 0x00, and if taken to AArch32 Hyp mode, reported using `HSR.EC` of 0x00.

The DTR access instructions can be executed at any Exception level, including EL0, regardless of any control register settings that might force these instructions to be UNALLOCATED or trapped in Non-debug state. These instruction are MRS and MSR:

- The MRS and MSR instructions that access `DBGDTR_EL0`, `DBGDTRTX_EL0`, and `DBGDTRRX_EL0` in AArch64 state.
- The MRC and MCR instructions that access `DBGDTRTXint` and `DBGDTRRXint` in AArch32 state.

All other instructions operate with the privilege determined by the current Exception level and security state. This applies to all special and system registers accesses, memory accesses, and UNALLOCATED instructions, and includes generating exceptions when the system registers trap or disable an instruction.

H2.4.7 Debug state instructions, DCPS, DRPS, MRS, MSR

ARMv8 defines instructions to change between Exception levels in Debug state. These instructions can also change the mode at the current Exception level.

DCPS

DCPS allows the debugger to move the PE to a higher Exception level or to a specific mode at the current Exception level.

If the DCPS instruction is executed in AArch32 state and the target Exception level is using AArch64:

- The current instruction set switches from T32 to A64.
- The effect on registers that are not visible or only partially visible in AArch32 state is the same as for system calls in Non-debug state. See [Execution state on page D1-1411](#).

Otherwise, the instruction set state does not change.

If the target Exception level is the same as the current Exception level, then the PE does not change Exception level. However, the PE can change mode.

The effect on endianness is the same as for exceptions and exception returns in Non-debug state:

- In AArch64, the current endianness is set according to [SCTLR_ELx.EE](#) for the target Exception level.
- In AArch32, the current endianness is set according to [SCTLR.EE](#) or [HSCTLR.EE](#) for the target Exception level.

The assembler syntax for the DCPS instructions is:

```
DCPS1    {#<uimm16>}
DCPS2    {#<uimm16>}
DCPS3    {#<uimm16>}
```

<uimm16> is only available in the A64 encoding and is ignored by hardware.

The decode can be found in the instruction descriptions for [DCPS1](#), [DCPS2](#), and [DCPS3](#) for A64, and [DCPS1](#), [DCPS2](#), [DCPS3](#) for T32.

DCPS is UNALLOCATED in Non-debug state.

[Table H2-5 on page H2-4352](#) shows the target of the instruction. In [Table H2-5 on page H2-4352](#) the column entries have the following meaning:

EL1h/Svc	This means that the target mode is EL1 handler mode, if EL1 is using AArch64. Otherwise this is Svc mode.
EL2h/Hyp	This means that the target mode is EL2 handler mode, if EL2 is using AArch64. Otherwise this is Hyp mode.

EL3h/Monitor This means that the target mode is EL3 handler mode, if EL3 is using AArch64. Otherwise this is Monitor mode.

Table H2-5 Target for DCPS instructions in Debug state

Instruction	Target modes when taken from Exception level				
	EL0	EL1	EL2	EL3 (AArch64)	EL3 (AArch32)
DCPS1	EL1h/Svc	EL1h/Svc	EL2h/Hyp	EL3h	Svc, clears NS to 0
DCPS2	EL2h/Hyp	EL2h/Hyp	EL2h/Hyp	EL3h	UNDEFINED
DCPS3	EL3h/Monitor	EL3h/Monitor	EL3h/Monitor	EL3h	Monitor, clears NS to 0

Note

- In AArch32 Monitor mode, [DCPS1](#) and [DCPS3](#) clear [SCR.NS](#) to 0.
- In AArch64, at EL3, DCPS does not change [SCR_EL3.NS](#).

However:

- [DCPS1](#) is UNALLOCATED at EL0 in Non-secure state if both:
 - EL2 is implemented.
 - [HCR_EL2.TGE](#) == 1.
- [DCPS2](#) is UNALLOCATED at all Exception levels if EL2 is not implemented.
- [DCPS2](#) is UNALLOCATED at the following Exception levels if EL2 is implemented:
 - At EL0 and EL1 in Secure state.
 - At EL3 if EL3 is using AArch32.
- [DCPS3](#) is UNALLOCATED at all Exception levels if either:
 - [EDSCR.SDD](#) == 1.
 - EL3 is not implemented.

DCPS is also defined in T32, see [DCPS1](#), [DCPS2](#), [DCPS3](#) on page F7-2597. There is no A32 encoding.

On executing a DCPS instruction:

- If the target Exception level is using AArch64:
 - [ELR_ELx](#) of the target Exception level becomes UNKNOWN.
 - [SPSR_ELx](#) of the target Exception level becomes UNKNOWN.
 - [ESR_ELx](#) of the target Exception level becomes UNKNOWN.
 - [DLR_EL0](#) and [DSPSR_EL0](#) become UNKNOWN.
- If the target Exception level is using AArch32 [DLR](#) and [DSPSR](#) become UNKNOWN and:
 - If the target Exception level is EL1 or EL3, the LR and SPSR of the target mode become UNKNOWN.
 - If the target Exception level is EL2, then [ELR_hyp](#), [SPSR_hyp](#), and [HSR](#) become UNKNOWN.

If the target Exception level is using AArch32, and the target Exception level is EL1 or EL3, the LR and SPSR of the target mode become UNKNOWN.

The pseudocode for DCPSInstruction() is as follows:

```
// DCPSInstruction()
// =====
// Operation of the DCPS instruction in Debug state

DCPSInstruction(bits(2) target_el)

SynchronizeContext();
```

```

case target_el of
  when EL1
    if PSTATE.EL == EL2 || (PSTATE.EL == EL3 && !UsingAArch32()) then handle_e1 = PSTATE.EL;
    elsif HaveEL(EL2) && !IsSecure() && HCR_EL2.TGE == '1' then UndefinedFault();
    else handle_e1 = EL1;

  when EL2
    if !HaveEL(EL2) then UndefinedFault();
    elsif PSTATE.EL == EL3 && !UsingAArch32() then handle_e1 = EL3;
    elsif IsSecure() then UndefinedFault();
    else handle_e1 = EL2;

  when EL3
    if EDSCR.SDD == '1' || !HaveEL(EL3) then UndefinedFault();
    handle_e1 = EL3;

if ELUsingAArch32(handle_e1) then
  if PSTATE.M == M32_Monitor then SCR.NS = '0';
  assert UsingAArch32(); // Cannot move from AArch64 to AArch32
  case handle_e1 of
    when EL1 AArch32.WriteMode(M32_Svc);
    when EL2 AArch32.WriteMode(M32_Hyp);
    when EL3 AArch32.WriteMode(M32_Monitor);
  if handle_e1 == EL2 then
    ELR_hyp = bits(32) UNKNOWN; HSR = bits(32) UNKNOWN;
  else
    LR = bits(32) UNKNOWN;
    SPSR[] = bits(32) UNKNOWN;
    PSTATE.E = SCTLRL[.EE];
  else // Targetting AArch64
    if UsingAArch32() then MaybeZeroRegisterUppers(handle_e1);
    ELR[] = bits(64) UNKNOWN; SPSR[] = bits(32) UNKNOWN; ESR[] = bits(32) UNKNOWN;
    PSTATE.nRW = '0'; PSTATE.SP = '1'; PSTATE.EL = handle_e1;

  DLR_EL0 = bits(64) UNKNOWN; DSPSR_EL0 = bits(32) UNKNOWN;
  UpdateEDSCRFields(); // Update EDSCR processor state flags.

return;

```

DRPS

DRPS allows the debugger to move the PE to a lower Exception level or to another mode at the current Exception level by copying the current SPSR to **PSTATE**.

If **DRPS** is executed in AArch64 state and the target Exception level is using AArch32:

- The current instruction set switches from A64 to T32.
- The effect on registers that are not visible or only partially visible in AArch32 state is the same as for exception returns in Non-debug state. See *Execution state on page D1-1411*.

Otherwise the instruction set state does not change.

If the target Exception level is the same as the current Exception level, then the PE does not change Exception level. However, the PE can change mode.

The effect on endianness is the same as for exceptions and exception returns in Non-debug state:

- If targeting an Exception level using AArch64, current endianness is set according to **SCTLRL_ELx.EE**, or **SCTLRL_EL1.EOE** for the target Exception level.
- If targeting an Exception level using AArch32, current endianness is set by SPSR.E as appropriate.

The assembler syntax for the DRPS instruction is:

```
DRPS
```

The decode can be found in the instruction description for [DRPS](#).

If the SPSR specifies an illegal exception return, then [PSTATE](#).{M, nRW, EL, SP} are unchanged and [PSTATE](#).IL is set to 1. For further information on illegal exception returns, see [Illegal return events on page D1-1441](#).

[PSTATE](#).{N, Z, C, V, Q, GE, IT, J, T, SS, D, A, I, F} are ignored in Debug state. This means that the effect of [DRPS](#) on these fields is to set them to an UNKNOWN value that might be the value from the SPSR. For more information see [Process state \(PSTATE\) in Debug state on page H2-4341](#).

All other [PSTATE](#) fields are copied from SPSR.

[DRPS](#) is UNALLOCATED at EL0 and in Non-debug state. In Debug state, the T32 encoding for [ERET](#) is decoded as [DRPS](#). There is no A32 encoding for [DRPS](#).

————— **Note** —————

Unlike an exception return, [DRPS](#) has no architecturally-defined effect on the Event Register and exclusive monitors. [DRPS](#) might set the Event Register or clear the exclusive monitors, or both, but this is not a requirement and debuggers must not rely on any implementation specific behavior.

On executing a [DRPS](#) instruction:

- If the target Exception level is using AArch64:
 - [DLR_EL0](#) and [DSPSR_EL0](#) become UNKNOWN.
- If the target Exception level is using AArch32:
 - [DLR](#) and [DSPSR](#) become UNKNOWN.

The pseudocode for [DRPSInstruction\(\)](#) is as follows:

```
// DRPSInstruction()
// =====
// Operation of the A64 DRPS and T32 ERET instructions in Debug state

DRPSInstruction()

    SynchronizeContext();

    bits(32) spsr = SPSR[];
    // This actions are the same as for an exception return. In particular, see [v8Exception] for
    // details of illegal exception return handling.
    // PSTATE.{NZCV,Q,GE,IT,J,T,SS,DAIF} are ignored and not observable in Debug state, so it
    // does not matter what they are set to by DRPS. The processor treats some of these fields as if
    // they have specific fixed values in Debug state. This code sets them to UNKNOWN values to
    // illustrate this.
    if spsr<4> == '1' then // returning to AArch32 state
        spsr<31:24,21,19:10,8:5> = bits(23) UNKNOWN; // SPSR[].{NZCV,Q,GE,IT,J,SS,AIF,T}
    else
        spsr<31:28,21,9:6> = bits(9) UNKNOWN; // SPSR[].{NZCV,SS,DAIF}

    // However, a possible implementation is to explicitly set them to values consistent with the
    // behavior in Debug state, or unchanged (meaning they are copied to PSTATE) but this is not
    // required. Such an implementation is shown in the following comments.
    // if spsr<4> == '1' then // returning to AArch32 state
    //     spsr<26:25,15:10> = Zeros(8); // SPSR[].IT
    //     spsr<24,5> = '01'; // SPSR[].{J,T}
    // else
    //     spsr<9> = '1'; // SPSR[].D
    //     spsr<21> = '0'; // SPSR[].SS
    //     spsr<8:6> = '111'; // SPSR[].{A,I,F}

    SetPSTATEFromSPSR(spsr);
    DLR_EL0 = bits(64) UNKNOWN; DSPSR_EL0 = bits(32) UNKNOWN;
    UpdateEDSCRFields(); // Update EDSCR processor state flags.

return;
```

MRS and MSR instructions to access DLR_EL0 and DSPSR_EL0

The other Debug state instructions are [MRS](#) and [MSR \(register\)](#) instructions to read or write [DLR_EL0](#) and [DSPSR_EL0](#), and the equivalent MRC and MCR operations in AArch32 state.

```
MRS <Xt>, DLR_EL0      ; Copy DLR_EL0 to <Xt>
MRS <Xt>, DSPSR_EL0   ; Copy DSPSR_EL0 to <Xt>
MSR DLR_EL0, <Xt>     ; Copy <Xt> to DLR_EL0
MSR DSPSR_EL0, <Xt>  ; Copy <Xt> to DSPSR_EL0
```

These instructions can be executed at any Exception level when in Debug state, including EL0. They are UNALLOCATED in Non-debug state.

H2.4.8 Exceptions in Debug state

The following sections describe how exceptions are handled in Debug state:

- [Generating exceptions in Debug state.](#)
- [Taking exceptions in Debug state on page H2-4356.](#)
- [Reset in Debug state on page H2-4357.](#)

Generating exceptions in Debug state

In Debug state:

- Instruction Abort exceptions cannot happen because instructions are not fetched from memory.
- Interrupts, including SError and virtual interrupts are ignored and remain pending:
 - The pending interrupt remains visible in [ISR](#).
- Debug exceptions are ignored.
- [SCR.EA](#) is treated as if it were set to 0, regardless of its actual state, other than for the purpose of reading the bit.
- All instruction bit patterns that are an allocated instruction at the current Exception level, but listed in [Executing instructions in Debug state on page H2-4341](#) as UNALLOCATED in Debug state, generate Undefined Instruction exceptions, which are taken to the current Exception level, or to EL1 if executing at EL0. This includes SVC, HVC, SMC, BRK, and HLT. The priority and syndrome for these exceptions is the same as for executing an encoding that does not have an allocated instruction.
- Instructions executed at EL2, EL1 and EL0 that are configured by EL3 control registers to trap to EL3:
 - Generate the appropriate trap exception taken to EL3 if [EDSCR.SDD](#) == 0.
 - Generate an Undefined Instruction exception taken to the current Exception level, or to EL1 if executing at EL0, if [EDSCR.SDD](#) == 1. If the exception is taken to an Exception level using AArch64 or AArch32 Hyp mode, this is reported with an exception class of 0x00.

Otherwise configurable traps, enables, and disables, for instructions are unaffected by Debug state, and executing the affected instructions generates the appropriate exceptions.

Otherwise, synchronous exceptions, including Data Aborts, are generated as they would be in Non-debug state and taken to the appropriate Exception level in Debug state.

———— Note —————

If [EDSCR.SDD](#) == 1 then an exception from Non-secure state is never taken to Secure state. See [Security in Debug state on page H2-4349](#).

Taking exceptions in Debug state

Once generated, exceptions, all of which are synchronous, are taken in Debug state. This means that:

- The target Exception level and mode are as defined for the exception in Non-debug state. That is:
 - For exceptions taken to an Exception level using AArch64, the mode is the handler mode for that Exception level.
 - For exceptions taken to an Exception level using AArch32, the mode is the exception mode appropriate for the exception.
- The exception is reported as defined for the exception in Non-debug state, using the syndrome register or registers for the target Exception level. In AArch64, these are [ESR_ELx](#), and [FAR_ELx](#). In AArch32, these are [DFSR](#), [DFAR](#), [HSR](#), [HDFAR](#), and [HPFAR](#). For example:
 - If a Data Abort exception is taken to Abort mode at EL1 or EL3 and the exception is taken from AArch32 state and using the Short-descriptor translation table format, the [DFSR](#) reports the exception using the Short-descriptor format fault encoding. For exceptions other than Data Abort exceptions taken in Abort mode, [DFSR](#) is not updated.
 - If an instruction is trapped to an Exception level using AArch64 due to a configurable trap, disable, or enable, the exception code reported is the same as it would be in Non-debug state.

The effect on auxiliary syndrome registers, such as AFSR, is IMPLEMENTATION DEFINED.

- The PE remains in Debug state and changes to the target mode.
- If EL3 is using AArch32 and the exception is taken from Monitor mode, [SCR.NS](#) is cleared to 0.
- If the exception is taken to an Exception level using AArch32, the PE continues to execute T32 instructions, regardless of the TE bit in the system control register for the target Exception level.
- The endianness switches to that indicated by the EE bit of the system control register for the target Exception level.
- The SPSR for the target Exception level or mode is corrupted and becomes UNKNOWN.
- If the target Exception level is using AArch64, [ELR_ELx](#) for the target Exception level becomes UNKNOWN.
- If the target Exception level is EL2 using AArch32, [ELR_hyp](#) becomes UNKNOWN.
- If the target Exception level is EL1 or EL3 using AArch32, [LR_<mode>](#) for the target mode becomes UNKNOWN.
- [DLR](#) and [DSPSR](#) become UNKNOWN.
- The cumulative error flag, [EDSCR.ERR](#), is set to 1. See [Cumulative error flag on page H4-4397](#).
- [PSTATE.IL](#) is cleared to 0.
- [PSTATE.{IT, J, T, SS, D, A, I, F}](#) are set to UNKNOWN values, and [PSTATE.{N, Z, C, V, Q, GE}](#) are unchanged. However, these fields are ignored and are not observable in Debug state. For more information see [Process state \(PSTATE\) in Debug state on page H2-4341](#).

The pseudocode for `TakeExceptionInDebugState()` is as follows:

```
// TakeExceptionInDebugState()  
// =====
```

```
TakeExceptionInDebugState(bits(2) target_exception_level, bits(5) target_mode)
```

```
if ELUsingAArch32(target_exception_level) then  
    assert target_mode<4> == '1';  
    if PSTATE.M == M32_Monitor then SCR_EL3.NS = '0';  
    PSTATE.M = target_mode;  
    // PSTATE.{IT, J, T, SS, D, A, I, F} are not observable and ignored in Debug state, so it does not  
    // matter what they are set to on taking an exception in Debug state. The processor treats  
    // them as if they have specific fixed values. This code sets them to UNKNOWN values to
```

```

// illustrate this.
PSTATE.<IT,J,T,SS,A,I,F> = bits(14) UNKNOWN;
// However, a possible implementation is to explicitly set them to values consistent with
// the behavior in Debug state, but this is not required. Such an implementation is shown in
// the following comments.
// PSTATE.<J,T> = '01';           // Force execution of T32 instructions
// PSTATE.IT = Zeros(8);         // Force IT bits ignored
// PSTATE.<A,I,F> = '111';       // Mask asynchronous exceptions
// PSTATE.SS = '0';             // Disable step
if PSTATE.EL == EL2 then ELR_hyp = bits(32) UNKNOWN;
else R[14] = bits(32) UNKNOWN;
PSTATE.E = SCTLR[].EE;
else
  PSTATE.EL = target_exception_level; PSTATE.nRW = '0'; PSTATE.SP = '1';
  ELR[] = bits(64) UNKNOWN;
  // See comments above.
  PSTATE.<SS,D,A,I,F> = bits(5) UNKNOWN;
  // PSTATE.<D,A,I,F> = '1111';   // Mask asynchronous exceptions
  // PSTATE.SS = '0';           // Disable step

_PC           = bits(64) UNKNOWN;           // PC is invisible in Debug state
SPSR[]        = bits(32) UNKNOWN;
PSTATE.IL     = '0';
DLR_EL0       = bits(64) UNKNOWN;
DPSR_EL0     = bits(32) UNKNOWN;
EDSCR.ERR    = '1';

UpdateEDSCRFields();                       // Update EDSCR processor state flags.

return;

```

The debugger must save any state that can be corrupted by an exception before executing an instruction that might generate another exception.

Reset in Debug state

If the PE is reset when in Debug state, it exits Debug state and enters Non-debug reset state. When the PE is in reset state, `EDSCR.STATUS == 0b000010` and writes to `EDITR` are ignored.

————— Note —————

If `EDECR.RCE == 1`, meaning that a Reset Catch debug event is programmed, and if halting is allowed on exiting reset state, then on exiting reset state the PE halts and re-enters Debug state. See [Reset Catch debug event on page H3-4382](#). All PE registers have taken their reset values, which might be UNKNOWN.

H2.4.9 Accessing registers in Debug state

Register accesses are unchanged in Debug state. The view of each register is determined by either the current Exception level or the mode, or both, and accesses might be disabled or trapped by controls at a higher Exception level.

General-purpose register access, other than SP access in AArch64 state

A single general-purpose register can be read by issuing an MSR instruction through the ITR to write `DBGDTR_EL0` in AArch64 state, or an MCR instruction through the ITR to write `DBGDTRXint` in AArch32 state. The debugger can then read the DTR register or registers through the external debug interface. The reverse sequence writes to a general-purpose register.

[Figure H2-1 on page H2-4358](#) shows the reading and writing of general-purpose registers, other than SP, in Debug state in AArch64 state.

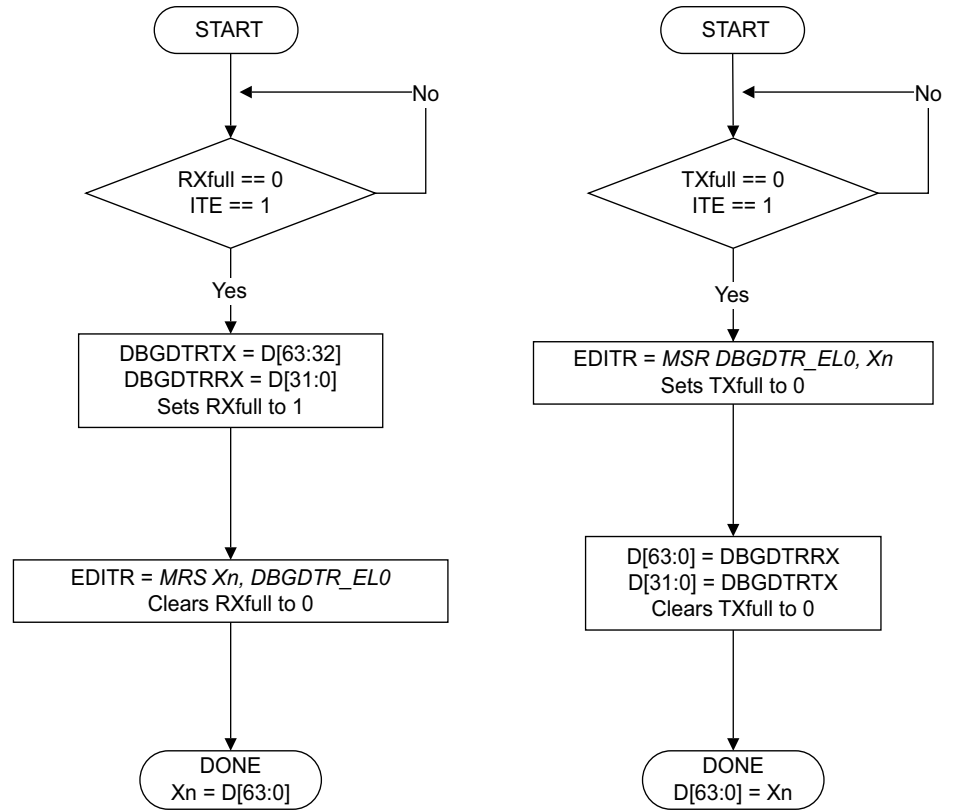

Figure H2-1 Reading and writing general-purpose registers, other than SP, in Debug state in AArch64 state

Figure H2-2 shows the reading and writing of general-purpose registers in Debug state in AArch32 state.

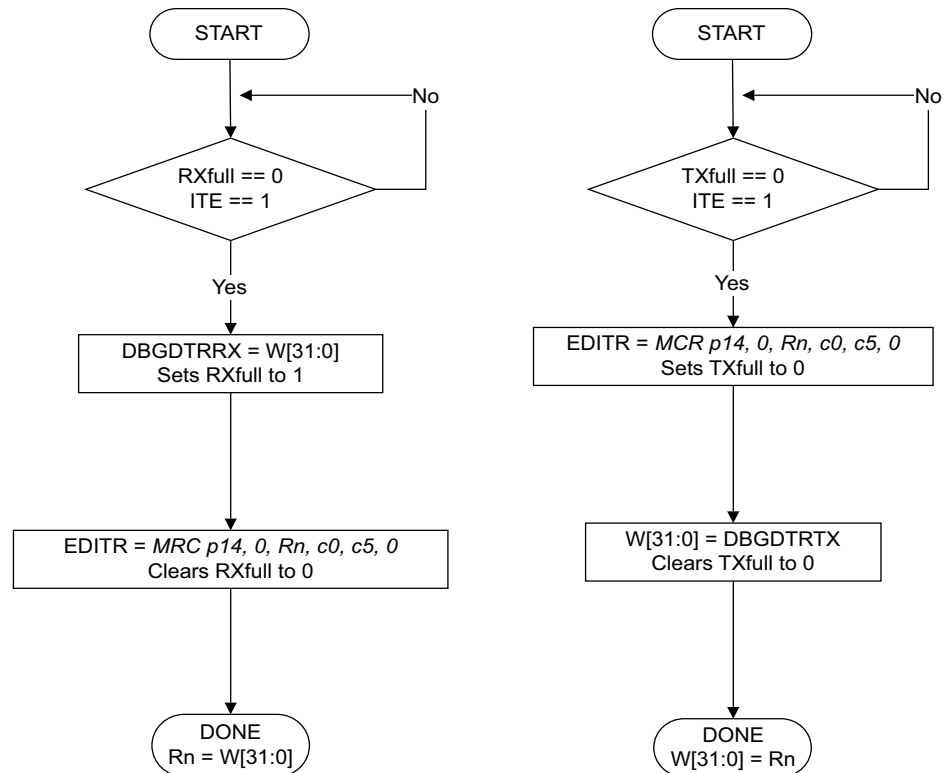

Figure H2-2 Reading and writing general-purpose registers in Debug state in AArch32 state

SIMD and floating-point, and system register accesses, and SP access in AArch64 state

To read a SIMD and floating-point register or a system register, the debugger must first copy the value into a general-purpose register using:

- An FMOV instruction in AArch64 or a VMOV instruction in AArch32 for floating-point transfers to SIMD and FP registers.
- A UMOV instruction in AArch64 or a VMOV instruction in AArch32 for SIMD transfers to SIMD and FP registers.
- An MRS instruction in AArch64 or an MRC instruction in AArch32 for system registers.
- A MOV Xd, SP instruction for the SP register in AArch64 state.

The debugger can then read out the particular general-purpose register. The reverse sequence writes a register.

PC and PSTATE access

The debugger reads the program counter and **PSTATE** of the process being debugged through the **DLR_EL0** and **DSPSR_EL0** system registers. The actual values of PC and **PSTATE** cannot be directly observed in Debug state:

- Instructions that are used for direct reads and writes of PC and **PSTATE** in Non-debug state are UNALLOCATED in Debug state.
- On taking an exception, **ELR_ELx** and **SPSR_ELx** at the target exception level are UNKNOWN. They do not record the PC and **PSTATE**.

PSTATE. {IL, E, M, nRW, EL, SP} are indirectly read by instructions executed in Debug state, but all other **PSTATE** fields are ignored and cannot be observed. See also:

- [Process state \(PSTATE\) in Debug state on page H2-4341.](#)
- [Executing instructions in Debug state on page H2-4341.](#)
- [Exceptions in Debug state on page H2-4355.](#)

H2.4.10 Accessing memory in Debug state

How the PE accesses memory is unchanged in Debug state. This includes:

- The operation of the MMU, including address translation, tagged address handling, access permissions, memory attribute determination, and the operation of any TLBs.
- The operation of any caches and coherency mechanisms.
- Alignment support.
- Endianness support.
- The Memory order model.

Simple memory transfers

Simple memory accesses can be performed in Debug state by issuing memory access instructions through the ITR and passing data through the DTR registers. [Executing instructions in Debug state on page H2-4341](#) lists the memory access instructions that are supported in Debug state.

Bulk memory transfers

Memory access mode can accelerate bulk memory transfers in Debug state. See [DCC and ITR access modes on page H4-4391](#).

H2.5 Exiting Debug state

The PE exits Debug state when it receives a Restart request trigger event. If `EDSCR.ITE == 0` the behavior of any instruction issued through the ITR in normal mode or an operation issued by a DTR access in memory access mode that has not completed execution is `CONSTRAINED UNPREDICTABLE`, and must do one of the following:

- It must complete execution in Debug state before the PE executes the restart sequence.
- It must complete execution in Non-debug state after the PE executes the restart sequence.
- It must be abandoned. This means that the instruction does not execute. Any registers or memory accessed by the instruction are left in an `UNKNOWN` state.

Note

- Implementations can set `EDSCR.ITE` to 1 to indicate that further instructions can be accepted by ITR before the previous instructions have completed. If any previous instruction has not completed and `EDSCR.ITE == 1`, then the PE must complete these instructions in Debug state before executing the restart sequence. `EDSCR.ITE == 0` indicates that the PE is not ready to restart.
- A debugger must observe that any instructions issued through `EDITR` that might generate a synchronous exception, as complete, before issuing a restart request. It can do this by observing the completion of a later instruction, as synchronous exceptions must occur in program order. For example, a debugger can observe that an instruction that reads or writes a DTR register is complete because of its effect on the `EDSCR.{TXfull, RXfull}` flags.

On exiting Debug state, the PE sets the program counter to the address in `DLR`, where:

- If exiting to AArch32 state:
 - Bits[63:32] of `DLR` are ignored.
 - Bits[31:1] of the PC are set to the value of bits[31:1] of `DLR`.
 - Bit[0] of the PC is set to a `CONSTRAINED UNPREDICTABLE` choice of 0 or the value of bit[0] in `DLR`.
- If exiting to AArch64 state:
 - Bits[63:56] of `DLR` might be ignored as part of tagged address handling. See *Address tagging in AArch64 state* on page D5-1708.
 - Otherwise the PC is set from `DLR`.

Exit from Debug state can give rise to a misaligned PC exception when the program counter is used. Unlike an exception return, this might also happen when returning to AArch32 state. For more information, see *PC alignment checking* on page D1-1423.

`PSTATE` is set from `DSPSR_EL0` in the same way that an exception return sets `PSTATE` from `SPSR_ELx`:

- The same illegal exception return checks that apply to an exception return also apply to exiting Debug state. If the return from Debug state is an illegal exception return then the effect on `PSTATE` and the PC is the same as for any other illegal exception return. See *Exception return* on page D1-1439.
- The checks on the `PSTATE.IT` bits that apply to exiting Debug state into AArch32 state are the same as those that apply to an exception return. See *Appendix A Architectural Constraints on UNPREDICTABLE behaviors*.
- `PSTATE.SS` is copied from `DSPSR.SS` if all of the following hold:
 - `MDSCR_EL1.SS == 1`.
 - The debug target Exception level is using AArch64.
 - Software step exceptions from the restart Exception level are enabled.
 See *Entering the active-not-pending state* on page D2-1637.

Note

- One important difference between Debug state exit and an exception return is that the PE can exit Debug state at EL0. Despite this, the behavior of an exit from Debug state is similar to an exception return. For example, `PSTATE.{D, A, I, F}` is updated regardless of the value of `SCTLR_EL1.UMA`.

- Exit from Debug state has no architecturally-defined effect on the Event Register and exclusive monitors. An exit from Debug state might set the Event Register or clear the exclusive monitors, or both, but this is not a requirement and debuggers must not rely on any implementation specific behavior.

The pseudocode for ExitDebugState() is as follows.

```
// ExitDebugState()
// =====

ExitDebugState()
  assert Halting();
  SynchronizeContext();

  // Although EDSCR.STATUS signals that the processor is restarting, debuggers must use EDPRSR.SDR
  // to detect that the processor has restarted.
  EDSCR.STATUS = '000001'; // Signal restarting
  // Return to saved processing state
  EDESRR2:0 = '000'; // Clear any pending Halting debug events

  from_32 = (PSTATE.nRW == '1');

  new_pc = DLR_EL0;
  spsr = DSPSR;

  SetPSTATEFromSPSR(spsr); // Can update privileged bits, even at EL0.

  if spsr<4> == '1' then
    // Requesting exit to AArch32 state. If coming from AArch64 and PSTATE.IL==1 then the state
    // did not change, but the PC alignment might have occurred
    // Align PC[1:0] according to the target instruction set state
    if from_32 || PSTATE.IL == '0' || ConstrainUnpredictableBool() then
      if spsr<5> == '1' then // T32 or T32EE state
        new_pc<0> = '0';
      else // A32 state
        new_pc<1:0> = '00';

    // Zero the 32 most significant bits of the target PC
    if from_32 || PSTATE.IL == '0' || ConstrainUnpredictableBool() then
      new_pc<63:32> = Zeros();

  if PSTATE.nRW == '1' then
    BranchTo(new_pc<31:0>, BranchType_UNKNOWN); // AArch32 branch
  else
    BranchTo(new_pc, BranchType_DBGEXIT); // A type of branch that is never predicted

  (EDSCR.STATUS, EDPRSR.SDR) = ('000010', '1'); // Atomically signal restarted
  UpdateEDSCRFields(); // Stop signalling processor state.
  DisableITRAndResumeInstructionPrefetch();

  return;
```

Chapter H3

Halting Debug Events

This chapter describes a particular class of debug events. It contains the following sections:

- *Introduction to Halting debug events* on page H3-4364.
- *Halting Step debug event* on page H3-4366.
- *Halt Instruction debug event* on page H3-4376.
- *Exception Catch debug event* on page H3-4377.
- *External Debug Request debug event* on page H3-4380.
- *OS Unlock Catch debug event* on page H3-4381.
- *Reset Catch debug event* on page H3-4382.
- *Software Access debug event* on page H3-4383.
- *Synchronization and Halting debug events* on page H3-4384.

Note

Table J-1 on page AppxJ-5088 disambiguates the general register references used in this chapter.

H3.1 Introduction to Halting debug events

External debug defines Halting debug events. The following Halting debug events are available in ARMv8:

- [Halting Step debug event on page H3-4366](#).
- [Halt Instruction debug event on page H3-4376](#).
- [Exception Catch debug event on page H3-4377](#).
- [External Debug Request debug event on page H3-4380](#).
- [OS Unlock Catch debug event on page H3-4381](#).
- [Reset Catch debug event on page H3-4382](#).
- [Software Access debug event on page H3-4383](#).

If halting is allowed, a Halting debug event halts the PE. The PE enters Debug state.

In addition, breakpoints and watchpoints might halt the PE if halting is allowed. See [Breakpoint and Watchpoint debug events on page H2-4330](#). Because breakpoints and watchpoints can generate an exception or halt the PE, Breakpoint and Watchpoint debug events are not classified as Halting debug events.

For a definition of Debug state, see [Chapter H2 Debug State](#). For a definition of halting allowed, see [Halting allowed and halting prohibited on page H2-4329](#).

[Debug state entry and debug event prioritization on page H2-4331](#) describes the behavior when multiple debug events are generated by an instruction.

See also [Synchronization and Halting debug events on page H3-4384](#).

[Table H3-1](#) shows the behavior of Breakpoint, Watchpoint, and Halting debug events.

Table H3-1 Summary of debug events and possible outcomes

Debug event type	Outcome	
	Halting allowed	Halting prohibited
Breakpoint and Watchpoint debug events on page H2-4330	Address mismatch breakpoint	Not possible ^a
	Other breakpoint	Halt
	Watchpoint	Halt
Halt Instruction debug event on page H3-4376	Halt	UNALLOCATED
Software Access debug event on page H3-4383	Halt	Ignored
Exception Catch debug event on page H3-4377	Halt	Ignored
Halting Step debug event on page H3-4366	Halt	Pended
External Debug Request debug event on page H3-4380	Halt	Pended
Reset Catch debug event on page H3-4382	Halt	Pended
OS Unlock Catch debug event on page H3-4381	Pended	Pended

a. Breakpoint programmed as Address Mismatch breakpoints are evaluated as Address Match breakpoints when halting. See [Legacy debug exceptions on page D2-1564](#).

[Table H3-2 on page H3-4365](#) shows where the pseudocode details for each Halting debug event type is located.

Table H3-2 Pseudocode details for Halting debug events

Halting debug event type	Pseudocode details
<i>Halt Instruction debug event on page H3-4376</i>	<i>HLT on page C5-484 for AArch64 and HLT on page F7-2608 for AArch32</i>
<i>Software Access debug event on page H3-4383</i>	<i>Pseudocode details for Software Access debug event on page H3-4383</i>
<i>Exception Catch debug event on page H3-4377</i>	<i>Pseudocode details for Exception Catch debug events on page H3-4379</i>
<i>Halting Step debug event on page H3-4366</i>	<i>Pseudocode details for Halting Step debug events on page H3-4375</i>
<i>External Debug Request debug event on page H3-4380</i>	<i>Pseudocode details for External Debug Request debug events on page H3-4380</i>
<i>Reset Catch debug event on page H3-4382</i>	<i>Pseudocode details for Reset Catch debug event on page H3-4382</i>
<i>OS Unlock Catch debug event on page H3-4381</i>	<i>Pseudocode details for OS Unlock Catch debug event on page H3-4381</i>

H3.2 Halting Step debug event

Halting Step is a debug resource that a debugger can use to make the PE step through code one instruction at a time. This section describes the Halting Step debug events. It is divided into the following sections:

- [Overview of a Halting Step debug event.](#)
- [The Halting Step state machine.](#)
- [Using Halting Step on page H3-4369.](#)
- [Detailed Halting Step state machine behavior on page H3-4369.](#)
- [Synchronization and the Halting Step state machine on page H3-4372.](#)
- [Stepping T32 IT instructions on page H3-4373.](#)
- [Disabling interrupts while stepping on page H3-4374.](#)
- [Syndrome information on Halting Step on page H3-4374.](#)
- [Pseudocode details for Halting Step debug events on page H3-4375.](#)

The architecture describes the behavior as a simple Halting Step state machine. See [The Halting Step state machine](#).

H3.2.1 Overview of a Halting Step debug event

The behavior of Halting Step is defined by a state machine, shown in [Figure H3-1 on page H3-4368](#). A Halting Step debug event executes a single instruction and then return control to the debugger. When debugger software wants to execute a Halting Step:

1. With the PE in Debug state, the debugger activates Halting Step.
2. The debugger signals the PE to exit Debug state and return to the instruction that is to be stepped.
3. The PE executes that single instruction.
4. The PE enters Debug state before executing the next instruction.

However, an exception might be generated while the instruction is being stepped. That is either:

- A synchronous exception generated by the instruction being stepped.
- An asynchronous exception taken before or after the instruction being stepped.

Halting Step has its own enable control bit, [EDECR.SS](#) and [EDES.R.SS](#).

———— Note —————

Because the Halting Step state machine states occur as a result of normal PE operation, the states can be described as both:

- PE states.
- Halting Step states.

H3.2.2 The Halting Step state machine

The state machine states are:

Inactive Halting Step is inactive. No Halting Step debug events can be generated, therefore execution is not affected by Halting Step. The PE is in this state whenever either of the following is true:

- Halting Step is disabled. That is, [EDECR.SS](#) is set to 0 and [EDES.R.SS](#) is set to 0.
- Halting is prohibited. See [Halting the PE on debug events on page H2-4329](#).

In [Figure H3-1 on page H3-4368](#) this state is shown in red.

Active-not-pending

Halting Step is enabled and active. This is the state in which the PE steps an instruction. [EDECR.SS](#) == 1 and [EDES.R.SS](#) == 0. A debugger must only set [EDECR.SS](#) to 1 when the PE is in Debug state.

In [Figure H3-1 on page H3-4368](#) this state is shown in green.

Active-pending

Halting Step is enabled and active. The step has completed, and the PE enters Debug state.
`EDESR.SS == 1`.

In [Figure H3-1 on page H3-4368](#) this state is shown in green.

Whenever Halting Step is enabled and active, whether the state machine is in the active-not-pending state or in the active-pending state depends on `EDESR.SS`. [Halting Step state machine states on page H3-4369](#) shows this.

In the simple sequential execution of the program the PE executes the Halting Step state machine, as follows:

1. Initially, Halting Step is inactive.
2. After exiting Debug state, Halting Step is active-not-pending.
3. The PE executes an instruction and Halting Step is active-pending.
4. The pending Debug state entry is taken on the next instruction and the step is complete.

Exceptions and other changes to the PE context can interrupt this sequence.

[Figure H3-1 on page H3-4368](#) shows a Halting Step state machine.

Halting step is disabled

Halting step is enabled

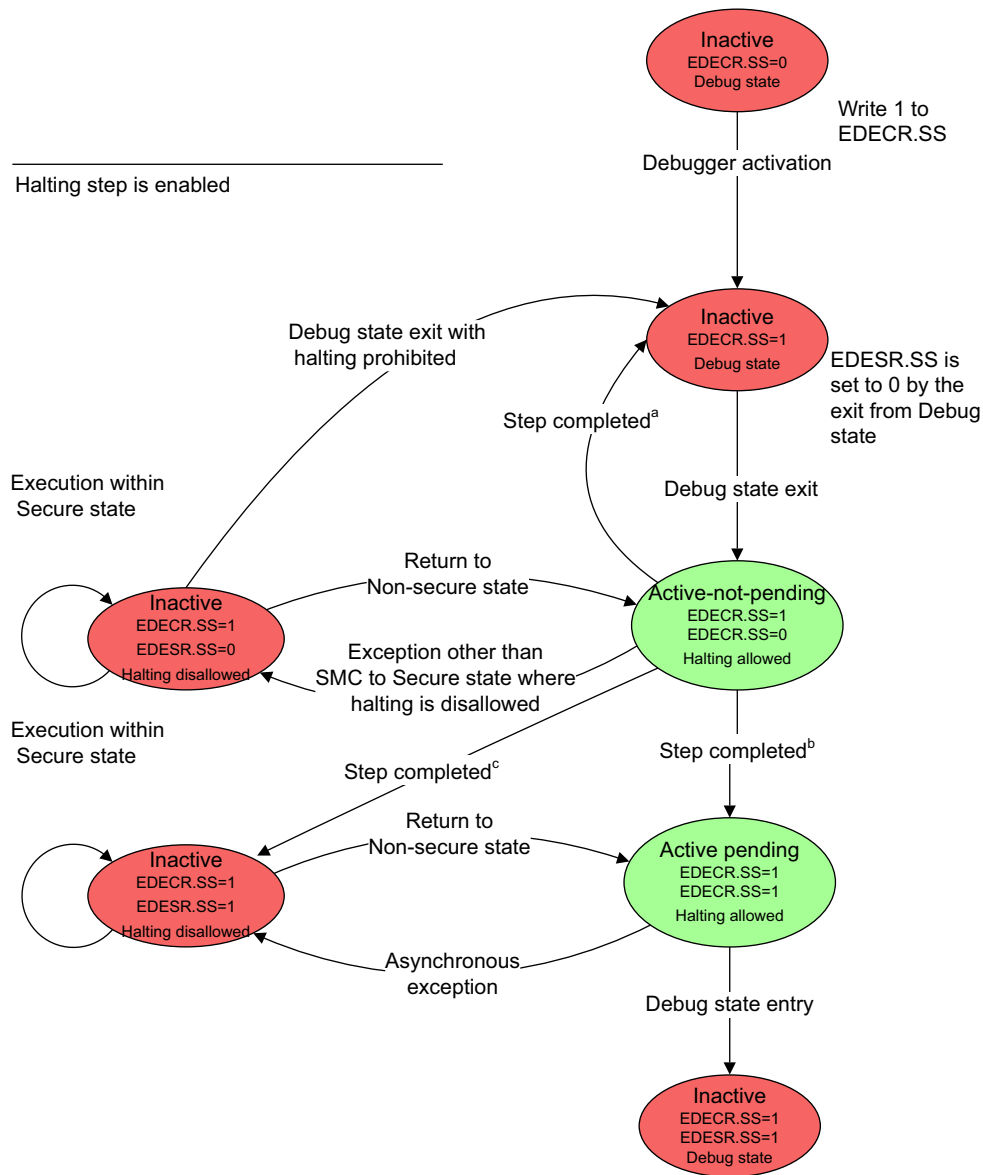

- a. Step completed occurs when:
 - A debug event, other than a Halting Step debug event, causes entry into Debug state.
- b. Step completed occurs when:
 - An instruction is executed without taking an exception.
 - An exception is taken to a state where halting is allowed.
 - A reset.
- c. Step completed occurs when:
 - An SMC exception is taken to Secure state where halting is prohibited.

Figure H3-1 Halting Step state machine

———— **Note** ————

Figure H3-1 on page H3-4368 only describes state transitions to and from the inactive state by exit from Debug state, executing an exception return, or taking an exception. Other changes to the PE context, including writes to registers such as [EDECR](#) and [OSDLR](#) and changes to the authentication interface can also cause changes to the Halting Step state machine. These can lead to UNPREDICTABLE behavior. See *Synchronization and the Halting Step state machine* on page H3-4372.

The following bits control the state machine, as shown in [Table H3-3](#):

- [EDECR.SS](#). This is the Halting Step enable bit.

———— **Note** ————

- The [EDECR](#) value is preserved over powerdown, meaning that the step active state is maintained over a powerdown event.
- A debugger must only set [EDECR.SS](#) to 1 when the PE is in Debug state.

- [EDES.R.SS](#).

[Table H3-3](#) shows the Halting Step state machine states. The letter X in a register column means that the relevant bit can be set to either zero or one.

Table H3-3 Halting Step state machine states

Halting	EDECR.SS	EDES.R.SS	Halting Step state
Prohibited	X	X	Inactive
Allowed	0	0	Inactive
Allowed	1	0	Active-not-pending
Allowed	X	1	Active-pending

H3.2.3 Using Halting Step

To step a single instruction the PE must be in Debug state:

1. The debugger sets [EDECR.SS](#) to 1 to enable Halting step.
2. The debugger signals the PE to exit Debug state with [DLR](#) set to the address of the instruction being stepped. The PE clears [EDES.R.SS](#) to 0 and the Halting Step state machine enter the active-not-pending state.
3. The PE executes the instruction being stepped.
If an exception is taken to a state where halting is prohibited, then [EDES.R.SS](#) is always correct for the preferred return address of the exception.
4. The PE enters Debug state before executing the next instruction and the step is complete.

H3.2.4 Detailed Halting Step state machine behavior

The behavior of the Halting Step state machine is described in the following sections:

- *Entering the active-not-pending state* on page H3-4370.
- *PE behavior in the active-not-pending state* on page H3-4370.
- *Entering the active-pending state* on page H3-4371.
- *PE behavior in the inactive state when in Non-debug state* on page H3-4372.
- *PE behavior in Debug state* on page H3-4372.

Entering the active-not-pending state

The PE enters the active-not-pending state:

- By exiting Debug state with `EDECR.SS == 1`.
- By an exception return from a state where halting is prohibited to a state where halting is allowed with `EDECR.SS == 1` and `EDESR.SS == 0`.
- As described in *Synchronization and the Halting Step state machine* on page H3-4372.

PE behavior in the active-not-pending state

When the PE is in the active-not-pending state it does one of the following:

- It executes one instruction and does one of the following:
 - Completes it without generating a synchronous exception.
 - Generates a synchronous exception.
 - Generates a debug event that causes entry to Debug state.
- It takes an asynchronous exception without executing any instruction.
- It takes an asynchronous debug event into Debug state.

If no exception or debug event is generated

If no exception or debug event is generated the PE sets `EDESR.SS` to 1. This means that the Halting Step state machine advances to the active-pending state.

If an exception or debug event is generated

The PE sets `EDESR.SS` according to all of the following:

- The type of exception.
- The target Exception level of the exception.
- If the exception is taken to Secure state, whether halting is prohibited in Secure state.
 - This is determined by the result of `ExternalSecureInvasiveDebugEnabled()`.

If an exception or debug event is generated, the PE sets `EDESR.SS` to 1 if one of the following applies:

- A synchronous exception is generated by the instruction and one of the following applies:
 - The exception is taken to EL1 or EL2.
 - The exception is not an SMC exception and `ExternalSecureInvasiveDebugEnabled() == TRUE`.
 - The exception is an SMC exception.
- An asynchronous exception is generated before executing an instruction and this is either:
 - Taken to EL1 or EL2.
 - Taken to EL3 and `ExternalSecureInvasiveDebugEnabled() == TRUE`.
- A PE reset occurs.

Otherwise `EDESR.SS` is unchanged. This happens when:

- No instruction is executed because either:
 - An asynchronous exception is taken to EL3 and `ExternalSecureInvasiveDebugEnabled() == FALSE`.
 - An asynchronous debug event causes entry to Debug state.
- An instruction is executed and either:
 - Generates a synchronous exception other than an SMC exception which is taken to EL3, and `ExternalSecureInvasiveDebugEnabled() == FALSE`.
 - Generates a synchronous debug event and causes entry to Debug state.

If halting is prohibited after taking the exception or debug event, then the Halting Step state machine advances to the inactive state. Otherwise the Halting Step state machine advances to the active-pending state.

———— **Note** ————

The underlying criteria for the value of `EDESR.SS` on an exception are:

- Whether halting is allowed at the target of the exception. If halting is allowed, the PE must step into the exception. If halting is prohibited, the PE must step over the exception.
- Whether the preferred return address of the exception is the instruction itself or the next instruction, if the PE steps over the exception.

Table H3-4 shows the behavior of the active-not-pending state. The letter X indicates that `ExternalSecureInvasiveDebugEnabled()` can be either TRUE or FALSE.

Table H3-4 Summary of active-not-pending state behavior

Event	Target EL	ExternalSecureInvasiveDebugEnabled()	Value written to EDESR.SS
No exception or debug event	Not applicable	X	1
SMC exception	EL3	X	1
Reset	Highest	X	1
Exception, other than SMC exception	EL1	X	1
	EL2	X	1
	EL3	TRUE	1
		FALSE	0
Debug event	Debug state	X	0

Entering the active-pending state

The PE enters the active-pending state by one of the following:

- From the active-not-pending state by:
 - Executing an instruction without taking an exception.
 - Taking an exception so that the PE remains in a state where halting is allowed.
- An exception return from a state where halting is prohibited when `EDESR.SS == 1`.

———— **Note** ————

That is, an exception return from Secure state with `ExternalSecureInvasiveDebugEnabled() == FALSE` to Non-secure state with `ExternalInvasiveDebugEnabled() == TRUE`.

- A reset when the value of `EDECR.SS == 1`, regardless of the state the PE was in before the reset occurred.
- Following the description in *Synchronization and the Halting Step state machine on page H3-4372*.

When the PE is in the active-pending state, it enters Debug state before executing an instruction. However, if `ExternalSecureInvasiveDebugEnabled() == FALSE`, the architecture does not define the prioritization of this Debug state entry with respect to any pending asynchronous exception that is taken from Non-secure state to EL3.

If an exception is prioritized over the halt, then `EDESR.SS` is unchanged. On return from the exception the Halting Step state machine re-enters the active-pending state.

The entry into Debug state has higher priority than all other types of exception, including all other asynchronous exceptions.

———— **Note** —————

This means that it is possible to step a reentrant exception in the exception vector table.

PE behavior in the inactive state when in Non-debug state

EDES_R.SS is not updated by the execution of an instruction or the taking of an exception when Halting Step is inactive. This means that EDES_R.SS is not changed by an exception handled in a state where halting is prohibited.

On return to a state where halting is allowed, the Halting Step state machine is restored either to the active-pending state or the active-not-pending state, depending on the value of EDES_R.SS. The return to a state where halting is allowed is normally by an exception return, which is a *Context synchronization operation*.

See also *Synchronization and the Halting Step state machine*.

PE behavior in Debug state

Entry to Debug state, the execution of an instruction in Debug state, or the taking of an exception when in Debug state, does not change EDES_R.SS.

EDES_R.SS is cleared to 0 on exiting Debug state as the result of a restart request. This forces the Halting Step state machine to active-not-pending if EDECR.SS == 1.

———— **Note** —————

Using Halting Step to step over an A32 instruction that generates a misaligned PC value does not suppress the resulting misaligned PC exception. On exiting Debug state, the misaligned PC value is written from DLR and a misaligned PC exception is generated.

However, if the PE exits Debug state as the result of a PE reset and EDECR.SS == 1, then the PE immediately enters the active-pending state, as EDES_R.SS is set to the value of EDECR.SS.

H3.2.5 Synchronization and the Halting Step state machine

The Halting Step state machine also changes state if:

- Halting becomes allowed or prohibited other than by exit from Debug state, an exception return, or taking an exception. This means that halting becomes allowed or prohibited because:
 - The security state changes without an exception return. See *State and mode changes without explicit context synchronization operations* on page D2-1647.
 - The external authentication interface changes.
 - The OS Double Lock status, DoubleLockStatus(), changes.
- A write to EDECR when the PE is in Non-debug state changes the value of EDECR.SS.
- A write to EDES_R when the PE is in Non-debug state clears EDES_R.SS to 0.

These operations are guaranteed to take effect only after a *Context synchronization operation*.

The PE must perform the required behavior of the new state before or immediately following the next *Context synchronization operation*, but it is not required to do so immediately. This means that the PE can perform the required behavior of the old state before the next *Context synchronization operation*. This is illustrated in *Example H3-1* on page H3-4373 and *Example H3-2* on page H3-4373.

Example H3-1 Synchronization requirements 1

EDECR.SS is set to 1 in Debug state, requesting the active-not-pending state on exit from Debug state. On exit from Debug state the PE immediately takes an exception to Secure state. `ExternalSecureInvasiveDebugEnabled() == FALSE`, meaning that halting is prohibited in Secure state. The PE does not step any instructions but executes the software in Secure state as normal. **EDESR.SS** remains set to 0. If `ExternalSecureInvasiveDebugEnabled()` subsequently becomes TRUE, meaning that halting is now allowed, the PE must perform the required behavior of the active-not-pending state before or immediately following the next *Context synchronization operation*, but it is not required to do so immediately.

Example H3-2 Synchronization requirements 2

EDECR.SS is set to 1 in Debug state. On exit from Debug the PE executes an MSR instruction that sets **OSDLR_EL1.DLK** to 1 and `DoubleLockStatus()` becomes TRUE. This change requires a *Context synchronization operation* to guarantee its effect, meaning it is CONstrained UNPREDICTABLE whether:

- Halting is allowed:
 - The PE enters Debug state on the next instruction.
- Halting is prohibited:
 - The PE does not enter Debug state.

The value in **EDESR.SS** depends on whether halting was allowed or prohibited when the write to **OSDLR_EL1.DLK** completed, and so it might be 0 or 1. If a second MSR instruction clears **OSDLR_EL1.DLK** to 0, the PE must perform the required behavior of the state indicated by **EDESR.SS** before or immediately following the next *Context synchronization operation*, but it is not required to do so immediately.

See also *Synchronization and Halting debug events* on page H3-4384.

H3.2.6 Stepping T32 IT instructions

The ARMv8 architecture permits a combination of one T32 IT instruction and another 16-bit T32 instruction to be treated as one 32-bit instruction when the value of **SCTLR.ITD**, **SCTLR_EL1.ITD** or **HSCTLR.ITD** as applicable, is 1.

For the purpose of stepping an item, it is IMPLEMENTATION DEFINED whether:

- The PE considers such a pair of instructions to be one instruction.
- The PE considers such a pair of instructions be two instructions.

It is IMPLEMENTATION DEFINED whether this behavior depends on the value of the applicable ITD bit. For example:

- The debug logic might consider such a pair of instructions to be one instruction, regardless of the state of **SCTLR.ITD**, **SCTLR_EL1.ITD**, or **HSCTLR.ITD**.
- The debug logic might consider such a pair of instructions to be two instructions, regardless of the state of **SCTLR.ITD**, **SCTLR_EL1.ITD**, or **HSCTLR.ITD**.
- The debug logic might consider such a pair of instructions to be one instruction when **SCTLR.ITD**, **SCTLR_EL1.ITD**, or **HSCTLR.ITD** is set to 1, and two instructions when the ITD bit is set to 0.

H3.2.7 Disabling interrupts while stepping

When using Halting Step, the sequence of entering Debug state, interacting with the debugger, and then exiting Debug state for each instruction reduces the rate at which the PE executes instructions. However, the rate at which certain interrupts, such as timer interrupts, are generated might be fixed by the system. This means it might be necessary to disable interrupts while using Halting Step by setting `EDSCR.INTdis`, to allow the code being debugged to make forward progress.

H3.2.8 Syndrome information on Halting Step

Three `EDSCR.STATUS` encodings record different scenarios for entering Debug state on a Halting Step debug event:

Halting Step, normal

An instruction other than a Load-Exclusive instruction was stepped.

Halting Step, exclusive

A Load-Exclusive instruction was stepped.

Halting Step, no syndrome

The syndrome data is not available.

If the PE enters Debug state due to a Halting Step debug event immediately after stepping an instruction in the active-not-pending state, `EDSCR.STATUS` is set to either:

- Halting Step, normal, if the stepped instruction was not a Load-Exclusive instruction.
- Halting Step, exclusive, if the stepped instruction was a Load-Exclusive instruction.

If the stepped instruction was a conditional Load-Exclusive instruction that failed its condition code test, `EDSCR.STATUS` is set to a CONSTRAINED UNPREDICTABLE choice of Halting Step, normal, or Halting Step, exclusive.

Otherwise the PE enters Debug state without stepping an instruction. This means that the Halting Step state machine enters the active-pending state directly from the inactive state, without going through active-not-pending state. In this case, `EDSCR.STATUS` is set to Halting Step, no syndrome. This happens when:

- The PE enters directly into the active-pending state on an exception return to Non-secure state from EL3 when Halting is prohibited in Secure state.
- A pending asynchronous exception is taken before the instruction is executed.
- The active-pending state is entered for other reasons. See [Synchronization and the Halting Step state machine on page H3-4372](#)

In these cases the debugger cannot determine whether the instruction that was stepped was a Load-Exclusive instruction.

In addition, `EDSCR.STATUS` is set to one of a CONSTRAINED UNPREDICTABLE choice if:

- The instruction being stepped generated a synchronous exception, meaning that it was not completed. In this case `EDSCR.STATUS` is set to a CONSTRAINED UNPREDICTABLE choice of:
 - Halting Step, no syndrome, or Halting Step, normal, if the stepped instruction was not a Load-Exclusive instruction.
 - Halting Step, no syndrome, or Halting Step, exclusive, if the stepped instruction was a Load-Exclusive instruction.
- The instruction that was stepped was an exception return instruction or an ISB. As these instructions are not in the Load-Exclusive instructions, `EDSCR.STATUS` is set to a CONSTRAINED UNPREDICTABLE choice of Halting Step, no syndrome or Halting Step, normal.

In all cases, if `EDSCR.STATUS` is not set to Halting Step, no syndrome, then it must indicate whether the stepped instruction was a Load-Exclusive instruction by setting `EDSCR.STATUS` to Halting Step, normal or Halting Step, exclusive.

———— **Note** —————

An implementation that always sets `EDSCR.STATUS` to Halting Step, no syndrome is not compliant.

H3.2.9 Pseudocode details for Halting Step debug events

There are two pseudocode functions for Halting Step debug events:

- `RunHaltingStep()`. This is called after an instruction has executed and any exception generated by the instruction is taken. It is also called after taking a reset before executing any instructions. That is, reset is treated like an asynchronous exception, even if `EDECR.RCE == 1`. `RunHaltingStep()` affects the next instruction.
- `CheckHaltingDebugStep()`. This is called before the next instruction is executed. If a step is pending, it generates the debug event.

```
// RunHaltingStep()
// =====

RunHaltingStep(boolean exception_generated, bits(2) exception_target, boolean syscall,
               boolean reset)
    // "exception_generated" is TRUE if the previous instruction generated a synchronous exception
    // or was cancelled by an asynchronous exception.
    // if "exception_generated" == TRUE then "exception_target" is the target of the exception, and
    // "syscall" is TRUE if the exception is a synchronous exception where the preferred return
    // address is the instruction following that which generated the exception.
    // "reset" = TRUE if exiting reset state into the highest EL.
    if reset then assert !Halted();           // Cannot come out of reset halted

    active = EDECR.SS == '1' && !Halted();

    if active && reset then                    // Coming out of reset with EDECR.SS set.
        EDESR.SS = '1';
    elseif active && HaltingAllowed() then
        if exception_generated && exception_target == EL3 then
            advance = syscall || ExternalSecureInvasiveDebugEnabled();
        else
            advance = TRUE;
        if advance then EDESR.SS = '1';

    return;

// CheckHaltingStep()
// =====
// Check whether EDESR.SS has been set by Halting Step

CheckHaltingStep()
    if HaltingAllowed() && EDESR.SS == '1' then
        // The STATUS code depends on how we arrived at the state where EDESR.SS == 1.
        if HaltingStep_DidNotStep() then
            Halt(DebugHalt_Step_NoSyndrome);
        elseif HaltingStep_SteppedEX() then
            Halt(DebugHalt_Step_Exclusive);
        else
            Halt(DebugHalt_Step_Normal);
```

H3.3 Halt Instruction debug event

A Halt Instruction debug event is generated when `EDSCR.HDE == 1`, halting is allowed, and software executes the Halting software breakpoint instruction, HLT.

The pseudocode for Halt Instruction Debug events is described in [HLT on page C5-484](#) for A64 and [HLT on page F7-2608](#) for A32 and T32.

HLT never generates a debug exception. It is UNALLOCATED if `EDSCR.HDE == 0`, or if halting is prohibited.

———— **Note** —————

A debugger can replace a program instruction with a Halt instruction to generate a Halting Software Breakpoint. Debuggers that use the HLT instruction must be aware of the ARMv8-A rules for concurrent modification of executable code, CMODX. The rules for concurrent modification and execution of instructions do not allow one thread of execution or an external debugger to replace an instruction with an HLT instruction when these same instructions are being executed by a different thread of execution. See [Concurrent modification and execution of instructions on page B2-91](#).

The T32 HLT instruction is unconditionally executed inside an IT block, even when it is UNALLOCATED. The A32 HLT instruction is CONSTRAINED UNPREDICTABLE if the condition code field is not `0b1110`, with the set of behaviors the same as for BKPT. See [Appendix A Architectural Constraints on UNPREDICTABLE behaviors](#).

———— **Note** —————

The HLT instruction is part of the external debug solution for ARMv8-A. As such, the presence of the HLT instruction is not indicated in the ID registers. In particular, the AArch32 CP15 register `ID_ISAR0.Debug` does not indicate the presence of the HLT instruction.

H3.3.1 HLT instructions as the first instruction in a T32 IT block

The ARMv8 architecture defines combinations of IT and a single 16-bit T32 instruction that can be treated as a 32-bit instruction when `SCTLR.ITD`, `SCTLR_EL1.ITD` or `HSCTLR.ITD`, as applicable, is set to 1.

The T32 HLT instruction is not such an instruction. If the first instruction in an IT block is an HLT instruction, then the behavior of the instruction depends on the value of `SCTLR.ITD`, `SCTLR_EL1.ITD` or `HSCTLR.ITD`, as applicable:

- If the ITD bit is set to 1, then the combination is UNALLOCATED and an Undefined Instruction exception is generated either by the IT instruction or by the HLT instruction.
- If the ITD bit is set to 0, then the HLT instruction either:
 - Is UNALLOCATED and generates an Undefined Instruction exception.
 - Generates an HLT Instruction debug event.

To set an HLT Instruction debug event on the first instruction of an IT block, debuggers must replace the IT instruction with an HLT instruction to ensure consistent behavior.

———— **Note** —————

An HLT instruction is always unconditional, even within an IT block.

H3.4 Exception Catch debug event

Exception Catch debug events:

- Are generated when the corresponding bit in the Exception Catch Control Register, [EDECCCR](#), is set to 1 on all entries to a given Exception level. This means:
 - Exceptions taken to the Exception level.
 - Exception returns to the Exception level.
 - Entry to the Exception level due to reset. This is an overlap with a Reset Catch debug event. See [Reset Catch debug event on page H3-4382](#).
 - Exit from Debug state to the Exception level.
- Are taken synchronously, after entry to the Exception level.
- Ignore the execution state of the target Exception level.
- Are ignored if halting is prohibited.

The [EDECCCR](#) contains two fields:

- One field for Non-secure state.
- One field for Secure state.

Each field contains one bit for each Exception level in that state. Bits corresponding to Exception levels that are not implemented are RES0. See [EDECCCR, External Debug Exception Catch Control Register on page H9-4501](#).

———— Note —————

- [EDECCCR](#) does not replace [DBGVCR](#):
 - [DBGVCR](#) is retained in AArch32 state for backwards compatibility.
 - [DBGVCR](#) is ignored in AArch64 state and never generates entries to Debug state.
 - [DBGVCR](#) cannot be accessed by the external debug interface.
- [EDECCCR](#) is only visible as [OSECCR_EL1](#) by System Register instructions in AArch64 state, and as [DBGOSECCR](#) by CP14 register access instructions in AArch32 state, when the OS Lock is locked to allow software to save and restore it over a powerdown.
- Exception Catch debug events are not disabled when the OS Lock is locked.

For an Exception Catch debug event generated after taking an exception to a trapped Exception level:

- The PE must not fetch instructions from the vector address before entering Debug state, if the translation regime MMU at the target Exception level is disabled.
- On entering Debug state:
 - The current Exception level is the target Exception level of the exception.
 - The ELR, SPSR, ESR, and other syndrome registers contain information about the exception.
 - [DLR](#) contains the exception vector address.

H3.4.1 Prioritization of Exception Catch debug events

Exception Catch debug events have a higher priority than all synchronous exceptions other than [Software Step exceptions on page D2-1634](#) and a lower priority than [Reset Catch debug event on page H3-4382](#). It is IMPLEMENTATION DEFINED whether Exception Catch debug events are higher or lower priority than both:

- [Software Step exceptions on page D2-1634](#).
- [Halting Step debug event on page H3-4366](#).

Note

As described in [Synchronous exception prioritization on page D1-1451](#), an exception trapping form of a Vector Catch debug event might generate a second debug exception as part of the exception entry, before the Exception Catch debug event is taken. See [Vector Catch exceptions on page D2-1627](#).

A second unmasked asynchronous exception can be taken before the PE enters Debug state. If this second exception does not generate an Exception Catch debug event, the exception handler executed at the higher Exception level later returns to the trapped Exception level, causing the Exception Catch debug event to be generated again.

See also [Debug state entry and debug event prioritization on page H2-4331](#).

H3.4.2 UNPREDICTABLE generation of Exception Catch debug events

When the PE is executing code at a given Exception level and the corresponding `EDECCR` bit is 1, it is CONSTRAINED UNPREDICTABLE whether an Exception Catch debug event is generated.

Note

It is possible to generate Exception Catch debug events:

- As a trap on all instruction fetches from the trapped Exception level as part of an instruction fetch.
- On entry to the Exception level, as described in [Detailed Halting Step state machine behavior on page H3-4369](#).

This is similar to the implementation options allowed for Vector Catch debug events. The architecture does not require that the event is generated following an ISB operation executed at the Exception level.

Examples of this are:

- If the debugger writes to `EDECCR` so that the current Exception level is trapped.
- If the OS restore code writes to `OSECCR` so that the current Exception level is trapped.
- If the code executing in AArch32 state changes the Exception level or security state other than by an exception return, and the target Exception level is trapped. See [State and mode changes without explicit context synchronization operations on page D2-1647](#).

H3.4.3 Examples of Exception Catch debug events

If `EDECCR == 0x20`, meaning that the Exception Catch debug event is enabled for Non-secure EL1, then the following exceptions generate Exception Catch debug events:

- An exception taken from Non-secure EL0 to Non-secure EL1.
- An exception return from EL2 to Non-secure EL1.
- An exception return from EL3 to Non-secure EL1.

For example, on taking a Data Abort exception from Non-secure EL0 to Non-secure EL1, using AArch64:

- `ELR_EL1` and `SPSR_EL1` are written with the preferred return address and PE state for a return to EL0.
- `ESR_EL1` and `FAR_EL1` are written with the syndrome information for the exception.
- `DLR_EL0` is set to `VBAR_EL1 + 0x400`, the synchronous exception vector.
- `DSPSR_EL0` is written with the PE state for an exit to EL1.

The following do not generate Exception Catch debug events:

- An exception taken from Non-secure EL0 to EL2 or EL3.
- An exception return from EL2 to Non-secure EL0.
- An exception taken from Secure EL0 to Secure EL1.
- An exception return from EL3 to Secure EL1.

H3.4.4 Pseudocode details for Exception Catch debug events

The pseudocode for the CheckExceptionCatch() function is as follows:

```
// CheckExceptionCatch()
// =====
// Check whether an Exception Catch debug event is set on the current Exception level

CheckExceptionCatch()
// Called after taking an exception, that is, such that IsSecure() and PSTATE.EL are correct
// for the exception target.
base = if IsSecure() then 0 else 4;
if HaltingAllowed() && EDECCR<UInt(PSTATE.EL) + base> == '1' then
    Halt(DebugHalt_ExceptionCatch);
```

H3.5 External Debug Request debug event

An External Debug Request debug event is generated when signaled by the embedded cross-trigger. See [Chapter H5 The Embedded Cross Trigger Interface](#).

———— **Note** —————

ARMv8-A requires the implementation of an embedded cross-trigger.

External Debug Request debug events are asynchronous debug events.

An implementation might also support IMPLEMENTATION DEFINED ways of generating an External Debug Request debug event.

H3.5.1 Pseudocode details for External Debug Request debug events

The pseudocode details for the ExternalDebugRequest() function is as follows:

```
// ExternalDebugRequest()
// =====

ExternalDebugRequest()
    if HaltingAllowed() then
        Halt(DebugHalt_EDBGRQ);
    // Otherwise the CTI continues to assert the debug request until it is taken.
```

H3.6 OS Unlock Catch debug event

An OS Unlock Catch debug event is generated when `EDECR.OSUCE == 1` and the state of the OS Lock changes from locked to unlocked.

When the OS Unlock Catch debug event is generated, it is recorded by setting `EDESR.OSUC` to 1, meaning it immediately becomes pending and is not guaranteed to be taken immediately. Clearing the OS Lock is not a self-synchronizing operation. See *Synchronization and Halting debug events* on page H3-4384.

OS Unlock Catch debug events are not generated if the OS Lock is unlocked when the PE is in Debug state. See also:

- *Debug behavior when the OS Lock is unlocked* on page H6-4432.
- *EDECR, External Debug Execution Control Register* on page H9-4503.
- *EDESR, External Debug Event Status Register* on page H9-4505.

`EDESR.OSUC` is cleared to 0 on a Warm reset and on exiting Debug state.

H3.6.1 Using the OS Unlock Catch debug event

If the debugger attempts to access a debug register when the Core power down domain is completely off or in a low-power state in which the core power domain registers cannot be accessed, and that access returns an error, then the debugger must retry the access. However, if the Core power domain is regularly powered down, this can lead to unreliable debugger behavior.

The debugger can program a Reset Catch debug event to halt the PE when it has powered-up, and can program the debug registers from Debug state. However, if the PE boot software restores the debug registers, as described in *Debug OS Save and Restore sequences* on page H6-4430, then newly written values are overwritten by the restore sequence.

The debugger can program an OS Unlock Catch debug event to halt the PE after the restore sequence has completed, and program the debug registers from Debug state.

H3.6.2 Pseudocode details for OS Unlock Catch debug event

The `CheckOSUnlockCatch()` function is called when the OS Lock is unlocked.

```
// CheckOSUnlockCatch()
// =====
// Called on unlocking the OS Lock to pend an OS Unlock Catch debug event
```

```
CheckOSUnlockCatch()
    if EDECR.OSUCE == '1' && !Halted() then EDESR.OSUC = '1';
```

The `CheckPendingOSUnlockCatch()` function is called before an instruction is executed. If an OS Unlock Catch is pending, it generates the debug event.

```
// CheckPendingOSUnlockCatch()
// =====
// Check whether EDESR.OSUC has been set by an OS Unlock Catch debug event
```

```
CheckPendingOSUnlockCatch()
    if HaltingAllowed() && EDESR.OSUC == '1' then
        Halt(DebugHalt_OSUnlockCatch);
```

H3.7 Reset Catch debug event

A Reset Catch debug event is generated when `EDECR.RCE == 1` and the PE exits reset state. When the Reset Catch debug event is generated, it is recorded by setting `EDESR.RC` to 1.

If halting is allowed when the event is generated, the Reset Catch debug event is taken immediately and synchronously. On entering Debug state, `DLR` has the address of the reset vector. The PE must not fetch any instructions from memory.

Otherwise, the Reset Catch debug event is pended and taken when halting is allowed. See also:

- [Synchronization and Halting debug events](#) on page H3-4384.
- [EDECR, External Debug Execution Control Register](#) on page H9-4503.
- [EDESR, External Debug Event Status Register](#) on page H9-4505.

This means that `EDESR.RC` is set to the value of `EDECR.RCE` on a Warm reset. `EDESR.RC` is cleared to 0 on exiting Debug state.

H3.7.1 Pseudocode details for Reset Catch debug event

The `CheckResetCatch()` function is called after reset before executing any instruction.

```
// CheckResetCatch()
// =====
// Called after reset
```

```
CheckResetCatch()
    if EDECR.RCE == '1' then
        EDESR.RC = '1';
        // If halting is allowed then halt immediately
        if HaltingAllowed() then Halt(DebugHalt_ResetCatch);
```

The `CheckPendingResetCatch()` function is called before an instruction is executed. If a Reset Catch is pending, it generates the Reset Catch debug event.

```
// CheckPendingResetCatch()
// =====
// Check whether EDESR.RC has been set by a Reset Catch debug event
```

```
CheckPendingResetCatch()
    if HaltingAllowed() && EDESR.RC == '1' then
        Halt(DebugHalt_ResetCatch);
```

H3.8 Software Access debug event

When the value of `EDSCR.TDA == 1`, software access to the following debug registers cause a trap to Debug state:

- The Breakpoint Value Registers, [DBGBVR](#).
- The Breakpoint Control Registers, [DBGBCR](#).
- The Watchpoint Value Registers, [DBGWVR](#).
- The Watchpoint Control Registers, [DBGWCR](#).

However, `EDSCR.TDA` is ignored if either:

- The value of `OSLSR.OSLK == 1`, meaning that the OS Lock is locked.
- Halting is prohibited. See [Halting allowed and halting prohibited on page H2-4329](#).

Note

- The accesses are only trapped into Debug state if they do not generate an exception. For more information see the relevant register description in [Chapter D8 AArch64 System Register Descriptions](#), [Chapter G4 AArch32 System Register Descriptions](#), or [Chapter I1 Memory-Mapped System Register Descriptions](#).
 - `DBGPRCR.CORENPDRQ` (Core No-powerdown Request), DCC registers, and CLAIM tag bits are also shared, but are deliberately excluded from this list.
-

H3.8.1 Pseudocode details for Software Access debug event

The pseudocode details for `CheckSoftwareAccessToDebugRegisters()` are as follows:

```
// CheckSoftwareAccessToDebugRegisters()
// =====
// Check for access to Breakpoint and Watchpoint registers.

CheckSoftwareAccessToDebugRegisters()
    if HaltingAllowed() && EDSCR.TDA == '1' && OSLSR_EL1.OSLK == '0' then
        Halt(DebugHalt_SoftwareAccess);
```

H3.9 Synchronization and Halting debug events

The behavior of external debug depends on:

- Indirect reads of:
 - External debug registers.
 - System registers, including system debug registers.
 - Special purpose registers.
- The state of the external authentication interface.

This means that any change to these registers or the external authentication interface requires explicit synchronization by a *Context synchronization operation* before the change takes effect. This ensures that for instructions appearing in program order after the change, the change affects the following:

- The generation and behavior of Software debug events. See *Synchronization and debug exceptions on page D2-1647*.
- The generation of all Halting debug events.
- Taking a pending Halting debug event or other asynchronous Debug event. See:
 - *Pending Halting debug events*.
 - *Taking Halting debug events asynchronously on page H3-4385*.
- The behavior of the Halting Step state machine. See *Synchronization and the Halting Step state machine on page H3-4372*.

If there is an instruction between the write and the *Context synchronization operation*, it is CONstrained UNPREDICTABLE whether the PE uses the old state or the new state.

Some register updates are self-synchronizing, but others require an explicit *Context synchronization operation*. For more information on the synchronization of register updates see:

- *Synchronization requirements for system registers on page D8-1866*.
- *Synchronization of changes to the external debug registers on page H8-4445*.
- *State and mode changes without explicit context synchronization operations on page D2-1647*.

A change on the external authentication interface is typically asynchronous to software and can happen without a *Context synchronization operation*.

External Debug Request debug events must be taken in finite time, without requiring the synchronization of any necessary change to the external authentication interface.

Example H3-3 shows an example of the synchronization requirements.

Example H3-3 Synchronization requirements

Secure software locks up in a tight loop, so it executes indefinitely without any synchronization operations. An External debug request must be able to break the PE out of that loop. This is a requirement even if **DBGEN** or **SPIDEN** or both are LOW on entry to the loop, meaning that halting is prohibited, and are only asserted HIGH later.

H3.9.1 Pending Halting debug events

A pending Halting debug event is taken when halting becomes allowed. This can happen without a *Context synchronization operation* if:

- The PE enters Non-secure state with `ExternalInvasiveDebugEnabled() == TRUE`, and this is not the result of an exception return. See *State and mode changes without explicit context synchronization operations on page D2-1647*.
- A change on the external authentication interface means halting becomes allowed in the current state.
- The OS Double Lock status, `DoubleLockStatus()` becomes FALSE. For example, this can happen when software clears `OSDLR.DLK` to 0 or sets `DBGPRCR.CORENPDRQ` to 1.

- The debug event is an OS Unlock Catch debug event. OS Unlock Catch debug events are generated in a pending state, rather than taken synchronously.

In these cases a pending Halting debug event is taken asynchronously.

H3.9.2 Taking Halting debug events asynchronously

The ARM architecture does not define when Halting debug events that are taken asynchronously are taken.

Any Halting debug event that is observed as pending in the [EDES](#)R before a *Context synchronization operation*, or an External Debug Request debug event that is asserted before a *Context synchronization operation*, is taken and the PE enters Debug state before the first instruction following the *Context synchronization operation* completes its execution. This is only possible if halting is allowed after completion of the *Context synchronization operation*.

If the first instruction after the *Context synchronization operation* generates a synchronous exception, or an asynchronous exception is also pending, then the architecture does not define the order in which the debug event and the exception or exceptions are taken, unless both:

- A Halting Step debug event is pending. `EDES`R.SS == 1.
- The *Context synchronization operation* is an exception return from a state where halting is prohibited to a state where halting is allowed.

———— **Note** —————

This applies to an exception return from Secure state with `ExternalSecureInvasiveDebugEnabled() == FALSE` to Non-secure state with `ExternalInvasiveDebugEnabled() == TRUE`.

In this case the order in which the debug events are handled is specified to avoid a double-step. See [Entering the active-pending state on page H3-4371](#).

———— **Note** —————

These rules are based on the rules that apply to taking asynchronous exceptions. See [Asynchronous exception types, routing, masking and priorities on page D1-1456](#).

Chapter H4

The Debug Communication Channel and Instruction Transfer Register

This chapter describes communication between a debugger and the implemented debug logic, using the *Debug Communications Channel* (DCC) and the *Instruction Transfer Register* (ITR), and associated control flags. It contains the following sections:

- [Introduction on page H4-4388.](#)
- [DCC and ITR registers on page H4-4389.](#)
- [DCC and ITR access modes on page H4-4391.](#)
- [Flow-control of the DCC and ITR registers on page H4-4395.](#)
- [Synchronization of DCC and ITR accesses on page H4-4398.](#)
- [Interrupt-driven use of the DCC on page H4-4402.](#)
- [Pseudocode details for the operation of the DCC and ITR registers on page H4-4403.](#)

———— **Note** —————

Where necessary [Table J-1 on page AppxJ-5088](#) disambiguates the general register references used in this chapter.

H4.1 Introduction

The *Debug Communications Channel*, DCC, is a channel for passing data between the PE and an external agent, such as a debugger. The DCC provides a communications channel between:

- An external debugger, described as the *debug host*.
- The debug implementation on the PE, described as the *debug target*.

The DCC can be used:

- As a 32-bit full-duplex channel.
- As a 64-bit half-duplex channel.

The DCC is an essential part of Debug state operation and can also be used in Non-debug state.

The *Instruction Transfer Register*, ITR, passes instructions to the PE to execute in Debug state.

The PE includes flow-control mechanisms for both the DCC and ITR.

H4.2 DCC and ITR registers

The DCC comprises *data transfer registers*, the DTRs, and associated flow-control flags. The data transfer registers are DTRRX and DTRTX.

The ITR comprises a single register, [EDITR](#), and associated flow-control flags.

In AArch64 state, software can access the data transfer registers as:

- A receive and transmit pair for 32-bit full duplex operation:
 - The write-only [DBGDTRTX_EL0](#) register to transmit data.
 - The read-only [DBGDTRRX_EL0](#) register to receive data.
- A single 64-bit read/write register, [DBGDTR_EL0](#), for 64-bit half-duplex operation.
- The read/write [OSDTRTX_EL1](#) and [OSDTRRX_EL1](#) registers for save and restore.

In AArch32 state, software can only access the data transfer registers as:

- A receive and transmit pair, for 32-bit full duplex operation:
 - The write-only [DBGDTRTXint](#) register to transmit data.
 - The read-only [DBGDTRRXint](#) register to receive data.
- The read/write [DBGDTRTXext](#) and [DBGDTRRXext](#) registers for save and restore.

The data transfer registers are also accessible by the external debug interface as a pair of 32-bit registers, [DBGDTRRX_EL0](#) and [DBGDTRTX_EL0](#). Both registers are read/write, allowing both 32-bit full-duplex and 64-bit half-duplex operation.

The DCC flow-control flags are [EDSCR](#).{RXfull, TXfull, RXO, TXU}:

- The RXfull and TXfull ready flags are used for flow-control and are visible to software in the debug system registers in [DCCSR](#).
- The RX overrun flag, RXO, and the TX underrun flag, TXU, report flow-control errors.
- The flow-control flags are also accessible by software as simple read/write bits for saving and restoring over a powerdown when the OS Lock is locked in [DSCR](#).
- The flow-control flags are accessible from the external debug interface in [EDSCR](#).

[Figure H4-1 on page H4-4390](#) shows the system register and external debug interface views of the [EDSCR](#) and DTR registers in both AArch64 state and AArch32 state. These figures do not include the save and restore views.

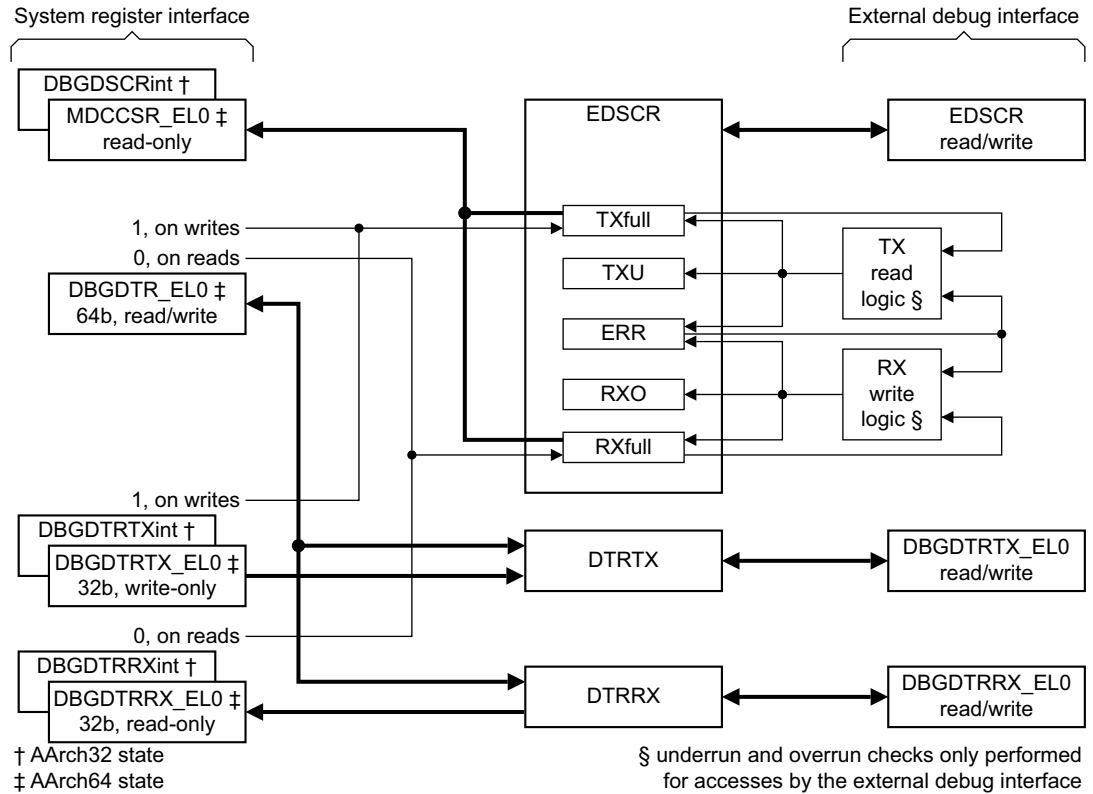

Figure H4-1 System register and external debug interface views of EDSCR and DTR registers, Normal access mode

EDITR and the ITR flow-control flags, EDSCR.{ITE, ITO} are accessible only by the external debug interface:

- The EDITR specifies an instruction to execute in Debug state.
- The ITR empty flag, ITE, is used for flow-control.
- The ITR overrun flag, ITO, reports flow-control errors.

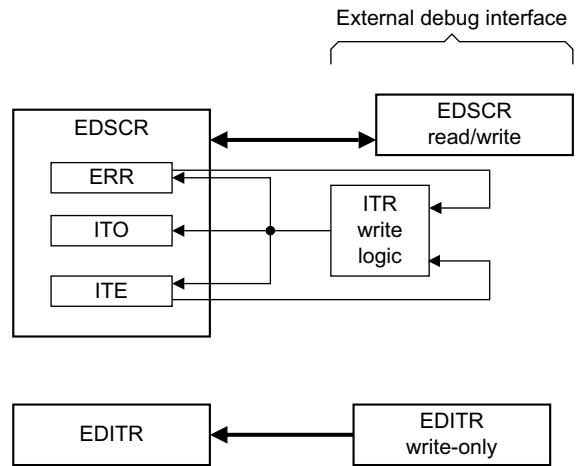

Figure H4-2 External debug interface views of EDSCR and EDITR registers, Normal access mode

The sticky overflow flag, EDSCR.ERR, is used by both the DCC and ITR to report flow-control errors.

H4.3 DCC and ITR access modes

The DCC and ITR support two access modes:

- *Normal access mode*, when `EDSCR.MA == 0` or the PE is in Non-debug state.
- *Memory access mode* on page H4-4392, when `EDSCR.MA == 1` and the PE is in Debug state.

H4.3.1 Normal access mode

The Normal access mode allows use of the DCC as a communications channel between target and host. It also allows the use of the ITR for issuing instructions to the PE in Debug state.

In Normal access mode, if there is no overrun or underrun, the following occurs:

For accesses by software:

- Direct writes to `DBGDTRTX` update the value in `DTRTX` and indirectly write 1 to `TXfull`.
- Direct reads from `DBGDTRRX` return the value in `DTRRX` and indirectly write 0 to `RXfull`.
- In AArch64 state, direct writes to `DBGDTR_EL0` update both `DTRTX` and `DTRRX`, indirectly write 1 to `TXfull`, and do not change `RXfull`:
 - `DTRTX` is set from bits[31:0] of the transfer register.
 - `DTRRX` is set from bits[63:32] of the transfer register.
- In AArch64 state, direct reads from `DBGDTR_EL0` return the concatenation of `DTRRX` and `DTRTX`, indirectly write 0 to `RXfull`, and do not change `TXfull`:
 - Bits[31:0] of the transfer register are set from `DTRRX`.
 - Bits[63:32] of the transfer register are set from `DTRTX`.

Note

For `DBGDTR_EL0`, the word order is reversed for reads with respect to writes.

Software reads `TXfull` and `RXfull` using `DCCSR`.

For accesses by the external debug interface:

- Writes to `EDITR` trigger the instruction to be executed if the PE is in Debug state:
 - If the PE is in AArch64 state, this is an A64 instruction.
 - If the PE is in AArch32 state, this is a T32 instruction. The T32 instruction is a pair of halfwords where the first halfword is taken from the lower 16-bits, and the second halfword is taken from the upper 16-bits.
- Reads of `DBGDTRTX_EL0` return the value in `DTRTX` and indirectly write 0 to `TXfull`.
- Writes to `DBGDTRTX_EL0` update the value in `DTRTX` and do not change `TXfull`.
- Reads of `DBGDTRRX_EL0` return the value in `DTRRX` and do not change `RXfull`.
- Writes to `DBGDTRRX_EL0` update the value in `DTRRX` and indirectly write 1 to `RXfull`.

`TXfull` and `RXfull` are visible to the external debug interface in `EDSCR`.

The PE detects overrun and underrun by the external debug interface, and records errors in `EDSCR.{TXU, RXO, ITO, ERR}`. See *Flow-control of the DCC and ITR registers* on page H4-4395.

See also *Synchronization of DCC and ITR accesses* on page H4-4398.

H4.3.2 Memory access mode

When the PE is in Debug state, a special Memory access mode can be selected to accelerate word-aligned block reads or writes of memory by an external debugger. Memory access mode can only be enabled in Debug state, and no instructions can be issued directly by the debugger when in Memory access mode.

If there is no overrun or underrun when in Memory access mode, an access by the external debug interface results in the following:

- External reads from [DBGDTRTX_ELO](#) cause:
 1. The existing value in DTRTX to be returned. This clears [EDSCR.TXfull](#) to 0.
 2. The equivalent of `LDR W1, [X0], #4`, if in AArch64 state, or `LDR R1, [R0], #4`, if in AArch32 state, to be executed.
 3. The equivalent of the MSR `DBGDTRTX_ELO, X1` instruction, if in AArch64 state, or the MCR `p14, 0, R1, c0, c5, 0` instruction, if in AArch32 state, to be executed.
 4. [EDSCR.{TXfull, ITE}](#) to be set to {1,1}, and X1 or R1 to be set to an UNKNOWN value.
- External writes to [DBGDTRRX_ELO](#) cause:
 1. The value in DTRRX to be updated. This sets [EDSCR.RXfull](#) to 1.
 2. The equivalent of the instruction `MRS X1, DBGDTRRX_ELO`, if in AArch64 state, or `MRC p14, 0, R1, c0, c5, 0` if in AArch32 state, to be executed.
 3. The equivalent of the instruction `STR W1, [X0], #4`, if in AArch64 state, or `STR R1, [R0], #4`, if in AArch32 state, to be executed.
 4. [EDSCR.{RXfull, ITE}](#) to be set to {0,1}, and X1 or R1 to be set to an UNKNOWN value.
- External reads from [DBGDTRRX_ELO](#) return the last value written to DTRRX.
- External writes to [EDITR](#) generate an overrun error.

During these accesses, [EDSCR.{TXfull, RXfull, ITE}](#) are used for flow control.

The architecture does not require precisely when these flags are set or cleared by the sequence of operations outlined in this section. For example, in the case of an external write to [DBGDTRRX_ELO](#), in AArch64 state, [RXfull](#) might be cleared after step 2, or it might not be cleared until after step 3, as an implementation is free to fuse these steps into a single operation. The architecture does require that the flags are set as at step 4 when the PE is ready to accept a further read or write without causing an overrun error or an underrun error.

The process outlined in this section represents a simple sequential execution model of Memory access mode. An implementation is free to pipeline, buffer, and re-order instructions and transactions, as long as the following remain true:

- Data items are transferred into and out of the DTR in order and without loss of data, other than as a result of an overrun or an underrun.
- Data Aborts occur in order.
- The constraints of the memory type are met.
- In the list describing [External reads from DBGDTRTX_ELO](#):
 - The MSR equivalent operation at step 3 of the sequence reads the value loaded by step 2.
 - If the list is performed in a loop, for all but the first iteration of this list, the value read by step 1 returns the values written by the MSR equivalent operation at the previous iteration of step 3.
- In the list describing [External writes to DBGDTRRX_ELO](#):
 - The MRS equivalent operation at step 2 of the sequence returns the value written at step 1.
 - The STR equivalent at step 3 of the sequence writes the value read at step 2.
- If the PE cannot accept a read or write, as applicable, during the sequence, then the flags are updated to indicate an overrun or underrun

See [Flow-control of the DCC and ITR registers on page H4-4395](#) for more information on overrun and underrun.

Ordering, access sizes and effect on exclusive monitors

For the purposes of memory ordering, access sizes, and effect on the exclusive monitor, accesses in Memory access mode are consistent with Load/Store word instructions executed by the PE.

Data aborts

If the memory access generates a Data Abort, then:

- The Data Abort exception is taken. See [Exceptions in Debug state on page H2-4355](#). In particular, `EDSCR.ERR` is set to 1. See [Cumulative error flag on page H4-4397](#).
- Register R0 retains the address that generated the abort.
- Register R1 is set to an UNKNOWN value.
- `EDSCR.TXfull`, for a load, or `EDSCR.RXfull`, for a store, is set to an UNKNOWN value.
- `DTRTX`, for a load, or `DTRRX`, for a store, is set to an UNKNOWN value.
- `EDSCR.ITE` is set to 1.

Illegal State exception

If `PSTATE.IL` is set to 1 when `EDSCR.MA == 1`, then on an external write access to `DBGDTRRX_ELO` or an external read from `DBGDTRTX_ELO`, it is CONSTRAINED UNPREDICTABLE whether the PE:

- Does all of the following without performing any operations:
 - The PE takes an Illegal State exception. See [Exceptions in Debug state on page H2-4355](#). In particular, `EDSCR.ERR` is set to 1, see [Cumulative error flag on page H4-4397](#).
 - Register R0 is unchanged.
 - Register R1 is set to an UNKNOWN value.
 - `EDSCR.TXfull` or `EDSCR.RXfull`, as applicable, is set to an UNKNOWN value.
 - `DTRTX` or `DTRRX`, as applicable, is set an UNKNOWN value.
 - `EDSCR.ITE` is set to 1.
- Ignores `PSTATE.IL`.

———— Note —————

The typical usage model for Memory access mode involves executing instructions in Normal mode to set up X0 before setting `EDSCR.MA` to 1. These instructions generate an Illegal State exception if `PSTATE.IL` is set to 1.

Alignment constraints

If the address in R0 is not aligned to a multiple of four, the behavior is as follows:

- For each external DTR access a CONSTRAINED UNPREDICTABLE choice of:
 1. The PE makes an unaligned memory access to R0. If alignment checking is enabled for the memory access, this generates an Alignment fault.
 2. The PE makes a memory access to `Align(X[0], 4)` in AArch64 state, or `Align(R[0], 4)` in AArch32 state.
 3. The PE generates an Alignment fault, regardless of whether alignment checking is enabled.
 4. The PE does nothing.
- Following each memory access, if there is no Data Abort, R0 is updated with an UNKNOWN value.

- For external writes to [DBGDTRRX_ELO](#), if the PE writes to memory, an UNKNOWN value is written.
- For external reads of [DBGDTRTX_ELO](#) an UNKNOWN value is returned.
- The RXfull and TXfull flags are left in an UNKNOWN state, meaning that a [DBGDTRTX_ELO](#) read can trigger a TX underrun, and a [DBGDTRTX_ELO](#) write can trigger an RX overrun.

H4.3.3 Memory-mapped accesses to the DCC and ITR

Writes to the flags in [EDSCR](#) by external debug interface accesses to the DCC and the ITR registers are indirect writes, because they are a side-effect of the access. The indirect write might not occur for a memory-mapped access to the external debug interface. For more information, see [Register access permissions for memory-mapped accesses](#) on page H8-4449.

H4.4 Flow-control of the DCC and ITR registers

This sub-section describes the flow-control of the DCC and ITR registers:

- [Ready flags](#).
- [Overflow and underflow flags](#).
- [Cumulative error flag](#) on page H4-4397.

H4.4.1 Ready flags

In Normal mode:

- For the DTR registers there are two ready flags:
 - [EDSCR.RXfull](#) == 1 indicates that [DBGDTRRX_ELO](#) contains a valid value that has been written by the external debugger and not yet read by software running on the target.
 - [EDSCR.TXfull](#) == 1 indicates that [DBGDTRTX_ELO](#) contains a valid value that has been written by software running on the target and not yet read by an external debugger.
- For the ITR register there is a single ready flag:
 - [EDSCR.ITE](#) == 1 indicates that the PE is ready to accept an instruction to the ITR.

———— **Note** —————

The architecture permits a PE to continue to accept and buffer instructions when previous instructions have not completed their architecturally defined behavior, as long as those instructions are discarded if [EDSCR.ERR](#) is set, either by an underflow or overflow or by any of the other error conditions described in this architecture, such as an instruction generating an abort.

In Memory access mode:

- [EDSCR.{RXfull, ITE}](#) == {0,1} indicates that [DBGDTRRX_ELO](#) is empty and the PE is ready to accept a word external write to [DBGDTRRX_ELO](#).
- [EDSCR.{TXfull, ITE}](#) == {1,1} indicates that [DBGDTRTX_ELO](#) is full and the PE is ready to accept a word external read from [DBGDTRTX_ELO](#).

All other values indicate that the PE is not ready, and result in a DTR overflow or underflow error, an ITR overflow error, or both, as defined in [Overflow and underflow flags](#).

H4.4.2 Overflow and underflow flags

Each of the ready flags has a corresponding overflow or a corresponding underflow flag. These are sticky status flags that are set if the register is accessed using the external debug interface when the corresponding ready flag is not in the ready state.

If the PE is in Debug state and Memory access mode, the corresponding error flag is also set if the PE is not ready to accept an operation because a previous load or store is still in progress. The sticky status flag remains set until cleared by writing 1 to [EDRCR.CSE](#).

———— **Note** —————

The architecture permits a PE to continue to accept and buffer data to write to memory in Memory access mode.

Table H4-1 shows DCC and ITR ready flags and the overrun and underrun flags associated with them.

Table H4-1 DCC and ITR ready flags and the associated overrun/underrun flags

External debug interface access	Overrun/Underrun condition	EDSCR flag
Write DBGDTRRX_ELO	$\text{EDSCR.RXfull} == '1' \mid\mid (\text{Halted}() \ \&\& \ \text{EDSCR.MA} == '1' \ \&\& \ \text{EDSCR.ITE} == '0')$	RXO
Read DBGDTRTX_ELO	$\text{EDSCR.TXfull} == '0' \mid\mid (\text{Halted}() \ \&\& \ \text{EDSCR.MA} == '1' \ \&\& \ \text{EDSCR.ITE} == '0')$	TXU
Write EDITR	$\text{Halted}() \ \&\& \ (\text{EDSCR.ITE} == '0' \mid\mid \text{EDSCR.MA} == '1')$	ITO

When an overrun or underrun flag is set to 1, the cumulative error flag, [EDSCR.ERR](#), described in *Cumulative error flag* on page H4-4397, is also set to 1. This has the effect that all subsequent external debug interface accesses to the [EDITR](#) or [DTR](#) registers are ignored.

In the event of an external write to [DBGDTRRX_ELO](#) or [EDITR](#) generating an overrun, or an external read from [DBGDTRTX_ELO](#) generating an underrun:

- For a write, the written value is ignored.
- For a read, an UNKNOWN value is returned.
- [EDSCR.TXfull](#), [EDSCR.RXfull](#) or [EDSCR.ITE](#), as applicable, are not updated.

There is no overrun or underrun detection on external reads of [DBGDTRRX_ELO](#) or external writes of [DBGDTRTX_ELO](#).

There is no overrun or underrun detection of direct reads and direct writes of the [DTR](#) system registers by software:

- If $\text{RXfull} == 0$, a direct read of [DBGDTRRX](#) or [DBGDTR_ELO](#) returns UNKNOWN.
- If $\text{TXfull} == 1$, a direct write of:
 - [DBGDTRTX](#) sets [DTRTX](#) to UNKNOWN.
 - [DBGDTR_ELO](#) sets [DTRRX](#) and [DTRTX](#) to UNKNOWN.

See *DCC accesses in Non-debug state* on page H4-4399 for more information.

Accessing 64-bit data

In AArch64 state, a software access to the [DBGDTR_ELO](#) register and an external debugger access to both [DBGDTRRX_ELO](#) and [DBGDTRTX_ELO](#) can perform a 64-bit half-duplex operation.

However, there is only overrun and underrun detection on one of the external debug registers. That is:

- If software directly writes a 64-bit value to [DBGDTR_ELO](#), only TXfull is set to 1, meaning:
 - A subsequent external write to [DBGDTRRX_ELO](#) would not be detected as an overrun.
 - If the external debugger reads [DBGDTRTX_ELO](#) first, software might observe [MDCCSR_ELO.TXfull](#) == 0 and send a second value before the external debugger reads [DBGDTRRX_ELO](#), leading to an undetected overrun.
- On external writes to both [DBGDTRRX_ELO](#) and [DBGDTRTX_ELO](#) only RXfull is set to 1, meaning:
 - A subsequent direct write of [DBGDTRTX_ELO](#) would not be detected as an overrun.
 - If the external debugger writes to [DBGDTRRX_ELO](#) first, software might observe [MDCCSR_ELO.RXfull](#) == 1 and read a full 64-bit value, before the external debugger writes to [DBGDTRTX_ELO](#), leading to an undetected underrun.

To avoid this, debuggers need to be aware of the data size used by software for transfers and ensure that 64-bit data is read or written in the correct order. If the PE is in Non-debug state, this order is as follows:

- The external debugger must check `EDSCR.{RXfull, TXfull}` before each transfer.
- To receive a 64-bit value from the target, the external debugger must read `DBGDTRRX_ELO` before reading `DBGDTRTX_ELO`.
- To send a 64-bit value to the target, the external debugger must write to `DBGDTRTX_ELO` before writing `DBGDTRRX_ELO`.

Because three accesses are required to transfer 64 bits of data, 64-bit transfers are not recommended for regular communication between host and target. The use of underrun and overrun detection means that only one access is required for 32 bits of data when using 32-bit transfers.

In Debug state, the debugger controls the instructions executed by the PE, so these limitations do not apply. 64-bit transfers provide a means to transfer a 64-bit general register between the host and the target in Debug state.

H4.4.3 Cumulative error flag

The cumulative error flag, `EDSCR.ERR`, is set to 1 on taking exceptions taken in Debug state and on any signaled overrun or underrun in the DCC or ITR.

When `EDSCR.ERR == 1`:

- External reads of `DBGDTRTX_ELO` do not have any side-effects.
- External writes to `DBGDTRRX_ELO` are ignored.
- External writes to `EDITR` are ignored.
- No further instructions can be issued in Debug state. This includes any instructions previously accepted as external writes to `EDITR` that occur in program order after the instruction or access that caused the error.

This allows a debugger to stream data, or, in Debug state, instructions, to the target without having to:

- Check `EDSCR.{RXfull, TXfull, ITE}` before each access.
- Check `EDSCR.{ITO, RXO, TXU}` following each access, for overrun or underrun.
- Check `PSTATE` or other syndrome registers, or both, for an exception following each instruction executed in Debug state that might generate a synchronous exception.

The cumulative error flag remains set until cleared by writing 1 to `EDRCR.CSE`. See *EDRCR, External Debug Reserve Control Register* on page H9-4529.

For overruns and underruns, `EDSCR.{ITO, RXO, TXU}` record the error type.

Pseudocode details for clearing the error flag

The pseudocode details for the `ClearStickyError()` function is as follows:

```
// ClearStickyErrors()
// =====

ClearStickyErrors()
    EDSCR.TXU = '0';           // Clear TX underrun flag
    EDSCR.RXO = '0';           // Clear RX overrun flag
    if Halted() then           // in Debug state
        EDSCR.ITO = '0';       // Clear ITR overrun flag
    EDSCR.ERR = '0';           // Clear cumulative error flag
    return;
```

H4.5 Synchronization of DCC and ITR accesses

In addition to the standard synchronization requirements for register accesses, the following subsections describe additional requirements that apply for the DCC and ITR registers:

- [Summary of system register accesses to the DCC.](#)
- [DCC accesses in Non-debug state on page H4-4399.](#)

In these sections, accesses by the external debug interface are referred to as external reads and external writes. Accesses to system registers are referred to as direct reads, direct writes, indirect reads, and indirect writes.

———— **Note** —————

In [Synchronization requirements for system registers on page D8-1866](#) external reads and external writes are described as forms of indirect access. This whole section uses more explicit terminology.

The DTR registers and the DCC flags, TXfull and RXfull, form a communication channel, with one end operating asynchronously to the other. Implementations must respect the ordering of accesses to these registers in order to maintain the correct behavior of the channel.

External reads of, and external writes to [DBGDTRRX_EL0](#) and [DBGDTRTX_EL0](#) are asynchronous to direct reads of, and direct writes to, [DBGDTRRX](#), [DBGDTRTX](#), and in AArch64 state [DBGDTR_EL0](#), made by software using system register access instructions. The direct reads and direct writes indirectly write to the DCC flags. The external reads and external writes indirectly read the DCC flags to check for underrun and overrun.

H4.5.1 Summary of system register accesses to the DCC

System register accesses to the DTR registers are direct reads and writes of those registers, as shown in [Table H4-2](#). Several of these instructions access the same registers using different encodings.

With the exception of the read and write bits, [DBGDTRRX](#) and [DBGDTRTX](#) are the same encoding, but use different registers. The ARMv8 architecture governs the order of these instructions, as described in [Synchronization requirements for system registers on page D8-1866](#). For more details, see the description of the individual register in the relevant chapter, [Chapter D8 AArch64 System Register Descriptions](#) or [Chapter G4 AArch32 System Register Descriptions](#).

[Table H4-2](#) shows a summary of system register accesses to the DCC.

Table H4-2 Summary of system register accesses to the DCC

Operation	OS Lock	AArch64 (MRS/MSR)	AArch32 (MRC/MCR)	Description
Read	-	DBGDTRRX_EL0	DBGDTRRXint	Direct read of DTRRX
Write	-	DBGDTRTX_EL0	DBGDTRTXint	Direct read of DTRTX
Read/write	-	DBGDTR_EL0	-	Direct read/write of both DTRRX and DTRTX
All of the above				Indirect write to the DCC flags
Read	-	MDCCSR_EL0	DBGDSCRint	Direct read of the DCC flags
Read/write	-	OSDTRRX_EL1	DBGDTRRXext	Direct read/write of DTRRX
Read/write	-	OSDTRTX_EL1	DBGDTRTXext	Direct read/write of DTRTX
Read	Unlocked	MDSCR_EL1	DBGDSCRext	Direct read of DCC flags
Read/write	Locked	MDSCR_EL1	DBGDSCRext	Direct read/write of DCC flags

H4.5.2 DCC accesses in Non-debug state

In Non-debug state DCC accesses are as described in *Normal access mode* on page H4-4391:

- If a direct read of `DCCSR` returns `RXfull == 1`, then a following direct read of `DBGDTRRX` or in AArch64 state of `DBGDTR_EL0`, returns valid data and indirectly writes 0 to `DCCSR.RXfull` as a side-effect.
- If a direct read of `DCCSR` returns `TXfull == 0`, then a following direct write to `DBGDTRTX`, or in AArch64 state to `DBGDTR_EL0`, writes the intended value, and indirectly writes 1 to `DCCSR.TXfull` as a side-effect.

No context synchronization operation is required between these two instructions. Overrun and underrun detection prevents intervening external reads and external writes affecting the outcome of the second instruction.

The indirect write to the DCC flags as part of the DTR access instruction is made atomically with the DTR access.

Because a direct read of `DBGDTRRX` is an indirect write to `DCCSR.RXfull`, it must occur in program order with respect to the direct read of `DCCSR`, meaning it must not return a speculative value for `DTTRX` that predates the `RXfull` flag returned by the read of `DCCSR`. The direct write to `DBGDTRTX` must not be executed speculatively.

Direct reads of `DBGDTRRX`, or in AArch64 state `DBGDTR_EL0`, and `DCCSR`, must occur in program order with respect to other direct reads of the same register using the same encoding.

All observers must observe the same order for accesses.

———— Note ————

These requirements do not create order where order does not otherwise exist. It applies only for ordered accesses.

The following accesses have an implied order within the atomic access:

- In the simple sequential execution of the program the indirect write of the DCC flags occurs immediately after the direct DTR access.
- In the simple sequential execution model, for an external read of `DBGDTRTX_EL0` or an external write of `DBGDTRRX_EL0`:
 - The check of the DCC flags for overrun or underrun occurs immediately before the access.
 - If there is no underrun or overrun, the update of the DCC flags occurs immediately after the access.
 - If there is underrun or overrun, the update of the DCC underrun or overrun flags occurs immediately after the access.

This means that:

- Following a direct read of `DBGDTRRX`, or in AArch64 state `DBGDTR_EL0`, made when the value of `RXfull` is 1, if an external write to `DBGDTRRX_EL0` checks the `RXfull` flag for overrun and observes that the value of `RXfull` is 0, the value returned by the previous direct read must not be affected by the external write.
- Following a direct write to `DBGDTRTX`, or in AArch64 state `DBGDTR_EL0`, made when the value of `TXfull` is 0, if an external read of `DBGDTRTX_EL0` checks the `TXfull` flag for underrun and observes that the value of `TXfull` is 1, the value returned by the external read must be the value written by the previous direct write.
- Following an external read of `DBGDTRTX_EL0` that does not underrun, if a direct read of `DCCSR` returns a `TXfull` value of 0, then the value returned by the external read must not be affected by a following direct write to `DBGDTRTX`, or in AArch64 state `DBGDTR_EL0`.
- Following an external write to `DBGDTRRX_EL0` that does not overrun, if a direct read of `DCCSR` returns the `RXfull` value of 1, then the value returned by a following direct read of `DBGDTRRX` must be the value written by the previous external write.

Without explicit synchronization following external writes and external reads:

- The value written by the external write to `DBGDTRRX_EL0` must be observable to direct reads of `DBGDTRRX` in finite time.

- The DCC flags that are updated as a side-effect of the external write or external read must be observable:
 - To direct reads of **DCCSR** in finite time.
 - To subsequent external reads of **EDSCR**.
 - To subsequent external reads of **DBGDTRRX_EL0** and external writes to **DBGDTRTX_EL0** when checking for overrun and underrun.

However, explicit synchronization is required to guarantee that a direct read of **DCCSR** returns up-to-date DCC flags. This means that if a signal is received from another agent that indicates that **DCCSR** must be read, an ISB is required to ensure that the read of **DCCSR** occurs after the signal has been received. This also synchronizes the value in **DBGDTRRX**, if applicable. However, if that signal is an interrupt exception triggered by **COMMIRQ**, **COMMTX**, or **COMMRX**, the exception entry is sufficient synchronization. See *Synchronization of DCC interrupt request signals*.

Explicit synchronization is required following a direct read or direct write:

- To ensure that a value directly written to **DBGDTRTX** is observable to external reads of **DBGDTRTX_EL0**.
- To ensure that a value directly written to **DBGDTR_EL0** is observable to external reads of **DBGDTRTX_EL0** and **DBGDTRRX_EL0**.
- To guarantee that the indirect writes to the DCC flags that were a side-effect of the direct read or direct write have occurred, and therefore that the updated values are:
 - Observable to external reads of **EDSCR**.
 - Observable to external reads of **DBGDTRRX_EL0**.
 - Observable to external writes of **DBGDTRTX_EL0** when checking for overrun and underrun
 - Returned by a following direct read of **DCCSR**.

See also *Memory-mapped accesses to the DCC and ITR* on page H4-4394 and *Synchronization of changes to the external debug registers* on page H8-4445.

———— **Note** —————

These ordering rules mean that software:

- Must not read **DBGDTRRX** without first checking **DCCSR.RXfull** or if the previously-read value of **DCCSR.RXfull** is 0.
It is not sufficient to read both registers and then later decide whether to discard the read value, as there might be an intervening write from the external debug interface.
- Must not write **DBGDTRTX** without first checking **DCCSR.TXfull** or if the previously-read value of **DCCSR.TXfull** is 1.
The write to **DBGDTRTX** overwrites the value in **DTRTX**, and the external debugger might or might not have read this value.
- Must ensure there is an explicit context synchronization operation following a DTR access, even if not immediately returning to read **DCCSR** again. This synchronization operation can be an exception return.

H4.5.3 Synchronization of DCC interrupt request signals

Following an external read or external write access to the DTR registers, the interrupt request signals, **COMMIRQ**, **COMMTX**, and **COMMRX**, must be updated in finite time without explicit synchronization.

The updated values must be observable to a direct read of **DCCSR** or **DBGDTRRX**, or a direct write of **DBGDTRTX** executed after taking an interrupt exception generated by the interrupt request. The updated values must also be observable to a direct write of **DBGDTRTX** executed after taking an interrupt exception generated by the interrupt request.

Following a direct read of [DBGDTRRX](#) or a direct write to [DBGDTRRX](#), software must execute a context synchronization operation to guarantee the interrupt request signals have been updated in finite time. This synchronization operation can be an exception return.

H4.5.4 DCC and ITR access in Debug state

In Debug state, stricter observability rules apply for instructions issued through the ITR, to maintain communication between a debugger and the PE, without requiring excessive explicit synchronization.

In Normal mode, without explicit synchronization:

- A direct read or direct write of the DTR registers by an instruction written to [EDITR](#) must be observable to an external write or an external read in finite time:

- A direct read of [DBGDTRRX](#) must be observable to an external write of [DBGDTRRX_ELO](#).

- A direct write of [DBGDTRTX](#) must be observable to an external read of [DBGDTRTX_ELO](#).

This includes the indirect write to the DCC flags that occurs atomically with the access as described in [DCC accesses in Non-debug state on page H4-4399](#).

The subsequent external write or external read must observe either the old or the new values of both the DTR contents and DCC flags. If the old values are observed, this typically results in overrun or underrun, assuming the old DCC flag values indicate an overrun or underrun condition, as would normally be the case.

This means the debugger can observe the direct read or direct write without explicit synchronization and without explicitly testing the DCC flags in [EDSCR](#), because it can rely on overrun and underrun tests.

- External reads of [DBGDTRTX_ELO](#) that do not underrun and external writes to [DBGDTRRX_ELO](#) that do not overrun must be observable to an instruction subsequently written to [EDITR](#) on completion of the first external access. This includes the indirect write to the DCC flags.

This means that without explicit synchronization and without the need to first check the DCC flags in [DCCSR](#):

- If the instruction is a direct read of [DBGDTRRX](#), it observes the external write.

- If the instruction is a direct write of [DBGDTRTX](#), it observes the external read.

- Writes to [EDITR](#) that do not overrun commit an instruction for execution immediately. The instruction must complete execution in finite time without requiring any further operation by the debugger.

In Memory access mode, these requirements shift to the instructions implicitly executed by external reads and external writes of the DTR registers, as described in [Memory access mode on page H4-4392](#).

H4.6 Interrupt-driven use of the DCC

ARM recommends implementations provide a level-sensitive DCC interrupt request through the IMPLEMENTATION DEFINED interrupt controller as a private peripheral interrupt for the originating PE.

———— **Note** —————

In addition to connection to the interrupt controller ARM also recommends **COMMIRQ**, **COMMTX**, and **COMMRX** signals that might be implemented for use by any legacy system peripherals.

The **DCCINT** register provides a first level of interrupt masking within the PE, meaning only a single interrupt source, **COMMIRQ**, is needed at the interrupt controller.

See also [Synchronization of DCC interrupt request signals on page H4-4400](#).

H4.7 Pseudocode details for the operation of the DCC and ITR registers

The basic operation of the DCC and ITR registers is shown by the following pseudocode functions. These functions do not cover the behavior when `OSLSR.OSLK == 1`, meaning that the OS lock is locked.

The definition of the DTR Registers is:

```
bits(32) DTRRX;
```

```
bits(32) DTRTX;
```

The pseudocode for the `DBGDTR_EL0()` function is as follows:

```
// DBGDTR_EL0[] (write)
// =====
// System register writes to DBGDTR_EL0, DBGDTRTX_EL0 (AArch64) and DBGDTRTXint (AArch32)

DBGDTR_EL0[] = bits(N) value
  // For MSR DBGDTRTX_EL0,<Rt> N=32, value=X[t]<31:0>, X[t]<63:32> is ignored
  // For MSR DBGDTR_EL0,<Xt> N=64, value=X[t]<63:0>
  assert(N == 32 || N == 64);
  if EDSCR.TXfull == '1' then
    value = bits(N) UNKNOWN;
  // On a 64-bit write, implement a half-duplex channel
  if N == 64 then DTRRX = value<63:32>;
  DTRTX = value<31:0>; // 32-bit or 64-bit write
  EDSCR.TXfull = '1';
  return;

// DBGDTR_EL0[] (read)
// =====
// System register reads of DBGDTR_EL0, DBGDTRRX_EL0 (AArch64) and DBGDTRRXint (AArch32)

bits(N) DBGDTR_EL0[]
  // For MRS <Rt>,DBGDTRTX_EL0 N=32, X[t]=Zeros(32):result
  // For MRS <Xt>,DBGDTR_EL0 N=64, X[t]=result
  assert(N == 32 || N == 64);
  bits(N) result;
  if EDSCR.RXfull == '0' then
    result = bits(N) UNKNOWN;
  else
    // On a 64-bit read, implement a half-duplex channel
    // NOTE: the word order is reversed on reads with regards to writes
    if N == 64 then result<63:32> = DTRTX;
    result<31:0> = DTRRX;
  EDSCR.RXfull = '0';
  return result;
```

The pseudocode for the `DBGDTRRX_EL0()` function is as follows:

```
// DBGDTRRX_EL0[] (external write)
// =====
// Called on writes to debug register 0x08C.

DBGDTRRX_EL0[boolean memory_mapped] = bits(32) value

  if EDPRSR<6:5,0> != '001' then // Check DLK, OSLK and PU bits
    IMPLEMENTATION_DEFINED "signal slave-generated error";
    return;

  if EDSCR.ERR == '1' then return; // Error flag set: ignore write

  // The Software lock is OPTIONAL.
  if memory_mapped && EDLSR.SLK == '1' then return; // Software lock locked: ignore write

  if EDSCR.RXfull == '1' || (Halted() && EDSCR.MA == '1' && EDSCR.ITE == '0') then
```

```

EDSCR.RXO = '1'; EDSCR.ERR = '1';           // Overrun condition: ignore write
return;

EDSCR.RXfull = '1';
DTRRX = value;

if Halted() && EDSCR.MA == '1' then
    EDSCR.ITE = '0';                         // See comments in EDITR[] (external write)

    if !UsingAArch32() then
        ExecuteA64(0xD5330501<31:0>);      // A64 "MRS X1,DBGDTRRX_EL0"
        ExecuteA64(0xB8004401<31:0>);      // A64 "STR W1,[X0],#4"
        X[1] = bits(64) UNKNOWN;
    else
        ExecuteT32(0xEE10<15:0> /*hw1*/, 0x1E15<15:0> /*hw2*/); // T32 "MRS R1,DBGDTRRXint"
        ExecuteT32(0xF840<15:0> /*hw1*/, 0x1B04<15:0> /*hw2*/); // T32 "STR R1,[R0],#4"
        R[1] = bits(32) UNKNOWN;

    // If the store aborts, the Data Abort exception is taken and EDSCR.ERR is set to 1
    if EDSCR.ERR == '1' then
        EDSCR.RXfull = bit UNKNOWN;
        DBGDTRRX_EL0 = bits(32) UNKNOWN;
    else
        // "MRS X1,DBGDTRRX_EL0" calls DBGDTR_EL0[] (read) which clears RXfull.
        assert EDSCR.RXfull == '0';

    EDSCR.ITE = '1';                         // See comments in EDITR[] (external write)
return;

// DBGDTRRX_EL0[] (external read)
// =====
bits(32) DBGDTRRX_EL0[boolean memory_mapped]
return DTRRX;

```

The pseudocode for the DBGDTRTX_EL0() function is as follows:

```

// DBGDTRTX_EL0[] (external read)
// =====
// Called on reads of debug register 0x080.

bits(32) DBGDTRTX_EL0[boolean memory_mapped]

if EDPRSR<6:5,0> != '001' then              // Check DLK, OSLK and PU bits
    IMPLEMENTATION_DEFINED "signal slave-generated error";
    return bits(32) UNKNOWN;

if EDSCR.ERR == '1' then return DTRTX;      // Error flag set: no side-effects

// The Software lock is OPTIONAL.
if memory_mapped && EDLSR.SLK == '1' then   // Software lock locked: no side-effects
    return DTRTX;

if EDSCR.TXfull == '0' || (Halted() && EDSCR.MA == '1' && EDSCR.ITE == '0') then
    EDSCR.TXU = '1'; EDSCR.ERR = '1';      // Underrun condition: block side-effects
    return bits(32) UNKNOWN;               // Return UNKNOWN

EDSCR.TXfull = '0';
value = DTRTX;                             // Return previous value of DTRTX

if Halted() && EDSCR.MA == '1' then
    EDSCR.ITE = '0';                       // See comments in EDITR[] (external write)

    if !UsingAArch32() then
        ExecuteA64(0xB8404401<31:0>);      // A64 "LDR W1,[X0],#4"
    else
        ExecuteT32(0xF850<15:0> /*hw1*/, 0x1B04<15:0> /*hw2*/); // T32 "LDR R1,[R0],#4"

```

```

// If the load aborts, the Data Abort exception is taken and EDSCR.ERR is set to 1
if EDSCR.ERR == '1' then
    EDSCR.TXfull = bit UNKNOWN;
    DBGDTRTX_EL0 = bits(32) UNKNOWN;
else
    if !UsingAArch32() then
        ExecuteA64(0xD5130501<31:0>); // A64 "MSR DBGDTRTX_EL0,X1"
    else
        ExecuteT32(0xEE00<15:0> /*hw1*/, 0x1E15<15:0> /*hw2*/); // T32 "MSR DBGDTRTXint,R1"
        // "MSR DBGDTRTX_EL0,X1" calls DBGDTR_EL0[] (write) which sets TXfull.
        assert EDSCR.TXfull == '1';

    if !UsingAArch32() then
        X[1] = bits(64) UNKNOWN;
    else
        R[1] = bits(32) UNKNOWN;

    EDSCR.ITE = '1'; // See comments in EDITR[] (external write)

return value;

// DBGDTRTX_EL0[] (external write)
// =====

DBGDTRTX_EL0[boolean memory_mapped] = bits(32) value
// The Software lock is OPTIONAL.
if memory_mapped && EDLSR.SLK == '1' then return; // Software lock locked: ignore write
DTRTX = value;
return;

```

The pseudocode for the EDITR() function is as follows:

```

// EDITR[] (external write)
// =====
// Called on writes to debug register 0x088.

EDITR[boolean memory_mapped] = bits(32) value
if EDPRSR<6:5,0> != '001' then // Check DLK, OSLK and PU bits
    IMPLEMENTATION_DEFINED "signal slave-generated error";
    return;

if EDSCR.ERR == '1' then return; // Error flag set: ignore write

// The Software lock is OPTIONAL.
if memory_mapped && EDLSR.SLK == '1' then return; // Software lock locked: ignore write

if !Halted() then return; // Non-debug state: ignore write

if EDSCR.ITE == '0' || EDSCR.MA == '1' then
    EDSCR.ITO = '1'; EDSCR.ERR = '1'; // Overrun condition: block write
    return;

// ITE indicates whether the processor is ready to accept another instruction; the processor
// may support multiple outstanding instructions. Unlike the "InstrComp1" flag in [v7A] there
// is no indication that the pipeline is empty (all instructions have completed). In this
// pseudocode, the assumption is that only one instruction can be executed at a time,
// meaning ITE acts like "InstrComp1".
EDSCR.ITE = '0';

if !UsingAArch32() then
    ExecuteA64(value);
else
    ExecuteT32(value<15:0> /*hw1*/, value<31:16> /*hw2*/);

EDSCR.ITE = '1';

```

```
return;
```

The pseudocode for the CheckForDCCInterrupts() function is as follows:

```
// CheckForDCCInterrupts()
// =====

CheckForDCCInterrupts()
  commrx = (EDSCR.RXfull == '1');
  commtx = (EDSCR.TXfull == '0');

  // COMMRX and COMMTX support is optional and not recommended for new designs.
  // SetInterruptRequestLevel(InterruptID_COMMRX, if commrx then HIGH else LOW);
  // SetInterruptRequestLevel(InterruptID_COMMTX, if commtx then HIGH else LOW);

  // The value to be driven onto the common COMMIRQ signal.
  commirq = ((commrx && MDCCINT_EL1.RX == '1') ||
             (commtx && MDCCINT_EL1.TX == '1'));
  SetInterruptRequestLevel(InterruptID_COMMIRQ, if commirq then HIGH else LOW);

return;
```

Chapter H5

The Embedded Cross Trigger Interface

This chapter describes the embedded cross-trigger interface. It contains the following sections:

- *About the Embedded Cross Trigger (ECT) on page H5-4408.*
- *Basic operation on the ECT on page H5-4410.*
- *Cross-triggers on a PE in an ARMv8 implementation on page H5-4414.*
- *Description and allocation of CTI triggers on page H5-4415.*
- *CTI registers programmers' model on page H5-4418.*
- *Examples on page H5-4419.*

H5.1 About the Embedded Cross Trigger (ECT)

The *Embedded Cross Trigger*, ECT, allows a debugger to:

- Send trigger events to a PE. For example, this might be done to halt the PE.
- Send a trigger event to one or more PEs when a trigger event occurs on another PE. For example, this might be done to halt all PEs when one individual PE halts.

Figure H5-1 shows the logical structure of an ECT.

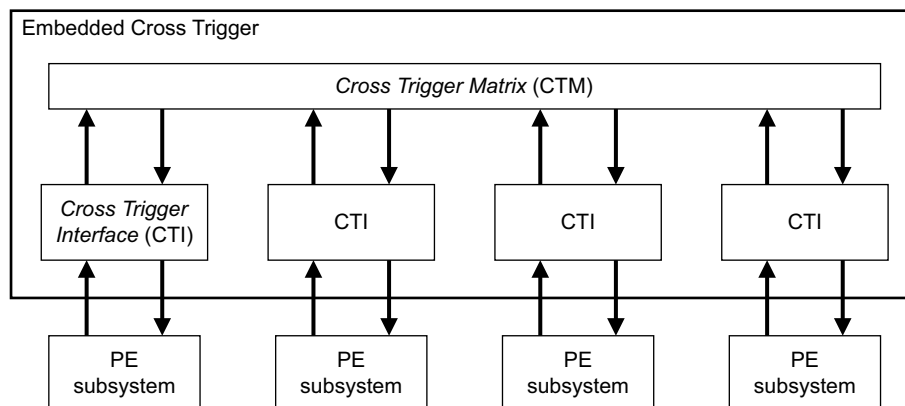

Figure H5-1 Structure of an embedded cross trigger

The ECT can deliver many types of trigger events, which are described in the following sections:

- [Debug request trigger event on page H5-4415.](#)
- [Restart request trigger event on page H5-4416.](#)
- [Cross-halt trigger event on page H5-4416.](#)
- [Performance Monitors overflow trigger event on page H5-4416.](#)
- [Generic trace external input trigger events on page H5-4417.](#)
- [Generic trace external output trigger events on page H5-4417.](#)
- [Generic CTI interrupt trigger event on page H5-4417.](#)

An ARMv8-A implementation must:

- Include a cross-trigger interface, CTI.
- Implement at least the input and output triggers defined in this architecture.

See [Cross-triggers on a PE in an ARMv8 implementation on page H5-4414.](#)

In addition, ARM recommends that the cross-trigger includes:

- The ability to route trigger events between Trace extensions:
 - These typically have advanced event triggering logic.
- An output trigger to the interrupt controller.

———— **Note** ————

The ECT and CTI must only signal trigger events for external debugging. They must not route software events, such as interrupts. For example, the Performance Monitors overflow input trigger is provided to allow entry to Debug state on a counter overflow, and the output trigger to the interrupt controller is provided to generally allow events from the external debug sub-system to be routed to a software agent. However, the combination of the two must not be used as a mechanism to route Performance Monitors overflows to an interrupt controller.

H5.1.1 Implementation with a CoreSight CTI

For details of the recommended connections in an ARMv8-A implementation, see [Appendix B Recommended External Debug Interface](#). See also *CoreSight™ SoC Technical Reference Manual*.

H5.2 Basic operation on the ECT

The ECT comprises a Cross-Trigger Matrix, CTM, and one Cross-Trigger Interface, CTI, for each PE. The CTM passes events between the CTI blocks over channels. The CTM can have a maximum of 32 channels.

The main interfaces of the cross-trigger interface, CTI, are:

- The input triggers:
 - These are trigger event inputs from the PE to the CTI.
- The output triggers:
 - These are trigger event outputs from the CTI to the PE.
- The input channels:
 - These are channel event inputs from the cross-trigger matrix, CTM, to the CTI.
- The output channels:
 - These are channel event outputs from the CTI to the CTM.

Each CTI block has:

- Up to 32 input triggers that come from the PE:
 - The input triggers are numbered 0-31.
- Up to 32 output triggers that go to the PE:
 - The output triggers are numbered 0-31.

[Figure H5-2 on page H5-4411](#) shows the logical internal structure of a CTI.

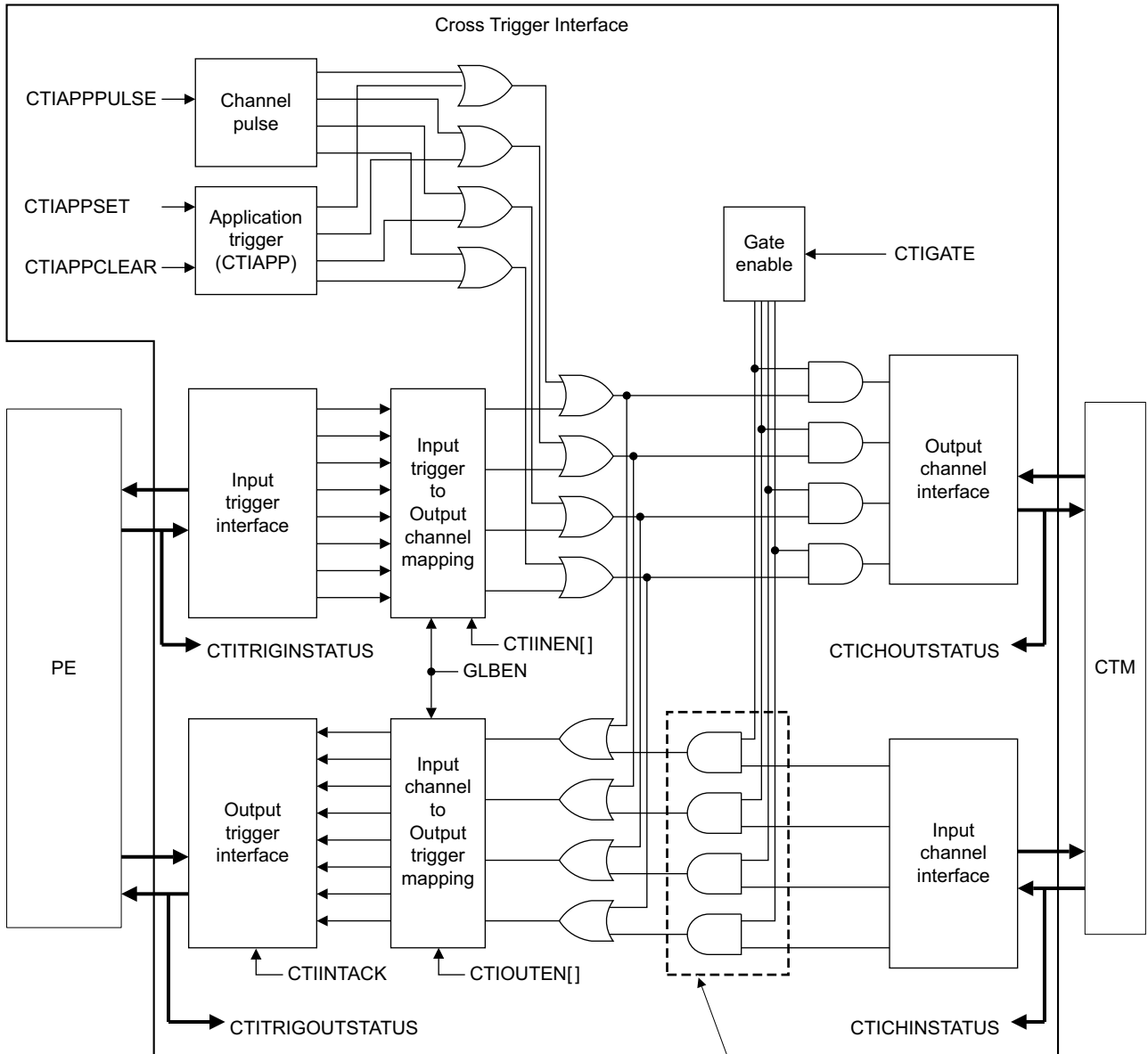

The input channel gate function was not implemented in previous versions of this architecture.

Figure H5-2 Structure of a cross-trigger interface

Note

- The number of triggers is IMPLEMENTATION DEFINED. [Figure H5-2](#) shows eight input and eight output triggers.
- The number of channels is IMPLEMENTATION DEFINED. [Figure H5-2](#) shows four channels.
- In [Figure H5-2](#) the input channel gate function is a CTIv2 feature.

When the CTI receives an input trigger event, this generates channel events on one or more internal channels, according to the *mapping function* defined by the *Input trigger→output channel mapping registers*, [CTIINEN<n>](#).

The CTI also contains an *application trigger* and *channel pulse* to allow a debugger to create channel events directly on internal channels by writing to the CTI control registers.

Channel events on each internal channel are passed to a corresponding output channel that is controlled by a *channel gate*. The channel gate can block propagation of channel events from an internal channel to an output channel.

The output channels from a CTI are combined, using a logical OR function, with the output channels from all other CTIs to form the input channels on other CTIs. The input channels of this CTI are the logical OR of the output channels on all other CTIs. This is the *cross-trigger matrix*, CTM. Therefore, the number of input channels must equal the number of output channels.

———— **Note** —————

The number of input triggers and output triggers is not required to be the same.

The internal channels form an internal cross-trigger matrix within the CTI. This delivers events directly from the input triggers to the output triggers. Therefore the number of internal channels is the same as the number of input and output channels on the external CTM, and there is a direct mapping between the two.

Channel events received on each input channel are passed to the corresponding internal channel. It is IMPLEMENTATION DEFINED whether the cross-trigger gate also blocks propagation of channel events from input channels to internal channels.

When the CTI receives a channel event on an internal channel this generates trigger events on one or more output triggers, according to the mapping function defined by the *Input channel* → *output trigger mapping registers*, `CTIOUTEN<n>`.

The CTI contains the input and output trigger interfaces to the PE and the interface of the cross-trigger matrix. The architecture does not define the signal protocol used on the trigger interfaces, and:

- It is IMPLEMENTATION DEFINED whether the CTI supports multicycle input trigger events.
- It is IMPLEMENTATION DEFINED whether the CTM supports multicycle channel events.

See *Multicycle events*.

However, an output trigger is asserted until acknowledged. The output trigger can be:

- Self-acknowledging. This means that no further action is required from the debugger.
- Acknowledged by the debugger writing 1 to the corresponding bit of `CTIINTACK`.

The time taken to propagate a trigger event from the first PE, through its CTI, across the CTM to another CTI, and thereby to a second PE is IMPLEMENTATION DEFINED.

———— **Note** —————

ARM recommends that this path is not longer than the shortest software communication path between those PEs. This is because if the first PE halts, the Cross-halt trigger event can propagate through the ECT and halt the second PE without causing software on the second PE to malfunction because the first PE is in Debug state and is not responding.

H5.2.1 Multicycle events

A multicycle event is one with a continuous state that might persist over many cycles, as opposed to a discrete event. A typical implementation of a multicycle event is a level-based signal interface, whereas a discrete event might be implemented as a pulse signal or message.

CTI support for multicycle trigger events is IMPLEMENTATION DEFINED. Use of multicycle trigger events is deprecated. Of the architecturally defined input trigger events, the Performance Monitors overflow trigger event and Generic trace external output trigger events can be multicycle input triggers.

CTM support for multicycle channel events is IMPLEMENTATION DEFINED. A CTM that does not support multicycle channel events cannot propagate a multicycle trigger event between CTIs.

———— **Note** —————

A full ECT might comprise a mix of CTIs, some of which can support multicycle trigger events. In bridging these components, multicycle channel events become single channel events at the boundary between the CTIs.

An ECT that supports multicycle trigger events

When an ECT supports multicycle trigger events, an input trigger event to the CTI continuously asserts channel events on all output channels mapped to it until either:

- The input trigger event is removed.
- The channel mapping function is disabled.

This means that an input trigger that is asserted for multiple cycles causes any channels that are mapped to it to become active for multiple cycles. Consequently, any output triggers mapped from that channel are asserted for multiple cycles.

———— **Note** —————

The output trigger remains asserted for at least as long as the channel remains active. This means that even if the output trigger is acknowledged, it remains asserted until the channel deactivates.

The CTI does not guarantee that these events have precisely the same duration, as the triggers and channels can cross between clock domains.

[CTIAPPSET](#) and [CTIAPPCLEAR](#) can set a channel active for multiple cycles. [CTIAPPULSE](#) generates a single channel event. [CTICHINSTATUS](#) and [CTICHOUTSTATUS](#) can report whether a channel is active.

An ECT that does not support multicycle trigger events

When an ECT does not support multicycle trigger events, an input trigger event to the CTI generates a single channel event on all output channels mapped to it, regardless of how long the input trigger event is asserted.

This means that an input trigger event that is asserted for multiple cycles generates a single channel event on any channels mapped to it. Consequently any self-acknowledging output triggers mapped from those channels are single trigger events.

———— **Note** —————

A single event is typically a single cycle, but there is no guarantee that this is always the case.

[CTIAPPSET](#) and [CTIAPPCLEAR](#) can only generate a single channel event. [CTIAPPULSE](#) generates a single channel event. If the ECT does not support multicycle channel events, use of [CTIAPPSET](#) and [CTIAPPCLEAR](#) is deprecated, and the debugger must only use [CTIAPPULSE](#). [CTICHINSTATUS](#) and [CTICHOUTSTATUS](#) must be treated as UNKNOWN.

H5.3 Cross-triggers on a PE in an ARMv8 implementation

An ARMv8 PE must include a cross-trigger interface, and the implementation must include at least the input and output triggers defined in this architecture. The number of channels in the cross-trigger matrix is IMPLEMENTATION DEFINED, but there must be a minimum of three. Software can read CTIDEVID.NUMCHAN to discover the number of implemented channels.

The CTM must connect to all PEs in the same Inner Shareability domain as the ARMv8-A PE, but can also connect to additional PEs. ARM strongly recommends that the CTM connects all PEs implementing a CTI in the system. This includes ARMv7-A PEs and other PEs that can be connected using a CoreSight CTI module.

———— **Note** —————

In a uniprocessor system the CTM is OPTIONAL. The CTM might be connected other CTI modules for non-PEs, such as triggers for system visibility components. ARM recommends that the CTM is implemented.

Any CTI connected to a PE that is not an ARMv8-A PE must implement at least:

- The Debug request trigger event.
- The Restart trigger event.
- The Cross-halt trigger event.

For more information about the CTI, see the *CoreSight™ SoC Technical Reference Manual*. ARMv8-A refines the generic CTI by defining roles for each of the implemented input and output triggers.

H5.4 Description and allocation of CTI triggers

Table H5-1 shows the output trigger events defined by the architecture and the related trigger numbers.

Table H5-1 Allocation of CTI output trigger events

Number	Source	Destination	Event description
0	CTI	PE	<i>Debug request trigger event</i>
1	CTI	PE	<i>Restart request trigger event on page H5-4416</i>
2	CTI	IRQ controller	<i>Generic CTI interrupt trigger event on page H5-4417</i>
3	-	-	Reserved
4 - 7	CTI	Trace extension	OPTIONAL <i>Generic trace external input trigger events on page H5-4417</i>

———— **Note** —————

Output triggers from the CTI are inputs to other blocks.

Table H5-2 shows the input trigger events defined by the architecture and the related trigger numbers.

Table H5-2 Allocation of CTI input trigger events

Number	Source	Destination	Event description
0	PE	CTI	<i>Cross-halt trigger event on page H5-4416</i>
1	PE	CTI	<i>Performance Monitors overflow trigger event on page H5-4416</i>
2 - 3	-	-	Reserved
4 - 7	Trace extension	CTI	OPTIONAL <i>Generic trace external output trigger events on page H5-4417</i>

———— **Note** —————

Input triggers to the CTI are outputs from other blocks.

Table H5-1 and Table H5-2 show the minimum set of trigger events defined by the architecture. However:

- The Generic trace external input and output trigger events are only required if the OPTIONAL Trace extension is implemented. If the OPTIONAL Trace extension is not implemented, these trigger events are reserved.
- Support for the generic CTI interrupt trigger event is IMPLEMENTATION DEFINED because details of interrupt handling in the system, including any interrupt controllers, are IMPLEMENTATION DEFINED. Details regarding how the CTI interrupt is connected to an interrupt controller and its allocated interrupt number lie outside the scope of the architecture. ARM strongly recommends that implementations provide a means to generate interrupts based on external debug events.
- The other trigger events are required by the architecture.

An ARMv8-A implementation can extend the CTI with additional triggers. These start with the number eight.

H5.4.1 Debug request trigger event

This is an output trigger event from the CTI, and an input trigger event to the PE, asserted by the CTI to force the PE into Debug state. The trigger event is asserted until acknowledged by the debugger. The debugger acknowledges the assert by writing 1 to `CTIINTACK[0]`.

If the PE is already in Debug state, the PE ignores the trigger event, but the CTI continues to assert it until it is removed by the debugger. See also [External Debug Request debug event on page H3-4380](#).

H5.4.2 Restart request trigger event

This is an output trigger event from the CTI, and an input trigger event to the PE, asserted by the CTI to request the PE to exit Debug state. If the PE is not in Debug state, the request is ignored and dropped by the CTI.

If a Restart request trigger event is received at or about the same time as the PE enters Debug state, it is CONstrained UNPREDICTABLE whether:

- The restart is ignored. In this case the PE enters Debug state and remains in Debug state.
- The PE enters Debug state and then immediately restarts.

Debuggers must program the CTI to send Restart request trigger events only to PEs that are halted. To enable the PE to disambiguate discrete Restart request trigger events, after sending a Restart request trigger event, the debugger must confirm that the PE has restarted and halted before sending another Restart request trigger event.

Debuggers can use `EDPRSR.{SDR, HALTED}` to determine the execution state of the PE.

The trigger event is self-acknowledging, meaning that the debugger requires no further action to remove the trigger event. See also [Exiting Debug state on page H2-4361](#).

H5.4.3 Cross-halt trigger event

This is an input trigger event to the CTI, and an output trigger event from the PE, asserted by a PE when it is entering Debug state.

———— **Note** —————

To reduce the latency of halting, ARM recommends that an implementation issues the Cross-halt trigger event early in the committed process of entering Debug state. This means that there is no requirement to wait until all aspects of entry to Debug state have completed before issuing the trigger event. Speculative emission of Cross-halt trigger events is not allowed. The Cross-halt trigger event must not be issued early enough for a subsequent Debug request trigger event, that might be derived from the Cross-halt trigger event, to be recorded in the `EDSCR.STATUS` field. This applies to Debug request trigger events that are acting as inputs to the PE.

H5.4.4 Performance Monitors overflow trigger event

This is an input trigger event to the CTI, and an output trigger event from the PE, asserted each time the PE asserts a new Performance Monitors counter overflow interrupt request. See [Chapter D6 The Performance Monitors Extension](#).

If the CTI supports multicycle trigger events, then the trigger event remains asserted until the overflow is cleared by a write to `PMOVSCLR_ELO`. Otherwise, the trigger event is not asserted again until the overflow is cleared by a write to `PMOVSCLR_ELO`.

———— **Note** —————

- This does not replace the recommended connection of Performance Monitors overflow trigger event to an interrupt controller. Software must be able to program an interrupt on Performance Monitors overflow without programming the CTI.
- Events can be counted when `ExternalNoninvasiveDebugEnabled() == FALSE`, and, in Secure state, when `ExternalSecureNoninvasiveDebugEnabled() == FALSE`. Secure software must be aware that overflow trigger events are nevertheless visible to the CTI.

H5.4.5 Generic trace external input trigger events

These are output trigger events from the CTI, and input trigger events to the OPTIONAL Trace extension, that are used in conjunction with the Generic trace external output trigger events to pass trigger events between:

- The PE and the OPTIONAL Trace extension.
- The OPTIONAL Trace extension and any other component attached to the CTM, including other Trace extensions.

There are four Generic trace external input trigger events.

The trigger events are self-acknowledging. This means that the debugger does not have to take any further action to remove the events.

H5.4.6 Generic trace external output trigger events

These are input trigger events to the CTI, and output trigger events from the OPTIONAL Trace extension, used in conjunction with the Generic trace external input trigger events to pass trigger events between:

- The PE and the OPTIONAL Trace extension.
- The OPTIONAL Trace extension and any other component attached to the CTM, including other Trace extensions.

There are four Generic trace external output trigger events.

H5.4.7 Generic CTI interrupt trigger event

This is an output trigger event from the CTI, and an input to an IMPLEMENTATION DEFINED interrupt controller, and can transfer trigger events from the PE, Trace extension, or any other component attached to the CTI and CTM to software as an interrupt. The Generic CTI interrupt trigger event must be connected to the interrupt controller as an interrupt that can target the originating PE.

———— **Note** —————

ARM recommends that the Generic CTI interrupt trigger event is a private peripheral interrupt, but implementations might instead make this trigger event available as a shared peripheral interrupt or a local peripheral interrupt.

It is IMPLEMENTATION DEFINED whether this trigger event is:

- Self-acknowledging. This means that the debugger is not required to take any further action, and that the interrupt controller must treat the trigger event as a pulse or edge-sensitive interrupt.
- Acknowledged by the debugger. The debugger acknowledges the trigger event by writing 1 to [CTIINTACK\[2\]](#). This means that the interrupt controller must treat the trigger event as a level-sensitive interrupt.

ARM recommends that the Generic CTI interrupt trigger event is a self-acknowledging trigger event.

H5.5 CTI registers programmers' model

The CTI registers programmers' model is described in [Chapter H8 About the External Debug Registers](#). The following sections contain information specific to the CTI:

- [External debug register resets](#) on page H8-4465.
- [External debug interface register access permissions](#) on page H8-4451.
- [Cross-trigger interface registers](#) on page H8-4461.
- The individual register descriptions in [Cross-Trigger Interface registers](#) on page H9-4554.

See also [Memory-mapped accesses to the external debug interface](#) on page H8-4449.

H5.5.1 CTI reset

An External Debug reset resets the CTI. See [External debug register resets](#) on page H8-4465 for details of CTI register resets. All CTI output triggers and output channels are deasserted on an External Debug reset.

H5.5.2 CTI authentication

The CTI ignores the state of the IMPLEMENTATION DEFINED authentication interface. This means that:

- [CTITRIGINSTATUS](#) shows the status of the input triggers and [CTICHINSTATUS](#) shows the status of the input channels, regardless of the value of `ExternalNoninvasiveDebugEnabled()`.

———— **Note** —————

The PE does not generate the Cross-halt trigger event and the Trace extension does not generate Generic trace external output trigger events when `ExternalNoninvasiveDebugEnabled() == FALSE`. However, the PE can generate Performance Monitors overflow trigger events.

- The CTI can generate external triggers regardless of the value of `ExternalInvasiveDebugEnabled()`.

———— **Note** —————

The PE ignores Debug request and Restart request trigger events when `ExternalInvasiveDebugEnabled() == FALSE`. The Trace extension ignores Generic trace external input trigger events when `ExternalNoninvasiveDebugEnabled() == FALSE`. The behavior of Generic CTI interrupt requests is part of the IMPLEMENTATION DEFINED handling of these interrupts, but it is permissible for an interrupt controller to receive these requests even when `ExternalInvasiveDebugEnabled() == FALSE`.

H5.6 Examples

The CTI is fully programmable and allows for flexible cross-triggering of events within a PE and between PEs in a multiprocessor system. For example:

- The Cross-halt trigger event and the Debug request trigger event can be used for cross-triggering in a multiprocessor system.
- The Cross-halt trigger event and the Generic interrupt trigger event can be used for event-driven debugging in a multiprocessor system.
- The Performance Monitors overflow trigger event and the Debug request trigger event can force entry to Debug state on overflow of a Performance Monitors event counter, for event-driven profiling.

———— **Note** —————

This does not replace the recommended connection of Performance Monitors overflow trigger events to an interrupt controller. Software must be able to program an interrupt on Performance Monitors overflow without programming the CTI. ARM recommends that the Performance Monitors overflow signal is directly available as a local interrupt source.

- The Generic trace external input and Generic trace external output trigger events can pass trace events into and out of the event logic of the Trace extension. They can do this:
 - To pass trace events between Trace extensions.
 - In conjunction with the Performance Monitors overflow trigger event, to couple the Performance Monitors to the Trace extension.
 - In conjunction with the Debug request trigger event, to trigger entry to Debug state on a trace event.
 - In conjunction with other CTIs, to signal a trace trigger event onto a CoreSight trace interconnect.

The following sections describe some examples in more detail:

- [Halting a single PE.](#)
- [Halting all PEs in a group when any one PE halts on page H5-4420.](#)
- [Synchronously restarting a group of PEs on page H5-4420.](#)
- [Halting a single PE on Performance Monitors overflow on page H5-4420.](#)

Example H5-1 Halting a single PE

To halt a single PE, set:

1. `CTIGATE[0] = 0`, so that the CTI does not pass channel events on internal channel 0 to the CTM.
2. `CTIOUTEN<n>[0] = 1`, so that the CTI generates a Debug request trigger event in response to a channel event on channel 0.

———— **Note** —————

In this example, *n* is 0.

3. `CTIAPPULSE[0] = 1`, to generate a channel event on channel 0.

When the PE has entered Debug state, clear the Debug request trigger event by writing 1 to `CTIINTACK[0]`, before restarting the PE.

Example H5-2 Halting all PEs in a group when any one PE halts

To program a group of PEs so that when one PE in the group halts, all of the PEs in that group halt, set the following registers for each PE in the group:

1. **CTIGATE**[2] = 1, so that each CTI passes channel events on internal channel 2 to the CTM.
2. **CTIINEN**<n>[2] = 1, so that each CTI generates a channel event on channel 2 in response to a Cross-halt trigger event.

———— **Note** —————

In this example, *n* is 0.

3. **CTIOUTEN**<n>[2] = 1, so that each CTI generates a Debug request trigger event in response to an channel event on channel 2.

———— **Note** —————

In this example, *n* is 0.

When a PE has halted, clear the Debug request trigger event by writing a value of 1 to **CTIINTACK**[0], before restarting the PE.

Example H5-3 Synchronously restarting a group of PEs

To restart a group of PEs, for each PE in the group set:

1. **CTIGATE**[1] = 1, so that each CTI passes channel events on internal channel 1 to the CTM.
2. **CTIOUTEN**<n>[1] = 1, so that each CTI generates a Restart request trigger event in response to a channel event on channel 1.

———— **Note** —————

In this example, *n* is 1.

3. **CTIAPPULSE**[1] = 1 on any one PE in the group, to generate a channel event on channel 1.
-

Example H5-4 Halting a single PE on Performance Monitors overflow

To halt a single PE on a Performance Monitors overflow set:

1. **CTIGATE**[3] = 0, so that the CTI does not pass channel events on internal channel 3 to the CTM.
2. **CTIINEN**<n>[3] = 1, so that the CTI generates a channel event on channel 3 in response to a Performance Monitors overflow trigger event.

———— **Note** —————

In this example, *n* is 1.

3. `CTIOUTEN<n>[3] = 1`, so that the CTI generates a Debug request trigger event in response to a channel event on channel 3.

———— **Note** ————

In this example, *n* is 0.

When the PE has entered Debug state, clear the Debug request trigger event by writing 1 to `CTINTACK[0]`, before restarting the PE. Clear the overflow status by writing to `PMOVSCLR_ELO`.

Chapter H6

Debug Reset and Powerdown Support

This chapter describes the reset and powerdown support in the Debug architecture. It contains the following sections:

- *About Debug over powerdown* on page H6-4424.
- *Power domains and debug* on page H6-4425.
- *Core power domain power states* on page H6-4426.
- *Emulating low-power states* on page H6-4428.
- *Debug OS Save and Restore sequences* on page H6-4430.

———— **Note** —————

Where necessary, [Table J-1 on page AppxJ-5088](#) disambiguates the general register references used in this chapter.

H6.1 About Debug over powerdown

Debug over powerdown is a facility for an operating system to save and restore the PE state on behalf of a self-hosted or external debugger or both.

For external debug over powerdown, the architecture defines the OS Lock, OS Double Lock, and the logical split of the hardware on which a PE executes into the *Core power domain* and the *Debug power domain*. See:

- [Power domains and debug on page H6-4425](#).
- [Core power domain power states on page H6-4426](#).

H6.2 Power domains and debug

The external debug component of ARMv8-A has two logical power domains, each with its own reset:

- The debug power domain contains the interface between the PE and the external debugger, and is powered up whenever an external debugger is connected to the SoC. It remains powered up while the external debugger is connected. Registers in this domain are reset by an external debug reset.
- The core power domain contains the rest of the PE, and is allowed to power up and power down independently of the Debug power domain.

The core power domain contains several types of registers:

- Non-debug logic refers to all registers and logic that are not associated with debug.
- Self-hosted debug logic refers to registers and logic associated solely with the self-hosted debug aspects of the architecture.
- Shared debug logic refers to registers and logic associated with both the self-hosted and external debug aspects of the architecture.
- External debug logic refers to registers and logic associated solely with the external debug aspects of the architecture.

Note

- The model of two logical power domains has an impact on the reset and access permission requirements of the debug programmers' model.
- The power domains are described as logical because the architecture defines the requirements but does not require two physical power domains. Any power domain split that meets the requirements of the programmers' model is a valid implementation.

Figure H6-1 shows the recommended power domain split. The signals **DBGPWRUPREQ**, **DBGNOPWRDWN**, and **DBGPWRDUP** shown in Figure H6-1 provide an interface between the power controller and the PE debug logic that is in the debug power domain. They are part of the recommended interface. See [Appendix B Recommended External Debug Interface](#).

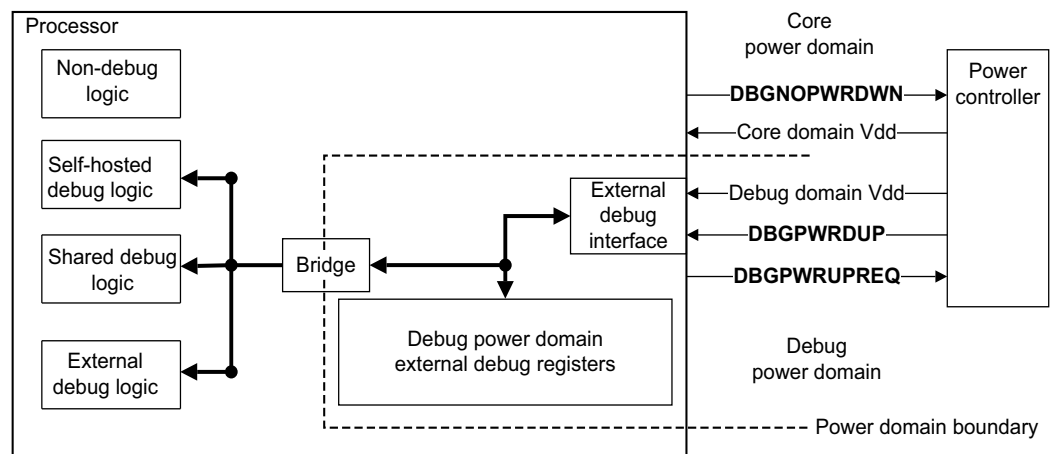

Figure H6-1 Recommended power domain split between core and debug power domains

H6.3 Core power domain power states

The ARM architecture does not define the power states of the PE as these are not normally visible to software. However, they are visible to the external debugger. The Debug architecture uses a four logical power states model for the core power domain. The four logical power states are as follows:

- Normal** The core power domain is fully powered on and the debug registers are accessible.
- Standby** The core power domain is on, but there are measures to reduce energy consumption. In a typical implementation, the PE enters standby by executing a WFI or WFE instruction, and exits on a wake-up event. There can be other IMPLEMENTATION DEFINED measures the OS can take to enter standby. The PE preserves the PE state, including the debug logic state. Changing from standby to normal operation does not involve a reset of the PE. Standby is the least invasive OS energy saving state. Standby implies only that the PE is unavailable and does not clear any debug settings. For standby, the debug architecture requires only the following:
- An External Debug Request debug event is a wake-up event when halting is allowed. This means that the PE must exit standby to handle the debug event. If the PE executed a WFE or a WFI instruction to enter standby, then it retires that instruction,
 - If the external debug interface is accessed, the PE must respond to that access. ARM recommends that, if the PE executed a WFI or WFE instruction to enter standby, then it does not retire that instruction.
- Standby is transparent, meaning that to software and to an external debugger it is indistinguishable from normal operation.
- Retention** The OS takes some measures, including IMPLEMENTATION DEFINED measures, to reduce energy consumption. The PE state, including debug settings, is preserved in low-power structures, allowing the core power domain to be at least partially turned off. Changing from low-power retention to normal operation does not involve a reset of the PE. The saved PE state is restored on changing from low-power retention state to normal operation. External Debug Request debug events stay pending and debug registers in the core power domain cannot be accessed.
- **Note** —————
- This model of retention does not include implementations where the PE exits the state in response to a debug register access. From the Debug architecture perspective, implementations like this are forms of standby.
- Powerdown** The OS takes some measures to reduce energy consumption by turning the core power domain off. These measures must include the OS saving any PE state, including the debug settings, that must be preserved over powerdown. Changing from powerdown to normal operation must include:
- A Cold reset of the PE after the power level has been restored.
 - The OS restoring the saved PE state.
- External Debug Request debug events stay pending and debug registers in the core power domain cannot be accessed.

The Debug architecture uses a simpler two states model for the Debug power domain. The two states are:

- Off** The debug power domain is turned off.
On The debug power domain is turned on.

The available power states, including the cross-product of core power domain and debug power domain power states is IMPLEMENTATION DEFINED. Implementations are not required to implement all of these states and might include additional states. These additional states must appear to the debugger as one of the logical power states defined by this model. The control of power states is IMPLEMENTATION DEFINED.

———— **Note** —————

As a result, it is IMPLEMENTATION DEFINED whether it is possible for the debug power domain to be on when the core power domain is off.

H6.4 Emulating low-power states

The control registers [DBGPRCR.CORENPDRQ](#) and [EDPRCR.COREPURQ](#) provide an interface between the power controller and the PE. They typically map directly to signals in the recommended external debug interface. With this interface the external debugger can request the power controller to:

- Emulate states where the core power domain is completely off or in a low-power state where the core power domain registers cannot be accessed. This simplifies the requirements on software by sacrificing entirely realistic behavior.
- Restore full power to the core power domain.

[EDPRSR.{SPD, PU}](#) indicates the core power domain power state. For more information see:

- [DBGPRCR_ELI, Debug Power Control Register on page D8-2093](#) and [DBGPRCR, Debug Power Control Register on page G4-4145](#).
- [EDPRCR, External Debug Power/Reset Control Register on page H9-4520](#).
- [EDPRSR, External Debug Processor Status Register on page H9-4523](#).
- [Appendix B Recommended External Debug Interface](#).

The measures to emulate powerdown are IMPLEMENTATION DEFINED. The ability of the debugger to access the state of the PE and the system might be limited as a result of the measures adopted.

In an emulated powerdown state, the debugger must be able to access all debug registers in both the debug power domain and the core power domain as if the core power domain were on. That is, the debugger must be able to read and write to such registers without receiving errors. This allows an external debugger to debug the powerup sequence. To stop the OS Double Lock preventing access to debug registers when powerdown is being emulated, `DoubleLockStatus() == FALSE` when [DBGPRCR.CORENPDRQ == 1](#).

Otherwise, the behavior of the PE in emulated powerdown must be similar to that in a real powerdown state. In particular, the PE must not respond to other system stimuli, such as interrupts.

[Example H6-1](#) and [Example H6-2](#) are examples of two approaches to emulating powerdown.

Example H6-1 An example of emulating powerdown

The PE is held in Standby state, isolated from any system stimuli. It is IMPLEMENTATION DEFINED whether the PE can respond to debug stimuli such as an External Debug Request debug event.

If the PE can enter Debug state, then the external debugger is able to use the ITR to execute instructions, such as loads and stores. This causes the external debugger to interact with the system. If the external debugger restarts the PE, the PE leaves Standby state and restarts fetching instructions from memory.

Example H6-2 Another example of emulating powerdown

The PE is held in Warm reset. This limits the ability of an external debugger to access the resources of the PE. For example, the PE cannot be put into Debug state.

On exit from emulated powerdown the PE is reset. However, the debug registers that are only reset by a Cold reset must not be reset. Typically this means that a Warm reset is substituted for the Cold reset.

Note

- Warm reset and Cold reset have different effects apart from resetting the debug registers. In particular, [RMR_ELx](#) is reset by a Cold reset and controls the reset state on a Warm reset. This means that if a Cold reset is substituted by a Warm reset, the behavior of the reset code might be different.
- The timing effects of powering down are typically not factored in the powerdown emulation. Examples of these timing effects are clock and voltage stabilization.

- Emulation does not model the state lost during powerdown, meaning that it might mask errors in the state storage and recovery routines.
-

H6.5 Debug OS Save and Restore sequences

In ARMv8-A, the following registers provide the OS Save and restore mechanism:

- The *OS Lock Access Register*, [OSLAR](#), locks the OS Lock to restrict access to debug registers before starting an OS Save sequence, and unlocks the OS Lock after an OS Restore sequence.
- The *OS Lock Status Register*, [OSLSR](#), shows the status of the OS Lock.
- The *External Debug Execution Control Register*, [EDECR](#), can be configured to generate a debug event when the OS Lock is unlocked.
- The *OS Double Lock Register*, [OSDLR](#), locks out an external debug interface entirely. This is only used immediately before a powerdown sequence.

See also:

- [Reset and debug on page H8-4463](#)
- [Appendix D Example OS Save and Restore sequences](#)

H6.5.1 Debug registers to save over powerdown

[Table H6-1](#) shows the different requirements for self-hosted debug over powerdown and external debug over powerdown:

- The column labeled Self-hosted lists registers that software must preserve over powerdown so that it can support self-hosted debug over powerdown. This does not require use of the OS Save and Restore mechanism.
- The column labeled External lists registers that software must preserve over powerdown so that it can support external debug over powerdown. This requires use of the OS Save and Restore mechanism:
 - Some external debug registers are not normally accessible to software executing on the PE. Additional debug registers are provided that give software the required access to save and restore these external debug registers when [OSLSR.OSLK](#) is locked. These registers include [OSECCR](#), [OSDTRRX](#), and [OSDTRTX](#).
- Some registers might only present in some implementations, or might not be accessible at all Exception levels or in Non-secure state. [DBGVCR32_EL2](#) and [SDER32_EL3](#) are only required to support AArch32.

[Table H6-1](#) does not include registers for the OPTIONAL Trace and Performance Monitor extensions.

Table H6-1 Debug registers to save over powerdown

Register in AArch64	Register in AArch32	Self-hosted	External
MDCR_EL1	DBGDSCRext	Yes	Yes ^a
DBGBVR<n>_EL1	DBGBVR<n>	Yes	Yes
DBGBCR<n>_EL1	DBGBCR<n>	Yes	Yes
DBGWVR<n>_EL1	DBGWVR<n>	Yes	Yes
DBGWCR<n>_EL1	DBGWCR<n>	Yes	Yes
DBGVCR32_EL2	DBGVCR	Yes	-
MDCR_EL2	HDCR	Yes	-
SDER32_EL3	SDER	Yes	-
MDCR_EL3	SDCR	Yes ^b	-
MDCCINT_EL1	DBGDCCINT	-	Yes ^b

Table H6-1 Debug registers to save over powerdown (continued)

Register in AArch64	Register in AArch32	Self-hosted	External
DBGCLAIMSET_EL1 DBGCLAIMCLR_EL1	DBGCLAIMSET, DBGCLAIMCLR	-	Yes ^c
OSECCR_EL1	DBGOSECCR	-	Yes ^{ab}
OSDTRRX_EL1 OSDTRTX_EL1	DBGDTRRXext DBGDTRTXext	-	Yes

- a. The OS Lock must be locked to save and restore for external debug. When the OS Lock is locked, **DSCR** is part of the software save and restore mechanism for external debug. It provides a mechanism for an operating system to access some fields of **EDSCR** that are otherwise read-only or not visible to software. This allows the operating system to save and restore these settings over a powerdown for the external debugger.
- b. This register is new in ARMv8-A. Sequences written for ARMv7 do not preserve the register over powerdown.
- c. Read **DBGCLAIMCLR** to save, write **DBGCLAIMSET** to restore.

H6.5.2 OS Save sequence

To preserve the debug logic state over a powerdown, the state must be saved to nonvolatile storage. This means the OS Save sequence must:

1. Lock the OS Lock by:
 - Writing the key value 0xC5ACCE55 to the **DBGOSLAR** in AArch32 state.
 - Writing 1 to **OSLAR_EL1.OSLK** in AArch64 state.
2. Execute an ISB instruction.
3. Walk through the debug registers listed in *Debug registers to save over powerdown on page H6-4430* and save the values to the nonvolatile storage.

Before removing power from the core power domain, software must:

1. Lock the OS Double Lock by writing 1 to **OSDLR_EL1.DLK**.
2. Execute a context synchronization operation.

H6.5.3 OS Restore sequence

After a powerdown, the OS Restore sequence must perform the following steps to restore the debug logic state from the non-volatile storage:

1. Lock the OS Lock, as described in *Debug registers to save over powerdown on page H6-4430*. The OS Lock is generally locked by the Cold reset, but this step ensures that it is locked.
2. Execute an ISB instruction.
3. Walk through the debug registers listed in *Debug registers to save over powerdown on page H6-4430*, and restore the values from the nonvolatile storage.
4. Execute an ISB instruction.
5. Unlock the OS Lock by:
 - Writing any non-key value to **DBGOSLAR** in AArch32 state.
 - Writing 0 to **OSLAR_EL1.OSLK** in AArch64 state.
6. Execute a context synchronization operation.

———— **Note** ————

The OS Restore sequence overwrites the debug registers with the values that were saved. If there are valid values in these registers immediately before the restore sequence, then those values are lost.

H6.5.4 Debug behavior when the OS Lock is locked

The main purpose of the OS Lock is to prevent updates to debug registers during an OS Save or OS Restore operation. The OS Lock is locked on a Cold reset.

When the OS Lock is locked:

- Access to debug registers through the system register interface is mainly unchanged except that:
 - Certain registers are read and written without side-effects.
 - Fields in [DSCR](#) and [OSECCR](#) that are normally read-only become read/write.This allows the state to be saved or restored. For more information, see the relevant register description in [Chapter H9 External Debug Register Descriptions](#).
- Access to debug registers by the external debug interface is restricted to prevent an external debugger modifying the registers that are being saved or restored. For more information see [External debug interface register access permissions summary on page H8-4453](#).
- Debug exceptions, other than Software Breakpoint Instruction exceptions are not generated.

The OS Lock has no effect on Software Breakpoint Instruction debug events and Halting debug events.

H6.5.5 Debug behavior when the OS Lock is unlocked

When the OS Lock is unlocked, an OS Unlock Catch debug event is generated if [EDEC.R.OUCE](#) is set to 1. See [OS Unlock Catch debug event on page H3-4381](#).

H6.5.6 Debug behavior when the OS Double Lock is locked

The OS Double Lock is locked immediately before a powerdown sequence. The OS Double Lock ensures that it is safe to remove core power by forcing the debug interfaces to be quiescent.

When `DoubleLockStatus() == TRUE`:

- The external debug interface only has restricted access to the debug registers, so that it is quiescent before removing power. See [External debug interface register access permissions summary on page H8-4453](#).
- Debug exceptions, other than Software Breakpoint Instruction exceptions, are not generated.
- Halting is prohibited. See [Halting allowed and halting prohibited on page H2-4329](#).

———— **Note** ————

Pending Halting debug events might be lost when core power is removed.

- No asynchronous debug events are WFI or WFE wake-up events.

Software must synchronize the update to [OSDLR](#) before it indicates to the system that core power can be removed. The interface between the PE and its power controller is IMPLEMENTATION DEFINED.

Typically software indicates that core power can be removed by entering the Wait For Interrupt state. This means that software must explicitly synchronize the [OSDLR](#) update before issuing the WFI instruction.

[OSDLR.DLK](#) is ignored and `DoubleLockStatus() == FALSE` if either:

- The PE is in Debug state.
- [DBGPRCR.CORENPDRQ](#) is set to 1.

———— **Note** ————

It is possible to enter Debug state with `OSDLR.DLK` set to 1. This is because a context synchronization operation is required to ensure the OS Double Lock is locked, meaning that Debug state might be entered before the `OSDLR` update is synchronized.

As the purpose of the OS Double Lock is to ensure that it is safe to remove core power, it is important to avoid race conditions that defeat this purpose. ARM recommends that:

- Once the write to `OSDLR.DLK` has been synchronized by a *Context synchronization operation* and `DoubleLockStatus() == TRUE`, a PE must:
 - Not allow a debug event generated before the *Context synchronization operation* to cause an entry to Debug state or act as a wake-up event for a WFI or WFE instruction after the context synchronization operation has completed.
 - Complete any external debug access started before the *Context synchronization operation* by the time the context synchronization operation completes.

———— **Note** ————

A debug register access might be in progress when software sets `OSDLR.DLK` to 1. An implementation must not permit the synchronization of locking the OS Double Lock to stall indefinitely while waiting for that access to complete. This means that any debug register access that is in progress when software sets `OSDLR.DLK` to 1 must complete or return an error in finite time.

- If a write to `DBGPRCR` or `EDPRCR` made when `OSDLR.DLK == 1` changes `DBGPRCR.CORENPDRQ` or `EDPRCR.CORENPDRQ` from 1 to 0, meaning `DoubleLockStatus()` changes from `FALSE` to `TRUE`, then before signaling to the system that the `CORENPDRQ` field has been cleared and emulation of powerdown is no longer requested, meaning the system can remove core power, the PE must ensure that all the requirements for `DoubleLockStatus() == TRUE` listed in this section are met.

In the standard OS Save sequence, the OS Lock is locked before the OS Double Lock is locked. This means that writes to `CORENPDRQ` are ignored by the time the OS Double Lock is locked. However, if `DoubleLockStatus() == FALSE`, an external debugger can clear the OS Lock at any time, and then write to `EDPRCR`.

The pseudocode for the `DoubleLockStatus()` function is as follows:

```
// DoubleLockStatus()
// =====

boolean DoubleLockStatus()
// Returns the value of EDPRSR.DLK:
// FALSE if OSDLR_EL1.DLK == 0 or DBGPRCR_EL1.CORENPDRQ == 1 or the processor is in Debug state.
// TRUE if OSDLR_EL1.DLK == 1 and DBGPRCR_EL1.CORENPDRQ == 0 and the processor is in Non-debug
// state.
return OSDLR_EL1.DLK == '1' && DBGPRCR_EL1.CORENPDRQ == '0' && !Halted();
```

Chapter H7

The Sample-based Profiling Extension

This chapter describes the Sample-based Profiling extension, that is an OPTIONAL extension to the ARMv8 architecture. The extension provides a non-invasive external debug component.

———— **Note** ————

This form of the Sample-based Profiling extension is OPTIONAL. ARM recommends that if extension [EDPCSR](#) is not implemented that an alternative IMPLEMENTATION DEFINED form of Sample-based Profiling is implemented.

It contains the following section:

- [Sample-based profiling on page H7-4436.](#)

H7.1 Sample-based profiling

Sample-based profiling is an OPTIONAL extension to the architecture. It provides a mechanism for coarse-grained profiling of software executing on the PE by an external debugger, without changing the behavior of that software. The following sections describe this extension:

- [The implemented Sample-based profiling registers](#)
- [Reads of the External Debug Program Counter Sampling Registers](#)
- [Reads of the External Debug Virtual Context Sample Register on page H7-4437](#)
- [Accuracy of sampling on page H7-4437](#)
- [Sample-based Profiling and security on page H7-4438](#)
- [Pseudocode details of Sample-based Profiling on page H7-4438](#)

H7.1.1 The implemented Sample-based profiling registers

An implementation that includes the Sample-based profiling extension implements the following external debug registers:

- **EDPCSR** is a 64-bit read-only register that contains a sampled program counter value. As external debug register accesses are atomic only at word granularity, **EDPCSR** is split into two registers: **EDPCSRhi** and **EDPCSRlo**. See [Reads of the External Debug Program Counter Sampling Registers](#).
- **EDCIDSR** is a read-only register that contains the sampled value of **CONTEXTIDR_EL1** captured on reading **EDPCSRlo**.

———— **Note** —————

If EL3 is implemented and using AArch32 then **CONTEXTIDR** is a Banked register and **EDCIDSR** samples the current Banked copy of **CONTEXTIDR**.

- **EDVIDSR** is a read-only register that contains sampled values captured on reading **EDPSRlo**. If neither EL3 nor EL2 are implemented, **EDVIDSR** is not implemented.

H7.1.2 Reads of the External Debug Program Counter Sampling Registers

A read of the **EDPCSRlo** normally has the side-effect of indirectly writing to **EDCIDSR**, **EDVIDSR**, and **EDPCSRhi**. When **EDPCSRlo** is read, the bottom 32 bits of a program counter sample are returned. The top 32 bits are captured in **EDPCSRhi** and can be read later. However:

- If the PE is in Debug state, or Sample-based Profiling is prohibited, **EDPCSRlo** reads as `0xFFFFFFFF` and **EDCIDSR**, **EDVIDSR** and **EDPCSRhi** become UNKNOWN. See [Sample-based Profiling and security on page H7-4438](#).
- If the PE is in Reset state, the sampled value is UNKNOWN and **EDCIDSR**, **EDVIDSR** and **EDPCSRhi** become UNKNOWN.
- If no instruction has been retired since the PE left Reset state, Debug state, or a state where Sample-based Profiling is prohibited, the sampled value is UNKNOWN and **EDCIDSR**, **EDVIDSR** and **EDPCSRhi** become UNKNOWN.
- The indirect writes to **EDCIDSR**, **EDVIDSR**, and **EDPCSRhi** might not occur for a memory-mapped access to the external debug interface. For more information, see [Memory-mapped accesses to the external debug interface on page H8-4449](#).

———— **Note** —————

In ARMv7 the Sample-based Profiling extension an offset was applied to the sampled program counter value and this offset and the instruction set state indicated in bits [1:0] of the sampled value. In the ARMv8 Sample-based Profiling extension, the sampled value is the address of an instruction that has executed, with no offset and no indication of the instruction set state.

H7.1.3 Reads of the External Debug Virtual Context Sample Register

A read of the [EDVIDSR](#) contains sampled values captured on reading [EDPSRlo](#), where:

- [EDVIDSR.NS](#) indicates the security state associated with the most recent [EDPCSR](#) sample.
- [EDVIDSR.E2](#) indicates whether the most recent [EDPCSR](#) sample was associated with EL2. If [EDVIDSR.NS](#) == 0, this bit is 0.
- [EDVIDSR.E3](#) indicates whether the most recent [EDPCSR](#) sample was associated with EL3 using AArch64. If [EDVIDSR.NS](#) == 1 or the PE was in AArch32 state when [EDPSRlo](#) was read, this bit is 0.
- [EDVIDSR.HV](#) indicates whether [EDPCSRhi](#) is valid, that is, bits [63:32] of the most recent program counter sample are non-zero.

———— **Note** —————

- [EDVIDSR.HV](#) == 1 does not mean that [EDPCSRhi](#) != 0. [EDVIDSR.HV](#) == 0 is a hint that [EDPCSRhi](#) does not need to be read.
- Tools must take care to avoid skewing sampled data by over-sampling code for which [EDVIDSR.HV](#) == 0.

- [EDVIDSR.VMID](#) indicates the value of the [VTTBR_EL2.VMID](#) register associated with the most recent [EDPSRlo](#) sample. If [EDVIDSR.NS](#) == 0 or [EDVIDSR.E2](#) == 1, this field is RAZ.

If EL2 is not implemented, [EDVIDSR.E2](#) and [EDVIDSR.VMID](#) are RES0.

If EL3 is not implemented, [EDVIDSR.E3](#) is RES0, and [EDVIDSR.NS](#) has a fixed read-only value.

H7.1.4 Accuracy of sampling

Sample-based Profiling is provided as a mechanism for tools to populate a statistical model of the performance of software executing on the PE. The statistical data returned by random sampling of [EDPCSR](#), [EDCIDSR](#), and [EDVIDSR](#) must allow such statistical modeling.

It must be possible to sample references to branch targets. It is IMPLEMENTATION DEFINED whether references to other instructions can be sampled. The branch target for a conditional branch instruction that fails its condition check is the instruction that follows the conditional branch instruction. The branch target for an exception is the exception vector address.

To keep the implementation and validation cost low, a reasonable degree of inaccuracy in the sampled data is acceptable. ARM does not define *a reasonable degree of inaccuracy* but recommends the following guidelines:

- Under normal operating conditions, the whole sample, [EDPCSR](#), [EDCIDSR](#), and [EDVIDSR](#), must reference an instruction, including its context.
- In exceptional circumstances, such as a change in security state or other boundary condition, it is acceptable for the sample to represent an instruction that was not committed for execution.
- Under very unusual non-repeating pathological cases the sample can represent an instruction that was not committed for execution. These cases are likely to occur as a result of asynchronous exceptions, such as interrupts, where the chance of a systematic error in sampling is very unlikely.

See also *Non-invasive behavior* on page D6-1824.

H7.1.5 Sample-based Profiling and security

Sample-based Profiling is a non-invasive external debug component, controlled by an IMPLEMENTATION DEFINED authentication interface. Sample-based Profiling is prohibited unless both:

- Allowed by the IMPLEMENTATION DEFINED authentication interface `ExternalNoninvasiveDebugEnabled()`
- Any one of:
 - Executing in Non-secure state.
 - EL3 is not implemented.
 - EL3 is implemented, executing in Secure state, and allowed by the IMPLEMENTATION DEFINED authentication interface `ExternalSecureNoninvasiveDebugEnabled()`.
 - EL3 is implemented, EL3 or EL1 is using AArch32, executing at EL0 in Secure state, and `SDER32_EL3.SUNIDEN == 1`.

The state of IMPLEMENTATION DEFINED authentication interface is visible through `DBGAUTHSTATUS_EL1`.

See also [Appendix B Recommended External Debug Interface](#).

H7.1.6 Pseudocode details of Sample-based Profiling

`PCSample()` records a PC sample for the EDPCSR and associated registers.

```
type PCSample is (
    boolean valid,
    bits(64) pc,
    bits(2) el,
    bit rw,
    bit ns,
    bits(32) contextidr,
    bits(8) vmid
)

PCSample pc_sample;
// CreatePCSample()
// =====

CreatePCSample()
// In a simple sequential execution of the program, CreatePCSample is executed each time the PE
// executes an instruction that can be sampled. An implementation is not constrained such that
// reads of EDPCSRlo return the current values of PC, etc.
enabled = (if IsSecure() then ExternalSecureNoninvasiveDebugEnabled()
           else ExternalNoninvasiveDebugEnabled());

pc_sample.valid = enabled && !Halted();
pc_sample.pc = ThisInstrAddr();
pc_sample.el = PSTATE.EL;
pc_sample.rw = if UsingAArch32() then '0' else '1';
pc_sample.ns = if IsSecure() then '0' else '1';
pc_sample.contextidr = CONTEXTIDR_GEN[];
pc_sample.vmid = VTTBR_EL2.VMID;

return;

// EDPCSRlo[] (read)
// =====

bits(32) EDPCSRlo[]

if pc_sample.valid then
    sample = pc_sample.pc<31:0>;
    EDPCSRhi = (if pc_sample.rw == '0' then Zeros(32) else pc_sample.pc<63:32>);
    EDCIDSR = pc_sample.contextidr;
    EDVIDSR.VMID = (if HaveEL(EL2) && pc_sample.ns == '1' && pc_sample.el IN {EL1,EL0}
                   then pc_sample.vmid else Zeros(8));
```

```
EDVIDSR.NS = pc_sample.ns;
EDVIDSR.E2 = (if pc_sample.el == EL2 then '1' else '0');
EDVIDSR.E3 = (if pc_sample.el == EL3 then '1' else '0') AND pc_sample.rw;
// The conditions for setting HV are not specified if PCSRhi is zero.
// An example implementation may be "pc_sample.rw".
EDVIDSR.HV = (if !IsZero(EDPCSRhi) then '1' else bit IMPLEMENTATION_DEFINED "0 or 1");
else
    sample = Ones(32);
    EDPCSRhi = bits(32) UNKNOWN;
    EDCIDSR = bits(32) UNKNOWN;
    EDVIDSR = (bits(4) UNKNOWN):Zeros(20):(bits(8) UNKNOWN);

return sample;
```

Chapter H8

About the External Debug Registers

This chapter provides some additional information about the external debug registers. It contains the following sections:

- *Relationship between external debug and System registers* on page H8-4442.
- *Supported access sizes* on page H8-4444.
- *Synchronization of changes to the external debug registers* on page H8-4445.
- *Memory-mapped accesses to the external debug interface* on page H8-4449.
- *External debug interface register access permissions* on page H8-4451.
- *External debug interface registers* on page H8-4456.
- *Cross-trigger interface registers* on page H8-4461.
- *Reset and debug* on page H8-4463.
- *External debug register resets* on page H8-4465.

———— **Note** —————

Where necessary [Table J-1 on page AppxJ-5088](#) disambiguates the general register references used in this chapter.

H8.1 Relationship between external debug and System registers

Table H8-1 shows the relationship between external debug registers and system registers. Where no relationship exists, the registers are not listed.

Table H8-1 Equivalence between external debug and System registers

External debug register	System register		Notes	
	AArch64	AArch32		
DBGDTRRX_EL0	DBGDTRRX_EL0	DBGDTRRXint	See also <i>Summary of system register accesses to the DCC</i> on page H4-4398	
DBGDTRTX_EL0	DBGDTRTX_EL0	DBGDTRTXint		
OSLAR_EL1	OSLAR_EL1	DBGOSLAR	-	
DBGBVR<n>_EL1[31:0]	DBGBVR<n>_EL1[31:0]	DBGBVR<n>	-	
DBGBVR<n>_EL1[63:32]	DBGBVR<n>_EL1[63:32]	DBGBXVR<n>		
DBGBCR<n>_EL1	DBGBCR<n>_EL1	DBGBCR<n>	-	
DBGWVR<n>_EL1[31:0]	DBGWVR<n>_EL1[31:0]	DBGWVR<n>	-	
DBGWVR<n>_EL1[63:32]	DBGWVR<n>_EL1[63:32]			
DBGWCR<n>_EL1	DBGWCR<n>_EL1	DBGWCR<n>	-	
DBGCLAIMSET_EL1	DBGCLAIMSET_EL1	DBGCLAIMSET	-	
DBGCLAIMCLR_EL1	DBGCLAIMCLR_EL1	DBGCLAIMCLR	-	
DBGAUTHSTATUS_EL1	DBGAUTHSTATUS_EL1	DBGAUTHSTATUS	Read-only	
EDSCR	MDSCR_EL1	DBGDSCRext	Only some fields map	
EDECCR	OSECCR_EL1	DBGOSECCR	Applies when the OS Lock is locked.	
MIDR_EL1	MIDR_EL1	MIDR	Read-only copies of Processor ID Registers	
ID_AA64DFR0_EL1	ID_AA64DFR0_EL1	-		
ID_AA64DFR1_EL1	ID_AA64DFR1_EL1			
ID_AA64ISAR0_EL1	ID_AA64ISAR0_EL1			
ID_AA64ISAR1_EL1	ID_AA64ISAR1_EL1			
ID_AA64MMFR0_EL1	ID_AA64MMFR0_EL1			
ID_AA64MMFR1_EL1	ID_AA64MMFR1_EL1			
ID_AA64PFR0_EL1	ID_AA64PFR0_EL1			
ID_AA64PFR1_EL1	ID_AA64PFR1_EL1			
EDDEVAFF0	MPIDR_EL1[31:0] ^a	MPIDR		Read-only copies of system ID registers
EDDEVAFF1	MPIDR_EL1[63:32] ^a			

a. This is a word of a 64-bit register.

In addition:

- [EDSCR](#).{TXfull, RXfull} are read-only aliases for [DCCSR](#).{TXfull, RXfull}.
- [EDPRCR](#).CORENPDRQ is a read/write alias for [DBGPRCR](#).CORENPDRQ.
- [EDPRSR](#).OSLK is a read-only alias for [OSLSR](#).OSLK.

- [EDPRSR.DLK](#) is a read-only function of [OSLSR.DLK](#).

H8.2 Supported access sizes

The memory access sizes supported by any peripheral is IMPLEMENTATION DEFINED by the peripheral. For accesses to the debug registers, Performance Monitor registers, and CTI registers, implementations must support:

- Word-aligned 32-bit accesses to access 32-bit registers or either half of a 64-bit register mapped to a doubleword-aligned pair of adjacent 32-bit locations.
- Doubleword-aligned 64-bit accesses to access 64-bit registers mapped to a doubleword-aligned pair of adjacent 32-bit locations.

———— **Note** —————

This means that a system implementing the debug registers using a 32-bit bus, such as an AMBA™ APB3, with a wider system interconnect must implement a bridge between the system and the debug bus that can split 64-bit accesses.

All registers are only single-copy atomic at word granularity. This means that for 64-bit accesses to a 64-bit register, the system might generate a pair of 32-bit accesses. The order in which the two halves are accessed is not specified.

The following accesses are not supported:

- Byte.
- Halfword.
- Unaligned word. These accesses are not word single-copy atomic.
- Unaligned doubleword. These accesses are not doubleword single-copy atomic.
- Doubleword accesses to a pair of 32-bit locations that are not a doubleword-aligned pair forming a 64-bit register.
- Quadword or higher.
- Exclusive accesses.

For each of these access types, it is CONSTRAINED UNPREDICTABLE whether:

- The access generates an external abort or not.
- The defined side-effects of a read occur or not. A read returns UNKNOWN data.
- A write is ignored or sets the accessed register or registers to UNKNOWN.

For accesses from the external debug interface, the size of an access is determined by the interface. For an access from an ADIV5-compliant Memory Access Port, MEM-AP, this is specified by the MEM-AP CSW register.

See [Access sizes for memory-mapped accesses on page H8-4450](#).

H8.3 Synchronization of changes to the external debug registers

This section describes the synchronization requirements for the external debug interface.

For more information on how these requirements affect debug, see:

- [Synchronization and debug exceptions on page D2-1647.](#)
- [Synchronization and Halting debug events on page H3-4384.](#)
- [Synchronization of DCC and ITR accesses on page H4-4398.](#)

This section refers to accesses from the external debug interface as external reads and external writes. It refers to accesses to system registers as direct reads, direct writes, indirect reads, and indirect writes.

———— **Note** —————

[Synchronization requirements for system registers on page D8-1866](#) defines direct read, direct write, indirect read, and indirect write, and classifies external reads as indirect reads, and external writes as indirect writes.

Writes to the same register are serialized, meaning they are observed in the same order by all observers, although some observers might not observe all of the writes. With the exception of `DBGBCR<n>_EL1`, `DBGBVR<n>_EL1`, `DBGWCR<n>_EL1`, and `DBGWVR<n>_EL1`, external writes to different registers are not necessarily observed in the same order by all observers as the order in which they complete.

[Synchronization of DCC and ITR accesses on page H4-4398](#) describes the synchronization requirements for the DCC and ITR.

Changes to the IMPLEMENTATION DEFINED authentication interface are external writes to the authentication status registers by the master of the authentication interface. See [Synchronization and the authentication interface on page H8-4446](#).

Explicit synchronization is not required for an external read or an external write by an external agent to be observable to a following external read or external write by that agent to the same register using the same address, and so is never required for registers that are accessible only in the external debug interface.

Some registers are guaranteed to be observable to all observers in finite time, without explicit synchronization. For more information, see [Synchronization requirements for system registers on page D8-1866](#). Otherwise, explicit synchronization is normally required following an external write to any register for that write to be observable by:

- A direct access.
- An indirect read by an instruction.
- An external read of the register using a different address.

This means that an external write by an external agent is guaranteed to have an effect on subsequent instructions executed by the PE only if all of the following are true:

- The write has completed.
- The PE has executed a context synchronization operation.
- The context synchronization operation was executed after the write completed.

The order and synchronization of direct reads and direct writes of system registers is defined by [Synchronization requirements for system registers on page D8-1866](#).

The external agent must be able to guarantee completion of a write. For example by:

- Marking the memory as Device-nGnRnE and executing a DSB barrier, if the system supports this property.
- Reading back the value written.
- Some guaranteed property of the connection between the PE and the external agent.

———— **Note** —————

For an external Debug Access Port, this is an IMPLEMENTATION DEFINED property. For a CoreSight system using APB-AP to access a debug APB, a write is guaranteed to complete before the APB-AP allows a second APB transaction to complete.

The external agent and PE can guarantee ordering by, for example, passing messages in an ordered way with respect to the external write and the context synchronization operation, and relying on the memory ordering rules provided by the memory model.

External reads and external writes complete in the order in which they arrive at the PE. For accesses to different register locations the external agent must create this order by:

- Marking the memory as Device-nGnRnE or Device-nGnRE.
- Using the appropriate memory barriers.
- Some guaranteed property of the connection between the PE and the external agent.

———— **Note** —————

For an external Debug Access Port, this is an IMPLEMENTATION DEFINED property. For a CoreSight system using APB-AP to access a debug APB, accesses complete in order.

However, the external agent cannot force synchronization of completed writes without halting the PE. Executing an ISB instruction, either in Debug state or in Non-debug state, and exiting from Debug state forces synchronization. If the PE is in Debug state, executing an ISB instruction is guaranteed to explicitly synchronize any external reads, external writes, and changes to the authentication interface that are ordered before the external write to [EDITR](#).

For any given observer, external writes to the following register groups are guaranteed to be observable in the same order in which they complete:

- The breakpoint registers, [DBGBCR<n>_EL1](#) and [DBGBVR<n>_EL1](#).
- The watchpoint registers, [DBGWCR<n>_EL1](#) and [DBGWVR<n>_EL1](#).

This guarantee only applies to external writes to registers within one of these groups. There is no guarantee regarding the ordering of the observability of external writes within these groups with respect to external writes to registers, for example [EDSCR](#), or between breakpoints and watchpoints, including watchpoints linked to context matching breakpoints.

———— **Note** —————

This means that a debugger can rely on the external writes to be observed in the same order in which they complete. It does not mean that a debugger can rely on the external writes being observed in finite time.

In a simple sequential execution an indirect write that occurs as a side-effect of an access happens atomically with the access, meaning no other accesses are allowed between the register access and its side-effect.

If two or more interfaces simultaneously access a register, the behavior must be as if the accesses occurred atomically and in any order. This is described in [Examples of the synchronization of changes to the external debug registers](#) on page H8-4447.

Some registers have the property that for certain bits a write of 0 is ignored and a write of 1 has an effect. This means that simultaneous writes must be merged. Registers that have this property and support both external debug and system register access include [DBGCLAIMSET_EL1](#), [DBGCLAIMCLR_EL1](#), [PMCR_ELO](#).{C,P}, [PMOVSET_ELO](#), [PMOVCLR_ELO](#), [PMCNTENSET_ELO](#), [PMCNTENCLR_ELO](#), [PMINTENSET_EL1](#), [PMINTENCLR_EL1](#), and [PMSWINC_ELO](#). This last register is OPTIONAL and deprecated in the external debug interface.

H8.3.1 Synchronization and the authentication interface

Changes to the authentication interface are indirect writes to the Authentication Status registers by the master of the authentication interface. For each of these Authentication Status registers, it is IMPLEMENTATION DEFINED whether a change on the authentication interface is guaranteed to be observable to an external debug interface read of the register only after a context synchronization operation or in finite time.

For [DBGAUTHSTATUS_EL1](#), a change on the authentication interface is guaranteed to be observable to a system register read of [DBGAUTHSTATUS_EL1](#) only after a context synchronization operation.

H8.3.2 Examples of the synchronization of changes to the external debug registers

Example H8-1, Example H8-2, and Example H8-3 show the synchronization of changes to the external debug registers.

Example H8-1 Order of synchronization of Breakpoint and Watchpoint register writes

Initially `DBGBVR<n>_EL1` is `0x8000` and `DBGBCR<n>_EL1` is `0x0181`. This means that a breakpoint is enabled on the halfword T32 instruction at address `0x8000`.

A sequence of external writes occurs in the following order:

1. `0x0000` is written to `DBGBCR<n>_EL1`, disabling the breakpoint.
2. `0x9000` is written to `DBGBVR<n>_EL1[31:0]`.
3. `0x0061` is written to `DBGBCR<n>_EL1`, enabling a breakpoint on the halfword at address `0x9002`.

The external writes must be observable to indirect reads in the same order as the external writes complete. This means that at no point is there a breakpoint enabled on either of the halfwords at address `0x8002` and `0x9000`.

Similarly a breakpoint or watchpoint must be disabled:

- If both halves of a 64-bit address have to be updated.
 - If any of the `DBGBCR<n>_EL1` or `DBGWCR<n>_EL1` fields are modified at the same time as updating the address.
-

Example H8-2 Simultaneous accesses to DTR registers

Initially `EDSCR.{TXfull, TXU, ERR}` are 0. Then:

- `0x0DCCDA7A` is directly written to `DBGDTRTX_EL0` by an MSR instruction.
- `DBGDTRTX_EL0` is indirectly read by the external debug interface.

These accesses might happen at the same time and in any order.

If the direct write of `0x0DCCDA7A` to `DBGDTRTX_EL0` is handled first, then:

- The external debug interface read of `DBGDTRTX_EL0` clears `EDSCR.TXfull` to 0.
- `EDSCR.{TXU, ERR}` are unchanged.
- The external debug interface read returns `0x0DCCDA7A`.

If the indirect read of `DBGDTRTX_EL0` by the external debug interface is handled first, then:

- The external debug interface read of `DBGDTRTX_EL0` causes an underrun and as a result `EDSCR.{TXU, ERR}` are both set to 1.
 - The external debug interface returns an UNKNOWN value.
 - Writing `0x0DCCDA7A` to `DBGDTRTX_EL0` sets `DTRTX` to `0x0DCCDA7A` and `EDSCR.TXfull` to 1.
-

Example H8-3 Simultaneous writes to CLAIM registers

Initially all CLAIM tag bits are 0. Then:

- `0x01` is written to `DBGCLAIMSET_EL1` by a direct write, followed by an explicit context synchronization operation.
- `0x02` is written to `DBGCLAIMSET_EL1` by an external write.

These events might happen at the same time and in either order.

After this:

- `DBGCLAIMCLR_EL1` is read by a direct read.

- [DBGCLAIMCLR_EL1](#) is read by an external read.

In this case, a direct read can return either 0x01 or 0x03, and the external read can return either 0x02 or 0x03.

The only permitted final result for the CLAIM tags is the value 0x03, because this would be the result regardless of whether 0x01 or 0x02 is written first. This is because the external write is guaranteed to be observable to a direct read in finite time. See [Synchronization requirements for system registers on page D8-1866](#).

It is not possible for a direct read to return 0x01 and the external read to return 0x02, because the writes to [DBGCLAIMCLR_EL1](#) are serialized.

In the following scenario, there is only one permitted result. Both observers observe the value 0x03, and then, at the same time, two writes occur:

- 0x04 is written to [DBGCLAIMSET_EL1](#) by a direct write, followed by an explicit context synchronization operation.
- 0x01 is written to [DBGCLAIMCLR_EL1](#) by an external write.

In this case only permitted final result for the CLAIM tags is the value 0x06.

H8.4 Memory-mapped accesses to the external debug interface

Support for memory-mapped access to the external debug interface is OPTIONAL.

If the external debug interface is CoreSight compliant, then an OPTIONAL Software Lock can be implemented for memory-mapped accesses to each component. The Software Locks are controlled by [EDLSR](#) and [EDLAR](#), [PMLSR](#) and [PMLAR](#), and [CTILSR](#) and [CTILAR](#). See *Management registers and CoreSight compliance on page AppxB-4782*.

With the exception of these registers and the effect of the Software Lock, the behavior of the memory-mapped accesses is the same as for other accesses to the external debug interface.

———— Note —————

The recommended memory-mapped accesses to the external debug interface are not compatible with the memory-mapped interface defined in ARMv7. In particular:

- The memory map is different.
- Memory-mapped accesses do not behave differently to Debug Access Port accesses when [OSLSR.OSLK == 1](#), meaning that the OS Lock is locked.

H8.4.1 Register access permissions for memory-mapped accesses

It is IMPLEMENTATION DEFINED whether unprivileged memory-mapped accesses are allowed. Privileged software is responsible for controlling memory-mapped accesses using the MMU.

If memory-mapped accesses are made through an ADiv5 interface, the Debug Access Port can block the access using [DBGSWENABLE](#). This is outside the scope of the ARMv8-A architecture. See *ARM® Debug Interface Architecture Specification ADiv5.0 to ADiv5.2*.

Effect of the OPTIONAL Software Lock on memory-mapped access

For memory-mapped accesses, if other controls permit access to a register, the OPTIONAL Software Lock is implemented, and [EDLSR.SLK](#), [PMLSR.SLK](#), or [CTILSR.SLK](#) is set to 1, meaning the Software Lock is locked, then with the exception of the LAR itself:

- If other controls permit access to a register, then writes are ignored. That is:
 - Read/write (RW) registers become read-only (RO).
 - Write-only (WO) registers become write-ignored (WI).
- Reads and writes have no side-effects. A side-effect is where a direct read or a direct write of a register creates an indirect write of the same or another register. When the Software Lock is locked, the indirect write does not occur.
- Writes to [EDLAR](#), [PMLAR](#), and [CTILAR](#) are unaffected.

This behavior must also apply to all IMPLEMENTATION DEFINED registers.

For example, if [EDLSR.SLK](#) is set to 1:

- [EDSCR](#).{TXfull, TXU, ERR} are unchanged by a memory-mapped read from [DBGDTRTX_ELO](#).
- [EDSCR](#).{RXfull, RXO, ERR} are unchanged by a memory-mapped write to [DBGDTRRX_ELO](#) that is ignored.
- [EDSCR](#).{ITE, ITO, ERR} are unchanged by a memory-mapped write to [EDITR](#) that is ignored.
- [OSLSR.OSLK](#) is unchanged by a memory-mapped write to [OSLAR_EL1](#) that is ignored.
- [EDPCSR](#)[63:32], [EDCIDS](#)R, and [EDVIDSR](#) are unchanged by a memory-mapped read from [EDPCSR](#)[31:0].

- [EDPRSR](#).{SDR, SPMAD, SDAD, SR, SPD} are unchanged by a memory-mapped read from [EDPRSR](#).
- [EDPRSR](#).SDAD is not set if an error response is returned due to a memory-mapped read or write of any debug register as the result of the value of the EDAD field.
- The CLAIM tags are unchanged by memory-mapped writes to [DBGCLAIMSET_EL1](#) and [DBGCLAIMCLR_EL1](#) which are ignored.

Similarly, if [PMLSR](#).SLK is set to 1, then [EDPRSR](#).SPMAD is not set if an error response is returned to a memory-mapped read or write of any Performance Monitors register due to the value of the EPMAD field.

Behavior of a not permitted memory-mapped access

Where the architecture requires that an external debug interface access generates an error response, a memory-mapped access must also generate an error response. However, it is IMPLEMENTATION DEFINED how the error response is handled, as this depends on the system.

ARM recommends that the error is returned as either:

- A synchronous external Data Abort.
- A System Error interrupt.

H8.4.2 Synchronization of memory-mapped accesses to external debug registers

The synchronization requirements for memory-mapped accesses to the external debug interface is described in [Synchronization of changes to the external debug registers on page H8-4445](#).

The synchronization requirements between different routes to the external debug interface, that is, between Debug Access Port accesses and memory-mapped accesses are IMPLEMENTATION DEFINED.

H8.4.3 Access sizes for memory-mapped accesses

For memory-mapped accesses from a PE that complies with an ARM architecture, the single-copy atomicity rules for the instruction, the type of instruction, and the type of memory accessed, determine the size of the access made by an instruction. [Example H8-4](#) shows this.

Example H8-4 Access sizes for memory-mapped accesses

Two Load Doubleword instructions made to consecutive doubleword-aligned locations generate a pair of single-copy atomic doubleword reads. However, if the accesses are made to Normal memory or Device-GRE memory they might appear as a single quadword access that is not supported by the peripheral.

ARMv8 does not require the size of each element accessed by a multi-register load or store instruction to be identifiable by the memory system beyond the PE. Any memory-mapped access to a debug register is defined to be beyond the PE.

Software must use a Device-nGRE or stronger memory-type and use only single register load and store instructions to create memory accesses that are supported by the peripheral. For more information, see [Memory types and attributes on page B2-89](#).

H8.5 External debug interface register access permissions

Some external accesses to debug registers and Performance Monitor registers are not permitted and return an error response if:

- The Core power domain is powered-down or is in low-power state where the registers cannot be accessed.
- `OSLSR.OSLK == 1`. The OS Lock is locked.
- `DoubleLockStatus() == TRUE`. The OS Double Lock is locked, that is, `EDPRSR.DLK == 1`.
- Access by the external debug interface is disabled by the authentication interface or secure monitor.

Not all registers are affected in all of these cases. For details, see [External debug interface register access permissions summary](#) on page H8-4453.

———— **Note** —————

`OSLSR.OSLK` is visible through `EDPRSR`.

H8.5.1 External debug over powerdown and locks

Accessing registers using the external debug interface is not possible when the Debug power domain is off. In this case all accesses return an error.

External accesses to debug and Performance Monitors registers in the Core power domain are not permitted and return an error response if:

- The Core power domain is off or in low-power state where the registers cannot be accessed.
- `OSLSR.OSLK == 1`, meaning that the OS Lock is locked. This allows software to prevent external debugger modification of the registers while it saves and restores them over powerdown.

———— **Note** —————

In this case `OSLAR_EL1` can be accessed, meaning an external debugger can override this lock.

- `DoubleLockStatus() == TRUE`. This means that the OS Double Lock is locked and `EDPRSR.DLK == 1`. The OS Double Lock ensures that it is safe to remove Core power by forcing the debug interface to be quiescent.

See also [Debug registers to save over powerdown](#) on page H6-4430.

The following pseudocode outlines the `AllowExternalAccess()` function.

```
// AllowExternalAccess()
// =====

boolean AllowExternalAccess()
    return !DoubleLockStatus() && OSLSR_EL1.OSLK == '0' && EDPRSR.PU == '1';
```

H8.5.2 External access disabled

Accesses are further controlled by the external authentication interface. An untrusted external debugger cannot program the breakpoint and watchpoint registers to generate spurious debug exceptions. If external invasive debugging is not enabled, these external accesses to the registers are disabled. If EL3 is implemented, then `SDCR` provides additional external access disable controls for those registers if Secure external invasive debugging is disabled.

The disable applies to:

- [DBGBVR<n>_EL1, Debug Breakpoint Value Registers, n = 0 - 15](#) on page H9-4474.
- [DBGBCR<n>_EL1, Debug Breakpoint Control Registers, n = 0 - 15](#) on page H9-4471.
- [DBGWVR<n>_EL1, Debug Watchpoint Value Registers, n = 0 - 15](#) on page H9-4484.
- [DBGWCR<n>_EL1, Debug Watchpoint Control Registers, n = 0 - 15](#) on page H9-4481.

The external debug interface cannot access these registers if either:

- External debugging is not enabled. `ExternalInvasiveDebugEnabled() == FALSE`.
- Secure external debugging is not enabled, meaning `ExternalSecureInvasiveDebugEnabled() == FALSE`, and any of the following:
 - EL3 is not implemented and the PE is Secure.
 - EL3 is implemented and `SDCR.EDAD == 1`.

The following pseudocode outlines the `AllowExternalDebugAccess()` function.

```
// AllowExternalDebugAccess()
// =====
// Returns the status of EDPRSR.EDAD.

boolean AllowExternalDebugAccess()
    // The access may also be subject to OS lock, power-down, etc.
    if AllowExternalAccess() && ExternalInvasiveDebugEnabled() then
        if ExternalSecureInvasiveDebugEnabled() then
            return TRUE;
        elseif HaveEL(EL3) then
            return (if ELUsingAArch32(EL3) then SDCR.EDAD else MDCR_EL3.EDAD) == '0';
        else
            return !IsSecure();
    else
        return FALSE;
```

PEs might also provide an OPTIONAL external debug interface to the Performance Monitor registers. The authentication interface and `SDCR` provide similar external access disable controls for those registers.

The external debug interface cannot access the Performance Monitor registers if either:

- External non-invasive debug is not enabled. `ExternalNoninvasiveDebugEnabled() == FALSE`.
- Secure external non-invasive debugging is not enabled, `ExternalSecureNoninvasiveDebugEnabled() == FALSE`, and any of:
 - EL3 is not implemented and the PE is Secure.
 - EL3 is implemented and `SDCR.EPMAD == 1`.

The following pseudocode outlines the `AllowExternalPMUAccess()` function.

```
// AllowExternalPMUAccess()
// =====
// Returns the status of EDPRSR.EPMAD.

boolean AllowExternalPMUAccess()
    // The access may also be subject to OS lock, power-down, etc.
    if AllowExternalAccess() && ExternalNoninvasiveDebugEnabled() then
        if ExternalSecureNoninvasiveDebugEnabled() then
            return TRUE;
        elseif HaveEL(EL3) then
            return (if ELUsingAArch32(EL3) then SDCR.EPMAD else MDCR_EL3.EPMAD) == '0';
        else
            return !IsSecure();
    else
        return FALSE;
```

———— **Note** —————

- ARM recommends that secure software that is not making use of debug hardware does not lock out the external debug interface.
- ARMv8-A does not provide the equivalent control over access to Trace extension registers.

H8.5.3 Behavior of a not permitted access

For an external debug interface access by a Debug Access Port, the Debug Access Port receives the error response and must signal this to the external debugger. For an ADIV5 implementation of a Debug Access Port, the error sets a sticky error flag in the Debug Access Port that the debugger can poll, and that suppresses further accesses until it is explicitly cleared.

When an error is returned because external access is disabled, and this is the highest priority error condition, a sticky error flag in [EDPRSR](#) is indirectly written to 1 as a side-effect of the access:

- For a debug register access when `AllowExternalDebugAccess() == FALSE`, [EDPRSR.SDAD](#) is indirectly written to 1.
- For Performance Monitor register access when `AllowExternalPMUAccess() == FALSE`, [EDPRSR.SPMAD](#) is indirectly written to 1.

The indirect write might not occur for a memory-mapped access to the external debug interface. For more information, see [Register access permissions for memory-mapped accesses on page H8-4449](#).

If no error is returned, or the error is returned because of a higher priority error condition, the flag in [EDPRSR](#) is unchanged.

See also [Behavior of a not permitted memory-mapped access on page H8-4450](#).

For more information, see *ARM® Debug Interface Architecture Specification*.

H8.5.4 Trapping software access to debug registers

When [EDSCR.TDA](#) == 1, software access to the breakpoint and watchpoint registers generate a Halting debug event and entry to Debug state. For more information see [Software Access debug event on page H3-4383](#).

H8.5.5 External debug interface register access permissions summary

For accesses to:

- IMPLEMENTATION DEFINED registers, see [implementation defined registers](#).
- OPTIONAL registers for CoreSight compliance, see [optional CoreSight management registers](#).
- Reserved, unallocated, or unimplemented registers, writes to read-only registers, and reads of write-only registers, see [Reserved and unallocated registers on page H8-4454](#).

For all other external debug interface, CTI, and Performance Monitor registers, [Table H8-3 on page H8-4459](#), [Table H8-4 on page H8-4461](#) and [Table I3-2 on page I3-4696](#), show the response of the PE to accesses by the external debug interface.

H8.5.6 IMPLEMENTATION DEFINED registers

For debug registers, Performance Monitors registers, CTI registers, IMPLEMENTATION DEFINED register access permissions are IMPLEMENTATION DEFINED. The power domain in which these registers are implemented is also IMPLEMENTATION DEFINED.

If OPTIONAL memory-mapped access to the external debug interface is supported, there are additional constraints on memory-mapped accesses to registers. These constraints must also apply to IMPLEMENTATION DEFINED registers. In particular, if the OPTIONAL Software Lock is locked, writes are ignored and accesses have no side-effects. For more information see [Register access permissions for memory-mapped accesses on page H8-4449](#).

H8.5.7 OPTIONAL CoreSight management registers

Compliance with CoreSight architecture requires additional registers in the range 0xF00 - 0xFFC that are always accessible. See [Management registers and CoreSight compliance on page AppxB-4782](#).

H8.5.8 Reserved and unallocated registers

The following information relates to certain types of reserved accesses:

- Reads and writes of unallocated locations. These accesses are reserved for the architecture.
- Reads and writes of locations for features that are not implemented, including:
 - OPTIONAL features that are not implemented.
 - Breakpoints and watchpoints that are not implemented.
 - Performance Monitors counters that are not implemented.
 - CTI triggers that are not implemented.

These accesses are reserved.

- Reads of WO locations. These accesses are reserved for the architecture.
- Writes to RO locations. These accesses are reserved for the architecture.

Reserved accesses are normally RES0. That is, they must return zero on reads and ignore writes.

———— Note ————

Reads of WO and writes to RO refers to the default access permissions for a register. For example, when the SLK field is set, meaning that the relevant registers become RO, a memory-mapped write to a RW register is ignored, and not treated as a reserved access.

The following reserved registers are RES0 in all conditions, other than when debug power is off:

- If the implementation is CoreSight architecture compliant, all reserved registers in the range 0xF00 - 0xFFC. See [Management register access permissions on page AppxB-4783](#).
- All unallocated Processor ID Registers. That is, unallocated debug registers in the range 0xD00 - 0xDFC.
- All reserved CTI registers.

Otherwise, the architecture defines that:

1. If debug power is off, all register accesses, including reserved accesses, return an error.
2. For reserved debug registers and Performance Monitors registers, the response is a CONSTRAINED UNPREDICTABLE choice of error or RES0, when any of the following hold:
 - Off** The Core power domain is either completely off or in a low-power state in which the Core power domain registers cannot be accessed.
 - DLK** DoubleLockStatus() == TRUE. The OS Double Lock is locked, that is, [EDPRSR.DLK](#) == 1.
 - OSLK** [OSLSR.OSLK](#) == 1. The OS Lock is locked.
3. In addition, for reserved debug registers in the address ranges 0x400 - 0x4FC and 0x800 - 0x8FC, the response is a CONSTRAINED UNPREDICTABLE choice of error or RES0 when conditions 1 or 2 do not apply and:
 - EDAD** AllowExternalDebugAccess() == FALSE. External debug is disabled.

———— Note ————

See also [Behavior of a not permitted access on page H8-4453](#).

4. In addition, for reserved Performance Monitors registers in the address ranges 0x000 - 0x0FC and 0x400 - 0x47C, the response is a CONSTRAINED UNPREDICTABLE choice of error or RES0 when conditions 1 or 2 do not apply and:
 - EPMAD** AllowExternalPMUAccess() == FALSE. External Performance Monitor access is disabled.

———— **Note** —————

See also *Behavior of a not permitted access* on page H8-4453.

H8.6 External debug interface registers

The external debug interface register map is described by:

- *Performance Monitors memory-mapped register views* on page I3-4694.
- *Cross-trigger interface registers* on page H8-4461.
- *Table H8-2.*

Table H8-2 External debug interface register map

Offset	Mnemonic	Register and location of further details
0x020	EDESR	<i>EDESR, External Debug Event Status Register</i> on page H9-4505
0x024	EDECR	<i>EDECR, External Debug Execution Control Register</i> on page H9-4503
0x030 0x034	EDWAR[31:0] EDWAR[63:32]	<i>EDWAR, External Debug Watchpoint Address Register</i> on page H9-4537
0x080	DBGDTRRX_ELO	Chapter H4 <i>The Debug Communication Channel and Instruction Transfer Register</i>
0x084	EDITR	<i>EDITR, External Debug Instruction Transfer Register</i> on page H9-4508
0x088	EDSCR	<i>EDSCR, External Debug Status and Control Register</i> on page H9-4531
0x08C	DBGDTRTX_ELO	Chapter H4 <i>The Debug Communication Channel and Instruction Transfer Register</i>
0x090	EDRCR	<i>EDRCR, External Debug Reserve Control Register</i> on page H9-4529
0x094	EDACR	<i>EDACR, External Debug Auxiliary Control Register</i> on page H9-4486
0x098	EDECCR	<i>EDECCR, External Debug Exception Catch Control Register</i> on page H9-4501
0x0A0	EDPCSR _{lo} ^a	<i>EDPCSR, External Debug Program Counter Sample Register</i> on page H9-4513
0x0A4	EDCIDS _R ^a	<i>EDCIDS_R, External Debug Context ID Sample Register</i> on page H9-4491
0x0A8	EDVIDS _R ^a	<i>EDVIDS_R, External Debug Virtual Context Sample Register</i> on page H9-4535
0x0AC	EDPCSR _{hi} ^a	<i>EDPCSR, External Debug Program Counter Sample Register</i> on page H9-4513
0x0300	OSLAR_EL1	<i>OSLAR_EL1, OS Lock Access Register</i> on page H9-4553
0x0310	EDPRCR	<i>EDPRCR, External Debug Power/Reset Control Register</i> on page H9-4520
0x0314	EDPRSR	<i>EDPRSR, External Debug Processor Status Register</i> on page H9-4523
0x0400+16×n 0x0404+16×n	DBGBVR<n>_EL1[31:0] ^{bc} DBGBVR<n>_EL1[63:32] ^{bc}	<i>DBGBVR<n>_EL1, Debug Breakpoint Value Registers, n = 0 - 15</i> on page H9-4474
0x0408+16×n	DBGBCR<n>_EL1	<i>DBGBCR<n>_EL1, Debug Breakpoint Control Registers, n = 0 - 15</i> on page H9-4471
0x800+16 0x804+16×n	DBGWVR<n>_EL1[31:0] ^{bc} DBGWVR<n>_EL1[63:32] ^{bc}	<i>DBGWVR<n>_EL1, Debug Watchpoint Value Registers, n = 0 - 15</i> on page H9-4484
0x808+16×n	DBGWCR<n>_EL1 ^c	<i>DBGWCR<n>_EL1, Debug Watchpoint Control Registers, n = 0 - 15</i> on page H9-4481
0xC00–0xCFC	IMPLEMENTATION DEFINED	-
0xD00	MIDR_EL1	Main ID register

Table H8-2 External debug interface register map (continued)

Offset	Mnemonic	Register and location of further details
0xD04-0xD1C	-	Reserved, RES0
0xD20	ID_AA64PFR0_EL1[31:0]	Processor Feature Register 0
0xD24	ID_AA64PFR0_EL1[63:32]	
0xD28	ID_AA64DFR0_EL1[31:0]	Debug Feature Register 0
0xD2C	ID_AA64DFR0_EL1[63:32]	
0xD30	ID_AA64ISAR0_EL1[31:0]	Instruction Set Attribute Register 0
0xD34	ID_AA64ISAR0_EL1[63:32]	
0xD38	ID_AA64MMFR0_EL1[31:0]	Memory Model Feature Register 0
0xD3C	ID_AA64MMFR0_EL1[63:32]	
0xD40	ID_AA64PFR1_EL1[31:0]	Processor Feature Register 1
0xD44	ID_AA64PFR1_EL1[63:32]	
0xD48	ID_AA64DFR1_EL1[31:0]	Debug Feature Register 1
0xD4C	ID_AA64DFR1_EL1[63:32]	
0xD50	ID_AA64ISAR1_EL1[31:0]	Instruction Set Attribute Register 1
0xD54	ID_AA64ISAR1_EL1[63:32]	
0xD58	ID_AA64MMFR1_EL1[31:0]	
0xD5C	ID_AA64MMFR1_EL1[63:32]	Memory Model Feature Register 1
0xD60-0xDFC	-	Reserved, RES0
0xE80-EFC	IMPLEMENTATION DEFINED	-
0xF00-E8C	Management registers	<i>Management registers and CoreSight compliance on page AppxB-4782</i>
0xFA0	DBGCLAIMSET_EL1	<i>DBGCLAIMSET_EL1, Debug Claim Tag Set register on page H9-4478</i>
0xFA4	DBGCLAIMCLR_EL1	<i>DBGCLAIMCLR_EL1, Debug Claim Tag Clear register on page H9-4477</i>
0xFA8	EDDEVAFF0	<i>EDDEVAFF0, External Debug Device Affinity register 0 on page H9-4492</i>
0xFAC	EDDEVAFF1	<i>EDDEVAFF1, External Debug Device Affinity register 1 on page H9-4493</i>
0xFB0-FB4	Management registers	<i>Management registers and CoreSight compliance on page AppxB-4782</i>
0xFB8	DBGAUTHSTATUS_EL1	<i>DBGAUTHSTATUS_EL1, Debug Authentication Status register on page H9-4469</i>
0xFC0	EDDEVID2	<i>EDDEVID, External Debug Device ID register 0 on page H9-4496</i>
0xFC4	EDDEVID1	<i>EDDEVID1, External Debug Device ID register 1 on page H9-4498</i>
0xFC8	EDDEVID	<i>EDDEVID2, External Debug Device ID register 2 on page H9-4499</i>
0xFD0-FFC	Management registers	<i>Management registers and CoreSight compliance on page AppxB-4782</i>

a. Only if the OPTIONAL Sample-based Profiling extension is implemented.

- b. A 64-bit register mapped to a pair of 32-bit locations. Doubleword accesses to this register are not guaranteed to be 64-bit single copy atomic. See [Supported access sizes on page H8-4444](#). Software must ensure a breakpoint or watchpoint is disabled before altering the value register.
- c. Implemented breakpoints and watchpoints only. *n* is the breakpoint or the watchpoint number.

————— **Note** —————

All other locations are reserved.

[Table H8-3 on page H8-4459](#) shows the access permissions for the external debug interface registers in an ARMv8-A Debug implementation. The terms are defined as follows:

Domain This describes the power domain in which the register is logically implemented. Registers described as implemented in the Core power domain might be implemented in the Debug power domain, as long as they exhibit the required behavior.

Conditions This lists the conditions under which the access is attempted.
To determine the access permissions for a register, read these columns from left to right, and stop at first column which lists the condition as being true.

The conditions are:

Off [EDPRSR.PU == 0](#). The Core power domain is completely off, or in low-power state. In these cases the Core power domain registers cannot be accessed.

————— **Note** —————

If debug power is off, then all external debug interface accesses return an error.

DLK [DoubleLockStatus\(\) == TRUE](#). The OS Double Lock is locked, that is, [EDPRSR.DLK == 1](#).

OSLK [OSLSR.OSLK == 1](#). The OS Lock is locked.

EDAD [AllowExternalDebugAccess\(\) == FALSE](#). External debug access is disabled. See also [Behavior of a not permitted access on page H8-4453](#).

EPMAD [AllowExternalPMUAccess\(\) == FALSE](#). Access to the external Performance Monitors is disabled. See also [Behavior of a not permitted access on page H8-4453](#).

Default This provides the default access permissions, if there are no conditions that prevent access to the register.

SLK This provides the modified default access permissions for OPTIONAL memory-mapped accesses to the external debug interface if the OPTIONAL Software Lock is locked. See [Register access permissions for memory-mapped accesses on page H8-4449](#). For all other accesses, this column is ignored.

The access permissions are:

- This means that the default access permission applies. See the Default column, or the SLK column, if applicable.

RO This means that the register or field is read-only.

RW This means that the register or field is read/write. Individual fields within the register might be RO. See the relevant register description for details.

RC This means that the bit clears to 0 after a read.

(SE) This means that accesses to this register have indirect write side-effects. A side-effect occurs when a direct read or a direct write of a register creates an indirect write to the same register or to another register.

WO This means that the register or field is write-only.

WI This means that the register or field ignores writes.

IMP DEF This means that the access permissions are IMPLEMENTATION DEFINED.

If OPTIONAL memory-mapped access to the external debug interface is supported, there might be additional constraints on memory-mapped accesses. See [Register access permissions for memory-mapped accesses on page H8-4449](#).

Table H8-3 Access permissions for the external debug interface registers

Offset	Register	Domain	Conditions (priority from left to right)				Default	SLK
			Off	DLK	OSLK	EDAD		
0x020	EDESR	Core	Error	Error	-	-	RW	RO
0x024	EDECR	Debug	-	-	-	-	RW	RO
0x030	EDWAR[31:0]	Core	Error	Error	Error	-	RO	-
0x034	EDWAR[63:32]							
0x080	DBGDTRRX_ELO	Core	Error	Error	Error	-	RW	RO
0x084	EDITR	Core	Error	Error	Error	-	WO	WI
0x088	EDSCR	Core	Error	Error	Error	-	RW	RO
0x08C	DBGDTRTX_ELO	Core	Error	Error	Error	-	RW	RO
0x090	EDRCR	Core	Error	Error	Error	-	WO	WI
0x094	EDACR	IMP DEF	IMP DEF	IMP DEF	IMP DEF	-	RW	RO
0x098	EDECCR	Core	Error	Error	Error	-	RW	RO
0x0A0	EDPCSR[31:0] ^a	Core	Error	Error	Error	-	RO	RO
0x0A4	EDCISR ^a	Core	Error	Error	Error	-	RO	RO
0x0A8	EDVIDSR ^a	Core	Error	Error	Error	-	RO	RO
0x0AC	EDPCSR[63:32] ^a	Core	Error	Error	Error	-	RO	RO
0x0300	OSLAR_EL1	Core	Error	Error	-	-	WO	WI
0x0310 ^b	EDPRCR	See register field descriptions for information						
0x0314 ^c	EDPRSR	See register field descriptions for information						
0x0400+16×n	DBGBVR<n>_EL1[31:0] ^d	Core	Error	Error	Error	Error	RW	RO
0x0404+16×n	DBGBVR<n>_EL1[63:32] ^d	Core	Error	Error	Error	Error	RW	RO
0x0408+16×n	DBGBCR<n>_EL1 ^d	Core	Error	Error	Error	Error	RW	RO
0x800+16×n	DBGWVR<n>_EL1[31:0] ^d	Core	Error	Error	Error	Error	RW	RO
0x804+16×n	DBGWVR<n>_EL1[63:32] ^d	Core	Error	Error	Error	Error	RW	RO
0x808+16×n	DBGWCR<n>_EL1 ^d	Core	Error	Error	Error	Error	RW	RO
0xD00	MIDR_EL1	Debug	-	-	-	-	RO	RO
0xD20	ID_AA64PFR0_EL1[31:0]	Debug	-	-	-	-	RO	RO
0xD24	ID_AA64PFR0_EL1[63:32]	Debug	-	-	-	-	RO	RO

Table H8-3 Access permissions for the external debug interface registers (continued)

Offset	Register	Domain	Conditions (priority from left to right)				Default	SLK
			Off	DLK	OSLK	EDAD		
0xD28	ID_AA64DFR0_EL1[31:0]	Debug	-	-	-	-	RO	RO
0xD2C	ID_AA64DFR0_EL1[63:32]	Debug	-	-	-	-	RO	RO
0xD30	ID_AA64ISAR0_EL1[31:0]	Debug	-	-	-	-	RO	RO
0xD34	ID_AA64ISAR0_EL1[63:32]	Debug	-	-	-	-	RO	RO
0xD38	ID_AA64MMFR0_EL1[31:0]	Debug	-	-	-	-	RO	RO
0xD3C	ID_AA64MMFR0_EL1[63:32]	Debug	-	-	-	-	RO	RO
0xD40	ID_AA64PFR1_EL1[31:0]	Debug	-	-	-	-	RO	RO
0xD44	ID_AA64PFR1_EL1[63:32]	Debug	-	-	-	-	RO	RO
0xD48	ID_AA64DFR1_EL1[31:0]	Debug	-	-	-	-	RO	RO
0xD4C	ID_AA64DFR1_EL1[63:32]	Debug	-	-	-	-	RO	RO
0xD50	ID_AA64ISAR1_EL1[31:0]	Debug	-	-	-	-	RO	RO
0xD54	ID_AA64ISAR1_EL1[63:32]	Debug	-	-	-	-	RO	RO
0xD58	ID_AA64MMFR1_EL1[31:0]	Debug	-	-	-	-	RO	RO
0xD5C	ID_AA64MMFR1_EL1[63:32]	Debug	-	-	-	-	RO	RO
0xFA0	DBGCLAIMSET_EL1	Core	Error	Error	Error	-	RW	RO
0xFA4	DBGCLAIMCLR_EL1	Core	Error	Error	Error	-	RW	RO
0xFA8	EDDEVAFF0	Debug	-	-	-	-	RO	RO
0xFAC	EDDEVAFF1	Debug	-	-	-	-	RO	RO
0xFB8	DBGAUTHSTATUS_EL1	Debug	-	-	-	-	RO	RO
0xFC0	EDDEVID2	Debug	-	-	-	-	RO	RO
0xFC4	EDDEVID1	Debug	-	-	-	-	RO	RO
0xFC8	EDDEVID	Debug	-	-	-	-	RO	RO

- Only if the Sample-based profiling extension is implemented.
- Some control bits are in the Core power domain. These bits ignore writes when Core power domain registers cannot be accessed as shown.
- Some status bits are fetched from the Core power domain. These bits read UNKNOWN when Core power domain registers cannot be accessed as shown.
- Implemented breakpoints and watchpoints only. *n* is the breakpoint or watchpoint number.

For the reset values for the external debug interface registers, see [Table H8-6 on page H8-4465](#).

H8.7 Cross-trigger interface registers

The embedded Cross-trigger Interface, CTI, is located within its own block of the external debug memory map. There must be one such block per PE or cluster of virtual PEs.

If the CTI of a PE does not implement the [CTIDEVAFF0](#) or [CTIDEVAFF1](#) registers it must be located 64KB above the debug registers in the external debug interface.

[Table H8-4](#) shows the CTI register map.

Table H8-4 Cross-trigger interface map

Offset	Mnemonic	Location of further details
0x000	CTICONTROL	CTICONTROL , <i>CTI Control register</i> on page H9-4568
0x010	CTIINTACK	CTIINTACK , <i>CTI Output Trigger Acknowledge register</i> on page H9-4580
0x014	CTIAPPSET	CTIAPPSET , <i>CTI Application Trigger Set register</i> on page H9-4557
0x018	CTIAPPCLEAR	CTIAPPCLEAR , <i>CTI Application Trigger Clear register</i> on page H9-4555
0x01C	CTIAPPULSE	CTIAPPULSE , <i>CTI Application Pulse register</i> on page H9-4556
0x020+4×n	CTIINEN<n> ^a	CTIINEN<n> , <i>CTI Input Trigger to Output Channel Enable registers, n = 0 - 31</i> on page H9-4579
0x0A0+4×n	CTIOUTEN<n> ^a	CTIOUTEN<n> , <i>CTI Input Channel to Output Trigger Enable registers, n = 0 - 31</i> on page H9-4586
0x130	CTITRIGINSTATUS	CTITRIGINSTATUS , <i>CTI Trigger In Status register</i> on page H9-4592
0x134	CTITRIGOUTSTATUS	CTITRIGOUTSTATUS , <i>CTI Trigger Out Status register</i> on page H9-4593
0x138	CTICHINSTATUS	CTICHINSTATUS , <i>CTI Channel In Status register</i> on page H9-4560
0x13C	CTICHOUTSTATUS	CTICHOUTSTATUS , <i>CTI Channel Out Status register</i> on page H9-4561
0x140	CTIGATE	CTIGATE , <i>CTI Channel Gate Enable register</i> on page H9-4578
0x144	ASICCTL	ASICCTL , <i>CTI External Multiplexer Control register</i> on page H9-4554
0xE80 - 0xEFC	IMPLEMENTATION DEFINED	IMPLEMENTATION DEFINED. See <i>Management registers and CoreSight compliance</i> on page AppxB-4782
0xF00 - 0xFBC	Management registers	<i>Management registers and CoreSight compliance</i> on page AppxB-4782
0xFC0	CTIDEVID2	CTIDEVID2 , <i>CTI Device ID register 2</i> on page H9-4576
0xFC4	CTIDEVID1	CTIDEVID1 , <i>CTI Device ID register 1</i> on page H9-4575
0xFC8	CTIDEVID	CTIDEVID , <i>CTI Device ID register 0</i> on page H9-4573
0xFD0 - 0xFFC	Management registers	<i>Management registers and CoreSight compliance</i> on page AppxB-4782

a. Implemented triggers, including triggers that are not connected, only. *n* is the trigger number.

Table H8-5 shows the access permissions for the CTI registers in an ARMv8-A Debug implementation. For a definition of the terms used, see [External debug interface registers on page H8-4456](#).

Table H8-5 Access permissions for the CTI registers

Offset	Register	Domain	Conditions (priority from left to right)				Default	SLK
			Off	DLK	OSLK	EDAD		
0x000	CTICONTROL	Debug	-	-	-	-	RW	RO
0x010	CTIINTACK	Debug	-	-	-	-	WO	WI
0x014	CTIAPPSET	Debug	-	-	-	-	RW	RO
0x018	CTIAPPCLEAR	Debug	-	-	-	-	WO	WI
0x01C	CTIAPPULSE	Debug	-	-	-	-	WO	WI
0x020+4×n	CTIINEN<n>^a	Debug	-	-	-	-	RW	RO
0x0A0+4×n	CTIOUTEN<n>	Debug	-	-	-	-	RW	RO
0x130	CTITRIGINSTATUS	Debug	-	-	-	-	RO	RO
0x134	CTITRIGOUTSTATUS	Debug	-	-	-	-	RO	RO
0x138	CTICHINSTATUS	Debug	-	-	-	-	RO	RO
0x13C	CTICHOUTSTATUS	Debug	-	-	-	-	RO	RO
0x140	CTIGATE	Debug	-	-	-	-	RW	RO
0xFC0	CTIDEVID2	Debug	-	-	-	-	RO	RO
0xFC4	CTIDEVID1	Debug	-	-	-	-	RO	RO
0xFC8	CTIDEVID	Debug	-	-	-	-	RO	RO

a. Implemented triggers only (including triggers that are not connected). *n* is the trigger number.

For the reset values of the CTI registers, see [Table H8-7 on page H8-4466](#).

H8.8 Reset and debug

All registers in the Core power domain are reset either by a Warm reset or a Cold reset, as described in [Reset on page D1-1426](#), including external debug logic registers.

All registers in the Debug power domain are reset by an External Debug reset.

Figure H8-1 shows this reset scheme. The following three reset signals are an example implementation of the reset scheme:

- **CORERESET**, which must be asserted for a Warm reset.
- **CPUPORESET**, which must be asserted for a Cold reset.
- **PRESETDBG**, which must be asserted for an External Debug reset.

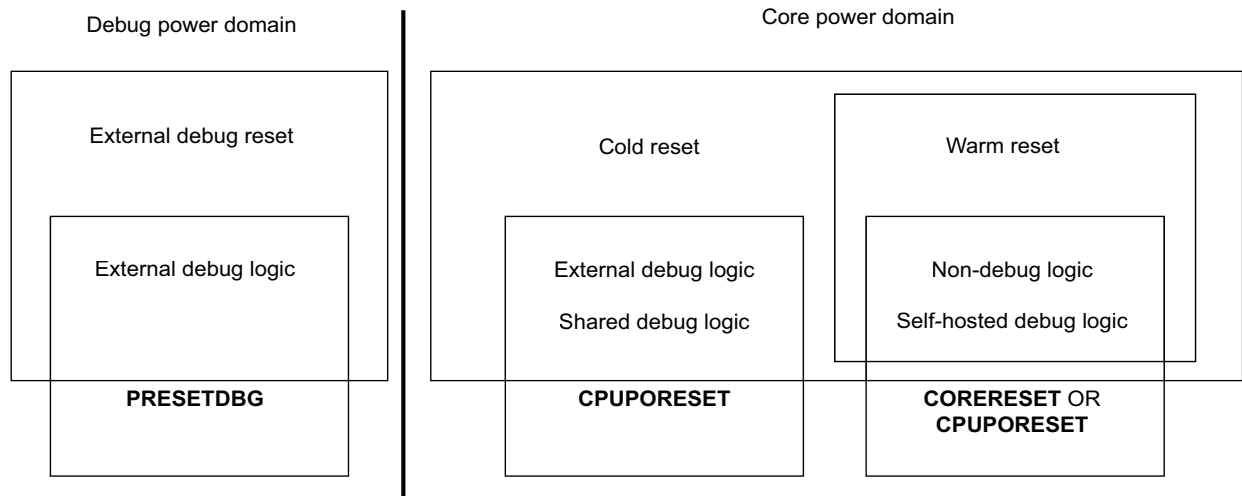

Figure H8-1 Power and reset domains

For more information about power domains and power states, see [Power domains and debug on page H6-4425](#).

When power is first applied to the Debug power domain, **PRESETDBG** must be asserted.

When power is first applied to the Core power domain, **CPUPORESET** must be asserted.

———— **Note** ————

In this scheme, logic in the Warm reset domain is reset by asserting either **CORERESET** or **CPUPORESET**. This implies a particular implementation style that permits these approaches.

CPUPORESET is not normally asserted on moving from a low-power state, where power has not been removed, to a full-power state. This can occur, for example, on exiting a low-power retention state. See also [Emulating low-power states on page H6-4428](#) and [EDPRSR, External Debug Processor Status Register on page H9-4523](#).

H8.8.1 External debug interface accesses to registers in reset

If a reset signal is asserted and the external debug interface:

- Writes a register, or indirectly writes a register or register field as a side-effect of an access:
 - Then, if the register or register field is reset by that reset signal, it is **CONSTRAINED UNPREDICTABLE** whether the register or register field takes the reset value or the value written. The reset value might be **UNKNOWN**.
 - Otherwise the register or register field takes the value that is written.
- Reads a register, or indirectly reads a register or register field, as part of an access:
 - Then, if the register or register field is reset by that reset signal, the value returned is **UNKNOWN**.

- Otherwise, the value of the register or register field is returned.

It is IMPLEMENTATION DEFINED whether any register can be accessed when External Debug reset is being asserted. The result of these accesses is IMPLEMENTATION DEFINED.

H8.9 External debug register resets

Each register or field has a defined reset domain:

- Registers and fields in the Warm reset domain are also reset by a Cold reset and unchanged by an External Debug reset that is not coincident with a Cold reset or a Warm reset.
- Registers and fields in the Cold reset domain are unchanged by a Warm reset or an External Debug reset that is not coincident with a Cold reset.
- Registers and fields in the External Debug reset domain are unchanged by a Cold reset or a Warm reset that is not coincident with an External Debug reset.

Table H8-6 and Table H8-7 on page H8-4466 show the external debug register and CTI register resets. For other debug registers and Performance Monitors registers, see *Management register resets* on page AppxB-4787 and *Power domains and Performance Monitors registers reset* on page I3-4697.

———— Note —————

By reference to Figure H8-1 on page H8-4463 the power domain can be deduced from the reset domain. Table B-7 on page AppxB-4787 also shows reset power domains.

Table H8-6 and Table H8-7 on page H8-4466 do not include:

- Read-only identification registers, such as Processor ID Registers and **PMCFGR**, that have a fixed value from reset.
- Read-only status registers, such as **EDSCR.RW**, that are evaluated each time the register is read and that have no meaningful reset value.
- Write-only registers, such as **EDRCR**, that only have an effect on writes, and have no meaningful reset value.
- Read/write registers, such as breakpoint and watchpoint registers, and **EDPRCR.CORENPDRQ**, that alias other registers. The reset values are described by the descriptions of those other registers.
- IMPLEMENTATION DEFINED registers. The reset values and reset domains of these registers are also IMPLEMENTATION DEFINED and might be UNKNOWN.

All other fields in the registers are set to an IMPLEMENTATION DEFINED value, that can be UNKNOWN. The register is in the specified reset domain.

Table H8-6 Summary of external debug register resets, debug registers

Register	Reset domain	Field	Value	Description
EDESR	Warm	SS	EDECR.SS	Halting Step debug event pending
		RC	EDECR.RCE	Reset Catch debug event pending
		OSUC	0	OS Unlock Catch debug event pending
EDECR	External debug	SS	0	Halting Step debug event enable
		RCE	0	Reset Catch debug event enable
		OSUCE	0	OS Unlock Catch debug event enable
EDWAR	Cold	-	-	All fields

Table H8-6 Summary of external debug register resets, debug registers (continued)

Register	Reset domain	Field	Value	Description
EDSCR	Cold	RXfull	0	DTRRX register full
		TXfull	0	DTRTX register full
		RXO	0	DTRRX overrun
		TXU	0	DTRTX underrun
		INTdis	0	Interrupt disable
		TDA	0	Trap debug register accesses to Debug state
		MA	0	Memory access mode in Debug state
		HDE	0	Halting debug mode enable
EDECCR	Cold	NSE[2:1]	0b00	Coarse-grained Non-secure exception catch
		SE[3,1]	0b00	Coarse-grained Secure exception catch
EDPCSR	Cold	-	-	All fields
EDCDSR	Cold	-	-	All fields
EDVIDSR	Cold	-	-	All fields
EDPRCR	External debug	COREPURQ	0	Core powerup request
EDPRSR	Warm	SDR	-	Sticky debug restart
	Cold	SPMAD	0	Sticky EPMAD error
		SDAD	0	Sticky EDAD error
	Warm	SR	1	Sticky reset status
	Cold	SPD	1	Sticky powerdown status

Table H8-7 shows the reset values for the CTI registers

Table H8-7 Summary of external debug register resets, CTI registers

Register	Reset domain	Field	Value	Description
CTICONTROL	External debug	GLBEN	0	CTI global enable
CTIAPPSET	External debug	-	-	All fields
CTIINEN<n>	External debug	-	-	All fields
CTIOUTEN<n>	External debug	-	-	All fields
CTIGATE	External debug	-	-	All fields

Chapter H9

External Debug Register Descriptions

This chapter provides a description of the external debug registers.

It contains the following items:

- [Introduction on page H9-4468](#)
- [Debug registers on page H9-4469](#)
- [Cross-Trigger Interface registers on page H9-4554](#)

H9.1 Introduction

The following sections describe the registers that are accessible through the external debug interface:

- [Debug registers on page H9-4469.](#)
- [Cross-Trigger Interface registers on page H9-4554.](#)

H9.2 Debug registers

This section describes the Debug registers that are accessible through the external debug interface.

H9.2.1 DBGAUTHSTATUS_EL1, Debug Authentication Status register

The DBGAUTHSTATUS_EL1 characteristics are:

Purpose

Provides information about the state of the IMPLEMENTATION DEFINED authentication interface for debug.

This register is part of the Debug registers functional group.

Usage constraints

This register is accessible as shown below:

Default

RO

Configurations

DBGAUTHSTATUS_EL1 is architecturally mapped to AArch64 register [DBGAUTHSTATUS_EL1](#).

DBGAUTHSTATUS_EL1 is architecturally mapped to AArch32 register [DBGAUTHSTATUS](#).

DBGAUTHSTATUS_EL1 is in the Debug power domain.

Attributes

DBGAUTHSTATUS_EL1 is a 32-bit register.

The DBGAUTHSTATUS_EL1 bit assignments are:

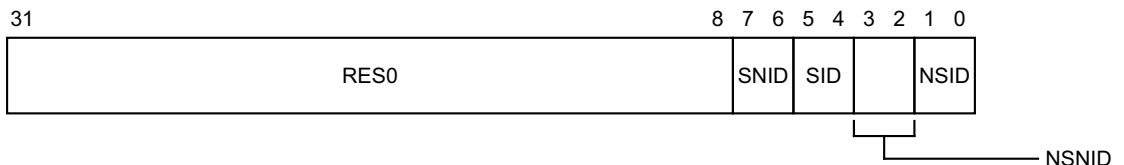

Bits [31:8]

Reserved, RES0.

SNID, bits [7:6]

Secure non-invasive debug. Possible values of this field are:

- 00 Not implemented. EL3 is not implemented and the processor is Non-secure.
 - 10 Implemented and disabled. ExternalSecureNoninvasiveDebugEnabled() == FALSE.
 - 11 Implemented and enabled. ExternalSecureNoninvasiveDebugEnabled() == TRUE.
- Other values are reserved.

SID, bits [5:4]

Secure invasive debug. Possible values of this field are:

- 00 Not implemented. EL3 is not implemented and the processor is Non-secure.
 - 10 Implemented and disabled. ExternalSecureInvasiveDebugEnabled() == FALSE.
 - 11 Implemented and enabled. ExternalSecureInvasiveDebugEnabled() == TRUE.
- Other values are reserved.

NSNID, bits [3:2]

Non-secure non-invasive debug. Possible values of this field are:

- 00 Not implemented. EL3 is not implemented and the processor is Secure.
 - 10 Implemented and disabled. ExternalNoninvasiveDebugEnabled() == FALSE.
 - 11 Implemented and enabled. ExternalNoninvasiveDebugEnabled() == TRUE.
- Other values are reserved.

NSID, bits [1:0]

Non-secure invasive debug. Possible values of this field are:

- 00 Not implemented. EL3 is not implemented and the processor is Secure.
 - 10 Implemented and disabled. ExternalInvasiveDebugEnabled() == FALSE.
 - 11 Implemented and enabled. ExternalInvasiveDebugEnabled() == TRUE.
- Other values are reserved.

Accessing the DBGAUTHSTATUS_EL1:

DBGAUTHSTATUS_EL1 can be accessed through the internal memory-mapped interface and the external debug interface:

Component	Offset
Debug	0xFB8

H9.2.2 DBGBCR<n>_EL1, Debug Breakpoint Control Registers, n = 0 - 15

The DBGBCR<n>_EL1 characteristics are:

Purpose

Holds control information for a breakpoint. Forms breakpoint n together with value register [DBGBVR<n>_EL1](#), where n is 0 to 15.

This register is part of the Debug registers functional group.

Usage constraints

This register is accessible as shown below:

Off	DLK	OSLK	EDAD	SLK	Default
Error	Error	Error	Error	RO	RW

When the E field is zero, all the other fields in the register are ignored.

Configurations

DBGBCR<n>_EL1 is architecturally mapped to AArch64 register [DBGBCR<n>_EL1](#).

DBGBCR<n>_EL1 is architecturally mapped to AArch32 register [DBGBCR<n>](#).

DBGBCR<n>_EL1 is in the Core power domain.

Attributes

DBGBCR<n>_EL1 is a 32-bit register.

The DBGBCR<n>_EL1 bit assignments are:

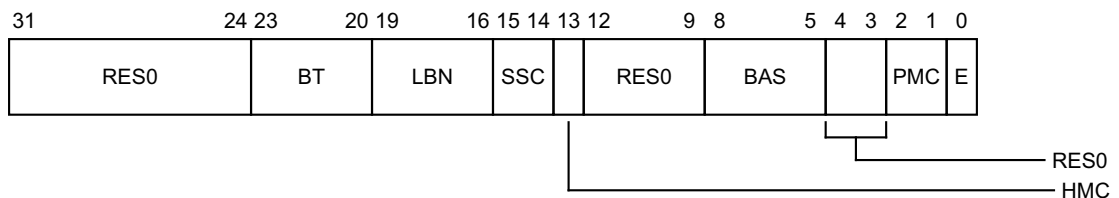

Bits [31:24]

Reserved, RES0.

BT, bits [23:20]

Breakpoint Type. Possible values are:

0000	Unlinked instruction address match.
0001	Linked instruction address match.
0010	Unlinked context ID match.
0011	Linked context ID match
0100	Unlinked instruction address mismatch.
0101	Linked instruction address mismatch.
1000	Unlinked VMID match.
1001	Linked VMID match.
1010	Unlinked VMID and context ID match.
1011	Linked VMID and context ID match.

The field breaks down as follows:

- BT[3:1]: Base type.
 - 000 Match address. `DBGVVR<n>_EL1` is the address of an instruction.
 - 010 Mismatch address. Behaves as type 0b000 if in an AArch64 translation, or if halting debug-mode is enabled and halting is allowed. Otherwise, `DBGVVR<n>_EL1` is the address of an instruction to be stepped.
 - 001 Match context ID. `DBGVVR<n>_EL1[31:0]` is a context ID.
 - 100 Match VMID. `DBGVVR<n>_EL1[39:32]` is a VMID.
 - 101 Match VMID and context ID. `DBGVVR<n>_EL1[31:0]` is a context ID, and `DBGVVR<n>_EL1[39:32]` is a VMID.
- BT[0]: Enable linking.

If the breakpoint is not context-aware, BT[3] and BT[1] are RES0. If EL2 is not implemented, BT[3] is RES0. If EL1 using AArch32 is not implemented, BT[2] is RES0.

The values 011x and 11xx are reserved, but must behave as if the breakpoint is disabled. Software must not rely on this property as the behavior of reserved values might change in a future revision of the architecture.

LBN, bits [19:16]

Linked breakpoint number. For Linked address matching breakpoints, this specifies the index of the Context-matching breakpoint linked to.

SSC, bits [15:14]

Security state control. Determines the security states under which a breakpoint debug event for breakpoint n is generated. This field must be interpreted along with the HMC and PMC fields.

HMC, bit [13]

Higher mode control. Determines the debug perspective for deciding when a breakpoint debug event for breakpoint n is generated. This field must be interpreted along with the SSC and PMC fields.

Bits [12:9]

Reserved, RES0.

BAS, bits [8:5]

Byte address select. Defines which half-words an address-matching breakpoint matches, regardless of the instruction set and execution state. In an AArch64-only implementation, this field is reserved, RES1. Otherwise:

- BAS[2] and BAS[0] are read/write.
- BAS[3] and BAS[1] are read-only copies of BAS[2] and BAS[0] respectively.

The values 0b0011 and 0b1100 are only supported if AArch32 is supported at any exception level.

The permitted values depend on the breakpoint type.

For Address match breakpoints in either AArch32 or AArch64 state:

BAS	Match instruction at	Constraint for debuggers
0b0011	<code>DBGVVR<n>_EL1</code>	Use for T32 and T32EE instructions.
0b1100	<code>DBGVVR<n>_EL1+2</code>	Use for T32 and T32EE instructions.
0b1111	<code>DBGVVR<n>_EL1</code>	Use for A64 and A32 instructions.

0b0000 is reserved and must behave as if the breakpoint is disabled or map to a permitted value.

For Address mismatch breakpoints in an AArch32 stage 1 translation regime:

BAS	Step instruction at	Constraint for debuggers
0b0000	-	Use for a match anywhere breakpoint.
0b0011	DBGBVR<n>_EL1	Use for stepping T32 and T32EE instructions.
0b1100	DBGBVR<n>_EL1+2	Use for stepping T32 and T32EE instructions.
0b1111	DBGBVR<n>_EL1	Use for stepping A64 and A32 instructions.

For Context matching breakpoints, this field is RES1 and ignored.

Bits [4:3]

Reserved, RES0.

PMC, bits [2:1]

Privilege mode control. Determines the exception level or levels at which a breakpoint debug event for breakpoint n is generated. This field must be interpreted along with the SSC and HMC fields.

E, bit [0]

Enable breakpoint [DBGBVR<n>_EL1](#). Possible values are:

- 0 Breakpoint disabled.
- 1 Breakpoint enabled.

Accessing the [DBGBCR<n>_EL1](#):

[DBGBCR<n>_EL1](#) can be accessed through the internal memory-mapped interface and the external debug interface:

Component	Offset
Debug	0x408 + 16n

H9.2.3 DBGBVR<n>_EL1, Debug Breakpoint Value Registers, n = 0 - 15

The DBGBVR<n>_EL1 characteristics are:

Purpose

Holds a virtual address, or a VMID and/or a context ID, for use in breakpoint matching. Forms breakpoint n together with control register [DBGBCR<n>_EL1](#), where n is 0 to 15.

This register is part of the Debug registers functional group.

Usage constraints

This register is accessible as shown below:

Off	DLK	OSLK	EDAD	SLK	Default
Error	Error	Error	Error	RO	RW

Configurations

DBGBVR<n>_EL1 is architecturally mapped to AArch64 register [DBGBVR<n>_EL1](#).

DBGBVR<n>_EL1[31:0] is architecturally mapped to AArch32 register [DBGBVR<n>](#).

DBGBVR<n>_EL1[63:32] is architecturally mapped to AArch32 register [DBGBXVR<n>](#).

DBGBVR<n>_EL1 is in the Core power domain.

Attributes

DBGBVR<n>_EL1 is a 64-bit register.

The DBGBVR<n>_EL1 bit assignments are:

When [DBGBCR<n>_EL1.BT==0b0x0x](#):

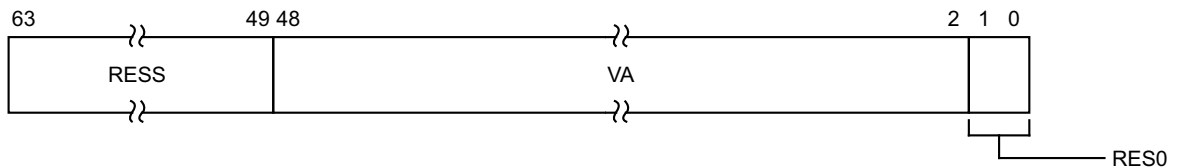

RESS, bits [63:49]

Reserved, Sign extended. Hardwired to the value of the sign bit, bit [48]. Hardware and software must treat this field as RES0 if bit[48] is 0, and as RES1 if bit[48] is 1.

VA, bits [48:2]

If the address is being matched in an AArch64 stage 1 translation regime, this field contains bits[48:2] of the address for comparison.

If the address is being matched in an AArch32 stage 1 translation regime, the first 16 bits of this field are RES0, and the rest of the field contains bits[31:2] of the address for comparison.

Bits [1:0]

Reserved, RES0.

When $DBGBCR\langle n \rangle_EL1.BT == 0b0x1x$:

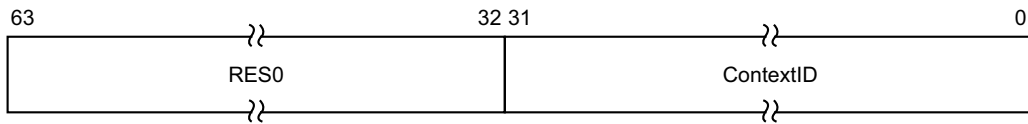

Bits [63:32]

Reserved, RES0.

ContextID, bits [31:0]

Context ID value for comparison.

When $DBGBCR\langle n \rangle_EL1.BT == 0b1x0x$ and EL2 implemented:

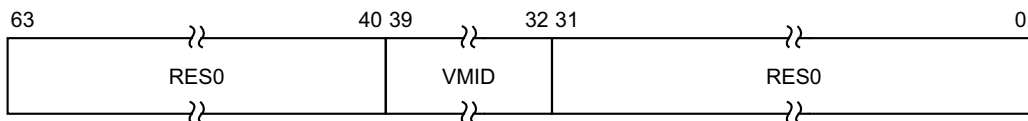

Bits [63:40]

Reserved, RES0.

VMID, bits [39:32]

VMID value for comparison.

Bits [31:0]

Reserved, RES0.

When $DBGBCR\langle n \rangle_EL1.BT == 0x1x1x$ and EL2 implemented:

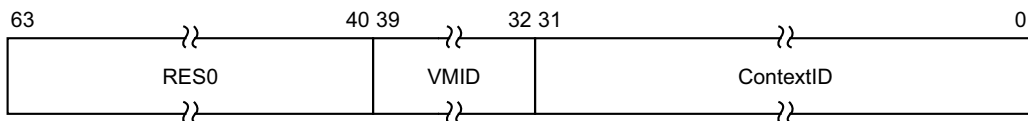

Bits [63:40]

Reserved, RES0.

VMID, bits [39:32]

VMID value for comparison.

ContextID, bits [31:0]

Context ID value for comparison.

Accessing the DBGBVR<n>_EL1:

DBGBVR<n>_EL1[31:0] can be accessed through the internal memory-mapped interface and the external debug interface:

Component	Offset
Debug	0x400 + 16n

DBGBVR<n>_EL1[63:32] can be accessed through the internal memory-mapped interface and the external debug interface:

Component	Offset
Debug	0x404 + 16n

H9.2.4 DBGCLAIMCLR_EL1, Debug Claim Tag Clear register

The DBGCLAIMCLR_EL1 characteristics are:

Purpose

Used by software to read the values of the CLAIM bits, and to clear these bits to 0.
This register is part of the Debug registers functional group.

Usage constraints

This register is accessible as shown below:

Off	DLK	OSLK	SLK	Default
Error	Error	Error	RO	RW

Configurations

DBGCLAIMCLR_EL1 is architecturally mapped to AArch64 register [DBGCLAIMCLR_EL1](#).
DBGCLAIMCLR_EL1 is architecturally mapped to AArch32 register [DBGCLAIMCLR](#).
DBGCLAIMCLR_EL1 is in the Core power domain.

Attributes

DBGCLAIMCLR_EL1 is a 32-bit register.

The DBGCLAIMCLR_EL1 bit assignments are:

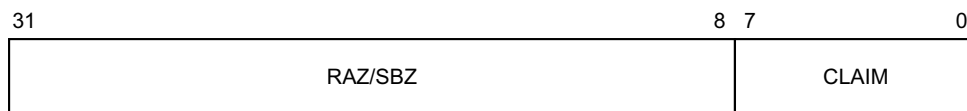

Bits [31:8]

Reserved, RAZ/SBZ. Software can rely on these bits reading as zero, and must use a should-be-zero policy on writes. Implementations must ignore writes.

CLAIM, bits [7:0]

Claim clear bits. Reading this field returns the current value of the CLAIM bits.

Writing a 1 to one of these bits clears the corresponding CLAIM bit to 0. This is an indirect write to the CLAIM bits.

A single write operation can clear multiple bits to 0. Writing 0 to one of these bits has no effect.

Accessing the DBGCLAIMCLR_EL1:

DBGCLAIMCLR_EL1 can be accessed through the internal memory-mapped interface and the external debug interface:

Component	Offset
Debug	0xFA4

H9.2.5 DBGCLAIMSET_EL1, Debug Claim Tag Set register

The DBGCLAIMSET_EL1 characteristics are:

Purpose

Used by software to set CLAIM bits to 1.

This register is part of the Debug registers functional group.

Usage constraints

This register is accessible as shown below:

Off	DLK	OSLK	SLK	Default
Error	Error	Error	RO	RW

Configurations

DBGCLAIMSET_EL1 is architecturally mapped to AArch64 register [DBGCLAIMSET_EL1](#).

DBGCLAIMSET_EL1 is architecturally mapped to AArch32 register [DBGCLAIMSET](#).

DBGCLAIMSET_EL1 is in the Core power domain.

Attributes

DBGCLAIMSET_EL1 is a 32-bit register.

The DBGCLAIMSET_EL1 bit assignments are:

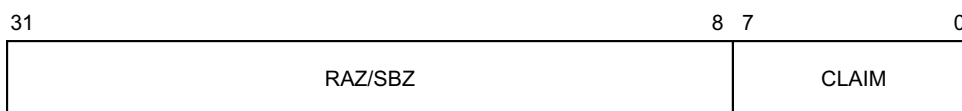

Bits [31:8]

Reserved, RAZ/SBZ. Software can rely on these bits reading as zero, and must use a should-be-zero policy on writes. Implementations must ignore writes.

CLAIM, bits [7:0]

Claim set bits. RAO.

Writing a 1 to one of these bits sets the corresponding CLAIM bit to 1. This is an indirect write to the CLAIM bits.

A single write operation can set multiple bits to 1. Writing 0 to one of these bits has no effect.

Accessing the DBGCLAIMSET_EL1:

DBGCLAIMSET_EL1 can be accessed through the internal memory-mapped interface and the external debug interface:

Component	Offset
Debug	0xFA0

H9.2.6 DBGDTRRX_EL0, Debug Data Transfer Register, Receive

The DBGDTRRX_EL0 characteristics are:

Purpose

Transfers 32 bits of data from an external host to the processor.
This register is part of the Debug registers functional group.

Usage constraints

This register is accessible as shown below:

Off	DLK	OSLK	SLK	Default
Error	Error	Error	RO	RW

Configurations

DBGDTRRX_EL0 is architecturally mapped to AArch64 register [DBGDTRRX_EL0](#).
DBGDTRRX_EL0 is architecturally mapped to AArch32 register [DBGDTRRXint](#).
DBGDTRRX_EL0 is in the Core power domain.

Attributes

DBGDTRRX_EL0 is a 32-bit register.

The DBGDTRRX_EL0 bit assignments are:

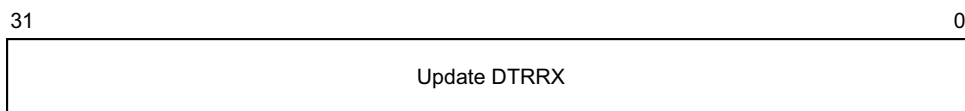

Bits [31:0]

Update DTRRX. Writes to this register update the value in DTRRX and set RXfull to 1.
Reads of this register return the last value written to DTRRX and do not change RXfull.

Accessing the DBGDTRRX_EL0:

DBGDTRRX_EL0 can be accessed through the internal memory-mapped interface and the external debug interface:

Component	Offset
Debug	0x080

H9.2.7 DBGDTRTX_EL0, Debug Data Transfer Register, Transmit

The DBGDTRTX_EL0 characteristics are:

Purpose

Transfers 32 bits of data from the processor to an external host.
This register is part of the Debug registers functional group.

Usage constraints

This register is accessible as shown below:

Off	DLK	OSLK	SLK	Default
Error	Error	Error	RO	RW

Configurations

DBGDTRTX_EL0 is architecturally mapped to AArch64 register [DBGDTRTX_EL0](#).
DBGDTRTX_EL0 is architecturally mapped to AArch32 register [DBGDTRTXint](#).
DBGDTRTX_EL0 is in the Core power domain.

Attributes

DBGDTRTX_EL0 is a 32-bit register.

The DBGDTRTX_EL0 bit assignments are:

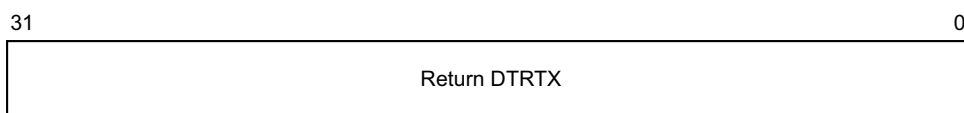

Bits [31:0]

Return DTRTX. Reads of this register return the value in DTRTX and clear TXfull to 0.
Writes of this register update the value in DTRTX and do not change TXfull.

Accessing the DBGDTRTX_EL0:

DBGDTRTX_EL0 can be accessed through the internal memory-mapped interface and the external debug interface:

Component	Offset
Debug	0x08C

H9.2.8 DBGWCR<n>_EL1, Debug Watchpoint Control Registers, n = 0 - 15

The DBGWCR<n>_EL1 characteristics are:

Purpose

Holds control information for a watchpoint. Forms watchpoint n together with value register [DBGWVR<n>_EL1](#), where n is 0 to 15.

This register is part of the Debug registers functional group.

Usage constraints

This register is accessible as shown below:

Off	DLK	OSLK	EDAD	SLK	Default
Error	Error	Error	Error	RO	RW

When the E field is zero, all the other fields in the register are ignored.

Configurations

DBGWCR<n>_EL1 is architecturally mapped to AArch64 register [DBGWCR<n>_EL1](#).

DBGWCR<n>_EL1 is architecturally mapped to AArch32 register [DBGWCR<n>](#).

DBGWCR<n>_EL1 is in the Core power domain.

Attributes

DBGWCR<n>_EL1 is a 32-bit register.

The DBGWCR<n>_EL1 bit assignments are:

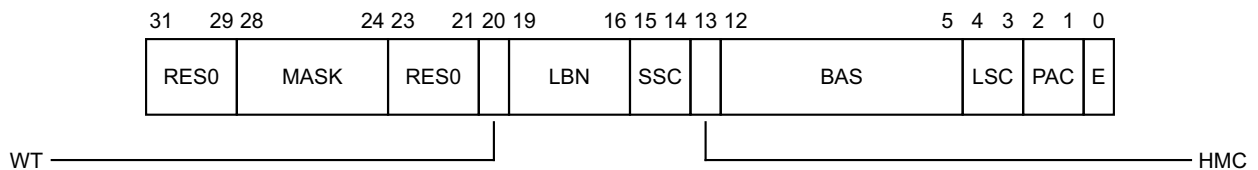

Bits [31:29]

Reserved, RES0.

MASK, bits [28:24]

Address mask. Only objects up to 2GB can be watched using a single mask.

00000 No mask.

00001 Reserved.

00010 Reserved.

Other values mask the corresponding number of address bits, from 0b00011 masking 3 address bits (0x00000007 mask for address) to 0b11111 masking 31 address bits (0xFFFFFFFF mask for address).

Bits [23:21]

Reserved, RES0.

WT, bit [20]

Watchpoint type. Possible values are:

0 Unlinked data address match.

1 Linked data address match.

LBN, bits [19:16]

Linked breakpoint number. For Linked data address watchpoints, this specifies the index of the Context-matching breakpoint linked to.

SSC, bits [15:14]

Security state control. Determines the security states under which a watchpoint debug event for watchpoint *n* is generated. This field must be interpreted along with the HMC and PAC fields.

HMC, bit [13]

Higher mode control. Determines the debug perspective for deciding when a watchpoint debug event for watchpoint *n* is generated. This field must be interpreted along with the SSC and PAC fields.

BAS, bits [12:5]

Byte address select. Each bit of this field selects whether a byte from within the word or double-word addressed by `DBGWVR<n>_EL1` is being watched.

BAS	Description
xxxxxx1	Match byte at <code>DBGWVR<n>_EL1</code>
xxxxx1x	Match byte at <code>DBGWVR<n>_EL1+1</code>
xxxx1xx	Match byte at <code>DBGWVR<n>_EL1+2</code>
xxx1xxx	Match byte at <code>DBGWVR<n>_EL1+3</code>

In cases where `DBGWVR<n>_EL1` addresses a double-word:

BAS	Description, if <code>DBGWVR<n>_EL1[2] == 0</code>
xxx1xxxx	Match byte at <code>DBGWVR<n>_EL1+4</code>
xx1xxxxx	Match byte at <code>DBGWVR<n>_EL1+5</code>
x1xxxxxx	Match byte at <code>DBGWVR<n>_EL1+6</code>
1xxxxxxx	Match byte at <code>DBGWVR<n>_EL1+7</code>

If `DBGWVR<n>_EL1[2] == 1`, only `BAS[3:0]` is used. ARM deprecates setting `DBGWVR<n>_EL1 == 1`.

The valid values for BAS are `0b0000000`, or a binary number all of whose set bits are contiguous. All other values are reserved and must not be used by software.

If BAS is zero, no bytes are watched by this watchpoint.

Ignored if E is 0.

LSC, bits [4:3]

Load/store control. This field enables watchpoint matching on the type of access being made. Possible values of this field are:

- 01 Match instructions that load from a watchpointed address.
- 10 Match instructions that store to a watchpointed address.
- 11 Match instructions that load from or store to a watchpointed address.

All other values are reserved, but must behave as if the watchpoint is disabled. Software must not rely on this property as the behavior of reserved values might change in a future revision of the architecture.

Ignored if E is 0.

PAC, bits [2:1]

Privilege of access control. Determines the exception level or levels at which a watchpoint debug event for watchpoint n is generated. This field must be interpreted along with the SSC and HMC fields.

E, bit [0]

Enable watchpoint n. Possible values are:

- 0 Watchpoint disabled.
- 1 Watchpoint enabled.

Accessing the DBGWCR<n>_EL1:

DBGWCR<n>_EL1 can be accessed through the internal memory-mapped interface and the external debug interface:

Component	Offset
Debug	0x808 + 16n

H9.2.9 DBGWVR<n>_EL1, Debug Watchpoint Value Registers, n = 0 - 15

The DBGWVR<n>_EL1 characteristics are:

Purpose

Holds a data address value for use in watchpoint matching. Forms watchpoint n together with control register [DBGWCR<n>_EL1](#), where n is 0 to 15.

This register is part of the Debug registers functional group.

Usage constraints

This register is accessible as shown below:

Off	DLK	OSLK	EDAD	SLK	Default
Error	Error	Error	Error	RO	RW

Configurations

DBGWVR<n>_EL1 is architecturally mapped to AArch64 register [DBGWVR<n>_EL1](#).

DBGWVR<n>_EL1[31:0] is architecturally mapped to AArch32 register [DBGWVR<n>](#).

DBGWVR<n>_EL1 is in the Core power domain.

Attributes

DBGWVR<n>_EL1 is a 64-bit register.

The DBGWVR<n>_EL1 bit assignments are:

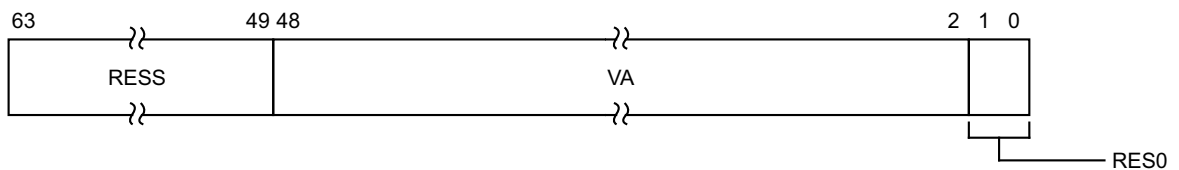

RESS, bits [63:49]

Reserved, Sign extended. Hardwired to the value of the sign bit, bit [48]. Hardware and software must treat this field as RES0 if bit[48] is 0, and as RES1 if bit[48] is 1.

VA, bits [48:2]

Bits[48:2] of the address value for comparison.

ARM deprecates setting [DBGWVR<n>_EL1\[2\] == 1](#).

Bits [1:0]

Reserved, RES0.

Accessing the DBGWVR<n>_EL1:

DBGWVR<n>_EL1[31:0] can be accessed through the internal memory-mapped interface and the external debug interface:

Component	Offset
Debug	0x800 + 16n

DBGWVR<n>_EL1[63:32] can be accessed through the internal memory-mapped interface and the external debug interface:

Component	Offset
Debug	0x804 + 16n

H9.2.10 EDACR, External Debug Auxiliary Control Register

The EDACR characteristics are:

Purpose

Allows implementations to support IMPLEMENTATION DEFINED controls.
This register is part of the Debug registers functional group.

Usage constraints

This register is accessible as shown below:

Off	DLK	OSLK	SLK	Default
IMP DEF	IMP DEF	IMP DEF	RO	RW

Configurations

It is IMPLEMENTATION DEFINED whether EDACR is in the Core power domain or in the Debug power domain.

Attributes

EDACR is a 32-bit register.

The EDACR bit assignments are:



Accessing the EDACR:

EDACR can be accessed through the internal memory-mapped interface and the external debug interface:

Component	Offset
Debug	0x094

H9.2.11 EDCIDR0, External Debug Component Identification Register 0

The EDCIDR0 characteristics are:

Purpose

Provides information to identify an external debug component.
This register is part of the Debug registers functional group.

Usage constraints

This register is accessible as shown below:

Default
RO

Configurations

EDCIDR0 is in the Debug power domain.
EDCIDR0 is optional to implement in the external register interface.
This register is required for CoreSight compliance.

Attributes

EDCIDR0 is a 32-bit register.

The EDCIDR0 bit assignments are:

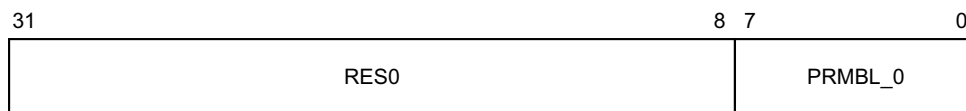

Bits [31:8]

Reserved, RES0.

PRMBL_0, bits [7:0]

Preamble. Must read as 0x00.

Accessing the EDCIDR0:

EDCIDR0 can be accessed through the internal memory-mapped interface and the external debug interface:

Component	Offset
Debug	0xFF0

H9.2.12 EDCIDR1, External Debug Component Identification Register 1

The EDCIDR1 characteristics are:

Purpose

Provides information to identify an external debug component.
This register is part of the Debug registers functional group.

Usage constraints

This register is accessible as shown below:

Default

RO

Configurations

EDCIDR1 is in the Debug power domain.
EDCIDR1 is optional to implement in the external register interface.
This register is required for CoreSight compliance.

Attributes

EDCIDR1 is a 32-bit register.

The EDCIDR1 bit assignments are:

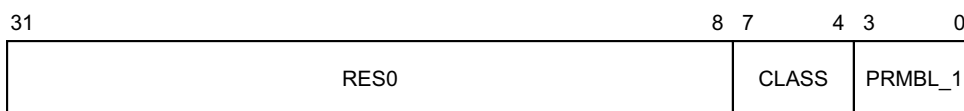

Bits [31:8]

Reserved, RES0.

CLASS, bits [7:4]

Component class. Reads as 0x9, debug component.

PRMBL_1, bits [3:0]

Preamble. RAZ.

Accessing the EDCIDR1:

EDCIDR1 can be accessed through the internal memory-mapped interface and the external debug interface:

Component	Offset
-----------	--------

Debug	0xFF4
-------	-------

H9.2.13 EDCIDR2, External Debug Component Identification Register 2

The EDCIDR2 characteristics are:

Purpose

Provides information to identify an external debug component.
This register is part of the Debug registers functional group.

Usage constraints

This register is accessible as shown below:

Default

RO

Configurations

EDCIDR2 is in the Debug power domain.
EDCIDR2 is optional to implement in the external register interface.
This register is required for CoreSight compliance.

Attributes

EDCIDR2 is a 32-bit register.

The EDCIDR2 bit assignments are:

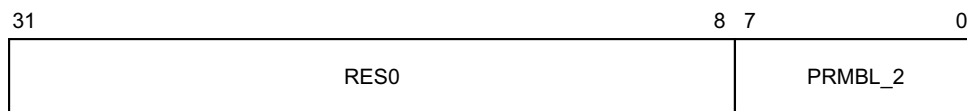

Bits [31:8]

Reserved, RES0.

PRMBL_2, bits [7:0]

Preamble. Must read as 0x05.

Accessing the EDCIDR2:

EDCIDR2 can be accessed through the internal memory-mapped interface and the external debug interface:

Component	Offset
-----------	--------

Debug	0xFF8
-------	-------

H9.2.14 EDCIDR3, External Debug Component Identification Register 3

The EDCIDR3 characteristics are:

Purpose

Provides information to identify an external debug component.
This register is part of the Debug registers functional group.

Usage constraints

This register is accessible as shown below:

Default

RO

Configurations

EDCIDR3 is in the Debug power domain.
EDCIDR3 is optional to implement in the external register interface.
This register is required for CoreSight compliance.

Attributes

EDCIDR3 is a 32-bit register.

The EDCIDR3 bit assignments are:

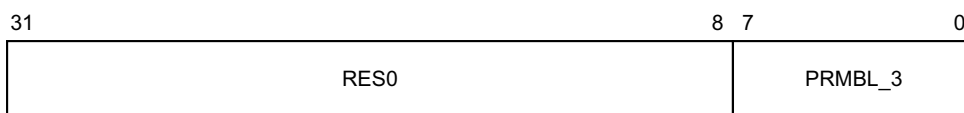

Bits [31:8]

Reserved, RES0.

PRMBL_3, bits [7:0]

Preamble. Must read as 0xB1.

Accessing the EDCIDR3:

EDCIDR3 can be accessed through the internal memory-mapped interface and the external debug interface:

Component	Offset
-----------	--------

Debug	0xFFC
-------	-------

H9.2.15 EDCIDSR, External Debug Context ID Sample Register

The EDCIDSR characteristics are:

Purpose

Contains the sampled value of [CONTEXTIDR_EL1](#), captured on reading the low half of [EDPCSR](#).
This register is part of the Debug registers functional group.

Usage constraints

This register is accessible as shown below:

Off	DLK	OSLK	Default
Error	Error	Error	RO

Configurations

EDCIDSR is in the Core power domain.

Attributes

EDCIDSR is a 32-bit register.

The EDCIDSR bit assignments are:

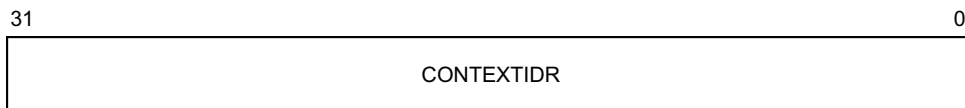

CONTEXTIDR, bits [31:0]

The sampled value of [CONTEXTIDR_EL1](#), captured on reading the low half of [EDPCSR](#).

If EL3 is implemented and using AArch32 then [CONTEXTIDR](#) is a Banked register, and EDCIDSR samples the current Banked copy of [CONTEXTIDR](#).

On Cold reset, the field reset value is architecturally UNKNOWN.

Accessing the EDCIDSR:

EDCIDSR can be accessed through the internal memory-mapped interface and the external debug interface:

Component	Offset
Debug	0x0A4

H9.2.16 EDDEVAFF0, External Debug Device Affinity register 0

The EDDEVAFF0 characteristics are:

Purpose

Copy of the low half of the processor [MPIDR_EL1](#) register that allows a debugger to determine which processor in a multiprocessor system the external debug component relates to.

This register is part of the Debug registers functional group.

Usage constraints

This register is accessible as shown below:

Default

RO

Configurations

EDDEVAFF0 is in the Debug power domain.

EDDEVAFF0 is optional to implement in the external register interface.

Attributes

EDDEVAFF0 is a 32-bit register.

The EDDEVAFF0 bit assignments are:

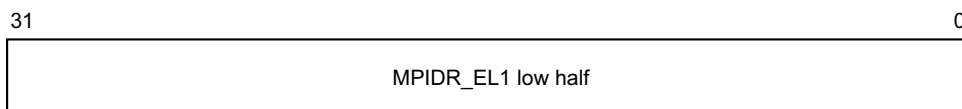

Bits [31:0]

[MPIDR_EL1](#) low half. Read-only copy of the low half of [MPIDR_EL1](#), as seen from the highest implemented exception level.

Accessing the EDDEVAFF0:

EDDEVAFF0 can be accessed through the internal memory-mapped interface and the external debug interface:

Component	Offset
-----------	--------

Debug	0xFA8
-------	-------

H9.2.17 EDDEVAFF1, External Debug Device Affinity register 1

The EDDEVAFF1 characteristics are:

Purpose

Copy of the high half of the processor [MPIDR_EL1](#) register that allows a debugger to determine which processor in a multiprocessor system the external debug component relates to.

This register is part of the Debug registers functional group.

Usage constraints

This register is accessible as shown below:

Default

RO

Configurations

EDDEVAFF1 is in the Debug power domain.

EDDEVAFF1 is optional to implement in the external register interface.

Attributes

EDDEVAFF1 is a 32-bit register.

The EDDEVAFF1 bit assignments are:

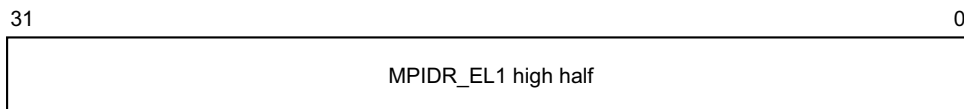

Bits [31:0]

[MPIDR_EL1](#) high half. Read-only copy of the high half of [MPIDR_EL1](#), as seen from the highest implemented exception level.

Accessing the EDDEVAFF1:

EDDEVAFF1 can be accessed through the internal memory-mapped interface and the external debug interface:

Component	Offset
-----------	--------

Debug	0xFAC
-------	-------

H9.2.18 EDDEVARCH, External Debug Device Architecture register

The EDDEVARCH characteristics are:

Purpose

Identifies the programmers' model architecture of the external debug component.
This register is part of the Debug registers functional group.

Usage constraints

This register is accessible as shown below:

Default

RO

Configurations

EDDEVARCH is in the Debug power domain.
EDDEVARCH is optional to implement in the external register interface.

Attributes

EDDEVARCH is a 32-bit register.

The EDDEVARCH bit assignments are:

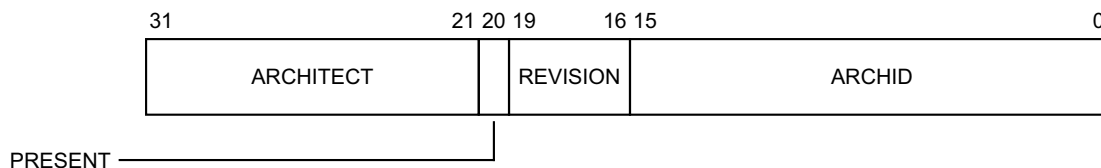

ARCHITECT, bits [31:21]

Defines the architecture of the component. For debug, this is ARM Limited.
Bits [31:28] are the JEP 106 continuation code, 0x4.
Bits [27:21] are the JEP 106 ID code, 0x3B.

PRESENT, bit [20]

When set to 1, indicates that the DEVARCH is present.
This field is 1 in v8-A.

REVISION, bits [19:16]

Defines the architecture revision. For architectures defined by ARM this is the minor revision.
For debug, the revision defined by v8-A is 0x0.
All other values are reserved.

ARCHID, bits [15:0]

Defines this part to be a v8-A debug component. For architectures defined by ARM this is further subdivided.

For debug:

- Bits [15:12] are the architecture version, 0x6.
- Bits [11:0] are the architecture part number, 0xA15.

This corresponds to debug architecture version v8-A.

Accessing the EDDEVARCH:

EDDEVARCH can be accessed through the internal memory-mapped interface and the external debug interface:

Component	Offset
Debug	0xFBC

H9.2.19 EDDEVID, External Debug Device ID register 0

The EDDEVID characteristics are:

Purpose

Provides extra information for external debuggers about features of the debug implementation.
This register is part of the Debug registers functional group.

Usage constraints

This register is accessible as shown below:

Default
RO

Configurations

EDDEVID is in the Debug power domain.

Attributes

EDDEVID is a 32-bit register.

The EDDEVID bit assignments are:

31	28 27	24 23	4 3	0
RES0	AuxRegs	RES0	PCSample	

Bits [31:28]

Reserved, RES0.

AuxRegs, bits [27:24]

Indicates support for Auxiliary registers. Permitted values for this field are:

0000 None supported.

0001 Support for External Debug Auxiliary Control Register, [EDACR](#).

All other values are reserved.

Bits [23:4]

Reserved, RES0.

PCSample, bits [3:0]

Indicates the level of Sample-based profiling support using external debug registers 40 through 43.
Permitted values of this field in v8-A are:

0000 Architecture-defined form of Sample-based profiling not implemented.

0010 [EDPCSR](#) and [EDCIDS](#)R are implemented (only permitted if EL3 and EL2 are not implemented).

0011 [EDPCSR](#), [EDCIDS](#)R, and [EDVIDS](#)R are implemented.

All other values are reserved.

Accessing the EDDEVID:

EDDEVID can be accessed through the internal memory-mapped interface and the external debug interface:

Component	Offset
Debug	0xFC8

H9.2.20 EDDEVID1, External Debug Device ID register 1

The EDDEVID1 characteristics are:

Purpose

Provides extra information for external debuggers about features of the debug implementation.
This register is part of the Debug registers functional group.

Usage constraints

This register is accessible as shown below:

Default

RO

Configurations

EDDEVID1 is in the Debug power domain.

Attributes

EDDEVID1 is a 32-bit register.

The EDDEVID1 bit assignments are:

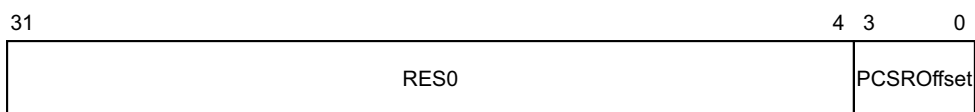

Bits [31:4]

Reserved, RES0.

PCSROffset, bits [3:0]

This field indicates the offset applied to PC samples returned by reads of [EDPCSR](#). Permitted values of this field in v8-A are:

0000 [EDPCSR](#) not implemented.

0010 [EDPCSR](#) implemented, and samples have no offset applied and do not sample the instruction set state in AArch32 state.

Accessing the EDDEVID1:

EDDEVID1 can be accessed through the internal memory-mapped interface and the external debug interface:

Component	Offset
-----------	--------

Debug	0xFC4
-------	-------

H9.2.21 EDDEVID2, External Debug Device ID register 2

The EDDEVID2 characteristics are:

Purpose

Reserved for future descriptions of features of the debug implementation.
This register is part of the Debug registers functional group.

Usage constraints

This register is accessible as shown below:

Default

RO

Configurations

EDDEVID2 is in the Debug power domain.

Attributes

EDDEVID2 is a 32-bit register.

The EDDEVID2 bit assignments are:

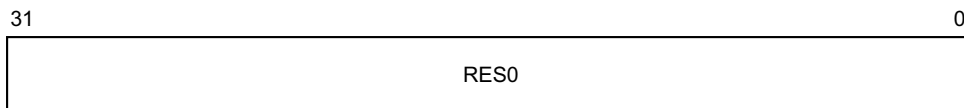

Bits [31:0]

Reserved, RES0.

Accessing the EDDEVID2:

EDDEVID2 can be accessed through the internal memory-mapped interface and the external debug interface:

Component	Offset
Debug	0xFC0

H9.2.22 EDDEVTYPE, External Debug Device Type register

The EDDEVTYPE characteristics are:

Purpose

Indicates to a debugger that this component is part of a processor's debug logic.
This register is part of the Debug registers functional group.

Usage constraints

This register is accessible as shown below:

Default
RO

Configurations

EDDEVTYPE is in the Debug power domain.
EDDEVTYPE is optional to implement in the external register interface.

Attributes

EDDEVTYPE is a 32-bit register.

The EDDEVTYPE bit assignments are:

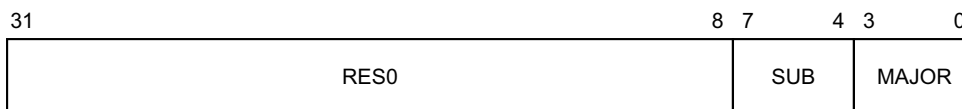

Bits [31:8]

Reserved, RES0.

SUB, bits [7:4]

Subtype. Must read as 0x1 to indicate this is a processor component.

MAJOR, bits [3:0]

Major type. Must read as 0x5 to indicate this is a debug logic component.

Accessing the EDDEVTYPE:

EDDEVTYPE can be accessed through the internal memory-mapped interface and the external debug interface:

Component	Offset
Debug	0xFCC

H9.2.23 EDECCR, External Debug Exception Catch Control Register

The EDECCR characteristics are:

Purpose

Controls exception catch debug events.

This register is part of the Debug registers functional group.

Usage constraints

This register is accessible as shown below:

Off	DLK	OSLK	SLK	Default
Error	Error	Error	RO	RW

Configurations

EDECCR is architecturally mapped to AArch64 register [OSECCR_EL1](#).

EDECCR is architecturally mapped to AArch32 register [DBGOSECCR](#).

EDECCR is in the Core power domain.

Attributes

EDECCR is a 32-bit register.

The EDECCR bit assignments are:

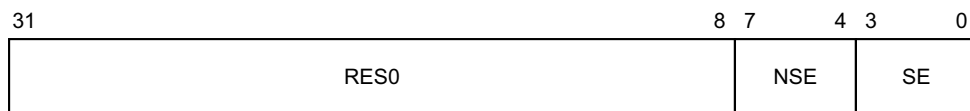

Bits [31:8]

Reserved, RES0.

NSE, bits [7:4]

Coarse-grained Non-secure exception catch. Possible values of this field are:

0000 Exception catch debug event disabled for Non-secure exception levels.

0010 Exception catch debug event enabled for Non-secure EL1.

0100 Exception catch debug event enabled for Non-secure EL2.

0110 Exception catch debug event enabled for Non-secure EL1 and EL2.

All other values are reserved. Bits [7,4] are reserved, RES0.

On Cold reset, the field resets to 0.

SE, bits [3:0]

Coarse-grained Secure exception catch. Possible values of this field are:

0000 Exception catch debug event disabled for Secure exception levels.

0010 Exception catch debug event enabled for Secure EL1.

1000 Exception catch debug event enabled for Secure EL3.

1010 Exception catch debug event enabled for Secure EL1 and EL3.

All other values are reserved. Bits [2,0] are reserved. RES0. Ignored if ExternalSecureInvasiveDebugEnabled() == FALSE.

On Cold reset, the field resets to 0.

Accessing the EDECCR:

EDECCR can be accessed through the internal memory-mapped interface and the external debug interface:

Component	Offset
Debug	0x098

H9.2.24 EDECR, External Debug Execution Control Register

The EDECR characteristics are:

Purpose

Controls Halting debug events.

This register is part of the Debug registers functional group.

Usage constraints

This register is accessible as shown below:

SLK	Default
RO	RW

Configurations

EDECR is in the Debug power domain.

Attributes

EDECR is a 32-bit register.

The EDECR bit assignments are:

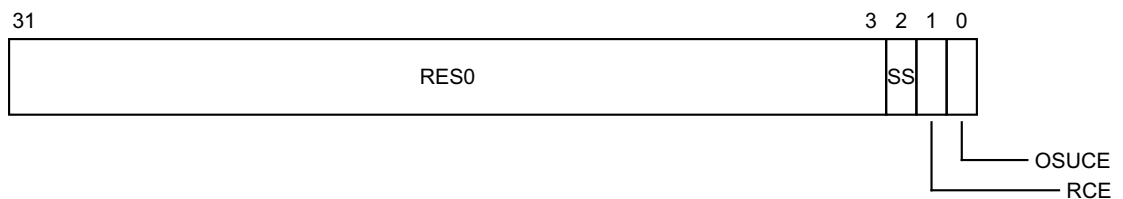

Bits [31:3]

Reserved, RES0.

SS, bit [2]

Halting step enable. Possible values of this field are:

0 Halting step debug event disabled.

1 Halting step debug event enabled.

If the value of EDECR.SS is changed when the processor is in Non-debug state, the resulting value of EDECR.SS is UNKNOWN.

On External debug reset, the field resets to 0.

RCE, bit [1]

Reset catch enable. Possible values of this field are:

0 Reset catch debug event disabled.

1 Reset catch debug event enabled.

On External debug reset, the field resets to 0.

OSUCE, bit [0]

OS unlock catch enabled. Possible values of this field are:

0 OS unlock catch debug event disabled.

1 OS unlock catch debug event enabled.

On External debug reset, the field resets to 0.

Accessing the EDECR:

EDECR can be accessed through the internal memory-mapped interface and the external debug interface:

Component	Offset
Debug	0x024

H9.2.25 EDESR, External Debug Event Status Register

The EDESR characteristics are:

Purpose

Indicates the status of internally pending Halting debug events.
This register is part of the Debug registers functional group.

Usage constraints

This register is accessible as shown below:

Off	DLK	SLK	Default
Error	Error	RO	RW

If a request to clear a pending Halting debug event is received at or about the time when halting becomes allowed, it is CONstrained UNPREDICTABLE whether the event is taken.

If Core power is removed while a Halting debug event is pending, it is lost. However, it may become pending again when the Core is powered back on and Cold reset.

Configurations

EDESR is in the Core power domain.

Attributes

EDESR is a 32-bit register.

The EDESR bit assignments are:

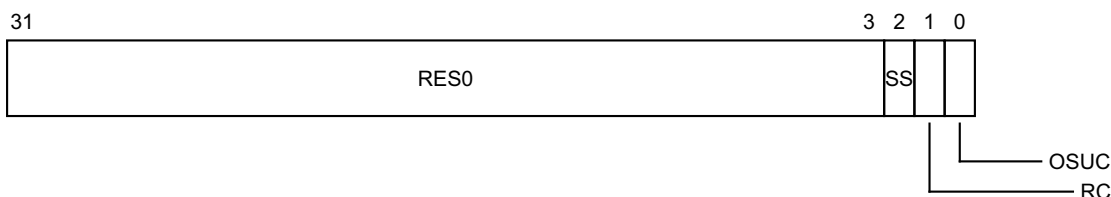

Bits [31:3]

Reserved, RES0.

SS, bit [2]

Halting step debug event pending. Possible values of this field are:

- 0 Reading this means that a Halting step debug event is not pending. Writing this means no action.
- 1 Reading this means that a Halting step debug event is pending. Writing this clears the pending Halting step debug event.

On Warm reset, the field resets to 0.

RC, bit [1]

Reset catch debug event pending. Possible values of this field are:

- 0 Reading this means that a Reset catch debug event is not pending. Writing this means no action.
- 1 Reading this means that a Reset catch debug event is pending. Writing this clears the pending Reset catch debug event.

On Warm reset, the field resets to 0.

OSUC, bit [0]

OS unlock debug event pending. Possible values of this field are:

- 0 Reading this means that an OS unlock catch debug event is not pending. Writing this means no action.
- 1 Reading this means that an OS unlock catch debug event is pending. Writing this clears the pending OS unlock catch debug event.

On Warm reset, the field resets to 0.

Accessing the EDESR:

EDESR can be accessed through the internal memory-mapped interface and the external debug interface:

Component	Offset
Debug	0x020

H9.2.26 EDITCTRL, External Debug Integration mode Control register

The EDITCTRL characteristics are:

Purpose

Enables the external debug to switch from its default mode into integration mode, where test software can control directly the inputs and outputs of the processor, for integration testing or topology detection.

This register is part of the Debug registers functional group.

Usage constraints

This register is accessible as shown below:

Off	DLK	OSLK	Default
IMP DEF	IMP DEF	IMP DEF	RW

Configurations

It is IMPLEMENTATION DEFINED whether EDITCTRL is in the Core power domain or in the Debug power domain.

EDITCTRL is optional to implement in the external register interface.

Attributes

EDITCTRL is a 32-bit register.

The EDITCTRL bit assignments are:

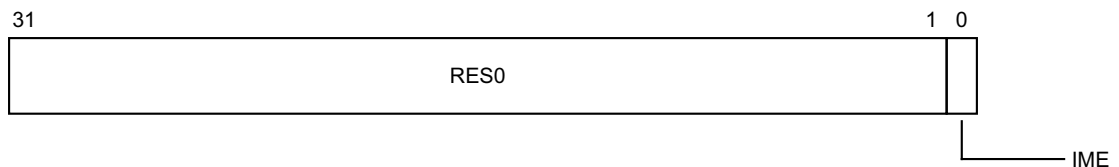

Bits [31:1]

Reserved, RES0.

IME, bit [0]

Integration mode enable. When IME == 1, the device reverts to an integration mode to enable integration testing or topology detection. The integration mode behavior is IMPLEMENTATION DEFINED.

0 Normal operation.

1 Integration mode enabled.

On IMPLEMENTATION DEFINED reset, the field resets to 0.

Accessing the EDITCTRL:

EDITCTRL can be accessed through the internal memory-mapped interface and the external debug interface:

Component	Offset
Debug	0xF00

H9.2.27 EDITR, External Debug Instruction Transfer Register

The EDITR characteristics are:

Purpose

Used in Debug state for passing instructions to the processor for execution.
This register is part of the Debug registers functional group.

Usage constraints

This register is accessible as shown below:

Off	DLK	OSLK	SLK	Default
Error	Error	Error	WI	WO

If `EDSCR.ITE == 0` when the processor exits Debug state on receiving a Restart request trigger event, the behavior of any instruction issued through the ITR in normal mode that has not completed execution is CONstrained UNPREDICTABLE, and must do one of the following:

- It must complete execution in Debug state before the processor executes the restart sequence.
- It must complete execution in Non-debug state before the processor executes the restart sequence.
- It must be abandoned. This means that the instruction does not execute. Any registers or memory accessed by the instruction are left in an UNKNOWN state.

Configurations

EDITR is in the Core power domain.

Attributes

EDITR is a 32-bit register.

The EDITR bit assignments are:

When in AArch32 state:

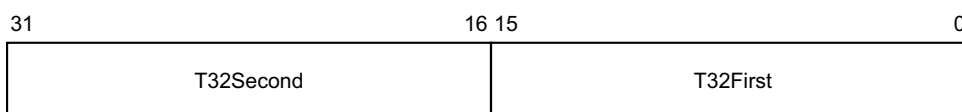

T32Second, bits [31:16]

Second halfword of the T32 instruction to be executed on the processor.

T32First, bits [15:0]

First halfword of the T32 instruction to be executed on the processor.

When in AArch64 state:

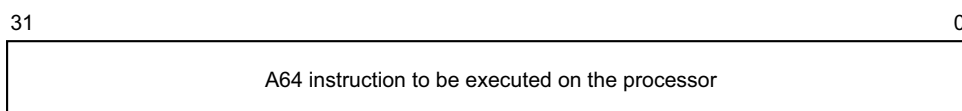

Bits [31:0]

A64 instruction to be executed on the processor.

Accessing the EDITR:

EDITR can be accessed through the internal memory-mapped interface and the external debug interface:

Component	Offset
Debug	0x084

H9.2.28 EDLAR, External Debug Lock Access Register

The EDLAR characteristics are:

Purpose

Allows or disallows access to the external debug registers through a memory-mapped interface.
This register is part of the Debug registers functional group.

Usage constraints

This register is accessible as shown below:

Default
WO

Configurations

EDLAR is in the Debug power domain.

If OPTIONAL memory-mapped access to the external debug interface is supported then an OPTIONAL Software lock can be implemented as part of CoreSight compliance.

EDLAR ignores writes if the Software lock is not implemented and ignores writes for other accesses to the external debug interface.

The Software lock provides a lock to prevent memory-mapped writes to the debug registers. Use of this lock mechanism reduces the risk of accidental damage to the contents of the debug registers. It does not, and cannot, prevent all accidental or malicious damage.

Software uses EDLAR to set or clear the lock, and [EDLSR](#) to check the current status of the lock.

Attributes

EDLAR is a 32-bit register.

The EDLAR bit assignments are:

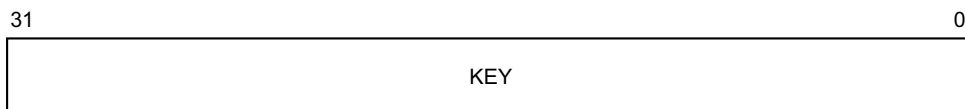

KEY, bits [31:0]

Lock Access control. Writing the key value 0xC5ACCE55 to this field unlocks the lock, enabling write accesses to this component's registers through a memory-mapped interface.

Writing any other value to this register locks the lock, disabling write accesses to this component's registers through a memory mapped interface.

Accessing the EDLAR:

EDLAR can be accessed through the internal memory-mapped interface:

Component	Offset
Debug	0xFB0

H9.2.29 EDLSR, External Debug Lock Status Register

The EDLSR characteristics are:

Purpose

Indicates the current status of the software lock for external debug registers.
This register is part of the Debug registers functional group.

Usage constraints

This register is accessible as shown below:

Default

RO

Configurations

EDLSR is in the Debug power domain.

If OPTIONAL memory-mapped access to the external debug interface is supported then an OPTIONAL Software lock can be implemented as part of CoreSight compliance.

EDLSR is RAZ if the Software lock is not implemented and is RAZ for other accesses to the external debug interface.

The Software lock provides a lock to prevent memory-mapped writes to the debug registers. Use of this lock mechanism reduces the risk of accidental damage to the contents of the debug registers. It does not, and cannot, prevent all accidental or malicious damage.

Software uses [EDLAR](#) to set or clear the lock, and EDLSR to check the current status of the lock.

Attributes

EDLSR is a 32-bit register.

The EDLSR bit assignments are:

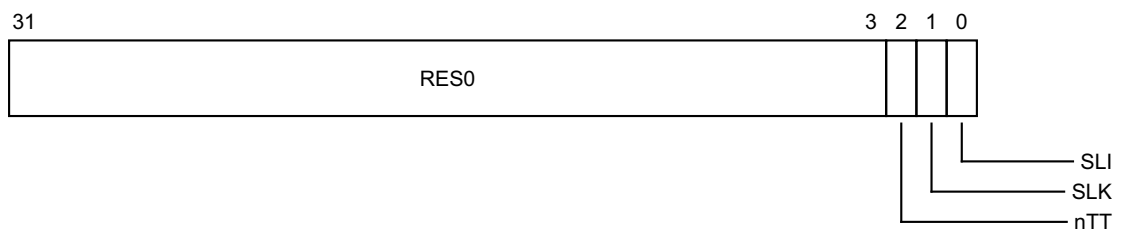

Bits [31:3]

Reserved, RES0.

nTT, bit [2]

Not thirty-two bit access required. RAZ.

SLK, bit [1]

Software lock status for this component. For an access to LSR that is not a memory-mapped access, or when the software lock is not implemented, this field is RES0.

For memory-mapped accesses when the software lock is implemented, possible values of this field are:

- 0 Lock clear. Writes are permitted to this component's registers.
- 1 Lock set. Writes to this component's registers are ignored, and reads have no side effects.

On External debug reset, the field resets to 1.

SLI, bit [0]

Software lock implemented. For an access to LSR that is not a memory-mapped access, this field is RAZ. For memory-mapped accesses, the value of this field is IMPLEMENTATION DEFINED. Permitted values are:

- 0 Software lock not implemented or not memory-mapped access.
- 1 Software lock implemented and memory-mapped access.

Accessing the EDLSR:

EDLSR can be accessed through the internal memory-mapped interface:

Component	Offset
Debug	0xFB4

H9.2.30 EDPCSR, External Debug Program Counter Sample Register

The EDPCSR characteristics are:

Purpose

Holds a sampled instruction address value.

This register is part of the Debug registers functional group.

Usage constraints

This register is accessible as shown below:

Off	DLK	OSLK	SLK	Default
Error	Error	Error	RO	RO

Configurations

EDPCSR is in the Core power domain.

EDPCSR is optional to implement in the external register interface.

Attributes

EDPCSR is a 64-bit register.

The EDPCSR bit assignments are:

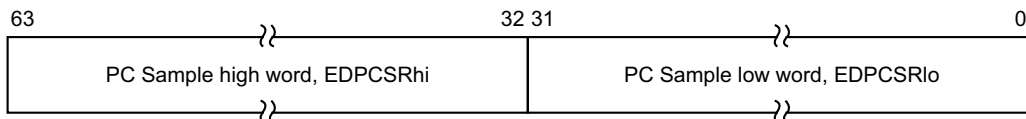

Bits [63:32]

PC Sample high word, EDPCSRhi. If `EDVIDSR.HV == 0` then this field is RAZ, otherwise bits [63:32] of the sampled PC.

On Cold reset, the field reset value is architecturally UNKNOWN.

Bits [31:0]

PC Sample low word, EDPCSRlo. Bits [31:0] of the sampled instruction address value. Reading EDPCSRlo has the side-effect of updating `EDCIDSR`, `EDVIDSR`, and `EDPCSRhi`. However:

- If the processor is in Debug state, or Sample-based profiling is prohibited, EDPCSRlo reads as 0xFFFFFFFF and `EDCIDSR`, `EDVIDSR`, and `EDPCSRhi` become UNKNOWN.
- If the processor is in Reset state, the sampled value is unknown and `EDCIDSR`, `EDVIDSR` and `EDPCSRhi` become UNKNOWN.
- If no instruction has been retired since the processor left Reset state, Debug state, or a state where Non-invasive debug is not permitted, the sampled value is UNKNOWN and `EDCIDSR`, `EDVIDSR`, and `EDPCSRhi` become UNKNOWN.
- For a read of EDPCSRlo from the memory-mapped interface, if `EDLSR.SLK == 1`, meaning the Software Lock is locked, then the access has no side-effects. That is, `EDCIDSR`, `EDVIDSR`, and `EDPCSRhi` are unchanged.

On Cold reset, the field reset value is architecturally UNKNOWN.

Accessing the EDPCSR:

EDPCSR[31:0] can be accessed through the internal memory-mapped interface and the external debug interface:

Component	Offset
Debug	0x0A0

EDPCSR[63:32] can be accessed through the internal memory-mapped interface and the external debug interface:

Component	Offset
Debug	0x0AC

H9.2.31 EDPIDR0, External Debug Peripheral Identification Register 0

The EDPIDR0 characteristics are:

Purpose

Provides information to identify an external debug component.
This register is part of the Debug registers functional group.

Usage constraints

This register is accessible as shown below:

Default
RO

Configurations

EDPIDR0 is in the Debug power domain.
EDPIDR0 is optional to implement in the external register interface.
This register is required for CoreSight compliance.

Attributes

EDPIDR0 is a 32-bit register.

The EDPIDR0 bit assignments are:

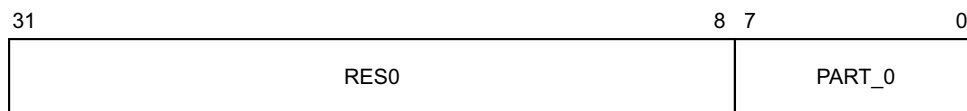

Bits [31:8]

Reserved, RES0.

PART_0, bits [7:0]

Part number, least significant byte.

Accessing the EDPIDR0:

EDPIDR0 can be accessed through the internal memory-mapped interface and the external debug interface:

Component	Offset
Debug	0xFE0

H9.2.32 EDPIDR1, External Debug Peripheral Identification Register 1

The EDPIDR1 characteristics are:

Purpose

Provides information to identify an external debug component.
This register is part of the Debug registers functional group.

Usage constraints

This register is accessible as shown below:

Default

RO

Configurations

EDPIDR1 is in the Debug power domain.
EDPIDR1 is optional to implement in the external register interface.
This register is required for CoreSight compliance.

Attributes

EDPIDR1 is a 32-bit register.

The EDPIDR1 bit assignments are:

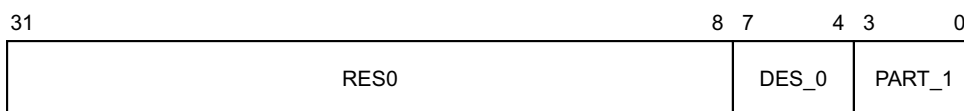

Bits [31:8]

Reserved, RES0.

DES_0, bits [7:4]

Designer, least significant nibble of JEP106 ID code. For ARM Limited, this field is 0b1011.

PART_1, bits [3:0]

Part number, most significant nibble.

Accessing the EDPIDR1:

EDPIDR1 can be accessed through the internal memory-mapped interface and the external debug interface:

Component	Offset
-----------	--------

Debug	0xFE4
-------	-------

H9.2.33 EDPIDR2, External Debug Peripheral Identification Register 2

The EDPIDR2 characteristics are:

Purpose

Provides information to identify an external debug component.
This register is part of the Debug registers functional group.

Usage constraints

This register is accessible as shown below:

Default

RO

Configurations

EDPIDR2 is in the Debug power domain.
EDPIDR2 is optional to implement in the external register interface.
This register is required for CoreSight compliance.

Attributes

EDPIDR2 is a 32-bit register.

The EDPIDR2 bit assignments are:

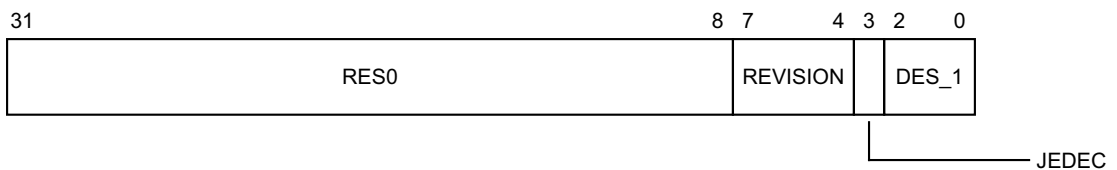

Bits [31:8]

Reserved, RES0.

REVISION, bits [7:4]

Part major revision. Parts can also use this field to extend Part number to 16-bits.

JEDEC, bit [3]

RAO. Indicates a JEP106 identity code is used.

DES_1, bits [2:0]

Designer, most significant bits of JEP106 ID code. For ARM Limited, this field is 0b011.

Accessing the EDPIDR2:

EDPIDR2 can be accessed through the internal memory-mapped interface and the external debug interface:

Component	Offset
Debug	0xFE8

H9.2.34 EDPIDR3, External Debug Peripheral Identification Register 3

The EDPIDR3 characteristics are:

Purpose

Provides information to identify an external debug component.
This register is part of the Debug registers functional group.

Usage constraints

This register is accessible as shown below:

Default
RO

Configurations

EDPIDR3 is in the Debug power domain.
EDPIDR3 is optional to implement in the external register interface.
This register is required for CoreSight compliance.

Attributes

EDPIDR3 is a 32-bit register.

The EDPIDR3 bit assignments are:

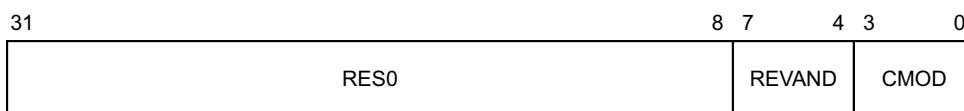

Bits [31:8]

Reserved, RES0.

REVAND, bits [7:4]

Part minor revision. Parts using [EDPIDR2.REVISION](#) as an extension to the Part number must use this field as a major revision number.

CMOD, bits [3:0]

Customer modified. Indicates someone other than the Designer has modified the component.

Accessing the EDPIDR3:

EDPIDR3 can be accessed through the internal memory-mapped interface and the external debug interface:

Component	Offset
Debug	0xFEC

H9.2.35 EDPIDR4, External Debug Peripheral Identification Register 4

The EDPIDR4 characteristics are:

Purpose

Provides information to identify an external debug component.
This register is part of the Debug registers functional group.

Usage constraints

This register is accessible as shown below:

Default

RO

Configurations

EDPIDR4 is in the Debug power domain.
EDPIDR4 is optional to implement in the external register interface.
This register is required for CoreSight compliance.

Attributes

EDPIDR4 is a 32-bit register.

The EDPIDR4 bit assignments are:

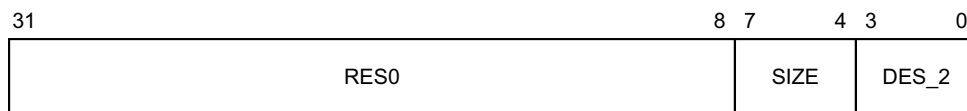

Bits [31:8]

Reserved, RES0.

SIZE, bits [7:4]

Size of the component. RAZ. \log_2 of the number of 4KB pages from the start of the component to the end of the component ID registers.

DES_2, bits [3:0]

Designer, JEP106 continuation code, least significant nibble. For ARM Limited, this field is 0b0100.

Accessing the EDPIDR4:

EDPIDR4 can be accessed through the internal memory-mapped interface and the external debug interface:

Component	Offset
-----------	--------

Debug	0xFD0
-------	-------

H9.2.36 EDPRCR, External Debug Power/Reset Control Register

The EDPRCR characteristics are:

Purpose

Controls processor functionality related to powerup, reset, and powerdown.
This register is part of the Debug registers functional group.

Usage constraints

Accessing this register depends on which field is being accessed; see the register field descriptions for the states that they are accessible in.

Configurations

EDPRCR contains fields that are in the Core power domain and fields that are in the Debug power domain.

Bit [0] of this register is mapped to [DBGPRCR.CORENPDRQ](#), bit [0] of the AArch32 view of this register.

Bit [0] of this register is mapped to [DBGPRCR_EL1.CORENPDRQ](#), bit [0] of the AArch64 view of this register.

The other bits in these registers are not mapped to each other.

Attributes

EDPRCR is a 32-bit register.

The EDPRCR bit assignments are:

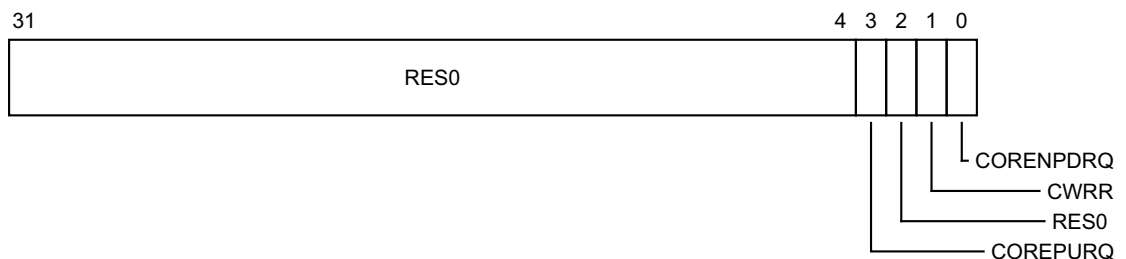

Bits [31:4]

Reserved, RES0.

COREPURQ, bit [3]

Core powerup request. Allows a debugger to request that the power controller power up the core, enabling access to the debug register in the Core power domain. The actions on writing to this bit are:

- 0 No effect.
- 1 Request the power controller to powerup the core.

In an implementation that includes the recommended external debug interface, this bit drives the [DBGPWRUPREQ](#) signal.

This bit can be read and written when the Core power domain is powered off.

The power controller must not allow the Core power domain to switch off while this bit is one.

On External debug reset, the field resets to 0.

This field is accessible as shown below:

SLK	Default
RO	RW

The meanings of the conditions in the table above are summarized in the "External debug register access permissions summary" section of the Debug specification (PRD03-PRDC-010486). The priority at which each condition applies is from highest priority on the left to lowest on the right.

Bit [2]

Reserved, RES0.

CWRR, bit [1]

Warm reset request. Write only bit that reads as zero. The actions on writing to this bit are:

- 0 No action.
- 1 Request Warm reset.

The processor ignores writes to this bit if any of the following are the case:

- ExternalInvasiveDebugEnabled() == FALSE, EL3 is not implemented, and the processor is Non-secure.
- ExternalSecureInvasiveDebugEnabled() == FALSE and one of the following is true:
 - EL3 is implemented.
 - The processor is Secure.
- The Core power domain is either completely off or in a low-power state where the Core power domain registers cannot be accessed.
- DoubleLockStatus() == TRUE (OS Double Lock is set).
- OLSR.OSLK == 1 (OS lock is locked).

In an implementation that includes the recommended external debug interface, this bit drives the DBGRSTREQ signal.

On Warm reset, the field resets to 0.

This field is accessible as shown below:

Off	DLK	OSLK	SLK	Default
WI	WI	WI	WI	WO

The meanings of the conditions in the table above are summarized in the "External debug register access permissions summary" section of the Debug specification (PRD03-PRDC-010486). The priority at which each condition applies is from highest priority on the left to lowest on the right.

CORENPDRQ, bit [0]

Core no powerdown request. Requests emulation of powerdown. Possible values of this bit are:

- 0 On a powerdown request, the system powers down the Core power domain.
- 1 On a powerdown request, the system emulates powerdown of the Core power domain. In this emulation mode the Core power domain is not actually powered down.

On Cold reset, the field reset value is architecturally UNKNOWN.

This field is accessible as shown below:

Off	DLK	OSLK	SLK	Default
WI	WI	WI	RO	RW

The meanings of the conditions in the table above are summarized in the "External debug register access permissions summary" section of the Debug specification (PRD03-PRDC-010486). The priority at which each condition applies is from highest priority on the left to lowest on the right.

Accessing the EDPRCR:

EDPRCR can be accessed through the internal memory-mapped interface and the external debug interface:

Component	Offset
Debug	0x310

H9.2.37 EDPRSR, External Debug Processor Status Register

The EDPRSR characteristics are:

Purpose

Holds information about the reset and powerdown state of the processor.
This register is part of the Debug registers functional group.

Usage constraints

Accessing this register depends on which field is being accessed; see the register field descriptions for the states that they are accessible in.

If the Core power domain is on (EDPRSR.PU == 1), then following a read of EDPRSR:

- If EDPRSR.DLK == 0, then:
 - EDPRSR.{SDR, SPMAD, SDAD, SPD} are cleared to 0.
 - EDPRSR.SR is cleared to 0 if the non-debug logic of the processor is not in reset state (EDPRSR.R == 0).
- Otherwise it is CONSTRAINED UNPREDICTABLE whether or not this clearing occurs.

Configurations

EDPRSR contains fields that are in the Core power domain and fields that are in the Debug power domain.

Attributes

EDPRSR is a 32-bit register.

The EDPRSR bit assignments are:

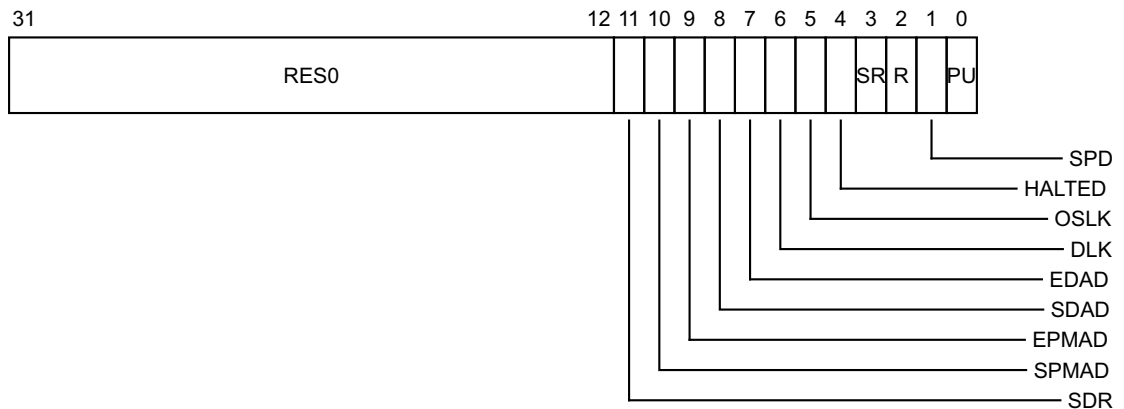

Bits [31:12]

Reserved, RES0.

SDR, bit [11]

Sticky debug restart. Set to 1 when the processor exits Debug state and cleared to 0 following reads of EDPRSR.

- 0 The processor has not restarted since EDPRSR was last read.
- 1 The processor has restarted since EDPRSR was last read.

This bit is UNKNOWN on reads if either of EDPRSR.{DLK, R} is 1, or EDPRSR.PU is 0.

This bit clears to 0 when following a read of EDPRSR.

On Warm reset, the field reset value is architecturally UNKNOWN.

This field is accessible as shown below:

Off	DLK	SLK	Default
UNK	UNK	RO	RC

The meanings of the conditions in the table above are summarized in the "External debug register access permissions summary" section of the Debug specification (PRD03-PRDC-010486). The priority at which each condition applies is from highest priority on the left to lowest on the right.

SPMAD, bit [10]

Sticky EPMAD error. Set to 1 if an access returns an error because AllowExternalPMUAccess() == FALSE.

0 No accesses to the external performance monitors registers have failed since EDPRSR was last read.

1 At least one access to the external performance monitors registers has failed since EDPRSR was last read.

This bit is UNKNOWN on reads if either of EDPRSR.{DLK, R} is 1, or EDPRSR.PU is 0.

This bit clears to 0 when following a read of EDPRSR.

On Cold reset, the field resets to 0.

This field is accessible as shown below:

Off	DLK	SLK	Default
UNK	UNK	RO	RC

The meanings of the conditions in the table above are summarized in the "External debug register access permissions summary" section of the Debug specification (PRD03-PRDC-010486). The priority at which each condition applies is from highest priority on the left to lowest on the right.

EPMAD, bit [9]

External performance monitors access disable status.

0 External performance monitors access enabled.

1 External performance monitors access disabled.

If external performance monitors access is not implemented, EPMAD is RAO. This bit is UNKNOWN on reads if either of EDPRSR.{DLK, R} is 1, or EDPRSR.PU is 0.

On Warm reset, the field reset value is architecturally UNKNOWN.

This field is accessible as shown below:

Off	DLK	Default
UNK	UNK	RO

The meanings of the conditions in the table above are summarized in the "External debug register access permissions summary" section of the Debug specification (PRD03-PRDC-010486). The priority at which each condition applies is from highest priority on the left to lowest on the right.

SDAD, bit [8]

Sticky EDAD error. Set to 1 if an access returns an error because AllowExternalDebugAccess() == FALSE.

0 No accesses to the external debug registers have failed since EDPRSR was last read.

1 At least one access to the external debug registers has failed since EDPRSR was last read.

This bit is UNKNOWN on reads if either of EDPRSR.{DLK, R} is 1, or EDPRSR.PU is 0.

This bit clears to 0 following a read of EDPRSR.

On Cold reset, the field resets to 0.

This field is accessible as shown below:

Off	DLK	SLK	Default
UNK	UNK	RO	RC

The meanings of the conditions in the table above are summarized in the "External debug register access permissions summary" section of the Debug specification (PRD03-PRDC-010486). The priority at which each condition applies is from highest priority on the left to lowest on the right.

EDAD, bit [7]

External debug access disable status.

0 External debug access enabled.

1 External debug access disabled.

This bit is UNKNOWN on reads if either of EDPRSR.{DLK, R} is 1, or EDPRSR.PU is 0.

On Warm reset, the field reset value is architecturally UNKNOWN.

This field is accessible as shown below:

Off	DLK	EDAD	Default
UNK	UNK	RAO	RAZ

The meanings of the conditions in the table above are summarized in the "External debug register access permissions summary" section of the Debug specification (PRD03-PRDC-010486). The priority at which each condition applies is from highest priority on the left to lowest on the right.

DLK, bit [6]

OS Double Lock status bit.

0 [OSDLR_EL1.DLK](#) == 0 or [EDPRCR.CORENPDRQ](#) == 1 or the processor is in Debug state.

1 [OSDLR_EL1.DLK](#) == 1 and [EDPRCR.CORENPDRQ](#) == 0 and the processor is in Non-debug state.

This bit is UNKNOWN on reads if EDPRSR.PU is 0.

On Warm reset, the field reset value is architecturally UNKNOWN.

This field is accessible as shown below:

Off	DLK	Default
UNK	RAO	RAZ

The meanings of the conditions in the table above are summarized in the "External debug register access permissions summary" section of the Debug specification (PRD03-PRDC-010486). The priority at which each condition applies is from highest priority on the left to lowest on the right.

OSLK, bit [5]

OS lock status bit. A read of this bit returns the value of [OSLSR_EL1.OSLK](#).

This bit is UNKNOWN on reads if either of EDPRSR.{DLK, R} is 1 or EDPRSR.PU is 0.

On Warm reset, the field reset value is architecturally UNKNOWN.

This field is accessible as shown below:

Off	DLK	OSLK	Default
UNK	UNK	RAO	RAZ

The meanings of the conditions in the table above are summarized in the "External debug register access permissions summary" section of the Debug specification (PRD03-PRDC-010486). The priority at which each condition applies is from highest priority on the left to lowest on the right.

HALTED, bit [4]

Halted status bit. Possible values are:

0 [EDSCR.STATUS](#) is 0b000010 (processor in Non-debug state).

1 [EDSCR.STATUS](#) is not 0b000010.

This bit is UNKNOWN on reads if EDPRSR.PU is 0.

On Warm reset, the field reset value is architecturally UNKNOWN.

This field is accessible as shown below:

Off	DLK	Default
UNK	RAZ	RO

The meanings of the conditions in the table above are summarized in the "External debug register access permissions summary" section of the Debug specification (PRD03-PRDC-010486). The priority at which each condition applies is from highest priority on the left to lowest on the right.

SR, bit [3]

Sticky core reset status bit. Possible values are:

0 The non-debug logic of the processor is not in reset state and has not been reset since the last time EDPRSR was read.

1 The non-debug logic of the processor is in reset state or has been reset since the last time EDPRSR was read.

This bit is UNKNOWN on reads if EDPRSR.DLK is 1 or EDPRSR.PU is 0.

This bit clears to 0 following a read of EDPRSR if the non-debug logic of the processor is not in reset state.

On Warm reset, the field resets to 1.

This field is accessible as shown below:

Off	DLK	SLK	Default
UNK	UNK	RO	RC

The meanings of the conditions in the table above are summarized in the "External debug register access permissions summary" section of the Debug specification (PRD03-PRDC-010486). The priority at which each condition applies is from highest priority on the left to lowest on the right.

R, bit [2]

Core reset status bit. Possible values are:

0 The non-debug logic of the processor is not in reset state.

1 The non-debug logic of the processor is in reset state.
This bit is UNKNOWN on reads if either EDPRSR.DLK is 1 or EDPRSR.PU is 0.
On Warm reset, the field reset value is architecturally UNKNOWN.
This field is accessible as shown below:

Off	DLK	Default
UNK	UNK	RO

The meanings of the conditions in the table above are summarized in the "External debug register access permissions summary" section of the Debug specification (PRD03-PRDC-010486). The priority at which each condition applies is from highest priority on the left to lowest on the right.

SPD, bit [1]

Sticky core power-down status bit.

This bit is set to 1 on Cold reset to indicate the state of the debug registers has been lost. Since a Cold reset is required on powering up the processor, this usually indicates the Core power domain has been completely powered off.

Possible values are:

0 If the Core power domain is off (EDPRSR.PU is 0), it is not known whether the state of the debug registers in the Core power domain is lost. Otherwise, the Core power domain is on, and the state of the debug registers in the Core power domain has not been lost.

1 The state of the debug registers in the Core power domain is lost.

This bit is UNKNOWN on reads if both EDPRSR.DLK and EDPRSR.PU are 1.

This bit clears to 0 following a read of EDPRSR if the processor is not in the powered down state.

There are two logical power off states for the Core power domain:

Retention The states of the debug registers, including EDPRSR.SPD, in the Core power domain is preserved, and restored on leaving retention state.

Power-down The states of the debug registers in the Core power domain is lost, and a Cold reset is asserted on leaving power-down state.

In these states, it is IMPLEMENTATION DEFINED whether:

- EDPRSR.SPD shows whether the state of the debug registers in the Core power domain has been lost since the last time EDPRSR was read when the Core power domain was on.
- EDPRSR.SPD reads-as-zero.

EDPRSR.SPD is not cleared following a read of EDPRSR in these states.

This means it is IMPLEMENTATION DEFINED whether a processor implements EDPRSR.SPD as:

- Fixed RAZ when in one or both of the retention and power-down states.
- Retaining its previous value when in the retention state.
- Fixed RAO in the power-down state.

Note that this definition does not allow EDPRSR.SPD to be fixed RAO in the low-power retention state, as the state of the debug registers in the Core power domain is not lost by entering this state. However, the bit can be read as 1 in this state if the state of the registers was lost before entering this state (i.e. EDPRSR has not been read since the last Cold reset).

ARM recommends that an implementation make EDPRSR.SPD fixed RAO when in the power-down state, particularly if it does not support a low-power retention state.

On Cold reset, the field resets to 1.

This field is accessible as shown below:

Off	DLK	SLK	Default
RO	UNK	RO	RC

The meanings of the conditions in the table above are summarized in the "External debug register access permissions summary" section of the Debug specification (PRD03-PRDC-010486). The priority at which each condition applies is from highest priority on the left to lowest on the right.

PU, bit [0]

Core power-up status bit. Indicates whether the Core power domain debug registers can be accessed:

0 Core is in a low-power or power-down state where the debug registers cannot be accessed.

1 Core is in a power-up state where the debug registers can be accessed.

On Warm reset, the field reset value is architecturally UNKNOWN.

This field is accessible as shown below:

Off	Default
RAZ	RAO

The meanings of the conditions in the table above are summarized in the "External debug register access permissions summary" section of the Debug specification (PRD03-PRDC-010486). The priority at which each condition applies is from highest priority on the left to lowest on the right.

Accessing the EDPRSR:

EDPRSR can be accessed through the internal memory-mapped interface and the external debug interface:

Component	Offset
Debug	0x314

H9.2.38 EDRCR, External Debug Reserve Control Register

The EDRCR characteristics are:

Purpose

This register is used to allow imprecise entry to Debug state and clear sticky bits in [EDSCR](#).
This register is part of the Debug registers functional group.

Usage constraints

This register is accessible as shown below:

Off	DLK	OSLK	SLK	Default
Error	Error	Error	WI	WO

Configurations

EDRCR is in the Core power domain.

Attributes

EDRCR is a 32-bit register.

The EDRCR bit assignments are:

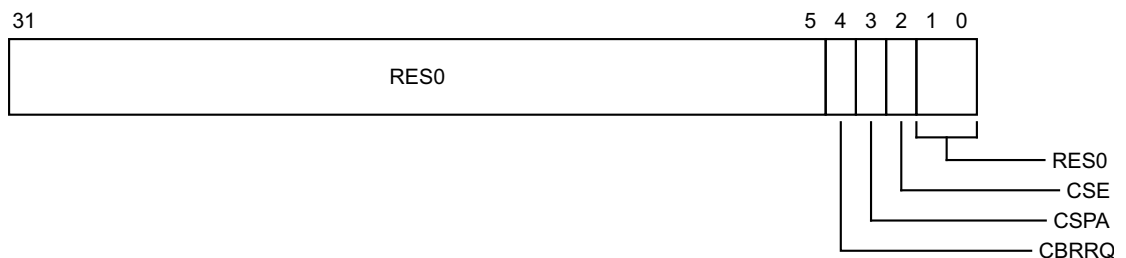

Bits [31:5]

Reserved, RES0.

CBRRQ, bit [4]

Allow imprecise entry to Debug state. The actions on writing to this bit are:

0 No action.

1 Allow imprecise entry to Debug state, for example by canceling pending bus accesses.

Setting this bit to 1 allows a debugger to request imprecise entry to Debug state. An External Debug Request debug event must be pending before the debugger sets this bit to 1.

This feature is optional. If this feature is not implemented, writes to this bit are ignored.

CSPA, bit [3]

Clear Sticky Pipeline Advance. This bit is used to clear the [EDSCR.PipeAdv](#) bit to 0. The actions on writing to this bit are:

0 No action.

1 Clear the [EDSCR.PipeAdv](#) bit to 0.

CSE, bit [2]

Clear Sticky Error. Used to clear the [EDSCR](#) cumulative error bits to 0. The actions on writing to this bit are:

0 No action.

- 1 Clear the [EDSCR](#).{TXU, RXO, ERR} bits, and, if the processor is in Debug state, the [EDSCR](#).ITO bit, to 0.

Bits [1:0]

Reserved, RES0.

Accessing the EDRCR:

EDRCR can be accessed through the internal memory-mapped interface and the external debug interface:

Component	Offset
Debug	0x090

H9.2.39 EDSCR, External Debug Status and Control Register

The EDSCR characteristics are:

Purpose

Main control register for the debug implementation.

This register is part of the Debug registers functional group.

Usage constraints

This register is accessible as shown below:

Off	DLK	OSLK	SLK	Default
Error	Error	Error	RO	RW

Configurations

EDSCR is in the Core power domain.

Attributes

EDSCR is a 32-bit register.

The EDSCR bit assignments are:

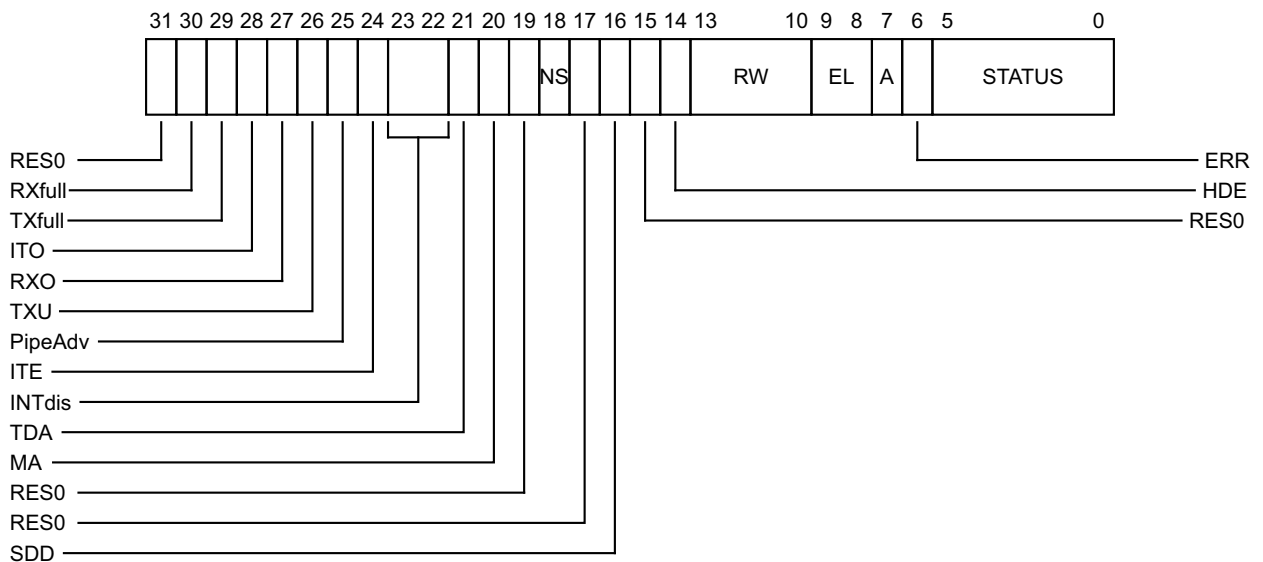

Bit [31]

Reserved, RES0.

RXfull, bit [30]

DTRRX full. This bit is RO.

On Cold reset, the field resets to 0.

TXfull, bit [29]

DTRTX full. This bit is RO.

On Cold reset, the field resets to 0.

ITO, bit [28]

EDITR overrun. This bit is RO.

If the processor is not in Debug state, this bit is UNKNOWN. ITO is set to 0 on entry to Debug state.

RXO, bit [27]

DTRRX overrun. This bit is RO.

On Cold reset, the field resets to 0.

TXU, bit [26]

DTRTX underrun. This bit is RO.

On Cold reset, the field resets to 0.

PipeAdv, bit [25]

Pipeline advance. Read-only. Set to 1 every time the processor pipeline retires one or more instructions. Cleared to 0 by a write to [EDRCR.CSPA](#).

The architecture does not define precisely when this bit is set to 1. It requires only that this happen periodically in Non-debug state to indicate that software execution is progressing.

ITE, bit [24]

ITR empty. This bit is RO.

If the processor is not in Debug state, this bit is UNKNOWN. It is always valid in Debug state.

INTdis, bits [23:22]

Interrupt disable. Disables taking interrupts (including virtual interrupts and System Error interrupts) in Non-Debug state.

If external invasive debug is disabled, the value of this field is ignored.

If external invasive debug is enabled, the possible values of this field are:

- | | |
|----|--|
| 00 | Do not disable interrupts |
| 01 | Disable interrupts targeting Non-secure EL1. |
| 10 | Disable interrupts targeting only Non-secure EL1 and Non-secure EL2. If external secure invasive debug is enabled, also disable interrupts targeting Secure EL1. |
| 11 | Disable interrupts targeting only Non-secure EL1 and Non-secure EL2. If external secure invasive debug is enabled, also disable all other interrupts. |

The value of INTdis does not affect whether an interrupt is a WFI wake-up event, but can mask an interrupt as a WFE wake-up event.

If EL3 and EL2 are not implemented, INTdis[0] is RO and reads the same value as INTdis[1], meaning only the values 0b00 and 0b11 can be selected.

On Cold reset, the field resets to 0.

TDA, bit [21]

Trap debug registers accesses.

On Cold reset, the field resets to 0.

MA, bit [20]

Memory access mode. Controls use of memory-access mode for accessing [EDITR](#) and the DCC. This bit is ignored if in Non-debug state and set to zero on entry to Debug state.

Possible values of this field are:

- | | |
|---|---------------------|
| 0 | Normal access mode |
| 1 | Memory access mode. |

On Cold reset, the field resets to 0.

Bit [19]

Reserved, RES0.

NS, bit [18]

Non-secure status. Read-only. When in Debug state, gives the current security state:

- 0 Secure state, `IsSecure() == TRUE`
- 1 Non-secure state, `IsSecure() == FALSE`.

In Non-debug state, this bit is UNKNOWN.

Bit [17]

Reserved, RES0.

SDD, bit [16]

Secure debug disabled. This bit is RO.

On entry to Debug state:

- If entering in Secure state, SDD is set to 0.
- If entering in Non-secure state, SDD is set to the inverse of `ExternalSecureInvasiveDebugEnabled()`.

In Debug state, the value of the SDD bit does not change, even if `ExternalSecureInvasiveDebugEnabled()` changes.

In Non-debug state:

- SDD returns the inverse of `ExternalSecureInvasiveDebugEnabled()`. If the authentication signals that control `ExternalSecureInvasiveDebugEnabled()` change, a context synchronization operation is required to guarantee their effect.
- This bit is unaffected by the Security state of the processor.

If EL3 is not implemented and the implementation is Non-secure, this bit is RES1.

Bit [15]

Reserved, RES0.

HDE, bit [14]

Halting debug mode enable. Possible values of this bit are:

- 0 Halting debug mode disabled.
- 1 Halting debug mode enabled.

On Cold reset, the field resets to 0.

RW, bits [13:10]

Exception level register-width status. Read-only. In Debug state, each bit gives the current register width status of each EL:

- 1111 All exception levels are AArch64 state.
- 1110 EL0 is AArch32 state. All other exception levels are AArch64 state.
- 1100 EL0 and EL1 are AArch32 state. All other exception levels are AArch64 state. Never seen if EL2 is not implemented in the current security state.
- 1000 EL0, EL1, and, if implemented in the current security state, EL2 are AArch32 state. All other exception levels are AArch64 state.
- 0000 All exception levels are set to AArch32 state (32-bit configuration).

However:

- If not at EL0: `RW[0] == RW[1]`.
- If EL2 is not implemented in the current security state: `RW[2] == RW[1]`.
- If EL3 is not implemented: `RW[3] == RW[2]`.

In Non-debug state, this field is RAO.

EL, bits [9:8]

Exception level. Read-only. In Debug state, this gives the current EL of the processor.

In Non-debug state, this field is RAZ.

A, bit [7]

System Error interrupt pending. Read-only. In Debug state, indicates whether a SError interrupt is pending:

- If `HCR_EL2.{AMO, TGE} = {1, 0}` and in Non-secure EL0 or EL1, a virtual SError interrupt.
- Otherwise, a physical SError interrupt.

0 No SError interrupt pending.

1 SError interrupt pending.

A debugger can read EDSCR to check whether a SError interrupt is pending without having to execute further instructions. A pending SError might indicate data from target memory is corrupted.

UNKNOWN in Non-debug state.

ERR, bit [6]

Cumulative error flag. This field is RO. It is set to 1 following exceptions in Debug state and on any signaled overrun or underrun on the DTR or EDITR.

On Cold reset, the field resets to 0.

STATUS, bits [5:0]

Debug status flags. This field is RO.

The possible values of this field are:

- 000010 Processor is in Non-debug state.
- 000001 Processor is restarting (exiting Debug state).
- 000111 Breakpoint.
- 010011 External debug request.
- 011011 Halting step, normal.
- 011111 Halting step, exclusive.
- 100011 OS unlock catch.
- 100111 Reset catch.
- 101011 Watchpoint.
- 101111 HLT instruction.
- 110011 Software access to debug register.
- 110111 Exception catch.
- 111011 Halting step, no syndrome.

All other values of STATUS are reserved.

Accessing the EDSCR:

EDSCR can be accessed through the internal memory-mapped interface and the external debug interface:

Component	Offset
Debug	0x088

H9.2.40 EDVIDSR, External Debug Virtual Context Sample Register

The EDVIDSR characteristics are:

Purpose

Contains sampled values captured on reading [EDPCSR](#).

This register is part of the Debug registers functional group.

Usage constraints

This register is accessible as shown below:

Off	DLK	OSLK	Default
Error	Error	Error	RO

Configurations

EDVIDSR is in the Core power domain.

Attributes

EDVIDSR is a 32-bit register.

The EDVIDSR bit assignments are:

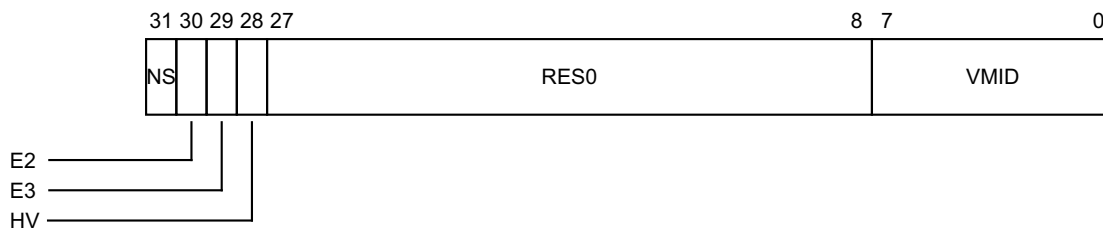

NS, bit [31]

Non-secure state sample. Indicates the security state associated with the most recent [EDPCSR](#) sample.

On Cold reset, the field reset value is architecturally UNKNOWN.

E2, bit [30]

Exception level 2 status sample. Indicates whether the most recent [EDPCSR](#) sample was associated with EL2. If $EDVIDSR.NS == 0$, this bit is 0.

On Cold reset, the field reset value is architecturally UNKNOWN.

E3, bit [29]

Exception level 3 status sample. Indicates whether the most recent [EDPCSR](#) sample was associated with AArch64 EL3. If $EDVIDSR.NS == 1$ or the processor was in AArch32 state when [EDPCSR](#) was read, this bit is 0.

On Cold reset, the field reset value is architecturally UNKNOWN.

HV, bit [28]

[EDPCSR](#) high half valid. Indicates whether bits [63:32] of the most recent [EDPCSR](#) sample are valid. If $EDVIDSR.HV == 0$, the value of [EDPCSR](#)[63:32] is RAZ.

On Cold reset, the field reset value is architecturally UNKNOWN.

Bits [27:8]

Reserved, RES0.

VMID, bits [7:0]

VMID sample. The value of [VTTBR_EL2.VMID](#) associated with the most recent [EDPCSR](#) sample. If [EDVIDSR.NS](#) == 0 or [EDVIDSR.E2](#) == 1, this field is RAZ.

On Cold reset, the field reset value is architecturally UNKNOWN.

Accessing the EDVIDSR:

EDVIDSR can be accessed through the internal memory-mapped interface and the external debug interface:

Component	Offset
Debug	0x0A8

H9.2.41 EDWAR, External Debug Watchpoint Address Register

The EDWAR characteristics are:

Purpose

Contains the virtual data address being accessed when a watchpoint debug event was triggered.
This register is part of the Debug registers functional group.

Usage constraints

This register is accessible as shown below:

Off	DLK	OSLK	Default
Error	Error	Error	RO

Configurations

EDWAR is in the Core power domain.

Attributes

EDWAR is a 64-bit register.

The EDWAR bit assignments are:

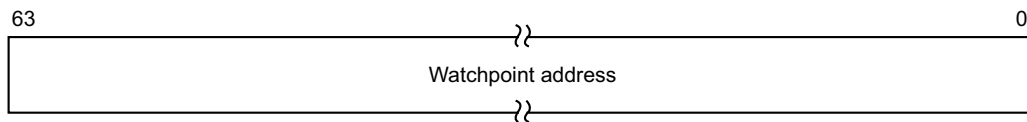

Bits [63:0]

Watchpoint address. The virtual data address being accessed when a watchpoint debug event was triggered and caused entry to Debug state.

UNKNOWN if the processor is not in Debug state, or if Debug state was entered other than for a watchpoint debug event.

The address must be within a naturally-aligned block of memory of power-of-two size no larger than the [DC ZVA](#) block size.

Accessing the EDWAR:

EDWAR[31:0] can be accessed through the internal memory-mapped interface and the external debug interface:

Component	Offset
Debug	0x030

EDWAR[63:32] can be accessed through the internal memory-mapped interface and the external debug interface:

Component	Offset
Debug	0x034

H9.2.42 ID_AA64DFR0_EL1, Debug Feature Register 0

The ID_AA64DFR0_EL1 characteristics are:

Purpose

Provides top level information about the debug system in AArch64.
This register is part of the Identification registers functional group.

Usage constraints

This register is accessible as shown below:

Default
RO

Configurations

ID_AA64DFR0_EL1 is architecturally mapped to AArch64 register [ID_AA64DFR0_EL1](#).
ID_AA64DFR0_EL1 is in the Debug power domain.

Attributes

ID_AA64DFR0_EL1 is a 64-bit register.

The ID_AA64DFR0_EL1 bit assignments are:

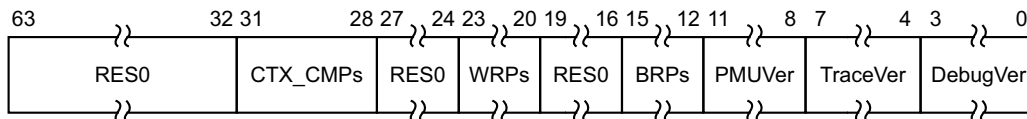

Bits [63:32]

Reserved, RES0.

CTX_CMPs, bits [31:28]

Number of breakpoints that are context-aware, minus 1. These are the highest numbered breakpoints.

Bits [27:24]

Reserved, RES0.

WRPs, bits [23:20]

Number of watchpoints, minus 1. The value of 0b0000 is reserved.

Bits [19:16]

Reserved, RES0.

BRPs, bits [15:12]

Number of breakpoints, minus 1. The value of 0b0000 is reserved.

PMUVer, bits [11:8]

Performance Monitors extension version. Indicates whether system register interface to Performance Monitors extension is implemented. Permitted values are:

0000	Performance Monitors extension system registers not implemented.
0001	Performance Monitors extension system registers implemented, PMUv3.
1111	IMPLEMENTATION DEFINED form of performance monitors supported, PMUv3 not supported.

All other values are reserved.

TraceVer, bits [7:4]

Trace extension. Indicates whether system register interface to Trace extension is implemented.

Permitted values are:

0000 Trace extension system registers not implemented.

0001 Trace extension system registers implemented.

All other values are reserved.

A value of 0b0000 only indicates that no system register interface to the trace extension is implemented. A trace extension may nevertheless be implemented without a system register interface.

DebugVer, bits [3:0]

Debug architecture version. Indicates presence of v8-A debug architecture.

0110 v8-A debug architecture.

All other values are reserved.

Accessing the ID_AA64DFR0_EL1:

ID_AA64DFR0_EL1[31:0] can be accessed through the internal memory-mapped interface and the external debug interface:

Component	Offset
Debug	0xD28

ID_AA64DFR0_EL1[63:32] can be accessed through the internal memory-mapped interface and the external debug interface:

Component	Offset
Debug	0xD2C

H9.2.43 ID_AA64DFR1_EL1, Debug Feature Register 1

The ID_AA64DFR1_EL1 characteristics are:

Purpose

Reserved for future expansion of top level information about the debug system in AArch64.
This register is part of the Identification registers functional group.

Usage constraints

This register is accessible as shown below:

Default
RO

Configurations

ID_AA64DFR1_EL1 is architecturally mapped to AArch64 register [ID_AA64DFR1_EL1](#).
ID_AA64DFR1_EL1 is in the Debug power domain.

Attributes

ID_AA64DFR1_EL1 is a 64-bit register.

The ID_AA64DFR1_EL1 bit assignments are:

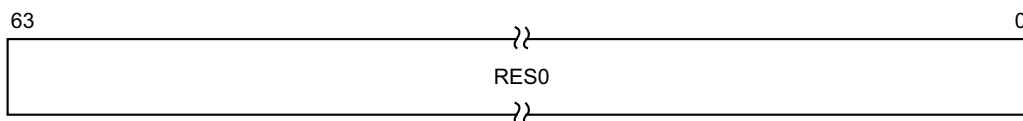

Bits [63:0]

Reserved, RES0.

Accessing the ID_AA64DFR1_EL1:

ID_AA64DFR1_EL1[31:0] can be accessed through the internal memory-mapped interface and the external debug interface:

Component	Offset
Debug	0xD48

ID_AA64DFR1_EL1[63:32] can be accessed through the internal memory-mapped interface and the external debug interface:

Component	Offset
Debug	0xD4C

H9.2.44 ID_AA64ISAR0_EL1, Instruction Set Attribute Register 0

The ID_AA64ISAR0_EL1 characteristics are:

Purpose

Provides information about the instructions implemented by the processor in AArch64.
This register is part of the Identification registers functional group.

Usage constraints

This register is accessible as shown below:

Default
RO

Configurations

ID_AA64ISAR0_EL1 is architecturally mapped to AArch64 register [ID_AA64ISAR0_EL1](#).
ID_AA64ISAR0_EL1 is in the Debug power domain.

Attributes

ID_AA64ISAR0_EL1 is a 64-bit register.

The ID_AA64ISAR0_EL1 bit assignments are:

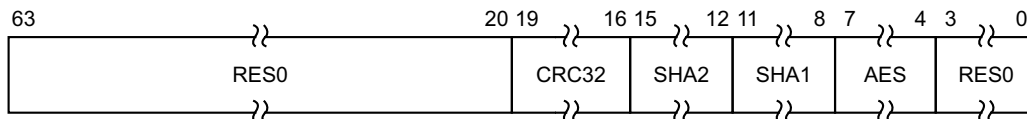

Bits [63:20]

Reserved, RES0.

CRC32, bits [19:16]

CRC32 instructions in AArch64. Possible values of this field are:

- 0000 No CRC32 instructions implemented.
- 0001 CRC32B, CRC32H, CRC32W, CRC32X, CRC32CB, CRC32CH, CRC32CW, and CRC32CX instructions implemented.

All other values are reserved.

This field must have the same value as [ID_ISAR5.CRC32](#). The architecture requires that if CRC32 is supported in one Execution state, it must be supported in both Execution states.

SHA2, bits [15:12]

SHA2 instructions in AArch64. Possible values of this field are:

- 0000 No SHA2 instructions implemented.
- 0001 SHA256H, SHA256H2, SHA256SU0, and SHA256SU1 instructions implemented.

All other values are reserved.

SHA1, bits [11:8]

SHA1 instructions in AArch64. Possible values of this field are:

- 0000 No SHA1 instructions implemented.
- 0001 SHA1C, SHA1P, SHA1M, SHA1H, SHA1SU0, and SHA1SU1 instructions implemented.

All other values are reserved.

AES, bits [7:4]

AES instructions in AArch64. Possible values of this field are:

- 0000 No AES instructions implemented.
- 0001 AESE, AESD, AESMC, and AESIMC instructions implemented.
- 0010 As for 0b0001, plus PMULL/PMULL2 instructions operating on 64-bit data quantities.

Bits [3:0]

Reserved, RES0.

Accessing the ID_AA64ISAR0_EL1:

ID_AA64ISAR0_EL1[31:0] can be accessed through the internal memory-mapped interface and the external debug interface:

Component	Offset
Debug	0xD30

ID_AA64ISAR0_EL1[63:32] can be accessed through the internal memory-mapped interface and the external debug interface:

Component	Offset
Debug	0xD34

H9.2.45 ID_AA64ISAR1_EL1, Instruction Set Attribute Register 1

The ID_AA64ISAR1_EL1 characteristics are:

Purpose

Reserved for future expansion of the information about the instruction sets implemented by the processor in AArch64.

This register is part of the Identification registers functional group.

Usage constraints

This register is accessible as shown below:

Default

RO

Configurations

ID_AA64ISAR1_EL1 is architecturally mapped to AArch64 register [ID_AA64ISAR1_EL1](#).

ID_AA64ISAR1_EL1 is in the Debug power domain.

Attributes

ID_AA64ISAR1_EL1 is a 64-bit register.

The ID_AA64ISAR1_EL1 bit assignments are:

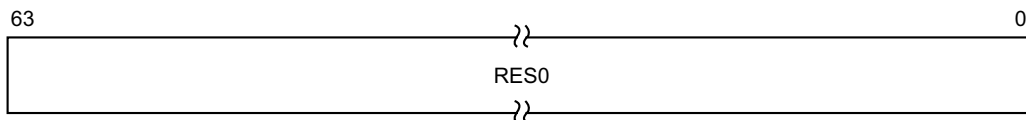

Bits [63:0]

Reserved, RES0.

Accessing the ID_AA64ISAR1_EL1:

ID_AA64ISAR1_EL1[31:0] can be accessed through the internal memory-mapped interface and the external debug interface:

Component	Offset
Debug	0xD50

ID_AA64ISAR1_EL1[63:32] can be accessed through the internal memory-mapped interface and the external debug interface:

Component	Offset
Debug	0xD54

H9.2.46 ID_AA64MMFR0_EL1, Memory Model Feature Register 0

The ID_AA64MMFR0_EL1 characteristics are:

Purpose

Provides information about the implemented memory model and memory management support in AArch64.

This register is part of the Identification registers functional group.

Usage constraints

This register is accessible as shown below:

Default

RO

Configurations

ID_AA64MMFR0_EL1 is architecturally mapped to AArch64 register [ID_AA64MMFR0_EL1](#).

ID_AA64MMFR0_EL1 is in the Debug power domain.

Attributes

ID_AA64MMFR0_EL1 is a 64-bit register.

The ID_AA64MMFR0_EL1 bit assignments are:

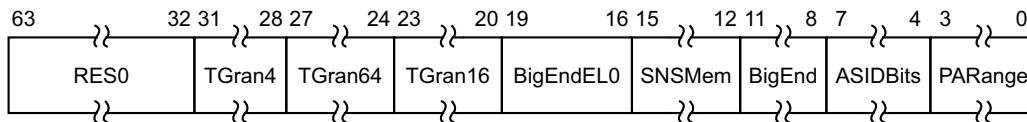

Bits [63:32]

Reserved, RES0.

TGran4, bits [31:28]

Support for 4 Kbyte memory translation granule size. Permitted values are:

0000 4 KB granule supported.

1111 4 KB granule not supported.

All other values are reserved.

TGran64, bits [27:24]

Support for 64 Kbyte memory translation granule size. Permitted values are:

0000 64 KB granule supported.

1111 64 KB granule not supported.

All other values are reserved.

TGran16, bits [23:20]

Support for 16 Kbyte memory translation granule size. Permitted values are:

0000 16 KB granule not supported.

0001 16 KB granule supported.

All other values are reserved.

BigEndEL0, bits [19:16]

Mixed-endian support at EL0 only. Permitted values are:

0000 No mixed-endian support at EL0. The `SCTLR_EL1.E0E` bit has a fixed value.

0001 Mixed-endian support at EL0. The `SCTLR_EL1.E0E` bit can be configured.

All other values are reserved.

This field is invalid and is RES0 if the `BigEnd` field, bits [11:8], is not 0b0000.

SNSMem, bits [15:12]

Secure versus Non-secure Memory distinction. Permitted values are:

0000 Does not support a distinction between Secure and Non-secure Memory.

0001 Does support a distinction between Secure and Non-secure Memory.

All other values are reserved.

BigEnd, bits [11:8]

Mixed-endian configuration support. Permitted values are:

0000 No mixed-endian support. The `SCTLR_ELx.EE` bits have a fixed value. See the `BigEndEL0` field, bits[19:16], for whether EL0 supports mixed-endian.

0001 Mixed-endian support. The `SCTLR_ELx.EE` and `SCTLR_EL1.E0E` bits can be configured.

All other values are reserved.

ASIDBits, bits [7:4]

Number of ASID bits. Permitted values are:

0000 8 bits.

0010 16 bits.

All other values are reserved.

PARange, bits [3:0]

Physical Address range supported. Permitted values are:

0000 32 bits, 4 GB.

0001 36 bits, 64 GB.

0010 40 bits, 1 TB.

0011 42 bits, 4 TB.

0100 44 bits, 16 TB.

0101 48 bits, 256 TB.

All other values are reserved.

Accessing the ID_AA64MMFR0_EL1:

ID_AA64MMFR0_EL1[31:0] can be accessed through the internal memory-mapped interface and the external debug interface:

Component	Offset
Debug	0xD38

ID_AA64MMFR0_EL1[63:32] can be accessed through the internal memory-mapped interface and the external debug interface:

Component	Offset
Debug	0xD3C

H9.2.47 ID_AA64MMFR1_EL1, Memory Model Feature Register 1

The ID_AA64MMFR1_EL1 characteristics are:

Purpose

Reserved for future expansion of the information about the implemented memory model and memory management support in AArch64.

This register is part of the Identification registers functional group.

Usage constraints

This register is accessible as shown below:

Default

RO

Configurations

ID_AA64MMFR1_EL1 is architecturally mapped to AArch64 register [ID_AA64MMFR1_EL1](#).

ID_AA64MMFR1_EL1 is in the Debug power domain.

Attributes

ID_AA64MMFR1_EL1 is a 64-bit register.

The ID_AA64MMFR1_EL1 bit assignments are:

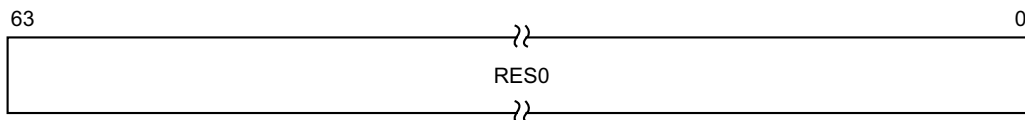

Bits [63:0]

Reserved, RES0.

Accessing the ID_AA64MMFR1_EL1:

ID_AA64MMFR1_EL1[31:0] can be accessed through the internal memory-mapped interface and the external debug interface:

Component	Offset
Debug	0xD58

ID_AA64MMFR1_EL1[63:32] can be accessed through the internal memory-mapped interface and the external debug interface:

Component	Offset
Debug	0xD5C

H9.2.48 ID_AA64PFR0_EL1, Processor Feature Register 0

The ID_AA64PFR0_EL1 characteristics are:

Purpose

Provides additional information about implemented processor features in AArch64.
This register is part of the Identification registers functional group.

Usage constraints

This register is accessible as shown below:

Default
RO

Configurations

ID_AA64PFR0_EL1 is architecturally mapped to AArch64 register [ID_AA64PFR0_EL1](#).
ID_AA64PFR0_EL1 is in the Debug power domain.

Attributes

ID_AA64PFR0_EL1 is a 64-bit register.

The ID_AA64PFR0_EL1 bit assignments are:

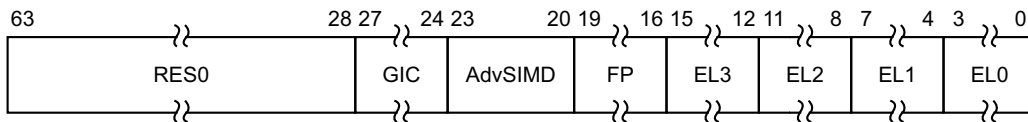

Bits [63:28]

Reserved, RES0.

GIC, bits [27:24]

GIC system register interface. Permitted values are:

- 0000 No GIC system registers are supported.
- 0001 GICv3 system registers are supported.

All other values are reserved.

AdvSIMD, bits [23:20]

Advanced SIMD. Permitted values are:

- 0000 Advanced SIMD is implemented.
- 1111 Advanced SIMD is not implemented.

All other values are reserved.

FP, bits [19:16]

Floating-point. Permitted values are:

- 0000 Floating-point is implemented.
- 1111 Floating-point is not implemented.

All other values are reserved.

EL3, bits [15:12]

EL3 exception level handling. Permitted values are:

- 0000 EL3 is not implemented.
 - 0001 EL3 can be executed in AArch64 state only.
 - 0010 EL3 can be executed in either AArch64 or AArch32 state.
- All other values are reserved.

EL2, bits [11:8]

EL2 exception level handling. Permitted values are:

- 0000 EL2 is not implemented.
 - 0001 EL2 can be executed in AArch64 state only.
 - 0010 EL2 can be executed in either AArch64 or AArch32 state.
- All other values are reserved.

EL1, bits [7:4]

EL1 exception level handling. Permitted values are:

- 0000 EL1 is not implemented.
 - 0001 EL1 can be executed in AArch64 state only.
 - 0010 EL1 can be executed in either AArch64 or AArch32 state.
- All other values are reserved.

EL0, bits [3:0]

EL0 exception level handling. Permitted values are:

- 0000 EL0 is not implemented.
 - 0001 EL0 can be executed in AArch64 state only.
 - 0010 EL0 can be executed in either AArch64 or AArch32 state.
- All other values are reserved.

Accessing the ID_AA64PFR0_EL1:

ID_AA64PFR0_EL1[31:0] can be accessed through the internal memory-mapped interface and the external debug interface:

Component	Offset
Debug	0xD20

ID_AA64PFR0_EL1[63:32] can be accessed through the internal memory-mapped interface and the external debug interface:

Component	Offset
Debug	0xD24

H9.2.49 ID_AA64PFR1_EL1, Processor Feature Register 1

The ID_AA64PFR1_EL1 characteristics are:

Purpose

Reserved for future expansion of information about implemented processor features in AArch64.
This register is part of the Identification registers functional group.

Usage constraints

This register is accessible as shown below:

Default
RO

Configurations

ID_AA64PFR1_EL1 is architecturally mapped to AArch64 register [ID_AA64PFR1_EL1](#).
ID_AA64PFR1_EL1 is in the Debug power domain.

Attributes

ID_AA64PFR1_EL1 is a 64-bit register.

The ID_AA64PFR1_EL1 bit assignments are:

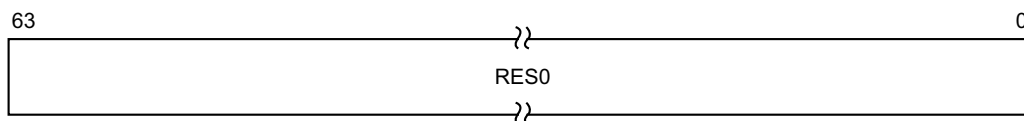

Bits [63:0]

Reserved, RES0.

Accessing the ID_AA64PFR1_EL1:

ID_AA64PFR1_EL1[31:0] can be accessed through the internal memory-mapped interface and the external debug interface:

Component	Offset
Debug	0xD40

ID_AA64PFR1_EL1[63:32] can be accessed through the internal memory-mapped interface and the external debug interface:

Component	Offset
Debug	0xD44

H9.2.50 MIDR_EL1, Main ID Register

The MIDR_EL1 characteristics are:

Purpose

Provides identification information for the processor, including an implementer code for the device and a device ID number.

This register is part of the Identification registers functional group.

Usage constraints

This register is accessible as shown below:

Default

RO

Configurations

MIDR_EL1 is architecturally mapped to AArch64 register [MIDR_EL1](#).

MIDR_EL1 is architecturally mapped to AArch32 register [MIDR](#).

MIDR_EL1 is in the Debug power domain.

Attributes

MIDR_EL1 is a 32-bit register.

The MIDR_EL1 bit assignments are:

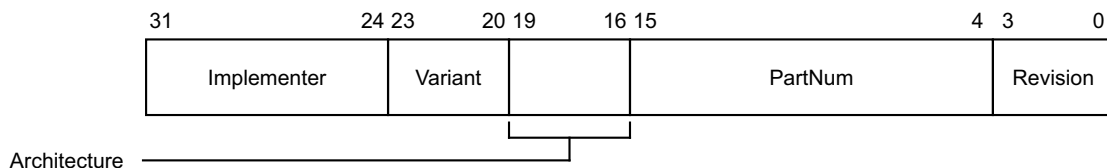

Implementer, bits [31:24]

The Implementer code. This field must hold an implementer code that has been assigned by ARM. Assigned codes include the following:

Hex representation	ASCII representation	Implementer
0x41	A	ARM Limited
0x42	B	Broadcom Corporation
0x43	C	Cavium Inc.
0x44	D	Digital Equipment Corporation
0x49	I	Infineon Technologies AG
0x4D	M	Motorola or Freescale Semiconductor Inc.
0x4E	N	NVIDIA Corporation
0x50	P	Applied Micro Circuits Corporation

Hex representation	ASCII representation	Implementer
0x51	Q	Qualcomm Inc.
0x56	V	Marvell International Ltd.
0x69	i	Intel Corporation

ARM can assign codes that are not published in this manual. All values not assigned by ARM are reserved and must not be used.

Variant, bits [23:20]

An IMPLEMENTATION DEFINED variant number. Typically, this field is used to distinguish between different product variants, or major revisions of a product.

Architecture, bits [19:16]

The permitted values of this field are:

0001	ARMv4
0010	ARMv4T
0011	ARMv5 (obsolete)
0100	ARMv5T
0101	ARMv5TE
0110	ARMv5TEJ
0111	ARMv6
1111	Defined by CPUID scheme

All other values are reserved.

PartNum, bits [15:4]

An IMPLEMENTATION DEFINED primary part number for the device.

On processors implemented by ARM, if the top four bits of the primary part number are 0x0 or 0x7, the variant and architecture are encoded differently.

Revision, bits [3:0]

An IMPLEMENTATION DEFINED revision number for the device.

Accessing the MIDR_EL1:

MIDR_EL1 can be accessed through the internal memory-mapped interface and the external debug interface:

Component	Offset
Debug	0xD00

H9.2.51 OSLAR_EL1, OS Lock Access Register

The OSLAR_EL1 characteristics are:

Purpose

Used to lock or unlock the OS lock.

This register is part of the Debug registers functional group.

Usage constraints

This register is accessible as shown below:

Off	DLK	SLK	Default
Error	Error	WI	WO

Configurations

OSLAR_EL1 is architecturally mapped to AArch64 register [OSLAR_EL1](#).

OSLAR_EL1 is architecturally mapped to AArch32 register [DBGOSLAR](#).

OSLAR_EL1 is in the Core power domain.

Attributes

OSLAR_EL1 is a 32-bit register.

The OSLAR_EL1 bit assignments are:



Bits [31:1]

Reserved, RES0.

OSLK, bit [0]

On writes to OSLAR_EL1, bit[0] is copied to the OS lock.

Use [EDPRSR.OSLK](#) to check the current status of the lock.

Accessing the OSLAR_EL1:

OSLAR_EL1 can be accessed through the internal memory-mapped interface and the external debug interface:

Component	Offset
Debug	0x300

H9.3 Cross-Trigger Interface registers

This section lists the Cross-Trigger Interface registers that are accessible through the external debug interface.

H9.3.1 ASICCTL, CTI External Multiplexer Control register

The ASICCTL characteristics are:

Purpose

Provides a control for external multiplexing of additional triggers into the CTI.

This register is part of the Cross-Trigger Interface registers functional group.

Usage constraints

This register is accessible as shown below:

SLK	Default
RO	RW

Configurations

ASICCTL is in the Debug power domain.

Attributes

ASICCTL is a 32-bit register.

The ASICCTL bit assignments are:

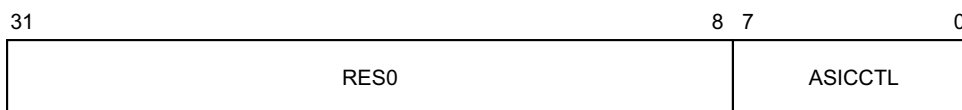

Bits [31:8]

Reserved, RES0.

ASICCTL, bits [7:0]

IMPLEMENTATION DEFINED ASIC control. Provides a control for external multiplexing of additional triggers into the CTI.

If external multiplexing of trigger signals is implemented then the number of multiplexed signals on each trigger must be reflected in [CTIDEVID.EXTMUXNUM](#).

If [CTIDEVID.EXTMUXNUM](#) is zero, this field is RAZ.

On IMPLEMENTATION DEFINED reset, the field resets to an IMPLEMENTATION DEFINED value.

Accessing the ASICCTL:

ASICCTL can be accessed through the internal memory-mapped interface and the external debug interface:

Component	Offset
CTI	0x144

H9.3.2 CTIAPPCLEAR, CTI Application Trigger Clear register

The CTIAPPCLEAR characteristics are:

Purpose

Clears bits of the Application Trigger register.

This register is part of the Cross-Trigger Interface registers functional group.

Usage constraints

This register is accessible as shown below:

SLK	Default
RO	WO

Configurations

CTIAPPCLEAR is in the Debug power domain.

Attributes

CTIAPPCLEAR is a 32-bit register.

The CTIAPPCLEAR bit assignments are:



APPCLEAR<x>, bit [x] for x = 0 to (N - 1)

Application trigger <x> disable.

N is the number of ECT channels implemented as defined by the [CTIDEVID.NUMCHAN](#) field.

Bits [31:N] are RAZ/WI.

Writing to this bit has the following effect:

0 No effect.

1 Clear corresponding bit in CTIAPPTRIG to 0 and clear the corresponding channel event.

If the ECT does not support multicycle channel events, use of CTIAPPCLEAR is deprecated and the debugger must only use [CTIAPPULSE](#).

Accessing the CTIAPPCLEAR:

CTIAPPCLEAR can be accessed through the internal memory-mapped interface and the external debug interface:

Component	Offset
CTI	0x018

H9.3.3 CTIAPPULSE, CTI Application Pulse register

The CTIAPPULSE characteristics are:

Purpose

Causes event pulses to be generated on ECT channels.

This register is part of the Cross-Trigger Interface registers functional group.

Usage constraints

This register is accessible as shown below:

SLK	Default
RO	WO

Configurations

CTIAPPULSE is in the Debug power domain.

Attributes

CTIAPPULSE is a 32-bit register.

The CTIAPPULSE bit assignments are:

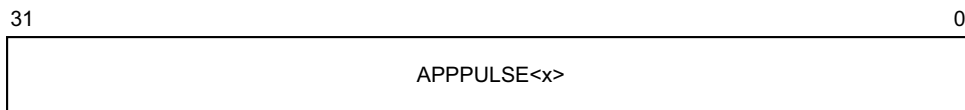

APPPULSE<x>, bit [x] for x = 0 to (N - 1)

Generate event pulse on ECT channel <x>.

N is the number of ECT channels implemented as defined by the [CTIDEVID.NUMCHAN](#) field.

Bits [31:N] are RAZ/WI.

Writing to this bit has the following effect:

0 No effect.

1 Channel <x> event pulse generated for one clock period.

Accessing the CTIAPPULSE:

CTIAPPULSE can be accessed through the internal memory-mapped interface and the external debug interface:

Component	Offset
CTI	0x01C

H9.3.4 CTIAPPSET, CTI Application Trigger Set register

The CTIAPPSET characteristics are:

Purpose

Sets bits of the Application Trigger register.

This register is part of the Cross-Trigger Interface registers functional group.

Usage constraints

This register is accessible as shown below:

SLK	Default
RO	RW

Configurations

CTIAPPSET is in the Debug power domain.

Attributes

CTIAPPSET is a 32-bit register.

The CTIAPPSET bit assignments are:



APPSET<x>, bit [x] for x = 0 to (N - 1)

Application trigger <x> enable.

N is the number of ECT channels implemented as defined by the [CTIDEVID.NUMCHAN](#) field.

Bits [31:N] are RAZ/WI.

Possible values of this bit are:

- 0 Reading this means the application trigger is inactive. Writing this has no effect.
- 1 Reading this means the application trigger is active. Writing this sets the corresponding bit in CTIAPPTRIG to 1 and generates a channel event.

If the ECT does not support multicycle channel events, use of CTIAPPSET is deprecated and the debugger must only use [CTIAPPULSE](#).

On External debug reset, the field reset value is architecturally UNKNOWN.

Accessing the CTIAPPSET:

CTIAPPSET can be accessed through the internal memory-mapped interface and the external debug interface:

Component	Offset
CTI	0x014

H9.3.5 CTIAUTHSTATUS, CTI Authentication Status register

The CTIAUTHSTATUS characteristics are:

Purpose

Provides information about the state of the IMPLEMENTATION DEFINED authentication interface for CTI.

This register is part of the Cross-Trigger Interface registers functional group.

Usage constraints

This register is accessible as shown below:

SLK	Default
RO	RO

Configurations

CTIAUTHSTATUS is in the Debug power domain.

This register is OPTIONAL, and is required for CoreSight compliance. ARM recommends that this register is implemented.

CTIAUTHSTATUS.{SNID,SID} are RAZ, because the CTI does not itself provide Secure authentication.

Attributes

CTIAUTHSTATUS is a 32-bit register.

The CTIAUTHSTATUS bit assignments are:

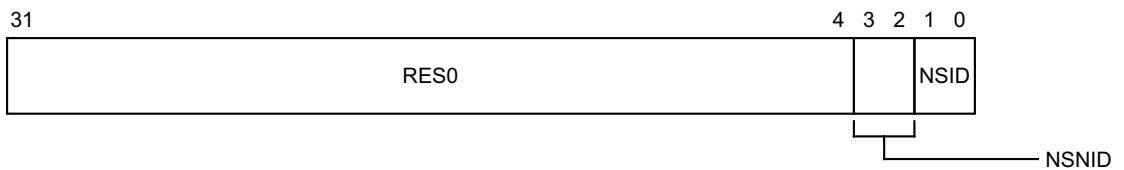

Bits [31:4]

Reserved, RES0.

NSNID, bits [3:2]

If EL3 is not implemented and the processor is Secure, holds the same value as [DBGAUTHSTATUS_EL1.SNID](#).

Otherwise, holds the same value as [DBGAUTHSTATUS_EL1.NSNID](#).

NSID, bits [1:0]

If EL3 is not implemented and the processor is Secure, holds the same value as [DBGAUTHSTATUS_EL1.SID](#).

Otherwise, holds the same value as [DBGAUTHSTATUS_EL1.NSID](#).

Accessing the CTIAUTHSTATUS:

CTIAUTHSTATUS can be accessed through the internal memory-mapped interface and the external debug interface:

Component	Offset
CTI	0xFB8

H9.3.6 CTICHINSTATUS, CTI Channel In Status register

The CTICHINSTATUS characteristics are:

Purpose

Provides the raw status of the ECT channel inputs to the CTI.
This register is part of the Cross-Trigger Interface registers functional group.

Usage constraints

This register is accessible as shown below:

SLK	Default
RO	RO

Configurations

CTICHINSTATUS is in the Debug power domain.

Attributes

CTICHINSTATUS is a 32-bit register.

The CTICHINSTATUS bit assignments are:

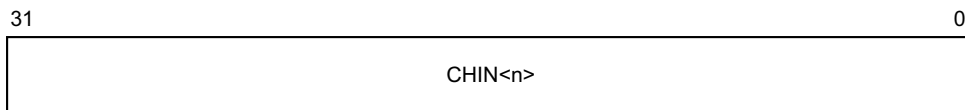

CHIN<n>, bit [x] for x = 0 to (N - 1)

Input channel <n> status.

N is the number of ECT channels implemented as defined by the [CTIDEVID.NUMCHAN](#) field.

Bits [31:N] are RAZ.

Possible values of this bit are:

- 0 Input channel <n> is inactive.
- 1 Input channel <n> is active.

Accessing the CTICHINSTATUS:

CTICHINSTATUS can be accessed through the internal memory-mapped interface and the external debug interface:

Component	Offset
CTI	0x138

H9.3.7 CTICHOUTSTATUS, CTI Channel Out Status register

The CTICHOUTSTATUS characteristics are:

Purpose

Provides the status of the ECT channel outputs from the CTI.

This register is part of the Cross-Trigger Interface registers functional group.

Usage constraints

This register is accessible as shown below:

SLK	Default
RO	RO

Configurations

CTICHOUTSTATUS is in the Debug power domain.

Attributes

CTICHOUTSTATUS is a 32-bit register.

The CTICHOUTSTATUS bit assignments are:

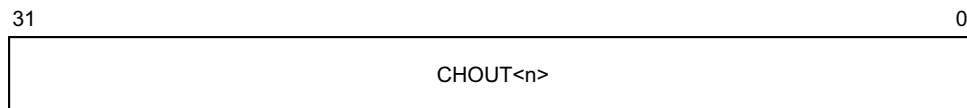

CHOUT<n>, bit [x] for x = 0 to (N - 1)

Output channel <n> status.

N is the number of ECT channels implemented as defined by the [CTIDEVID.NUMCHAN](#) field.

Bits [31:N] are RAZ.

Possible values of this bit are:

- 0 Output channel <n> is inactive.
- 1 Output channel <n> is active.

Accessing the CTICHOUTSTATUS:

CTICHOUTSTATUS can be accessed through the internal memory-mapped interface and the external debug interface:

Component	Offset
CTI	0x13C

H9.3.8 CTICIDR0, CTI Component Identification Register 0

The CTICIDR0 characteristics are:

Purpose

Provides information to identify a CTI component.

This register is part of the Cross-Trigger Interface registers functional group.

Usage constraints

This register is accessible as shown below:

SLK	Default
RO	RO

Configurations

CTICIDR0 is in the Debug power domain.

CTICIDR0 is optional to implement in the external register interface.

This register is required for CoreSight compliance.

Attributes

CTICIDR0 is a 32-bit register.

The CTICIDR0 bit assignments are:

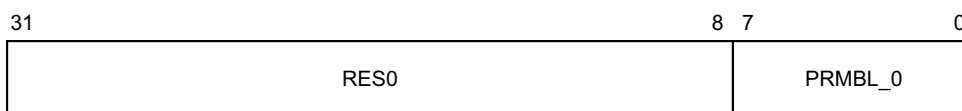

Bits [31:8]

Reserved, RES0.

PRMBL_0, bits [7:0]

Preamble. Must read as 0x00.

Accessing the CTICIDR0:

CTICIDR0 can be accessed through the internal memory-mapped interface and the external debug interface:

Component	Offset
CTI	0xFF0

H9.3.9 CTICIDR1, CTI Component Identification Register 1

The CTICIDR1 characteristics are:

Purpose

Provides information to identify a CTI component.

This register is part of the Cross-Trigger Interface registers functional group.

Usage constraints

This register is accessible as shown below:

SLK	Default
RO	RO

Configurations

CTICIDR1 is in the Debug power domain.

CTICIDR1 is optional to implement in the external register interface.

This register is required for CoreSight compliance.

Attributes

CTICIDR1 is a 32-bit register.

The CTICIDR1 bit assignments are:

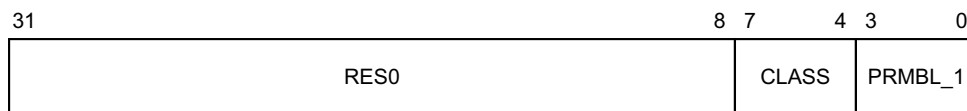

Bits [31:8]

Reserved, RES0.

CLASS, bits [7:4]

Component class. Reads as 0x9, debug component.

PRMBL_1, bits [3:0]

Preamble. RAZ.

Accessing the CTICIDR1:

CTICIDR1 can be accessed through the internal memory-mapped interface and the external debug interface:

Component	Offset
CTI	0xFF4

H9.3.10 CTICIDR2, CTI Component Identification Register 2

The CTICIDR2 characteristics are:

Purpose

Provides information to identify a CTI component.

This register is part of the Cross-Trigger Interface registers functional group.

Usage constraints

This register is accessible as shown below:

SLK	Default
RO	RO

Configurations

CTICIDR2 is in the Debug power domain.

CTICIDR2 is optional to implement in the external register interface.

This register is required for CoreSight compliance.

Attributes

CTICIDR2 is a 32-bit register.

The CTICIDR2 bit assignments are:

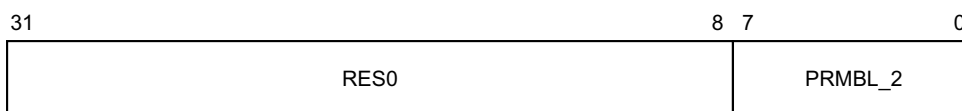

Bits [31:8]

Reserved, RES0.

PRMBL_2, bits [7:0]

Preamble. Must read as 0x05.

Accessing the CTICIDR2:

CTICIDR2 can be accessed through the internal memory-mapped interface and the external debug interface:

Component	Offset
CTI	0xFF8

H9.3.11 CTICIDR3, CTI Component Identification Register 3

The CTICIDR3 characteristics are:

Purpose

Provides information to identify a CTI component.

This register is part of the Cross-Trigger Interface registers functional group.

Usage constraints

This register is accessible as shown below:

SLK	Default
RO	RO

Configurations

CTICIDR3 is in the Debug power domain.

CTICIDR3 is optional to implement in the external register interface.

This register is required for CoreSight compliance.

Attributes

CTICIDR3 is a 32-bit register.

The CTICIDR3 bit assignments are:

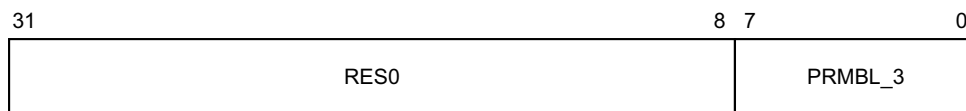

Bits [31:8]

Reserved, RES0.

PRMBL_3, bits [7:0]

Preamble. Must read as 0xB1.

Accessing the CTICIDR3:

CTICIDR3 can be accessed through the internal memory-mapped interface and the external debug interface:

Component	Offset
CTI	0xFFC

H9.3.12 CTICLAIMCLR, CTI Claim Tag Clear register

The CTICLAIMCLR characteristics are:

Purpose

Used by software to read the values of the CLAIM bits, and to clear these bits to 0.
This register is part of the Cross-Trigger Interface registers functional group.

Usage constraints

This register is accessible as shown below:

SLK	Default
RO	RW

Configurations

CTICLAIMCLR is in the Debug power domain.
CTICLAIMCLR is optional to implement in the external register interface.

Attributes

CTICLAIMCLR is a 32-bit register.

The CTICLAIMCLR bit assignments are:

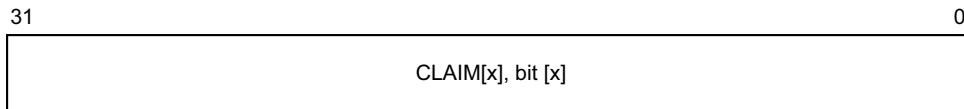

CLAIM[x], bit [x], bits [31:0]

Clear CLAIM tag. If x is greater than or equal to the IMPLEMENTATION DEFINED number of CLAIM tags, this bit is RAZ/SBZ. Software can rely on these bits reading as zero, and must use a should-be-zero policy on writes. Implementations must ignore writes.

Otherwise, reads return the value of CLAIM[x] and the behavior on writes is:

- 0 No action.
- 1 Indirectly clear CLAIM[x] to 0.

A single write to CTICLAIMCLR can clear multiple tags to 0.

Accessing the CTICLAIMCLR:

CTICLAIMCLR can be accessed through the internal memory-mapped interface and the external debug interface:

Component	Offset
CTI	0xFA4

H9.3.13 CTICLAIMSET, CTI Claim Tag Set register

The CTICLAIMSET characteristics are:

Purpose

Used by software to set CLAIM bits to 1.

This register is part of the Cross-Trigger Interface registers functional group.

Usage constraints

This register is accessible as shown below:

SLK	Default
RO	RW

Configurations

CTICLAIMSET is in the Debug power domain.

CTICLAIMSET is optional to implement in the external register interface.

Attributes

CTICLAIMSET is a 32-bit register.

The CTICLAIMSET bit assignments are:

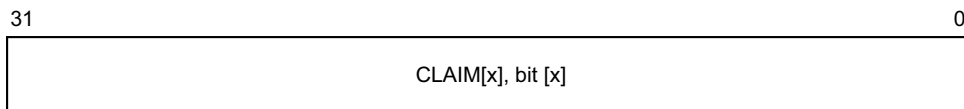

CLAIM[x], bit [x], bits [31:0]

CLAIM tag set bit. If x is greater than or equal to the IMPLEMENTATION DEFINED number of CLAIM tags, this bit is RAZ/SBZ. Software can rely on these bits reading as zero, and must use a should-be-zero policy on writes. Implementations must ignore writes.

Otherwise, the bit is RAO and the behavior on writes is:

0 No action.

1 Indirectly set CLAIM[x] tag to 1.

A single write to CTICLAIMSET can set multiple tags to 1.

Accessing the CTICLAIMSET:

CTICLAIMSET can be accessed through the internal memory-mapped interface and the external debug interface:

Component	Offset
CTI	0xFA0

H9.3.14 CTICONTROL, CTI Control register

The CTICONTROL characteristics are:

Purpose

Controls whether the CTI is enabled.

This register is part of the Cross-Trigger Interface registers functional group.

Usage constraints

This register is accessible as shown below:

SLK	Default
RO	RW

Configurations

CTICONTROL is in the Debug power domain.

Attributes

CTICONTROL is a 32-bit register.

The CTICONTROL bit assignments are:

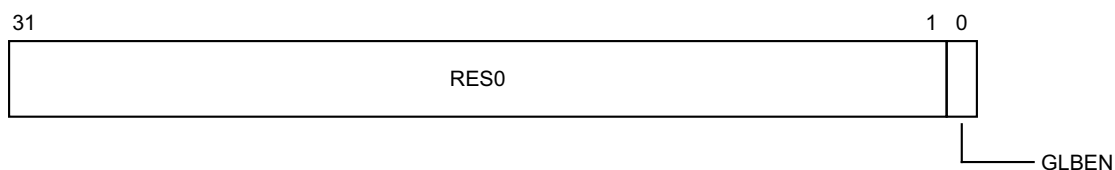

Bits [31:1]

Reserved, RES0.

GLBEN, bit [0]

Enables or disables the CTI mapping functions. Possible values of this field are:

- 0 CTI mapping functions disabled.
- 1 CTI mapping functions enabled.

When the mapping functions are disabled, no new events are signaled on either output triggers or output channels. If a previously asserted output trigger has not been acknowledged, it remains asserted after the mapping functions are disabled. All output triggers are disabled by CTI reset.

On External debug reset, the field resets to 0.

Accessing the CTICONTROL:

CTICONTROL can be accessed through the internal memory-mapped interface and the external debug interface:

Component	Offset
CTI	0x000

H9.3.15 CTIDEVAFF0, CTI Device Affinity register 0

The CTIDEVAFF0 characteristics are:

Purpose

Copy of the low half of the processor [MPIDR_EL1](#) register that allows a debugger to determine which processor in a multiprocessor system the CTI component relates to.

This register is part of the Cross-Trigger Interface registers functional group.

Usage constraints

This register is accessible as shown below:

SLK	Default
RO	RO

Configurations

CTIDEVAFF0 is in the Debug power domain.

CTIDEVAFF0 is optional to implement in the external register interface.

Attributes

CTIDEVAFF0 is a 32-bit register.

The CTIDEVAFF0 bit assignments are:

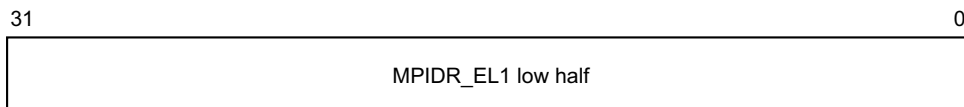

Bits [31:0]

[MPIDR_EL1](#) low half. Read-only copy of the low half of [MPIDR_EL1](#), as seen from the highest implemented exception level.

Accessing the CTIDEVAFF0:

CTIDEVAFF0 can be accessed through the internal memory-mapped interface and the external debug interface:

Component	Offset
CTI	0xFA8

H9.3.16 CTIDEVAFF1, CTI Device Affinity register 1

The CTIDEVAFF1 characteristics are:

Purpose

Copy of the high half of the processor [MPIDR_EL1](#) register that allows a debugger to determine which processor in a multiprocessor system the CTI component relates to.

This register is part of the Cross-Trigger Interface registers functional group.

Usage constraints

This register is accessible as shown below:

SLK	Default
RO	RO

Configurations

CTIDEVAFF1 is in the Debug power domain.

CTIDEVAFF1 is optional to implement in the external register interface.

Attributes

CTIDEVAFF1 is a 32-bit register.

The CTIDEVAFF1 bit assignments are:

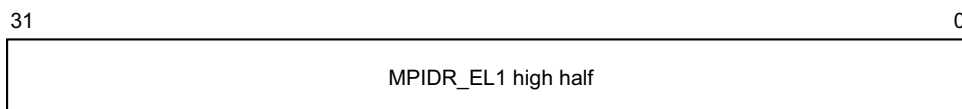

Bits [31:0]

[MPIDR_EL1](#) high half. Read-only copy of the high half of [MPIDR_EL1](#), as seen from the highest implemented exception level.

Accessing the CTIDEVAFF1:

CTIDEVAFF1 can be accessed through the internal memory-mapped interface and the external debug interface:

Component	Offset
CTI	0xFAC

H9.3.17 CTIDEVARCH, CTI Device Architecture register

The CTIDEVARCH characteristics are:

Purpose

Identifies the programmers' model architecture of the CTI component.
This register is part of the Cross-Trigger Interface registers functional group.

Usage constraints

This register is accessible as shown below:

SLK	Default
RO	RO

Configurations

CTIDEVARCH is in the Debug power domain.
CTIDEVARCH is optional to implement in the external register interface.

Attributes

CTIDEVARCH is a 32-bit register.

The CTIDEVARCH bit assignments are:

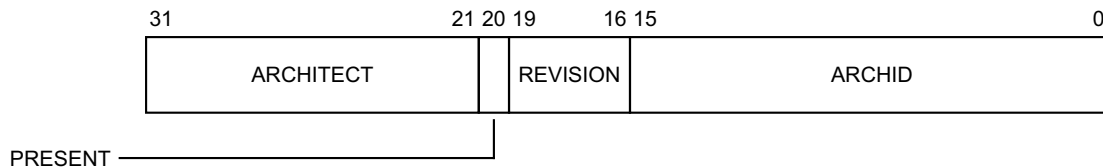

ARCHITECT, bits [31:21]

Defines the architecture of the component. For CTI, this is ARM Limited.
Bits [31:28] are the JEP 106 continuation code, 0x4.
Bits [27:21] are the JEP 106 ID code, 0x3B.

PRESENT, bit [20]

When set to 1, indicates that the DEVARCH is present.
This field is 1 in v8-A.

REVISION, bits [19:16]

Defines the architecture revision. For architectures defined by ARM this is the minor revision.
For CTI, the revision defined by v8-A is 0x0.
All other values are reserved.

ARCHID, bits [15:0]

Defines this part to be a v8-A debug component. For architectures defined by ARM this is further subdivided.

For CTI:

- Bits [15:12] are the architecture version, 0x1.
- Bits [11:0] are the architecture part number, 0xA14.

This corresponds to CTI architecture version CTIv2.

Accessing the CTIDEVARCH:

CTIDEVARCH can be accessed through the internal memory-mapped interface and the external debug interface:

Component	Offset
CTI	0xFBC

H9.3.18 CTIDEVID, CTI Device ID register 0

The CTIDEVID characteristics are:

Purpose

Describes the CTI component to the debugger.

This register is part of the Cross-Trigger Interface registers functional group.

Usage constraints

This register is accessible as shown below:

SLK	Default
RO	RO

Configurations

CTIDEVID is in the Debug power domain.

Attributes

CTIDEVID is a 32-bit register.

The CTIDEVID bit assignments are:

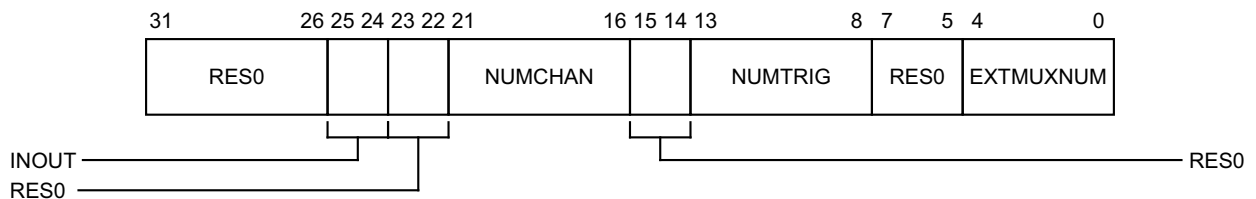

Bits [31:26]

Reserved, RES0.

INOUT, bits [25:24]

Input/output options. Indicates presence of the input gate. If the CTM is not implemented, this field is RAZ.

00 **CTIGATE** does not mask propagation of input events from external channels.

01 **CTIGATE** masks propagation of input events from external channels.

All other values are reserved.

Bits [23:22]

Reserved, RES0.

NUMCHAN, bits [21:16]

Number of ECT channels implemented. IMPLEMENTATION DEFINED. For v8-A, valid values are:

000011 3 channels (0-2) implemented.

000100 4 channels (0-3) implemented.

000101 5 channels (0-4) implemented.

000110 6 channels (0-5) implemented.

and so on up to 0b100000, 32 channels (0-31) implemented.

All other values are reserved.

Bits [15:14]

Reserved, RES0.

NUMTRIG, bits [13:8]

Number of triggers implemented. IMPLEMENTATION DEFINED. This is one more than the index of the largest trigger, rather than the actual number of triggers.

For v8-A, valid values are:

000011 Up to 3 triggers (0-2) implemented.

001000 Up to 8 triggers (0-7) implemented.

001001 Up to 9 triggers (0-8) implemented.

001010 Up to 10 triggers (0-9) implemented.

and so on up to 0b100000, 32 triggers (0-31) implemented.

All other values are reserved. If the Trace Extension is implemented, this field must be at least 001000. There is no guarantee that any of the implemented triggers, including the highest numbered, are connected to any components.

Bits [7:5]

Reserved, RES0.

EXTMUXNUM, bits [4:0]

Maximum number of external triggers available for multiplexing into the CTI. This relates only to additional external triggers outside those defined for v8-A.

Accessing the CTIDEVID:

CTIDEVID can be accessed through the internal memory-mapped interface and the external debug interface:

Component	Offset
CTI	0xFC8

H9.3.19 CTIDEVID1, CTI Device ID register 1

The CTIDEVID1 characteristics are:

Purpose

Reserved for future information about the CTI component to the debugger.
This register is part of the Cross-Trigger Interface registers functional group.

Usage constraints

This register is accessible as shown below:

SLK	Default
RO	RO

Configurations

CTIDEVID1 is in the Debug power domain.

Attributes

CTIDEVID1 is a 32-bit register.

The CTIDEVID1 bit assignments are:

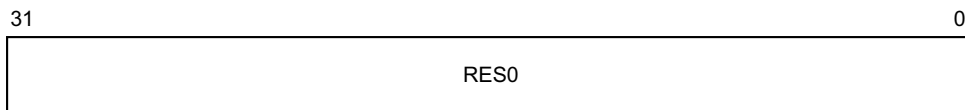

Bits [31:0]

Reserved, RES0.

Accessing the CTIDEVID1:

CTIDEVID1 can be accessed through the internal memory-mapped interface and the external debug interface:

Component	Offset
CTI	0xFC4

H9.3.20 CTIDEVID2, CTI Device ID register 2

The CTIDEVID2 characteristics are:

Purpose

Reserved for future information about the CTI component to the debugger.
This register is part of the Cross-Trigger Interface registers functional group.

Usage constraints

This register is accessible as shown below:

SLK	Default
RO	RO

Configurations

CTIDEVID2 is in the Debug power domain.

Attributes

CTIDEVID2 is a 32-bit register.

The CTIDEVID2 bit assignments are:

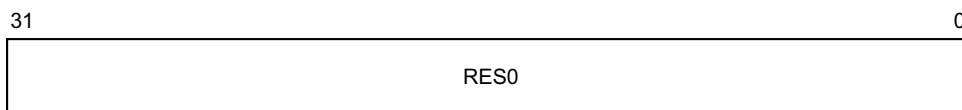

Bits [31:0]

Reserved, RES0.

Accessing the CTIDEVID2:

CTIDEVID2 can be accessed through the internal memory-mapped interface and the external debug interface:

Component	Offset
CTI	0xFC0

H9.3.21 CTIDEVTYPE, CTI Device Type register

The CTIDEVTYPE characteristics are:

Purpose

Indicates to a debugger that this component is part of a processor's cross-trigger interface.
This register is part of the Cross-Trigger Interface registers functional group.

Usage constraints

This register is accessible as shown below:

SLK	Default
RO	RO

Configurations

CTIDEVTYPE is in the Debug power domain.
CTIDEVTYPE is optional to implement in the external register interface.

Attributes

CTIDEVTYPE is a 32-bit register.

The CTIDEVTYPE bit assignments are:

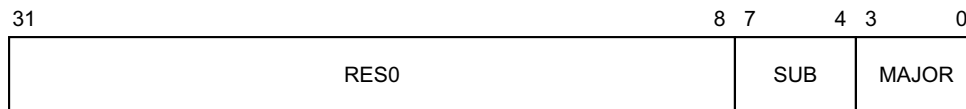

Bits [31:8]

Reserved, RES0.

SUB, bits [7:4]

Subtype. Must read as 0x1 to indicate this is a processor component.

MAJOR, bits [3:0]

Major type. Must read as 0x4 to indicate this is a cross-trigger component.

Accessing the CTIDEVTYPE:

CTIDEVTYPE can be accessed through the internal memory-mapped interface and the external debug interface:

Component	Offset
CTI	0xFCC

H9.3.22 CTIGATE, CTI Channel Gate Enable register

The CTIGATE characteristics are:

Purpose

Determines whether events on channels propagate through the CTM to other ECT components, or from the CTM into the CTI.

This register is part of the Cross-Trigger Interface registers functional group.

Usage constraints

This register is accessible as shown below:

SLK	Default
RO	RW

Configurations

CTIGATE is in the Debug power domain.

Attributes

CTIGATE is a 32-bit register.

The CTIGATE bit assignments are:

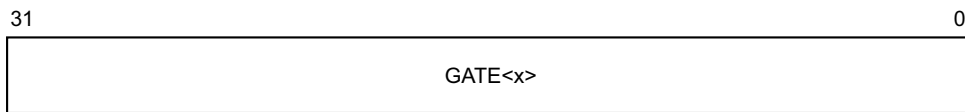

GATE<x>, bit [x] for x = 0 to (N - 1)

Channel <x> gate enable.

N is the number of ECT channels implemented as defined by the [CTIDEVID.NUMCHAN](#) field.

Bits [31:N] are RAZ/WI.

Possible values of this bit are:

0 Disable output and, if [CTIDEVID.INOUT](#) == 0b01, input channel <x> propagation.

1 Enable output and, if [CTIDEVID.INOUT](#) == 0b01, input channel <x> propagation.

On External debug reset, the field reset value is architecturally UNKNOWN.

Accessing the CTIGATE:

CTIGATE can be accessed through the internal memory-mapped interface and the external debug interface:

Component	Offset
CTI	0x140

H9.3.23 CTIINEN<n>, CTI Input Trigger to Output Channel Enable registers, n = 0 - 31

The CTIINEN<n> characteristics are:

Purpose

Enables the signaling of an event on output channels when input trigger event n is received by the CTI.

This register is part of the Cross-Trigger Interface registers functional group.

Usage constraints

This register is accessible as shown below:

SLK	Default
RO	RW

Configurations

CTIINEN<n> is in the Debug power domain.

Attributes

CTIINEN<n> is a 32-bit register.

The CTIINEN<n> bit assignments are:

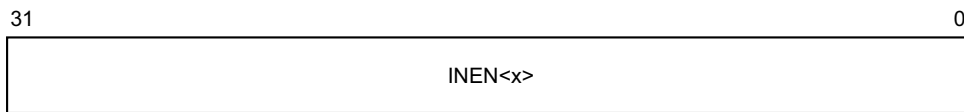

INEN<x>, bit [x] for x = 0 to (N - 1)

Input trigger <n> to output channel <x> enable.

N is the number of ECT channels implemented as defined by the [CTIDEVID.NUMCHAN](#) field.

Bits [31:N] are RAZ/WI.

Possible values of this bit are:

0 Input trigger <n> will not generate an event on output channel <x>.

1 Input trigger <n> will generate an event on output channel <x>.

On External debug reset, the field reset value is architecturally UNKNOWN.

Accessing the CTIINEN<n>:

CTIINEN<n> can be accessed through the internal memory-mapped interface and the external debug interface:

Component	Offset
CTI	0x020 + 4n

H9.3.24 CTIINTACK, CTI Output Trigger Acknowledge register

The CTIINTACK characteristics are:

Purpose

Can be used to create soft acknowledges for output triggers.

This register is part of the Cross-Trigger Interface registers functional group.

Usage constraints

This register is accessible as shown below:

SLK	Default
RO	WO

Configurations

CTIINTACK is in the Debug power domain.

Attributes

CTIINTACK is a 32-bit register.

The CTIINTACK bit assignments are:

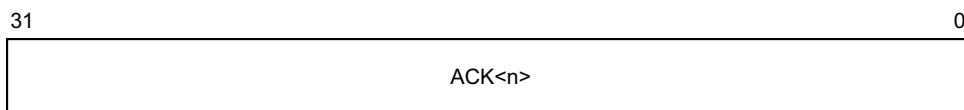

ACK<n>, bit [x] for x = 0 to (N - 1)

Acknowledge for output trigger <n>.

N is the number of CTI triggers implemented as defined by the [CTIDEVID.NUMTRIG](#) field. Bits [31:N] are RAZ/WI.

If any of the following is true, writes to ACK<n> are ignored:

- $n \geq \text{CTIDEVID.NUMTRIG}$, the number of implemented triggers.
- Output trigger n is not active.
- The channel mapping function output, as controlled by [CTIOUTEN<n>](#), is still active.

Otherwise, if any of the following are true, it is IMPLEMENTATION DEFINED whether writes to ACK<n> are ignored:

- Output trigger n is not implemented.
- Output trigger n is not connected.
- Output trigger n is self-acknowledging and does not require software acknowledge.

Otherwise, the behavior on writes to ACK<n> is as follows:

- | | |
|---|-------------------------|
| 0 | No effect |
| 1 | Deactivate the trigger. |

Accessing the CTIINTACK:

CTIINTACK can be accessed through the internal memory-mapped interface and the external debug interface:

Component	Offset
CTI	0x010

H9.3.25 CTIITCTRL, CTI Integration mode Control register

The CTIITCTRL characteristics are:

Purpose

Enables the CTI to switch from its default mode into integration mode, where test software can control directly the inputs and outputs of the processor, for integration testing or topology detection.

This register is part of the Cross-Trigger Interface registers functional group.

Usage constraints

This register is accessible as shown below:

Default
RW

Configurations

CTIITCTRL is in the Debug power domain.

CTIITCTRL is optional to implement in the external register interface.

Attributes

CTIITCTRL is a 32-bit register.

The CTIITCTRL bit assignments are:

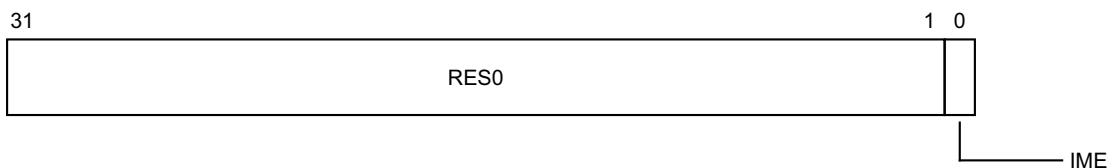

Bits [31:1]

Reserved, RES0.

IME, bit [0]

Integration mode enable. When IME == 1, the device reverts to an integration mode to enable integration testing or topology detection. The integration mode behavior is IMPLEMENTATION DEFINED.

0 Normal operation.

1 Integration mode enabled.

On IMPLEMENTATION DEFINED reset, the field resets to 0.

Accessing the CTIITCTRL:

CTIITCTRL can be accessed through the internal memory-mapped interface and the external debug interface:

Component	Offset
CTI	0xF00

H9.3.26 CTILAR, CTI Lock Access Register

The CTILAR characteristics are:

Purpose

Allows or disallows access to the CTI registers through a memory-mapped interface.
This register is part of the Cross-Trigger Interface registers functional group.

Usage constraints

This register is accessible as shown below:

Default
WO

Configurations

CTILAR is in the Debug power domain.

If OPTIONAL memory-mapped access to the external debug interface is supported then an OPTIONAL Software lock can be implemented as part of CoreSight compliance.

CTILAR ignores writes if the Software lock is not implemented and ignores writes for other accesses to the external debug interface.

The Software lock provides a lock to prevent memory-mapped writes to the Cross-Trigger Interface registers. Use of this lock mechanism reduces the risk of accidental damage to the contents of the Cross-Trigger Interface registers. It does not, and cannot, prevent all accidental or malicious damage.

Software uses CTILAR to set or clear the lock, and CTILSR to check the current status of the lock.

Attributes

CTILAR is a 32-bit register.

The CTILAR bit assignments are:

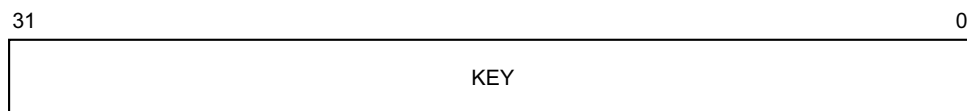

KEY, bits [31:0]

Lock Access control. Writing the key value 0xC5ACCE55 to this field unlocks the lock, enabling write accesses to this component's registers through a memory-mapped interface.

Writing any other value to this register locks the lock, disabling write accesses to this component's registers through a memory mapped interface.

Accessing the CTILAR:

CTILAR can be accessed through the internal memory-mapped interface:

Component	Offset
CTI	0xFB0

H9.3.27 CTILSR, CTI Lock Status Register

The CTILSR characteristics are:

Purpose

Indicates the current status of the software lock for CTI registers.
This register is part of the Cross-Trigger Interface registers functional group.

Usage constraints

This register is accessible as shown below:

Default
RO

Configurations

CTILSR is in the Debug power domain.
If OPTIONAL memory-mapped access to the external debug interface is supported then an OPTIONAL Software lock can be implemented as part of CoreSight compliance.
CTILSR is RAZ if the Software lock is not implemented and is RAZ for other accesses to the external debug interface.
The Software lock provides a lock to prevent memory-mapped writes to the Cross-Trigger Interface registers. Use of this lock mechanism reduces the risk of accidental damage to the contents of the Cross-Trigger Interface registers. It does not, and cannot, prevent all accidental or malicious damage.
Software uses [CTILAR](#) to set or clear the lock, and CTILSR to check the current status of the lock.

Attributes

CTILSR is a 32-bit register.

The CTILSR bit assignments are:

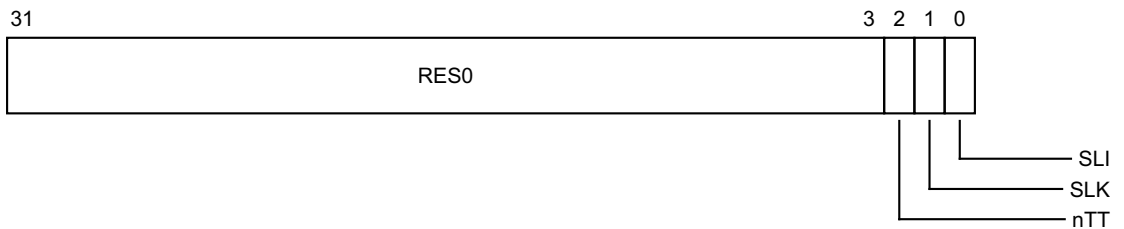

Bits [31:3]

Reserved, RES0.

nTT, bit [2]

Not thirty-two bit access required. RAZ.

SLK, bit [1]

Software lock status for this component. For an access to LSR that is not a memory-mapped access, or when the software lock is not implemented, this field is RES0.

For memory-mapped accesses when the software lock is implemented, possible values of this field are:

0 Lock clear. Writes are permitted to this component's registers.

- 1 Lock set. Writes to this component's registers are ignored, and reads have no side effects.

On External debug reset, the field resets to 1.

SLI, bit [0]

Software lock implemented. For an access to LSR that is not a memory-mapped access, this field is RAZ. For memory-mapped accesses, the value of this field is IMPLEMENTATION DEFINED. Permitted values are:

- 0 Software lock not implemented or not memory-mapped access.
- 1 Software lock implemented and memory-mapped access.

Accessing the CTILSR:

CTILSR can be accessed through the internal memory-mapped interface:

Component	Offset
CTI	0xFB4

H9.3.28 CTIOUTEN<n>, CTI Input Channel to Output Trigger Enable registers, n = 0 - 31

The CTIOUTEN<n> characteristics are:

Purpose

Defines which input channels generate output trigger n.

This register is part of the Cross-Trigger Interface registers functional group.

Usage constraints

This register is accessible as shown below:

SLK	Default
RO	RW

Configurations

CTIOUTEN<n> is in the Debug power domain.

Attributes

CTIOUTEN<n> is a 32-bit register.

The CTIOUTEN<n> bit assignments are:

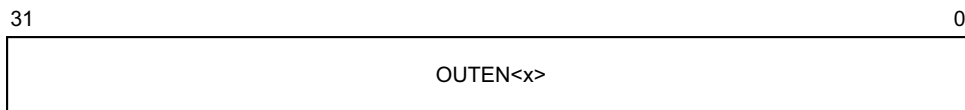

OUTEN<x>, bit [x] for x = 0 to (N - 1)

Input channel <x> to output trigger <n> enable.

N is the number of ECT channels implemented as defined by the CTIDEVID.NUMCHAN field.

Bits [31:N] are RAZ/WI.

Possible values of this bit are:

- 0 An event on input channel <x> will not cause output trigger <n> to be asserted.
- 1 An event on input channel <x> will cause output trigger <n> to be asserted.

On External debug reset, the field reset value is architecturally UNKNOWN.

Accessing the CTIOUTEN<n>:

CTIOUTEN<n> can be accessed through the internal memory-mapped interface and the external debug interface:

Component	Offset
CTI	0x0A0 + 4n

H9.3.29 CTIPIDR0, CTI Peripheral Identification Register 0

The CTIPIDR0 characteristics are:

Purpose

Provides information to identify a CTI component.

This register is part of the Cross-Trigger Interface registers functional group.

Usage constraints

This register is accessible as shown below:

SLK	Default
RO	RO

Configurations

CTIPIDR0 is in the Debug power domain.

CTIPIDR0 is optional to implement in the external register interface.

This register is required for CoreSight compliance.

Attributes

CTIPIDR0 is a 32-bit register.

The CTIPIDR0 bit assignments are:

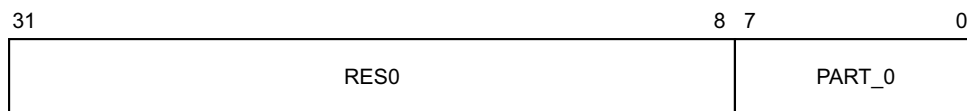

Bits [31:8]

Reserved, RES0.

PART_0, bits [7:0]

Part number, least significant byte.

Accessing the CTIPIDR0:

CTIPIDR0 can be accessed through the internal memory-mapped interface and the external debug interface:

Component	Offset
CTI	0xFE0

H9.3.30 CTIPIDR1, CTI Peripheral Identification Register 1

The CTIPIDR1 characteristics are:

Purpose

Provides information to identify a CTI component.

This register is part of the Cross-Trigger Interface registers functional group.

Usage constraints

This register is accessible as shown below:

SLK	Default
RO	RO

Configurations

CTIPIDR1 is in the Debug power domain.

CTIPIDR1 is optional to implement in the external register interface.

This register is required for CoreSight compliance.

Attributes

CTIPIDR1 is a 32-bit register.

The CTIPIDR1 bit assignments are:

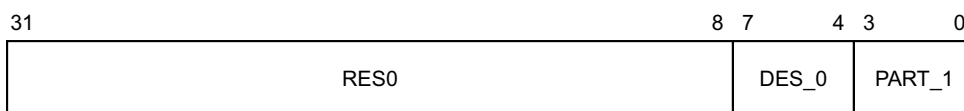

Bits [31:8]

Reserved, RES0.

DES_0, bits [7:4]

Designer, least significant nibble of JEP106 ID code. For ARM Limited, this field is 0b1011.

PART_1, bits [3:0]

Part number, most significant nibble.

Accessing the CTIPIDR1:

CTIPIDR1 can be accessed through the internal memory-mapped interface and the external debug interface:

Component	Offset
CTI	0xFE4

H9.3.31 CTIPIDR2, CTI Peripheral Identification Register 2

The CTIPIDR2 characteristics are:

Purpose

Provides information to identify a CTI component.

This register is part of the Cross-Trigger Interface registers functional group.

Usage constraints

This register is accessible as shown below:

SLK	Default
RO	RO

Configurations

CTIPIDR2 is in the Debug power domain.

CTIPIDR2 is optional to implement in the external register interface.

This register is required for CoreSight compliance.

Attributes

CTIPIDR2 is a 32-bit register.

The CTIPIDR2 bit assignments are:

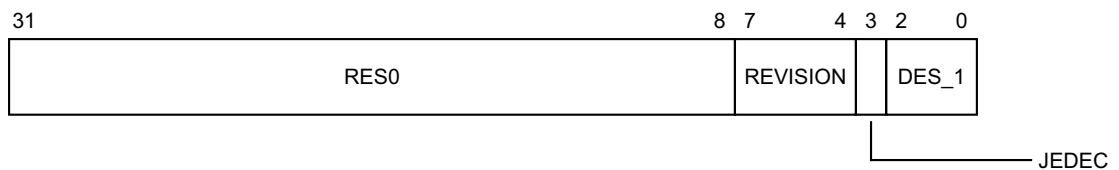

Bits [31:8]

Reserved, RES0.

REVISION, bits [7:4]

Part major revision. Parts can also use this field to extend Part number to 16-bits.

JEDEC, bit [3]

RAO. Indicates a JEP106 identity code is used.

DES_1, bits [2:0]

Designer, most significant bits of JEP106 ID code. For ARM Limited, this field is 0b011.

Accessing the CTIPIDR2:

CTIPIDR2 can be accessed through the internal memory-mapped interface and the external debug interface:

Component	Offset
CTI	0xFE8

H9.3.32 CTIPIDR3, CTI Peripheral Identification Register 3

The CTIPIDR3 characteristics are:

Purpose

Provides information to identify a CTI component.

This register is part of the Cross-Trigger Interface registers functional group.

Usage constraints

This register is accessible as shown below:

SLK	Default
RO	RO

Configurations

CTIPIDR3 is in the Debug power domain.

CTIPIDR3 is optional to implement in the external register interface.

This register is required for CoreSight compliance.

Attributes

CTIPIDR3 is a 32-bit register.

The CTIPIDR3 bit assignments are:

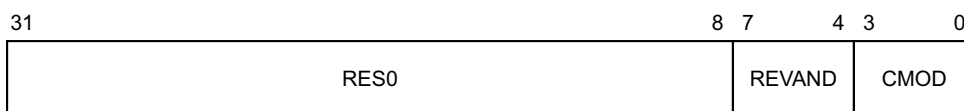

Bits [31:8]

Reserved, RES0.

REVAND, bits [7:4]

Part minor revision. Parts using [CTIPIDR2.REVISION](#) as an extension to the Part number must use this field as a major revision number.

CMOD, bits [3:0]

Customer modified. Indicates someone other than the Designer has modified the component.

Accessing the CTIPIDR3:

CTIPIDR3 can be accessed through the internal memory-mapped interface and the external debug interface:

Component	Offset
CTI	0xFEC

H9.3.33 CTIPIDR4, CTI Peripheral Identification Register 4

The CTIPIDR4 characteristics are:

Purpose

Provides information to identify a CTI component.

This register is part of the Cross-Trigger Interface registers functional group.

Usage constraints

This register is accessible as shown below:

SLK	Default
RO	RO

Configurations

CTIPIDR4 is in the Debug power domain.

CTIPIDR4 is optional to implement in the external register interface.

This register is required for CoreSight compliance.

Attributes

CTIPIDR4 is a 32-bit register.

The CTIPIDR4 bit assignments are:

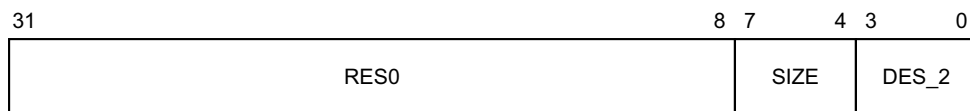

Bits [31:8]

Reserved, RES0.

SIZE, bits [7:4]

Size of the component. RAZ. \log_2 of the number of 4KB pages from the start of the component to the end of the component ID registers.

DES_2, bits [3:0]

Designer, JEP106 continuation code, least significant nibble. For ARM Limited, this field is 0b0100.

Accessing the CTIPIDR4:

CTIPIDR4 can be accessed through the internal memory-mapped interface and the external debug interface:

Component	Offset
CTI	0xFD0

H9.3.34 CTITRIGINSTATUS, CTI Trigger In Status register

The CTITRIGINSTATUS characteristics are:

Purpose

Provides the status of the trigger inputs.

This register is part of the Cross-Trigger Interface registers functional group.

Usage constraints

This register is accessible as shown below:

SLK	Default
RO	RO

Configurations

CTITRIGINSTATUS is in the Debug power domain.

Attributes

CTITRIGINSTATUS is a 32-bit register.

The CTITRIGINSTATUS bit assignments are:

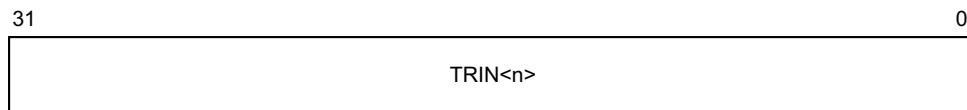

TRIN<n>, bit [x] for x = 0 to (N - 1)

Trigger input <n> status.

N is the number of CTI triggers implemented as defined by the [CTIDEVID.NUMTRIG](#) field.

Bits [31:N] are RAZ.

Possible values of this bit are:

0 Input trigger n is inactive.

1 Input trigger n is active.

Not implemented and not-connected input triggers are always inactive.

Accessing the CTITRIGINSTATUS:

CTITRIGINSTATUS can be accessed through the internal memory-mapped interface and the external debug interface:

Component	Offset
CTI	0x130

H9.3.35 CTITRIGOUTSTATUS, CTI Trigger Out Status register

The CTITRIGOUTSTATUS characteristics are:

Purpose

Provides the status of the trigger outputs.

This register is part of the Cross-Trigger Interface registers functional group.

Usage constraints

This register is accessible as shown below:

SLK	Default
RO	RO

Configurations

CTITRIGOUTSTATUS is in the Debug power domain.

Attributes

CTITRIGOUTSTATUS is a 32-bit register.

The CTITRIGOUTSTATUS bit assignments are:

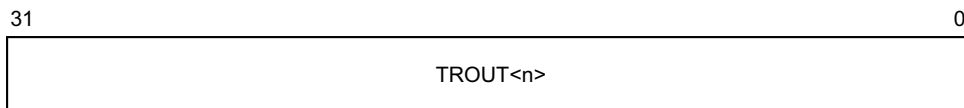

TROUT<n>, bit [x] for x = 0 to (N - 1)

Trigger output <n> status.

N is the number of CTI triggers implemented as defined by the [CTIDEVID.NUMTRIG](#) field.

Bits [31:N] are RAZ.

If output trigger <n> is implemented and connected, possible values of this bit are:

0 Output trigger n is inactive.

1 Output trigger n is active.

Otherwise it is IMPLEMENTATION DEFINED whether TROUT<n> is RAZ or behaves as above.

Accessing the CTITRIGOUTSTATUS:

CTITRIGOUTSTATUS can be accessed through the internal memory-mapped interface and the external debug interface:

Component	Offset
CTI	0x134

Part I

Memory-mapped Components of the ARMv8 Architecture

Chapter I1

Memory-Mapped System Register Descriptions

This chapter describes the memory-mapped system control registers.

It contains the following items:

- [Introduction on page I1-4598.](#)
- [Performance Monitors registers on page I1-4599.](#)
- [Generic Timer registers on page I1-4647.](#)

I1.1 Introduction

The following sections describe the memory-mapped system control registers:

- [Performance Monitors registers on page I1-4599.](#)
- [Generic Timer registers on page I1-4647.](#)

11.2 Performance Monitors registers

This section describes the Performance Monitoring registers.

11.2.1 PMAUTHSTATUS, Performance Monitors Authentication Status register

The PMAUTHSTATUS characteristics are:

Purpose

Provides information about the state of the IMPLEMENTATION DEFINED authentication interface for Performance Monitors.

This register is part of the Performance Monitors registers functional group.

Usage constraints

This register is accessible as shown below:

SLK	Default
RO	RO

Configurations

PMAUTHSTATUS is in the Debug power domain.

This register is OPTIONAL, and is required for CoreSight compliance. ARM recommends that this register is implemented.

Attributes

PMAUTHSTATUS is a 32-bit register.

The PMAUTHSTATUS bit assignments are:

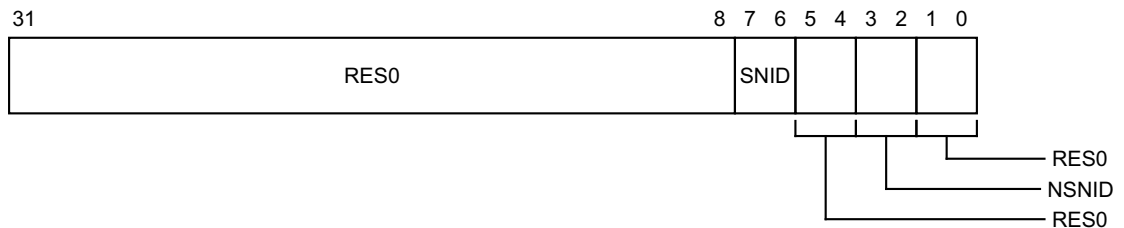

Bits [31:8]

Reserved, RES0.

SNID, bits [7:6]

Holds the same value as [DBGAUTHSTATUS_EL1.SNID](#).

Bits [5:4]

Reserved, RES0.

NSNID, bits [3:2]

Holds the same value as [DBGAUTHSTATUS_EL1.NSNID](#).

Bits [1:0]

Reserved, RES0.

Accessing the PMAUTHSTATUS:

PMAUTHSTATUS can be accessed through the internal memory-mapped interface and the external debug interface:

Component	Offset
PMU	0xFB8

11.2.2 PMCCFILTR_EL0, Performance Monitors Cycle Counter Filter Register

The PMCCFILTR_EL0 characteristics are:

Purpose

Determines the modes in which the Cycle Counter, [PMCCNTR_EL0](#), increments.
This register is part of the Performance Monitors registers functional group.

Usage constraints

This register is accessible as shown below:

Off	DLK	OSLK	EPMAD	SLK	Default
Error	Error	Error	Error	RO	RW

Configurations

PMCCFILTR_EL0 is architecturally mapped to AArch64 register [PMCCFILTR_EL0](#).
PMCCFILTR_EL0 is architecturally mapped to AArch32 register [PMCCFILTR](#).
PMCCFILTR_EL0 is in the Core power domain.

Attributes

PMCCFILTR_EL0 is a 32-bit register.

The PMCCFILTR_EL0 bit assignments are:

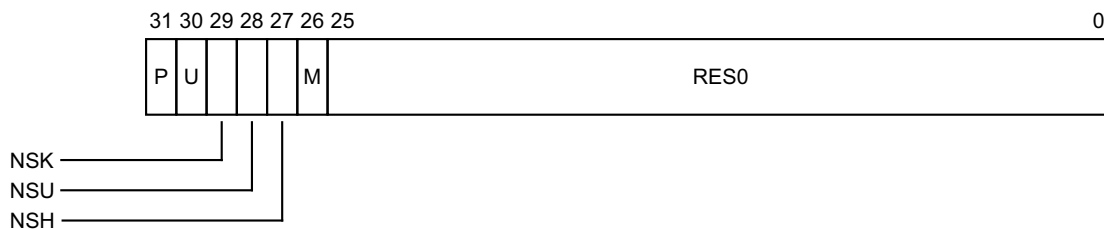

P, bit [31]

EL1 modes filtering bit. Controls counting in EL1. If EL3 is implemented, then counting in Non-secure EL1 is further controlled by the NSK bit. The possible values of this bit are:

- 0 Count cycles in EL1.
- 1 Do not count cycles in EL1.

U, bit [30]

EL0 filtering bit. Controls counting in EL0. If EL3 is implemented, then counting in Non-secure EL0 is further controlled by the NSU bit. The possible values of this bit are:

- 0 Count cycles in EL0.
- 1 Do not count cycles in EL0.

NSK, bit [29]

Non-secure kernel modes filtering bit. Controls counting in Non-secure EL1. If EL3 is not implemented, this bit is RES0.

If the value of this bit is equal to the value of P, cycles in Non-secure EL1 are counted. Otherwise, cycles in Non-secure EL1 are not counted.

NSU, bit [28]

Non-secure user modes filtering bit. Controls counting in Non-secure EL0. If EL3 is not implemented, this bit is RES0.

If the value of this bit is equal to the value of U, cycles in Non-secure EL0 are counted.

Otherwise, cycles in Non-secure EL0 are not counted.

NSH, bit [27]

Non-secure Hyp modes filtering bit. Controls counting in Non-secure EL2. If EL2 is not implemented, this bit is RES0.

0 Do not count cycles in EL2.

1 Count cycles in EL2.

M, bit [26]

Secure EL3 filtering bit. Most applications can ignore this bit and set the value to zero. If EL3 is not implemented, this bit is RES0.

If the value of this bit is equal to the value of P, cycles in Secure EL3 are counted.

Otherwise, cycles in Secure EL3 are not counted.

Bits [25:0]

Reserved, RES0.

Accessing the PMCCFILTR_EL0:

PMCCFILTR_EL0 can be accessed through the internal memory-mapped interface and the external debug interface:

Component	Offset
PMU	0x47C

11.2.3 PMCCNTR_EL0, Performance Monitors Cycle Counter

The PMCCNTR_EL0 characteristics are:

Purpose

Holds the value of the processor Cycle Counter, CCNT, that counts processor clock cycles.
This register is part of the Performance Monitors registers functional group.

Usage constraints

This register is accessible as shown below:

Off	DLK	OSLK	EP MAD	SLK	Default
Error	Error	Error	Error	RO	RW

Configurations

PMCCNTR_EL0 is architecturally mapped to AArch64 register [PMCCNTR_EL0](#).
PMCCNTR_EL0 is architecturally mapped to AArch32 register [PMCCNTR](#).
PMCCNTR_EL0 is in the Core power domain.

Attributes

PMCCNTR_EL0 is a 64-bit register.

The PMCCNTR_EL0 bit assignments are:

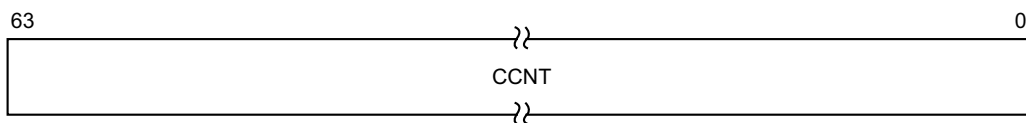

CCNT, bits [63:0]

Cycle count. Depending on the values of [PMCR_EL0](#).{LC,D}, the cycle count increments in one of the following ways:

- Every processor clock cycle.
- Every 64th processor clock cycle.

The cycle count can be reset to zero by writing 1 to [PMCR_EL0.C](#).

Accessing the PMCCNTR_EL0:

PMCCNTR_EL0[31:0] can be accessed through the internal memory-mapped interface and the external debug interface:

Component	Offset
PMU	0x0F8

PMCCNTR_EL0[63:32] can be accessed through the internal memory-mapped interface and the external debug interface:

Component	Offset
PMU	0x0FC

I1.2.4 PMCEID0_EL0, Performance Monitors Common Event Identification register 0

The PMCEID0_EL0 characteristics are:

Purpose

Defines which common architectural and common microarchitectural feature events are implemented. If a particular bit is set to 1, then the event for that bit is implemented.

This register is part of the Performance Monitors registers functional group.

Usage constraints

This register is accessible as shown below:

Off	DLK	OSLK	EPMAD	SLK	Default
Error	Error	Error	Error	RO	RO

Configurations

PMCEID0_EL0 is architecturally mapped to AArch64 register [PMCEID0_EL0](#).

PMCEID0_EL0 is architecturally mapped to AArch32 register [PMCEID0](#).

PMCEID0_EL0 is in the Core power domain.

Attributes

PMCEID0_EL0 is a 32-bit register.

The PMCEID0_EL0 bit assignments are:

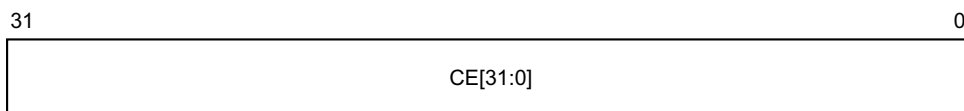

CE[31:0], bits [31:0]

Common architectural and microarchitectural feature events that can be counted by the PMU event counters.

For each bit described in the following table, the event is implemented if the bit is set to 1, or not implemented if the bit is set to 0.

Bit	Event number	Event mnemonic
31	0x01F	L1D_CACHE_ALLOCATE
30	0x01E	CHAIN
29	0x01D	BUS_CYCLES
28	0x01C	TTBR_WRITE_RETIRED
27	0x01B	INST_SPEC
26	0x01A	MEMORY_ERROR
25	0x019	BUS_ACCESS
24	0x018	L2D_CACHE_WB
23	0x017	L2D_CACHE_REFILL

Bit	Event number	Event mnemonic
22	0x016	L2D_CACHE
21	0x015	L1D_CACHE_WB
20	0x014	L1I_CACHE
19	0x013	MEM_ACCESS
18	0x012	BR_PRED
17	0x011	CPU_CYCLES
16	0x010	BR_MIS_PRED
15	0x00F	UNALIGNED_LDST_RETIRED
14	0x00E	BR_RETURN_RETIRED
13	0x00D	BR_IMMED_RETIRED
12	0x00C	PC_WRITE_RETIRED
11	0x00B	CID_WRITE_RETIRED
10	0x00A	EXC_RETURN
9	0x009	EXC_TAKEN
8	0x008	INST_RETIRED
7	0x007	ST_RETIRED
6	0x006	LD_RETIRED
5	0x005	L1D_TLB_REFILL
4	0x004	L1D_CACHE
3	0x003	L1D_CACHE_REFILL
2	0x002	L1I_TLB_REFILL
1	0x001	L1I_CACHE_REFILL
0	0x000	SW_INCR

Accessing the PMCEID0_EL0:

PMCEID0_EL0 can be accessed through the internal memory-mapped interface and the external debug interface:

Component	Offset
PMU	0xE20

I1.2.5 PMCEID1_EL0, Performance Monitors Common Event Identification register 1

The PMCEID1_EL0 characteristics are:

Purpose

Reserved for future indication of which common architectural and common microarchitectural feature events are implemented.

This register is part of the Performance Monitors registers functional group.

Usage constraints

This register is accessible as shown below:

Off	DLK	OSLK	EPMAD	SLK	Default
Error	Error	Error	Error	RO	RO

Configurations

PMCEID1_EL0 is architecturally mapped to AArch64 register [PMCEID1_EL0](#).

PMCEID1_EL0 is architecturally mapped to AArch32 register [PMCEID1](#).

PMCEID1_EL0 is in the Core power domain.

Attributes

PMCEID1_EL0 is a 32-bit register.

The PMCEID1_EL0 bit assignments are:

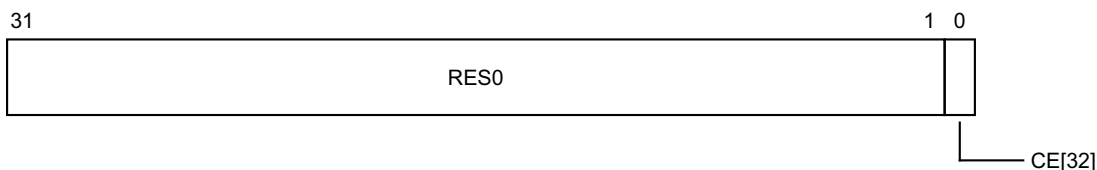

Bits [31:1]

Reserved, RES0.

CE[32], bit [0]

Common architectural and microarchitectural feature events that can be counted by the PMU event counters.

For the bit described in the following table, the event is implemented if the bit is set to 1, or not implemented if the bit is set to 0.

Bit	Event number	Event mnemonic
0	0x020	L2D_CACHE_ALLOCATE

Accessing the PMCEID1_EL0:

PMCEID1_EL0 can be accessed through the internal memory-mapped interface and the external debug interface:

Component	Offset
PMU	0xE24

I1.2.6 PMCFGR, Performance Monitors Configuration Register

The PMCFGR characteristics are:

Purpose

Contains PMU-specific configuration data.

This register is part of the Performance Monitors registers functional group.

Usage constraints

This register is accessible as shown below:

Off	DLK	OSLK	EPMA	SLK	Default
Error	Error	Error	Error	RO	RO

Configurations

PMCFGR is in the Core power domain.

Attributes

PMCFGR is a 32-bit register.

The PMCFGR bit assignments are:

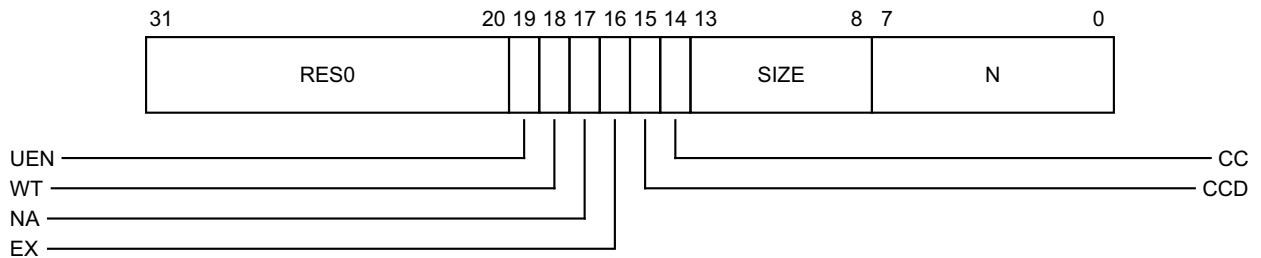

Bits [31:20]

Reserved, RES0.

UEN, bit [19]

User-mode Enable Register supported. [PMUSERENR_ELO](#) is not visible in the external debug interface, so this bit is RES0.

WT, bit [18]

This feature is not supported, so this bit is RES0.

NA, bit [17]

This feature is not supported, so this bit is RES0.

EX, bit [16]

Export supported. Value is IMPLEMENTATION DEFINED.

0 [PMCR_ELO.X](#) is RES0.

1 [PMCR_ELO.X](#) is read/write.

CCD, bit [15]

Cycle counter has prescale. This is RES1 if AArch32 is supported at any EL, and RES0 otherwise.

0 [PMCR_ELO.D](#) is RES0.

1 [PMCR_ELO.D](#) is read/write.

CC, bit [14]

Dedicated cycle counter (counter 31) supported. This bit is RES1.

SIZE, bits [13:8]

Size of counters. This field determines the spacing of counters in the memory-map.

In v8-A the counters are at doubleword-aligned addresses, and the largest counter is 64-bits, so this field is `0b111111`.

N, bits [7:0]

Number of counters implemented in addition to the cycle counter, [PMCCNTR_ELO](#). The maximum number of event counters is 31, so bits[7:5] are always RES0.

`00000000` Only [PMCCNTR_ELO](#) implemented.

`00000001` [PMCCNTR_ELO](#) plus one event counter implemented.

and so on up to `0b00011111`, which indicates [PMCCNTR_ELO](#) and 31 event counters implemented.

Accessing the PMCFGR:

PMCFGR can be accessed through the internal memory-mapped interface and the external debug interface:

Component	Offset
PMU	0xE00

I1.2.7 PMCIDR0, Performance Monitors Component Identification Register 0

The PMCIDR0 characteristics are:

Purpose

Provides information to identify a Performance Monitor component.
 This register is part of the Performance Monitors registers functional group.

Usage constraints

This register is accessible as shown below:

SLK	Default
RO	RO

Configurations

PMCIDR0 is in the Debug power domain.
 PMCIDR0 is optional to implement in the external register interface.
 This register is required for CoreSight compliance.

Attributes

PMCIDR0 is a 32-bit register.

The PMCIDR0 bit assignments are:

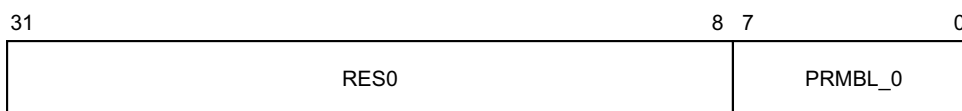

Bits [31:8]

Reserved, RES0.

PRMBL_0, bits [7:0]

Preamble. Must read as 0x00.

Accessing the PMCIDR0:

PMCIDR0 can be accessed through the internal memory-mapped interface and the external debug interface:

Component	Offset
PMU	0xFF0

11.2.8 PMCIDR1, Performance Monitors Component Identification Register 1

The PMCIDR1 characteristics are:

Purpose

Provides information to identify a Performance Monitor component.

This register is part of the Performance Monitors registers functional group.

Usage constraints

This register is accessible as shown below:

SLK	Default
RO	RO

Configurations

PMCIDR1 is in the Debug power domain.

PMCIDR1 is optional to implement in the external register interface.

This register is required for CoreSight compliance.

Attributes

PMCIDR1 is a 32-bit register.

The PMCIDR1 bit assignments are:

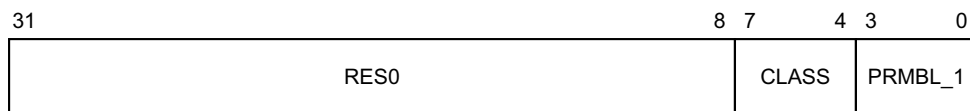

Bits [31:8]

Reserved, RES0.

CLASS, bits [7:4]

Component class. Reads as 0x9, debug component.

PRMBL_1, bits [3:0]

Preamble. RAZ.

Accessing the PMCIDR1:

PMCIDR1 can be accessed through the internal memory-mapped interface and the external debug interface:

Component	Offset
PMU	0xFF4

I1.2.9 PMCIDR2, Performance Monitors Component Identification Register 2

The PMCIDR2 characteristics are:

Purpose

Provides information to identify a Performance Monitor component.
This register is part of the Performance Monitors registers functional group.

Usage constraints

This register is accessible as shown below:

SLK	Default
RO	RO

Configurations

PMCIDR2 is in the Debug power domain.
PMCIDR2 is optional to implement in the external register interface.
This register is required for CoreSight compliance.

Attributes

PMCIDR2 is a 32-bit register.

The PMCIDR2 bit assignments are:

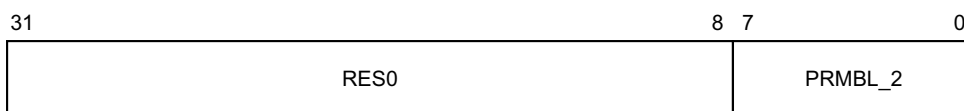

Bits [31:8]

Reserved, RES0.

PRMBL_2, bits [7:0]

Preamble. Must read as 0x05.

Accessing the PMCIDR2:

PMCIDR2 can be accessed through the internal memory-mapped interface and the external debug interface:

Component	Offset
PMU	0xFF8

11.2.10 PMCIDR3, Performance Monitors Component Identification Register 3

The PMCIDR3 characteristics are:

Purpose

Provides information to identify a Performance Monitor component.
 This register is part of the Performance Monitors registers functional group.

Usage constraints

This register is accessible as shown below:

SLK	Default
RO	RO

Configurations

PMCIDR3 is in the Debug power domain.
 PMCIDR3 is optional to implement in the external register interface.
 This register is required for CoreSight compliance.

Attributes

PMCIDR3 is a 32-bit register.

The PMCIDR3 bit assignments are:

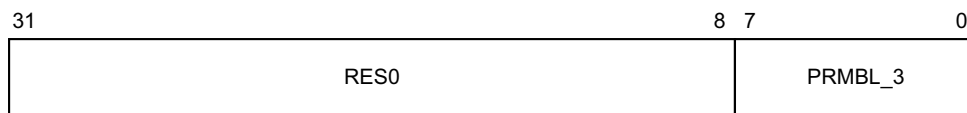

Bits [31:8]

Reserved, RES0.

PRMBL_3, bits [7:0]

Preamble. Must read as 0xB1.

Accessing the PMCIDR3:

PMCIDR3 can be accessed through the internal memory-mapped interface and the external debug interface:

Component	Offset
PMU	0xFFC

I1.2.11 PMCNTENCLR_ELO, Performance Monitors Count Enable Clear register

The PMCNTENCLR_ELO characteristics are:

Purpose

Disables the Cycle Count Register, [PMCCNTR_ELO](#), and any implemented event counters [PMEVCNTR<x>](#). Reading this register shows which counters are enabled.

This register is part of the Performance Monitors registers functional group.

Usage constraints

This register is accessible as shown below:

Off	DLK	OSLK	EPMAD	SLK	Default
Error	Error	Error	Error	RO	RW

Configurations

PMCNTENCLR_ELO is architecturally mapped to AArch64 register [PMCNTENCLR_ELO](#).

PMCNTENCLR_ELO is architecturally mapped to AArch32 register [PMCNTENCLR](#).

PMCNTENCLR_ELO is in the Core power domain.

Attributes

PMCNTENCLR_ELO is a 32-bit register.

The PMCNTENCLR_ELO bit assignments are:

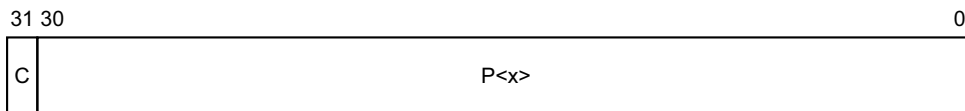

C, bit [31]

[PMCCNTR_ELO](#) disable bit. Disables the cycle counter register. Possible values are:

- 0 When read, means the cycle counter is disabled. When written, has no effect.
- 1 When read, means the cycle counter is enabled. When written, disables the cycle counter.

P<x>, bit [x] for x = 0 to (N - 1)

Event counter disable bit for [PMEVCNTR<x>](#).

N is the value in [PMCR_ELO.N](#). Bits [30:N] are RAZ/WI.

Possible values of each bit are:

- 0 When read, means that [PMEVCNTR<x>](#) is disabled. When written, has no effect.
- 1 When read, means that [PMEVCNTR<x>](#) is enabled. When written, disables [PMEVCNTR<x>](#).

Accessing the PMCNTENCLR_ELO:

PMCNTENCLR_ELO can be accessed through the internal memory-mapped interface and the external debug interface:

Component	Offset
PMU	0xC20

I1.2.12 PMCNTENSET_EL0, Performance Monitors Count Enable Set register

The PMCNTENSET_EL0 characteristics are:

Purpose

Enables the Cycle Count Register, [PMCCNTR_EL0](#), and any implemented event counters [PMEVCNTR<x>](#). Reading this register shows which counters are enabled.

This register is part of the Performance Monitors registers functional group.

Usage constraints

This register is accessible as shown below:

Off	DLK	OSLK	EPMAD	SLK	Default
Error	Error	Error	Error	RO	RW

Configurations

PMCNTENSET_EL0 is architecturally mapped to AArch64 register [PMCNTENSET_EL0](#).

PMCNTENSET_EL0 is architecturally mapped to AArch32 register [PMCNTENSET](#).

PMCNTENSET_EL0 is in the Core power domain.

Attributes

PMCNTENSET_EL0 is a 32-bit register.

The PMCNTENSET_EL0 bit assignments are:

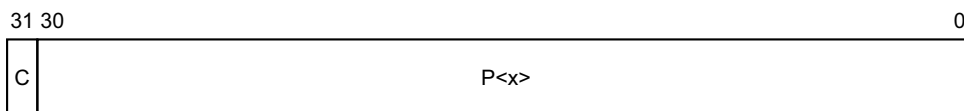

C, bit [31]

[PMCCNTR_EL0](#) enable bit. Enables the cycle counter register. Possible values are:

- 0 When read, means the cycle counter is disabled. When written, has no effect.
- 1 When read, means the cycle counter is enabled. When written, enables the cycle counter.

P<x>, bit [x] for x = 0 to (N - 1)

Event counter enable bit for [PMEVCNTR<x>](#).

N is the value in [PMCR_EL0.N](#). Bits [30:N] are RAZ/WI.

Possible values of each bit are:

- 0 When read, means that [PMEVCNTR<x>](#) is disabled. When written, has no effect.
- 1 When read, means that [PMEVCNTR<x>](#) event counter is enabled. When written, enables [PMEVCNTR<x>](#).

Accessing the PMCNTENSET_ELO:

PMCNTENSET_ELO can be accessed through the internal memory-mapped interface and the external debug interface:

Component	Offset
PMU	0xC00

11.2.13 PMCR_ELO, Performance Monitors Control Register

The PMCR_ELO characteristics are:

Purpose

Provides details of the Performance Monitors implementation, including the number of counters implemented, and configures and controls the counters.

This register is part of the Performance Monitors registers functional group.

Usage constraints

This register is accessible as shown below:

Off	DLK	OSLK	EPMAD	SLK	Default
Error	Error	Error	Error	RO	RW

Configurations

PMCR_ELO is architecturally mapped to AArch64 register [PMCR_ELO](#).

PMCR_ELO is architecturally mapped to AArch32 register [PMCR](#).

PMCR_ELO is in the Core power domain.

Bits [31:11] of this register must be implemented as RAZ/WI despite the mapping to the internal [PMCR](#) system register. An external agent must use other means to discover this information, such as [PMCFGR](#) and the ID registers.

Attributes

PMCR_ELO is a 32-bit register.

The PMCR_ELO bit assignments are:

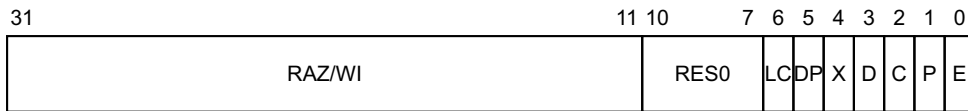

Bits [31:11]

Reserved, RAZ/WI.

Bits [10:7]

Reserved, RES0.

LC, bit [6]

Long cycle counter enable. Determines which [PMCCNTR_ELO](#) bit generates an overflow recorded by [PMOVSr](#)[31].

0 Cycle counter overflow on increment that changes [PMCCNTR_ELO](#)[31] from 1 to 0.

1 Cycle counter overflow on increment that changes [PMCCNTR_ELO](#)[63] from 1 to 0.

ARM deprecates use of `PMCR_ELO.LC = 0`.

DP, bit [5]

Disable cycle counter when event counting is prohibited. The possible values of this bit are:

0 [PMCCNTR_ELO](#), if enabled, counts when event counting is prohibited.

1 [PMCCNTR_ELO](#) does not count when event counting is prohibited.

Event counting is prohibited when `ProfilingProhibited(IsSecure(),PSTATE.EL) == TRUE`.

This bit is RW.

X, bit [4]

Enable export of events in an IMPLEMENTATION DEFINED event stream. The possible values of this bit are:

- 0 Do not export events.
- 1 Export events where not prohibited.

This bit is used to permit events to be exported to another debug device, such as an OPTIONAL trace extension, over an event bus. If the implementation does not include such an event bus, this bit is RAZ/WI.

This bit does not affect the generation of Performance Monitors overflow interrupt requests or signaling to a cross-trigger interface (CTI) that can be implemented as signals exported from the processor.

If the implementation does not include an exported event stream, this bit is RAZ/WI. Otherwise this bit is RW.

D, bit [3]

Clock divider. The possible values of this bit are:

- 0 When enabled, [PMCCNTR_ELO](#) counts every clock cycle.
- 1 When enabled, [PMCCNTR_ELO](#) counts once every 64 clock cycles.

This bit is RW.

If [PMCR_ELO.LC](#) == 1, this bit is ignored and the cycle counter counts every clock cycle.

ARM deprecates use of [PMCR.D](#) = 1.

C, bit [2]

Cycle counter reset. This bit is WO. The effects of writing to this bit are:

- 0 No action.
- 1 Reset [PMCCNTR_ELO](#) to zero.

This bit is always RAZ.

Resetting [PMCCNTR_ELO](#) does not clear the [PMCCNTR_ELO](#) overflow bit to 0.

P, bit [1]

Event counter reset. This bit is WO. The effects of writing to this bit are:

- 0 No action.
- 1 Reset all event counters, not including [PMCCNTR_ELO](#), to zero.

This bit is always RAZ.

Resetting the event counters does not clear any overflow bits to 0.

E, bit [0]

Enable. The possible values of this bit are:

- 0 All counters, including [PMCCNTR_ELO](#), are disabled.
- 1 All counters are enabled by [PMCNTENSET_ELO](#).

This bit is RW.

Accessing the [PMCR_ELO](#):

[PMCR_ELO](#) can be accessed through the internal memory-mapped interface and the external debug interface:

Component	Offset
PMU	0xE04

11.2.14 PMDEVAFF0, Performance Monitors Device Affinity register 0

The PMDEVAFF0 characteristics are:

Purpose

Copy of the low half of the processor [MPIDR_EL1](#) register that allows a debugger to determine which processor in a multiprocessor system the Performance Monitor component relates to.

This register is part of the Performance Monitors registers functional group.

Usage constraints

This register is accessible as shown below:

SLK	Default
RO	RO

Configurations

PMDEVAFF0 is in the Debug power domain.

PMDEVAFF0 is optional to implement in the external register interface.

Attributes

PMDEVAFF0 is a 32-bit register.

The PMDEVAFF0 bit assignments are:

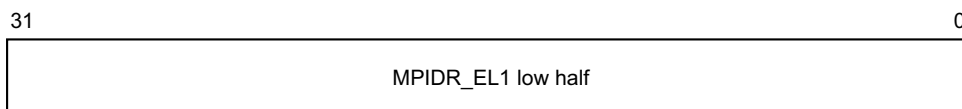

Bits [31:0]

[MPIDR_EL1](#) low half. Read-only copy of the low half of [MPIDR_EL1](#), as seen from the highest implemented exception level.

Accessing the PMDEVAFF0:

PMDEVAFF0 can be accessed through the internal memory-mapped interface and the external debug interface:

Component	Offset
PMU	0xFA8

11.2.15 PMDEVAFF1, Performance Monitors Device Affinity register 1

The PMDEVAFF1 characteristics are:

Purpose

Copy of the high half of the processor [MPIDR_EL1](#) register that allows a debugger to determine which processor in a multiprocessor system the Performance Monitor component relates to.

This register is part of the Performance Monitors registers functional group.

Usage constraints

This register is accessible as shown below:

SLK	Default
RO	RO

Configurations

PMDEVAFF1 is in the Debug power domain.

PMDEVAFF1 is optional to implement in the external register interface.

Attributes

PMDEVAFF1 is a 32-bit register.

The PMDEVAFF1 bit assignments are:

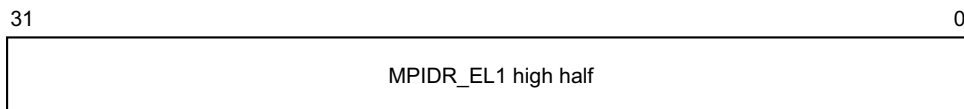

Bits [31:0]

[MPIDR_EL1](#) high half. Read-only copy of the high half of [MPIDR_EL1](#), as seen from the highest implemented exception level.

Accessing the PMDEVAFF1:

PMDEVAFF1 can be accessed through the internal memory-mapped interface and the external debug interface:

Component	Offset
PMU	0xFAC

I1.2.16 PMDEVARCH, Performance Monitors Device Architecture register

The PMDEVARCH characteristics are:

Purpose

This register is part of the Performance Monitors registers functional group.

Usage constraints

This register is accessible as shown below:

SLK	Default
RO	RO

Configurations

PMDEVARCH is in the Debug power domain.

PMDEVARCH is optional to implement in the external register interface.

Attributes

PMDEVARCH is a 32-bit register.

The PMDEVARCH bit assignments are:

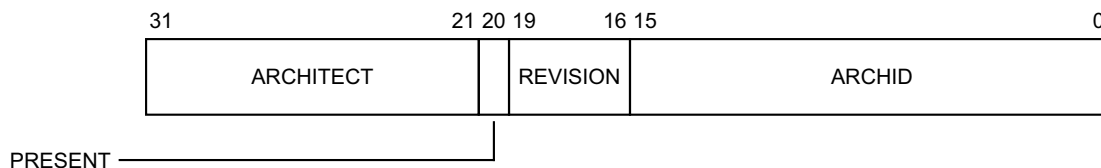

ARCHITECT, bits [31:21]

Defines the architecture of the component. For Performance Monitors, this is ARM Limited.

Bits [31:28] are the JEP 106 continuation code, 0x4.

Bits [27:21] are the JEP 106 ID code, 0x3B.

PRESENT, bit [20]

When set to 1, indicates that the DEVARCH is present.

This field is 1 in v8-A.

REVISION, bits [19:16]

Defines the architecture revision. For architectures defined by ARM this is the minor revision.

For Performance Monitors, the revision defined by v8-A is 0x0.

All other values are reserved.

ARCHID, bits [15:0]

Defines this part to be a v8-A debug component. For architectures defined by ARM this is further subdivided.

For Performance Monitors:

- Bits [15:12] are the architecture version, 0x2.
- Bits [11:0] are the architecture part number, 0xA16.

This corresponds to Performance Monitors architecture version PMUv3.

Accessing the PMDEVARCH:

PMDEVARCH can be accessed through the internal memory-mapped interface and the external debug interface:

Component	Offset
PMU	0xFBC

I1.2.17 PMDEVTYPE, Performance Monitors Device Type register

The PMDEVTYPE characteristics are:

Purpose

Indicates to a debugger that this component is part of a processor's performance monitor interface.
 This register is part of the Performance Monitors registers functional group.

Usage constraints

This register is accessible as shown below:

SLK	Default
RO	RO

Configurations

PMDEVTYPE is in the Debug power domain.
 PMDEVTYPE is optional to implement in the external register interface.

Attributes

PMDEVTYPE is a 32-bit register.

The PMDEVTYPE bit assignments are:

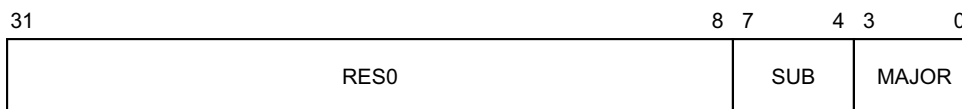

Bits [31:8]

Reserved, RES0.

SUB, bits [7:4]

Subtype. Must read as 0x1 to indicate this is a processor component.

MAJOR, bits [3:0]

Major type. Must read as 0x6 to indicate this is a performance monitor component.

Accessing the PMDEVTYPE:

PMDEVTYPE can be accessed through the internal memory-mapped interface and the external debug interface:

Component	Offset
PMU	0xFCC

11.2.18 PMEVCNTR<n>_EL0, Performance Monitors Event Count Registers, n = 0 - 30

The PMEVCNTR<n>_EL0 characteristics are:

Purpose

Holds event counter n, which counts events, where n is 0 to 30.

This register is part of the Performance Monitors registers functional group.

Usage constraints

This register is accessible as shown below:

Off	DLK	OSLK	EPMAD	SLK	Default
Error	Error	Error	Error	RO	RW

External accesses to the performance monitors ignore [PMUSERENR_EL0](#) and, if implemented, [MDCR_EL2](#).{TPM, TPMCR, HPMN} and [MDCR_EL3](#).TPM. This means that all counters are accessible regardless of the current EL or privilege of the access.

Configurations

PMEVCNTR<n>_EL0 is architecturally mapped to AArch64 register [PMEVCNTR<n>_EL0](#).

PMEVCNTR<n>_EL0 is architecturally mapped to AArch32 register [PMEVCNTR<n>](#).

PMEVCNTR<n>_EL0 is in the Core power domain.

Attributes

PMEVCNTR<n>_EL0 is a 32-bit register.

The PMEVCNTR<n>_EL0 bit assignments are:

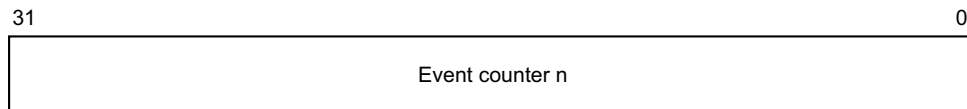

Bits [31:0]

Event counter n. Value of event counter n, where n is the number of this register and is a number from 0 to 30.

Accessing the PMEVCNTR<n>_EL0:

PMEVCNTR<n>_EL0 can be accessed through the internal memory-mapped interface and the external debug interface:

Component	Offset
PMU	0x000 + 8n

I1.2.19 PMEVTYPER<n>_EL0, Performance Monitors Event Type Registers, n = 0 - 30

The PMEVTYPER<n>_EL0 characteristics are:

Purpose

Configures event counter n, where n is 0 to 30.

This register is part of the Performance Monitors registers functional group.

Usage constraints

This register is accessible as shown below:

Off	DLK	OSLK	EPMA	SLK	Default
Error	Error	Error	Error	RO	RW

Configurations

PMEVTYPER<n>_EL0 is architecturally mapped to AArch64 register [PMEVTYPER<n>_EL0](#).

PMEVTYPER<n>_EL0 is architecturally mapped to AArch32 register [PMEVTYPER<n>](#).

PMEVTYPER<n>_EL0 is in the Core power domain.

Attributes

PMEVTYPER<n>_EL0 is a 32-bit register.

The PMEVTYPER<n>_EL0 bit assignments are:

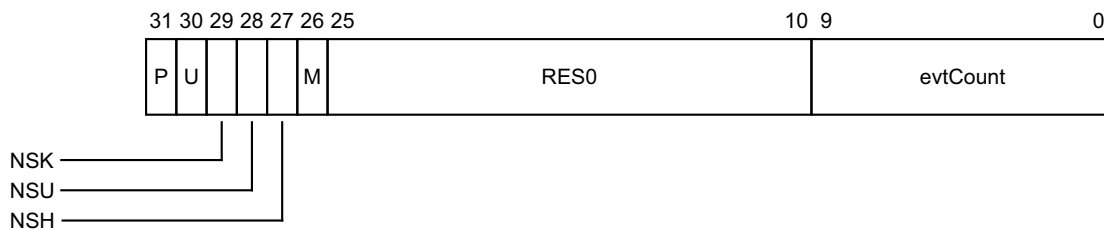

P, bit [31]

EL1 modes filtering bit. Controls counting in EL1. If EL3 is implemented, then counting in Non-secure EL1 is further controlled by the NSK bit. The possible values of this bit are:

- 0 Count events in EL1.
- 1 Do not count events in EL1.

U, bit [30]

EL0 filtering bit. Controls counting in EL0. If EL3 is implemented, then counting in Non-secure EL0 is further controlled by the NSU bit. The possible values of this bit are:

- 0 Count events in EL0.
- 1 Do not count events in EL0.

NSK, bit [29]

Non-secure kernel modes filtering bit. Controls counting in Non-secure EL1. If EL3 is not implemented, this bit is RES0.

If the value of this bit is equal to the value of P, events in Non-secure EL1 are counted.

Otherwise, events in Non-secure EL1 are not counted.

NSU, bit [28]

Non-secure user modes filtering bit. Controls counting in Non-secure EL0. If EL3 is not implemented, this bit is RES0.

If the value of this bit is equal to the value of U, events in Non-secure EL0 are counted.

Otherwise, events in Non-secure EL0 are not counted.

NSH, bit [27]

Non-secure Hyp modes filtering bit. Controls counting in Non-secure EL2. If EL2 is not implemented, this bit is RES0.

0 Do not count events in EL2.

1 Count events in EL2.

M, bit [26]

Secure EL3 filtering bit. Most applications can ignore this bit and set the value to zero. If EL3 is not implemented, this bit is RES0.

If the value of this bit is equal to the value of P, events in Secure EL3 are counted.

Otherwise, events in Secure EL3 are not counted.

Bits [25:10]

Reserved, RES0.

evtCount, bits [9:0]

Event to count. The event number of the event that is counted by event counter [PMEVCNTR<n>_EL0](#).

Software must program this field with an event defined by the processor or a common event defined by the architecture.

If evtCount is programmed to an event that is reserved or not implemented, the behavior depends on the event type.

For common architectural and microarchitectural events:

- No events are counted.
- The value read back on evtCount is the value written.

For IMPLEMENTATION DEFINED events:

- It is UNPREDICTABLE what event, if any, is counted. UNPREDICTABLE in this case means the event must not expose privileged information.
- The value read back on evtCount is an UNKNOWN value with the same effect.

ARM recommends that the behavior across a family of implementations is defined such that if a given implementation does not include an event from a set of common IMPLEMENTATION DEFINED events, then no event is counted and the value read back on evtCount is the value written.

Accessing the PMEVTYPER<n>_EL0:

PMEVTYPER<n>_EL0 can be accessed through the internal memory-mapped interface and the external debug interface:

Component	Offset
PMU	0x400 + 4n

11.2.20 PMINTENCLR_EL1, Performance Monitors Interrupt Enable Clear register

The PMINTENCLR_EL1 characteristics are:

Purpose

Disables the generation of interrupt requests on overflows from the Cycle Count Register, [PMCCNTR_ELO](#), and the event counters [PMEVCNTR<n>_ELO](#). Reading the register shows which overflow interrupt requests are enabled.

This register is part of the Performance Monitors registers functional group.

Usage constraints

This register is accessible as shown below:

Off	DLK	OSLK	EPMAD	SLK	Default
Error	Error	Error	Error	RO	RW

Configurations

PMINTENCLR_EL1 is architecturally mapped to AArch64 register [PMINTENCLR_EL1](#).

PMINTENCLR_EL1 is architecturally mapped to AArch32 register [PMINTENCLR](#).

PMINTENCLR_EL1 is in the Core power domain.

Attributes

PMINTENCLR_EL1 is a 32-bit register.

The PMINTENCLR_EL1 bit assignments are:

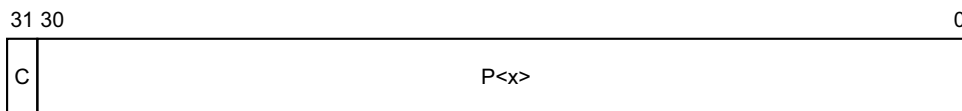

C, bit [31]

[PMCCNTR_ELO](#) overflow interrupt request disable bit. Possible values are:

- 0 When read, means the cycle counter overflow interrupt request is disabled. When written, has no effect.
- 1 When read, means the cycle counter overflow interrupt request is enabled. When written, disables the cycle count overflow interrupt request.

P<x>, bit [x] for x = 0 to (N - 1)

Event counter overflow interrupt request disable bit for [PMEVCNTR<x>_ELO](#).

N is the value in [PMCR_ELO.N](#). Bits [30:N] are RAZ/WI.

Possible values are:

- 0 When read, means that the [PMEVCNTR<x>_ELO](#) event counter interrupt request is disabled. When written, has no effect.
- 1 When read, means that the [PMEVCNTR<x>_ELO](#) event counter interrupt request is enabled. When written, disables the [PMEVCNTR<x>_ELO](#) interrupt request.

Accessing the PMINTENCLR_EL1:

PMINTENCLR_EL1 can be accessed through the internal memory-mapped interface and the external debug interface:

Component	Offset
PMU	0xC60

11.2.21 PMINTENSET_EL1, Performance Monitors Interrupt Enable Set register

The PMINTENSET_EL1 characteristics are:

Purpose

Enables the generation of interrupt requests on overflows from the Cycle Count Register, [PMCCNTR_ELO](#), and the event counters [PMEVCNTR<n>_ELO](#). Reading the register shows which overflow interrupt requests are enabled.

This register is part of the Performance Monitors registers functional group.

Usage constraints

This register is accessible as shown below:

Off	DLK	OSLK	EPMAD	SLK	Default
Error	Error	Error	Error	RO	RW

Configurations

PMINTENSET_EL1 is architecturally mapped to AArch64 register [PMINTENSET_EL1](#).

PMINTENSET_EL1 is architecturally mapped to AArch32 register [PMINTENSET](#).

PMINTENSET_EL1 is in the Core power domain.

Attributes

PMINTENSET_EL1 is a 32-bit register.

The PMINTENSET_EL1 bit assignments are:

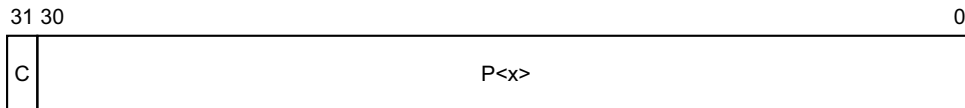

C, bit [31]

[PMCCNTR_ELO](#) overflow interrupt request enable bit. Possible values are:

- 0 When read, means the cycle counter overflow interrupt request is disabled. When written, has no effect.
- 1 When read, means the cycle counter overflow interrupt request is enabled. When written, enables the cycle count overflow interrupt request.

P<x>, bit [x] for x = 0 to (N - 1)

Event counter overflow interrupt request enable bit for [PMEVCNTR<x>_ELO](#).

N is the value in [PMCR_ELO.N](#). Bits [30:N] are RAZ/WI.

Possible values are:

- 0 When read, means that the [PMEVCNTR<x>_ELO](#) event counter interrupt request is disabled. When written, has no effect.
- 1 When read, means that the [PMEVCNTR<x>_ELO](#) event counter interrupt request is enabled. When written, enables the [PMEVCNTR<x>_ELO](#) interrupt request.

Accessing the PMINTENSET_EL1:

PMINTENSET_EL1 can be accessed through the internal memory-mapped interface and the external debug interface:

Component	Offset
PMU	0xC40

I1.2.22 PMITCTRL, Performance Monitors Integration mode Control register

The PMITCTRL characteristics are:

Purpose

Enables the Performance Monitors to switch from default mode into integration mode, where test software can control directly the inputs and outputs of the processor, for integration testing or topology detection.

This register is part of the Performance Monitors registers functional group.

Usage constraints

This register is accessible as shown below:

Off	DLK	OSLK	Default
IMP DEF	IMP DEF	IMP DEF	RW

Configurations

It is IMPLEMENTATION DEFINED whether PMITCTRL is in the Core power domain or in the Debug power domain.

PMITCTRL is optional to implement in the external register interface.

Attributes

PMITCTRL is a 32-bit register.

The PMITCTRL bit assignments are:

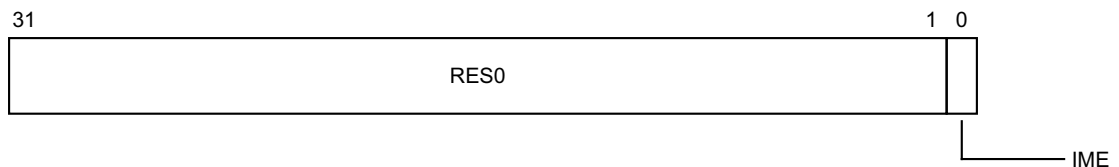

Bits [31:1]

Reserved, RES0.

IME, bit [0]

Integration mode enable. When IME == 1, the device reverts to an integration mode to enable integration testing or topology detection. The integration mode behavior is IMPLEMENTATION DEFINED.

0 Normal operation.

1 Integration mode enabled.

On IMPLEMENTATION DEFINED reset, the field resets to 0.

Accessing the PMITCTRL:

PMITCTRL can be accessed through the internal memory-mapped interface and the external debug interface:

Component	Offset
PMU	0xF00

I1.2.23 PMLAR, Performance Monitors Lock Access Register

The PMLAR characteristics are:

Purpose

Allows or disallows access to the Performance Monitors registers through a memory-mapped interface.

This register is part of the Performance Monitors registers functional group.

Usage constraints

This register is accessible as shown below:

Default

WO

Configurations

PMLAR is in the Debug power domain.

If OPTIONAL memory-mapped access to the external debug interface is supported then an OPTIONAL Software lock can be implemented as part of CoreSight compliance.

PMLAR ignores writes if the Software lock is not implemented and ignores writes for other accesses to the external debug interface.

The Software lock provides a lock to prevent memory-mapped writes to the Performance Monitors registers. Use of this lock mechanism reduces the risk of accidental damage to the contents of the Performance Monitors registers. It does not, and cannot, prevent all accidental or malicious damage.

Software uses PMLAR to set or clear the lock, and [PMLSR](#) to check the current status of the lock.

Attributes

PMLAR is a 32-bit register.

The PMLAR bit assignments are:

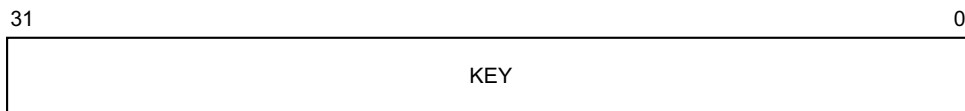

KEY, bits [31:0]

Lock Access control. Writing the key value 0xC5ACCE55 to this field unlocks the lock, enabling write accesses to this component's registers through a memory-mapped interface.

Writing any other value to this register locks the lock, disabling write accesses to this component's registers through a memory mapped interface.

Accessing the PMLAR:

PMLAR can be accessed through the internal memory-mapped interface:

Component	Offset
PMU	0xFB0

I1.2.24 PMLSR, Performance Monitors Lock Status Register

The PMLSR characteristics are:

Purpose

Indicates the current status of the software lock for Performance Monitors registers.
 This register is part of the Performance Monitors registers functional group.

Usage constraints

This register is accessible as shown below:

Default
RO

Configurations

PMLSR is in the Debug power domain.

If OPTIONAL memory-mapped access to the external debug interface is supported then an OPTIONAL Software lock can be implemented as part of CoreSight compliance.

PMLSR is RAZ if the Software lock is not implemented and is RAZ for other accesses to the external debug interface.

The Software lock provides a lock to prevent memory-mapped writes to the Performance Monitors registers. Use of this lock mechanism reduces the risk of accidental damage to the contents of the Performance Monitors registers. It does not, and cannot, prevent all accidental or malicious damage.

Software uses [PMLAR](#) to set or clear the lock, and PMLSR to check the current status of the lock.

Attributes

PMLSR is a 32-bit register.

The PMLSR bit assignments are:

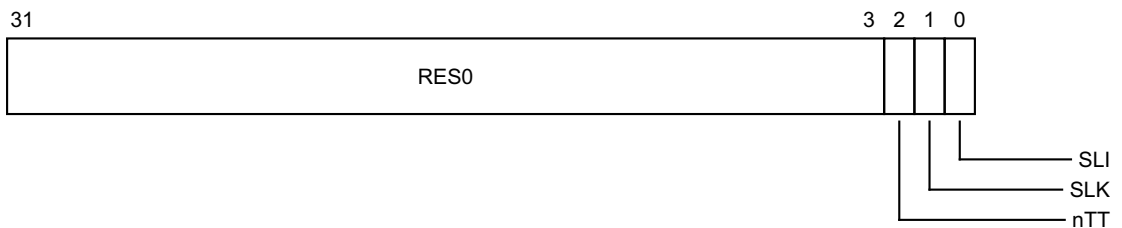

Bits [31:3]

Reserved, RES0.

nTT, bit [2]

Not thirty-two bit access required. RAZ.

SLK, bit [1]

Software lock status for this component. For an access to LSR that is not a memory-mapped access, or when the software lock is not implemented, this field is RES0.

For memory-mapped accesses when the software lock is implemented, possible values of this field are:

- 0 Lock clear. Writes are permitted to this component's registers.
- 1 Lock set. Writes to this component's registers are ignored, and reads have no side effects.

On External debug reset, the field resets to 1.

SLI, bit [0]

Software lock implemented. For an access to LSR that is not a memory-mapped access, this field is RAZ. For memory-mapped accesses, the value of this field is IMPLEMENTATION DEFINED. Permitted values are:

- 0 Software lock not implemented or not memory-mapped access.
- 1 Software lock implemented and memory-mapped access.

Accessing the PMLSR:

PMLSR can be accessed through the internal memory-mapped interface:

Component	Offset
PMU	0xFB4

I1.2.25 PMOVSLR_ELO, Performance Monitors Overflow Flag Status Clear register

The PMOVSLR_ELO characteristics are:

Purpose

Contains the state of the overflow bit for the Cycle Count Register, [PMCCNTR_ELO](#), and each of the implemented event counters [PMEVCNTR<x>](#). Writing to this register clears these bits.

This register is part of the Performance Monitors registers functional group.

Usage constraints

This register is accessible as shown below:

Off	DLK	OSLK	EPMAD	SLK	Default
Error	Error	Error	Error	RO	RW

Configurations

PMOVSLR_ELO is architecturally mapped to AArch64 register [PMOVSLR_ELO](#).

PMOVSLR_ELO is architecturally mapped to AArch32 register [PMOVSR](#).

PMOVSLR_ELO is in the Core power domain.

Attributes

PMOVSLR_ELO is a 32-bit register.

The PMOVSLR_ELO bit assignments are:

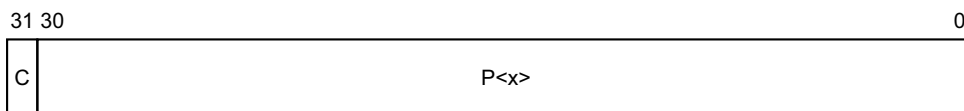

C, bit [31]

[PMCCNTR_ELO](#) overflow bit. Possible values are:

- 0 When read, means the cycle counter has not overflowed. When written, has no effect.
- 1 When read, means the cycle counter has overflowed. When written, clears the overflow bit to 0.

PMCR_ELO.LC is used to control from which bit of [PMCCNTR_ELO](#) (bit 31 or bit 63) an overflow is detected.

P<x>, bit [x] for x = 0 to (N - 1)

Event counter overflow clear bit for [PMEVCNTR<x>](#).

N is the value in [PMCR_ELO.N](#). Bits [30:N] are RAZ/WI.

Possible values of each bit are:

- 0 When read, means that [PMEVCNTR<x>](#) has not overflowed. When written, has no effect.
- 1 When read, means that [PMEVCNTR<x>](#) has overflowed. When written, clears the [PMEVCNTR<x>](#) overflow bit to 0.

Accessing the PMOVSLR_EL0:

PMOVSLR_EL0 can be accessed through the internal memory-mapped interface and the external debug interface:

Component	Offset
PMU	0xC80

I1.2.26 PMOVSSET_EL0, Performance Monitors Overflow Flag Status Set register

The PMOVSSET_EL0 characteristics are:

Purpose

Sets the state of the overflow bit for the Cycle Count Register, [PMCCNTR_EL0](#), and each of the implemented event counters [PMEVCNTR<x>](#).

This register is part of the Performance Monitors registers functional group.

Usage constraints

This register is accessible as shown below:

Off	DLK	OSLK	EPMAD	SLK	Default
Error	Error	Error	Error	RO	RW

Configurations

PMOVSSET_EL0 is architecturally mapped to AArch64 register [PMOVSSET_EL0](#).

PMOVSSET_EL0 is architecturally mapped to AArch32 register [PMOVSSET](#).

PMOVSSET_EL0 is in the Core power domain.

Attributes

PMOVSSET_EL0 is a 32-bit register.

The PMOVSSET_EL0 bit assignments are:

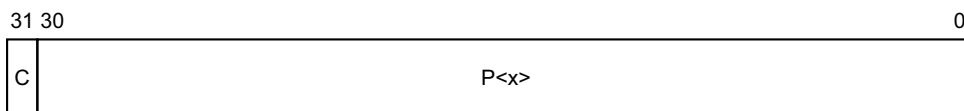

C, bit [31]

[PMCCNTR_EL0](#) overflow bit. Possible values are:

- 0 When read, means the cycle counter has not overflowed. When written, has no effect.
- 1 When read, means the cycle counter has overflowed. When written, sets the overflow bit to 1.

P<x>, bit [x] for x = 0 to (N - 1)

Event counter overflow set bit for [PMEVCNTR<x>](#).

N is the value in [PMCR_EL0.N](#). Bits [30:N] are RAZ/WI.

Possible values are:

- 0 When read, means that [PMEVCNTR<x>](#) has not overflowed. When written, has no effect.
- 1 When read, means that [PMEVCNTR<x>](#) has overflowed. When written, sets the [PMEVCNTR<x>](#) overflow bit to 1.

Accessing the PMOVSSET_ELO:

PMOVSSET_ELO can be accessed through the internal memory-mapped interface and the external debug interface:

Component	Offset
PMU	0xCC0

I1.2.27 PMPIDR0, Performance Monitors Peripheral Identification Register 0

The PMPIDR0 characteristics are:

Purpose

Provides information to identify a Performance Monitor component.
 This register is part of the Performance Monitors registers functional group.

Usage constraints

This register is accessible as shown below:

SLK	Default
RO	RO

Configurations

PMPIDR0 is in the Debug power domain.
 PMPIDR0 is optional to implement in the external register interface.
 This register is required for CoreSight compliance.

Attributes

PMPIDR0 is a 32-bit register.

The PMPIDR0 bit assignments are:

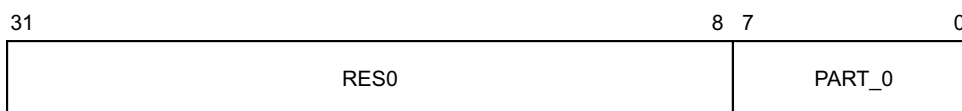

Bits [31:8]

Reserved, RES0.

PART_0, bits [7:0]

Part number, least significant byte.

Accessing the PMPIDR0:

PMPIDR0 can be accessed through the internal memory-mapped interface and the external debug interface:

Component	Offset
PMU	0xFE0

11.2.28 PMPIDR1, Performance Monitors Peripheral Identification Register 1

The PMPIDR1 characteristics are:

Purpose

Provides information to identify a Performance Monitor component.
 This register is part of the Performance Monitors registers functional group.

Usage constraints

This register is accessible as shown below:

SLK	Default
RO	RO

Configurations

PMPIDR1 is in the Debug power domain.
 PMPIDR1 is optional to implement in the external register interface.
 This register is required for CoreSight compliance.

Attributes

PMPIDR1 is a 32-bit register.

The PMPIDR1 bit assignments are:

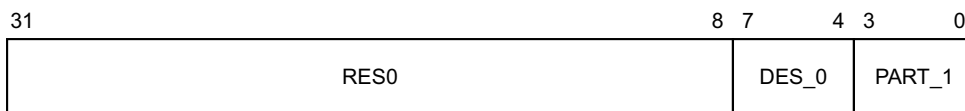

Bits [31:8]

Reserved, RES0.

DES_0, bits [7:4]

Designer, least significant nibble of JEP106 ID code. For ARM Limited, this field is 0b1011.

PART_1, bits [3:0]

Part number, most significant nibble.

Accessing the PMPIDR1:

PMPIDR1 can be accessed through the internal memory-mapped interface and the external debug interface:

Component	Offset
PMU	0xFE4

I1.2.29 PMPIDR2, Performance Monitors Peripheral Identification Register 2

The PMPIDR2 characteristics are:

Purpose

Provides information to identify a Performance Monitor component.
 This register is part of the Performance Monitors registers functional group.

Usage constraints

This register is accessible as shown below:

SLK	Default
RO	RO

Configurations

PMPIDR2 is in the Debug power domain.
 PMPIDR2 is optional to implement in the external register interface.
 This register is required for CoreSight compliance.

Attributes

PMPIDR2 is a 32-bit register.

The PMPIDR2 bit assignments are:

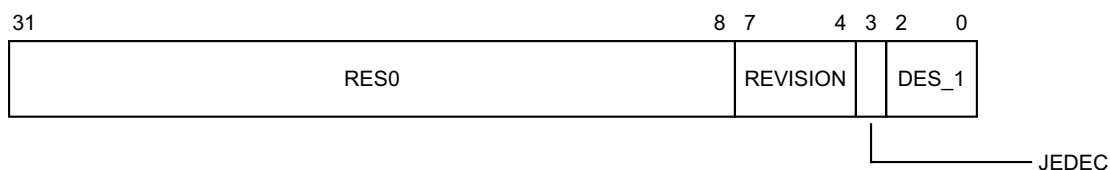

Bits [31:8]

Reserved, RES0.

REVISION, bits [7:4]

Part major revision. Parts can also use this field to extend Part number to 16-bits.

JEDEC, bit [3]

RAO. Indicates a JEP106 identity code is used.

DES_1, bits [2:0]

Designer, most significant bits of JEP106 ID code. For ARM Limited, this field is 0b011.

Accessing the PMPIDR2:

PMPIDR2 can be accessed through the internal memory-mapped interface and the external debug interface:

Component	Offset
PMU	0xFE8

11.2.30 PMPIDR3, Performance Monitors Peripheral Identification Register 3

The PMPIDR3 characteristics are:

Purpose

Provides information to identify a Performance Monitor component.
 This register is part of the Performance Monitors registers functional group.

Usage constraints

This register is accessible as shown below:

SLK	Default
RO	RO

Configurations

PMPIDR3 is in the Debug power domain.
 PMPIDR3 is optional to implement in the external register interface.
 This register is required for CoreSight compliance.

Attributes

PMPIDR3 is a 32-bit register.

The PMPIDR3 bit assignments are:

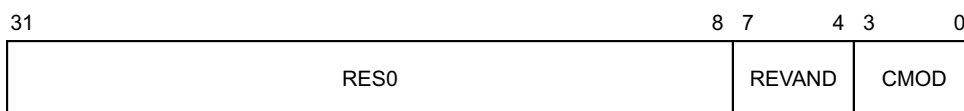

Bits [31:8]

Reserved, RES0.

REVAND, bits [7:4]

Part minor revision. Parts using PMPIDR2.REVISION as an extension to the Part number must use this field as a major revision number.

CMOD, bits [3:0]

Customer modified. Indicates someone other than the Designer has modified the component.

Accessing the PMPIDR3:

PMPIDR3 can be accessed through the internal memory-mapped interface and the external debug interface:

Component	Offset
PMU	0xFEC

I1.2.31 PMPIDR4, Performance Monitors Peripheral Identification Register 4

The PMPIDR4 characteristics are:

Purpose

Provides information to identify a Performance Monitor component.
 This register is part of the Performance Monitors registers functional group.

Usage constraints

This register is accessible as shown below:

SLK	Default
RO	RO

Configurations

PMPIDR4 is in the Debug power domain.
 PMPIDR4 is optional to implement in the external register interface.
 This register is required for CoreSight compliance.

Attributes

PMPIDR4 is a 32-bit register.

The PMPIDR4 bit assignments are:

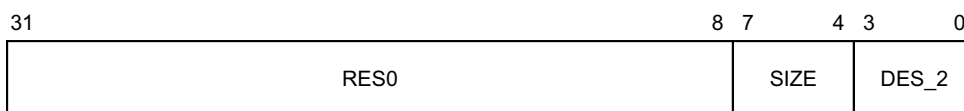

Bits [31:8]

Reserved, RES0.

SIZE, bits [7:4]

Size of the component. RAZ. \log_2 of the number of 4KB pages from the start of the component to the end of the component ID registers.

DES_2, bits [3:0]

Designer, JEP106 continuation code, least significant nibble. For ARM Limited, this field is 0b0100.

Accessing the PMPIDR4:

PMPIDR4 can be accessed through the internal memory-mapped interface and the external debug interface:

Component	Offset
PMU	0xFD0

11.2.32 PMSWINC_EL0, Performance Monitors Software Increment register

The PMSWINC_EL0 characteristics are:

Purpose

Increments a counter that is configured to count the Software increment event, event 0x00.
 This register is part of the Performance Monitors registers functional group.

Usage constraints

This register is accessible as shown below:

Off	DLK	OSLK	EPMA	SLK	Default
Error	Error	Error	Error	RO	WO

Configurations

PMSWINC_EL0 is architecturally mapped to AArch64 register [PMSWINC_EL0](#).

PMSWINC_EL0 is architecturally mapped to AArch32 register [PMSWINC](#).

PMSWINC_EL0 is in the Core power domain.

PMSWINC_EL0 is optional to implement in the external register interface.

If this register is implemented, use of it is deprecated.

If 1 is written to bit [x] from the external debug interface, it is CONstrained UNPREDICTABLE whether or not a SW_INCR event is created for counter x. This is consistent with not implementing the register in the external debug interface.

Attributes

PMSWINC_EL0 is a 32-bit register.

The PMSWINC_EL0 bit assignments are:

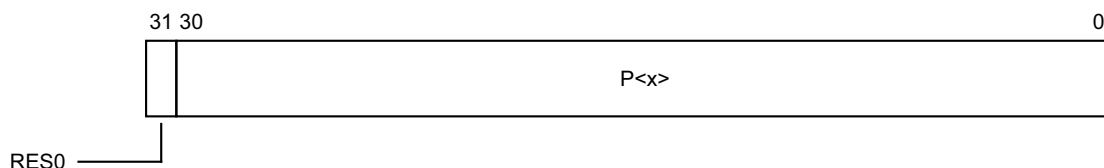

Bit [31]

Reserved, RES0.

P<x>, bit [x] for x = 0 to (N - 1)

Event counter software increment bit for [PMEVCNTR<x>](#).

P<x> is WI if $x \geq \text{PMCR_EL0.N}$, the number of implemented counters.

Otherwise, the effects of writing to this bit are:

0 No action. The write to this bit is ignored.

1 It is CONstrained UNPREDICTABLE whether a SW_INCR event is generated for event counter x.

Accessing the PMSWINC_EL0:

PMSWINC_EL0 can be accessed through the internal memory-mapped interface and the external debug interface:

Component	Offset
PMU	0xCA0

I1.3 Generic Timer registers

This section describes the Generic Timer registers.

I1.3.1 CNTACR<n>, Counter-timer Access Control Registers, n = 0 - 7

The CNTACR<n> characteristics are:

Purpose

Provides top-level access controls for the elements of a timer frame. CNTACR<n> provides the controls for frame CNTBaseN.

In addition to the CNTACR<n> control:

- CNTNSAR controls whether CNTACR<n> is accessible from Non-secure state.
- If frame CNTELOBaseN is implemented, the CNTELOACR in frame CNTBaseN provides additional control of accesses to frame CNTELOBaseN.

This register is part of the Generic Timer registers functional group.

Usage constraints

This register is accessible as shown below:

Default
RW

In a system that implements both Secure and Non-secure states:

- This register is always accessible in Secure state.
- CNTNSAR.NS<n> determines whether CNTACR<n> is accessible in Non-secure state.

Configurations

Implemented only if CNTTIDR.FI<n> is RAO.

An implementation of the counters might not provide configurable access to some or all of the features. In this case, the associated field in the CNTACR<n> register is:

- RAZ/WI if access is always denied.
- RAO/WI if access is always permitted.

Attributes

CNTACR<n> is a 32-bit register.

The CNTACR<n> bit assignments are:

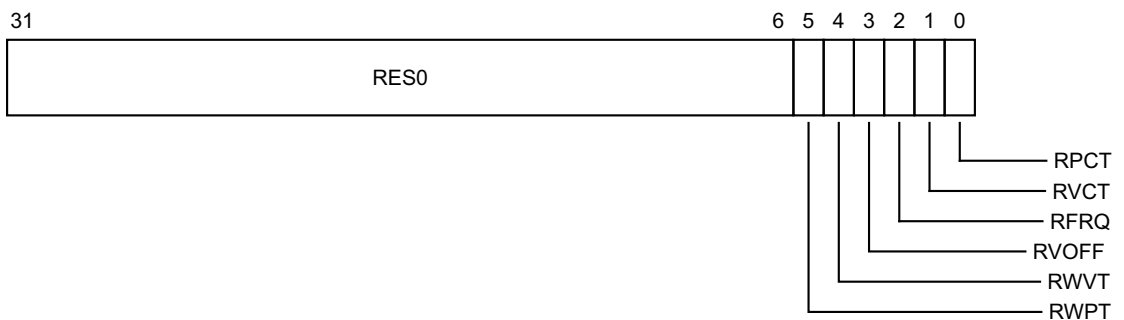

Bits [31:6]

Reserved, RES0.

RWPT, bit [5]

Read/write access to the EL1 Physical Timer registers [CNTP_CVAL](#), [CNTP_TVAL](#), and [CNTP_CTL](#), in frame <n>. The possible values of this bit are:

- 0 No access to the EL1 Physical Timer registers in frame <n>. The registers are RES0.
- 1 Read/write access to the EL1 Physical Timer registers in frame <n>.

RWVT, bit [4]

Read/write access to the Virtual Timer register [CNTV_CVAL](#), [CNTV_TVAL](#), and [CNTV_CTL](#), in frame <n>. The possible values of this bit are:

- 0 No access to the Virtual Timer registers in frame <n>. The registers are RES0.
- 1 Read/write access to the Virtual Timer registers in frame <n>.

RVOFF, bit [3]

Read-only access to [CNTVOFF](#), in frame <n>. The possible values of this bit are:

- 0 No access to [CNTVOFF](#) in frame <n>. The register is RES0.
- 1 Read-only access to [CNTVOFF](#) in frame <n>.

RFRQ, bit [2]

Read-only access to [CNTFRQ](#), in frame <n>. The possible values of this bit are:

- 0 No access to [CNTFRQ](#) in frame <n>. The register is RES0.
- 1 Read-only access to [CNTFRQ](#) in frame <n>.

RVCT, bit [1]

Read-only access to [CNTVCT](#), in frame <n>. The possible values of this bit are:

- 0 No access to [CNTVCT](#) in frame <n>. The register is RES0.
- 1 Read-only access to [CNTVCT](#) in frame <n>.

RPCT, bit [0]

Read-only access to [CNTPCT](#), in frame <n>. The possible values of this bit are:

- 0 No access to [CNTPCT](#) in frame <n>. The register is RES0.
- 1 Read-only access to [CNTPCT](#) in frame <n>.

Accessing the CNTACR<n>:

CNTACR<n> can be accessed through the internal memory-mapped interface:

Component	Frame	Offset
Timer	CNTCTLBase	0x040 + 4n

I1.3.2 CNTCR, Counter Control Register

The CNTCR characteristics are:

Purpose

Enables the counter, controls the counter frequency setting, and controls counter behavior during debug.

This register is part of the Generic Timer registers functional group.

Usage constraints

This register is accessible as shown below:

Default

RW

In a system that implements both Secure and Non-secure states, this register is only writable in Secure state.

Configurations

There are no configuration notes.

Attributes

CNTCR is a 32-bit register.

The CNTCR bit assignments are:

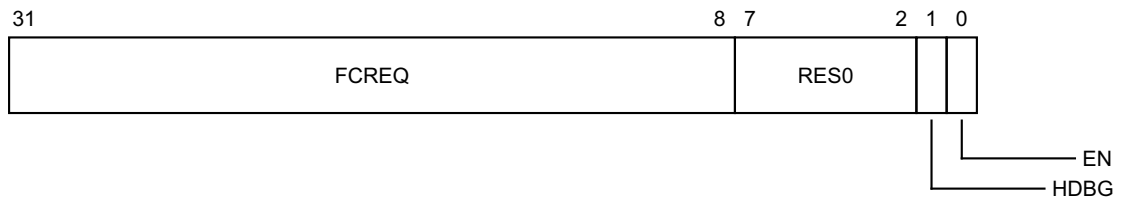

FCREQ, bits [31:8]

Frequency change request. Indicates the number of the entry in the frequency table to select. Selecting an unimplemented entry, or the 0 entry (base frequency) has no effect on the counter. Resets to 0.

Bits [7:2]

Reserved, RES0.

HDBG, bit [1]

Halt-on-debug. Controls whether a Halt-on-debug signal halts the system counter:

0 System counter ignores Halt-on-debug.

1 Asserted Halt-on-debug signal halts system counter update.

Reset value is architecturally UNKNOWN.

EN, bit [0]

Enables the counter:

0 System counter disabled.

1 System counter enabled.

Resets to 0.

Accessing the CNTCR:

CNTCR can be accessed through the internal memory-mapped interface:

Component	Frame	Offset
Timer	CNTControlBase	0x000

I1.3.3 CNTCV, Counter Count Value register

The CNTCV characteristics are:

Purpose

Indicates the current count value.

This register is part of the Generic Timer registers functional group.

Usage constraints

This register is accessible as shown below:

Default

RW in CNTControlBase, RO in CNTReadBase

Configurations

There are no configuration notes.

Attributes

CNTCV is a 64-bit register.

The CNTCV bit assignments are:

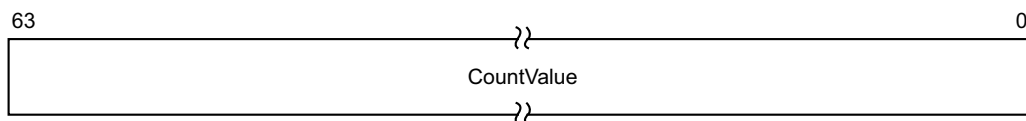

CountValue, bits [63:0]

Indicates the counter value.

Accessing the CNTCV:

CNTCV[31:0] can be accessed through the internal memory-mapped interface:

Component	Frame	Offset
Timer	CNTControlBase	0x008
Timer	CNTReadBase	0x000

CNTCV[63:32] can be accessed through the internal memory-mapped interface:

Component	Frame	Offset
Timer	CNTControlBase	0x00C
Timer	CNTReadBase	0x004

11.3.4 CNTELOACR, Counter-timer EL0 Access Control Register

The CNTELOACR characteristics are:

Purpose

An implementation of CNTELOACR in the frame at CNTBaseN controls whether the [CNTPCT](#), [CNTVCT](#), [CNTFRQ](#), EL1 Physical Timer, and Virtual Timer registers are visible in the frame at CNTELOBaseN.

This register is part of the Generic Timer registers functional group.

Usage constraints

This register is accessible as shown below:

Default

RW

Configurations

CNTELOACR is optional to implement in the external register interface.

In each implemented CNTBaseN frame, CNTELOACR is optional. If it is not implemented:

- Its location is RAZ/WI.
- The registers it controls are not visible in the corresponding CNTELOBaseN frame.

Attributes

CNTELOACR is a 32-bit register.

The CNTELOACR bit assignments are:

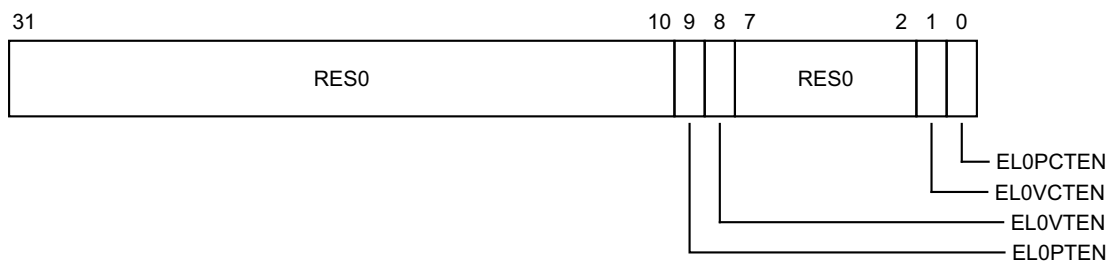

Bits [31:10]

Reserved, RES0.

EL0PTEN, bit [9]

Second view read/write access control for the EL1 Physical Timer registers. This bit controls whether the [CNTP_CVAL](#), [CNTP_TVAL](#), and [CNTP_CTL](#) registers in the current CNTBaseN frame are also accessible in the corresponding CNTELOBaseN frame. The possible values of this bit are:

- 0 No access. Registers are RES0 in the second view.
- 1 Access permitted. If the registers are accessible in the current frame then they are accessible in the second view.

EL0VTEN, bit [8]

Second view read/write access control for the Virtual Timer registers. This bit controls whether the [CNTV_CVAL](#), [CNTV_TVAL](#), and [CNTV_CTL](#) registers in the current CNTBaseN frame are also accessible in the corresponding CNTELOBaseN frame. The possible values of this bit are:

- 0 No access. Registers are RES0 in the second view.
- 1 Access permitted. If the registers are accessible in the current frame then they are accessible in the second view.

The definition of this bit means that, if the Virtual Timer registers are not implemented in the current CNTBaseN frame, then the Virtual Timer register addresses are RES0 in the corresponding CNTELOBaseN frame, regardless of the value of this bit.

Bits [7:2]

Reserved, RES0.

EL0VCTEN, bit [1]

Second view read access control for [CNTVCT](#) and [CNTFRQ](#). The possible values of this bit are:

- 0 [CNTVCT](#) is not visible in the second view.
If EL0PCTEN is set to 0, [CNTFRQ](#) is not visible in the second view.
- 1 Access permitted. If [CNTVCT](#) and [CNTFRQ](#) are visible in the current frame then they are visible in the second view.

EL0PCTEN, bit [0]

Second view read access control for [CNTPCT](#) and [CNTFRQ](#). The possible values of this bit are:

- 0 [CNTPCT](#) is not visible in the second view.
If EL0VCTEN is set to 0, [CNTFRQ](#) is not visible in the second view.
- 1 Access permitted. If [CNTPCT](#) and [CNTFRQ](#) are visible in the current frame then they are visible in the second view.

Accessing the CNTELOACR:

CNTELOACR can be accessed through the internal memory-mapped interface:

Component	Frame	Offset
Timer	CNTBaseN	0x014

11.3.5 CNTFID0, Counter Frequency ID

The CNTFID0 characteristics are:

Purpose

Indicates the base frequency of the system counter.

This register is part of the Generic Timer registers functional group.

Usage constraints

This register is accessible as shown below:

Default

RO or RW

Configurations

The possible frequencies for the system counter are stored as 32-bit words starting with the base frequency, CNTFID0.

A 32-bit word of zero value after the final frequency mode entry marks the end of the frequency modes table.

Typically, the frequency modes table will be in read-only memory. However, a system implementation might use read/write memory for the table, and initialise the table entries as part of its start-up sequence.

If the frequency modes table is in read/write memory, ARM strongly recommends that the frequency modes table is not updated once the system is running.

Attributes

CNTFID0 is a 32-bit register.

The CNTFID0 bit assignments are:

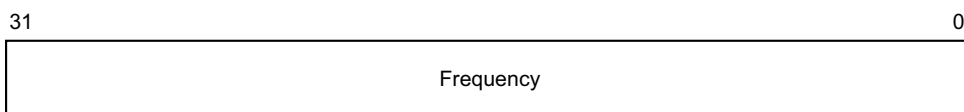

Frequency, bits [31:0]

The base frequency of the system counter, in Hz.

Accessing the CNTFID0:

CNTFID0 can be accessed through the internal memory-mapped interface:

Component	Frame	Offset
Timer	CNTControlBase	0x020

I1.3.6 CNTFID<n>, Counter Frequency IDs, n = 1 - 23

The CNTFID<n> characteristics are:

Purpose

Indicates alternative system counter update frequencies.

This register is part of the Generic Timer registers functional group.

Usage constraints

This register is accessible as shown below:

Default

RO or RW

Configurations

CNTFID<n> is optional to implement in the external register interface.

The possible frequencies for the system counter are stored as 32-bit words starting with the base frequency, CNTFID0.

A 32-bit word of zero value after the final frequency mode entry marks the end of the frequency modes table. The only required entry in the table is the entry for CNTFID0.

Typically, the frequency modes table will be in read-only memory. However, a system implementation might use read/write memory for the table, and initialise the table entries as part of its start-up sequence.

If the frequency modes table is in read/write memory, ARM strongly recommends that the frequency modes table is not updated once the system is running.

Attributes

CNTFID<n> is a 32-bit register.

The CNTFID<n> bit assignments are:

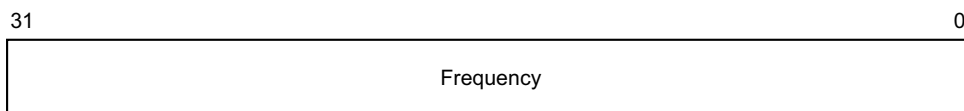

Frequency, bits [31:0]

A system counter update frequency, in Hz. Must be an exact divisor of the base frequency. ARM strongly recommends that all frequency values in the table are integer power-of-two divisors of the base frequency.

When the system timer is operating at a lower frequency than the base frequency, the increment applied at each counter update is given by:

$$\text{increment} = (\text{base frequency}) / \text{selected frequency}$$

Accessing the CNTFID<n>:

CNTFID<n> can be accessed through the internal memory-mapped interface:

Component	Frame	Offset
Timer	CNTControlBase	0x020 + 4n

11.3.7 CNTFRQ, Counter-timer Frequency

The CNTFRQ characteristics are:

Purpose

Holds the clock frequency of the system counter.

This register is part of the Generic Timer registers functional group.

Usage constraints

This register is accessible as shown below:

Default
RO

In a system that implements both Secure and Non-secure states, this register is only accessible in Secure state.

Configurations

CNTFRQ is architecturally mapped to AArch64 register [CNTFRQ_ELO](#).

CNTFRQ is architecturally mapped to AArch32 register [CNTFRQ](#).

Attributes

CNTFRQ is a 32-bit register.

The CNTFRQ bit assignments are:

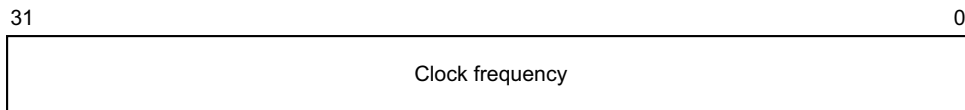

Bits [31:0]

Clock frequency. Indicates the system counter clock frequency, in Hz.

Accessing the CNTFRQ:

CNTFRQ can be accessed through the internal memory-mapped interface:

Component	Frame	Offset
Timer	CNTBaseN	0x010
Timer	CNTELOBaseN	0x010
Timer	CNTCTLBase	0x000

11.3.8 CNTNSAR, Counter-timer Non-secure Access Register

The CNTNSAR characteristics are:

Purpose

Provides the highest-level control of whether frames CNTBaseN and CNTEL0BaseN are accessible by Non-secure accesses.

This register is part of the Generic Timer registers functional group.

Usage constraints

This register is accessible as shown below:

Default
RW

In a system that implements both Secure and Non-secure states, this register is only accessible in Secure state.

Configurations

There are no configuration notes.

Attributes

CNTNSAR is a 32-bit register.

The CNTNSAR bit assignments are:

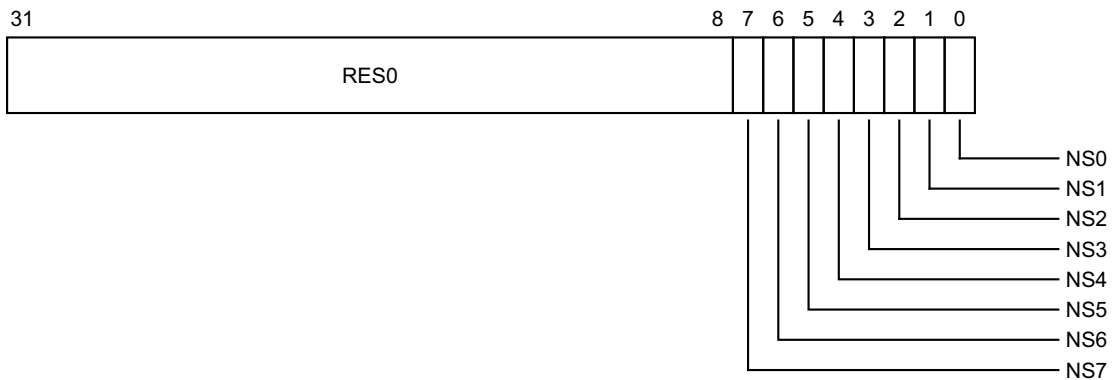

Bits [31:8]

Reserved, RES0.

NS<n>, bit [n], for n = 0 to 7

Non-secure access to frame n. The possible values of this bit are:

- 0 Secure access only. Behaves as RES0 to Non-secure accesses.
- 1 Secure and Non-secure accesses permitted.

If frame CNTBase<n>:

- Is not implemented, then NS<n> is RES0.
- Is not Configurable access, and is accessible only by Secure accesses, then NS<n> is RES0.
- Is not Configurable access, and is accessible only by Non-secure accesses, then NS<n> is RES1.

Accessing the CNTNSAR:

CNTNSAR can be accessed through the internal memory-mapped interface:

Component	Frame	Offset
Timer	CNTCTLBase	0x004

I1.3.9 CNTP_CTL, Counter-timer Physical Timer Control

The CNTP_CTL characteristics are:

Purpose

Control register for the physical timer.

This register is part of the Generic Timer registers functional group.

Usage constraints

This register is accessible as shown below:

Default
RW

[CNTACR<n>](#).RWPT enables access to this register in frame <n>.

Configurations

CNTP_CTL is architecturally mapped to AArch64 register [CNTP_CTL_ELO](#).

CNTP_CTL is architecturally mapped to AArch32 register [CNTP_CTL](#).

Attributes

CNTP_CTL is a 32-bit register.

The CNTP_CTL bit assignments are:

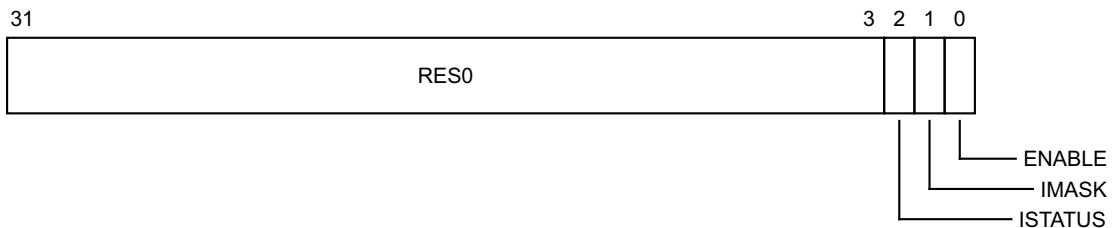

Bits [31:3]

Reserved, RES0.

ISTATUS, bit [2]

The status of the timer interrupt:

0 Interrupt not asserted.

1 Interrupt asserted.

This bit is read-only.

A register write that sets IMASK to 1 latches this bit to reflect the status of the interrupt immediately before that write.

IMASK, bit [1]

Timer interrupt mask bit. Permitted values are:

0 Timer interrupt is not masked.

1 Timer interrupt is masked.

ENABLE, bit [0]

Enables the timer. Permitted values are:

0 Timer disabled.

1 Timer enabled.

Disabling the timer masks the timer interrupt, but the timer value continues to count down.

Accessing the CNTP_CTL:

CNTP_CTL can be accessed through the internal memory-mapped interface:

Component	Frame	Offset
Timer	CNTBaseN	0x02C
Timer	CNTELOBaseN	0x02C

I1.3.10 CNTP_CVAL, Counter-timer Physical Timer CompareValue

The CNTP_CVAL characteristics are:

Purpose

Holds the 64-bit compare value for the EL1 physical timer.
 This register is part of the Generic Timer registers functional group.

Usage constraints

This register is accessible as shown below:

Default
RW

[CNTACR<n>](#).RWPT enables access to this register in frame <n>.

If the implementation supports 64-bit atomic accesses, then the CNTP_CVAL register must be accessible as an atomic 64-bit value.

Configurations

CNTP_CVAL is architecturally mapped to AArch64 register [CNTP_CVAL_EL0](#).

CNTP_CVAL is architecturally mapped to AArch32 register [CNTP_CVAL](#).

Attributes

CNTP_CVAL is a 64-bit register.

The CNTP_CVAL bit assignments are:

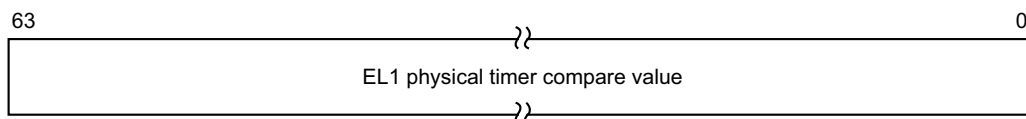

Bits [63:0]

EL1 physical timer compare value.

Accessing the CNTP_CVAL:

CNTP_CVAL[31:0] can be accessed through the internal memory-mapped interface:

Component	Frame	Offset
Timer	CNTBaseN	0x020
Timer	CNTEL0BaseN	0x020

CNTP_CVAL[63:32] can be accessed through the internal memory-mapped interface:

Component	Frame	Offset
Timer	CNTBaseN	0x024
Timer	CNTEL0BaseN	0x024

I1.3.11 CNTP_TVAL, Counter-timer Physical Timer TimerValue

The CNTP_TVAL characteristics are:

Purpose

Holds the timer value for the EL1 physical timer. This provides a 32-bit downcounter.
 This register is part of the Generic Timer registers functional group.

Usage constraints

This register is accessible as shown below:

Default
RW

[CNTACR<n>](#).RWPT enables access to this register in frame <n>.

Configurations

CNTP_TVAL is architecturally mapped to AArch64 register [CNTP_TVAL_ELO](#).

CNTP_TVAL is architecturally mapped to AArch32 register [CNTP_TVAL](#).

Attributes

CNTP_TVAL is a 32-bit register.

The CNTP_TVAL bit assignments are:

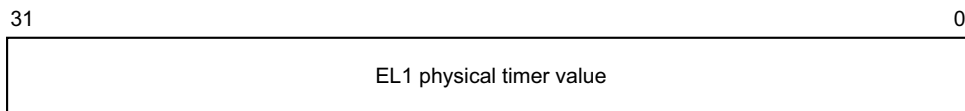

Bits [31:0]

EL1 physical timer value.

Accessing the CNTP_TVAL:

CNTP_TVAL can be accessed through the internal memory-mapped interface:

Component	Frame	Offset
Timer	CNTBaseN	0x028
Timer	CNTELOBaseN	0x028

I1.3.12 CNTPCT, Counter-timer Physical Count

The CNTPCT characteristics are:

Purpose

Holds the 64-bit physical count value.

This register is part of the Generic Timer registers functional group.

Usage constraints

This register is accessible as shown below:

Default
RO

[CNTACR<n>.RPCT](#) enables access to this register in frame <n>.

If the implementation supports 64-bit atomic accesses, then the CNTPCT register must be accessible as an atomic 64-bit value.

Configurations

CNTPCT is architecturally mapped to AArch64 register [CNTPCT_EL0](#).

CNTPCT is architecturally mapped to AArch32 register [CNTPCT](#).

Attributes

CNTPCT is a 64-bit register.

The CNTPCT bit assignments are:

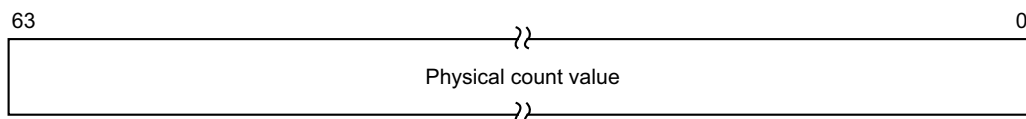

Bits [63:0]

Physical count value.

Accessing the CNTPCT:

CNTPCT[31:0] can be accessed through the internal memory-mapped interface:

Component	Frame	Offset
Timer	CNTBaseN	0x000
Timer	CNTELOBaseN	0x000

CNTPCT[63:32] can be accessed through the internal memory-mapped interface:

Component	Frame	Offset
Timer	CNTBaseN	0x004
Timer	CNTELOBaseN	0x004

11.3.13 CNTSR, Counter Status Register

The CNTSR characteristics are:

Purpose

Provides counter frequency status information.
 This register is part of the Generic Timer registers functional group.

Usage constraints

This register is accessible as shown below:

Default
RO

Configurations

There are no configuration notes.

Attributes

CNTSR is a 32-bit register.

The CNTSR bit assignments are:

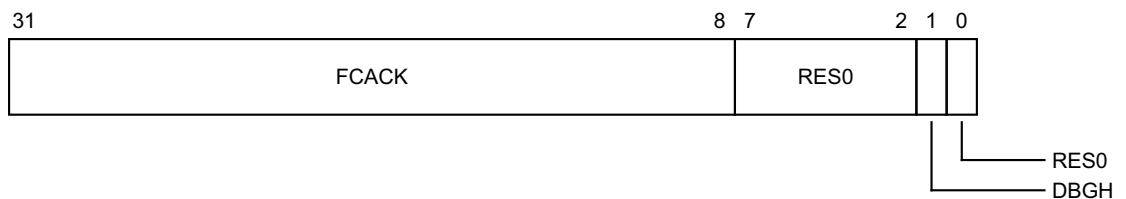

FCACK, bits [31:8]

Frequency change acknowledge. Indicates the currently selected entry in the frequency table.
 Selecting an unimplemented entry, or the 0 entry (base frequency) has no effect on the counter.
 Resets to 0.

Bits [7:2]

Reserved, RES0.

DBGH, bit [1]

Indicates whether the counter is halted because the Halt-on-Debug signal is asserted:

- 0 Counter is not halted.
- 1 Counter is halted.

Reset value is architecturally UNKNOWN.

Bit [0]

Reserved, RES0.

Accessing the CNTSR:

CNTSR can be accessed through the internal memory-mapped interface:

Component	Frame	Offset
Timer	CNTControlBase	0x004

11.3.14 CNTTIDR, Counter-timer Timer ID Register

The CNTTIDR characteristics are:

Purpose

Indicates the implemented timers in the memory map, and their features. For each value of N from 0 to 7 it indicates whether:

- Frame CNTBaseN is a view of an implemented timer.
- Frame CNTBaseN has a second view, CNTEL0BaseN.
- Frame CNTBaseN has a virtual timer capability.

This register is part of the Generic Timer registers functional group.

Usage constraints

This register is accessible as shown below:

Default

RO

Configurations

There are no configuration notes.

Attributes

CNTTIDR is a 32-bit register.

The CNTTIDR bit assignments are:

31	28 27	24 23	20 19	16 15	12 11	8 7	4 3	0
Frame7	Frame6	Frame5	Frame4	Frame3	Frame2	Frame1	Frame0	

Frame<n>, bits [4n+3:4n], for n = 0 to 7

A 4-bit field indicating the features of frame CNTBase<n>.

Bit[3] of the field is RES0.

Bit[2] indicates whether frame CNTBase<n> has a second view, CNTEL0Base<n>. The possible values of this bit are:

Bit[2]	Meaning
0	Frame <n> does not have a second view. CNTEL0Base<n> is RES0.
1	Frame <n> has a second view, CNTEL0Base<n>.

If bit[0] is 0, bit[2] is RES0.

Bit[1] indicates whether both:

- Frame CNTBase<n> implements the virtual timer registers CNTV_CVAL, CNTV_TVAL, and CNTV_CTL.
- This CNTCTLBase frame implements the virtual timer offset register CNTVOFF<n>.

The possible values of bit[1] are:

Bit[1]	Meaning
0	Frame <n> does not have virtual capability. The virtual time and offset registers are RES0.
1	Frame <n> has virtual capability. The virtual time and offset registers are implemented.

If bit[0] is 0, bit[1] is RES0.

Bit[0] indicates whether frame <n> is implemented. The possible values of this bit are:

Bit[0]	Meaning
0	Frame <n> not implemented. All registers associated with the frame are RES0.
1	Frame <n> is implemented.

Accessing the CNTTIDR:

CNTTIDR can be accessed through the internal memory-mapped interface:

Component	Frame	Offset
Timer	CNTCTLBase	0x008

11.3.15 CNTV_CTL, Counter-timer Virtual Timer Control

The CNTV_CTL characteristics are:

Purpose

Control register for the virtual timer.

This register is part of the Generic Timer registers functional group.

Usage constraints

This register is accessible as shown below:

Default

RW

Bit [1] of [CNTTIDR.Frame<n>](#) indicates whether CNTV_CTL is implemented for frame <n>.

If CNTV_CTL is implemented, [CNTACR<n>.RWVT](#) enables access to the register in frame <n>.

If CNTV_CTL is not implemented, the register location is RAZ/WI.

Configurations

CNTV_CTL is architecturally mapped to AArch64 register [CNTV_CTL_EL0](#).

CNTV_CTL is architecturally mapped to AArch32 register [CNTV_CTL](#).

CNTV_CTL is optional to implement in the external register interface.

Attributes

CNTV_CTL is a 32-bit register.

The CNTV_CTL bit assignments are:

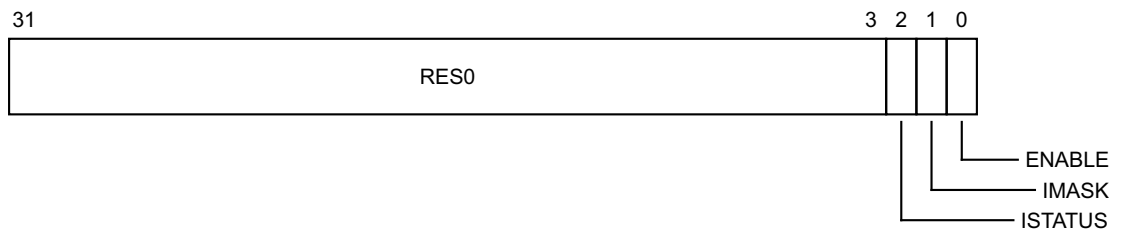

Bits [31:3]

Reserved, RES0.

ISTATUS, bit [2]

The status of the timer interrupt:

0 Interrupt not asserted.

1 Interrupt asserted.

This bit is read-only.

A register write that sets IMASK to 1 latches this bit to reflect the status of the interrupt immediately before that write.

IMASK, bit [1]

Timer interrupt mask bit. Permitted values are:

0 Timer interrupt is not masked.

1 Timer interrupt is masked.

ENABLE, bit [0]

Enables the timer. Permitted values are:

- 0 Timer disabled.
- 1 Timer enabled.

Disabling the timer masks the timer interrupt, but the timer value continues to count down.

Accessing the CNTV_CTL:

CNTV_CTL can be accessed through the internal memory-mapped interface:

Component	Frame	Offset
Timer	CNTBaseN	0x03C
Timer	CNTELOBaseN	0x03C

I1.3.16 CNTV_CVAL, Counter-timer Virtual Timer CompareValue

The CNTV_CVAL characteristics are:

Purpose

Holds the 64-bit compare value for the virtual timer.

This register is part of the Generic Timer registers functional group.

Usage constraints

This register is accessible as shown below:

Default

RW

Bit [1] of [CNTTIDR.Frame<n>](#) indicates whether CNTV_CVAL is implemented for frame <n>.

If CNTV_CVAL is implemented, [CNTACR<n>.RWVT](#) enables access to the register in frame <n>.

If CNTV_CVAL is not implemented, the register location is RAZ/WI.

If the implementation supports 64-bit atomic accesses, then the CNTV_CVAL register must be accessible as an atomic 64-bit value.

Configurations

CNTV_CVAL is architecturally mapped to AArch64 register [CNTV_CVAL_EL0](#).

CNTV_CVAL is architecturally mapped to AArch32 register [CNTV_CVAL](#).

CNTV_CVAL is optional to implement in the external register interface.

Attributes

CNTV_CVAL is a 64-bit register.

The CNTV_CVAL bit assignments are:

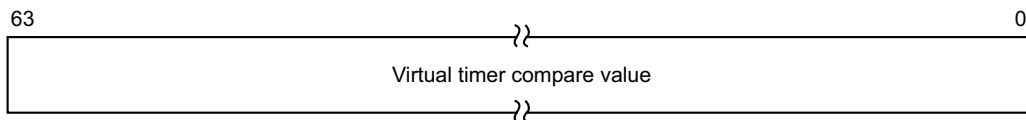

Bits [63:0]

Virtual timer compare value.

Accessing the CNTV_CVAL:

CNTV_CVAL[31:0] can be accessed through the internal memory-mapped interface:

Component	Frame	Offset
Timer	CNTBaseN	0x030
Timer	CNTELOBaseN	0x030

CNTV_CVAL[63:32] can be accessed through the internal memory-mapped interface:

Component	Frame	Offset
Timer	CNTBaseN	0x034
Timer	CNTELOBaseN	0x034

11.3.17 CNTV_TVAL, Counter-timer Virtual Timer TimerValue

The CNTV_TVAL characteristics are:

Purpose

Holds the timer value for the virtual timer.

This register is part of the Generic Timer registers functional group.

Usage constraints

This register is accessible as shown below:

Default
RW

Bit [1] of [CNTTIDR](#).Frame<n> indicates whether CNTV_TVAL is implemented for frame <n>. If CNTV_TVAL is implemented, [CNTACR](#)<n>.RWVT enables access to the register in frame <n>. If CNTV_TVAL is not implemented, the register location is RAZ/WI.

Configurations

CNTV_TVAL is architecturally mapped to AArch64 register [CNTV_TVAL_EL0](#).

CNTV_TVAL is architecturally mapped to AArch32 register [CNTV_TVAL](#).

CNTV_TVAL is optional to implement in the external register interface.

Attributes

CNTV_TVAL is a 32-bit register.

The CNTV_TVAL bit assignments are:

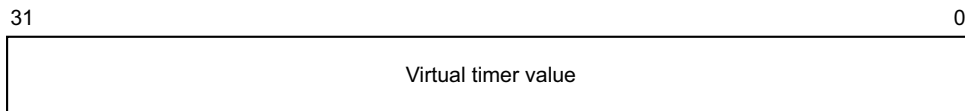

Bits [31:0]

Virtual timer value.

Accessing the CNTV_TVAL:

CNTV_TVAL can be accessed through the internal memory-mapped interface:

Component	Frame	Offset
Timer	CNTBaseN	0x038
Timer	CNTELOBaseN	0x038

I1.3.18 CNTVCT, Counter-timer Virtual Count

The CNTVCT characteristics are:

Purpose

Holds the 64-bit virtual count value.

This register is part of the Generic Timer registers functional group.

Usage constraints

This register is accessible as shown below:

Default
RO

[CNTACR<n>.RVCT](#) enables access to this register in frame <n>.

If the implementation supports 64-bit atomic accesses, then the [CNTPCT](#) register must be accessible as an atomic 64-bit value.

Configurations

CNTVCT is architecturally mapped to AArch64 register [CNTVCT_EL0](#).

CNTVCT is architecturally mapped to AArch32 register [CNTVCT](#).

Attributes

CNTVCT is a 64-bit register.

The CNTVCT bit assignments are:

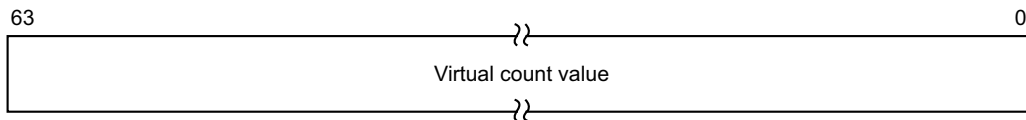

Bits [63:0]

Virtual count value.

Accessing the CNTVCT:

CNTVCT[31:0] can be accessed through the internal memory-mapped interface:

Component	Frame	Offset
Timer	CNTBaseN	0x008
Timer	CNTELOBaseN	0x008

CNTVCT[63:32] can be accessed through the internal memory-mapped interface:

Component	Frame	Offset
Timer	CNTBaseN	0x00C
Timer	CNTELOBaseN	0x00C

11.3.19 CNTVOFF, Counter-timer Virtual Offset

The CNTVOFF characteristics are:

Purpose

Holds the 64-bit virtual offset.

This register is part of the Generic Timer registers functional group.

Usage constraints

This register is accessible as shown below:

Default

RO

If the implementation supports 64-bit atomic accesses, then the CNTVOFF register must be accessible as an atomic 64-bit value.

Configurations

CNTVOFF is architecturally mapped to AArch64 register [CNTVOFF_EL2](#).

CNTVOFF is architecturally mapped to AArch32 register [CNTVOFF](#).

[CNTACR<n>.RVOFF](#) enables access to this register for frame CNTBase<n>.

Attributes

CNTVOFF is a 64-bit register.

The CNTVOFF bit assignments are:

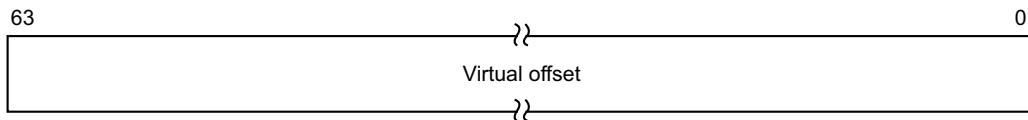

Bits [63:0]

Virtual offset.

Accessing the CNTVOFF:

CNTVOFF[31:0] can be accessed through the internal memory-mapped interface:

Component	Frame	Offset
Timer	CNTBaseN	0x018

CNTVOFF[63:32] can be accessed through the internal memory-mapped interface:

Component	Frame	Offset
Timer	CNTBaseN	0x01C

11.3.20 CNTVOFF<n>, Counter-timer Virtual Offsets, n = 0 - 7

The CNTVOFF<n> characteristics are:

Purpose

Holds the 64-bit virtual offset for frame CNTBase<n>.

This register is part of the Generic Timer registers functional group.

Usage constraints

This register is accessible as shown below:

Default
RW

If the implementation supports 64-bit atomic accesses, then the CNTVOFF<n> registers must be accessible as atomic 64-bit values.

Configurations

CNTVOFF<n> is architecturally mapped to AArch64 register [CNTVOFF_EL2](#).

CNTVOFF<n> is architecturally mapped to AArch32 register [CNTVOFF](#).

CNTVOFF<n> is optional to implement in the external register interface.

CNTVOFF<n> is accessible in the CNTCTLBase register map if [CNTACR<n>.RVOFF](#) is 1 and bit [1] of [CNTTIDR.Frame<n>](#) is 1.

If bit [1] of [CNTTIDR.Frame<n>](#) is 0, or [CNTACR<n>.RVOFF](#) is 1, CNTVOFF<n> is RAZ/WI.

Attributes

CNTVOFF<n> is a 64-bit register.

The CNTVOFF<n> bit assignments are:

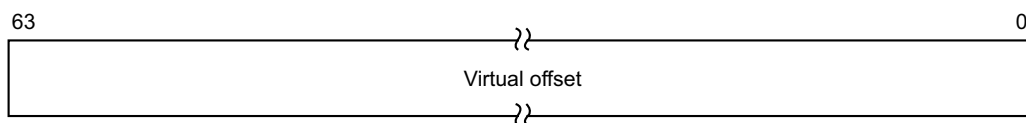

Bits [63:0]

Virtual offset.

Accessing the CNTVOFF<n>:

CNTVOFF<n>[31:0] can be accessed through the internal memory-mapped interface:

Component	Frame	Offset
Timer	CNTCTLBase	0x080 + 8n

CNTVOFF<n>[63:32] can be accessed through the internal memory-mapped interface:

Component	Frame	Offset
Timer	CNTCTLBase	0x084 + 8n

11.3.21 CounterID<n>, Counter ID registers, n = 0 - 11

The CounterID<n> characteristics are:

Purpose

IMPLEMENTATION DEFINED identification registers 0 to 11 for the memory-mapped Generic Timer.
This register is part of the Generic Timer registers functional group.

Usage constraints

This register is accessible as shown below:

Default

RO

Configurations

These registers are implemented independently in each of the frames accessed through the different memory maps.

If the implementation of the Counter ID registers requires an architecture version, the value for this version of the ARM Generic Timer is version 0.

The Counter ID registers can be implemented as a set of CoreSight ID registers, comprising Peripheral ID Registers and Component ID Registers. An implementation of these registers for the Generic Timer must use a Component class value of 0xF.

Attributes

CounterID<n> is a 32-bit register.

The CounterID<n> bit assignments are:



Accessing the CounterID<n>:

CounterID<n> can be accessed through the internal memory-mapped interface:

Component	Frame	Offset
Timer	CNTControlBase	0xFD0 + 4n
Timer	CNTReadBase	0xFD0 + 4n
Timer	CNTBaseN	0xFD0 + 4n
Timer	CNTELOBaseN	0xFD0 + 4n
Timer	CNTCTLBase	0xFD0 + 4n

Chapter I2

System Level Implementation of the Generic Timer

This chapter defines the system level implementation of the optional Generic Timer. It contains the following sections:

- *About the Generic Timer specification* on page I2-4680.
- *Memory-mapped counter module* on page I2-4681.
- *Counter module control and status register summary* on page I2-4684.
- *About the memory-mapped view of the counter and timer* on page I2-4686.
- *The CNTBaseN and CNTPL0BaseN frames* on page I2-4687.
- *The CNTCTLBase frame* on page I2-4689.
- *Providing a complete set of counter and timer features* on page I2-4690.
- *Gray-count scheme for timer distribution scheme* on page I2-4692.

Note

- *Generic Timer registers* on page I1-4647 describes the System level Generic Timer registers. These registers are memory-mapped.
 - *Chapter D7 The Generic Timer* gives a general description of the Generic Timer, and describes the system control register interface to the Generic Timer.
-

I2.1 About the Generic Timer specification

[Chapter D7 The Generic Timer](#) describes the ARM Generic Timer, and its implementation as an optional extension to an ARMv8 processor implementation. [Chapter D7](#) includes the definition of the low-latency System register interface to the Generic Timer Extension. However, the ARM Generic Timer architecture requires the implementation of some parts of the timer at the system level. This system level implementation includes a memory-mapped interface to the timer that:

- Provides some top-level management of the Generic Timer, that is not available from the System register interface from any PE in the system.
- Provides memory-mapped access to Generic Timer features, for system components that cannot implement a System register interface to the timer. The latency of this memory-mapped access can be significantly higher than the latency of System register accesses.

The Generic Timer architecture defines both a counter and a timer. The counter and timer work in combination, but each has a distinct purpose:

- The counter counts the passing of time.
- The timer schedules the triggering of events.

See [About the Generic Timer on page D7-1856](#) for more information about the timer and the counter. [Generic Timer example on page D7-1856](#) shows a system-wide implementation of the Generic Timer.

Most of this chapter describes the system level implementation of the Generic Timer. [Gray-count scheme for timer distribution scheme on page I2-4692](#) describes a possible scheme for distributing the counter value across this system.

I2.1.1 The memory-mapped view of the Generic Timer

The memory-mapped view of the Generic Timer provides:

- Access to the system level features of the Generic Timer:
 - [Memory-mapped counter module on page I2-4681](#) describes these features.
 - [Counter module control and status register summary on page I2-4684](#) describes the memory-mapped interface to those features.
- Memory-mapped access to the Generic Timer features defined in [Chapter D7 The Generic Timer](#). This provides memory-mapped access to different views of the system control registers described in that chapter. [About the memory-mapped view of the counter and timer on page I2-4686](#) describes this access.

I2.2 Memory-mapped counter module

The memory-mapped counter module provides top-level control of the system counter. It provides:

- A RW control register [CNTCR](#), that provides:
 - An enable bit for the system counter.
 - An enable bit for Halt-on-Debug. When this is enabled, if the debug halt signal into the system counter is asserted, it halts the system counter. Otherwise, the system counter ignores the state of this halt signal. For more information about Halt-on-Debug, contact ARM.
 - A field that can be written to request a change to the update frequency of the system counter, with a corresponding change to the increment made at each update. For more information see [Control of counter operating frequency and increment on page I2-4682](#).

Writes to this register are rare. In a system that uses security, this register is writable only by Secure writes.

- A RO status register, [CNTSR](#), that provides:
 - A bit that indicates whether the system counter is halted because of an asserted Halt-on-Debug signal.
 - A field that indicates the current update frequency of the system counter. This field can be polled to determine when a requested change to the update frequency has been made.
- Two contiguous RW registers that hold the current system counter value, [CNTCV](#). If the system supports 64-bit atomic accesses, these two registers must be accessible by such accesses.

The system counter must be disabled before writing to these registers, otherwise the effect of the write is UNPREDICTABLE.

Writes to these registers are rare. In a system that uses security, these registers are writable only by Secure writes.

- A table of one or more 32-bit entries, where:
 - The first entry defines the *base frequency* of the system counter. This is the maximum frequency at which the counter updates.
 - Each subsequent entry defines an alternative frequency of the system counter, and must be an exact divisor of the base frequency.

A 32-bit zero entry immediately follows the last table entry.

This table can be WO or RW. For more information, see [The frequency modes table on page I2-4682](#).

- Two contiguous RO registers that hold the current system counter value, [CNTCV](#). If the system supports 64-bit atomic accesses, these two registers must be accessible by such accesses.

These registers are located in two memory *frames*, identified by different base addresses:

- The locations of the RO copies of [CNTCV](#) are defined relative to the CNTReadBase base address.
- The locations of all the other registers are defined relative to the CNTControlBase base address.

———— **Note** —————

The final twelve words of the first or only 4KB block of a register memory frame is an ID block.

[Counter module control and status register summary on page I2-4684](#) describes CNTReadBase and CNTControlBase memory maps, and the registers in each frame.

I2.2.1 Control of counter operating frequency and increment

The system counter has a fixed *base frequency*, and must maintain the required counter accuracy, meaning ARM recommends that it does not gain or lose more than ten seconds in a 24-hour period, see [System counter on page D7-1857](#). However, the counter can increment at a lower frequency than the base frequency, using a correspondingly larger increment. For example, it can increment by four at a quarter of the base frequency. Any lower-frequency operation, and any switching between operating frequencies, must not reduce the accuracy of the counter.

Control of the system counter frequency and increment is provided only through the memory-mapped counter module. The following sections describe this control:

- [The frequency modes table](#)
- [Changing the system counter and increment](#).

The frequency modes table

The frequency modes table starts at offset 0x20 from CNTControlBase.

Table entries are 32-bits, and each entry specifies a system counter update frequency, in Hz.

The first entry in the table specifies the base frequency of the system counter.

To ensure overall counter accuracy is maintained, any subsequent entries in the table must be exact divisors of the base frequency. That is, ARM strongly recommends that all frequency values in the table are integer power-of-two divisors of the base frequency.

When the system timer is operating at a lower frequency than the base frequency, the increment applied at each counter update is given by:

$$\text{increment} = (\text{base_frequency}) / (\text{selected_frequency})$$

A 32-bit word of zero value marks the end of the table. That is, the word of memory immediately after the last entry in the table must be zero.

The only required entry in the table is the entry for the base frequency.

Typically, the frequency modes table are in RO memory. However, a system implementation might use RW memory for the table, and initialize the table entries as part of its startup sequence. Therefore, the CNTControlBase memory map shows the table region as RO or RW.

ARM strongly recommends that the frequency modes table is not updated once the system is running.

The architecture can support up to 1004 entries in the frequency modes table, and the maximum number of entries is IMPLEMENTATION DEFINED, up to this limit.

———— **Note** —————

ARM considers it unlikely that implementations will require significantly fewer entries than the architectural limit.

Changing the system counter and increment

The CNTCR.FREQ field defines which frequency modes table entry specifies the system counter update frequency. The value in the FCREQ specifies the entry.

Changing the value of CNTCR.FREQ requests a change to the system counter update frequency. To ensure the frequency change does not affect the overall accuracy of the counter, it is made as follows:

- When changing from a higher frequency to a lower frequency, the counter:
 1. Continues running at the higher frequency until the count reaches an integer multiple of the required lower frequency.
 2. Switches to operating at the lower frequency.
- When changing from a lower frequency to a higher frequency, the counter:
 1. Waits until the end of the current lower-frequency cycle.

2. Makes the counter increment required for operation at that lower frequency.
3. Switches to operating at the higher frequency.

When the frequency has changed, **CNTSR** is updated to indicate the new frequency. Therefore, a system component that is waiting for a frequency change can poll **CNTSR** to detect the change.

I2.3 Counter module control and status register summary

The Counter module control and status registers are memory-mapped registers in the following register memory frames:

- A control frame, with base address CNTControlBase.
- A status frame, with base address CNTReadBase.

Each of these register memory frames is at least 4KB in size, or is at least the size of the memory protection granule if this granule size is larger than 4KB. Similarly, each base address must be aligned to 4KB, or to the memory protection granule if that is larger than 4KB.

———— **Note** —————

The memory protection granule is either 4KB or 64KB.

In each register memory frame, the memory at offset 0xFD0-0xFFF is reserved for twelve 32-bit IMPLEMENTATION DEFINED ID registers, see the [CounterID<n>](#) register descriptions for more information.

The counter is assumed to be little-endian.

In an implementation that supports Secure and Non-secure memory spaces, CNTControlBase is implemented only in the Secure memory space.

[Table I2-1](#) shows the CNTControlBase control registers, in order of their offsets from CNTControlBase. [Generic Timer registers on page I1-4647](#) describes each of these registers.

Table I2-1 CNTControlBase memory map

Offset	Name	Type	Description
0x000	CNTCR	RW	Counter Control Register.
0x004	CNTSR	RO	Counter Status Register.
0x008	CNTCV[31:0]	RW	Counter Count Value register.
0x00C	CNTCV[63:32]	RW	
0x010-0x01C	-	RES0	Reserved.
0x020	CNTFID0	RO or RW	Frequency modes table, and end marker.
0x020+4n	CNTFIDn	RO or RW	CNTFID0 is the base frequency, and each CNTFIDn is an alternative frequency. For more information see The frequency modes table on page I2-4682 .
0x024+4n	-	RO or RW	
(0x024+4n)-0x0BC	-	RES0	Reserved.
0x0C0-0x0FC	-	IMPLEMENTATION DEFINED	Reserved for IMPLEMENTATION DEFINED registers.
0x100-0xFCC	-	RES0	Reserved.
0xFD0-0xFFC	CounterID<n>	RO	Counter ID registers 0-11.

Table I2-2 shows the CNTReadBase control registers, in order of their offsets from CNTReadBase. *Generic Timer registers* on page I1-4647 describes each of these registers.

Table I2-2 CNTReadBase memory map

Offset	Name	Type	Description
0x000	CNTCV[31:0]	RO	Counter Count Value register
0x004	CNTCV[63:32]	RO	
0x008-0xFCC	-	RES0	Reserved
0xFD0-0xFFC	CounterID<n>	RO	Counter ID registers 0-11

I2.4 About the memory-mapped view of the counter and timer

To provide the Generic Timer functionality to any programmable system components that cannot implement a coprocessor interface to the Generic Timer, the Generic Timer specification defines a memory-mapped component that can be placed close to such a component. ARM recommends that the system implementation includes an instance of this memory-mapped structure for each system component requiring memory-mapped access to the Generic Timer.

The memory map consists of up to 8 timer *frames*. Each timer frame:

- Provides its own set of timers and associated interrupts.
- Is in its own memory protection region that is:
 - In its own memory protection region, with a system-defined size of 4KB or 64KB.
 - At a start address that is aligned to 4KB.

———— **Note** —————

The 4KB alignment requirement applies regardless of the memory protection region size.

The base address of a frame is $CNTBaseN$, where N numbers from 0 up to a maximum permitted value of 7.

The system provides a second view of each implemented $CNTBaseN$ frame. The base address of the second view of the $CNTBaseN$ frame is $CNTPL0BaseN$, and in this view:

- All registers visible in $CNTBaseN$ are visible, except for [CNTVOFF](#) and [CNTELOACR](#).
- The offsets of all visible registers are the same as their offsets in the $CNTBaseN$ frame.

In addition, the system provides a control frame at base address $CNTCTLBase$.

The memory protection region and alignment requirements for the $CNTPL0BaseN$ and $CNTCTLBase$ frames are the same as the requirements for the $CNTBaseN$ frames.

The system defines the position of each frame in the memory map. This means the values of each of the $CNTBaseN$, $CNTPL0BaseN$, and $CNTCTLBase$ base addresses is IMPLEMENTATION DEFINED.

The memory-mapped timers are assumed to be little-endian.

The following sections describe the implementation of a memory-mapped view of the counter and timer:

- [The \$CNTBaseN\$ and \$CNTPL0BaseN\$ frames on page I2-4687.](#)
- [The \$CNTCTLBase\$ frame on page I2-4689.](#)
- [Providing a complete set of counter and timer features on page I2-4690.](#)

12.5 The CNTBaseN and CNTPL0BaseN frames

Table I2-3 shows the CNTBaseN registers, in order of their offsets from CNTBaseN. Whether a frame includes a virtual timer is IMPLEMENTATION DEFINED. If it does not then memory at offsets 0x030-0x03C is RAZ/WI. Except for CNTELOACR and the CounterID<n> registers, these registers are also implemented in the system control register interface to the Generic Timer.

Generic Timer registers on page I1-4647 describes each of these registers.

Table I2-3 CNTBaseN memory map

Offset	Register, VMSA	Type	Description
0x000	CNTPCT[31:0] ^a	RO	Physical Count register
0x004	CNTPCT[63:32] ^a	RO	
0x008	CNTVCT[31:0] ^a	RO	Virtual Count register
0x00C	CNTVCT[63:32] ^a	RO	
0x010	CNTRFQ ^a	RO ^b	Counter Frequency register
0x014	CNTELOACR	RW ^c	Counter EL0 Access Control Register, optional in the CNTBaseN memory map
0x018	CNTVOFF[31:0] ^a	RO ^d	Virtual Offset register, if implementation includes EL2
0x01C	CNTVOFF[63:32] ^a	RO ^d	
0x020	CNTP_CVAL[31:0] ^a	RW	EL1 Physical Timer CompareValue register
0x024	CNTP_CVAL[63:32] ^a	RW	
0x028	CNTP_TVAL ^a	RW	EL1 Physical TimerValue register
0x02C	CNTP_CTL ^a	RW	EL1 Physical Timer Control register
0x030	CNTV_CVAL[31:0] ^a	RW ^c	Virtual Timer CompareValue register, optional in the CNTBaseN memory map
0x034	CNTV_CVAL[63:32] ^a	RW ^c	
0x038	CNTV_TVAL ^a	RW ^c	Virtual TimerValue register, optional in the CNTBaseN memory map
0x03C	CNTV_CTL ^a	RW ^c	Virtual Timer Control register, optional in the CNTBaseN memory map
0x040-0x0FC	-	RES0	Reserved
0xFD0-0xFFC	CounterID<n>	RO	Counter ID registers 0-11

a. These registers are also defined in the System register interface to the Generic Timer, and therefore are also described in *Generic Timer registers* on page D8-2170 and *Generic Timer registers* on page G4-4208. The bit assignments of the registers are identical in the System register interface and in the memory-mapped system level interface.

b. But must be writable for initial configuration.

c. Address is reserved, RAZ/WI if register not implemented

d. The CNTCTLBase frame includes a RW view of this register.

For any value of N, the layout of the registers in the frame at CNTPL0BaseN is identical to that at CNTBaseN, except that:

- CNTVOFF is not visible, and the memory at 0x018-0x01C is RAZ/WI.
- CNTELOACR is never visible, and the memory at 0x014 is always RAZ/WI.

- If implemented in the frame at CNTBaseN, CNTELOACR controls whether CNTPCT, CNTVCT, CNTFRQ, the EL1 Physical Timer, and the Virtual Timer registers are visible in the frame at CNTPL0BaseN. If CNTELOACR is not implemented then these registers are not visible in the frame at CNTPL0BaseN, and their addresses are RAZ/WI.
- If CNTFRQ is visible it is always RO. That is, it is not RW for initial configuration.

If an implementation supports 64-bit atomic accesses, then CNTPCT, CNTVCT, CNTVOFF, CNTP_CVAL, and CNTV_CVAL must be accessible as atomic 64-bit values.

I2.6 The CNTCTLBase frame

The CNTCTLBase frame contains an identification register for the features of the memory-mapped counter and timer implementation, access controls for each CNTBase N frame, and a virtual offset register for frames that implement a virtual timer. Table I2-4 shows the CNTCTLBase registers, in order of their offsets from CNTCTLBase. The CNTFRQ and CNTVOFF registers are also implemented in the Secure system control register interface to the Generic Timer.

Generic Timer registers on page I1-4647 describes each of these registers.

Table I2-4 CNTCTLBase memory map

Offset	Register	Type	Security	Description
0x000	CNTFRQ ^a	RW	Secure	Counter Frequency register.
0x004	CNTNSAR	RW	Secure	Counter Non-Secure Access Register.
0x008	CNTTIDR	RO	Both	Counter Timer ID Register.
0x00C- 0x03F	-	RES0	-	Reserved.
0x040+4 N ^b	CNTACR< n >	RW	Configurable ^c	Counter Access Control Register N .
0x060- 0x07F	-	RES0	-	Reserved.
0x080+8 N ^b	CNTVOFF< n >[31:0] ^a	RW ^d	Configurable ^c	Virtual Offset register, if implementation includes EL2. Optional in the CNTCTLBase memory map
0x084+8 N ^b	CNTVOFF< n >[63:32] ^a	RW ^d		
0x0C0- 0xFCF	-	RES0	-	Reserved.
0xFD0- 0xFFC	CounterID< n >	RO	Both	Counter ID registers 0-11.

- These registers are also defined in the Secure System registers interface to the Generic Timer, and therefore are also described in *Generic Timer registers on page D8-2170* and *Generic Timer registers on page G4-4208*. The bit assignments of the registers are identical in the System registers interface and in the memory-mapped system level interface.
- Implemented for each value of N from 0 to 7.
- The CNTNSAR determines the Non-secure accessibility of the CNTACR< n >s and the CNTVOFF< n >s in the CNTCTLBase frame. For more information, see the register descriptions.
- Address is reserved, RAZ/WI if register not implemented.

I2.7 Providing a complete set of counter and timer features

Using the general model for implementing a memory-mapped interface to the Generic Timer described in this section, the feature set of a System registers counter and timer, in an implementation that includes EL2 and EL3, can be implemented using the following set of timer frames:

- A CNTCTLBase control frame.
- The following CNTBase N timer frames:
 - Frame 0** Accessible from Non-secure state, with second view and virtual capability. This provide the Non-secure EL1&0 timers.
 - Frame 1** Accessible from Non-secure state, with no second view and no virtual capability. This provide the Non-secure EL2 timers.
 - Frame 2** Accessible only Secure state, with a second view but no virtual capability. This provide the Secure EL1&0 timers.

In this implementation, the full set of implemented frames, and their configuration in the memory map, is as follows:

CNTCTLBase

The control frame. This frame is located in both Secure and Non-secure physical memory, and:

- In the Secure EL1&0 translation regime, this frame is accessible only at EL1.
- In the Non-secure EL2 translation regime, this frame is accessible.
- In the Non-secure EL1&0 translation regime, this frame is not accessible.

CNTBase0 The first view of the Non-secure EL1&0 timers. This frame is located only in Non-secure physical memory, and:

- In the Secure EL1&0 translation regime, this frame is accessible only at EL1.
- In the Non-secure EL2 translation regime, this frame is accessible.
- In the Non-secure EL1&0 translation regime, this frame is accessible only at EL1.

CNTPL0Base0

The second view of CNTBase0, meaning it is the EL0 view of the Non-secure EL1&0 timers. This frame is located only in Non-secure physical memory, and:

- In the Secure EL1&0 translation regime, this frame can be accessible at EL1, or at EL1 and EL0, but this is not required.
- In the Non-secure EL2 translation regime, this frame is accessible.
- In the Non-secure EL1&0 translation regime, this frame is accessible at EL1 and EL0.

CNTBase1 The first and only view of the Non-secure EL2 timers. This frame is located only in Non-secure physical memory, and:

- In the Secure EL1&0 translation regime, this frame is accessible only at EL1.
- In the Non-secure EL2 translation regime, this frame is accessible.
- In the Non-secure EL1&0 translation regime, this frame is not accessible.

CNTBase2 The first view of the Secure EL1&0 timers. This frame is located only in Secure physical memory, and:

- In the Secure EL1&0 translation regime, this frame is accessible only at EL1.
- Because the frame is in Secure memory, it is not accessible in any Non-secure translation regime.

CNTPL0Base2

The second view of CNTBase2, meaning it is the EL0 view of the Secure EL1&0 timers. This frame is located only in Secure physical memory, and:

- In the Secure EL1&0 translation regime, this frame is accessible at EL1 and EL0.
- Because the frame is in Secure memory, it is not accessible in any Non-secure translation regime.

———— **Note** —————

[About VMSAv8-32 on page G3-3562](#) describes the translation regimes.

I2.8 Gray-count scheme for timer distribution scheme

The distribution of the Counter value using a Gray-code provides a relatively simple mechanism to avoid any danger of the count being sampled with an intermediate value even if the clocking is asynchronous. It has a further advantage that the distribution is relatively low power, since only one bit changes on the main distribution wires for each clock tick.

A suitable Gray-coding scheme can be achieved with the following logic:

$$\text{Gray}[N] = \text{Count}[N]$$

$$\text{Gray}[i] = (\text{XOR}(\text{Gray}[N:i+1])) \text{ XOR } \text{Count}[i] \text{ for } N-1 \geq i \geq 0$$

$$\text{Count}[i] = \text{XOR}(\text{Gray}[N:i]) \text{ for } N \geq i \geq 0$$

This is for an N+1 bit counter, where Count is a conventional binary count value, and Gray is the corresponding Gray count value.

———— **Note** —————

This scheme has the advantage of being relatively simple to switch, in either direction, between operating with low-frequency and low-precision, and operating with high-frequency and high-precision. To achieve this, the ratio of the frequencies must be 2^n , where n is an integer. A switch-over can occur only on the $2n+1$ boundary to avoid losing the Gray-coding property on a switch-over.

Chapter I3

Recommended Memory-mapped Interfaces to the Performance Monitors

This chapter describes the recommended memory-mapped and external debug interfaces to the Performance Monitors. It contains the following section:

- [About the memory-mapped views of the Performance Monitors registers on page I3-4694.](#)

———— **Note** —————

[Performance Monitors registers on page I1-4599](#) describes the memory-mapped registers for the Performance Monitors.

—————

I3.1 About the memory-mapped views of the Performance Monitors registers

An implementation can provide:

- Memory-mapped access to the Performance Monitors registers. Software running on any processor in a system can use this interface to access counters in the Performance Monitors.
- Access to the Performance Monitors registers through an external debug interface. A debugger can use this interface to access counters in the Performance Monitors.

ARM recommends that any external debug interface is implemented as defined in the *ARM Debug Interface v5 Architecture Specification*.

An external debug interface provides a memory-mapped view of the Performance Monitors registers.

The following sections describe the memory-mapped views of the Performance Monitors registers:

- [Differences in the memory-mapped views of the Performance Monitors registers](#).
- [Synchronization of changes to the memory-mapped views](#).
- [Performance Monitors memory-mapped register views](#).
- [Access permissions for memory-mapped views of the Performance Monitors on page I3-4695](#).

In this appendix, unless the context explicitly indicates otherwise, any reference to a *memory-mapped view* applies equally to a register view using:

- A access through an external debug interface.
- A memory-mapped access.

I3.1.1 Differences in the memory-mapped views of the Performance Monitors registers

A memory-mapped view of the Performance Monitors registers accesses the same registers as the System registers interface described in [Performance Monitors Extension registers on page D6-1851](#), except that:

1. The **PMSELR** is accessible only in the System registers interface.
2. The **PMCFGR**, **PMLAR**, **PMLSR**, **PMAUTHSTATUS**, **PMDEVTYPE**, **PMPIDR0**, **PMPIDR1**, **PMPIDR2**, **PMPIDR3**, **PMPIDR4**, **PMCIDR0**, **PMCIDR1**, **PMCIDR2** and **PMCIDR3** registers are accessible only in memory-mapped views. [Performance Monitors registers on page I1-4599](#) describes these registers.
3. The following controls do not affect the memory-mapped view:
 - **PMSELR**.
 - **PMUSERENR**.
 - **HDCR**.{TPM, TPMCR, HPMN}.

Instead, see the register descriptions in [Chapter I1 Memory-Mapped System Register Descriptions](#).

I3.1.2 Synchronization of changes to the memory-mapped views

If a Performance Monitor is visible in both system register and a memory-mapped views, and is accessed simultaneously through these two mechanisms, the behavior must be as if the access occurred atomically in any order. For more information, see [Synchronization of changes to the external debug registers on page H8-4445](#).

I3.1.3 Performance Monitors memory-mapped register views

[Table I3-1 on page I3-4695](#) shows the memory-mapped view of the Performance Monitors registers. All other entries are reserved.

———— **Note** —————

- Counters that are reserved because **HDCR.HPMN** has been changed from its reset value remain visible in any memory-mapped view.

- The registers that relate to an implemented event counter, PMN_x, are [PMEVCNTR<n>](#) and [PMEVTYPER<n>](#).

Table I3-1 Performance Monitors memory-mapped register views

Offset	Type	Name	Description
0x000+8xn	RW	PMEVCNTR<n>_EL0^a	Performance Monitors Event Counter Register.
0x0F8-0x0FC	RW	PMCCNTR_EL0[31:0]^{aP} MCCNTR_EL0[63:32]^a	Performance Monitors Cycle Counter Register ^b
0x400+4xn	RW	PMEVTYPER<n>_EL0^a	Performance Monitors Event Type and Filter Register.
0x47C	RW	PMCCFILTR_EL0^a	Performance Monitors Cycle Counter Filter Register
0x600-0x6FC	-	-	IMPLEMENTATION DEFINED
0xA00-0xBFC	-	-	IMPLEMENTATION DEFINED
0xC00	RW	PMCNTENSET_EL0^a	Performance Monitors Count Enable Set register
0xC20	RW	PMCNTENCLR_EL0^a	Performance Monitors Count Enable Clear register
0xC40	RW	PMINTENSET_EL1^a	Performance Monitors Interrupt Enable Set register
0xC60	RW	PMINTENCLR_EL1^a	Performance Monitors Interrupt Enable Clear register
0xC80	RW	PMOVSCLR_EL0^a	Performance Monitors Overflow Flag Status Clear register
0xCA0	WO	PMSWINC_EL0^a	Performance Monitors Software Increment register
0xCC0	RW	PMOVSSET_EL0^a	Performance Monitors Overflow Flag Status Set register
0xD80-0xDFC	-	-	IMPLEMENTATION DEFINED
0xE00	RO	PMCFGR^c	Performance Monitors Configuration Register
0xE04	RW	PMCR_EL0^a	Performance Monitors Control Register
0xE20	RO	PMCEID0_EL0^a	Performance Monitors Common Event Identification register 0
0xE24	RO	PMCEID1_EL0^a	Performance Monitors Common Event Identification register 1
0xE80-0xEFC	-	-	IMPLEMENTATION DEFINED
0xF00-0xFFC	-	-	<i>Management registers and CoreSight compliance on page AppxB-4782</i>

- These registers are also defined in the System registers interface to the Performance Monitors.
- The interface must support at least single-copy atomic 32-bit accesses. If single-copy atomic 64-bit access to the registers is not possible, software must use a high-low-high read access to read the counter value if the counter is enabled.
- These registers are defined only in the memory-mapped views of the Performance Monitors.

13.1.4 Access permissions for memory-mapped views of the Performance Monitors

For more information, see [External debug interface register access permissions on page H8-4451](#).

[Table I3-2 on page I3-4696](#) shows the access permissions for the Performance Monitors registers in a v8 Debug implementation. This table uses the following terms:

DLK When the OS Double Lock is locked, `EDPRSR.DLK == 1`, accesses to some registers produce an error. Applies to both interfaces.

- EPMAD** When AllowExternalPMUAccess() == FALSE, external debug access is disabled. See also *Behavior of a not permitted memory-mapped access* on page H8-4450.
- Error** Indicates that the access gives an error response.
- Default** This shows the default access permissions, if none of the conditions in this list prevent access to the register.
- Off** When EDPRSR.PU == 0, the Core power domain is completely off, or in a low-power state where the Core power domain registers cannot be accessed.
- **Note** —————
- If debug power is off, then all external debug interface accesses return an error.
-
- OSLK** When the OS Lock is locked, OSLAR_EL1.OSLK == 1, accesses to some registers produces an error. This column shows the effect of this control on accesses using the external debug interface.
- SLK** This indicates the modified default access permissions for OPTIONAL memory-mapped accesses to the external debug interface if the OPTIONAL Software lock is locked. See *Register access permissions for memory-mapped accesses* on page H8-4449.
- For all other accesses, this column is ignored.
- Indicates that the control has no effect on the behavior of the access:
- If no other control affects the behavior, the Default access behavior applies.
 - However, another control might determine the behavior.

Table I3-2 Access permissions for the Performance Monitors registers

Offset	Register	Domain	Off	DLK	OSLK	EPMAD	Default	SLK
0x000+8xn	PMEVCNTR<n>_EL0 ^a	Core	Error	Error	Error	Error	RW	RO
0x0F8	PMCCNTR_EL0[31:0]	Core	Error	Error	Error	Error	RW	RO
0x0FC	PMCCNTR_EL0[63:32]	Core	Error	Error	Error	Error	RW	RO
0x400+4xn	PMEVTPER<n>_EL0 ^a	Core	Error	Error	Error	Error	RW	RO
0x47C	PMCCFILTR_EL0	Core	Error	Error	Error	Error	RW	RO
0x600-0x6FC	-	-	Access is IMPLEMENTATION DEFINED					
0xA00-0xBFC	-	-	Access is IMPLEMENTATION DEFINED					
0xC00	PMCNTENSET_EL0	Core	Error	Error	Error	Error	RW	RO
0xC20	PMCNTENCLR_EL0	Core	Error	Error	Error	Error	RW	RO
0xC40	PMINTENSET_EL1	Core	Error	Error	Error	Error	RW	RO
0xC60	PMINTENCLR_EL1	Core	Error	Error	Error	Error	RW	RO
0xC80	PMOVSLR_EL0	Core	Error	Error	Error	Error	RW	RO
0xCA0	PMSWINC_EL0 ^b	Core	Error	Error	Error	Error	WO	WI
0xCC0	PMOVSSSET_EL0	Core	Error	Error	Error	Error	RW	RO
0xD80-0xDFC	-	-	Access is IMPLEMENTATION DEFINED					
0xE00	PMCFGR	Core	Error	Error	Error	Error	RO	RO
0xE04	PMCR_EL0	Core	Error	Error	Error	Error	RW	RO

Table I3-2 Access permissions for the Performance Monitors registers (continued)

Offset	Register	Domain	Off	DLK	OSLK	EPMAD	Default	SLK
0xE20	PMCEID0_EL0	Core	Error	Error	Error	Error	RO	RO
0xE24	PMCEID1_EL0	Core	Error	Error	Error	Error	RO	RO
0xE80-0xEFC	Integration registers	-	Access is IMPLEMENTATION DEFINED					
0xF00-0xFFC	Management registers and CoreSight compliance on page AppxB-4782							

- a. Implemented counters only. *n* is the counter number.
- b. Only if the OPTIONAL PMSWINC_EL0 register is implemented in the external debug interface.

13.1.5 Power domains and Performance Monitors registers reset

For ARMv8-A implementations, ARM recommends that Performance Monitors are implemented as part of the core power domain, not as part of a separate debug power domain. There is no interface to access the Performance Monitors registers when the core power domain is powered down.

A Warm or Cold reset sets the Performance Monitors registers to their reset values. An External Debug reset does not change the values of the Performance Monitors registers.

For more information about the reset scheme recommended for a v8 Debug implementation see [Chapter H6 Debug Reset and Powerdown Support](#).

[Table I3-3](#) shows the Performance Monitors register resets for writable register fields. The column headings use the following terms:

- 64** This is the architectural reset value when resetting into AArch64 state.
- 32** This is the architectural reset value when resetting into AArch32 state.
- This indicates an IMPLEMENTATION DEFINED reset value on the specified reset. This might be UNKNOWN.

———— **Note** —————

This table does not include:

- Read-only identification registers and fields that have a fixed value. In this case, the reset value is that fixed value. An example of this is [PMCR_EL0.N](#).
- Write-only registers and fields that only have an effect on writes. These do not have a reset value. An example of this is [PMSWINC_EL0](#).
- IMPLEMENTATION DEFINED registers. In this case, the reset domains are IMPLEMENTATION DEFINED. The reset values are IMPLEMENTATION DEFINED and might be UNKNOWN.

Table I3-3 Performance Monitors system register resets

Register	Domain	Field	64	32	Description
PMCR_EL0	Warm	DP	-	0	Disable PMCCNTR_EL0 when prohibited
		X	-	0	Export enable
		D	-	0	Clock divider
		E	0	0	Performance Monitors enable

Table I3-3 Performance Monitors system register resets (continued)

Register	Domain	Field	64	32	Description
PMCNTENSET_ELO PMCNTENCLR_ELO	Warm	-	-	-	All fields in register
PMOVSSSET_ELO PMOVSSCLR_ELO	Warm	-	-	-	All fields in register
PMSELR_ELO	Warm	SEL	-	-	Selected event counter
PMCCNTR_ELO	Warm	-	-	-	All fields in register
PMEVTPER<n>_ELO	Warm	-	-	-	All fields in register
PMCCFILTR_ELO	Warm	[31:26]	-	0x00	PMCCNTR_ELO filtering controls
PMEVCNTR<n>_ELO	Warm	-	-	-	All fields in register
PMUSERENR_ELO	Warm	ER	-	0	Enable counter read access in ELO
		CR	-	0	Enable PMCCNTR_ELO read access in ELO
		SW	-	0	Enable PMSWINC_ELO write access in ELO
		EN	-	0	Enable Performance Monitors access in ELO
PMINTENSET_EL1 PMINTENCLR_EL1	Warm	-	-	-	All fields in register

Part J

Appendixes

Appendix A

Architectural Constraints on UNPREDICTABLE behaviors

This chapter describes the architectural constraints on UNPREDICTABLE behaviors in the ARMv8 architecture. It contains the following sections:

- [AArch32 CONSTRAINED UNPREDICTABLE behaviors on page AppxA-4702.](#)
- [Constraints on AArch64 state UNPREDICTABLE behaviors on page AppxA-4765.](#)

A.1 AArch32 CONSTRAINED UNPREDICTABLE behaviors

ARMv8 defines architecturally-required constraints on many behaviors that are UNPREDICTABLE in ARMv7. The following sections define those constraints:

- [Overview of the constraints on ARMv7 UNPREDICTABLE behaviors.](#)
- [CONSTRAINED UNPREDICTABLE behavior for A32 and T32 instructions.](#)
- [CONSTRAINED UNPREDICTABLE behavior, A32 and T32 system instructions on page AppxA-4753.](#)
- [CONSTRAINED UNPREDICTABLE behavior in Debug state on page AppxA-4759.](#)
- [Using R13 on page AppxA-4759.](#)
- [Using R15 on page AppxA-4760.](#)
- [SBZ or SBO fields in instructions on page AppxA-4760.](#)
- [CONSTRAINED UNPREDICTABLE behavior in an IT block on page AppxA-4761.](#)
- [Branching into an IT block on page AppxA-4762.](#)
- [Syndrome register handling for CONSTRAINED UNPREDICTABLE instructions treated as UNDEFINED on page AppxA-4762.](#)
- [Unallocated values in register fields of CP14 and CP 15 registers and translation table entries on page AppxA-4762.](#)
- [Unallocated CP14 and CP15 instructions on page AppxA-4763.](#)
- [Loads and Stores to unaligned locations on page AppxA-4763.](#)
- [Branching to an unaligned PC on page AppxA-4763.](#)
- [Unpredictable CPACR and NSACR settings on page AppxA-4763.](#)
- [Instruction fetches from Device memory on page AppxA-4764.](#)
- [Multi-access instructions that load the PC from Device memory on page AppxA-4764.](#)
- [Out of range virtual address on page AppxA-4764.](#)
- [Translation Table Base Address alignment on page AppxA-4764.](#)

A.1.1 Overview of the constraints on ARMv7 UNPREDICTABLE behaviors

The term UNPREDICTABLE describes a number of cases where the architecture has a feature that software must not use. For execution in AArch32 state, where previous versions of the architecture define behavior as UNPREDICTABLE, the ARMv8-A architecture specifies a narrow range of permitted behaviors. This range is the range of CONSTRAINED UNPREDICTABLE behavior. All implementations that are compliant with the architecture must follow the CONSTRAINED UNPREDICTABLE behavior.

———— **Note** —————

Software designed to be compatible with the ARMv8-A architecture must not rely on these CONSTRAINED UNPREDICTABLE cases being handled in any way other than those listed under the heading CONSTRAINED UNPREDICTABLE.

A.1.2 CONSTRAINED UNPREDICTABLE behavior for A32 and T32 instructions

This section lists the CONSTRAINED UNPREDICTABLE behavior for the different A32 and T32 instructions listed in [Alphabetical list of T32 and A32 base instruction set instructions on page F7-2534](#) and [Alphabetical list of floating-point and Advanced SIMD instructions on page F8-3076](#).

BFC

For a description of these instructions and the encodings, see [BFC on page F7-2568](#).

CONSTRAINED UNPREDICTABLE behavior

If $msbit < 1sbit$, then one of the following behaviors can occur:

- The instruction is UNDEFINED.
- The instruction executes as a NOP.

- The output value is the registers in UNKNOWN.

BFI

For a description of these instructions and the encodings, see [BFI on page F7-2569](#).

CONSTRAINED UNPREDICTABLE behavior

If $msbit < 1sbit$, then one of the following behaviors can occur:

- The instruction is UNDEFINED.
- The instruction executes as a NOP.
- The output value is the registers in UNKNOWN.

BKPT

For a description of this instruction and the encoding, see [BKPT on page F7-2575](#).

CONSTRAINED UNPREDICTABLE behavior

For the A1 encoding:

- If $cond \neq '1110'$, then one of the following behaviors can occur:
 - The instruction is UNDEFINED.
 - The instruction executes as a NOP.
 - The instruction executes unconditionally.
 - The instruction executes conditionally.

CLZ

For a description of this instruction and the encoding, see [CLZ on page F7-2585](#).

CONSTRAINED UNPREDICTABLE behavior

For the T1 encoding:

- If $!consistent(Rm)$, then one of the following behaviors can occur:
 - The instruction is UNDEFINED.
 - The instruction executes as a NOP.
 - The register specified by $hw1[3:0]$ is used as the source register.
 - The register specified by $hw2[3:0]$ is used as the source register.
 - The value in the destination register is UNKNOWN.

CMP (register)

For a description of this instruction and the encoding, see [CMP \(register\) on page F7-2590](#).

CONSTRAINED UNPREDICTABLE behavior

For the T2 encoding:

- If $n < 8$ && $m < 8$, then one of the following behaviors can occur:
 - The instruction is UNDEFINED.
 - The instruction executes as a NOP.
 - The instruction performs the comparison between Rn and Rm .
 - The condition flags become UNKNOWN.

CRC32, CRC32C

For a description of this instruction and the encoding, see [CRC32, CRC32C](#) on page F7-2594.

CONSTRAINED UNPREDICTABLE behavior

If `size == 64`, then one of the following behaviors can occur:

- The instruction is UNDEFINED.
- The instruction executes as a NOP.
- The instruction behaves as if `sz == '10'`.

For the A1 encoding:

- If `cond != '1110'`, then one of the following behaviors can occur:
 - The instruction is UNDEFINED.
 - The instruction executes as a NOP.
 - The instruction is executed unconditionally.
 - The instruction is executed conditionally.

HLT

For a description of this instruction and the encoding, see [HLT](#) on page F7-2608.

CONSTRAINED UNPREDICTABLE behavior

For the A1 encoding:

- If `cond != '1110'`, then one of the following behaviors can occur:
 - The instruction is UNDEFINED.
 - The instruction executes as a NOP.
 - The instruction is executed unconditionally.
 - The instruction is executed conditionally.

IT

For a description of this instruction and the encoding, see [IT](#) on page F7-2610.

CONSTRAINED UNPREDICTABLE behavior

For the T1 encoding:

- If `firstcond == '1111' || (firstcond == '1110' && BitCount(mask) != 1)` then one of the following behaviors occurs:
 - The instruction is undefined.
 - The instruction executes as a NOP.
 - `firstcond == '1111'` is treated the same as `firstcond == '1110'`, meaning the always condition, and the ITSTATE state machine is progressed in the same way as for any other `cond_base` value.

LDC/LDC2 (literal)

For a description of this instruction and the encoding, see [LDC, LDC2 \(literal\)](#) on page F7-2622.

CONSTRAINED UNPREDICTABLE behavior

If `W == '1' || (P == '0' && CurrentInstrSet() != InstrSet_ARM)`, then one of the following behaviors can occur:

- The instruction is undefined.
- The instruction executes as a NOP.
- The load instruction operates without writeback.

———— **Note** —————

This is consistent with ignoring writes to the PC.

- The instruction uses the addressing mode described in the equivalent immediate offset instruction.

LDM/LDMIA/LDMFD (T32)

For a description of this instruction and the encoding, see [LDM/LDMIA/LDMFD \(T32\)](#) on page F7-2624.

CONSTRAINED UNPREDICTABLE behavior

For the T1 encoding:

- If $\text{BitCount}(\text{registers}) < 1$, then one of the following behaviors can occur:
 - The instruction is UNDEFINED.
 - The instruction executes as a NOP.
 - The instruction operates as an LDM with the same addressing mode but targeting an unspecified set of registers. These registers might include R15.

For the T2 encoding:

- If $\text{BitCount}(\text{registers}) < 2$, then one of the following behaviors can occur:
 - The instruction is UNDEFINED.
 - The instruction executes as a NOP.
 - The instruction loads a single register using the specified addressing modes.
 - The instruction operates as an LDM with the same addressing mode but targeting an unspecified set of registers. These registers might include R15.
- If $\text{hw2}[13]$ is set to 1, then one of the following behaviors can occur:
 - The instruction is undefined.
 - The instruction executes as a NOP.
 - The instruction performs all of the loads using the specified addressing mode, but R13 is UNKNOWN.

———— **Note** —————

This is an exception to the requirements described in [SBZ or SBO fields in instructions](#) on page AppxA-4760.

- If $P == '1' \ \&\& \ M == '1'$, then one of the following behaviors can occur:
 - The instruction is undefined.
 - The instruction executes as a NOP.
 - The instruction loads the register list and either R14 or R15, both R14 and R15, or neither of these registers.
- If $\text{wback} \ \&\& \ \text{registers}\langle n \rangle == '1'$, then one of the following behaviors can occur:
 - The instruction is UNDEFINED.
 - The instruction executes as a NOP.
 - The instruction performs all of the loads using the specified addressing mode, and the content of the register being written back in UNKNOWN. In addition, if an exception occurs during such an instruction, the base address might be corrupted so that the instruction cannot be repeated.

LDM/LDMIA/LDMFD (A32)

For a description of this instruction and the encoding, see [LDM/LDMIA/LDMFD \(A32\)](#) on page F7-2626.

CONSTRAINED UNPREDICTABLE behavior

For the A1 encoding:

- If $\text{BitCount}(\text{registers}) < 1$, then one of the following behaviors can occur:
 - The instruction is UNDEFINED.
 - The instruction executes as a NOP.
 - The instruction operates as an LDM with the same addressing mode but targeting an unspecified set of registers. These registers might include R15.
- If $\text{wback} \ \&\& \ \text{registers}\langle n \rangle == '1'$, then one of the following behaviors can occur:
 - The instruction is UNDEFINED.
 - The instruction executes as a NOP.
 - The instruction performs all of the loads using the specified addressing mode, and the content of the register being written back in UNKNOWN. In addition, if an exception occurs during such an instruction, the base address might be corrupted so that the instruction cannot be repeated.

LMDMA/LDMFA

For a description of this instruction and the encoding, see [LMDMA/LDMFA on page F7-2628](#).

CONSTRAINED UNPREDICTABLE behavior

For the A1 encoding:

- If $\text{BitCount}(\text{registers}) < 1$, then one of the following behaviors can occur:
 - The instruction is undefined.
 - The instruction executes as a NOP.
 - The instruction operates as an LDM with the same addressing mode, but targeting an unspecified set of registers. These registers might include R15.
- If $\text{wback} \ \&\& \ \text{registers}\langle n \rangle == '1'$, then one of the following behaviors can occur:
 - The instruction is UNDEFINED.
 - The instruction executes as a NOP.
 - The instruction performs all of the loads using the specified addressing mode and the content of the register that is written back in UNKNOWN. In addition, if an exception occurs during such as instruction, the base address might be corrupted so that the instruction cannot be repeated.

LDMIB/LDMED

For a description of this instruction and the encoding, see [LDMIB/LDMED on page F7-2632](#).

CONSTRAINED UNPREDICTABLE behavior

For the A1 encoding:

- If $\text{BitCount}(\text{registers}) < 1$, then one of the following behaviors can occur:
 - The instruction is undefined.
 - The instruction executes as a NOP.
 - The instruction operates as an LDM with the same addressing mode, but targeting an unspecified set of registers. These registers might include R15.
- If $\text{wback} \ \&\& \ \text{registers}\langle n \rangle == '1'$, then one of the following behaviors can occur:
 - The instruction is UNDEFINED.
 - The instruction executes as a NOP.

- The instruction performs all of the loads using the specified addressing mode and the content of the register that is written back in UNKNOWN. In addition, if an exception occurs during such as instruction, the base address might be corrupted so that the instruction cannot be repeated.

LDMDB/LDMEA

For a description of this instruction and the encoding, see [LDMDB/LDMEA on page F7-2630](#).

CONSTRAINED UNPREDICTABLE behavior

For all encodings:

- If `wback && registers<n> == '1'`, then one of the following behaviors can occur:
 - The instruction is UNDEFINED.
 - The instruction executes as a NOP.
 - The instruction performs all of the loads using the specified addressing mode and the content of the register that is written back is UNKNOWN. In addition, if an exception occurs during such as instruction, the base address might be corrupted so that the instruction cannot be repeated.

For the A1 encoding:

- If `BitCount(registers) < 1`, then one of the following behaviors can occur:
 - The instruction is UNDEFINED
 - The instruction executes as a NOP.
 - The instruction operates as an LDM with the same addressing mode, but targeting an unspecified set of registers. These registers might include R15.

For the T1 encoding:

- If `BitCount(registers) < 2`, one of the following behaviors can occur:
 - The instruction is UNDEFINED.
 - The instruction executes as a NOP.
 - The instruction loads a single register using the specified addressing modes.
 - The instruction operates as an LDM with the same addressing mode, but targeting an unspecified set of registers. These registers might include R15.
- If `hw2[13]` is set to 1, then one of the following behaviors can occur:
 - The instruction is UNDEFINED.
 - The instruction executes as a NOP.
 - The instruction performs all of the loads using the specified addressing mode, but R13 is UNKNOWN.

Note

This is an exception to the requirements described in [SBZ or SBO fields in instructions on page AppxA-4760](#).

- If `P == '1' && M == '1'`, then one of the following behaviors can occur:
 - The instruction is undefined.
 - The instruction executes as a NOP.
 - The instruction loads the register list and either R14 or R15, both R14 and R15, or neither of these registers.

LDR (immediate, T32)

For a description of this instruction and the encoding, see [LDR \(immediate, T32\) on page F7-2634](#).

CONSTRAINED UNPREDICTABLE behavior

For the T4 encoding:

- If `wback && n == t`, then one of the following behaviors can occur:
 - The instruction is UNDEFINED.
 - The instruction executes as a NOP.
 - The instruction performs all the loads using the specified addressing mode and the content of the register that is written back is UNKNOWN. In addition, if an exception occurs during such as instruction, the base register might be corrupted so that the instruction cannot be repeated.

LDR (immediate, A32)

For a description of this instruction and the encoding, see [LDR \(immediate, A32\)](#) on page F7-2636.

CONSTRAINED UNPREDICTABLE behavior

For the A1 encoding:

- If `wback && n == t`, then one of the following behaviors can occur:
 - The instruction is UNDEFINED.
 - The instruction executes as a NOP.
 - The instruction performs all the loads using the specified addressing mode and the content of the register that is written back is UNKNOWN. In addition, if an exception occurs during such as instruction, the base register might be corrupted so that the instruction cannot be repeated.

LDR (register, A32)

For a description of this instruction and the encoding, see [LDR \(register, A32\)](#) on page F7-2642.

CONSTRAINED UNPREDICTABLE behavior

For the A1 encoding:

- If `wback && n == t`, then one of the following behaviors can occur:
 - The instruction is UNDEFINED.
 - The instruction executes as a NOP.
 - The instruction performs all the loads using the specified addressing mode and the content of the register that is written back is UNKNOWN. In addition, if an exception occurs during such as instruction, the base register might be corrupted so that the instruction cannot be repeated.

LDRB (immediate, T32)

For a description of this instruction and the encoding, see [LDRB \(immediate, T32\)](#) on page F7-2644.

CONSTRAINED UNPREDICTABLE behavior

For the T3 encoding:

- If `wback && n == t`, then one of the following behaviors can occur:
 - The instruction is UNDEFINED.
 - The instruction executes as a NOP.
 - The instruction performs all the loads using the specified addressing mode and the content of the register that is written back is UNKNOWN. In addition, if an exception occurs during such as instruction, the base register might be corrupted so that the instruction cannot be repeated.

LDRB (immediate, A32)

For a description of this instruction and the encoding, see [LDRB \(immediate, A32\)](#) on page F7-2646.

CONSTRAINED UNPREDICTABLE behavior

For the A1 encoding:

- If `wback && n == t`, then one of the following behaviors can occur:
 - The instruction is UNDEFINED.
 - The instruction executes as a NOP.
 - The instruction performs all the loads using the specified addressing mode and the content of the register that is written back is UNKNOWN. In addition, if an exception occurs during such as instruction, the base register might be corrupted so that the instruction cannot be repeated.

LDRB (register)

For a description of this instruction and the encoding, see [LDRB \(register\)](#) on page F7-2650.

CONSTRAINED UNPREDICTABLE behavior

For the A1 encoding:

- If `wback && n == t`, then one of the following behaviors can occur:
 - The instruction is UNDEFINED.
 - The instruction executes as a NOP.
 - The instruction performs all the loads using the specified addressing mode and the content of the register that is written back is UNKNOWN. In addition, if an exception occurs during such as instruction, the base register might be corrupted so that the instruction cannot be repeated.

LDRBT

For a description of this instruction and the encoding, see [LDRBT](#) on page F7-2652.

CONSTRAINED UNPREDICTABLE behavior

For the A1 and A2 encoding:

- If `wback && n == t`, then one of the following behaviors can occur:
 - The instruction is UNDEFINED.
 - The instruction executes as a NOP.
 - The instruction performs all the loads using the specified addressing mode and the content of the register that is written back is UNKNOWN. In addition, if an exception occurs during such as instruction, the base register might be corrupted so that the instruction cannot be repeated.

———— Note —————

Pre-indexed and post-indexed addressing implies writeback.

- When the `Rn` field specifies R15, then this instruction can be treated either as described in this section or as described in [LDRB \(literal\)](#) on page AppxA-4713.

LDRH (immediate, T32)

For a description of this instruction and the encoding, see [LDRH \(immediate, T32\)](#) on page F7-2664.

CONSTRAINED UNPREDICTABLE behavior

For the T3 encoding:

- If `wback && n == t`, then one of the following behaviors can occur:
 - The instruction is UNDEFINED.
 - The instruction executes as a NOP.
 - The instruction performs all the loads using the specified addressing mode and the content of the register that is written back is UNKNOWN. In addition, if an exception occurs during such as instruction, the base register might be corrupted so that the instruction cannot be repeated.

LDRH (immediate, A32)

For a description of this instruction and the encoding, see [LDRH \(immediate, A32\) on page F7-2666](#).

CONSTRAINED UNPREDICTABLE behavior

For the A1 encoding:

- If `wback && n == t`, then one of the following behaviors can occur:
 - The instruction is UNDEFINED.
 - The instruction executes as a NOP.
 - The instruction performs all the loads using the specified addressing mode and the content of the register that is written back is UNKNOWN. In addition, if an exception occurs during such as instruction, the base register might be corrupted so that the instruction cannot be repeated.

LDRH (register)

For a description of this instruction and the encoding, see [LDRH \(register\) on page F7-2670](#).

CONSTRAINED UNPREDICTABLE behavior

For the A1 encoding:

- If `wback && n == t`, then one of the following behaviors can occur:
 - The instruction is UNDEFINED.
 - The instruction executes as a NOP.
 - The instruction performs all the loads using the specified addressing mode and the content of the register that is written back is UNKNOWN. In addition, if an exception occurs during such as instruction, the base register might be corrupted so that the instruction cannot be repeated.

LDRHT

For a description of this instruction and the encoding, see [LDRHT on page F7-2672](#).

CONSTRAINED UNPREDICTABLE behavior

For the A1 and A2 encoding:

- If `wback && n == t`, then one of the following behaviors can occur:
 - The instruction is UNDEFINED.
 - The instruction executes as a NOP.
 - The instruction performs all the loads using the specified addressing mode and the content of the register that is written back is UNKNOWN. In addition, if an exception occurs during such as instruction, the base register might be corrupted so that the instruction cannot be repeated.

———— **Note** —————

Pre-indexed and post-indexed addressing implies writeback.

- When the Rn field specifies R15, then this instruction can be treated either as described in this section or as described in [LDRH \(literal\)](#) on page AppxA-4714.

LDRSB (immediate)

For a description of this instruction and the encoding, see [LDRSB \(immediate\)](#) on page F7-2674.

CONSTRAINED UNPREDICTABLE behavior

For the A1 encoding:

- If wback && n == t, then one of the following behaviors can occur:
 - The instruction is UNDEFINED.
 - The instruction executes as a NOP.
 - The instruction performs all the loads using the specified addressing mode and the content of the register that is written back is UNKNOWN. In addition, if an exception occurs during such as instruction, the base register might be corrupted so that the instruction cannot be repeated.

LDRSB (register)

For a description of this instruction and the encoding, see [LDRSB \(register\)](#) on page F7-2678.

CONSTRAINED UNPREDICTABLE behavior

For the A1 encoding:

- If wback && n == t, then one of the following behaviors can occur:
 - The instruction is UNDEFINED.
 - The instruction executes as a NOP.
 - The instruction performs all the loads using the specified addressing mode and the content of the register that is written back is UNKNOWN. In addition, if an exception occurs during such as instruction, the base register might be corrupted so that the instruction cannot be repeated.

LDRSBT

For a description of this instruction and the encoding, see [LDRSBT](#) on page F7-2680.

CONSTRAINED UNPREDICTABLE behavior

For the A1 and A2 encoding:

- If wback && n == t, then one of the following behaviors can occur:
 - The instruction is UNDEFINED.
 - The instruction executes as a NOP.
 - The instruction performs all the loads using the specified addressing mode and the content of the register that is written back is UNKNOWN. In addition, if an exception occurs during such as instruction, the base register might be corrupted so that the instruction cannot be repeated.

———— **Note** —————

Pre-indexed and post-indexed addressing implies writeback.

- When the Rn field specifies R15, then this instruction can be treated either as described in this section or as described in [LDRSB \(literal\)](#) on page AppxA-4714.

LDRSH (immediate)

For a description of this instruction and the encoding, see [LDRSH \(immediate\)](#) on page F7-2682.

CONSTRAINED UNPREDICTABLE behavior

For the T2 and A1 encoding:

- If wback && n == t, then one of the following behaviors can occur:
 - The instruction is UNDEFINED.
 - The instruction executes as a NOP.
 - The instruction performs all the loads using the specified addressing mode and the content of the register that is written back is UNKNOWN. In addition, if an exception occurs during such as instruction, the base register might be corrupted so that the instruction cannot be repeated.

LDRSH (register)

For a description of this instruction and the encoding, see [LDRSH \(register\)](#) on page F7-2686.

CONSTRAINED UNPREDICTABLE behavior

For the A1 encoding:

- If wback && n == t, then one of the following behaviors can occur:
 - The instruction is UNDEFINED.
 - The instruction executes as a NOP.
 - The instruction performs all the loads using the specified addressing mode and the content of the register that is written back is UNKNOWN. In addition, if an exception occurs during such as instruction, the base register might be corrupted so that the instruction cannot be repeated.

LDRSHT

For a description of this instruction and the encoding, see [LDRSHT](#) on page F7-2688.

For the A1 and A2 encoding:

- If wback && n == t, then one of the following behaviors can occur:
 - The instruction is UNDEFINED.
 - The instruction executes as a NOP.
 - The instruction performs all the loads using the specified addressing mode and the content of the register that is written back is UNKNOWN. In addition, if an exception occurs during such as instruction, the base register might be corrupted so that the instruction cannot be repeated.

———— **Note** —————

Pre-indexed and post-indexed addressing implies writeback.

- When the Rn field specifies R15, then this instruction can be treated either as described in this section or as described in [LDRSB \(literal\)](#) on page AppxA-4714.

LDRT

For a description of this instruction and the encoding, see [LDRT on page F7-2690](#).

For the A1 and A2 encoding:

- If `wback && n == t`, then one of the following behaviors can occur:
 - The instruction is UNDEFINED.
 - The instruction executes as a NOP.
 - The instruction performs all the loads using the specified addressing mode and the content of the register that is written back is UNKNOWN. In addition, if an exception occurs during such as instruction, the base register might be corrupted so that the instruction cannot be repeated.

Note

Pre-indexed and post-indexed addressing implies writeback.

- When the Rn field specifies R15, then this instruction can be treated either as described in this section or as described in [LDRSB \(literal\) on page AppxA-4714](#).

LDR (literal)

For a description of this instruction and the encoding, see [LDR \(literal\) on page F7-2638](#).

CONSTRAINED UNPREDICTABLE behavior

For the A1 encoding:

- If `bit[24]` has the same value as `bit[21]`:
 - The instruction is UNDEFINED.
 - The instruction is treated as a NOP.
 - The instruction is treated as if `bit[24]` had value of 1 and `bit[21]` had a value of 0.
 - The instruction treats `bit[24]` as the P bit, and `bit[21]` as the writeback bit, and uses the same addressing mode as described in the immediate offset instruction. If this results in writeback to the PC, then the requirements described in [Using R15 on page AppxA-4760](#) apply.

Note

This is an exception to the principle in [SBZ or SBO fields in instructions on page AppxA-4760](#).

- If `bit[24] == 0` and `bit[21] == 1`, then the instruction can be handled according to the requirements described in [SBZ or SBO fields in instructions on page AppxA-4760](#) or the requirements described in [LDR \(immediate, T32\) on page AppxA-4707](#).

LDRB (literal)

For a description of this instruction and the encoding, see [LDRB \(literal\) on page F7-2648](#).

CONSTRAINED UNPREDICTABLE behavior

For the A1 encoding:

- If `bit[24]` has the same value as `bit[21]`:
 - The instruction is UNDEFINED.
 - The instruction is treated as a NOP.
 - The instruction is treated as if `bit[24]` had value of 1 and `bit[21]` had a value of 0.

- The instruction treats bit[24] as the P bit, and bit[21] as the writeback bit, and uses the same addressing mode as described in the immediate offset instruction. If this results in writeback to the PC, then the requirements described in [Using R15 on page AppxA-4760](#) apply.

———— **Note** —————

This is an exception to the principle in [SBZ or SBO fields in instructions on page AppxA-4760](#).

- If bit[24] == 0 and bit[21] == 1, then the instruction can be handled according to the requirements described in [SBZ or SBO fields in instructions on page AppxA-4760](#) or the requirements described in [LDRB \(immediate, T32\) on page AppxA-4708](#).

LDRH (literal)

For a description of this instruction and the encoding, see [LDRH \(literal\) on page F7-2668](#).

CONSTRAINED UNPREDICTABLE behavior

For the A1 encoding:

- If bit[24] has the same value as bit[21]:
 - The instruction is UNDEFINED.
 - The instruction is treated as a NOP.
 - The instruction is treated as if bit[24] had value of 1 and bit[21] had a value of 0.
 - The instruction treats bit[24] as the P bit, and bit[21] as the writeback bit, and uses the same addressing mode as described in the immediate offset instruction. If this results in writeback to the PC, then the requirements described in [Using R15 on page AppxA-4760](#) apply.

———— **Note** —————

This is an exception to the principle in [SBZ or SBO fields in instructions on page AppxA-4760](#).

- If bit[24] == 0 and bit[21] == 1, then the instruction can be handled according to the requirements described in [SBZ or SBO fields in instructions on page AppxA-4760](#) or the requirements described in [LDRH \(immediate, T32\) on page AppxA-4709](#).

LDRSB (literal)

For a description of this instruction and the encoding, see [LDRSB \(literal\) on page F7-2676](#).

CONSTRAINED UNPREDICTABLE behavior

For the A1 encoding:

- If bit[24] has the same value as bit[21]:
 - The instruction is UNDEFINED.
 - The instruction is treated as a NOP.
 - The instruction is treated as if bit[24] had value of 1 and bit[21] had a value of 0.
 - The instruction treats bit[24] as the P bit, and bit[21] as the writeback bit, and uses the same addressing mode as described in the immediate offset instruction. If this results in writeback to the PC, then the requirements described in [Using R15 on page AppxA-4760](#) apply.

———— **Note** —————

This is an exception to the principle in [SBZ or SBO fields in instructions on page AppxA-4760](#).

- If bit[24] == 0 and bit[21] == 1, then the instruction can be handled according to the requirements described in [SBZ or SBO fields in instructions on page AppxA-4760](#) or the requirements described in [LDRSB \(immediate\) on page AppxA-4711](#).

LDRSH (literal)

For a description of this instruction and the encoding, see [LDRSH \(literal\)](#) on page F7-2684.

CONSTRAINED UNPREDICTABLE behavior

For the A1 encoding:

- If bit[24] has the same value as bit[21]:
 - The instruction is UNDEFINED.
 - The instruction is treated as a NOP.
 - The instruction is treated as if bit[24] had value of 1 and bit[21] had a value of 0.
 - The instruction treats bit[24] as the P bit, and bit[21] as the writeback bit, and uses the same addressing mode as described in the immediate offset instruction. If this results in writeback to the PC, then the requirements described in [Using R15](#) on page AppxA-4760 apply.

———— **Note** —————

This is an exception to the principle in [SBZ or SBO fields in instructions](#) on page AppxA-4760.

- If bit[24] == 0 and bit[21] == 1, then the instruction can be handled according to the requirements described in [SBZ or SBO fields in instructions](#) on page AppxA-4760 or the requirements described in [LDRSH \(immediate\)](#) on page AppxA-4712.

LDRD (immediate)

For a description of this instruction and the encoding, see [LDRD \(immediate\)](#) on page F7-2654.

CONSTRAINED UNPREDICTABLE behavior

For all encodings:

- If wback && (n == t || n == t2), then one of the following behaviors can occur:
 - The instruction is UNDEFINED.
 - The instruction executes as a NOP.
 - The instruction performs all the loads using the specified addressing mode and the content of the register that is written back is UNKNOWN. In addition, if an exception occurs during such an instruction, the base address might be corrupted so that the instruction cannot be repeated.

For the T1 encoding:

- If t == t2, then one of the following behaviors can occur:
 - The instruction is UNDEFINED.
 - The instruction executes as a NOP.
 - The instruction performs all of the loads using the specified addressing mode and the register that is loaded takes an UNKNOWN value.

For the A1 encoding:

- If P == '0' && W == '1' then one of the following behaviors can occur:
 - The instruction is UNDEFINED.
 - The instruction executes as a NOP.
 - The instruction behaves as if the values of P and W were as follows:
 - P == '1' && W == '0'
 - P == '1' && W == '1'
 - P == '0' && W == '0'

- If $Rt<0> == '1'$, then one of the following behaviors can occur:
 - The instruction is UNDEFINED.
 - The instruction executes as a NOP.
 - The behavior is the same as if $Rt<0> == '0'$.
 - The registers accessed are both specified by Rt . This means that Rt and $Rt+1$ are the same, and both have $bit[0] == 1$.
 - The registers accessed are specified by Rt and $Rt+1$.

———— **Note** —————

This does not apply if $Rt == '1111'$.

LDRD (register)

For a description of this instruction and the encoding, see [LDRD \(register\)](#) on page F7-2658.

CONSTRAINED UNPREDICTABLE behavior

For the A1 encoding:

- If $wback \ \&\& \ (n == t \ || \ n == t2)$, then one of the following behaviors can occur:
 - The instruction is UNDEFINED.
 - The instruction executes as a NOP.
 - The instruction performs all the loads using the specified addressing mode and the content of the register that is written back is UNKNOWN. In addition, if an exception occurs during such an instruction, the base address might be corrupted so that the instruction cannot be repeated.
- If $P == '0' \ \&\& \ W == '1'$, then one of the following behaviors can occur:
 - The instruction is UNDEFINED.
 - The instruction executes as a NOP.
 - The instruction behaves as if the values of P and W were as follows:
 - $P == '1' \ \&\& \ W == '0'$
 - $P == '1' \ \&\& \ W == '1'$
 - $P == '0' \ \&\& \ W == '0'$
- If $m == t \ || \ m == t2$, then one of the following behaviors can occur:
 - The instruction is UNDEFINED.
 - The instruction is treated as a NOP.
 - The instruction loads register Rm with an UNKNOWN value.
- If $Rt<0> == '1'$, then one of the following behaviors can occur:
 - The instruction is UNDEFINED.
 - The instruction executes as a NOP.
 - The behavior is the same as if $Rt<0> == '0'$.
 - The registers accessed are both specified by Rt . This means that Rt and $Rt+1$ are the same, and in both cases $bit[0] == 1$.
 - The registers accessed are specified by Rt and $Rt+1$.

———— **Note** —————

This does not apply if $Rt == '1111'$.

LDRD (literal)

For a description of this instruction and the encoding, see [LDRD \(literal\)](#) on page F7-2656.

CONSTRAINED UNPREDICTABLE behavior

For the A1 encoding:

- If bit[24] and bit[21] do not have their *should be* values, then one of the following behaviors can occur:
 - The instruction is UNDEFINED.
 - The instruction executes as a NOP.
 - The instruction is treated as if the bits had their *should be* values.
- If $Rt_{<0>} == '1'$, then one of the following behaviors can occur:
 - The instruction is UNDEFINED.
 - The instruction executes as a NOP.
 - The behavior is the same as if $Rt_{<0>} == '0'$.
 - The registers accessed are both specified by Rt . This means that Rt and $Rt+1$ are the same, and both have bit[0] equal to 1.
 - The registers accessed are specified by Rt and $Rt+1$.

Note

This does not apply if $Rt == '1111'$.

For the T1 encoding:

- If $t == t2$, then one of the following behaviors can occur:
 - The instruction is UNDEFINED.
 - The instruction executes as a NOP.
 - The instruction performs all of the loads using the specified addressing mode and the register that is loaded takes an UNKNOWN value.
- If $W == '1'$, then one of the following behaviors can occur:
 - The instruction is UNDEFINED.
 - The instruction executes as a NOP.
 - The instruction is treated as if $W == '0'$.
 - The instruction uses the P and W bits as described for [LDRD \(immediate\)](#) on page AppxA-4715.

LDREX

For a description of this instruction and the encoding, see [LDREX](#) on page F7-2660.

CONSTRAINED UNPREDICTABLE behavior

If the Load-Exclusive is to any type of Device memory, then the instruction operates as if the access were to Normal memory.

LDREXH

For a description of this instruction and the encoding, see [LDREXH](#) on page F7-2663.

CONSTRAINED UNPREDICTABLE behavior

If the Load-Exclusive is to any type of Device memory, then the instruction operates as if the access were to Normal memory.

LDREXB

For a description of this instruction and the encoding, see [LDREXB on page F7-2661](#).

CONSTRAINED UNPREDICTABLE behavior

If the Load-Exclusive is to any type of Device memory, then the instruction operates as if the access were to Normal memory.

LDAEX

For a description of this instruction and the encoding, see [LDAEX on page F7-2614](#).

CONSTRAINED UNPREDICTABLE behavior

If the Load-Exclusive is to any type of Device memory, then the instruction operates as if the access were to Normal memory.

LDAEXH

For a description of this instruction and the encoding, see [LDAEXH on page F7-2617](#).

CONSTRAINED UNPREDICTABLE behavior

If the Load-Exclusive is to any type of Device memory, then the instruction operates as if the access were to Normal memory.

LDAEXB

For a description of this instruction and the encoding, see [LDAEXB on page F7-2615](#).

CONSTRAINED UNPREDICTABLE behavior

If the Load-Exclusive is to any type of Device memory, then the instruction operates as if the access were to Normal memory.

LDREXD

For a description of this instruction and the encoding, see [LDREXD on page F7-2662](#).

CONSTRAINED UNPREDICTABLE behavior

For all encodings:

- If the Load-Exclusive is to any type of Device memory, then the instruction operates as if the access were to Normal memory.

For the T1 encoding:

- If $t_1 == t_2$, then one of the following behaviors can occur:
 - The instruction is UNDEFINED.
 - The instruction executes as a NOP.
 - The instruction performs all of the loads using the specified addressing mode and the register that is loaded takes an UNKNOWN value.

For the A1 encoding:

- If $Rt_{<0>} == '1'$, then one of the following behaviors can occur:
 - The instruction is UNDEFINED.
 - The instruction executes as a NOP.

- The behavior is the same as if the $Rt \ll 0 \gg == '0'$.
- The registers accessed are both specified by Rt . This means that Rt and $Rt+1$ are the same, and both have $bit[0] == 1$.
- The registers accessed are specified by Rt and $Rt+1$.

———— **Note** —————

If $t2 == 15$, then the requirements described in [Using R15 on page AppxA-4760](#) apply.

LDAEXD

For a description of this instruction and the encoding, see [LDAEXD on page F7-2616](#).

CONSTRAINED UNPREDICTABLE behavior

For all encodings:

- If the Load-Exclusive is to any type of Device memory, then the instruction operates as if the access were to Normal memory.

For the T1 encoding:

- If $t == t2$, then one of the following behaviors can occur:
 - The instruction is UNDEFINED.
 - The instruction executes as a NOP.
 - The instruction performs all of the loads using the specified addressing mode and the register that is loaded takes an UNKNOWN value.

For the A1 encoding:

- If $Rt \ll 0 \gg == '1'$, then one of the following behaviors can occur:
 - The instruction is UNDEFINED.
 - The instruction executes as a NOP.
 - The behavior is the same as if the $Rt \ll 0 \gg == '0'$.
 - The registers accessed are both specified by Rt . This means that Rt and $Rt+1$ are the same, and both have $bit[0] == 1$.
 - The registers accessed are specified by Rt and $Rt+1$.

———— **Note** —————

If $t2 == 15$, then the requirements described in [Using R15 on page AppxA-4760](#) apply.

MOV (register, T32)

For a description of this instruction and the encoding, see [MOV \(register, T32\) on page F7-2710](#).

CONSTRAINED UNPREDICTABLE behavior

For the T2 encoding:

- If $InITBlock()$, then one of the following behaviors can occur:
 - The instruction generates an UNDEFINED exception.
 - The instruction is executed as if it passed its condition code check.
 - The instruction executes as a NOP. That is, it behaves as if it failed its condition code check.
 - The instruction is treated as MOV Rd, Rm.

Note

This is an exception to the general behavior described in *CONSTRAINED UNPREDICTABLE behavior in an IT block* on page AppxA-4761.

MRRC, MRRC2

For a description of this instruction and the encoding, see *MRRC, MRRC2* on page F7-2718.

CONSTRAINED UNPREDICTABLE behavior

For all encodings:

- If $t == t2$, then one of the following behaviors can occur:
 - The instruction is UNDEFINED.
 - The instruction executes as a NOP.
 - The register that is transferred takes an UNKNOWN value.

MSR (register)

For a description of this instruction and the encoding, see *MSR (register)* on page F7-2724.

CONSTRAINED UNPREDICTABLE behavior

For all encodings:

- If $mask == '00'$, then one of the following behaviors can occur:
 - The instruction is UNDEFINED.
 - The instruction executes as a NOP.

POP (T32)

For a description of this instruction and the encoding, see *POP (T32)* on page F7-2756.

CONSTRAINED UNPREDICTABLE behavior

For the T1 encoding:

- If $BitCount(registers) < 1$, then one of the following behaviors can occur:
 - The instruction is UNDEFINED.
 - The instruction executes as a NOP.
 - The instruction operates as a POP with the same addressing mode but targeting an unspecified set of registers. These registers might include R15.

For the T2 encoding:

- If $BitCount(registers) < 2$, one of the following behaviors can occur:
 - The instruction is UNDEFINED.
 - The instruction executes as a NOP.
 - The instruction loads a single register using the specified addressing modes.
 - The instruction operates as an LDM with the same addressing mode but targeting an unspecified set of registers. These might include R15.
- If $hw2\ bit[13]$ is set to 1, then one of the following behaviors can occur:
 - The instruction is UNDEFINED.
 - The instruction executes as a NOP.

- The instruction performs all of the loads using the specified addressing mode but R13 is UNKNOWN. In addition, if an exception occurs during such an instruction, the base address might be corrupted so that the instruction cannot be repeated.

———— **Note** —————

This is an exception to the requirements described in [SBZ or SBO fields in instructions on page AppxA-4760](#).

- If $P == '1'$ && $M == '1'$, then one of the following behaviors can occur:
 - The instruction is UNDEFINED.
 - The instruction executes as a NOP.
 - The instruction loads the register list and either R14 or R15, both R14 and R15, or neither of these registers.

For the T3 encoding:

- If $t == 13$, then one of the following behaviors can occur:
 - The instruction is UNDEFINED.
 - The instruction executes as a NOP.
 - The instruction performs the load using the specified addressing mode but R15 is UNKNOWN.

———— **Note** —————

This is an exception to the requirements described in [Using R13 on page AppxA-4759](#).

POP (A32)

For a description of this instruction and the encoding, see [POP \(A32\) on page F7-2758](#).

CONSTRAINED UNPREDICTABLE behavior

For the A1 encoding:

- If bit[13] is set to 1, then one of the following behaviors can occur:
 - The instruction is UNDEFINED.
 - The instruction executes as a NOP.
 - The instruction performs all of the loads using the specified addressing mode but R13 is UNKNOWN. In addition, if an exception occurs during such an instruction, the base address might be corrupted so that the instruction cannot be repeated.

For the A2 encoding:

- If $t == 13$, then one of the following behaviors can occur:
 - The instruction is UNDEFINED.
 - The instruction executes as a NOP.
 - The instruction performs the load using the specified addressing mode but R15 is UNKNOWN.

———— **Note** —————

This is an exception to the requirements described in [Using R13 on page AppxA-4759](#).

PUSH

For a description of this instruction and the encoding, see [PUSH on page F7-2760](#).

CONSTRAINED UNPREDICTABLE behavior

For the T1 encoding:

- If $\text{BitCount}(\text{registers}) < 1$, then one of the following behaviors can occur:
 - The instruction is UNDEFINED.
 - The instruction executes as a NOP.
 - The instruction operates as a PUSH with the same addressing mode but targeting an unspecified set of registers. These registers might include R15.

For the T2 encoding:

- If $\text{BitCount}(\text{registers}) < 2$, one of the following behaviors can occur:
 - The instruction is UNDEFINED.
 - The instruction executes as a NOP.
 - The instruction stores a single register using the specified addressing modes.
 - The instruction operates as a PUSH with the same addressing mode but targeting an unspecified set of registers. These might include R15.
- If hw2 bit[13] is set, then one of the following behaviors can occur:
 - The instruction is UNDEFINED.
 - The instruction executes as a NOP.
 - The instruction performs all of the stores using the specified addressing mode but R13 is UNKNOWN.

Note

This is an exception to the requirements described in [SBZ or SBO fields in instructions on page AppxA-4760](#).

- If hw2 bit[15] is set to 1, then one of the following behaviors can occur:
 - The instruction is UNDEFINED.
 - The instruction executes as a NOP.
 - The instruction performs all of the stores using the specified addressing mode, but R15 is UNKNOWN.

RBIT

For a description of this instruction and the encoding, see [RBIT on page F7-2772](#).

CONSTRAINED UNPREDICTABLE behavior

For the T1 encoding:

- If $\text{! Consistent}(\text{Rm})$, then one of the following behaviors can occur:
 - The instruction is UNDEFINED.
 - The instruction executes as a NOP.
 - The register specified by Rm in halfword 1 is used as the source register.
 - The register specified by Rm in halfword 2] is used as the source register.
 - The value in the destination register is UNKNOWN.

REV

For a description of this instruction and the encoding, see [REV on page F7-2773](#).

CONSTRAINED UNPREDICTABLE behavior

For the T2 encoding:

- If ! Consistent(Rm), then one of the following behaviors can occur:
 - The instruction is UNDEFINED.
 - The instruction executes as a NOP.
 - The register specified by Rm in halfword 1 is used as the source register.
 - The register specified by Rm in halfword 2 is used as the source register.
 - The value in the destination register is UNKNOWN.

REV16

For a description of this instruction and the encoding, see [REV16 on page F7-2774](#).

CONSTRAINED UNPREDICTABLE behavior

For the T2 encoding:

- If ! Consistent(Rm), then one of the following behaviors can occur:
 - The instruction is UNDEFINED.
 - The instruction executes as a NOP.
 - The register specified by Rm in halfword 1 is used as the source register.
 - The register specified by Rm in halfword 2 is used as the source register.
 - The value in the destination register is UNKNOWN.

REVSH

For a description of this instruction and the encoding, see [REVSH on page F7-2775](#).

CONSTRAINED UNPREDICTABLE behavior

For the T2 encoding:

- If ! Consistent(Rm), then one of the following behaviors can occur:
 - The instruction is UNDEFINED.
 - The instruction executes as a NOP.
 - The register specified by Rm in halfword 1 is used as the source register.
 - The register specified by Rm in halfword 2 is used as the source register.
 - The value in the destination register is UNKNOWN.

SBFX

For a description of this instruction and the encoding, see [SBFX on page F7-2798](#).

CONSTRAINED UNPREDICTABLE behavior

For all encodings:

- If msbit > 31, then one of the following behaviors can occur:
 - The instruction is UNDEFINED.
 - The instruction executes as a NOP.
 - The output value in the register is UNKNOWN.

UBFX

For a description of this instruction and the encoding, see [UBFX on page F7-2960](#).

CONSTRAINED UNPREDICTABLE behavior

For all encodings:

- If $\text{msbit} > 31$, then one of the following behaviors can occur:
 - The instruction is UNDEFINED.
 - The instruction executes as a NOP.
 - The output value in the register is UNKNOWN.

SDIV

For a description of this instruction and the encoding, see [SDIV on page F7-2800](#).

CONSTRAINED UNPREDICTABLE behavior

For all encodings:

- If halfword 2 bits[15:12] != '1111', then one of the following behaviors can occur:
 - The instruction is UNDEFINED.
 - The instruction executes as a NOP.
 - The instruction performs a divide with no side-effects on other registers.
 - The instruction performs a divide and the register specified by bits[15:12] becomes UNKNOWN.

Note

This is an exception to the requirements described in [SBZ or SBO fields in instructions on page AppxA-4760](#).

UDIV

For a description of this instruction and the encoding, see [UDIV on page F7-2964](#).

CONSTRAINED UNPREDICTABLE behavior

For all encodings:

- If halfword 2 bits[15:12] != '1111', then one of the following behaviors can occur:
 - The instruction is UNDEFINED.
 - The instruction executes as a NOP.
 - The instruction performs a divide with no side-effects on other registers.
 - The instruction performs a divide and the register specified by bits[15:12] becomes UNKNOWN.

Note

This is an exception to the requirements described in [SBZ or SBO fields in instructions on page AppxA-4760](#).

SMULL

For a description of this instruction and the encoding, see [SMULL on page F7-2838](#).

CONSTRAINED UNPREDICTABLE behavior

For all encodings:

- If $\text{dHi} == \text{dLo}$, then one of the following behaviors can occur:
 - The instruction is UNDEFINED.
 - The instruction executes as a NOP.
 - The target register takes an UNKNOWN value.

SMLAL

For a description of this instruction and the encoding, see [SMLAL on page F7-2816](#).

CONSTRAINED UNPREDICTABLE behavior

For all encodings:

- If $dHi == dLo$, then one of the following behaviors can occur:
 - The instruction is UNDEFINED.
 - The instruction executes as a NOP.
 - The target register takes an UNKNOWN value.

SMLALBB, SMLALBT, SMLALTB, SMLALTT

For a description of this instruction and the encoding, see [SMLALBB](#), [SMLALBT](#), [SMLALTB](#), [SMLALTT](#) on page F7-2818.

CONSTRAINED UNPREDICTABLE behavior

For all encodings:

- If $dHi == dLo$, then one of the following behaviors can occur:
 - The instruction is UNDEFINED.
 - The instruction executes as a NOP.
 - The target register takes an UNKNOWN value.

SMLALD

For a description of this instruction and the encoding, see [SMLALD on page F7-2820](#).

CONSTRAINED UNPREDICTABLE behavior

For all encodings:

- If $dHi == dLo$, then one of the following behaviors can occur:
 - The instruction is UNDEFINED.
 - The instruction executes as a NOP.
 - The target register takes an UNKNOWN value.

SMLS LD

For a description of this instruction and the encoding, see [SMLS LD on page F7-2826](#).

CONSTRAINED UNPREDICTABLE behavior

For all encodings:

- If $dHi == dLo$, then one of the following behaviors can occur:
 - The instruction is UNDEFINED.
 - The instruction executes as a NOP.
 - The target register takes an UNKNOWN value.

UMULL

For a description of this instruction and the encoding, see [UMULL on page F7-2982](#).

CONSTRAINED UNPREDICTABLE behavior

For all encodings:

- If $dHi == dLo$, then one of the following behaviors can occur:
 - The instruction is UNDEFINED.
 - The instruction executes as a NOP.
 - The target register takes an UNKNOWN value.

UMAAL

For a description of this instruction and the encoding, see [UMAAL on page F7-2978](#).

CONSTRAINED UNPREDICTABLE behavior

For all encodings:

- If $dHi == dLo$, then one of the following behaviors can occur:
 - The instruction is UNDEFINED.
 - The instruction executes as a NOP.
 - The target register takes an UNKNOWN value.

UMLAL

For a description of this instruction and the encoding, see [UMLAL on page F7-2980](#).

CONSTRAINED UNPREDICTABLE behavior

For all encodings:

- If $dHi == dLo$, then one of the following behaviors can occur:
 - The instruction is UNDEFINED.
 - The instruction executes as a NOP.
 - The target register takes an UNKNOWN value.

STC, STC2

For a description of this instruction and the encoding, see [STC, STC2 on page F7-2854](#).

CONSTRAINED UNPREDICTABLE behavior

For all encodings:

- If $n == 15$ && ($wback || CurrentInstrSet() != InstrSet_A32$), then one of the following behaviors can occur:
 - The instruction is UNDEFINED.
 - The instruction executes as a NOP.
 - The store instruction operates without writeback.

———— **Note** —————

This is consistent with ignoring writes to the PC.

- The instruction set uses the addressing mode described in the equivalent immediate offset instruction. If this results in writeback to the PC, then the requirements described in [Using R15 on page AppxA-4760](#) apply.

For the T1 and T2 encoding:

- The value used by stores using R15 as a base register follows the requirements described in [Using R15 on page AppxA-4760](#).

STM (STMIA, STMEA)

For a description of this instruction and the encoding, see [STM \(STMIA, STMEA\)](#) on page F7-2870.

CONSTRAINED UNPREDICTABLE behavior

For all encodings:

- The value used by stores using R15 as a base register follow the requirements described in [Using R15](#) on page AppxA-4760.

For the T1 and A1 encoding:

- If $\text{BitCount}(\text{registers}) < 1$, then one of the following behaviors can occur:
 - The instruction is UNDEFINED.
 - The instruction executes as a NOP.
 - The instruction operates as an STM with the same addressing mode but targeting an unspecified set of registers. These registers might include R15.

For the T2 encoding:

- If $\text{BitCount}(\text{registers}) < 2$, then one of the following behaviors occurs:
 - The instruction is UNDEFINED.
 - The instruction executes as a NOP.
 - The instruction stores a single register using the specified addressing modes.
 - The instruction operates as an STM with the same addressing mode but targeting an unspecified set of registers. These might include R15.
- If hw2 bit[13] is set, then one of the following behaviors can occur:
 - The instruction is UNDEFINED.
 - The instruction executes as a NOP.
 - The instruction performs all the stores using the specified addressing mode but the value of R13 is UNKNOWN.

———— **Note** —————

This is an exception to the requirements described in [SBZ or SBO fields in instructions](#) on page AppxA-4760.

- If hw2 bit[15] is set to 1, then one of the following behaviors can occur:
 - The instruction is UNDEFINED.
 - The instruction executes as a NOP.
 - The instruction performs all of the stores using the specified addressing mode but the value of R15 is UNKNOWN.

———— **Note** —————

This is an exception to the requirements described in [SBZ or SBO fields in instructions](#) on page AppxA-4760.

- If $\text{wback} \ \&\& \ \text{registers}\langle n \rangle == '1'$, then one of the following behaviors can occur:
 - The instruction is UNDEFINED.
 - The instruction executes as a NOP.
 - The instruction performs all of the stores using the specified addressing mode and the value stored for the base register is UNKNOWN.

STMDA (STMED)

For a description of this instruction and the encoding, see [STMDA \(STMED\)](#) on page F7-2872.

CONSTRAINED UNPREDICTABLE behavior

For the A1 encoding:

- If $\text{BitCount}(\text{registers}) < 1$, then one of the following behaviors can occur:
 - The instruction is UNDEFINED.
 - The instruction executes as a NOP.
 - The instruction operates as an STM with the same addressing mode but targeting an unspecified set of registers. These registers might include R15.
- The value used by stores using R15 as a base register follow the requirements described in [Using R15 on page AppxA-4760](#).

STMIB (STMFA)

For a description of this instruction and the encoding, see [STMIB \(STMFA\) on page F7-2876](#).

CONSTRAINED UNPREDICTABLE behavior

For the A1 encoding:

- If $\text{BitCount}(\text{registers}) < 1$, then one of the following behaviors can occur:
 - The instruction is UNDEFINED.
 - The instruction executes as a NOP.
 - The instruction operates as an STM with the same addressing mode but targeting an unspecified set of registers. These registers might include R15.
- The value used by stores using R15 as a base register follow the requirements described in [Using R15 on page AppxA-4760](#).

STMDB (STMFD)

For a description of this instruction and the encoding, see [STMDB \(STMFD\) on page F7-2874](#).

CONSTRAINED UNPREDICTABLE behavior

For all encodings:

- The value used by stores using R15 as a base register follow the requirements described in [Using R15 on page AppxA-4760](#).

For the A1 encoding:

- If $\text{BitCount}(\text{registers}) < 1$, then one of the following behaviors can occur:
 - The instruction is UNDEFINED.
 - The instruction executes as a NOP.
 - The store instruction operates as an STM with the same addressing mode but targeting an unspecified set of registers. These registers might include R15.

For the T1 encoding:

- If $\text{BitCount}(\text{register}) < 2$, then one of the following behaviors can occur:
 - The instruction is UNDEFINED.
 - The instruction executes as a NOP.
 - The instruction stores a single register using the specified addressing mode.
 - The instruction operates as an STM with the same addressing mode but targeting an unspecified set of registers. These might include R15.
- If $\text{wback} \ \&\& \ \text{registers}\langle n \rangle == '1'$, then one of the following behaviors can occur:
 - The instruction is UNDEFINED.

- The instruction executes as a NOP.
- The instruction performs all of the stores using the specified addressing mode and the value stored for the base register is UNKNOWN.
- If hw2 bit[13] is set to 1, then one of the following behaviors occurs:
 - The instruction is UNDEFINED.
 - The instruction executes as a NOP.
 - The instruction performs all of the stores using the specified addressing mode but the value of R13 is UNKNOWN.

———— **Note** —————

This is an exception to the requirements described in [SBZ or SBO fields in instructions on page AppxA-4760](#).

- If hw2 bit[15] is set to 1, then one of the following behaviors occurs:
 - The instruction is UNDEFINED.
 - The instruction executes as a NOP.
 - The instruction performs all of the stores using the specified addressing mode but the value of R15 is UNKNOWN.

———— **Note** —————

This is an exception to the requirement described in [SBZ or SBO fields in instructions on page AppxA-4760](#).

STR (immediate, T32)

For a description of this instruction and the encoding, see [STR \(immediate, T32\) on page F7-2878](#).

CONSTRAINED UNPREDICTABLE behavior

For the T3 encoding:

- If $t == 15$ is UNPREDICTABLE, then one of the following behaviors can occur:
 - The instruction is UNDEFINED.
 - The instruction executes as a NOP.
 - The store instruction performs the store using the specified addressing mode but the value corresponding to R15 is UNKNOWN.
- The value used by stores using R15 as a base register follow the requirements described in [Using R15 on page AppxA-4760](#).

For the T4 encoding:

- If $wback \ \&\& \ n == t$, then one of the following behaviors can occur:
 - The instruction is UNDEFINED.
 - The instruction executes as a NOP.
 - The instruction performs the store using the specified addressing mode but the value stored is UNKNOWN.
- If $wback \ \&\& \ n == 15$, then one of the following behaviors can occur:
 - The instruction is UNDEFINED.
 - The instruction executes as a NOP.
 - The store instruction operates without writeback.

———— **Note** —————

This is consistent with ignoring writes to the PC.

- The instruction uses the addressing mode described in the equivalent immediate offset instruction. If this results in writeback to the PC, then the requirements described in [Using R15 on page AppxA-4760](#) apply.

———— **Note** —————

Pre-indexed and post-indexed addressing implies writeback.

- The value used by stores using R15 as a base register follow the requirements described in [Using R15 on page AppxA-4760](#).

STR (immediate, A32)

For a description of this instruction and the encoding, see [STR \(immediate, A32\) on page F7-2880](#).

CONSTRAINED UNPREDICTABLE behavior

For the A1 encoding:

- If $t == 15$ is UNPREDICTABLE, then one of the following behaviors can occur:
 - The instruction is UNDEFINED.
 - The instruction executes as a NOP.
 - The store instruction performs the store using the specified addressing mode but the value corresponding to R15 is UNKNOWN.
- If $wback \ \&\& \ n == t$, then one of the following behaviors can occur:
 - The instruction is UNDEFINED.
 - The instruction executes as a NOP.
 - The instruction performs the store using the specified addressing mode but the value stored is UNKNOWN.
- If $wback \ \&\& \ n == 15$, then one of the following behaviors can occur:
 - The instruction is UNDEFINED.
 - The instruction executes as a NOP.
 - The store instruction operates without writeback.

———— **Note** —————

This is consistent with ignoring writes to the PC.

- The instruction uses the addressing mode described in the equivalent immediate offset instruction. If this results in writeback to the PC, then the requirements described in [Using R15 on page AppxA-4760](#) apply.

———— **Note** —————

Pre-indexed and post-indexed addressing implies writeback.

- The value used by stores using R15 as a base register follow the requirements described in [Using R15 on page AppxA-4760](#).

STR (register)

For a description of this instruction and the encoding, see [STR \(register\)](#) on page F7-2882.

CONSTRAINED UNPREDICTABLE behavior

For the T2 encoding:

- If $t == 15$ is UNPREDICTABLE, then one of the following behaviors can occur:
 - The instruction is UNDEFINED.
 - The instruction executes as a NOP.
 - The store instruction performs the store using the specified addressing mode but the value corresponding to R15 is UNKNOWN.
- The value used by stores using R15 as a base register follow the requirements described in [Using R15 on page AppxA-4760](#).

For the A1 encoding:

- If $wback \ \&\& \ n == t$, then one of the following behaviors can occur:
 - The instruction is UNDEFINED.
 - The instruction executes as a NOP.
 - The instruction performs the store using the specified addressing mode but the value stored is UNKNOWN.
- If $wback \ \&\& \ n == 15$, then one of the following behaviors can occur:
 - The instruction is UNDEFINED.
 - The instruction executes as a NOP.
 - The store instruction operates without writeback.
 - **Note** —————
 - This is consistent with ignoring writes to the PC.
 - The instruction uses the addressing mode described in the equivalent immediate offset instruction. If this results in writeback to the PC, then the requirements described in [Using R15 on page AppxA-4760](#) apply.
 - **Note** —————
 - Pre-indexed and post-indexed addressing implies writeback.
- The value used by stores using R15 as a base register follow the requirements described in [Using R15 on page AppxA-4760](#).

STRB (immediate, T32)

For a description of this instruction and the encoding, see [STRB \(immediate, T32\)](#) on page F7-2884.

CONSTRAINED UNPREDICTABLE behavior

For the T3 encoding:

- If $t == 15$ is UNPREDICTABLE, then one of the following behaviors can occur:
 - The instruction is UNDEFINED.
 - The instruction executes as a NOP.

- The store instruction performs the store using the specified addressing mode but the value corresponding to R15 is UNKNOWN.
- If `wback && n == t`, then one of the following behaviors can occur:
 - The instruction is UNDEFINED.
 - The instruction executes as a NOP.
 - The instruction performs the store using the specified addressing mode but the value stored is UNKNOWN.
- If `wback && n == 15`, then one of the following behaviors can occur:
 - The instruction is UNDEFINED.
 - The instruction executes as a NOP.
 - The store instruction operates without writeback.

Note

This is consistent with ignoring writes to the PC.

- The instruction uses the addressing mode described in the equivalent immediate offset instruction. If this results in writeback to the PC, then the requirements described in [Using R15 on page AppxA-4760](#) apply.

Note

Pre-indexed and post-indexed addressing implies writeback.

- The value used by stores using R15 as a base register follow the requirements described in [Using R15 on page AppxA-4760](#).

STRB (immediate, A32)

For a description of this instruction and the encoding, see [STRB \(immediate, A32\) on page F7-2886](#).

CONSTRAINED UNPREDICTABLE behavior

For the A1 encoding:

- If `t == 15` is UNPREDICTABLE, then one of the following behaviors can occur:
 - The instruction is UNDEFINED.
 - The instruction executes as a NOP.
 - The store instruction performs the store using the specified addressing mode but the value corresponding to R15 is UNKNOWN.
- If `wback && n == t`, then one of the following behaviors can occur:
 - The instruction is UNDEFINED.
 - The instruction executes as a NOP.
 - The instruction performs the store using the specified addressing mode but the value stored is UNKNOWN.
- If `wback && n == 15`, then one of the following behaviors can occur:
 - The instruction is UNDEFINED.
 - The instruction executes as a NOP.
 - The store instruction operates without writeback.

Note

This is consistent with ignoring writes to the PC.

- The instruction uses the addressing mode described in the equivalent immediate offset instruction. If this results in writeback to the PC, then the requirements described in [Using R15 on page AppxA-4760](#) apply.

———— **Note** —————

Pre-indexed and post-indexed addressing implies writeback.

- The value used by stores using R15 as a base register follow the requirements described in [Using R15 on page AppxA-4760](#).

STRB (register)

For a description of this instruction and the encoding, see [STRB \(register\) on page F7-2888](#).

CONSTRAINED UNPREDICTABLE behavior

For the A1 and T2 encoding:

- If $t == 15$ is UNPREDICTABLE, then one of the following behaviors can occur:
 - The instruction is UNDEFINED.
 - The instruction executes as a NOP.
 - The store instruction performs the store using the specified addressing mode but the value corresponding to R15 is UNKNOWN.

For the A1 encoding:

- If $wback \ \&\& \ n == t$, then one of the following behaviors can occur:
 - The instruction is UNDEFINED.
 - The instruction executes as a NOP.
 - The instruction performs the store using the specified addressing mode but the value stored is UNKNOWN.
- If $wback \ \&\& \ n == 15$, then one of the following behaviors can occur:
 - The instruction is UNDEFINED.
 - The instruction executes as a NOP.
 - The store instruction operates without writeback.

———— **Note** —————

This is consistent with ignoring writes to the PC.

- The instruction uses the addressing mode described in the equivalent immediate offset instruction. If this results in writeback to the PC, then the requirements described in [Using R15 on page AppxA-4760](#) apply.

———— **Note** —————

Pre-indexed and post-indexed addressing implies writeback.

- The value used by stores using R15 as a base register follow the requirements described in [Using R15 on page AppxA-4760](#).

STRBT

For a description of this instruction and the encoding, see [STRBT on page F7-2890](#).

CONSTRAINED UNPREDICTABLE behavior

For all encodings:

- If $t == 15$ is UNPREDICTABLE, then one of the following behaviors can occur:
 - The instruction is UNDEFINED.
 - The instruction executes as a NOP.
 - The store instruction performs the store using the specified addressing mode but the value corresponding to R15 is UNKNOWN.
- The value used by stores using R15 as a base register follow the requirements described in [Using R15 on page AppxA-4760](#).

For the T4 encoding:

- If $wback \ \&\& \ n == t$, then one of the following behaviors can occur:
 - The instruction is UNDEFINED.
 - The instruction executes as a NOP.
 - The instruction performs the store using the specified addressing mode but the value stored is UNKNOWN.
 - If $wback \ \&\& \ n == 15$, then one of the following behaviors can occur:
 - The instruction is UNDEFINED.
 - The instruction executes as a NOP.
 - The store instruction operates without writeback.

———— **Note** —————
This is consistent with ignoring writes to the PC.
—————
 - The instruction uses the addressing mode described in the equivalent immediate offset instruction. If this results in writeback to the PC, then the requirements described in [Using R15 on page AppxA-4760](#) apply.
- **Note** —————
Pre-indexed and post-indexed addressing implies writeback.
—————

STRH (immediate, T32)

For a description of this instruction and the encoding, see [STRH \(immediate, T32\) on page F7-2904](#).

CONSTRAINED UNPREDICTABLE behavior

For the T3 and T4 encoding:

- If $t == 15$ is UNPREDICTABLE, then one of the following behaviors can occur:
 - The instruction is UNDEFINED.
 - The instruction executes as a NOP.
 - The store instruction performs the store using the specified addressing mode but the value corresponding to R15 is UNKNOWN.
- The value used by stores using R15 as a base register follow the requirements described in [Using R15 on page AppxA-4760](#).

For the T4 encoding:

- If $wback \ \&\& \ n == t$, then one of the following behaviors can occur:
 - The instruction is UNDEFINED.
 - The instruction executes as a NOP.

- The instruction performs the store using the specified addressing mode but the value stored is UNKNOWN.
 - If `wback && n == 15`, then one of the following behaviors can occur:
 - The instruction is UNDEFINED.
 - The instruction executes as a NOP.
 - The store instruction operates without writeback.
- **Note** —————
- This is consistent with ignoring writes to the PC.
-
- The instruction uses the addressing mode described in the equivalent immediate offset instruction. If this results in writeback to the PC, then the requirements described in [Using R15 on page AppxA-4760](#) apply.
- **Note** —————
- Pre-indexed and post-indexed addressing implies writeback.
-

STRH (immediate, A32)

For a description of this instruction and the encoding, see [STRH \(immediate, A32\) on page F7-2906](#).

CONSTRAINED UNPREDICTABLE behavior

For the A1 encoding:

- If `t == 15` is UNPREDICTABLE, then one of the following behaviors can occur:
 - The instruction is UNDEFINED.
 - The instruction executes as a NOP.
 - The store instruction performs the store using the specified addressing mode but the value corresponding to R15 is UNKNOWN.
 - If `wback && n == t`, then one of the following behaviors can occur:
 - The instruction is UNDEFINED.
 - The instruction executes as a NOP.
 - The instruction performs the store using the specified addressing mode but the value stored is UNKNOWN.
 - If `wback && n == 15`, then one of the following behaviors can occur:
 - The instruction is UNDEFINED.
 - The instruction executes as a NOP.
 - The store instruction operates without writeback.
- **Note** —————
- This is consistent with ignoring writes to the PC.
-
- The instruction uses the addressing mode described in the equivalent immediate offset instruction. If this results in writeback to the PC, then the requirements described in [Using R15 on page AppxA-4760](#) apply.
- **Note** —————
- Pre-indexed and post-indexed addressing implies writeback.
-
- The value used by stores using R15 as a base register follow the requirements described in [Using R15 on page AppxA-4760](#).

STRH (register)

For a description of this instruction and the encoding, see [STRH \(register\)](#) on page F7-2908.

CONSTRAINED UNPREDICTABLE behavior

For the T2 and A1 encoding:

- If $t == 15$ is UNPREDICTABLE, then one of the following behaviors can occur:
 - The instruction is UNDEFINED.
 - The instruction executes as a NOP.
 - The store instruction performs the store using the specified addressing mode but the value corresponding to R15 is UNKNOWN.
- The value used by stores using R15 as a base register follow the requirements described in [Using R15 on page AppxA-4760](#).

For the A1 encoding:

- If $wback \ \&\& \ n == t$, then one of the following behaviors can occur:
 - The instruction is UNDEFINED.
 - The instruction executes as a NOP.
 - The instruction performs the store using the specified addressing mode but the value stored is UNKNOWN.
- If $wback \ \&\& \ n == 15$, then one of the following behaviors can occur:
 - The instruction is UNDEFINED.
 - The instruction executes as a NOP.
 - The store instruction operates without writeback.
 - **Note** —————
 - This is consistent with ignoring writes to the PC.
 - The instruction uses the addressing mode described in the equivalent immediate offset instruction. If this results in writeback to the PC, then the requirements described in [Using R15 on page AppxA-4760](#) apply.
 - **Note** —————
 - Pre-indexed and post-indexed addressing implies writeback.

STRHT

For a description of this instruction and the encoding, see [STRHT](#) on page F7-2910.

CONSTRAINED UNPREDICTABLE behavior

For all encodings:

- If $t == 15$ is UNPREDICTABLE, then one of the following behaviors can occur:
 - The instruction is UNDEFINED.
 - The instruction executes as a NOP.
 - The store instruction performs the store using the specified addressing mode but the value corresponding to R15 is UNKNOWN.
- The value used by stores using R15 as a base register follow the requirements described in [Using R15 on page AppxA-4760](#).

For the A1 and A2 encoding:

- If `wback && n == t`, then one of the following behaviors can occur:
 - The instruction is UNDEFINED.
 - The instruction executes as a NOP.
 - The instruction performs the store using the specified addressing mode but the value stored is UNKNOWN.
- If `wback && n == 15`, then one of the following behaviors can occur:
 - The instruction is UNDEFINED.
 - The instruction executes as a NOP.
 - The store instruction operates without writeback.

Note

This is consistent with ignoring writes to the PC.

 - The instruction uses the addressing mode described in the equivalent immediate offset instruction. If this results in writeback to the PC, then the requirements described in [Using R15 on page AppxA-4760](#) apply.

Note

Pre-indexed and post-indexed addressing implies writeback.

STRT

For a description of this instruction and the encoding, see [STRT on page F7-2912](#).

CONSTRAINED UNPREDICTABLE behavior

For the T1 encoding:

- If `t == 15` is UNPREDICTABLE, then one of the following behaviors can occur:
 - The instruction is UNDEFINED.
 - The instruction executes as a NOP.
 - The store instruction performs the store using the specified addressing mode but the value corresponding to R15 is UNKNOWN.

For the A1 and A2 encoding:

- If `wback && n == t`, then one of the following behaviors can occur:
 - The instruction is UNDEFINED.
 - The instruction executes as a NOP.
 - The instruction performs the store using the specified addressing mode but the value stored is UNKNOWN.
- If `wback && n == 15`, then one of the following behaviors can occur:
 - The instruction is UNDEFINED.
 - The instruction executes as a NOP.
 - The store instruction operates without writeback.

Note

This is consistent with ignoring writes to the PC.

 - The instruction uses the addressing mode described in the equivalent immediate offset instruction. If this results in writeback to the PC, then the requirements described in [Using R15 on page AppxA-4760](#) apply.

———— **Note** —————

Pre-indexed and post-indexed addressing implies writeback.

- The value used by stores using R15 as a base register follow the requirements described in [Using R15 on page AppxA-4760](#).

STRD (immediate)

For a description of this instruction and the encoding, see [STRD \(immediate\) on page F7-2892](#).

CONSTRAINED UNPREDICTABLE behavior

For all encodings:

- If $t == 15$ or $t2 == 15$, then one of the following behaviors can occur:
 - The instruction is UNDEFINED.
 - The instruction executes as a NOP.
 - The store instruction performs the store using the specified addressing mode but the value corresponding to R15 is UNKNOWN.
- If $wback \ \&\& \ (n == t \ || \ n == t2)$, then one of the following behaviors can occur:
 - The instruction is UNDEFINED.
 - The instruction executes as a NOP.
 - The instruction performs the store of the registers specified using the specified addressing mode but the value of the registers stored is UNKNOWN.
- The value used by stores using R15 as a base register follow the requirements described in [Using R15 on page AppxA-4760](#).

For the A1 encoding:

- If $wback \ \&\& \ n == 15$, then one of the following behaviors can occur:
 - The instruction is UNDEFINED.
 - The instruction executes as a NOP.
 - The store instruction operates without writeback.

———— **Note** —————

This is consistent with ignoring writes to the PC.

- The instruction uses the addressing mode described in the equivalent immediate offset instruction. If this results in writeback to the PC, then the requirements described in [Using R15 on page AppxA-4760](#) apply.

———— **Note** —————

Pre-indexed and post-indexed addressing implies writeback.

- If $Rt<0> == '1'$, then one of the following behaviors can occur:
 - The instruction is UNDEFINED.
 - The instruction executes as a NOP.
 - The behavior is the same as if $Rt<0> == '0'$.
 - The registers accessed are both specified by Rt. For example, Rt and Rt+1 are the same, and both have bit[0] equal to 1.
 - The registers accessed are specified by Rt and Rt+1.

———— **Note** —————

This does not apply if Rt=='1111'.

- If P == '0' && W == '1', then one of the following behaviors can occur:
 - The instruction is UNDEFINED.
 - The instruction is treated as a NOP.
 - The instruction behaves as if the values of P and W were one of:
 - P == '1' && W == '0'
 - P == '1' && W == '1'
 - P == '0' && W == '0'

STRD (register)

For a description of this instruction and the encoding, see [STRD \(register\)](#) on page F7-2894.

CONSTRAINED UNPREDICTABLE behavior

For all encodings:

- If t2 == 15, then one of the following behaviors can occur:
 - The instruction is UNDEFINED.
 - The instruction executes as a NOP.
 - The store instruction performs the store using the specified addressing mode but the value corresponding to R15 is UNKNOWN.
- If wback && (n == t || n == t2), then one of the following behaviors can occur:
 - The instruction is UNDEFINED.
 - The instruction executes as a NOP.
 - The instruction performs the store of the registers specified using the specified addressing mode but the value of the registers stored is UNKNOWN.
- The value used by stores using R15 as a base register follow the requirements described in [Using R15](#) on page AppxA-4760.
- If wback && n == 15, then one of the following behaviors can occur:
 - The instruction is UNDEFINED.
 - The instruction executes as a NOP.
 - The store instruction operates without writeback.

———— **Note** —————

This is consistent with ignoring writes to the PC.

- The instruction uses the addressing mode described in the equivalent immediate offset instruction. If this results in writeback to the PC, then the requirements described in [Using R15](#) on page AppxA-4760 apply.

———— **Note** —————

Pre-indexed and post-indexed addressing implies writeback.

- If Rt<0>=='1', then one of the following behaviors can occur:
 - The instruction is UNDEFINED.
 - The instruction executes as a NOP.
 - The behavior is the same as if Rt<0>=='0'.

- The registers accessed are both specified by Rt. For example, Rt and Rt+1 are the same, and both have bit[0] equal to 1.
- The registers accessed are specified by Rt and Rt+1.

————— **Note** —————

This does not apply if Rt== '1111'.

- If P == '0' && W == '1', then one of the following behaviors can occur:
 - The instruction is UNDEFINED.
 - The instruction is treated as a NOP.
 - The instruction behaves as if the values of P and W were one of:
 - P == '1' && W == '0'
 - P == '1' && W == '1'
 - P == '0' && W == '0'

STREX

For a description of this instruction and the encoding, see [STREX on page F7-2896](#).

CONSTRAINED UNPREDICTABLE behavior

For all encodings:

- If d == t, then one of the following behaviors can occur:
 - The instruction is UNDEFINED.
 - The instruction executes as a NOP.
 - The store instruction executes, but the value stored is UNKNOWN.
- If d == n, then one of the following behaviors can occur:
 - The instruction is UNDEFINED.
 - The instruction executes as a NOP.
 - The instruction performs the store to an UNKNOWN address.
- If the Store-Exclusive is to any type of Device memory, then the instruction operates as if the access were to Normal memory.
- If the instruction specifies that t2==15, then the requirements described in [Using R15 on page AppxA-4760](#) apply.

STREXB

For a description of this instruction and the encoding, see [STREXB on page F7-2898](#).

CONSTRAINED UNPREDICTABLE behavior

For all encodings:

- If d == t, then one of the following behaviors can occur:
 - The instruction is UNDEFINED.
 - The instruction executes as a NOP.
 - The store instruction executes, but the value stored is UNKNOWN.
- If d == n, then one of the following behaviors can occur:
 - The instruction is UNDEFINED.
 - The instruction executes as a NOP.
 - The instruction performs the store to an UNKNOWN address.

- If the Store-Exclusive is to any type of Device memory, then the instruction operates as if the access were to Normal memory.
- If the instruction specifies that $t2==15$, then the requirements described in [Using R15 on page AppxA-4760](#) apply.

STREXD

For a description of this instruction and the encoding, see [STREXD on page F7-2900](#).

CONSTRAINED UNPREDICTABLE behavior

For all encodings:

- If $d == t$, then one of the following behaviors can occur:
 - The instruction is UNDEFINED.
 - The instruction executes as a NOP.
 - The store instruction executes, but the value stored is UNKNOWN.
- If $d == n$, then one of the following behaviors can occur:
 - The instruction is UNDEFINED.
 - The instruction executes as a NOP.
 - The instruction performs the store to an UNKNOWN address.
- If the Store-Exclusive is to any type of Device memory, then the instruction operates as if the access were to Normal memory.
- If the instruction specifies that $t2==15$, then the requirements described in [Using R15 on page AppxA-4760](#) apply.

For the A1 encoding:

- If $Rt<0>== '1'$, then one of the following behaviors can occur:
 - The instruction is UNDEFINED.
 - The instruction executes as a NOP.
 - The behavior is the same as if $Rt<0>== '0'$.
 - The register accessed are both specified by Rt . For example, Rt and $Rt+1$ are the same, and both have $bit[0] == 1$.
 - The registers accessed are specified by Rt and $R+1$.

STREXH

For a description of this instruction and the encoding, see [STREXH on page F7-2902](#).

CONSTRAINED UNPREDICTABLE behavior

For all encodings:

- If $d == t$, then one of the following behaviors can occur:
 - The instruction is UNDEFINED.
 - The instruction executes as a NOP.
 - The store instruction executes, but the value stored is UNKNOWN.
- If $d == n$, then one of the following behaviors can occur:
 - The instruction is UNDEFINED.
 - The instruction executes as a NOP.
 - The instruction performs the store to an UNKNOWN address.

- If the Store-Exclusive is to any type of Device memory, then the instruction operates as if the access were to Normal memory.
- If the instruction specifies that $t2=15$, then the requirements described in [Using R15 on page AppxA-4760](#) apply.

STLEX

For a description of this instruction and the encoding, see [STLEX on page F7-2860](#).

CONSTRAINED UNPREDICTABLE behavior

For all encodings:

- If $d == t$, then one of the following behaviors can occur:
 - The instruction is UNDEFINED.
 - The instruction executes as a NOP.
 - The store instruction executes, but the value stored is UNKNOWN.
- If $d == n$, then one of the following behaviors can occur:
 - The instruction is UNDEFINED.
 - The instruction executes as a NOP.
 - The instruction performs the store to an UNKNOWN address.
- If the Store-Exclusive is to any type of Device memory, then the instruction operates as if the access were to Normal memory.
- If the instruction specifies that $t2=15$, then the requirements described in [Using R15 on page AppxA-4760](#) apply.

STLEXB

For a description of this instruction and the encoding, see [STLEXB on page F7-2862](#).

CONSTRAINED UNPREDICTABLE behavior

For all encodings:

- If $d == t$, then one of the following behaviors can occur:
 - The instruction is UNDEFINED.
 - The instruction executes as a NOP.
 - The store instruction executes, but the value stored is UNKNOWN.
- If $d == n$, then one of the following behaviors can occur:
 - The instruction is UNDEFINED.
 - The instruction executes as a NOP.
 - The instruction performs the store to an UNKNOWN address.
- If the Store-Exclusive is to any type of Device memory, then the instruction operates as if the access were to Normal memory.
- If the instruction specifies that $t2=15$, then the requirements described in [Using R15 on page AppxA-4760](#) apply.

STLEXD

For a description of this instruction and the encoding, see [STLEXD on page F7-2864](#).

CONSTRAINED UNPREDICTABLE behavior

For all encodings:

- If $d == t$, then one of the following behaviors can occur:
 - The instruction is UNDEFINED.
 - The instruction executes as a NOP.
 - The store instruction executes, but the value stored is UNKNOWN.
- If $d == n$, then one of the following behaviors can occur:
 - The instruction is UNDEFINED.
 - The instruction executes as a NOP.
 - The instruction performs the store to an UNKNOWN address.
- If the Store-Exclusive is to any type of Device memory, then the instruction operates as if the access were to Normal memory.
- If the instruction specifies that $t2==15$, then the requirements described in [Using R15 on page AppxA-4760](#) apply.

For the A1 encoding:

- If $Rt<0>== '1'$, then one of the following behaviors can occur:
 - The instruction is UNDEFINED.
 - The instruction executes as a NOP.
 - The behavior is the same as if $Rt<0>== '0'$.
 - The register accessed are both specified by Rt . For example, Rt and $Rt+1$ are the same, and both have $bit[0] == 1$.
 - The registers accessed are specified by Rt and $R+1$.

STLEXH

For a description of this instruction and the encoding, see [STLEXH on page F7-2866](#).

CONSTRAINED UNPREDICTABLE behavior

For all encodings:

- If $d == t$, then one of the following behaviors can occur:
 - The instruction is UNDEFINED.
 - The instruction executes as a NOP.
 - The store instruction executes, but the value stored is UNKNOWN.
- If $d == n$, then one of the following behaviors can occur:
 - The instruction is UNDEFINED.
 - The instruction executes as a NOP.
 - The instruction performs the store to an UNKNOWN address.
- If the Store-Exclusive is to any type of Device memory, then the instruction operates as if the access were to Normal memory.
- If the instruction specifies that $t2==15$, then the requirements described in [Using R15 on page AppxA-4760](#) apply.

VCVT (between floating-point and fixed-point)

For a description of this instruction and the encoding, see [VCVT \(between floating-point and fixed-point, floating-point\) on page F8-3148](#).

CONSTRAINED UNPREDICTABLE behavior

For all encodings:

- If `frac_bits < 0`, then one of the following behaviors can occur:
 - The instruction is UNDEFINED.
 - The instruction executes as a NOP.
 - The result of the conversion is UNKNOWN.

If this instruction is not UNDEFINED, then whether it is affected by traps or enables relating to the use of the SIMD&FP registers when it is CONSTRAINED UNPREDICTABLE is IMPLEMENTATION DEFINED. The implementation must ensure that the CONSTRAINED UNPREDICTABLE behavior does not corrupt registers that are not accessible at the current Exception level by instructions that are not CONSTRAINED UNPREDICTABLE.

VLD1 (multiple single elements)

For a description of this instruction and the encoding, see [VLD1 \(multiple single elements\)](#) on page F8-3174.

CONSTRAINED UNPREDICTABLE behavior

For all encodings:

- If `d+regs > 32`, then one of the following behaviors can occur:
 - The instruction is UNDEFINED.
 - The instruction executes as a NOP.
 - One or more of the SIMD and floating-point registers are UNKNOWN. If the instruction specifies writeback, the base register becomes UNKNOWN. This behavior does not affect any general-purpose registers.

If this instruction is not UNDEFINED, then whether it is affected by traps or enables relating to the use of the SIMD&FP registers when it is CONSTRAINED UNPREDICTABLE is IMPLEMENTATION DEFINED. The implementation must ensure that the CONSTRAINED UNPREDICTABLE behavior does not corrupt registers that are not accessible at the current Exception level by instructions that are not CONSTRAINED UNPREDICTABLE.

VLD1 (single element to all lanes)

For a description of this instruction and the encoding, see [VLD1 \(single element to all lanes\)](#) on page F8-3178.

CONSTRAINED UNPREDICTABLE behavior

For all encodings:

- If `d+regs > 32`, then one of the following behaviors can occur:
 - The instruction is UNDEFINED.
 - The instruction executes as a NOP.
 - One or more of the SIMD and floating-point registers are UNKNOWN. If the instruction specifies writeback, the base register becomes UNKNOWN. This behavior does not affect any general-purpose registers.

If this instruction is not UNDEFINED, then whether it is affected by traps or enables relating to the use of the SIMD&FP registers when it is CONSTRAINED UNPREDICTABLE is IMPLEMENTATION DEFINED. The implementation must ensure that the CONSTRAINED UNPREDICTABLE behavior does not corrupt registers that are not accessible at the current Exception level by instructions that are not CONSTRAINED UNPREDICTABLE.

VLD2 (multiple 2-element structures)

For a description of this instruction and the encoding, see [VLD2 \(multiple 2-element structures\)](#) on page F8-3180.

CONSTRAINED UNPREDICTABLE behavior

For all encodings:

- If $d2 + \text{regs} > 32$, then one of the following behaviors can occur:
 - The instruction is UNDEFINED.
 - The instruction executes as a NOP.
 - One or more of the SIMD and floating-point registers are UNKNOWN. If the instruction specifies writeback, the base register becomes UNKNOWN. This behavior does not affect any general-purpose registers.

If this instruction is not UNDEFINED, then whether it is affected by traps or enables relating to the use of the SIMD&FP registers when it is CONSTRAINED UNPREDICTABLE is IMPLEMENTATION DEFINED. The implementation must ensure that the CONSTRAINED UNPREDICTABLE behavior does not corrupt registers that are not accessible at the current Exception level by instructions that are not CONSTRAINED UNPREDICTABLE.

VLD2 (single 2-element structure to one lane)

For a description of this instruction and the encoding, see [VLD2 \(single 2-element structure to one lane\) on page F8-3182](#).

CONSTRAINED UNPREDICTABLE behavior

For all encodings:

- If $d2 > 31$, then one of the following behaviors can occur:
 - The instruction is UNDEFINED.
 - The instruction executes as a NOP.
 - One or more of the SIMD and floating-point registers are UNKNOWN. If the instruction specifies writeback, the base register becomes UNKNOWN. This behavior does not affect any general-purpose registers.

If this instruction is not UNDEFINED, then whether it is affected by traps or enables relating to the use of the SIMD&FP registers when it is CONSTRAINED UNPREDICTABLE is IMPLEMENTATION DEFINED. The implementation must ensure that the CONSTRAINED UNPREDICTABLE behavior does not corrupt registers that are not accessible at the current Exception level by instructions that are not CONSTRAINED UNPREDICTABLE.

VLD2 (single 2-element structure to all lanes)

For a description of this instruction and the encoding, see [VLD2 \(single 2-element structure to all lanes\) on page F8-3184](#).

CONSTRAINED UNPREDICTABLE behavior

For all encodings:

- If $d2 > 31$, then one of the following behaviors can occur:
 - The instruction is UNDEFINED.
 - The instruction executes as a NOP.
 - One or more of the SIMD and floating-point registers are UNKNOWN. If the instruction specifies writeback, the base register becomes UNKNOWN. This behavior does not affect any general-purpose registers.

If this instruction is not UNDEFINED, then whether it is affected by traps or enables relating to the use of the SIMD&FP registers when it is CONSTRAINED UNPREDICTABLE is IMPLEMENTATION DEFINED. The implementation must ensure that the CONSTRAINED UNPREDICTABLE behavior does not corrupt registers that are not accessible at the current Exception level by instructions that are not CONSTRAINED UNPREDICTABLE.

VLD3 (multiple 3-element structures)

For a description of this instruction and the encoding, see [VLD3 \(multiple 3-element structures\)](#) on page F8-3186.

CONSTRAINED UNPREDICTABLE behavior

For all encodings:

- If $d3 > 31$, then one of the following behaviors can occur:
 - The instruction is UNDEFINED.
 - The instruction executes as a NOP.
 - One or more of the SIMD and floating-point registers are UNKNOWN. If the instruction specifies writeback, the base register becomes UNKNOWN. This behavior does not affect any general-purpose registers.

If this instruction is not UNDEFINED, then whether it is affected by traps or enables relating to the use of the SIMD&FP registers when it is CONSTRAINED UNPREDICTABLE is IMPLEMENTATION DEFINED. The implementation must ensure that the CONSTRAINED UNPREDICTABLE behavior does not corrupt registers that are not accessible at the current Exception level by instructions that are not CONSTRAINED UNPREDICTABLE.

VLD3 (single 3-element structure to one lane)

For a description of this instruction and the encoding, see [VLD3 \(single 3-element structure to one lane\)](#) on page F8-3188.

CONSTRAINED UNPREDICTABLE behavior

For all encodings:

- If $d3 > 31$, then one of the following behaviors can occur:
 - The instruction is UNDEFINED.
 - The instruction executes as a NOP.
 - One or more of the SIMD and floating-point registers are UNKNOWN. If the instruction specifies writeback, the base register becomes UNKNOWN. This behavior does not affect any general-purpose registers.

If this instruction is not UNDEFINED, then whether it is affected by traps or enables relating to the use of the SIMD&FP registers when it is CONSTRAINED UNPREDICTABLE is IMPLEMENTATION DEFINED. The implementation must ensure that the CONSTRAINED UNPREDICTABLE behavior does not corrupt registers that are not accessible at the current Exception level by instructions that are not CONSTRAINED UNPREDICTABLE.

VLD3 (single 3-element structure to all lanes)

For a description of this instruction and the encoding, see [VLD3 \(single 3-element structure to all lanes\)](#) on page F8-3190.

CONSTRAINED UNPREDICTABLE behavior

For all encodings:

- If $d+regs > 32$, then one of the following behaviors can occur:
 - The instruction is UNDEFINED.
 - The instruction executes as a NOP.
 - One or more of the SIMD and floating-point registers are UNKNOWN. If the instruction specifies writeback, the base register becomes UNKNOWN. This behavior does not affect any general-purpose registers.

If this instruction is not UNDEFINED, then whether it is affected by traps or enables relating to the use of the SIMD&FP registers when it is CONSTRAINED UNPREDICTABLE is IMPLEMENTATION DEFINED. The implementation must ensure that the CONSTRAINED UNPREDICTABLE behavior does not corrupt registers that are not accessible at the current Exception level by instructions that are not CONSTRAINED UNPREDICTABLE.

VLD4 (multiple 4-element structures)

For a description of this instruction and the encoding, see [VLD4 \(multiple 4-element structures\)](#) on page F8-3192.

CONSTRAINED UNPREDICTABLE behavior

If $d3 > 31$, then one of the following behaviors can occur:

- The instruction is UNDEFINED.
- The instruction executes as a NOP.
- One or more of the SIMD and floating-point registers are UNKNOWN. If the instruction specifies writeback, the base register becomes UNKNOWN. This behavior does not affect any general-purpose registers.

If this instruction is not UNDEFINED, then whether it is affected by traps or enables relating to the use of the SIMD&FP registers when it is CONSTRAINED UNPREDICTABLE is IMPLEMENTATION DEFINED. The implementation must ensure that the CONSTRAINED UNPREDICTABLE behavior does not corrupt registers that are not accessible at the current Exception level by instructions that are not CONSTRAINED UNPREDICTABLE.

VLD4 (single 4-element structure to one lane)

For a description of this instruction and the encoding, see [VLD4 \(single 4-element structure to one lane\)](#) on page F8-3194.

CONSTRAINED UNPREDICTABLE behavior

For all encodings:

- If $d4 > 31$, then one of the following behaviors can occur:
 - The instruction is UNDEFINED.
 - The instruction executes as a NOP.
 - One or more of the SIMD and floating-point registers are UNKNOWN. If the instruction specifies writeback, the base register becomes UNKNOWN. This behavior does not affect any general-purpose registers.

If this instruction is not UNDEFINED, then whether it is affected by traps or enables relating to the use of the SIMD&FP registers when it is CONSTRAINED UNPREDICTABLE is IMPLEMENTATION DEFINED. The implementation must ensure that the CONSTRAINED UNPREDICTABLE behavior does not corrupt registers that are not accessible at the current Exception level by instructions that are not CONSTRAINED UNPREDICTABLE.

VLD4 (single 4-element structure to all lanes)

For a description of this instruction and the encoding, see [VLD4 \(single 4-element structure to all lanes\)](#) on page F8-3196.

CONSTRAINED UNPREDICTABLE behavior

For all encodings:

- If $d4 > 31$, then one of the following behaviors can occur:
 - The instruction is UNDEFINED.
 - The instruction executes as a NOP.
 - One or more of the SIMD and floating-point registers are UNKNOWN. If the instruction specifies writeback, the base register becomes UNKNOWN. This behavior does not affect any general-purpose registers.

If this instruction is not UNDEFINED, then whether it is affected by traps or enables relating to the use of the SIMD&FP registers when it is CONSTRAINED UNPREDICTABLE is IMPLEMENTATION DEFINED. The implementation must ensure that the CONSTRAINED UNPREDICTABLE behavior does not corrupt registers that are not accessible at the current Exception level by instructions that are not CONSTRAINED UNPREDICTABLE.

VLDM

For a description of this instruction and the encoding, see [VLDM on page F8-3198](#).

CONSTRAINED UNPREDICTABLE behavior

For all encodings:

- If `regs == 0`, then one of the following behaviors can occur:
 - The instruction is UNDEFINED.
 - The instruction executes as a NOP.
 - The instruction operates as a VLDM or a VPOP with the same addressing mode but loads no registers.
- If the register list includes a register that is out of range, then one of the following behaviors can occur:
 - The instruction is UNDEFINED.
 - The instruction executes as a NOP.
 - One or more of the SIMD&FP registers become UNKNOWN. If the instruction specifies writeback, the base register becomes UNKNOWN. This behavior does not affect any general-purpose registers.

Note

Out of range means that the register list includes:

- A register with a number greater than the number of registers implemented.
- More than 16 double word registers.
- A double word register greater than D16 with an odd value of `imm8`.

If this instruction is not UNDEFINED, then whether it is affected by traps or enables relating to the use of the SIMD&FP registers when it is CONSTRAINED UNPREDICTABLE is IMPLEMENTATION DEFINED. The implementation must ensure that the CONSTRAINED UNPREDICTABLE behavior does not corrupt registers that are not accessible at the current Exception level by instructions that are not CONSTRAINED UNPREDICTABLE.

VPOP

For a description of this instruction and the encoding, see [VPOP on page F8-3268](#).

CONSTRAINED UNPREDICTABLE behavior

For all encodings:

- If `regs == 0`, then one of the following behaviors can occur:
 - The instruction is UNDEFINED.
 - The instruction executes as a NOP.
 - The instruction operates as a VLDM or a VPOP with the same addressing mode but loads no registers.
- If the register list includes a register that is out of range, then one of the following behaviors can occur:
 - The instruction is UNDEFINED.
 - The instruction executes as a NOP.
 - One or more of the SIMD&FP registers become UNKNOWN. If the instruction specifies writeback, the base register becomes UNKNOWN. This behavior does not affect any general-purpose registers.

Note

Out of range means that the register list includes:

- A register with a number greater than the number of registers implemented.
- More than 16 double word registers.
- A double word register greater than D16 with an odd value of `imm8`.

If this instruction is not UNDEFINED, then whether it is affected by traps or enables relating to the use of the SIMD&FP registers when it is CONSTRAINED UNPREDICTABLE is IMPLEMENTATION DEFINED. The implementation must ensure that the CONSTRAINED UNPREDICTABLE behavior does not corrupt registers that are not accessible at the current Exception level by instructions that are not CONSTRAINED UNPREDICTABLE.

VMOV (between two general-purpose registers and two single-precision registers)

For a description of this instruction and the encoding, see [VMOV \(between two general-purpose registers and two single-precision registers\)](#) on page F8-3224.

CONSTRAINED UNPREDICTABLE behavior

For all encodings:

- If $to_arm_registers \ \&\& \ t == t2$, then one of the following behaviors can occur:
 - The instruction is UNDEFINED.
 - The instruction executes as a NOP.
 - The destination register becomes UNKNOWN.

If this instruction is not UNDEFINED, then whether it is affected by traps or enables relating to the use of the SIMD&FP registers when it is CONSTRAINED UNPREDICTABLE is IMPLEMENTATION DEFINED. The implementation must ensure that the CONSTRAINED UNPREDICTABLE behavior does not corrupt registers that are not accessible at the current Exception level by instructions that are not CONSTRAINED UNPREDICTABLE.

- If $m == 31$, then one of the following behaviors can occur:
 - The instruction is UNDEFINED.
 - The instruction executes as a NOP.
 - One or more of the SIMD&FP single-precision registers become UNKNOWN for a move to the single-precision register. The general-purpose registers listed in the instruction become UNKNOWN for a move from the single-precision registers. This behavior does not affect any other general-purpose registers.

VMOV (between two general-purpose registers and a doubleword extension register)

For a description of this instruction and the encoding, see [VMOV \(between two general-purpose registers and a doubleword extension register\)](#) on page F8-3226.

CONSTRAINED UNPREDICTABLE behavior

For all encodings:

- If $to_arm_registers \ \&\& \ t == t2$, then one of the following behaviors can occur:
 - The instruction is UNDEFINED.
 - The instruction executes as a NOP.
 - The destination register becomes UNKNOWN.

If this instruction is not UNDEFINED, then whether it is affected by traps or enables relating to the use of the SIMD&FP registers when it is CONSTRAINED UNPREDICTABLE is IMPLEMENTATION DEFINED. The implementation must ensure that the CONSTRAINED UNPREDICTABLE behavior does not corrupt registers that are not accessible at the current Exception level by instructions that are not CONSTRAINED UNPREDICTABLE.

VST1 (multiple single elements)

For a description of this instruction and the encoding, see [VST1 \(multiple single elements\)](#) on page F8-3356.

CONSTRAINED UNPREDICTABLE behavior

For all encodings:

- If $d+regs > 32$, then one of the following behaviors can occur:
 - The instruction is UNDEFINED.
 - The instruction executes as a NOP.
 - The memory locations specified by the instruction and the number of registers specified by the instruction if the register list had not gone out of range, become UNKNOWN. If the instruction specifies writeback, then that register become unknown. This behavior does not affect any other memory locations.

If this instruction is not UNDEFINED, then whether it is affected by traps or enables relating to the use of the SIMD&FP registers when it is CONSTRAINED UNPREDICTABLE is IMPLEMENTATION DEFINED. The implementation must ensure that the CONSTRAINED UNPREDICTABLE behavior does not corrupt registers that are not accessible at the current Exception level by instructions that are not CONSTRAINED UNPREDICTABLE.

VST2 (multiple 2-element structures)

For a description of this instruction and the encoding, see [VST2 \(multiple 2-element structures\)](#) on page F8-3360.

CONSTRAINED UNPREDICTABLE behavior

For all encodings:

- If $d2+regs > 32$, then one of the following behaviors can occur:
 - The instruction is UNDEFINED.
 - The instruction executes as a NOP.
 - The memory locations specified by the instruction and the number of registers specified by the instruction if the register list had not gone out of range, become UNKNOWN. If the instruction specifies writeback, then that register become unknown. This behavior does not affect any other memory locations.

If this instruction is not UNDEFINED, then whether it is affected by traps or enables relating to the use of the SIMD&FP registers when it is CONSTRAINED UNPREDICTABLE is IMPLEMENTATION DEFINED. The implementation must ensure that the CONSTRAINED UNPREDICTABLE behavior does not corrupt registers that are not accessible at the current Exception level by instructions that are not CONSTRAINED UNPREDICTABLE.

VST2 (single 2-element structure from one lane)

For a description of this instruction and the encoding, see [VST2 \(single 2-element structure from one lane\)](#) on page F8-3362.

CONSTRAINED UNPREDICTABLE behavior

For all encodings:

- If $d2 > 31$, then one of the following behaviors can occur:
 - The instruction is UNDEFINED.
 - The instruction executes as a NOP.
 - The memory locations specified by the instruction and the number of registers specified by the instruction if the register list had not gone out of range, become UNKNOWN. If the instruction specifies writeback, then that register become unknown. This behavior does not affect any other memory locations.

If this instruction is not UNDEFINED, then whether it is affected by traps or enables relating to the use of the SIMD&FP registers when it is CONSTRAINED UNPREDICTABLE is IMPLEMENTATION DEFINED. The implementation must ensure that the CONSTRAINED UNPREDICTABLE behavior does not corrupt registers that are not accessible at the current Exception level by instructions that are not CONSTRAINED UNPREDICTABLE.

VST3 (multiple 3-element structures)

For a description of this instruction and the encoding, see [VST3 \(multiple 3-element structures\)](#) on page F8-3364.

CONSTRAINED UNPREDICTABLE behavior

For all encodings:

- If $d3 > 31$, then one of the following behaviors can occur:
 - The instruction is UNDEFINED.
 - The instruction executes as a NOP.
 - The memory locations specified by the instruction and the number of registers specified by the instruction if the register list had not gone out of range, become UNKNOWN. If the instruction specifies writeback, then that register become unknown. This behavior does not affect any other memory locations.

If this instruction is not UNDEFINED, then whether it is affected by traps or enables relating to the use of the SIMD&FP registers when it is CONSTRAINED UNPREDICTABLE is IMPLEMENTATION DEFINED. The implementation must ensure that the CONSTRAINED UNPREDICTABLE behavior does not corrupt registers that are not accessible at the current Exception level by instructions that are not CONSTRAINED UNPREDICTABLE.

VST3 (single 3-element structure from one lane)

For a description of this instruction and the encoding, see [VST3 \(single 3-element structure from one lane\)](#) on page F8-3366.

CONSTRAINED UNPREDICTABLE behavior

For all encodings:

- If $d3 > 31$, then one of the following behaviors can occur:
 - The instruction is UNDEFINED.
 - The instruction executes as a NOP.
 - The memory locations specified by the instruction and the number of registers specified by the instruction if the register list had not gone out of range, become UNKNOWN. If the instruction specifies writeback, then that register become unknown. This behavior does not affect any other memory locations.

If this instruction is not UNDEFINED, then whether it is affected by traps or enables relating to the use of the SIMD&FP registers when it is CONSTRAINED UNPREDICTABLE is IMPLEMENTATION DEFINED. The implementation must ensure that the CONSTRAINED UNPREDICTABLE behavior does not corrupt registers that are not accessible at the current Exception level by instructions that are not CONSTRAINED UNPREDICTABLE.

VST4 (multiple 4-element structures)

For a description of this instruction and the encoding, see [VST4 \(multiple 4-element structures\)](#) on page F8-3368.

CONSTRAINED UNPREDICTABLE behavior

For all encodings:

- If $d4 > 31$, then one of the following behaviors can occur:
 - The instruction is UNDEFINED.
 - The instruction executes as a NOP.
 - The memory locations specified by the instruction and the number of registers specified by the instruction if the register list had not gone out of range, become UNKNOWN. If the instruction specifies writeback, then that register become unknown. This behavior does not affect any other memory locations.

If this instruction is not UNDEFINED, then whether it is affected by traps or enables relating to the use of the SIMD&FP registers when it is CONSTRAINED UNPREDICTABLE is IMPLEMENTATION DEFINED. The implementation must ensure that the CONSTRAINED UNPREDICTABLE behavior does not corrupt registers that are not accessible at the current Exception level by instructions that are not CONSTRAINED UNPREDICTABLE.

VST4 (single 4-element structure from one lane)

For a description of this instruction and the encoding, see [VST4 \(single 4-element structure from one lane\)](#) on page F8-3370.

CONSTRAINED UNPREDICTABLE behavior

For all encodings:

- If $d4 > 31$, then one of the following behaviors can occur:
 - The instruction is UNDEFINED.
 - The instruction executes as a NOP.
 - The memory locations specified by the instruction and the number of registers specified by the instruction if the register list had not gone out of range, become UNKNOWN. If the instruction specifies writeback, then that register become unknown. This behavior does not affect any other memory locations.

If this instruction is not UNDEFINED, then whether it is affected by traps or enables relating to the use of the SIMD&FP registers when it is CONSTRAINED UNPREDICTABLE is IMPLEMENTATION DEFINED. The implementation must ensure that the CONSTRAINED UNPREDICTABLE behavior does not corrupt registers that are not accessible at the current Exception level by instructions that are not CONSTRAINED UNPREDICTABLE.

VSTM

For a description of this instruction and the encoding, see [VSTM](#) on page F8-3372.

CONSTRAINED UNPREDICTABLE behavior

For all encodings:

- If $regs == 0$, then one of the following behaviors can occur:
 - The instruction is UNDEFINED.
 - The instruction executes as a NOP.
 - The instruction operates as a VSTM or VPUSH with the same addressing mode but loads no registers.
- If the register list includes a register that is out of range, then one of the following behaviors can occur:
 - The instruction is UNDEFINED.
 - The instruction executes as a NOP.
 - The memory locations specified by the instruction and the number of registers specified by the instruction if the register list had not gone out of range, become UNKNOWN. If the instruction specifies writeback, then that register become unknown. This behavior does not affect any other memory locations.

———— Note —————

Out of range means that the register list includes:

- A register with a number greater than the number of registers implemented.
- More than 16 double word registers.
- A double word register greater than D16 with an odd value of $imm8$.

If this instruction is not UNDEFINED, then whether it is affected by traps or enables relating to the use of the SIMD&FP registers when it is CONSTRAINED UNPREDICTABLE is IMPLEMENTATION DEFINED. The implementation must ensure that the CONSTRAINED UNPREDICTABLE behavior does not corrupt registers that are not accessible at the current Exception level by instructions that are not CONSTRAINED UNPREDICTABLE.

VPUSH

For a description of this instruction and the encoding, see [VPUSH](#) on page F8-3270.

CONSTRAINED UNPREDICTABLE behavior

For all encodings:

- If $\text{regs} == 0$, then one of the following behaviors can occur:
 - The instruction is UNDEFINED.
 - The instruction executes as a NOP.
 - The instruction operates as a VSTM or VPUSH with the same addressing mode but loads no registers.
- If the register list includes a register that is out of range, then one of the following behaviors can occur:
 - The instruction is UNDEFINED.
 - The instruction executes as a NOP.
 - The memory locations specified by the instruction and the number of registers specified by the instruction if the register list had not gone out of range, become UNKNOWN. If the instruction specifies writeback, then that register become unknown. This behavior does not affect any other memory locations.

———— Note —————

Out of range means that the register list includes:

- A register with a number greater than the number of registers implemented.
- More than 16 double word registers.
- A double word register greater than D16 with an odd value of imm8 .

If this instruction is not UNDEFINED, then whether it is affected by traps or enables relating to the use of the SIMD&FP registers when it is CONSTRAINED UNPREDICTABLE is IMPLEMENTATION DEFINED. The implementation must ensure that the CONSTRAINED UNPREDICTABLE behavior does not corrupt registers that are not accessible at the current Exception level by instructions that are not CONSTRAINED UNPREDICTABLE.

VTBL, VTBX

For a description of this instruction and the encoding, see [VTBL, VTBX](#) on page F8-3386.

CONSTRAINED UNPREDICTABLE behavior

For all encodings:

- If $n + \text{length} > 32$, then one of the following behaviors can occur:
 - The instruction is UNDEFINED.
 - The instruction executes as a NOP.
 - One or more of the SIMD&FP registers become UNKNOWN. This behavior does not affect any general-purpose registers.

A.1.3 CONSTRAINED UNPREDICTABLE behavior, A32 and T32 system instructions

This section lists the CONSTRAINED UNPREDICTABLE behavior for the different A32 and T32 system instructions listed in [Alphabetical list of system instructions](#) on page F7-3033 in alphabetical order. Unless specifically stated otherwise, the CONSTRAINED UNPREDICTABLE behavior applies to all encodings that can result in CONSTRAINED UNPREDICTABLE behavior,

CPS (A32)

For a description of this instruction and the encoding, see [CPS \(A32\) on page F7-3036](#).

CONSTRAINED UNPREDICTABLE behavior

If the instruction transfers an illegal mode encoding to the **CPSR** mode field, then this invokes the Illegal Exception Return mechanism by not the changing the mode, and setting **CPSR.IL**.

————— Note —————

- An illegal mode encoding is either an UNALLOCATED mode encoding or one that is not accessible at the current Exception level.
- CPS executed from User mode acts as a NOP.

For the A1 encoding:

- If $(\text{imod} == '00 \ \&\& \ M == '0') \ || \ \text{imod} == '01'$, then one of the following behaviors can occur:
 - The instruction is UNDEFINED.
 - The instruction executes as a NOP.
- If $\text{mode} != '00000' \ \&\& \ M == '0'$, then one of the following behaviors can occur:
 - The instruction is UNDEFINED.
 - The instruction executes as a NOP.
 - The instruction operates as if $M == '1'$.
 - The instruction operates as if $\text{mode} == '0000'$.
- If $(\text{imod}<1> == '1' \ \&\& \ A:I:F == '000')$, then one of the following behaviors can occur:
 - The instruction is UNDEFINED.
 - The instruction executes as a NOP.
 - The instruction behaves as if $\text{imod}<1> == '0'$.
 - The instruction behaves as if A:I:F had an UNKNOWN nonzero value.
- If $(\text{imod}<1> == '0' \ \&\& \ A:I:F != 000)$ then one of the following behaviors can occur:
 - The instruction is UNDEFINED.
 - The instruction executes as a NOP.
 - The instruction behaves as if $\text{imod}<1> == '1'$.
 - The instruction behaves as if $A:I:F == 000$.

CPS (T32)

For a description of this instruction and the encoding, see [CPS \(T32\) on page F7-3034](#).

CONSTRAINED UNPREDICTABLE behavior

If the instruction transfers an illegal mode encoding to the **CPSR** mode field, then this invokes the Illegal Exception Return mechanism by not the changing the mode, and setting **CPSR.IL**.

————— Note —————

- An illegal mode encoding is either an UNALLOCATED mode encoding or one that is not accessible at the current Exception level.
- CPS executed from User mode acts as a NOP.

For the T1 encoding:

- If $A:I:F == '000'$, then one of the following behaviors can occur:
 - The instruction is UNDEFINED.
 - The instruction executes as a NOP.

For the T2 encoding:

- If $\text{imod} == '01'$, then one of the following behaviors can occur:
 - The instruction is UNDEFINED.
 - The instruction executes as a NOP.
- If $\text{mode} != '00000' \ \&\& \ M == '0'$, then one of the following behaviors can occur:
 - The instruction is UNDEFINED.
 - The instruction executes as a NOP.
 - The instruction operates as if $M == '1'$.
 - The instruction behaves as if $\text{mode} == '0000'$.
- If $(\text{imod}<1> == '1' \ \&\& \ A:I:F == '000')$, then one of the following behaviors can occur:
 - The instruction is UNDEFINED.
 - The instruction executes as a NOP.
 - The instruction behaves as if $\text{imod}<1> == '0'$.
 - The instruction behaves as if A:I:F had an UNKNOWN nonzero value.
- If $(\text{imod}<1> == '0' \ \&\& \ A:I:F != '000')$ then one of the following behaviors can occur:
 - The instruction is UNDEFINED.
 - The instruction executes as a NOP.
 - The instruction behaves as if $\text{imod}<1> == '1'$.
 - The instruction behaves as if A:I:F == '000'.

LDM (exception return)

For a description of this instruction and the encoding, see [LDM \(exception return\) on page F7-3042](#).

CONSTRAINED UNPREDICTABLE behavior

If this instruction is executed in User mode or in System mode, then one of the following behaviors can occur:

- The instruction is UNDEFINED.
- The instruction executes as a NOP.

If $\text{wback} \ \&\& \ \text{registers}<n> == '1'$, then one of the following behaviors can occur:

- The instruction is UNDEFINED.
- The instruction executes as a NOP.
- The instruction performs all the loads using the specified addressing mode and the content of the register being written back is UNKNOWN. In addition, if an exception occurs during the execution of this instruction, the base address might be corrupted so that the instruction cannot be repeated.

If the instruction transfers an illegal mode encoding to the CPSR mode field, then this invokes the Illegal Exception Return mechanism.

————— Note —————

An illegal mode encoding is either an UNALLOCATED mode encoding or one that is not accessible at the current Exception level.

LDM (User registers)

For a description of this instruction and the encoding, see [LDM \(User registers\) on page F7-3044](#).

CONSTRAINED UNPREDICTABLE behavior

If $\text{BitCount}(\text{registers}) < 1$, then one of the following behaviors can occur:

- The instruction is UNDEFINED.
- The instruction executes as a NOP.
- The instruction operates as an LDM with the same addressing mode but targeting an unspecified set of registers. These registers might include R15.

If this instruction is executed in User mode or in System mode, then one of the following behaviors can occur:

- The instruction is undefined.
- The instruction executes as a NOP.
- The instruction operates as an LDM with the same addressing mode but targeting an unspecified set of registers. These registers might include R15.

MRS

For a description of this instruction and the encoding, see [MRS on page F7-3046](#).

CONSTRAINED UNPREDICTABLE behavior

If this instruction is executed in User mode or in System mode and is accessing the [SPSR](#), then one of the following behaviors can occur:

- The instruction is UNDEFINED.
- The instruction executes as a NOP.

MSR (immediate)

For a description of this instruction and the encoding, see [MSR \(immediate\) on page F7-3052](#).

CONSTRAINED UNPREDICTABLE behavior

If this instruction is executed in User mode or in System mode and is accessing the [SPSR](#), then one of the following behaviors can occur:

- The instruction is UNDEFINED.
- The instruction executes as a NOP.

If $\text{mask} == '0000'$ && $R == '1'$, then one of the following behaviors can occur:

- The instruction is UNDEFINED.
- The instruction executes as a NOP.

If the instruction transfers an illegal mode encoding to the [CPSR](#) mode field, then this invokes the Illegal Exception Return mechanism by not the changing the mode, and setting [CPSR.IL](#).

———— **Note** —————

An illegal mode encoding is either an UNALLOCATED mode encoding or one that is not accessible at the current Exception level.

MSR (register)

For a description of this instruction and the encoding, see [MSR \(register\) on page F7-3054](#).

CONSTRAINED UNPREDICTABLE behavior

If this instruction is executed in User mode or in System mode and is accessing the [SPSR](#), then one of the following behaviors can occur:

- The instruction is UNDEFINED.
- The instruction executes as a NOP.

If mask == '0000', then one of the following behaviors can occur:

- The instruction is UNDEFINED.
- The instruction executes as a NOP.

If the instruction transfers an illegal mode encoding to the [CPSR](#) mode field, then this invokes the Illegal Exception Return mechanism by not the changing the mode, and setting [CPSR.IL](#).

———— **Note** ————

An illegal mode encoding is either an UNALLOCATED mode encoding or one that is not accessible at the current Exception level.

RFE

For a description of this instruction and the encoding, see [RFE on page F7-3056](#).

CONSTRAINED UNPREDICTABLE behavior

If this instruction is executed in User mode or in T32EE state, then one of the following behaviors can occur:

- The instruction is UNDEFINED.
- The instruction executes as a NOP.

If the instruction transfers an illegal mode encoding to the [CPSR](#) mode field, then this invokes the Illegal Exception Return mechanism.

———— **Note** ————

An illegal mode encoding is either an UNALLOCATED mode encoding or one that is not accessible at the current Exception level.

SRS (T32)

For a description of this instruction and the encoding, see [SRS \(T32\) on page F7-3060](#).

CONSTRAINED UNPREDICTABLE behavior

If this instruction is executed in User mode or in System mode, or the instruction is executed in T32EE state, then one of the following behaviors can occur:

- The instruction is UNDEFINED.
- The instruction executes as a NOP.

If the instruction specifies an illegal mode field, then one of the following behaviors can occur:

- The instruction is UNDEFINED.
- The instruction executes as a NOP.
- R13 of the current mode is used.
- The store occurs to an UNKNOWN address, and if the instruction specifies writeback, any general-purpose register that can be accessed without privilege violation from the current Exception level become unknown.

SRS (A32)

For a description of this instruction and the encoding, see [SRS \(A32\) on page F7-3062](#).

CONSTRAINED UNPREDICTABLE behavior

If this instruction is executed in User mode or in System mode, then one of the following behaviors can occur:

- The instruction is UNDEFINED.
- The instruction executes as a NOP.

If the instruction specifies an illegal mode field, then one of the following behaviors can occur:

- The instruction is UNDEFINED.
- The instruction executes as a NOP.
- R13 of the current mode is used.
- The store occurs to an UNKNOWN address, and if the instruction specifies writeback, any general-purpose register that can be accessed without privilege violation from the current Exception level become unknown.

STM (User registers)

For a description of this instruction and the encoding, see [STM \(User registers\) on page F7-3064](#).

CONSTRAINED UNPREDICTABLE behavior

If $\text{BitCount}(\text{registers}) < 1$, then one of the following behaviors can occur:

- The instruction is UNDEFINED.
- The instruction executes as a NOP.
- The instruction operates as an STM with the same addressing mode but targeting an unspecified set of registers. These registers might include R15.

If the instruction is executed from User mode or System mode, then one of the following behaviors can occur:

- The instruction is UNDEFINED.
- The instruction executes as a NOP.
- The instruction operates as an STM with the same addressing mode but targeting an unspecified set of registers. These registers might include R15.

SUBS PC, LR and related instructions (T32)

For a description of this instruction and the encoding, see [SUBS PC, LR and related instructions \(T32\) on page F7-3066](#).

CONSTRAINED UNPREDICTABLE behavior

If this instruction is executed in User mode or in System mode, or the instructions are executed in T32EE state, then one of the following behaviors can occur:

- The instruction is UNDEFINED.
- The instruction executes as a NOP.

If the instruction transfers an illegal mode encoding to the CPSR mode field, then this invokes the Illegal Exception Return mechanism.

———— **Note** —————

An illegal mode encoding is either an UNALLOCATED mode encoding or one that is not accessible at the current Exception level.

SUBS PC. LR and related instructions (A32)

For a description of this instruction and the encoding, see [SUBS PC, LR and related instructions \(A32\)](#) on page F7-3068.

CONSTRAINED UNPREDICTABLE behavior

If this instruction is executed in User mode or in System mode, then one of the following behaviors can occur:

- The instruction is UNDEFINED.
- The instruction executes as a NOP.

If the instruction transfers an illegal mode encoding to the CPSR mode field, then this invokes the Illegal Exception Return mechanism.

———— Note —————

An illegal mode encoding is either an UNALLOCATED mode encoding or one that is not accessible at the current Exception level.

VMRS

For a description of this instruction and the encoding, see [VMRS](#) on page F7-3070.

CONSTRAINED UNPREDICTABLE behavior

If $t == 15$ && $reg != '0001'$, then one of the following behaviors can occur:

- The instruction is UNDEFINED.
- The instruction executes as a NOP.
- The instruction transfers an UNKNOWN value to the specified general-purpose register.

In addition, `CheckVFPEnabled(FALSE)` can be called by this instruction for the CONSTRAINED UNPREDICTABLE cases.

VMSR

For a description of this instruction and the encoding, see [VMSR](#) on page F7-3072.

CONSTRAINED UNPREDICTABLE behavior

If $reg == "001x" || reg == "01xx"$, then one of the following behaviors can occur:

- The instruction is UNDEFINED.
- The instruction executes as a NOP.
- The instruction transfers the value in the general-purpose register to one of the allocated registers accessible using VMSR at the same Exception level.

In addition, `CheckVFPEnabled(FALSE)` can be called by this instruction for the CONSTRAINED UNPREDICTABLE cases.

A.1.4 CONSTRAINED UNPREDICTABLE behavior in Debug state

[Behavior in Debug state](#) on page H2-4341 of this manual describes the CONSTRAINED UNPREDICTABLE behaviors that are specifically associated with Debug state.

A.1.5 Using R13

In prior versions of the architecture, the use of R13 as a named register specifier was described as UNPREDICTABLE in the pseudocode. In the ARMv8-A architecture, the use of R13 as a named register specifier is not UNPREDICTABLE, and R13 can be used in the regular form. Bits[1:0] of R13 are not treated as RES0, but can hold any values programmed into them.

A.1.6 Using R15

All uses of R15 as a named register specifier for a source register that are described as CONSTRAINED UNPREDICTABLE in the pseudocode or in other places in this reference manual can do one of the following:

- Cause the instruction to be treated as an UNDEFINED instruction.
- Cause the instruction to execute as a NOP.
- Read the PC with the standard offset that applies for the current instruction set.
- Read the PC with the standard offset that applies for the current instruction set with alignment to a word boundary.
- Read 0.
- Read an UNKNOWN value.

All uses of R15 as a named register specifier for a destination register that are described as CONSTRAINED UNPREDICTABLE in the pseudocode or in other places in this reference manual can do one of the following:

- Cause the instruction to be treated as UNDEFINED.
- Cause the instruction to execute as a NOP.
- Ignore the write.
- Branch to an UNKNOWN location in either A32 or T32 state.

The choice between these behaviors might in some implementations vary from instruction to instruction, or between different instances of the same instruction.

Instructions that are CONSTRAINED UNPREDICTABLE when the base register is R15 and the instruction specifies a writeback of the base register, are treated as having R15 as both a source register and a destination register.

For instructions that have two destination registers, for example LDRD, MRRC, and many of the multiply instructions, if Rt, Rt2, RdLo, or RdHi is R15, then the other destination register of the pair is UNKNOWN if the CONSTRAINED UNPREDICTABLE behavior for the write to R15 is either to ignore the write or to branch to an UNKNOWN location.

For instructions that affect any or all of CPSR.NZCV, CPSR.Q, and CPSR.GE when the register specifier is not R15, if the instruction is CONSTRAINED UNPREDICTABLE when the register specifier is R15, then the flags that the instruction would affect become UNKNOWN.

In addition, for MRC instructions for CP14 and CP15 that use R15 as the destination register descriptor, and thereby target APSR.NZCV, where these are described as being CONSTRAINED UNPREDICTABLE, ASPR.NZCV becomes UNKNOWN.

A.1.7 SBZ or SBO fields in instructions

[Many of the A32 and T32 instructions have (0) or (1) in the instruction decode to indicate *should-be-zero*, SBZ, or *should-be-one*, SBO. Except for the specific cases called out in [CONSTRAINED UNPREDICTABLE behavior for A32 and T32 instructions on page AppxA-4702](#), if the instruction bit pattern of an instruction is executed with these fields not having the *should be* values, one of the following can occur:

- The instruction is UNDEFINED.
- The instruction executes as a NOP.
- The instruction operates as if the bit had the *should-be* value.

The exceptions to this rule are:

- [LDM/LDMIA/LDMFD \(T32\) on page AppxA-4705](#).
- [LDMDB/LDMEA on page AppxA-4707](#).
- [LDR \(literal\) on page AppxA-4713](#).
- [LDRB \(literal\) on page AppxA-4713](#).
- [LDRH \(literal\) on page AppxA-4714](#).

- [LDRSB \(literal\)](#) on page AppxA-4714.
- [LDRSH \(literal\)](#) on page AppxA-4715.
- [LDRD \(immediate\)](#) on page AppxA-4715.
- [LDRD \(register\)](#) on page AppxA-4716.
- [LDRD \(literal\)](#) on page AppxA-4717.
- [POP \(T32\)](#) on page AppxA-4720.
- [POP \(A32\)](#) on page AppxA-4721.
- [PUSH](#) on page AppxA-4721.
- [SDIV](#) on page AppxA-4724.
- [UDIV](#) on page AppxA-4724.
- [STM \(STMIA, STMEA\)](#) on page AppxA-4727.
- [STMDB \(STMTD\)](#) on page AppxA-4728.

A.1.8 CONSTRAINED UNPREDICTABLE behavior in an IT block

A number of instructions in the architecture are described as being CONSTRAINED UNPREDICTABLE either:

- Anywhere within an IT block.
- As an instruction in an IT block other than the last instruction within an IT block.

Unless otherwise stated in this manual, when these instructions are committed for execution, one of the following occurs:

- An UNDEFINED exception results.
- The instructions are executed as if they had passed their condition code.
- The instructions are treated as NOPS. This means that they behave as if they had failed the condition code.

The behavior might in some implementations vary from instruction to instruction, or between different instances of the same instruction.

Many instructions that are CONSTRAINED UNPREDICTABLE in an IT block are branch instructions or other non-sequential instructions that change the PC. Where these instructions are not treated as UNDEFINED within an IT block, the remaining iterations of the [CPSR.ITSTATE](#) state machine can:

- Clear [CPSR.ITSTATE](#).
- Advance [CPSR.ITSTATE](#) for either a sequential or a nonsequential change of the PC in the same way as they would do for instructions that are not CONSTRAINED UNPREDICTABLE that cause a sequential change of the PC.

———— **Note** —————

This does not apply to an instruction that is the last instruction in an IT block.

The instructions addressed by the updated PC can be:

- Executed as if they had passed the condition code check for the remaining iterations of the [CPSR.ITSTATE](#) state machine.
- Executed as NOPS. That is, they behave as if they failed the condition code check for the remaining iterations of the [CPSR.ITSTATE](#) state machine.
- Executed as if they were unconditional, or, if the instructions are part of another IT block, in accordance with the behavior in [Branching into an IT block on page AppxA-4762](#).

The behavior might in some implementations vary from instruction to instruction, or between different instances of the same instruction.

For exception returns or Debug state exits that cause [CPSR.ITSTATE](#) to be set to a reserved value in T32 state or that return to A32 state with a nonzero value in [CPSR.ITSTATE](#), the ITSTATE bits are forced to 00000000.

The reserved values are:

```
ITState[7:4] != '0000' && ITState[3:0] = '0000'  
ITState[2:0] != '000' when SCTLR/SCTLR_EL1.ITD == '1'
```

Exception returns or Debug state exits that set **CPSR.ITSTATE** to a non-reserved value in T32 state can occur when the flow of execution returns to a point:

- Outside an IT block, but with **ITSTATE** set to a value other than 0b00000000.
- Inside an IT block, but with a different value of **ITSTATE** than if the IT block had been executed without an exception return or Debug state exit.

In this case the instructions at the target of the exception return or Debug state exit can:

- Execute as if they passed the condition code check for the remaining iterations of the **ITSTATE** state machine.
- Execute as NOPs. That is, they behave as if they failed the condition code check for the remaining iterations of the **ITState** state machine.
- Execute as if they were unconditional, or as if the instruction were part of another IT block, in accordance with the behavior in *Branching into an IT block*.

The remaining iterations of the **CPSR.ITSTATE** state machine can behave as follows:

- The **ITSTATE** state machine advances as if it were in an IT block.
- The **ITSTATE** bits are ignored.
- The **ITSTATE** bits are forced to 00000000.

A.1.9 Branching into an IT block

Branching into an IT block leads to **CONSTRAINED UNPREDICTABLE** behavior. Execution starts from the address determined by the branch, but each instruction in the IT block is:

- Executed as if it were not in an IT block. This means that it is executed unconditionally.
- Executed as if it had passed its condition code check within an IT block.
- Executed as a NOP. That is, it behaves as if it had failed its condition code checks.

A.1.10 Syndrome register handling for **CONSTRAINED UNPREDICTABLE** instructions treated as **UNDEFINED**

When a **CONSTRAINED UNPREDICTABLE** instruction is treated as **UNDEFINED**, this generates an **UNDEFINED** instruction exception:

- If this exception is taken in AArch64, then **ESR_ELx** is UNKNOWN.
- If this exception is taken at EL2 in AArch32, then **HSR** is unknown.

———— **Note** ————

The value written in **ESR** or **HSR** must be consistent with a value that could be created as the result of an exception from the same Exception level that generated the exception, but was the result of a situation that is not **CONSTRAINED UNPREDICTABLE** at that Exception level. This is to avoid a possible privilege violation.

A.1.11 Unallocated values in register fields of CP14 and CP 15 registers and translation table entries

Unless otherwise stated, all unallocated or reserved values of fields with allocated values within CP15 registers and translation table entries behave in one of the following ways:

- The encoding maps onto any of the allocated values, but otherwise does not cause **CONSTRAINED UNPREDICTABLE** behavior.

- The encoding causes effects that could be achieved by a combination of more than one of the allocated encodings.
- The encoding causes the field to have no functional effect.

A.1.12 Unallocated CP14 and CP15 instructions

In ARMv8-A, accesses to unallocated CP14 and CP15 register encodings are UNDEFINED.

A.1.13 Loads and Stores to unaligned locations

Some unaligned loads and stores in the ARMv7 architecture are described as UNPREDICTABLE. These are defined in the ARMv8-A architecture to do one of the following:

- Take an alignment fault.
- Perform the specified load or store to the unaligned memory location.

A.1.14 Branching to an unaligned PC

If branching to an address in A32 state which is not word aligned is defined to be UNPREDICTABLE, then one of the following behaviors can occur:

- The unaligned location is forced to be aligned.
- The unaligned address generates a Prefetch Abort exception on the first instruction using the unaligned PC value. If this is executed in EL0 when EL2 is using AArch32 and `HCR.TGE == 1`, or EL2 is using AArch64 and `HCR_EL2.TGE == 1`, then the exception is taken to EL2.

Where the exception is taken to EL1 or EL3 using AArch32:

- If `TTBCR.EAE == 0`, `IFSR[10, 3:0]` takes the value 00001.
- If `TTBCR.EAE == 1`, `IFSR[5:0]` takes the value 100001.

If the exception is taken to EL2 using AArch32, then:

- The `HCR.EC` code of `0x22` is used.
- `HSR.IL` is UNKNOWN
- `HCR.ISS [24:0]` is RES0.

The `IFAR` or `HIFAR` takes the value of the address that faulted, including the misaligned low order bit[1].

The `R14_abt/ELR` holds the address that faulted, including the misaligned low order bit[1] with the standard offset associated with that exception.

————— Note —————

Because bit[0] is used for interworking, it is impossible to specify a branch to A32 state when the bottom bit of the target address is 1. Therefore the bottom bit of `IFAR` or `HIFAR` is 0 for all these cases.

A.1.15 Unpredictable CPACR and NSACR settings

If `CPACR.cp<n>` contains the encoding `0b10`, then one of the following behaviors can occur:

- The encoding maps onto any of the allocated values, but otherwise does not cause UNPREDICTABLE behavior.
- The encoding causes effects that could be achieved by a combination of more than one of the allocated encodings.

————— Note —————

In ARMv7, `CPACR` had a `D32DIS` bit, and `NSACR` had a `NSD32DIS` bit. There is no `CPACR.D32DIS` or `NSACR.NSD32DIS` in ARMv8-A, and the corresponding bits in the two registers are RES0.

A.1.16 Instruction fetches from Device memory

Instruction fetches from Device memory are UNPREDICTABLE.

If a location in memory with the Device attribute is not marked as execute-never, then an implementation might perform speculative instruction accesses to this memory location at times when the MMU is enabled.

If branches cause the program counter to point to an area of memory with the Device attribute that is not marked as execute-never for the current Exception level for instruction fetches, then an implementation can perform one of the following behaviors:

- It can treat the instruction fetch as if it were to a memory location with the Normal, Non-cacheable attribute.
- It can take a permission fault.

A.1.17 Multi-access instructions that load the PC from Device memory

Multi-access instructions that load the PC from Device memory when the MMU is enabled are unpredictable in AArch32 state. In the ARMv8-A architecture in AArch32, an implementation can perform one of the following behaviors:

- It can load the PC from the memory location as if the memory location had the Normal Non-cacheable attribute.
- It can take a permission fault.

A.1.18 Out of range virtual address

If the PE executes an instruction for which the instruction address, size, and alignment mean it contains the bytes 0xFFFFFFFF and 0x00000000, then the bytes that wrap around and appear to be from 0x00000000 onwards come from an UNKNOWN address.

If the PE executes a load or store instruction for which the computed address, total access size, and alignment mean it accesses bytes 0xFFFFFFFF and 0x00000000, then the bytes that wrap around and appear to be from 0x00000000 onwards come from an UNKNOWN address.

A.1.19 Translation Table Base Address alignment

An misaligned Translation Table Base Address can occur if:

- The VMSAv8-32 Short-descriptor translation table format is enabled and **TTBR0**[13-N:7], which is defined to be RES0, contains one or more nonzero values.
- The VMSAv8-32 Long-descriptor translation table format is enabled, and **TTBR0**[x-1:3], **TTBR1**[x-1:3], **HTTBR**[x-1:3], or **VTTBR**[x-1:3], which are defined to be RES0, contain one or more nonzero values.

If a misaligned Translation Table Base Address occurs, then one of the following behaviors can occur:

- The field that is defined to be RES0 is treated as if all bits were zero:
 - The value that is read back might be the value written or it might be zero.
- The calculation of an address for a translation table walk using that register can be corrupted in those bits that are nonzero.

A.2 Constraints on AArch64 state UNPREDICTABLE behaviors

It contains the following sections:

- [Overview of the constraints on AArch64 UNPREDICTABLE behaviors.](#)
- [CONSTRAINED UNPREDICTABLE behavior for A64 instructions.](#)

A.2.1 Overview of the constraints on AArch64 UNPREDICTABLE behaviors

The term UNPREDICTABLE describes a number of cases where the architecture has a feature that software must not use. For execution in AArch64 state, the ARMv8-A architecture specifies a narrow range of permitted behaviors. This range is the range of CONSTRAINED UNPREDICTABLE behavior. All implementations that are compliant with the architecture must follow the CONSTRAINED UNPREDICTABLE behavior.

———— **Note** —————

Software designed to be compatible with the ARMv8-A architecture must not rely on these CONSTRAINED UNPREDICTABLE cases being handled in any way other than those listed under the heading CONSTRAINED UNPREDICTABLE.

A.2.2 CONSTRAINED UNPREDICTABLE behavior for A64 instructions

This section lists the CONSTRAINED UNPREDICTABLE behavior for the different A64 instructions listed in [Chapter C5 A64 Base Instruction Descriptions](#) and [Chapter C6 A64 SIMD and Floating-point Instruction Descriptions](#).

LDR (immediate)

For a description of this instruction and the encoding, see [LDR \(immediate\) on page C5-517](#).

CONSTRAINED UNPREDICTABLE behavior

If the instruction encoding specifies pre-indexed addressing or post-indexed addressing, and $n == t \ \&\& \ n \neq 31$, then one of the following behaviors can occur:

- The instruction is UNDEFINED.
- The instruction executes as a NOP.
- The instruction performs the load using the specified addressing mode, and the base register is set to an UNKNOWN value. In addition, if an exception occurs during such an instruction, the base register might be corrupted so that the instruction cannot be repeated.

———— **Note** —————

Pre-indexed and post-indexed addressing implies writeback.

LDRB (immediate)

For a description of this instruction and the encoding, see [LDRB \(immediate\) on page C5-524](#).

CONSTRAINED UNPREDICTABLE behavior

If the instruction encoding specifies pre-indexed addressing or post-indexed addressing, and $n == t \ \&\& \ n \neq 31$, then one of the following behaviors can occur:

- The instruction is UNDEFINED.
- The instruction executes as a NOP.
- The instruction performs the load using the specified addressing mode, and the base register is set to an UNKNOWN value. In addition, if an exception occurs during such an instruction, the base register might be corrupted so that the instruction cannot be repeated.

———— **Note** —————

Pre-indexed and post-indexed addressing implies writeback.

LDRH (immediate)

For a description of this instruction and the encoding, see [LDRH \(immediate\)](#) on page C5-530.

CONSTRAINED UNPREDICTABLE behavior

If the instruction encoding specifies pre-indexed addressing or post-indexed addressing, and $n == t \ \&\& \ n \neq 31$, then one of the following behaviors can occur:

- The instruction is UNDEFINED.
- The instruction executes as a NOP.
- The instruction performs the load using the specified addressing mode, and the base register is set to an UNKNOWN value. In addition, if an exception occurs during such an instruction, the base register might be corrupted so that the instruction cannot be repeated.

———— **Note** —————

Pre-indexed and post-indexed addressing implies writeback.

LDRSB (immediate)

For a description of this instruction and the encoding, see [LDRSB \(immediate\)](#) on page C5-536.

CONSTRAINED UNPREDICTABLE behavior

If the instruction encoding specifies pre-indexed addressing or post-indexed addressing, and $n == t \ \&\& \ n \neq 31$, then one of the following behaviors can occur:

- The instruction is UNDEFINED.
- The instruction executes as a NOP.
- The instruction performs the load using the specified addressing mode, and the base register is set to an UNKNOWN value. In addition, if an exception occurs during such an instruction, the base register might be corrupted so that the instruction cannot be repeated.

———— **Note** —————

Pre-indexed and post-indexed addressing implies writeback.

LDRSH (immediate)

For a description of this instruction and the encoding, see [LDRSH \(immediate\)](#) on page C5-542.

CONSTRAINED UNPREDICTABLE behavior

If the instruction encoding specifies pre-indexed addressing or post-indexed addressing, and $n == t \ \&\& \ n \neq 31$, then one of the following behaviors can occur:

- The instruction is UNDEFINED.
- The instruction executes as a NOP.
- The instruction performs the load using the specified addressing mode, and the base register is set to an UNKNOWN value. In addition, if an exception occurs during such an instruction, the base register might be corrupted so that the instruction cannot be repeated.

———— **Note** —————

Pre-indexed and post-indexed addressing implies writeback.

LDRSW (immediate)

For a description of this instruction and the encoding, see [LDRSW \(immediate\)](#) on page C5-548.

CONSTRAINED UNPREDICTABLE behavior

If the instruction encoding specifies pre-indexed addressing or post-indexed addressing, and $n == t \ \&\& \ n \neq 31$, then one of the following behaviors can occur:

- The instruction is UNDEFINED.
- The instruction executes as a NOP.
- The instruction performs the load using the specified addressing mode, and the base register is set to an UNKNOWN value. In addition, if an exception occurs during such an instruction, the base register might be corrupted so that the instruction cannot be repeated.

———— Note —————

Pre-indexed and post-indexed addressing implies writeback.

LDP

For a description of this instruction and the encoding, see [LDP](#) on page C5-511.

CONSTRAINED UNPREDICTABLE behavior

If the instruction encoding specifies pre-indexed addressing or post-indexed addressing, and $(t == n \ || \ t2 == n) \ \&\& \ n \neq 31$, then one of the following behaviors can occur:

- The instruction is UNDEFINED.
- The instruction executes as a NOP.
- The instruction performs a load using the specified addressing mode, and the base register is set to an UNKNOWN value. In addition, if an exception occurs during such an instruction, the base register might be corrupted so that the instruction cannot be repeated.

If $t == t2$, then one of the following behaviors can occur:

- The instruction is UNDEFINED.
- The instruction executes as a NOP.
- The instruction performs all of the loads using the specified addressing mode, and the register loaded is set to an UNKNOWN value.

———— Note —————

Pre-indexed and post-indexed addressing implies writeback.

LDPSW

For a description of this instruction and the encoding, see [LDPSW](#) on page C5-514.

CONSTRAINED UNPREDICTABLE behavior

If the instruction encoding specifies pre-indexed addressing or post-indexed addressing, and $(t == n \ || \ t2 == n) \ \&\& \ n \neq 31$, then one of the following behaviors can occur:

- The instruction is UNDEFINED.
- The instruction executes as a NOP.
- The instruction performs a load using the specified addressing mode, and the base register is set to an UNKNOWN value. In addition, if an exception occurs during such an instruction, the base register might be corrupted so that the instruction cannot be repeated.

If $t == t2$, then one of the following behaviors can occur:

- The instruction is UNDEFINED.

- The instruction executes as a NOP.
- The instruction performs all of the loads using the specified addressing mode, and the register loaded is set to an UNKNOWN value.

———— **Note** —————

Pre-indexed and post-indexed addressing implies writeback.

LDNP (SIMD&FP)

For a description of this instruction and the encoding, see [LDNP \(SIMD&FP\) on page C6-1052](#).

CONSTRAINED UNPREDICTABLE behavior

If $t == t2$, then one of the following behaviors can occur:

- The instruction is UNDEFINED.
- The instruction executes as a NOP.
- The instruction performs a load using the specified addressing mode, and the base register is set to an UNKNOWN value.

LDP (SIMD&FP)

For a description of this instruction and the encoding, see [LDP \(SIMD&FP\) on page C6-1054](#).

CONSTRAINED UNPREDICTABLE behavior

If $t == t2$, then one of the following behaviors can occur:

- The instruction is UNDEFINED.
- The instruction executes as a NOP.
- The instruction performs a load using the specified addressing mode, and the base register is set to an UNKNOWN value.

LDAXP

For a description of this instruction and the encoding, see [LDAXP on page C5-497](#)[LDP on page C5-511](#).

CONSTRAINED UNPREDICTABLE behavior

If $t == t2$, then one of the following behaviors can occur:

- The instruction is UNDEFINED.
- The instruction executes as a NOP.
- The instruction performs a load using the specified addressing mode, and the base register is set to an UNKNOWN value.

LDXP

For a description of this instruction and the encoding, see [LDXP on page C5-579](#).

CONSTRAINED UNPREDICTABLE behavior

If $t == t2$, then one of the following behaviors can occur:

- The instruction is UNDEFINED.
- The instruction executes as a NOP.
- The instruction performs a load using the specified addressing mode, and the base register is set to an UNKNOWN value.

STR (immediate)

For a description of this instruction and the encoding, see [STR \(immediate\)](#) on page C5-694.

CONSTRAINED UNPREDICTABLE behavior

If the instruction encoding specifies pre-indexed addressing or post-indexed addressing, and $n == t \ \&\& \ n \neq 31$, then one of the following behaviors can occur:

- The instruction is UNDEFINED.
- The instruction executes as a NOP.
- The instruction performs a store using the specified addressing mode but the value stored is UNKNOWN.

———— **Note** —————

Pre-indexed and post-indexed addressing implies writeback.

STRB (immediate)

For a description of this instruction and the encoding, see [STRB \(immediate\)](#) on page C5-700.

CONSTRAINED UNPREDICTABLE behavior

If the instruction encoding specifies pre-indexed addressing or post-indexed addressing, and $n == t \ \&\& \ n \neq 31$, then one of the following behaviors can occur:

- The instruction is UNDEFINED.
- The instruction executes as a NOP.
- The instruction performs a store using the specified addressing mode but the value stored is UNKNOWN.

———— **Note** —————

Pre-indexed and post-indexed addressing implies writeback.

STRH (immediate)

For a description of this instruction and the encoding, see [STRH \(immediate\)](#) on page C5-706.

CONSTRAINED UNPREDICTABLE behavior

If the instruction encoding specifies pre-indexed addressing or post-indexed addressing, and $n == t \ \&\& \ n \neq 31$, then one of the following behaviors can occur:

- The instruction is UNDEFINED.
- The instruction executes as a NOP.
- The instruction performs a store using the specified addressing mode but the value stored is UNKNOWN.

———— **Note** —————

Pre-indexed and post-indexed addressing implies writeback.

STP

For a description of this instruction and the encoding, see [STP](#) on page C5-691.

CONSTRAINED UNPREDICTABLE behavior

If the instruction encoding specifies pre-indexed addressing or post-indexed addressing, and $(t == n \ || \ t2 == n) \ \&\& \ n \neq 31$, then one of the following behaviors can occur:

- The instruction is UNDEFINED.
- The instruction executes as a NOP.

- The instruction performs a store using the specified addressing mode but the value stored is UNKNOWN.

———— **Note** —————

Pre-indexed and post-indexed addressing implies writeback.

—————

STLXR

For a description of this instruction and the encoding, see [STLXR on page C5-680](#).

CONSTRAINED UNPREDICTABLE behavior

If $s == t$ || (pair && $s == t2$), then one of the following behaviors can occur:

- The instruction is UNDEFINED.
- The instruction executes as a NOP.
- The instruction performs the store to the specified address, but the value stored is UNKNOWN.

If $s == n$ && $n != 31$ then one of the following behaviors can occur:

- The instruction is UNDEFINED.
- The instruction executes as a NOP.
- The instruction performs the store to an UNKNOWN address.

STLXRB

For a description of this instruction and the encoding, see [STLXRB on page C5-683](#).

CONSTRAINED UNPREDICTABLE behavior

If $s == t$ || (pair && $s == t2$), then one of the following behaviors can occur:

- The instruction is UNDEFINED.
- The instruction executes as a NOP.
- The instruction performs the store to the specified address, but the value stored is UNKNOWN.

If $s == n$ && $n != 31$ then one of the following behaviors can occur:

- The instruction is UNDEFINED.
- The instruction executes as a NOP.
- The instruction performs the store to an UNKNOWN address.

STLXRH

For a description of this instruction and the encoding, see [STLXRH on page C5-686](#).

CONSTRAINED UNPREDICTABLE behavior

If $s == t$ || (pair && $s == t2$), then one of the following behaviors can occur:

- The instruction is UNDEFINED.
- The instruction executes as a NOP.
- The instruction performs the store to the specified address, but the value stored is UNKNOWN.

If $s == n$ && $n != 31$ then one of the following behaviors can occur:

- The instruction is UNDEFINED.
- The instruction executes as a NOP.
- The instruction performs the store to an UNKNOWN address.

STXR

For a description of this instruction and the encoding, see [STXR on page C5-727](#).

CONSTRAINED UNPREDICTABLE behavior

If $s == t \parallel (\text{pair } \&\& s == t2)$, then one of the following behaviors can occur:

- The instruction is UNDEFINED.
- The instruction executes as a NOP.
- The instruction performs the store to the specified address, but the value stored is UNKNOWN.

If $s == n \&\& n != 31$ then one of the following behaviors can occur:

- The instruction is UNDEFINED.
- The instruction executes as a NOP.
- The instruction performs the store to an UNKNOWN address.

STXRB

For a description of this instruction and the encoding, see [STXRB on page C5-730](#).

CONSTRAINED UNPREDICTABLE behavior

If $s == t \parallel (\text{pair } \&\& s == t2)$, then one of the following behaviors can occur:

- The instruction is UNDEFINED.
- The instruction executes as a NOP.
- The instruction performs the store to the specified address, but the value stored is UNKNOWN.

If $s == n \&\& n != 31$ then one of the following behaviors can occur:

- The instruction is UNDEFINED.
- The instruction executes as a NOP.
- The instruction performs the store to an UNKNOWN address.

STXRH

For a description of this instruction and the encoding, see [STXRH on page C5-733](#).

CONSTRAINED UNPREDICTABLE behavior

If $s == t \parallel (\text{pair } \&\& s == t2)$, then one of the following behaviors can occur:

- The instruction is UNDEFINED.
- The instruction executes as a NOP.
- The instruction performs the store to the specified address, but the value stored is UNKNOWN.

If $s == n \&\& n != 31$ then one of the following behaviors can occur:

- The instruction is UNDEFINED.
- The instruction executes as a NOP.
- The instruction performs the store to an UNKNOWN address.

STLXP

For a description of this instruction and the encoding, see [STLXP on page C5-677](#).

CONSTRAINED UNPREDICTABLE behavior

If $s == t \parallel (\text{pair } \&\& s == t2)$, then one of the following behaviors can occur:

- The instruction is UNDEFINED.
- The instruction executes as a NOP.
- The instruction performs the store to the specified address, but the value stored is UNKNOWN.

If $s == n \&\& n != 31$ then one of the following behaviors can occur:

- The instruction is UNDEFINED.
- The instruction executes as a NOP.

- The instruction performs the store to an UNKNOWN address.

STXP

For a description of this instruction and the encoding, see [STXP on page C5-724](#).

CONSTRAINED UNPREDICTABLE behavior

If $s == t$ || (pair && $s == t2$), then one of the following behaviors can occur:

- The instruction is UNDEFINED.
- The instruction executes as a NOP.
- The instruction performs the store to the specified address, but the value stored is UNKNOWN.

If $s == n$ && $n != 31$ then one of the following behaviors can occur:

- The instruction is UNDEFINED.
- The instruction executes as a NOP.
- The instruction performs the store to an UNKNOWN address.

Appendix B

Recommended External Debug Interface

This appendix describes the recommended external debug interface. It contains the following sections:

- [About the recommended external debug interface on page AppxB-4774.](#)
- [PMUEVENT bus on page AppxB-4777.](#)
- [DBGCPUDONE on page AppxB-4778.](#)
- [Recommended authentication interface on page AppxB-4779.](#)
- [Management registers and CoreSight compliance on page AppxB-4782.](#)

———— **Note** —————

This recommended external debug interface specification is not part of the ARM architecture specification. Implementers and users of the ARMv8 architecture must not consider this appendix as a requirement of the architecture. It is included as an appendix to this manual only:

- As reference material for users of ARM products that implement this interface.
- As an example of how an external debug interface might be implemented.

The inclusion of this appendix is no indication of whether any ARM products might, or might not, implement this external debug interface. For details of the implemented external debug interface you must always see the appropriate product documentation.

B.1 About the recommended external debug interface

See the *Note* on the first page of this appendix for information about the architectural status of this recommended debug interface.

This specification provides a recommended external debug interface for ARMv8 to define a standard set of connections for validation environments. The connection between components, such as between the PE and Trace extension or between the PE and the CTI, is not described here. [Table B-1](#) shows the signals in the recommended interface.

Table B-1 Recommended debug interface signals

Name	Direction	Description	Notes
DBGGEN	In	External debug enable	-
SPIDEN	In	Secure privileged external debug enable	-
		Secure privileged self-hosted debug enable	Only in Secure AArch32 modes when enabled by MDCR_EL3.SPD32
NIDEN	In	External profiling and trace enable	-
SPNIDEN	In	Secure external profiling and trace enable	-
DBGRESTART	In	External debug restart	
DBGRESTARTED	Out	External debug restart acknowledge	
EDBGRQ	In	External halt request	Provided for legacy connections only.
DBGACK	Out	External halt request acknowledge	
DBGTRIGGER	Out	External trigger notification	
DBGTRIGGERACK	In	External trigger notification acknowledge	
DBGCPUDONE	Out	PE is in Debug state	See DBGCPUDONE on page AppxB-4778
COMMIRQ	Out	DCC interrupt	Interface to an interrupt controller. See Interrupt-driven use of the DCC on page H4-4402 and the pseudocode for function <code>CheckForDCCInterrupts()</code> in Pseudocode details for the operation of the DCC and ITR registers on page H4-4403.
PMUIRQ	Out	Performance Monitor overflow	Interface to an interrupt controller. See Behavior on overflow on page D6-1826.
COMMRX	Out	DTRRX is full	Provided for legacy connection to an interrupt controller only. See Interrupt-driven use of the DCC on page H4-4402 and the pseudocode for function <code>CheckForDCCInterrupts()</code> in Pseudocode details for the operation of the DCC and ITR registers on page H4-4403.
COMMTX	Out	DTRTX is empty	
PMUEVENT[n:0]	Out	Performance Monitors event bus	See PMUEVENT bus on page AppxB-4777

Table B-1 Recommended debug interface signals (continued)

Name	Direction	Description	Notes
DBGNOPWRDWN	Out	Core no powerdown request	Interface to a power controller. See DBGPRCR_EL1.CORENPDRQ .
DBGPWRUPREQ	Out	Core powerup request	Interface to a power controller. See EDPRCR.COREPURQ .
DBGRSTREQ	Out	Warm reset request	Interface to a power controller. See EDPRCR.CWRR .
DBGBUSCANCELREQ	Out	All asynchronous entry to Debug state	Extension to the bus interface. See EDPRCR.CBRRQ .
DBGPWRDUP	In	Core powerup status	Interface to a power controller. See EDPRSR.PU .
DBGROMADDR[n:12]	In	MDRAR_EL1.ROMADDR	<i>n</i> depends on the size of the physical address space.
DBGROMADDRV	In	MDRAR_EL1.Valid	-
PRESETDBG	In	External debug reset	-
CPUPORESET	In	Cold reset	-
CORERESET	In	Warm reset	-
PSELDBG	In		
PENABLEDBG	In		
PWRITEDBG	In		
PRDATADBG[31:0]	Out	Debug APB slave port	For details see <i>AMBA APB3</i> . ARM recommends a single slave port for all integrated debug components. PADDRDBG31 distinguishes memory-mapped and DAP accesses: 0 Memory-mapped access 1 DAP access
PWDATADBG[31:0]	In		
PADDRDBG[n:2] ^a	In		
PREADYDBG	Out		
PSLVERRDBG	Out		
PCLKDBG	In		
PCLKENDBG	In		

a. The value of *n* depends on the size of the address space occupied by the Debug port.

Figure B-1 on page AppxB-4776 shows the recommended debug interface.

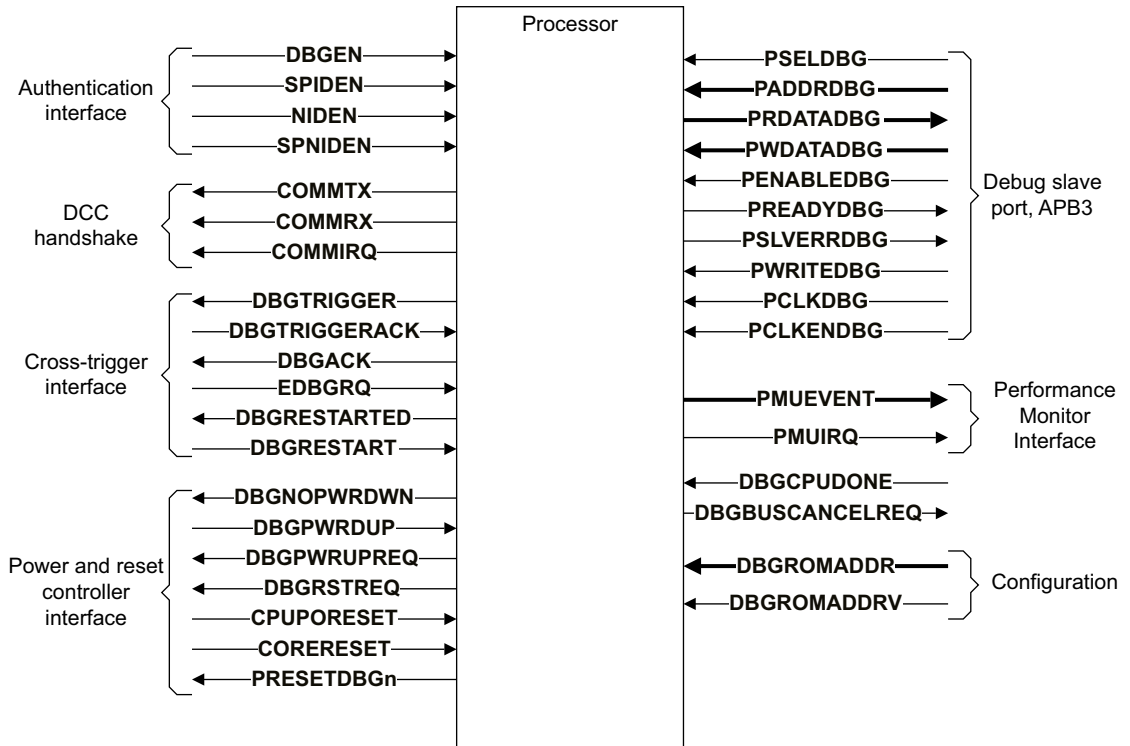

Figure B-1 Recommended external debug interface, including the APB3 slave port

In Figure B-1, signals with a lower-case n suffix are active LOW and all other signals are active HIGH.

B.2 PMUEVENT bus

The **PMUEVENT** bus exports Performance Monitor events from the PE to an on-chip agent. ARM recommends that it has the following characteristics:

- The bus is synchronous.
- The width of the bus is IMPLEMENTATION DEFINED.
- It is IMPLEMENTATION DEFINED which events are exported on the bus.
- Each exported event occupies a contiguous sub-field of the bus. ARM recommends that the sub-fields of the bus are occupied in the same order as the event numbers.
- If the event can only occur once per cycle, it occupies a single bit. If the event can occur more than once per cycle, it is IMPLEMENTATION DEFINED how the event is encoded. The encoding depends on constraints such as the designated use of the event bus and the number of pins available. For example, the event can be encoded:
 - As a count, using a plain binary number. This is the most useful encoding when exporting to an external counter. It is not a useful encoding for exporting to a Trace extension external input.
 - As a count, using thermometer encoding. This is the most useful encoding when exporting to a Trace extension.
 - Using a single bit encoding to indicate whether the event count is zero or non-zero. This is useful for exporting to an activity monitor where the number of pins is constrained.

If a Trace extension is implemented, the **PMUEVENT** bus is normally connected to the Trace extension using the external inputs. TRCEXTINSELR multiplexes a wide **PMUEVENT** bus to a narrow set of inputs. An external **PMUEVENT** bus might also be provided. For more information, contact ARM.

B.3 DBGCPUDONE

The PE asserts **DBGCPUDONE** only after it has completed all Non-debug state memory accesses. Therefore, the system can use **DBGCPUDONE** as an indicator that all memory accesses issued by the PE result from operations performed by a debugger.

B.4 Recommended authentication interface

The details of the debug authentication interface are IMPLEMENTATION DEFINED.

ARM recommends the use of the CoreSight interface, which has four signals for external debug authentication:

- **DBGEN**,
- **SPIDEN**.
- **NIDEN**.
- **SPNIDEN**.

CoreSight forbids asserting **SPIDEN** without also asserting **DBGEN**. CoreSight also forbids asserting **SPNIDEN** without also asserting **NIDEN**.

ARM recommends an interface in which **DBGEN** and **SPIDEN** are also used for self-hosted secure debug authentication if either:

- EL3 is using AArch32 and `SDCR.SPD == 0b00`.
- Secure EL1 is using AArch32 and `MDCR_EL3.SPD32 == 0b00`.

If EL3 is not implemented and the PE is in Non-secure state, **SPIDEN** and **SPNIDEN** are not implemented, and the PE behaves as if these signals were tied LOW.

If EL3 is not implemented and the PE is in Secure state, **SPIDEN** is usually connected to **DBGEN** and **SPNIDEN** is connected to **NIDEN**, but this is not required. The recommended interface is defined as if all four signals are implemented.

How the authentication signals are driven is IMPLEMENTATION DEFINED. For example, the signals might be hard-wired, connected to fuses, or to an authentication module. The architecture permits PEs within a cluster to have independent authentication interfaces, but this is not required. ARM recommends that any Trace extension has the same authentication interface as the PE it is connected to.

Table B-2 shows the debug authentication pseudocode functions and the recommended implementations.

Table B-2 Recommended implementation of debug enable pseudocode functions

Pseudocode function	Description	Implementation
<code>AArch32SelfHostedSecurePrivilegedInvasiveDebugEnabled()</code> See <i>Pseudocode details for AArch32 Self-Hosted Secure Privileged Invasive Debug Enabled</i> on page AppxB-4780	Secure invasive self-hosted debug enabled in AArch32 state (legacy)	(DBGEN AND SPIDEN)
<code>ExternalSecureNonInvasiveDebugEnabled()</code> See <i>Pseudocode details for External Invasive Debug Enabled</i> on page AppxB-4780	Secure non-invasive debug enabled	(DBGEN OR NIDEN) AND (SPIDEN OR SPNIDEN)
<code>ExternalSecureInvasiveDebugEnabled()</code> See <i>Pseudocode details for External Secure Invasive Debug Enabled</i> on page AppxB-4780	Secure invasive debug enabled	(DBGEN AND SPIDEN)
<code>ExternalNonInvasiveDebugEnabled()</code> See <i>Pseudocode details for External Non-invasive Debug Enabled</i> on page AppxB-4781	Non-secure non-invasive debug enabled	(DBGEN OR NIDEN)
<code>ExternalInvasiveDebugEnabled()</code> See <i>Pseudocode details for External Secure Non-invasive Debug Enabled</i> on page AppxB-4781	Non-secure invasive debug enabled	DBGEN

The following assertions must apply to all implementations:

```
if !ExternalInvasiveDebugEnabled() then assert !ExternalSecureInvasiveDebugEnabled()
```

```
if !ExternalNonInvasiveDebugEnabled() then assert !ExternalSecureNonInvasiveDebugEnabled()
```

```
if ExternalInvasiveDebugEnabled() then assert ExternalNoninvasiveDebugEnabled()  
if ExternalSecureInvasiveDebugEnabled() then assert ExternalSecureNoninvasiveDebugEnabled()
```

The definition for the Debug_authentication() function is as follows:

```
signal DBGEN;
```

```
signal NIDEN;
```

```
signal SPIDEN;
```

```
signal SPNIDEN;
```

B.4.1 Pseudocode details for AArch32 Self-Hosted Secure Privileged Invasive Debug Enabled

The pseudocode for the AArch32SelfHostedSecurePrivilegedInvasiveDebugEnabled() function is as follows:

```
// AArch32SelfHostedSecurePrivilegedInvasiveDebugEnabled()  
// =====  
  
boolean AArch32SelfHostedSecurePrivilegedInvasiveDebugEnabled()  
    // In the recommended interface, AArch32SelfHostedSecurePrivilegedInvasiveDebugEnabled returns  
    // the state of the (DBGEN AND SPIDEN) signal.  
    if !HaveEL(EL3) && !IsSecure() then return FALSE;  
    return DBGEN == HIGH && SPIDEN == HIGH;
```

B.4.2 Pseudocode details for External Invasive Debug Enabled

The pseudocode for the ExternalInvasiveDebugEnabled() function is as follows:

```
// ExternalInvasiveDebugEnabled()  
// =====  
  
boolean ExternalInvasiveDebugEnabled()  
    // In the recommended interface, ExternalInvasiveDebugEnabled returns the state of the DBGEN  
    // signal.  
    return DBGEN == HIGH;
```

B.4.3 Pseudocode details for External Secure Invasive Debug Enabled

The pseudocode for the ExternalSecureInvasiveDebugEnabled() function is as follows:

```
// ExternalSecureInvasiveDebugEnabled()  
// =====  
  
boolean ExternalSecureInvasiveDebugEnabled()
```

```
// In the recommended interface, ExternalSecureInvasiveDebugEnabled returns the state of the
// (DBGEN AND SPIDEN) signal.
// CoreSight allows asserting SPIDEN without also asserting DBGEN, but this is not recommended.
if !HaveEL(EL3) && !IsSecure() then return FALSE;
return ExternalInvasiveDebugEnabled() && SPIDEN == HIGH;
```

B.4.4 Pseudocode details for External Non-invasive Debug Enabled

The pseudocode for the ExternalNoninvasiveDebugEnabled() function is as follows:

```
// ExternalNoninvasiveDebugEnabled()
// =====

boolean ExternalNoninvasiveDebugEnabled()
    // In the recommended interface, ExternalNoninvasiveDebugEnabled returns the state of the (DBGEN
    // OR NIDEN) signal.
    return ExternalInvasiveDebugEnabled() || NIDEN == HIGH;
```

B.4.5 Pseudocode details for External Secure Non-invasive Debug Enabled

The pseudocode for the ExternalSecureNoninvasiveDebugEnabled() function is as follows:

```
// ExternalSecureNoninvasiveDebugEnabled()
// =====

boolean ExternalSecureNoninvasiveDebugEnabled()
    // In the recommended interface, ExternalSecureNoninvasiveDebugEnabled returns the state of the
    // (DBGEN OR NIDEN) AND (SPIDEN OR SPNIDEN) signal.
    if !HaveEL(EL3) && !IsSecure() then return FALSE;
    return ExternalNoninvasiveDebugEnabled() && (SPIDEN == HIGH || SPNIDEN == HIGH);
```

B.5 Management registers and CoreSight compliance

The CoreSight architecture requires the implementation of a set of management registers that occupy the memory map from 0xF00 upwards in each of the debug components.

CoreSight compliance and complete implementation of the management registers is OPTIONAL, but ARM recommends that the registers are implemented.

The CoreSight architecture specification recommends that any integration test registers are implemented starting from 0xEFC downwards. Each of the debug components has an IMPLEMENTATION DEFINED region from 0xE80 to 0xEFC for this purpose.

B.5.1 CoreSight interface register map

Table B-3 shows the external management register maps for the following registers:

- ED** These are the external debug register.
- CTI** These are the Cross-trigger interface registers.
- PMU** These are the Performance Monitors registers.

Table B-3 CoreSight interface register map

Offset	Mnemonic			Name
	ED	CTI	PMU	
0xF00	EDITCTRL	CTIITCTRL	PMITCTRL	Integration Model Control registers
0xF04-0xF8C	-	-	-	Reserved, RES0
0xFA0	DBGCLAIMSET_EL1 ^a	CTICLAIMSET ^b	-	Claim Tag Set registers
0xFA4	DBGCLAIMCLR_EL1 ^a	CTICLAIMCLR ^b	-	Claim Tag Clear registers
0xFA8	EDDEVAFF0 ^a	CTIDEVAFF0 ^c	PMDEVAFF0	Device Affinity registers
0xFAC	EDDEVAFF1 ^a	CTIDEVAFF1 ^c	PMDEVAFF0	
0xFB0	EDLAR ^d	CTILAR ^d	PMLAR ^d	Lock Access register
0xFB4	EDLSR ^d	CTILSR ^d	PMLSR ^d	Lock Status register
0xFB8	DBGAUTHSTATUS_EL1 ^a	CTIAUTHSTATUS	PMAUTHSTATUS	Authentication Status register
0xFBC	EDDEVARCH	CTIDEVARCH	PMDEVARCH	Device Architecture register
0xFC0	EDDEVID2 ^a	CTIDEVID2 ^a	-	Device ID register
0xFC4	EDDEVID1 ^a	CTIDEVID1 ^a	-	
0xFC8	EDDEVID ^a	CTIDEVID ^a	-	
0xFCC	EDDEVTYPE	CTIDEVTYPE	PMDEVTYPE	Device Type register
0xFD0	EDPIDR4	CTIPIDR4	PMPIDR4	Peripheral ID registers
0xFD4-0xFDC	-	-	-	Reserved, RES0
0xFE0	EDPIDR0	CTIPIDR0	PMPIDR0	Peripheral ID registers
0xFE4	EDPIDR1	CTIPIDR1	PMPIDR1	
0xFE8	EDPIDR2	CTIPIDR2	PMPIDR2	
0xFEC	EDPIDR3	CTIPIDR3	PMPIDR3	

Table B-3 CoreSight interface register map (continued)

Offset	Mnemonic			Name
	ED	CTI	PMU	
0xFF0	EDCIDR0	CTICIDR0	PMCIDR0	Component ID registers
0xFF4	EDCIDR1	CTICIDR1	PMCIDR1	
0xFF8	EDCIDR2	CTICIDR2	PMCIDR2	
0xFFC	EDCIDR3	CTICIDR3	PMCIDR3	

- This register must always be implemented, regardless of whether the component is CoreSight compliant.
- If implemented, the number of CLAIM bits is IMPLEMENTATION DEFINED and can be discovered by reading CLAIMSET.
- If the CTI implements CTIV1, this register is not implemented. See the register description for details.
- The Software lock registers are defined as part of CoreSight compliance, but their contents depend on the type of access that is made and whether the OPTIONAL Software lock is implemented. See the register description for details.

B.5.2 Management register access permissions

Access to the OPTIONAL Integration Control register (ITCTRL) is IMPLEMENTATION DEFINED.

If the Debug power domain is off, all register accesses return an error.

Otherwise, [Table B-4 on page AppxB-4784](#), [Table B-5 on page AppxB-4785](#), and [Table B-6 on page AppxB-4786](#) show the response to accesses by the external debug interface to the CoreSight management registers. For definitions of the terms used in the tables, see [External debug interface register access permissions summary on page H8-4453](#).

———— Note ————

Access to the CoreSight management registers is not affected by the values of EDAD and EPMAD.

[Table B-4 on page AppxB-4784](#), [Table B-5 on page AppxB-4785](#), and [Table B-6 on page AppxB-4786](#) include reserved management registers, because the CoreSight architecture requires that these registers are always RES0. The descriptions in [Reserved and unallocated registers on page H8-4454](#) does not apply to reserved management registers if the implementation is CoreSight compliant.

If OPTIONAL memory-mapped access to the external debug interface is supported, there are additional constraints on memory-mapped accesses. See [Register access permissions for memory-mapped accesses on page H8-4449](#).

The terms in [Table B-4 on page AppxB-4784](#), [Table B-5 on page AppxB-4785](#), and [Table B-6 on page AppxB-4786](#) are defined as follows:

Domain This describes the power domain in which the register is logically implemented. Registers described as implemented in the Core power domain might be implemented in the Debug power domain, as long as they exhibit the required behavior.

Conditions This lists the conditions under which the access is attempted.

To determine the access permissions for a register, read these columns from left to right, and stop at first column which lists the condition as being true.

The conditions are:

Off [EDPRSR.PU == 0](#). The Core power domain is completely off, or in low-power state. In these cases the Core power domain registers cannot be accessed.

———— Note ————

If debug power is off, then all external debug interface accesses return an error.

DLK	DoubleLockStatus() == TRUE. The OS Double Lock is locked, that is, EDPRSR.DLK == 1 .
OSLK	OSLSR.OSLK == 1 . The OS Lock is locked.
Default	This provides the default access permissions, if there are no conditions that prevent access to the register.
SLK	This provides the modified default access permissions for OPTIONAL memory-mapped accesses to the external debug interface if the OPTIONAL Software Lock is locked. See Register access permissions for memory-mapped accesses on page H8-4449 . For all other accesses, this column is ignored.

The access permissions are:

- This means that the default access permission applies. See the Default column, or the SLK column, if applicable.
- RO** This means that the register or field is read-only.
- RW** This means that the register or field is read/write. Individual fields within the register might be RO. See the relevant register description for details.
- RC** This means that the bit clears to 0 after a read.
- (SE)** This means that accesses to this register have indirect write side-effects. A side-effect occurs when a direct read or a direct write of a register creates an indirect write to the same register or to another register.
- WO** This means that the register or field is write-only.
- WI** This means that the register or field ignores writes.
- IMP DEF** This means that the access permissions are IMPLEMENTATION DEFINED.

Table B-4 External debug interface access permissions, CoreSight registers (debug)

Offset	Register	Domain	Conditions (priority left to right)				
			Off	DLK	OSLK	Default	SLK
0xF00	EDITCTRL	IMP DEF	IMPLEMENTATION DEFINED			IMP DEF	RO/WI
0xF04 - 0xF8C	Reserved	Debug	-	-	-	RES0	-
0xFA0	DBGCLAIMSET_EL1	Core	Error	Error	Error	RW (SE)	RO
0xFA4	DBGCLAIMCLR_EL1	Core	Error	Error	Error	RW (SE)	RO
0xFA8	EDDEVAFF0	Debug	-	-	-	RO	-
0xFAC	EDDEVAFF1	Debug	-	-	-	RO	-
0xFB0	EDLAR	Debug	-	-	-	WO (SE)	-
0xFB4	EDLSR	Debug	-	-	-	RO	-
0xFB8	DBGAUTHSTATUS_EL1	Debug	-	-	-	RO	-
0xFBC	EDDEVARCH	Debug	-	-	-	RO	-
0xFC0	EDDEVID2	Debug	-	-	-	RO	-
0xFC4	EDDEVID1	Debug	-	-	-	RO	-

Table B-4 External debug interface access permissions, CoreSight registers (debug) (continued)

Offset	Register	Domain	Conditions (priority left to right)				
			Off	DLK	OSLK	Default	SLK
0xFC8	EDDEVID	Debug	-	-	-	RO	-
0xFCC	EDDEVTYPE	Debug	-	-	-	RO	-
0xFD0	EDPIDR4	Debug	-	-	-	RO	-
0xFD4 - 0xFDC	Reserved	Debug	-	-	-	RES0	-
0xFE0 - 0xFEC	EDPIDR0	Debug	-	-	-	RO	-
0xFE4	EDPIDR1	Debug	-	-	-	RO	-
0xFE8	EDPIDR2	Debug	-	-	-	RO	-
0xFEC	EDPIDR3	Debug	-	-	-	RO	-
0xFF0	EDCIDR0	Debug	-	-	-	RO	-
0xFF4	EDCIDR1	Debug	-	-	-	RO	-
0xFF8	EDCIDR2	Debug	-	-	-	RO	-
0xFFC	EDCIDR3	Debug	-	-	-	RO	-

Table B-5 External debug interface access permissions, CoreSight registers (CTI)

Offset	Register	Domain	Off	DLK	OSLK	Default	SLK
0xF00	CTIITCTRL	IMP DEF	IMPLEMENTATION DEFINED			IMP DEF	RO/WI
0xF04 - 0xF8C	Reserved	Debug	-	-	-	RES0	-
0xFA0	CTICLAIMSET	Debug	-	-	-	RW (SE)	RO
0xFA4	CTICLAIMCLR	Debug	-	-	-	RW (SE)	RO
0xFA8	CTIDEVAFF0	Debug	-	-	-	RO	-
0xFAC	CTIDEVAFF1	Debug	-	-	-	RO	-
0xFB0	CTILAR	Debug	-	-	-	WO (SE)	-
0xFB4	CTILSR	Debug	-	-	-	RO	-
0xFB8	CTIAUTHSTATUS	Debug	-	-	-	RO	-
0xFBC	CTIDEVARCH	Debug	-	-	-	RO	-
0xFC0	CTIDEVID2	Debug	-	-	-	RO	-
0xFC4	CTIDEVID1	Debug	-	-	-	RO	-
0xFC8	CTIDEVID	Debug	-	-	-	RO	-

Table B-5 External debug interface access permissions, CoreSight registers (CTI) (continued)

Offset	Register	Domain	Off	DLK	OSLK	Default	SLK
0xFCC	CTIDEVTYPE	Debug	-	-	-	RO	-
0xFD0	CTIPIDR4	Debug	-	-	-	RO	-
0xFD4 - 0xFDC	Reserved	Debug	-	-	-	RES0	-
0xFE0	CTIPIDR0	Debug	-	-	-	RO	-
0xFE4	CTIPIDR1	Debug	-	-	-	RO	-
0xFE8	CTIPIDR2	Debug	-	-	-	RO	-
0xFEC	CTIPIDR3	Debug	-	-	-	RO	-
0xFF0	CTICIDR0	Debug	-	-	-	RO	-
0xFF4	CTICIDR1	Debug	-	-	-	RO	-
0xFF8	CTICIDR2	Debug	-	-	-	RO	-
0xFFC	CTICIDR3	Debug	-	-	-	RO	-

Table B-6 External debug interface access permissions, CoreSight registers (PMU)

Offset	Register	Domain	Off	DLK	OSLK	Default	SLK
0xF00	PMITCTRL	IMP DEF	IMPLEMENTATION DEFINED			IMP DEF	RO/WI
0xF04 - 0xFA4	Reserved	Debug	-	-	-	RES0	-
0xFA8	PMDEVAFF0	Debug	-	-	-	RO	-
0xFAC	PMDEVAFF1	Debug	-	-	-	RO	-
0xFB0	PMLAR	Debug	-	-	-	WO (SE)	-
0xFB4	PMLSR	Debug	-	-	-	RO	-
0xFB8	PMAUTHSTATUS	Debug	-	-	-	RO	-
0xFBC	PMDEVARCH	Debug	-	-	-	RO	-
0xFC0 - 0xFC8	Reserved	Debug	-	-	-	RES0	-
0xFCC	PMDEVTYPE	Debug	-	-	-	RO	-
0xFD0	PMPIDR4	Debug	-	-	-	RO	-
0xFD4 - 0xFDC	Reserved	Debug	-	-	-	RES0	-
0xFE0	PMPIDR0	Debug	-	-	-	RO	-
0xFE4	PMPIDR1	Debug	-	-	-	RO	-

Table B-6 External debug interface access permissions, CoreSight registers (PMU) (continued)

Offset	Register	Domain	Off	DLK	OSLK	Default	SLK
0xFE8	PMPIDR2	Debug	-	-	-	RO	-
0xFEC	PMPIDR3	Debug	-	-	-	RO	-
0xFF0	PMCIDR0	Debug	-	-	-	RO	-
0xFF4	PMCIDR1	Debug	-	-	-	RO	-
0xFF8	PMCIDR2	Debug	-	-	-	RO	-
0xFFC	PMCIDR3	Debug	-	-	-	RO	-

B.5.3 Management register resets

Table B-7 shows the management register resets. This table does not include:

- Read-only identification registers that have a fixed value from reset. These registers include those with the DEVAFFn, DEVARCH, DEVID{n}, DEVTYPE, PIDRn, and CIDRn mnemonics.
- Registers that have the AUTHSTATUS mnemonic. This is a read-only status register that reflects the status outside of the reset domain of the register.
- Registers that have the LAR mnemonic. These are write-only registers that only have an effect on writes.

All other fields in the management registers are reset to an IMPLEMENTATION DEFINED value which can be UNKNOWN. The registers are in the reset domain specified in the table.

Table B-7 shows a summary of the management register resets.

Table B-7 Management register resets

Register	Reset domain	Field	Value	Description
CTIITCTRL EDITCTRL PMITCTRL	IMPLEMENTATION DEFINED	IME	0	Integration mode enable
DBGCLAIMCLR_EL1 CTICLAIMCLR ^a	External debug	CLAIM	0x0	Claim tags
CTILSR ^b EDLSR ^b PMLSR ^b	External debug	SLK	1	Software Lock

a. CTICLAIMCLR only if implemented. For DBGCLAIMCLR_EL1, see *DBGCLAIMCLR_EL1, Debug Claim Tag Clear register* on page H9-4477.

b. Only if the OPTIONAL Software Lock is implemented

Appendix C

Recommendations for Performance Monitors Event Numbers for IMPLEMENTATION DEFINED Events

This appendix describes the ARM recommendations for the use of the IMPLEMENTATION DEFINED event numbers. It contains the following section:

- [ARM recommendations for IMPLEMENTATION DEFINED event numbers on page AppxC-4790.](#)
- [Summary of events taken to an Exception Level using AArch64 on page AppxC-4801.](#)

C.1 ARM recommendations for IMPLEMENTATION DEFINED event numbers

These are the ARM recommendations for the use of the IMPLEMENTATION DEFINED event numbers. ARM does not define these events as rigorously as those in the architectural and microarchitectural event lists, and an implementation might:

- Modify the definition of an event to better correspond to the implementation.
- Not use some, or many, of these event numbers.
- Include cumulative occupancy for resource queues such as data access queues, and entry/exit counts, so that average latencies can be determined and counts for key resources that might exist can be separated.
- Provide registers in the IMPLEMENTATION DEFINED space to further extend such counts by, for example, specifying a minimum latency for an event to be counted.
- Use cumulative occupancy for resource queues, such as data access queues, and entry/exit counts, so that average latencies can be determined, separating out counts for key resources that might exist:
 - An implementation might also provide registers in the IMPLEMENTATION DEFINED space to further extend such counts, by, for example specifying a minimum latency for an event to be counted.

Table C-1 lists the PMU IMPLEMENTATION DEFINED event numbers in event number order.

Table C-1 PMU IMPLEMENTATION DEFINED event numbers

Event number	Event mnemonic	Description
0x40	L1D_CACHE_LD	Level 1 data cache access, read
0x41	L1D_CACHE_ST	Level 1 data cache access, write
0x42	L1D_CACHE_REFILL_LD	Level 1 data cache refill, read
0x43	L1D_CACHE_REFILL_ST	Level 1 data cache refill, write
0x44	L1D_CACHE_REFILL_INNER	Level 1 data cache refill, inner
0x45	L1D_CACHE_REFILL_OUTER	Level 1 data cache refill, outer
0x46	L1D_CACHE_WB_VICTIM	Level 1 data cache write-back, victim
0x47	L1D_CACHE_WB_CLEAN	Level 1 data cache write-back, cleaning and coherency
0x48	L1D_CACHE_INVALID	Level 1 data cache invalidate
0x49-0x4B	-	Reserved
0x4C	L1D_TLB_REFILL_LD	Level 1 data TLB refill, read
0x4D	L1D_TLB_REFILL_ST	Level 1 data TLB refill, write
0x4E-0x4F	-	Reserved
0x50	L2D_CACHE_LD	Level 2 data cache access, read
0x51	L2D_CACHE_ST	Level 2 data cache access, write
0x52	L2D_CACHE_REFILL_LD	Level 2 data cache refill, read
0x53	L2D_CACHE_REFILL_ST	Level 2 data cache refill, write
0x54-0x55	-	Reserved
0x56	L2D_CACHE_WB_VICTIM	Level 2 data cache write-back, victim
0x57	L2D_CACHE_WB_CLEAN	Level 2 data cache write-back, cleaning and coherency

Table C-1 PMU IMPLEMENTATION DEFINED event numbers (continued)

Event number	Event mnemonic	Description
0x58	L2D_CACHE_INVALID	Level 2 data cache invalidate
0x59-0x5F	-	Reserved
0x60	BUS_ACCESS_LD	Bus access, read
0x61	BUS_ACCESS_ST	Bus access, write
0x62	BUS_ACCESS_SHARED	Bus access, Normal, Cacheable, Shareable
0x63	BUS_ACCESS_NOT_SHARED	Bus access, not Normal, Cacheable, Shareable
0x64	BUS_ACCESS_NORMAL	Bus access, normal
0x65	BUS_ACCESS_PERIPH	Bus access, peripheral
0x66	MEM_ACCESS_LD	Data memory access, read
0x67	MEM_ACCESS_ST	Data memory access, write
0x68	UNALIGNED_LD_SPEC	Unaligned access, read
0x69	UNALIGNED_ST_SPEC	Unaligned access, write
0x6A	UNALIGNED_LDST_SPEC	Unaligned access
0x6B	-	Reserved
0x6C	LDREX_SPEC	Exclusive operation speculatively executed, LDREX or LDX
0x6D	STREX_PASS_SPEC	Exclusive operation speculatively executed, STREX or STX pass
0x6E	STREX_FAIL_SPEC	Exclusive operation speculatively executed, STREX or STX pass
0x6F	STREX_SPEC	Exclusive operation speculatively executed, STREX or STX
0x70	LD_SPEC	Operation speculatively executed, load
0x71	ST_SPEC	Operation speculatively executed, store
0x72	LDST_SPEC	Operation speculatively executed, load or store
0x73	DP_SPEC	Operation speculatively executed, integer data-processing
0x74	ASE_SPEC	Operation speculatively executed, Advanced SIMD instruction
0x75	VFP_SPEC	Operation speculatively executed, floating-point instruction
0x76	PC_WRITE_SPEC	Operation speculatively executed, software change of the PC
0x77	CRYPTO_SPEC	Operation speculatively executed, Cryptographic instruction
0x78	BR_IMMED_SPEC	Branch speculatively executed, immediate branch
0x79	BR_RETURN_SPEC	Branch speculatively executed, procedure return
0x7A	BR_INDIRECT_SPEC	Branch speculatively executed, indirect branch
0x7B	-	Reserved
0x7C	ISB_SPEC	Barrier speculatively executed, ISB
0x7D	DSB_SPEC	Barrier speculatively executed, DSB

Table C-1 PMU IMPLEMENTATION DEFINED event numbers (continued)

Event number	Event mnemonic	Description
0x7E	DMB_SPEC	Barrier speculatively executed, DMB
0x7F-0x80	-	Reserved
0x81	EXC_UNDEF	Exception taken, Other synchronous
0x82	EXC_SVC	Exception taken, Supervisor Call
0x83	EXC_PABORT	Exception taken, Instruction Abort
0x84	EXC_DABORT	Exception taken, Data Abort and SError
0x85	-	Reserved
0x86	EXC_IRQ	Exception taken, IRQ
0x87	EXC_FIQ	Exception taken, FIQ
0x88	EXC_SMC	Exception taken, Secure Monitor Call
0x89	-	Reserved
0x8A	EXC_HVC	Exception taken, Hypervisor Call
0x8B	EXC_TRAP_PABORT	Exception taken, Instruction Abort not taken locally
0x8C	EXC_TRAP_DABORT	Exception taken, Data Abort or SError not taken locally
0x8D	EXC_TRAP_OTHER	Exception taken, Other traps not taken locally
0x8E	EXC_TRAP_IRQ	Exception taken, IRQ not taken locally
0x8F	EXC_TRAP_FIQ	Exception taken, FIQ not taken locally
0x90	RC_LD_SPEC	Release consistency operation speculatively executed, Load-Acquire
0x91	RC_ST_SPEC	Release consistency operation speculatively executed, Store-Release

0x40, Level 1 data cache access, read

This event is similar to Level 1 data cache access but the counter counts only memory-read operations that access at least the Level 1 data or unified cache.

0x41, Level 1 data cache access, write

This event is similar to Level 1 data cache access but the counter counts only memory-write operations that access at least the Level 1 data or unified cache.

The counter counts [DC ZVA](#) as a store instruction.

0x42, Level 1 data cache refill, read

This event is similar to Level 1 data cache refill but the counter counts only memory-read operations that cause a refill of at least the Level 1 data or unified cache.

0x43, Level 1 data cache refill, write

This event is similar to Level 1 data cache refill but the counter counts only memory-write operations that cause a refill of at least the Level 1 data or unified cache.

The counter counts [DC ZVA](#) as a store instruction.

0x44, Level 1 data cache refill, inner

This event is similar to Level 1 data cache refill but the counter counts only memory-read and memory-write operations that generate refills satisfied by transfer from another cache inside of the immediate cluster.

———— **Note** ————

The boundary between *inner* and *outer* is IMPLEMENTATION DEFINED, and it is not necessarily linked to other similar boundaries, such as the boundary between Inner Cacheable and Outer Cacheable or the boundary between Inner Shareable and Outer Shareable.

0x45, Level 1 data cache refill, outer

This event is similar to Level 1 data cache refill but the counter counts only memory-read and memory-write operations that generate refills satisfied from outside of the immediate cluster.

0x46, Level 1 data cache write-back, victim

This event is similar to Level 1 data cache write-back but the counter counts only write-backs that are a result of the line being allocated for an access made by the PE.

CP15 cache maintenance operations do not count as events.

It is IMPLEMENTATION DEFINED whether a write of a whole cache line that is not the result of the eviction of a line from the cache is counted. For example, this might occur if the PE detects streaming writes to memory and does not allocate lines to the cache, or as the result of a [DC ZVA](#).

0x47, Level 1 data cache write-back, cleaning and coherency

This event is similar to Level 1 data cache write-back but the counter counts only write-backs that are a result of a coherency operation made by another PE or from a CP15 cache maintenance operation. Whether write-backs made as a result of CP15 cache maintenance operations are counted is IMPLEMENTATION DEFINED.

If a coherency request from a requestor outside the PE results in a write-back, it is an Unattributable event.

———— **Note** ————

The transfer of a dirty cache line from the Level 1 data cache of this PE to the Level 1 data cache of another PE due to a hardware coherency operation is not counted unless the dirty cache line is also written back to a Level 2 cache or memory.

0x48, Level 1 data cache invalidate

The counter counts each invalidation of a cache line in the Level 1 data or unified cache.

The counter does not count events:

- If a cache refill invalidates a line.
- For locally executed CP15 cache set/way maintenance operations.

If a coherency request from a requestor outside the PE results in a write-back, it is an Unattributable event.

0x4C, Level 1 data TLB refill, read

This event is similar to Level 1 data TLB refill but the counter counts only memory-read operations that cause a data TLB refill of a least the Level 1 data or unified TLB.

0x4D, Level 1 data TLB refill, write

This event is similar to Level 1 data TLB refill but the counter counts only memory-write operations that cause a data TLB refill of a least the Level 1 data or unified TLB.

The counter counts [DC ZVA](#) as a store instruction.

0x50, Level 2 data cache access, read

This event is similar to Level 2 data cache access but the counter counts only memory-read operations that access at least the Level 2 data or unified cache.

0x51, Level 2 data cache access, write

This event is similar to Level 2 data cache access but the counter counts only memory-write operations that access at least the Level 2 data or unified cache.

The counter counts [DC ZVA](#) as a store instruction.

0x52, Level 2 data cache refill, read

This event is similar to Level 2 data cache refill but the counter counts only memory-read operations that cause a refill of at least the Level 2 data or unified cache.

0x53, Level 2 data cache refill, write

This event is similar to Level 2 data cache refill but the counter counts only memory-write operations that cause a refill of at least the Level 2 data or unified cache.

The counter counts [DC ZVA](#) as a store instruction.

0x56, Level 2 data cache write-back, victim

This event is similar to Level 2 data cache write-back but the counter counts only write-backs that are a result of the line being allocated for an access made by the PE.

CP15 cache maintenance operations do not count as events.

It is IMPLEMENTATION DEFINED whether a write of a whole cache line that is not the result of the eviction of a line from the cache is counted. For example, this might occur if the PE detects streaming writes to memory and does not allocate lines to the cache, or as the result of a [DC ZVA](#).

0x57, Level 2 data cache write-back, cleaning and coherency

This event is similar to Level 2 data cache write-back but the counter counts only write-backs that are a result of a coherency operation made by another PE or CP15 cache maintenance operation. Whether write-backs made as a result of CP15 cache maintenance operations are counted is IMPLEMENTATION DEFINED.

———— **Note** —————

The transfer of a dirty cache line from the Level 2 data cache of this PE to the Level 2 data cache of another PE due to a hardware coherency operation is not counted unless the dirty cache line is also written back to a Level 3 cache or memory.

—————

If a coherency request from a requestor outside the PE results in a write-back, it is an Unattributable event.

0x58, Level 2 data cache invalidate

The counter counts each invalidation of a cache line in the Level 2 data or unified cache.

The counter does not count events:

- If a cache refill invalidates a line.
- For locally executed CP15 set/way cache maintenance operations.

———— **Note** —————

Software that uses this event must know whether the Level 2 data cache is shared with other PEs. This event does not follow the general rule of Level 2 data cache events of only counting events that directly affect this PE.

—————

If a coherency request from a requestor outside the PE results in a write-back, it is an Unattributable event.

0x60, Bus access, read

This event is similar to bus access but the counter counts only memory-read operations that access outside the boundary of the PE and its closely-coupled caches.

0x61, Bus access, write

This event is similar to bus access but the counter counts only memory-write operations that access outside the boundary of the PE and its closely-coupled caches.

0x62, Bus access, Normal, Cacheable, Shareable

This event is similar to bus access but the counter counts only memory-read and memory-write operations that make Normal, Cacheable, Shareable accesses outside the boundary of the PE and its closely-coupled caches.

———— **Note** —————

It is IMPLEMENTATION DEFINED how the PE translates the attributes from the translation table entry for a region to the attributes on the bus.

In particular, a region of memory designated as Normal, Cacheable, Inner Shareable, Not Outer Shareable by a translation table entry, might be marked as either Shareable or Not Shareable at the boundary of the PE and its closely-coupled caches. This depends on where the IMPLEMENTATION DEFINED boundary lies, between Inner and Outer Shareable.

If the Inner Shareable extends beyond the PE boundary, and the bus indicates the distinction between Inner and Outer Shareable, then either is counted as Shareable for the purposes of defining this event.

0x63, Bus access, not Normal, Cacheable, Shareable

This event is similar to bus access but the counter counts only memory-read and memory-write operations that make accesses outside the boundary of the PE and its closely-coupled caches that are not Normal, Cacheable, Shareable. For example, the counter counts accesses marked as:

- Normal, Cacheable, Not Shareable.
- Normal, Not Cacheable.
- Device.

———— **Note** —————

It is IMPLEMENTATION DEFINED, how the PE translates the attributes from the translation table entries for a region to the attributes on the bus.

In particular, a region of memory designated as Normal, Cacheable, Inner Shareable, Not Outer Shareable by a translation table entry, might be marked as either Shareable or Not Shareable at the boundary of the PE and its closely-coupled caches. This depends on where the IMPLEMENTATION DEFINED boundary lies, between Inner and Outer Shareable.

If the Inner Shareable extends beyond the PE boundary, and the bus indicates the distinction between Inner and Outer Shareable, then either is counted as Shareable for the purposes of defining this event.

0x64, Bus access, normal

This event is similar to bus access but the counter counts only memory-read and memory-write operations that make Normal accesses outside the boundary of the PE and its closely-coupled caches. For example, the counter counts Normal, Cacheable and Normal, Not Cacheable accesses but does not count Device accesses.

0x65, Bus access, peripheral

This event is similar to bus access but the counter counts only memory-read and memory-write operations that make Device accesses outside the boundary of the PE and its closely-coupled caches.

0x66, Data memory access, read

This event is similar to data memory access but the counter counts only memory-read operations that the PE made.

0x67, Data memory access, write

This event is similar to data memory access but the counter counts only memory-write operations made by the PE.

0x68, Unaligned access, read

This event is similar to data memory access but the counter counts only unaligned memory-read operations that the PE made. It also counts unaligned accesses if they are subsequently transposed into multiple aligned accesses.

0x69, Unaligned access, write

This event is similar to data memory access but the counter counts only unaligned memory-read operations that the PE made. It also counts unaligned accesses if they are subsequently transposed into multiple aligned accesses.

0x6A, Unaligned access

This event is similar to data memory access but the counter counts only unaligned memory-read operations and unaligned memory-write operations that the PE made. It also counts unaligned accesses if they are subsequently transposed into multiple aligned accesses.

0x6C, Exclusive operation speculatively executed, Load-Exclusive

The counter counts Load-Exclusive instructions speculatively executed.

The definition of speculatively executed is IMPLEMENTATION DEFINED.

0x6D, Exclusive operation speculatively executed, Store-Exclusive pass

The counter counts Store-Exclusive instructions speculatively executed that completed a write.

The definition of speculatively executed is IMPLEMENTATION DEFINED but must be the same as for the exclusive operation speculatively executed, Load-Exclusive event.

0x6E, Exclusive operation speculatively executed, Store-Exclusive fail

The counter counts Store-Exclusive instructions speculatively executed that fail to complete a write. It is within the IMPLEMENTATION DEFINED definition of speculatively executed whether this includes conditional instructions that fail the condition code check.

The definition of speculatively executed is IMPLEMENTATION DEFINED but must be the same as for the exclusive operation speculatively executed, Load-Exclusive event.

0x6F, Exclusive operation speculatively executed, Store-Exclusive

The counter counts Store-Exclusive instructions speculatively executed.

The definition of speculatively executed is IMPLEMENTATION DEFINED but it must be the same as for the exclusive operation speculatively executed, Load-Exclusive event.

ARM recommends that this event is implemented if it is not possible to implement the exclusive operation speculatively executed, Store-Exclusive pass, and exclusive operation speculatively executed, Store-Exclusive fail, events with the same degree of speculation as the exclusive operation speculatively executed, Load-Exclusive event.

0x70, Operation speculatively executed, load

This event is similar to the operation speculatively executed but the counter counts only memory-reading instructions. Defined by the instruction architecturally executed, condition code check pass, load event, see [Common event numbers on page D6-1839](#).

The definition of speculatively executed is IMPLEMENTATION DEFINED but must be the same as for the operation speculatively executed event.

0x71, Operation speculatively executed, store

This event is similar to the operation speculatively executed but the counter counts only memory-writing instructions. Defined by the instruction architecturally executed, condition code check pass, store event, see [Common event numbers on page D6-1839](#).

The counter counts [DC ZVA](#) as a store operation.

The definition of speculatively executed is IMPLEMENTATION DEFINED but must be the same as for the operation speculatively executed event.

0x72, Operation speculatively executed, load or store

This event is similar to the operation speculatively executed but the counter counts only memory-reading instructions and memory-writing instructions. Defined by the instruction architecturally executed, condition code check pass, load and instruction architecturally executed, condition code check pass, store events, see [Common event numbers on page D6-1839](#).

The definition of speculatively executed is IMPLEMENTATION DEFINED but must be the same as for the operation speculatively executed event.

0x73, Operation speculatively executed, integer data-processing

This event is similar to the operation speculatively executed but counts only integer data-processing instructions. It counts the following operations that operate on the general-purpose registers:

- In AArch64 state, [Data processing - immediate on page C2-140](#) and [Data processing - register on page C2-145](#).
- In AArch32 state, [Data-processing instructions on page F1-2383](#).

This includes MOV and MVN operations.

This event also counts the following miscellaneous instructions:

- In AArch64 state, [System register instructions on page C2-126](#), [System instructions on page C2-126](#), and [Hint instructions on page C2-127](#).
- In AArch32 state, [Status register access instructions on page F1-2391](#), [Banked register access instructions on page F1-2391](#), [Miscellaneous instructions on page F1-2395](#), other than ISB and preloads, and [Coprocessor instructions on page F1-2397](#), other than coprocessor load and store instructions.

If the preload instructions PRFM, PLD, PLDW, and PLI, do not count as memory-reading instructions then they must count as integer data-processing instructions.

If ISBs do not count as software change of the PC then they must count as integer data-processing instructions.

The definition of speculatively executed is IMPLEMENTATION DEFINED, but must be the same as for the operation speculatively executed event.

It is IMPLEMENTATION DEFINED whether the following instructions are counted as integer data-processing operations, SIMD operations, or floating-point operations, but ARM recommends that the instructions are all counted as integer data-processing operations:

- For AArch64 state, from the A64 floating-point convert to integer class, operations that move a value between a general-purpose register and a SIMD and floating-point register without type conversion:
 - FMOV (general).
- For AArch64 state, from the SIMD Move group, operations that move a values between a general-purpose register and an element or elements in a SIMD and floating-point register:
 - DUP (general).
 - SMOV.
 - UMOV.
 - INS (general).

- In AArch32 state:
 - VDUP (general-purpose register) and all VMOV instructions that transfer data between a general-purpose register and a SIMD and floating-point register.
 - VMRS.
 - VMSR.

0x74, Operation speculatively executed, Advanced SIMD

This event is similar to the operation speculatively executed but the counter counts only Advanced SIMD data-processing instructions, see:

- For AArch64 state, the SIMD operations listed in [Data processing - SIMD and floating-point on page C2-152](#)
- For AArch32 state, [Advanced SIMD data-processing instructions on page F1-2401](#)

This includes all operations that operate on the SIMD and floating-point registers, except those that are counted as:

- Integer data-processing operations.
- Floating-point data-processing operations.
- Memory-reading operations.
- Memory-writing operations.
- Cryptographic operations other than PMULL, in AArch64 state.
- VMULL, in AArch32 state.

Advanced SIMD scalar operations are counted as Advanced SIMD operations, including those which operate on floating-point values. In AArch64 state, PMULL, and in AArch32 state, VMULL are counted as Advanced SIMD operations.

The definition of speculatively executed is IMPLEMENTATION DEFINED, but must be the same as for the operation speculatively executed event.

0x75, Operation speculatively executed, floating-point

This event is similar to the operation speculatively executed but the counter counts only floating-point data-processing instructions, see:

- In AArch64 state, the floating-point operations listed in [Data processing - SIMD and floating-point on page C2-152](#).
- In AArch32 state, [Floating-point data-processing instructions on page F1-2408](#).

This includes all operations that operate on the SIMD and floating-point registers as floating-point values, except for SIMD scalar operations and those that are counted as one of:

- Integer data-processing.
- Memory-reading operations.
- Memory-writing operations.

The following instructions that take both an integer register and a floating-point register argument and perform a type conversion (to/from integer or to/from fixed-point), are counted as floating-point data-processing operations:

- In AArch64 state, FCVT{<mode>}, UCVTF, and SCVTF.
- In AArch32, VCVT<mode>(floating-point), VCVT, VCVTT, and VCVTB.

The definition of speculatively executed is IMPLEMENTATION DEFINED, but must be the same as for the operation speculatively executed event.

0x76, Operation speculatively executed, software change of the PC

This event is similar to the operation speculatively executed but the counter counts only software changes of the PC. Defined by the instruction architecturally executed, condition code check pass, software change of the PC event, see [Common event numbers on page D6-1839](#).

The definition of speculatively executed is IMPLEMENTATION DEFINED but must be the same as for the operation speculatively executed event.

See also PC_WRITE_RETIRED in [Table D6-6 on page D6-1839](#).

0x77, Operation speculatively executed, Cryptographic instruction

This event is similar to the operation speculatively executed but the counter counts only Cryptographic instructions, except PMULL and VMULL, see [Cryptography extensions on page C2-169](#).

The definition of speculatively executed is IMPLEMENTATION DEFINED but must be the same as for the operation speculatively executed event.

0x78, Branch speculatively executed, immediate branch

The counter counts immediate branch instructions speculatively executed. Defined by the instruction architecturally executed, immediate branch event, see [Common event numbers on page D6-1839](#).

The definition of speculatively executed is IMPLEMENTATION DEFINED.

See also BR_IMMED_RETIRED in [Table D6-6 on page D6-1839](#).

0x79, Branch speculatively executed, procedure return

The counter counts procedure return instructions speculatively executed. Defined by the instruction architecturally executed, condition code check pass, procedure return event, see [Common event numbers on page D6-1839](#).

The definition of speculatively executed is IMPLEMENTATION DEFINED.

See also BR_RETURN_RETIRED in [Table D6-6 on page D6-1839](#).

0x7A, Branch speculatively executed, indirect branch

The counter counts indirect branch instructions speculatively executed. This includes software change of the PC other than exception-generating instructions and immediate branch instructions.

The definition of speculatively executed is IMPLEMENTATION DEFINED.

0x7C, Barrier speculatively executed, ISB

The counter counts instruction synchronization barrier instructions speculatively executed, including [CP15ISB](#).

The definition of speculatively executed is IMPLEMENTATION DEFINED.

0x7D, Barrier speculatively executed, DSB

The counter counts data synchronization barrier instructions speculatively executed, including [CP15DSB](#).

The definition of speculatively executed is IMPLEMENTATION DEFINED.

0x7E, Barrier speculatively executed, DMB

The counter counts data memory barrier instructions speculatively executed, including [CP15DSB](#). It does not include the implied barrier operations of load/store operations with release consistency semantics.

The definition of speculatively executed is IMPLEMENTATION DEFINED.

0x81, Exception taken, other synchronous

This event is similar to exception taken but the counter counts only synchronous exceptions that are not counted by the other Exception taken events. This event counts only exceptions taken locally.

0x82, Exception taken, Supervisor Call

This event is similar to exception taken but the counter counts only Supervisor Call exceptions. This event counts only exceptions taken locally.

0x83, Exception taken, Instruction Abort

This event is similar to exception taken but the counter counts only Instruction Abort exceptions. This event counts only exceptions taken locally.

0x84, Exception taken, Data Abort or SError

This event is similar to exception taken but the counter counts only Data Abort or SError interrupt exceptions. The counter counts only exceptions taken locally.

0x86, Exception taken, IRQ

This event is similar to exception taken but the counter counts only IRQ exceptions. The counter counts only exceptions taken locally, including Virtual IRQ exceptions.

0x87, Exception taken, FIQ

This event is similar to exception taken but the counter counts only FIQ exceptions. The counter counts only exceptions taken locally, including Virtual FIQ exceptions.

0x88, Exception taken, Secure Monitor Call

This event is similar to exception taken but the counter counts only Secure Monitor Call exceptions. The counter does not increment on SMC instructions trapped as a Hyp Trap exception.

0x8A, Exception taken, Hypervisor Call

This event is similar to exception taken but the counter counts only Hypervisor Call exceptions. The counter counts for both Hypervisor Call exceptions taken locally in the hypervisor and those taken as an exception from Non-secure EL1.

0x8B, Exception taken, Instruction Abort not taken locally

This event is similar to exception taken but the counter counts only Instruction Abort exceptions not taken locally.

0x8C, Exception taken, Data Abort or SError not taken locally

This event is similar to exception taken but the counter counts only Data Abort or SError interrupt exceptions not taken locally.

0x8D, Exception taken, other traps not taken locally

This event is similar to exception taken but the counter counts only those traps that are not counted as:

- Exception taken, Hypervisor Call.
- Exception taken, Instruction Abort not taken locally.
- Exception taken, Data Abort or SError not taken locally.
- Exception taken, IRQ not taken locally.
- Exception taken, FIQ not taken locally.

0x8E, Exception taken, IRQ not taken locally

This event is similar to exception taken but the counter counts only IRQ exceptions not taken locally.

0x8F, Exception taken, FIQ not taken locally

This event is similar to exception taken but the counter counts only FIQ exceptions not taken locally.

0x90, Release consistency operation speculatively executed, Load-Acquire

The counter counts Load-Acquire operations that are speculatively executed. The definition of speculatively executed is IMPLEMENTATION DEFINED.

0x91, Release consistency operation speculatively executed, Store-Release

The counter counts Store-Release operations that are speculatively executed. The definition of speculatively executed is IMPLEMENTATION DEFINED.

C.2 Summary of events taken to an Exception Level using AArch64

Table C-2 shows the events for exceptions taken to an Exception level using AArch64.

Table C-2 Events for exceptions taken to an EL using AArch64

ESR.EC	Description	Event number and classification for exception taken to	
		EL1, or the current EL	EL2 or EL3, from below
0x00	Unknown or uncategorized	0x081, Other synchronous	0x08D, Other traps not taken locally
0x01	WFE/WFI traps	0x081, Other synchronous	0x08D, Other traps not taken locally
0x03	AArch32 CP15 MCR/MRC traps	0x081, Other synchronous	0x08D, Other traps not taken locally
0x04	AArch32 CP15 MCRR/MRRC traps	0x081, Other synchronous	0x08D, Other traps not taken locally
0x05	AArch32 CP14 MCR/MRC traps	0x081, Other synchronous	0x08D, Other traps not taken locally
0x06	AArch32 CP14 LDC/STC traps	0x081, Other synchronous	0x08D, Other traps not taken locally
0x07	Advanced SIMD or FP traps	0x081, Other synchronous	0x08D, Other traps not taken locally
0x08	AArch32 MVFR* and FPSID traps	-	0x08D, Other traps not taken locally
0x0C	AArch32 CP14 MCRR/MRRC traps	0x081, Other synchronous	0x08D, Other traps not taken locally
0x0E	Illegal instruction set state	0x081, Other synchronous	0x08D, Other traps not taken locally
0x11	AArch32 SVC	0x082, Supervisor Call	0x08D, Other traps not taken locally
0x12	AArch32 HVC that is not disabled	-	0x08A, Hypervisor Call
0x13	AArch32 SMC that is not disabled	to EL2	-
		to EL3	-
0x15	AArch64 SVC	0x082, Supervisor Call	0x08D, Other traps not taken locally
0x16	AArch64 HVC that is not disabled	0x08A, Hypervisor Call	0x08A, Hypervisor Call
0x17	AArch64 SMC that is not disabled	to EL2	-
		to EL3	0x088, Secure Monitor Call
0x18	AArch64 MSR, MRS and system instruction traps	0x081, Other synchronous	0x08D, Other traps not taken locally
0x20	Instruction abort from below	0x083, Instruction Abort	0x08B, Instruction Abort not taken locally
0x21	Instruction abort from current EL	0x083, Instruction Abort	-
0x22	PC alignment	0x083, Instruction Abort	0x08B, Instruction Abort not taken locally
0x24	Data Abort from below	0x084, Data Abort or SError	0x08C, Data Abort or SError not taken locally
0x25	Data Abort from current EL	0x084, Data Abort or SError	-
0x26	Stack pointer alignment	0x084, Data Abort or SError	0x08C, Data Abort or SError not taken locally

Table C-2 Events for exceptions taken to an EL using AArch64 (continued)

ESR.EC	Description	Event number and classification for exception taken to	
		EL1, or the current EL	EL2 or EL3, from below
0x28	AArch32 FP exception	0x081, Other synchronous	0x08D, Other traps not taken locally
0x2C	AArch64 FP exception	0x081, Other synchronous	0x08D, Other traps not taken locally
0x2F	SError interrupt	0x084, Data Abort or SError	0x08C, Data Abort or SError not taken locally
0x30	Breakpoint from below	0x083, Instruction Abort	0x08B, Instruction Abort not taken locally
0x31	Breakpoint from current EL	0x083, Instruction Abort	-
0x32	Software step from below	0x083, Instruction Abort	0x08B, Instruction Abort not taken locally
0x33	Software step from current EL	0x083, Instruction Abort	-
0x34	Watchpoint from below	0x084, Data Abort or SError	0x08C, Data Abort or SError not taken locally
0x35	Watchpoint from current EL	0x084, Data Abort or SError	-
0x38	AArch32 BKPT instruction	0x083, Instruction Abort	0x08B, Instruction Abort not taken locally
0x3A	AArch32 Vector Catch debug event	0x083, Instruction Abort	0x08B, Instruction Abort not taken locally
0x3C	AArch64 BRK instruction	0x083, Instruction Abort	0x08B, Instruction Abort not taken locally
-	IRQ interrupt	0x086, IRQ	0x08E, IRQ not taken locally
-	FIQ interrupt	0x087, FIQ	0x08F, FIQ not taken locally

———— **Note** —————

In these definitions, an exception that is *taken locally* means an exception that is taken to the default Exception level, and is not routed to another Exception level. See [Exception levels on page D1-1408](#) for more information.

Appendix D

Example OS Save and Restore sequences

This appendix provides possible OS Save and Restore sequences for a v8 Debug implementation. It contains the following sections:

- [Save Debug registers on page AppxD-4804.](#)
- [Restore Debug registers on page AppxD-4806.](#)

D.1 Save Debug registers

This section shows how to save the registers that are used by an external debugger.

; On entry, X0 points to a block to save the debug registers in.

; Returns the pointer beyond the block and corrupts X1-X3

SaveDebugRegisters

; (1) Set OS lock.

MOV X2,#1 ; Set the OS lock. In AArch64 state, the OS lock

MSR OSLAR_EL1,X2 ; is writable via OSLAR.

ISB ; Context synchronization operation

; (2) Walk through the registers, saving them

MRS X1,OSDTRRX_EL1 ; Read DTRRX

MRS X2,OSDTRTX_EL1 ; Read DTRTX

STP W1,W2,[X0],#8 ; Save { DTRRX, DTRTX }

MRS X1,MDSR_EL1 ; Read DSCR

MRS X2,0SECCR_EL1 ; Read ECCR

STP W1,W2,[X0],#8 ; Save { DSCR, ECCR }

[AARCH32_SUPPORTED

MRS X1,DBGVCR32_EL2 ; Read DBGVCR

MRS X2,DBGCLAIMCLR_EL1 ; Read CLAIM - note, have to read via CLAIMCLR

STP W1,W2,[X0],#8 ; Save { VCR, CLAIM }

]

;; Macros for saving off a "register pair"

;; \$WB is W for watchpoint, B for breakpoint

;; \$num is the pair's number

;; X0 contains a pointer for the value words

;; X1 contains a pointer for the control words

;; W2 contains the max index

MACRO

SaveRP \$WB,\$num, \$exit

MRS X3,DBG\$WB.VR\$num._EL1 ; Read DBGxVRn

STR X3,[X0],#8 ; Save { xVRn }

MRS X3,DBG\$WB.CR\$num._EL1 ; Read DBGxCrN

STR W3,[X0],#4 ; Save { xCrN }.

[\$num > 1 :LAND: \$num < 15

```
CMP    W1,#$num
BEQ    $exit
]
MEND
```

```
; (3) Breakpoints
```

```
MRS    X1,ID_AA64DFR0_EL1
UBFX   W1,W1,#12,#4           ; Extract BRPs field
```

```
MACRO
```

```
SaveBRP $num                ; Save a Breakpoint Register Pair
```

```
SaveRP  B,$num,SaveDebugRegisters_Watchpoints
```

```
MEND
```

```
SaveBRP 0
```

```
SaveBRP 1
```

```
SaveBRP 2
```

```
;; and so on to ...
```

```
SaveBRP 15
```

```
SaveDebugRegisters_Watchpoints
```

```
; (4) Watchpoints
```

```
MRS    X1,ID_AA64DFR0_EL1     ; Read DBGDIDR
```

```
UBFX   W1,W1,#20,#4           ; Extract WRPs field
```

```
MACRO
```

```
SaveWRP $num                ; Save a Watchpoint Register Pair
```

```
SaveRP  W,$num,SaveDebugRegisters_Exit
```

```
MEND
```

```
SaveWRP 0
```

```
SaveWRP 1
```

```
SaveWRP 2
```

```
;; and so on to ...
```

```
SaveWRP 15
```

```
SaveDebugRegisters_Exit
```

```
; (5) Return the pointer to first word not read. This pointer is already in X0, so
```

```
; all that is needed is to return from this function. The OS double-lock (OSDLR_EL1.DLK) is
```

```
; locked later, just before the final entry to WFI state.
```

```
RET
```

D.2 Restore Debug registers

This section shows how to restore the registers that are used by an external debugger.

; On entry, X0 points to a block of saved debug registers.

; Returns the pointer beyond the block and corrupts R1-R3,R12.

RestoreDebugRegisters

; (1) Lock OS lock. The lock will already be set, but this write is included to ensure it
; is locked.

MOV X2,#1 ; Lock the OS lock. In AArch64 state, the OS lock

MSR OSLAR_EL1,X2 ; is writable via OSLAR.

ISB ; Context synchronization operation

; (2) Walk through the registers, restoring them

LDP W1,W2,[X0],#8 ; Read { DTRRX,DTRTX }

MSR OSDTRRX_EL1,X1 ; Restore DTRRX

MSR OSDTRTX_EL1,X2 ; Restore DTRTX

LDP W1,W2,[X0],#8 ; Read { DSCR, ECCR }

MSR MDSCR_EL1,X1 ; Restore DSCR

MSR OSECCR_EL1,X2 ; Restore ECCR

[AARCH32_SUPPORTED

LDP W1,W2,[X0],#8 ; Read { VCR,CLAIM }

MSR DBGVCR32_EL2,X1 ; Restore DBGVCR

MSR DBGCLAIMSET_EL1,X2 ; Restore CLAIM – note, writes CLAIMSET

]

;; Macro for restoring a “register pair”

MACRO

RestoreRP \$WB,\$num,\$exit

LDR X3,[X0],#8 ; Read { xVRn }

MSR DBG\$WB.VR\$num._EL1,X3 ; Restore DBGxVRn

LDR W3,[X0],#4 ; Read { xCRn }

MSR DBG\$WB.CR\$num._EL1,X3 ; Restore DBGxCRn

[\$num >= 1 :LAND: \$num < 15

CMP W1,#\$num

BEQ \$exit

]

MEND

```
; (3) Breakpoints
MRS    X1, ID_AA64DFR0_EL1
UBFX   W1, W1, #12, #4           ; Extract BRPs field
MACRO
RestoreBRP $num                  ; Restore a Breakpoint Register Pair
RestoreRP B, $num, RestoreDebugRegisters_Watchpoints
MEND
RestoreBRP 0
RestoreBRP 1
RestoreBRP 2
;; and so on until ...
RestoreBRP 15

RestoreDebugRegisters_Watchpoints
; (4) Watchpoints
MRS    X1, ID_AA64DFR0_EL1       ; Read DBGDIDR
UBFX   W1, W1, #20, #4           ; Extract WRPs field
MACRO
RestoreWRP $num                  ; Restore a Watchpoint Register Pair
RestoreRP W, $num, RestoreDebugRegisters_Exit
MEND
RestoreWRP 0
RestoreWRP 1
RestoreWRP 2
;; and so on until ...
RestoreWRP 15

RestoreDebugRegisters_Exit
; (5) Clear the OS lock.
ISB
MOV     X2, #0                   ; Clear the OS lock. In AArch64 state, the OS lock
MSR     OSLAR_EL1, X2           ; is writable via OSLAR.

; (6) A final ISB guarantees the restored register values are visible to subsequent
; instructions.
ISB
```

```
; (7) Return the pointer to first word not read. This pointer is already in X0, so  
; all that is needed is to return from this function.  
RET
```

Appendix E

Additional Guidance

This chapter provides information about implementing and using the ARM architecture. It contains the following sections:

- *Implementation guidance for multiple views of Debug registers* on page AppxE-4810.
- *AArch32 equivalent Advanced SIMD Mnemonics* on page AppxE-4813.
- *Identifying the cache resources in ARMv8* on page AppxE-4821.
- *Memory access mode in Debug state* on page AppxE-4822.

———— **Note** —————

This description is not part of the ARM architecture specification. It is included here as supplementary information, for the convenience of developers and users who might find this information useful.

E.1 Implementation guidance for multiple views of Debug registers

Table E-1 and Table E-2 on page AppxE-4811 show the aliases and list the access permissions for each of the bits in the Debug System Control Registers.

For definitions of each system register bit see [MDSCR_EL1](#)[18:15, 13:12, 5:2, 0], and [EDSCR](#)[30:29, 27:26, 23:21, 14, 6]. All other bits are reserved, RES0.

Table E-1 shows the implementation requirements for Debug system control registers in AArch64 state, but software must not rely on reserved fields being RAZ or RAZ/WI.

Table E-1 Implementation requirements for Debug system control registers (AArch64 state)

Bits	Physical register or status value for system register views	EDSCR	MDCCSR_ELO (read-only)	MDSCR_EL1	
				OSLK == 0	OSLK == 1
31	Reserved	RAZ/WI	RAZ	RAZ/WI	RAZ/WI
30	EDSCR.RXfull	RO	RO	RO ^a	R/W
29	EDSCR.TXfull	RO	RO	RO ^a	RO
28	Reserved	(ITO) ^b	RAZ	RAZ/WI	RAZ/WI
27	EDSCR.RXO	RO	RAZ	RO ^a	R/W ^c
26	EDSCR.TXO	RO	RAZ	RO ^a	R/W ^c
25	Reserved	(PipeAdv) ^b	RAZ	RAZ/WI	RAZ/WI
24	Reserved	(ITE) ^c	RAZ	RAZ/WI	RAZ/WI
23:22	EDSCR.INTdis	R/W	RAZ	RO ^a	R/W ^c
21	EDSCR.TDA	R/W	RAZ	RO ^a	R/W ^c
20	Reserved	(MA) ^b	RAZ	RAZ/WI	RAZ/WI
19	Reserved	RAZ/WI	RAZ	RAZ/WI	RAZ/WI
18	!IsSecure()	RO	RAZ	RAZ/WI	RAZ/WI
17	ProfilingProhibited(TRUE, EL1)	RAZ/WI	RAZ	RAZ/WI	RAZ/WI
16	!DebugSPD32()	(SDD) ^b	RAZ	RAZ/WI	RAZ/WI
15	MDSCR_EL1.MDE	RAZ/WI	RAZ	R/W	R/W
14	EDSCR.HDE	R/W	RAZ	RO ^a	R/W ^c
13	MDSCR_EL1.KDE	(RW[3]) ^b	RAZ	R/W	R/W
12	MDSCR_EL1.TDCC	(RW[2]) ^b	RAZ	R/W	R/W
11:10	Reserved	(RW[1:0]) ^b	RAZ	RAZ/WI	RAZ/WI
9:8	Reserved	(EL) ^b	RAZ	RAZ/WI	RAZ/WI
7	Reserved	(A) ^b	RAZ	RAZ/WI	RAZ/WI
6	EDSCR.ERR	RO	RAZ	RO ^a	R/W ^c

Table E-1 Implementation requirements for Debug system control registers (AArch64 state) (continued)

Bits	Physical register or status value for system register views	EDSCR	MDCCSR_ELO (read-only)	MDSCR_EL1	
				OSLK == 0	OSLK == 1
5:2	DBGDSCRext.MOE	(STATUS[5:2]) ^b	RAZ	RES0	RES0
1	Reserved	(STATUS[1]) ^b	RAZ	RAZ/WI	RAZ/WI
0	MDSCR_EL1.SS	(STATUS[0]) ^b	RAZ	R/W	R/W

- a. Software must not rely on this bit ignoring writes when OSLK == 0, and must treat the value read as UNKNOWN.
- b. This field does not map to a system register view. See *EDSCR, External Debug Status and Control Register* on page H9-4531.
- c. Software must treat this value as an UNKNOWN value on save. It must be preserved on restore.

Table E-2 shows the implementation requirements for Debug system control registers in AArch32 state, but software must not rely on reserved fields being RAZ or RAZ/WI.

Table E-2 Implementation requirements for Debug system control registers (AArch32 state)

Bits	Physical register or status value for system register views	EDSCR	DBGDSCRint (read-only)	DBGDSCRext	
				OSLK == 0	OSLK == 1
31	Reserved	RAZ/WI	RAZ	RAZ/WI	RAZ/WI
30	EDSCR.RXfull	RO	RO	RO ^a	R/W
29	EDSCR.TXfull	RO	RO	RO ^a	R/W
28	Reserved	(ITO) ^b	RAZ	RAZ/WI	RAZ/WI
27	EDSCR.RXO	RO	RAZ	RO ^a	R/W ^c
26	EDSCR.TXO	RO	RAZ	RO ^a	R/W ^c
25	Reserved	(PipeAdv) ^b	RAZ	RAZ/WI	RAZ/WI
24	Reserved	(ITE) ^c	RAZ	RAZ/WI	RAZ/WI
23:22	EDSCR.INTdis	R/W	RAZ	RO ^a	R/W ^c
21	EDSCR.TDA	R/W	RAZ	RO ^a	R/W ^c
20	Reserved	(MA) ^b	RAZ	RAZ/WI	RAZ/WI
19	Reserved	RAZ/WI	RAZ	RAZ/WI	RAZ/WI
18	!IsSecure()	RO	RO ^a	RO ^a	RO ^a
17	ProfilingProhibited(TRUE, EL1)	RAZ/WI	RO ^a	RO ^a	RO ^a
16	!DebugSPD32()	(SDD) ^b	RO	RO ^a	RO ^a
15	MDSCR_EL1.MDE	RAZ/WI	RO ^d	R/W	R/W
14	EDSCR.HDE	R/W	RAZ	RO ^e	R/W ^c
13	MDSCR_EL1.KDE	(RW[3]) ^b	RAZ	RES0 ^g	RES0 ^g

Table E-2 Implementation requirements for Debug system control registers (AArch32 state) (continued)

Bits	Physical register or status value for system register views	EDSCR	DBGDSCRint (read-only)	DBGDSCRext	
				OSLK == 0	OSLK == 1
12	MDSCR_EL1.TDCC	(RW[2]) ^b	RO ^f	R/W	R/W
11:10	Reserved	(RW[1:0]) ^b	RAZ	RAZ/WI	RAZ/WI
9:8	Reserved	(EL) ^b	RAZ	RAZ/WI	RAZ/WI
7	Reserved	(A) ^b	RAZ	RAZ/WI	RAZ/WI
6	EDSCR.ERR	RO	RAZ	RO ^c	R/W ^c
5:2	DBGDSCRext.MOE	(STATUS[5:2]) ^b	RAZ	RES0 ^g	RES0 ^d
1	Reserved	(STATUS[1]) ^b	RAZ	RAZ/WI	RAZ/WI
0	MDSCR_EL1.SS	(STATUS[0]) ^b	RAZ	RES0 ^g	RES0 ^g

- a. ARM deprecates the use of this field.
- b. This field does not map to a system register view. See [EDSCR, External Debug Status and Control Register](#) on page H9-4531.
- c. Software must treat this value as an UNKNOWN value on save. It must be preserved on restore.
- d. UNKNOWN at EL0.
- e. Software must not rely on this bit ignoring writes when OSLK == 0, and must treat the value read as UNKNOWN.
- f. UNKNOWN at EL0. ARM deprecates the use of this field.
- g. See [RES0](#) for details of how RES0 applies to this bit.

E.2 AArch32 equivalent Advanced SIMD Mnemonics

Table E-3 shows a comparison of the AArch32 instructions and their AArch64 counterparts. It also lists instructions that are new to AArch64.

———— **Note** ————

All Advanced SIMD floating-point functionality changes implicitly to comply with the FPCR rounding mode field, the Default NaN control, the Flush-to-Zero control, and, where supported by the implementation, the Exception trap enable bits.

Table E-3 AArch32 equivalent SIMD mnemonics

AArch32	AArch64					Description
	Agnostic	Integer		Floating-point	Polynomial	
		Unsigned	Signed			
VABA	-	UABA	SABA	-	-	Integer vector absolute difference and accumulate
VABAL	-	UBAL UABAL2	SABAL SABAL2	-	-	Integer vector absolute difference and accumulate long
VABD	-	UABD	SABD	FABD	-	Vector absolute difference
VABDL	-	UABDL UABDL2	SABDL SABDL2	-	-	Integer vector absolute difference long
VABS	-	-	ABS	FABS	-	Vector absolute value
VACGE	-	-	-	FACGE	-	Floating-point vector absolute compare greater than or equal
VACGT	-	-	-	FACGT	-	Floating-point vector absolute compare greater than
VACLE	-	-	-	FACLE	-	Floating-point vector absolute compare less than or equal
VACLT	-	-	-	FACTL	-	Floating-point vector absolute compare less than
VADD	ADD	-	-	FADD	-	Vector add
VADDHN	ADDHN ADDHN2	-	-	-	-	Integer vector add returning high narrow
VADDL	-	UADDL UADDL2	SADDL SADDL2	-	-	Integer vector add long
VADDW	-	UADDW UADDW2	SADDW SADDW2	-	-	Integer vector add wide
VAND	AND	-	-	-	-	Bitwise vector AND

Table E-3 AArch32 equivalent SIMD mnemonics (continued)

AArch64						
AArch32	Integer					Description
	Agnostic	Unsigned	Signed	Floating-point	Polynomial	
VBIC	BIC	-	-	-	-	Bitwise vector bit clear
VBIF	BIF	-	-	-	-	Bitwise vector insert if false
VBIT	BIT	-	-	-	-	Bitwise vector insert if true
VBSL	BSL	-	-	-	-	Bitwise vector select
VCEQ	CMEQ	-	-	FCMEQ	-	Vector compare equal
VCGE	-	CMHS	CMGE	FCMGE	-	Vector compare greater than or equal
VCGT	-	CMHI	CMGT	FCMGT	-	Vector compare greater than
VCLE	-	CMLS	CMLE	FCMLE	-	Vector compare less than or equal
VCLS	CLS	-	-	-	-	Integer vector count leading sign bits
VCLT	-	CML0	CMLT	FCMLT	-	Vector compare less than
VCLZ	CLZ	-	-	-	-	Integer vector count leading zero bits
VCMP	-	-	-	FCMP	-	Floating-point compare
VCMPE	-	-	-	FCMPE	-	Floating-point compare (exception on quiet NaNs)
VCNT	CNT	-	-	-	-	Vector count non-zero bits
VCVT.s32.f32	-	-	-	FCVTZS	-	Vector floating-point convert to signed integer (round to zero)
new	-	-	-	FCVTxS	-	Vector floating-point convert to signed integer (round to x)
VCVT.u32.f32	-	-	-	FCVTZU	-	Vector floating-point convert to unsigned integer (round to zero)
new	-	-	-	FCVTxU	-	Vector floating-point convert to unsigned integer (round to x)
VCVT.f32.i32	-	UCVTF	SCVTF	-	-	Vector integer convert to floating-point
VCVT.f*.f*	-	-	-	FCVTN FCVTL	-	Vector convert floating-point precision

Table E-3 AArch32 equivalent SIMD mnemonics (continued)

AArch64						
AArch32	Integer					Description
	Agnostic	Unsigned	Signed	Floating-point	Polynomial	
new	-	-	-	FCVTXN	-	Vector convert double-precision to single-precision (rounding to odd)
new	-	-	-	FRINTx	-	Vector floating-point round to integral floating-point value (towards x)
new	-	-	-	FDIV	-	Vector floating point divide
VDUP	DUP	-	-	-	-	Duplicate single vector element to all elements
new	INS	-	-	-	-	Insert single element in another element
VEOR	EOR	-	-	-	-	Bitwise exclusive OR
VEXT	EXT	-	-	-	-	Bitwise vector extract
VHADD	-	UHADD	SHADD	-	-	Integer vector halving add
VHSUB	-	UHSUB	SHSUB	-	-	Integer vector halving subtract
VLD1..4	LD1..4	-	-	-	-	Vector structure/element load
VLD1..4R	LD1..4R	-	-	-	-	Vector replicated element load
VLDM/VLDR	LDP/LDR	-	-	-	-	Vector load pair/register
VMAX	-	UMAX	SMAX	FMAX	-	Vector maximum
new	-	-	-	FMAXNM	-	Floating-point vector maxNum
VMIN	-	UMIN	SMIN	FMIN	-	Vector minimum
new	-	-	-	FMINNM	-	Floating-point vector minNum
VMLA	MLA	-	-	n/a	-	Vector chained multiply-add
VFMA	-	-	-	FMLA	-	Vector fused multiply-add
VMLAL	-	UMLAL UMLAL2	SMLAL SMLAL2	-	-	Integer vector multiply-add long
VMLS	MLS	-	-	n/a	-	Vector chained multiply-subtract

Table E-3 AArch32 equivalent SIMD mnemonics (continued)

AArch64						
AArch32	Integer					Description
	Agnostic	Unsigned	Signed	Floating-point	Polynomial	
VFMS	-	-	-	FMLS	-	Vector fused multiply-subtract
VMLS	-	UMLS UMLS2	SMLS SMLS2	-	-	Integer vector multiply-subtract long
VMOV	MOV	UMOV	SMOV	FMOV	-	Vector move
VMOVL	-	UXTL UXTL2	SXTL SXTL2	-	-	Integer vector lengthen (pseudo for USHL#0 or SSHL#0)
VMOVN	XTN	-	-	-	-	Integer vector narrow
VMUL	MUL	-	-	FMUL	PMUL	Vector multiply
new	-	-	-	FMULX	-	Floating-point vector multiply extended (0xINF → 2)
VMULL	-	UMULL UMULL2	SMULL SMULL2	-	PMULL PMULL2	Vector multiply long
VMVN	MVN	-	-	-	-	Bitwise vector NOT
VNEG	-	-	NEG	FNEG	-	Vector negate
VORN	ORN	-	-	-	-	Bitwise vector OR NOT
VORR	ORR	-	-	-	-	Bitwise vector OR
VPADAL	-	UADALP	SADALP	-	-	Integer vector add and accumulate long pair
VPADD	ADDP	-	-	FADDP	-	Vector add pair
VPADDL	-	UADDLP	SADDLP	-	-	Integer vector add long pair
VPMAX	-	UMAXP	SMAXP	FMAXP	-	Vector max pair
new	-	-	-	FMAXNMP	-	Floating-point vector maxNum pair
VPMIN	-	UMINP	SMINP	FMINP	-	Vector min pair
new	-	-	-	FMINNMP	-	Floating-point vector minNum pair
VQABS	-	-	SQABS	-	-	Signed integer saturating vector absolute
VQADD	-	UQADD	SQADD	-	-	Integer saturating vector add

Table E-3 AArch32 equivalent SIMD mnemonics (continued)

AArch32	AArch64					Description
	Agnostic	Integer		Floating-point	Polynomial	
		Unsigned	Signed			
new	-	SUQADD	-	-	-	Signed integer saturating vector accumulate of unsigned value
new	-	-	USQADD	-	-	Unsigned integer saturating vector accumulate of signed value
VQDMLAL	-	-	SQDMLAL SQDMLAL2	-	-	Signed integer saturating vector doubling multiply add long
VQDMSL	-	-	SQDMSL SQDMSL2	-	-	Signed integer saturating vector doubling multiply subtract long
VQDMULH	-	-	SQDMULH	-	-	Signed integer saturating vector doubling multiply high half
VQDMULL	-	-	SQDMULL SQDMULL2	-	-	Signed integer saturating vector doubling multiply long
VQMOVN	-	UQXTN UQXTN2	SQXTN SQXTN2	-	-	Integer saturating vector narrow
VQMOVUN	-	-	SQXTUN SQXTUN2	-	-	Signed integer saturating vector and unsigned narrow
VQNEG	-	-	SQNEG	-	-	Signed integer saturating vector negate
VQRDMULH	-	-	SQRDMULH	-	-	Signed integer vector saturating rounding doubling multiply high half
VQRSHL	-	UQRSHL	SQRSHL	-	-	Integer saturating vector rounding shift left
VQRSHRN	-	UQRSHRN	SQRSHRN	-	-	Integer saturating vector shift right rounded narrow
VQRSHRUN	-	-	SQRSHRUN	-	-	Signed integer saturating vector shift right rounded unsigned narrow
VQSHL	-	UQSHL	SQSHL	-	-	Integer saturating vector shift left
VQSHLU	-	-	SQSHLU	-	-	Signed integer saturating vector shift left unsigned

Table E-3 AArch32 equivalent SIMD mnemonics (continued)

AArch64						
AArch32	Integer					Description
	Agnostic	Unsigned	Signed	Floating-point	Polynomial	
VQSHRN	-	UQSHRN	SQSHRN	-	-	Integer saturating vector shift right narrow
VQSHRUN	-	-	SQSHRUN	-	-	Signed integer saturating vector shift right unsigned narrow
VQSUB	-	UQSUB	SQSUB	-	-	Integer saturating vector subtract
VRADDHN	RADDHN	-	-	-	-	Integer vector rounding add returning high narrow
VRECPE	-	URECPE	-	FRECPE	-	Vector reciprocal estimate
VRECPS	-	-	-	FRECPS	-	Floating-point vector reciprocal step <p style="text-align: center;">———— Note ———— FRECPS uses fused mac, VRECPS remains non-fused</p>
new	-	-	-	FRECPIX	-	Floating-point reciprocal exponent
new	RBIT	-	-	-	-	Vector reverse bits in bytes
VREV16	REV16	-	-	-	-	Vector reverse elements
VREV32	REV32					
VREV64	REV64					
VRHADD	-	URHADD	SRHADD	-	-	Integer rounding vector halving add
VRSHL	-	URSHL	SRSHL	-	-	Integer rounding vector shift left
VRSHR	-	URSHR	SRSHR	-	-	Integer rounding vector shift right
VRSHRN	RSHRN RSHRN2	-	-	-	-	Integer rounding vector shift right narrow
VRSQRTE	-	URSQRTE	-	FRSQRTE	-	Vector reciprocal square root estimate
VRSQRTS	-	-	-	FRSQRTS	-	Floating-point reciprocal square root step. <p style="text-align: center;">———— Note ———— FRSQRTS uses fused mac, VRSQRTS remains non-fused</p>

Table E-3 AArch32 equivalent SIMD mnemonics (continued)

AArch64						
AArch32	Integer					Description
	Agnostic	Unsigned	Signed	Floating-point	Polynomial	
VRSRA	-	URSRA	SRSRA	-	-	Integer rounding vector shift right and accumulate
VRSUBHN	RSUBHN RSUBHN2	-	-	-	-	Integer rounding vector subtract returning high narrow
VSHL	SHL	-	-	-	-	Integer vector shift left
VSHLL	-	USHLL	SSHLL	-	-	Integer vector shift left long
VSHR	-	USHR	SSHR	-	-	Integer vector shift right
VSHRN	SHRN SHRN2	-	-	-	-	Integer vector shift right narrow
VSLI	SLI	-	-	-	-	Integer vector shift left and insert
new	-	-	-	FSQRT	-	Floating-point vector square root
VSRA	-	USRA	SSRA	-	-	Integer vector shift right and accumulate
VSRI	SRI	-	-	-	-	Integer vector shift right and insert
VST1..4	ST1..4	-	-	-	-	Vector structure store
VSTM or VSTR	STP or STR	-	-	-	-	Vector store pair/register
VSUB	SUB	-	-	FSUB	-	Vector subtract
VSUBHN	SUBHN SUBHN2	-	-	-	-	Integer vector subtract returning high narrow
VSUBL	-	USUBL USUBL2	SSUBL SSUBL2	-	-	Integer vector subtract long
VSUBW	-	USUBW USUBW2	SSUBW SSUBW2	-	-	Integer vector subtract wide
VSWP	-	-	-	-	-	Vector swap
VTBL	TBL	-	-	-	-	Vector table lookup
VTBX	TBX	-	-	-	-	Vector table extension
VTRN	TRN1 TRN2	-	-	-	-	Vector element transpose
VTST	CMTST	-	-	-	-	Vector test bits

Table E-3 AArch32 equivalent SIMD mnemonics (continued)

AArch32	AArch64					Description
	Integer					
	Agnostic	Unsigned	Signed	Floating-point	Polynomial	
VUZP	UZP1 UZP2	-	-	-	-	Vector element unzip
VZIP	ZIP ZIP2	-	-	-	-	Vector element zip
new	ADDV	-	-	-	-	Integer sum elements in vector
new	-	SADDLV	UADDLV	-	-	Integer sum elements in vector long
new	-	SMAXV	UMAXV	FMAXV	-	Maximum element in vector
new	-	-	-	FMAXNMV	-	Floating-point maxNum element in vector
new	-	SMINV	UMINV	FMINV	-	Minimum element in vector
new	-	-	-	FMINNMV	-	Floating-point minNum element in vector

E.3 Identifying the cache resources in ARMv8

In ARMv8 the architecture defines support for multiple levels of cache, up to a maximum of seven levels. This complicates the process of identifying the cache resources available to a PE on an ARMv8 implementation. To obtain this information, software must:

1. Read the Cache Type Register to find the indexing and tagging policy used for the Level 1 instruction cache. This register also provides the size of the smallest cache lines used for the instruction caches, and for the data and unified caches. These values are used in cache maintenance operations.
2. Read the Cache Level ID Register to find what caches are implemented. The register includes seven Cache type fields, for cache levels 1 to 7. Scanning these fields, starting from Level 1, identifies the instruction, data or unified caches implemented at each level. This scan ends when it reaches a level at which no caches are defined. The Cache Level ID Register also provides the Level of Unification and the Level of Coherency for the cache implementation.
3. For each cache identified at stage 2:
 - Write to the Cache Size Selection Register to select the required cache. A cache is identified by its level, and whether it is:
 - An instruction cache.
 - A data or unified cache.
 - Read the Cache Size ID Register to find details of the cache.

E.4 Memory access mode in Debug state

The following subsections provide information about memory access modes in Debug state:

- [Alignment constraints](#).
- [Using memory access mode in AArch64 state](#).

This information is an addition to the information provided in [Chapter H4 The Debug Communication Channel and Instruction Transfer Register](#).

E.4.1 Alignment constraints

If the address in X0 or R0 is not aligned to a multiple of four, the behavior is as follows:

- For each external DTR access a CONSTRAINED UNPREDICTABLE choice of:
 1. The PE makes an unaligned memory access to X0 or R0. If alignment checking is enabled for the memory access, this generates an Alignment fault.
 2. The PE makes a memory access to $\text{Align}(X[0],4)$ in AArch64 state, or $\text{Align}(R[0],4)$ in AArch32 state.
 3. The PE generates an Alignment fault, regardless of whether alignment checking is enabled.
 4. The PE does nothing.
- Following each memory access, if there is no Data Abort, X0 or R0 is updated with an UNKNOWN value.
- For external writes to [DBGDTRRX_EL0](#), if the PE writes to memory, an UNKNOWN value is written.
- For external reads of [DBGDTRTX_EL0](#) an UNKNOWN value is returned.
- The RXfull and TXfull flags are left in an UNKNOWN state, meaning that a [DBGDTRTX_EL0](#) read can trigger a TX underrun, and a [DBGDTRRX_EL0](#) write can trigger an RX overrun.

The ARM preferred implementation is:

- The PE makes an unaligned memory access to X0 or R0. If alignment checking is enabled for the memory access, this generates an Alignment fault.
- Following each memory access, if there is no Data Abort, X0 is updated with $X0 + 4$ or R0 is updated with $R0 + 4$.
- For external writes to [DBGDTRRX_EL0](#), if the PE writes to memory, the word written to [DBGDTRRX_EL0](#) is written.
- For external reads of [DBGDTRTX_EL0](#), the result of the unaligned load is returned.
- The RXfull and TXfull flags are updated as normal.

E.4.2 Using memory access mode in AArch64 state

[Figure E-1 on page AppxE-4823](#) and [Figure E-2 on page AppxE-4824](#) show the processes for using memory access mode to implement a download (external host to target) and an upload (target to external host).

To transfer n words of data:

- The download sequence needs $n+6$ accesses by the external debug interface.
- The upload sequence needs $n+8$ accesses by the external debug interface.

In both cases, in the innermost loop the debugger can make an external access to a DTR without polling [EDSCR](#) after each write as underrun and overrun detection prevent failure. Normally external accesses from the debugger are outpaced by the memory accesses of the PE, making underruns and overruns unlikely. If this is not the case, the [EDSCR.ERR](#) flag is set to 1. This is checked once at the end of the sequence, although a debugger can check it more often, for example once for each page. If the [EDSCR.ERR](#) flag is set to 1 because of overrun or underrun, the debugger can restart. The address to restart from is frozen in X0. [EDSCR.ERR](#) might also be set because of a Data abort.

If underruns and overruns are common, the debugger can pace itself accordingly.

Note

- The base address must be a multiple of 4.
- The order of the writes that set up the address does not matter in Debug state.

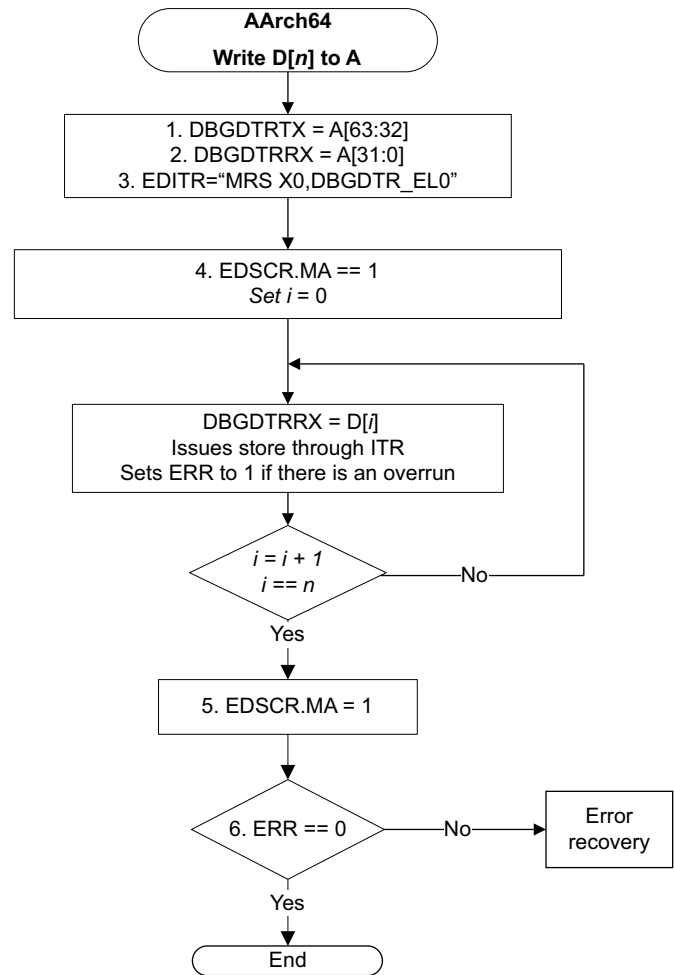

Figure E-1 Fast code download in AArch64 (external host to target)

In [Figure E-1](#), the sequence for the fast code download is as follows:

1. Setup. From the external debug interface:
 - a. Write address [31:0] to `DBGDTRRX_EL0`.
 - b. Write address [63:32] to `DBGDTRTX_EL0`.
 - c. Write `MRS X0, DBGDTR_EL0` to `EDITR`. The PE executes this instruction.
 - d. Set `EDSCR.MA` to 1.
2. Loop n times. From the external debug interface:
 - a. Write to `DBGDTRRX_EL0`. The PE reads the word from `DTRRX` and stores it to memory. It increments `X0` by 4.
3. Epilogue. From the external debug interface:
 - a. Clear `EDSCR.MA` to 0.
 - b. Read `EDSCR` to check for overruns or Data Aborts during download.

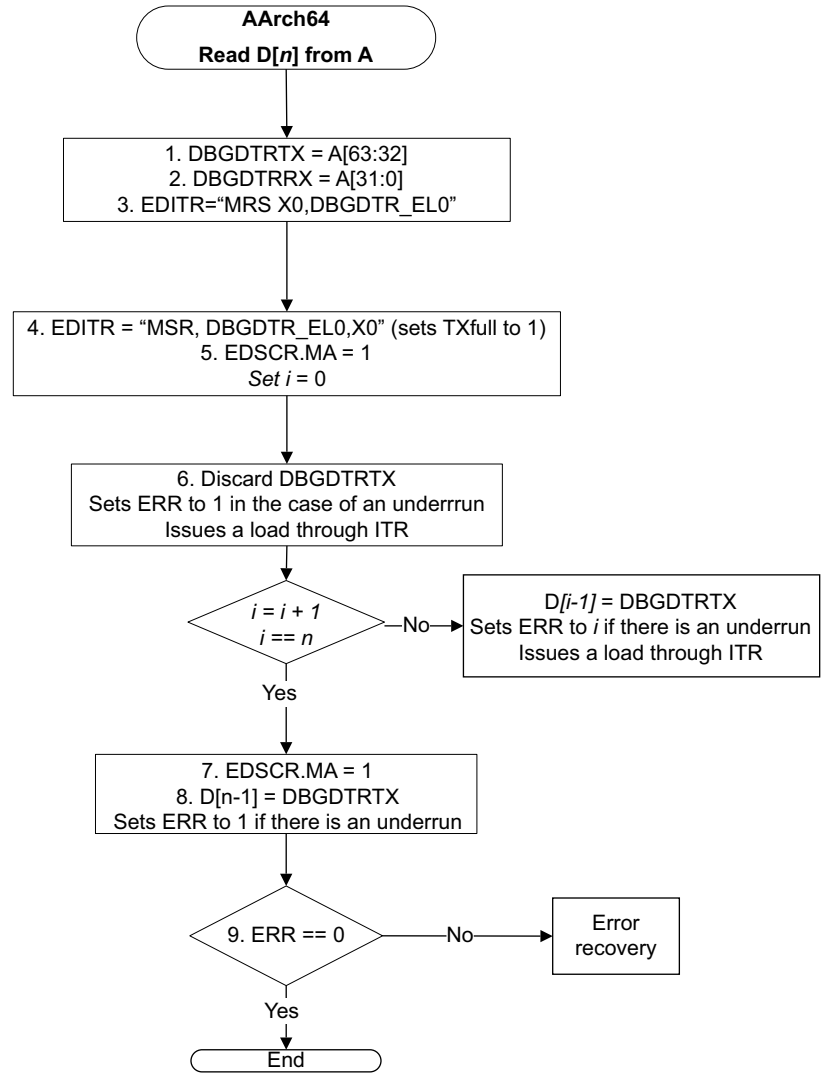

Figure E-2 Fast data upload in AArch64 (target to external host)

In Figure E-2, the sequence for the fast code download is as follows:

1. Setup. From the external debug interface:
 - a. Write address [31:0] to `DBGDTRRX_EL0`.
 - b. Write address [63:32] to `DBGDTRTX_EL0`.
 - c. Write `MRS X0, DBGDTR_EL0` to `EDITR`.
 - d. Write `MSR DBGDTR_EL0, X0` to `EDITR`. This dummy operation ensures `EDSCR.TXfull == 1`.
 - e. Set `EDSCR.MA` to 1.
 - f. Read `DBGDTRTX_EL0` and discard the value. The PE returns the previous DTR value, loads the first word, and writes it to DTR. It increments `X0` by 4.
2. Loop $n-1$ times. From the external debug interface:
 - a. Read `DBGDTRTX_EL0`. The PE returns the previous DTRTX value, loads a new word, and writes it to DTRTX. It increments `X0` by 4.
3. Epilogue. From the external debug interface:
 - a. Clear `EDSCR.MA` to 0.
 - b. Read `DBGDTRTX_EL0` for the n^{th} value.

- c. Read [EDSCR](#) to check for underruns, overruns or Data Aborts during upload.

Appendix F

Barrier Litmus Tests

This appendix gives examples of the use of the barrier instructions provided by the ARMv8 architecture. It contains the following sections:

- [Introduction on page AppxF-4828.](#)
- [Load-Acquire, Store-Release and barriers on page AppxF-4831.](#)
- [Load-Acquire Exclusive, Store-Release Exclusive and barriers on page AppxF-4839.](#)
- [Using a mailbox to send an interrupt on page AppxF-4845.](#)
- [Cache and TLB maintenance operations and barriers on page AppxF-4846.](#)
- [ARMv7 compatible approaches for ordering, using DMB and DSB barriers on page AppxF-4859.](#)

Note

This information is not part of the ARM architecture specification. It is included here as supplementary information, for the convenience of developers and users who might require this information.

F.1 Introduction

The exact rules for the insertion of barriers into code sequences is a very complicated subject, and this appendix describes many of the corner cases and behaviors that are possible in an implementation of the ARMv8 architecture.

This appendix is to help programmers, hardware design engineers, and validation engineers understand the need for the different kinds of barriers.

F.1.1 Overview of memory consistency

Early generations of microprocessors were relatively simple processing engines that executed each instruction in program order. In such processors, the effective behavior was that each instruction was executed in its entirety before a subsequent instruction started to be executed. This behavior is sometimes referred to as the *Sequential Execution Model* (SEM).

In later processor generations, the needs to increase processor performance, both in terms of the frequency of operation and the number of instructions executed each cycle, mean that such a simple form of execution is abandoned. Many techniques, such as pipelining, write buffering, caching, speculation, and out-of-order execution, are introduced to provide improved performance.

For general purpose PEs, such as ARM, these microarchitectural innovations are largely hidden from the programmer by a number of microarchitectural techniques. These techniques ensure that, within an individual PE, the behavior of the PE largely remains the same as the SEM. There are some exceptions to this where explicit synchronization is required. In the ARM architecture, these are limited to cases such as:

- Synchronization of changes to the instruction stream.
- Synchronization of changes to system control registers.

In both these cases, the ISB instruction provides the necessary synchronization.

While the effect of ordering is largely hidden from the programmer within a single PE, the microarchitectural innovations have a profound impact on the ordering of memory accesses. Write buffering, speculation, and cache coherency protocols, in particular, can all mean that the order in which memory accesses occur, as seen by an external observer, differs significantly from the order of accesses that would appear in the SEM. This is usually invisible in a uniprocessor environment, but the effect becomes much more significant when multiple PEs are trying to communicate in memory. In reality, these effects are often only significant at particular synchronization boundaries between the different threads of execution.

The problems that arise from memory ordering considerations are sometimes described as the problem of *memory consistency*. Processor architectures have adopted one or more *memory consistency models*, or *memory models*, that describe the permitted limits of the memory re-ordering that can be performed by an implementation of the architecture. The comparison and categorization of these has generated significant research and comment in academic circles, and ARM recommends the *Memory Consistency Models for Shared Memory-Multiprocessors* paper as an excellent detailed treatment of this subject.

This appendix does not reproduce such a work, but instead concentrates on some cases that demonstrate the features of the weakly-ordered memory model of the ARM architecture from ARMv6. In particular, the examples show how the use of the DMB and DSB memory barrier instructions can provide the necessary safeguards to limit memory ordering effects at the required synchronization points.

F.1.2 Barrier operation definitions

The following reference, or provide, definitions of terms used in this appendix:

DMB See [Data Memory Barrier \(DMB\)](#) on page B2-85.

DSB See [Data Synchronization Barrier \(DSB\)](#) on page B2-86.

ISB See [Instruction Synchronization Barrier \(ISB\)](#) on page B2-85.

Observer, Completion

See [Observability and completion](#) on page B2-82.

Program order

The order of instructions as they appear in an assembly language program. This appendix does not attempt to describe or define the legal transformations from a program written in a higher level programming language, such as C or C++, into the machine language that can then be disassembled to give an equivalent assembly language program. Such transformations are a function of the semantics of the higher level language and the capabilities and options on the compiler.

F.1.3 Conventions

Many of the examples are written in a stylized extension to ARM assembler, to avoid confusing the examples with unnecessary code sequences.

AArch32

The construct `WAIT([Rx]==1)` describes the following sequence:

```
loop
    LDR R12, [Rx]
    CMP R12, #1
    BNE loop
```

Also, the construct `WAIT_ACQ([Rx]==1)` describes the following sequence:

```
loop
    LDA R12, [Rx]      ; load acquire ensures it is ordered before subsequent loads/stores
    CMP R12, #1
    BNE loop
```

R12 is chosen as an arbitrary temporary register that is not in use. It is named to permit the generation of a false dependency to ensure ordering.

AArch64

The construct `WAIT([Xx]==1)` describes the following sequence:

```
loop
    LDR W12, [Xx]
    CMP W12, #1
    B.NE loop
```

Also, the construct `WAIT_ACQ([Xx]==1)` and describes the following sequence:

```
loop
    LDAR W12, [Xx]    ; load acquire ensures it is ordered before subsequent loads/stores
    CMP W12, #1
    B.NE loop
```

For each example, a code sequence is preceded by an identifier of the observer running it:

- P0, P1...Px refer to caching coherent PEs that implement the ARMv8 architecture, and are in the same shareability domain.
- E0, E1...Ex refer to non-caching observers, that do not participate in the coherency protocol, but execute ARM instructions and have a weakly-ordered memory model. This does not preclude these observers being different objects, such as DMA engines or other system masters.

These observers are unsynchronized other than as required by the documented code sequence.

———— **Note** ————

Throughout this appendix, *ARM instruction* and *instruction* refer to instructions from the A64, A32, or T32 instruction set, provided by ARMv8 implementations.

Results are expressed in terms of <agent>:<register>, such as P0:R5. The results can be described as:

- | | |
|------------------------|--|
| Permissible | This does not imply that the results expressed are required or are the only possible results. In most cases they are results that would not be possible under a sequentially consistent running of the code sequences on the agents involved. In general terms, this means that these results might be unexpected to anyone unfamiliar with memory consistency issues. |
| Not permissible | Results that the architecture expressly forbids. |
| Required | Results that the architecture expressly requires. |

The examples omit the required shareability domain arguments of DMB and DSB instructions. The arguments are assumed to be selected appropriately for the shareability domains of the observers.

In AArch32 state, where the barrier function in the litmus test can be achieved by a DMB ST, that is a barrier to stores only, this is shown by the use of DMB [ST]. This indicates that the ST qualifier can be omitted without affecting the result of the test. In some implementations DMB ST is faster than DMB.

For AArch64 code, the shareability domain of the DMB or DSB must be included. This is shown in this document using the notation DMB <domain> and DSB <domain> respectively.

Except where otherwise stated, other conventions are:

- All memory initializes to 0.
- R0 and W0 contain the value 1.
- R1 - R4 and W1 - W4 contain arbitrary independent addresses that initialize to the same value on all PEs. The addresses held in these registers are Shareable and:
 - The addresses held in R1 and R2 are in Write-Back Cacheable Normal memory.
 - The address held in R3 is in Write-Through Cacheable Normal memory.
 - The address held in R4 is in Non-cacheable Normal memory.
- R5 - R8 and W5 - W8 contain:
 - When used with an STR instruction, 0x55, 0x66, 0x77, and 0x88 respectively.
 - When used with an LDR instruction, the value 0.
- R11 and W11 contain a new instruction or new translation table entry, as appropriate, and R10 contains the virtual address and the ASID, for use in this change of translation table entry.
- Memory locations are Normal memory locations unless otherwise stated.

The examples use mnemonics for the cache maintenance and TLB maintenance operations. The following tables describe the mnemonics:

- [Cache maintenance operations, functional group on page G3-3743](#)
- [TLB maintenance operations, functional group on page G3-3744](#).

Notes on timing effects

The ARMv8 architecture makes no statement about when an instruction will occur. In particular, stores may take an unbounded time to be observed by other observers. Therefore the WAIT loop waiting for the result of that store may take an unbounded time to move forward.

In cases that it is necessary to guarantee the completion of a store, a DSB instruction can be used to force this drain.

In general, the examples in this document associated with ordering assume that stores will become observable over time and so a final DSB barrier to ensure the completion of stores is omitted.

F.2 Load-Acquire, Store-Release and barriers

The Load-Acquire and Store-Release instructions are described in *Load-Acquire, Store-Release* on page B2-87.

The following sections show that most of the examples in sections *Simple ordering and barrier cases* on page AppxF-4859 and *Load-Exclusive, Store-Exclusive and barriers* on page AppxF-4866 can be achieved using the Load-Acquire and Store-Release instructions without the need for additional barriers.

F.2.1 Message passing

The following sections describe:

- *Resolving weakly-ordered message passing by using Acquire and Release.*
- *Resolving message passing by the use of Store-Release and address dependency on page AppxF-4832.*

Resolving weakly-ordered message passing by using Acquire and Release

The message passing problem described in *Weakly-ordered message passing problem* on page AppxF-4859 can be solved by the use of Load-Acquire and Store-Release instructions when accessing the communications flag:

AArch32

P1

```
STR R5, [R1]          ; set new data
STL R0, [R2]          ; send flag indicating data ready, which is ordered after all
```

P2

```
WAIT_ACQ([R2]==1)    ; wait on flag
LDR R5, [R1]
```

AArch64

P1

```
STR W5, [X1]          ; set new data
STL W0, [X2]          ; send flag indicating data ready, which is ordered after all
```

P2

```
WAIT_ACQ([X2]==1)    ; wait on flag
LDR W5, [X1]
```

This ensures the observed order of both the reads and the writes allows transfer of data such that the result P2:R5==0x55 is guaranteed.

This approach also works with multiple observers, in a way that further observers use the same sequence as P2 uses:

AArch32

P3

```
WAIT_ACQ([R2]==1)    ; wait on flag
LDR R5, [R1]
```

AArch64

P3

```
WAIT_ACQ([X2]==1)    ; wait on flag  
LDR W5, [X1]
```

Resolving message passing by the use of Store-Release and address dependency

The lack of ordering of stores discussed in [Message passing with multiple observers on page AppxF-4861](#) can be resolved by the use of Store-Release for the store of the valid flag by P1, even when the observers are using an address dependency:

AArch32

P1

```
STR R5, [R1]          ; set new data  
STL R0, [R2]          ; send flag indicating data ready using a Store Release
```

P2

```
WAIT([R2]==1)  
AND R12, R12, #0      ; R12 is destination of LDR in WAIT macro  
LDR R5, [R1, R12]     ; Load is dependent and so is ordered after the flag has been seen
```

AArch64

P1

```
STR W5, [X1]          ; set new data  
STLR W0, [X2]         ; send flag indicating data ready using a Store Release
```

P2

```
WAIT([X2]==1)  
AND W12, W12, WZR     ; R12 is destination of LDR in WAIT macro  
LDR W5, [X1, X12]     ; Load is dependent and so is ordered after the flag has been seen
```

This ensures the observed order of the writes allows transfer of data such that P2:R5 and P3:R5 contain the same value of 0x55.

This approach also works with multiple observers, in a way that further observers use the same sequence as P2 uses:

AArch32

P3

```
WAIT([R2]==1)  
AND R12, R12, #0      ; R12 is destination of LDR in WAIT macro  
LDR R5, [R1, R12]     ; Load is dependent and so is ordered after the flag has been seen
```

AArch64

P3

```
WAIT([X2]==1)
AND W12, W12, WZR ; R12 is destination of LDR in WAIT macro
LDR W5, [X1, X12] ; Load is dependent and so is ordered after the flag has been seen
```

F.2.2 Address dependency with object construction

When accessing an object-oriented data structure, the address dependency rule means that barriers are not required, even when initializing the object. A Store-Release can be used to ensure the order of the update of the base address:

AArch32

P1

```
STR R5, [R1, #offset] ; set new data in a field
STL R1, [R2] ; update base address
```

P2

```
LDR R1, [R2] ; read for base address
CMP R1, #0 ; check if it is valid
BEQ null_trap
LDR R5, [R1, #offset] ; use base address to read field
```

AArch64

P1

```
STR W5, [X1, #offset] ; set new data in a field
STLR X1, [X2] ; update base address
```

P2

```
LDR X1, [X2] ; read for base address
CMP X1, #0 ; check if it is valid
B.EQ null_trap
LDR W5, [X1, #offset] ; use base address to read field
```

It is required that P2:R5==0x55 if the null_trap is not taken. This avoids P2 observing a partially constructed object from P1. Significantly, P2 does not need a barrier to ensure this behavior.

The read of the base address in P2 could be a Load-Acquire, but it is not necessary in this case.

F.2.3 Causal consistency issues with multiple observers

The cause consistent problem discussed in *Causal consistency issues with multiple observers* on page AppxF-4862 can be addressed by the use of a Store-Release, as this requires that the store is multicopy atomic in the case of a Load-Acquire. In addition, a Store-Release has an effect on the observation order of any stores observed by the observer executing the Store-Release.

The following sequences guarantee causal consistency:

- *Using multi-copy atomicity of the Store-Release when observed by Load-Acquire.*
- *Using ordering property of Store-Release on stores observed by the PE on page AppxF-4835.*

Using multi-copy atomicity of the Store-Release when observed by Load-Acquire

AArch32

P1

```
STL R0, [R2]      ; set new data
                  ; this is made multi-copy atomic
```

P2

```
WAIT_ACQ([R2]==1) ; wait to see new data from P1
STR R0, [R3]      ; send flag
                  ; must be after the new data has been by P2 as stores must not be speculative
                  ; this does not need to be a store release, though it could be a store
release
```

P3

```
WAIT([R3]==1)    ; wait for P2 flag
                  ; this does not need to be a WAIT_ACQ, although
                  ; it could be a WAIT_ACQ (at which point the dependency is not needed)
AND R12, R12, #0 ; dependency to ensure order (only needed for a WAIT, not WAIT_ACQ)
LDA R0, [R2, R12] ; read P1 data using a Load-Acquire
```

AArch64

P1

```
STLR W0, [X2]    ; set new data
                  ; this is made multi-copy atomic
```

P2

```
WAIT_ACQ([X2]==1) ; wait to see new data from P1
STR W0, [X3]      ; send flag
                  ; must be after the new data has been by P2 as stores
                  ; must not be speculative
                  ; this does not need to be a store release, though it could be a
                  ; store release
```

P3

```
WAIT([X3]==1)    ; wait for P2 flag
                  ; this does not need to be a WAIT_ACQ, though
```



```

                                ; it could be a WAIT_ACQ (at which point the dependency is not needed)
AND W12, W12, WZR                ; dependency to ensure order (only needed for a WAIT, not WAIT_ACQ)
LDAR W0, [X2, X12]              ; read P1 data using a Load-Acquire

```

In this case, P3:R0 == 0 is not permissible. P3 is guaranteed to see the store from P1 if P2 has seen the store from P1 using a Load-Acquire.

Using ordering property of Store-Release on stores observed by the PE

AArch32

P1

```

STR R0, [R2]                    ; set new data
                                ; this does not have to be a store release, though it
                                ; could be a store release

```

P2

```

WAIT ([R2]==1)                 ; wait to see new data from P1
                                ; this does not need to be a WAIT_ACQ, though it could be a WAIT_ACQ
STL R0, [R3]                   ; send flag
                                ; must be after the new data has been by P2 as stores must not be speculative
                                ; as a store release, this orders P1 store

```

P3

```

WAIT([R3]==1)                  ; wait for P2 flag
                                ; this does not need to be a WAIT_ACQ, although it could be a WAIT_ACQ
                                ; (at which point the dependency is not needed)
AND R12, R12, #0               ; dependency to ensure order (only needed for a WAIT, not WAIT_ACQ)
LDR R0, [R2, R12]              ; read P1 data

```

AArch64

P1

```

STR W0, [X2]                   ; set new data
                                ; this does not have to be a store release, though it
                                ; could be a store release

```

P2

```

WAIT ([X2]==1)                 ; wait to see new data from P1
                                ; this does not need to be a WAIT_ACQ, though it could be a WAIT_ACQ
STLR W0, [X3]                  ; send flag
                                ; must be after the new data has been by P2 as stores must not be speculative
                                ; as a store release, this orders P1 store

```

P3

```

WAIT([X3]==1)                  ; wait for P2 flag
                                ; this does not need to be a WAIT_ACQ, though it could be a WAIT_ACQ

```

```
                                ; at which point the dependency is not needed
AND W12, W12, WZR              ; dependency to ensure order
                                ; only needed for a WAIT, not WAIT_ACQ
LDR W0, [X2, X12]              ; read P1 data
```

In this case, P3:R0 == 0 is not permissible. P3 is guaranteed to see the store from P1 if P2 has seen the store from P1 using a Load-Acquire.

———— **Note** —————

The use of dependency by P3 could be replaced by a Load-Acquire.

F.2.4 Multiple observers of writes to multiple locations

The ARM weakly consistent memory model means that different observers can observe writes to different locations in different orders as was shown in [Multiple observers of writes to multiple locations on page AppxF-4863](#), but the use of Load-Acquire and Store-Release can resolve this. In this case, the loads by P3 and P4 must be Load-Acquire in order to ensure the perceived multi-copy atomicity of the stores:

AArch32

P1

```
STL R0, [R1]                    ; set new data
```

P2

```
STL R0, [R2]                    ; set new data
```

P3

```
LDA R10, [R2]                   ; read P2 data before P1
LDA R9, [R1]                    ;
BIC R9, R10, R9                 ; R9 <- R10 & ~R9
                                ; R9 contains 1 if read from [R2] is observed to be 1 and
                                ; read from [R1] is observed to be 0
```

P4

```
LDA R9, [R1]
LDA R10, [R2]
BIC R9, R9, R10                 ; R9 <- R9 & ~R10
                                ; R9 contains 1 if read from [R2] is observed to be 0 and
                                ; read from [R1] is observed to be 1
```

AArch64

P1

```
STLR W0, [X1]                   ; set new data
```

P2

```
STLR W0, [X2]                   ; set new data
```

P3

```
LDAR W10, [X2]                  ; read P2 data before P1
```

```
LDAR W9, [X1]      ;
BIC W9, W10, W9    ; W9 <- W10 & ~W9
                   ; W9 contains 1 if read from [X2] is observed to be 1 and
                   ; read from [X1] is observed to be 0
```

P4

```
LDAR W9, [X1]
LDAR W10, [X2]
BIC W9, W9, W10    ; W9 <- W9 & ~W10
                   ; W9 contains 1 if read from [X2] is observed to be 0 and
                   ; read from [X1] is observed to be 1
```

In this case, the result P3:R9==1 and P4:R9==1 is not permissible, as the stores from P1 and P2 are multi-copy atomic when read by Load-Acquire.

Therefore, if P3 gets R10==1, then we know that the P3 load of R9 can only be observed after we know that P4 has also observed the P2 store to [R2]. Similarly, if the P4 load of R9 returns 1, and the P3 load of R9 returns 0, then the P3 load must have occurred before the P4 load.

Therefore, if the P3 load of R10 returns 1 and the P3 load of R9 returns 0, then we know that if the P4 load of R9 returns 1, it must have happened after P4 has observed the P2 store to [R2], so the P4 load of R10 must return 1.

This shows that, of the 4 possible values for {P3:R9, P4:R9}, the use of these instructions makes the result {1,1} impossible.

F.2.5 WFE and WFI and barriers

The Wait For Event and Wait For Interrupt instructions permit the PE to suspend execution and enter a low-power state. An explicit DSB barrier instruction is required if it is necessary to ensure memory accesses made before the WFI or WFE are visible to other observers, unless some other mechanism has ensured this visibility. Examples of other mechanism that would guarantee the required visibility are the DMB described in [Posting a store before polling for acknowledgement on page AppxF-4864](#), or a dependency on a load.

The following example requires the DSB to ensure that the store is visible:

AArch32

P1

```
STR R0, [R2]
DSB
Loop
WFI
B Loop
```

AArch64

P1

```
STR W0, [X2]
DSB <domain>
Loop
```

WFI

B Loop

This requirement is unchanged in ARMv8 by the presence of Load-Acquire or Store-Release.

F.3 Load-Acquire Exclusive, Store-Release Exclusive and barriers

The ARMv8 architecture adds the acquire and release semantics to Load-Exclusive and Store-Exclusive instructions, which allows them to gain ordering acquire and/or release semantics.

The Load-Exclusive instruction can be specified to have acquire semantics, and the Store-Exclusive instruction can be specified to have release semantics. These can be arbitrarily combined to allow the atomic update created by a successful Load-Exclusive and Store-Exclusive pair to have any of:

- No Ordering semantics (using LDREX and STREX).
- Acquire only semantics (using LDAEX and STREX).
- Release only semantics (using LDREX and STLEX).
- Sequentially consistent semantics (using LDAEX and STLEX).

In addition, the ARMv8 specification requires that the clearing of a global monitor will generate an event for the PE associated with the global monitor, which can simplify the use of WFE, by removing the need for a DSB barrier and SEV instruction.

F.3.1 Acquiring a lock

A common use of Load-Exclusive and Store-Exclusive instructions is to claim a lock to permit entry into a critical region. This is typically performed by testing a lock variable that indicates 0 for a free lock and some other value, commonly 1 or an identifier of the process holding the lock, for a taken lock.

For a critical region, the requirement on taking a lock is usually for acquire semantics, while the clearing of a lock requires release semantics:

AArch32

Px

```
    PLDW[R1]          ; preload into cache in unique state
```

Loop

```
    LDAEX R5, [R1]    ; read lock with acquire
    CMP R5, #0        ; check if 0
    STREXEQ R5, R0, [R1] ; attempt to store new value
    CMPEQ R5, #0      ; test if store succeeded
    BNE Loop          ; retry if not
```

```
    ; loads and stores in the critical region can now be performed
```

AArch64

Px

```
    PRFM PSTL1KEEP, [X1] ; preload into cache in unique state
```

Loop

```
    LDAXR W5, [X1]     ; read lock with acquire
    CBNZ W5, Loop      ; check if 0
    STXR W5, W0, [X1]  ; attempt to store new value
    CBNZ W5, Loop      ; test if store succeeded and retry if not
```

```
    ; loads and stores in the critical region can now be performed
```

The acquire associated with the load is sufficient to ensure the required ordering in a lock situation. The Store-Exclusive will fail (and so be retried) if there is a store to the location being monitored between the Load-Exclusive and the Store-Exclusive.

F.3.2 Releasing a lock

The converse operation of releasing a lock does not require the use of Load-Exclusive and Store-Exclusive instructions, because only a single observer is able to write to the lock. However, often it is necessary for any observer to observe any memory updates, or any values that are loaded into memory, before they observe the release of the lock. Therefore, the lock release needs release semantics:

AArch32

Px

```
    ; loads and stores in the critical region
    MOV R0, #0
    STL R0, [R1]          ; clear the lock with release semantics
```

AArch64

Px

```
    ; loads and stores in the critical region
    STLR WZR, [X1]       ; clear the lock with release semantics
```

F.3.3 Ticket locks

When a lock is free, in order to avoid a rush to get the lock by many PEs, the use of ticket locks is common in more advanced systems. When the use is requested, the ticket locks determine the order of the users of the critical sections, in order to avoid starvation that can occur with a simple contention based spin lock.

A ticket lock allocates each thread a ticket number when it first requests the lock, and then compares that number with the current number for the lock. If they are the same, then the critical section can be entered. Otherwise the thread waits until the current number is equal to the ticket number for that thread.

The reading of the current number of the lock needs acquire semantics for the lock to be acquired.

———— **Note** ————

The code in this section is little-endian code, as it views the combined current and next values as a single combined quantity. The addresses of the current and next ticket values need to be adjusted for a big-endian system.

This is shown in the implementation below:

AArch32

Px

```
    ; R1 holds two 16 bit quantities
    ; the lower halfword holds the current ticket number
    ; the higher halfword holds the next ticket number

    PLDW[R1]          ; preload into cache in unique state
Loop1
    LDAEX R5, [R1]    ; read current and next
```

```
ADD R5, R5, #0x10000 ; increment the next number
STREX R6, R5, [R1] ; and update the value
CMP R6, #0 ; did the exclusive pass
BNE Loop1 ; retry if not
CMP R5, R5, ROR #16 ; is the current ticket ours
BEQ block_start

Loop2
LDAH R6, [R1] ; read current value
CMP R6, R5, LSR #16 ; compare it with our allocated ticket
BNE Loop2 ; retry (spin) if it is not the same

block_start
```

AArch64

Px

```
; X1 holds 2 16 bit quantities
; the lower halfword holds the current ticket number
; the higher halfword holds the next ticket number

PRFM PSTL1KEEP, [X1] ; preload into cache in unique state

Loop1
LDAXR W5, [X1] ; read current and next
ADD W5, W5, #0x10000 ; increment the next number
STXR W6, W5, [X1] ; and update the value
CBNZ W6, Loop1 ; did the exclusive pass - retry if not

AND W6, W5, #0xFFFF
CMP W6, W5, LSR #16 ; is the current ticket ours
B.EQ block_start

Loop2
LDARH W6, [X1] ; read current value
CMP W6, W5, LSR #16 ; compare it with the our allocated ticket
B.NE Loop2 ; retry (spin) if it isn't the same

block_start
```

Releasing the ticket lock simply involves incrementing the current ticket number, that is still assumed to be in R3, and doing a Store-Release:

AArch32

```
ADD R6, R6, #1
```

```
STLH R6, [R1]
```

AArch64

```
ADD W6, W6, #1
```

```
STLRH W6, [X1]
```

F.3.4 Use of Wait For Event (WFE) and Send Event (SEV) with locks

The ARMv8 architecture can use the Wait For Event mechanism to minimise the energy cost of polling variables by putting the PE into a low power state, suspending execution, until an asynchronous exception or an explicit event is seen by that PE. In ARMv8, the event can be generated as a result of clearing the global monitor, so removing the need for a DSB barrier or an explicit send event message.

This can be used with simple locks or with ticket locks.

Simple lock

The following is an example of lock acquire code using WFE:

AArch32

Px

```
PLDW[R1] ; preload into cache in unique state
```

Loop

```
LDAEX R5, [R1] ; read lock with acquire  
CMP R5, #0 ; check if 0  
WFENE ; sleep if the lock is held  
STREXEQ R5, R0, [R1] ; attempt to store new value  
CMPEQ R5, #0 ; test if store succeeded  
BNE Loop ; retry if not
```

AArch64

Px

```
SEVL ; invalidates the WFE on the first loop iteration  
PRFM PSTL1KEEP, [X1] ; allocate into cache in unique state
```

Loop

```
WFE  
LDAXR W5, [X1] ; read lock with acquire  
CBNZ W5, Loop ; check if 0  
STXR W5, W0, [X1] ; attempt to store new value  
CBNZ W5, Loop ; test if store succeeded and retry if not
```

```
; loads and stores in the critical region can now be performed
```

And the following is an example of lock release code:

AArch32

Px

```
; loads and stores in the critical region
MOV R0, #0
STL R0, [R1] ; clear the lock
```

AArch64

Px

```
; loads and stores in the critical region
STLR WZR, [X1] ; clear the lock
```

Ticket lock

In the Ticket lock case, the Load-Exclusive instruction can be used to move the monitor into the exclusive state for the express purpose of creating an event when the monitor changes state:

AArch32

Px

```
; R1 holds 2 16 bit quantities
; the lower halfword holds the current ticket number
; the higher halfword holds the next ticket number

    PLDW[R1] ; preload into cache in unique state
Loop1
    LDAEX R5, [R1] ; read current and next
    ADD R5, R5, #0x10000 ; increment the next number
    STREX R6, R5, [R1] ; and update the value
    CMP R6, #0 ; did the exclusive pass
    BNE Loop ; retry if not
    CMP R5, R5, ROR #16 ; is the current ticket ours
    BEQ block_start
    SEVL
Loop2
    WFE ; wait if there has not been a change to the count since last
        ; read
    LDAEXH R6, [R1] ; check the current count
    CMP R6, R5, LSR #16 ; check if it is equal
    BNE Loop2
block_start
```

AArch64

Px

```
; X1 holds 2 16 bit quantities
; the lower halfword holds the current ticket number
; the higher halfword holds the next ticket number

    PRFM PSTL1KEEP, [X1] ; preload into cache in unique state
Loop1
    LDAXR W5, [X1] ; read current and next
    ADD W5, W5, #0x10000 ; increment the next number
    STXR W6, W5, [X1] ; and update the value
    CBNZ W6, Loop1 ; did the exclusive pass - retry if not

    AND W6, W5, 0xFFFF
    CMP W6, W5, LSR #16 ; is the current ticket ours
```

Appendix F Barrier Litmus Tests
F.3 Load-Acquire Exclusive, Store-Release Exclusive and barriers

```
B.EQ block_start
SEVL
Loop2
WFE
LDAXRH W6, [X1] ; read current value
CMP W6, W5, LSR #16 ; compare it with our allocated ticket
B.NE Loop2 ; retry (spin) if it is not the same
block_start
```

F.4 Using a mailbox to send an interrupt

In some message passing systems, it is common for one observer to update memory and then notify a second observer of the update by sending an interrupt, using a mailbox.

Although a memory access might be made to initiate the sending of the mailbox interrupt, a DSB instruction is required to ensure the completion of previous memory accesses.

Therefore, the following sequence is required to ensure that P2 observes the updated value:

AArch32

P1

```
STR R5, [R1]          ; message stored to shared memory location
```

```
DSB ST
```

```
STR R0, [R4]          ; R4 contains the address of a mailbox
```

P2

```
; interrupt service routine
```

```
LDR R5, [R1]
```

AArch64

P1

```
STR W5, [X1]          ; message stored to shared memory location
```

```
DSB ST
```

```
STR W0, [X4]          ; R4 contains the address of a mailbox
```

P2

```
; interrupt service routine
```

```
LDR W5, [X1]
```

These rules are required in connection to the ARM Generic Interrupt Controller (GIC).

F.5 Cache and TLB maintenance operations and barriers

The following sections describe the use of barriers with cache and TLB maintenance operations:

- [Data cache maintenance operations](#)
- [Instruction cache maintenance operations](#) on page AppxF-4851
- [TLB maintenance operations and barriers](#) on page AppxF-4854.

F.5.1 Data cache maintenance operations

The following sections describe the use of barriers with data cache maintenance operations:

- [Message passing to non-caching observers](#)
- [Multiprocessing message passing to non-caching observers](#) on page AppxF-4847
- [Invalidating DMA buffers, non-functional example](#) on page AppxF-4848
- [Invalidating DMA buffers, functional example with single PE](#) on page AppxF-4849
- [Invalidating DMA buffers, functional example with multiple coherent PEs](#) on page AppxF-4850.

Message passing to non-caching observers

The ARMv8 architecture requires the use of DMB instructions to ensure the ordering of data cache maintenance operations and their effects. The Load-Acquire and Store-Release instructions have no effect on cache maintenance operation. This means the following message passing approaches can be used when communicating between caching observers and non-caching observers:

AArch32

P1

```
STR R5, [R1]          ; update data (assumed to be in P1 cache)
DCCMVA C1             ; clean cache to point of coherency
DMB                  ; ensure effects of the clean will be observed before the
                    ; flag is set
STR R0, [R4]         ; send flag to external agent (Non-cacheable location)
```

E1

```
WAIT_ACQ ([R4] == 1) ; wait for the flag (with order)
LDR R5, [R1]         ; read the data
```

AArch64

P1

```
STR W5, [X1]          ; update data (assumed to be in P1 cache)
DC CVAC, X1          ; clean cache to point of coherency
DMB ISH             ; ensure effects of the clean will be observed before the
                    ; flag is set
STR W0, [X4]         ; send flag to external agent (Non-cacheable location)
```

E1

```
WAIT_ACQ ([X4] == 1) ; wait for the flag (with order)
LDR W5, [X1]         ; read the data
```

In this example, it is required that E1:R5==0x55.

Multiprocessing message passing to non-caching observers

The broadcast nature of the cache maintenance operations combined with properties of barriers, means that the message passing principle for non-caching observers is:

AArch32

P1

```
STR R5, [R1]          ; update data (assumed to be in P1 cache)
STL R0, [R2]          ; send a flag for P2 (ordered by the store release)
```

P2

```
WAIT ([R2] == 1)     ; wait for P1 flag
DMB                  ; ensure cache clean is observed after P1 flag is observed
DCCMVA R1            ; clean cache to point of coherency ?will clean P1 cache
DMB                  ; ensure effects of the clean will be observed before the
                    ; flag to E1 is set
STR R0, [R4]         ; send flag to E1
```

E1

```
WAIT_ACQ ([R4] == 1) ; wait for P2 flag (ordered)
LDR R5, [R1]         ; read data
```

AArch64

P1

```
STR W5, [X1]          ; update data (assumed to be in P1 cache)
STLR W0, [X2]         ; send a flag for P2 (ordered)
```

P2

```
WAIT ([X2] == 1)     ; wait for P1 flag
DMB SY               ; ensure cache clean is observed after P1 flag is observed
DC CVAC, X1          ; clean cache to point of coherency, will clean P1 cache
DMB SY               ; ensure effects of the clean will be observed before the
                    ; flag to E1 is set
STR W0, [X4]         ; send flag to E1
```

E1

```
WAIT_ACQ ([X4] == 1) ; wait for P2 flag
LDR W5, [X1]         ; read data
```

In this example, it is required that E1:R5==0x55. The clean operation executed by P2 affects the data location in the P1 cache. The cast-out from the P1 cache is guaranteed to be observed before P2 updates [R4].

———— **Note** —————

The cache maintenance operations are not ordered by the Load-Acquire and Store-Release instructions.

Invalidating DMA buffers, non-functional example

The basic scheme for communicating with an external observer that is a process that passes data in to a Cacheable memory region must take account of the architectural requirement that regions marked as Cacheable can be allocated into a cache at any time, for example as a result of speculation. The following example shows this possibility:

AArch32

P1

```
DCIMVAC R1          ; ensure cache clean wrt memory. A clean operation could be used
                    ; but as the DMA will subsequently overwrite this region an
                    ; invalidate operation is sufficient and usually more efficient

DMB                 ; ensures cache invalidation is observed before the next store
                    ; is observed

STR R0, [R3]        ; send flag to external agent

WAIT_ACQ ([R4]==1) ; wait for a different flag from an external agent

LDR R5, [R1]
```

E1

```
WAIT ([R3] == 1)   ; wait for flag

STR R5, [R1]        ; store new data

STL R0, [R4]        ; send a flag
```

AArch64

P1

```
DC IVAC, X1        ; ensure cache clean wrt memory. A clean operation could be used
                    ; but as the DMA will subsequently overwrite this region an
                    ; invalidate operation is sufficient and usually more efficient

DMB SY             ; ensures cache invalidation is observed before the next store
                    ; is observed

STR W0, [X3]       ; send flag to external agent

WAIT_ACQ ([X4]==1) ; wait for a different flag from an external agent

LDR W5, [X1]
```

E1

```
WAIT ([X3] == 1)   ; wait for flag

STR W5, [X1]        ; store new data

STLR W0, [X4]       ; send a flag
```

If a speculative access occurs, there is no guarantee that the cache line containing [R1] is not brought back into the cache after the cache invalidation, but before [R1] is written by E1. Therefore, the result P1:R5=0 is permissible.

Invalidating DMA buffers, functional example with single PE

AArch32

P1

```
DCIMVAC R1      ; ensure cache clean wrt memory. A clean operation could be used
                ; but as the DMA will subsequently overwrite this region an
                ; invalidate operation is sufficient and usually more efficient

DMB             ; ensures cache invalidation is observed before the next store
                ; is observed

STR R0, [R3]    ; send flag to external agent

WAIT ([R4]==1)  ; wait for a different flag from an external agent

DMB             ; ensure that cache invalidate is observed after the flag
                ; from external agent is observed

DCIMVAC R1      ; ensure cache discards stale copies before use

LDR R5, [R1]
```

E1

```
WAIT ([R3] == 1) ; wait for flag

STR R5, [R1]     ; store new data

STL R0, [R4]     ; send a flag
```

AArch64

P1

```
DC IVAC, X1     ; ensure cache clean wrt memory. A clean operation could be used
                ; but as the DMA will subsequently overwrite this region an
                ; invalidate operation is sufficient and usually more efficient

DMB SY         ; ensures cache invalidation is observed before the next store
                ; is observed

STR W0, [X3]    ; send flag to external agent

WAIT ([X4]==1) ; wait for a different flag from an external agent

DMB SY         ; ensure that cache invalidate is observed after the flag
                ; from external agent is observed

DC IVAC, X1     ; ensure cache discards stale copies before use

LDR W5, [X1]
```

E1

```
WAIT ([X3] == 1) ; wait for flag

STR W5, [X1]     ; store new data

STLR W0, [X4]    ; send a flag
```

In this example, the result P1:R5 == 0x55 is required. Including a cache invalidation after the store by E1 to [R1] is observed ensures that the line is fetched from external memory after it has been updated.

Invalidating DMA buffers, functional example with multiple coherent PEs

The broadcasting of cache maintenance operations, and the use of DMB instructions to ensure their observability, means that the previous example extends naturally to a multiprocessor system. Typically this requires a transfer of ownership of the region that the external observer is updating.

AArch32

P0

(Use data from [R1], potentially using [R1] as scratch space)

```
STL R0, [R2]          ; signal release of [R1]
WAIT_ACQ ([R2] == 0) ; wait for new value from DMA
LDR R5, [R1]
```

P1

```
WAIT ([R2] == 1)      ; wait for release of [R1] by P0
DCIMVAC R1            ; ensure caches are clean wrt memory, invalidate is sufficient
DMB
STR R0, [R3]          ; request new data for [R1]
WAIT ([R4] == 1)      ; wait for new data
DMB
DCIMVAC R1            ; ensure caches discard stale copies before use
DMB
MOV R0, #0
STR R0, [R2]          ; signal availability of new [R1]
```

E1

```
WAIT ([R3] == 1)      ; wait for new data request
STR R5, [R1]          ; send new [R1]
DMB [ST]
STR R0, [R4]          ; indicate new data available to P1
```

AArch64

P0

(Use data from [X1], potentially using [X1] as scratch space)

```
STLR W0, [X2]         ; signal release of [X1]
WAIT_ACQ ([X2] == 0) ; wait for new value from DMA
LDR W5, [X1]
```

P1

```
WAIT ([X2] == 1)      ; wait for release of [R1] by P0
DC IVAC, X1           ; ensure caches are clean wrt memory, invalidate is sufficient
DMB SY
STR W0, [X3]          ; request new data for [R1]
WAIT ([X4] == 1)      ; wait for new data
```



```

DMB SY
DCIMVAC X1          ; ensure caches discard stale copies before use
DMB SY
STR WZR, [X2]       ; signal availability of new [R1]
  
```

E1

```

WAIT ([X3] == 1)    ; wait for new data request
STR W5, [X1]        ; send new [R1]
STR W0, [X4]        ; indicate new data available to P1
  
```

In this example, the result P0:R5 == 0x55 is required. The DMB issued by P1 after the first data cache invalidation ensures that effect of the cache invalidation on P0 is seen by E1 before the store by E1 to [R1]. The DMB issued by P1 after the second data cache invalidation ensures that its effects are seen before the store of 0 to the semaphore location in [R2].

F.5.2 Instruction cache maintenance operations

The following sections describe the use of barriers with instruction cache maintenance operations:

- [Ensuring the visibility of updates to instructions for a uniprocessor](#)
- [Ensuring the visibility of updates to instructions for a multiprocessor on page AppxF-4852.](#)

Ensuring the visibility of updates to instructions for a uniprocessor

On a single PE, the agent that causes instruction fetches, or instruction cache linefills, is a separate memory system observer from the agent that causes data accesses. Therefore, any operations to invalidate the instruction cache can rely only on seeing updates to memory that are complete. This must be ensured by the use of a DSB instruction.

Also, instruction cache maintenance operations are only guaranteed to complete after the execution of a DSB, and an ISB is required to discard any instructions that might have been prefetched before the instruction cache invalidation completed. Therefore, on a uniprocessor, to ensure the visibility of an update to code and to branch to it, the following sequence is required:

AArch32

P1

```

STR R11, [R1]       ; R11 contains a new instruction to stored in program memory
DCCMVAU R1          ; clean to PoU makes visible to instruction cache
DSB
ICIMVAU R1          ; ensure instruction cache/branch predictor discard stale data
BPIMVA R1
DSB                 ; ensure completion of the invalidation
ISB                 ; ensure instruction fetch path sees new I cache state
BX R1
  
```

In AArch64, the branch predictor maintenance is not required.

AArch64

P1

```

STR W11, [X1]       ; W11 contains a new instruction to stored in program memory
DC CVAU, X1         ; clean to PoU makes visible to instruction cache
  
```

```
DSB ISH
IC IVAU, X1      ; ensure instruction cache/branch predictor discard stale data
DSB ISH          ; ensure completion of the invalidation
ISB              ; ensure instruction fetch path sees new I cache state
BR X1
```

———— **Note** ————

Where the changes to the instructions span multiple cache lines, then the data cache and instruction cache maintenance instructions can be duplicated to cover each of the lines to be cleaned and to be invalidated.

Ensuring the visibility of updates to instructions for a multiprocessor

The ARMv8 architecture requires a PE that performs an instruction cache maintenance operation to execute a DSB instruction to ensure completion of the maintenance operation. This ensures that the cache maintenance operation is complete on all PEs in the Inner Shareable shareability domain.

An ISB is not broadcast, and so does not affect other PEs. This means that any other PE must perform its own ISB synchronization after it knows that the update is visible, if it is necessary to ensure its synchronization with the update. The following example shows how this might be done:

AArch32

P1

```
STR R11, [R1]    ; R11 contains a new instruction to stored in program memory
DCCMVAU R1      ; clean to PoU makes visible to instruction cache
DSB              ; ensure completion of the clean on all processors
ICIMVAU R1      ; ensure instruction cache/branch predictor discard stale data
BPIMVA R1
DSB              ; ensure completion of the ICache and branch predictor
                 ; invalidation on all processors
STR R0, [R2]    ; set flag to signal completion
ISB              ; synchronize context on this processor
BX R1           ; branch to new code
```

P2-Px

```
WAIT ([R2] == 1) ; wait for flag signalling completion
ISB              ; synchronize context on this processor
BX R1           ; branch to new code
```

AArch64

P1

```
STR X11, [X1]   ; X11 contains a new instruction to stored in program memory
DC CVAU, X1     ; clean to PoU makes visible to instruction cache
DSB ISH        ; ensure completion of the clean on all processors
IC IVAU, X1    ; ensure instruction cache/branch predictor discard stale data
DSB ISH        ; ensure completion of the ICache and branch predictor
```

```

; invalidation on all processors
STR W0, [X2] ; set flag to signal completion
ISB ; synchronize context on this processor
BR R1 ; branch to new code

```

P2-Px

```

WAIT ([X2] == 1) ; wait for flag signalling completion
ISB ; synchronize context on this processor
BR X1 ; branch to new code

```

Nonfunctional approach

The following sequence does not have the same effect, because a DSB is not required to complete the instruction cache maintenance operations that other PEs issue:

AArch32

P1

```

STR R11, [R1] ; R11 contains a new instruction to stored in program memory
DCCMVAU R1 ; clean to PoU makes visible to instruction cache
DSB ; ensure completion of the clean on all processors
ICIMVAU R1 ; ensure instruction cache/branch predictor discard stale data
BPIMVA R1
DMB ; ensure ordering of the store after the invalidation
; DOES NOT guarantee completion of instruction cache/branch
; predictor on other processors
STR R0, [R2] ; set flag to signal completion
DSB ; ensure completion of the invalidation on all processors
ISB ; synchronize context on this processor
BX R1 ; branch to new code

```

P2-Px

```

WAIT ([R2] == 1) ; wait for flag signalling completion
DSB ; this DSB does not guarantee completion of P1
; ICIMVAU/BPIMVA
ISB
BX R1

```

AArch64

P1

```

STR W11, [X1] ; W11 contains a new instruction to stored in program memory
DC CVAU, X1 ; clean to PoU makes visible to instruction cache
DSB ISH ; ensure completion of the clean on all processors
IC IVAU, X1 ; ensure instruction cache/branch predictor discard stale data

```

```
DMB ISH          ; ensure ordering of the store after the invalidation
                  ; DOES NOT guarantee completion of instruction cache/branch
                  ; predictor on other processors

STR W0, [X2]     ; set flag to signal completion

DSB ISH          ; ensure completion of the invalidation on all processors

ISB              ; synchronize context on this processor

BR X1            ; branch to new code
```

P2-Px

```
WAIT ([X2] == 1) ; wait for flag signalling completion

DSB ISH          ; this DSB does not guarantee completion of P1
                  ; ICIMVAU/BPIMVA

ISB

BR X1
```

In this example, P2...Px might not see the updated region of code at R1.

F.5.3 TLB maintenance operations and barriers

The following sections describe the use of barriers with TLB maintenance operations:

- [Ensuring the visibility of updates to translation tables for a uniprocessor](#)
- [Ensuring the visibility of updates to translation tables for a multiprocessor on page AppxF-4855](#)
- [Paging memory in and out on page AppxF-4856.](#)

Ensuring the visibility of updates to translation tables for a uniprocessor

On a single PE, the agent that causes translation table walks is a separate memory system observer from the agent that causes data accesses. Therefore, any operations to invalidate the TLB can only rely on seeing updates to memory that are complete. This must be ensured by the use of a DSB instruction.

The ARMv8 architecture requires that translation table walks look in the data or unified caches at L1, so such systems do not require data cache cleaning.

After the translation tables update, any old copies of entries that might be held in the TLBs must be invalidated. This operation is only guaranteed to affect all instructions, including instruction fetches and data accesses, after the execution of a DSB and an ISB. Therefore, the code for updating a translation table entry is:

AArch32

P1

```
STR R11, [R1]    ; update the translation table entry

DSB              ; ensure visibility of the update to translation table walks

TLBIMVA R10

BPIALL

DSB              ; ensure completion of the BP and TLB invalidation

ISB              ; synchronise context on this processor

                ; new translation table entry can be relied upon at this point and all accesses
                ; generated by this observer using
                ; the old mapping have been completed
```

AArch64

P1

```
STR X11, [X1]      ; update the translation table entry
DSB ISH            ; ensure visibility of the update to translation table walks
TLBI VAE1, X10    ; assumes we are in the EL1
DSB ISH            ; ensure completion of the TLB invalidation
ISB                ; synchronise context on this processor
; new translation table entry can be relied upon at this point and all accesses
; generated by this observer using
; the old mapping have been completed
```

Importantly, by the end of this sequence, all accesses that used the old translation table mappings have been observed by all observers.

An example of this is where a translation table entry is marked as invalid. Such a system must provide a mechanism to ensure that any access to a region of memory being marked as invalid has completed before any action is taken as a result of the region being marked as invalid.

Ensuring the visibility of updates to translation tables for a multiprocessor

The same code sequence can be used in a multiprocessing system. The ARMv8 architecture requires a PE that performs a TLB maintenance operation to execute a DSB instruction to ensure completion of the maintenance operation. This ensures that the TLB maintenance operation is complete on all PEs in the Inner Shareable shareability domain.

The completion of a DSB that completes a TLB maintenance operation ensures that all accesses that used the old mapping have completed.

AArch32

P1

```
STR R11, [R1]     ; update the translation table entry
DSB               ; ensure visibility of the update to translation table walks
TLBIMVAIS R10
BPIALLIS
DSB               ; ensure completion of the BP and TLB invalidation
ISB               ; Note ISB is not broadcast and must be executed locally
                  ; on other processors
; new translation table entry can be relied upon at this point and all accesses
; generated by any observers affected by the broadcast TLBIMVAIS operation using
; the old mapping have been completed
```

AArch64

P1

```
STR X11, [X1]     ; update the translation table entry
DSB ISH           ; ensure visibility of the update to translation table walks
TLBI VAE1IS, X10
```

```
DSB ISH          ; ensure completion of the TLB invalidation
ISB              ; Note ISB is not broadcast and must be executed locally
                ; on other processors
                ; new translation table entry can be relied upon at this point and all accesses
                ; generated by any observers affected by the broadcast TLBIMVAIS operation using
                ; the old mapping have been completed
```

The completion of the TLB maintenance operation is guaranteed only by the execution of a DSB by the observer that performed the TLB maintenance operation. The execution of a DSB by a different observer does not have this effect, even if the DSB is known to be executed after the TLB maintenance operation is observed by that different observer.

Paging memory in and out

In a multiprocessor system there is a requirement to ensure the visibility of translation table updates when paging regions of memory into RAM from a backing store. This might, or might not, also involve paging existing locations in memory from RAM to a backing store. In such situations, the operating system selects one or more pages of memory that might be in use but are suitable to discard, with or without copying to a backing store, depending on whether or not the region of memory is writable. Disabling the translation table mappings for a page, and ensuring the visibility of that update to the translation tables, prevents agents accessing the page.

For this reason, it is important that the DSB that is performed after the TLB invalidation ensures that no other updates to memory using those mappings are possible.

An example sequence for the paging out of an updated region of memory, and the subsequent paging in of memory, is as follows:

AArch32

P1

```
STR R11, [R1]    ; update the translation table for the region being paged out
DSB              ; ensure visibility of the update to translation table walks
TLBIMVAIS R10    ; invalidate the old entry
DSB              ; ensure completion of the invalidation on all processors
ISB              ; ensure visibility of the invalidation
BL SaveMemoryPageToBackingStore
BL LoadMemoryFromBackingStore
DSB              ; ensure completion of the memory transfer (this could be part of
                ; LoadMemoryFromBackingStore
ICIALLUIS        ; also invalidates the branch predictor
STR R9, [R1]     ; create a new translation table entry with a new mapping
DSB              ; ensure completion of the I Cache & Branch Predictor invalidation
                ; AND ensure visibility of the new translation table mapping
ISB              ; ensure synchronisation of this instruction stream
```

AArch64

P1

```
STR X11, [X1]    ; update the translation table for the region being paged out
DSB ISH          ; ensure visibility of the update to translation table walks
```

```

TLBI VAE1IS, X10      ; invalidate the old entry
DSB ISH                ; ensure completion of the invalidation on all processors
ISB                    ; ensure visibility of the invalidation
BL SaveMemoryPageToBackingStore
BL LoadMemoryFromBackingStore
DSB ISH                ; ensure completion of the memory transfer (this could be part of
                       ; LoadMemoryFromBackingStore
IC IALLUIS             ; also invalidates the branch predictor
STR X9, [X1]          ; create a new translation table entry with a new mapping
DSB ISH                ; ensure completion of the I Cache & Branch Predictor invalidation
                       ; AND ensure visibility of the new translation table mapping
ISB                    ; ensure synchronisation of this instruction stream
  
```

This example assumes the memory copies are performed by an observer that is coherent with the caches of PE P1. This observer might be P1 itself, using a specific paging mapping. For clarity, the example omits the functional descriptions of `SaveMemoryPageToBackingStore` and `LoadMemoryFromBackingStore`. `LoadMemoryFromBackingStore` is required to ensure that the memory updates that it makes are visible to instruction fetches.

In this example, the use of `IC IALLUIS` in AArch32 and `IC IALLUIS` in AArch64 to invalidate the entire instruction cache is a simplification, that might not be optimal for performance. An alternative approach involves invalidating all of the lines in the caches using `ICIMVAU` and `IC IVAU` operations in AArch32 and AArch64 respectively. This invalidation must be done when the mapping used for the `ICIMVAU` and `IC IVAU` operations is valid but not executable.

F.5.4 Ordering of Memory-mapped device control with payloads

With a Memory-mapped peripheral, such as a DMA, which can also access memory for its own use, it is common to have control or status registers which are Memory-mapped. These registers need to be accessed in an ordered manner with respect to the data that the Memory-mapped peripheral is handling.

Two simple examples of this are:

- When a Processing Element is writing a buffer of data, and then writing to a control register in the DMA peripheral to start that peripheral to access the buffer of data.
- When a DMA peripheral has written to a buffer of data in memory, and the Processing Element is reading a status register to determine that the DMA transfer has completed, and then is reading the data.

For the case of the Processing Element writing a buffer of data, before starting the DMA peripheral, the ordering requirements between the stores to the data buffer and the stores to the Memory-mapped a to the DMA peripheral can be met by the insertion of a `DSB <domain>` instruction between these sets of accesses as this ensures the global observation of the stores before the DMA is started. this is shown by the following code:

AArch32

P1

```

STR R5, [R2]          ; data written to the data buffer
DSB
STR R0, [R4]          ; R4 contains the address of the DMA control register
  
```

AArch64

P1

```

STR W5, [X2]          ; data written to the data buffer
  
```

```
DSB <domain>  
STR W0, [X4] ; X4 contains the address of the DMA control register
```

For the case of DMA peripheral writing the data buffer and then setting a status register when those stores are complete (and so globally observed) and then having this status register polled by the Processing element before the processing element reads the data buffer, the processing element must insert a DSB <domain> between the load that reads the status register, and the read of the buffer. A DMB, or load-acquire, is not sufficient as this problem is not solely concerned with observation order, since the polling read is actually a read of a status register at a slave, not the polling a data value that has been written by an observer.

For this case, the code is therefore:

AArch32

P1

```
WAIT ([R4] == 1) ; R4 contains the address of the status register,  
; and the value '1' indicates completion of the DMA transfer  
DSB  
LDR R5, [R2] ; read data from the data buffer
```

AArch64

P1

```
WAIT ([X4] == 1) ; X4 contains the address of the status register,  
; and the value '1' indicates completion of the DMA transfer  
DSB <domain>  
LDR W5, [X2] ; read data from the data buffer
```

F.6 ARMv7 compatible approaches for ordering, using DMB and DSB barriers

The following sections describe the ARMv7 compatible approaches for ordering, using DMB and DSB barriers:

- [Simple ordering and barrier cases](#).
- [Load-Exclusive, Store-Exclusive and barriers](#) on page AppxF-4866.
- [Using a mailbox to send an interrupt](#) on page AppxF-4868.
- [Cache and TLB maintenance operations and barriers](#) on page AppxF-4868.

F.6.1 Simple ordering and barrier cases

ARM implements a weakly consistent memory model for Normal memory. In general terms, this means that the order of memory accesses observed by other observers might not be the order that appears in the program, for either loads or stores.

This section includes examples of this.

Simple weakly consistent ordering example

```
P1
    STR R5, [R1]
    LDR R6, [R2]

P2
    STR R6, [R2]
    LDR R5, [R1]
```

In the absence of barriers, the result of P1: R6=0, P2: R5=0 is permissible.

Message passing

The following sections describe:

- [Weakly-ordered message passing problem](#)
- [Message passing with multiple observers](#) on page AppxF-4861.

Weakly-ordered message passing problem

```
P1
    STR R5, [R1]           ; set new data
    STR R0, [R2]           ; send flag indicating data ready

P2
    WAIT([R2]==1)         ; wait on flag
    LDR R5, [R1]           ; read new data
```

In the absence of barriers, an end result of P2: R5=0 is permissible.

Resolving by the addition of barriers

The addition of barriers, to ensure the observed order of the reads and the writes, ensures that data is transferred so that the result P2:R5==0x55 is guaranteed, as follows:

```
P1
    STR R5, [R1]           ; set new data
    DMB [ST]               ; ensure all observers observe data before the flag
```

```

    STR R0, [R2]           ; send flag indicating data ready

P2

    WAIT([R2]==1)        ; wait on flag

    DMB                   ; ensure that the load of data is after the flag has been observed

    LDR R5, [R1]
  
```

Resolving by the use of barriers and address dependency

There is a rule within the ARM architecture that:

- Where the value returned by a read is used for computation of the virtual address of a subsequent read or write, then these two memory accesses are observed in program order.
- Where the value returned by a read is used for computation of the virtual address of a subsequent read or write, this is called an *address dependency*. An address dependency exists even if the value returned by the first read has no effect on the virtual address. This might occur if the value returned is masked off before it is used, or if it confirms a predicted address value that it might have changed.
- This restriction applies only when the data value returned by a read is used as a data value to calculate the address of a subsequent read or write. It does not apply if the data value returned by a read determines the condition flags values, and the values of the flags are used for condition code evaluation to determine the address of a subsequent read, either through conditional execution or the evaluation of a branch. This is called a *control dependency*.
- Where both a control and address dependency exist, the ordering behavior is consistent with the address dependency.

Table F-1 shows examples of address dependencies, control dependencies, and an address and control dependency.

Table F-1 Dependency examples

Address dependency		Control dependency		Address and control dependency ^a
(a)	(b)	(c)	(d)	(e)
LDR r1, [r0]	LDR r1, [r0]	LDR r1, [r0]	LDR r1, [r0]	LDR r1, [r0]
LDR r2, [r1]	AND r1, r1, #0	CMP r1, #55	CMP r1, #55	CMP r1, #0
	LDR r2, [r3, r1]	LDRNE r2, [r3]	MOVNE r4, #22	LDRNE r2, [r1]
			LDR r2, [r3, r4]	

a. The address dependency takes priority.

This means that the data transfer example of *Weakly-ordered message passing problem* on page AppxF-4859 can also be satisfied as shown in the following example:

```

P1

    STR R5, [R1]           ; set new data

    DMB [ST]              ; ensure all observers observe data before the flag

    STR R0, [R2]           ; send flag indicating data ready

P2

    WAIT([R2]==1)

    AND R12, R12, #0       ; R12 is destination of LDR in WAIT macro

    LDR R5, [R1, R12]     ; Load is dependent and so is ordered after the flag has been seen
  
```

The load of R5 by P2 is ordered with respect to the load from [R2] because there is an address dependency using R12. P1 uses a DMB to ensure that P2 does not observe the write of [R2] before the write of [R1].

Message passing with multiple observers

Where the ordering of Normal memory accesses is not resolved by the use of barriers or dependencies, then different observers might observe the accesses in a different order, as shown in the following example:

```
P1
    STR R5, [R1]           ; set new data
    STR R0, [R2]           ; send flag indicating data ready

P2
    WAIT([R2]==1)
    AND R12, R12, #0       ; R12 is destination of LDR in WAIT macro
    LDR R5, [R1, R12]      ; Load is dependent and so is ordered after the flag has been seen

P3
    WAIT([R2]==1)
    AND R12, R12, #0       ; R12 is destination of LDR in WAIT macro
    LDR R5, [R1, R12]      ; Load is dependent and so is ordered after the flag has been seen
```

In this case, it is permissible for P2:R5 and P3:R5 to contain different values, because there is no order guaranteed between the two stores performed by P1.

Resolving by the addition of barriers

The addition of a barrier by P1, as shown in the following example, ensures the observed order of the writes, transferring data so that P2:R5 and P3:R5 both contain the value 0x55:

```
P1
    STR R5, [R1]           ; set new data
    DMB [ST]               ; ensure all observers observe data before the flag
    STR R0, [R2]           ; send flag indicating data ready

P2
    WAIT([R2]==1)
    AND R12, R12, #0       ; R12 is destination of LDR in WAIT macro
    LDR R5, [R1, R12]      ; Load is dependent and so is ordered after the flag has been seen

P3
    WAIT([R2]==1)
    AND R12, R12, #0       ; R12 is destination of LDR in WAIT macro
    LDR R5, [R1, R12]      ; Load is dependent and so is ordered after the flag has been seen
```

Address dependency with object construction

When accessing an object-oriented data structure, the address dependency rule means that barriers are not required, even when initializing the object:

```
P1
    STR R5, [R1, #offset]  ; set new data in a field
```

```
DMB [ST]           ; ensure all observers observe data before base address is updated
STR R1, [R2]       ; update base address

P2

LDR R1, [R2]       ; read for base address
CMP R1, #0         ; check if it is valid
BEQ null_trap

LDR R5, [R1, #offset] ; use base address to read field
```

If the `null_trap` is not taken, it is required that `P2:R5==0x55`. This avoids P2 observing a partially constructed object from P1. Significantly, P2 does not require a barrier to ensure this behavior.

P1 requires a barrier to ensure the observed order of the writes by P1. In general, the impact of requiring a barrier during the construction phase is much less than the impact of requiring a barrier for every read access.

Causal consistency issues with multiple observers

The fact that different observers can observe memory accesses in different orders extends, in the absence of barriers, to behaviors that do not fit naturally expected causal properties, as the following example shows:

```
P1
STR R0, [R2]       ; set new data

P2
WAIT([R2]==1)     ; wait to see new data from P1
STR R0, [R3]       ; send flag, must be after the new data has been by P2 as stores
                   ; must not be speculative

P3
WAIT([R3]==1)     ; wait for P2's flag
AND R12, R12, #0  ; dependency to ensure order
LDR R0, [R2, R12] ; read P1's data
```

In this example, `P3:R0==0` is permissible. P3 is not guaranteed to see the stores from P1 and P2 in any particular order. This applies despite the fact that the store from P2 can only happen after P2 has observed the store from P1.

This example shows that the ARM memory order model for Normal memory does not conform to *causal consistency*. This means that the apparently transitive causal relationship between two variables is not guaranteed to be transitive.

The following example shows the insertion of a barrier by P2 to create causal consistency:

```
P1
STR R0, [R2]       ; set new data

P2
WAIT([R2]==1)     ; wait to see new data from P1
DMB               ; ensure P1's data is observed by all observers before any following store
STR R0, [R3]       ; send flag

P3
WAIT([R3]==1)     ; wait for P2's flag
AND R12, R12, #0  ; dependency to ensure order
```

```
LDR R0, [R2, R12]      ; read P1's data
```

This creates causal consistency because a DMB is required to order all accesses that the executing PE observed before the DMB, not only those it issued, before any of the accesses that follow the DMB.

Multiple observers of writes to multiple locations

The ARM weakly consistent memory model means that different observers can observe writes to different locations in different orders, as the following example shows:

P1

```
STR R0, [R1]           ; set new data
```

P2

```
STR R0, [R2]           ; set new data
```

P3

```
LDR R10, [R2]          ; read P2's data before P1's
LDR R9, [R1]           ;
BIC R9, R10, R9        ; R9 <- R10 && ~R9
                        ; R9 contains 1 iff read from [R2] is observed to be 1 and
                        ; read from [R1] is observed to be 0.
```

P4

```
LDR R9, [R1]
LDR R10, [R2]
BIC R9, R9, R10        ; R9 <- R9 && ~R10
                        ; R9 contains 1 iff read from [R2] is observed to be 0 and
                        ; read from [R1] is observed to be 1.
```

In this example, the result P3:R9==1 and P4:R9==1 is permissible. This means that P3 and P4 observed the stores from P1 and P2 in different orders.

The following example shows the use of DMB instructions to ensure sequential consistency:

P1

```
STR R0, [R1]           ; set new data
```

P2

```
STR R0, [R2]           ; set new data
```

P3

```
LDR R10, [R2]          ; read P2's data before P1's
DMB
LDR R9, [R1]
BIC R9, R10, R9        ; R9 <- R10 && ~R9
                        ; R9 contains 1 iff read from [R2] is observed to be 1 and
                        ; read from [R1] is observed to be 0.
```

P4

```
LDR R9, [R1]           ; read P1's data before P2's
```

```
DMB
LDR R10, [R2]
BIC R9, R9, R10      ; R9 <- R9 && ~R10
                     ; R9 contains 1 iff read from [R2] is observed to be 0 and
                     ; read from [R1] is observed to be 1.
```

In this example:

- the DMB executed by P3 ensures that, if the P3 load from [R2] observes the P2 store to [R2], then all observers observe the P2 store to [R2] before they observe the P3 load from [R1]
- the DMB executed by P4 ensures that, if the P4 load from [R1] observes the P1 store to [R1], then all observers observe the P1 store to [R1] before they observe the P4 load from [R2].

If the P3 load from [R1] returns 0, then it has not observed the P1 store to [R1]. Also, if the P3 load of [R2] returns 1, then all observers must have observed the P2 store to [R2] before they observed the P1 store to [R1]. This means that P4 cannot observe the P1 store to [R1] without also observing the P2 store to [R2].

Alternatively, if the P4 load from [R2] returns 0, then it has not observed the P2 store to [R2]. If, also, the P4 load of [R1] returns 1, then all observers must have observed the P1 store to [R1] before they observed the P2 store to [R2]. This means that P3 cannot observe the P2 store to [R2] without also observing the P1 store to [R1].

This shows that, of the four possible results for {P3:R9, P4:R9}, the insertion of these barriers makes the result {1, 1} impossible.

Posting a store before polling for acknowledgement

In the case where an observer stores to a location, and then polls for an acknowledge from a different observer, the weak ordering of the memory model can lead to a deadlock, as the following example shows:

```
P1
STR R0, [R2]
WAIT ([R3]==1)

P2
WAIT ([R2]==1)
STR R0, [R3]
```

In ARMv7 implementations that do not include the Multiprocessing Extensions, then this can deadlock because P2 might not observe the store by P1 in finite time. For ARMv7 implementations with the Multiprocessing Extensions and for ARMv8, this is not an issue as all stores must be observed by all observers within their shareability domain in finite time.

The addition of a DMB instruction prevents this deadlock in ARMv7 implementations that do not include the Multiprocessing Extensions:

```
P1
STR R0, [R2]
DMB
WAIT ([R3]==1)

P2
WAIT ([R2]==1)
STR R0, [R3]
```

The DMB executed by P1 ensures that P2 observes the store by P1 before it observes the load by P1. This ensures a timely completion.

The following example is a variant of the previous example, where the two observers poll the same memory location:

```
P1
    STR R0, [R2]
    WAIT ([R2]==2)

P2
    WAIT ([R2]==1)
    LDR R0, [R2]
    ADD R0, R0, #1
    STR R0, [R2]
```

In this example, the same deadlock can occur, because the architecture permits P1 to read the result of its own store to [R2] early, and continue doing so for an indefinite amount of time. The addition of a DMB instruction prevents this deadlock:

```
P1
    STR R0, [R2]
    DMB
    WAIT ([R2]==2)

P2
    WAIT ([R2]==1)
    LDR R0, [R2]
    ADD R0, R0, #1
    STR R0, [R2]
```

WFE and WFI and barriers

The Wait For Event and Wait For Interrupt instructions permit the PE to suspend execution and enter a low-power state. A DSB barrier instruction is required if it is necessary to ensure that memory accesses made before the WFI or WFE are visible to other observers, unless some other mechanism has ensured this visibility. Examples of other mechanism that would guarantee the required visibility are the DMB described in [Posting a store before polling for acknowledgement on page AppxF-4864](#), or a dependency on a load.

The following example requires the DSB to ensure that the store is visible:

```
P1
    STR R0, [R2]
    DSB

Loop
    WFI
    B Loop
```

However, if the example in [Posting a store before polling for acknowledgement on page AppxF-4864](#) is extended to include a WFE, there is no risk of a deadlock. The extended example is:

```
P1
```

```
    STR R0, [R2]
    DMB
Loop
    LDR R12, [R3]
    CMP R12, #1
    WFENE
    BNE Loop
P2
    WAIT ([R2]==1)
    STR R0, [R3]
    DSB
    SEV
```

In this example:

- the DMB by P1 ensures that P2 observes the store by P1 before it observes the load by P1
- the dependency of the WFE on the result of the load by P1 means that this load must complete before P1 executes the WFE.

For more information about SEV, see [Use of Wait For Event \(WFE\) and Send Event \(SEV\) with locks on page AppxF-4867](#).

F.6.2 Load-Exclusive, Store-Exclusive and barriers

The Load-Exclusive and Store-Exclusive instructions, described in [Synchronization and semaphores on page B2-100](#), are predictable only with Normal memory. These instructions do not have any implicit barrier functionality. Therefore, any use of these instructions to implement locks of any type requires the addition of explicit barriers.

Acquiring a lock

A common use of Load-Exclusive and Store-Exclusive instructions is to claim a lock to permit entry into a critical region. This is typically performed by testing a lock variable that indicates 0 for a free lock and some other value, commonly 1 or an identifier of the process holding the lock, for a taken lock.

The lack of implicit barriers in the Load-Exclusive and Store-Exclusive instructions means that the mechanism requires a DMB instruction between acquiring a lock and making the first access to the critical region, to ensure that all observers observe the successful claim of the lock before they observe any subsequent loads or stores to the region. This example shows Px acquiring a lock:

```
Px
Loop
    LDREX R5, [R1]          ; read lock
    CMP R5, #0             ; check if 0
    STREXEQ R5, R0, [R1]   ; attempt to store new value
    CMPEQ R5, #0           ; test if store succeeded
    BNE Loop              ; retry if not
    DMB                   ; ensures that all subsequent accesses are observed after the
                          ; gaining of the lock is observed
```

; loads and stores in the critical region can now be performed

Releasing a lock

The converse operation of releasing a lock does not require the use of Load-Exclusive and Store-Exclusive instructions, because only a single observer is able to write to the lock. However, often it is necessary for any observer to observe any memory updates, or any values that are loaded into memory, before they observe the release of the lock. Therefore, a DMB usually precedes the lock release, as the following example shows.

Px

```

; loads and stores in the critical region
MOV R0, #0
DMB                ; ensure all previous accesses are observed before the lock is cleared
STR R0, [R1]      ; clear the lock

```

Use of Wait For Event (WFE) and Send Event (SEV) with locks

The ARMv8 architecture includes Wait For Event and Send Event instructions, that can be executed to reduce the required number of iterations of a lock-acquire loop, or *spinlock*, to reduce power. The basic mechanism involves an observer that is in a spinlock executing a WFE instruction that suspends execution on that observer until an asynchronous exception or an explicit event, sent by some other observer using the SEV instruction, is seen by the suspended observer. An observer that holds the lock executes an SEV instruction to send an event after it has released the lock.

The Event signal is a non-memory communication, and therefore the memory update that releases the lock must be observable by all observers before the SEV instruction is executed and the event is sent. This requires the use of DSB instruction, rather than DMB.

Therefore, the following is an example of lock acquire code using WFE:

Px

```

Loop
LDREX R5, [R1]    ; read lock
CMP R5, #0       ; check if 0
WFENE            ; sleep if the lock is held
STREXEQ R5, R0, [R1] ; attempt to store new value
CMPEQ R5, #0     ; test if store succeeded
BNE Loop        ; retry if not
DMB             ; ensures that all subsequent accesses are observed after the
                ; gaining of the lock is observed
; loads and stores in the critical region can now be performed

```

And the following is an example of lock release code using SEV:

Px

```

; loads and stores in the critical region
MOV R0, #0
DMB                ; ensure all previous accesses are observed before the lock is cleared
STR R0, [R1]      ; clear the lock
DSB               ; ensure completion of the store that cleared the lock before

```

```
                                ; sending the event  
  
SEV
```

F.6.3 Using a mailbox to send an interrupt

In some message passing systems, it is common for one observer to update memory and then notify a second observer of the update by sending an interrupt, using a mailbox.

Although a memory access might be made to initiate the sending of the mailbox interrupt, a DSB instruction is required to ensure the completion of previous memory accesses.

Therefore, the following sequence is required to ensure that P2 observes the updated value:

```
P1  
  
    STR R5, [R1]                ; message stored to shared memory location  
  
    DSB [ST]  
  
    STR R1, [R4]                ; R4 contains the address of a mailbox  
  
P2  
  
    ; interrupt service routine  
  
    LDR R5, [R1]
```

———— **Note** —————

The DSB executed by P1 ensures global observation of the store to [R1]. The interrupt timing ensures that the code executed by P2 is executed after the global observation of the update to [R1], and therefore must see this update. In some implementations, this might be implemented by requiring that interrupts flush non-coherent buffers that hold speculatively loaded data.

F.6.4 Cache and TLB maintenance operations and barriers

The following sections describe the use of barriers with cache and TLB maintenance operations:

- [Data cache maintenance operations](#)
- [Instruction cache maintenance operations](#) on page AppxF-4871
- [TLB maintenance operations and barriers](#) on page AppxF-4873.

Data cache maintenance operations

The following sections describe the use of barriers with data cache maintenance operations:

- [Message passing to non-caching observers](#)
- [Multiprocessing message passing to non-caching observers](#) on page AppxF-4869
- [Invalidating DMA buffers, non-functional example](#) on page AppxF-4869
- [Invalidating DMA buffers, functional example with single PE](#) on page AppxF-4870
- [Invalidating DMA buffers, functional example with multiple coherent PEs](#) on page AppxF-4870.

Message passing to non-caching observers

The ARMv8 architecture requires the use of DMB instructions to ensure the ordering of data cache maintenance operations and their effects. This means the following message passing approaches can be used when communicating between caching observers and non-caching observers:

```
P1  
  
    STR R5, [R1]                ; update data (assumed to be in P1's cache)  
  
    DCCMVA R1                  ; clean cache to point of coherency
```

```

DMB                ; ensure effects of the clean will be observed before the flag is set
STR R0, [R4]       ; send flag to external agent (Non-cacheable location)
E1
WAIT ([R4] == 1)   ; wait for the flag
DMB                ; ensure that flag has been seen before reading data
LDR R5, [R1]       ; read the data

```

In this example, it is required that E1:R5==0x55.

Multiprocessing message passing to non-caching observers

The broadcast nature of the cache maintenance operations in ARMv8, and in ARMv7 implementations that include the Multiprocessing Extensions, combined with properties of barriers, means that the message passing principle for non-caching observers is:

```

P1
STR R5, [R1]       ; update data (assumed to be in P1's cache)
DMB [ST]          ; ensure new data is observed before the flag to P2 is set
STR R0, [R2]       ; send flag to P2
P2
WAIT ([R2] == 1)   ; wait for flag from P1
DMB                ; ensure cache clean is observed after P1's flag is observed
DCCMVA R1         ; clean cache to point of coherency - this cleans the cache of P1
DMB                ; ensure effects of the clean are observed before the flag to E1 is set
STR R0, [R4]       ; send flag to E1
E1
WAIT ([R4] == 1)   ; wait for flag from P2
DMB                ; ensure that flag has been observed before reading the data
LDR R5, [R1]       ; read the data

```

In this example, it is required that E1:R5==0x55. The clean operation executed by P2 affects the data location in the P1 cache. The cast-out from the P1 cache is guaranteed to be observed before P2 updates [R4].

Invalidating DMA buffers, non-functional example

The basic scheme for communicating with an external observer that is a process that passes data in to a Cacheable memory region must take account of the architectural requirement that regions marked as Cacheable can be allocated into a cache at any time, for example as a result of speculation. The following example shows this possibility:

```

P1
DCIMVAC R1        ; ensure cache clean with respect to memory. A clean operation could be
                  ; used but the DMA overwrites this region so an invalidate operation
                  ; is sufficient and usually more efficient
DMB                ; ensures cache invalidation is observed before the next store is observed
STR R0, [R3]       ; send flag to external agent
WAIT ([R4]==1)    ; wait for a different flag from an external agent

```

```
DMB ; observe flag from external agent before reading new data. However [R1]
; could have been brought into cache earlier

LDR R5, [R1]
E1
WAIT ([R3] == 1) ; wait for flag
STR R5, [R1] ; store new data
DMB
STR R0, [R4] ; send a flag
```

If a speculative access occurs, there is no guarantee that the cache line containing [R1] is not brought back into the cache after the cache invalidation, but before [R1] is written by E1. Therefore, the result P1:R5=0 is permissible.

Invalidating DMA buffers, functional example with single PE

```
P1
DCIMVAC R1 ; ensure cache clean with respect to memory. A clean operation could be
; used but the DMA overwrites this region so an invalidate operation
; is sufficient and usually more efficient

DMB ; ensures cache invalidation is observed before the next store is observed
STR R0, [R3] ; send flag to external agent
WAIT ([R4]==1) ; wait for a different flag from an external agent
DMB ; ensure that cache invalidate is observed after the flag
; from external agent is observed

DCIMVAC R1 ; ensure cache discards stale copies before use
LDR R5, [R1]
E1
WAIT ([R3] == 1) ; wait for flag
STR R5, [R1] ; store new data
DMB [ST]
STR R0, [R4] ; send a flag
```

In this example, the result P1:R5 == 0x55 is required. Including a cache invalidation after the store by E1 to [R1] is observed ensures that the line is fetched from external memory after it has been updated.

Invalidating DMA buffers, functional example with multiple coherent PEs

The broadcasting of cache maintenance operations, and the use of DMB instructions to ensure their observability, means that the previous example extends naturally to a multiprocessor system. Typically this requires a transfer of ownership of the region that the external observer is updating.

```
P0
(Use data from [R1], potentially using [R1] as scratch space)
DMB
STR R0, [R2] ; signal release of [R1]
WAIT ([R2] == 0) ; wait for new value from DMA
```

```

DMB
LDR R5, [R1]
P1
WAIT ([R2] == 1)      ; wait for release of [R1] by P0
DCIMVAC R1           ; ensure caches are clean with respect to memory, invalidate is sufficient
DMB
STR R0, [R3]         ; request new data for [R1]
WAIT ([R4] == 1)     ; wait for new data
DMB
DCIMVAC R1           ; ensure caches discard stale copies before use
DMB
MOV R0, #0
STR R0, [R2]         ; signal availability of new [R1]
E1
WAIT ([R3] == 1)     ; wait for new data request
STR R5, [R1]         ; send new [R1]
DMB [ST]
STR R0, [R4]         ; indicate new data available to P1

```

In this example, the result $P0:R5 == 0x55$ is required. The DMB issued by P1 after the first data cache invalidation ensures that effect of the cache invalidation on P0 is seen by E1 before the store by E1 to [R1]. The DMB issued by P1 after the second data cache invalidation ensures that its effects are seen before the store of 0 to the semaphore location in [R2].

Instruction cache maintenance operations

The following sections describe the use of barriers with instruction cache maintenance operations:

- [Ensuring the visibility of updates to instructions for a uniprocessor](#)
- [Ensuring the visibility of updates to instructions for a multiprocessor on page AppxF-4872.](#)

Ensuring the visibility of updates to instructions for a uniprocessor

On a single PE, the agent that causes instruction fetches, or instruction cache linefills, is a separate memory system observer from the agent that causes data accesses. Therefore, any operations to invalidate the instruction cache can rely only on seeing updates to memory that are complete. This must be ensured by the use of a DSB instruction.

Also, instruction cache maintenance operations are only guaranteed to complete after the execution of a DSB, and an ISB is required to discard any instructions that might have been prefetched before the instruction cache invalidation completed. Therefore, on a uniprocessor, to ensure the visibility of an update to code and to branch to it, the following sequence is required:

```

P1
STR R11, [R1]        ; R11 contains a new instruction to store in program memory
DCCMVAU R1          ; clean to PoU makes visible to instruction cache
DSB
ICIMVAU R1          ; ensure instruction cache and branch predictor discards stale data
BPIMVA R1

```

```
DSB                ; ensure completion of the invalidation
ISB                ; ensure instruction fetch path observes new instruction cache state
BX R1
```

Ensuring the visibility of updates to instructions for a multiprocessor

ARMv8, and an ARMv7 implementation that includes the Multiprocessing Extensions, requires a PE that performs an instruction cache maintenance operation to execute a DSB instruction to ensure completion of the maintenance operation. This ensures that the cache maintenance operation is complete on all PEs in the Inner Shareable shareability domain.

An ISB is not broadcast, and so does not affect other PEs. This means that any other PE must perform its own ISB synchronization after it knows that the update is visible, if it is necessary to ensure its synchronization with the update. The following example shows how this might be done:

```
P1
STR R11, [R1]      ; R11 contains a new instruction to store in program memory
DCCMVAU R1        ; clean to PoU makes visible to instruction cache
DSB               ; ensure completion of the clean on all processors
ICIMVAU R1       ; ensure instruction cache/branch predictor discards stale data
BPIMVA R1
DSB               ; ensure completion of the ICache and branch predictor
                 ; invalidation on all processors
STR R0, [R2]      ; set flag to signal completion
ISB               ; synchronize context on this processor
BX R1             ; branch to new code

P2-Px
WAIT ([R2] == 1) ; wait for flag signaling completion
ISB               ; synchronize context on this processor
BX R1             ; branch to new code
```

Nonfunctional approach

The following sequence does not have the same effect, because a DSB is not required to complete the instruction cache maintenance operations that other PEs issue:

```
P1
STR R11, [R1]      ; R11 contains a new instruction to store in program memory
DCCMVAU R1        ; clean to PoU makes visible to instruction cache
DSB               ; ensure completion of the clean on all processors
ICIMVAU R1       ; ensure instruction cache/branch predictor discards stale data
BPIMVA R1
DMB               ; ensure ordering of the store after the invalidation
                 ; DOES NOT guarantee completion of instruction cache/branch
                 ; predictor on other processors
STR R0, [R2]      ; set flag to signal completion
```

```
DSB                ; ensure completion of the invalidation on all processors
ISB                ; synchronize context on this processor
BX R1              ; branch to new code

P2-Px

WAIT ([R2] == 1)   ; wait for flag signaling completion
DSB                ; this DSB does not guarantee completion of P1's ICIMVAU/BPIMVA
ISB
BX R1
```

In this example, P2...Px might not see the updated region of code at R1.

TLB maintenance operations and barriers

The following sections describe the use of barriers with TLB maintenance operations:

- [Ensuring the visibility of updates to translation tables for a uniprocessor](#)
- [Ensuring the visibility of updates to translation tables for a multiprocessor on page AppxF-4874](#)
- [Paging memory in and out on page AppxF-4874.](#)

Ensuring the visibility of updates to translation tables for a uniprocessor

On a single PE, the agent that causes translation table walks is a separate memory system observer from the agent that causes data accesses. Therefore, any operations to invalidate the TLB can only rely on seeing updates to memory that are complete. This must be ensured by the use of a DSB instruction.

In the ARMv8 architecture, and in an ARMv7 implementation that includes the Multiprocessing Extensions, translation table walks must look in the data or unified caches at L1, so such systems do not require data cache cleaning.

After the translation tables update, any old copies of entries that might be held in the TLBs must be invalidated. This operation is only guaranteed to affect all instructions, including instruction fetches and data accesses, after the execution of a DSB and an ISB. Therefore, the code for updating a translation table entry is:

```
P1

STR R11, [R1]      ; update the translation table entry
DSB                ; ensure visibility of the update to translation table walks
TLBIMVA R10
BPIALL

DSB                ; ensure completion of the BP and TLB invalidation
ISB                ; synchronize context on this processor
;
; new translation table entry can be relied upon at this point and all accesses
; generated by this observer using the old mapping have been completed
```

Importantly, by the end of this sequence, all accesses that used the old translation table mappings have been observed by all observers.

An example of this is where a translation table entry is marked as invalid. Such a system must provide a mechanism to ensure that any access to a region of memory being marked as invalid has completed before any action is taken as a result of the region being marked as invalid.

Ensuring the visibility of updates to translation tables for a multiprocessor

The same code sequence can be used in a multiprocessing system. In the ARMv8 architecture, and in an ARMv7 implementation that includes the Multiprocessing Extensions, a PE that performs a TLB maintenance operation must execute a DSB instruction to ensure completion of the maintenance operation. This ensures that the TLB maintenance operation is complete on all PEs in the Inner Shareable shareability domain.

The completion of a DSB that completes a TLB maintenance operation ensures that all accesses that used the old mapping have completed.

P1

```
STR R11, [R1]          ; update the translation table entry
DSB                    ; ensure visibility of the update to translation table walks
TLBIMVAIS R10
BPIALLIS
DSB                    ; ensure completion of the BP and TLB invalidation
ISB                    ; Note ISB is not broadcast and must be executed locally on other processors
;
; new translation table entry can be relied upon at this point and all accesses generated by any
; observers affected by the broadcast TLBIMVAIS operation using the old mapping have completed
```

The completion of the TLB maintenance operation is guaranteed only by the execution of a DSB by the observer that performed the TLB maintenance operation. The execution of a DSB by a different observer does not have this effect, even if the DSB is known to be executed after the TLB maintenance operation is observed by that different observer.

Paging memory in and out

In a multiprocessor system there is a requirement to ensure the visibility of translation table updates when paging regions of memory into RAM from a backing store. This might, or might not, also involve paging existing locations in memory from RAM to a backing store. In such situations, the operating system selects one or more pages of memory that might be in use but are suitable to discard, with or without copying to a backing store, depending on whether or not the region of memory is writable. Disabling the translation table mappings for a page, and ensuring the visibility of that update to the translation tables, prevents agents accessing the page.

For this reason, it is important that the DSB that is performed after the TLB invalidation ensures that no other updates to memory using those mappings are possible.

An example sequence for the paging out of an updated region of memory, and the subsequent paging in of memory, is as follows:

P1

```
STR R11, [R1]          ; update the translation table for the region being paged out
DSB                    ; ensure visibility of the update to translation table walks
TLBIMVAIS R10         ; invalidate the old entry
DSB                    ; ensure completion of the invalidation on all processors
ISB                    ; ensure visibility of the invalidation
BL SaveMemoryPageToBackingStore
BL LoadMemoryFromBackingStore
DSB                    ; ensure completion of the memory transfer (this could be part of
; LoadMemoryFromBackingStore
ICIALLUIS             ; also invalidates the branch predictor
```



```
STR R9, [R1]          ; create a new translation table entry with a new mapping
DSB                   ; ensure completion of instruction cache and branch predictor invalidation
                       ; and ensure visibility of the new translation table mapping
ISB                   ; ensure synchronization of this instruction stream
```

This example assumes the memory copies are performed by an observer that is coherent with the caches of PE P1. This observer might be P1 itself, using a specific paging mapping. For clarity, the example omits the functional descriptions of `SaveMemoryPageToBackingStore` and `LoadMemoryFromBackingStore`. `LoadMemoryFromBackingStore` is required to ensure that the memory updates that it makes are visible to instruction fetches.

In this example, the use of `ICIALLUIS` to invalidate the entire instruction cache is a simplification, that might not be optimal for performance. An alternative approach involves invalidating all of the lines in the caches using `ICIMVAU` operations. This invalidation must be done when the mapping used for the `ICIMVAU` operations is valid but not executable.

Appendix G

ARMv8 Pseudocode Library

This appendix contains the ARMv8 pseudocode library. It contains the following sections:

- [Library pseudocode for AArch64 on page AppxG-4878.](#)
- [Library pseudocode for AArch32 on page AppxG-4927.](#)
- [Common library pseudocode on page AppxG-4986.](#)

Note

Status of this appendix in the beta release document

ARM is currently working to improve the organization and presentation of the pseudocode in this document, including providing improved linking within the pseudocode. Currently, this chapter contains the complete pseudocode library for ARMv8, split between:

- Functions, or versions of functions, that are specific to execution in AArch64 state.
- Functions, or versions of functions, that are specific to execution in AArch32state.
- Functions that apply to execution in either Execution state.

Many pseudocode functions are included elsewhere in the document, to accompany the description of the associated functionality. Currently, those functions are repeated in this appendix.

G.1 Library pseudocode for AArch64

This section holds the pseudocode for execution in AArch64 state. Functions listed in this section are identified as AArch64.FunctionName. Some of these functions have an equivalent AArch32 function, AArch32.FunctionName. This section is organized by functional groups, with the functional groups being indicated by hierarchical path names, for example aarch64/debug/breakpoint.

G.1.1 aarch64/debug

This section contains the pseudocode for AArch64 state that relates to debug.

aarch64/debug/breakpoint

```
// Breakpoints in an AArch64 translation regime

// AArch64.BreakpointValueMatch()
// =====
boolean AArch64.BreakpointValueMatch(integer n, bits(64) vaddress, boolean linked_to)

    // "n" is the identity of the breakpoint unit to match against
    // "vaddress" is the current instruction address, ignored if linked_to is TRUE and Context
    // matching breakpoints.
    // "linked_to" is TRUE if this is a call from StateMatch for linking.

    // If a non-existent breakpoint then it is CONSTRAINED UNPREDICTABLE whether this gives
    // no match or the breakpoint is mapped to another UNKNOWN implemented breakpoint.
    if n > UInt(ID_AA64DFR0_EL1.BRPs) then
        (c, n) = ConstrainUnpredictableInteger(0, UInt(ID_AA64DFR0_EL1.BRPs));
        assert c IN {Constraint_NONE, Constraint_UNKNOWN};
        if c == Constraint_NONE then return FALSE;

    // If this breakpoint is not enabled, it cannot generate a match. (This could also happen on a
    // call from StateMatch for linking.)
    if DBGBCR_EL1[n].E == '0' then return FALSE;

    // Return FALSE if BT is set to a reserved type.
    if DBGBCR_EL1[n].BT IN {'011x', '11xx'} then return FALSE;

    // Determine what to compare against.
    match_addr = DBGBCR_EL1[n].BT<3,1> == '00';
    match_vmid = DBGBCR_EL1[n].BT<3> == '1';
    match_cid = DBGBCR_EL1[n].BT<1> == '1';
    linked     = DBGBCR_EL1[n].BT<0> == '1';

    // Assertions based on the definition of DBGBCR_EL1[n].BT.
    // Unless this breakpoint is context-aware, BT<3,1> are RAZ, and
    // doesn't match VMID or CONTEXTIDR
    assert (n >= UInt(ID_AA64DFR0_EL1.BRPs) - UInt(ID_AA64DFR0_EL1.CTX_CMPs) ||
           (IsZero(DBGBCR_EL1[n].BT<3,1>) && !match_vmid && !match_cid));

    // Must be matching either address, or one or both of CONTEXTIDR and VMID. This assertion is
    // obviously true given the definition of these variables.
    assert ((match_addr && !match_cid && !match_vmid) ||
           (!match_addr && match_cid) || (!match_addr && match_vmid));

    // VMID matching is not possible/allowable if no EL2 support.
    assert HaveEL(EL2) || !match_vmid;

    // If this is a call from StateMatch, return FALSE if the breakpoint is not programmed for a
    // VMID and/or context ID match, or if not context-aware. The above assertions mean that the
    // code can just test for match_addr == TRUE to confirm all these things.
    if linked_to && (!linked || match_addr) then return FALSE;

    // If this is a call from BreakpointMatch return FALSE for Linked context ID and/or
    // VMID matches.
    if !linked_to && linked && !match_addr then return FALSE;
```

```

// Do the comparison.
if match_addr then
    top = AddrTop(vaddress);
    byte_select_match = (DBGBCR_EL1[n].BAS<0> != '0');
    BVR_match = vaddress<top:2> == DBGBVR_EL1[n]<top:2> && byte_select_match;
elseif match_cid then
    BVR_match = (PSTATE.EL IN {EL0,EL1} && CONTEXTIDR_EL1 == DBGBVR_EL1[n]<31:0>);
if match_vmid then
    BXVR_match = (CurrentStateHasEL2() && PSTATE.EL IN {EL1,EL0} &&
        VTTBR_EL2.VMID == DBGBVR_EL1[n]<39:32>);

match = (!match_vmid || BXVR_match) && (!(match_addr || match_cid) || BVR_match);
return match;

// AArch64.StateMatch()
// =====

boolean AArch64.StateMatch(bits(2) SSC, bit HMC, bits(2) PxC, boolean linked, bits(4) LBN,
    boolean ispriv)
// Function used in both Breakpoint and Watchpoint matching to determine whether the point is
// enabled in the current mode and state.
// "SSC", "HMC", "PxC" and "LBN" are the control fields from the DBGBCRn_EL1 or DBGWCRn_EL1
// register.
// "ispriv" is only valid for watchpoints, and selects between privileged and unprivileged
// accesses.
// "linked" is TRUE if this is a linked breakpoint/watchpoint address type.
// Return FALSE if parameters are set to a reserved type.

if (HMC:SSC:PxC) IN {'100x0', '101x0', '11010', '011xx', '111x1', '11110'} then return FALSE;

EL3_match = HaveEL(EL3) && HMC == '1' && SSC<0> == '0';
EL2_match = HaveEL(EL2) && HMC == '1';
EL1_match = PxC<0> == '1';
EL0_match = PxC<1> == '1';

case PSTATE.EL of
    when EL3 priv_match = EL3_match;
    when EL2 priv_match = EL2_match;
    when EL1 priv_match = if ispriv then EL1_match else EL0_match;
    when EL0 priv_match = EL0_match;

// The determination of security_state_match relies on these assertions to avoid reserved cases.
if !HaveEL(EL3) then assert SSC<0> == SSC<1>;
if SSC == '11' then assert HMC == '1';
case SSC of
    when '00' security_state_match = TRUE; // Both
    when '01' security_state_match = !IsSecure(); // Non-secure only
    when '10' security_state_match = IsSecure(); // Secure only
    when '11' security_state_match = TRUE; // Both

if linked then
    // "LBN" must be an enabled context-aware breakpoint unit. If it is not context-aware
    // then it is CONSTRAINED UNPREDICTABLE whether this gives no match, or LBN is mapped to
    // some UNKNOWN breakpoint that is context-aware.
    lbn = UInt(LBN);
    first_ctx_cmp = (UInt(ID_AA64DFR0_EL1.BRPs) - UInt(ID_AA64DFR0_EL1.CTX_CMPS));
    last_ctx_cmp = UInt(ID_AA64DFR0_EL1.BRPs);
    if (lbn < first_ctx_cmp || lbn > last_ctx_cmp) then
        (c, lbn) = ConstrainUnpredictableInteger(first_ctx_cmp, last_ctx_cmp);
        assert c IN {Constraint_NONE, Constraint_UNKNOWN};
        if c == Constraint_NONE then return FALSE;
    vaddress = bits(64) UNKNOWN;
    linked_to = TRUE;
    linked_match = AArch64.BreakpointValueMatch(lbn, vaddress, linked_to);

return priv_match && security_state_match && (!linked || linked_match);

```

```
// AArch64.BreakpointMatch()
// =====
// Breakpoint matching in an AArch64 translation regime.

boolean AArch64.BreakpointMatch(integer n, bits(64) vaddress, integer size)
// For details of arguments and return values, see BreakpointValueMatch.
assert !ELUsingAArch32(TranslationRegime());
assert n <= UInt(ID_AA64DFR0_EL1.BRPs);

enabled = DBGBCR_EL1[n].E == '1';
ispriv = PSTATE.EL != EL0;
linked = DBGBCR_EL1[n].BT == '0x01';
linked_to = FALSE;

state_match = AArch64.StateMatch(DBGBCR_EL1[n].SSC, DBGBCR_EL1[n].HMC, DBGBCR_EL1[n].PMC,
                                linked, DBGBCR_EL1[n].LBN, ispriv);
value_match = AArch64.BreakpointValueMatch(n, vaddress, linked_to);

if HaveAnyAArch32() && size == 4 then // Check second halfword
// If the breakpoint address and BAS of an Address breakpoint match the address of the
// second halfword of an instruction, but not the address of the first halfword, it is
// CONSTRAINED UNPREDICTABLE whether or not this breakpoint generates a Breakpoint debug
// event.
match_i = AArch64.BreakpointValueMatch(n, vaddress + 2, linked_to);
if !value_match && match_i then
value_match = ConstrainUnpredictableBool();

if vaddress<1> == '1' && DBGBCR_EL1[n].BAS == '1111' then
// The above notwithstanding, if DBGBCR_EL1[n].BAS == '1111', then it is CONSTRAINED
// UNPREDICTABLE whether or not a Breakpoint debug event is generated for an instruction
// at the address DBGBCR_EL1[n]+2.
if value_match then value_match = ConstrainUnpredictableBool();

match = value_match && state_match && enabled;

return match;
```

aarch64/debug/enables

```
// Debug enables etc. in an AArch64 translation regime

// AArch64.GenerateDebugExceptionsFrom()
// =====

boolean AArch64.GenerateDebugExceptionsFrom(bits(2) from, boolean secure, bit mask)

if OSLSR_EL1.OSLK == '1' || DoubleLockStatus() || Halted() then
return FALSE;

route_to_e12 = HaveEL(EL2) && !secure && (HCR_EL2.TGE == '1' || MDCR_EL2.TDE == '1');

if HaveEL(EL3) && secure then
enabled = MDCR_EL3.SDD == '0' && from != EL3;
else
enabled = TRUE;

if (route_to_e12 && from == EL2) || (!route_to_e12 && from == EL1) then
enabled = enabled && (MDSCR_EL1.KDE == '1' && mask == '0');

return enabled;

// AArch64.GenerateDebugExceptions()
// =====

boolean AArch64.GenerateDebugExceptions()
return AArch64.GenerateDebugExceptionsFrom(PSTATE.EL, IsSecure(), PSTATE.D);
```

aarch64/debug/watchpoint

```
// Watchpoints in an AArch64 translation regime

// AArch64.WatchpointByteMatch()
// =====

boolean AArch64.WatchpointByteMatch(integer n, bits(64) vaddress)

    top = AddrTop(vaddress);
    bottom = if DBGWVR_EL1[n]<2> == '1' then 2 else 3;
    byte_select_match = (DBGWCR_EL1[n].BAS<UInt(vaddress<bottom-1:0>)> != '0');
    mask = UInt(DBGWCR_EL1[n].MASK);

    // If the address mask is set to a reserved value, no address masking is performed.
    if mask <= 2 then mask = bottom;

    // If masked bits of DBGWVR_EL1[n] are not zero, no Watchpoint debug event is generated.
    if mask > bottom then
        WVR_match = vaddress<top:mask>:Zeros(mask - bottom) == DBGWVR_EL1[n]<top:bottom>;
    else
        WVR_match = vaddress<top:bottom> == DBGWVR_EL1[n]<top:bottom>;

    // If DBGWCR_EL1[n].MASK is set to a non-zero (not reserved) value, DBGWCR_EL1[n].BAS is not set
    // to '11111111', the generation of Watchpoint debug events by that watchpoint is CONSTRAINED
    // UNPREDICTABLE.
    if UInt(DBGWCR_EL1[n].MASK) > 2 && !IsOnes(DBGWCR_EL1[n].BAS) then
        // See Constraints on programming Watchpoint debug events.
        c = ConstrainUnpredictable();
        case c of
            when Constraint_IGNOREMASK
                WVR_match = vaddress<top:bottom> == DBGWVR_EL1[n]<top:bottom>;
            when Constraint_IGNOREBAS
                byte_select_match = TRUE;
            when Constraint_REPEATBAS
                /*do nothing*/
            otherwise Unreachable();
        else
            // If DBGWCR_EL1[n].BAS specifies a non-contiguous set of bytes, the generation of
            // Watchpoint debug events for the doubleword is CONSTRAINED UNPREDICTABLE.
            LSB = (DBGWCR_EL1[n].BAS AND NOT(DBGWCR_EL1[n].BAS - 1)); MSB = (DBGWCR_EL1[n].BAS + LSB);
            if !IsZero(MSB AND (MSB - 1)) && vaddress<top:3> == DBGWVR_EL1[n]<top:3> then
                byte_select_match = ConstrainUnpredictableBool();

    return WVR_match && byte_select_match;

// AArch64.WatchpointMatch()
// =====
// Watchpoint matching in an AArch64 translation regime.

boolean AArch64.WatchpointMatch(integer n, bits(64) vaddress, integer size, boolean ispriv,
                                boolean iswrite)
    assert !ELUsingAArch32(TranslationRegime());
    assert n <= UInt(ID_AA64DFR0_EL1.WRPs);

    // "ispriv" is FALSE for LDTR/STTR instructions executed at EL1 and all
    // load/stores at EL0, TRUE for all other load/stores. "iswrite" is TRUE for stores, FALSE for
    // loads.
    enabled = DBGWCR_EL1[n].E == '1';
    linked = DBGWCR_EL1[n].WT == '1';

    state_match = AArch64.StateMatch(DBGWCR_EL1[n].SSC, DBGWCR_EL1[n].HMC, DBGWCR_EL1[n].PAC,
                                     linked, DBGWCR_EL1[n].LBN, ispriv);

    ls_match = (DBGWCR_EL1[n].LSC<(if iswrite then 1 else 0)> == '1');

    value_match = FALSE;
    for byte = 0 to size - 1
```

```
value_match = value_match || AArch64.WatchpointByteMatch(n, vaddress + byte);  
return value_match && state_match && !s_match && enabled;
```

G.1.2 aarch64/exceptions

This section contains the pseudocode for AArch64 state that relates to exception handling.

aarch64/exceptions/aborts

```
// ~~~~~  
// AArch64 Exception Mode1  
// ~~~~~  
  
// ~~~~~  
// Abort exceptions  
// ~~~~~  
  
// AArch64.AbortSyndrome()  
// =====  
// Creates an exception syndrome record for Abort and Watchpoint exceptions  
// from an AArch64 translation regime.  
  
ExceptionRecord AArch64.AbortSyndrome(Exception type, FaultRecord fault, bits(64) vaddress)  
  
    exception = ExceptionSyndrome(type);  
  
    d_side = type IN {Exception_DataAbort, Exception_Watchpoint};  
  
    exception.syndrome = FaultSyndrome(d_side, fault);  
    exception.vaddress = ZeroExtend(vaddress);  
    if IPInvalid(fault) then  
        exception.ipinvalid = TRUE;  
        exception.ipaddress = fault.ipaddress;  
    else  
        exception.ipinvalid = FALSE;  
  
    return exception;  
  
// AArch64.InstructionAbort()  
// =====  
  
AArch64.InstructionAbort(bits(64) vaddress, FaultRecord fault)  
  
    route_to_el3 = HaveEL(EL3) && SCR_EL3.EA == '1' && IsExternalAbort(fault);  
    route_to_el2 = AArch64.GeneralExceptionsToEL2() || IsSecondStage(fault);  
  
    bits(64) preferred_exception_return = ThisInstrAddr();  
    exception = AArch64.AbortSyndrome(Exception_InstructionAbort, fault, vaddress);  
    vect_offset = 0x0;  
  
    if PSTATE.EL == EL3 || route_to_el3 then  
        AArch64.TakeException(EL3, exception, preferred_exception_return, vect_offset);  
    elseif PSTATE.EL == EL2 || route_to_el2 then  
        AArch64.TakeException(EL2, exception, preferred_exception_return, vect_offset);  
    else  
        AArch64.TakeException(EL1, exception, preferred_exception_return, vect_offset);  
  
// AArch64.CheckPCAlignment()  
// =====  
  
AArch64.CheckPCAlignment()  
  
    bits(64) pc = ThisInstrAddr();  
    if pc<1:0> != '00' then  
        AArch64.PCAlignmentFault();
```



```
// AArch64.PCAlignmentFault()
// =====
// Called on unaligned program counter in AArch64 state.

AArch64.PCAlignmentFault()

    exception = ExceptionSyndrome(Exception_PCAlignment);
    exception.vaddress = ThisInstrAddr();
    bits(64) preferred_exception_return = ThisInstrAddr();
    vect_offset = 0x0;

    if UInt(PSTATE.EL) > UInt(EL1) then
        AArch64.TakeException(PSTATE.EL, exception, preferred_exception_return, vect_offset);
    elseif AArch64.GeneralExceptionsToEL2() then
        AArch64.TakeException(EL2, exception, preferred_exception_return, vect_offset);
    else
        AArch64.TakeException(EL1, exception, preferred_exception_return, vect_offset);

// AArch64.SPAlignmentFault()
// =====
// Called on an unaligned stack pointer in AArch64 state.

AArch64.SPAlignmentFault()

    exception = ExceptionSyndrome(Exception_SPAlignment);
    bits(64) preferred_exception_return = ThisInstrAddr();
    vect_offset = 0x0;

    if UInt(PSTATE.EL) > UInt(EL1) then
        AArch64.TakeException(PSTATE.EL, exception, preferred_exception_return, vect_offset);
    elseif AArch64.GeneralExceptionsToEL2() then
        AArch64.TakeException(EL2, exception, preferred_exception_return, vect_offset);
    else
        AArch64.TakeException(EL1, exception, preferred_exception_return, vect_offset);

// AArch64.DataAbort()
// =====

AArch64.DataAbort(bits(64) vaddress, FaultRecord fault)

    route_to_el3 = HaveEL(EL3) && SCR_EL3.EA == '1' && IsExternalAbort(fault);
    route_to_el2 = AArch64.GeneralExceptionsToEL2() || IsSecondStage(fault);

    bits(64) preferred_exception_return = ThisInstrAddr();
    exception = AArch64.AbortSyndrome(Exception_DataAbort, fault, vaddress);
    vect_offset = 0x0;

    if PSTATE.EL == EL3 || route_to_el3 then
        AArch64.TakeException(EL3, exception, preferred_exception_return, vect_offset);
    elseif PSTATE.EL == EL2 || route_to_el2 then
        AArch64.TakeException(EL2, exception, preferred_exception_return, vect_offset);
    else
        AArch64.TakeException(EL1, exception, preferred_exception_return, vect_offset);

// AArch64.Abort()
// =====
// Abort and Debug exception handling in an AArch64 translation regime.

AArch64.Abort(bits(64) vaddress, FaultRecord fault)

    if IsDebugException(fault) then
        if fault.acctype == AccType_IFETCH then
            if UsingAArch32() && fault.debugmoe == DebugException_VectorCatch then
                AArch64.VectorCatchException(fault);
            else
                AArch64.BreakpointException(fault);
        else
            AArch64.WatchpointException(vaddress, fault);
```

```

elseif fault.acctype == AccType_IFETCH then
    AArch64.InstructionAbort(vaddress, fault);
else
    AArch64.DataAbort(vaddress, fault);

```

aarch64/exceptions/asynch

```

// ~~~~~
// AArch64 Exception Mode1
// ~~~~~

// ~~~~~
// Interrupt exceptions
// ~~~~~

// AArch64.TakePhysicalSystemErrorException()
// =====

AArch64.TakePhysicalSystemErrorException(boolean syndrome_valid, bits(24) syndrome)

    route_to_e13 = HaveEL(EL3) && SCR_EL3.EA == '1';
    route_to_e12 = (AArch64.GeneralExceptionsToEL2() ||
        (HaveEL(EL2) && !IsSecure() && HCR_EL2.AMO == '1'));

    exception = ExceptionSyndrome(Exception_SError);
    if syndrome_valid then
        exception.syndrome<24> = '1';
        exception.syndrome<23:0> = syndrome;
    bits(64) preferred_exception_return = ThisInstrAddr();
    vect_offset = 0x180;

    if PSTATE.EL == EL3 || route_to_e13 then
        AArch64.TakeException(EL3, exception, preferred_exception_return, vect_offset);
    elseif PSTATE.EL == EL2 || route_to_e12 then
        AArch64.TakeException(EL2, exception, preferred_exception_return, vect_offset);
    else
        AArch64.TakeException(EL1, exception, preferred_exception_return, vect_offset);

// AArch64.TakeVirtualSystemErrorException()
// =====

AArch64.TakeVirtualSystemErrorException()
    assert HaveEL(EL2) && !IsSecure() && PSTATE.EL != EL2 && HCR_EL2.TGE == '0';

    exception = ExceptionSyndrome(Exception_SError);
    if boolean IMPLEMENTATION_DEFINED "Virtual System Error syndrome valid" then
        exception.syndrome<24> = '1';
        exception.syndrome<23:0> = bits(24) IMPLEMENTATION_DEFINED "Virtual System Error syndrome";
    bits(64) preferred_exception_return = ThisInstrAddr();
    vect_offset = 0x180;

    HCR_EL2.VSE = '0';
    AArch64.TakeException(EL1, exception, preferred_exception_return, vect_offset);

// AArch64.TakePhysicalIRQException()
// =====
// Take an enabled physical IRQ exception.

AArch64.TakePhysicalIRQException()

    route_to_e13 = HaveEL(EL3) && SCR_EL3.IRQ == '1';
    route_to_e12 = (AArch64.GeneralExceptionsToEL2() ||
        (HaveEL(EL2) && !IsSecure() && HCR_EL2.IMO == '1'));

    exception = ExceptionSyndrome(Exception_IRQ);
    bits(64) preferred_exception_return = ThisInstrAddr();
    vect_offset = 0x80;

```

```

if route_to_el3 then
    AArch64.TakeException(EL3, exception, preferred_exception_return, vect_offset);
elseif route_to_el2 then
    assert PSTATE.EL != EL3;
    AArch64.TakeException(EL2, exception, preferred_exception_return, vect_offset);
else
    assert PSTATE.EL IN {EL0,EL1};
    AArch64.TakeException(EL1, exception, preferred_exception_return, vect_offset);

// AArch64.TakeVirtualIRQException()
// =====

AArch64.TakeVirtualIRQException()
    assert HaveEL(EL2) && !IsSecure() && PSTATE.EL != EL2 && HCR_EL2.TGE == '0';

    exception = ExceptionSyndrome(Exception_IRQ);
    bits(64) preferred_exception_return = ThisInstrAddr();
    vect_offset = 0x80;

    AArch64.TakeException(EL1, exception, preferred_exception_return, vect_offset);

// AArch64.TakePhysicalFIQException()
// =====

AArch64.TakePhysicalFIQException()

    route_to_el3 = HaveEL(EL3) && SCR_EL3.FIQ == '1';
    route_to_el2 = (AArch64.GeneralExceptionsToEL2() ||
        (HaveEL(EL2) && !IsSecure() && HCR_EL2.FMO == '1'));

    exception = ExceptionSyndrome(Exception_FIQ);
    bits(64) preferred_exception_return = ThisInstrAddr();
    vect_offset = 0x100;

    if route_to_el3 then
        AArch64.TakeException(EL3, exception, preferred_exception_return, vect_offset);
    elseif route_to_el2 then
        assert PSTATE.EL != EL3;
        AArch64.TakeException(EL2, exception, preferred_exception_return, vect_offset);
    else
        assert PSTATE.EL IN {EL0,EL1};
        AArch64.TakeException(EL1, exception, preferred_exception_return, vect_offset);

// AArch64.TakeVirtualFIQException()
// =====

AArch64.TakeVirtualFIQException()
    assert HaveEL(EL2) && !IsSecure() && PSTATE.EL != EL2 && HCR_EL2.TGE == '0';

    exception = ExceptionSyndrome(Exception_FIQ);
    bits(64) preferred_exception_return = ThisInstrAddr();
    vect_offset = 0x100;

    AArch64.TakeException(EL1, exception, preferred_exception_return, vect_offset);

```

aarch64/exceptions/debug

```

// ~~~~~
// AArch64 Exception Mode1
// ~~~~~

// ~~~~~
// Debug exceptions

// AArch64.SoftwareBreakpoint()
// =====

```

```
AArch64.SoftwareBreakpoint(bits(16) immediate)

    route_to_el2 = (AArch64.GeneralExceptionsToEL2() ||
                   (HaveEL(EL2) && !IsSecure() && MDCR_EL2.TDE == '1'));

    exception = ExceptionSyndrome(Exception_SoftwareBreakpoint);
    exception.syndrome<15:0> = immediate;
    bits(64) preferred_exception_return = ThisInstrAddr();
    vect_offset = 0x0;

    if UInt(PSTATE.EL) > UInt(EL1) then
        AArch64.TakeException(PSTATE.EL, exception, preferred_exception_return, vect_offset);
    elsif route_to_el2 then
        AArch64.TakeException(EL2, exception, preferred_exception_return, vect_offset);
    else
        AArch64.TakeException(EL1, exception, preferred_exception_return, vect_offset);

// BRKInstruction()
// =====

BRKInstruction(bits(16) immediate)

    AArch64.SoftwareBreakpoint(immediate);

// AArch64.BreakpointException()
// =====

AArch64.BreakpointException(FaultRecord fault)
    assert PSTATE.EL != EL3;

    route_to_el2 = (AArch64.GeneralExceptionsToEL2() ||
                   (HaveEL(EL2) && !IsSecure() && MDCR_EL2.TDE == '1'));

    vaddress = bits(64) UNKNOWN;
    exception = AArch64.AbortSyndrome(Exception_Breakpoint, fault, vaddress);
    bits(64) preferred_exception_return = ThisInstrAddr();
    vect_offset = 0x0;

    if PSTATE.EL == EL2 || route_to_el2 then
        AArch64.TakeException(EL2, exception, preferred_exception_return, vect_offset);
    else
        AArch64.TakeException(EL1, exception, preferred_exception_return, vect_offset);

// AArch64.VectorCatchException()
// =====
// Vector Catch taken from EL0 or EL1 to EL2. This can only be called when debug exceptions are
// being routed to EL2, as Vector Catch is a legacy debug event.

AArch64.VectorCatchException(FaultRecord fault)
    assert PSTATE.EL != EL2;
    assert AArch64.GeneralExceptionsToEL2() || (HaveEL(EL2) && !IsSecure() && MDCR_EL2.TDE == '1');

    vaddress = bits(64) UNKNOWN;
    exception = AArch64.AbortSyndrome(Exception_VectorCatch, fault, vaddress);
    bits(64) preferred_exception_return = ThisInstrAddr();
    vect_offset = 0x0;

    AArch64.TakeException(EL2, exception, preferred_exception_return, vect_offset);

// AArch64.WatchpointException()
// =====

AArch64.WatchpointException(bits(64) vaddress, FaultRecord fault)
    assert PSTATE.EL != EL3;

    route_to_el2 = (AArch64.GeneralExceptionsToEL2() ||
                   (HaveEL(EL2) && !IsSecure() && MDCR_EL2.TDE == '1'));
```

```

exception = AArch64.AbortSyndrome(Exception_Watchpoint, fault, vaddress);

bits(64) preferred_exception_return = ThisInstrAddr();
vect_offset = 0x0;

if PSTATE.EL == EL2 || route_to_el2 then
    AArch64.TakeException(EL2, exception, preferred_exception_return, vect_offset);
else
    AArch64.TakeException(EL1, exception, preferred_exception_return, vect_offset);

// AArch64.SoftwareStepException()
// =====

AArch64.SoftwareStepException()
    assert PSTATE.EL != EL3;

    route_to_el2 = (AArch64.GeneralExceptionsToEL2() ||
        (HaveEL(EL2) && !IsSecure() && MDCR_EL2.TDE == '1'));

    ExceptionRecord exception;
    exception = ExceptionSyndrome(Exception_SoftwareStep);
    if SoftwareStep_DidNotStep() then
        exception.syndrome<24> = '0';
    else
        exception.syndrome<24> = '1';
        exception.syndrome<6> = if SoftwareStep_SteppedEX() then '1' else '0';
    bits(64) preferred_exception_return = ThisInstrAddr();
    vect_offset = 0x0;

    if PSTATE.EL == EL2 || route_to_el2 then
        AArch64.TakeException(EL2, exception, preferred_exception_return, vect_offset);
    else
        AArch64.TakeException(EL1, exception, preferred_exception_return, vect_offset);

```

aarch64/exceptions/exceptions

```

// ~~~~~
// AArch64 Exception Model
// ~~~~~

// ~~~~~
// Functions for entering exception handling modes and reporting the syndrome information.
// ~~~~~

// AArch64.ExceptionClass()
// =====
// Return the Exception Class and Instruction Length fields for reported in ESR

(integer,bit) AArch64.ExceptionClass(Exception type, bits(2) target_el)

    il = if ThisInstrLength() == 32 then '1' else '0';
    from_32 = UsingAArch32();
    assert from_32 || il == '1';           // AArch64 instructions always 32-bit

    case type of
        when Exception_Uncategorized          ec = 0x00; il = '1';
        when Exception_WFxTrap                ec = 0x01;
        when Exception_CP15RRTTrap           ec = 0x03;          assert from_32;
        when Exception_CP15RRTTrap           ec = 0x04;          assert from_32;
        when Exception_CP14RRTTrap           ec = 0x05;          assert from_32;
        when Exception_CP14DTRap             ec = 0x06;          assert from_32;
        when Exception_AdvSIMDFPAAccessTrap  ec = 0x07;
        when Exception_FPIDTrap              ec = 0x08;
        when Exception_CP14RRTTrap           ec = 0x0C;          assert from_32;
        when Exception_IllegalState          ec = 0x0E; il = '1';
        when Exception_SupervisorCall        ec = 0x11;
        when Exception_HypervisorCall        ec = 0x12;
        when Exception_MonitorCall           ec = 0x13;

```

```

        when Exception_SystemRegisterTrap    ec = 0x18;          assert !from_32;
        when Exception_InstructionAbort     ec = 0x20; i1 = '1';
        when Exception_PCAlignment         ec = 0x22; i1 = '1';
        when Exception_DataAbort           ec = 0x24;
        when Exception_SPAlignment         ec = 0x26; i1 = '1'; assert !from_32;
        when Exception_FPTrappedException  ec = 0x28;
        when Exception_SError               ec = 0x2F; i1 = '1';
        when Exception_Breakpoint          ec = 0x30; i1 = '1';
        when Exception_SoftwareStep        ec = 0x32; i1 = '1';
        when Exception_Watchpoint          ec = 0x34; i1 = '1';
        when Exception_SoftwareBreakpoint  ec = 0x38;
        when Exception_VectorCatch         ec = 0x3A; i1 = '1'; assert from_32;
        otherwise                           Unreachable();

    if ec IN {0x20,0x24,0x30,0x32,0x34} && target_e1 == PSTATE.EL then
        ec = ec + 1;

    if ec IN {0x11,0x12,0x13,0x28,0x38} && !from_32 then
        ec = ec + 4;

    return (ec,i1);

// AArch64.ReportException()
// =====
// Report syndrome information for exception taken to AArch64 state.
AArch64.ReportException(ExceptionRecord exception, bits(2) target_e1)

    Exception type = exception.type;

    (ec,i1) = AArch64.ExceptionClass(type, target_e1);
    iss = exception.syndrome;

    // IL is not valid for Data Abort exceptions without valid instruction syndrome information
    if ec IN {0x24,0x25} && iss<24> == '0' then
        i1 = '1';

    ESR[target_e1] = ec<5:0>;i1:iss;

    if type IN {Exception_InstructionAbort, Exception_PCAlignment, Exception_DataAbort,
                Exception_Watchpoint} then
        FAR[target_e1] = exception.vaddress;
    else
        FAR[target_e1] = bits(64) UNKNOWN;

    if target_e1 == EL2 && exception.ipavalid then
        HPFAR_EL2<39:4> = exception.ipaddress<47:12>;

    return;

// AArch64.TakeException()
// =====
// Take an exception to an Exception Level using AArch64.
AArch64.TakeException(bits(2) target_e1, ExceptionRecord exception,
                      bits(64) preferred_exception_return, integer vect_offset)
    assert !ELUsingAArch32(target_e1);
    assert UInt(target_e1) >= UInt(PSTATE.EL);

    // If being routed to from AArch32 state, the top parts of the X[] registers may
    // be set to zero
    if UsingAArch32() then MaybeZeroRegisterUppers(target_e1);

    if UInt(target_e1) > UInt(PSTATE.EL) then
        boolean lower_32;
        if target_e1 == EL3 then
            if !IsSecure() && HaveEL(EL2) then
                lower_32 = ELUsingAArch32(EL2);

```

```

        else
            lower_32 = ELUsingAArch32(EL1);
        else
            lower_32 = ELUsingAArch32(target_el - 1);
            vect_offset = vect_offset + (if lower_32 then 0x600 else 0x400);

    elseif PSTATE.SP == '1' then
        vect_offset = vect_offset + 0x200;

    spsr = GetSPSRFromPSTATE();

    if !(exception.type IN {Exception_IRQ, Exception_FIQ}) then
        AArch64.ReportException(exception, target_el);

    PSTATE.EL = target_el;
    PSTATE.nRW = '0';
    PSTATE.SP = '1';

    SPSR[] = spsr;
    ELR[] = preferred_exception_return;

    PSTATE.<D,A,I,F> = '1111';
    if spsr<4> == '1' then // Coming from AArch32
        PSTATE.IT = '00000000';
        PSTATE.J = '0';
        PSTATE.T = '0';

    BranchTo(VBAR[] + vect_offset, BranchType_EXCEPTION);
    EndOfInstruction();

// AArch64.GeneralExceptionsToEL2()
// =====
// Return TRUE if HCR_EL2.TGE is in force to route general exceptions to EL2

boolean AArch64.GeneralExceptionsToEL2()

    return HaveEL(EL2) && !IsSecure() && PSTATE.EL != EL2 && HCR_EL2.TGE == '1';

```

aarch64/exceptions/ieeefp

```

// ~~~~~
// AArch64 Exception Model
// ~~~~~

// ~~~~~
// Optional trapped IEEE floating-point

// AArch64.FPTrappedException()
// =====

AArch64.FPTrappedException(boolean is_ase, integer element, bits(8) accumulated_exceptions)
    exception = ExceptionSyndrome(Exception_FPTrappedException);
    exception.syndrome<23> = '1'; // TFV
    exception.syndrome<7,4:0> = accumulated_exceptions<7,4:0>; // IDF,IXF,UFF,OFF,DZF,IOF

    bits(64) preferred_exception_return = ThisInstrAddr();
    vect_offset = 0x0;

    if UInt(PSTATE.EL) > UInt(EL1) then
        AArch64.TakeException(PSTATE.EL, exception, preferred_exception_return, vect_offset);
    elseif AArch64.GeneralExceptionsToEL2() then
        AArch64.TakeException(EL2, exception, preferred_exception_return, vect_offset);
    else
        AArch64.TakeException(EL1, exception, preferred_exception_return, vect_offset);

```

aarch64/exceptions/syscalls

```
// ~~~~~  
// AArch64 Exception Mode1  
// ~~~~~  
  
// ~~~~~  
// System call exceptions  
// ~~~~~  
  
// AArch64.CallSecureMonitor()  
// =====  
  
AArch64.CallSecureMonitor(bits(16) immediate)  
    assert HaveEL(EL3) && !ELUsingAArch32(EL3);  
  
    if UsingAArch32() then AArch32.ITAdvance();  
    SSAdvance();  
  
    bits(64) preferred_exception_return = NextInstrAddr();  
    exception = ExceptionSyndrome(Exception_MonitorCall);  
    exception.syndrome<15:0> = immediate;  
    vect_offset = 0x0;  
  
    AArch64.TakeException(EL3, exception, preferred_exception_return, vect_offset);  
  
// AArch64.CallHypervisor()  
// =====  
// Performs a HVC call  
  
AArch64.CallHypervisor(bits(16) immediate)  
  
    if UsingAArch32() then AArch32.ITAdvance();  
    SSAdvance();  
  
    exception = ExceptionSyndrome(Exception_HypervisorCall);  
    exception.syndrome<15:0> = immediate;  
    bits(64) preferred_exception_return = NextInstrAddr();  
    vect_offset = 0x0;  
  
    AArch64.TakeException(EL2, exception, preferred_exception_return, vect_offset);  
  
// AArch64.CallSupervisor()  
// =====  
// Calls the Supervisor  
  
AArch64.CallSupervisor(bits(16) immediate)  
  
    if UsingAArch32() then AArch32.ITAdvance();  
    SSAdvance();  
  
    route_to_el2 = AArch64.GeneralExceptionsToEL2();  
  
    bits(64) preferred_exception_return = NextInstrAddr();  
    exception = ExceptionSyndrome(Exception_SupervisorCall);  
    exception.syndrome<15:0> = immediate;  
    vect_offset = 0x0;  
  
    if UInt(PSTATE.EL) > UInt(EL1) then  
        AArch64.TakeException(PSTATE.EL, exception, preferred_exception_return, vect_offset);  
    elseif route_to_el2 then  
        AArch64.TakeException(EL2, exception, preferred_exception_return, vect_offset);  
    else  
        AArch64.TakeException(EL1, exception, preferred_exception_return, vect_offset);
```

aarch64/exceptions/traps

```
// ~~~~~
// AArch64 Exception Mode1
// ~~~~~

// ~~~~~
// Configurable traps and enables and Undefined Instruction exceptions
// ~~~~~

// AArch64.UndefinedFault()
// =====

AArch64.UndefinedFault()

    route_to_e12 = AArch64.GeneralExceptionsToEL2();

    bits(64) preferred_exception_return = ThisInstrAddr();
    exception = ExceptionSyndrome(Exception_Uncategorized);
    vect_offset = 0x0;

    if UInt(PSTATE.EL) > UInt(EL1) then
        AArch64.TakeException(PSTATE.EL, exception, preferred_exception_return, vect_offset);
    elsif route_to_e12 then
        AArch64.TakeException(EL2, exception, preferred_exception_return, vect_offset);
    else
        AArch64.TakeException(EL1, exception, preferred_exception_return, vect_offset);

// AArch64.CheckIllegalState()
// =====
// Check PSTATE.IL bit and generate Illegal State exception if set.

AArch64.CheckIllegalState()

    if PSTATE.IL == '1' then
        route_to_e12 = AArch64.GeneralExceptionsToEL2();

        bits(64) preferred_exception_return = ThisInstrAddr();
        exception = ExceptionSyndrome(Exception_IllegalState);
        vect_offset = 0x0;

        if UInt(PSTATE.EL) > UInt(EL1) then
            AArch64.TakeException(PSTATE.EL, exception, preferred_exception_return, vect_offset);
        elsif route_to_e12 then
            AArch64.TakeException(EL2, exception, preferred_exception_return, vect_offset);
        else
            AArch64.TakeException(EL1, exception, preferred_exception_return, vect_offset);

// AArch64.SMCTrap()
// =====

AArch64.SMCTrap()

    bits(64) preferred_exception_return = ThisInstrAddr();
    exception = ExceptionSyndrome(Exception_MonitorCall);
    vect_offset = 0x0;

    AArch64.TakeException(EL2, exception, preferred_exception_return, vect_offset);

// AArch64.WFxTrap()
// =====
// Trapped WFE or WFI instruction

AArch64.WFxTrap(bits(2) target_e1, boolean is_wfe)
    assert UInt(target_e1) > UInt(PSTATE.EL);

    exception = ExceptionSyndrome(Exception_WFxTrap);
    exception.syndrome<0> = if is_wfe then '1' else '0';
    bits(64) preferred_exception_return = ThisInstrAddr();
```

```

vect_offset = 0x0;

if target_e1 == EL1 && AArch64.GeneralExceptionsToEL2() then
    AArch64.TakeException(EL2, exception, preferred_exception_return, vect_offset);
else
    AArch64.TakeException(target_e1, exception, preferred_exception_return, vect_offset);

// AArch64.SystemRegisterTrap()
// =====
// Trapped system register access other than due to HCPTR_EL2 and CPACR_EL1

AArch64.SystemRegisterTrap(bits(2) target_e1, bits(2) op0, bits(3) op2, bits(3) op1, bits(4) crn,
    bits(5) rt, bits(4) crm, bit dir)

assert UInt(target_e1) >= UInt(PSTATE.EL);

exception = ExceptionSyndrome(Exception_SystemRegisterTrap);
exception.syndrome<21:20> = op0;
exception.syndrome<19:17> = op2;
exception.syndrome<16:14> = op1;
exception.syndrome<13:10> = crn;
exception.syndrome<9:5> = rt;
exception.syndrome<4:1> = crm;
exception.syndrome<0> = dir;
bits(64) preferred_exception_return = ThisInstrAddr();
vect_offset = 0x0;

if target_e1 == EL1 && AArch64.GeneralExceptionsToEL2() then
    AArch64.TakeException(EL2, exception, preferred_exception_return, vect_offset);
else
    AArch64.TakeException(target_e1, exception, preferred_exception_return, vect_offset);

// AArch64.CPRegTrap()
// =====
// Trapped AArch32 CP14 and CP15 access other than due to CPTR_EL2 or CPACR_EL1.

AArch64.CPRegTrap(bits(2) target_e1, bits(32) aarch32_instr)
    assert HaveEL(target_e1) && target_e1 != EL0 && UInt(target_e1) >= UInt(PSTATE.EL);

exception = CPRegTrapSyndrome(aarch32_instr);
bits(64) preferred_exception_return = ThisInstrAddr();
vect_offset = 0x0;

if target_e1 == EL1 && AArch64.GeneralExceptionsToEL2() then
    AArch64.TakeException(EL2, exception, preferred_exception_return, vect_offset);
else
    AArch64.TakeException(target_e1, exception, preferred_exception_return, vect_offset);

// AArch64.AdvSIMDFPAccessTrap()
// =====
// Trapped access to Advanced SIMD or FP registers due to CPACR_EL1, CPTR_EL2, or CPTR_EL3.

AArch64.AdvSIMDFPAccessTrap(bits(2) target_e1)
    assert UInt(target_e1) >= UInt(PSTATE.EL);
    assert target_e1 != EL0;
    assert HaveEL(target_e1);

bits(64) preferred_exception_return = ThisInstrAddr();
vect_offset = 0x0;

if target_e1 == EL1 && AArch64.GeneralExceptionsToEL2() then
    exception = ExceptionSyndrome(Exception_Uncategorized);
    AArch64.TakeException(EL2, exception, preferred_exception_return, vect_offset);
else
    exception = ExceptionSyndrome(Exception_AdvSIMDFPAccessTrap);
    // No syndrome information when taken to AArch64 state
    AArch64.TakeException(target_e1, exception, preferred_exception_return, vect_offset);

```

```
// AArch64.CheckFPAdvSIMDEnabled()
// =====
// Check against CPACR_EL1, CPTR_EL2 and CPTR_EL3.

AArch64.CheckFPAdvSIMDEnabled()

    if PSTATE.EL != EL2 then
        // Check if access disabled in CPACR_EL1
        case CPACR_EL1.FPEN of
            when 'x0' disabled = TRUE;
            when '01' disabled = (PSTATE.EL == EL0);
            otherwise disabled = FALSE;
        if disabled then AArch64.AdvSIMDFPAccessTrap(EL1);

    if HaveEL(EL2) && !IsSecure() then
        // Check if access disabled in CPTR_EL2
        if CPTR_EL2.TFP == '1' then AArch64.AdvSIMDFPAccessTrap(EL2);

    if HaveEL(EL3) then
        // Check if access disabled in CPTR_EL3
        if CPTR_EL3.TFP == '1' then AArch64.AdvSIMDFPAccessTrap(EL3);

    return;

// CheckFPAdvSIMDEnabled64()
// =====
// AArch64 instruction wrapper

CheckFPAdvSIMDEnabled64()
    AArch64.CheckFPAdvSIMDEnabled();
```

G.1.3 aarch64/functions

This section contains the general pseudocode functions for AArch64 state.

aarch64/functions/aborts

```
// ~~~~~
// AArch64 Abort handling
// ~~~~~

// AArch64.CreateFaultRecord()
// =====

FaultRecord AArch64.CreateFaultRecord(Fault type, bits(48) ipaddress,
                                       integer level, AccType acctype, boolean write, bit extflag,
                                       boolean secondstage, boolean s2fs1walk)

    FaultRecord fault;
    fault.type = type;
    fault.domain = bits(4) UNKNOWN;           // Not used from AArch64
    fault.debugmoe = bits(4) UNKNOWN;        // Not used from AArch64
    fault.ipaddress = ipaddress;
    fault.level = level;
    fault.acctype = acctype;
    fault.write = write;
    fault.extflag = extflag;
    fault.secondstage = secondstage;
    fault.s2fs1walk = s2fs1walk;

    return fault;
```

aarch64/functions/exclusive

```
// AArch64.IsExclusiveVA()  
// =====  
  
// An optional IMPLEMENTATION DEFINED test for an exclusive access to a virtual  
// address region of size bytes starting at address.  
//  
// It is permitted (but not required) for this function to return FALSE and  
// and cause a store exclusive to fail if the virtual address region is not  
// totally included within the region recorded by MarkExclusiveVA().  
//  
// It is always safe to return TRUE which will check the physical address only.  
boolean AArch64.IsExclusiveVA(bits(64) address, integer processorid, integer size);  
  
// AArch64.MarkExclusiveVA()  
// =====  
  
// Optionally record an exclusive access to the virtual address region of size bytes  
// starting at address for processorid.  
AArch64.MarkExclusiveVA(bits(64) address, integer processorid, integer size);  
  
// AArch64.SetExclusiveMonitors()  
// =====  
  
// Sets the Exclusive Monitors for the current PE to record the addresses associated  
// with the virtual address region of size bytes starting at address.  
AArch64.SetExclusiveMonitors(bits(64) address, integer size)  
  
    acctype = AccType_ATOMIC;  
    iswrite = FALSE;  
    aligned = (address != Align(address, size));  
  
    memaddrdesc = AArch64.TranslateAddress(address, acctype, iswrite, aligned, size);  
  
    // Check for aborts or debug exceptions  
    if IsFault(memaddrdesc) then  
        return;  
  
    if memaddrdesc.memattrs.shareable then  
        MarkExclusiveGlobal(memaddrdesc.paddress, ProcessorID(), size);  
  
        MarkExclusiveLocal(memaddrdesc.paddress, ProcessorID(), size);  
  
        AArch64.MarkExclusiveVA(address, ProcessorID(), size);  
  
// AArch64.ExclusiveMonitorsPass()  
// =====  
  
// Return TRUE if the Exclusive Monitors for the current PE include all of the addresses  
// associated with the virtual address region of size bytes starting at address.  
// The immediately following memory write must be to the same addresses.  
boolean AArch64.ExclusiveMonitorsPass(bits(64) address, integer size)  
  
    // It is IMPLEMENTATION DEFINED whether the detection of memory aborts happens  
    // before or after the check on the local Exclusive Monitor. As a result a failure  
    // of the local monitor can occur on some implementations even if the memory  
    // access would give a memory abort.  
  
    acctype = AccType_ATOMIC;  
    iswrite = TRUE;  
    aligned = (address == Align(address, size));  
  
    if !aligned then  
        secondstage = FALSE;  
        AArch64.Abort(address, AArch64.AlignmentFault(acctype, iswrite, secondstage));  
  
    passed = AArch64.IsExclusiveVA(address, ProcessorID(), size);
```

```

if !passed then
    return FALSE;

memaddrdesc = AArch64.TranslateAddress(address, acctype, iswrite, aligned, size);

// Check for aborts or debug exceptions
if IsFault(memaddrdesc) then
    AArch64.Abort(address, memaddrdesc.fault);

passed = IsExclusiveLocal(memaddrdesc.paddress, ProcessorID(), size);
if passed && memaddrdesc.memattrs.shareable then
    passed = IsExclusiveGlobal(memaddrdesc.paddress, ProcessorID(), size);

if passed then
    ClearExclusiveLocal(ProcessorID());

return passed;

```

aarch64/functions/fusedrstep

```

// FPrecipStepFused()
// =====

bits(N) FPrecipStepFused(bits(N) op1, bits(N) op2)
    assert N IN {32, 64};
    bits(N) result;
    op1 = FPNeg(op1); // per FMSUB/FMLS
    (type1,sign1,value1) = FPUnpack(op1, FPCR);
    (type2,sign2,value2) = FPUnpack(op2, FPCR);
    (done,result) = FPProcessNaNs(type1, type2, op1, op2, FPCR);
    if !done then
        inf1 = (type1 == FPType_Infinity);
        inf2 = (type2 == FPType_Infinity);
        zero1 = (type1 == FPType_Zero);
        zero2 = (type2 == FPType_Zero);
        if (inf1 && zero2) || (zero1 && inf2) then
            result = FPTwo('0');
        elsif inf1 || inf2 then
            result = FPinfinity(sign1 EOR sign2);
        else
            // Fully fused multiply-add
            result_value = 2.0 + (value1 * value2);
            if result_value == 0.0 then
                // Sign of exact zero result depends on rounding mode
                sign = if FPRoundingMode(FPCR) == FPRounding_NEGINF then '1' else '0';
                result = FPZero(sign);
            else
                result = FPRound(result_value, FPCR);
    return result;

// FPRSqrtStepFused()
// =====

bits(N) FPRSqrtStepFused(bits(N) op1, bits(N) op2)
    assert N IN {32, 64};
    bits(N) result;
    op1 = FPNeg(op1); // per FMSUB/FMLS
    (type1,sign1,value1) = FPUnpack(op1, FPCR);
    (type2,sign2,value2) = FPUnpack(op2, FPCR);
    (done,result) = FPProcessNaNs(type1, type2, op1, op2, FPCR);
    if !done then
        inf1 = (type1 == FPType_Infinity);
        inf2 = (type2 == FPType_Infinity);
        zero1 = (type1 == FPType_Zero);
        zero2 = (type2 == FPType_Zero);
        if (inf1 && zero2) || (zero1 && inf2) then
            result = FPOnePointFive('0');

```

```

elseif inf1 || inf2 then
    result = FPInfinity(sign1 EOR sign2);
else
    // Fully fused multiply-add and halve
    result_value = (3.0 + (value1 * value2)) / 2.0;
    if result_value == 0.0 then
        // Sign of exact zero result depends on rounding mode
        sign = if FPRoundingMode(FPCR) == FPRounding_NEGINF then '1' else '0';
        result = FPZero(sign);
    else
        result = FPRound(result_value, FPCR);
return result;

```

aarch64/functions/memory

```

// AArch64.CheckAlignment()
// =====

boolean AArch64.CheckAlignment(bits(64) address, integer size, AccType acctype, boolean iswrite)

    aligned = (address == Align(address, size));
    A = SCTLR[.A];

    if !aligned && (acctype == AccType_ATOMIC || acctype == AccType_ORDERED || A == '1') then
        secondstage = FALSE;
        AArch64.Abort(address, AArch64.AlignmentFault(acctype, iswrite, secondstage));

    return aligned;

// CheckSPAlignment()
// =====
// Check correct stack pointer alignment for AArch64 state.

CheckSPAlignment()
    bits(64) sp = SP[];

    if PSTATE.EL == EL0 then
        stack_align_check = (SCTLR_EL1.SA0 != '0');
    else
        stack_align_check = (SCTLR[.SA] != '0');

    if stack_align_check && sp != Align(sp, 16) then
        AArch64.SPAlignmentFault();

    return;

// MemSingle[] - non-assignment (read) form
// =====

bits(size*8) MemSingle[bits(64) address, integer size, AccType acctype, boolean wasaligned]
    assert size IN {1, 2, 4, 8, 16};
    assert address == Align(address, size);

    AddressDescriptor memaddrdesc;
    bits(size*8) value;
    iswrite = FALSE;

    // MMU or MPU
    memaddrdesc = AArch64.TranslateAddress(address, acctype, iswrite, wasaligned, size);

    // Check for aborts or debug exceptions
    if IsFault(memaddrdesc) then
        AArch64.Abort(address, memaddrdesc.fault);

    // Memory array access
    value = _Mem[memaddrdesc, size, acctype];
    return value;

```

```

// MemSingle[] - assignment (write) form
// =====

MemSingle[bits(64) address, integer size, AccType acctype, boolean wasaligned] = bits(size*8) value
assert size IN {1, 2, 4, 8, 16};
assert address == Align(address, size);

AddressDescriptor memaddrdesc;
iswrite = TRUE;

// MMU or MPU
memaddrdesc = AArch64.TranslateAddress(address, acctype, iswrite, wasaligned, size);

// Check for aborts or debug exceptions
if IsFault(memaddrdesc) then
    AArch64.Abort(address, memaddrdesc.fault);

// Effect on exclusives
if memaddrdesc.memattrs.shareable then
    ClearExclusiveByAddress(memaddrdesc.paddress, ProcessorID(), size);

// Memory array access
_Mem[memaddrdesc, size, acctype] = value;
return;

// Mem[] - non-assignment (read) form
// =====

bits(size*8) Mem[bits(64) address, integer size, AccType acctype]
assert size IN {1, 2, 4, 8, 16};
bits(size*8) value;
integer i;
boolean iswrite = FALSE;

aligned = AArch64.CheckAlignment(address, size, acctype, iswrite);
atomic = (aligned && !(acctype IN {AccType_VEC, AccType_VECSTREAM})) || size == 1;

if !atomic then
    assert size > 1;
    value<7:0> = MemSingle[address, 1, acctype, aligned];

    // For subsequent bytes it is CONSTRAINED UNPREDICTABLE whether an unaligned Device memory
    // access will generate an Alignment Fault, as to get this far means the first byte did
    // not, so we must be changing to a new translation page.
    if !aligned then
        c = ConstrainUnpredictable();
        assert c IN {Constraint_FAULT, Constraint_NONE};
        if c == Constraint_NONE then aligned = TRUE;

        for i = 1 to size-1
            value<8*i+7:8*i> = MemSingle[address+i, 1, acctype, aligned];
    else
        value = MemSingle[address, size, acctype, aligned];

    if BigEndian() then
        value = BigEndianReverse(value);
    return value;

// Mem[] - assignment (write) form
// =====

Mem[bits(64) address, integer size, AccType acctype] = bits(size*8) value
integer i;
boolean iswrite = TRUE;

if BigEndian() then
    value = BigEndianReverse(value);

```

```

aligned = AArch64.CheckAlignment(address, size, acctype, iswrite);
atomic = (aligned && !(acctype IN {AccType_VEC, AccType_VECSTREAM})) || size == 1;

if !atomic then
    assert size > 1;
    MemSingle[address, 1, acctype, aligned] = value<7:0>;

    // For subsequent bytes it is CONSTRAINED UNPREDICTABLE whether an unaligned Device memory
    // access will generate an Alignment Fault, as to get this far means the first byte did
    // not, so we must be changing to a new translation page.
    if !aligned then
        c = ConstrainUnpredictable();
        assert c IN {Constraint_FAULT, Constraint_NONE};
        if c == Constraint_NONE then aligned = TRUE;

    for i = 1 to size-1
        MemSingle[address+i, 1, acctype, aligned] = value<8*i+7:8*i>;
    else
        MemSingle[address, size, acctype, aligned] = value;
return;

```

aarch64/functions/registers

```

// General registers
// ++++++

// X[] - assignment form
// =====
// Write to general-purpose register from either a 32-bit and 64-bit value.

X[integer n] = bits(width) value
    assert n >= 0 && n <= 31;
    assert width IN {32,64};
    if n != 31 then
        _R[n] = ZeroExtend(value);
    return;

// X[] - non-assignment form
// =====
// Read from general-purpose register with implicit slice of 8, 16, 32 or 64 bits.

bits(width) X[integer n]
    assert n >= 0 && n <= 31;
    assert width IN {8,16,32,64};
    if n != 31 then
        return _R[n]<width-1:0>;
    else
        return Zeros(width);

// Stack pointers
// ++++++

// SP_EL3
// =====
// SP_EL3 is not accessible as a System Register, but SP_EL0 to SP_EL2 are

bits(64) _SP_EL3;

// SP[] - assignment form
// =====
// Write to stack pointer from either a 32-bit and 64-bit value.

SP[] = bits(width) value
    assert width IN {32,64};
    if PSTATE.SP == '0' then
        SP_EL0 = ZeroExtend(value);

```



```

else
  case PSTATE.EL of
    when EL0 SP_EL0 = ZeroExtend(value);
    when EL1 SP_EL1 = ZeroExtend(value);
    when EL2 SP_EL2 = ZeroExtend(value);
    when EL3 _SP_EL3 = ZeroExtend(value);
  return;

// SP[] - non-assignment form
// =====
// Read stack pointer with implicit slice of 8, 16, 32 or 64 bits.

bits(width) SP[]
  assert width IN {8,16,32,64};
  if PSTATE.SP == '0' then
    return SP_EL0<width-1:0>;
  else
    case PSTATE.EL of
      when EL0 return SP_EL0<width-1:0>;
      when EL1 return SP_EL1<width-1:0>;
      when EL2 return SP_EL2<width-1:0>;
      when EL3 return _SP_EL3<width-1:0>;

// SIMD&FP registers
// ++++++

// V[] - assignment form
// =====
// Write to SIMD&FP register with implicit extension from
// 8, 16, 32, 64 or 128 bits.

V[integer n] = bits(width) value
  assert n >= 0 && n <= 31;
  assert width IN {8,16,32,64,128};
  _V[n] = ZeroExtend(value);
  return;

// V[] - non-assignment form
// =====
// Read from SIMD&FP register with implicit slice of 8, 16
// 32, 64 or 128 bits.

bits(width) V[integer n]
  assert n >= 0 && n <= 31;
  assert width IN {8,16,32,64,128};
  return _V[n]<width-1:0>;

// Vpart[] - non-assignment form
// =====
// Read lower half of a SIMD&FP register with implicit slice
// of 8, 16, 32 or 64 bits, or read upper half as 64 bits.

bits(width) Vpart[integer n, integer part]
  assert n >= 0 && n <= 31;
  assert part IN {0, 1};
  if part == 0 then
    assert width IN {8,16,32,64};
    return _V[n]<width-1:0>;
  else
    assert width == 64;
    return _V[n]<127:64>;

// Vpart[] - assignment form
// =====
// Write lower half of a SIMD&FP register with implicit extension
// from 8, 16, 32, or 64 bits, or write upper half from 64 bits.

Vpart[integer n, integer part] = bits(width) value

```

```
    assert n >= 0 && n <= 31;
    assert part IN {0, 1};
    if part == 0 then
        assert width IN {8,16,32,64};
        _V[n] = ZeroExtend(value);
    else
        assert width == 64;
        _V[n]<127:64> = value<63:0>;

// Program counter
// ++++++

// PC - non-assignment form
// =====
// Read program counter.

bits(64) PC[]
    return _PC;
```

aarch64/functions/sysregisters

```
// SCTLRTYPE
// =====

// Placeholder for generic AArch64 SCTLRL_ELx system register definition

type SCTLRLType;

// SCTLRL[] - non-assignment form
// =====

SCTLRLType SCTLRL[bits(2) regime]
    bits(32) r;
    case regime of
        when EL1 r = SCTLRL_EL1;
        when EL2 r = SCTLRL_EL2;
        when EL3 r = SCTLRL_EL3;
        otherwise Unreachable();
    return r;

// SCTLRL[] - non-assignment form
// =====

SCTLRLType SCTLRL[]
    return SCTLRL[TranslationRegime()];

// FAR[] - non-assignment form
// =====

bits(64) FAR[bits(2) regime]
    bits(64) r;
    case regime of
        when EL1 r = FAR_EL1;
        when EL2 r = FAR_EL2;
        when EL3 r = FAR_EL3;
        otherwise Unreachable();
    return r;

// FAR[] - non-assignment form
// =====

bits(64) FAR[]
    return FAR[TranslationRegime()];

// FAR[] - assignment form
// =====
```

```

FAR[bits(2) regime] = bits(64) value
  bits(64) r = value;
  case regime of
    when EL1 FAR_EL1 = r;
    when EL2 FAR_EL2 = r;
    when EL3 FAR_EL3 = r;
    otherwise Unreachable();
  return;

// FAR[] - assignment form
// =====

FAR[] = bits(64) value
  FAR[TranslationRegime()] = value;
  return;

// ELR[] - non-assignment form
// =====

bits(64) ELR[bits(2) e1]
  bits(64) r;
  case e1 of
    when EL1 r = ELR_EL1;
    when EL2 r = ELR_EL2;
    when EL3 r = ELR_EL3;
    otherwise Unreachable();
  return r;

// ELR[] - non-assignment form
// =====

bits(64) ELR[]
  assert PSTATE.EL != EL0;
  return ELR[PSTATE.EL];

// ELR[] - assignment form
// =====

ELR[bits(2) e1] = bits(64) value
  bits(64) r = value;
  case e1 of
    when EL1 ELR_EL1 = r;
    when EL2 ELR_EL2 = r;
    when EL3 ELR_EL3 = r;
    otherwise Unreachable();
  return;

// ELR[] - assignment form
// =====

ELR[] = bits(64) value
  assert PSTATE.EL != EL0;
  ELR[PSTATE.EL] = value;
  return;

// VBAR[] - non-assignment form
// =====

bits(64) VBAR[bits(2) regime]
  bits(64) r;
  case regime of
    when EL1 r = VBAR_EL1;
    when EL2 r = VBAR_EL2;
    when EL3 r = VBAR_EL3;
    otherwise Unreachable();
  return r;

// VBAR[] - non-assignment form

```

```

// =====

bits(64) VBAR[]
    return VBAR[TranslationRegime()];

// TTBR0[] - non-assignment form
// =====

bits(64) TTBR0[bits(2) regime]
    bits(64) r;
    case regime of
        when EL1 r = TTBR0_EL1;
        when EL2 r = TTBR0_EL2;
        when EL3 r = TTBR0_EL3;
        otherwise Unreachable();
    return r;

// TTBR0[] - non-assignment form
// =====

bits(64) TTBR0[]
    return TTBR0[TranslationRegime()];

// ESRTYPE
// =====

// Placeholder for generic AArch64 ESR_ELx system register definition

type ESRTYPE;

// ESR[] - non-assignment form
// =====

ESRTYPE ESR[bits(2) regime]
    bits(32) r;
    case regime of
        when EL1 r = ESR_EL1;
        when EL2 r = ESR_EL2;
        when EL3 r = ESR_EL3;
        otherwise Unreachable();
    return r;

// ESR[] - non-assignment form
// =====

ESRTYPE ESR[]
    return ESR[TranslationRegime()];

// ESR[] - assignment form
// =====

ESR[bits(2) regime] = ESRTYPE value
    bits(32) r = value;
    case regime of
        when EL1 ESR_EL1 = r;
        when EL2 ESR_EL2 = r;
        when EL3 ESR_EL3 = r;
        otherwise Unreachable();
    return;

// ESR[] - assignment form
// =====

ESR[] = ESRTYPE value
    ESR[TranslationRegime()] = value;

// MAIRTYPE
// =====

```

```
// Placeholder for generic AArch64 MAIR_ELx system register definition

type MAIRType;

// MAIR[] - non-assignment form
// =====

MAIRType MAIR[bits(2) regime]
    bits(64) r;
    case regime of
        when EL1 r = MAIR_EL1;
        when EL2 r = MAIR_EL2;
        when EL3 r = MAIR_EL3;
        otherwise Unreachable();
    return r;

// MAIR[] - non-assignment form
// =====

MAIRType MAIR[]
    return MAIR[TranslationRegime()];

// TCRTType
// =====

// Placeholder for generic AArch64 TCR_ELx system register definition

type TCRTType;

// TCR[] - non-assignment form
// =====

TCRTType TCR[bits(2) regime]
    bits(64) r;
    case regime of
        when EL1 r = TCR_EL1;
        when EL2 r = ZeroExtend(TCR_EL2);
        when EL3 r = ZeroExtend(TCR_EL3);
        otherwise Unreachable();
    return r;

// TCR[] - non-assignment form
// =====

TCRTType TCR[]
    return TCR[TranslationRegime()];
```

aarch64/functions/system

```
// CheckSystemAccess()
// =====

CheckSystemAccess(bits(3) op1)
    // Perform the generic checks that an AArch64 MSR/MRS/SYS instruction is valid at the
    // current exception level, based on the opcode's 'op1' field value.
    // Further checks for enables/disables/traps specific to a particular system register
    // or operation will be performed in System_Put(), System_Get(), SysOp_W(), or SysOp_R().
    boolean need_secure = FALSE;
    bits(2) min_EL;
    case op1 of
        when '00x', '010'
            min_EL = EL1;
        when '011'
            min_EL = EL0;
        when '100'
            min_EL = EL2;
```

```

    when '101'
        UnallocatedEncoding();
    when '110'
        min_EL = EL3;
    when '111'
        min_EL = EL1;
        need_secure = TRUE;
    if UInt(PSTATE.EL) < UInt(min_EL) then
        UnallocatedEncoding();
    if need_secure && !IsSecure() then
        UnallocatedEncoding();

// System_Put()
// =====

// Write to system register
System_Put(integer op0, integer op1, integer crn, integer crm, integer op2, bits(64) val);

// System_Get()
// =====

// Read from system register
bits(64) System_Get(integer op0, integer op1, integer crn, integer crm, integer op2);

// SysOp_W()
// =====

// Execute system operation with write (source operand)
SysOp_W(integer op0, integer op1, integer crn, integer crm, integer op2, bits(64) val);

// SysOp_R()
// =====

// Execute system operation with read (result operand)
bits(64) SysOp_R(integer op0, integer op1, integer crn, integer crm, integer op2);

```

G.1.4 aarch64/instrs

This section contains the pseudocode for AArch64 state that relates to instruction execution.

aarch64/instrs/branch/eret

```

// AArch64.ExceptionReturn()
// =====

AArch64.ExceptionReturn(bits(64) new_pc, bits(32) spsr)

    SetPSTATEFromSPSR(spsr);
    ClearExclusiveLocal(ProcessorID());
    EventRegisterSet();

    if spsr<4> == '1' then // Attempted to change to AArch32 state
        // Align PC[1:0] according to the target instruction set state
        // If PSTATE.IL==1 then the state did not change, but the PC alignment might have occurred
        if PSTATE.IL == '0' || ConstrainUnpredictableBool() then
            if spsr<5> == '1' then // T32 or T32EE state
                new_pc = Align(new_pc, 2);
            else // A32 state
                new_pc = Align(new_pc, 4);

        // Zero the 32 most significant bits of the target PC
        if PSTATE.IL == '0' || ConstrainUnpredictableBool() then
            new_pc<63:32> = Zeros();

    if PSTATE.nRW == '1' then
        BranchTo(new_pc<31:0>, BranchType_UNKNOWN);

```

```

else
    BranchTo(new_pc, BranchType_ERET);

return;

```

aarch64/instrs/countop

```

// CountOp
// =====

// Bit counting instruction types
enumeration CountOp    {CountOp_CLZ, CountOp_CLS, CountOp_CNT};

```

aarch64/instrs/extendreg

```

// ~~~~~
// AArch64 register extend and shift
// ~~~~~

// ExtendType
// =====

enumeration ExtendType {ExtendType_SXTB, ExtendType_SXTH, ExtendType_SXTW, ExtendType_SXTX,
                        ExtendType_UXTB, ExtendType_UXTH, ExtendType_UXTW, ExtendType_UXTX};

// DecodeRegExtend()
// =====
// Decode a register extension option

ExtendType DecodeRegExtend(bits(3) op)
    case op of
        when '000' return ExtendType_UXTB;
        when '001' return ExtendType_UXTH;
        when '010' return ExtendType_UXTW;
        when '011' return ExtendType_UXTX;
        when '100' return ExtendType_SXTB;
        when '101' return ExtendType_SXTH;
        when '110' return ExtendType_SXTW;
        when '111' return ExtendType_SXTX;

// ExtendReg()
// =====
// Perform a register extension and shift

bits(N) ExtendReg(integer reg, ExtendType type, integer shift)
    assert shift >= 0 && shift <= 4;
    bits(N) val = X[reg];
    boolean unsigned;
    integer len;

    case type of
        when ExtendType_SXTB unsigned = FALSE; len = 8;
        when ExtendType_SXTH unsigned = FALSE; len = 16;
        when ExtendType_SXTW unsigned = FALSE; len = 32;
        when ExtendType_SXTX unsigned = FALSE; len = 64;
        when ExtendType_UXTB unsigned = TRUE; len = 8;
        when ExtendType_UXTH unsigned = TRUE; len = 16;
        when ExtendType_UXTW unsigned = TRUE; len = 32;
        when ExtendType_UXTX unsigned = TRUE; len = 64;

    // Note the extended width of the intermediate value and
    // that sign extension occurs from bit <len+shift-1>, not
    // from bit <len-1>. This is equivalent to the instruction
    // [SU]BFIZ Rtmp, Rreg, #shift, #len
    // It may also be seen as a sign/zero extend followed by a shift:
    // LSL(Extend(val<len-1:0>, N, unsigned), shift);

```

```
len = Min(len, N - shift);  
return Extend(val<len-1:0> : Zeros(shift), N, unsigned);
```

aarch64/instrs/float/arithmetic/max-min/fpmaxminop

```
// FPMaxMinOp  
// =====  
  
// Floating-point min/max instruction types  
enumeration FPMaxMinOp {FPMaxMinOp_MAX, FPMaxMinOp_MIN,  
                        FPMaxMinOp_MAXNUM, FPMaxMinOp_MINNUM};
```

aarch64/instrs/float/arithmetic/unary/fpunaryop

```
// FPUUnaryOp  
// =====  
  
// Floating-point unary instruction types  
enumeration FPUUnaryOp {FPUUnaryOp_ABS, FPUUnaryOp_MOV,  
                       FPUUnaryOp_NEG, FPUUnaryOp_SQRT};
```

aarch64/instrs/float/convert/fpconvop

```
// FPConvOp  
// =====  
  
// Floating-point convert/move instruction types  
enumeration FPConvOp {FPConvOp_CVT_FtoI, FPConvOp_CVT_ItoF,  
                     FPConvOp_MOV_FtoI, FPConvOp_MOV_ItoF};
```

aarch64/instrs/integer/arithmetic/rev/revop

```
// RevOp  
// =====  
  
// Reverse bit/byte instruction types  
enumeration RevOp {RevOp_RBIT, RevOp_REV16, RevOp_REV32, RevOp_REV64};
```

aarch64/instrs/integer/bitfield/bfxpreferred

```
// BFXPreferred()  
// =====  
//  
// Return TRUE if UBFX or SBFX is the preferred disassembly of a  
// UBFM or SBFM bitfield instruction. Must exclude more specific  
// aliases UBFIZ, SBFIZ, UXT[BH], SXT[BHW], LSL, LSR and ASR.  
  
boolean BFXPreferred(bit sf, bit uns, bits(6) imms, bits(6) immr)  
    integer S = UInt(imms);  
    integer R = UInt(immr);  
  
    // must not match UBFIZ/SBFIX alias  
    if UInt(imms) < UInt(immr) then  
        return FALSE;  
  
    // must not match LSR/ASR/LSL alias (imms == 31 or 63)  
    if imms == sf:'11111' then  
        return FALSE;  
  
    // must not match UXTx/SXTx alias  
    if immr == '000000' then  
        // must not match 32-bit UXT[BH] or SXT[BH]  
        if sf == '0' && imms IN {'000111', '001111'} then
```



```

        return FALSE;
    // must not match 64-bit SXT[BHW]
    if sf:uns == '10' && imms IN {'000111', '001111', '011111'} then
        return FALSE;

    // must be UBFX/SBFX alias
    return TRUE;

```

aarch64/instrs/integer/bitmasks

```

// DecodeBitMasks()
// =====

// Decode AArch64 bitfield and logical immediate masks which use a similar encoding structure

(bits(M), bits(M)) DecodeBitMasks (bit immN, bits(6) imms, bits(6) immr, boolean immediate)
    bits(M) tmask, wmask;
    bits(6) levels;

    // Compute log2 of element size
    // 2^len must be in range [2, M]
    len = HighestSetBit(immN:NOT(imms));
    if len < 1 then ReservedValue();
    assert M >= (1 << len);

    // Determine S, R and S - R parameters
    levels = ZeroExtend(Ones(len), 6);

    // For logical immediates an all-ones value of S is reserved
    // since it would generate a useless all-ones result (many times)
    if immediate && (imms AND levels) == levels then
        ReservedValue();

    S = UInt(imms AND levels);
    R = UInt(immr AND levels);
    diff = S - R;    // 6-bit subtract with borrow

    esize = 1 << len;
    d = UInt(diff < len-1:0>);
    welem = ZeroExtend(Ones(S + 1), esize);
    telem = ZeroExtend(Ones(d + 1), esize);
    wmask = Replicate(ROR(welem, R));
    tmask = Replicate(telem);
    return (wmask, tmask);

```

aarch64/instrs/integer/ins-ext/insert/movewide/movewideop

```

// MoveWideOp
// =====

// Move wide 16-bit immediate instruction types
enumeration MoveWideOp {MoveWideOp_N, MoveWideOp_Z, MoveWideOp_K};

```

aarch64/instrs/integer/logical/movwpreferred

```

//
// MoveWidePreferred()
// =====
//
// Return TRUE if a bitmask immediate encoding would generate an immediate
// value that could also be represented by a single MOVZ or MOVN instruction.
// Used as a condition for the preferred MOV<-ORR alias.

boolean MoveWidePreferred(bit sf, bit immN, bits(6) imms, bits(6) immr)
    integer S = UInt (imms);
    integer R = UInt (immr);

```

```
integer width = if sf == '1' then 64 else 32;

// element size must equal total immediate size
if sf == '1' && immN:imms != '1xxxxx' then
    return FALSE;
if sf == '0' && immN:imms != '00xxxxx' then
    return FALSE;

// for MOVZ must contain no more than 16 ones
if S < 16 then
    // ones must not span halfword boundary when rotated
    return (-R MOD 16) <= (15 - S);

// for MOVN must contain no more than 16 zeros
if S >= width - 15 then
    // zeros must not span halfword boundary when rotated
    return (R MOD 16) <= (S - (width - 15));

return FALSE;
```

aarch64/instrs/integer/shiftreg

```
// ~~~~~~
// AArch64 register shifts
// ~~~~~~

// ShiftType
// =====

enumeration ShiftType {ShiftType_LSL, ShiftType_LSR, ShiftType_ASR, ShiftType_ROR};

// DecodeShift()
// =====
// Decode shift encodings

ShiftType DecodeShift(bits(2) op)
    case op of
        when '00' return ShiftType_LSL;
        when '01' return ShiftType_LSR;
        when '10' return ShiftType_ASR;
        when '11' return ShiftType_ROR;

// ShiftReg()
// =====
// Perform shift of a register operand

bits(N) ShiftReg(integer reg, ShiftType type, integer amount)
    bits(N) result = X[reg];
    case type of
        when ShiftType_LSL result = LSL(result, amount);
        when ShiftType_LSR result = LSR(result, amount);
        when ShiftType_ASR result = ASR(result, amount);
        when ShiftType_ROR result = ROR(result, amount);
    return result;
```

aarch64/instrs/logicalop

```
// LogicalOp
// =====

// Logical instruction types
enumeration LogicalOp {LogicalOp_AND, LogicalOp_EOR, LogicalOp_ORR};
```

aarch64/instrs/memory/memop

```
// MemOp
// =====

// Memory access instruction types
enumeration MemOp {MemOp_LOAD, MemOp_STORE, MemOp_PREFETCH};
```

aarch64/instrs/memory/prefetch

```
// Prefetch()
// =====

// Decode and execute the prefetch hint on ADDRESS specified by PRFOP

Prefetch(bits(64) address, bits(5) prfop)
  PrefetchHint hint;
  integer target;
  boolean stream;

  case prfop<4:3> of
    when '00' hint = Prefetch_READ; // PLD: prefetch for load
    when '01' hint = Prefetch_EXEC; // PLI: preload instructions
    when '10' hint = Prefetch_WRITE; // PST: prepare for store
    when '11' return; // unallocated hint
  target = UInt(prfop<2:1>); // target cache level
  stream = (prfop<0> != '0'); // streaming (non-temporal)
  Hint_Prefetch(address, hint, target, stream);
  return;
```

aarch64/instrs/system/barriers/barrierop

```
// MemBarrierOp
// =====

// Memory barrier instruction types
enumeration MemBarrierOp {MemBarrierOp_DSB, MemBarrierOp_DMB, MemBarrierOp_ISB};
```

aarch64/instrs/system/hints/syshintop

```
// SystemHintOp
// =====

// System Hint instruction types
enumeration SystemHintOp {SystemHintOp_NOP, SystemHintOp_YIELD,
                          SystemHintOp_WFE, SystemHintOp_WFI,
                          SystemHintOp_SEV, SystemHintOp_SEVL};
```

aarch64/instrs/system/register/cpsr/pstatefield

```
// PSTATEField
// =====

// MSR (immediate) instruction destinations
enumeration PSTATEField {PSTATEField_DAIFFset, PSTATEField_DAIFFclr,
                         PSTATEField_SP};
```

aarch64/instrs/system/sysops/sysop

```
// SystemOp
// =====

// System operation instruction types
enumeration SystemOp {Sys_AT, Sys_DC, Sys_IC, Sys_TLBI, Sys_SYS};
```

```

// SysOp()
// =====

SystemOp SysOp(bits(3) op1, bits(4) CRn, bits(4) CRm, bits(3) op2)
case op1:CRn:CRm:op2 of
  when '000 0111 1000 000' return Sys_AT; // S1E1R
  when '100 0111 1000 000' return Sys_AT; // S1E2R
  when '110 0111 1000 000' return Sys_AT; // S1E3R
  when '000 0111 1000 001' return Sys_AT; // S1E1W
  when '100 0111 1000 001' return Sys_AT; // S1E2W
  when '110 0111 1000 001' return Sys_AT; // S1E3W
  when '000 0111 1000 010' return Sys_AT; // S1E0R
  when '000 0111 1000 011' return Sys_AT; // S1E0W
  when '100 0111 1000 100' return Sys_AT; // S12E1R
  when '100 0111 1000 101' return Sys_AT; // S12E1W
  when '100 0111 1000 110' return Sys_AT; // S12E0R
  when '100 0111 1000 111' return Sys_AT; // S12E0W
  when '011 0111 0100 001' return Sys_DC; // ZVA
  when '000 0111 0110 001' return Sys_DC; // IVAC
  when '000 0111 0110 010' return Sys_DC; // ISW
  when '011 0111 1010 001' return Sys_DC; // CVAC
  when '000 0111 1010 010' return Sys_DC; // CSW
  when '011 0111 1011 001' return Sys_DC; // CVAU
  when '011 0111 1110 001' return Sys_DC; // CIVAC
  when '000 0111 1110 010' return Sys_DC; // CISW
  when '000 0111 0001 000' return Sys_IC; // IALLUIS
  when '000 0111 0101 000' return Sys_IC; // IALLU
  when '011 0111 0101 001' return Sys_IC; // IVAU
  when '100 1000 0000 001' return Sys_TLBI; // IPAS2E1IS
  when '100 1000 0000 101' return Sys_TLBI; // IPAS2LE1IS
  when '000 1000 0011 000' return Sys_TLBI; // VMALLE1IS
  when '100 1000 0011 000' return Sys_TLBI; // ALLE2IS
  when '110 1000 0011 000' return Sys_TLBI; // ALLE3IS
  when '000 1000 0011 001' return Sys_TLBI; // VAE1IS
  when '100 1000 0011 001' return Sys_TLBI; // VAE2IS
  when '110 1000 0011 001' return Sys_TLBI; // VAE3IS
  when '000 1000 0011 010' return Sys_TLBI; // ASIDE1IS
  when '000 1000 0011 011' return Sys_TLBI; // VAAE1IS
  when '100 1000 0011 100' return Sys_TLBI; // ALLE1IS
  when '000 1000 0011 101' return Sys_TLBI; // VALE1IS
  when '100 1000 0011 101' return Sys_TLBI; // VALE2IS
  when '110 1000 0011 101' return Sys_TLBI; // VALE3IS
  when '100 1000 0011 110' return Sys_TLBI; // VMALLS12E1IS
  when '000 1000 0011 111' return Sys_TLBI; // VAALE1IS
  when '100 1000 0100 001' return Sys_TLBI; // IPAS2E1
  when '100 1000 0100 101' return Sys_TLBI; // IPAS2LE1
  when '000 1000 0111 000' return Sys_TLBI; // VMALLE1
  when '100 1000 0111 000' return Sys_TLBI; // ALLE2
  when '110 1000 0111 000' return Sys_TLBI; // ALLE3
  when '000 1000 0111 001' return Sys_TLBI; // VAE1
  when '100 1000 0111 001' return Sys_TLBI; // VAE2
  when '110 1000 0111 001' return Sys_TLBI; // VAE3
  when '000 1000 0111 010' return Sys_TLBI; // ASIDE1
  when '000 1000 0111 011' return Sys_TLBI; // VAAE1
  when '100 1000 0111 100' return Sys_TLBI; // ALLE1
  when '000 1000 0111 101' return Sys_TLBI; // VALE1
  when '100 1000 0111 101' return Sys_TLBI; // VALE2
  when '110 1000 0111 101' return Sys_TLBI; // VALE3
  when '100 1000 0111 110' return Sys_TLBI; // VMALLS12E1
  when '000 1000 0111 111' return Sys_TLBI; // VAALE1
return Sys_SYS;

```

aarch64/instrs/vector/arithmetic/binary/uniform/logical/bsl-eor/vbitop

```
// VBitOp
// =====

// Vector bit select instruction types
enumeration VBitOp {VBitOp_VBIF, VBitOp_VBIT, VBitOp_VBSL, VBitOp_VEOR};
```

aarch64/instrs/vector/arithmetic/unary/cmp/compareop

```
// CompareOp
// =====

// Vector compare instruction types
enumeration CompareOp {CompareOp_GT, CompareOp_GE, CompareOp_EQ,
                      CompareOp_LE, CompareOp_LT};
```

aarch64/instrs/vector/crypto/enabled

```
// CheckCryptoEnabled64()
// =====

CheckCryptoEnabled64()
    AArch64.CheckFPAdvSIMDEnabled();
    return;
```

aarch64/instrs/vector/logical/immediateop

```
// ImmediateOp
// =====

// Vector logical immediate instruction types
enumeration ImmediateOp {ImmediateOp_MOVI, ImmediateOp_MVNI,
                        ImmediateOp_ORR, ImmediateOp_BIC};
```

aarch64/instrs/vector/reduce/reduceop

```
// ReduceOp
// =====

// Vector reduce instruction types
enumeration ReduceOp {ReduceOp_FMNUM, ReduceOp_FMAXNUM,
                    ReduceOp_FMIN, ReduceOp_FMAX,
                    ReduceOp_FADD, ReduceOp_ADD};

// Reduce()
// =====

bits(esize) Reduce(ReduceOp op, bits(N) input, integer esize)
    integer half;
    bits(esize) hi;
    bits(esize) lo;
    bits(esize) result;

    if N == esize then
        return input;

    half = N DIV 2;
    hi = Reduce (op, input<N-1:half>, esize);
    lo = Reduce (op, input<half-1:0>, esize);

    case op of
        when ReduceOp_FMNUM
```

```

        result = FMinNum(lo, hi, FPCR);
    when ReduceOp_FMAXNUM
        result = FMaxNum(lo, hi, FPCR);
    when ReduceOp_FMIN
        result = FMin(lo, hi, FPCR);
    when ReduceOp_FMAX
        result = FMax(lo, hi, FPCR);
    when ReduceOp_FADD
        result = FAdd(lo, hi, FPCR);
    when ReduceOp_ADD
        result = lo + hi;

return result;

```

G.1.5 aarch64/translation

This section contains the pseudocode for AArch64 state that relates to address translation.

aarch64/translation/attrs

```

// ~~~~~
// AArch64 Translation System
// ~~~~~

// ~~~~~
// Functions for decoding attributes

// AArch64.TranslateAddressS10ff()
// =====
// Called for stage 1 translations when translation is disabled to supply a default translation.
// Note that there are additional constraints on instruction prefetching that are not described in
// this pseudocode.

TLBRecord AArch64.TranslateAddressS10ff(bits(64) vaddress, AccType acctype, boolean iswrite)
    assert !ELUsingAArch32(TranslationRegime());

    TLBRecord result;

    Top = AddrTop(vaddress);
    if !IsZero(vaddress<Top:PAMax(>) then
        level = 0;
        ipaddress = bits(48) UNKNOWN;
        secondstage = FALSE;
        s2fs1walk = FALSE;
        result.addrdesc.fault = AArch64.AddressSizeFault(ipaddress, level, acctype,
            iswrite, secondstage, s2fs1walk);

        return result;

    if HaveEL(EL2) && !IsSecure() && PSTATE.EL != EL2 && HCR_EL2.DC == '1' then
        // Use default cacheable settings
        result.addrdesc.memattrs.type = MemType_Normal;
        result.addrdesc.memattrs.device = DeviceType_UNKNOWN;
        result.addrdesc.memattrs.inner.attrs = MemAttr_WB; // Write-back
        result.addrdesc.memattrs.inner.hints = MemHint_RWA;
        result.addrdesc.memattrs.shareable = FALSE;
        result.addrdesc.memattrs.outershareable = FALSE;
        if HCR_EL2.VM != '1' then UNPREDICTABLE;
    elseif acctype != AccType_IFETCH then
        // Treat data as Device
        result.addrdesc.memattrs.type = MemType_Device;
        result.addrdesc.memattrs.device = DeviceType_nGnRnE;
        result.addrdesc.memattrs.inner = MemAttrHints_UNKNOWN;
        result.addrdesc.memattrs.shareable = TRUE;
        result.addrdesc.memattrs.outershareable = TRUE;
    else
        // Instruction cacheability controlled by SCTLR_ELx.I

```

```

cacheable = SCTLRL.I == '1';
result.addrdesc.memattrs.type = MemType_Normal;
result.addrdesc.memattrs.device = DeviceType_UNKNOWN;
if cacheable then
    result.addrdesc.memattrs.inner.attrs = MemAttr_WT;
    result.addrdesc.memattrs.inner.hints = MemHint_RA;
else
    result.addrdesc.memattrs.inner.attrs = MemAttr_NC;
    result.addrdesc.memattrs.inner.hints = MemHint_No;
result.addrdesc.memattrs.shareable = TRUE;
result.addrdesc.memattrs.outershareable = TRUE;

result.addrdesc.memattrs.outer = result.addrdesc.memattrs.inner;

result.perms.ap = bits(3) UNKNOWN;
result.perms.xn = '0';
result.perms.pxn = '0';

result.nG = bit UNKNOWN;
result.contiguous = boolean UNKNOWN;
result.domain = bits(4) UNKNOWN;
result.level = integer UNKNOWN;
result.blocksize = integer UNKNOWN;
result.addrdesc.paddress.physicaladdress = vaddress<47:0>;
result.addrdesc.paddress.NS = if IsSecure() then '0' else '1';
result.addrdesc.fault = AArch64.NoFault();

return result;

// AArch64.InstructionDevice()
// =====
// Instruction fetches from memory marked as Device but not execute-never might generate a
// Permission Fault but are otherwise treated as if from Normal Non-cacheable memory.

AddressDescriptor AArch64.InstructionDevice(AddressDescriptor addrdesc, bits(64) vaddress,
                                           bits(48) ipaddress, integer level,
                                           AccType acctype, boolean iswrite, boolean secondstage,
                                           boolean s2fs1walk)

if ConstrainUnpredictableBool() then
    addrdesc.fault = AArch64.PermissionFault(ipaddress, level, acctype, iswrite,
                                             secondstage, s2fs1walk);
else
    addrdesc.memattrs.type = MemType_Normal;
    addrdesc.memattrs.device = DeviceType_UNKNOWN;
    addrdesc.memattrs.inner.attrs = MemAttr_NC;
    addrdesc.memattrs.inner.hints = MemHint_No;
    addrdesc.memattrs.outer = addrdesc.memattrs.inner;
    addrdesc.memattrs.shareable = TRUE;
    addrdesc.memattrs.outershareable = TRUE;

return addrdesc;

// AArch64.S1AttrDecode()
// =====
// Converts the Stage 1 attribute fields, using the MAIR, to orthogonal
// attributes and hints.

MemoryAttributes AArch64.S1AttrDecode(bits(2) SH, bits(3) attr, AccType acctype)

MemoryAttributes memattrs;

mair = MAIR[];
index = 8 * UInt(attr);
attrfield = mair<index+7:index>;

if ((attrfield<7:4> != '0000' && attrfield<3:0> == '0000') ||
    (attrfield<7:4> == '0000' && !(attrfield<3:0> IN {'000x', '1x00'}))) then

```

```

// Reserved, maps to an allocated value
(-, attrfield) = ConstrainUnpredictableBits();

if attrfield<7:4> == '0000' then // Device
    memattrs.type = MemType_Device;
    memattrs.inner = MemAttrHints UNKNOWN;
    memattrs.outer = MemAttrHints UNKNOWN;
    memattrs.shareable = TRUE;
    memattrs.outershareable = TRUE;
    case attrfield<3:0> of
        when '0000' memattrs.device = DeviceType_nGnRnE;
        when '0001' memattrs.device = DeviceType_nGnRE;
        when '1000' memattrs.device = DeviceType_nGRE;
        when '1100' memattrs.device = DeviceType_GRE;
        otherwise Unreachable(); // Reserved, handled above

elseif attrfield<3:0> != '0000' then // Normal
    memattrs.type = MemType_Normal;
    memattrs.outer = LongConvertAttrHints(attrfield<7:4>, acctype);
    memattrs.inner = LongConvertAttrHints(attrfield<3:0>, acctype);
    memattrs.device = DeviceType_UNKNOWN;
    memattrs.shareable = SH<1> == '1';
    memattrs.outershareable = SH == '10';

else
    Unreachable(); // Reserved, handled above

return memattrs;

```

aarch64/translation/checks

```

// ~~~~~
// AArch64 Translation System
// ~~~~~

// ~~~~~
// Functions for checking permissions
// ~~~~~

// AArch64.CheckPermission()
// =====
// Function used for permission checking from AArch64 stage 1 translations

FaultRecord AArch64.CheckPermission(Permissions perms, bits(64) address, integer level,
                                     bit NS, AccType acctype, boolean iswrite)
assert !ELUsingAArch32(TranslationRegime());

wxn = SCTLR[] .WXN == '1';

if PSTATE.EL IN {EL0,EL1} then
    priv_r = TRUE;
    priv_w = perms.ap<2> == '0';
    user_r = perms.ap<1> == '1';
    user_w = perms.ap<2:1> == '01';
    user_x = perms.xn == '0' && !(user_w && wxn);
    priv_x = perms.pxn == '0' && !(priv_w && wxn) && !user_w;
    ispriv = PSTATE.EL == EL1 && acctype != AccType_UNPRIV;

    if ispriv then
        (r, w, x) = (priv_r, priv_w, priv_x);
    else
        (r, w, x) = (user_r, user_w, user_x);
else
    // Access from EL2 or EL3
    r = TRUE;
    w = perms.ap<2> == '0';
    x = perms.xn == '0' && !(w && wxn);

```



```

secure_instr_fetch = SCR_EL3.SIF; // Restriction on Secure instruction fetch
if HaveEL(EL3) && IsSecure() && NS == '1' && secure_instr_fetch == '1' then
    x = FALSE;

if acctype == AccType_IFETCH then
    fail = !x;
elseif iswrite then
    fail = !w;
else
    fail = !r;

if fail then
    secondstage = FALSE;
    s2fs1walk = FALSE;
    ipaddress = bits(48) UNKNOWN;
    return AArch64.PermissionFault(ipaddress, level, acctype, iswrite, secondstage,
                                   s2fs1walk);
else
    return AArch64.NoFault();

// AArch64.CheckS2Permission()
// =====
// Function used for permission checking from AArch64 stage 2 translations

FaultRecord AArch64.CheckS2Permission(Permissions perms, bits(64) vaddress, bits(48) ipaddress,
                                       integer level, AccType acctype, boolean iswrite,
                                       boolean s2fs1walk)
    assert HaveEL(EL2) && !IsSecure() && !ELUsingAArch32(EL2) && PSTATE.EL != EL2;

    r = perms.ap<1> == '0';
    w = perms.ap<2> == '0';
    x = perms.xn == '0';

    // Stage 1 walk is checked as a read, regardless of the original type
    if acctype == AccType_IFETCH && !s2fs1walk then
        fail = !x;
    elseif iswrite && !s2fs1walk then
        fail = !w;
    else
        fail = !r;

    if fail then
        domain = bits(4) UNKNOWN;
        secondstage = TRUE;
        return AArch64.PermissionFault(ipaddress, level, acctype, iswrite, secondstage,
                                       s2fs1walk);
    else
        return AArch64.NoFault();

```

aarch64/translation/debug

```

// ~~~~~
// AArch64 Translation System
// ~~~~~

// ~~~~~
// Debug functions that are part of the translation system.
// ~~~~~

// AArch64.CheckDebug()
// =====
// Called on each access to check for a debug exception or entry to Debug state.

FaultRecord AArch64.CheckDebug(bits(64) vaddress, AccType acctype, boolean iswrite, integer size)

    FaultRecord fault = AArch64.NoFault();

    d_side = (acctype != AccType_IFETCH);

```

```

generate_exception = AArch64.GenerateDebugExceptions() && MDSCR_EL1.MDE == '1';
halt = HaltOnBreakpointOrWatchpoint();

if generate_exception || halt then
    if d_side then
        fault = AArch64.CheckWatchpoint(vaddress, acctype, iswrite, size);
    else
        fault = AArch64.CheckBreakpoint(vaddress, size);

return fault;

// AArch64.CheckBreakpoint()
// =====
// Called before executing the instruction of length "size" bytes at "vaddress" in an AArch64
// translation regime.
// The breakpoint can in fact be evaluated well ahead of execution, for example, at instruction
// fetch. This is the simple sequential execution of the program.

FaultRecord AArch64.CheckBreakpoint(bits(64) vaddress, integer size)
    assert !ELUsingAArch32(TranslationRegime());
    assert (UsingAArch32() && size IN {2,4}) || size == 4;

    match = FALSE;

    for i = 0 to UInt(ID_AA64DFR0_EL1.BRPs)
        match_i = AArch64.BreakpointMatch(i, vaddress, size);
        match = match || match_i;

    if match && HaltOnBreakpointOrWatchpoint() then
        reason = DebugHalt_Breakpoint;
        Halt(reason);
    elseif match && MDSCR_EL1.MDE == '1' && AArch64.GenerateDebugExceptions() then
        acctype = AccType_IFETCH;
        iswrite = FALSE;
        return AArch64.DebugFault(acctype, iswrite);
    else
        return AArch64.NoFault();

// AArch64.CheckWatchpoint()
// =====
// Called before accessing the memory location of "size" bytes at "address".

FaultRecord AArch64.CheckWatchpoint(bits(64) vaddress, AccType acctype,
                                     boolean iswrite, integer size)
    assert !ELUsingAArch32(TranslationRegime());

    match = FALSE;
    ispriv = PSTATE.EL != EL0 && !(PSTATE.EL == EL1 && acctype == AccType_UNPRIV);

    for i = 0 to UInt(ID_AA64DFR0_EL1.WRPs)
        match = match || AArch64.WatchpointMatch(i, vaddress, size, ispriv, iswrite);

    if match && HaltOnBreakpointOrWatchpoint() then
        reason = DebugHalt_Watchpoint;
        Halt(reason);
    elseif match && MDSCR_EL1.MDE == '1' && AArch64.GenerateDebugExceptions() then
        return AArch64.DebugFault(acctype, iswrite);
    else
        return AArch64.NoFault();

```

aarch64/translation/faults

```

// ~~~~~
// AArch64 Translation System
// ~~~~~

// ~~~~~

```

```
// Wrapper functions for generating Aborts.

// AArch64.NoFault()
// =====

FaultRecord AArch64.NoFault()

    ipaddress = bits(48) UNKNOWN;
    level = integer UNKNOWN;
    acctype = AccType_NORMAL;
    iswrite = boolean UNKNOWN;
    extflag = bit UNKNOWN;
    secondstage = FALSE;
    s2fs1walk = FALSE;

    return AArch64.CreateFaultRecord(Fault_None, ipaddress, level, acctype, iswrite,
                                     extflag, secondstage, s2fs1walk);

// AArch64.TranslationFault()
// =====

FaultRecord AArch64.TranslationFault(bits(48) ipaddress, integer level,
                                     AccType acctype, boolean iswrite, boolean secondstage,
                                     boolean s2fs1walk)

    extflag = bit UNKNOWN;
    return AArch64.CreateFaultRecord(Fault_Translation, ipaddress, level, acctype, iswrite,
                                     extflag, secondstage, s2fs1walk);

// AArch64.AccessFlagFault()
// =====

FaultRecord AArch64.AccessFlagFault(bits(48) ipaddress, integer level,
                                     AccType acctype, boolean iswrite, boolean secondstage,
                                     boolean s2fs1walk)

    extflag = bit UNKNOWN;
    return AArch64.CreateFaultRecord(Fault_AccessFlag, ipaddress, level, acctype, iswrite,
                                     extflag, secondstage, s2fs1walk);

// AArch64.AddressSizeFault()
// =====

FaultRecord AArch64.AddressSizeFault(bits(48) ipaddress, integer level,
                                     AccType acctype, boolean iswrite, boolean secondstage,
                                     boolean s2fs1walk)

    extflag = bit UNKNOWN;
    return AArch64.CreateFaultRecord(Fault_AddressSize, ipaddress, level, acctype, iswrite,
                                     extflag, secondstage, s2fs1walk);

// AArch64.PermissionFault()
// =====

FaultRecord AArch64.PermissionFault(bits(48) ipaddress, integer level,
                                     AccType acctype, boolean iswrite, boolean secondstage,
                                     boolean s2fs1walk)

    extflag = bit UNKNOWN;
    return AArch64.CreateFaultRecord(Fault_Permission, ipaddress, level, acctype, iswrite,
                                     extflag, secondstage, s2fs1walk);

// AArch64.AlignmentFault()
// =====

FaultRecord AArch64.AlignmentFault(AccType acctype, boolean iswrite, boolean secondstage)

    ipaddress = bits(48) UNKNOWN;
```

```

    level = integer UNKNOWN;
    extflag = bit UNKNOWN;
    s2fs1walk = boolean UNKNOWN;

    return AArch64.CreateFaultRecord(Fault_Alignment, ipaddress, level, acctype, iswrite,
                                     extflag, secondstage, s2fs1walk);

// AArch64.DebugFault()
// =====

FaultRecord AArch64.DebugFault(AccType acctype, boolean iswrite)

    ipaddress = bits(48) UNKNOWN;
    level = integer UNKNOWN;
    extflag = bit UNKNOWN;
    secondstage = FALSE;
    s2fs1walk = FALSE;

    return AArch64.CreateFaultRecord(Fault_Debug, ipaddress, level, acctype, iswrite,
                                     extflag, secondstage, s2fs1walk);

// AArch64.AsynchExternalAbort()
// =====
// Wrapper function for asynchronous external aborts

FaultRecord AArch64.AsynchExternalAbort(boolean parity, bit extflag)

    type = if parity then Fault_AsyncParity else Fault_AsyncExternal;
    ipaddress = bits(48) UNKNOWN;
    level = integer UNKNOWN;
    acctype = AccType_NORMAL;
    iswrite = boolean UNKNOWN;
    secondstage = FALSE;
    s2fs1walk = FALSE;

    return AArch64.CreateFaultRecord(type, ipaddress, level, acctype, iswrite, extflag,
                                     secondstage, s2fs1walk);

```

aarch64/translation/translation

```

// ~~~~~
// AArch64 Translation System
// ~~~~~
// ~~~~~
// Top level address translation functions.

// AArch64.TranslateAddress()
// =====
// Main entry point for translating an address

AddressDescriptor AArch64.TranslateAddress(bits(64) vaddress, AccType acctype, boolean iswrite,
                                          boolean wasaligned, integer size)

    result = AArch64.FullTranslate(vaddress, acctype, iswrite, wasaligned, size);

    if !(acctype IN {AccType_PTW, AccType_IC, AccType_AT}) && !IsFault(result) then
        result.fault = AArch64.CheckDebug(vaddress, acctype, iswrite, size);

    return result;

// AArch64.FullTranslate()
// =====
// This function is called to perform both stage 1 and stage 2 translation walks for the current
// translation regime. The function used by Address Translation operations is similar except it uses
// the translation regime specified for the instruction.

AddressDescriptor AArch64.FullTranslate(bits(64) vaddress, AccType acctype, boolean iswrite,

```

```

boolean wasaligned, integer size)

// First Stage Translation
S1 = AArch64.FirstStageTranslate(vaddress, acctype, iswrite, wasaligned, size);

if !IsFault(S1) && HaveEL(EL2) && !IsSecure() && PSTATE.EL != EL2 then
    s2fs1walk = FALSE;
    result = AArch64.SecondStageTranslate(S1, vaddress, acctype, iswrite, wasaligned, s2fs1walk,
                                         size);
else
    result = S1;

return result;

// AArch64.FirstStageTranslate()
// =====
// This function is called to perform a stage 1 translation walk. If necessary,
// it calls SecondStageTranslate to perform the stage 2 translation walk.
// The function used by Address Translation operations is similar except it uses
// the translation regime specified for the instruction.

AddressDescriptor AArch64.FirstStageTranslate(bits(64) vaddress, AccType acctype, boolean iswrite,
                                             boolean wasaligned, integer size)

    s1_enabled = SCTRL[.M] == '1';

    ipaddress = bits(48) UNKNOWN;
    secondstage = FALSE;
    s2fs1walk = FALSE;

    boolean permissioncheck = TRUE;           // By default, permissions will need to be checked

    if s1_enabled then                       // First stage enabled
        S1 = AArch64.TranslationTableWalk(ipaddress, vaddress, acctype, iswrite, secondstage,
                                           s2fs1walk, size);
    else
        S1 = AArch64.TranslateAddressS10ff(vaddress, acctype, iswrite);
        permissioncheck = FALSE;

    // Check for unaligned data accesses to Device memory
    if (!wasaligned && !IsFault(S1.addrdesc) && S1.addrdesc.memattr.type == MemType_Device &&
        acctype != AccType_IFETCH) then
        S1.addrdesc.fault = AArch64.AlignmentFault(acctype, iswrite, secondstage);

    if !IsFault(S1.addrdesc) && permissioncheck then
        S1.addrdesc.fault = AArch64.CheckPermission(S1.perms, vaddress, S1.level,
                                                    S1.addrdesc.address.NS,
                                                    acctype, iswrite);

    // Check for instruction fetches from Device memory not marked as execute-never. If there has
    // not been a Permission Fault then the memory is not marked execute-never.
    if (!IsFault(S1.addrdesc) && S1.addrdesc.memattr.type == MemType_Device &&
        acctype == AccType_IFETCH) then
        S1.addrdesc = AArch64.InstructionDevice(S1.addrdesc, vaddress, ipaddress, S1.level,
                                                acctype, iswrite,
                                                secondstage, s2fs1walk);

    return S1.addrdesc;

// AArch64.SecondStageTranslate()
// =====
// This function is called to perform a stage 2 translation walk.

AddressDescriptor AArch64.SecondStageTranslate(AddressDescriptor S1, bits(64) vaddress,
                                             AccType acctype, boolean iswrite, boolean wasaligned,
                                             boolean s2fs1walk, integer size)

    assert HaveEL(EL2) && !IsSecure() && PSTATE.EL != EL2;

```

```

s2_enabled = HCR_EL2.VM == '1';
secondstage = TRUE;

if s2_enabled then // Second stage enabled
    ipaddress = S1.paddress.physicaladdress<47:0>;
    S2 = AArch64.TranslationTableWalk(ipaddress, vaddress, acctype, iswrite, secondstage,
                                     s2fs1walk, size);

    // Check for unaligned data accesses to Device memory
    if (!wasaligned && !IsFault(S2.addrdesc) && S2.addrdesc.memattrs.type == MemType_Device &&
        acctype != AccType_IFETCH) then
        S2.addrdesc.fault = AArch64.AlignmentFault(acctype, iswrite, secondstage);

    if !IsFault(S2.addrdesc) then
        S2.addrdesc.fault = AArch64.CheckS2Permission(S2.perms, vaddress, ipaddress, S2.level,
                                                    acctype, iswrite, s2fs1walk);

    // Check for instruction fetches from Device memory not marked as execute-never. As there
    // has not been a Permission Fault then the memory is not marked execute-never.
    if (!IsFault(S2.addrdesc) && S2.addrdesc.memattrs.type == MemType_Device &&
        acctype == AccType_IFETCH) then
        S2.addrdesc = AArch64.InstructionDevice(S2.addrdesc, vaddress, ipaddress, S2.level,
                                                acctype, iswrite,
                                                secondstage, s2fs1walk);

    // Check for protected table walk
    if (s2fs1walk && !IsFault(S2.addrdesc) && HCR_EL2.PTW == '1' &&
        S2.addrdesc.memattrs.type == MemType_Device) then
        S2.addrdesc.fault = AArch64.PermissionFault(ipaddress, S2.level, acctype,
                                                    iswrite, secondstage, s2fs1walk);

    result = CombineS1S2Desc(S1, S2.addrdesc);
else
    result = S1;

return result;

// AArch64.SecondStageWalk()
// =====
// This function is called from a stage 1 translation table walk when
// the accesses generated from that requires a second stage of translation

AddressDescriptor AArch64.SecondStageWalk(AddressDescriptor S1, bits(64) vaddress, AccType acctype,
                                         integer size)
    assert HaveEL(EL2) && !IsSecure() && PSTATE.EL != EL2;

    iswrite = FALSE;
    s2fs1walk = TRUE;
    wasaligned = TRUE;
    return AArch64.SecondStageTranslate(S1, vaddress, acctype, iswrite, wasaligned, s2fs1walk,
                                       size);

```

aarch64/translation/walk

```

// ~~~~~
// AArch64 Translation System
// ~~~~~

// ~~~~~
// Main translation table walk functions

// AArch64.TranslationTableWalk()
// =====
// Returns a result of a translation table walk
//
// Implementations might cache information from memory in any number of non-coherent TLB
// caching structures, and so avoid memory accesses that have been expressed in this
// pseudocode. The use of such TLBs is not expressed in this pseudocode.

```

```

TLBRecord AArch64.TranslationTableWalk(bits(48) ipaddress, bits(64) vaddress,
                                         AccType acctype, boolean iswrite, boolean secondstage,
                                         boolean s2fs1walk, integer size)

if !secondstage then
    assert !ELUsingAArch32(TranslationRegime());
else
    assert HaveEL(EL2) && !IsSecure() && !ELUsingAArch32(EL2) && PSTATE.EL != EL2;

TLBRecord result;
AddressDescriptor descaddr;

domain = bits(4) UNKNOWN;
baseaddress = Zeros(48);
basefound = FALSE;
bits(64) base;

descaddr.memattrs.type = MemType_Normal;

// Determine parameters for the page table walk:
// grainsize = Log2(Size of Table) - one of 4KB, 16KB or 64KB
// stride = Log2(Address per level)
// firstblocklevel = first level where a block entry is allowed
// psize = Physical Address size as encoded in TCR_EL1.IPS or TCR_ELx/VTCCR_EL2.PS
// tablesize = Log2(Address Size)
// level = level to start walk from
// This means that the number of levels after start level = 3-level

if !secondstage then
    // First stage translation
    bits(64) inputaddr = ZeroExtend(vaddress);
    if PSTATE.EL == EL3 then
        tablesize = 64 - UInt(TCR_EL3.T0SZ);
        if tablesize > 48 then tablesize = 48;
        if tablesize < 25 then tablesize = 25;
        largegrain = TCR_EL3.TG0 == '01';
        midgrain = TCR_EL3.TG0 == '10';
        reversedescriptors = SCTLRL_EL3.EE == '1';
        psize = TCR_EL3.PS;
        top = AddrTop(inputaddr);
        basefound = tablesize == 48 || IsZero(inputaddr<top:tablesize>);
        base = TTBR0_EL3;
        descaddr.memattrs = WalkAttrDecode(TCR_EL3.SH0, TCR_EL3.ORGNO, TCR_EL3.IRGNO);
        lookupsecure = TRUE;
        singlepriv = TRUE;
    elseif PSTATE.EL == EL2 then
        tablesize = 64 - UInt(TCR_EL2.T0SZ);
        if tablesize > 48 then tablesize = 48;
        if tablesize < 25 then tablesize = 25;
        largegrain = TCR_EL2.TG0 == '01';
        midgrain = TCR_EL2.TG0 == '10';
        psize = TCR_EL2.PS;
        top = AddrTop(inputaddr);
        basefound = tablesize == 48 || IsZero(inputaddr<top:tablesize>);
        base = TTBR0_EL2;
        descaddr.memattrs = WalkAttrDecode(TCR_EL2.SH0, TCR_EL2.ORGNO, TCR_EL2.IRGNO);
        reversedescriptors = SCTLRL_EL2.EE == '1';
        lookupsecure = FALSE;
        singlepriv = TRUE;
    else
        psize = TCR_EL1.IPS;
        top = AddrTop(inputaddr);
        if inputaddr<top> == '0' then
            tablesize = 64 - UInt(TCR_EL1.T0SZ);
            if tablesize > 48 then tablesize = 48;
            if tablesize < 25 then tablesize = 25;
            largegrain = TCR_EL1.TG0 == '01';
            midgrain = TCR_EL1.TG0 == '10';

```

```

        basefound = IsZero(inputaddr<top:tablesize>) && TCR_EL1.EPD0 == '0';
        base = TTBR0_EL1;
        descaddr.memattrs = WalkAttrDecode(TCR_EL1.SH0, TCR_EL1.ORGNO, TCR_EL1.IRGN0);
    else
        tablesize = 64 - UInt(TCR_EL1.T1SZ);
        if tablesize > 48 then tablesize = 48;
        if tablesize < 25 then tablesize = 25;
        largegrain = TCR_EL1.TG1 == '11'; // TG1 and TG0 encodings differ
        midgrain = TCR_EL1.TG1 == '01';
        basefound = IsOnes(inputaddr<top:tablesize>) && TCR_EL1.EPD1 == '0';
        base = TTBR1_EL1;
        descaddr.memattrs = WalkAttrDecode(TCR_EL1.SH1, TCR_EL1.ORGNI, TCR_EL1.IRGN1);
        reversedescriptors = SCTLR_EL1.EE == '1';
        lookupsecure = IsSecure();
        singlepriv = FALSE;

    if largegrain then // 64KB pages
        grainsize = 16;
        stride = grainsize - 3;
        if tablesize > (grainsize + 2*stride) then level = 1;
        elsif tablesize > (grainsize + stride) then level = 2;
        else level = 3;
        firstblocklevel = 2;
    elsif midgrain then // 16KB pages
        grainsize = 14;
        stride = grainsize - 3;
        if tablesize > (grainsize + 3*stride) then level = 0;
        elsif tablesize > (grainsize + 2*stride) then level = 1;
        elsif tablesize > (grainsize + stride) then level = 2;
        else level = 3;
        firstblocklevel = 2;
    else // Small grain, 4KB pages
        grainsize = 12;
        stride = grainsize - 3;
        if tablesize > (grainsize + 3*stride) then level = 0;
        elsif tablesize > (grainsize + 2*stride) then level = 1;
        else level = 2;
        firstblocklevel = 1;
    else
        // Second stage translation
        bits(64) inputaddr = ZeroExtend(ipaddress);
        lookupsecure = FALSE;
        singlepriv = TRUE;
        tablesize = 64 - UInt(VTCR_EL2.T0SZ);
        if tablesize > 48 then tablesize = 48;
        if tablesize < 25 then tablesize = 25;
        largegrain = VTCR_EL2.TG0 == '01';
        midgrain = VTCR_EL2.TG0 == '10';
        base = VTTBR_EL2;
        basefound = IsZero(inputaddr<63:tablesize>);
        descaddr.memattrs = WalkAttrDecode(VTCR_EL2.IRGN0, VTCR_EL2.ORGNO, VTCR_EL2.SH0);
        reversedescriptors = SCTLR_EL2.EE == '1';
        psize = VTCR_EL2.PS;

        startlevel = UInt(VTCR_EL2.SL0);

        // Limits on IPA controls based on implemented PA size
        if startlevel == 3 then basefound = FALSE;
        if midgrain then
            if PAMax() < 41 && startlevel == 2 then basefound = FALSE;
        else
            if PAMax() < 43 && startlevel == 2 then basefound = FALSE;

        // force the tablesize not to exceed the PAMax value
        if tablesize > PAMax() then tablesize = PAMax();

        if largegrain then
            grainsize = 16;

```



```

        stride = grainsize - 3;
        level = 3 - startlevel;
        firstblocklevel = 2;
    elseif midgrain then
        grainsize = 14;
        stride = grainsize - 3;
        level = 3 - startlevel;
        firstblocklevel = 2;
    else
        grainsize = 12;
        stride = grainsize - 3;
        level = 2 - startlevel;
        firstblocklevel = 1;

    // Check for Translation Table of fewer than 2 entries or more than 16*(2^grainsize/8)
    // entries
    // Number entries in start table level =
    // (Address Size)/((Address per level)^Num of levels after start + Size of Table)
    // Upper bound check is
    // (tablesize - stride*(3-level) - grainsize > (grainsize - 3) + 4)
    // Lower bound check is
    // (tablesize - stride*(3-level) - grainsize < 1
    if ((tablesize > stride*(3-level) + 2*grainsize + 1) ||
        (tablesize < stride*(3-level) + grainsize + 1)) then
        basefound = FALSE;

if !basefound then
    result.addrdesc.fault = AArch64.TranslationFault(ipaddress, 0, acctype, iswrite,
                                                    secondstage, s2fslwalk);
    return result;

case psize of
    when '000' cpamax = 32;
    when '001' cpamax = 36;
    when '010' cpamax = 40;
    when '011' cpamax = 42;
    when '100' cpamax = 44;
    when '101' cpamax = 48;
    otherwise cpamax = 48;

if cpamax > PAMax() then cpamax = PAMax();

if cpamax != 48 && !IsZero(base<47:cpamax>) then
    result.addrdesc.fault = AArch64.AddressSizeFault(ipaddress, 0, acctype, iswrite,
                                                    secondstage, s2fslwalk);
    return result;

// Bottom bound of the Base address is:
// log2(8 bytes per entry)+log2(num of entries in start table level)
// Number of entries in start table level =
// (Address Size)/((Address per level)^Num of levels after start level + Size of Table)

baselowerbound = 3 + tablesize - stride*(3-level) - grainsize;
baseaddress = base<47:baselowerbound>:Zeros(baselowerbound);

ns_table = if lookupsecure then '0' else '1';
ap_table = if singlepriv then '10' else '11';
xn_table = '0';
pxn_table = '0';

addrselecttop = tablesize - 1;

repeat
    addrselectbottom = (3-level)*stride + grainsize;

    bits(48) index = ZeroExtend(inputaddr<addrselecttop:addrselectbottom>:'000');
    descaddr.paddress.physicaladdress = baseaddress OR index;
    descaddr.paddress.NS = ns_table;

```

```

// If there are two stages of translation, then the first stage table walk addresses
// are themselves subject to translation
if !HaveEL(EL2) || secondstage || IsSecure() || PSTATE.EL == EL2 then
    descaddr2 = descaddr;
else
    descaddr2 = AArch64.SecondStageWalk(descaddr, vaddress, acctype, 8);
desc = _Mem[descaddr2, 8, AccType_PTW];
if reversedescriptors then
    desc = BigEndianReverse(desc);

// Process descriptor
case desc<1:0> of
    when 'x0' // Fault or reserved
        result.addrdesc.fault = AArch64.TranslationFault(ipaddress,
                                                         level, acctype, iswrite,
                                                         secondstage, s2fs1walk);
        return result;

    when '01'
        if level == 3 then // Invalid at level 3
            result.addrdesc.fault = AArch64.TranslationFault(ipaddress,
                                                             level, acctype, iswrite,
                                                             secondstage, s2fs1walk);
            return result;
        else // Block
            blocktranslate = TRUE;

    when '11'
        if level != 3 then // Table
            if cpamax != 48 && !IsZero(desc<47:cpamax>) then
                result.addrdesc.fault = AArch64.AddressSizeFault(ipaddress,
                                                                level, acctype,
                                                                iswrite, secondstage,
                                                                s2fs1walk);

                return result;

            baseaddress = desc<47:grainsize>:Zeros(grainsize);

            if !secondstage then
                // Unpack the upper and lower table attributes
                // pxn_table and ap_table[0] apply only in EL0&1 translation regimes
                ns_table = ns_table AND desc<63>;
                ap_table<1> = ap_table<1> AND desc<62>;
                xn_table = xn_table OR desc<60>;
                if !singlepriv then
                    ap_table<0> = ap_table<0> AND desc<61>;
                    pxn_table = pxn_table OR desc<59>;

                level = level + 1;
                addrselecttop = addrselectbottom - 1;
                blocktranslate = FALSE;
            else // Page
                blocktranslate = TRUE;
until blocktranslate;

// Check block size is supported at this level
if level < firstblocklevel then
    result.addrdesc.fault = AArch64.TranslationFault(ipaddress, level, acctype,
                                                    iswrite, secondstage, s2fs1walk);
    return result;

if cpamax != 48 && !IsZero(desc<47:cpamax>) then
    result.addrdesc.fault = AArch64.AddressSizeFault(ipaddress, level, acctype,
                                                    iswrite, secondstage, s2fs1walk);
    return result;

physicaladdress = desc<47:addrselectbottom>:inputaddr<addrselectbottom-1:0>;

```

```

// check for misprogramming of the contiguous bit
if largegrain then
    contiguousbitcheck = level == 2 && tablesizesize < 34;
elseif midgrain then
    contiguousbitcheck = level == 2 && tablesizesize < 38;
else
    contiguousbitcheck = level == 1 && tablesizesize < 34;

if contiguousbitcheck && desc<52> == '1' then
    if boolean IMPLEMENTATION_DEFINED "Translation fault on misprogrammed contiguous bit" then
        result.addrdesc.fault = AArch64.TranslationFault(ipaddress, level,
            acctype, iswrite,
            secondstage, s2fs1walk);

        return result;

// Check the access flag
if desc<10> == '0' then
    result.addrdesc.fault = AArch64.AccessFlagFault(ipaddress, level,
        acctype, iswrite,
        secondstage, s2fs1walk);

    return result;

// Unpack the upper and lower block attributes
xn = desc<54>;
pxn = desc<53>;
contiguousbit = desc<52>;
nG = desc<11>;
sh = desc<9:8>;
ap = desc<7:6>:'1';
memattr = desc<5:2>; // AttrIndx and NS bit in stage 1

result.domain = bits(4) UNKNOWN; // Domains not used
result.level = level;
result.blocksize = 2^((3-level)*stride + grainsize);

// Stage 1 translation regimes also inherit attributes from the tables
if !secondstage then
    result.perms.xn = xn OR xn_table;
    result.perms.ap<2> = ap<2> OR ap_table<1>;

// PXN, nG and AP[1] apply only in EL0&1 stage 1 translation regimes
if !singlepriv then
    result.perms.ap<1> = ap<1> OR NOT(ap_table<0>);
    result.perms.pxn = pxn OR pxn_table;
    // Pages from Non-secure tables are marked Global in Secure EL0&1
    if IsSecure() then
        result.nG = nG OR ns_table;
    else
        result.nG = nG;
else
    result.perms.ap<1> = '1';
    result.perms.pxn = '0';
    result.nG = '0';
    result.perms.ap<0> = '1';
    result.addrdesc.memattr = AArch64.S1AttrDecode(sh, memattr<2:0>, acctype);
    result.addrdesc.paddress.NS = if lookupsecure then (memattr<3> OR ns_table) else '1';
else
    result.perms.ap<2:1> = ap<2:1>;
    result.perms.ap<0> = '1';
    result.perms.xn = xn;
    result.perms.pxn = '0';
    result.nG = '0';
    result.addrdesc.memattr = S2AttrDecode(sh, memattr, acctype);
    result.addrdesc.paddress.NS = '1';

result.addrdesc.paddress.physicaladdress = physicaladdress;
result.addrdesc.fault = AArch64.NoFault();

```

```
result.contiguous = contiguousbit == '1';  
return result;
```

G.2 Library pseudocode for AArch32

This section holds the pseudocode for execution in AArch32 state. Functions listed in this section are identified as AArch32.FunctionName. Some of these functions have an equivalent AArch64 function, AArch64.FunctionName. This section is organized by functional groups, with the functional groups being indicated by hierarchical path names, for example aarch32/debug/breakpoint.

G.2.1 aarch32/debug

This section contains the pseudocode for AArch32 state that relates to debug.

aarch32/debug/VCRMatch

```
// AArch32.VCRMatch()
// =====

boolean AArch32.VCRMatch(bits(32) vaddress)

    if UsingAArch32() && ELUsingAArch32(EL1) && IsZero(vaddress<1:0>) && PSTATE.EL != EL2 then
        // Each bit position in this string corresponds to a bit in DBGVCR and an exception vector.
        match_word = Zeros(32);

        if vaddress<31:5> == ExcVectorBase()<31:5> then
            if HaveEL(EL3) && !IsSecure() then
                match_word<UInt(vaddress<4:2>) + 24> = '1';    // Non-secure vectors
            else
                match_word<UInt(vaddress<4:2>) + 0> = '1';    // Secure vectors (or no EL3)
        if HaveEL(EL3) && ELUsingAArch32(EL3) && IsSecure() && vaddress<31:5> == MVBAR<31:5> then
            match_word<UInt(vaddress<4:2>) + 8> = '1';    // Monitor vectors

        // Mask out bits not corresponding to vectors.
        if !HaveEL(EL3) then
            mask = '00000000':'00000000':'00000000':'11011110'; // DBGVCR[31:8] are RES0
        elseif !ELUsingAArch32(EL3) then
            mask = '11011110':'00000000':'00000000':'11011110'; // DBGVCR[15:8] are RES0
        else
            mask = '11011110':'00000000':'11011100':'11011110';

        match_word = match_word AND DBGVCR AND mask;
        match = !IsZero(match_word);

        // Check for UNPREDICTABLE case - match on Prefetch Abort and Data Abort vectors
        if !IsZero(match_word<28:27,12:11,4:3>) && DebugTarget() == PSTATE.EL then
            match = ConstrainUnpredictableBool();
    else
        match = FALSE;

    return match;
```

aarch32/debug/breakpoint

```
// Breakpoints in an AArch32 translation regime

// AArch32.BreakpointValueMatch()
// =====
// The first result is whether an Address Match or Context breakpoint is programmed
// on the instruction at "address".
// The second result is whether an Address Mismatch breakpoint is programmed on the instruction,
// that is, whether the instruction is one which has a "mismatch" step pending on it. This only
// applies in an AArch32 code translation regime, for v7-A compatibility.

(boolean,boolean) AArch32.BreakpointValueMatch(integer n, bits(32) vaddress, boolean linked_to)

    // "n" is the identity of the breakpoint unit to match against
    // "vaddress" is the current instruction address, ignored if linked_to is TRUE and Context
```

```

// matching breakpoints.
// "linked_to" is TRUE if this is a call from StateMatch for linking.

// If a non-existent breakpoint then it is CONSTRAINED UNPREDICTABLE whether this gives
// no match or the breakpoint is mapped to another UNKNOWN implemented breakpoint.
if n > UInt(DBGDIDR.BRPs) then
    (c, n) = ConstrainUnpredictableInteger(0, UInt(DBGDIDR.BRPs));
    assert c IN {Constraint_NONE, Constraint_UNKNOWN};
    if c == Constraint_NONE then return (FALSE,FALSE);

// If this breakpoint is not enabled, it cannot generate a match. (This could also happen on a
// call from StateMatch for linking.)
if DBGBCR[n].E == '0' then return (FALSE,FALSE);

// Return FALSE if BT is set to a reserved type.
if DBGBCR[n].BT IN {'011x','11xx'} then return (FALSE,FALSE);

// Determine what to compare against.
match_addr = DBGBCR[n].BT<3,1> == '00';
match_vmid = DBGBCR[n].BT<3> == '1';
mismatch = DBGBCR[n].BT<2> == '1' && !HaltOnBreakpointOrWatchpoint();
match_cid = DBGBCR[n].BT<1> == '1';
linked = DBGBCR[n].BT<0> == '1';

// Assertions based on the definition of DBGBCR[n].BT.
// Unless this breakpoint is context-aware, BT<3,1> are RAZ, and
// doesn't match VMID or CONTEXTIDR
assert (n >= UInt(DBGDIDR.BRPs) - UInt(DBGDIDR.CTX_CMPS) ||
        (IsZero(DBGBCR[n].BT<3,1>) && !match_vmid && !match_cid));

// Unless EL1 using AArch32 is supported, BT<2> is RAZ, and doesn't support mismatch
assert HaveAArch32EL(EL1) || (IsZero(DBGBCR[n].BT<2>) && !mismatch);

// Must be matching either address, or one or both of CONTEXTIDR and VMID. This assertion is
// obviously true given the definition of these variables.
assert ((match_addr && !match_cid && !match_vmid) ||
        (!match_addr && match_cid) || (!match_addr && match_vmid));

// VMID matching is not possible/allowable if no EL2 support.
assert HaveEL(EL2) || !match_vmid;

// If this is a call from StateMatch, return FALSE if the breakpoint is not programmed for a
// VMID and/or context ID match, or if not context-aware. The above assertions mean that the
// code can just test for match_addr == TRUE to confirm all these things.
if linked_to && (!linked || match_addr) then return (FALSE,FALSE);

// If this is a call from BreakpointMatch return FALSE for Linked context ID and/or
// VMID matches.
if !linked_to && linked && !match_addr then return (FALSE,FALSE);

// Do the comparison.
if match_addr then
    assert vaddress<0> == '0'; // Direct execution of Java bytecodes not supported in v8-A.
    byte = UInt(vaddress<1:0>); assert byte IN {2,0};
    assert DBGBCR[n].BAS<byte+1> == DBGBCR[n].BAS<byte>;
    byte_select_match = (DBGBCR[n].BAS<byte> != '0');
    BVR_match = vaddress<31:2> == DBGBVR[n]<31:2> && byte_select_match;
elseif match_cid then
    BVR_match = ((PSTATE.EL != EL3 || ELUsingAArch32(EL3)) && PSTATE.EL != EL2 &&
        CONTEXTIDR_GEN[] == DBGBVR[n]<31:0>);
if match_vmid then
    BXVR_match = (CurrentStateHasEL2() && PSTATE.EL IN {EL1,EL0} &&
        VTTBR_EL2.VMID == DBGXVR[n]<7:0>);

match = (!match_vmid || BXVR_match) && (!(match_addr || match_cid) || BVR_match);
return (match && !mismatch, !match && mismatch);

// AArch32.StateMatch()

```

```
// =====
boolean AArch32.StateMatch(bits(2) SSC, bit HMC, bits(2) PxC, boolean linked, bits(4) LBN,
                           boolean isbreakpnt, boolean ispriv)
// Function used in both Breakpoint and Watchpoint matching to determine whether the point is
// enabled in the current mode and state.
// "SSC", "HMC", "PxC" and "LBN" are the control fields from the DBGBCRn_EL1 or DBGWCRn_EL1
// register.
// "ispriv" is only valid for watchpoints, and selects between privileged and unprivileged
// accesses.
// "linked" is TRUE if this is a linked breakpoint/watchpoint address type.
// "isbreakpnt" is TRUE for breakpoints if any of EL3, EL2 or EL1 is using AArch32, FALSE for
// watchpoints. It allows selection of the "Svs/Sys/User" match in AArch32 modes.
// Return FALSE if parameters are set to a reserved type.

if (HMC:SSC:PxC) IN {'100x0', '101x0', '11010', '011xx', '111x1', '11110'} then return FALSE;

PL3_match = HaveEL(EL3) && HMC == '1' && SSC<0> == '0';
PL2_match = HaveEL(EL2) && HMC == '1';
PL1_match = PxC<0> == '1';
PL0_match = PxC<1> == '1';
SSU_match = HMC == '0' && PxC == '00' && SSC != '11';

// no Sys/Svc/Usr matching for watchpoints or for breakpoints when EL1 is using AArch64.
if !isbreakpnt && SSU_match then return FALSE;

if SSU_match then
    priv_match = PSTATE.M IN {M32_User, M32_Svc, M32_System};
else
    case PSTATE.EL of
        when EL3, EL1 priv_match = if ispriv then PL1_match else PL0_match;
        when EL2      priv_match = PL2_match;
        when EL0      priv_match = PL0_match;

// The determination of security_state_match relies on these assertions to avoid reserved cases.
if !HaveEL(EL3) then assert SSC<0> == SSC<1>;
if SSC == '11' then assert HMC == '1';
case SSC of
    when '00' security_state_match = TRUE;           // Both
    when '01' security_state_match = !IsSecure();   // Non-secure only
    when '10' security_state_match = IsSecure();    // Secure only
    when '11' security_state_match = TRUE;           // Both

if linked then
    // "LBN" must be an enabled context-aware breakpoint unit. If it is not context-aware
    // then it is CONSTRAINED UNPREDICTABLE whether this gives no match, or LBN is mapped to
    // some UNKNOWN breakpoint that is context-aware.
    lbn = UInt(LBN);
    first_ctx_cmp = (UInt(DBGDIDR.BRPs) - UInt(DBGDIDR.CTX_CMPs));
    last_ctx_cmp = UInt(DBGDIDR.BRPs);
    if (lbn < first_ctx_cmp || lbn > last_ctx_cmp) then
        (c, lbn) = ConstrainUnpredictableInteger(first_ctx_cmp, last_ctx_cmp);
        assert c IN {Constraint_NONE, Constraint_UNKNOWN};
        if c == Constraint_NONE then return FALSE;
    vaddress = bits(32) UNKNOWN;
    linked_to = TRUE;
    (linked_match, -) = AArch32.BreakpointValueMatch(lbn, vaddress, linked_to);

return priv_match && security_state_match && (!linked || linked_match);

// AArch32.BreakpointMatch()
// =====
// Breakpoint matching in an AArch32 translation regime.

(boolean, boolean) AArch32.BreakpointMatch(integer n, bits(32) vaddress, integer size)
// For details of arguments and return values, see BreakpointValueMatch.
assert ELUsingAArch32(TranslationRegime());
assert n <= UInt(DBGDIDR.BRPs);
```

```

enabled = DBGBCR[n].E == '1';
ispriv = PSTATE.EL != EL0;
linked = DBGBCR[n].BT == '0x01';
isbreakpnt = TRUE;
linked_to = FALSE;

state_match = AArch32.StateMatch(DBGBCR[n].SSC, DBGBCR[n].HMC, DBGBCR[n].PMC,
                                linked, DBGBCR[n].LBN, isbreakpnt, ispriv);
(value_match, value_mismatch) = AArch32.BreakpointValueMatch(n, vaddress, linked_to);

if size == 4 then // Check second halfword
    // If the breakpoint address and BAS of an Address breakpoint match the address of the
    // second halfword of an instruction, but not the address of the first halfword, it is
    // CONSTRAINED UNPREDICTABLE whether or not this breakpoint generates a Breakpoint debug
    // event.
    (match_i, mismatch_i) = AArch32.BreakpointValueMatch(n, vaddress + 2, linked_to);
    if !value_match && match_i then
        value_match = ConstrainUnpredictableBool();
    if value_mismatch && !mismatch_i then
        value_mismatch = ConstrainUnpredictableBool();

if vaddress<1> == '1' && DBGBCR[n].BAS == '1111' then
    // The above notwithstanding, if DBGBCR[n].BAS == '1111', then it is CONSTRAINED
    // UNPREDICTABLE whether or not a Breakpoint debug event is generated for an instruction
    // at the address DBGBCR[n].BAS.
    if value_match then value_match = ConstrainUnpredictableBool();
    if !value_mismatch then value_mismatch = ConstrainUnpredictableBool();

match = value_match && state_match && enabled;
mismatch = value_mismatch && state_match && enabled;

return (match, mismatch);

```

aarch32/debug/enables

```

// Debug enables etc. in an AArch32 translation regime

// AArch32.GenerateDebugExceptionsFrom()
// =====

boolean AArch32.GenerateDebugExceptionsFrom(bits(2) from, boolean secure)

if OSLSR_EL1.OSLK == '1' || DoubleLockStatus() || Halted() then
    return FALSE;

if from == EL0 && !ELStateUsingAArch32(EL1, secure) then
    mask = bit UNKNOWN; // PSTATE.D mask, unused for EL0 case
    return AArch64.GenerateDebugExceptionsFrom(from, secure, mask);

route_to_hyp = HaveEL(EL2) && !secure && (HCR.TGE == '1' || HDCR.TDE == '1');

if HaveEL(EL3) && secure then
    spd = (if ELUsingAArch32(EL3) then SDCR.SPD else MDCR_EL3.SPD32);
    if spd<1> == '1' then
        enabled = spd<0> == '1';
    else
        // SPD == 0b01 is reserved, but behaves the same as 0b00.
        enabled = AArch32SelfHostedSecurePrivilegedInvasiveDebugEnabled();
    if from == EL0 then enabled = enabled || SDER.SUIDEN == '1';
else
    enabled = from != EL2;

return enabled;

// AArch32.GenerateDebugExceptions()
// =====

```



```
boolean AArch32.GenerateDebugExceptions()
    return AArch32.GenerateDebugExceptionsFrom(PSTATE.EL, IsSecure());
```

aarch32/debug/watchpoint

```
// Watchpoints in an AArch32 translation regime

// AArch32.WatchpointByteMatch()
// =====

boolean AArch32.WatchpointByteMatch(integer n, bits(32) vaddress)

    bottom = if DBGWVR[n]<2> == '1' then 2 else 3;
    byte_select_match = (DBGWCR[n].BAS<UInt(vaddress<bottom-1:0>)> != '0');
    mask = UInt(DBGWCR[n].MASK);

    // If the address mask is set to a reserved value, no address masking is performed.
    if mask <= 2 then mask = bottom;

    // If masked bits of DBGWVR[n] are not zero, no Watchpoint debug event is generated.
    if mask > bottom then
        WVR_match = vaddress<31:mask>:Zeros(mask - bottom) == DBGWVR[n]<31:bottom>;
    else
        WVR_match = vaddress<31:bottom> == DBGWVR[n]<31:bottom>;

    // If DBGWCR[n].MASK is set to a non-zero (not reserved) value, DBGWCR[n].BAS is not set
    // to '1111111', the generation of Watchpoint debug events by that watchpoint is CONSTRAINED
    // UNPREDICTABLE.
    if UInt(DBGWCR[n].MASK) > 2 && !IsOnes(DBGWCR[n].BAS) then
        // See Constraints on programming Watchpoint debug events.
        c = ConstrainUnpredictable();
        case c of
            when Constraint_IGNOREMASK
                WVR_match = vaddress<31:bottom> == DBGWVR[n]<31:bottom>;
            when Constraint_IGNOREBAS
                byte_select_match = TRUE;
            when Constraint_REPEATBAS
                /*do nothing*/
            otherwise Unreachable();
        else
            // If DBGWCR[n].BAS specifies a non-contiguous set of bytes, the generation of
            // Watchpoint debug events for the doubleword is CONSTRAINED UNPREDICTABLE.
            LSB = (DBGWCR[n].BAS AND NOT(DBGWCR[n].BAS - 1)); MSB = (DBGWCR[n].BAS + LSB);
            if !IsZero(MSB AND (MSB - 1)) && vaddress<31:3> == DBGWVR[n]<31:3> then
                byte_select_match = ConstrainUnpredictableBool();

    return WVR_match && byte_select_match;

// AArch32.WatchpointMatch()
// =====
// Watchpoint matching in an AArch32 translation regime.

boolean AArch32.WatchpointMatch(integer n, bits(32) vaddress, integer size, boolean ispriv,
                                boolean iswrite)
    assert EUsingAArch32(TranslationRegime());
    assert n <= UInt(DBGDIDR.WRPs);

    // "ispriv" is FALSE for LDRT/STRT instructions executed at EL1 and all
    // load/stores at EL0, TRUE for all other load/stores. "iswrite" is TRUE for stores, FALSE for
    // loads.
    enabled = DBGWCR[n].E == '1';
    linked = DBGWCR[n].WT == '1';
    isbreakpt = FALSE;

    state_match = AArch32.StateMatch(DBGWCR[n].SSC, DBGWCR[n].HMC, DBGWCR[n].PAC,
                                     linked, DBGWCR[n].LBN, isbreakpt, ispriv);
```

```

ls_match = (DBGWCR[n].LSC<(if iswrite then 1 else 0)> == '1');

value_match = FALSE;
for byte = 0 to size - 1
    value_match = value_match || AArch32.WatchpointByteMatch(n, vaddress + byte);

return value_match && state_match && ls_match && enabled;

```

G.2.2 aarch32/exceptions

This section contains the pseudocode for AArch32 state that relates to exception handling.

aarch32/exceptions/aborts

```

// ~~~~~
// AArch32 Exception Model
// ~~~~~

// ~~~~~
// Abort exceptions
// ~~~~~

// AArch32.AbortSyndrome()
// =====
// Creates an exception syndrome record for Abort exceptions taken to Hyp mode
// from an AArch32 translation regime.

ExceptionRecord AArch32.AbortSyndrome(Exception type, FaultRecord fault, bits(32) vaddress)

    exception = ExceptionSyndrome(type);

    d_side = type == Exception_DataAbort;

    exception.syndrome = FaultSyndrome(d_side, fault);
    exception.vaddress = ZeroExtend(vaddress);
    if IPAValid(fault) then
        exception.ipavalid = TRUE;
        exception.ipaddress = ZeroExtend(fault.ipaddress);
    else
        exception.ipavalid = FALSE;

    return exception;

// AArch32.ReportPrefetchAbort()
// =====
// Report syndrome information for aborts taken to modes other than Hyp mode. Called after entering
// the mode in case there is a change in state.

AArch32.ReportPrefetchAbort(boolean secure, FaultRecord fault, bits(32) vaddress)

    d_side = FALSE;
    if TTBCR.EAE == '1' then
        fsr = AArch32.FaultStatusLD(d_side, fault);
    else
        fsr = AArch32.FaultStatusSD(d_side, fault);

    if secure then
        IFSR_s = fsr;
        IFAR_s = vaddress;
    else
        IFSR_ns = fsr;
        IFAR_ns = vaddress;

    return;

// AArch32.TakePrefetchAbortException()

```

```
// =====
AArch32.TakePrefetchAbortException(bits(32) vaddress, FaultRecord fault)

    route_to_monitor = HaveEL(EL3) && SCR_GEN[.EA == '1' && IsExternalAbort(fault);
    take_to_hyp = PSTATE.EL == EL2;
    route_to_hyp = (AArch32.GeneralExceptionsToHyp() || IsSecondStage(fault) ||
        (HaveEL(EL2) && !IsSecure() && IsDebugException(fault) && HDCR.TDE == '1'));

    bits(32) preferred_exception_return = ThisInstrAddr();
    vect_offset = 0x0C;
    lr_offset = 4;

    secure = route_to_monitor || IsSecure();

    if IsDebugException(fault) then DBGDSCRext.MOE = fault.debugmoe;

    if route_to_monitor then
        AArch32.ReportPrefetchAbort(secure, fault, vaddress);
        AArch32.EnterMonitorMode(preferred_exception_return, lr_offset, vect_offset);
    elseif take_to_hyp || route_to_hyp then
        if fault.type == Fault_Alignment then // PC Alignment fault
            exception = ExceptionSyndrome(Exception_PCAalignment);
        else
            exception = AArch32.AbortSyndrome(Exception_InstructionAbort, fault, vaddress);
        if take_to_hyp then
            AArch32.EnterHypMode(exception, preferred_exception_return, vect_offset);
        else
            AArch32.EnterHypMode(exception, preferred_exception_return, 0x14);
    else
        AArch32.ReportPrefetchAbort(secure, fault, vaddress);
        AArch32.EnterMode(M32_Abort, preferred_exception_return, lr_offset, vect_offset);

// AArch32.CheckPCAalignment()
// =====
AArch32.CheckPCAalignment()

    bits(32) pc = ThisInstrAddr();
    if (CurrentInstrSet() == InstrSet_A32 && pc<1> == '1' || pc<0> == '1' then
        if AArch32.GeneralExceptionsToAArch64() then
            AArch64.PCAalignmentFault();

        vaddress = pc;
        acctype = AccType_IFETCH;
        iswrite = FALSE;
        secondstage = FALSE;
        AArch32.Abort(vaddress, AArch32.AlignmentFault(acctype, iswrite, secondstage));
// AArch32.ReportDataAbort()
// =====
// Report syndrome information for aborts taken to modes other than Hyp mode.

AArch32.ReportDataAbort(boolean secure, FaultRecord fault, bits(32) vaddress)

    d_side = TRUE;
    if TTBCR.EAE == '1' then
        syndrome = AArch32.FaultStatusLD(d_side, fault);
    else
        syndrome = AArch32.FaultStatusSD(d_side, fault);

    if fault.acctype == AccType_IC then
        if (TTBCR.EAE == '0' &&
            boolean IMPLEMENTATION_DEFINED "Report I-cache maintenance fault in IFSR") then
            i_syndrome = syndrome;
            syndrome<10,3:0> = EncodeSDFSC(Fault_ICacheMaint, 1);
        else
            i_syndrome = bits(32) UNKNOWN;
        if secure then
```

```

        IFSR_s = i_syndrome;
    else
        IFSR_ns = i_syndrome;

    if secure then
        DFSR_s = syndrome;
        DFAR_s = vaddress;
    else
        DFSR_ns = syndrome;
        DFAR_ns = vaddress;

    return;

// AArch32.TakeDataAbortException()
// =====

AArch32.TakeDataAbortException(bits(32) vaddress, FaultRecord fault)

    route_to_monitor = HaveEL(EL3) && SCR_GEN[].EA == '1' && IsExternalAbort(fault);
    take_to_hyp = PSTATE.EL == EL2;
    route_to_hyp = (AArch32.GeneralExceptionsToHyp() || IsSecondStage(fault) ||
        (HaveEL(EL2) && !IsSecure() && IsDebugException(fault) && HDCR.TDE == '1'));

    bits(32) preferred_exception_return = ThisInstrAddr();
    vect_offset = 0x10;
    lr_offset = 8;

    secure = route_to_monitor || IsSecure();

    if IsDebugException(fault) then DBGDSCRExt.MOE = fault.debugmoe;

    if route_to_monitor then
        AArch32.ReportDataAbort(secure, fault, vaddress);
        AArch32.EnterMonitorMode(preferred_exception_return, lr_offset, vect_offset);
    elseif take_to_hyp || route_to_hyp then
        exception = AArch32.AbortSyndrome(Exception_DataAbort, fault, vaddress);
        if take_to_hyp then
            AArch32.EnterHypMode(exception, preferred_exception_return, vect_offset);
        else
            AArch32.EnterHypMode(exception, preferred_exception_return, 0x14);
    else
        AArch32.ReportDataAbort(secure, fault, vaddress);
        AArch32.EnterMode(M32_Abort, preferred_exception_return, lr_offset, vect_offset);

// AArch32.Abort()
// =====
// Abort and Debug exception handling in an AArch32 translation regime.

AArch32.Abort(bits(32) vaddress, FaultRecord fault)

    route_to_monitor = HaveEL(EL3) && SCR_GEN[].EA == '1' && IsExternalAbort(fault);
    route_to_hyp = (AArch32.GeneralExceptionsToHyp() || IsSecondStage(fault) ||
        (HaveEL(EL2) && !IsSecure() && IsDebugException(fault) && HDCR.TDE == '1'));

    if (route_to_monitor && !ELUsingAArch32(EL3)) || (route_to_hyp && !ELUsingAArch32(EL2)) then
        AArch64.Abort(ZeroExtend(vaddress), fault);

    if fault.acctype == AccType_IFETCH then
        AArch32.TakePrefetchAbortException(vaddress, fault);
    else
        AArch32.TakeDataAbortException(vaddress, fault);

```

aarch32/exceptions/asynch

```

// ~~~~~
// AArch32 Exception Model
// ~~~~~

```

```
// ~~~~~
// Interrupt exceptions

// AArch32.TakePhysicalAsynchAbortException()
// =====

AArch32.TakePhysicalAsynchAbortException(boolean parity, bit extflag,
                                         boolean syndrome_valid, bits(24) full_syndrome)

    route_to_monitor = HaveEL(EL3) && SCR_GEN[].EA == '1';
    take_to_hyp = PSTATE.EL == EL2;
    route_to_hyp = (AArch32.GeneralExceptionsToHyp() ||
                   (HaveEL(EL2) && !IsSecure() && HCR.AMO == '1'));

    if AArch32.ExceptionToAArch64(route_to_monitor, route_to_hyp) then
        AArch64.TakePhysicalSystemErrorException(syndrome_valid, full_syndrome);

    fault = AArch32.AsynchExternalAbort(parity, extflag);
    secure = route_to_monitor || IsSecure();
    vaddress = bits(32) UNKNOWN;

    vect_offset = 0x10;
    bits(32) preferred_exception_return = ThisInstrAddr();
    lr_offset = 8;

    if route_to_monitor then
        AArch32.ReportDataAbort(secure, fault, vaddress);
        AArch32.EnterMonitorMode(preferred_exception_return, lr_offset, vect_offset);
    elseif take_to_hyp || route_to_hyp then
        exception = AArch32.AbortSyndrome(Exception_DataAbort, fault, vaddress);
        if take_to_hyp then
            AArch32.EnterHypMode(exception, preferred_exception_return, vect_offset);
        else
            AArch32.EnterHypMode(exception, preferred_exception_return, 0x14);
    else
        AArch32.ReportDataAbort(secure, fault, vaddress);
        AArch32.EnterMode(M32_Abort, preferred_exception_return, lr_offset, vect_offset);

// AArch32.TakeVirtualAsynchAbortException()
// =====

AArch32.TakeVirtualAsynchAbortException()
    assert HaveEL(EL2) && !IsSecure() && PSTATE.EL != EL2 && HCR.TGE == '0';

    if !ELUsingAArch32(EL1) then
        AArch64.TakeVirtualSystemErrorException();

    secure = FALSE;
    parity = FALSE;
    extflag = bit IMPLEMENTATION_DEFINED "Virtual Asynchronous Abort EXT bit";
    fault = AArch32.AsynchExternalAbort(parity, extflag);
    vaddress = bits(32) UNKNOWN;

    vect_offset = 0x10;
    bits(32) preferred_exception_return = ThisInstrAddr();
    lr_offset = 8;

    HCR.VA = '0';
    AArch32.ReportDataAbort(secure, fault, vaddress);
    AArch32.EnterMode(M32_Abort, preferred_exception_return, lr_offset, vect_offset);

// AArch32.TakePhysicalIRQException()
// =====
// Take an enabled physical IRQ exception.

AArch32.TakePhysicalIRQException()
```

```

route_to_monitor = HaveEL(EL3) && SCR_GEN[].IRQ == '1';
take_to_hyp = PSTATE.EL == EL2;
route_to_hyp = (AArch32.GeneralExceptionsToHyp() ||
               (HaveEL(EL2) && !IsSecure() && HCR.IMO == '1'));

if AArch32.ExceptionToAArch64(route_to_monitor, route_to_hyp) then
    AArch64.TakePhysicalIRQException();

vect_offset = 0x18;
bits(32) preferred_exception_return = ThisInstrAddr();
lr_offset = 4;

if route_to_monitor then
    AArch32.EnterMonitorMode(preferred_exception_return, lr_offset, vect_offset);
elseif take_to_hyp || route_to_hyp then
    exception = ExceptionSyndrome(Exception_IRQ);
    AArch32.EnterHypMode(exception, preferred_exception_return, vect_offset);
else
    AArch32.EnterMode(M32_IRQ, preferred_exception_return, lr_offset, vect_offset);

// AArch32.TakeVirtualIRQException()
// =====

AArch32.TakeVirtualIRQException()
    assert HaveEL(EL2) && !IsSecure() && PSTATE.EL != EL2 && HCR.TGE == '0';

    if !ELUsingAArch32(EL1) then
        AArch64.TakeVirtualFIQException();

    vect_offset = 0x18;
    bits(32) preferred_exception_return = ThisInstrAddr();
    lr_offset = 4;

    AArch32.EnterMode(M32_IRQ, preferred_exception_return, lr_offset, vect_offset);

// AArch32.TakePhysicalFIQException()
// =====

AArch32.TakePhysicalFIQException()

    route_to_monitor = HaveEL(EL3) && SCR_GEN[].FIQ == '1';
    take_to_hyp = PSTATE.EL == EL2;
    route_to_hyp = (AArch32.GeneralExceptionsToHyp() ||
                  (HaveEL(EL2) && !IsSecure() && HCR.FMO == '1'));

    if AArch32.ExceptionToAArch64(route_to_monitor, route_to_hyp) then
        AArch64.TakePhysicalFIQException();

    vect_offset = 0x1C;
    bits(32) preferred_exception_return = ThisInstrAddr();
    lr_offset = 4;

    if route_to_monitor then
        AArch32.EnterMonitorMode(preferred_exception_return, lr_offset, vect_offset);
    elseif take_to_hyp || route_to_hyp then
        exception = ExceptionSyndrome(Exception_FIQ);
        AArch32.EnterHypMode(exception, preferred_exception_return, vect_offset);
    else
        AArch32.EnterMode(M32_IRQ, preferred_exception_return, lr_offset, vect_offset);

// AArch32.TakeVirtualFIQException()
// =====

AArch32.TakeVirtualFIQException()
    assert HaveEL(EL2) && !IsSecure() && PSTATE.EL != EL2 && HCR.TGE == '0';

    if !ELUsingAArch32(EL1) then
        AArch64.TakeVirtualFIQException();

```

```
vect_offset = 0x1C;
bits(32) preferred_exception_return = ThisInstrAddr();
lr_offset = 4;

AArch32.EnterMode(M32_FIQ, preferred_exception_return, lr_offset, vect_offset);
```

aarch32/exceptions/debug

```
// ~~~~~
// AArch32 Exception Model
// ~~~~~

// ~~~~~
// Debug exceptions
// ~~~~~

// DebugException
// =====
// Reason codes for debug exceptions, taken to AArch32

constant bits(4) DebugException_Breakpoint = '0001';
constant bits(4) DebugException_BKPT      = '0011';
constant bits(4) DebugException_VectorCatch = '0101';
constant bits(4) DebugException_Watchpoint = '1010';

// AArch32.BKPTInstrDebugEvent()
// =====

AArch32.BKPTInstrDebugEvent(bits(16) immediate)

    route_to_hyp = (AArch32.GeneralExceptionsToHyp() ||
                    (HaveEL(EL2) && !IsSecure() && HDCR.TDE == '1'));

    if route_to_hyp && !ELUsingAArch32(EL2) then
        AArch64.SoftwareBreakpoint(immediate);

    vaddress = bits(32) UNKNOWN;
    acctype = AccType_IFETCH;           // Take as a Prefetch Abort
    iswrite = FALSE;
    entry = DebugException_BKPT;

    fault = AArch32.DebugFault(acctype, iswrite, entry);
    AArch32.Abort(vaddress, fault);
```

aarch32/exceptions/exceptions

```
// ExcVectorBase()
// =====

bits(32) ExcVectorBase()
    if SCTL.R.V == '1' then // Hivecs selected, base = 0xFFFFF000
        return Ones(16):Zeros(16);
    else
        return VBAR;

// ~~~~~
// AArch32 Exception Model
// ~~~~~

// ~~~~~
// Functions for entering exception handling modes and reporting the syndrome information.
// ~~~~~

// AArch32.ExceptionClass()
// =====
// Return the Exception Class and Instruction Length fields for reported in HSR
```

```
(integer,bit) AArch32.ExceptionClass(Exception type)

    il = if ThisInstrLength() == 32 then '1' else '0';

    case type of
        when Exception_Uncategorized          ec = 0x00; il = '1';
        when Exception_WFxTrap                ec = 0x01;
        when Exception_CP15RTTTrap           ec = 0x03;
        when Exception_CP15RRTTrap           ec = 0x04;
        when Exception_CP14RTTTrap           ec = 0x05;
        when Exception_CP14DTTTrap           ec = 0x06;
        when Exception_AdvSIMDFPAccessTrap   ec = 0x07;
        when Exception_FPIDTTrap             ec = 0x08;
        when Exception_CP14RRTTrap           ec = 0x0C;
        when Exception_IllegalState          ec = 0x0E; il = '1';
        when Exception_SupervisorCall        ec = 0x11;
        when Exception_HypervisorCall        ec = 0x12;
        when Exception_MonitorCall           ec = 0x13;
        when Exception_InstructionAbort       ec = 0x20; il = '1';
        when Exception_PCAlignment           ec = 0x22; il = '1';
        when Exception_DataAbort             ec = 0x24;
        when Exception_FPTrappedException    ec = 0x28;
        otherwise                             Unreachable();

    if ec IN {0x20,0x24} && PSTATE.EL == EL2 then
        ec = ec + 1;

    return (ec,il);

// AArch32.ReportHypEntry()
// =====
// Report syndrome information to Hyp mode registers.

AArch32.ReportHypEntry(ExceptionRecord exception)

    Exception type = exception.type;

    (ec,il) = AArch32.ExceptionClass(type);
    iss = exception.syndrome;

    // IL is not valid for Data Abort exceptions without valid instruction syndrome information
    if ec IN {0x24,0x25} && iss<24> == '0' then
        il = '1';

    HSR = ec<5:0>:il:iss;

    if type IN {Exception_InstructionAbort, Exception_PCAlignment} then
        HIFAR = exception.vaddress<31:0>;
        HDFAR = bits(32) UNKNOWN;
    elseif type == Exception_DataAbort then
        HIFAR = bits(32) UNKNOWN;
        HDFAR = exception.vaddress<31:0>;

    if exception.ipavalid then
        HPFAR<31:4> = exception.ipaddress<39:12>;

    return;

// AArch32.EnterMonitorMode()
// =====
// Take an exception to Monitor mode.

AArch32.EnterMonitorMode(bits(32) preferred_exception_return, integer lr_offset,
                        integer vect_offset)
    assert HaveEL(EL3) && ELUsingAArch32(EL3);

    spsr = GetSPSRFromPSTATE();
    if PSTATE.M == M32_Monitor then SCR.NS = '0';
```



```

AArch32.WriteMode(M32_Monitor);
SPSR[] = spsr;
R[14] = preferred_exception_return + lr_offset;
PSTATE.J = '0';
PSTATE.T = SCTLR.TE;
PSTATE.E = SCTLR.EE;
PSTATE.<A,I,F> = '111';
PSTATE.IT = '00000000';
BranchTo(MVBAR + vect_offset, BranchType_UNKNOWN);

// AArch32.EnterHypMode()
// =====
// Take an exception to Hyp mode.

AArch32.EnterHypMode(ExceptionRecord exception, bits(32) preferred_exception_return,
                    integer vect_offset)
    assert HaveEL(EL2) && !IsSecure() && ELUsingAArch32(EL2);

    spsr = GetSPSRFromPSTATE();
    AArch32.WriteMode(M32_Hyp);
    if !(exception.type IN {Exception_IRQ, Exception_FIQ}) then
        AArch32.ReportHypEntry(exception);
    SPSR[] = spsr;
    R[14] = preferred_exception_return;
    PSTATE.J = '0';
    PSTATE.T = HSCTLR.TE;
    PSTATE.E = HSCTLR.EE;
    if !HaveEL(EL3) || SCR_GEN[].EA == '0' then PSTATE.A = '1';
    if !HaveEL(EL3) || SCR_GEN[].IRQ == '0' then PSTATE.I = '1';
    if !HaveEL(EL3) || SCR_GEN[].FIQ == '0' then PSTATE.F = '1';
    PSTATE.IT = '00000000';
    BranchTo(HVBAR + vect_offset, BranchType_UNKNOWN);

// AArch32.EnterMode()
// =====
// Take an exception to a mode other than Monitor and Hyp mode.

AArch32.EnterMode(bits(5) target_mode, bits(32) preferred_exception_return, integer lr_offset,
                 integer vect_offset)
    assert ELUsingAArch32(EL1);

    spsr = GetSPSRFromPSTATE();
    if PSTATE.M == M32_Monitor then SCR.NS = '0';
    AArch32.WriteMode(target_mode);
    SPSR[] = spsr;
    R[14] = preferred_exception_return + lr_offset;
    PSTATE.J = '0';
    PSTATE.T = SCTLR.TE;
    PSTATE.E = SCTLR.EE;
    if target_mode == M32_FIQ then
        PSTATE.<A,I,F> = '111';
    elsif target_mode IN {M32_Abort, M32_IRQ} then
        PSTATE.<A,I> = '11';
    else
        PSTATE.I = '1';
    PSTATE.IT = '00000000';
    BranchTo(ExcVectorBase() + vect_offset, BranchType_UNKNOWN);

// AArch32.GeneralExceptionsToHyp()
// =====
// Return TRUE if HCR.TGE is in force to route general exceptions to Hyp mode

boolean AArch32.GeneralExceptionsToHyp()

    return HaveEL(EL2) && !IsSecure() && PSTATE.EL != EL2 && HCR.TGE == '1';

// AArch32.ExceptionToAArch64()
// =====

```

```
// Returns TRUE if the exception is routed to an exception level using AArch64, given
// the exception routing information passed.

boolean AArch32.ExceptionToAArch64(boolean route_to_monitor, boolean route_to_hyp)

    if route_to_monitor then
        return !ELUsingAArch32(EL3);
    elseif route_to_hyp then
        return !ELUsingAArch32(EL2);
    else
        return !ELUsingAArch32(EL1);

// AArch32.GeneralExceptionsToAArch64()
// =====
// Returns TRUE if exceptions normally routed to EL1 are being handled at an Exception
// level using AArch64, because either EL1 is using AArch64 or TGE is in force and EL2
// is using AArch64.

boolean AArch32.GeneralExceptionsToAArch64()

    route_to_monitor = FALSE;
    route_to_hyp = AArch32.GeneralExceptionsToHyp();

    return AArch32.ExceptionToAArch64(route_to_monitor, route_to_hyp);
```

aarch32/exceptions/ieeefp

```
// ~~~~~
// AArch32 Exception Model
// ~~~~~

// ~~~~~
// Optional trapped IEEE floating-point

// AArch32.FPTrappedException()
// =====

AArch32.FPTrappedException(bits(8) accumulated_exceptions)
    if AArch32.GeneralExceptionsToAArch64() then
        is_ase = FALSE;
        element = 0;
        AArch64.FPTrappedException(is_ase, element, accumulated_exceptions);

    bits(32) syndrome = Zeros();
    syndrome<29> = '1'; // DEX
    syndrome<26> = '1'; // TFV
    syndrome<7,4:0> = accumulated_exceptions<7,4:0>; // IDF,IXF,UFF,OFF,DZF,IOF

    FPEXC = syndrome;

    AArch32.TakeUndefInstrException();
```

aarch32/exceptions/syscalls

```
// ~~~~~
// AArch32 Exception Model
// ~~~~~

// ~~~~~
// System call exceptions

// AArch32.TakeSMCException()
// =====

AArch32.TakeSMCException()
    assert HaveEL(EL3) && ELUsingAArch32(EL3);
```

```

AArch32.ITAdvance();
SSAdvance();

bits(32) preferred_exception_return = NextInstrAddr();
vect_offset = 0x08;
lr_offset = 0;

AArch32.EnterMonitorMode(preferred_exception_return, lr_offset, vect_offset);

// AArch32.CallHypervisor()
// =====
// Performs a HVC call

AArch32.CallHypervisor(bits(16) immediate)

    if !ELUsingAArch32(EL2) then
        AArch64.CallHypervisor(immediate);

    AArch32.TakeHVCException(immediate);

// AArch32.TakeHVCException()
// =====

AArch32.TakeHVCException(bits(16) immediate)
    assert ELUsingAArch32(EL2);

    AArch32.ITAdvance();
    SSAdvance();

    exception = ExceptionSyndrome(Exception_HypervisorCall);
    exception.syndrome<15:0> = immediate;
    bits(32) preferred_exception_return = NextInstrAddr();
    vect_offset = 0x08;

    if PSTATE.EL == EL2 then
        AArch32.EnterHypMode(exception, preferred_exception_return, vect_offset);
    else
        AArch32.EnterHypMode(exception, preferred_exception_return, 0x14);

// AArch32.CallSupervisor()
// =====
// Calls the Supervisor

AArch32.CallSupervisor(bits(16) immediate)

    if AArch32.CurrentCond() != '1110' then
        immediate = bits(16) UNKNOWN;

    if AArch32.GeneralExceptionsToAArch64() then
        AArch64.CallSupervisor(immediate);

    AArch32.TakeSVCException(immediate);

// AArch32.TakeSVCException()
// =====

AArch32.TakeSVCException(bits(16) immediate)
    assert !AArch32.GeneralExceptionsToAArch64();

    AArch32.ITAdvance();
    SSAdvance();

    take_to_hyp = PSTATE.EL == EL2;
    route_to_hyp = AArch32.GeneralExceptionsToHyp();

    bits(32) preferred_exception_return = NextInstrAddr();
    vect_offset = 0x08;

```

```

lr_offset = 0;

if take_to_hyp || route_to_hyp then
    exception = ExceptionSyndrome(Exception_SupervisorCall);
    exception.syndrome<15:0> = immediate;
    if take_to_hyp then
        AArch32.EnterHypMode(exception, preferred_exception_return, vect_offset);
    else
        AArch32.EnterHypMode(exception, preferred_exception_return, 0x14);
else
    AArch32.EnterMode(M32_Svc, preferred_exception_return, lr_offset, vect_offset);

```

aarch32/exceptions/traps

```

// ~~~~~
// AArch32 Exception Model
// ~~~~~

// ~~~~~
// Configurable traps and enables and Undefined Instruction exceptions

// AArch32.TakeHypTrapException()
// =====
// Exceptions routed to Hyp mode as a Hyp Trap exception.

AArch32.TakeHypTrapException(ExceptionRecord exception)
    assert HaveEL(EL2) && !IsSecure() && ELUsingAArch32(EL2);

    bits(32) preferred_exception_return = ThisInstrAddr();
    AArch32.EnterHypMode(exception, preferred_exception_return, 0x14);

// AArch32.UndefinedFault()
// =====

AArch32.UndefinedFault()

    if AArch32.GeneralExceptionsToAArch64() then
        AArch64.UndefinedFault();

    AArch32.TakeUndefInstrException();

// AArch32.TakeUndefInstrException()
// =====

AArch32.TakeUndefInstrException()
    assert !AArch32.GeneralExceptionsToAArch64();

    take_to_hyp = PSTATE.EL == EL2;
    route_to_hyp = AArch32.GeneralExceptionsToHyp();

    bits(32) preferred_exception_return = ThisInstrAddr();
    vect_offset = 0x4;
    lr_offset = if CurrentInstrSet() == InstrSet_A32 then 8 else 4;

    if take_to_hyp || route_to_hyp then
        exception = ExceptionSyndrome(Exception_Uncategorized);
        if take_to_hyp then
            AArch32.EnterHypMode(exception, preferred_exception_return, vect_offset);
        else
            AArch32.EnterHypMode(exception, preferred_exception_return, 0x14);
    else
        AArch32.EnterMode(M32_Undef, preferred_exception_return, lr_offset, vect_offset);

// AArch32.CheckIllegalState()
// =====
// Check PSTATE.IL bit and generate Illegal State exception if set.

```

```

AArch32.CheckIllegalState()

    if PSTATE.IL == '1' then
        take_to_hyp = PSTATE.EL == EL2;
        route_to_hyp = AArch32.GeneralExceptionsToHyp();

        if route_to_hyp && !ELUsingAArch32(EL2) then
            AArch64.CheckIllegalState();

        bits(32) preferred_exception_return = ThisInstrAddr();
        vect_offset = 0x4;

        if take_to_hyp || route_to_hyp then
            exception = ExceptionSyndrome(Exception_IllegalState);
            if take_to_hyp then
                AArch32.EnterHypMode(exception, preferred_exception_return, vect_offset);
            else
                AArch32.EnterHypMode(exception, preferred_exception_return, 0x14);
        else
            AArch32.TakeUndefInstrException();

// AArch32.SMCTrap()
// =====

AArch32.SMCTrap()

    if !ELUsingAArch32(EL2) then
        AArch64.SMCTrap();

    exception = ExceptionSyndrome(Exception_MonitorCall);
    AArch32.TakeHypTrapException(exception);

// AArch32.WFxTrap()
// =====
// Trapped WFE or WFI instruction

AArch32.WFxTrap(bits(2) target_el, boolean is_wfe)
    assert UInt(target_el) > UInt(PSTATE.EL);

    if !ELUsingAArch32(target_el) || AArch32.GeneralExceptionsToAArch64() then
        AArch64.WFxTrap(target_el, is_wfe);

    if target_el == EL2 then
        exception = ExceptionSyndrome(Exception_WFxTrap);
        exception.syndrome<0> = if is_wfe then '1' else '0';
        AArch32.TakeHypTrapException(exception);
    else
        AArch32.TakeUndefInstrException();

// AArch32.CPRegTrap()
// =====
// Trapped AArch32 CP14 and CP15 access other than due to HCPTR or CPACR.

AArch32.CPRegTrap(bits(2) target_el, bits(32) instr)
    assert HaveEL(target_el) && target_el != EL0 && UInt(target_el) >= UInt(PSTATE.EL);

    if !ELUsingAArch32(target_el) || AArch32.GeneralExceptionsToAArch64() then
        AArch64.CPRegTrap(target_el, instr);

    assert target_el IN {EL1,EL2};

    if target_el == EL2 then
        exception = CPRegTrapSyndrome(instr);
        AArch32.TakeHypTrapException(exception);
    else
        AArch32.TakeUndefInstrException();

// AArch32.AdvSIMDFPAccessTrap()

```

```

// =====
// Trapped access to Advanced SIMD or FP registers due to CPACR, HCPTR, or CPTR_EL3.

AArch32.AdvSIMDFPAccessTrap(bits(2) target_el, boolean advsimd, bits(32) instr)
    assert UInt(target_el) >= UInt(PSTATE.EL);
    assert target_el != EL0;
    assert HaveEL(target_el);

    if !ELUsingAArch32(target_el) || AArch32.GeneralExceptionsToAArch64() then
        AArch64.AdvSIMDFPAccessTrap(target_el);

    if target_el == EL2 then
        exception = ExceptionSyndrome(Exception_AdvSIMDFPAccessTrap);
        if advsimd then
            exception.syndrome<5> = '1';
        else
            exception.syndrome<5> = '0';
            exception.syndrome<3:0> = instr<11:8>; // coproc number
            AArch32.TakeHypTrapException(exception);
        else
            AArch32.TakeUndefInstrException();

// AArch32.CheckAdvSIMDOrFPEEnabled()
// =====
// Check against CPACR, FPEXC, HCPTR, NSACR, and CPTR_EL3.

AArch32.CheckAdvSIMDOrFPEEnabled(boolean fpexc_check, boolean advsimd, bits(32) instr)

    if !ELUsingAArch32(EL1) then
        AArch64.CheckFPAdvSIMDEnabled();
    else
        cpacr_asedis = CPACR.ASEDIS;
        cpacr_cp10 = CPACR.cp10;

        if HaveEL(EL2) && !IsSecure() then
            hcptr_tase = if ELUsingAArch32(EL2) then HCPTR.TASE else '0';
            hcptr_cp10 = HCPTR.TCP10;

        if HaveEL(EL3) && ELUsingAArch32(EL3) && !IsSecure() then
            // Check if access disabled in NSACR
            if NSACR.NSASEDIS == '1' then
                cpacr_asedis = '1';
                if HaveEL(EL2) then hcptr_tase = '1';
            if NSACR.cp10 == '0' then
                cpacr_cp10 = '00';
                if HaveEL(EL2) then hcptr_cp10 = '1';

        if PSTATE.EL != EL2 then
            // Check if Advanced SIMD disabled in CPACR
            if advsimd && cpacr_asedis == '1' then
                AArch32.AdvSIMDFPAccessTrap(EL1, advsimd, instr);

            // Check if access disabled in CPACR
            if cpacr_cp10<0> == '0' || (cpacr_cp10<1> == '0' && PSTATE.EL == EL0) then
                AArch32.AdvSIMDFPAccessTrap(EL1, advsimd, instr);

            // If required, check FPEXC enabled bit. If EL1 is using AArch64, then do not
            // make this check
            if fpexc_check && FPEXC.EN == '0' then UNDEFINED;

        if HaveEL(EL2) && !IsSecure() then
            // Check if Advanced SIMD access disabled in HCPTR
            if advsimd && hcptr_tase == '1' then
                AArch32.AdvSIMDFPAccessTrap(EL2, advsimd, instr);

            // Check if access disabled in HCPTR
            if hcptr_cp10 == '1' then
                AArch32.AdvSIMDFPAccessTrap(EL2, advsimd, instr);

```

```

    if HaveEL(EL3) && !ELUsingAArch32(EL3) then
        // Check if access disabled in CPTR_EL3
        if CPTR_EL3.TFP == '1' then
            AArch64.AdvSIMDAccessTrap(EL3);

return;

```

G.2.3 aarch32/functions

This section contains the general pseudocode functions for AArch32 state.

aarch32/functions/aborts

```

// ~~~~~
// AArch32 Abort handling
// ~~~~~

// AArch32.DomainValid()
// =====
// Returns TRUE if the Domain is valid for a Short-descriptor translation scheme.

boolean AArch32.DomainValid(Fault type, integer level)
    assert type != Fault_None;

    case type of
        when Fault_Domain            return TRUE;
        when Fault_Translation, Fault_AccessFlag, Fault_SyncExternalOnWalk, Fault_SyncParityOnWalk
            return level == 2;
        otherwise
            return FALSE;

// AArch32.CreateFaultRecord()
// =====

FaultRecord AArch32.CreateFaultRecord(Fault type, bits(40) ipaddress, bits(4) domain,
                                      integer level, AccType acctype, boolean write, bit extflag,
                                      bits(4) debugmoe, boolean secondstage, boolean s2fs1walk)

    FaultRecord fault;
    fault.type = type;
    if (PSTATE.EL != EL2 && TTBCR.EAE == '0' && !secondstage && !s2fs1walk &&
        AArch32.DomainValid(type, level)) then
        fault.domain = domain;
    else
        fault.domain = bits(4) UNKNOWN;
    fault.debugmoe = debugmoe;
    fault.ipaddress = ZeroExtend(ipaddress);
    fault.level = level;
    fault.acctype = acctype;
    fault.write = write;
    fault.extflag = extflag;
    fault.secondstage = secondstage;
    fault.s2fs1walk = s2fs1walk;

    return fault;

// EncodeSDFSC()
// =====
// Function that gives the Short-descriptor FSR code for different types of Fault

bits(5) EncodeSDFSC(Fault type, integer level)

    bits(5) result;

    case type of

```

```

        when Fault_AccessFlag           result = if level == 1 then '00011' else '00110';
        when Fault_Alignment           result = '00001';
        when Fault_Permission          result = '0111':level<1>;
        when Fault_Domain              result = '0101':level<1>;
        when Fault_Translation         result = '0011':level<1>;
        when Fault_SyncExternal        result = '01000';
        when Fault_SyncExternalOnWalk result = '0110':level<1>;
        when Fault_SyncParity          result = '11001';
        when Fault_SyncParityOnWalk   result = '1110':level<1>;
        when Fault_AsyncParity         result = '11000';
        when Fault_AsyncExternal       result = '10110';
        when Fault_Debug               result = '00010';
        when Fault_TLBConflict         result = '10000';
        when Fault_Lockdown            result = '10100';
        when Fault_Coproc              result = '11010';
        when Fault_ICacheMaint         result = '00100';
        otherwise                      Unreachable();

    return result;

// AArch32.FaultStatusLD()
// =====
// Creates an exception fault status value for Abort and Watchpoint exceptions taken
// to Abort mode using AArch32 and Long-descriptor format.

bits(32) AArch32.FaultStatusLD(boolean d_side, FaultRecord fault)
    assert fault.type != Fault_None;

    bits(32) fsr = Zeros();
    if d_side then
        fsr<13> = if fault.acctype IN {AccType_DC, AccType_IC} then '1' else '0';
        fsr<11> = if fault.write then '1' else '0';
    if IsExternalAbort(fault) then fsr<12> = fault.extflag;
    fsr<9> = '1';
    fsr<5:0> = EncodeLDFSC(fault.type, fault.level);

    return fsr;

// AArch32.FaultStatusSD()
// =====
// Creates an exception fault status value for Abort and Watchpoint exceptions taken
// to Abort mode using AArch32 and Short-descriptor format.

bits(32) AArch32.FaultStatusSD(boolean d_side, FaultRecord fault)
    assert fault.type != Fault_None;

    bits(32) fsr = Zeros();
    if d_side then
        fsr<13> = if fault.acctype IN {AccType_DC, AccType_IC} then '1' else '0';
        fsr<11> = if fault.write then '1' else '0';
    if IsExternalAbort(fault) then fsr<12> = fault.extflag;
    fsr<9> = '0';
    fsr<10,3:0> = EncodeSDFSC(fault.type, fault.level);
    if d_side then
        fsr<7:4> = fault.domain;           // Domain field (data fault only)

    return fsr;

```

aarch32/functions/common

```

// AArch32-specific common functions

enumeration SRType {SRType_LSL, SRType_LSR, SRType_ASR, SRType_ROR, SRType_RRX};

// ARMEExpandImm_C()
// =====

```



```

(bits(32), bit) ARMEExpandImm_C(bits(12) imm12, bit carry_in)
    unrotated_value = ZeroExtend(imm12<7:0>, 32);
    (imm32, carry_out) = Shift_C(unrotated_value, SRTType_ROR, 2*UInt(imm12<11:8>), carry_in);

    return (imm32, carry_out);

// ARMEExpandImm()
// =====

bits(32) ARMEExpandImm(bits(12) imm12)

    // APSR.C argument to following function call does not affect the imm32 result.
    (imm32, -) = ARMEExpandImm_C(imm12, APSR.C);

    return imm32;

// DecodeImmShift()
// =====

(SRTType, integer) DecodeImmShift(bits(2) type, bits(5) imm5)

    case type of
        when '00'
            shift_t = SRTType_LSL; shift_n = UInt(imm5);
        when '01'
            shift_t = SRTType_LSR; shift_n = if imm5 == '00000' then 32 else UInt(imm5);
        when '10'
            shift_t = SRTType_ASR; shift_n = if imm5 == '00000' then 32 else UInt(imm5);
        when '11'
            if imm5 == '00000' then
                shift_t = SRTType_RRX; shift_n = 1;
            else
                shift_t = SRTType_ROR; shift_n = UInt(imm5);

    return (shift_t, shift_n);

// DecodeRegShift()
// =====

SRTType DecodeRegShift(bits(2) type)
    case type of
        when '00' shift_t = SRTType_LSL;
        when '01' shift_t = SRTType_LSR;
        when '10' shift_t = SRTType_ASR;
        when '11' shift_t = SRTType_ROR;
    return shift_t;

// RRX_C()
// =====

(bits(N), bit) RRX_C(bits(N) x, bit carry_in)
    result = carry_in : x<N-1:1>;
    carry_out = x<0>;
    return (result, carry_out);

// RRX()
// =====

bits(N) RRX(bits(N) x, bit carry_in)
    (result, -) = RRX_C(x, carry_in);
    return result;

// Shift_C()
// =====

(bits(N), bit) Shift_C(bits(N) value, SRTType type, integer amount, bit carry_in)
    assert !(type == SRTType_RRX && amount != 1);

```

```

if amount == 0 then
    (result, carry_out) = (value, carry_in);
else
    case type of
        when SRTType_LSL
            (result, carry_out) = LSL_C(value, amount);
        when SRTType_LSR
            (result, carry_out) = LSR_C(value, amount);
        when SRTType_ASR
            (result, carry_out) = ASR_C(value, amount);
        when SRTType_ROR
            (result, carry_out) = ROR_C(value, amount);
        when SRTType_RRX
            (result, carry_out) = RRX_C(value, carry_in);

    return (result, carry_out);

// Shift()
// =====

bits(N) Shift(bits(N) value, SRTType type, integer amount, bit carry_in)
    (result, -) = Shift_C(value, type, amount, carry_in);
    return result;

// ThumbExpandImm_C()
// =====

(bits(32), bit) ThumbExpandImm_C(bits(12) imm12, bit carry_in)

    if imm12<11:10> == '00' then

        case imm12<9:8> of
            when '00'
                imm32 = ZeroExtend(imm12<7:0>, 32);
            when '01'
                if imm12<7:0> == '00000000' then UNPREDICTABLE;
                imm32 = '00000000' : imm12<7:0> : '00000000' : imm12<7:0>;
            when '10'
                if imm12<7:0> == '00000000' then UNPREDICTABLE;
                imm32 = imm12<7:0> : '00000000' : imm12<7:0> : '00000000';
            when '11'
                if imm12<7:0> == '00000000' then UNPREDICTABLE;
                imm32 = imm12<7:0> : imm12<7:0> : imm12<7:0> : imm12<7:0>;
            carry_out = carry_in;

        else

            unrotated_value = ZeroExtend('1':imm12<6:0>, 32);
            (imm32, carry_out) = ROR_C(unrotated_value, UInt(imm12<11:7>));

    return (imm32, carry_out);

// ThumbExpandImm()
// =====

bits(32) ThumbExpandImm(bits(12) imm12)

    // APSR.C argument to following function call does not affect the imm32 result.
    (imm32, -) = ThumbExpandImm_C(imm12, APSR.C);

    return imm32;

```

aarch32/functions/coproc

```

// AArch32 coprocessor functions

// GenerateCoproprocessorException()
// =====

GenerateCoproprocessorException()
    UNDEFINED;

// Coproc_Accepted()
// =====
// Determines whether the AArch32 CP14 or CP15 coprocessor instruction is accepted.

boolean Coproc_Accepted(integer cp_num, bits(32) instr)
    assert UsingAArch32();
    assert !(cp_num IN {10,11});
    assert cp_num == UInt(instr<11:8>);

    if instr<27:24> == '1110' && instr<4> == '1' && instr<31:28> != '1111' then
        // MRC/MCR
        nreg = 1;
        opc1 = UInt(instr<23:21>);
        opc2 = UInt(instr<7:5>);
        CRn = UInt(instr<19:16>);
        CRm = UInt(instr<3:0>);
    elseif instr<27:21> == '110010' && instr<31:28> != '1111' then
        // MRRC/MCRR
        nreg = 2;
        opc1 = UInt(instr<7:4>);
        CRm = UInt(instr<3:0>);
    elseif instr<27:25> == '110' && instr<31:28> != '1111' then
        // LDC/STC
        nreg = 0;
        CRn = UInt(instr<15:12>);
    else
        Unreachable();

    case cp_num of
        when 14
            if Coproc_UnallocatedAtEL(PSTATE.EL, instr) then UNDEFINED;
            // Coarse-grained decode of CP14 based on opc1 field
            case opc1 of
                when 0 accepted = CP14DebugInstrDecode(instr);
                when 1 accepted = CP14TraceInstrDecode(instr);
                when 6 accepted = CP14TEEinstrDecode(instr);
                otherwise
                    Unreachable(); // All other codes are UNDEFINED

        when 15
            // Check for coarse-grained Hyp traps
            if HaveEL(EL2) && !IsSecure() then
                // Disabled in HSTR
                if CRn != 14 && HSTR<CRn> == '1' then
                    if (PSTATE.EL == EL0 && Coproc_UnallocatedAtEL(EL0, instr) &&
                        boolean IMPLEMENTATION_DEFINED "choice to be UNDEFINED") then
                        UNDEFINED;
                    AArch32.CPRegTrap(EL2, instr);

                // Check for TIDCP as a coarse-grain check for PL1 accesses
                if (HCR.TIDCP == '1' && nreg == 1 &&
                    ((CRn == 9 && CRm IN {0, 2, 5,6,7,8 }) ||
                     (CRn == 10 && CRm IN {0,1, 4, 8 }) ||
                     (CRn == 11 && CRm IN {0,1,2,3,4,5,6,7,8,15}))) then
                    if (PSTATE.EL == EL0 && Coproc_UnallocatedAtEL(EL0, instr) &&
                        boolean IMPLEMENTATION_DEFINED "choice to be UNDEFINED") then
                        UNDEFINED;
                    AArch32.CPRegTrap(EL2, instr);

```

```
        if Coproc_UnallocatedAtEL(PSTATE.EL, instr) then
            UNDEFINED;
        else
            accepted = CP15InstrDecode(instr);

        otherwise
            // In ARMv8 this case should be Unreachable()
            Unreachable();

        return accepted;

// Coproc_DoneLoading()
// =====

boolean Coproc_DoneLoading(integer cp_num, bits(32) instr)

// Coproc_DoneStoring()
// =====

boolean Coproc_DoneStoring(integer cp_num, bits(32) instr)

// Coproc_GetOneWord()
// =====

bits(32) Coproc_GetOneWord(integer cp_num, bits(32) instr)

// Coproc_GetTwoWords()
// =====

(bits(32), bits(32)) Coproc_GetTwoWords(integer cp_num, bits(32) instr)

// Coproc_GetWordToStore()
// =====

bits(32) Coproc_GetWordToStore(integer cp_num, bits(32) instr)

// Coproc_InternalOperation()
// =====

Coproc_InternalOperation(integer cp_num, bits(32) instr)

// Coproc_SendLoadedWord()
// =====

Coproc_SendLoadedWord(bits(32) word, integer cp_num, bits(32) instr)

// Coproc_SendOneWord()
// =====

Coproc_SendOneWord(bits(32) word, integer cp_num, bits(32) instr)

// Coproc_SendTwoWords()
// =====

Coproc_SendTwoWords(bits(32) word2, bits(32) word1, integer cp_num, bits(32) instr)

// CP14DebugInstrDecode()
// =====

boolean CP14DebugInstrDecode(bits(32) instr)

// CP14JazelleInstrDecode()
// =====

boolean CP14JazelleInstrDecode(bits(32) instr)

// CP14TraceInstrDecode()
```

```
// =====
boolean CP14TraceInstrDecode(bits(32) instr)

// CP15InstrDecode()
// =====

boolean CP15InstrDecode(bits(32) instr)
```

aarch32/functions/exclusive

```
// AArch32.IsExclusiveVA()
// =====

// An optional IMPLEMENTATION DEFINED test for an exclusive access to a virtual
// address region of size bytes starting at address.
//
// It is permitted (but not required) for this function to return FALSE and
// and cause a store exclusive to fail if the virtual address region is not
// totally included within the region recorded by MarkExclusiveVA().
//
// It is always safe to return TRUE which will check the physical address only.
boolean AArch32.IsExclusiveVA(bits(32) address, integer processorid, integer size);

// AArch32.MarkExclusiveVA()
// =====

// Optionally record an exclusive access to the virtual address region of size bytes
// starting at address for processorid.
AArch32.MarkExclusiveVA(bits(32) address, integer processorid, integer size);

// AArch32.SetExclusiveMonitors()
// =====

// Sets the Exclusive Monitors for the current PE to record the addresses associated
// with the virtual address region of size bytes starting at address.
AArch32.SetExclusiveMonitors(bits(32) address, integer size)

    acctype = AccType_ATOMIC;
    iswrite = FALSE;
    aligned = (address != Align(address, size));

    memaddrdesc = AArch32.TranslateAddress(address, acctype, iswrite, aligned, size);

    // Check for aborts or debug exceptions
    if IsFault(memaddrdesc) then
        return;

    if memaddrdesc.memattrs.shareable then
        MarkExclusiveGlobal(memaddrdesc.paddress, ProcessorID(), size);

        MarkExclusiveLocal(memaddrdesc.paddress, ProcessorID(), size);

        AArch32.MarkExclusiveVA(address, ProcessorID(), size);

// AArch32.ExclusiveMonitorsPass()
// =====

// Return TRUE if the Exclusive Monitors for the current PE include all of the addresses
// associated with the virtual address region of size bytes starting at address.
// The immediately following memory write must be to the same addresses.
boolean AArch32.ExclusiveMonitorsPass(bits(32) address, integer size)

    // It is IMPLEMENTATION DEFINED whether the detection of memory aborts happens
    // before or after the check on the local Exclusive Monitor. As a result a failure
    // of the local monitor can occur on some implementations even if the memory
    // access would give an memory abort.
```

```

acctype = AccType_ATOMIC;
iswrite = TRUE;
aligned = (address == Align(address, size));

if !aligned then
    secondstage = FALSE;
    AArch32.Abort(address, AArch32.AlignmentFault(acctype, iswrite, secondstage));

passed = AArch32.IsExclusiveVA(address, ProcessorID(), size);
if !passed then
    return FALSE;

memaddrdesc = AArch32.TranslateAddress(address, acctype, iswrite, aligned, size);

// Check for aborts or debug exceptions
if IsFault(memaddrdesc) then
    AArch32.Abort(address, memaddrdesc.fault);

passed = IsExclusiveLocal(memaddrdesc.paddress, ProcessorID(), size);
if passed && memaddrdesc.memattrs.shareable then
    passed = IsExclusiveGlobal(memaddrdesc.paddress, ProcessorID(), size);

if passed then
    ClearExclusiveLocal(ProcessorID());

return passed;

```

aarch32/functions/float

```

// AArch32-specific FP functions

// CheckAdvSIMDEnabled()
// =====

CheckAdvSIMDEnabled()

    fpexc_check = TRUE;
    advsimd = TRUE;
    instr = ThisInstr();

    AArch32.CheckAdvSIMDOrFPEnabled(fpexc_check, advsimd, instr);
    // Return from CheckAdvSIMDOrFPEnabled() occurs only if Advanced SIMD access is permitted

    // Make temporary copy of D registers
    // _Dclone[] is used as input data for instruction pseudocode
    for i = 0 to 31
        _Dclone[i] = D[i];

    return;

// CheckAdvSIMDOrVFPEEnabled()
// =====

CheckAdvSIMDOrVFPEEnabled(boolean include_fpexc_check, boolean advsimd)
    instr = ThisInstr();
    AArch32.CheckAdvSIMDOrFPEnabled(include_fpexc_check, advsimd, instr);
    // Return from CheckAdvSIMDOrFPEnabled() occurs only if VFP access is permitted
    return;

// CheckCryptoEnabled32()
// =====

CheckCryptoEnabled32()
    CheckAdvSIMDEnabled();
    // Return from CheckAdvSIMDEnabled() occurs only if access is permitted
    return;

```

```

// CheckVFPEEnabled()
// =====

CheckVFPEEnabled(boolean include_fpxc_check)
    advsimd = FALSE;
    instr = ThisInstr();
    AArch32.CheckAdvSIMDOrFPEEnabled(include_fpxc_check, advsimd, instr);
    // Return from CheckAdvSIMDOrFPEEnabled() occurs only if VFP access is permitted
    return;

// FPHalvedSub()
// =====

bits(N) FPHalvedSub(bits(N) op1, bits(N) op2, FPCRType fpcr)
    assert N IN {32,64};
    rounding = FPRoundingMode(fpcr);
    (type1,sign1,value1) = FPUnpack(op1, fpcr);
    (type2,sign2,value2) = FPUnpack(op2, fpcr);
    (done,result) = FPProcessNaNs(type1, type2, op1, op2, fpcr);
    if !done then
        inf1 = (type1 == FPType_Infinity); inf2 = (type2 == FPType_Infinity);
        zero1 = (type1 == FPType_Zero); zero2 = (type2 == FPType_Zero);
        if inf1 && inf2 && sign1 == sign2 then
            result = FPDefaultNaN();
            FPProcessException(FPExc_InvalidOp, fpcr);
        elseif (inf1 && sign1 == '0') || (inf2 && sign2 == '1') then
            result = FPinfinity('0');
        elseif (inf1 && sign1 == '1') || (inf2 && sign2 == '0') then
            result = FPinfinity('1');
        elseif zero1 && zero2 && sign1 != sign2 then
            result = FPZero(sign1);
        else
            result_value = (value1 - value2) / 2.0;
            if result_value == 0.0 then // Sign of exact zero result depends on rounding mode
                result_sign = if rounding == FPRounding_NEGINF then '1' else '0';
                result = FPZero(result_sign);
            else
                result = FPRound(result_value, fpcr);
    return result;

// FPrecipStep()
// =====

bits(32) FPrecipStep(bits(32) op1, bits(32) op2)
    FPCRType fpcr = StandardFPCRValue();
    (type1,sign1,value1) = FPUnpack(op1, fpcr);
    (type2,sign2,value2) = FPUnpack(op2, fpcr);
    (done,result) = FPProcessNaNs(type1, type2, op1, op2, fpcr)
    if !done then
        inf1 = (type1 == FPType_Infinity); inf2 = (type2 == FPType_Infinity);
        zero1 = (type1 == FPType_Zero); zero2 = (type2 == FPType_Zero);
        bits(32) product();
        if(inf1 && zero2) || (zero1 && inf2) then
            product = FPZero('0');
        else
            product = FPMul(op1, op2, fpcr);
            result = FPSub(FPTwo('0'), product, fpcr);
    return result;

// FPRSqrtStep()
// =====

bits(32) FPRSqrtStep(bits(32) op1, bits(32) op2)
    FPCRType fpcr = StandardFPCRValue();
    (type1,sign1,value1) = FPUnpack(op1, fpcr);
    (type2,sign2,value2) = FPUnpack(op2, fpcr);
    (done,result) = FPProcessNaNs(type1, type2, op1, op2, fpcr);

```

```

    if !done then
      inf1 = (type1 == FPType_Infinity); inf2 = (type2 == FPType_Infinity);
      zero1 = (type1 == FPType_Zero); zero2 = (type2 == FPType_Zero);
      bits(32) product;
      if (inf1 && zero2) || (zero1 && inf2) then
        product = FPZero('0');
      else
        product = FPMul(op1, op2, fpcr);
        result = FPHalvedSub(FPThree('0'), product, fpcr);
      return result;
  
```

```

// StandardFPSCRValue()
// =====
  
```

```

FPCRTYPE StandardFPSCRValue()
  return '00000' : FPSCR.AHP : '11000000000000000000000000000000';
  
```

```

// SerializeVFP()
// =====
  
```

```

SerializeVFP()
  
```

```

// VFPExcBarrier()
// =====
  
```

```

VFPExcBarrier()
  
```

```

// VFPSmallRegisterBank()
// =====
  
```

```

boolean VFPSmallRegisterBank()
  
```

aarch32/functions/memory

```

// AArch32.CheckAlignment()
// =====
  
```

```

boolean AArch32.CheckAlignment(bits(32) address, integer size, AccType acctype, boolean iswrite)
  
```

```

    aligned = (address == Align(address, size));
    A = (if PSTATE.EL == EL2 then HSCTLR.A else SCTLR.A);

    if !aligned && (acctype == AccType_ATOMIC || acctype == AccType_ORDERED || A == '1') then
      secondstage = FALSE;
      AArch32.Abort(address, AArch32.AlignmentFault(acctype, iswrite, secondstage));

    return aligned;
  
```

```

// MemA_with_type[] - non-assignment (read) form
// =====
  
```

```

bits(size*8) MemA_with_type(bits(32) address, integer size, AccType acctype, boolean wasaligned)
  assert size IN {1, 2, 4, 8, 16};
  assert address == Align(address, size);
  
```

```

  AddressDescriptor memaddrdesc;
  bits(size*8) value;
  iswrite = FALSE;
  
```

```

  // MMU or MPU
  memaddrdesc = AArch32.TranslateAddress(address, acctype, iswrite, wasaligned, size);
  
```

```

  // Check for aborts or debug exceptions
  if IsFault(memaddrdesc) then
    AArch32.Abort(address, memaddrdesc.fault);
  
```

```

  // Memory array access
  
```



```

    value = _Mem[memaddrdesc, size, acctype];
    return value;

// MemA_with_type[] - assignment (write) form
// =====

MemA_with_type[bits(32) address, integer size, AccType acctype, boolean wasaligned] = bits(size*8) value
    assert size IN {1, 2, 4, 8, 16};
    assert address == Align(address, size);

    AddressDescriptor memaddrdesc;
    iswrite = TRUE;

    // MMU or MPU
    memaddrdesc = AArch32.TranslateAddress(address, acctype, iswrite, wasaligned, size);

    // Check for aborts or debug exceptions
    if IsFault(memaddrdesc) then
        AArch32.Abort(address, memaddrdesc.fault);

    // Effect on exclusives
    if memaddrdesc.memattrs.shareable then
        ClearExclusiveByAddress(memaddrdesc.paddress, ProcessorID(), size);

    // Memory array access
    _Mem[memaddrdesc, size, acctype] = value;
    return;

// MemU_with_type[] - non-assignment (read) form
// =====

bits(size*8) MemU_with_type[bits(32) address, integer size, AccType acctype]
    assert size IN {1, 2, 4, 8, 16};
    bits(size*8) value;
    integer i;
    boolean iswrite = FALSE;

    aligned = AArch32.CheckAlignment(address, size, acctype, iswrite);

    if !aligned then
        assert size > 1;
        value<7:0> = MemA_with_type[address, 1, acctype, aligned];

        // For subsequent bytes it is CONSTRAINED UNPREDICTABLE whether an unaligned Device memory
        // access will generate an Alignment Fault, as to get this far means the first byte did
        // not, so we must be changing to a new translation page.
        c = ConstrainUnpredictable();
        assert c IN {Constraint_FAULT, Constraint_NONE};
        if c == Constraint_NONE then aligned = TRUE;

        for i = 1 to size-1
            value<8*i+7:8*i> = MemA_with_type[address+i, 1, acctype, aligned];
    else
        value = MemA_with_type[address, size, acctype, aligned];

    if BigEndian() then
        value = BigEndianReverse(value);
    return value;

// MemU_with_type[] - assignment (write) form
// =====

MemU_with_type[bits(32) address, integer size, AccType acctype] = bits(size*8) value
    integer i;
    boolean iswrite = TRUE;

    if BigEndian() then
        value = BigEndianReverse(value);

```

```

aligned = AArch32.CheckAlignment(address, size, acctype, iswrite);

if !aligned then
    assert size > 1;
    MemA_with_type[address, 1, acctype, aligned] = value<7:0>;

    // For subsequent bytes it is CONSTRAINED UNPREDICTABLE whether an unaligned Device memory
    // access will generate an Alignment Fault, as to get this far means the first byte did
    // not, so we must be changing to a new translation page.
    c = ConstrainUnpredictable();
    assert c IN {Constraint_FAULT, Constraint_NONE};
    if c == Constraint_NONE then aligned = TRUE;

    for i = 1 to size-1
        MemA_with_type[address+i, 1, acctype, aligned] = value<8*i+7:8*i>;
else
    MemA_with_type[address, size, acctype, aligned] = value;
return;

// MemA[] - non-assignment form
// =====

bits(8*size) MemA[bits(32) address, integer size]
    acctype = AccType_ATOMIC;
    return MemU_with_type[address, size, acctype];

// MemA[] - assignment form
// =====

MemA[bits(32) address, integer size] = bits(8*size) value
    acctype = AccType_ATOMIC;
    MemU_with_type[address, size, acctype] = value;
    return;

// MemU[] - non-assignment form
// =====

bits(8*size) MemU[bits(32) address, integer size]
    acctype = AccType_NORMAL;
    return MemU_with_type[address, size, acctype];

// MemU[] - assignment form
// =====

MemU[bits(32) address, integer size] = bits(8*size) value
    acctype = AccType_NORMAL;
    MemU_with_type[address, size, acctype] = value;
    return;

// MemU_unpriv[] - non-assignment form
// =====

bits(8*size) MemU_unpriv[bits(32) address, integer size]
    acctype = AccType_UNPRIV;
    return MemU_with_type[address, size, acctype];

// MemU_unpriv[] - assignment form
// =====

MemU_unpriv[bits(32) address, integer size] = bits(8*size) value
    acctype = AccType_UNPRIV;
    MemU_with_type[address, size, acctype] = value;
    return;

// NullCheckIfThumbEE()
// =====

```

```

NullCheckIfThumbEE(integer n)
    if CurrentInstrSet() == InstrSet_T32EE then
        if n == 15 then
            if IsZero(Align(PC,4)) then UNPREDICTABLE;
        elsif n == 13 then
            if IsZero(SP) then UNPREDICTABLE;
        else
            if IsZero(R[n]) then
                LR = PC<31:1> : '1'; // PC holds this instruction's address plus 4
                ITSTATE.IT = '00000000';
                BranchWritePC(TEEHBR - 4);
                EndOfInstruction();
            return;

// Hint_PreloadDataForWrite()
// =====

Hint_PreloadDataForWrite(bits(32) address)

// Hint_PreloadData()
// =====

Hint_PreloadData(bits(32) address)

// Hint_PreloadInstr()
// =====

Hint_PreloadInstr(bits(32) address)

// AArch32 vector code also calls GenerateAlignmentException()

// GenerateAlignmentException()
// =====

GenerateAlignmentException()

```

aarch32/functions/registers

```

// AArch32 general-purpose registers

// Monitor_mode_registers
// =====
// The Monitor mode registers do not map to X registers, so must be defined separately

bits(32) SP_mon;

bits(32) LR_mon;

// RBankSelect()
// =====

integer RBankSelect(bits(5) mode, integer usr, integer fiq, integer irq,
                    integer svc, integer abt, integer und, integer hyp)

    case mode of
        when M32_User    result = usr; // User mode
        when M32_FIQ    result = fiq; // FIQ mode
        when M32_IRQ    result = irq; // IRQ mode
        when M32_Svc    result = svc; // Supervisor mode
        when M32_Abort  result = abt; // Abort mode
        when M32_Hyp    result = hyp; // Hyp mode
        when M32_Undef  result = und; // Undefined mode
        when M32_System result = usr; // System mode uses User mode registers
        otherwise       Unreachable(); // Monitor mode

    return result;

```

```

// LookUpRIndex()
// =====

integer LookUpRIndex(integer n, bits(5) mode)
    assert n >= 0 && n <= 14;

    case n of // Select index by mode:   usr fiq irq svc abt und hyp
        when 8   result = RBankSelect(mode, 8, 24, 8, 8, 8, 8, 8);
        when 9   result = RBankSelect(mode, 9, 25, 9, 9, 9, 9, 9);
        when 10  result = RBankSelect(mode, 10, 26, 10, 10, 10, 10, 10);
        when 11  result = RBankSelect(mode, 11, 27, 11, 11, 11, 11, 11);
        when 12  result = RBankSelect(mode, 12, 28, 12, 12, 12, 12, 12);
        when 13  result = RBankSelect(mode, 13, 29, 17, 19, 21, 23, 15);
        when 14  result = RBankSelect(mode, 14, 30, 16, 18, 20, 22, 14);
        otherwise result = n;

    return result;

// Rmode[] - non-assignment form
// =====

bits(32) Rmode[integer n, bits(5) mode]
    assert n >= 0 && n <= 14;

    // Check for attempted use of Monitor mode in Non-secure state.
    if !IsSecure() then assert mode != M32_Monitor;
    assert !BadMode(mode);

    if mode == M32_Monitor && n == 13 then
        return SP_mon;
    elseif mode == M32_Monitor && n == 14 then
        return LR_mon;
    else
        return _R[LookUpRIndex(n, mode)]<31:0>;

// Rmode[] - assignment form
// =====

Rmode[integer n, bits(5) mode] = bits(32) value
    assert n >= 0 && n <= 14;

    // Check for attempted use of Monitor mode in Non-secure state.
    if !IsSecure() then assert mode != M32_Monitor;
    assert !BadMode(mode);

    if mode == M32_Monitor && n == 13 then
        SP_mon = value;
    elseif mode == M32_Monitor && n == 14 then
        LR_mon = value;
    else
        // It is CONSTRAINED UNPREDICTABLE whether the upper 32 bits of the X
        // register are unchanged or set to zero. This is also tested for on
        // exception entry, as this applies to all AArch32 registers.
        if ConstrainUnpredictableBool() then
            _R[LookUpRIndex(n, mode)] = ZeroExtend(value);
        else
            _R[LookUpRIndex(n, mode)]<31:0> = value;

    return;

// R[] - assignment form
// =====

R[integer n] = bits(32) value
    Rmode[n, PSTATE.M] = value;
    return;

// R[] - non-assignment form

```

```

// =====

bits(32) R[integer n]
  if n == 15 then
    offset = (if CurrentInstrSet() == InstrSet_A32 then 8 else 4);
    return _PC<31:0> + offset;
  else
    return Rmode[n, PSTATE.M];

// Aliases for AArch32 general-purpose registers

// LR - assignment form
// =====

LR = bits(32) value
  R[14] = value;
  return;

// LR - non-assignment form
// =====

bits(32) LR    return R[14];

// SP - assignment form
// =====

SP = bits(32) value
  R[13] = value;
  return;

// SP - non-assignment form
// =====

bits(32) SP
  return R[13];

// AArch32 SIMD&FP registers

// S[] - non-assignment form
// =====

bits(32) S[integer n]
  assert n >= 0 && n <= 31;
  base = (n MOD 4) * 32;
  return _V[n DIV 4]<base+31:base>;

// S[] - assignment form
// =====

S[integer n] = bits(32) value
  assert n >= 0 && n <= 31;
  base = (n MOD 4) * 32;
  _V[n DIV 4]<base+31:base> = value;
  return;

// D[] - non-assignment form
// =====

bits(64) D[integer n]
  assert n >= 0 && n <= 31;
  base = (n MOD 2) * 64;
  return _V[n DIV 2]<base+63:base>;

// D[] - assignment form
// =====

D[integer n] = bits(64) value
  assert n >= 0 && n <= 31;

```

```

    base = (n MOD 2) * 64;
    _V[n DIV 2]<base+63:base> = value;
    return;

// Q[] - non-assignment form
// =====

bits(128) Q[integer n]
    assert n >= 0 && n <= 15;
    return _V[n];

// Q[] - assignment form
// =====

Q[integer n] = bits(128) value
    assert n >= 0 && n <= 15;
    _V[n] = value;
    return;

// AArch32 program counter

// PC - non-assignment form
// =====

bits(32) PC
    return R[15];          // This includes the offset from AArch32 state

// Other AArch32 registers functions

// ALUWritePC()
// =====

ALUWritePC(bits(32) address)
    if CurrentInstrSet() == InstrSet_A32 then
        BXWritePC(address);
    else
        BranchWritePC(address);

// BranchWritePC()
// =====

BranchWritePC(bits(32) address)
    if CurrentInstrSet() == InstrSet_A32 then
        address<1:0> = '00';
    else
        address<0> = '0';
        BranchTo(address, BranchType_UNKNOWN);

// BXWritePC()
// =====

BXWritePC(bits(32) address)
    if CurrentInstrSet() == InstrSet_T32EE then
        if address<0> == '1' then
            // Remaining in T32EE state
            address<0> = '0';
        else
            // For branches to an unaligned PC counter in T32EE state, the processor takes the
            // branch and does one of:
            // * take the branch and remain in T32EE state
            // * take the branch and enter A32 state
            // * take the branch and set PSTATE.IL to 1, meaning the target generates an Illegal
            // Execution State exception.
            UNPREDICTABLE;
    else // T32 or A32 state
        if address<0> == '1' then
            SelectInstrSet(InstrSet_T32);
            address<0> = '0';

```

```

else
    SelectInstrSet(InstrSet_A32);
    // For branches to an unaligned PC counter in A32 state, the processor takes the branch
    // and does one of:
    // * Forces the address to be aligned
    // * Leaves the PC unaligned, meaning the target generates a PC Alignment fault.
    if address<1> == '1' && ConstrainUnpredictableBool() then
        address<1> = '0';
    BranchTo(address, BranchType_UNKNOWN);

// LoadWritePC()
// =====

LoadWritePC(bits(32) address)
    BXWritePC(address);

// PCStoreValue()
// =====

bits(32) PCStoreValue()
    // This function returns the PC value. On architecture versions before ARMv7, it
    // is permitted to instead return PC+4, provided it does so consistently. It is
    // used only to describe ARM instructions, so it returns the address of the current
    // instruction plus 8 (normally) or 12 (when the alternative is permitted).
    return PC;

// _Dclone[]
// =====

// Clone the 64-bit Advanced SIMD and VFP extension register bank for use as input to
// instruction pseudocode, to avoid read-after-write for Advanced SIMD and VFP operations.

array bits(64) _Dclone[0..31];

// Din[] - non-assignment form
// =====

bits(64) Din[integer n]
    assert n >= 0 && n <= 31;
    if n >= 16 && VFPSmallRegisterBank() then UNDEFINED;
    return _Dclone[n];

// Qin[] - non-assignment form
// =====

bits(128) Qin[integer n]
    assert n >= 0 && n <= 15;
    return Din[2*n+1]:Din[2*n];

```

aarch32/functions/system

```

// AArch32.WriteMode()
// =====

// Function for dealing with writes to CPSR.M from AArch32 state only.
// This ensures that PSTATE.EL and PSTATE.SP are always valid.
//
// The functions in [v7A] that write to CPSR.M directly are:
// TakeReset, TakeUndefInstrException, TakeSVCEException, TakePrefetchAbortException,
// TakeDataAbortException, TakeVirtualAbortException, TakePhysicalIRQException,
// TakeVirtualIRQException, TakePhysicalFIQException, TakeVirtualFIQException,
// EnterMonitorMode, EnterHypMode and CPSRWriteByInstr

AArch32.WriteMode(bits(5) mode)
    (valid,e1) = ELFromM32(mode);
    if !valid then
        PSTATE.IL = '1';

```

```

else
    PSTATE.M = mode;
    PSTATE.EL = e1;
    PSTATE.nRW = '1';
    PSTATE.SP = if mode IN {M32_User,M32_System} then '0' else '1';
return;

// AArch32.ITAdvance()
// =====

AArch32.ITAdvance()
    if PSTATE.IT<2:0> == '000' then
        PSTATE.IT = '0000000';
    else
        PSTATE.IT<4:0> = LSL(PSTATE.IT<4:0>, 1);
    return;

// AArch32.ExceptionReturn()
// =====

AArch32.ExceptionReturn(bits(32) new_pc, bits(32) spsr)

    // Attempts to change to an illegal mode, or return to Hyp mode with PSTATE.<J,T> = '11'
    // will invoke the Illegal Execution State mechanism
    CPSRWriteByInstr(spsr, '1111', TRUE);

    if PSTATE.T == '1' then // T32 or T32EE
        new_pc<0> = '0';
    elseif spsr<5> == '1' && ConstrainUnpredictableBool() then
        // Arrived in A32 state but was attempting change to T32 or T32EE
        new_pc<0> = '0';
    else // A32
        new_pc<1:0> = '00';

    BranchTo(new_pc, BranchType_UNKNOWN);

// CPSRType
// =====
// Placeholder for AArch32 CPSR special-purpose register definition, subset of PSTATE

type CPSRType;

// APSRType
// =====
// Placeholder for AArch32 APSR special-purpose register definition, application level subset of CPSR

type APSRType;

// ITSTATEType
// =====
// Placeholder for AArch32 ITSTATE register definitions

type ITSTATEType;

// CPSR - non-assignment form
// =====

CPSRType CPSR
    bits(32) cpsr = GetSPSRFromPSTATE();
    return cpsr;

// CPSR - assignment form
// =====

CPSR = CPSRType cpsr
    bits(32) v = cpsr;
    SetPSTATEFromSPSR(v);

```



```

// ISETSTATE - non-assignment form
// =====

bits(2) ISETSTATE
    return CPSR.<J,T>;

// ISETSTATE - assignment form
// =====

ISETSTATE = bits(2) iset
    CPSR.<J,T> = iset;

// ITSTATE - non-assignment form
// =====

ITSTATEType ITSTATE
    bits(8) v = CPSR.IT;
    return v;

// ITSTATE - assignment form
// =====

ITSTATE = ITSTATEType it
    bits(8) v = it;
    CPSR.IT = v;

// ENDIANSTATE - non-assignment form
// =====

bits(1) ENDIANSTATE
    return CPSR.E;

// ENDIANSTATE - assignment form
// =====

ENDIANSTATE = bits(1) e
    CPSR.E = e;

// APSR - non-assignment form
// =====

APSRType APSR
    APSRType apsr = Zeros();
    apsr.<N,Z,C,V,Q,GE> = CPSR.<N,Z,C,V,Q,GE>;
    return apsr;

// APSR - assignment form
// =====

APSR = APSRType apsr
    CPSR.<N,Z,C,V,Q,GE> = apsr.<N,Z,C,V,Q,GE>;

// Other AArch32 system functions

// BadMode()
// =====

boolean BadMode(bits(5) mode)
    case mode of
        when M32_User    result = FALSE;
        when M32_FIQ    result = FALSE;
        when M32_IRQ    result = FALSE;
        when M32_Svc    result = FALSE;
        when M32_Monitor result = HaveEL(EL3);
        when M32_Abort   result = FALSE;
        when M32_Hyp     result = HaveEL(EL2);
        when M32_Undef   result = FALSE;
        when M32_System  result = FALSE;

```

```

        otherwise    result = TRUE;
    return result;

// BankedRegisterAccessValid()
// =====
// Checks for MRS (Banked register) or MSR (Banked register) accesses to registers
// other than the SPSRs that are invalid. This includes ELR_hyp accesses.

BankedRegisterAccessValid(bits(5) SYSm, bits(5) mode)

    if SYSm<4:3> == '00' then // User mode registers
        if SYSm<2:0> == '111' then
            UNPREDICTABLE;
        elseif SYSm<2:0> == '110' then // LR_usr
            if mode IN {M32_Hyp,M32_System} then
                UNPREDICTABLE;
            elseif SYSm<2:0> == '101' then // SP_usr
                if mode == M32_System then
                    UNPREDICTABLE;
                elseif mode != M32_FIQ then
                    UNPREDICTABLE;

    elseif SYSm<4:3> == '01' then // FIQ mode registers
        if SYSm<2:0> == '111' || mode == M32_FIQ then
            UNPREDICTABLE;

    elseif SYSm<4:3> == '11' then // Registers for Monitor or Hyp mode
        if SYSm<2> == '0' then
            UNPREDICTABLE;
        elseif SYSm<1> == '0' then // LR_mon or SP_mon
            if !IsSecure() || mode == M32_Monitor then
                UNPREDICTABLE;
            elseif SYSm<0> == '0' then // ELR_hyp, only from Monitor or Hyp mode
                if !(mode == M32_Monitor) || (mode == M32_Hyp) then
                    UNPREDICTABLE;
            else // SP_hyp, only from Monitor mode
                if mode != M32_Monitor then
                    UNPREDICTABLE;

    return;

// ConditionPassed()
// =====

boolean ConditionPassed()
    return ConditionHolds(AArch32.CurrentCond());

// CPSRWriteByInstr()
// =====

CPSRWriteByInstr(bits(32) value, bits(4) bytemask, boolean is_excpt_return)
    privileged = CurrentModeIsNotUser();

    new_cpsr = CPSR;

    if bytemask<3> == '1' then
        new_cpsr<31:27> = value<31:27>; // N,Z,C,V,Q flags
        if is_excpt_return then
            new_cpsr<26:24> = value<26:24>; // IT<1:0>,J execution state bits

    if bytemask<2> == '1' then
        // bits <23:20> are RES0
        new_cpsr<19:16> = value<19:16>; // GE<3:0> flags

    if bytemask<1> == '1' then
        if is_excpt_return then
            new_cpsr<15:10> = value<15:10>; // IT<7:2> execution state bits
            new_cpsr<9> = value<9>; // E bit is user-writable

```

```

        if privileged then
            new_cpsr<8> = value<8>;           // A interrupt mask

    if bytemask<0> == '1' then
        if privileged then
            new_cpsr<7> = value<7>;           // I interrupt mask
            new_cpsr<6> = value<6>;           // F interrupt mask
        if is_excpt_return then
            new_cpsr<5> = value<5>;           // T execution state bit
        if privileged then
            new_cpsr<4:0> = value<4:0>;       // mode bits

    // Attempts to change to an illegal mode, or return to Hyp mode with CPSR.<J,T> = '11'
    // will invoke the Illegal Execution State mechanism
    CPSR = new_cpsr;                          // Assign new CPSR value

    return;

// CurrentModeIsHyp()
// =====

boolean CurrentModeIsHyp()
    if BadMode(CPSR.M) then UNPREDICTABLE;
    if CPSR.M == M32_Hyp then return TRUE;
    return FALSE; // Other modes

// CurrentModeIsNotUser()
// =====

boolean CurrentModeIsNotUser()
    if BadMode(CPSR.M) then UNPREDICTABLE;
    if CPSR.M == M32_User then return FALSE;
    return TRUE; // Other modes

// CurrentModeIsUserOrSystem()
// =====

boolean CurrentModeIsUserOrSystem()
    if BadMode(CPSR.M) then UNPREDICTABLE;
    if CPSR.M == M32_User then return TRUE;
    if CPSR.M == M32_System then return TRUE;
    return FALSE; // Other modes

// InITBlock()
// =====

boolean InITBlock()
    if CurrentInstrSet() IN {InstrSet_T32, InstrSet_T32EE} then
        return ITSTATE.IT<3:0> != '0000';
    else
        return FALSE;

// LastInITBlock()
// =====

boolean LastInITBlock()
    return (ITSTATE.IT<3:0> == '1000');

// SelectInstrSet()
// =====

SelectInstrSet(InstrSet iset)
    assert CurrentInstrSet() != InstrSet_A64;
    case iset of
        when InstrSet_A32
            assert CurrentInstrSet() != InstrSet_T32EE;
            ISETSTATE = '00';
        when InstrSet_T32

```

```

        ISETSTATE = '01';
    when InstrSet_T32EE
        assert CurrentInstrSet() != InstrSet_A32;
        ISETSTATE = '11';
    otherwise
        Unreachable();
    return;

// SPSRaccessValid()
// =====
// Checks for MRS (Banked register) or MSR (Banked register) accesses to the SPSRs
// that are UNPREDICTABLE.

SPSRaccessValid(bits(5) SYSm, bits(5) mode)
    case SYSm of
        when '01110' // SPSR_fiq
            if mode == M32_FIQ then UNPREDICTABLE;
        when '10000' // SPSR_irq
            if mode == M32_IRQ then UNPREDICTABLE;
        when '10010' // SPSR_svc
            if mode == M32_Svc then UNPREDICTABLE;
        when '10100' // SPSR_abt
            if mode == M32_Abort then UNPREDICTABLE;
        when '10110' // SPSR_und
            if mode == M32_Undef then UNPREDICTABLE;
        when '11100' // SPSR_mon
            if mode == M32_Monitor || !IsSecure() then UNPREDICTABLE;
        when '11110' // SPSR_hyp
            if mode != M32_Monitor then UNPREDICTABLE;
        otherwise
            UNPREDICTABLE;

    return;

// SPSRwriteByInstr()
// =====

SPSRwriteByInstr(bits(32) value, bits(4) bytemask)

    if CurrentModeIsUserOrSystem() then UNPREDICTABLE;

    if bytemask<3> == '1' then
        SPSR[]<31:24> = value<31:24>; // N,Z,C,V,Q flags, IT<1:0>,J execution state bits

    if bytemask<2> == '1' then
        // bits <23:20> are reserved SBZP bits
        SPSR[]<19:16> = value<19:16>; // GE<3:0> flags

    if bytemask<1> == '1' then
        SPSR[]<15:8> = value<15:8>; // IT<7:2> execution state bits, E bit, A interrupt mask

    if bytemask<0> == '1' then
        SPSR[]<7:5> = value<7:5>; // I,F interrupt masks, T execution state bit
        if BadMode(value<4:0>) then // Mode bits
            UNPREDICTABLE;
        else
            SPSR[]<4:0> = value<4:0>;

    return;

// CurrentCond()
// =====

bits(4) AArch32.CurrentCond()

// GenerateIntegerZeroDivide()
// =====

```

```

GenerateIntegerZeroDivide()

// IntegerZeroDivideTrappingEnabled()
// =====

boolean IntegerZeroDivideTrappingEnabled()

// JazelleAcceptsExecution()
// =====

boolean JazelleAcceptsExecution()

```

aarch32/functions/v6simd

```

// AArch32 functions for v6 SIMD operations

// UnsignedSat()
// =====

bits(N) UnsignedSat(integer i, integer N)
    (result, -) = UnsignedSatQ(i, N);
    return result;

// SignedSat()
// =====

bits(N) SignedSat(integer i, integer N)
    (result, -) = SignedSatQ(i, N);
    return result;

// Sat()
// =====

bits(N) Sat(integer i, integer N, boolean unsigned)
    result = if unsigned then UnsignedSat(i, N) else SignedSat(i, N);
    return result;

```

G.2.4 aarch32/translation

This section contains the pseudocode for AArch32 state that relates to address translation.

aarch32/translation/attrs

```

// ~~~~~
// AArch32 Translation System
// ~~~~~

// ~~~~~
// Functions for decoding attributes

// AArch32.TranslateAddressS10ff()
// =====
// Called for stage 1 translations when translation is disabled to supply a default translation.
// Note that there are additional constraints on instruction prefetching that are not described in
// this pseudocode.

TLBRecord AArch32.TranslateAddressS10ff(bits(32) vaddress, AccType acctype, boolean iswrite)
    assert ELUsingAArch32(TranslationRegime());

    TLBRecord result;

    if HaveEL(EL2) && !IsSecure() && PSTATE.EL != EL2 && HCR.DC == '1' then
        // Use default cacheable settings
        result.addrdesc.memattrs.type = MemType_Normal;
        result.addrdesc.memattrs.device = DeviceType_UNKNOWN;

```

```

        result.addrdesc.memattrs.inner.attrs = MemAttr_WB;           // Write-back
        result.addrdesc.memattrs.inner.hints = MemHint_RWA;
        result.addrdesc.memattrs.shareable = FALSE;
        result.addrdesc.memattrs.outershareable = FALSE;
        if HCR.VM != '1' then UNPREDICTABLE;
    elsif acctype != Acctype_IFETCH then
        // Treat data as Device
        result.addrdesc.memattrs.type = MemType_Device;
        result.addrdesc.memattrs.device = DeviceType_nGnRnE;
        result.addrdesc.memattrs.inner = MemAttrHints UNKNOWN;
        result.addrdesc.memattrs.shareable = TRUE;
        result.addrdesc.memattrs.outershareable = TRUE;
    else
        // Instruction cacheability controlled by SCTL/HSCTL.I
        if PSTATE.EL == EL2 then
            cacheable = HSCTL.I == '1';
        else
            cacheable = SCTL.I == '1';
        result.addrdesc.memattrs.type = MemType_Normal;
        result.addrdesc.memattrs.device = DeviceType UNKNOWN;
        if cacheable then
            result.addrdesc.memattrs.inner.attrs = MemAttr_WT;
            result.addrdesc.memattrs.inner.hints = MemHint_RA;
        else
            result.addrdesc.memattrs.inner.attrs = MemAttr_NC;
            result.addrdesc.memattrs.inner.hints = MemHint_No;
            result.addrdesc.memattrs.shareable = TRUE;
            result.addrdesc.memattrs.outershareable = TRUE;

        result.addrdesc.memattrs.outer = result.addrdesc.memattrs.inner;

        result.perms.ap = bits(3) UNKNOWN;
        result.perms.xn = '0';
        result.perms.pxn = '0';

        result.nG = bit UNKNOWN;
        result.contiguous = boolean UNKNOWN;
        result.domain = bits(4) UNKNOWN;
        result.level = integer UNKNOWN;
        result.blocksize = integer UNKNOWN;
        result.addrdesc.paddress.physicaladdress = ZeroExtend(vaddress);
        result.addrdesc.paddress.NS = if IsSecure() then '0' else '1';
        result.addrdesc.fault = AArch32.NoFault();

        return result;

// AArch32.InstructionDevice()
// =====
// Instruction fetches from memory marked as Device but not execute-never might generate a
// Permission Fault but are otherwise treated as if from Normal Non-cacheable memory.

AddressDescriptor AArch32.InstructionDevice(AddressDescriptor addrdesc, bits(32) vaddress,
                                           bits(40) ipaddress, integer level, bits(4) domain,
                                           AccType acctype, boolean iswrite, boolean secondstage,
                                           boolean s2fs1walk)

    if ConstrainUnpredictableBool() then
        addrdesc.fault = AArch32.PermissionFault(ipaddress, domain, level, acctype, iswrite,
                                                secondstage, s2fs1walk);
    else
        addrdesc.memattrs.type = MemType_Normal;
        addrdesc.memattrs.device = DeviceType UNKNOWN;
        addrdesc.memattrs.inner.attrs = MemAttr_NC;
        addrdesc.memattrs.inner.hints = MemHint_No;
        addrdesc.memattrs.outer = addrdesc.memattrs.inner;
        addrdesc.memattrs.shareable = TRUE;
        addrdesc.memattrs.outershareable = TRUE;

```

```

return addrdesc;

// AArch32.S1AttrDecode()
// =====
// Converts the Stage 1 attribute fields, using the MAIR, to orthogonal
// attributes and hints.

MemoryAttributes AArch32.S1AttrDecode(bits(2) SH, bits(3) attr, AccType acctype)

    MemoryAttributes memattrs;

    if PSTATE.EL == EL2 then
        mair = HMAIR1:HMAIR0;
    else
        mair = MAIR1:MAIR0;
    index = 8 * UInt(attr);
    attrfield = mair<index+7:index>;

    if ((attrfield<7:4> != '0000' && attrfield<3:0> == '0000') ||
        (attrfield<7:4> == '0000' && !(attrfield<3:0> IN {'000x', '1x00'}))) then
        // Reserved, maps to an allocated value
        (-, attrfield) = ConstrainUnpredictableBits();

    if attrfield<7:4> == '0000' then // Device
        memattrs.type = MemType_Device;
        memattrs.inner = MemAttrHints UNKNOWN;
        memattrs.outer = MemAttrHints UNKNOWN;
        memattrs.shareable = TRUE;
        memattrs.outershareable = TRUE;
        case attrfield<3:0> of
            when '0000' memattrs.device = DeviceType_nGnRnE;
            when '0001' memattrs.device = DeviceType_nGnRE;
            when '1000' memattrs.device = DeviceType_nGRE;
            when '1100' memattrs.device = DeviceType_GRE;
            otherwise Unreachable(); // Reserved, handled above

    elsif attrfield<3:0> != '0000' then // Normal
        memattrs.type = MemType_Normal;
        memattrs.outer = LongConvertAttrHints(attrfield<7:4>, acctype);
        memattrs.inner = LongConvertAttrHints(attrfield<3:0>, acctype);
        memattrs.device = DeviceType UNKNOWN;
        memattrs.shareable = SH<1> == '1';
        memattrs.outershareable = SH == '10';

    else
        Unreachable(); // Reserved, handled above

    return memattrs;

// AArch32.DefaultTEXDecode()
// =====

MemoryAttributes AArch32.DefaultTEXDecode(bits(3) TEX, bit C, bit B, bit S, AccType acctype)

    MemoryAttributes memattrs;

    // Reserved values map to allocated values
    if (TEX == '001' && C:B == '01') || (TEX == '010' && C:B != '00') || TEX == '011' then
        bits(5) texcb;
        (-, texcb) = ConstrainUnpredictableBits();
        TEX = texcb<4:2>; C = texcb<1>; B = texcb<0>;

    case TEX:C:B of
        when '00000'
            // Device-nGnRnE
            memattrs.type = MemType_Device;
            memattrs.device = DeviceType_nGnRnE;
            memattrs.shareable = TRUE;

```

```

when '00001'
  // Device-nGnRE Shareable
  memattrs.type = MemType_Device;
  memattrs.device = DeviceType_nGnRE;
  memattrs.shareable = TRUE;
when '00010', '00011', '00100'
  // Write-back or Write-through Read allocate, or Non-cacheable
  memattrs.type = MemType_Normal;
  memattrs.inner = ShortConvertAttrHints(C:B, acctype);
  memattrs.outer = ShortConvertAttrHints(C:B, acctype);
  memattrs.shareable = (S == '1');
when '00110'
  memattrs = MemoryAttributes IMPLEMENTATION_DEFINED;
when '00111'
  // Non-cacheable, or Write-back Write allocate
  memattrs.type = MemType_Normal;
  memattrs.inner = ShortConvertAttrHints('01', acctype);
  memattrs.outer = ShortConvertAttrHints('01', acctype);
  memattrs.shareable = (S == '1');
when '01000'
  // Device-nGnRE Non-shareable
  memattrs.type = MemType_Device;
  memattrs.device = DeviceType_nGnRE;
  memattrs.shareable = FALSE;
when '1xxxx'
  // Cacheable, TEX<1:0> = Outer attrs, {C,B} = Inner attrs
  memattrs.type = MemType_Normal;
  memattrs.inner = ShortConvertAttrHints(C:B, acctype);
  memattrs.outer = ShortConvertAttrHints(TEX<1:0>, acctype);
  memattrs.shareable = (S == '1');
otherwise
  // Reserved, handled above
  Unreachable();

// transient bits are not supported in this format
memattrs.inner.transient = FALSE;
memattrs.outer.transient = FALSE;

if memattrs.type == MemType_Device then
  memattrs.inner = MemAttrHints UNKNOWN;
  memattrs.outer = MemAttrHints UNKNOWN;
else
  memattrs.device = DeviceType UNKNOWN;

memattrs.outershareable = memattrs.shareable;

return memattrs;

// AArch32.RemappedTEXDecode()
// =====
MemoryAttributes AArch32.RemappedTEXDecode(bits(3) TEX, bit C, bit B, bit S, AccType acctype)

MemoryAttributes memattrs;

region = UInt(TEX<0>:C:B); // TEX<2:1> are ignored in this mapping scheme
if region == 6 then
  memattrs = MemoryAttributes IMPLEMENTATION_DEFINED;
else
  base = 2 * region;
  attrfield = PRRR<base+1:base>;

  if attrfield == '11' then // Reserved, maps to allocated value
    (-, attrfield) = ConstrainUnpredictableBits();

  case attrfield of
    when '00' // Device-nGnRE
      memattrs.type = MemType_Device;

```



```

        memattrs.device = DeviceType_nGnRnE;
        memattrs.shareable = TRUE;
        memattrs.outershareable = TRUE;
    when '01' // Device-nGnRE
        memattrs.type = MemType_Device;
        memattrs.device = DeviceType_nGnRnE;
        memattrs.shareable = TRUE;
        memattrs.outershareable = TRUE;
    when '10'
        memattrs.type = MemType_Normal;
        memattrs.inner = ShortConvertAttrHints(NMRR<base+1:base>, acctype);
        memattrs.outer = ShortConvertAttrHints(NMRR<base+17:base+16>, acctype);
        s_bit = if S == '0' then PRRR.NS0 else PRRR.NS1;
        memattrs.shareable = (s_bit == '1');
        memattrs.outershareable = (s_bit == '1' && PRRR<region+24> == '0');
    when '11'
        Unreachable();

// transient bits are not supported in this format
memattrs.inner.transient = FALSE;
memattrs.outer.transient = FALSE;

if memattrs.type == MemType_Device then
    memattrs.inner = MemAttrHints UNKNOWN;
    memattrs.outer = MemAttrHints UNKNOWN;
else
    memattrs.device = DeviceType UNKNOWN;

return memattrs;

```

aarch32/translation/checks

```

// ~~~~~
// AArch32 Translation System
// ~~~~~

// ~~~~~
// Functions for checking permissions
// ~~~~~

// AArch32.CheckDomain()
// =====

(boolea, FaultRecord) AArch32.CheckDomain(bits(4) domain, bits(32) vaddress, integer level,
                                         Acctype acctype, boolea iswrite)

    index = 2 * UInt(domain);
    attrfield = DACR<index+1:index>;

    if attrfield == '10' then // Reserved, maps to an allocated value
        // Reserved value maps to an allocated value
        (-, attrfield) = ConstrainUnpredictableBits();

    if attrfield == '00' then
        fault = AArch32.DomainFault(domain, level, acctype, iswrite);
    else
        fault = AArch32.NoFault();

    permissioncheck = (attrfield == '01');

    return (permissioncheck, fault);

// AArch32.CheckPermission()
// =====
// Function used for permission checking from AArch32 stage 1 translations

FaultRecord AArch32.CheckPermission(Permissions perms, bits(32) vaddress, integer level,
                                     bits(4) domain, bit NS, Acctype acctype, boolea iswrite)

```

```

assert ELUsingAArch32(TranslationRegime());

if PSTATE.EL != EL2 then
    wxn = SCTL.R.WXN == '1';
    if TTBCR.EAE == '1' || SCTL.R.AFE == '1' || perms.ap<0> == '1' then
        priv_r = TRUE;
        priv_w = perms.ap<2> == '0';
        user_r = perms.ap<1> == '1';
        user_w = perms.ap<2:1> == '01';
    else
        priv_r = perms.ap<2:1> != '00';
        priv_w = perms.ap<2:1> == '01';
        user_r = perms.ap<1> == '1';
        user_w = FALSE;
    uwxn = SCTL.R.UWXN == '1';
    user_x = user_r && perms.xn == '0' && !(user_w && wxn);
    priv_x = (priv_r && perms.xn == '0' && perms.pxn == '0' &&
        !(priv_w && wxn) && !(user_w && uwxn));
    ispriv = PSTATE.EL == EL1 && acctype != AccType_UNPRIV;

    if ispriv then
        (r, w, x) = (priv_r, priv_w, priv_x);
    else
        (r, w, x) = (user_r, user_w, user_x);
else
    // Access from EL2
    wxn = HSCTL.R.WXN == '1';
    r = TRUE;
    w = perms.ap<2> == '0';
    x = perms.xn == '0' && !(w && wxn);

secure_instr_fetch = SCR_GEN[].SIF; // Restriction on Secure instruction fetch
if HaveEL(EL3) && IsSecure() && NS == '1' && secure_instr_fetch == '1' then
    x = FALSE;

if acctype == AccType_IFETCH then
    fail = !x;
elseif iswrite then
    fail = !w;
else
    fail = !r;

if fail then
    secondstage = FALSE;
    s2fs1walk = FALSE;
    ipaddress = bits(40) UNKNOWN;
    return AArch32.PermissionFault(ipaddress, domain, level, acctype, iswrite, secondstage,
        s2fs1walk);
else
    return AArch32.NoFault();

// AArch32.CheckS2Permission()
// =====
// Function used for permission checking from AArch32 stage 2 translations

FaultRecord AArch32.CheckS2Permission(Permissions perms, bits(32) vaddress, bits(40) ipaddress,
    integer level, AccType acctype, boolean iswrite,
    boolean s2fs1walk)
assert HaveEL(EL2) && !IsSecure() && ELUsingAArch32(EL2) && PSTATE.EL != EL2;

r = perms.ap<1> == '0';
w = perms.ap<2> == '0';
x = r && perms.xn == '0';

// Stage 1 walk is checked as a read, regardless of the original type
if acctype == AccType_IFETCH && !s2fs1walk then
    fail = !x;
elseif iswrite && !s2fs1walk then

```

```

        fail = !w;
    else
        fail = !r;

    if fail then
        domain = bits(4) UNKNOWN;
        secondstage = TRUE;
        return AArch32.PermissionFault(ipaddress, domain, level, acctype, iswrite, secondstage,
                                       s2fs1walk);
    else
        return AArch32.NoFault();

```

aarch32/translation/debug

```

// ~~~~~
// AArch32 Translation System
// ~~~~~

// ~~~~~
// Debug functions that are part of the translation system.
// ~~~~~

// AArch32.CheckDebug()
// =====
// Called on each access to check for a debug exception or entry to Debug state.

FaultRecord AArch32.CheckDebug(bits(32) vaddress, AccType acctype, boolean iswrite, integer size)

    FaultRecord fault = AArch32.NoFault();

    d_side = (acctype != AccType_IFETCH);
    generate_exception = AArch32.GenerateDebugExceptions() && DBGDSCRExt.MDBGGen == '1';
    halt = HaltOnBreakpointOrWatchpoint();
    // Relative priority of Vector Catch and Breakpoint exceptions not defined in the architecture
    vector_catch_first = ConstrainUnpredictableBool();

    if !d_side && vector_catch_first && generate_exception then
        fault = AArch32.CheckVectorCatch(vaddress, size);

    if fault.type == Fault_None && (generate_exception || halt) then
        if d_side then
            fault = AArch32.CheckWatchpoint(vaddress, acctype, iswrite, size);
        else
            fault = AArch32.CheckBreakpoint(vaddress, size);

    if fault.type == Fault_None && !d_side && !vector_catch_first && generate_exception then
        return AArch32.CheckVectorCatch(vaddress, size);

    return fault;

// AArch32.CheckBreakpoint()
// =====
// Called before executing the instruction of length "size" bytes at "vaddress" in an AArch32
// translation regime.
// The breakpoint can in fact be evaluated well ahead of execution, for example, at instruction
// fetch. This is the simple sequential execution of the program.

FaultRecord AArch32.CheckBreakpoint(bits(32) vaddress, integer size)
    assert ELUsingAArch32(TranslationRegime());
    assert size IN {2,4};

    match = FALSE;
    mismatch = FALSE;

    for i = 0 to UInt(DBGDIDR.BRPs)
        (match_i, mismatch_i) = AArch32.BreakpointMatch(i, vaddress, size);
        match = match || match_i;
        mismatch = mismatch || mismatch_i;

```

```

if match && HaltOnBreakpointOrWatchpoint() then
    reason = DebugHalt_Breakpoint;
    Halt(reason);
elseif (match || mismatch) && DBGDSCRExt.MDBGGen == '1' && AArch32.GenerateDebugExceptions() then
    acctype = AccType_IFETCH;
    iswrite = FALSE;
    debugmoe = DebugException_Breakpoint;
    return AArch32.DebugFault(acctype, iswrite, debugmoe);
else
    return AArch32.NoFault();

// AArch32.CheckVectorCatch()
// =====
// Called before executing the instruction of length "size" bytes at "vaddress" in an AArch32
// translation regime.
// Vector Catch can in fact be evaluated well ahead of execution, for example, at instruction
// fetch. This is the simple sequential execution of the program.

FaultRecord AArch32.CheckVectorCatch(bits(32) vaddress, integer size)
    assert ELUsingAArch32(TranslationRegime());

    match = AArch32.VCRMatch(vaddress);
    if size == 4 && !match && AArch32.VCRMatch(vaddress + 2) then
        match = ConstrainUnpredictableBool();

    if match && DBGDSCRExt.MDBGGen == '1' && AArch32.GenerateDebugExceptions() then
        acctype = AccType_IFETCH;
        iswrite = FALSE;
        debugmoe = DebugException_VectorCatch;
        return AArch32.DebugFault(acctype, iswrite, debugmoe);
    else
        return AArch32.NoFault();

// AArch32.CheckWatchpoint()
// =====
// Called before accessing the memory location of "size" bytes at "address".

FaultRecord AArch32.CheckWatchpoint(bits(32) vaddress, AccType acctype,
                                     boolean iswrite, integer size)
    assert ELUsingAArch32(TranslationRegime());

    match = FALSE;
    ispriv = PSTATE.EL != EL0 && !(PSTATE.EL == EL1 && acctype == AccType_UNPRIV);

    for i = 0 to UInt(DBGDIDR.WRPs)
        match = match || AArch32.WatchpointMatch(i, vaddress, size, ispriv, iswrite);

    if match && HaltOnBreakpointOrWatchpoint() then
        reason = DebugHalt_Watchpoint;
        Halt(reason);
    elseif match && DBGDSCRExt.MDBGGen == '1' && AArch32.GenerateDebugExceptions() then
        debugmoe = DebugException_Watchpoint;
        return AArch32.DebugFault(acctype, iswrite, debugmoe);
    else
        return AArch32.NoFault();

```

aarch32/translation/faults

```

// ~~~~~
// AArch32 Translation System
// ~~~~~

// ~~~~~
// Wrapper functions for generating Aborts.

// AArch32.NoFault()

```

```
// =====
FaultRecord AArch32.NoFault()

    ipaddress = bits(40) UNKNOWN;
    domain = bits(4) UNKNOWN;
    level = integer UNKNOWN;
    acctype = AccType_NORMAL;
    iswrite = boolean UNKNOWN;
    extflag = bit UNKNOWN;
    debugmoe = bits(4) UNKNOWN;
    secondstage = FALSE;
    s2fs1walk = FALSE;

    return AArch32.CreateFaultRecord(Fault_None, ipaddress, domain, level, acctype, iswrite,
                                     extflag, debugmoe, secondstage, s2fs1walk);

// AArch32.TranslationFault()
// =====

FaultRecord AArch32.TranslationFault(bits(40) ipaddress, bits(4) domain, integer level,
                                     AccType acctype, boolean iswrite, boolean secondstage,
                                     boolean s2fs1walk)

    extflag = bit UNKNOWN;
    debugmoe = bits(4) UNKNOWN;
    return AArch32.CreateFaultRecord(Fault_Translation, ipaddress, domain, level, acctype, iswrite,
                                     extflag, debugmoe, secondstage, s2fs1walk);

// AArch32.AccessFlagFault()
// =====

FaultRecord AArch32.AccessFlagFault(bits(40) ipaddress, bits(4) domain, integer level,
                                     AccType acctype, boolean iswrite, boolean secondstage,
                                     boolean s2fs1walk)

    extflag = bit UNKNOWN;
    debugmoe = bits(4) UNKNOWN;
    return AArch32.CreateFaultRecord(Fault_AccessFlag, ipaddress, domain, level, acctype, iswrite,
                                     extflag, debugmoe, secondstage, s2fs1walk);

// AArch32.AddressSizeFault()
// =====

FaultRecord AArch32.AddressSizeFault(bits(40) ipaddress, bits(4) domain, integer level,
                                     AccType acctype, boolean iswrite, boolean secondstage,
                                     boolean s2fs1walk)

    extflag = bit UNKNOWN;
    debugmoe = bits(4) UNKNOWN;
    return AArch32.CreateFaultRecord(Fault_AddressSize, ipaddress, domain, level, acctype, iswrite,
                                     extflag, debugmoe, secondstage, s2fs1walk);

// AArch32.PermissionFault()
// =====

FaultRecord AArch32.PermissionFault(bits(40) ipaddress, bits(4) domain, integer level,
                                     AccType acctype, boolean iswrite, boolean secondstage,
                                     boolean s2fs1walk)

    extflag = bit UNKNOWN;
    debugmoe = bits(4) UNKNOWN;
    return AArch32.CreateFaultRecord(Fault_Permission, ipaddress, domain, level, acctype, iswrite,
                                     extflag, debugmoe, secondstage, s2fs1walk);

// AArch32.AlignmentFault()
// =====
```

```
FaultRecord AArch32.AlignmentFault(Acctype acctype, boolean iswrite, boolean secondstage)

    ipaddress = bits(40) UNKNOWN;
    domain = bits(4) UNKNOWN;
    level = integer UNKNOWN;
    extflag = bit UNKNOWN;
    debugmoe = bits(4) UNKNOWN;
    s2fs1walk = boolean UNKNOWN;

    return AArch32.CreateFaultRecord(Fault_Alignment, ipaddress, domain, level, acctype, iswrite,
                                     extflag, debugmoe, secondstage, s2fs1walk);

// AArch32.DomainFault()
// =====

FaultRecord AArch32.DomainFault(bits(4) domain, integer level, Acctype acctype, boolean iswrite)

    ipaddress = bits(40) UNKNOWN;
    extflag = bit UNKNOWN;
    debugmoe = bits(4) UNKNOWN;
    secondstage = FALSE;
    s2fs1walk = FALSE;

    return AArch32.CreateFaultRecord(Fault_Domain, ipaddress, domain, level, acctype, iswrite,
                                     extflag, debugmoe, secondstage, s2fs1walk);

// AArch32.DebugFault()
// =====

FaultRecord AArch32.DebugFault(Acctype acctype, boolean iswrite, bits(4) debugmoe)

    ipaddress = bits(40) UNKNOWN;
    domain = bits(4) UNKNOWN;
    level = integer UNKNOWN;
    extflag = bit UNKNOWN;
    secondstage = FALSE;
    s2fs1walk = FALSE;

    return AArch32.CreateFaultRecord(Fault_Debug, ipaddress, domain, level, acctype, iswrite,
                                     extflag, debugmoe, secondstage, s2fs1walk);

// AArch32.AsynchExternalAbort()
// =====
// Wrapper function for asynchronous external aborts

FaultRecord AArch32.AsynchExternalAbort(boolean parity, bit extflag)

    type = if parity then Fault_AsyncParity else Fault_AsyncExternal;
    ipaddress = bits(40) UNKNOWN;
    domain = bits(4) UNKNOWN;
    level = integer UNKNOWN;
    acctype = Acctype_NORMAL;
    iswrite = boolean UNKNOWN;
    debugmoe = bits(4) UNKNOWN;
    secondstage = FALSE;
    s2fs1walk = FALSE;

    return AArch32.CreateFaultRecord(type, ipaddress, domain, level, acctype, iswrite, extflag,
                                     debugmoe, secondstage, s2fs1walk);
```

aarch32/translation/translation

```
// ~~~~~
// AArch32 Translation System
// ~~~~~
// ~~~~~
// Top level address translation functions.
```

```

// AArch32.TranslateAddress()
// =====
// Main entry point for translating an address

AddressDescriptor AArch32.TranslateAddress(bits(32) vaddress, AccType acctype, boolean iswrite,
                                          boolean wasaligned, integer size)

    if PSTATE.EL == EL0 && !ELUsingAArch32(EL1) then
        return AArch64.TranslateAddress(ZeroExtend(vaddress, 64), acctype, iswrite, wasaligned,
                                         size);

    result = AArch32.FullTranslate(vaddress, acctype, iswrite, wasaligned, size);

    if !(acctype IN {AccType_PTW, AccType_IC, AccType_AT}) && !IsFault(result) then
        result.fault = AArch32.CheckDebug(vaddress, acctype, iswrite, size);

    return result;

// AArch32.FullTranslate()
// =====
// This function is called to perform both stage 1 and stage 2 translation walks for the current
// translation regime. The function used by Address Translation operations is similar except it uses
// the translation regime specified for the instruction.

AddressDescriptor AArch32.FullTranslate(bits(32) vaddress, AccType acctype, boolean iswrite,
                                       boolean wasaligned, integer size)

    // First Stage Translation
    S1 = AArch32.FirstStageTranslate(vaddress, acctype, iswrite, wasaligned, size);

    if !IsFault(S1) && HaveEL(EL2) && !IsSecure() && PSTATE.EL != EL2 then
        s2fs1walk = FALSE;
        result = AArch32.SecondStageTranslate(S1, vaddress, acctype, iswrite, wasaligned, s2fs1walk,
                                             size);
    else
        result = S1;

    return result;

// AArch32.FirstStageTranslate()
// =====
// This function is called to perform a stage 1 translation walk. If necessary,
// it calls SecondStageTranslate to perform the stage 2 translation walk.
// The function used by Address Translation operations is similar except it uses
// the translation regime specified for the instruction.

AddressDescriptor AArch32.FirstStageTranslate(bits(32) vaddress, AccType acctype, boolean iswrite,
                                             boolean wasaligned, integer size)

    if PSTATE.EL == EL2 then
        s1_enabled = HSCTLR.M == '1';
    else
        s1_enabled = SCTL.R.M == '1';

    ipaddress = bits(40) UNKNOWN;
    secondstage = FALSE;
    s2fs1walk = FALSE;

    boolean permissioncheck = TRUE; // By default, permissions will need to be checked

    if s1_enabled then // First stage enabled
        use_long_descriptor_format = PSTATE.EL == EL2 || TTBCR.EAE == '1';
        if use_long_descriptor_format then
            S1 = AArch32.TranslationTableWalkLD(ipaddress, vaddress, acctype, iswrite, secondstage,
                                                s2fs1walk, size);
        else
            S1 = AArch32.TranslationTableWalkSD(vaddress, acctype, iswrite, size);

```

```

        if !IsFault(S1.addrdesc) then
            (permissioncheck, abort) = AArch32.CheckDomain(S1.domain, vaddress, S1.level,
                acctype, iswrite);
            S1.addrdesc.fault = abort;
        else
            S1 = AArch32.TranslateAddressS10ff(vaddress, acctype, iswrite);
            permissioncheck = FALSE;

// Check for unaligned data accesses to Device memory
if (!wasaligned && !IsFault(S1.addrdesc) && S1.addrdesc.memattrs.type == MemType_Device &&
    acctype != AccType_IFETCH) then
    S1.addrdesc.fault = AArch32.AlignmentFault(acctype, iswrite, secondstage);

if !IsFault(S1.addrdesc) && permissioncheck then
    S1.addrdesc.fault = AArch32.CheckPermission(S1.perms, vaddress, S1.level,
        S1.domain, S1.addrdesc.paddress.NS,
        acctype, iswrite);

// Check for instruction fetches from Device memory not marked as execute-never. If there has
// not been a Permission Fault then the memory is not marked execute-never.
if (!IsFault(S1.addrdesc) && S1.addrdesc.memattrs.type == MemType_Device &&
    acctype == AccType_IFETCH) then
    S1.addrdesc = AArch32.InstructionDevice(S1.addrdesc, vaddress, ipaddress, S1.level,
        S1.domain, acctype, iswrite,
        secondstage, s2fs1walk);

return S1.addrdesc;

// AArch32.SecondStageTranslate()
// =====
// This function is called to perform a stage 2 translation walk.
AddressDescriptor AArch32.SecondStageTranslate(AddressDescriptor S1, bits(32) vaddress,
    Acctype acctype, boolean iswrite, boolean wasaligned,
    boolean s2fs1walk, integer size)
assert HaveEL(EL2) && !IsSecure() && PSTATE.EL != EL2;
assert IsZero(S1.paddress.physicaladdress<47:40>);

if !ELUsingAArch32(EL2) then
    return AArch64.SecondStageTranslate(S1, ZeroExtend(vaddress, 64), acctype, iswrite,
        wasaligned, s2fs1walk, size);

s2_enabled = HCR.VM == '1';
secondstage = TRUE;

if s2_enabled then // Second stage enabled
    ipaddress = S1.paddress.physicaladdress<39:0>;
    S2 = AArch32.TranslationTableWalkLD(ipaddress, vaddress, acctype, iswrite, secondstage,
        s2fs1walk, size);

// Check for unaligned data accesses to Device memory
if (!wasaligned && !IsFault(S2.addrdesc) && S2.addrdesc.memattrs.type == MemType_Device &&
    acctype != AccType_IFETCH) then
    S2.addrdesc.fault = AArch32.AlignmentFault(acctype, iswrite, secondstage);

if !IsFault(S2.addrdesc) then
    S2.addrdesc.fault = AArch32.CheckS2Permission(S2.perms, vaddress, ipaddress, S2.level,
        acctype, iswrite, s2fs1walk);

// Check for instruction fetches from Device memory not marked as execute-never. As there
// has not been a Permission Fault then the memory is not marked execute-never.
if (!IsFault(S2.addrdesc) && S2.addrdesc.memattrs.type == MemType_Device &&
    acctype == AccType_IFETCH) then
    domain = bits(4) UNKNOWN;
    S2.addrdesc = AArch32.InstructionDevice(S2.addrdesc, vaddress, ipaddress, S2.level,
        domain, acctype, iswrite,
        secondstage, s2fs1walk);

```



```

// Check for protected table walk
if (s2fs1walk && !IsFault(S2.addrdesc) && HCR.PTW == '1' &&
    S2.addrdesc.memattrs.type == MemType_Device) then
    domain = bits(4) UNKNOWN;
    S2.addrdesc.fault = AArch32.PermissionFault(ipaddress, domain, S2.level, acctype,
                                                iswrite, secondstage, s2fs1walk);

    result = CombineS1S2Desc(S1, S2.addrdesc);
else
    result = S1;

return result;

// AArch32.SecondStageWalk()
// =====
// This function is called from a stage 1 translation table walk when
// the accesses generated from that requires a second stage of translation
AddressDescriptor AArch32.SecondStageWalk(AddressDescriptor S1, bits(32) vaddress, AccType acctype,
                                          integer size)
    assert HaveEL(EL2) && !IsSecure() && PSTATE.EL != EL2;

    iswrite = FALSE;
    s2fs1walk = TRUE;
    wasaligned = TRUE;
    return AArch32.SecondStageTranslate(S1, vaddress, acctype, iswrite, wasaligned, s2fs1walk,
                                        size);

```

aarch32/translation/walk

```

// ~~~~~
// AArch32 Translation System
// ~~~~~

// ~~~~~
// Main translation table walk functions

// AArch32.TranslationTableWalkLD()
// =====
// Returns a result of a translation table walk using the Long-descriptor format
//
// Implementations might cache information from memory in any number of non-coherent TLB
// caching structures, and so avoid memory accesses that have been expressed in this
// pseudocode. The use of such TLBs is not expressed in this pseudocode.

TLBRecord AArch32.TranslationTableWalkLD(bits(40) ipaddress, bits(32) vaddress,
                                          AccType acctype, boolean iswrite, boolean secondstage,
                                          boolean s2fs1walk, integer size)

    if !secondstage then
        assert ELUsingAArch32(TranslationRegime());
    else
        assert HaveEL(EL2) && !IsSecure() && ELUsingAArch32(EL2) && PSTATE.EL != EL2;

    TLBRecord result;
    AddressDescriptor descaddr;

    domain = bits(4) UNKNOWN;
    baseaddress = Zeros(40);
    basefound = FALSE;
    bits(64) base;

    descaddr.memattrs.type = MemType_Normal;

    // Determine parameters for the page table walk:
    // grainsize = Log2(Size of Table) - in AArch32 this is a constant
    // stride = Log2(Address per level) - in AArch32 this is a constant
    constant integer grainsize = 12; // 4KB pages
    constant integer stride = grainsize - 3;

```

```

// tablesize = Log2(Address Size)
// level = level to start walk from
// This means that the number of levels after start level = 3-level

if !secondstage then
    // First stage translation
    bits(40) inputaddr = ZeroExtend(vaddress);
    if PSTATE.EL == EL2 then
        tablesize = 32 - UInt(HTCR.T0SZ);
        basefound = tablesize == 32 || IsZero(inputaddr<31:tablesize>);
        base = TTBR0_EL2;
        descaddr.memattrs = WalkAttrDecode(HTCR.SH0, HTCR.ORGNO, HTCR.IRGN0);
        reversedescriptors = HSCTLR.EE == '1';
        lookupsecure = FALSE;
        singlepriv = TRUE;
    else
        tablesize = 32 - UInt(TTBCR.T0SZ);
        if tablesize == 32 || IsZero(inputaddr<31:tablesize>) then
            basefound = TTBCR.EPD0 == '0';
            base = TTBR0_EL1;
            descaddr.memattrs = WalkAttrDecode(TTBCR.SH0, TTBCR.ORGNO, TTBCR.IRGN0);
        else
            tablesize = 32 - UInt(TTBCR.T1SZ);
            basefound = (tablesize == 32 || IsOnes(inputaddr<31:tablesize>)) && TTBCR.EPD1 == '0';
            base = TTBR1_EL1;
            descaddr.memattrs = WalkAttrDecode(TTBCR.SH1, TTBCR.ORGNO, TTBCR.IRGN1);
            reversedescriptors = SCTLR.EE == '1';
            lookupsecure = IsSecure();
            singlepriv = FALSE;

        if tablesize > (grainsize + 2*stride) then
            level = 1;
        else
            level = 2;
    else
        // Second stage translation
        bits(40) inputaddr = ipaddress;
        lookupsecure = FALSE;
        singlepriv = TRUE;
        tablesize = 32 - SInt(VTCR.T0SZ);

        base = VTTBR;
        basefound = tablesize == 40 || IsZero(inputaddr<39:tablesize>);
        descaddr.memattrs = WalkAttrDecode(VTCR.IRGN0, VTCR.ORGNO, VTCR.SH0);
        reversedescriptors = HSCTLR.EE == '1';

        level = 2 - UInt(VTCR.SL0);
        if level <= 0 then basefound = FALSE;

        // Check for Translation Table of fewer than 2 entries or more than 16*(2^grainsize/8)
        // entries
        // Number entries in start table level =
        // (Address Size)/(Address per level)^Num of levels after start + Size of Table)
        if ((tablesize > stride*(3-level) + 2*grainsize + 1) ||
            (tablesize < stride*(3-level) + grainsize + 1)) then
            basefound = FALSE;

    if !basefound then
        result.addrdesc.fault = AArch32.TranslationFault(ipaddress, domain, 0, acctype, iswrite,
            secondstage, s2fs1walk);
        return result;

    if !IsZero(base<47:40>) then
        result.addrdesc.fault = AArch32.AddressSizeFault(ipaddress, domain, 0, acctype, iswrite,
            secondstage, s2fs1walk);
        return result;

// Bottom bound of the Base address is:

```

```

//      log2(8 bytes per entry)+log2(num of entries in start table level)
// Number of entries in start table level =
//      (Address Size)/((Address per level)^Num of levels after start level + Size of Table)

baselowerbound = 3 + tablesize - stride*(3-level) - grainsize;
baseaddress = base<39:baselowerbound>:Zeros(baselowerbound);

ns_table = if lookupsecure then '0' else '1';
ap_table = if singlepriv then '10' else '11';
xn_table = '0';
pxn_table = '0';

addrselecttop = tablesize - 1;

repeat
  addrselectbottom = (3-level)*stride + grainsize;

  bits(40) index = ZeroExtend(inputaddr<addrselecttop:addrselectbottom>:'000');
  descaddr.paddress.physicaladdress = ZeroExtend(baseaddress OR index);
  descaddr.paddress.NS = ns_table;

  // If there are two stages of translation, then the first stage table walk addresses
  // are themselves subject to translation
  if !HaveEL(EL2) || secondstage || IsSecure() || PSTATE.EL == EL2 then
    descaddr2 = descaddr;
  else
    descaddr2 = AArch32.SecondStageWalk(descaddr, vaddress, acctype, 8);
  desc = _Mem[descaddr2, 8, Acctype_PTW];
  if reversedescriptors then
    desc = BigEndianReverse(desc);

  // Process descriptor
  case desc<1:0> of
    when 'x0' // Fault or reserved
      result.addrdesc.fault = AArch32.TranslationFault(ipaddress, domain,
                                                         level, acctype, iswrite,
                                                         secondstage, s2fs1walk);

      return result;

    when '01'
      if level == 3 then // Invalid at level 3
        result.addrdesc.fault = AArch32.TranslationFault(ipaddress, domain,
                                                           level, acctype, iswrite,
                                                           secondstage, s2fs1walk);

        return result;
      else // Block
        blocktranslate = TRUE;

    when '11'
      if level != 3 then // Table
        if !IsZero(desc<47:40>) then
          result.addrdesc.fault = AArch32.AddressSizeFault(ipaddress, domain,
                                                             level, acctype,
                                                             iswrite, secondstage,
                                                             s2fs1walk);

          return result;

  baseaddress = desc<39:grainsize>:Zeros(grainsize);

  if !secondstage then
    // Unpack the upper and lower table attributes
    // pxn_table and ap_table[0] apply only in EL0&1 translation regimes
    ns_table = ns_table AND desc<63>;
    ap_table<1> = ap_table<1> AND desc<62>;
    xn_table = xn_table OR desc<60>;
    if !singlepriv then
      ap_table<0> = ap_table<0> AND desc<61>;
      pxn_table = pxn_table OR desc<59>;

```

```

        level = level + 1;
        addrselecttop = addrselectbottom - 1;
        blocktranslate = FALSE;
    else // Page
        blocktranslate = TRUE;
until blocktranslate;

if !IsZero(desc<47:40>) then
    result.addrdesc.fault = AArch32.AddressSizeFault(ipaddress, domain, level, acctype,
                                                    iswrite, secondstage, s2fslwalk);
    return result;

physicaladdress = desc<39:addrselectbottom>:inputaddr<addrselectbottom-1:0>;

// Check the access flag
if desc<10> == '0' then
    result.addrdesc.fault = AArch32.AccessFlagFault(ipaddress, domain, level,
                                                    acctype, iswrite,
                                                    secondstage, s2fslwalk);

    return result;

// Unpack the upper and lower block attributes
xn = desc<54>;
pxn = desc<53>;
contiguousbit = desc<52>;
nG = desc<11>;
sh = desc<9:8>;
ap = desc<7:6>:'1';
memattr = desc<5:2>; // AttrIndx and NS bit in stage 1

result.domain = bits(4) UNKNOWN; // Domains not used
result.level = level;
result.blocksize = 2^((3-level)*stride + grainsize);

// Stage 1 translation regimes also inherit attributes from the tables
if !secondstage then
    result.perms.xn = xn OR xn_table;
    result.perms.ap<2> = ap<2> OR ap_table<1>;

    // PNX, nG and AP[1] apply only in EL0&1 stage 1 translation regimes
    if !singlepriv then
        result.perms.ap<1> = ap<1> OR NOT(ap_table<0>);
        result.perms.pxn = pxn OR pxn_table;
        // Pages from Non-secure tables are marked Global in Secure EL0&1
        if IsSecure() then
            result.nG = nG OR ns_table;
        else
            result.nG = nG;
    else
        result.perms.ap<1> = '1';
        result.perms.pxn = '0';
        result.nG = '0';
        result.perms.ap<0> = '1';
        result.addrdesc.memattrs = AArch32.S1AttrDecode(sh, memattr<2:0>, acctype);
        result.addrdesc.paddress.NS = if lookupsecure then (memattr<3> OR ns_table) else '1';
else
    result.perms.ap<2:1> = ap<2:1>;
    result.perms.ap<0> = '1';
    result.perms.xn = xn;
    result.perms.pxn = '0';
    result.nG = '0';
    result.addrdesc.memattrs = S2AttrDecode(sh, memattr, acctype);
    result.addrdesc.paddress.NS = '1';

result.addrdesc.paddress.physicaladdress = ZeroExtend(physicaladdress);
result.addrdesc.fault = AArch32.NoFault();
result.contiguous = contiguousbit == '1';

```

```

    return result;

// RemapRegsHaveResetValues()
// =====

boolean RemapRegsHaveResetValues();

// AArch32.TranslationTableWalkSD()
// =====
// Returns a result of a translation table walk using the Short-descriptor format
//
// Implementations might cache information from memory in any number of non-coherent TLB
// caching structures, and so avoid memory accesses that have been expressed in this
// pseudocode. The use of such TLBs is not expressed in this pseudocode.

TLBRecord AArch32.TranslationTableWalkSD(bits(32) vaddress, AccType acctype, boolean iswrite,
                                         integer size)
    assert ELUsingAArch32(TranslationRegime());

    // This is only called when the MMU is enabled
    TLBRecord    result;
    AddressDescriptor l1descaddr;
    AddressDescriptor l2descaddr;
    bits(40)    physicaladdress;

    // Variables for Abort functions
    ipaddress = bits(40) UNKNOWN;
    secondstage = FALSE;
    s2fs1walk = FALSE;

    // Default setting of the domain
    domain = bits(4) UNKNOWN;

    // Determine correct Translation Table Base Register to use.
    bits(64) ttbr;
    n = UInt(TTBCR.N);
    if n == 0 || IsZero(vaddress<31:(32-n)>) then
        ttbr = TTBR0;
        disabled = (TTBCR.PD0 == '1');
    else
        ttbr = TTBR1;
        disabled = (TTBCR.PD1 == '1');
        n = 0; // TTBR1 translation always works like N=0 TTBR0 translation

    // Check this Translation Table Base Register is not disabled.
    if disabled then
        level = 1;
        result.addrdesc.fault = AArch32.TranslationFault(ipaddress, domain, level, acctype, iswrite,
                                                         secondstage, s2fs1walk);

        return result;

    // Obtain First level descriptor.
    l1descaddr.paddress.physicaladdress = ZeroExtend(ttbr<31:14-n>:vaddress<31-n:20>:'00');
    l1descaddr.paddress.NS = if IsSecure() then '0' else '1';
    IRGN = ttbr<0>:ttbr<6>; // TTBR.IRGN
    RGN = ttbr<4:3>; // TTBR.RGN
    SH = ttbr<1>:ttbr<5>; // TTBR.S:TTBR.NOS
    l1descaddr.memattrs = WalkAttrDecode(SH, RGN, IRGN);

    if !HaveEL(EL2) || IsSecure() then
        // if only 1 stage of translation
        l1descaddr2 = l1descaddr;
    else
        l1descaddr2 = AArch32.SecondStageWalk(l1descaddr, vaddress, acctype, 4);

    l1desc = _Mem[l1descaddr2, 4, AccType_PTW];
    if SCTLR.EE == '1' then

```

```

    l1desc = BigEndianReverse(l1desc);

// Process First level descriptor.
case l1desc<1:0> of
    when '00' // Fault, Reserved
        level = 1;
        result.addrdesc.fault = AArch32.TranslationFault(ipaddress, domain, level, acctype,
            iswrite, secondstage, s2fs1walk);
        return result;

    when '01' // Large page or Small page
        domain = l1desc<8:5>;
        level = 2;
        pxn = l1desc<2>;
        NS = l1desc<3>;

// Obtain Second level descriptor.
l2descaddr.paddress.physicaladdress = ZeroExtend(l1desc<31:10>:vaddress<19:12>:'00');
l2descaddr.paddress.NS = if IsSecure() then '0' else '1';
l2descaddr.memattrs = l1descaddr.memattrs;

if !HaveEL(EL2) || IsSecure() then
    // if only 1 stage of translation
    l2descaddr2 = l2descaddr;
else
    l2descaddr2 = AArch32.SecondStageWalk(l2descaddr, vaddress, acctype, 4);
l2desc = _Mem[l2descaddr2, 4, AccType_PTW];
if SCTL.R.EE == '1' then
    l2desc = BigEndianReverse(l2desc);

// Process Second level descriptor.
if l2desc<1:0> == '00' then
    result.addrdesc.fault = AArch32.TranslationFault(ipaddress, domain, level, acctype,
        iswrite, secondstage, s2fs1walk);
    return result;

nG = l2desc<11>;
S = l2desc<10>;
ap = l2desc<9,5:4>;

if SCTL.R.AFE == '1' && l2desc<4> == '0' then
    // Hardware access to the Access Flag is not supported in ARMv8
    result.addrdesc.fault = AArch32.AccessFlagFault(ipaddress, domain, level, acctype,
        iswrite, secondstage, s2fs1walk);
    return result;

if l2desc<1> == '0' then // Large page
    xn = l2desc<15>;
    tex = l2desc<14:12>;
    c = l2desc<3>;
    b = l2desc<2>;
    blocksize = 64;
    physicaladdress = ZeroExtend(l2desc<31:16>:vaddress<15:0>);
else // Small page
    tex = l2desc<8:6>;
    c = l2desc<3>;
    b = l2desc<2>;
    xn = l2desc<0>;
    blocksize = 4;
    physicaladdress = ZeroExtend(l2desc<31:12>:vaddress<11:0>);

when '1x' // Section or Supersection
    NS = l1desc<19>;
    nG = l1desc<17>;
    S = l1desc<16>;
    ap = l1desc<15,11:10>;
    tex = l1desc<14:12>;
    xn = l1desc<4>;

```

```

c = l1desc<3>;
b = l1desc<2>;
pxn = l1desc<0>;
level = 1;

if SCTL.R.AFE == '1' && l1desc<10> == '0' then
  // Hardware management of the Access Flag is not supported in ARMv8
  result.addrdesc.fault = AArch32.AccessFlagFault(ipaddress, domain, level, acctype,
                                                    iswrite, secondstage, s2fslwalk);
  return result;

if l1desc<18> == '0' then // Section
  domain = l1desc<8:5>;
  blocksize = 1024;
  physicaladdress = ZeroExtend(l1desc<31:20>:vaddress<19:0>);
else // Supersection
  domain = '0000';
  blocksize = 16384;
  physicaladdress = l1desc<8:5>:l1desc<23:20>:l1desc<31:24>:vaddress<23:0>;

// Decode the TEX, C, B and S bits to produce the TLBRecord's memory attributes
if SCTL.R.TRE == '0' then
  if RemapRegsHaveResetValues() then
    result.addrdesc.memattrs = AArch32.DefaultTEXDecode(tex, c, b, S, acctype);
  else
    result.addrdesc.memattrs = MemoryAttributes IMPLEMENTATION_DEFINED;
else
  if SCTL.R.M == '0' then
    result.addrdesc.memattrs = AArch32.DefaultTEXDecode(tex, c, b, S, acctype);
  else
    result.addrdesc.memattrs = AArch32.RemappedTEXDecode(tex, c, b, S, acctype);

// Set the rest of the TLBRecord, try to add it to the TLB, and return it.
result.perms.ap = ap;
result.perms.xn = xn;
result.perms.pxn = pxn;
result.nG = nG;
result.domain = domain;
result.level = level;
result.blocksize = blocksize;
result.addrdesc.paddress.physicaladdress = ZeroExtend(physicaladdress);
result.addrdesc.paddress.NS = if IsSecure() then NS else '1';
result.addrdesc.fault = AArch32.NoFault();

return result;

```

G.3 Common library pseudocode

This section holds the pseudocode that is common to execution in AArch64 state and in AArch32 state. Functions listed in this section are identified only by a `FunctionName`, without an `AArch64.` or `AArch32.` prefix. This section is organized by functional groups, with the functional groups being indicated by hierarchical path names, for example `shared/debug/DebugTarget`.

G.3.1 shared/debug

This section contains the pseudocode that relates to debug and is common to AArch32 state and AArch64 state.

shared/debug/CONTEXTIDR_GEN

```
// CONTEXTIDR_GEN()
// =====

bits(32) CONTEXTIDR_GEN[]
// AArch32 CONTEXTIDR is Banked, but there is no banking in AArch64.
return (if ELUsingAArch32(EL3) && IsSecure() then CONTEXTIDR_S else CONTEXTIDR_EL1);
```

shared/debug/ClearStickyErrors

```
// ClearStickyErrors()
// =====

ClearStickyErrors()
    EDSCR.TXU = '0';           // Clear TX underrun flag
    EDSCR.RXO = '0';           // Clear RX overrun flag
    if Halted() then           // in Debug state
        EDSCR.ITO = '0';       // Clear ITR overrun flag
    EDSCR.ERR = '0';           // Clear cumulative error flag
    return;
```

shared/debug/DebugTarget

```
// DebugTargetFrom()
// =====

bits(2) DebugTargetFrom(boolean secure)
// Returns the debug exception target EL
route_to_el2 = HaveEL(EL2) && !secure && (MDCR_EL2.TDE == '1' || HCR_EL2.TGE == '1');

if route_to_el2 then
    target = EL2;
elseif HaveEL(EL3) && HighestELUsingAArch32() && secure then
    target = EL3;
else
    target = EL1;

return target;

// DebugTarget()
// =====

bits(2) DebugTarget()
    secure = IsSecure();
    return DebugTargetFrom(secure);
```

shared/debug/DoubleLockStatus

```
// DoubleLockStatus()
// =====
```



```

boolean DoubleLockStatus()
    // Returns the value of EDPRSR.DLK:
    // FALSE if OSDLR_EL1.DLK == 0 or DBGPRCR_EL1.CORENPDRQ == 1 or the processor is in Debug state.
    // TRUE if OSDLR_EL1.DLK == 1 and DBGPRCR_EL1.CORENPDRQ == 0 and the processor is in Non-debug
    // state.
    return OSDLR_EL1.DLK == '1' && DBGPRCR_EL1.CORENPDRQ == '0' && !Halted();

```

shared/debug/FindWatchpoint

```

// FindWatchpoint()
// =====

integer FindWatchpoint()
    address = FAR[];
    base = Align(address, ZVAGranuleSize());
    limit = base + ZVAGranuleSize();
    repeat
        for i = 0 to UInt(ID_AA64DFR0_EL1.WRPs)
            if WatchpointByteMatch(i, address) then // Candidate found
                return i;
            address = address + 1;
            if address == limit then address = base; // Wrap round, as this must be a DC ZVA
    while address != FAR[];
    return -1; // No candidate found (should not happen)

```

shared/debug/authentication

```

// Debug authentication
// ~~~~~

// Debug_authentication signals
// =====

signal DBGEN;
signal NIDEN;
signal SPIDEN;
signal SPNIDEN;

// AArch32SelfHostedSecurePrivilegedInvasiveDebugEnabled()
// =====

boolean AArch32SelfHostedSecurePrivilegedInvasiveDebugEnabled()
    // In the recommended interface, AArch32SelfHostedSecurePrivilegedInvasiveDebugEnabled returns
    // the state of the (DBGEN AND SPIDEN) signal.
    if !HaveEL(EL3) && !IsSecure() then return FALSE;
    return DBGEN == HIGH && SPIDEN == HIGH;

// ExternalNoninvasiveDebugEnabled()
// =====

boolean ExternalNoninvasiveDebugEnabled()
    // In the recommended interface, ExternalNoninvasiveDebugEnabled returns the state of the (DBGEN
    // OR NIDEN) signal.
    return ExternalInvasiveDebugEnabled() || NIDEN == HIGH;

// ExternalInvasiveDebugEnabled()
// =====

boolean ExternalInvasiveDebugEnabled()
    // In the recommended interface, ExternalInvasiveDebugEnabled returns the state of the DBGEN
    // signal.
    return DBGEN == HIGH;

// ExternalSecureInvasiveDebugEnabled()
// =====

```

```

boolean ExternalSecureInvasiveDebugEnabled()
    // In the recommended interface, ExternalSecureInvasiveDebugEnabled returns the state of the
    // (DBGEN AND SPIDEN) signal.
    // CoreSight allows asserting SPIDEN without also asserting DBGEN, but this is not recommended.
    if !HaveEL(EL3) && !IsSecure() then return FALSE;
    return ExternalInvasiveDebugEnabled() && SPIDEN == HIGH;

// ExternalSecureNoninvasiveDebugEnabled()
// =====

boolean ExternalSecureNoninvasiveDebugEnabled()
    // In the recommended interface, ExternalSecureNoninvasiveDebugEnabled returns the state of the
    // (DBGEN OR NIDEN) AND (SPIDEN OR SPNIDEN) signal.
    if !HaveEL(EL3) && !IsSecure() then return FALSE;
    return ExternalNoninvasiveDebugEnabled() && (SPIDEN == HIGH || SPNIDEN == HIGH);

// AllowExternalAccess()
// =====

boolean AllowExternalAccess()
    return !DoubleLockStatus() && OSLSR_EL1.OSLK == '0' && EDPRSR.PU == '1';

// AllowExternalDebugAccess()
// =====
// Returns the status of EDPRSR.EDAD.

boolean AllowExternalDebugAccess()
    // The access may also be subject to OS lock, power-down, etc.
    if AllowExternalAccess() && ExternalInvasiveDebugEnabled() then
        if ExternalSecureInvasiveDebugEnabled() then
            return TRUE;
        elseif HaveEL(EL3) then
            return (if ELUsingAArch32(EL3) then SDCR.EDAD else MDCR_EL3.EDAD) == '0';
        else
            return !IsSecure();
    else
        return FALSE;

// AllowExternalPMUAccess()
// =====
// Returns the status of EDPRSR.EPMAD.

boolean AllowExternalPMUAccess()
    // The access may also be subject to OS lock, power-down, etc.
    if AllowExternalAccess() && ExternalNoninvasiveDebugEnabled() then
        if ExternalSecureNoninvasiveDebugEnabled() then
            return TRUE;
        elseif HaveEL(EL3) then
            return (if ELUsingAArch32(EL3) then SDCR.EPMAD else MDCR_EL3.EPMAD) == '0';
        else
            return !IsSecure();
    else
        return FALSE;

```

shared/debug/cti

```

// Cross-Trigger Interface
// ~~~~~

// CrossTrigger
// =====

enumeration CrossTriggerOut {CrossTriggerOut_DebugRequest, CrossTriggerOut_RestartRequest,
                             CrossTriggerOut_IRQ,           CrossTriggerOut_RSVD3,
                             CrossTriggerOut_TraceExtIn0,    CrossTriggerOut_TraceExtIn1,
                             CrossTriggerOut_TraceExtIn2,    CrossTriggerOut_TraceExtIn3};

```

```

enumeration CrossTriggerIn {CrossTriggerIn_CrossHalt,    CrossTriggerIn_PMUOverflow,
                           CrossTriggerIn_RSVD2,       CrossTriggerIn_RSVD3,
                           CrossTriggerIn_TraceExtOut0, CrossTriggerIn_TraceExtOut1,
                           CrossTriggerIn_TraceExtOut2, CrossTriggerIn_TraceExtOut3};

// CTI_SetEventLevel()
// =====
// Set a Cross Trigger multi-cycle input event trigger to the specified level

CTI_SetEventLevel(CrossTriggerIn id, signal level);

// CTI_SignalEvent()
// =====
// Signal a discrete event on a Cross Trigger input event trigger

CTI_SignalEvent(CrossTriggerIn id);

```

shared/debug/dccanditr

```

// Debug comms channel and instruction transfer register
// ~~~~~

// DTR
// ===

bits(32) DTRRX;
bits(32) DTRTX;

// DBGDTR_EL0[] (write)
// =====
// System register writes to DBGDTR_EL0, DBGDTRTX_EL0 (AArch64) and DBGDTRTXint (AArch32)

DBGDTR_EL0[] = bits(N) value
// For MSR DBGDTRTX_EL0,<Rt> N=32, value=X[t]<31:0>, X[t]<63:32> is ignored
// For MSR DBGDTR_EL0,<Xt> N=64, value=X[t]<63:0>
assert N IN {32,64};
if EDSCR.TXfull == '1' then
    value = bits(N) UNKNOWN;
// On a 64-bit write, implement a half-duplex channel
if N == 64 then DTRRX = value<63:32>;
DTRTX = value<31:0>; // 32-bit or 64-bit write
EDSCR.TXfull = '1';
return;

// DBGDTR_EL0[] (read)
// =====
// System register reads of DBGDTR_EL0, DBGDTRRX_EL0 (AArch64) and DBGDTRRXint (AArch32)

bits(N) DBGDTR_EL0[]
// For MRS <Rt>,DBGDTRTX_EL0 N=32, X[t]=Zeros(32):result
// For MRS <Xt>,DBGDTR_EL0 N=64, X[t]=result
assert N IN {32,64};
bits(N) result;
if EDSCR.RXfull == '0' then
    result = bits(N) UNKNOWN;
else
    // On a 64-bit read, implement a half-duplex channel
    // NOTE: the word order is reversed on reads with regards to writes
    if N == 64 then result<63:32> = DTRTX;
    result<31:0> = DTRRX;
EDSCR.RXfull = '0';
return result;

// DBGDTRRX_EL0[] (external write)
// =====
// Called on writes to debug register 0x08C.

```

```

DBGDTRRX_EL0[boolean memory_mapped] = bits(32) value

if EDPRSR<6:5,0> != '001' then // Check DLK, OSLK and PU bits
    IMPLEMENTATION_DEFINED "signal slave-generated error";
    return;

if EDSCR.ERR == '1' then return; // Error flag set: ignore write

// The Software lock is OPTIONAL.
if memory_mapped && EDLSR.SLK == '1' then return; // Software lock locked: ignore write

if EDSCR.RXfull == '1' || (Halted() && EDSCR.MA == '1' && EDSCR.ITE == '0') then
    EDSCR.RXO = '1'; EDSCR.ERR = '1'; // Overrun condition: ignore write
    return;

EDSCR.RXfull = '1';
DTRRX = value;

if Halted() && EDSCR.MA == '1' then
    EDSCR.ITE = '0'; // See comments in EDITR[] (external write)

    if !UsingAArch32() then
        ExecuteA64(0xD5330501<31:0>); // A64 "MRS X1,DBGDTRRX_EL0"
        ExecuteA64(0xB8004401<31:0>); // A64 "STR W1,[X0],#4"
        X[1] = bits(64) UNKNOWN;
    else
        ExecuteT32(0xEE10<15:0> /*hw1*/, 0x1E15<15:0> /*hw2*/); // T32 "MRS R1,DBGDTRRXint"
        ExecuteT32(0xF840<15:0> /*hw1*/, 0x1B04<15:0> /*hw2*/); // T32 "STR R1,[R0],#4"
        R[1] = bits(32) UNKNOWN;

    // If the store aborts, the Data Abort exception is taken and EDSCR.ERR is set to 1
    if EDSCR.ERR == '1' then
        EDSCR.RXfull = bit UNKNOWN;
        DBGDTRRX_EL0 = bits(32) UNKNOWN;
    else
        // "MRS X1,DBGDTRRX_EL0" calls DBGDTR_EL0[] (read) which clears RXfull.
        assert EDSCR.RXfull == '0';

        EDSCR.ITE = '1'; // See comments in EDITR[] (external write)
    return;

// DBGDTRRX_EL0[] (external read)
// =====

bits(32) DBGDTRRX_EL0[boolean memory_mapped]
return DTRRX;

// DBGDTRTX_EL0[] (external read)
// =====
// Called on reads of debug register 0x080.

bits(32) DBGDTRTX_EL0[boolean memory_mapped]

if EDPRSR<6:5,0> != '001' then // Check DLK, OSLK and PU bits
    IMPLEMENTATION_DEFINED "signal slave-generated error";
    return bits(32) UNKNOWN;

if EDSCR.ERR == '1' then return DTRTX; // Error flag set: no side-effects

// The Software lock is OPTIONAL.
if memory_mapped && EDLSR.SLK == '1' then // Software lock locked: no side-effects
    return DTRTX;

if EDSCR.TXfull == '0' || (Halted() && EDSCR.MA == '1' && EDSCR.ITE == '0') then
    EDSCR.TXO = '1'; EDSCR.ERR = '1'; // Underrun condition: block side-effects
    return bits(32) UNKNOWN; // Return UNKNOWN

EDSCR.TXfull = '0';

```

```

value = DTRTX; // Return previous value of DTRTX

if Halted() && EDSCR.MA == '1' then
    EDSCR.ITE = '0'; // See comments in EDITR[] (external write)

    if !UsingAArch32() then
        ExecuteA64(0xB8404401<31:0>); // A64 "LDR W1,[X0],#4"
    else
        ExecuteT32(0xF850<15:0> /*hw1*/, 0x1B04<15:0> /*hw2*/); // T32 "LDR R1,[R0],#4"

    // If the load aborts, the Data Abort exception is taken and EDSCR.ERR is set to 1
    if EDSCR.ERR == '1' then
        EDSCR.TXfull = bit UNKNOWN;
        DBGDTRTX_EL0 = bits(32) UNKNOWN;
    else
        if !UsingAArch32() then
            ExecuteA64(0xD5130501<31:0>); // A64 "MSR DBGDTRTX_EL0,X1"
        else
            ExecuteT32(0xEE00<15:0> /*hw1*/, 0x1E15<15:0> /*hw2*/); // T32 "MSR DBGDTRTXint,R1"
            // "MSR DBGDTRTX_EL0,X1" calls DBGDTR_EL0[] (write) which sets TXfull.
            assert EDSCR.TXfull == '1';

        if !UsingAArch32() then
            X[1] = bits(64) UNKNOWN;
        else
            R[1] = bits(32) UNKNOWN;

        EDSCR.ITE = '1'; // See comments in EDITR[] (external write)

    return value;

// DBGDTRTX_EL0[] (external write)
// =====

DBGDTRTX_EL0[boolean memory_mapped] = bits(32) value
// The Software lock is OPTIONAL.
if memory_mapped && EDLSR.SLK == '1' then return; // Software lock locked: ignore write
DTRTX = value;
return;

// CheckForDCCInterrupts()
// =====

CheckForDCCInterrupts()
    commr = (EDSCR.RXfull == '1');
    commtx = (EDSCR.TXfull == '0');

    // COMMRX and COMMTX support is optional and not recommended for new designs.
    // SetInterruptRequestLevel(InterruptID_COMMRX, if commr then HIGH else LOW);
    // SetInterruptRequestLevel(InterruptID_COMMTX, if commtx then HIGH else LOW);

    // The value to be driven onto the common COMMIRQ signal.
    commir = ((commr && MDCCINT_EL1.RX == '1') ||
              (commtx && MDCCINT_EL1.TX == '1'));
    SetInterruptRequestLevel(InterruptID_COMMIRQ, if commir then HIGH else LOW);

    return;

// EDITR[] (external write)
// =====
// Called on writes to debug register 0x088.

EDITR[boolean memory_mapped] = bits(32) value
if EDPRSR<6:5,0> != '001' then // Check DLK, OSLK and PU bits
    IMPLEMENTATION_DEFINED "signal slave-generated error";
    return;

if EDSCR.ERR == '1' then return; // Error flag set: ignore write

```

```

// The Software lock is OPTIONAL.
if memory_mapped && EDLSR.SLK == '1' then return; // Software lock locked: ignore write

if !Halted() then return; // Non-debug state: ignore write

if EDSCR.ITE == '0' || EDSCR.MA == '1' then
  EDSCR.ITO = '1'; EDSCR.ERR = '1'; // Overrun condition: block write
  return;

// ITE indicates whether the processor is ready to accept another instruction; the processor
// may support multiple outstanding instructions. Unlike the "InstrComp1" flag in [v7A] there
// is no indication that the pipeline is empty (all instructions have completed). In this
// pseudocode, the assumption is that only one instruction can be executed at a time,
// meaning ITE acts like "InstrComp1".
EDSCR.ITE = '0';

if !UsingAArch32() then
  ExecuteA64(value);
else
  ExecuteT32(value<15:0>/hw1*/, value<31:16> /hw2*/);

EDSCR.ITE = '1';

return;

```

shared/debug/halting

```

// Debug state processing
// ~~~~~

// DebugHalt
// =====
// Reason codes for entry to Debug state

constant bits(6) DebugHalt_Breakpoint = '000111';
constant bits(6) DebugHalt_EDBGRQ = '010011';
constant bits(6) DebugHalt_Step_Normal = '011011';
constant bits(6) DebugHalt_Step_Exclusive = '011111';
constant bits(6) DebugHalt_OSUnlockCatch = '100011';
constant bits(6) DebugHalt_ResetCatch = '100111';
constant bits(6) DebugHalt_Watchpoint = '101011';
constant bits(6) DebugHalt_HaltInstruction = '101111';
constant bits(6) DebugHalt_SoftwareAccess = '110011';
constant bits(6) DebugHalt_ExceptionCatch = '110111';
constant bits(6) DebugHalt_Step_NoSyndrome = '111011';

// Halt()
// =====

Halt(bits(6) reason)

  CTI_SignalEvent(CrossTriggerIn_CrossHalt); // Trigger other cores to halt

  // Save debug entry state in DLR_EL0 and DSPSR_EL0 (see text). Note: no offset on DLR_EL0.
  // Preferred return address is always the address of instruction that generated the debug event.
  // For a Halting Step debug event this is the address of the next instruction.
  // For an Exception Catch debug event this is the target address inside the target EL.
  DLR_EL0 = ThisInstrAddr();
  DSPSR_EL0 = GetSPSRFromPSTATE();

  DSPSR_EL0.SS = PSTATE.SS; // Always save PSTATE.SS

  // Set up EDSCR bits
  EDSCR.ITE = '1'; EDSCR.ITO = '0';
  if IsSecure() then
    EDSCR.SDD = '0'; // If entered in Secure state, allow debug

```

```

elseif HaveEL(EL3) then
    EDSCR.SDD = (if ExternalSecureInvasiveDebugEnabled() then '0' else '1');
else
    assert EDSCR.SDD == '1';           // Otherwise EDSCR.SDD is RES1
    EDSCR.MA = '0';

// ERR is not explicitly cleared. An RX0 or TXU error may be pending.
// PSTATE.<IT,J,T,SS,D,A,I,F> are not observable and ignored in Debug state, so it does not
// matter what they are set to on entry to Debug state. The processor treats them as if they
// have specific fixed values. This code sets them to UNKNOWN values to illustrate this.
if UsingAArch32() then                // entering from AArch32 state
    PSTATE.<IT,J,T,SS,A,I,F> = bits(14) UNKNOWN;
else
    PSTATE.<SS,D,A,I,F> = bits(5) UNKNOWN;

// However, a possible implementation is to to explicitly set them to values consistent with the
// behavior in Debug state, but this is not required. Such an implementation is shown in the
// following comments. See Effect of entering Debug state on PSTATE.
// if UsingAArch32() then                // entering from AArch32 state
//     PSTATE.<J,T> = '01';                // Force execution of T32 instructions
//     PSTATE.IT = Zeros(8);              // Force IT bits ignored
//     PSTATE.<A,I,F> = '111';            // Mask asynchronous exceptions
// else
//     PSTATE.<D,A,I,F> = '1111';          // Mask asynchronous exceptions
//     PSTATE.SS = '0';

// PSTATE.IL is cleared on entry to Debug state.
PSTATE.IL = '0';

// PSTATE.<E,M,nRW,EL,SP> and PSTATE.<N,Z,C,V,Q,GE> are unchanged.

StopInstructionPrefetchAndEnableITR();
EDSCR.STATUS = reason;                 // Signal entered Debug state
UpdateEDSCRFields();                  // Update EDSCR processor state flags.

return;

// Halted()
// =====

boolean Halted()
    return !(EDSCR.STATUS IN {'000001', '000010'});           // Halted

// Restarting()
// =====

boolean Restarting()
    return EDSCR.STATUS == '000001';                           // Restarting

// HaltingAllowed()
// =====
// Returns TRUE if halting is currently allowed, FALSE if halting is prohibited.

boolean HaltingAllowed()
    if Halted() || DoubleLockStatus() then
        return FALSE;
    elseif IsSecure() then
        return ExternalSecureInvasiveDebugEnabled();
    else
        return ExternalInvasiveDebugEnabled();

// HaltOnBreakpointOrWatchpoint()
// =====
// Returns TRUE if the Breakpoint and Watchpoint debug events should be considered for Debug
// state entry, FALSE if they should be considered for a debug exception.

boolean HaltOnBreakpointOrWatchpoint()
    return HaltingAllowed() && EDSCR.HDE == '1' && OSLSR_EL1.OSLK == '0';

```

```

// DisableITRAndResumeInstructionPrefetch()
// =====

DisableITRAndResumeInstructionPrefetch();

// StopInstructionPrefetchAndEnableITR()
// =====

StopInstructionPrefetchAndEnableITR();

// ExecuteA64()
// =====
// Execute an A64 instruction in Debug state

ExecuteA64(bits(32) instr);

// ExecuteT32()
// =====
// Execute a T32 instruction in Debug state

ExecuteT32(bits(16) hw1, bits(16) hw2);

// TakeExceptionInDebugState()
// =====

TakeExceptionInDebugState(bits(2) target_exception_level, bits(5) target_mode)

    if ELUsingAArch32(target_exception_level) then
        assert target_mode<4> == '1';
        if PSTATE.M == M32_Monitor then SCR_EL3.NS = '0';
        PSTATE.M = target_mode;
        // PSTATE.<IT,J,T,SS,D,A,I,F> are not observable and ignored in Debug state, so it does not
        // matter what they are set to on taking an exception in Debug state. The processor treats
        // them as if they have specific fixed values. This code sets them to UNKNOWN values to
        // illustrate this.
        PSTATE.<IT,J,T,SS,A,I,F> = bits(14) UNKNOWN;
        // However, a possible implementation is to explicitly set them to values consistent with
        // the behavior in Debug state, but this is not required. Such an implementation is shown in
        // the following comments.
        // PSTATE.<J,T> = '01';           // Force execution of T32 instructions
        // PSTATE.IT = Zeros(8);         // Force IT bits ignored
        // PSTATE.<A,I,F> = '111';       // Mask asynchronous exceptions
        // PSTATE.SS = '0';             // Disable step
        if PSTATE.EL == EL2 then ELR_hyp = bits(32) UNKNOWN;
        else R[14] = bits(32) UNKNOWN;
        PSTATE.E = SCTLR[.EE];
    else
        PSTATE.EL = target_exception_level; PSTATE.nRW = '0'; PSTATE.SP = '1';
        ELR[] = bits(64) UNKNOWN;
        // See comments above.
        PSTATE.<SS,D,A,I,F> = bits(5) UNKNOWN;
        // PSTATE.<D,A,I,F> = '1111';   // Mask asynchronous exceptions
        // PSTATE.SS = '0';           // Disable step

        _PC          = bits(64) UNKNOWN; // PC is invisible in Debug state
        SPSR[]       = bits(32) UNKNOWN;
        PSTATE.IL    = '0';
        DLR_EL0      = bits(64) UNKNOWN;
        DSPSR_EL0    = bits(32) UNKNOWN;
        EDSCR.ERR    = '1';

        UpdateEDSCRFIELDS(); // Update EDSCR processor state flags.

    return;

// UpdateEDSCRFIELDS()
// =====

```



```
// Update EDSCR processor state fields

UpdateEDSCRFields()

// This might be invoked at any time, but updates are explicitly visible only following a
// context synchronization operation and after entry to Debug state.
// This function illustrates how EDSCR.RW is constructed.

if !Halted() then
    EDSCR.EL = '00';
    EDSCR.NS = bit UNKNOWN;
    EDSCR.RW = '1111';
else
    EDSCR.EL = PSTATE.EL;
    EDSCR.NS = if IsSecure() then '0' else '1';
    EDSCR.RW<3> = (if HighestELUsingAArch32() then '0' else '1');
    EDSCR.RW<2> = EDSCR.RW<3> AND (if !HaveEL(EL3) then '1' else SCR_GEN[].RW);
    EDSCR.RW<1> = EDSCR.RW<2> AND (if !CurrentStateHasEL2() then '1' else HCR_EL2.RW);
    EDSCR.RW<0> = EDSCR.RW<1> AND (if PSTATE.EL != EL0 || !UsingAArch32() then '1' else '0');

return;

// DCPSInstruction()
// =====
// Operation of the DCPS instruction in Debug state

DCPSInstruction(bits(2) target_el)

    SynchronizeContext();

    case target_el of
        when EL1
            if PSTATE.EL == EL2 || (PSTATE.EL == EL3 && !UsingAArch32()) then handle_el = PSTATE.EL;
            elsif HaveEL(EL2) && !IsSecure() && HCR_EL2.TGE == '1' then UndefinedFault();
            else handle_el = EL1;

        when EL2
            if !HaveEL(EL2) then UndefinedFault();
            elsif PSTATE.EL == EL3 && !UsingAArch32() then handle_el = EL3;
            elsif IsSecure() then UndefinedFault();
            else handle_el = EL2;

        when EL3
            if EDSCR.SDD == '1' || !HaveEL(EL3) then UndefinedFault();
            handle_el = EL3;

    if ELUsingAArch32(handle_el) then
        if PSTATE.M == M32_Monitor then SCR.NS = '0';
        assert UsingAArch32(); // Cannot move from AArch64 to AArch32
        case handle_el of
            when EL1 AArch32.WriteMode(M32_Svc);
            when EL2 AArch32.WriteMode(M32_Hyp);
            when EL3 AArch32.WriteMode(M32_Monitor);
        if handle_el == EL2 then
            ELR_hyp = bits(32) UNKNOWN; HSR = bits(32) UNKNOWN;
        else
            LR = bits(32) UNKNOWN;
            SPSR[] = bits(32) UNKNOWN;
            PSTATE.E = SCTLR[].EE;
    else // Targetting AArch64
        if UsingAArch32() then MaybeZeroRegisterUppers(handle_el);
        ELR[] = bits(64) UNKNOWN; SPSR[] = bits(32) UNKNOWN; ESR[] = bits(32) UNKNOWN;
        PSTATE.nRW = '0'; PSTATE.SP = '1'; PSTATE.EL = handle_el;

    DLR_EL0 = bits(64) UNKNOWN; DSPSR_EL0 = bits(32) UNKNOWN;
    UpdateEDSCRFields(); // Update EDSCR processor state flags.

return;
```

```

// DRPSInstruction()
// =====
// Operation of the A64 DRPS and T32 ERET instructions in Debug state

DRPSInstruction()

    SynchronizeContext();

    bits(32) spsr = SPSR[];
    // This actions are the same as for an exception return. In particular, see [v8Exception] for
    // details of illegal exception return handling.
    // PSTATE.{NZCV,Q,GE,IT,J,T,SS,DAIF} are ignored and not observable in Debug state, so it
    // does not matter what they are set to by DRPS. The processor treats some of these fields as if
    // they have specific fixed values in Debug state. This code sets them to UNKNOWN values to
    // illustrate this.
    if spsr<4> == '1' then // returning to AArch32 state
        spsr<31:24,21,19:10,8:5> = bits(23) UNKNOWN; // SPSR[].[NZCV,Q,GE,IT,J,SS,AIF,T}
    else
        spsr<31:28,21,9:6> = bits(9) UNKNOWN; // SPSR[].[NZCV,SS,DAIF}

    // However, a possible implementation is to explicitly set them to values consistent with the
    // behavior in Debug state, or unchanged (meaning they are copied to PSTATE) but this is not
    // required. Such an implementation is shown in the following comments.
    // if spsr<4> == '1' then // returning to AArch32 state
    //     spsr<26:25,15:10> = Zeros(8); // SPSR[.IT
    //     spsr<24,5> = '01'; // SPSR[.]{J,T}
    // else
    //     spsr<9> = '1'; // SPSR[.D
    //     spsr<21> = '0'; // SPSR[.SS
    //     spsr<8:6> = '111'; // SPSR[.]{A,I,F}

    SetPSTATEFromSPSR(spsr);
    DLR_EL0 = bits(64) UNKNOWN; DSPSR_EL0 = bits(32) UNKNOWN;
    UpdateEDSCRFields(); // Update EDSCR processor state flags.

    return;

// ExitDebugState()
// =====

ExitDebugState()
    assert Halted();
    SynchronizeContext();

    // Although EDSCR.STATUS signals that the processor is restarting, debuggers must use EDPRSR.SDR
    // to detect that the processor has restarted.
    EDSCR.STATUS = '000001'; // Signal restarting
    // Return to saved processing state
    EDESR<2:0> = '000'; // Clear any pending Halting debug events

    from_32 = (PSTATE.nRW == '1');

    new_pc = DLR_EL0;
    spsr = DSPSR;

    SetPSTATEFromSPSR(spsr); // Can update privileged bits, even at EL0.

    if spsr<4> == '1' then
        // Requesting exit to AArch32 state. If coming from AArch64 and PSTATE.IL==1 then the state
        // did not change, but the PC alignment might have occurred
        // Align PC[1:0] according to the target instruction set state
        if from_32 || PSTATE.IL == '0' || ConstrainUnpredictableBool() then
            if spsr<5> == '1' then // T32 or T32EE state
                new_pc<0> = '0';
            else // A32 state
                new_pc<1:0> = '00';

```

```

// Zero the 32 most significant bits of the target PC
if from_32 || PSTATE.IL == '0' || ConstrainUnpredictableBool() then
    new_pc<63:32> = Zeros();

if PSTATE.nRW == '1' then
    BranchTo(new_pc<31:0>, BranchType_UNKNOWN); // AArch32 branch
else
    BranchTo(new_pc, BranchType_DBGEXIT); // A type of branch that is never predicted

(EDSCR.STATUS,EDPRSR.SDR) = ('000010','1'); // Atomically signal restarted
UpdateEDSCRFields(); // Stop signalling processor state.
DisableITRAndResumeInstructionPrefetch();

return;

```

shared/debug/haltingevents

```

// RunHaltingStep()
// =====

RunHaltingStep(boolean exception_generated, bits(2) exception_target, boolean syscall,
               boolean reset)
    // "exception_generated" is TRUE if the previous instruction generated a synchronous exception
    // or was cancelled by an asynchronous exception.
    // if "exception_generated" == TRUE then "exception_target" is the target of the exception, and
    // "syscall" is TRUE if the exception is a synchronous exception where the preferred return
    // address is the instruction following that which generated the exception.
    // "reset" = TRUE if exiting reset state into the highest EL.
    if reset then assert !Halted(); // Cannot come out of reset halted

    active = EDECR.SS == '1' && !Halted();

    if active && reset then // Coming out of reset with EDECR.SS set.
        EDESR.SS = '1';
    elseif active && HaltingAllowed() then
        if exception_generated && exception_target == EL3 then
            advance = syscall || ExternalSecureInvasiveDebugEnabled();
        else
            advance = TRUE;
        if advance then EDESR.SS = '1';

    return;

// HaltingStep_DidNotStep()
// =====
// Returns TRUE if the previously executed instruction was executed in the inactive state, that is,
// it was not itself stepped

boolean HaltingStep_DidNotStep();

// HaltingStep_SteppedEX()
// =====
// Returns TRUE if the previously executed instruction was a Load-Exclusive class instruction
// executed in the active-not-pending state

boolean HaltingStep_SteppedEX();

// CheckHaltingStep()
// =====
// Check whether EDESR.SS has been set by Halting Step

CheckHaltingStep()
    if HaltingAllowed() && EDESR.SS == '1' then
        // The STATUS code depends on how we arrived at the state where EDESR.SS == 1.
        if HaltingStep_DidNotStep() then
            Halt(DebugHalt_Step_NoSyndrome);
        elseif HaltingStep_SteppedEX() then

```

```

        Halt(DebugHalt_Step_Exclusive);
    else
        Halt(DebugHalt_Step_Normal);

// CheckPendingResetCatch()
// =====
// Check whether EDESR.RC has been set by a Reset Catch debug event

CheckPendingResetCatch()
    if HaltingAllowed() && EDESR.RC == '1' then
        Halt(DebugHalt_ResetCatch);

// CheckResetCatch()
// =====
// Called after reset

CheckResetCatch()
    if EDECR.RCE == '1' then
        EDESR.RC = '1';
        // If halting is allowed then halt immediately
        if HaltingAllowed() then Halt(DebugHalt_ResetCatch);

// CheckPendingOSUnlockCatch()
// =====
// Check whether EDESR.OSUC has been set by an OS Unlock Catch debug event

CheckPendingOSUnlockCatch()
    if HaltingAllowed() && EDESR.OSUC == '1' then
        Halt(DebugHalt_OSUnlockCatch);

// CheckOSUnlockCatch()
// =====
// Called on unlocking the OS Lock to pend an OS Unlock Catch debug event

CheckOSUnlockCatch()
    if EDECR.OSUCE == '1' && !Halted() then EDESR.OSUC = '1';

// CheckExceptionCatch()
// =====
// Check whether an Exception Catch debug event is set on the current Exception level

CheckExceptionCatch()
    // Called after taking an exception, that is, such that IsSecure() and PSTATE.EL are correct
    // for the exception target.
    base = if IsSecure() then 0 else 4;
    if HaltingAllowed() && EDECCR<U>Int(PSTATE.EL) + base >= '1' then
        Halt(DebugHalt_ExceptionCatch);

// CheckSoftwareAccessToDebugRegisters()
// =====
// Check for access to Breakpoint and Watchpoint registers.

CheckSoftwareAccessToDebugRegisters()
    if HaltingAllowed() && EDECCR.TDA == '1' && OSLSR_EL1.OSLK == '0' then
        Halt(DebugHalt_SoftwareAccess);

// ExternalDebugRequest()
// =====

ExternalDebugRequest()
    if HaltingAllowed() then
        Halt(DebugHalt_EDBGRQ);
    // Otherwise the CTI continues to assert the debug request until it is taken.

```

shared/debug/interrupts

```
// Debug interrupts (possibly generic)
// ~~~~~

// InterruptID
// =====

enumeration InterruptID {InterruptID_PMUIRQ, InterruptID_COMMIRQ, InterruptID_CTIIRQ,
                        InterruptID_COMMRX, InterruptID_COMMTX};

// SetInterruptRequestLevel()
// =====
// Set a level-sensitive interrupt to the specified level

SetInterruptRequestLevel(InterruptID id, signal level);
```

shared/debug/pmu

```
// Performance Monitors
// ~~~~~

// CheckForPMUOverflow()
// =====
// Signal Performance Monitors overflow IRQ and CTI overflow events

CheckForPMUOverflow()

    pmuirq = (PMCR_EL0.E == '1' && PMINTENSET_EL1<31> == '1' && PMOVSSET_EL0<31> == '1');
    for n = 0 to UInt(PMCR_EL0.N) - 1
        E = (if !HaveEL(EL2) || n < UInt(MDCR_EL2.HPMN) then PMCR_EL0.E else MDCR_EL2.HPME);
        if E == '1' && PMINTENSET_EL1<n> == '1' && PMOVSSET_EL0<n> == '1' then pmuirq = TRUE;

    SetInterruptRequestLevel(InterruptID_PMUIRQ, if pmuirq then HIGH else LOW);

    CTI_SetEventLevel(CrossTriggerIn_PMUOverflow, if pmuirq then HIGH else LOW);

    // The request remains set until the condition is cleared. (For example, an interrupt handler
    // or cross-triggered event handler clears the overflow status flag by writing to PMOVSCLR_EL0.)

    return;

// ProfilingProhibited()
// =====
// Determine whether Performance Monitors counting is prohibited in the current state.

boolean ProfilingProhibited(boolean secure, bits(2) el)
    // Events are always counted in Non-secure state.
    if !secure then return FALSE;

    // Counting events in Secure state is prohibited unless any one of:
    // * EL3 is not implemented
    if !HaveEL(EL3) then return FALSE;

    // * EL3 is using AArch64 and MDCR_EL3.SPME == 1
    // * EL3 is using AArch32 and SDCR.SPME == 1
    spme = (if ELUsingAArch32(EL3) then SDCR.SPME else MDCR_EL3.SPME);
    if spme == '1' then return FALSE;

    // * Allowed by the IMPLEMENTATION DEFINED authentication interface
    if ExternalSecureNoninvasiveDebugEnabled() then return FALSE;

    // * EL3 or EL1 is using AArch32, executing at EL0, and SDER32_EL3.SUNIDEN == 1.
    if el == EL0 && ELUsingAArch32(EL1) && SDER32_EL3.SUNIDEN == '1' then return FALSE;

    return TRUE;
```

```
// CountEvents()
// =====

boolean CountEvents(integer n)
  assert(n == 31 || n < UInt(PMCR_EL0.N));

  filter = (if n == 31 then PMCCFILTR_EL0<31:26> else PMEVTYPER_EL0[n]<31:26>);

  M = if !HaveEL(EL3) then '0' else (filter<5> EOR filter<0>);
  H = if !HaveEL(EL2) then '0' else filter<1>;
  P = filter<5>; U = filter<4>;
  if !IsSecure() && HaveEL(EL3) then
    P = P EOR filter<3>; U = U EOR filter<2>;

  prohibited = ProfilingProhibited(TRUE, PSTATE.EL);
  if prohibited && n == 31 && PMCR_EL0.DP == '0' then prohibited = FALSE;

  E = (if !HaveEL(EL2) || n == 31 || n < UInt(MDCR_EL2.HPMN) then PMCR_EL0.E else MDCR_EL2.HPME);
  enabled = (E == '1' && PMCNENSET_EL0<n> == '1');

  case PSTATE.EL of
    when EL0 filtered = U == '1';
    when EL1 filtered = P == '1';
    when EL2 filtered = H == '0';           // assert kpmuen; assert HaveEL(EL2);
    when EL3 filtered = M == '1';           // assert HaveEL(EL3);

  return !prohibited && !filtered && enabled && !Halted();
```

shared/debug/samplebasedprofiling

```
// PCSample
// =====

type PCSample is (
  boolean valid,
  bits(64) pc,
  bits(2) el,
  bit rw,
  bit ns,
  bits(32) contextidr,
  bits(8) vmid
)

PCSample pc_sample;

// CreatePCSample()
// =====

CreatePCSample()
  // In a simple sequential execution of the program, CreatePCSample is executed each time the PE
  // executes an instruction that can be sampled. An implementation is not constrained such that
  // reads of EDPCSRlo return the current values of PC, etc.
  enabled = (if IsSecure() then ExternalSecureNoninvasiveDebugEnabled()
             else ExternalNoninvasiveDebugEnabled());

  pc_sample.valid = enabled && !Halted();
  pc_sample.pc = ThisInstrAddr();
  pc_sample.el = PSTATE.EL;
  pc_sample.rw = if UsingAArch32() then '0' else '1';
  pc_sample.ns = if IsSecure() then '0' else '1';
  pc_sample.contextidr = CONTEXTIDR_GEN[];
  pc_sample.vmid = VTTBR_EL2.VMID;

  return;

// EDPCSRlo[] (read)
// =====
```

```

bits(32) EDPCSRlo[]

if pc_sample.valid then
    sample = pc_sample.pc<31:0>;
    EDPCSRhi = (if pc_sample.rw == '0' then Zeros(32) else pc_sample.pc<63:32>);
    EDCIDSR = pc_sample.contextidr;
    EDVIDSR.VMID = (if HaveEL(EL2) && pc_sample.ns == '1' && pc_sample.e1 IN {EL1,EL0}
                    then pc_sample.vmid else Zeros(8));
    EDVIDSR.NS = pc_sample.ns;
    EDVIDSR.E2 = (if pc_sample.e1 == EL2 then '1' else '0');
    EDVIDSR.E3 = (if pc_sample.e1 == EL3 then '1' else '0') AND pc_sample.rw;
    // The conditions for setting HV are not specified if PCSRhi is zero.
    // An example implementation may be "pc_sample.rw".
    EDVIDSR.HV = (if !IsZero(EDPCSRhi) then '1' else bit IMPLEMENTATION_DEFINED "0 or 1");
else
    sample = Ones(32);
    EDPCSRhi = bits(32) UNKNOWN;
    EDCIDSR = bits(32) UNKNOWN;
    EDVIDSR = (bits(4) UNKNOWN):Zeros(20):(bits(8) UNKNOWN);

return sample;

```

shared/debug/softwarestep

```

// Software Step state machine
// ~~~~~

// SSAdvance()
// =====
// Advance the Software Step state machine.

SSAdvance()

    // A simpler implementation of this function just clears PSTATE.SS to zero regardless of the
    // current Software Step state machine. However, this check is made to illustrate that the
    // processor only needs to consider advancing the state machine from the active-not-pending
    // state.
    target = DebugTarget();
    step_enabled = !ELUsingAArch32(target) && MDSCR_EL1.SS == '1';
    active_not_pending = step_enabled && PSTATE.SS == '1';

    if active_not_pending then PSTATE.SS = '0';

return;

// CheckSoftwareStep()
// =====
// Take a Software Step exception if in the active-pending state

CheckSoftwareStep()

    if (!ELUsingAArch32(DebugTarget()) && AArch64.GenerateDebugExceptions() &&
        MDSCR_EL1.SS == '1' && PSTATE.SS == '0') then
        AArch64.SoftwareStepException();

// DebugExceptionReturnSS()
// =====
// Returns value to write to PSTATE.SS on an exception return or Debug state exit.

bit DebugExceptionReturnSS(bits(32) spsr)
    assert Halted() || Restarting() || PSTATE.EL != EL0;

    SS_bit = '0';

    if MDSCR_EL1.SS == '1' then
        if Restarting() then

```

```

        enabled_at_source = FALSE;
    elseif UsingAArch32() then
        enabled_at_source = AArch32.GenerateDebugExceptions();
    else
        enabled_at_source = AArch64.GenerateDebugExceptions();

    if IllegalExceptionReturn(spsr) then
        dest = PSTATE.EL;
    else
        (valid, dest) = ELFromSPSR(spsr); assert valid;

    secure = IsSecureBelowEL3() || dest == EL3;

    if ELUsingAArch32(dest) then
        enabled_at_dest = AArch32.GenerateDebugExceptionsFrom(dest, secure);
    else
        mask = spsr<9>;
        enabled_at_dest = AArch64.GenerateDebugExceptionsFrom(dest, secure, mask);

    ELd = DebugTargetFrom(secure);
    if !ELUsingAArch32(ELd) && !enabled_at_source && enabled_at_dest then
        SS_bit = spsr<21>;

    return SS_bit;

// SoftwareStep_DidNotStep()
// =====
// Returns TRUE if the previously executed instruction was executed in the inactive state, that is,
// it was not itself stepped

boolean SoftwareStep_DidNotStep();

// SoftwareStep_SteppedEX()
// =====
// Returns TRUE if the previously executed instruction was a Load-Exclusive class instruction
// executed in the active-not-pending state

boolean SoftwareStep_SteppedEX();

```

G.3.2 shared/exceptions

This section contains the pseudocode that relates to exception handling and is common to AArch32 state and AArch64 state.

shared/exceptions/exceptions

```

// ~~~~~
// Shared Exception Model
// ~~~~~

// Typical flow through a translation for EL0 using AArch32 under EL1 using AArch64
// is as follows:
//
//
// WFE instruction pseudocode (AArch32)
// |
// '-> AArch32.WFxTrap(EL2)
// |
// '-> AArch32.TakeHypTrapException()
// |
// '-> AArch32.EnterHypMode()
// |
// |-> AArch32.ReportHypEntry()
// |
// '-> AArch32.BranchTo(HVBAR + offset)
//

```



```

// However, as necessary the exception handlers are marshalled to the correct
// exception regime for the exception type:
//
// WFE instruction pseudocode (AArch32)
// |
// `-> AArch32.WFxTrap(EL2)
// |
// `-> AArch64.WFxTrap(EL2)
// |
// `-> AArch64.TakeException(EL2)
// |
// |-> MaybeZeroRegisterUppers()
// |
// |-> AArch64.ReportException()
// |
// `-> AArch64.BranchTo(VBAR[EL2] + offset)
//
// Syndrome handling is different in the two worlds, and this is deliberate (though
// not necessarily fortunate). AArch64 passes the syndrome down to the exception
// entry which writes ESR and FAR; AArch32 does this for Hyp entries but otherwise
// writes these before calling the entry point. This is necessary in the AArch32
// case because of the variance due to descriptor format, eventual destination of
// the exception, etc.

// Exception
// =====
// Classes of exception

enumeration Exception {Exception_Uncategorized, // Uncategorized or unknown reason
                        Exception_WFxTrap,      // Trapped WFI or WFE instruction
                        Exception_CP15RTTTrap,  // Trapped AArch32 MCR or MRC access to CP15
                        Exception_CP15RRTTTrap, // Trapped AArch32 MCRR or MRRC access to CP15
                        Exception_CP14RTTTrap,  // Trapped AArch32 MCR or MRC access to CP14
                        Exception_CP14DTTTrap,  // Trapped AArch32 LDC or STC access to CP14
                        Exception_AdvSIMDFPAccessTrap, // HCPTR-trapped access to SIMD or FP
                        Exception_FPIDTTrap,    // Trapped access to SIMD or FP ID register
                        // Trapped BXJ instruction not supported in ARMv8
                        Exception_CP14RRTTTrap, // Trapped MRRC access to CP14 from AArch32
                        Exception_IllegalState, // Illegal state
                        Exception_SupervisorCall, // Supervisor Call
                        Exception_HypervisorCall, // Hypervisor Call
                        Exception_MonitorCall, // Monitor Call or Trapped SMC instruction
                        Exception_SystemRegisterTrap, // Trapped MRS or MSR system register access
                        Exception_InstructionAbort, // Instruction/Prefetch Abort
                        Exception_PCAlignment, // PC alignment
                        Exception_DataAbort, // Data Abort
                        Exception_SPAAlignment, // SP alignment
                        Exception_FPTrappedException, // IEEE trapped FP exception
                        Exception_SError, // System Error/Asynchronous Abort
                        Exception_Breakpoint, // Hardware breakpoint
                        Exception_SoftwareStep, // Hardware single-step
                        Exception_Watchpoint, // Hardware watchpoint
                        Exception_SoftwareBreakpoint, // BRK or BKPT instruction
                        Exception_VectorCatch, // AArch32 Vector catch
                        Exception_IRQ, // IRQ interrupt
                        Exception_FIQ}; // FIQ interrupt

// ExceptionRecord
// =====

type ExceptionRecord is (Exception type, // Exception class
                        bits(25) syndrome, // Syndrome record
                        bits(64) vaddress, // Virtual fault address
                        boolean ipavalid, // Physical fault address is valid
                        bits(48) ipaddress) // Physical fault address for second stage faults

// ExceptionSyndrome()
// =====

```

```
// Return a blank exception syndrome record for an exception of the given type.
ExceptionRecord ExceptionSyndrome(Exception type)

    ExceptionRecord r;

    r.type = type;

    r.syndrome = Zeros();
    if r.type IN {Exception_WFxTrap, Exception_CP15RTTTrap, Exception_CP15RRRTTrap,
                Exception_CP14RTTTrap, Exception_CP14DTTTrap,
                Exception_AdvSIMDFPAccessTrap, Exception_CP14RRRTTrap} then
        if UsingAArch32() then
            cond = AArch32.CurrentCond();
            case CurrentInstrSet() of
                when InstrSet_A32
                    r.syndrome<24> = '1';
                    // A conditional A32 instruction that is known to pass its condition code check
                    // can be presented either with COND set to 0xE, the value for unconditional, or
                    // the COND value held in the instruction.
                    if ConditionHolds(cond) && ConstrainUnpredictableBool() then
                        r.syndrome<23:20> = '1110';
                    else
                        r.syndrome<23:20> = cond;

                when InstrSet_T32, InstrSet_T32EE
                    // When a T32 instruction is trapped, it is IMPLEMENTATION DEFINED whether:
                    // * CV set to 0 and COND is set to an UNKNOWN value
                    // * CV set to 1 and COND is set to the condition code for the condition that
                    //   applied to the instruction.
                    if boolean IMPLEMENTATION_DEFINED "Condition valid for trapped T32" then
                        r.syndrome<24> = '1';
                        r.syndrome<23:20> = cond;
                    else
                        r.syndrome<24> = '1';
                        r.syndrome<23:20> = bits(4) UNKNOWN;
            else
                r.syndrome<24> = '1';
                r.syndrome<23:20> = '1110';

    // Initialize all other fields
    r.vaddress = Zeros();
    r.ipvalid = FALSE;
    r.ipaddress = Zeros();

    return r;
```

shared/exceptions/traps

```
// ~~~~~
// Shared Exception Model
// ~~~~~

// ~~~~~
// Configurable traps and enables and Undefined Instruction exceptions

// UnallocatedEncoding()
// =====

UnallocatedEncoding()

// If the unallocated encoding is an AArch32 CP10 or CP11 instruction, FPEXC.DEX must be written
// to zero. This is omitted from this code.
if UsingAArch32() && !AArch32.GeneralExceptionsToAArch64() then
    AArch32.TakeUndefInstrException();
else
    AArch64.UndefinedFault();
```

```

// ReservedValue()
// =====

ReservedValue()

    if UsingAArch32() && !AArch32.GeneralExceptionsToAArch64() then
        AArch32.TakeUndefInstrException();
    else
        AArch64.UndefinedFault();

// CPreTrapSyndrome()
// =====
// Return the syndrome information for coprocessor register traps other than
// due to HCPTR or CPACR

ExceptionRecord CPreTrapSyndrome(bits(32) instr)

    ExceptionRecord exception;
    cpnum = UInt(instr<11:8>);

    bits(25) iss = Zeros();
    if instr<27:24> == '1110' && instr<4> == '1' && instr<31:28> != '1111' then
        // MRC/MCR
        case cpnum of
            when 10    exception = ExceptionSyndrome(Exception_FPIDTrap);
            when 14    exception = ExceptionSyndrome(Exception_CPI4RTTTrap);
            when 15    exception = ExceptionSyndrome(Exception_CPI5RTTTrap);
            otherwise  Unreachable();
        iss<19:17> = instr<7:5>;    // opc2
        iss<16:14> = instr<23:21>; // opc1
        iss<13:10> = instr<19:16>; // CRn
        iss<8:5>   = instr<15:12>; // Rt
        iss<4:1>  = instr<3:0>;   // CRm
    elseif instr<27:21> == '110010' && instr<31:28> != '1111' then
        // MRRC/MCRR
        case cpnum of
            when 14    exception = ExceptionSyndrome(Exception_CPI4RRRTTrap);
            when 15    exception = ExceptionSyndrome(Exception_CPI5RRRTTrap);
            otherwise  Unreachable();
        iss<19:16> = instr<7:4>;    // opc1
        iss<13:10> = instr<19:16>; // Rt2
        iss<8:5>   = instr<15:12>; // Rt
        iss<4:1>  = instr<3:0>;   // CRm
    elseif instr<27:25> == '110' && instr<31:28> != '1111' then
        // LDC/STC
        assert cpnum == 14;
        exception = ExceptionSyndrome(Exception_CPI4DTTTrap);
        iss<19:12> = instr<7:0>;    // imm8
        iss<4,2:1> = instr<24:23,21>;
        if instr<19:16> == '1111' then // Literal addressing
            iss<8:5> = bits(4) UNKNOWN;
            iss<3>  = '1';
        else
            iss<8:5> = instr<19:16>; // Rn
            iss<3>  = '0';
    else
        Unreachable();
    iss<0> = instr<20>; // Direction
    exception.syndrome = iss;

    return exception;

```

G.3.3 shared/functions

This section contains the general pseudocode functions that are common to AArch32 state and AArch64 state.

shared/functions/aborts

```
// ~~~~~  
// Shared Abort handling  
// ~~~~~  
  
// IsFault()  
// =====  
// Return true if a fault is associated with an address descriptor  
  
boolean IsFault(AddressDescriptor addrdesc)  
    return addrdesc.fault.type != Fault_None;  
  
// IPValid()  
// =====  
// Return TRUE if the IPA is reported for the abort  
  
boolean IPValid(FaultRecord fault)  
    assert fault.type != Fault_None;  
  
    if fault.s2fs1walk then  
        return fault.type IN {Fault_AccessFlag, Fault_Permission, Fault_Translation,  
                               Fault_AddressSize};  
    elseif fault.secondstage then  
        return fault.type IN {Fault_AccessFlag, Fault_Translation, Fault_AddressSize};  
    else  
        return FALSE;  
  
// IsExternalAbort()  
// =====  
  
boolean IsExternalAbort(Fault type)  
    assert type != Fault_None;  
  
    return (type IN {Fault_SyncExternal, Fault_SyncParity, Fault_AsyncExternal, Fault_AsyncParity,  
                    Fault_SyncExternalOnWalk, Fault_SyncParityOnWalk});  
  
// IsExternalAbort()  
// =====  
  
boolean IsExternalAbort(FaultRecord fault)  
    return IsExternalAbort(fault.type);  
  
// IsDebugException()  
// =====  
  
boolean IsDebugException(FaultRecord fault)  
    assert fault.type != Fault_None;  
    return fault.type == Fault_Debug;  
  
// IsSecondStage()  
// =====  
  
boolean IsSecondStage(FaultRecord fault)  
    assert fault.type != Fault_None;  
  
    return fault.secondstage;  
  
// IsAsyncAbort()  
// =====  
  
boolean IsAsyncAbort(Fault type)  
    assert type != Fault_None;
```

```

    return (type IN {Fault_AsyncExternal, Fault_AsyncParity});

// IsAsyncAbort()
// =====

boolean IsAsyncAbort(FaultRecord fault)
    return IsAsyncAbort(fault.type);

// EncodeLDFSC()
// =====
// Function that gives the Long-descriptor FSC code for types of Fault

bits(6) EncodeLDFSC(Fault type, integer level)

    bits(6) result;

    case type of
        when Fault_AddressSize      result = '0000':level<1:0>;
        when Fault_AccessFlag       result = '0010':level<1:0>;
        when Fault_Permission       result = '0011':level<1:0>;
        when Fault_Translation      result = '0001':level<1:0>;
        when Fault_SyncExternal     result = '010000';
        when Fault_SyncExternalOnWalk result = '0101':level<1:0>;
        when Fault_SyncParity       result = '011000';
        when Fault_SyncParityOnWalk result = '0111':level<1:0>;
        when Fault_AsyncParity      result = '011001';
        when Fault_AsyncExternal    result = '010001';
        when Fault_Alignment        result = '100001';
        when Fault_Debug            result = '100010';
        when Fault_TLBConflict      result = '110000';
        when Fault_Lockdown        result = '110100';
        when Fault_Coproc          result = '111010';
        otherwise                   Unreachable();

    return result;

// LSInstructionSyndrome()
// =====
// Returns the extended syndrome information for a second stage fault.
// <10> - Syndrome valid bit. The syndrome is only valid for certain types of access instruction.
// <9:8> - Access size.
// <7> - Sign extended (for loads).
// <6:2> - Transfer register.
// <1> - Transfer register is 64-bit.
// <0> - Instruction has acquire/release semantics.

bits(11) LSInstructionSyndrome();

// FaultSyndrome()
// =====
// Creates an exception syndrome value for Abort and Watchpoint exceptions taken to
// AArch32 Hyp mode or an Exception Level using AArch64.

bits(25) FaultSyndrome(boolean d_side, FaultRecord fault)
    assert fault.type != Fault_None;

    bits(25) iss = Zeros();
    if d_side && IsSecondStage(fault) then
        iss<24:14> = LSInstructionSyndrome();
    if IsExternalAbort(fault) then iss<9> = fault.extflag;
    if d_side then
        iss<8> = if fault.acctype IN {AccType_DC, AccType_IC} then '1' else '0';
        iss<7> = if fault.s2fs1walk then '1' else '0';
        iss<6> = if fault.write then '1' else '0';
        iss<5:0> = EncodeLDFSC(fault.type, fault.level);

    return iss;

```

shared/functions/common

```
// Helpers mostly identical to the ARM ARM

// IsZero()
// =====

boolean IsZero(bits(N) x)
    return x == Zeros(N);

// IsZeroBit()
// =====

bit IsZeroBit(bits(N) x)
    return if IsZero(x) then '1' else '0';

// IsOnes()
// =====

boolean IsOnes(bits(N) x)
    return x == Ones(N);

// LSL()
// =====

bits(N) LSL(bits(N) x, integer shift)
    assert shift >= 0;
    if shift == 0 then
        result = x;
    else
        (result, -) = LSL_C(x, shift);
    return result;

// LSL_C()
// =====

(bits(N), bit) LSL_C(bits(N) x, integer shift)
    assert shift > 0;
    extended_x = x : Zeros(shift);
    result = extended_x<N-1:0>;
    carry_out = extended_x<N>;
    return (result, carry_out);

// LSR()
// =====

bits(N) LSR(bits(N) x, integer shift)
    assert shift >= 0;
    if shift == 0 then
        result = x;
    else
        (result, -) = LSR_C(x, shift);
    return result;

// LSR_C()
// =====

(bits(N), bit) LSR_C(bits(N) x, integer shift)
    assert shift > 0;
    extended_x = ZeroExtend(x, shift+N);
    result = extended_x<shift+N-1:shift>;
    carry_out = extended_x<shift-1>;
    return (result, carry_out);

// ASR()
// =====

bits(N) ASR(bits(N) x, integer shift)
```

```

    assert shift >= 0;
    if shift == 0 then
        result = x;
    else
        (result, -) = ASR_C(x, shift);
    return result;

// ASR_C()
// =====

(bits(N), bit) ASR_C(bits(N) x, integer shift)
    assert shift > 0;
    extended_x = SignExtend(x, shift+N);
    result = extended_x<shift+N-1:shift>;
    carry_out = extended_x<shift-1>;
    return (result, carry_out);

// ROR()
// =====

bits(N) ROR(bits(N) x, integer shift)
    assert shift >= 0;
    if shift == 0 then
        result = x;
    else
        (result, -) = ROR_C(x, shift);
    return result;

// ROR_C()
// =====

(bits(N), bit) ROR_C(bits(N) x, integer shift)
    assert shift != 0;
    m = shift MOD N;
    result = LSR(x,m) OR LSL(x,N-m);
    carry_out = result<N-1>;
    return (result, carry_out);

// Replicate()
// =====

bits(M*N) Replicate(bits(M) x, integer N);

// Replicate()
// =====

bits(N) Replicate(bits(M) x)
    assert N MOD M == 0;
    return Replicate(x, N DIV M);

// RoundDown()
// =====

integer RoundDown(real x);

// RoundUp()
// =====

integer RoundUp(real x);

// RoundTowardsZero()
// =====

integer RoundTowardsZero(real x)
    return if x == 0.0 then 0 else if x >= 0.0 then RoundDown(x) else RoundUp(x);

// SignExtend()
// =====

```

```
bits(N) SignExtend(bits(M) x, integer N)
    assert N >= M;
    return Replicate(x<M-1>, N-M) : x;

// SignExtend()
// =====

bits(N) SignExtend(bits(M) x)
    return SignExtend(x, N);

// ZeroExtend()
// =====

bits(N) ZeroExtend(bits(M) x, integer N)
    assert N >= M;
    return Zeros(N-M) : x;

// ZeroExtend()
// =====

bits(N) ZeroExtend(bits(M) x)
    return ZeroExtend(x, N);

// Extend()
// =====

bits(N) Extend(bits(M) x, integer N, boolean unsigned)
    return if unsigned then ZeroExtend(x, N) else SignExtend(x, N);

// Extend()
// =====

bits(N) Extend(bits(M) x, boolean unsigned)
    return Extend(x, N, unsigned);

// Zeros()
// =====

bits(N) Zeros(integer N)
    return Replicate('0',N);

// Zeros()
// =====

bits(N) Zeros()
    return Zeros(N);

// Ones()
// =====

bits(N) Ones(integer N)
    return Replicate('1',N);

// Ones()
// =====

bits(N) Ones()
    return Ones(N);

// NOT()
// =====

bits(N) NOT(bits(N) x);

// UInt()
// =====
```



```

integer UInt(bits(N) x)
    result = 0;
    for i = 0 to N-1
        if x<i> == '1' then result = result + 2Λi;
    return result;

// SInt()
// =====

integer SInt(bits(N) x)
    result = 0;
    for i = 0 to N-1
        if x<i> == '1' then result = result + 2Λi;
    if x<N-1> == '1' then result = result - 2ΛN;
    return result;

// Int()
// =====

integer Int(bits(N) x, boolean unsigned)
    result = if unsigned then UInt(x) else SInt(x);
    return result;

// Abs()
// =====

integer Abs(integer x)
    return if x >= 0 then x else -x;

// Abs()
// =====

real Abs(real x)
    return if x >= 0.0 then x else -x;

// Max()
// =====

integer Max(integer a, integer b)
    return if a >= b then a else b;

// Max()
// =====

real Max(real a, real b)
    return if a >= b then a else b;

// Min()
// =====

integer Min(integer a, integer b)
    return if a <= b then a else b;

// Min()
// =====

real Min(real a, real b)
    return if a <= b then a else b;

// LowestSetBit()
// =====

integer LowestSetBit(bits(N) x)
    for i = 0 to N-1
        if x<i> == '1' then return i;
    return N;

// HighestSetBit()

```

```

// =====

integer HighestSetBit(bits(N) x)
  for i = N-1 downto 0
    if x<i> == '1' then return i;
  return -1;

// BitCount()
// =====

integer BitCount(bits(N) x)
  integer result = 0;
  for i = 0 to N-1
    if x<i> == '1' then
      result = result + 1;
  return result;

// CountLeadingZeroBits()
// =====

integer CountLeadingZeroBits(bits(N) x)
  return N - 1 - HighestSetBit(x);

// CountLeadingSignBits()
// =====

integer CountLeadingSignBits(bits(N) x)
  return CountLeadingZeroBits(x<N-1:1> EOR x<N-2:0>);

// Align()
// =====

integer Align(integer x, integer y)
  return y * (x DIV y);

// Align()
// =====

bits(N) Align(bits(N) x, integer y)
  return Align(UInt(x), y)<N-1:0>;

// GetVectorElement()
// =====

bits(size) GetVectorElement(bits(N) vector, integer e)
  assert e >= 0 && (e+1)*size <= N;
  return vector<e*size+size-1 : e*size>;

// SetVectorElement()
// =====

bits(N) SetVectorElement(bits(N) vector, integer e, bits(size) value)
  assert e >= 0 && (e+1)*size <= N;
  vector<(e+1)*size-1:e*size> = value;
  return vector;

// Elem[] - non-assignment form
// =====

bits(size) Elem[bits(N) vector, integer e, integer size]
  assert e >= 0 && (e+1)*size <= N;
  return vector<e*size+size-1 : e*size>;

// Elem[] - non-assignment form
// =====

bits(size) Elem[bits(N) vector, integer e]
  return Elem[vector, e, size];

```

```
// Elem[] - assignment form
// =====

Elem[bits(N) &vector, integer e, integer size] = bits(size) value
    assert e >= 0 && (e+1)*size <= N;
    vector<(e+1)*size-1:e*size> = value;
    return;

// Elem[] - assignment form
// =====

Elem[bits(N) &vector, integer e] = bits(size) value
    Elem[vector, e, size] = value;
    return;
```

shared/functions/crc

```
// HaveCRCExt()
// =====

boolean HaveCRCExt()
    return boolean IMPLEMENTATION_DEFINED;

// BitReverse()
// =====

bits(N) BitReverse(bits(N) data)
    bits(N) result;
    for i = 0 to N-1
        result<N-i-1> = data<i>;
    return result;

// Poly32Mod2()
// =====

// Poly32Mod2 on a bitstring does a polynomial Modulus over {0,1} operation

bits(32) Poly32Mod2(bits(N) data, bits(32) poly)
    assert N > 32;
    for i = N-1 downto 32
        if data<i> == '1' then
            data<i-1:0> = data<i-1:0> EOR poly:Zeros(i-32);
    return data<31:0>;
```

shared/functions/crypto

```
// HaveCryptoExt()
// =====

boolean HaveCryptoExt();

// ROL()
// =====

bits(N) ROL(bits(N) x, integer shift)
    assert shift >= 0 && shift <= N;
    if (shift == 0) then
        return x;
    return ROR(x, N-shift);

// AES
// +++

// AES worker functions
// As described in FIPS 197
```

```
// Each 128-bit value is assumed to hold an array of 16 bytes loaded
// into a vector with little-endian element ordering, i.e.
//
//   a[15]:a[14]:a[13]:a[12]:...:a[1]:a[0]
//
// In other words as if loaded from memory using an LD1 {Vt.16B} instruction.
//
// Note that this differs from the FIPS 197 documentation which illustrates
// a big-endian data organisation.

// AESShiftRows
// =====

bits(128) AESShiftRows(bits(128) op);

// AESInvShiftRows()
// =====

bits(128) AESInvShiftRows(bits(128) op);

// AESSubBytes()
// =====

bits(128) AESSubBytes(bits(128) op);

// AESInvSubBytes()
// =====

bits(128) AESInvSubBytes(bits(128) op);

// AESMixColumns()
// =====

bits(128) AESMixColumns(bits (128) op);

// AESInvMixColumns()
// =====

bits(128) AESInvMixColumns(bits (128) op);

// SHA
// +++

// SHAchoose()
// =====

bits(32) SHAchoose(bits(32) x, bits(32) y, bits(32) z)
    return ((y EOR z) AND x) EOR z;

// SHAparity()
// =====

bits(32) SHAparity(bits(32) x, bits(32) y, bits(32) z)
    return (x EOR y EOR z);

// SHAmajority()
// =====

bits(32) SHAmajority(bits(32) x, bits(32) y, bits(32) z)
    return ((x AND y) OR ((x OR y) AND z));

// SHAhashSIGMA0()
// =====

bits(32) SHAhashSIGMA0(bits(32) x)
    return ROR(x, 2) EOR ROR(x, 13) EOR ROR(x, 22);
```

```
// SHAhashSIGMA1()
// =====

bits(32) SHAhashSIGMA1(bits(32) x)
    return ROR(x, 6) EOR ROR(x, 11) EOR ROR(x, 25);

// SHA-256
// ++++++

// SHA256hash()
// =====

bits(128) SHA256hash (bits (128) X, bits(128) Y, bits(128) W, boolean part1)
    bits(32) chs, maj, t;

    for e = 0 to 3
        chs = SHAchoose(Y<31:0>, Y<63:32>, Y<95:64>);
        maj = SHAmajority(X<31:0>, X<63:32>, X<95:64>);
        t = Y<127:96> + SHAhashSIGMA1(Y<31:0>) + chs + Elem[W, e, 32];
        X<127:96> = t + X<127:96>;
        Y<127:96> = t + SHAhashSIGMA0(X<31:0>) + maj;
        <Y, X> = ROL(Y : X, 32);
    return (if part1 then X else Y);
```

shared/functions/exclusive

```
// ProcessorID()
// =====

// Return the Processor ID of the currently executing PE.
integer ProcessorID();

// IsExclusiveLocal()
// =====

// Return TRUE if the local Exclusive Monitor for processorid includes all of
// the physical address region of size bytes starting at paddress.
boolean IsExclusiveLocal(FullAddress paddress, integer processorid, integer size);

// IsExclusiveGlobal()
// =====

// Return TRUE if the global Exclusive Monitor for processorid includes all of
// the physical address region of size bytes starting at paddress.
boolean IsExclusiveGlobal(FullAddress paddress, integer processorid, integer size);

// MarkExclusiveLocal()
// =====

// Record the physical address region of size bytes starting at address in
// the local Exclusive Monitor for processorid.
MarkExclusiveLocal(FullAddress paddress, integer processorid, integer size);

// MarkExclusiveGlobal()
// =====

// Record the physical address region of size bytes starting at address in
// the global Exclusive Monitor for processorid.
MarkExclusiveGlobal(FullAddress paddress, integer processorid, integer size);

// ClearExclusiveLocal()
// =====

// Clear the local Exclusive Monitor for the specified processorid.
ClearExclusiveLocal(integer processorid);

// ClearExclusiveMonitors()
```

```
// =====

// Clear the local Exclusive Monitor for the executing PE.
ClearExclusiveMonitors()
    ClearExclusiveLocal(ProcessorID());

// ClearExclusiveByAddress()
// =====

// Clear the global Exclusive Monitors for all processors EXCEPT processorid if they
// record any part the physical address region of size bytes starting at address.
// It is IMPLEMENTATION DEFINED whether the global Exclusive Monitor for processorid
// is also cleared if it records any part of the address region.
ClearExclusiveByAddress(FullAddress address, integer processorid, integer size);

// ExclusiveMonitorsStatus()
// =====

// Returns '0' to indicate success if the last memory write by this processor was to
// the same physical address region endorsed by ExclusiveMonitorsPass().
// Returns '1' to indicate failure if address translation resulted in a different
// physical address.
bit ExclusiveMonitorsStatus();
```

shared/functions/float

```
// ~~~~~
// Floating-point support code
// ~~~~~

// FPRounding
// =====

// The new AArch64 conversion and rounding functions take an explicit
// rounding mode enumeration instead of booleans or FPCR values.

enumeration FPRounding {FPRounding_TIEEVEN, FPRounding_POSINF,
                       FPRounding_NEGINF, FPRounding_ZERO,
                       FPRounding_TIEAWAY, FPRounding_ODD};

// FPType
// =====

enumeration FPType     {FPType_Nonzero, FPType_Zero, FPType_Infinity,
                       FPType_QNaN, FPType_SNaN};

// FPCRTYPE
// =====

// Placeholder for AArch64 FPCR and (part of) AArch32 FPSR special-purpose register definitions
type FPCRTYPE;

// FPEXC
// =====

enumeration FPEXC     {FPEXC_InvalidOp, FPEXC_DivideByZero, FPEXC_Overflow,
                       FPEXC_Underflow, FPEXC_Inexact, FPEXC_InputDenorm};

// FPPROCESSEXCEPTION()
// =====
//
// The 'fpcr' argument supplies FPCR control bits. Status information is
// updated directly in the FPSR where appropriate.

FPPROCESSEXCEPTION(FPEXC exception, FPCRTYPE fpcr)
    // Determine the cumulative exception bit number
```

```

case exception of
  when FPExc_InvalidOp      cumul = 0;
  when FPExc_DivideByZero  cumul = 1;
  when FPExc_Overflow      cumul = 2;
  when FPExc_Underflow     cumul = 3;
  when FPExc_Inexact       cumul = 4;
  when FPExc_InputDenorm   cumul = 7;
enable = cumul + 8;
if fpcr<enable> == '1' then
  // Trapping of the exception enabled.
  // It is IMPLEMENTATION DEFINED whether the enable bit may be set at all, and
  // if so then how exceptions may be accumulated before calling FPTrapException()
  IMPLEMENTATION_DEFINED "floating-point trap handling";
else if UsingArch32() then
  // Set the cumulative exception bit
  FPSCR<cumul> = '1';
else
  // Set the cumulative exception bit
  FPSR<cumul> = '1';
return;

// FPUnpack()
// =====
//
// Unpack a floating-point number into its type, sign bit and the real number
// that it represents. The real number result has the correct sign for numbers
// and infinities, is very large in magnitude for infinities, and is 0.0 for
// NaNs. (These values are chosen to simplify the description of comparisons
// and conversions.)
//
// The 'fpcr' argument supplies FPCR control bits. Status information is
// updated directly in the FPSR where appropriate.

(FPType, bit, real) FPUnpack(bits(N) fpval, FPCRTYPE fpcr)
  assert N IN {16,32,64};

  if N == 16 then
    sign = fpval<15>;
    exp16 = fpval<14:10>;
    frac16 = fpval<9:0>;
    if IsZero(exp16) then
      // Produce zero if value is zero
      if IsZero(frac16) then
        type = FPTYPE_Zero; value = 0.0;
      else
        type = FPTYPE_Nonzero; value = 2.0-14 * (UInt(frac16) * 2.0-10);
    elsif IsOnes(exp16) && fpcr.AHP == '0' then // Infinity or NaN in IEEE format
      if IsZero(frac16) then
        type = FPTYPE_Infinity; value = 2.01000000;
      else
        type = if frac16<9> == '1' then FPTYPE_QNaN else FPTYPE_SNaN;
        value = 0.0;
    else
      type = FPTYPE_Nonzero; value = 2.0(UInt(exp16)-15) * (1.0 + UInt(frac16) * 2.0-10);

  elsif N == 32 then

    sign = fpval<31>;
    exp32 = fpval<30:23>;
    frac32 = fpval<22:0>;
    if IsZero(exp32) then
      // Produce zero if value is zero or flush-to-zero is selected.
      if IsZero(frac32) || fpcr.FZ == '1' then
        type = FPTYPE_Zero; value = 0.0;
      if !IsZero(frac32) then // Denormalized input flushed to zero
        FPPProcessException(FPExc_InputDenorm, fpcr);
    else
      type = FPTYPE_Nonzero; value = 2.0-126 * (UInt(frac32) * 2.0-23);

```

```

    elseif IsOnes(exp32) then
      if IsZero(frac32) then
        type = FPType_Infinity; value = 2.0^1000000;
      else
        type = if frac32<22> == '1' then FPType_QNaN else FPType_SNaN;
        value = 0.0;
    else
      type = FPType_Nonzero; value = 2.0^(UInt(exp32)-127) * (1.0 + UInt(frac32) * 2.0^-23);

else // N == 64

  sign = fpval<63>;
  exp64 = fpval<62:52>;
  frac64 = fpval<51:0>;
  if IsZero(exp64) then
    // Produce zero if value is zero or flush-to-zero is selected.
    if IsZero(frac64) || fpcr.FZ == '1' then
      type = FPType_Zero; value = 0.0;
      if !IsZero(frac64) then // Denormalized input flushed to zero
        FPPProcessException(FPExc_InputDenorm, fpcr);
    else
      type = FPType_Nonzero; value = 2.0^-1022 * (UInt(frac64) * 2.0^-52);
  elseif IsOnes(exp64) then
    if IsZero(frac64) then
      type = FPType_Infinity; value = 2.0^1000000;
    else
      type = if frac64<51> == '1' then FPType_QNaN else FPType_SNaN;
      value = 0.0;
  else
    type = FPType_Nonzero; value = 2.0^(UInt(exp64)-1023) * (1.0 + UInt(frac64) * 2.0^-52);

  if sign == '1' then value = -value;
  return (type, sign, value);

// FPPProcessNaN()
// =====

bits(N) FPPProcessNaN(FPType type, bits(N) op, FPCRTYPE fpcr)
  assert N IN {32,64};
  assert type IN {FPType_QNaN, FPType_SNaN};

  topfrac = if N == 32 then 22 else 51;
  result = op;
  if type == FPType_SNaN then
    result<topfrac> = '1';
    FPPProcessException(FPExc_InvalidOp, fpcr);
  if fpcr.DN == '1' then // DefaultNaN requested
    result = FPDefaultNaN();
  return result;

// FPPProcessNaNs()
// =====
//
// The boolean part of the return value says whether a NaN has been found and
// processed. The bits(N) part is only relevant if it has and supplies the
// result of the operation.
//
// The 'fpcr' argument supplies FPCR control bits. Status information is
// updated directly in the FPSR where appropriate.

(boolean, bits(N)) FPPProcessNaNs(FPType type1, FPType type2,
                                  bits(N) op1, bits(N) op2,
                                  FPCRTYPE fpcr)
  assert N IN {32,64};
  if type1 == FPType_SNaN then
    done = TRUE; result = FPPProcessNaN(type1, op1, fpcr);
  elseif type2 == FPType_SNaN then
    done = TRUE; result = FPPProcessNaN(type2, op2, fpcr);

```



```

elseif type1 == FPType_QNaN then
    done = TRUE; result = FPProcessNaN(type1, op1, fpcr);
elseif type2 == FPType_QNaN then
    done = TRUE; result = FPProcessNaN(type2, op2, fpcr);
else
    done = FALSE; result = Zeros(); // 'Don't care' result
return (done, result);

// FPProcessNaNs3()
// =====
//
// The boolean part of the return value says whether a NaN has been found and
// processed. The bits(N) part is only relevant if it has and supplies the
// result of the operation.
//
// The 'fpcr' argument supplies FPCR control bits. Status information is
// updated directly in the FPSR where appropriate.

(boolean, bits(N)) FPProcessNaNs3(FPType type1, FPType type2, FPType type3,
                                  bits(N) op1, bits(N) op2, bits(N) op3,
                                  FPCRTYPE fpcr)

    assert N IN {32,64};
    if type1 == FPType_SNaN then
        done = TRUE; result = FPProcessNaN(type1, op1, fpcr);
    elseif type2 == FPType_SNaN then
        done = TRUE; result = FPProcessNaN(type2, op2, fpcr);
    elseif type3 == FPType_SNaN then
        done = TRUE; result = FPProcessNaN(type3, op3, fpcr);
    elseif type1 == FPType_QNaN then
        done = TRUE; result = FPProcessNaN(type1, op1, fpcr);
    elseif type2 == FPType_QNaN then
        done = TRUE; result = FPProcessNaN(type2, op2, fpcr);
    elseif type3 == FPType_QNaN then
        done = TRUE; result = FPProcessNaN(type3, op3, fpcr);
    else
        done = FALSE; result = Zeros(); // 'Don't care' result
    return (done, result);

// FPDecodeRM()
// =====

// Decode most common AArch32 floating-point rounding encoding.

FPRounding FPDecodeRM(bits(2) rm)
    case rm of
        when '00' return FPRounding_TIEAWAY; // A
        when '01' return FPRounding_TIEEVEN; // N
        when '10' return FPRounding_POSINF; // P
        when '11' return FPRounding_NEGINF; // M

// FPDecodeRounding()
// =====

// Decode floating-point rounding mode and common AArch64 encoding.

FPRounding FPDecodeRounding(bits(2) rmode)
    case rmode of
        when '00' return FPRounding_TIEEVEN; // N
        when '01' return FPRounding_POSINF; // P
        when '10' return FPRounding_NEGINF; // M
        when '11' return FPRounding_ZERO; // Z

// FPRoundingMode()
// =====

// Return the current floating-point rounding mode.

```

```

FPRounding FPRoundingMode(FPCRTYPE fpcr)
    return FPDecodeRounding(fpcr.RMode);

// FPRound()
// =====

// Convert a real number OP into an N-bit floating-point value using the
// supplied rounding mode RMODE.

bits(N) FPRound(real op, FPCRTYPE fpcr, FPRounding rounding)
    assert N IN {16,32,64};
    assert op != 0.0;
    assert rounding != FPRounding_TIEAWAY;
    bits(N) result;

    // Obtain format parameters - minimum exponent, numbers of exponent and fraction bits.
    if N == 16 then
        minimum_exp = -14; E = 5; F = 10;
    elsif N == 32 then
        minimum_exp = -126; E = 8; F = 23;
    else // N == 64
        minimum_exp = -1022; E = 11; F = 52;

    // Split value into sign, unrounded mantissa and exponent.
    if op < 0.0 then
        sign = '1'; mantissa = -op;
    else
        sign = '0'; mantissa = op;
    exponent = 0;
    while mantissa < 1.0 do
        mantissa = mantissa * 2.0; exponent = exponent - 1;
    while mantissa >= 2.0 do
        mantissa = mantissa / 2.0; exponent = exponent + 1;

    // Deal with flush-to-zero.
    if fpcr.FZ == '1' && N != 16 && exponent < minimum_exp then
        // Flush-to-zero never generates a trapped exception
        if UsingAArch32() then
            FPSCR.UFC = '1';
        else
            FPSR.UFC = '1';
        return FPZero(sign);

    // Start creating the exponent value for the result. Start by biasing the actual exponent
    // so that the minimum exponent becomes 1, lower values 0 (indicating possible underflow).
    biased_exp = Max(exponent - minimum_exp + 1, 0);
    if biased_exp == 0 then mantissa = mantissa / 2^(minimum_exp - exponent);

    // Get the unrounded mantissa as an integer, and the "units in last place" rounding error.
    int_mant = RoundDown(mantissa * 2^F); // < 2^F if biased_exp == 0, >= 2^F if not
    error = mantissa * 2^F - int_mant;

    // Underflow occurs if exponent is too small before rounding, and result is inexact or
    // the Underflow exception is trapped.
    if biased_exp == 0 && (error != 0.0 || fpcr.UFE == '1') then
        FPPProcessException(FPExc_Underflow, fpcr);

    // Round result according to rounding mode.
    case rounding of
        when FPRounding_TIEEVEN
            round_up = (error > 0.5 || (error == 0.5 && int_mant < 0 == '1'));
            overflow_to_inf = TRUE;
        when FPRounding_POSINF
            round_up = (error != 0.0 && sign == '0');
            overflow_to_inf = (sign == '0');
        when FPRounding_NEGINF
            round_up = (error != 0.0 && sign == '1');
            overflow_to_inf = (sign == '1');

```

```

when FPRounding_ZERO, FPRounding_ODD
    round_up = FALSE;
    overflow_to_inf = FALSE;

if round_up then
    int_mant = int_mant + 1;
    if int_mant == 2^F then // Rounded up from denormalized to normalized
        biased_exp = 1;
    if int_mant == 2^(F+1) then // Rounded up to next exponent
        biased_exp = biased_exp + 1; int_mant = int_mant DIV 2;

// Handle rounding to odd aka Von Neumann rounding
if error != 0.0 && rounding == FPRounding_ODD then
    int_mant<0> = '1';

// Deal with overflow and generate result.
if N != 16 || fpcr.AHP == '0' then // Single, double or IEEE half precision
    if biased_exp >= 2^E - 1 then
        result = if overflow_to_inf then FPInfinity(sign) else FPMMaxNormal(sign);
        FPPProcessException(FPExc_Overflow, fpcr);
        error = 1.0; // Ensure that an Inexact exception occurs
    else
        result = sign : biased_exp<N-F-2:0> : int_mant<F-1:0>;
else // Alternative half precision
    if biased_exp >= 2^E then
        result = sign : Ones(N-1);
        FPPProcessException(FPExc_InvalidOp, fpcr);
        error = 0.0; // Ensure that an Inexact exception does not occur
    else
        result = sign : biased_exp<N-F-2:0> : int_mant<F-1:0>;

// Deal with Inexact exception.
if error != 0.0 then
    FPPProcessException(FPExc_Inexact, fpcr);

return result;

// FPRound()
// =====

bits(N) FPRound(real op, FPCRTYPE fpcr)
    return FPRound(op, fpcr, FPRoundingMode(fpcr));

// FPToFixed()
// =====

// Convert N-bit precision floating point OP to M-bit fixed point with
// FBITS fractional bits, controlled by UNSIGNED and ROUNDING.

bits(M) FPToFixed(bits(N) op, integer fbits, boolean unsigned, FPCRTYPE fpcr, FPRounding rounding)
    assert N IN {32,64};
    assert M IN {32,64};
    assert fbits >= 0;
    assert rounding != FPRounding_ODD;

// Unpack using fpcr to determine if subnormals are flushed-to-zero
(type,sign,value) = FPUunpack(op, fpcr);

// If NaN, set cumulative flag or take exception
if type == FPTYPE_SNaN || type == FPTYPE_QNaN then
    FPPProcessException(FPExc_InvalidOp, fpcr);

// Scale by fractional bits and produce integer rounded towards minus-infinity
value = value * 2^fbits;
int_result = RoundDown(value);
error = value - int_result;

// Determine whether supplied rounding mode requires an increment

```

```

case rounding of
  when FPRounding_TIEEVEN
    round_up = (error > 0.5 || (error == 0.5 && int_result<0> == '1'));
  when FPRounding_POSINF
    round_up = (error != 0.0);
  when FPRounding_NEGINF
    round_up = FALSE;
  when FPRounding_ZERO
    round_up = (error != 0.0 && int_result < 0);
  when FPRounding_TIEAWAY
    round_up = (error > 0.5 || (error == 0.5 && int_result >= 0));

if round_up then int_result = int_result + 1;

// Generate saturated result and exceptions
(result, overflow) = SatQ(int_result, M, unsigned);
if overflow then
  FPProcessException(FPExc_InvalidOp, fpcr);
elseif error != 0.0 then
  FPProcessException(FPExc_Inexact, fpcr);

return result;

// FixedToFP()
// =====

// Convert M-bit fixed point OP with FBITS fractional bits to
// N-bit precision floating point, controlled by UNSIGNED and ROUNDING.

bits(N) FixedToFP(bits(M) op, integer fbits, boolean unsigned, FPCRTyp e fpcr, FPRounding rounding)
  assert N IN {32,64};
  assert M IN {32,64};
  bits(N) result;
  assert fbits >= 0;
  assert rounding != FPRounding_ODD;

  // Correct signed-ness
  int_operand = Int(op, unsigned);

  // Scale by fractional bits and generate a real value
  real_operand = int_operand / 2^fbits;

  if real_operand == 0.0 then
    result = FPZero('0');
  else
    result = FPRound(real_operand, fpcr, rounding);

  return result;

// FPConvertNaN()
// =====

// Converts a NaN of one floating-point type to another

bits(M) FPConvertNaN(bits(N) op)
  assert N IN {16,32,64};
  assert M IN {16,32,64};
  bits(M) result;
  bits(51) frac;

  sign = op<N-1>;

  // Unpack payload from input NaN
  case N of
    when 64 frac = op<50:0>;
    when 32 frac = op<21:0>:Zeros(29);
    when 16 frac = op<8:0>:Zeros(42);

```

```

// Repack payload into output NaN, while
// converting an SNaN to a QNaN.
case M of
    when 64 result = sign:Ones(M-52):frac;
    when 32 result = sign:Ones(M-23):frac<50:29>;
    when 16 result = sign:Ones(M-10):frac<50:42>;

return result;

// FPConvert()
// =====

// Convert floating point OP with N-bit precision to M-bit precision,
// with rounding controlled by ROUNDING.

bits(M) FPConvert(bits(N) op, FPCRTYPE fpcr, FPRounding rounding)
    assert M IN {16,32,64};
    assert N IN {16,32,64};
    bits(M) result;

// Unpack floating-point operand optionally with flush-to-zero.
(type,sign,value) = FPUntpack(op, fpcr);

alt_hp = (M == 16) && (fpcr.AHP == '1');

if type == FPTYPE_SNaN || type == FPTYPE_QNaN then
    if alt_hp then
        result = FPZero(sign);
    elseif fpcr.DN == '1' then
        result = FPDefaultNaN();
    else
        result = FPConvertNaN(op);
        if type == FPTYPE_SNaN || alt_hp then
            FPProcessException(FPExc_InvalidOp, fpcr);
elseif type == FPTYPE_Infinity then
    if alt_hp then
        result = sign:Ones(M-1);
        FPProcessException(FPExc_InvalidOp, fpcr);
    else
        result = FPinfinity(sign);
elseif type == FPTYPE_Zero then
    result = FPZero(sign);
else
    result = FPRound(value, fpcr, rounding);

return result;

// FPConvert()
// =====

bits(M) FPConvert(bits(N) op, FPCRTYPE fpcr)
    return FPConvert(op, fpcr, FPRoundingMode(fpcr));

// FPRoundInt()
// =====

// Round OP to nearest integral floating point value using rounding mode ROUNDING.
// If EXACT is TRUE, set FPSR.IXC if result is not numerically equal to OP.

bits(N) FPRoundInt(bits(N) op, FPCRTYPE fpcr, FPRounding rounding, boolean exact)
    assert rounding != FPRounding_ODD;
    assert N IN {32,64};

// Unpack using FPCR to determine if subnormals are flushed-to-zero
(type,sign,value) = FPUntpack(op, fpcr);

if type == FPTYPE_SNaN || type == FPTYPE_QNaN then
    result = FPProcessNaN(type, op, fpcr);

```

```

elseif type == FType_Infinity then
    result = FPInfinity(sign);
elseif type == FType_Zero then
    result = FPZero(sign);
else
    // extract integer component
    int_result = RoundDown(value);
    error = value - int_result;

    // Determine whether supplied rounding mode requires an increment
    case rounding of
        when FPRounding_TIEEVEN
            round_up = (error > 0.5 || (error == 0.5 && int_result<0> == '1'));
        when FPRounding_POSINF
            round_up = (error != 0.0);
        when FPRounding_NEGINF
            round_up = FALSE;
        when FPRounding_ZERO
            round_up = (error != 0.0 && int_result < 0);
        when FPRounding_TIEAWAY
            round_up = (error > 0.5 || (error == 0.5 && int_result >= 0));

    if round_up then int_result = int_result + 1;

    // Convert integer value into an equivalent real value
    real_result = 1.0 * int_result;

    // Re-encode as a floating-point value, result is always exact
    if real_result == 0.0 then
        result = FPZero(sign);
    else
        result = FPRound(real_result, fpcr, FPRounding_ZERO);

    // Generate inexact exceptions
    if error != 0.0 && exact then
        FPProcessException(FPExc_Inexact, fpcr);

return result;

// FPZero()
// =====

bits(N) FPZero(bit sign)
    assert N IN {16,32,64};
    constant integer E = (if N == 16 then 5 elsif N == 32 then 8 else 11);
    constant integer F = N - E - 1;
    exp = Zeros(E);
    frac = Zeros(F);
    return sign : exp : frac;

// FPTwo()
// =====

bits(N) FPTwo(bit sign)
    assert N IN {32,64};
    constant integer E = (if N == 32 then 8 else 11);
    constant integer F = N - E - 1;
    exp = '1':Zeros(E-1);
    frac = Zeros(F);
    return sign : exp : frac;

// FPThree()
// =====

bits(N) FPThree(bit sign)
    assert N IN {32,64};
    constant integer E = (if N == 32 then 8 else 11);
    constant integer F = N - E - 1;

```

```

    exp = '1':Zeros(E-1);
    frac = '1':Zeros(F-1);
    return sign : exp : frac;

// FPOnePointFive()
// =====

bits(N) FPOnePointFive(bit sign)
    assert N IN {32,64};
    constant integer E = (if N == 32 then 8 else 11);
    constant integer F = N - E - 1;
    exp = '0':Ones(E-1);
    frac = '1':Zeros(F-1);
    return sign : exp : frac;

// FPInfinity()
// =====

bits(N) FPInfinity(bit sign)
    assert N IN {16,32,64};
    constant integer E = (if N == 16 then 5 elsif N == 32 then 8 else 11);
    constant integer F = N - E - 1;
    exp = Ones(E);
    frac = Zeros(F);
    return sign : exp : frac;

// FPDefaultNaN()
// =====

bits(N) FPDefaultNaN()
    assert N IN {16,32,64};
    constant integer E = (if N == 16 then 5 elsif N == 32 then 8 else 11);
    constant integer F = N - E - 1;
    sign = '0';
    exp = Ones(E);
    frac = '1':Zeros(F-1);
    return sign : exp : frac;

// FPMaxNormal()
// =====

bits(N) FPMaxNormal(bit sign)
    assert N IN {16,32,64};
    constant integer E = (if N == 16 then 5 elsif N == 32 then 8 else 11);
    constant integer F = N - E - 1;
    exp = Ones(E-1):'0';
    frac = Ones(F);
    return sign : exp : frac;

// VFPEExpandImm()
// =====

bits(N) VFPEExpandImm(bits(8) imm8)
    assert N IN {32,64};
    constant integer E = (if N == 32 then 8 else 11);
    constant integer F = N - E - 1;
    sign = imm8<7>;
    exp = NOT(imm8<6>):Replicate(imm8<6>,E-3):imm8<5:4>;
    frac = imm8<3:0>:Zeros(F-4);
    return sign : exp : frac;

// FPAbs()
// =====

bits(N) FPAbs(bits(N) op)
    assert N IN {32,64};
    return '0' : op<N-2:0>;

```

```

// FPNeg()
// =====

bits(N) FPNeg(bits(N) op)
    assert N IN {32,64};
    return NOT(op<N-1>) : op<N-2:0>;

// FPCompare()
// =====

bits(4) FPCompare(bits(N) op1, bits(N) op2, boolean signal_nans, FPCRType fpcr)
    assert N IN {32,64};
    (type1,sign1,value1) = FPUntpack(op1, fpcr);
    (type2,sign2,value2) = FPUntpack(op2, fpcr);
    if type1==FPTType_SNaN || type1==FPTType_QNaN || type2==FPTType_SNaN || type2==FPTType_QNaN then
        result = '0011';
        if type1==FPTType_SNaN || type2==FPTType_SNaN || signal_nans then
            FPProcessException(FPExc_InvalidOp, fpcr);
    else
        // All non-NaN cases can be evaluated on the values produced by FPUntpack()
        if value1 == value2 then
            result = '0110';
        elsif value1 < value2 then
            result = '1000';
        else // value1 > value2
            result = '0010';
    return result;

// FPCompareEQ()
// =====

boolean FPCompareEQ(bits(N) op1, bits(N) op2, FPCRType fpcr)
    assert N IN {32,64};
    (type1,sign1,value1) = FPUntpack(op1, fpcr);
    (type2,sign2,value2) = FPUntpack(op2, fpcr);
    if type1==FPTType_SNaN || type1==FPTType_QNaN || type2==FPTType_SNaN || type2==FPTType_QNaN then
        result = FALSE;
        if type1==FPTType_SNaN || type2==FPTType_SNaN then
            FPProcessException(FPExc_InvalidOp, fpcr);
    else
        // All non-NaN cases can be evaluated on the values produced by FPUntpack()
        result = (value1 == value2);
    return result;

// FPCompareGE()
// =====

boolean FPCompareGE(bits(N) op1, bits(N) op2, FPCRType fpcr)
    assert N IN {32,64};
    (type1,sign1,value1) = FPUntpack(op1, fpcr);
    (type2,sign2,value2) = FPUntpack(op2, fpcr);
    if type1==FPTType_SNaN || type1==FPTType_QNaN || type2==FPTType_SNaN || type2==FPTType_QNaN then
        result = FALSE;
        FPProcessException(FPExc_InvalidOp, fpcr);
    else
        // All non-NaN cases can be evaluated on the values produced by FPUntpack()
        result = (value1 >= value2);
    return result;

// FPCompareGT()
// =====

boolean FPCompareGT(bits(N) op1, bits(N) op2, FPCRType fpcr)
    assert N IN {32,64};
    (type1,sign1,value1) = FPUntpack(op1, fpcr);
    (type2,sign2,value2) = FPUntpack(op2, fpcr);
    if type1==FPTType_SNaN || type1==FPTType_QNaN || type2==FPTType_SNaN || type2==FPTType_QNaN then
        result = FALSE;

```



```

        FPProcessException(FPExc_InvalidOp, fpcr);
    else
        // All non-NaN cases can be evaluated on the values produced by FPUunpack()
        result = (value1 > value2);
    return result;

// FAdd()
// =====

bits(N) FAdd(bits(N) op1, bits(N) op2, FPCRTType fpcr)
    assert N IN {32,64};
    rounding = FPRoundingMode(fpcr);
    (type1,sign1,value1) = FPUunpack(op1, fpcr);
    (type2,sign2,value2) = FPUunpack(op2, fpcr);
    (done,result) = FPProcessNaNs(type1, type2, op1, op2, fpcr);
    if !done then
        inf1 = (type1 == FPType_Infinity);  inf2 = (type2 == FPType_Infinity);
        zero1 = (type1 == FPType_Zero);      zero2 = (type2 == FPType_Zero);
        if inf1 && inf2 && sign1 == NOT(sign2) then
            result = FPDefaultNaN();
            FPProcessException(FPExc_InvalidOp, fpcr);
        elseif (inf1 && sign1 == '0') || (inf2 && sign2 == '0') then
            result = FPinfinity('0');
        elseif (inf1 && sign1 == '1') || (inf2 && sign2 == '1') then
            result = FPinfinity('1');
        elseif zero1 && zero2 && sign1 == sign2 then
            result = FPZero(sign1);
        else
            result_value = value1 + value2;
            if result_value == 0.0 then // Sign of exact zero result depends on rounding mode
                result_sign = if rounding == FPRounding_NEGINF then '1' else '0';
                result = FPZero(result_sign);
            else
                result = FPRound(result_value, fpcr, rounding);
    return result;

// FSub()
// =====

bits(N) FSub(bits(N) op1, bits(N) op2, FPCRTType fpcr)
    assert N IN {32,64};
    rounding = FPRoundingMode(fpcr);
    (type1,sign1,value1) = FPUunpack(op1, fpcr);
    (type2,sign2,value2) = FPUunpack(op2, fpcr);
    (done,result) = FPProcessNaNs(type1, type2, op1, op2, fpcr);
    if !done then
        inf1 = (type1 == FPType_Infinity);
        inf2 = (type2 == FPType_Infinity);
        zero1 = (type1 == FPType_Zero);
        zero2 = (type2 == FPType_Zero);
        if inf1 && inf2 && sign1 == sign2 then
            result = FPDefaultNaN();
            FPProcessException(FPExc_InvalidOp, fpcr);
        elseif (inf1 && sign1 == '0') || (inf2 && sign2 == '1') then
            result = FPinfinity('0');
        elseif (inf1 && sign1 == '1') || (inf2 && sign2 == '0') then
            result = FPinfinity('1');
        elseif zero1 && zero2 && sign1 == NOT(sign2) then
            result = FPZero(sign1);
        else
            result_value = value1 - value2;
            if result_value == 0.0 then // Sign of exact zero result depends on rounding mode
                result_sign = if rounding == FPRounding_NEGINF then '1' else '0';
                result = FPZero(result_sign);
            else
                result = FPRound(result_value, fpcr, rounding);
    return result;

```

```

// FPMu1()
// =====

bits(N) FPMu1(bits(N) op1, bits(N) op2, FPCRType fpcr)
    assert N IN {32,64};
    (type1,sign1,value1) = FPUnpack(op1, fpcr);
    (type2,sign2,value2) = FPUnpack(op2, fpcr);
    (done,result) = FPProcessNaNs(type1, type2, op1, op2, fpcr);
    if !done then
        inf1 = (type1 == FPType_Infinity);
        inf2 = (type2 == FPType_Infinity);
        zero1 = (type1 == FPType_Zero);
        zero2 = (type2 == FPType_Zero);
        if (inf1 && zero2) || (zero1 && inf2) then
            result = FPDefaultNaN();
            FPProcessException(FPExc_InvalidOp, fpcr);
        elsif inf1 || inf2 then
            result = FPinfinity(sign1 EOR sign2);
        elsif zero1 || zero2 then
            result = FPZero(sign1 EOR sign2);
        else
            result = FPRound(value1*value2, fpcr);
    return result;

// FPMu1X()
// =====

bits(N) FPMu1X(bits(N) op1, bits(N) op2, FPCRType fpcr)
    assert N IN {32,64};
    bits(N) result;
    (type1,sign1,value1) = FPUnpack(op1, fpcr);
    (type2,sign2,value2) = FPUnpack(op2, fpcr);
    (done,result) = FPProcessNaNs(type1, type2, op1, op2, fpcr);
    if !done then
        inf1 = (type1 == FPType_Infinity);
        inf2 = (type2 == FPType_Infinity);
        zero1 = (type1 == FPType_Zero);
        zero2 = (type2 == FPType_Zero);
        if (inf1 && zero2) || (zero1 && inf2) then
            result = FPTwo(sign1 EOR sign2);
        elsif inf1 || inf2 then
            result = FPinfinity(sign1 EOR sign2);
        elsif zero1 || zero2 then
            result = FPZero(sign1 EOR sign2);
        else
            result = FPRound(value1*value2, fpcr);
    return result;

// FPMu1Add()
// =====
//
// Calculates addend + op1*op2 with a single rounding.

bits(N) FPMu1Add(bits(N) addend, bits(N) op1, bits(N) op2, FPCRType fpcr)
    assert N IN {32,64};
    rounding = FPRoundingMode(fpcr);
    (typeA,signA,valueA) = FPUnpack(addend, fpcr);
    (type1,sign1,value1) = FPUnpack(op1, fpcr);
    (type2,sign2,value2) = FPUnpack(op2, fpcr);
    inf1 = (type1 == FPType_Infinity); zero1 = (type1 == FPType_Zero);
    inf2 = (type2 == FPType_Infinity); zero2 = (type2 == FPType_Zero);
    (done,result) = FPProcessNaNs3(typeA, type1, type2, addend, op1, op2, fpcr);

    if typeA == FPType_QNaN && ((inf1 && zero2) || (zero1 && inf2)) then
        result = FPDefaultNaN();
        FPProcessException(FPExc_InvalidOp, fpcr);

    if !done then

```

```

infA = (typeA == FPType_Infinity); zeroA = (typeA == FPType_Zero);

// Determine sign and type product will have if it does not cause an Invalid
// Operation.
signP = sign1 EOR sign2;
infP = inf1 || inf2;
zeroP = zero1 || zero2;

// Non SNaN-generated Invalid Operation cases are multiplies of zero by infinity and
// additions of opposite-signed infinities.
if (inf1 && zero2) || (zero1 && inf2) || (infA && infP && signA != signP) then
    result = FPDefaultNaN();
    FPProcessException(FPExc_InvalidOp, fpcr);

// Other cases involving infinities produce an infinity of the same sign.
elseif (infA && signA == '0') || (infP && signP == '0') then
    result = FPInfinity('0');
elseif (infA && signA == '1') || (infP && signP == '1') then
    result = FPInfinity('1');

// Cases where the result is exactly zero and its sign is not determined by the
// rounding mode are additions of same-signed zeros.
elseif zeroA && zeroP && signA == signP then
    result = FPZero(signA);

// Otherwise calculate numerical result and round it.
else
    result_value = valueA + (value1 * value2);
    if result_value == 0.0 then // Sign of exact zero result depends on rounding mode
        result_sign = if rounding == FPRounding_NEGINF then '1' else '0';
        result = FPZero(result_sign);
    else
        result = FPRound(result_value, fpcr);

return result;

// FPrepX()
// =====

bits(N) FPrepX(bits(N) op, FPCRTYPE fpcr)
    assert N IN {32,64};
    bits(N) result;
    integer esize = if N == 32 then 8 else 11;
    bits(esize) exp;
    bits(esize) max_exp;
    bits(N-esome-1) frac = Zeros();

    if N == 32 then
        exp = op<23+esome-1:23>;
    else
        exp = op<52+esome-1:52>;
    max_exp = Ones(esize) - 1;

    (type,sign,value) = FPUunpack(op, fpcr);
    if type == FPType_SNaN || type == FPType_QNaN then
        result = FPProcessNaN(type, op, fpcr);
    else
        if IsZero(exp) then // Zero and denormals
            result = sign:max_exp:frac;
        else // Infinities and normals
            result = sign:NOT(exp):frac;

    return result;

// FPrepEstimate()
// =====

bits(N) FPrepEstimate(bits(N) operand, FPCRTYPE fpcr)

```

```

assert N IN {32, 64};
(type,sign,value) = FPUnpack(operand, fpcr);
if type == FPType_SNaN || type == FPType_QNaN then
    result = FPProcessNaN(type, operand, fpcr);
elseif type == FPType_Infinity then
    result = FPZero(sign);
elseif type == FPType_Zero then
    result = FPInfinity(sign);
    FPProcessException(FPExc_DivideByZero, fpcr);
elseif (N == 32 && Abs(value) < 2.0^-128)
    || (N == 64 && Abs(value) < 2.0^-1024) then
    case FPRoundingMode(fpcr) of
        when FPRounding_TIEEVEN
            overflow_to_inf = TRUE;
        when FPRounding_POSINF
            overflow_to_inf = (sign == '0');
        when FPRounding_NEGINF
            overflow_to_inf = (sign == '1');
        when FPRounding_ZERO
            overflow_to_inf = FALSE;
    result = if overflow_to_inf then FPInfinity(sign) else FPMaxNormal(sign);
    FPProcessException(FPExc_Overflow, fpcr);
    FPProcessException(FPExc_Inexact, fpcr);
elseif fpcr.FZ == '1'
    && ((N == 32 && Abs(value) >= 2.0^126)
        || (N == 64 && Abs(value) >= 2.0^1022)) then
    // Result flushed to zero of correct sign
    result = FPZero(sign);
    FPProcessException(FPExc_Underflow, fpcr);
else
    // Scale to a double-precision value in the range 0.5 <= x < 1.0, and
    // calculate result exponent. Scaled value has copied sign bit,
    // exponent = 1022 = double-precision biased version of -1,
    // fraction = original fraction extended with zeros.

    if N == 32 then
        fraction = operand<22:0> : Zeros(29);
        exp = UInt(operand<30:23>);
    else // N == 64
        fraction = operand<51:0>;
        exp = UInt(operand<62:52>);

    if exp == 0 then
        if fraction<51> == 0 then
            exp = -1;
            fraction = fraction<49:0>:'00';
        else
            fraction = fraction<50:0>:'0';
    scaled = '0' : '0111111110' : fraction<51:44> : Zeros(44);

    if N == 32 then
        result_exp = 253 - exp; // In range 253-254 = -1 to 253+1 = 254
    else // N == 64
        result_exp = 2045 - exp; // In range 2045-2046 = -1 to 2045+1 = 2046

    // Call C function to get reciprocal estimate of scaled value.
    // Input is rounded down to a multiple of 1/512.
    estimate = recip_estimate(scaled);

    // Result is double-precision and a multiple of 1/256 in the range 1 to 511/256.
    // Convert to scaled single-precision result with copied sign bit and high-order
    // fraction bits, and exponent calculated above.

    fraction = estimate<51:0>;
    if result_exp == 0 then
        fraction = '1' : fraction<51:1>;
    elseif result_exp == -1 then
        fraction = '01' : fraction<51:2>;

```

```

        result_exp = 0;
    if N == 32 then
        result = sign : result_exp<N-25:0> : fraction<51:29>;
    else // N == 64
        result = sign : result_exp<N-54:0> : fraction<51:0>;

    return result;

// FPRsqrtEstimate()
// =====

bits(N) FPRsqrtEstimate(bits(N) operand, FPCRType fpcr)
    assert N IN {32, 64};
    (type,sign,value) = FPUnpack(operand, fpcr);
    if type == FPType_SNaN || type == FPType_QNaN then
        result = FPProcessNaN(type, operand, fpcr);
    elseif type == FPType_Zero then
        result = FPInfinity(sign);
        FPProcessException(FPExc_DivideByZero, fpcr);
    elseif sign == '1' then
        result = FPDefaultNaN();
        FPProcessException(FPExc_InvalidOp, fpcr);
    elseif type == FPType_Infinity then
        result = FPZero('0');
    else
        // Scale to a double-precision value in the range 0.25 <= x < 1.0, with the
        // evenness or oddness of the exponent unchanged, and calculate result exponent.
        // Scaled value has copied sign bit, exponent = 1022 or 1021 = double-precision
        // biased version of -1 or -2, fraction = original fraction extended with zeros.

        if N == 32 then
            fraction = operand<22:0> : Zeros(29);
            exp = UInt(operand<30:23>);
        else // N == 64
            fraction = operand<51:0>;
            exp = UInt(operand<62:52>);

        if exp == 0 then
            while fraction<51> == 0 do
                fraction = fraction<50:0> : '0';
                exp = exp - 1;
            fraction = fraction<50:0> : '0';

        if exp<0> == '0' then
            scaled = '0' : '0111111110' : fraction<51:44> : Zeros(44);
        else
            scaled = '0' : '0111111101' : fraction<51:44> : Zeros(44);

        if N == 32 then
            result_exp = (380 - exp) DIV 2;
        else // N == 64
            result_exp = (3068 - exp) DIV 2;

        // Call C function to get reciprocal estimate of scaled value.
        estimate = recip_sqrt_estimate(scaled);

        // Result is double-precision and a multiple of 1/256 in the range 1 to 511/256.
        // Convert to scaled single-precision result with copied sign bit and high-order
        // fraction bits, and exponent calculated above.

        if N == 32 then
            result = '0' : result_exp<N-25:0> : estimate<51:29>;
        else // N == 64
            result = '0' : result_exp<N-54:0> : estimate<51:0>;
    return result;

```

```

// FPMIn()
// =====

bits(N) FPMIn(bits(N) op1, bits(N) op2, FPCRTType fpcr)
    assert N IN {32,64};
    (type1,sign1,value1) = FPUnpack(op1, fpcr);
    (type2,sign2,value2) = FPUnpack(op2, fpcr);
    (done,result) = FPProcessNaNs(type1, type2, op1, op2, fpcr);
    if !done then
        if value1 < value2 then
            (type,sign,value) = (type1,sign1,value1);
        else
            (type,sign,value) = (type2,sign2,value2);
        if type == FPType_Infinity then
            result = FPInfinity(sign);
        elseif type == FPType_Zero then
            sign = sign1 OR sign2; // Use most negative sign
            result = FPZero(sign);
        else
            result = FPRound(value, fpcr);
    return result;

// FPMaX()
// =====

bits(N) FPMaX(bits(N) op1, bits(N) op2, FPCRTType fpcr)
    assert N IN {32,64};
    (type1,sign1,value1) = FPUnpack(op1, fpcr);
    (type2,sign2,value2) = FPUnpack(op2, fpcr);
    (done,result) = FPProcessNaNs(type1, type2, op1, op2, fpcr);
    if !done then
        if value1 > value2 then
            (type,sign,value) = (type1,sign1,value1);
        else
            (type,sign,value) = (type2,sign2,value2);
        if type == FPType_Infinity then
            result = FPInfinity(sign);
        elseif type == FPType_Zero then
            sign = sign1 AND sign2; // Use most positive sign
            result = FPZero(sign);
        else
            result = FPRound(value, fpcr);
    return result;

// FPMInNum()
// =====

bits(N) FPMInNum(bits(N) op1, bits(N) op2, FPCRTType fpcr)
    assert N IN {32,64};

    (type1,-,-) = FPUnpack(op1, fpcr);
    (type2,-,-) = FPUnpack(op2, fpcr);

    // Treat a single quiet-NaN as +Infinity
    if type1 == FPType_QNaN && type2 != FPType_QNaN then
        op1 = FPInfinity('0');
    elseif type1 != FPType_QNaN && type2 == FPType_QNaN then
        op2 = FPInfinity('0');

    return FPMIn(op1, op2, fpcr);

// FPMaXNum()
// =====

bits(N) FPMaXNum(bits(N) op1, bits(N) op2, FPCRTType fpcr)
    assert N IN {32,64};

    (type1,-,-) = FPUnpack(op1, fpcr);

```

```

(type2,-,-) = FPUnpack(op2, fpcr);

// treat a single quiet-NaN as -Infinity
if type1 == FPType_QNaN && type2 != FPType_QNaN then
    op1 = FPInfinity('1');
elseif type1 != FPType_QNaN && type2 == FPType_QNaN then
    op2 = FPInfinity('1');

return FPMax(op1, op2, fpcr);

// FPDIV()
// =====

bits(N) FPDIV(bits(N) op1, bits(N) op2, FPCRTYPE fpcr)
    assert N IN {32,64};
    (type1,sign1,value1) = FPUnpack(op1, fpcr);
    (type2,sign2,value2) = FPUnpack(op2, fpcr);
    (done,result) = FPPROCESSNaNs(type1, type2, op1, op2, fpcr);
    if !done then
        inf1 = (type1 == FPType_Infinity);
        inf2 = (type2 == FPType_Infinity);
        zero1 = (type1 == FPType_Zero);
        zero2 = (type2 == FPType_Zero);
        if (inf1 && inf2) || (zero1 && zero2) then
            result = FPDefaultNaN();
            FPPROCESSException(FPEXC_InvalidOp, fpcr);
        elseif inf1 || zero2 then
            result = FPInfinity(sign1 EOR sign2);
            if !inf1 then FPPROCESSException(FPEXC_DivideByZero, fpcr);
        elseif zero1 || inf2 then
            result = FPZero(sign1 EOR sign2);
        else
            result = FPRound(value1/value2, fpcr);
    return result;

// FPSQRT()
// =====

bits(N) FPSQRT(bits(N) op, FPCRTYPE fpcr)
    assert N IN {32,64};
    (type,sign,value) = FPUnpack(op, fpcr);
    if type == FPType_SNaN || type == FPType_QNaN then
        result = FPPROCESSNaN(type, op, fpcr);
    elseif type == FPType_Zero then
        result = FPZero(sign);
    elseif type == FPType_Infinity && sign == '0' then
        result = FPInfinity(sign);
    elseif sign == '1' then
        result = FPDefaultNaN();
        FPPROCESSException(FPEXC_InvalidOp, fpcr);
    else
        result = FPRound(Sqrt(value), fpcr);
    return result;

```

shared/functions/gray

```

// BinaryToGray()
// =====
//
// Convert plain binary to reflected-binary Gray code

bits(N) BinaryToGray(bits(N) value)

    if N >= 2 then
        value<N-2:0> = value<N-2:0> EOR value<N-1:1>;

    return value;

```

```
// GrayToBinary()
// =====
//
// Convert binary-reflected Gray code to plain binary

bits(N) GrayToBinary(bits(N) value)

    if N >= 2 then
        for i = 2 to N
            value<N-i> = value<N-i> EOR value<N-i+1>;

    return value;
```

shared/functions/integer

```
// ~~~~~
// Integer arithmetic
// ~~~~~

// AddWithCarry()
// =====
// Integer addition with carry input, returning result and NZCV flags

(bits(N), bits(4)) AddWithCarry(bits(N) x, bits(N) y, bit carry_in)
    integer unsigned_sum = UInt(x) + UInt(y) + UInt(carry_in);
    integer signed_sum = SInt(x) + SInt(y) + UInt(carry_in);
    bits(N) result = unsigned_sum<N-1:0>; // same value as signed_sum<N-1:0>
    bit n = result<N-1>;
    bit z = if IsZero(result) then '1' else '0';
    bit c = if UInt(result) == unsigned_sum then '0' else '1';
    bit v = if SInt(result) == signed_sum then '0' else '1';
    return (result, n:z:c:v);
```

shared/functions/memory

```
// AccType
// =====
// Access types

enumeration AccType {AccType_NORMAL, AccType_VEC, // Normal loads and stores
                    AccType_STREAM, AccType_VECSTREAM, // Streaming loads and stores
                    AccType_ATOMIC, // Atomic loads and stores
                    AccType_ORDERED, // Load-Acquire and Store-Release
                    AccType_UNPRIV, // Load and store unprivileged
                    AccType_IFETCH, // Instruction fetch
                    AccType_PTW, // Page table walk
                    // Other operations
                    AccType_DC, // Data cache maintenance
                    AccType_IC, // Instruction cache maintenance
                    AccType_AT}; // Address translation

// MemType
// =====
// Basic memory types

enumeration MemType {MemType_Normal, MemType_Device};

// DeviceType
// =====
// Extended memory types for Device memory

enumeration DeviceType {DeviceType_GRE, DeviceType_nGRE, DeviceType_nGnRE, DeviceType_nGnRnE};

// MemAttrHints
// =====
```



```
// Attributes and hints for Normal memory

type MemAttrHints is (
    bits(2) attrs, // The possible encodings for each attributes field are as below
    bits(2) hints, // The possible encodings for the hints are below
    boolean transient
)

// Cacheability attributes
// =====

constant bits(2) MemAttr_NC = '00'; // Non-cacheable
constant bits(2) MemAttr_WT = '10'; // Write-through
constant bits(2) MemAttr_WB = '11'; // Write-back

// Allocation hints
// =====

constant bits(2) MemHint_No = '00'; // No allocate
constant bits(2) MemHint_WA = '01'; // Write-allocate, Read-no-allocate
constant bits(2) MemHint_RA = '10'; // Read-allocate, Write-no-allocate
constant bits(2) MemHint_RWA = '11'; // Read-allocate and Write-allocate

// MemoryAttributes
// =====
// Memory attributes descriptor

type MemoryAttributes is (
    MemType    type,

    DeviceType device, // For Device memory types
    MemAttrHints inner, // Inner hints and attributes
    MemAttrHints outer, // Outer hints and attributes

    boolean shareable,
    boolean outershareable
)

// FullAddress
// =====
// Physical address type. Although AArch32 only has access to 40 bits of
// physical address space, the full address type has 48 bits to allow
// interprocessing with AArch64. The maximum physical address size is
// IMPLEMENTATION DEFINED and up-to 48 bits.

type FullAddress is (
    bits(48) physicaladdress,
    bit NS // '0' = Secure, '1' = Non-secure
)

// Fault
// =====
// Fault types.

enumeration Fault {Fault_None,
    Fault_AccessFlag,
    Fault_Alignment,
    Fault_Background,
    Fault_Domain,
    Fault_Permission,
    Fault_Translation,
    Fault_AddressSize,
    Fault_SyncExternal,
    Fault_SyncExternalOnWalk,
    Fault_SyncParity,
    Fault_SyncParityOnWalk,
    Fault_AsyncParity,
    Fault_AsyncExternal,
```

```

        Fault_Debug,
        Fault_TLBConflict,
        Fault_Lockdown,
        Fault_Coproc,
        Fault_ICacheMaint};

// FaultRecord
// =====

// Fields that relate only to Faults
type FaultRecord is (Fault    type,           // Fault Status
                    AccType  acctype,       // Type of access that faulted
                    bits(48) ipaddress,     // Intermediate physical address
                    boolean  s2fs1walk,    // Is on a Stage 1 page table walk
                    boolean  write,        // TRUE for a read, FALSE for a write
                    integer  level,        // For translation, access flag and permission faults
                    bit      extflag,      // IMPLEMENTATION DEFINED syndrome for external aborts
                    boolean  secondstage,  // Is a Stage 2 abort
                    bits(4)  domain,      // Domain number, AArch32 only
                    bits(4)  debugmoe)    // Debug method of entry, from AArch32 only

// AddressDescriptor
// =====
// Descriptor used to access the underlying memory array

type AddressDescriptor is (
    FaultRecord  fault,           // fault.type indicates whether the address is valid
    MemoryAttributes memattrs,
    FullAddress  paddress
)

// Permissions
// =====
// Access permissions descriptor

type Permissions is (
    bits(3) ap, // Access permission bits
    bit    xn, // Execute-never bit
    bit    pxn // Privileged execute-never bit
)

// TLBRecord
// =====

type TLBRecord is (
    Permissions  perms,
    bit          nG,           // '0' = Global, '1' = not Global
    bits(4)     domain,       // AArch32 only
    boolean     contiguous,   // Contiguous bit from page table
    integer     level,        // In AArch32 Short-descriptor format, indicates Section/Page
    integer     blocksize,    // Describes size of memory translated in KBytes
    AddressDescriptor addrdesc
)

// MBRReqDomain
// =====

// Memory barrier domain
enumeration MBRReqDomain {MBRReqDomain_Nonshareable, MBRReqDomain_InnerShareable,
                          MBRReqDomain_OuterShareable, MBRReqDomain_FullSystem};

// MBRReqTypes
// =====

// Memory barrier read/write
enumeration MBRReqTypes {MBRReqTypes_Reads, MBRReqTypes_Writes, MBRReqTypes_All};

// DataSynchronizationBarrier()

```

```
// =====

DataSynchronizationBarrier(MBReqDomain domain, MBReqTypes types);

// DataMemoryBarrier()
// =====

DataMemoryBarrier(MBReqDomain domain, MBReqTypes types);

// PrefetchHint
// =====
// Prefetch hint types

enumeration PrefetchHint {Prefetch_READ, Prefetch_WRITE, Prefetch_EXEC};

// Hint_Prefetch()
// =====

// Signals the memory system that memory accesses of type HINT to or from the specified ADDRESS are
// likely in the near future. The memory system may take some action to speed up the memory accesses
// when they do occur, such as pre-loading the the specified address into one or more caches as
// indicated by the innermost cache level TARGET (0=L1, 1=L2, etc) and non-temporal hint STREAM.

// Any or all prefetch hints may be treated as a NOP. A prefetch hint must not cause a synchronous
// abort due to alignment or translation faults and the like. Its only effect on software visible
// state should be on caches and TLBs associated with ADDRESS, which must be accessible by reads,
// writes or execution as defined in the translation regime of the current exception level.
// It is guaranteed not to access Device memory.

// A Prefetch_EXEC hint must not result in any access that could not be performed by a speculative
// instruction fetch, therefore if all associated MMUs are disabled, then it cannot access any
// memory location that cannot be accessed by instruction fetches.

Hint_Prefetch(bits(64) address, PrefetchHint hint, integer target, boolean stream);

// BigEndian()
// =====

boolean BigEndian()
    boolean bigend;
    if UsingAArch32() then
        bigend = (PSTATE.E != '0');
    elsif PSTATE.EL == EL0 then
        bigend = (SCTLR_EL1.E0E != '0');
    else
        bigend = (SCTLR[.].EE != '0');
    return bigend;

// AddrTop()
// =====

integer AddrTop(bits(64) address)
    // Return the MSB number of a virtual address in the current stage 1 translation
    // regime. If EL1 is using AArch64 then addresses from EL0 using AArch32
    // are zero-extended to 64 bits.
    if UsingAArch32() && !(PSTATE.EL == EL0 && !ELUsingAArch32(EL1)) then
        // AArch32 translation regime.
        return 31;
    else
        // AArch64 translation regime.
        case PSTATE.EL of
            when EL0, EL1
                tbi = if address<55> == '1' then TCR_EL1.TBI1 else TCR_EL1.TBI0;
            when EL2
                tbi = TCR_EL2.TBI;
            when EL3
                tbi = TCR_EL3.TBI;
        return (if tbi == '1' then 55 else 63);
```

```

// _Mem[]
// =====

// These two _Mem[] accessors are the hardware operations which perform
// single-copy atomic, aligned, little-endian memory accesses of SIZE
// bytes from/to the underlying physical memory array of bytes.
//
// The functions address the array using DESC.PADDRESS which supplies:
//
// * A 48-bit physical address
// * A single NS bit to select between Secure and Non-secure parts of
//   the array.
//
// The ACCTYPE parameter describes the access type: normal, exclusive,
// ordered, streaming, etc.

// _Mem[] - non-assignment (memory read) form
// =====

bits(8*size) _Mem[AddressDescriptor desc, integer size, AccType acctype];

// _Mem[] - assignment (memory write) form
// =====

_Mem[AddressDescriptor desc, integer size, AccType acctype] = bits(8*size) value;

// BigEndianReverse()
// =====

bits(width) BigEndianReverse (bits(width) value)
    assert width IN {8, 16, 32, 64, 128};
    integer half = width DIV 2;
    if width == 8 then return value;
    return BigEndianReverse(value<half-1:0>) : BigEndianReverse(value<width-1:half>);

```

shared/functions/registers

```

// _R[] - the general-purpose register file
// =====

array bits(64) _R[0..30];

// _V[] - the SIMD&FP register file
// =====

array bits(128) _V[0..31];

// _PC - the program counter
// =====

bits(64) _PC;

// BranchType
// =====

// Hint associated with a change in control flow

enumeration BranchType {BranchType_CALL, BranchType_ERET, BranchType_DBGEXIT,
                        BranchType_RET, BranchType_JMP, BranchType_EXCEPTION,
                        BranchType_UNKNOWN};

// Hint_Branch()
// =====

// Report hint passed to BranchTo, for consideration when processing the next instruction

```

```

Hint_Branch(BranchType hint);

// BranchTo()
// =====

// Set program counter to a new address, with a branch reason hint
// for possible use by hardware fetching the next instruction.

BranchTo(bits(N) target, BranchType branch_type)
    HintBranch(branch_type);
    if N == 32 then
        assert UsingAArch32();
        _PC = ZeroExtend(target);
    else
        assert N == 64 && !UsingAArch32();
        // Remove the tag bits from a tagged target
        case PSTATE.EL of
            when EL0, EL1
                if target<55> == '1' && TCR_EL1.TBI1 == '1' then
                    target<63:56> = '11111111';
                if target<55> == '0' && TCR_EL1.TBI0 == '1' then
                    target<63:56> = '00000000';
            when EL2
                if TCR_EL2.TBI == '1' then
                    target<63:56> = '00000000';
            when EL3
                if TCR_EL3.TBI == '1' then
                    target<63:56> = '00000000';
        _PC = target<63:0>;
    return;

// ThisInstrAddr()
// =====
// Return address of the current instruction.

bits(N) ThisInstrAddr()
    assert N == 64 || (N == 32 && UsingAArch32());
    return _PC<N-1:0>;

```

shared/functions/sysregisters

```

// Shared system register wrappers
// ~~~~~

// SPSR[] - non-assignment form
// =====

bits(32) SPSR[]
    bits(32) result;
    if UsingAArch32() then
        case CPSR.M of
            when M32_FIQ      result = SPSR_fiq;
            when M32_IRQ      result = SPSR_irq;
            when M32_Svc      result = SPSR_svc;
            when M32_Monitor  result = SPSR_mon;
            when M32_Abort    result = SPSR_abt;
            when M32_Hyp      result = SPSR_hyp;
            when M32_Undef    result = SPSR_und;
            otherwise        Unreachable();
    else
        case PSTATE.EL of
            when EL1          result = SPSR_EL1;
            when EL2          result = SPSR_EL2;
            when EL3          result = SPSR_EL3;
            otherwise        Unreachable();

    return result;

```

```
// SPSR[] - assignment form
// =====

SPSR[] = bits(32) value
if UsingAArch32() then
  case CPSR.M of
    when M32_FIQ      SPSR_fiq = value;
    when M32_IRQ      SPSR_irq = value;
    when M32_Svc      SPSR_svc = value;
    when M32_Monitor  SPSR_mon = value;
    when M32_Abort    SPSR_abt = value;
    when M32_Hyp      SPSR_hyp = value;
    when M32_Undef    SPSR_und = value;
    otherwise         Unreachable();
  else
    case PSTATE.EL of
      when EL1        SPSR_EL1 = value;
      when EL2        SPSR_EL2 = value;
      when EL3        SPSR_EL3 = value;
      otherwise       Unreachable();

return;
```

shared/functions/system

```
// Mode_Bits
// =====
// AArch32 PSTATE.M mode bits

constant bits(5) M32_User   = '10000';
constant bits(5) M32_FIQ   = '10001';
constant bits(5) M32_IRQ   = '10010';
constant bits(5) M32_Svc   = '10011';
constant bits(5) M32_Monitor = '10110';
constant bits(5) M32_Abort  = '10111';
constant bits(5) M32_Hyp    = '11010';
constant bits(5) M32_Undef  = '11011';
constant bits(5) M32_System = '11111';

// EL0-3
// =====
// PSTATE.EL exception level bits

constant bits(2) EL3 = '11';
constant bits(2) EL2 = '10';
constant bits(2) EL1 = '01';
constant bits(2) EL0 = '00';

// ProcState
// =====
// ARMv8 processor state bits.
// There is no significance to the field order.

type ProcState is (
  bits (1) N,      // Negative condition flag
  bits (1) Z,      // Zero condition flag
  bits (1) C,      // Carry condition flag
  bits (1) V,      // oVerflow condition flag
  bits (1) D,      // Debug mask bit [AArch64 only]
  bits (1) A,      // Asynchronous abort mask bit
  bits (1) I,      // IRQ mask bit
  bits (1) F,      // FIQ mask bit
  bits (1) SS,     // Single-step bit
  bits (1) IL,     // Illegal state bit
  bits (2) EL,     // Exception Level (see above)
  bits (1) nRW,   // not Register Width: 0=64, 1=32
```

```

bits (1) SP,      // Stack pointer select: 0=SP0, 1=SPx [AArch64 only]
bits (1) Q,      // Cumulative saturation flag          [AArch32 only]
bits (4) GE,     // Greater than or Equal flags          [AArch32 only]
bits (8) IT,     // If-then state                                       [AArch32 only]
bits (1) J,      // Jazelle state                                       [AArch32 only]
bits (1) T,      // Thumb state                                         [AArch32 only]
bits (1) E,      // Endian state                                        [AArch32 only]
bits (5) M       // Mode field (see above)                             [AArch32 only]
)

// PSTATE
// =====
// Global per-processor state

ProcState PSTATE;

// PrivilegeLevel
// =====
// Privilege Level abstraction

enumeration PrivilegeLevel {PL3, PL2, PL1, PL0};

// HaveAnyAArch32()
// =====

boolean HaveAnyAArch32()
    // Return TRUE if AArch32 state is supported at any exception level
    return boolean IMPLEMENTATION_DEFINED;

// HighestELUsingAArch32()
// =====

boolean HighestELUsingAArch32()
    // Return TRUE if configured to boot into AArch32 operation
    if !HaveAnyAArch32() then return FALSE;
    return boolean IMPLEMENTATION_DEFINED;    // e.g. CFG32SIGNAL == HIGH

// HaveEL()
// =====

boolean HaveEL(bits(2) e1)
    // Return TRUE if exception level 'e1' is supported
    if e1 IN {EL1, EL0} then
        return TRUE;    // EL1 and EL0 must exist
    return boolean IMPLEMENTATION_DEFINED;

// HighestEL()
// =====
// Returns the highest implemented exception level.

bits(2) HighestEL()
    if HaveEL(EL3) then
        return EL3;
    elsif HaveEL(EL2) then
        return EL2;
    else
        return EL1;

// HaveAArch32EL()
// =====

boolean HaveAArch32EL(bits(2) e1)
    // Return TRUE if exception level 'e1' supports AArch32
    if !HaveEL(e1) then
        return FALSE;
    elsif !HaveAnyAArch32() then
        return FALSE;    // No exception level can use AArch32
    elsif HighestELUsingAArch32() then

```

```

        return TRUE; // All exception levels must use AArch32
    elseif e1 == EL0 then
        return TRUE; // EL0 must support using AArch32
    return boolean IMPLEMENTATION_DEFINED;

// UsingAArch32()
// =====

// Return TRUE if the current EL is using AArch32, FALSE if using AArch64.

boolean UsingAArch32()
    boolean aarch32 = (PSTATE.nRW == '1');
    if !HaveAnyAArch32() then assert !aarch32;
    if HighestELUsingAArch32() then assert aarch32;
    return aarch32;

// ELFromM32()
// =====

// Function to convert an AArch32 mode encoding to an EL.

(boolean, bits(2)) ELFromM32(bits(5) mode)
    case mode of
        when M32_Monitor
            if HaveAArch32EL(EL3) then
                return (TRUE, EL3);
        when M32_Hyp
            if HaveAArch32EL(EL2) && CurrentStateHasEL2() then
                return (TRUE, EL2);
        when M32_FIQ, M32_IRQ, M32_Svc, M32_Abort, M32_Undef, M32_System
            if HaveAArch32EL(EL1) then
                if HaveAArch32EL(EL3) && SCR.NS == '0' then
                    return (TRUE, EL3);
                return (TRUE, EL1);
        when M32_User
            if HaveAArch32EL(EL0) then
                return (TRUE, EL0);
    return (FALSE, bits(2) UNKNOWN); // Passed an illegal mode value

// ELFromSPSR()
// =====

// Convert an SPSR value encoding to an EL.
// Returns (valid,EL):
// 'valid' is TRUE if 'spsr' represents a valid mode for the current state.
// 'EL' is the exception level from 'spsr'.

(boolean, bits(2)) ELFromSPSR(bits(32) spsr)
    if spsr<4> == '0' then // AArch64 state
        e1 = spsr<3:2>;
        if HighestELUsingAArch32() then // No AArch64 support
            valid = FALSE;
        elseif !HaveEL(e1) then // EL must be implemented
            valid = FALSE;
        elseif spsr<1> == '1' then // M[1] must be 0
            valid = FALSE;
        elseif e1 == EL0 && spsr<0> == '1' then // for EL0, M[0] must be 0
            valid = FALSE;
        elseif e1 == EL2 && !CurrentStateHasEL2() then // EL2 only valid in Non-secure state
            valid = FALSE;
        else
            valid = TRUE;
    else // AArch32 state
        (valid, e1) = ELFromM32(spsr<4:0>);
    return (valid, e1);

// ELStateUsingAArch32K()
// =====

```



```

(boolean,boolean) ELStateUsingAArch32K(bits(2) e1, boolean secure)
    // Returns (known, aarch32):
    // 'known' is FALSE for EL0 if the current exception level is not EL0 and EL1 is
    // using AArch64, since it cannot determine the state of EL0; TRUE otherwise.
    // 'aarch32' is TRUE if the specified exception level is using AArch32; FALSE otherwise.
    boolean known = TRUE;
    boolean aarch32;
    if !HaveAArch32EL(e1) then
        aarch32 = FALSE; // All levels are using AArch64
    elsif HighestELUsingAArch32() then
        aarch32 = TRUE; // All levels are using AArch32
    else
        SCR_RW = (if HaveEL(EL3) then SCR_EL3.RW else '1');
        HCR_RW = (if StateHasEL2(secure) then HCR_EL2.RW else SCR_RW);
        case e1 of
            when EL3 // EL3 must be using AArch64
                aarch32 = FALSE;
            when EL2 // EL2 controlled SCR_EL3.RW
                assert StateHasEL2(secure);
                aarch32 = (SCR_RW == '0');
            when EL1 // EL1 controlled by HCR_EL2 if EL2 using AArch64
                aarch32 = (SCR_RW == '0' || HCR_RW == '0');
            when EL0
                if PSTATE.EL == EL0 then
                    aarch32 = (PSTATE.nRW == '1'); // EL0 controlled by processor state
                elsif ELStateUsingAArch32(EL1, secure) then
                    aarch32 = TRUE; // EL0 using AArch32 if EL1 using AArch32
                else
                    known = FALSE; // EL0 state is unknown
                    aarch32 = boolean UNKNOWN;
        return (known, aarch32);

// ELStateUsingAArch32()
// =====

boolean ELStateUsingAArch32(bits(2) e1, boolean secure)
    // See ELStateUsingAArch32K() for description. Must only be called in circumstances where
    // result is valid (typically, that means 'e1 IN {EL1,EL2,EL3}').
    (known, aarch32) = ELStateUsingAArch32K(e1, secure);
    assert known;
    return aarch32;

// ELUsingAArch32K()
// =====

(boolean,boolean) ELUsingAArch32K(bits(2) e1)
    return ELStateUsingAArch32K(e1, IsSecureBelowEL3());

// ELUsingAArch32()
// =====

boolean ELUsingAArch32(bits(2) e1)
    return ELStateUsingAArch32(e1, IsSecureBelowEL3());

// IllegalExceptionReturn()
// =====

boolean IllegalExceptionReturn(bits(32) spsr)

    // Check for return:
    // * to an unimplemented exception level
    // * to EL2 in Secure state
    // * to EL0 using AArch64 state, with SPSR.M[0]==1
    // * to AArch64 state with SPSR.M[1]==1
    // * to AArch32 state with an illegal value of SPSR.M
    (valid, target) = ELFromSPSR(spsr);
    if !valid then return TRUE;

```

```

// Check for return to higher exception level
if UInt(target) > UInt(PSTATE.EL) then return TRUE;

from32 = (spsr<4> == '1');

// Check for return:
// * to EL1, EL2 or EL3 with register width specified in the SPSR
//   different from the register width used in the exception level
//   being returned to, as determined by the SCR_EL3.RW or HCR_EL2.RW
//   bits, or as configured from reset.
// * to EL0 where the register width specified in the SPSR is greater
//   than the target Register Width state for EL1 as determined by
//   the SCR_EL3.RW or HCR_EL2.RW bits or as configured from reset.
// * in AArch32 state when the SPSR indicates a return to AArch64 EL0
//   execution (should be caught by above)
(known, to32) = ELUsingAArch32K(target);
assert known || (target == EL0 && !ELUsingAArch32(EL1));
if known then
    if from32 != to32 then return TRUE;

if from32 then
    // Check for illegal return to AArch32 T32EE state (J=1, T=1)
    if spsr<24> == '1' && spsr<5> == '1' then
        if target == EL2 then return TRUE;
        if SCTLR_EL1.THEE == '0' then return TRUE;
    else // from AArch64 state
        // Check for illegal return from AArch32 to AArch64
        if PSTATE.nRW == '1' then return TRUE;

// Check for illegal returns to EL1 in Non-secure state when HCR_EL2.TGE is set
if target == EL1 && !IsSecureBelowEL3() && HCR_EL2.TGE == '1' then return TRUE;

return FALSE;

// SetPSTATEFromSPSR()
// =====
// Set PSTATE based on an SPSR value
SetPSTATEFromSPSR(bits(32) spsr)

SynchronizeContext();

PSTATE.SS = DebugExceptionReturnSS(spsr);

if IllegalExceptionReturn(spsr) then
    PSTATE.IL = '1';
else
    // State that is reinstated only on a legal exception return
    PSTATE.IL = spsr<20>;
    if spsr<4> == '1' then // AArch32 state
        AArch32.WriteMode(spsr<4:0>); // Sets PSTATE.EL correctly
    else // AArch64 state
        PSTATE.nRW = '0';
        PSTATE.EL = spsr<3:2>;
        PSTATE.SP = spsr<0>;

// If PSTATE.IL is set and returning to AArch32 state, it is CONSTRAINED UNPREDICTABLE whether
// the IT, J and T bits are each set to zero or copied from SPSR. This can be either because the
// exception return was illegal or because SPSR[20] was set to 1.
if PSTATE.IL == '1' then
    if ConstrainUnpredictableBool() then spsr<26:25,15:10> = Zeros();
    if ConstrainUnpredictableBool() then spsr<24> = '0';
    if ConstrainUnpredictableBool() then spsr<5> = '0';

// State that is reinstated regardless of illegal exception return
PSTATE.<N,Z,C,V> = spsr<31:28>;
if PSTATE.nRW == '1' then // AArch32 state

```

```

        PSTATE.Q    = spsr<27>;
        PSTATE.IT   = spsr<26:25,15:10>;
        PSTATE.J    = spsr<24>;
        PSTATE.GE   = spsr<19:16>;
        PSTATE.E    = spsr<9>;
        PSTATE.<D,A,I,F> = '0':spsr<8:6>;           // No PSTATE.D in AArch32 state
        PSTATE.T    = spsr<5>;
    else
        PSTATE.<D,A,I,F> = spsr<9:6>;           // AArch64 state

    return;

// GetSPSRFromPSTATE()
// =====

bits(32) GetSPSRFromPSTATE()
// Return an SPSR value which represents the current PSTATE
bits(32) spsr = Zeros();
spsr<31:28> = PSTATE.<N,Z,C,V>;
spsr<21>    = PSTATE.IL;
spsr<20>    = PSTATE.SS;
if PSTATE.nRW == '1' then // AArch32 state
    spsr<27>    = PSTATE.Q;
    spsr<26:25> = PSTATE.IT<7:6>;
    spsr<24>    = PSTATE.J;
    spsr<19:16> = PSTATE.GE;
    spsr<15:10> = PSTATE.IT<5:0>;
    spsr<9>     = PSTATE.E;
    spsr<8:6>   = PSTATE.<A,I,F>;           // No PSTATE.D in AArch32 state
    spsr<5>     = PSTATE.T;
    assert PSTATE.M<4> == PSTATE.nRW;     // bit [4] is the discriminator
    spsr<4:0>   = PSTATE.M;
else // AArch64 state
    spsr<9:6>   = PSTATE.<D,A,I,F>;
    spsr<4>     = PSTATE.nRW;
    spsr<3:2>   = PSTATE.EL;
    spsr<0>     = PSTATE.SP;
return spsr;

// PLOfEL()
// =====

PrivilegeLevel PLOfEL(bits(2) e1)
    case e1 of
        when EL3 return if HighestELUsingAArch32() then PL1 else PL3;
        when EL2 return PL2;
        when EL1 return PL1;
        when EL0 return PL0;

// CurrentPL()
// =====

PrivilegeLevel CurrentPL()
    return PLOfEL(PSTATE.EL);

// SCRType
// =====

// Placeholder for generic AArch64 SCR_EL3 & AArch32 SCR system register definition
type SCRType;

// SCR_GEN[]
// =====

SCRType SCR_GEN[]
    // AArch32 secure & AArch64 EL3 registers are not architecturally mapped
    bits(32) r;

```

```

    if HaveAArch32EL(EL3) then
        r = SCR;
    else
        r = SCR_EL3;
    return r;

// IsSecureBelowEL3()
// =====

// Return TRUE if an exception level below EL3 is in Secure state
// or would be following an exception return to that level.
//
// Differs from IsSecure in that it ignores the current EL or Mode
// in considering security state.
// That is, if at AArch64 EL3 or in AArch32 Monitor mode, whether an
// exception return would pass to Secure or Non-secure state.

boolean IsSecureBelowEL3()
    if HaveEL(EL3) then
        return SCR_GEN[].NS == '0';
    elseif HaveEL(EL2) then
        return FALSE;
    else
        // TRUE if processor is Secure or FALSE if Non-secure;
        return boolean IMPLEMENTATION_DEFINED;

// IsSecure()
// =====

boolean IsSecure()
    // Return TRUE if current exception level is in Secure state.
    if HaveEL(EL3) && !UsingAArch32() && PSTATE.EL == EL3 then
        return TRUE;
    elseif HaveEL(EL3) && UsingAArch32() && PSTATE.M == M32_Monitor then
        return TRUE;
    return IsSecureBelowEL3();

// StateHasEL2()
// =====

boolean StateHasEL2(boolean secure)
    // TRUE if EL2 is implemented in the indicated security state, that is EL2 is
    // implemented and in Non-secure state.
    // FALSE if EL2 is either unimplemented, or Secure state is indicated
    if HaveEL(EL3) then
        return HaveEL(EL2) && !secure;
    return HaveEL(EL2);

// CurrentStateHasEL2()
// =====

boolean CurrentStateHasEL2()
    // TRUE if EL2 is implemented in the current security state, FALSE otherwise.
    return StateHasEL2(IsSecureBelowEL3());

// ConditionHolds()
// =====

// Return TRUE iff COND currently holds

boolean ConditionHolds(bits(4) cond)
    // Evaluate base condition.
    case cond<3:1> of
        when '000' result = (PSTATE.Z == '1'); // EQ or NE
        when '001' result = (PSTATE.C == '1'); // CS or CC
        when '010' result = (PSTATE.N == '1'); // MI or PL
        when '011' result = (PSTATE.V == '1'); // VS or VC
        when '100' result = (PSTATE.C == '1' && PSTATE.Z == '0'); // HI or LS

```

```

        when '101' result = (PSTATE.N == PSTATE.V); // GE or LT
        when '110' result = (PSTATE.N == PSTATE.V && PSTATE.Z == '0'); // GT or LE
        when '111' result = TRUE; // AL

// Condition flag values in the set '111x' indicate always true
// Otherwise, invert condition if necessary.
if cond<0> == '1' && cond != '1111' then
    result = !result;

return result;

// InstrSet
// =====

enumeration InstrSet {InstrSet_A64, InstrSet_A32, InstrSet_T32, InstrSet_T32EE};

// CurrentInstrSet()
// =====

InstrSet CurrentInstrSet()

    if UsingAArch32() then
        case PSTATE.<J,T> of
            when '00' result = InstrSet_A32;
            when '01' result = InstrSet_T32;
            when '10' Unreachable(); // Non-trivial implementation of Jazelle not permitted
            when '11' result = InstrSet_T32EE;
        else
            return InstrSet_A64;
    return result;

// MaybeZeroRegisterUppers()
// =====
// On taking an exception to "handle_e1" using AArch64 from AArch32, it is CONSTRAINED
// UNPREDICTABLE whether the top 32 bits of registers visible at any lower Exception level
// using AArch32 are set to zero.

MaybeZeroRegisterUppers(bits(2) handle_e1)
    assert UsingAArch32() && !ELUsingAArch32(handle_e1);

    SCR_RW = if HaveEL(EL3) then SCR_EL3.RW else '1';
    HCR_RW = if CurrentStateHasEL2() && SCR_RW == '1' then HCR_EL2.RW else SCR_RW;

    case SCR_RW:HCR_RW:handle_e1 of
        when '0011' first = 0; last = 30; include_R15 = TRUE;
        when '101x' first = 0; last = 30; include_R15 = FALSE;
        when '11xx' first = 0; last = 14; include_R15 = FALSE;
        otherwise Unreachable();

    for n = first to last
        if (n != 15 || include_R15) && ConstrainUnpredictableBool() then
            _R[n]<63:32> = Zeros();

    return;

// EndOfInstruction()
// =====
// Terminate processing of current instruction

EndOfInstruction();

// Hint_Yield()
// =====

Hint_Yield();

// Hint_Debug()
// =====

```

```
Hint_Debug(bits(4) option);

// SendEvent()
// =====
// Signal an event to all processors

SendEvent();

// EventRegisterSet()
// =====
// Set this processor's local event register

EventRegisterSet();

// ClearEventRegister()
// =====

ClearEventRegister();

// EventRegistered()
// =====

boolean EventRegistered();

// WaitForEvent()
// =====

WaitForEvent();

// WaitForInterrupt()
// =====

WaitForInterrupt();

// InstructionSynchronizationBarrier()
// =====

InstructionSynchronizationBarrier();

// SynchronizeContext()
// =====

SynchronizeContext();

// Unreachable()
// =====

Unreachable()
    assert FALSE;

// ThisInstrLength()
// =====

integer ThisInstrLength();

// ThisInstr()
// =====

bits(32) ThisInstr();

// ArchVersion()
// =====

integer ArchVersion()
    return 8;
```

shared/functions/unpredictable

```
// Constrained Unpredictable handling
// ++++++

// Unpredictable
// =====

// Constraint
// =====

// List of Constrained Unpredictable behaviours
enumeration Constraint { // General:
    Constraint_NONE, Constraint_UNKNOWN,
    Constraint_UNDEF, Constraint_NOP,
    Constraint_TRUE, Constraint_FALSE,
    Constraint_UNKINRANGE,
    // Load-store:
    Constraint_WBSUPPRESS, Constraint_FAULT,
    // Debug watchpoints:
    Constraint_IGNOREMASK, Constraint_IGNOREBAS,
    Constraint_REPEATBAS};

// ConstrainUnpredictable()
// =====

// This definition is an example placeholder only and does not imply a fixed implementation of these
// behaviors. Indeed the intention is that it should be defined by each implementation, according
// to its implementation choices.

// The function returns the appropriate Constraint result above to control the caller's behavior.

Constraint ConstrainUnpredictable()
    return Constraint IMPLEMENTATION_DEFINED;

// ConstrainUnpredictableBool()
// =====

// This is a simple wrapper function for cases where the constrained result is either TRUE or FALSE.

boolean ConstrainUnpredictableBool()

    c = ConstrainUnpredictable();
    assert c IN {Constraint_TRUE, Constraint_FALSE};
    return (c == Constraint_TRUE);

// ConstrainUnpredictableInteger()
// =====

// This is a variant of ConstrainUnpredictable for when the result can be Constraint_UNKINRANGE. If
// the result is Constraint_UNKINRANGE then the function also returns an UNKNOWN value in the range
// low to high, inclusive.

// This is an example placeholder only and does not imply a fixed implementation of the integer part
// of the result.

(Constraint, integer) ConstrainUnpredictableInteger(integer low, integer high)

    c = ConstrainUnpredictable();

    if c == Constraint_UNKINRANGE then
        return (c, low); // See notes; this is an example implementation only
    else
        return (c, integer UNKNOWN); // integer result not used

// ConstrainUnpredictableBits()
// =====
```

```
// This is a variant of ConstrainUnpredictable for when the result can be Constraint_UNKINRANGE.
// If the result is Constraint_UNKINRANGE then the function also returns UNKNOWN value, but that
// value is always an allocated value; that is, one for which the behavior is not itself
// CONSTRAINED.

// This is an example placeholder only and does not imply a fixed implementation of the bits part
// of the result, and may not be applicable in all cases.

(Constraint, bits(width)) ConstrainUnpredictableBits()

c = ConstrainUnpredictable();

if c == Constraint_UNKINRANGE then
    return (c, Zeros(width)); // See notes; this is an example implementation only
else
    return (c, bits(width) UNKNOWN); // bits result not used
```

shared/functions/vector

```
// UnsignedRecipEstimate()
// =====

bits(32) UnsignedRecipEstimate(bits(32) operand)

if operand<31> == '0' then // Operands <= 0x7FFFFFFF produce 0xFFFFFFFF
    result = Ones(32);
else
    // Generate double-precision value = operand * 2^(-32). This has zero sign bit, with:
    //   exponent = 1022 = double-precision representation of 2^(-1)
    //   fraction taken from operand, excluding its most significant bit.
    dp_operand = '0 0111111110' : operand<30:0> : Zeros(21);

    // Call C function to get reciprocal estimate of scaled value.
    estimate = recip_estimate(dp_operand);

    // Result is double-precision and a multiple of 1/256 in the range 1 to 511/256.
    // Multiply by 2^31 and convert to an unsigned integer - this just involves
    // concatenating the implicit units bit with the top 31 fraction bits.
    result = '1' : estimate<51:21>;

return result;

// UnsignedRSqrtEstimate()
// =====

bits(32) UnsignedRSqrtEstimate(bits(32) operand)

if operand<31:30> == '00' then // Operands <= 0x3FFFFFFF produce 0xFFFFFFFF
    result = Ones(32);
else
    // Generate double-precision value = operand * 2^(-32). This has zero sign bit, with:
    //   exponent = 1022 or 1021 = double-precision representation of 2^(-1) or 2^(-2)
    //   fraction taken from operand, excluding its most significant one or two bits.
    if operand<31> == '1' then
        dp_operand = '0 0111111110' : operand<30:0> : Zeros(21);
    else // operand<31:30> == '01'
        dp_operand = '0 0111111101' : operand<29:0> : Zeros(22);

    // Call C function to get reciprocal estimate of scaled value.
    estimate = recip_sqrt_estimate(dp_operand);

    // Result is double-precision and a multiple of 1/256 in the range 1 to 511/256.
    // Multiply by 2^31 and convert to an unsigned integer - this just involves
    // concatenating the implicit units bit with the top 31 fraction bits.
    result = '1' : estimate<51:21>;

return result;
```



```

// SignedSatQ()
// =====

(bits(N), boolean) SignedSatQ(integer i, integer N)
  if i > 2^(N-1) - 1 then
    result = 2^(N-1) - 1; saturated = TRUE;
  elsif i < -(2^(N-1)) then
    result = -(2^(N-1)); saturated = TRUE;
  else
    result = i; saturated = FALSE;
  return (result<N-1:0>, saturated);

// UnsignedSatQ()
// =====

(bits(N), boolean) UnsignedSatQ(integer i, integer N)
  if i > 2^N - 1 then
    result = 2^N - 1; saturated = TRUE;
  elsif i < 0 then
    result = 0; saturated = TRUE;
  else
    result = i; saturated = FALSE;
  return (result<N-1:0>, saturated);

// SatQ()
// =====

(bits(N), boolean) SatQ(integer i, integer N, boolean unsigned)
  (result, sat) = if unsigned then UnsignedSatQ(i, N) else SignedSatQ(i, N);
  return (result, sat);

// AdvSIMDEExpandImm()
// =====

bits(64) AdvSIMDEExpandImm(bit op, bits(4) cmode, bits(8) imm8)
  case cmode<3:1> of
    when '000'
      imm64 = Replicate(Zeros(24):imm8, 2);
    when '001'
      imm64 = Replicate(Zeros(16):imm8:Zeros(8), 2);
    when '010'
      imm64 = Replicate(Zeros(8):imm8:Zeros(16), 2);
    when '011'
      imm64 = Replicate(imm8:Zeros(24), 2);
    when '100'
      imm64 = Replicate(Zeros(8):imm8, 4);
    when '101'
      imm64 = Replicate(imm8:Zeros(8), 4);
    when '110'
      if cmode<0> == '0' then
        imm64 = Replicate(Zeros(16):imm8:Ones(8), 2);
      else
        imm64 = Replicate(Zeros(8):imm8:Ones(16), 2);
    when '111'
      if cmode<0> == '0' && op == '0' then
        imm64 = Replicate(imm8, 8);
      if cmode<0> == '0' && op == '1' then
        imm8a = Replicate(imm8<7>, 8); imm8b = Replicate(imm8<6>, 8);
        imm8c = Replicate(imm8<5>, 8); imm8d = Replicate(imm8<4>, 8);
        imm8e = Replicate(imm8<3>, 8); imm8f = Replicate(imm8<2>, 8);
        imm8g = Replicate(imm8<1>, 8); imm8h = Replicate(imm8<0>, 8);
        imm64 = imm8a:imm8b:imm8c:imm8d:imm8e:imm8f:imm8g:imm8h;
      if cmode<0> == '1' && op == '0' then
        imm32 = imm8<7>:NOT(imm8<6>):Replicate(imm8<6>,5):imm8<5:0>:Zeros(19);
        imm64 = Replicate(imm32, 2);
      if cmode<0> == '1' && op == '1' then
        if UsingAArch32() then ReservedEncoding();

```

```

imm64 = imm8<7>:NOT(imm8<6>):Replicate(imm8<6>,8):imm8<5:0>:Zeros(48);

return imm64;

// PolynomialMult()
// =====

bits(M+N) PolynomialMult(bits(M) op1, bits(N) op2)
  result = Zeros(M+N);
  extended_op2 = ZeroExtend(op2, M+N);
  for i=0 to M-1
    if op1<i> == '1' then
      result = result EOR LSL(extended_op2, i);
  return result;

```

G.3.4 shared/translation

This section contains the pseudocode that relates to address translation and is common to AArch32 state and AArch64 state

shared/translation/attrs

```

// ~~~~~
// Shared Translation System
// ~~~~~

// ~~~~~
// Functions for decoding attributes

// CacheDisabled()
// =====

boolean CacheDisabled(AccType acctype)

  if TranslationRegime() == EL3 && ELUsingAArch32(EL3) then
    // SCTLRL_EL3 is not architecturally mapped to any AArch32 system control register,
    // so this function explicitly references the Secure AArch32 SCTLRL.
    enable = if acctype == AccType_IFETCH then SCTLRL.I else SCTLRL.C;
  else
    // SCTLRL[] returns the AArch64 SCTLRL_ELx for the current translation regime, which
    // maps to the appropriate AArch32 register.
    enable = if acctype == AccType_IFETCH then SCTLRL[].I else SCTLRL[].C;

  if !HaveEL(EL2) || IsSecure() || PSTATE.EL == EL2 then
    return enable == '0';
  else
    return enable == '0' || S2CacheDisabled(acctype);

  return enable == '0';

// S2CacheDisabled()
// =====

boolean S2CacheDisabled(AccType acctype)

  // HCR_EL2.{ID,CD} are mapped to the AArch32 system registers HCR2.{ID,CD}
  disable = if acctype == AccType_IFETCH then HCR_EL2.ID else HCR_EL2.CD;

  return disable == '1';

// CombineS1S2Device()
// =====
// Combines device types from stage 1 and stage 2

DeviceType CombineS1S2Device(DeviceType s1device, DeviceType s2device)

```

```

if s2device == DeviceType_nGnRnE || s1device == DeviceType_nGnRnE then
    result = DeviceType_nGnRnE;
elseif s2device == DeviceType_nGnRE || s1device == DeviceType_nGnRE then
    result = DeviceType_nGnRE;
elseif s2device == DeviceType_nGRE || s1device == DeviceType_nGRE then
    result = DeviceType_nGRE;
else
    result = DeviceType_GRE;

return result;

// CombineS1S2AttrHints()
// =====

MemAttrHints CombineS1S2AttrHints(MemAttrHints s1desc, MemAttrHints s2desc)

    MemAttrHints result;

    if s2desc.attrs == '01' || s1desc.attrs == '01' then
        result.attrs = bits(2) UNKNOWN; // Reserved
    elseif s2desc.attrs == MemAttr_NC || s1desc.attrs == MemAttr_NC then
        result.attrs = MemAttr_NC; // Non-cacheable
    elseif s2desc.attrs == MemAttr_WT || s1desc.attrs == MemAttr_WT then
        result.attrs = MemAttr_WT; // Write-through
    else
        result.attrs = MemAttr_WB; // Write-back

    result.hints = s1desc.hints;
    result.transient = s1desc.transient;

    return result;

// CombineS1S2Desc()
// =====
// Combines the address descriptors from stage 1 and stage 2

AddressDescriptor CombineS1S2Desc(AddressDescriptor s1desc, AddressDescriptor s2desc)

    AddressDescriptor result;

    result.paddress = s2desc.paddress;

    if IsFault(s1desc) || IsFault(s2desc) then
        result = if IsFault(s1desc) then s1desc else s2desc;
    elseif s2desc.memattrs.type == MemType_Device || s1desc.memattrs.type == MemType_Device then
        result.memattrs.type = MemType_Device;
        if s1desc.memattrs.type == MemType_Normal then
            result.memattrs.device = s2desc.memattrs.device;
        elseif s2desc.memattrs.type == MemType_Normal then
            result.memattrs.device = s1desc.memattrs.device;
        else // Both Device
            result.memattrs.device = CombineS1S2Device(s1desc.memattrs.device,
                s2desc.memattrs.device);

        result.memattrs.inner = MemAttrHints UNKNOWN;
        result.memattrs.outer = MemAttrHints UNKNOWN;
        result.memattrs.shareable = TRUE;
        result.memattrs.outershareable = TRUE;
    else // Both Normal
        result.memattrs.type = MemType_Normal;
        result.memattrs.device = DeviceType UNKNOWN;
        result.memattrs.inner = CombineS1S2AttrHints(s1desc.memattrs.inner, s2desc.memattrs.inner);
        result.memattrs.outer = CombineS1S2AttrHints(s1desc.memattrs.outer, s2desc.memattrs.outer);
        if (result.memattrs.inner.attrs == MemAttr_NC &&
            result.memattrs.outer.attrs == MemAttr_NC) then
            // something Non-cacheable at each level is Outer Shareable
            result.memattrs.shareable = TRUE;
            result.memattrs.outershareable = TRUE;
        else

```

```

        result.memattrs.shareable = (s1desc.memattrs.shareable || s2desc.memattrs.shareable);
        result.memattrs.outershareable = (s1desc.memattrs.outershareable ||
                                           s2desc.memattrs.outershareable);

    return result;

// ShortConvertAttrsHints()
// =====
// Converts the short attribute fields for Normal memory as used in the TTBR and
// TEX fields to orthogonal attributes and hints

MemAttrHints ShortConvertAttrsHints(bits(2) RGN, AccType acctype)

    MemAttrHints result;

    if CacheDisabled(acctype) then // Force Non-cacheable
        result.attrs = MemAttr_NC;
        result.hints = MemHint_No;
    else
        case RGN of
            when '00' // Non-cacheable (no allocate)
                result.attrs = MemAttr_NC;
                result.hints = MemHint_No;
            when '01' // Write-back, Read and Write allocate
                result.attrs = MemAttr_WB;
                result.hints = MemHint_RWA;
            when '10' // Write-through, Read allocate
                result.attrs = MemAttr_WT;
                result.hints = MemHint_RA;
            when '11' // Write-back, Read allocate
                result.attrs = MemAttr_WB;
                result.hints = MemHint_RA;

        result.transient = FALSE;

    return result;

// LongConvertAttrsHints()
// =====
// Convert the long attribute fields for Normal memory as used in the MAIR fields
// to orthogonal attributes and hints

MemAttrHints LongConvertAttrsHints(bits(4) attrfield, AccType acctype)
    assert !IsZero(attrfield);

    MemAttrHints result;

    if CacheDisabled(acctype) then // Force Non-cacheable
        result.attrs = MemAttr_NC;
        result.hints = MemHint_No;
    else
        if attrfield<3:2> == '00' then // Write-through transient
            result.attrs = MemAttr_WT;
            result.hints = attrfield<1:0>;
            result.transient = TRUE;
        elsif attrfield<3:0> == '0100' then // Non-cacheable (no allocate)
            result.attrs = MemAttr_NC;
            result.hints = MemHint_No;
            result.transient = FALSE;
        elsif attrfield<3:2> == '01' then // Write-back transient
            result.attrs = attrfield<1:0>;
            result.hints = MemAttr_WB;
            result.transient = TRUE;
        else // Write-through/Write-back non-transient
            result.attrs = attrfield<3:2>;
            result.hints = attrfield<1:0>;
            result.transient = FALSE;
    
```

```

    return result;

// S2ConvertAttrsHints()
// =====
// Converts the attribute fields for Normal memory as used in stage 2
// descriptors to orthogonal attributes and hints

MemAttrHints S2ConvertAttrsHints(bits(2) attr, AccType acctype)
    assert !IsZero(attr);

    MemAttrHints result;

    if S2CacheDisabled(acctype) then // Force Non-cacheable
        result.attrs = MemAttr_NC;
        result.hints = MemHint_No;
    else
        case attr of
            when '01' // Non-cacheable (no allocate)
                result.attrs = MemAttr_NC;
                result.hints = MemHint_No;
            when '10' // Write-through
                result.attrs = MemAttr_WT;
                result.hints = MemHint_RWA;
            when '11' // Write-back
                result.attrs = MemAttr_WB;
                result.hints = MemHint_RWA;

        result.transient = FALSE;

    return result;

// S2AttrDecode()
// =====
// Converts the Stage 2 attribute fields into orthogonal attributes and hints

MemoryAttributes S2AttrDecode(bits(2) SH, bits(4) attr, AccType acctype)

    MemoryAttributes memattrs;

    if attr<3:2> == '00' then // Device
        memattrs.type = MemType_Device;
        memattrs.inner = MemAttrHints UNKNOWN;
        memattrs.outer = MemAttrHints UNKNOWN;
        case attr<1:0> of
            when '00' memattrs.device = DeviceType_nGnRnE;
            when '01' memattrs.device = DeviceType_nGnRE;
            when '10' memattrs.device = DeviceType_nGRE;
            when '11' memattrs.device = DeviceType_GRE;
        memattrs.shareable = TRUE;
        memattrs.outershareable = TRUE;

    elsif attr<1:0> != '00' then // Normal
        memattrs.type = MemType_Normal;
        memattrs.device = DeviceType UNKNOWN;
        memattrs.outer = S2ConvertAttrsHints(attr<3:2>, acctype);
        memattrs.inner = S2ConvertAttrsHints(attr<1:0>, acctype);
        memattrs.shareable = SH<1> == '1';
        memattrs.outershareable = SH == '10';

    else
        memattrs = MemoryAttributes UNKNOWN; // Reserved

    return memattrs;

// WalkAttrDecode()
// =====

MemoryAttributes WalkAttrDecode(bits(2) SH, bits(2) ORGN, bits(2) IRGN)

```

```

MemoryAttributes memattrs;

AccType acctype = AccType_NORMAL;

memattrs.type = MemType_Normal;
memattrs.device = DeviceType_UNKNOWN;
memattrs.inner = ShortConvertAttrHints(IRGN, acctype);
memattrs.outer = ShortConvertAttrHints(ORGN, acctype);
memattrs.shareable = SH<1> == '1';
memattrs.outershareable = SH == '10';

return memattrs;

```

shared/translation/translation

```

// ~~~~~
// Shared Translation System
// ~~~~~
// Shared exception model and translation table walking code.
//
// Typical flow through a translation for EL0 using AArch32 under EL1 using AArch64
// is as follows:
//
// AArch32.TranslateAddress(bits(32) vaddress)
// |
// |--> AArch64.TranslateAddress(ZeroExtend(vaddress, 64))
// |
// |--> AArch64.FirstStageTranslate(vaddress)
// |
// |   |--> AArch64.TranslationTableWalkLD()
// |   |
// |   |   |--> AArch64.SecondStageWalk()
// |   |   |
// |   |   |   |--> AArch64.SecondStageTranslate()
// |   |   |   |
// |   |   |   |   |--> AArch64.TranslationTableWalkLD()
// |   |   |   |
// |   |   |--> AArch64.SecondStageTranslate(vaddress)
// |   |   |
// |   |--> AArch64.TranslationTableWalkLD()
// |
//
// In ARMv7 "SecondStageTranslate" was used only for the recursive call from
// TranslationTableWalk{SD|LD}. For ARMv8 it is extended to deal with all
// second stage translations, so as to support EL0 and EL1 using AArch32
// under EL2 using AArch64:
//
// AArch32.TranslateAddress(bits(32) vaddress)
// |
// |--> AArch32.FirstStageTranslate(vaddress)
// |
// |   |--> AArch32.TranslationTableWalkLD()
// |   |
// |   |   |--> AArch32.SecondStageWalk()
// |   |   |
// |   |   |   |--> AArch32.SecondStageTranslate()
// |   |   |   |
// |   |   |   |   |--> AArch64.SecondStageTranslate()
// |   |   |   |   |
// |   |   |   |   |   |--> AArch64.TranslationTableWalkLD()
// |   |   |   |   |
// |   |   |--> AArch32.SecondStageTranslate(vaddress)
// |   |   |
// |   |--> AArch64.SecondStageTranslate(vaddress)
// |   |
// |   |--> AArch64.TranslationTableWalkLD()
// |
//

```

```
// Should translation fail then it calls DataAbort, but importantly it stays in
// the right translation regime so calls the correct exception handler.

// PAMax()
// =====
// Returns the IMPLEMENTATION DEFINED upper limit on the physical address
// size for this processor, as log2().

integer PAMax()

    case ID_AA64MMFR0_EL1.PARange of
        when '0000' pa_size = 32;
        when '0001' pa_size = 36;
        when '0010' pa_size = 40;
        when '0011' pa_size = 42;
        when '0100' pa_size = 44;
        when '0101' pa_size = 48;
        otherwise Unreachable();

    return pa_size;

// TranslationRegime()
// =====
// Returns the Exception Level controlling the current translation regime. For the most part this
// is unused in code because the system register accessors (SCTLR[], etc.) implicitly return the
// correct value.

bits(2) TranslationRegime()
    if PSTATE.EL != EL0 then
        return PSTATE.EL;
    elseif IsSecure() && HaveEL(EL3) && ELUsingAArch32(EL3) then
        return EL3;
    else
        return EL1;
```

Appendix H

ARM Pseudocode Definition

This appendix provides a definition of the pseudocode used in this manual, and defines some *helper* procedures and functions used by pseudocode. It contains the following sections:

- [About the ARM pseudocode on page AppxH-5060.](#)
- [Pseudocode for instruction descriptions on page AppxH-5061.](#)
- [Data types on page AppxH-5063.](#)
- [Expressions on page AppxH-5067.](#)
- [Operators and built-in functions on page AppxH-5069.](#)
- [Statements and program structure on page AppxH-5074.](#)
- [Miscellaneous helper procedures and functions on page AppxH-5078.](#)

———— **Note** —————

Status of this appendix in the beta release document

ARM is currently working to improve the organization and presentation of the pseudocode in this document. Currently, this chapter contains the ARMv7 definition, and needs updating to incorporate changes and extensions to the pseudocode made for ARMv8. These updates will appear in the next issue of this manual.

The pseudocode in this manual describes ARMv8 execution in both AArch32 state and AArch64 state. It does not describe differences in earlier versions of the architecture.

H.1 About the ARM pseudocode

See the *Note* on the front page of this appendix, [Status of this appendix in the beta release document on page AppxH-5059](#).

The ARM pseudocode provides precise descriptions of some areas of the ARM architecture. This includes description of the decoding and operation of all valid instructions. [Pseudocode for instruction descriptions on page AppxH-5061](#) gives general information about this instruction pseudocode, including its limitations.

The following sections describe the ARM pseudocode in detail:

- [Data types on page AppxH-5063](#).
- [Expressions on page AppxH-5067](#).
- [Operators and built-in functions on page AppxH-5069](#).
- [Statements and program structure on page AppxH-5074](#).

[Miscellaneous helper procedures and functions on page AppxH-5078](#) describes some pseudocode helper functions, that are used by the pseudocode functions that are described elsewhere in this manual. [Appendix I](#) contains the indexes to the pseudocode.

H.1.1 General limitations of ARM pseudocode

The pseudocode statements IMPLEMENTATION_DEFINED, SEE, SUBARCHITECTURE_DEFINED, UNDEFINED, and UNPREDICTABLE indicate behavior that differs from that indicated by the pseudocode being executed. If one of them is encountered:

- Earlier behavior indicated by the pseudocode is only specified as occurring to the extent required to determine that the statement is executed.
- No subsequent behavior indicated by the pseudocode occurs. This means that these statements terminate pseudocode execution.

For more information, see [Simple statements on page AppxH-5074](#).

H.2 Pseudocode for instruction descriptions

Each instruction description includes pseudocode that provides a precise description of what the instruction does, subject to the limitations described in *General limitations of ARM pseudocode* on page AppxH-5060 and *Limitations of the instruction pseudocode* on page AppxH-5062.

In the instruction pseudocode, instruction fields are referred to by the names shown in the encoding diagram for the instruction. *Instruction encoding diagrams and instruction pseudocode* gives more information about the pseudocode provided for each instruction.

H.2.1 Instruction encoding diagrams and instruction pseudocode

———— **Note** —————

Currently this appendix only describes A32/T32 instruction pseudocode. This information is only partially applicable to the A64 instruction descriptions. This will be corrected in the next issue of the document.

Instruction descriptions in this manual contain:

- An Encoding section, containing one or more encoding diagrams, each followed by some encoding-specific pseudocode that translates the fields of the encoding into inputs for the common pseudocode of the instruction, and picks out any encoding-specific special cases.
- An Operation section, containing common pseudocode that applies to all of the encodings being described. The Operation section pseudocode contains a call to the `EncodingSpecificOperations()` function, either at its start or only after a condition code check performed by `if ConditionPassed()` then.

An encoding diagram specifies each bit of the instruction as one of the following:

- An obligatory 0 or 1, represented in the diagram as 0 or 1. If this bit does not have this value, the encoding corresponds to a different instruction.
- A *should be* 0 or 1, represented in the diagram as (0) or (1). If this bit does not have this value, the instruction is UNPREDICTABLE. For more information, see *SBZ or SBO fields in instructions* on page AppxA-4760.
- A named single bit or a bit in a named multi-bit field. The `cond` field in bits[31:28] of many A32/T32 instructions has some special rules associated with it.

An encoding diagram matches an instruction if all obligatory bits are identical in the encoding diagram and the instruction, and one of the following is true:

- The encoding diagram is not for an A32/T32 instruction.
- The encoding diagram is for an A32/T32 instruction that does not have a `cond` field in bits[31:28].
- The encoding diagram is for an A32/T32 instruction that has a `cond` field in bits[31:28], and bits[31:28] of the instruction are not `0b1111`.

In the context of the instruction pseudocode, the execution model for an instruction is:

1. Find all encoding diagrams that match the instruction. It is possible that no encoding diagram matches. In that case, abandon this execution model and consult the relevant instruction set chapter instead to find out how the instruction is to be treated. The bit pattern of such an instruction is usually reserved and UNDEFINED, though there are some other possibilities. For example, unallocated hint instructions are documented as being reserved and executed as NOPs.
2. If the operation pseudocode for the matching encoding diagrams starts with a condition code check, perform that check. If the condition code check fails, abandon this execution model and treat the instruction as a NOP. If there are multiple matching encoding diagrams, either all or none of their corresponding pieces of common pseudocode start with a condition code check.

3. Perform the encoding-specific pseudocode for each of the matching encoding diagrams independently and in parallel. Each such piece of encoding-specific pseudocode starts with a bitstring variable for each named bit or multi-bit field in its corresponding encoding diagram, named the same as the bit or multi-bit field and initialized with the values of the corresponding bit or bits from the bit pattern of the instruction.

In a few cases, the encoding diagram contains more than one bit or field with same name. In these cases, the values of the different instances of those bits or fields must be identical. The encoding-specific pseudocode contains a special case using the `Consistent()` function to specify what happens if they are not identical. `Consistent()` returns `TRUE` if all instruction bits or fields with the same name as its argument have the same value, and `FALSE` otherwise.

If there are multiple matching encoding diagrams, all but one of the corresponding pieces of pseudocode must contain a special case that indicates that it does not apply. Discard the results of all such pieces of pseudocode and their corresponding encoding diagrams.

There is now one remaining piece of pseudocode and its corresponding encoding diagram left to consider. This pseudocode might also contain a special case, most commonly one indicating that it is `UNPREDICTABLE`. If so, abandon this execution model and treat the instruction according to the special case.

4. Check the *should be* bits of the encoding diagram against the corresponding bits of the bit pattern of the instruction. If any of them do not match, abandon this execution model and treat the instruction as `UNPREDICTABLE`.
5. Perform the rest of the operation pseudocode for the instruction description that contains the encoding diagram. That pseudocode starts with all variables set to the values they were left with by the encoding-specific pseudocode.

The `ConditionPassed()` call in the common pseudocode, if present, performs step 2, and the `EncodingSpecificOperations()` call performs steps 3 and 4.

H.2.2 Limitations of the instruction pseudocode

The pseudocode descriptions of instruction functionality have a number of limitations. These are mainly due to the fact that, for clarity and brevity, the pseudocode is a sequential and mostly deterministic language.

These limitations include:

- Pseudocode does not describe the ordering requirements when an instruction generates multiple memory accesses. For a description of the ordering requirements on memory accesses see [Ordering requirements on page E2-2351](#).
- Pseudocode does not describe the exact rules when an `UNDEFINED` instruction fails its condition code check. In such cases, the `UNDEFINED` pseudocode statement lies inside the `if ConditionPassed() then ...` structure, either directly or in the `EncodingSpecificOperations()` function call, and so the pseudocode indicates that the instruction executes as a `NOP`. [Conditional execution of undefined instructions on page G1-3478](#) describes the exact rules.
- Pseudocode does not describe the exact ordering requirements when a single floating-point instruction generates more than one floating-point exception and one or more of those floating-point exceptions is trapped. [Combinations of exceptions on page E1-2309](#) describes the exact rules.

————— **Note** —————

There is no limitation in the case where all the floating-point exceptions are untrapped, because the pseudocode specifies the same behavior as the cross-referenced section.

- An exception can be taken during execution of the pseudocode for an instruction, either explicitly as a result of the execution of a pseudocode function such as `Abort()`, or implicitly, for example if an interrupt is taken during execution of an `LDM` instruction. If this happens, the pseudocode does not describe the extent to which the normal behavior of the instruction occurs. To determine that, see the descriptions of the exceptions in [Handling exceptions that are taken to an Exception level using AArch32 on page G1-3431](#).

H.3 Data types

This section describes:

- [General data type rules](#).
- [Bitstrings](#).
- [Integers](#) on page AppxH-5064.
- [Reals](#) on page AppxH-5064.
- [Booleans](#) on page AppxH-5064.
- [Enumerations](#) on page AppxH-5064.
- [Lists](#) on page AppxH-5065.
- [Arrays](#) on page AppxH-5066.

H.3.1 General data type rules

ARM architecture pseudocode is a strongly-typed language. Every constant and variable is of one of the following types:

- Bitstring.
- Integer.
- Boolean.
- Real.
- Enumeration.
- List.
- Array.

The type of a constant is determined by its syntax. The type of a variable is normally determined by assignment to the variable, with the variable being implicitly declared to be of the same type as whatever is assigned to it. For example, the assignments $x = 1$, $y = '1'$, and $z = \text{TRUE}$ implicitly declare the variables x , y and z to have types integer, bitstring of length 1, and Boolean, respectively.

Variables can also have their types declared explicitly by preceding the variable name with the name of the type. This is most often done in function definitions for the arguments and the result of the function.

The remaining subsections describe each data type in more detail.

H.3.2 Bitstrings

A bitstring is a finite-length string of 0s and 1s. Each length of bitstring is a different type. The minimum permitted length of a bitstring is 1.

The type name for bitstrings of length N is `bits(N)`. A synonym of `bits(1)` is `bit`.

Bitstring constants are written as a single quotation mark, followed by the string of 0s and 1s, followed by another single quotation mark. For example, the two constants of type `bit` are `'0'` and `'1'`. Spaces can be included in bitstrings for clarity.

A special form of bitstring constant with `'x'` bits is permitted in bitstring comparisons, see [Equality and non-equality testing](#) on page AppxH-5069.

Every bitstring value has a left-to-right order, with the bits being numbered in standard *little-endian* order. That is, the leftmost bit of a bitstring of length N is bit $(N-1)$ and its right-most bit is bit 0. This order is used as the most-significant-to-least-significant bit order in conversions to and from integers. For bitstring constants and bitstrings derived from encoding diagrams, this order matches the way they are printed.

Bitstrings are the only concrete data type in pseudocode, in the sense that they correspond directly to the contents of registers, memory locations, instructions, and so on. All of the remaining data types are abstract.

H.3.3 Integers

Pseudocode integers are unbounded in size and can be either positive or negative. That is, they are mathematical integers rather than what computer languages and architectures commonly call integers. Computer integers are represented in pseudocode as bitstrings of the appropriate length, associated with suitable functions to interpret those bitstrings as integers.

The type name for integers is `integer`.

Integer constants are normally written in decimal, such as `0`, `15`, `-1234`. They can also be written in C-style hexadecimal, such as `0x55` or `0x80000000`. Hexadecimal integer constants are treated as positive unless they have a preceding minus sign. For example, `0x80000000` is the integer $+2^{31}$. If -2^{31} needs to be written in hexadecimal, it must be written as `-0x80000000`.

H.3.4 Reals

Pseudocode reals are unbounded in size and precision. That is, they are mathematical real numbers, not computer floating-point numbers. Computer floating-point numbers are represented in pseudocode as bitstrings of the appropriate length, associated with suitable functions to interpret those bitstrings as reals.

The type name for reals is `real`.

Real constants are written in decimal with a decimal point. This means `0` is an integer constant, but `0.0` is a real constant.

H.3.5 Booleans

A Boolean is a logical TRUE or FALSE value.

The type name for Booleans is `boolean`. This is not the same type as `bit`, which is a length-1 bitstring. Boolean constants are TRUE and FALSE.

H.3.6 Enumerations

An enumeration is a defined set of symbolic constants, such as:

```
enumeration InstrSet {InstrSet_ARM, InstrSet_Thumb, InstrSet_Jazelle, InstrSet_ThumbEE};
```

An enumeration always contains at least one symbolic constant, and a symbolic constant must not be shared between enumerations.

Enumerations must be declared explicitly, although a variable of an enumeration type can be declared implicitly by assigning one of the symbolic constants to it. By convention, each of the symbolic constants starts with the name of the enumeration followed by an underscore. The name of the enumeration is its *type name*, or *type*, and the symbolic constants are its possible *constants*.

———— **Note** —————

A `boolean` is a pre-declared enumeration that does not follow the normal naming convention and that has a special role in some pseudocode constructs, such as `if` statements. This means the enumeration of a `boolean` is:

```
enumeration boolean {FALSE, TRUE};
```

H.3.7 Lists

A list is an ordered set of other data items, separated by commas and enclosed in parentheses, for example:

```
(bits(32) shifter_result, bit shifter_carry_out)
```

A list always contains at least one data item.

Lists are often used as the return type for a function that returns multiple results. For example, the list at the start of this section is the return type of the function `Shift_C()` that performs a standard A32/T32 shift or rotation, when its first operand is of type `bits(32)`.

Some specific pseudocode operators use lists surrounded by other forms of bracketing than the (...) parentheses. These are:

- Bitstring extraction operators, that use lists of bit numbers or ranges of bit numbers surrounded by angle brackets `<...>`.
- Array indexing, that uses lists of array indexes surrounded by square brackets `[...]`.
- Array-like function argument passing, that uses lists of function arguments surrounded by square brackets `[...]`.

Each combination of data types in a list is a separate type, with type name given by listing the data types. This means that the example list at the start of this section is of type `(bits(32), bit)`. The general principle that types can be declared by assignment extends to the types of the individual list items in a list. For example:

```
(shift_t, shift_n) = ('00', 0);
```

implicitly declares:

- `shift_t` to be of type `bits(2)`.
- `shift_n` to be of type `integer`.
- `(shift_t, shift_n)` to be of type `(bits(2), integer)`.

A list type can also be explicitly named, with explicitly named elements in the list. For example:

```
type ShiftSpec is (bits(2) shift, integer amount);
```

After this definition and the declaration:

```
ShiftSpec abc;
```

The elements of the resulting list can then be referred to as `abc.shift` and `abc.amount`. This qualified naming of list elements is only permitted for variables that have been explicitly declared, not for those that have been declared by assignment only.

Explicitly naming a type does not alter what type it is. For example, after the above definition of `ShiftSpec`, `ShiftSpec` and `(bits(2), integer)` are two different names for the same type, not the names of two different types. To avoid ambiguity in references to list elements, it is an error to declare a list variable multiple times using different names of its type or to qualify it with list element names not associated with the name by which it was declared.

An item in a list that is being assigned to can be written as “-” to indicate that the corresponding item of the assigned list value is discarded. For example:

```
(shifted, -) = LSL_C(operand, amount);
```

List constants are written as a list of constants of the appropriate types, for example the `('00', 0)` in the earlier example.

H.3.8 Arrays

Pseudocode arrays are indexed by either enumerations or integer ranges. An integer range is represented by the lower inclusive end of the range, then `..`, then the upper inclusive end of the range.

For example:

```
array bits(64) _R[0..30];
```

Arrays are always explicitly declared, and there is no notation for a constant array. Arrays always contain at least one element, because:

- Enumerations always contain at least one symbolic constant.
- Integer ranges always contain at least one integer.

Arrays do not usually appear directly in pseudocode. The items that syntactically look like arrays in pseudocode are usually array-like functions such as `R[i]`, `MemU[address, size]` or `Elem[vector, i, size]`. These functions package up and abstract additional operations normally performed on accesses to the underlying arrays, such as register banking, memory protection, endian-dependent byte ordering, exclusive-access housekeeping and Advanced SIMD element processing.

H.4 Expressions

This section describes:

- [General expression syntax.](#)
- [Operators and functions - polymorphism and prototypes on page AppxH-5068.](#)
- [Precedence rules on page AppxH-5068.](#)

H.4.1 General expression syntax

An expression is one of the following:

- A constant.
- A variable, optionally preceded by a data type name to declare its type.
- The word UNKNOWN preceded by a data type name to declare its type.
- The result of applying a language-defined operator to other expressions.
- The result of applying a function to other expressions.

Variable names normally consist of alphanumeric and underscore characters, starting with an alphabetic or underscore character.

Each register described in the text is to be regarded as declaring a correspondingly named bitstring variable, and that variable has the stated behavior of the register. For example, if a bit of a register is defined as RAZ/WI, then the corresponding bit of its variable reads as 0 and ignore writes.

An expression like `bits(32) UNKNOWN` indicates that the result of the expression is a value of the given type, but the architecture does not specify what value it is and software must not rely on such values. The value produced must not:

- Return information that cannot be accessed at the current or a lower level of privilege using instructions that are not UNPREDICTABLE and do not return UNKNOWN values,
- Be promoted as providing any useful information to software.

———— **Note** —————

UNKNOWN values are similar to the definition of UNPREDICTABLE, but do not indicate that the entire architectural state becomes unspecified.

Only the following expressions are assignable. This means that these are the only expressions that can be placed on the left-hand side of an assignment.

- Variables.
- The results of applying some operators to other expressions.
The description of each language-defined operator that can generate an assignable expression specifies the circumstances under which it does so. For example, those circumstances might require that one or more of the expressions the operator operates on is an assignable expression.
- The results of applying array-like functions to other expressions. The description of an array-like function specifies the circumstances under which it can generate an assignable expression.

Every expression has a data type.

- For a constant, this data type is determined by the syntax of the constant.
- For a variable, there are the following possible sources for the data type
 - An optional preceding data type name.
 - A data type the variable was given earlier in the pseudocode by recursive application of this rule.
 - A data type the variable is being given by assignment, either by direct assignment to the variable, or by assignment to a list of which the variable is a member.

It is a pseudocode error if none of these data type sources exists for a variable, or if more than one of them exists and they do not agree about the type.

- For a language-defined operator, the definition of the operator determines the data type.
- For a function, the definition of the function determines the data type.

H.4.2 Operators and functions - polymorphism and prototypes

Operators and functions in pseudocode can be polymorphic, producing different functionality when applied to different data types. Each resulting form of an operator or function has a different prototype definition. For example, the operator + has forms that act on various combinations of integers, reals and bitstrings.

One particularly common form of polymorphism is between bitstrings of different lengths. This is represented by using `bits(N)`, `bits(M)`, or similar, in the prototype definition.

H.4.3 Precedence rules

The precedence rules for expressions are:

1. Constants, variables and function invocations are evaluated with higher priority than any operators using their results.
2. Expressions on integers follow the normal operator precedence rules of *exponentiation before multiply/divide before add/subtract*, with sequences of multiply/divides or add/subtracts evaluated left-to-right.
3. Other expressions must be parenthesized to indicate operator precedence if ambiguity is possible, but need not be if all permitted precedence orders under the type rules necessarily lead to the same result. For example, if `i`, `j` and `k` are integer variables, `i > 0 && j > 0 && k > 0` is acceptable, but `i > 0 && j > 0 || k > 0` is not.

H.5 Operators and built-in functions

This section describes:

- [Operations on generic types.](#)
- [Operations on Booleans.](#)
- [Bitstring manipulation.](#)
- [Arithmetic on page AppxH-5072.](#)

H.5.1 Operations on generic types

The following operations are defined for all types.

Equality and non-equality testing

Any two values x and y of the same type can be tested for equality by the expression $x == y$ and for non-equality by the expression $x != y$. In both cases, the result is of type `boolean`.

A special form of comparison is defined with a bitstring constant that includes 'x' bits as well as '0' and '1' bits. The bits corresponding to the 'x' bits are ignored in determining the result of the comparison. For example, if opcode is a 4-bit bitstring, $\text{opcode} == \text{'1x0x'}$, this matches the values '1000', '1100', '1001' and '1101'.

———— **Note** —————

This special form is permitted in the implied equality comparisons in when parts of case ... of ... structures.

Conditional selection

If x and y are two values of the same type and t is a value of type `boolean`, then `if t then x else y` is an expression of the same type as x and y that produces x if t is `TRUE` and y if t is `FALSE`.

H.5.2 Operations on Booleans

If x is a `boolean`, then `!x` is its logical inverse.

If x and y are `booleans`, then $x \&\& y$ is the result of ANDing them together. As in the C language, if x is `FALSE`, the result is determined to be `FALSE` without evaluating y .

If x and y are `booleans`, then $x \|\| y$ is the result of ORing them together. As in the C language, if x is `TRUE`, the result is determined to be `TRUE` without evaluating y .

———— **Note** —————

If x and y are `booleans`, then the result of $x != y$ is the same as the result of exclusive-ORing x and y together.

H.5.3 Bitstring manipulation

The following bitstring manipulation functions are defined:

Bitstring length and most significant bit

If x is a bitstring:

- The bitstring length function `Len(x)` returns the length of x as an integer.
- `TopBit(x)` is the leftmost bit of x . Using bitstring extraction, this means:
`TopBit(x) = x <Len(x)-1>`.

Bitstring concatenation and replication

If x and y are bitstrings of lengths N and M respectively, then $x:y$ is the bitstring of length $N+M$ constructed by concatenating x and y in left-to-right order.

If x is a bitstring and n is an integer with $n > 0$:

- $\text{Replicate}(x, n)$ is the bitstring of length $n \cdot \text{Len}(x)$ consisting of n copies of x concatenated together.
- $\text{Zeros}(n) = \text{Replicate}('0', n)$, $\text{Ones}(n) = \text{Replicate}('1', n)$.

Bitstring extraction

The bitstring extraction operator extracts a bitstring from either another bitstring or an integer. Its syntax is $x\langle\text{integer_list}\rangle$, where x is the integer or bitstring being extracted from, and $\langle\text{integer_list}\rangle$ is a list of integers enclosed in angle brackets rather than the usual parentheses. The length of the resulting bitstring is equal to the number of integers in $\langle\text{integer_list}\rangle$. In $x\langle\text{integer_list}\rangle$, each of the integers in $\langle\text{integer_list}\rangle$ must be:

- ≥ 0 .
- $< \text{Len}(x)$ if x is a bitstring.

The definition of $x\langle\text{integer_list}\rangle$ depends on whether integer_list contains more than one integer:

- If integer_list contains more than one integer, $x\langle i, j, k, \dots, n \rangle$ is defined to be the concatenation:
 $x\langle i \rangle : x\langle j \rangle : x\langle k \rangle : \dots : x\langle n \rangle$.
- If integer_list consists of just one integer i , $x\langle i \rangle$ is defined to be:
 - If x is a bitstring, '0' if bit i of x is a zero and '1' if bit i of x is a one.
 - If x is an integer, let y be the unique integer in the range 0 to $2^{i+1}-1$ that is congruent to x modulo 2^{i+1} . Then $x\langle i \rangle$ is '0' if $y < 2^i$ and '1' if $y \geq 2^i$.
Loosely, this definition treats an integer as equivalent to a sufficiently long two's complement representation of it as a bitstring.

In $\langle\text{integer_list}\rangle$, the notation $i:j$ with $i \geq j$ is shorthand for the integers in order from i down to j , with both end values included. For example, $\text{instr}\langle 31:28 \rangle$ is shorthand for $\text{instr}\langle 31, 30, 29, 28 \rangle$.

The expression $x\langle\text{integer_list}\rangle$ is assignable provided x is an assignable bitstring and no integer appears more than once in $\langle\text{integer_list}\rangle$. In particular, $x\langle i \rangle$ is assignable if x is an assignable bitstring and $0 \leq i < \text{Len}(x)$.

Encoding diagrams for registers frequently show named bits or multi-bit fields. For example, the encoding diagram for the [APSR](#) shows its $\text{bit}\langle 31 \rangle$ as N . In such cases, the syntax $\text{APSR}.N$ is used as a more readable synonym for $\text{APSR}\langle 31 \rangle$.

Logical operations on bitstrings

If x is a bitstring, $\text{NOT}(x)$ is the bitstring of the same length obtained by logically inverting every bit of x .

If x and y are bitstrings of the same length, $x \text{ AND } y$, $x \text{ OR } y$, and $x \text{ EOR } y$ are the bitstrings of that same length obtained by logically ANDing, ORing, and exclusive-ORing corresponding bits of x and y together.

Bitstring count

If x is a bitstring, $\text{BitCount}(x)$ produces an integer result equal to the number of bits of x that are ones.

Testing a bitstring for being all zero or all ones

If x is a bitstring:

- $\text{IsZero}(x)$ produces TRUE if all of the bits of x are zeros and FALSE if any of them are ones
- $\text{IsZeroBit}(x)$ produces '1' if all of the bits of x are zeros and '0' if any of them are ones.

$\text{IsOnes}(x)$ and $\text{IsOnesBit}(x)$ work in the corresponding ways. This means:

```
IsZero(x)    = (BitCount(x) == 0)
IsOnes(x)   = (BitCount(x) == Len(x))
IsZeroBit(x) = if IsZero(x) then '1' else '0'
IsOnesBit(x) = if IsOnes(x) then '1' else '0'
```

Lowest and highest set bits of a bitstring

If x is a bitstring, and $N = \text{Len}(x)$:

- $\text{LowestSetBit}(x)$ is the minimum bit number of any of its bits that are ones. If all of its bits are zeros, $\text{LowestSetBit}(x) = N$.
- $\text{HighestSetBit}(x)$ is the maximum bit number of any of its bits that are ones. If all of its bits are zeros, $\text{HighestSetBit}(x) = -1$.
- $\text{CountLeadingZeroBits}(x)$ is the number of zero bits at the left end of x , in the range 0 to N . This means:
 $\text{CountLeadingZeroBits}(x) = N - 1 - \text{HighestSetBit}(x)$.
- $\text{CountLeadingSignBits}(x)$ is the number of copies of the sign bit of x at the left end of x , excluding the sign bit itself, and is in the range 0 to $N-1$. This means:
 $\text{CountLeadingSignBits}(x) = \text{CountLeadingZeroBits}(x \ll N-1) \text{ EOR } x \ll N-2$.

Zero-extension and sign-extension of bitstrings

If x is a bitstring and i is an integer, then $\text{ZeroExtend}(x, i)$ is x extended to a length of i bits, by adding sufficient zero bits to its left. That is, if $i = \text{Len}(x)$, then $\text{ZeroExtend}(x, i) = x$, and if $i > \text{Len}(x)$, then:

```
ZeroExtend(x, i) = Replicate('0', i-Len(x)) : x
```

If x is a bitstring and i is an integer, then $\text{SignExtend}(x, i)$ is x extended to a length of i bits, by adding sufficient copies of its leftmost bit to its left. That is, if $i = \text{Len}(x)$, then $\text{SignExtend}(x, i) = x$, and if $i > \text{Len}(x)$, then:

```
SignExtend(x, i) = Replicate(TopBit(x), i-Len(x)) : x
```

It is a pseudocode error to use either $\text{ZeroExtend}(x, i)$ or $\text{SignExtend}(x, i)$ in a context where it is possible that $i < \text{Len}(x)$.

Converting bitstrings to integers

If x is a bitstring, $\text{SInt}(x)$ is the integer whose two's complement representation is x :

```
// SInt()
```

```
// =====
```

```
integer SInt(bits(N) x)
    result = 0;
    for i = 0 to N-1
        if x<i> == '1' then result = result + 2^i;
        if x<N-1> == '1' then result = result - 2^N;
```

```
return result;
```

UInt(x) is the integer whose unsigned representation is x:

```
// UInt()  
// =====
```

```
integer UInt(bits(N) x)  
  
    result = 0;  
    for i = 0 to N-1  
        if x<i> == '1' then result = result + 2i;  
    return result;
```

Int(x, unsigned) returns either SInt(x) or UInt(x) depending on the value of its second argument:

```
// Int()  
// =====
```

```
integer Int(bits(N) x, boolean unsigned)  
  
    result = if unsigned then UInt(x) else SInt(x);  
    return result;
```

H.5.4 Arithmetic

Most pseudocode arithmetic is performed on integer or real values, with operands being obtained by conversions from bitstrings and results converted back to bitstrings afterwards. As these data types are the unbounded mathematical types, no issues arise about overflow or similar errors.

Unary plus, minus and absolute value

If x is an integer or real, then +x is x unchanged, -x is x with its sign reversed, and Abs(x) is the absolute value of x. All three are of the same type as x.

Addition and subtraction

If x and y are integers or reals, x+y and x-y are their sum and difference. Both are of type integer if x and y are both of type integer, and real otherwise.

Addition and subtraction are particularly common arithmetic operations in pseudocode, and so it is also convenient to have definitions of addition and subtraction acting directly on bitstring operands.

If x and y are bitstrings of the same length N, so that $N = \text{Len}(x) = \text{Len}(y)$, then x+y and x-y are the least significant N bits of the results of converting them to integers and adding or subtracting them. Signed and unsigned conversions produce the same result:

```
x+y = (SInt(x) + SInt(y))<N-1:0>  
      = (UInt(x) + UInt(y))<N-1:0>  
x-y = (SInt(x) - SInt(y))<N-1:0>  
      = (UInt(x) - UInt(y))<N-1:0>
```

If x is a bitstring of length N and y is an integer, x+y and x-y are the bitstrings of length N defined by $x+y = x + y<N-1:0>$ and $x-y = x - y<N-1:0>$. Similarly, if x is an integer and y is a bitstring of length M, x+y and x-y are the bitstrings of length M defined by $x+y = x<M-1:0> + y$ and $x-y = x<M-1:0> - y$.

Comparisons

If x and y are integers or reals, then $x == y$, $x != y$, $x < y$, $x <= y$, $x > y$, and $x >= y$ are equal, not equal, less than, less than or equal, greater than, and greater than or equal comparisons between them, producing Boolean results. In the case of $==$ and $!=$, this extends the generic definition applying to any two values of the same type to also act between integers and reals.

Multiplication

If x and y are integers or reals, then $x * y$ is the product of x and y . It is of type `integer` if x and y are both of type `integer`, and `real` otherwise.

Division and modulo

If x and y are integers or reals, then x/y is the result of dividing x by y , and is always of type `real`.

If x and y are integers, then $x \text{ DIV } y$ and $x \text{ MOD } y$ are defined by:

$$\begin{aligned} x \text{ DIV } y &= \text{RoundDown}(x/y) \\ x \text{ MOD } y &= x - y * (x \text{ DIV } y) \end{aligned}$$

It is a pseudocode error to use any of x/y , $x \text{ MOD } y$, or $x \text{ DIV } y$ in any context where y can be zero.

Square root

If x is an integer or a real, $\text{Sqrt}(x)$ is its square root, and is always of type `real`.

Rounding and aligning

If x is a real:

- $\text{RoundDown}(x)$ produces the largest integer n such that $n \leq x$.
- $\text{RoundUp}(x)$ produces the smallest integer n such that $n \geq x$.
- $\text{RoundTowardsZero}(x)$ produces $\text{RoundDown}(x)$ if $x > 0.0$, 0 if $x == 0.0$, and $\text{RoundUp}(x)$ if $x < 0.0$.

If x and y are both of type `integer`, $\text{Align}(x, y) = y * (x \text{ DIV } y)$ is of type `integer`.

If x is of type `bitstring` and y is of type `integer`, $\text{Align}(x, y) = (\text{Align}(\text{UInt}(x), y)) \langle \text{Len}(x) - 1 : 0 \rangle$ is a bitstring of the same length as x .

It is a pseudocode error to use either form of $\text{Align}(x, y)$ in any context where y can be 0. In practice, $\text{Align}(x, y)$ is only used with y a constant power of two, and the bitstring form used with $y = 2^n$ has the effect of producing its argument with its n low-order bits forced to zero.

Scaling

If x and n are of type `integer`, then:

- $x \ll n = \text{RoundDown}(x * 2^n)$.
- $x \gg n = \text{RoundDown}(x * 2^{(-n)})$.

Maximum and minimum

If x and y are integers or reals, then $\text{Max}(x, y)$ and $\text{Min}(x, y)$ are their maximum and minimum respectively. Both are of type `integer` if x and y are both of type `integer`, and `real` otherwise.

Raising to a power

If x is an integer or a real and n is an integer then x^n is the result of raising x to the power of n , and:

- If x is of type `integer` then x^n is of type `integer`.
- If x is of type `real` then x^n is of type `real`.

H.6 Statements and program structure

This section describes the control statements used in the pseudocode.

H.6.1 Simple statements

Each of the following simple statements must be terminated with a semicolon, as shown.

Assignments

An assignment statement takes the form:

```
<assignable_expression> = <expression>;
```

Procedure calls

A procedure call takes the form:

```
<procedure_name>(<arguments>;
```

Return statements

A procedure return takes the form:

```
return;
```

And a function return takes the form:

```
return <expression>;
```

where <expression> is of the type declared in the function prototype line.

UNDEFINED

This subsection describes the statement:

```
UNDEFINED;
```

This statement indicates a special case that replaces the behavior defined by the current pseudocode, apart from behavior required to determine that the special case applies. The replacement behavior is that the Undefined Instruction exception is taken.

UNPREDICTABLE

This subsection describes the statement:

```
UNPREDICTABLE;
```

This statement indicates a special case that replaces the behavior defined by the current pseudocode, apart from behavior required to determine that the special case applies. The replacement behavior is UNPREDICTABLE.

SEE...

This subsection describes the statement:

```
SEE <reference>;
```

This statement indicates a special case that replaces the behavior defined by the current pseudocode, apart from behavior required to determine that the special case applies. The replacement behavior is that nothing occurs as a result of the current pseudocode because some other piece of pseudocode defines the required behavior. The <reference> indicates where that other pseudocode can be found.

It usually refers to another instruction, but can also refer to another encoding or note of the same instruction.

IMPLEMENTATION_DEFINED

This subsection describes the statement:

```
IMPLEMENTATION_DEFINED {<text>;
```

This statement indicates a special case that replaces the behavior defined by the current pseudocode, apart from behavior required to determine that the special case applies. The replacement behavior is IMPLEMENTATION_DEFINED. An optional <text> field can give more information.

SUBARCHITECTURE_DEFINED

This subsection describes the statement:

```
SUBARCHITECTURE_DEFINED {<text>;
```

This statement indicates a special case that replaces the behavior defined by the current pseudocode, apart from behavior required to determine that the special case applies. The replacement behavior is SUBARCHITECTURE_DEFINED. An optional <text> field can give more information.

H.6.2 Compound statements

Indentation normally indicates the structure in compound statements. The statements contained in structures such as if ... then ... else ... or procedure and function definitions are indented more deeply than the statement itself, and their end is indicated by returning to the original indentation level or less.

Indentation is normally done by four spaces for each level.

if ... then ... else ...

A multi-line if ... then ... else ... structure takes the form:

```
if <boolean_expression> then
    <statement 1>
    <statement 2>
    ...
    <statement n>
elseif <boolean_expression> then
    <statement a>
    <statement b>
    ...
    <statement z>
else
    <statement A>
    <statement B>
    ...
    <statement Z>
```

The block of lines consisting of elseif and its indented statements is optional, and multiple elseif blocks can be used.

The block of lines consisting of else and its indented statements is optional.

Abbreviated one-line forms can be used when there are only simple statements in the then part and in the else part, if it is present, such as:

```
if <boolean_expression> then <statement 1>
if <boolean_expression> then <statement 1> else <statement A>
if <boolean_expression> then <statement 1> <statement 2> else <statement A>
```

————— Note —————

In these forms, <statement 1>, <statement 2> and <statement A> must be terminated by semicolons. This and the fact that the else part is optional are differences from the if ... then ... else ... expression.

repeat ... until ...

A repeat ... until ... structure takes the form:

```
repeat
  <statement 1>
  <statement 2>
  ...
  <statement n>
until <boolean_expression>;
```

while ... do

A while ... do structure takes the form:

```
while <boolean_expression> do
  <statement 1>
  <statement 2>
  ...
  <statement n>
```

for ...

A for ... structure takes the form:

```
for <assignable_expression> = <integer_expr1> to <integer_expr2>
  <statement 1>
  <statement 2>
  ...
  <statement n>
```

case ... of ...

A case ... of ... structure takes the form:

```
case <expression> of
  when <constant values>
    <statement 1>
    <statement 2>
    ...
    <statement n>
  ... more "when" groups ...
  otherwise
    <statement A>
    <statement B>
    ...
    <statement Z>
```

In this structure, <constant values> consists of one or more constant values of the same type as <expression>, separated by commas. Abbreviated one line forms of when and otherwise parts can be used when they contain only simple statements.

If <expression> has a bitstring type, <constant values> can also include bitstring constants containing 'x' bits. For details see [Equality and non-equality testing on page AppxH-5069](#).

Procedure and function definitions

A procedure definition takes the form:

```
<procedure name>(<argument prototypes>)  
  <statement 1>  
  <statement 2>  
  ...  
  <statement n>
```

where <argument prototypes> consists of zero or more argument definitions, separated by commas. Each argument definition consists of a type name followed by the name of the argument.

————— **Note** —————

This first prototype line is not terminated by a semicolon. This helps to distinguish it from a procedure call.

A function definition is similar, but also declares the return type of the function:

```
<return type> <function name>(<argument prototypes>)  
  <statement 1>  
  <statement 2>  
  ...  
  <statement n>
```

An array-like function is similar, but with square brackets:

```
<return type> <function name>[<argument prototypes>]  
  <statement 1>  
  <statement 2>  
  ...  
  <statement n>
```

An array-like function also usually has an assignment prototype:

```
<function name>[<argument prototypes>] = <value prototypes>  
  <statement 1>  
  <statement 2>  
  ...  
  <statement n>
```

H.6.3 Comments

Two styles of pseudocode comment exist:

- // starts a comment that is terminated by the end of the line.
- /* starts a comment that is terminated by */.

H.7 Miscellaneous helper procedures and functions

The functions described in this section are not part of the pseudocode specification. They are miscellaneous *helper* procedures and functions used by pseudocode that are not described elsewhere in this manual. Each has a brief description and a pseudocode prototype, except that the prototype is omitted where it is identical to the section title.

H.7.1 ArchVersion()

This function returns the major version number of the architecture.

```
// ArchVersion()  
// =====
```

```
integer ArchVersion()  
    return 8;
```

H.7.2 EndOfInstruction()

This procedure terminates processing of the current instruction.

```
EndOfInstruction();
```

H.7.3 GenerateAlignmentException()

This procedure generates the appropriate exception for an alignment error.

In all architecture variants and profiles described in this manual, `GenerateAlignmentException()` generates a Data Abort exception.

H.7.4 GenerateCoproprocessorException()

This procedure generates the appropriate exception for a rejected coprocessor instruction.

In all architecture variants and profiles described in this manual, `GenerateCoproprocessorException()` generates an Undefined Instruction exception.

H.7.5 Hint_Debug()

This procedure supplies a hint to the debug system.

```
Hint_Debug(bits(4) option);
```

H.7.6 Hint_PreloadData()

This procedure performs a *preload data* hint.

```
Hint_PreloadData(bits(32) address);
```

H.7.7 Hint_PreloadDataForWrite()

This procedure performs a *preload data* hint with a probability that the use will be for a write.

```
Hint_PreloadDataForWrite(bits(32) address);
```

H.7.8 Hint_PreloadInstr()

This procedure performs a *preload instructions* hint.

```
Hint_PreloadInstr(bits(32) address);
```

H.7.9 Hint_Yield()

This procedure performs a *Yield* hint.

```
Hint_Yield();
```

H.7.10 IntegerZeroDivideTrappingEnabled()

This function returns TRUE if the trapping of divisions by zero in the integer division instructions SDIV and UDIV is enabled, and FALSE otherwise.

The A-profile SDIV and UDIV implementation does not support trapping of integer division by zero and therefore this function always returns FALSE.

```
boolean IntegerZeroDivideTrappingEnabled();
```

H.7.11 IsExternalAbort()

This function returns TRUE if the abort currently being processed is an external abort and FALSE otherwise. It is used only in exception entry pseudocode.

```
boolean IsExternalAbort(Fault type)
```

```
    assert type != Fault_None;
```

```
boolean IsExternalAbort(FaultRecord fault);
```

H.7.12 IsAsyncAbort()

This function returns TRUE if the abort currently being processed is an asynchronous abort, and FALSE otherwise. It is used only in exception entry pseudocode.

```
boolean IsAsyncAbort(Fault type)
```

```
    assert type != Fault_None;
```

```
boolean IsAsyncAbort(FaultRecord fault);
```

H.7.13 JazelleAcceptsExecution()

This function indicates whether Jazelle hardware will take over execution when a BXJ instruction is executed.

```
boolean JazelleAcceptsExecution();
```

H.7.14 LSInstructionSyndrome()

This function returns the extended syndrome information for a fault reported in the [HSR](#).

```
bits(11) LSInstructionSyndrome();
```

H.7.15 ProcessorID()

This function returns an integer that uniquely identifies the executing PE in the system.

```
integer ProcessorID();
```

H.7.16 RemapRegsHaveResetValues()

This function returns TRUE if the remap registers PRRR and NMRR have their IMPLEMENTATION DEFINED reset values, and FALSE otherwise.

```
boolean RemapRegsHaveResetValues();
```

H.7.17 ThisInstr()

This function returns the bitstring encoding of the currently-executing instruction.

```
bits(32) ThisInstr();
```

———— **Note** —————

Currently, this function is used only on 32-bit instruction encodings.

H.7.18 ThisInstrLength()

This function returns the length, in bits, of the current instruction. This means it returns 32 or 16:

```
integer ThisInstrLength();
```

Appendix I

Pseudocode Index

This appendix provides indexes to pseudocode definitions and to the pseudocode functions. It contains the following sections:

- [Pseudocode operators and keywords on page AppxI-5082.](#)
- [Pseudocode indexes on page AppxI-5085.](#)

Note

Status of this appendix in the beta release document

ARM is currently working to improve the organization of the pseudocode in this document, including providing improved linking within the pseudocode. The pseudocode indexes will be added as part of this work. At present, this chapter contains only a list of the pseudocode operators and keywords.

I.1 Pseudocode operators and keywords

Table I-1 shows the pseudocode operators and keywords.

Table I-1 Pseudocode operators and keywords

Operator	Meaning
-	Unary minus on integers or reals
-	Subtraction of integers, reals and bitstrings
+	Unary plus on integers or reals
+	Addition of integers, reals and bitstrings
.	Extract named member from a list
.	Extract named bit or field from a register
:	Bitstring concatenation
:	Integer range in bitstring extraction operator
!	Boolean NOT
!=	Compare for non-equality (any type)
!=	Compare for non-equality (between integers and reals)
(...)	Around arguments of procedure
(...)	Around arguments of function
[...]	Around array index
[...]	Around arguments of array-like function
*	Multiplication of integers and reals
/	Division of integers and reals (real result)
/*...*/	Comment delimiters
//	Introduces comment terminated by end of line
&&	Boolean AND
<	<i>Less than</i> comparison of integers and reals
<...>	Extraction of specified bits of bitstring or integer
<<	Multiply integer by power of 2 (with rounding towards -infinity)
<=	<i>Less than or equal</i> comparison of integers and reals
=	Assignment
==	Compare for equality (any type)
==	Compare for equality (between integers and reals)
>	<i>Greater than</i> comparison of integers and reals
>=	<i>Greater than or equal</i> comparison of integers and reals
>>	Divide integer by power of 2 (with rounding towards -infinity)

Table I-1 Pseudocode operators and keywords (continued)

Operator	Meaning
	Boolean OR
x ^N	N th integer power of integers or real ^a
AND	Bitwise AND of bitstrings
array	Keyword introducing array type definition
bit	Bitstring type of length 1
bits(N)	Bitstring type of length N
boolean	Boolean type
case ... of ...	Control structure
DIV	Quotient from integer division
enumeration	Keyword introducing enumeration type definition
EOR	Bitwise EOR of bitstrings
FALSE	Boolean constant
for ...	Control structure
for ... downto	Counts down
if ... then ... else ...	Expression selecting between two values
if ... then ... else ...	Control structure
IN	Tests membership of a set of values
IMPLEMENTATION_DEFINED	Describes IMPLEMENTATION_DEFINED behavior
integer	Unbounded integer type
MOD	Remainder from integer division
OR	Bitwise OR of bitstrings
otherwise	Introduces default case in case ... of ... control structure
real	Real number type
repeat ... until ...	Control structure
return	Procedure or function return
SEE	Points to other pseudocode to use instead
SUBARCHITECTURE_DEFINED	Describes SUBARCHITECTURE_DEFINED behavior
TRUE	Boolean constant
type	Names a type
UNDEFINED	Cause Undefined Instruction exception
UNKNOWN	Unspecified value

Table I-1 Pseudocode operators and keywords (continued)

Operator	Meaning
UNPREDICTABLE	Unspecified behavior
when	Introduces specific case in case ... of ... control structure
while ... do ...	Control structure

a. N must be an integer, x can be an integer or a real.

I.2 Pseudocode indexes

———— **Note** —————

ARM is continuing to work on the structuring and linking of the pseudocode in this document. The next release of this manual will include a pseudocode index by function or procedure name.

Appendix J

Registers Index

This appendix provides indexes to the register descriptions in this manual. It contains the following sections:

- *Introduction and register disambiguation on page AppxJ-5088.*
- *Alphabetical index of AArch64 registers and system instructions on page AppxJ-5092.*
- *Functional index of AArch64 registers and system instructions on page AppxJ-5102.*
- *Alphabetical index of AArch32 registers and system instructions on page AppxJ-5113.*
- *Functional index of AArch32 registers and system instructions on page AppxJ-5122.*
- *Alphabetical index of memory-mapped registers on page AppxJ-5133.*
- *Functional index of memory-mapped registers on page AppxJ-5138.*

J.1 Introduction and register disambiguation

In some sections of this manual, registers are referred to by a *general name*, where the description applies to more than one context. Generally, this is one of the following:

- The description applies to both AArch32 state and AArch64 state, and therefore the register names could apply to either AArch32 system registers or AArch64 system registers.
- The description applies to multiple Exception levels, and therefore at a particular Exception level the register names need to take the appropriate Exception. level suffix, `_EL0`, `_EL1`, `_EL2`, or `_EL3`.

The following sections disambiguate the general register names:

- [Register name disambiguation by Execution state.](#)
- [Register name disambiguation by Exception level on page AppxJ-5091.](#)

J.1.1 Register name disambiguation by Execution state

[Table J-1](#) disambiguates the general names of the registers by Execution state.

Table J-1 Disambiguation of general names of registers by Execution state

General name	Short description	AArch64 register	AArch32 register
CONTEXTIDR	Context ID	CONTEXTIDR_EL1	CONTEXTIDR
DBGBCR	Debug Breakpoint Control Registers	DBGBCR<n>_EL1	DBGBCR<n>
DBGBVR	Debug Breakpoint Value Registers	DBGBVR<n>_EL1	DBGBVR<n> DBGXVR<n>
DBGCLAIMCLR	Debug Claim Tag Clear register	DBGCLAIMCLR_EL1	DBGCLAIMCLR
DBGCLAIMSET	Debug Claim Tag Set register	DBGCLAIMSET_EL1	DBGCLAIMSET
DBGDTRRX	Debug Data Transfer Register, Receive	DBGDTRRX_EL0	DBGDTRRXint
DBGDTRTX	Debug Data Transfer Register, Transmit	DBGDTRTX_EL0	DBGDTRTXint
DBGPRCR	Debug Power Control Register	DBGPRCR_EL1	DBGPRCR
DBGVCR	Debug Vector Catch Register	DBGVCR32_EL2	DBGVCR
DBGWCR	Debug Watchpoint Control Registers	DBGWCR<n>_EL1	DBGWCR<n>
DBGWVR	Debug Watchpoint Value Registers	DBGWVR<n>_EL1	DBGWVR<n>
DCCINT	Debug Comms Channel Interrupt Enable Register	MDCCINT_EL1	DBGDCCINT
DCCSR	Debug Comms Channel Status Register	MDCCSR_EL0	DBGDSCRint
DBGAUTHSTATUS	Debug Authentication Status	DBGAUTHSTATUS_EL1	DBGAUTHSTATUS
DLR	Debug Link Register	DLR_EL0[31:0]	DLR
DSCR	Debug System Control Register	MDSCR_EL1	DBGDSCRext
DSPSR	Debug Saved PE State Register	DSPSR_EL0	DSPSR
FAR	Fault Address Register	FAR_EL1 FAR_EL2 FAR_EL3 HPFAR_EL2	DFAR, IFAR HDFAR, HIFAR FAR_EL3 HPFAR

Table J-1 Disambiguation of general names of registers by Execution state (continued)

General name	Short description	AArch64 register	AArch32 register
HCR	Hypervisor Configuration Register	HCR_EL2	HCR HCR2
HDCR	Hyp or EL2 Debug Control Register	MDCR_EL2	HDCR
HSCTLR	Hypervisor System Control Register	SCTLR_EL2	HSCTLR
HTTBR	EL2 Translation Table Base Register	TTBR0_EL2	HTTBR
ISR	Interrupt Status Register	ISR_EL1	ISR
OSDLR	OS Double-Lock Register	OSDLR_EL1	DBGOSDLR
OSDTRRX	OS Lock Data Transfer Register, Receive	OSDTRRX_EL1	DBGDTRRXext
OSDTRTX	OS Lock Data Transfer Register, Transmit	OSDTRTX_EL1	DBGDTRTXext
OSECCR	OS Lock Exception Catch Control Register	OSECCR_EL1	DBGOSECCR
OSLAR	OS Lock Access Register	OSLAR_EL1	DBGOSLAR
OSLSR	OS Lock Status Register	OSLSR_EL1	DBGOSLSR
SCR	EL3 Debug Control Register	SCR_EL3	SCR
SCTLR	System Control Register	SCTLR_EL1 SCTLR_EL2 SCTLR_EL3	SCTLR (NS) HSCTLR SCTLR (S)
SDCR	Secure or EL3 Debug Configuration Register	MDCR_EL3	SDCR
SDER	Secure Debug Enable Register	SDER32_EL3	SDER
SPSR	Saved Program Status Register	SPSR_EL1 SPSR_EL2 SPSR_EL3	SPSR
TCR	Translation Control Register	TCR_EL1 TCR_EL2 TCR_EL3	TTBCR(NS) HTCR TTBCR(S)
TTBR	Translation Table Base Register	TTBR0_EL1 TTBR0_EL2 TTBR1_EL1	TTBR0 TTBR1
VCR	EL1&0 stage 2 Translation Control Register	VTCR_EL2	VTCR
VTTBR	EL1&0 stage 2 Translation Table Base Register	VTTBR_EL2	VTTBR

Table J-2 disambiguates the general names of the System registers that provide access to the Performance Monitors by Execution state.

Table J-2 Disambiguation of general names of the Performance Monitors System registers by Execution state

General name	Short description	AArch64 register	AArch32 register
PMCCFILTR	Cycle Count Filter Register	PMCCFILTR_EL0	PMCCFILTR
PMCCNTR	Cycle Count Register	PMCCNTR_EL0	PMCCNTR
PMCEID0	Performance Monitors Cycle Count Filter Register 0	PMCEID0_EL0	PMCEID0
PMCEID1	Performance Monitors Cycle Count Filter Register 1	PMCEID1_EL0	PMCEID1
PMCNTENCLR	Performance Monitors Count Enable Clear register	PMCNTENCLR_EL0	PMINTENCLR
PMCNTENSET	Performance Monitors Count Enable Set register	PMCNTENSET_EL0	PMCNTENSET
PMCR	Performance Monitors Control Register	PMCR_EL0	PMCR
PMEVCNTR<n>	Performance Monitors Event Count Registers, n = 0-30	PMEVCNTR<n>_EL0	PMEVCNTR<n>
PMEVTYPER<n>	Performance Monitors Event Type Registers, n = 0-30	PMEVTYPER<n>_EL0	PMEVTYPER<n>
PMINTENCLR	Performance Monitors Interrupt Enable Clear register	PMINTENCLR_EL1	PMINTENCLR
PMINTENSET	Performance Monitors Interrupt Enable Set register	PMINTENSET_EL1	PMINTENSET
PMOVSCLR	Performance Monitors Overflow Flag Status Register	PMOVSCLR_EL0	PMOVSR
PMOVSSET	Performance Monitors Overflow Flag Status Set register	PMOVSSET_EL0	PMOVSSET
PMSELR	Performance Monitors Event Counter Selection Register	PMSELR_EL0	PMSELR
PMSWINC	Performance Monitors Software Increment register	PMSWINC_EL0	PMSWINC
PMUSERENR	Performance Monitors User Enable Register	PMUSERENR_EL0	PMUSERENR
PMXEVCNTR	Performance Monitors Selected Event Count Register	PMXEVCNTR_EL0	PMXEVCNTR
PMXEVTYPER	Performance Monitors Selected Event Type Register	PMXEVTYPER_EL0	PMXEVTYPER

Table J-3 disambiguates the general names of the System registers that provide access to the Performance Monitors by Execution state.

Table J-3 Disambiguation of general names of the Generic Timer System registers by Execution state

General name	Short description	AArch64 register	AArch32 register
CNTRFQ	Counter-timer Frequency register	CNTRFQ_EL0	CNTRFQ
CNTHCTL	Counter-timer Hypervisor Control register	CNTHCTL_EL2	CNTHCTL
CNTHP_CTL	Counter-timer Hypervisor Physical Timer Control register	CNTHP_CTL_EL2	CNTHP_CTL
CNTHP_CVAL	Counter-timer Hypervisor Physical Timer Compare Value register	CNTHP_CVAL_EL2	CNTHP_CVAL
CNTHP_TVAL	Counter-timer Hypervisor Physical Timer Timer Value register	CNTHP_TVAL_EL2	CNTHP_TVAL
CNTKCTL	Counter-timer Kernel Control register	CNTKCTL_EL1	CNTKCTL

Table J-3 Disambiguation of general names of the Generic Timer System registers by Execution state (continued)

General name	Short description	AArch64 register	AArch32 register
CNTP_CTL	Counter-timer Physical Timer Control register	CNTP_CTL_EL0	CNTP_CTL
CNTP_CVAL	Counter-timer Physical Timer CompareValue register	CNTP_CVAL_EL0	CNTP_CVAL
CNTP_TVAL	Counter-timer Physical Timer TimerValue register	CNTP_TVAL_EL0	CNTP_TVAL
CNTPCT	Counter-timer Physical Count register	CNTPCT_EL0	CNTPCT
CNTPS_CTL	Counter-timer Physical Secure Timer Control register	CNTPS_CTL_EL1	-
CNTPS_CVAL	Counter-timer Physical Secure Timer CompareValue register	CNTPS_CVAL_EL1	-
CNTPS_TVAL	Counter-timer Physical Secure Timer TimerValue register	CNTPS_TVAL_EL1	-
CNTV_CTL	Counter-timer Virtual Timer Control register	CNTV_CTL_EL0	CNTV_CTL
CNTV_CVAL	Counter-timer Virtual Timer CompareValue register	CNTV_CVAL_EL0	CNTV_CVAL
CNTV_TVAL	Counter-timer Virtual Timer TimerValue register	CNTV_TVAL_EL0	CNTV_TVAL
CNTVCT	Counter-timer Virtual Count register	CNTVCT_EL0	CNTVCT
CNTVOFF	Counter-timer Virtual Offset register	CNTVOFF_EL2	CNTVOFF

J.1.2 Register name disambiguation by Exception level

Table J-4 disambiguates the general names of the AArch64 System registers by Exception level.

Table J-4 Disambiguation of AArch64 system registers by Exception level

General form	EL0	EL1	EL2	EL3
AFSR0_ELx	-	AFSR0_EL1	AFSR0_EL2	AFSR0_EL3
AFSR1_ELx	-	AFSR1_EL1	AFSR1_EL2	AFSR1_EL3
ELR_ELx	-	ELR_EL1	ELR_EL2	ELR_EL3
ESR_ELx	-	ESR_EL1	ESR_EL2	ESR_EL3
FAR_ELx	-	FAR_EL1	FAR_EL2	FAR_EL3
MAIR_ELx	-	MAIR_EL1	MAIR_EL2	MAIR_EL3
RMR_ELx	-	RMR_EL1	RMR_EL2	RMR_EL3
RVBAR_ELx	-	RVBAR_EL1	RVBAR_EL2	RVBAR_EL3
SCTLR_ELx	-	SCTLR_EL1	SCTLR_EL2	SCTLR_EL3
SP_ELx	SP_EL0	SP_EL1	SP_EL2	SP_EL3
SPSR_ELx	-	SPSR_EL1	SPSR_EL2	SPSR_EL3
TCR_ELx	-	TCR_EL1	TCR_EL2	TCR_EL3
VBAR_ELx	-	VBAR_EL1	VBAR_EL2	VBAR_EL3

J.2 Alphabetical index of AArch64 registers and system instructions

This section is an index of AArch64 registers and system instructions in alphabetical order.

Table J-5 Alphabetical index of AArch64 Registers

Register	Description, see
ACTLR_EL1	<i>ACTLR_EL1, Auxiliary Control Register (EL1) on page D8-1870</i>
ACTLR_EL2	<i>ACTLR_EL2, Auxiliary Control Register (EL2) on page D8-1871</i>
ACTLR_EL3	<i>ACTLR_EL3, Auxiliary Control Register (EL3) on page D8-1872</i>
AFSR0_EL1	<i>AFSR0_EL1, Auxiliary Fault Status Register 0 (EL1) on page D8-1873</i>
AFSR0_EL2	<i>AFSR0_EL2, Auxiliary Fault Status Register 0 (EL2) on page D8-1874</i>
AFSR0_EL3	<i>AFSR0_EL3, Auxiliary Fault Status Register 0 (EL3) on page D8-1875</i>
AFSR1_EL1	<i>AFSR1_EL1, Auxiliary Fault Status Register 1 (EL1) on page D8-1876</i>
AFSR1_EL2	<i>AFSR1_EL2, Auxiliary Fault Status Register 1 (EL2) on page D8-1877</i>
AFSR1_EL3	<i>AFSR1_EL3, Auxiliary Fault Status Register 1 (EL3) on page D8-1878</i>
AIDR_EL1	<i>AIDR_EL1, Auxiliary ID Register on page D8-1879</i>
AMAIR_EL1	<i>AMAIR_EL1, Auxiliary Memory Attribute Indirection Register (EL1) on page D8-1880</i>
AMAIR_EL2	<i>AMAIR_EL2, Auxiliary Memory Attribute Indirection Register (EL2) on page D8-1881</i>
AMAIR_EL3	<i>AMAIR_EL3, Auxiliary Memory Attribute Indirection Register (EL3) on page D8-1882</i>
AT S12E0R	<i>AT S12E0R, Address Translate Stages 1 and 2 EL0 Read on page C4-323</i>
AT S12E0W	<i>AT S12E0W, Address Translate Stages 1 and 2 EL0 Write on page C4-324</i>
AT S12E1R	<i>AT S12E1R, Address Translate Stages 1 and 2 EL1 Read on page C4-325</i>
AT S12E1W	<i>AT S12E1W, Address Translate Stages 1 and 2 EL1 Write on page C4-326</i>
AT S1E0R	<i>AT S1E0R, Address Translate Stage 1 EL0 Read on page C4-327</i>
AT S1E0W	<i>AT S1E0W, Address Translate Stage 1 EL0 Write on page C4-328</i>
AT S1E1R	<i>AT S1E1R, Address Translate Stage 1 EL1 Read on page C4-329</i>
AT S1E1W	<i>AT S1E1W, Address Translate Stage 1 EL1 Write on page C4-330</i>
AT S1E2R	<i>AT S1E2R, Address Translate Stage 1 EL2 Read on page C4-331</i>
AT S1E2W	<i>AT S1E2W, Address Translate Stage 1 EL2 Write on page C4-332</i>
AT S1E3R	<i>AT S1E3R, Address Translate Stage 1 EL3 Read on page C4-333</i>
AT S1E3W	<i>AT S1E3W, Address Translate Stage 1 EL3 Write on page C4-334</i>
CCSIDR_EL1	<i>CCSIDR_EL1, Current Cache Size ID Register on page D8-1883</i>
CLIDR_EL1	<i>CLIDR_EL1, Cache Level ID Register on page D8-1885</i>
CNTFRQ_EL0	<i>CNTFRQ_EL0, Counter-timer Frequency register on page D8-2170</i>
CNTHCTL_EL2	<i>CNTHCTL_EL2, Counter-timer Hypervisor Control register on page D8-2171</i>
CNTHP_CTL_EL2	<i>CNTHP_CTL_EL2, Counter-timer Hypervisor Physical Timer Control register on page D8-2173</i>

Table J-5 Alphabetical index of AArch64 Registers (continued)

Register	Description, see
CNTHP_CVAL_EL2	<i>CNTHP_CVAL_EL2</i> , Counter-timer Hypervisor Physical Timer CompareValue register on page D8-2175
CNTHP_TVAL_EL2	<i>CNTHP_TVAL_EL2</i> , Counter-timer Hypervisor Physical Timer TimerValue register on page D8-2176
CNTKCTL_EL1	<i>CNTKCTL_EL1</i> , Counter-timer Kernel Control register on page D8-2177
CNTP_CTL_EL0	<i>CNTP_CTL_EL0</i> , Counter-timer Physical Timer Control register on page D8-2179
CNTP_CVAL_EL0	<i>CNTP_CVAL_EL0</i> , Counter-timer Physical Timer CompareValue register on page D8-2181
CNTP_TVAL_EL0	<i>CNTP_TVAL_EL0</i> , Counter-timer Physical Timer TimerValue register on page D8-2182
CNTPCT_EL0	<i>CNTPCT_EL0</i> , Counter-timer Physical Count register on page D8-2183
CNTPS_CTL_EL1	<i>CNTPS_CTL_EL1</i> , Counter-timer Physical Secure Timer Control register on page D8-2184
CNTPS_CVAL_EL1	<i>CNTPS_CVAL_EL1</i> , Counter-timer Physical Secure Timer CompareValue register on page D8-2186
CNTPS_TVAL_EL1	<i>CNTPS_TVAL_EL1</i> , Counter-timer Physical Secure Timer TimerValue register on page D8-2187
CNTV_CTL_EL0	<i>CNTV_CTL_EL0</i> , Counter-timer Virtual Timer Control register on page D8-2188
CNTV_CVAL_EL0	<i>CNTV_CVAL_EL0</i> , Counter-timer Virtual Timer CompareValue register on page D8-2190
CNTV_TVAL_EL0	<i>CNTV_TVAL_EL0</i> , Counter-timer Virtual Timer TimerValue register on page D8-2191
CNTVCT_EL0	<i>CNTVCT_EL0</i> , Counter-timer Virtual Count register on page D8-2192
CNTVOFF_EL2	<i>CNTVOFF_EL2</i> , Counter-timer Virtual Offset register on page D8-2193
CONTEXTIDR_EL1	<i>CONTEXTIDR_EL1</i> , Context ID Register on page D8-1887
CPACR_EL1	<i>CPACR_EL1</i> , Architectural Feature Access Control Register on page D8-1888
CPTR_EL2	<i>CPTR_EL2</i> , Architectural Feature Trap Register (EL2) on page D8-1890
CPTR_EL3	<i>CPTR_EL3</i> , Architectural Feature Trap Register (EL3) on page D8-1892
CSSELR_EL1	<i>CSSELR_EL1</i> , Cache Size Selection Register on page D8-1894
CTR_EL0	<i>CTR_EL0</i> , Cache Type Register on page D8-1895
CurrentEL	<i>CurrentEL</i> , Current Exception Level on page C4-252
DACR32_EL2	<i>DACR32_EL2</i> , Domain Access Control Register on page D8-1897
DAIF	<i>DAIF</i> , Interrupt Mask Bits on page C4-254
DBGAUTHSTATUS_EL1	<i>DBGAUTHSTATUS_EL1</i> , Debug Authentication Status register on page D8-2077
DBGBCR<n>_EL1	<i>DBGBCR<n>_EL1</i> , Debug Breakpoint Control Registers, <i>n</i> = 0 - 15 on page D8-2079
DBGBVR<n>_EL1	<i>DBGBVR<n>_EL1</i> , Debug Breakpoint Value Registers, <i>n</i> = 0 - 15 on page D8-2082
DBGCLAIMCLR_EL1	<i>DBGCLAIMCLR_EL1</i> , Debug Claim Tag Clear register on page D8-2085
DBGCLAIMSET_EL1	<i>DBGCLAIMSET_EL1</i> , Debug Claim Tag Set register on page D8-2086
DBGDTR_EL0	<i>DBGDTR_EL0</i> , Debug Data Transfer Register, half-duplex on page D8-2087

Table J-5 Alphabetical index of AArch64 Registers (continued)

Register	Description, see
DBGDTRRX_EL0	<i>DBGDTRRX_EL0, Debug Data Transfer Register, Receive</i> on page D8-2089
DBGDTRTX_EL0	<i>DBGDTRTX_EL0, Debug Data Transfer Register, Transmit</i> on page D8-2091
DBGPRCR_EL1	<i>DBGPRCR_EL1, Debug Power Control Register</i> on page D8-2093
DBGVCR32_EL2	<i>DBGVCR32_EL2, Debug Vector Catch Register</i> on page D8-2094
DBGWCR<n>_EL1	<i>DBGWCR<n>_EL1, Debug Watchpoint Control Registers, n = 0 - 15</i> on page D8-2098
DBGWVR<n>_EL1	<i>DBGWVR<n>_EL1, Debug Watchpoint Value Registers, n = 0 - 15</i> on page D8-2101
DC CISW	<i>DC CISW, Data or unified Cache line Clean and Invalidate by Set/Way</i> on page C4-307
DC CIVAC	<i>DC CIVAC, Data or unified Cache line Clean and Invalidate by VA to PoC</i> on page C4-309
DC CSW	<i>DC CSW, Data or unified Cache line Clean by Set/Way</i> on page C4-310
DC CVAC	<i>DC CVAC, Data or unified Cache line Clean by VA to PoC</i> on page C4-312
DC CVAU	<i>DC CVAU, Data or unified Cache line Clean by VA to PoU</i> on page C4-313
DC ISW	<i>DC ISW, Data or unified Cache line Invalidate by Set/Way</i> on page C4-314
DC IVAC	<i>DC IVAC, Data or unified Cache line Invalidate by VA to PoC</i> on page C4-316
DC ZVA	<i>DC ZVA, Data Cache Zero by VA</i> on page C4-317
DCZID_EL0	<i>DCZID_EL0, Data Cache Zero ID register</i> on page D8-1898
DLR_EL0	<i>DLR_EL0, Debug Link Register</i> on page D8-2103
DSPSR_EL0	<i>DSPSR_EL0, Debug Saved Program Status Register</i> on page D8-2104
ELR_EL1	<i>ELR_EL1, Exception Link Register (EL1)</i> on page C4-258
ELR_EL2	<i>ELR_EL2, Exception Link Register (EL2)</i> on page C4-259
ELR_EL3	<i>ELR_EL3, Exception Link Register (EL3)</i> on page C4-260
ESR_EL1	<i>ESR_EL1, Exception Syndrome Register (EL1)</i> on page D8-1899
ESR_EL2	<i>ESR_EL2, Exception Syndrome Register (EL2)</i> on page D8-1904
ESR_EL3	<i>ESR_EL3, Exception Syndrome Register (EL3)</i> on page D8-1909
FAR_EL1	<i>FAR_EL1, Fault Address Register (EL1)</i> on page D8-1914
FAR_EL2	<i>FAR_EL2, Fault Address Register (EL2)</i> on page D8-1915
FAR_EL3	<i>FAR_EL3, Fault Address Register (EL3)</i> on page D8-1917
FPCR	<i>FPCR, Floating-point Control Register</i> on page C4-261
FPEXC32_EL2	<i>FPEXC32_EL2, Floating-point Exception Control register</i> on page D8-1918
FPSR	<i>FPSR, Floating-point Status Register</i> on page C4-264
HACR_EL2	<i>HACR_EL2, Hypervisor Auxiliary Control Register</i> on page D8-1922
HCR_EL2	<i>HCR_EL2, Hypervisor Configuration Register</i> on page D8-1923
HPFAR_EL2	<i>HPFAR_EL2, Hypervisor IPA Fault Address Register</i> on page D8-1930

Table J-5 Alphabetical index of AArch64 Registers (continued)

Register	Description, see
HSTR_EL2	<i>HSTR_EL2, Hypervisor System Trap Register on page D8-1931</i>
IC IALLU	<i>IC IALLU, Instruction Cache Invalidate All to PoU on page C4-319</i>
IC IALLUIS	<i>IC IALLUIS, Instruction Cache Invalidate All to PoU, Inner Shareable on page C4-320</i>
IC IVAU	<i>IC IVAU, Instruction Cache line Invalidate by VA to PoU on page C4-321</i>
ICC_AP0R0_EL1	<i>ICC_AP0R0_EL1, Interrupt Controller Active Priorities Register (0,0) on page D8-2194</i>
ICC_AP0R1_EL1	<i>ICC_AP0R1_EL1, Interrupt Controller Active Priorities Register (0,1) on page D8-2196</i>
ICC_AP0R2_EL1	<i>ICC_AP0R2_EL1, Interrupt Controller Active Priorities Register (0,2) on page D8-2198</i>
ICC_AP0R3_EL1	<i>ICC_AP0R3_EL1, Interrupt Controller Active Priorities Register (0,3) on page D8-2200</i>
ICC_AP1R0_EL1	<i>ICC_AP1R0_EL1, Interrupt Controller Active Priorities Register (1,0) on page D8-2202</i>
ICC_AP1R1_EL1	<i>ICC_AP1R1_EL1, Interrupt Controller Active Priorities Register (1,1) on page D8-2204</i>
ICC_AP1R2_EL1	<i>ICC_AP1R2_EL1, Interrupt Controller Active Priorities Register (1,2) on page D8-2206</i>
ICC_AP1R3_EL1	<i>ICC_AP1R3_EL1, Interrupt Controller Active Priorities Register (1,3) on page D8-2208</i>
ICC_ASGI1R_EL1	<i>ICC_ASGI1R_EL1, Interrupt Controller Alias Software Generated Interrupt group 1 Register on page D8-2210</i>
ICC_BPR0_EL1	<i>ICC_BPR0_EL1, Interrupt Controller Binary Point Register 0 on page D8-2212</i>
ICC_BPR1_EL1	<i>ICC_BPR1_EL1, Interrupt Controller Binary Point Register 1 on page D8-2214</i>
ICC_CTLR_EL1	<i>ICC_CTLR_EL1, Interrupt Controller Control Register (EL1) on page D8-2216</i>
ICC_CTLR_EL3	<i>ICC_CTLR_EL3, Interrupt Controller Control Register (EL3) on page D8-2219</i>
ICC_DIR_EL1	<i>ICC_DIR_EL1, Interrupt Controller Deactivate Interrupt Register on page D8-2222</i>
ICC_EOIR0_EL1	<i>ICC_EOIR0_EL1, Interrupt Controller End Of Interrupt Register 0 on page D8-2223</i>
ICC_EOIR1_EL1	<i>ICC_EOIR1_EL1, Interrupt Controller End Of Interrupt Register 1 on page D8-2225</i>
ICC_HPPIR0_EL1	<i>ICC_HPPIR0_EL1, Interrupt Controller Highest Priority Pending Interrupt Register 0 on page D8-2226</i>
ICC_HPPIR1_EL1	<i>ICC_HPPIR1_EL1, Interrupt Controller Highest Priority Pending Interrupt Register 1 on page D8-2228</i>
ICC_IAR0_EL1	<i>ICC_IAR0_EL1, Interrupt Controller Interrupt Acknowledge Register 0 on page D8-2229</i>
ICC_IAR1_EL1	<i>ICC_IAR1_EL1, Interrupt Controller Interrupt Acknowledge Register 1 on page D8-2231</i>
ICC_IGRPEN0_EL1	<i>ICC_IGRPEN0_EL1, Interrupt Controller Interrupt Group 0 Enable register on page D8-2232</i>
ICC_IGRPEN1_EL1	<i>ICC_IGRPEN1_EL1, Interrupt Controller Interrupt Group 1 Enable register on page D8-2234</i>
ICC_IGRPEN1_EL3	<i>ICC_IGRPEN1_EL3, Interrupt Controller Interrupt Group 1 Enable register (EL3) on page D8-2236</i>
ICC_PMR_EL1	<i>ICC_PMR_EL1, Interrupt Controller Interrupt Priority Mask Register on page D8-2238</i>
ICC_RPR_EL1	<i>ICC_RPR_EL1, Interrupt Controller Running Priority Register on page D8-2240</i>
ICC_SEIEN_EL1	<i>ICC_SEIEN_EL1, Interrupt Controller System Error Interrupt Enable register on page D8-2241</i>

Table J-5 Alphabetical index of AArch64 Registers (continued)

Register	Description, see
ICC_SGI0R_EL1	<i>ICC_SGI0R_EL1, Interrupt Controller Software Generated Interrupt group 0 Register on page D8-2242</i>
ICC_SGI1R_EL1	<i>ICC_SGI1R_EL1, Interrupt Controller Software Generated Interrupt group 1 Register on page D8-2244</i>
ICC_SRE_EL1	<i>ICC_SRE_EL1, Interrupt Controller System Register Enable register (EL1) on page D8-2246</i>
ICC_SRE_EL2	<i>ICC_SRE_EL2, Interrupt Controller System Register Enable register (EL2) on page D8-2248</i>
ICC_SRE_EL3	<i>ICC_SRE_EL3, Interrupt Controller System Register Enable register (EL3) on page D8-2250</i>
ICH_AP0R0_EL2	<i>ICH_AP0R0_EL2, Interrupt Controller Hyp Active Priorities Register (0,0) on page D8-2252</i>
ICH_AP0R1_EL2	<i>ICH_AP0R1_EL2, Interrupt Controller Hyp Active Priorities Register (0,1) on page D8-2254</i>
ICH_AP0R2_EL2	<i>ICH_AP0R2_EL2, Interrupt Controller Hyp Active Priorities Register (0,2) on page D8-2256</i>
ICH_AP0R3_EL2	<i>ICH_AP0R3_EL2, Interrupt Controller Hyp Active Priorities Register (0,3) on page D8-2258</i>
ICH_AP1R0_EL2	<i>ICH_AP1R0_EL2, Interrupt Controller Hyp Active Priorities Register (1,0) on page D8-2260</i>
ICH_AP1R1_EL2	<i>ICH_AP1R1_EL2, Interrupt Controller Hyp Active Priorities Register (1,1) on page D8-2262</i>
ICH_AP1R2_EL2	<i>ICH_AP1R2_EL2, Interrupt Controller Hyp Active Priorities Register (1,2) on page D8-2264</i>
ICH_AP1R3_EL2	<i>ICH_AP1R3_EL2, Interrupt Controller Hyp Active Priorities Register (1,3) on page D8-2266</i>
ICH_EISR_EL2	<i>ICH_EISR_EL2, Interrupt Controller End of Interrupt Status Register on page D8-2268</i>
ICH_ELSR_EL2	<i>ICH_ELSR_EL2, Interrupt Controller Empty List Register Status Register on page D8-2270</i>
ICH_HCR_EL2	<i>ICH_HCR_EL2, Interrupt Controller Hyp Control Register on page D8-2272</i>
ICH_LR<n>_EL2	<i>ICH_LR<n>_EL2, Interrupt Controller List Registers, n = 0 - 15 on page D8-2275</i>
ICH_MISR_EL2	<i>ICH_MISR_EL2, Interrupt Controller Maintenance Interrupt State Register on page D8-2277</i>
ICH_VMCR_EL2	<i>ICH_VMCR_EL2, Interrupt Controller Virtual Machine Control Register on page D8-2279</i>
ICH_VSEIR_EL2	<i>ICH_VSEIR_EL2, Interrupt Controller Virtual System Error Interrupt Register on page D8-2281</i>
ICH_VTR_EL2	<i>ICH_VTR_EL2, Interrupt Controller VGIC Type Register on page D8-2282</i>
ID_AA64AFR0_EL1	<i>ID_AA64AFR0_EL1, AArch64 Auxiliary Feature Register 0 on page D8-1933</i>
ID_AA64AFR1_EL1	<i>ID_AA64AFR1_EL1, AArch64 Auxiliary Feature Register 1 on page D8-1934</i>
ID_AA64DFR0_EL1	<i>ID_AA64DFR0_EL1, AArch64 Debug Feature Register 0 on page D8-1935</i>
ID_AA64DFR1_EL1	<i>ID_AA64DFR1_EL1, AArch64 Debug Feature Register 1 on page D8-1937</i>
ID_AA64ISAR0_EL1	<i>ID_AA64ISAR0_EL1, AArch64 Instruction Set Attribute Register 0 on page D8-1938</i>
ID_AA64ISAR1_EL1	<i>ID_AA64ISAR1_EL1, AArch64 Instruction Set Attribute Register 1 on page D8-1940</i>
ID_AA64MMFR0_EL1	<i>ID_AA64MMFR0_EL1, AArch64 Memory Model Feature Register 0 on page D8-1941</i>
ID_AA64MMFR1_EL1	<i>ID_AA64MMFR1_EL1, AArch64 Memory Model Feature Register 1 on page D8-1943</i>
ID_AA64PFR0_EL1	<i>ID_AA64PFR0_EL1, AArch64 Processor Feature Register 0 on page D8-1944</i>
ID_AA64PFR1_EL1	<i>ID_AA64PFR1_EL1, AArch64 Processor Feature Register 1 on page D8-1946</i>

Table J-5 Alphabetical index of AArch64 Registers (continued)

Register	Description, see
ID_AFR0_EL1	<i>ID_AFR0_EL1</i> , AArch32 Auxiliary Feature Register 0 on page D8-1947
ID_DFR0_EL1	<i>ID_DFR0_EL1</i> , AArch32 Debug Feature Register 0 on page D8-1948
ID_ISAR0_EL1	<i>ID_ISAR0_EL1</i> , AArch32 Instruction Set Attribute Register 0 on page D8-1950
ID_ISAR1_EL1	<i>ID_ISAR1_EL1</i> , AArch32 Instruction Set Attribute Register 1 on page D8-1952
ID_ISAR2_EL1	<i>ID_ISAR2_EL1</i> , AArch32 Instruction Set Attribute Register 2 on page D8-1955
ID_ISAR3_EL1	<i>ID_ISAR3_EL1</i> , AArch32 Instruction Set Attribute Register 3 on page D8-1958
ID_ISAR4_EL1	<i>ID_ISAR4_EL1</i> , AArch32 Instruction Set Attribute Register 4 on page D8-1961
ID_ISAR5_EL1	<i>ID_ISAR5_EL1</i> , AArch32 Instruction Set Attribute Register 5 on page D8-1964
ID_MMFR0_EL1	<i>ID_MMFR0_EL1</i> , AArch32 Memory Model Feature Register 0 on page D8-1966
ID_MMFR1_EL1	<i>ID_MMFR1_EL1</i> , AArch32 Memory Model Feature Register 1 on page D8-1969
ID_MMFR2_EL1	<i>ID_MMFR2_EL1</i> , AArch32 Memory Model Feature Register 2 on page D8-1973
ID_MMFR3_EL1	<i>ID_MMFR3_EL1</i> , AArch32 Memory Model Feature Register 3 on page D8-1976
ID_PFR0_EL1	<i>ID_PFR0_EL1</i> , AArch32 Processor Feature Register 0 on page D8-1979
ID_PFR1_EL1	<i>ID_PFR1_EL1</i> , AArch32 Processor Feature Register 1 on page D8-1981
IFSR32_EL2	<i>IFSR32_EL2</i> , Instruction Fault Status Register (EL2) on page D8-1984
ISR_EL1	<i>ISR_EL1</i> , Interrupt Status Register on page D8-1988
MAIR_EL1	<i>MAIR_EL1</i> , Memory Attribute Indirection Register (EL1) on page D8-1990
MAIR_EL2	<i>MAIR_EL2</i> , Memory Attribute Indirection Register (EL2) on page D8-1992
MAIR_EL3	<i>MAIR_EL3</i> , Memory Attribute Indirection Register (EL3) on page D8-1994
MDCCINT_EL1	<i>MDCCINT_EL1</i> , Monitor DCC Interrupt Enable Register on page D8-2110
MDCCSR_EL0	<i>MDCCSR_EL0</i> , Monitor DCC Status Register on page D8-2112
MDCR_EL2	<i>MDCR_EL2</i> , Monitor Debug Configuration Register (EL2) on page D8-2114
MDCR_EL3	<i>MDCR_EL3</i> , Monitor Debug Configuration Register (EL3) on page D8-2117
MDRAR_EL1	<i>MDRAR_EL1</i> , Monitor Debug ROM Address Register on page D8-2120
MDSCR_EL1	<i>MDSCR_EL1</i> , Monitor Debug System Control Register on page D8-2122
MIDR_EL1	<i>MIDR_EL1</i> , Main ID Register on page D8-1996
MPIDR_EL1	<i>MPIDR_EL1</i> , Multiprocessor Affinity Register on page D8-1998
MVFR0_EL1	<i>MVFR0_EL1</i> , Media and VFP Feature Register 0 on page D8-2000
MVFR1_EL1	<i>MVFR1_EL1</i> , Media and VFP Feature Register 1 on page D8-2003
MVFR2_EL1	<i>MVFR2_EL1</i> , Media and VFP Feature Register 2 on page D8-2006
NZCV	<i>NZCV</i> , Condition Flags on page C4-267
OSDLR_EL1	<i>OSDLR_EL1</i> , OS Double Lock Register on page D8-2125

Table J-5 Alphabetical index of AArch64 Registers (continued)

Register	Description, see
OSDTRRX_EL1	<i>OSDTRRX_EL1, OS Lock Data Transfer Register, Receive</i> on page D8-2126
OSDTRTX_EL1	<i>OSDTRTX_EL1, OS Lock Data Transfer Register, Transmit</i> on page D8-2127
OSECCR_EL1	<i>OSECCR_EL1, OS Lock Exception Catch Control Register</i> on page D8-2128
OSLAR_EL1	<i>OSLAR_EL1, OS Lock Access Register</i> on page D8-2129
OSLSR_EL1	<i>OSLSR_EL1, OS Lock Status Register</i> on page D8-2130
PAR_EL1	<i>PAR_EL1, Physical Address Register</i> on page D8-2008
PMCCFILTR_EL0	<i>PMCCFILTR_EL0, Performance Monitors Cycle Count Filter Register</i> on page D8-2134
PMCCNTR_EL0	<i>PMCCNTR_EL0, Performance Monitors Cycle Count Register</i> on page D8-2136
PMCEID0_EL0	<i>PMCEID0_EL0, Performance Monitors Common Event Identification register 0</i> on page D8-2138
PMCEID1_EL0	<i>PMCEID1_EL0, Performance Monitors Common Event Identification register 1</i> on page D8-2140
PMCNTENCLR_EL0	<i>PMCNTENCLR_EL0, Performance Monitors Count Enable Clear register</i> on page D8-2142
PMCNTENSET_EL0	<i>PMCNTENSET_EL0, Performance Monitors Count Enable Set register</i> on page D8-2144
PMCR_EL0	<i>PMCR_EL0, Performance Monitors Control Register</i> on page D8-2146
PMEVCNTR<n>_EL0	<i>PMEVCNTR<n>_EL0, Performance Monitors Event Count Registers, n = 0 - 30</i> on page D8-2149
PMEVTYPER<n>_EL0	<i>PMEVTYPER<n>_EL0, Performance Monitors Event Type Registers, n = 0 - 30</i> on page D8-2151
PMINTENCLR_EL1	<i>PMINTENCLR_EL1, Performance Monitors Interrupt Enable Clear register</i> on page D8-2154
PMINTENSET_EL1	<i>PMINTENSET_EL1, Performance Monitors Interrupt Enable Set register</i> on page D8-2156
PMOVSLR_EL0	<i>PMOVSLR_EL0, Performance Monitors Overflow Flag Status Clear Register</i> on page D8-2158
PMOVSSET_EL0	<i>PMOVSSET_EL0, Performance Monitors Overflow Flag Status Set register</i> on page D8-2160
PMSELR_EL0	<i>PMSELR_EL0, Performance Monitors Event Counter Selection Register</i> on page D8-2162
PMSWINC_EL0	<i>PMSWINC_EL0, Performance Monitors Software Increment register</i> on page D8-2164
PMUSERENR_EL0	<i>PMUSERENR_EL0, Performance Monitors User Enable Register</i> on page D8-2166
PMXVCNTR_EL0	<i>PMXVCNTR_EL0, Performance Monitors Selected Event Count Register</i> on page D8-2168
PMXEVTYPER_EL0	<i>PMXEVTYPER_EL0, Performance Monitors Selected Event Type Register</i> on page D8-2169
REVIDR_EL1	<i>REVIDR_EL1, Revision ID Register</i> on page D8-2011
RMR_EL1	<i>RMR_EL1, Reset Management Register (if EL2 and EL3 not implemented)</i> on page D8-2012
RMR_EL2	<i>RMR_EL2, Reset Management Register (if EL3 not implemented)</i> on page D8-2014
RMR_EL3	<i>RMR_EL3, Reset Management Register (if EL3 implemented)</i> on page D8-2016
RVBAR_EL1	<i>RVBAR_EL1, Reset Vector Base Address Register (if EL2 and EL3 not implemented)</i> on page D8-2018

Table J-5 Alphabetical index of AArch64 Registers (continued)

Register	Description, see
RVBAR_EL2	<i>RVBAR_EL2, Reset Vector Base Address Register (if EL3 not implemented) on page D8-2019</i>
RVBAR_EL3	<i>RVBAR_EL3, Reset Vector Base Address Register (if EL3 implemented) on page D8-2020</i>
S3_<op1>_<Cn>_<Cm>_<op2>	<i>S3_<op1>_<Cn>_<Cm>_<op2>, IMPLEMENTATION DEFINED registers on page D8-2021</i>
SCR_EL3	<i>SCR_EL3, Secure Configuration Register on page D8-2022</i>
SCTLR_EL1	<i>SCTLR_EL1, System Control Register (EL1) on page D8-2025</i>
SCTLR_EL2	<i>SCTLR_EL2, System Control Register (EL2) on page D8-2031</i>
SCTLR_EL3	<i>SCTLR_EL3, System Control Register (EL3) on page D8-2035</i>
SDER32_EL3	<i>SDER32_EL3, AArch32 Secure Debug Enable Register on page D8-2132</i>
SP_EL0	<i>SP_EL0, Stack Pointer (EL0) on page C4-269</i>
SP_EL1	<i>SP_EL1, Stack Pointer (EL1) on page C4-270</i>
SP_EL2	<i>SP_EL2, Stack Pointer (EL2) on page C4-271</i>
SP_EL3	<i>SP_EL3, Stack Pointer (EL3) on page C4-272</i>
SPSel	<i>SPSel, Stack Pointer Select on page C4-273</i>
SPSR_abt	<i>SPSR_abt, Saved Program Status Register (Abort mode) on page C4-274</i>
SPSR_EL1	<i>SPSR_EL1, Saved Program Status Register (EL1) on page C4-278</i>
SPSR_EL2	<i>SPSR_EL2, Saved Program Status Register (EL2) on page C4-283</i>
SPSR_EL3	<i>SPSR_EL3, Saved Program Status Register (EL3) on page C4-288</i>
SPSR_fiq	<i>SPSR_fiq, Saved Program Status Register (FIQ mode) on page C4-294</i>
SPSR_irq	<i>SPSR_irq, Saved Program Status Register (IRQ mode) on page C4-298</i>
SPSR_und	<i>SPSR_und, Saved Program Status Register (Undefined mode) on page C4-302</i>
TCR_EL1	<i>TCR_EL1, Translation Control Register (EL1) on page D8-2038</i>
TCR_EL2	<i>TCR_EL2, Translation Control Register (EL2) on page D8-2043</i>
TCR_EL3	<i>TCR_EL3, Translation Control Register (EL3) on page D8-2046</i>
TEECR32_EL1	<i>TEECR32_EL1, T32EE Configuration Register on page D8-2049</i>
TEEHBR32_EL1	<i>TEEHBR32_EL1, T32EE Handler Base Register on page D8-2051</i>
TLBI ALLE1	<i>TLBI ALLE1, TLB Invalidate All entries, EL1 on page C4-336</i>
TLBI ALLE1IS	<i>TLBI ALLE1IS, TLB Invalidate All entries, EL1, Inner Shareable on page C4-337</i>
TLBI ALLE2	<i>TLBI ALLE2, TLB Invalidate All entries, EL2 on page C4-338</i>
TLBI ALLE2IS	<i>TLBI ALLE2IS, TLB Invalidate All entries, EL2, Inner Shareable on page C4-339</i>
TLBI ALLE3	<i>TLBI ALLE3, TLB Invalidate All entries, EL3 on page C4-340</i>
TLBI ALLE3IS	<i>TLBI ALLE3IS, TLB Invalidate All entries, EL3, Inner Shareable on page C4-341</i>
TLBI ASIDE1	<i>TLBI ASIDE1, TLB Invalidate by ASID, EL1 on page C4-342</i>

Table J-5 Alphabetical index of AArch64 Registers (continued)

Register	Description, see
TLBI ASIDE1IS	<i>TLBI ASIDE1IS, TLB Invalidate by ASID, EL1, Inner Shareable on page C4-343</i>
TLBI IPAS2E1	<i>TLBI IPAS2E1, TLB Invalidate by Intermediate Physical Address, Stage 2, EL1 on page C4-344</i>
TLBI IPAS2E1IS	<i>TLBI IPAS2E1IS, TLB Invalidate by Intermediate Physical Address, Stage 2, EL1, Inner Shareable on page C4-345</i>
TLBI IPAS2LE1	<i>TLBI IPAS2LE1, TLB Invalidate by Intermediate Physical Address, Stage 2, Last level, EL1 on page C4-346</i>
TLBI IPAS2LE1IS	<i>TLBI IPAS2LE1IS, TLB Invalidate by Intermediate Physical Address, Stage 2, Last level, EL1, Inner Shareable on page C4-347</i>
TLBI VAAE1	<i>TLBI VAAE1, TLB Invalidate by VA, All ASID, EL1 on page C4-348</i>
TLBI VAAE1IS	<i>TLBI VAAE1IS, TLB Invalidate by VA, All ASID, EL1, Inner Shareable on page C4-350</i>
TLBI VAALE1	<i>TLBI VAALE1, TLB Invalidate by VA, All ASID, Last level, EL1 on page C4-352</i>
TLBI VAALE1IS	<i>TLBI VAALE1IS, TLB Invalidate by VA, All ASID, EL1, Inner Shareable on page C4-354</i>
TLBI VAE1	<i>TLBI VAE1, TLB Invalidate by VA, EL1 on page C4-356</i>
TLBI VAE1IS	<i>TLBI VAE1IS, TLB Invalidate by VA, EL1, Inner Shareable on page C4-358</i>
TLBI VAE2	<i>TLBI VAE2, TLB Invalidate by VA, EL2 on page C4-360</i>
TLBI VAE2IS	<i>TLBI VAE2IS, TLB Invalidate by VA, EL2, Inner Shareable on page C4-362</i>
TLBI VAE3	<i>TLBI VAE3, TLB Invalidate by VA, EL3 on page C4-364</i>
TLBI VAE3IS	<i>TLBI VAE3IS, TLB Invalidate by VA, EL3, Inner Shareable on page C4-366</i>
TLBI VALE1	<i>TLBI VALE1, TLB Invalidate by VA, Last level, EL1 on page C4-368</i>
TLBI VALE1IS	<i>TLBI VALE1IS, TLB Invalidate by VA, Last level, EL1, Inner Shareable on page C4-370</i>
TLBI VALE2	<i>TLBI VALE2, TLB Invalidate by VA, Last level, EL2 on page C4-372</i>
TLBI VALE2IS	<i>TLBI VALE2IS, TLB Invalidate by VA, Last level, EL2, Inner Shareable on page C4-374</i>
TLBI VALE3	<i>TLBI VALE3, TLB Invalidate by VA, Last level, EL3 on page C4-376</i>
TLBI VALE3IS	<i>TLBI VALE3IS, TLB Invalidate by VA, Last level, EL3, Inner Shareable on page C4-378</i>
TLBI VMALLE1	<i>TLBI VMALLE1, TLB Invalidate by VMID, All entries at stage 1, EL1 on page C4-380</i>
TLBI VMALLE1IS	<i>TLBI VMALLE1IS, TLB Invalidate by VMID, All entries at stage 1, EL1, Inner Shareable on page C4-381</i>
TLBI VMALLS12E1	<i>TLBI VMALLS12E1, TLB Invalidate by VMID, All entries at Stage 1 and 2, EL1 on page C4-382</i>
TLBI VMALLS12E1IS	<i>TLBI VMALLS12E1IS, TLB Invalidate by VMID, All entries at Stage 1 and 2, EL1, Inner Shareable on page C4-383</i>
TPIDR_EL0	<i>TPIDR_EL0, Thread Pointer / ID Register (EL0) on page D8-2052</i>
TPIDR_EL1	<i>TPIDR_EL1, Thread Pointer / ID Register (EL1) on page D8-2053</i>
TPIDR_EL2	<i>TPIDR_EL2, Thread Pointer / ID Register (EL2) on page D8-2054</i>
TPIDR_EL3	<i>TPIDR_EL3, Thread Pointer / ID Register (EL3) on page D8-2055</i>

Table J-5 Alphabetical index of AArch64 Registers (continued)

Register	Description, see
TPIDRRO_EL0	<i>TPIDRRO_EL0, Thread Pointer / ID Register, Read-Only (EL0) on page D8-2056</i>
TTBR0_EL1	<i>TTBR0_EL1, Translation Table Base Register 0 (EL1) on page D8-2057</i>
TTBR0_EL2	<i>TTBR0_EL2, Translation Table Base Register 0 (EL2) on page D8-2059</i>
TTBR0_EL3	<i>TTBR0_EL3, Translation Table Base Register 0 (EL3) on page D8-2061</i>
TTBR1_EL1	<i>TTBR1_EL1, Translation Table Base Register 1 on page D8-2063</i>
VBAR_EL1	<i>VBAR_EL1, Vector Base Address Register (EL1) on page D8-2065</i>
VBAR_EL2	<i>VBAR_EL2, Vector Base Address Register (EL2) on page D8-2066</i>
VBAR_EL3	<i>VBAR_EL3, Vector Base Address Register (EL3) on page D8-2067</i>
VMPIDR_EL2	<i>VMPIDR_EL2, Virtualization Multiprocessor ID Register on page D8-2068</i>
VPIDR_EL2	<i>VPIDR_EL2, Virtualization Processor ID Register on page D8-2070</i>
VTCR_EL2	<i>VTCR_EL2, Virtualization Translation Control Register on page D8-2072</i>
VTTBR_EL2	<i>VTTBR_EL2, Virtualization Translation Table Base Register on page D8-2075</i>

J.3 Functional index of AArch64 registers and system instructions

This section is an index of the AArch64 registers and system instructions, divided by functional group.

J.3.1 Special-purpose registers

This section is an index to the registers in the Special purpose and Processor state functional groups.

Table J-6 Special-purpose registers

Register	Description, see
DLR_EL0	<i>DLR_EL0, Debug Link Register</i> on page D8-2103
DSPSR_EL0	<i>DSPSR_EL0, Debug Saved Program Status Register</i> on page D8-2104
ELR_EL1	<i>ELR_EL1, Exception Link Register (EL1)</i> on page C4-258
ELR_EL2	<i>ELR_EL2, Exception Link Register (EL2)</i> on page C4-259
ELR_EL3	<i>ELR_EL3, Exception Link Register (EL3)</i> on page C4-260
FPCR	<i>FPCR, Floating-point Control Register</i> on page C4-261
FPSR	<i>FPSR, Floating-point Status Register</i> on page C4-264
SP_EL0	<i>SP_EL0, Stack Pointer (EL0)</i> on page C4-269
SP_EL1	<i>SP_EL1, Stack Pointer (EL1)</i> on page C4-270
SP_EL2	<i>SP_EL2, Stack Pointer (EL2)</i> on page C4-271
SP_EL3	<i>SP_EL3, Stack Pointer (EL3)</i> on page C4-272
SPSR_abt	<i>SPSR_abt, Saved Program Status Register (Abort mode)</i> on page C4-274
SPSR_EL1	<i>SPSR_EL1, Saved Program Status Register (EL1)</i> on page C4-278
SPSR_EL2	<i>SPSR_EL2, Saved Program Status Register (EL2)</i> on page C4-283
SPSR_EL3	<i>SPSR_EL3, Saved Program Status Register (EL3)</i> on page C4-288
SPSR_fiq	<i>SPSR_fiq, Saved Program Status Register (FIQ mode)</i> on page C4-294
SPSR_irq	<i>SPSR_irq, Saved Program Status Register (IRQ mode)</i> on page C4-298
SPSR_und	<i>SPSR_und, Saved Program Status Register (Undefined mode)</i> on page C4-302

J.3.2 VMSA-specific registers

This section is an index to the registers in the Virtual memory control functional group.

Table J-7 VMSA-specific registers

Register	Description, see
AMAIR_EL1	<i>AMAIR_EL1, Auxiliary Memory Attribute Indirection Register (EL1)</i> on page D8-1880
AMAIR_EL2	<i>AMAIR_EL2, Auxiliary Memory Attribute Indirection Register (EL2)</i> on page D8-1881
AMAIR_EL3	<i>AMAIR_EL3, Auxiliary Memory Attribute Indirection Register (EL3)</i> on page D8-1882
CONTEXTIDR_EL1	<i>CONTEXTIDR_EL1, Context ID Register</i> on page D8-1887
DACR32_EL2	<i>DACR32_EL2, Domain Access Control Register</i> on page D8-1897

Table J-7 VMSA-specific registers (continued)

Register	Description, see
MAIR_EL1	<i>MAIR_EL1, Memory Attribute Indirection Register (EL1)</i> on page D8-1990
MAIR_EL2	<i>MAIR_EL2, Memory Attribute Indirection Register (EL2)</i> on page D8-1992
MAIR_EL3	<i>MAIR_EL3, Memory Attribute Indirection Register (EL3)</i> on page D8-1994
TCR_EL1	<i>TCR_EL1, Translation Control Register (EL1)</i> on page D8-2038
TCR_EL2	<i>TCR_EL2, Translation Control Register (EL2)</i> on page D8-2043
TCR_EL3	<i>TCR_EL3, Translation Control Register (EL3)</i> on page D8-2046
TTBR0_EL1	<i>TTBR0_EL1, Translation Table Base Register 0 (EL1)</i> on page D8-2057
TTBR0_EL2	<i>TTBR0_EL2, Translation Table Base Register 0 (EL2)</i> on page D8-2059
TTBR0_EL3	<i>TTBR0_EL3, Translation Table Base Register 0 (EL3)</i> on page D8-2061
TTBR1_EL1	<i>TTBR1_EL1, Translation Table Base Register 1</i> on page D8-2063
VTCR_EL2	<i>VTCR_EL2, Virtualization Translation Control Register</i> on page D8-2072
VTTBR_EL2	<i>VTTBR_EL2, Virtualization Translation Table Base Register</i> on page D8-2075

J.3.3 ID registers

This section is an index to the registers in the Identification functional group.

Table J-8 ID registers

Register	Description, see
AIDR_EL1	<i>AIDR_EL1, Auxiliary ID Register</i> on page D8-1879
CCSIDR_EL1	<i>CCSIDR_EL1, Current Cache Size ID Register</i> on page D8-1883
CLIDR_EL1	<i>CLIDR_EL1, Cache Level ID Register</i> on page D8-1885
CSSELR_EL1	<i>CSSELR_EL1, Cache Size Selection Register</i> on page D8-1894
CTR_EL0	<i>CTR_EL0, Cache Type Register</i> on page D8-1895
DCZID_EL0	<i>DCZID_EL0, Data Cache Zero ID register</i> on page D8-1898
ID_AA64AFR0_EL1	<i>ID_AA64AFR0_EL1, AArch64 Auxiliary Feature Register 0</i> on page D8-1933
ID_AA64AFR1_EL1	<i>ID_AA64AFR1_EL1, AArch64 Auxiliary Feature Register 1</i> on page D8-1934
ID_AA64DFR0_EL1	<i>ID_AA64DFR0_EL1, AArch64 Debug Feature Register 0</i> on page D8-1935
ID_AA64DFR1_EL1	<i>ID_AA64DFR1_EL1, AArch64 Debug Feature Register 1</i> on page D8-1937
ID_AA64ISAR0_EL1	<i>ID_AA64ISAR0_EL1, AArch64 Instruction Set Attribute Register 0</i> on page D8-1938
ID_AA64ISAR1_EL1	<i>ID_AA64ISAR1_EL1, AArch64 Instruction Set Attribute Register 1</i> on page D8-1940
ID_AA64MMFR0_EL1	<i>ID_AA64MMFR0_EL1, AArch64 Memory Model Feature Register 0</i> on page D8-1941
ID_AA64MMFR1_EL1	<i>ID_AA64MMFR1_EL1, AArch64 Memory Model Feature Register 1</i> on page D8-1943
ID_AA64PFR0_EL1	<i>ID_AA64PFR0_EL1, AArch64 Processor Feature Register 0</i> on page D8-1944

Table J-8 ID registers (continued)

Register	Description, see
ID_AA64PFR1_EL1	<i>ID_AA64PFR1_EL1</i> , AArch64 Processor Feature Register 1 on page D8-1946
ID_AFR0_EL1	<i>ID_AFR0_EL1</i> , AArch32 Auxiliary Feature Register 0 on page D8-1947
ID_DFR0_EL1	<i>ID_DFR0_EL1</i> , AArch32 Debug Feature Register 0 on page D8-1948
ID_ISAR0_EL1	<i>ID_ISAR0_EL1</i> , AArch32 Instruction Set Attribute Register 0 on page D8-1950
ID_ISAR1_EL1	<i>ID_ISAR1_EL1</i> , AArch32 Instruction Set Attribute Register 1 on page D8-1952
ID_ISAR2_EL1	<i>ID_ISAR2_EL1</i> , AArch32 Instruction Set Attribute Register 2 on page D8-1955
ID_ISAR3_EL1	<i>ID_ISAR3_EL1</i> , AArch32 Instruction Set Attribute Register 3 on page D8-1958
ID_ISAR4_EL1	<i>ID_ISAR4_EL1</i> , AArch32 Instruction Set Attribute Register 4 on page D8-1961
ID_ISAR5_EL1	<i>ID_ISAR5_EL1</i> , AArch32 Instruction Set Attribute Register 5 on page D8-1964
ID_MMFR0_EL1	<i>ID_MMFR0_EL1</i> , AArch32 Memory Model Feature Register 0 on page D8-1966
ID_MMFR1_EL1	<i>ID_MMFR1_EL1</i> , AArch32 Memory Model Feature Register 1 on page D8-1969
ID_MMFR2_EL1	<i>ID_MMFR2_EL1</i> , AArch32 Memory Model Feature Register 2 on page D8-1973
ID_MMFR3_EL1	<i>ID_MMFR3_EL1</i> , AArch32 Memory Model Feature Register 3 on page D8-1976
ID_PFR0_EL1	<i>ID_PFR0_EL1</i> , AArch32 Processor Feature Register 0 on page D8-1979
ID_PFR1_EL1	<i>ID_PFR1_EL1</i> , AArch32 Processor Feature Register 1 on page D8-1981
MIDR_EL1	<i>MIDR_EL1</i> , Main ID Register on page D8-1996
MPIDR_EL1	<i>MPIDR_EL1</i> , Multiprocessor Affinity Register on page D8-1998
MVFR0_EL1	<i>MVFR0_EL1</i> , Media and VFP Feature Register 0 on page D8-2000
MVFR1_EL1	<i>MVFR1_EL1</i> , Media and VFP Feature Register 1 on page D8-2003
MVFR2_EL1	<i>MVFR2_EL1</i> , Media and VFP Feature Register 2 on page D8-2006
REVIDR_EL1	<i>REVIDR_EL1</i> , Revision ID Register on page D8-2011
VMPIDR_EL2	<i>VMPIDR_EL2</i> , Virtualization Multiprocessor ID Register on page D8-2068
VPIDR_EL2	<i>VPIDR_EL2</i> , Virtualization Processor ID Register on page D8-2070

J.3.4 Performance monitors registers

This section is an index to the registers in the Performance Monitors functional group.

Table J-9 Performance monitors registers

Register	Description, see
PMCCFILTR_EL0	<i>PMCCFILTR_EL0</i> , Performance Monitors Cycle Count Filter Register on page D8-2134
PMCCNTR_EL0	<i>PMCCNTR_EL0</i> , Performance Monitors Cycle Count Register on page D8-2136
PMCEID0_EL0	<i>PMCEID0_EL0</i> , Performance Monitors Common Event Identification register 0 on page D8-2138
PMCEID1_EL0	<i>PMCEID1_EL0</i> , Performance Monitors Common Event Identification register 1 on page D8-2140

Table J-9 Performance monitors registers (continued)

Register	Description, see
PMCNTENCLR_ELO	<i>PMCNTENCLR_ELO, Performance Monitors Count Enable Clear register on page D8-2142</i>
PMCNTENSET_ELO	<i>PMCNTENSET_ELO, Performance Monitors Count Enable Set register on page D8-2144</i>
PMCR_ELO	<i>PMCR_ELO, Performance Monitors Control Register on page D8-2146</i>
PMEVCNTR<n>_ELO	<i>PMEVCNTR<n>_ELO, Performance Monitors Event Count Registers, n = 0 - 30 on page D8-2149</i>
PMEVTYPER<n>_ELO	<i>PMEVTYPER<n>_ELO, Performance Monitors Event Type Registers, n = 0 - 30 on page D8-2151</i>
PMINTENCLR_EL1	<i>PMINTENCLR_EL1, Performance Monitors Interrupt Enable Clear register on page D8-2154</i>
PMINTENSET_EL1	<i>PMINTENSET_EL1, Performance Monitors Interrupt Enable Set register on page D8-2156</i>
PMOVSCLR_ELO	<i>PMOVSCLR_ELO, Performance Monitors Overflow Flag Status Clear Register on page D8-2158</i>
PMOVSSET_ELO	<i>PMOVSSET_ELO, Performance Monitors Overflow Flag Status Set register on page D8-2160</i>
PMSELR_ELO	<i>PMSELR_ELO, Performance Monitors Event Counter Selection Register on page D8-2162</i>
PMSWINC_ELO	<i>PMSWINC_ELO, Performance Monitors Software Increment register on page D8-2164</i>
PMUSERENR_ELO	<i>PMUSERENR_ELO, Performance Monitors User Enable Register on page D8-2166</i>
PMXEVCNTR_ELO	<i>PMXEVCNTR_ELO, Performance Monitors Selected Event Count Register on page D8-2168</i>
PMXEVTYPER_ELO	<i>PMXEVTYPER_ELO, Performance Monitors Selected Event Type Register on page D8-2169</i>

J.3.5 Debug registers

This section is an index to the registers in the Debug functional group.

Table J-10 Debug registers

Register	Description, see
DBGAUTHSTATUS_EL1	<i>DBGAUTHSTATUS_EL1, Debug Authentication Status register on page D8-2077</i>
DBGBCR<n>_EL1	<i>DBGBCR<n>_EL1, Debug Breakpoint Control Registers, n = 0 - 15 on page D8-2079</i>
DBGBVR<n>_EL1	<i>DBGBVR<n>_EL1, Debug Breakpoint Value Registers, n = 0 - 15 on page D8-2082</i>
DBGCLAIMCLR_EL1	<i>DBGCLAIMCLR_EL1, Debug Claim Tag Clear register on page D8-2085</i>
DBGCLAIMSET_EL1	<i>DBGCLAIMSET_EL1, Debug Claim Tag Set register on page D8-2086</i>
DBGDTR_ELO	<i>DBGDTR_ELO, Debug Data Transfer Register, half-duplex on page D8-2087</i>
DBGDTRRX_ELO	<i>DBGDTRRX_ELO, Debug Data Transfer Register, Receive on page D8-2089</i>
DBGDTRTX_ELO	<i>DBGDTRTX_ELO, Debug Data Transfer Register, Transmit on page D8-2091</i>
DBGPRCR_EL1	<i>DBGPRCR_EL1, Debug Power Control Register on page D8-2093</i>
DBGVCR32_EL2	<i>DBGVCR32_EL2, Debug Vector Catch Register on page D8-2094</i>
DBGWCR<n>_EL1	<i>DBGWCR<n>_EL1, Debug Watchpoint Control Registers, n = 0 - 15 on page D8-2098</i>
DBGWVR<n>_EL1	<i>DBGWVR<n>_EL1, Debug Watchpoint Value Registers, n = 0 - 15 on page D8-2101</i>
DLR_ELO	<i>DLR_ELO, Debug Link Register on page D8-2103</i>

Table J-10 Debug registers (continued)

Register	Description, see
DSPSR_EL0	<i>DSPSR_EL0</i> , Debug Saved Program Status Register on page D8-2104
MDCCINT_EL1	<i>MDCCINT_EL1</i> , Monitor DCC Interrupt Enable Register on page D8-2110
MDCCSR_EL0	<i>MDCCSR_EL0</i> , Monitor DCC Status Register on page D8-2112
MDCR_EL2	<i>MDCR_EL2</i> , Monitor Debug Configuration Register (EL2) on page D8-2114
MDCR_EL3	<i>MDCR_EL3</i> , Monitor Debug Configuration Register (EL3) on page D8-2117
MDRAR_EL1	<i>MDRAR_EL1</i> , Monitor Debug ROM Address Register on page D8-2120
MDSCR_EL1	<i>MDSCR_EL1</i> , Monitor Debug System Control Register on page D8-2122
OSDLR_EL1	<i>OSDLR_EL1</i> , OS Double Lock Register on page D8-2125
OSDTRRX_EL1	<i>OSDTRRX_EL1</i> , OS Lock Data Transfer Register, Receive on page D8-2126
OSDTRTX_EL1	<i>OSDTRTX_EL1</i> , OS Lock Data Transfer Register, Transmit on page D8-2127
OSECCR_EL1	<i>OSECCR_EL1</i> , OS Lock Exception Catch Control Register on page D8-2128
OSLAR_EL1	<i>OSLAR_EL1</i> , OS Lock Access Register on page D8-2129
OSLSR_EL1	<i>OSLSR_EL1</i> , OS Lock Status Register on page D8-2130
SDER32_EL3	<i>SDER32_EL3</i> , AArch32 Secure Debug Enable Register on page D8-2132

J.3.6 Generic timer registers

This section is an index to the registers in the Generic Timer functional group.

Table J-11 Generic timer registers

Register	Description, see
CNTRFQ_EL0	<i>CNTRFQ_EL0</i> , Counter-timer Frequency register on page D8-2170
CNTHCTL_EL2	<i>CNTHCTL_EL2</i> , Counter-timer Hypervisor Control register on page D8-2171
CNTHP_CTL_EL2	<i>CNTHP_CTL_EL2</i> , Counter-timer Hypervisor Physical Timer Control register on page D8-2173
CNTHP_CVAL_EL2	<i>CNTHP_CVAL_EL2</i> , Counter-timer Hypervisor Physical Timer CompareValue register on page D8-2175
CNTHP_TVAL_EL2	<i>CNTHP_TVAL_EL2</i> , Counter-timer Hypervisor Physical Timer TimerValue register on page D8-2176
CNTKCTL_EL1	<i>CNTKCTL_EL1</i> , Counter-timer Kernel Control register on page D8-2177
CNTP_CTL_EL0	<i>CNTP_CTL_EL0</i> , Counter-timer Physical Timer Control register on page D8-2179
CNTP_CVAL_EL0	<i>CNTP_CVAL_EL0</i> , Counter-timer Physical Timer CompareValue register on page D8-2181
CNTP_TVAL_EL0	<i>CNTP_TVAL_EL0</i> , Counter-timer Physical Timer TimerValue register on page D8-2182
CNTPCT_EL0	<i>CNTPCT_EL0</i> , Counter-timer Physical Count register on page D8-2183
CNTPS_CTL_EL1	<i>CNTPS_CTL_EL1</i> , Counter-timer Physical Secure Timer Control register on page D8-2184
CNTPS_CVAL_EL1	<i>CNTPS_CVAL_EL1</i> , Counter-timer Physical Secure Timer CompareValue register on page D8-2186

Table J-11 Generic timer registers (continued)

Register	Description, see
CNTPS_TVAL_EL1	<i>CNTPS_TVAL_EL1</i> , Counter-timer Physical Secure Timer TimerValue register on page D8-2187
CNTV_CTL_EL0	<i>CNTV_CTL_EL0</i> , Counter-timer Virtual Timer Control register on page D8-2188
CNTV_CVAL_EL0	<i>CNTV_CVAL_EL0</i> , Counter-timer Virtual Timer CompareValue register on page D8-2190
CNTV_TVAL_EL0	<i>CNTV_TVAL_EL0</i> , Counter-timer Virtual Timer TimerValue register on page D8-2191
CNTVCT_EL0	<i>CNTVCT_EL0</i> , Counter-timer Virtual Count register on page D8-2192
CNTVOFF_EL2	<i>CNTVOFF_EL2</i> , Counter-timer Virtual Offset register on page D8-2193

J.3.7 Generic Interrupt Controller CPU interface registers

This section is an index to the registers in the GIC functional group.

Table J-12 Generic Interrupt Controller CPU interface registers

Register	Description, see
ICC_AP0R0_EL1	<i>ICC_AP0R0_EL1</i> , Interrupt Controller Active Priorities Register (0,0) on page D8-2194
ICC_AP0R1_EL1	<i>ICC_AP0R1_EL1</i> , Interrupt Controller Active Priorities Register (0,1) on page D8-2196
ICC_AP0R2_EL1	<i>ICC_AP0R2_EL1</i> , Interrupt Controller Active Priorities Register (0,2) on page D8-2198
ICC_AP0R3_EL1	<i>ICC_AP0R3_EL1</i> , Interrupt Controller Active Priorities Register (0,3) on page D8-2200
ICC_APIR0_EL1	<i>ICC_APIR0_EL1</i> , Interrupt Controller Active Priorities Register (1,0) on page D8-2202
ICC_APIR1_EL1	<i>ICC_APIR1_EL1</i> , Interrupt Controller Active Priorities Register (1,1) on page D8-2204
ICC_APIR2_EL1	<i>ICC_APIR2_EL1</i> , Interrupt Controller Active Priorities Register (1,2) on page D8-2206
ICC_APIR3_EL1	<i>ICC_APIR3_EL1</i> , Interrupt Controller Active Priorities Register (1,3) on page D8-2208
ICC_ASGIIR_EL1	<i>ICC_ASGIIR_EL1</i> , Interrupt Controller Alias Software Generated Interrupt group 1 Register on page D8-2210
ICC_BPR0_EL1	<i>ICC_BPR0_EL1</i> , Interrupt Controller Binary Point Register 0 on page D8-2212
ICC_BPR1_EL1	<i>ICC_BPR1_EL1</i> , Interrupt Controller Binary Point Register 1 on page D8-2214
ICC_CTLR_EL1	<i>ICC_CTLR_EL1</i> , Interrupt Controller Control Register (EL1) on page D8-2216
ICC_CTLR_EL3	<i>ICC_CTLR_EL3</i> , Interrupt Controller Control Register (EL3) on page D8-2219
ICC_DIR_EL1	<i>ICC_DIR_EL1</i> , Interrupt Controller Deactivate Interrupt Register on page D8-2222
ICC_EOIR0_EL1	<i>ICC_EOIR0_EL1</i> , Interrupt Controller End Of Interrupt Register 0 on page D8-2223
ICC_EOIR1_EL1	<i>ICC_EOIR1_EL1</i> , Interrupt Controller End Of Interrupt Register 1 on page D8-2225
ICC_HPPIR0_EL1	<i>ICC_HPPIR0_EL1</i> , Interrupt Controller Highest Priority Pending Interrupt Register 0 on page D8-2226
ICC_HPPIR1_EL1	<i>ICC_HPPIR1_EL1</i> , Interrupt Controller Highest Priority Pending Interrupt Register 1 on page D8-2228
ICC_IAR0_EL1	<i>ICC_IAR0_EL1</i> , Interrupt Controller Interrupt Acknowledge Register 0 on page D8-2229
ICC_IAR1_EL1	<i>ICC_IAR1_EL1</i> , Interrupt Controller Interrupt Acknowledge Register 1 on page D8-2231
ICC_IGRPEN0_EL1	<i>ICC_IGRPEN0_EL1</i> , Interrupt Controller Interrupt Group 0 Enable register on page D8-2232

Table J-12 Generic Interrupt Controller CPU interface registers (continued)

Register	Description, see
ICC_IGRPEN1_EL1	<i>ICC_IGRPEN1_EL1, Interrupt Controller Interrupt Group 1 Enable register on page D8-2234</i>
ICC_IGRPEN1_EL3	<i>ICC_IGRPEN1_EL3, Interrupt Controller Interrupt Group 1 Enable register (EL3) on page D8-2236</i>
ICC_PMR_EL1	<i>ICC_PMR_EL1, Interrupt Controller Interrupt Priority Mask Register on page D8-2238</i>
ICC_RPR_EL1	<i>ICC_RPR_EL1, Interrupt Controller Running Priority Register on page D8-2240</i>
ICC_SEIEN_EL1	<i>ICC_SEIEN_EL1, Interrupt Controller System Error Interrupt Enable register on page D8-2241</i>
ICC_SGI0R_EL1	<i>ICC_SGI0R_EL1, Interrupt Controller Software Generated Interrupt group 0 Register on page D8-2242</i>
ICC_SGI1R_EL1	<i>ICC_SGI1R_EL1, Interrupt Controller Software Generated Interrupt group 1 Register on page D8-2244</i>
ICC_SRE_EL1	<i>ICC_SRE_EL1, Interrupt Controller System Register Enable register (EL1) on page D8-2246</i>
ICC_SRE_EL2	<i>ICC_SRE_EL2, Interrupt Controller System Register Enable register (EL2) on page D8-2248</i>
ICC_SRE_EL3	<i>ICC_SRE_EL3, Interrupt Controller System Register Enable register (EL3) on page D8-2250</i>
ICH_AP0R0_EL2	<i>ICH_AP0R0_EL2, Interrupt Controller Hyp Active Priorities Register (0,0) on page D8-2252</i>
ICH_AP0R1_EL2	<i>ICH_AP0R1_EL2, Interrupt Controller Hyp Active Priorities Register (0,1) on page D8-2254</i>
ICH_AP0R2_EL2	<i>ICH_AP0R2_EL2, Interrupt Controller Hyp Active Priorities Register (0,2) on page D8-2256</i>
ICH_AP0R3_EL2	<i>ICH_AP0R3_EL2, Interrupt Controller Hyp Active Priorities Register (0,3) on page D8-2258</i>
ICH_AP1R0_EL2	<i>ICH_AP1R0_EL2, Interrupt Controller Hyp Active Priorities Register (1,0) on page D8-2260</i>
ICH_AP1R1_EL2	<i>ICH_AP1R1_EL2, Interrupt Controller Hyp Active Priorities Register (1,1) on page D8-2262</i>
ICH_AP1R2_EL2	<i>ICH_AP1R2_EL2, Interrupt Controller Hyp Active Priorities Register (1,2) on page D8-2264</i>
ICH_AP1R3_EL2	<i>ICH_AP1R3_EL2, Interrupt Controller Hyp Active Priorities Register (1,3) on page D8-2266</i>
ICH_EISR_EL2	<i>ICH_EISR_EL2, Interrupt Controller End of Interrupt Status Register on page D8-2268</i>
ICH_ELSR_EL2	<i>ICH_ELSR_EL2, Interrupt Controller Empty List Register Status Register on page D8-2270</i>
ICH_HCR_EL2	<i>ICH_HCR_EL2, Interrupt Controller Hyp Control Register on page D8-2272</i>
ICH_LR<n>_EL2	<i>ICH_LR<n>_EL2, Interrupt Controller List Registers, n = 0 - 15 on page D8-2275</i>
ICH_MISR_EL2	<i>ICH_MISR_EL2, Interrupt Controller Maintenance Interrupt State Register on page D8-2277</i>
ICH_VMCR_EL2	<i>ICH_VMCR_EL2, Interrupt Controller Virtual Machine Control Register on page D8-2279</i>
ICH_VSEIR_EL2	<i>ICH_VSEIR_EL2, Interrupt Controller Virtual System Error Interrupt Register on page D8-2281</i>
ICH_VTR_EL2	<i>ICH_VTR_EL2, Interrupt Controller VGIC Type Register on page D8-2282</i>

J.3.8 Cache maintenance system instructions

This section is an index to the system instructions in the Cache maintenance functional group.

Table J-13 Cache maintenance system instructions

Register	Description, see
DC CISW	<i>DC CISW, Data or unified Cache line Clean and Invalidate by Set/Way on page C4-307</i>
DC CIVAC	<i>DC CIVAC, Data or unified Cache line Clean and Invalidate by VA to PoC on page C4-309</i>
DC CSW	<i>DC CSW, Data or unified Cache line Clean by Set/Way on page C4-310</i>
DC CVAC	<i>DC CVAC, Data or unified Cache line Clean by VA to PoC on page C4-312</i>
DC CVAU	<i>DC CVAU, Data or unified Cache line Clean by VA to PoU on page C4-313</i>
DC ISW	<i>DC ISW, Data or unified Cache line Invalidate by Set/Way on page C4-314</i>
DC IVAC	<i>DC IVAC, Data or unified Cache line Invalidate by VA to PoC on page C4-316</i>
DC ZVA	<i>DC ZVA, Data Cache Zero by VA on page C4-317</i>
IC IALLU	<i>IC IALLU, Instruction Cache Invalidate All to PoU on page C4-319</i>
IC IALLUIS	<i>IC IALLUIS, Instruction Cache Invalidate All to PoU, Inner Shareable on page C4-320</i>
IC IVAU	<i>IC IVAU, Instruction Cache line Invalidate by VA to PoU on page C4-321</i>

J.3.9 Address translation system instructions

This section is an index to the system instructions in the Address translation functional group.

Table J-14 Address translation system instructions

Register	Description, see
AT S12E0R	<i>AT S12E0R, Address Translate Stages 1 and 2 EL0 Read on page C4-323</i>
AT S12E0W	<i>AT S12E0W, Address Translate Stages 1 and 2 EL0 Write on page C4-324</i>
AT S12E1R	<i>AT S12E1R, Address Translate Stages 1 and 2 EL1 Read on page C4-325</i>
AT S12E1W	<i>AT S12E1W, Address Translate Stages 1 and 2 EL1 Write on page C4-326</i>
AT S1E0R	<i>AT S1E0R, Address Translate Stage 1 EL0 Read on page C4-327</i>
AT S1E0W	<i>AT S1E0W, Address Translate Stage 1 EL0 Write on page C4-328</i>
AT S1E1R	<i>AT S1E1R, Address Translate Stage 1 EL1 Read on page C4-329</i>
AT S1E1W	<i>AT S1E1W, Address Translate Stage 1 EL1 Write on page C4-330</i>
AT S1E2R	<i>AT S1E2R, Address Translate Stage 1 EL2 Read on page C4-331</i>
AT S1E2W	<i>AT S1E2W, Address Translate Stage 1 EL2 Write on page C4-332</i>
AT S1E3R	<i>AT S1E3R, Address Translate Stage 1 EL3 Read on page C4-333</i>
AT S1E3W	<i>AT S1E3W, Address Translate Stage 1 EL3 Write on page C4-334</i>

J.3.10 TLB maintenance system instructions

This section is an index to the system instructions in the TLB maintenance functional group.

Table J-15 TLB maintenance system instructions

Register	Description, see
TLBI ALLE1	<i>TLBI ALLE1, TLB Invalidate All entries, EL1 on page C4-336</i>
TLBI ALLE1IS	<i>TLBI ALLE1IS, TLB Invalidate All entries, EL1, Inner Shareable on page C4-337</i>
TLBI ALLE2	<i>TLBI ALLE2, TLB Invalidate All entries, EL2 on page C4-338</i>
TLBI ALLE2IS	<i>TLBI ALLE2IS, TLB Invalidate All entries, EL2, Inner Shareable on page C4-339</i>
TLBI ALLE3	<i>TLBI ALLE3, TLB Invalidate All entries, EL3 on page C4-340</i>
TLBI ALLE3IS	<i>TLBI ALLE3IS, TLB Invalidate All entries, EL3, Inner Shareable on page C4-341</i>
TLBI ASIDE1	<i>TLBI ASIDE1, TLB Invalidate by ASID, EL1 on page C4-342</i>
TLBI ASIDE1IS	<i>TLBI ASIDE1IS, TLB Invalidate by ASID, EL1, Inner Shareable on page C4-343</i>
TLBI IPAS2E1	<i>TLBI IPAS2E1, TLB Invalidate by Intermediate Physical Address, Stage 2, EL1 on page C4-344</i>
TLBI IPAS2E1IS	<i>TLBI IPAS2E1IS, TLB Invalidate by Intermediate Physical Address, Stage 2, EL1, Inner Shareable on page C4-345</i>
TLBI IPAS2LE1	<i>TLBI IPAS2LE1, TLB Invalidate by Intermediate Physical Address, Stage 2, Last level, EL1 on page C4-346</i>
TLBI IPAS2LE1IS	<i>TLBI IPAS2LE1IS, TLB Invalidate by Intermediate Physical Address, Stage 2, Last level, EL1, Inner Shareable on page C4-347</i>
TLBI VAAE1	<i>TLBI VAAE1, TLB Invalidate by VA, All ASID, EL1 on page C4-348</i>
TLBI VAAE1IS	<i>TLBI VAAE1IS, TLB Invalidate by VA, All ASID, EL1, Inner Shareable on page C4-350</i>
TLBI VAALE1	<i>TLBI VAALE1, TLB Invalidate by VA, All ASID, Last level, EL1 on page C4-352</i>
TLBI VAALE1IS	<i>TLBI VAALE1IS, TLB Invalidate by VA, All ASID, EL1, Inner Shareable on page C4-354</i>
TLBI VAE1	<i>TLBI VAE1, TLB Invalidate by VA, EL1 on page C4-356</i>
TLBI VAE1IS	<i>TLBI VAE1IS, TLB Invalidate by VA, EL1, Inner Shareable on page C4-358</i>
TLBI VAE2	<i>TLBI VAE2, TLB Invalidate by VA, EL2 on page C4-360</i>
TLBI VAE2IS	<i>TLBI VAE2IS, TLB Invalidate by VA, EL2, Inner Shareable on page C4-362</i>
TLBI VAE3	<i>TLBI VAE3, TLB Invalidate by VA, EL3 on page C4-364</i>
TLBI VAE3IS	<i>TLBI VAE3IS, TLB Invalidate by VA, EL3, Inner Shareable on page C4-366</i>
TLBI VALE1	<i>TLBI VALE1, TLB Invalidate by VA, Last level, EL1 on page C4-368</i>
TLBI VALE1IS	<i>TLBI VALE1IS, TLB Invalidate by VA, Last level, EL1, Inner Shareable on page C4-370</i>
TLBI VALE2	<i>TLBI VALE2, TLB Invalidate by VA, Last level, EL2 on page C4-372</i>
TLBI VALE2IS	<i>TLBI VALE2IS, TLB Invalidate by VA, Last level, EL2, Inner Shareable on page C4-374</i>
TLBI VALE3	<i>TLBI VALE3, TLB Invalidate by VA, Last level, EL3 on page C4-376</i>
TLBI VALE3IS	<i>TLBI VALE3IS, TLB Invalidate by VA, Last level, EL3, Inner Shareable on page C4-378</i>

Table J-15 TLB maintenance system instructions (continued)

Register	Description, see
TLBI VMALLE1	<i>TLBI VMALLE1, TLB Invalidate by VMID, All entries at stage 1, EL1</i> on page C4-380
TLBI VMALLE1IS	<i>TLBI VMALLE1IS, TLB Invalidate by VMID, All entries at stage 1, EL1, Inner Shareable</i> on page C4-381
TLBI VMALLS12E1	<i>TLBI VMALLS12E1, TLB Invalidate by VMID, All entries at Stage 1 and 2, EL1</i> on page C4-382
TLBI VMALLS12E1IS	<i>TLBI VMALLS12E1IS, TLB Invalidate by VMID, All entries at Stage 1 and 2, EL1, Inner Shareable</i> on page C4-383

J.3.11 Base system registers

This section is an index to the registers that are not a part of any of the other functional groups in this index.

Table J-16 Base system registers

Register	Description, see
ACTLR_EL1	<i>ACTLR_EL1, Auxiliary Control Register (EL1)</i> on page D8-1870
ACTLR_EL2	<i>ACTLR_EL2, Auxiliary Control Register (EL2)</i> on page D8-1871
ACTLR_EL3	<i>ACTLR_EL3, Auxiliary Control Register (EL3)</i> on page D8-1872
AFSR0_EL1	<i>AFSR0_EL1, Auxiliary Fault Status Register 0 (EL1)</i> on page D8-1873
AFSR0_EL2	<i>AFSR0_EL2, Auxiliary Fault Status Register 0 (EL2)</i> on page D8-1874
AFSR0_EL3	<i>AFSR0_EL3, Auxiliary Fault Status Register 0 (EL3)</i> on page D8-1875
AFSR1_EL1	<i>AFSR1_EL1, Auxiliary Fault Status Register 1 (EL1)</i> on page D8-1876
AFSR1_EL2	<i>AFSR1_EL2, Auxiliary Fault Status Register 1 (EL2)</i> on page D8-1877
AFSR1_EL3	<i>AFSR1_EL3, Auxiliary Fault Status Register 1 (EL3)</i> on page D8-1878
CPACR_EL1	<i>CPACR_EL1, Architectural Feature Access Control Register</i> on page D8-1888
CPTR_EL2	<i>CPTR_EL2, Architectural Feature Trap Register (EL2)</i> on page D8-1890
CPTR_EL3	<i>CPTR_EL3, Architectural Feature Trap Register (EL3)</i> on page D8-1892
CurrentEL	<i>CurrentEL, Current Exception Level</i> on page C4-252
DAIF	<i>DAIF, Interrupt Mask Bits</i> on page C4-254
ESR_EL1	<i>ESR_EL1, Exception Syndrome Register (EL1)</i> on page D8-1899
ESR_EL2	<i>ESR_EL2, Exception Syndrome Register (EL2)</i> on page D8-1904
ESR_EL3	<i>ESR_EL3, Exception Syndrome Register (EL3)</i> on page D8-1909
FAR_EL1	<i>FAR_EL1, Fault Address Register (EL1)</i> on page D8-1914
FAR_EL2	<i>FAR_EL2, Fault Address Register (EL2)</i> on page D8-1915
FAR_EL3	<i>FAR_EL3, Fault Address Register (EL3)</i> on page D8-1917
FPEXC32_EL2	<i>FPEXC32_EL2, Floating-point Exception Control register</i> on page D8-1918
HACR_EL2	<i>HACR_EL2, Hypervisor Auxiliary Control Register</i> on page D8-1922

Table J-16 Base system registers (continued)

Register	Description, see
HCR_EL2	<i>HCR_EL2, Hypervisor Configuration Register</i> on page D8-1923
HPFAR_EL2	<i>HPFAR_EL2, Hypervisor IPA Fault Address Register</i> on page D8-1930
HSTR_EL2	<i>HSTR_EL2, Hypervisor System Trap Register</i> on page D8-1931
IFSR32_EL2	<i>IFSR32_EL2, Instruction Fault Status Register (EL2)</i> on page D8-1984
ISR_EL1	<i>ISR_EL1, Interrupt Status Register</i> on page D8-1988
NZCV	<i>NZCV, Condition Flags</i> on page C4-267
PAR_EL1	<i>PAR_EL1, Physical Address Register</i> on page D8-2008
RMR_EL1	<i>RMR_EL1, Reset Management Register (if EL2 and EL3 not implemented)</i> on page D8-2012
RMR_EL2	<i>RMR_EL2, Reset Management Register (if EL3 not implemented)</i> on page D8-2014
RMR_EL3	<i>RMR_EL3, Reset Management Register (if EL3 implemented)</i> on page D8-2016
RVBAR_EL1	<i>RVBAR_EL1, Reset Vector Base Address Register (if EL2 and EL3 not implemented)</i> on page D8-2018
RVBAR_EL2	<i>RVBAR_EL2, Reset Vector Base Address Register (if EL3 not implemented)</i> on page D8-2019
RVBAR_EL3	<i>RVBAR_EL3, Reset Vector Base Address Register (if EL3 implemented)</i> on page D8-2020
S3_<op1>_<Cn>_<Cm>_<op2>	<i>S3_<op1>_<Cn>_<Cm>_<op2>, IMPLEMENTATION DEFINED registers</i> on page D8-2021
SCR_EL3	<i>SCR_EL3, Secure Configuration Register</i> on page D8-2022
SCTLR_EL1	<i>SCTLR_EL1, System Control Register (EL1)</i> on page D8-2025
SCTLR_EL2	<i>SCTLR_EL2, System Control Register (EL2)</i> on page D8-2031
SCTLR_EL3	<i>SCTLR_EL3, System Control Register (EL3)</i> on page D8-2035
SPSel	<i>SPSel, Stack Pointer Select</i> on page C4-273
TPIDR_EL0	<i>TPIDR_EL0, Thread Pointer / ID Register (EL0)</i> on page D8-2052
TPIDR_EL1	<i>TPIDR_EL1, Thread Pointer / ID Register (EL1)</i> on page D8-2053
TPIDR_EL2	<i>TPIDR_EL2, Thread Pointer / ID Register (EL2)</i> on page D8-2054
TPIDR_EL3	<i>TPIDR_EL3, Thread Pointer / ID Register (EL3)</i> on page D8-2055
TPIDRRO_EL0	<i>TPIDRRO_EL0, Thread Pointer / ID Register, Read-Only (EL0)</i> on page D8-2056
VBAR_EL1	<i>VBAR_EL1, Vector Base Address Register (EL1)</i> on page D8-2065
VBAR_EL2	<i>VBAR_EL2, Vector Base Address Register (EL2)</i> on page D8-2066
VBAR_EL3	<i>VBAR_EL3, Vector Base Address Register (EL3)</i> on page D8-2067

J.4 Alphabetical index of AArch32 registers and system instructions

This section is an index of AArch32 registers and system instructions in alphabetical order.

Table J-17 Alphabetical index of AArch32 Registers

Register	Description, see
ACTLR	<i>ACTLR, Auxiliary Control Register on page G4-3773</i>
ADFSR	<i>ADFSR, Auxiliary Data Fault Status Register on page G4-3775</i>
AIDR	<i>AIDR, Auxiliary ID Register on page G4-3777</i>
AIFSR	<i>AIFSR, Auxiliary Instruction Fault Status Register on page G4-3778</i>
AMAIRO	<i>AMAIRO, Auxiliary Memory Attribute Indirection Register 0 on page G4-3780</i>
AMAIR1	<i>AMAIR1, Auxiliary Memory Attribute Indirection Register 1 on page G4-3782</i>
APSR	<i>APSR, Application Program Status Register on page G4-3784</i>
ATS12NSOPR	<i>ATS12NSOPR, Address Translate Stages 1 and 2 Non-secure Only PL1 Read on page G4-3786</i>
ATS12NSOPW	<i>ATS12NSOPW, Address Translate Stages 1 and 2 Non-secure Only PL1 Write on page G4-3787</i>
ATS12NSOUR	<i>ATS12NSOUR, Address Translate Stages 1 and 2 Non-secure Only Unprivileged Read on page G4-3788</i>
ATS12NSOUW	<i>ATS12NSOUW, Address Translate Stages 1 and 2 Non-secure Only Unprivileged Write on page G4-3789</i>
ATS1CPR	<i>ATS1CPR, Address Translate Stage 1 Current state PL1 Read on page G4-3790</i>
ATS1CPW	<i>ATS1CPW, Address Translate Stage 1 Current state PL1 Write on page G4-3791</i>
ATS1CUR	<i>ATS1CUR, Address Translate Stage 1 Current state Unprivileged Read on page G4-3792</i>
ATS1CUW	<i>ATS1CUW, Address Translate Stage 1 Current state Unprivileged Write on page G4-3793</i>
ATS1HR	<i>ATS1HR, Address Translate Stage 1 Hyp mode Read on page G4-3794</i>
ATS1HW	<i>ATS1HW, Address Translate Stage 1 Hyp mode Write on page G4-3795</i>
BPIALL	<i>BPIALL, Branch Predictor Invalidate All on page G4-3796</i>
BPIALLIS	<i>BPIALLIS, Branch Predictor Invalidate All, Inner Shareable on page G4-3797</i>
BPIMVA	<i>BPIMVA, Branch Predictor Invalidate VA on page G4-3798</i>
CCSIDR	<i>CCSIDR, Current Cache Size ID Register on page G4-3799</i>
CLIDR	<i>CLIDR, Cache Level ID Register on page G4-3801</i>
CNTFRQ	<i>CNTFRQ, Counter-timer Frequency register on page G4-4208</i>
CNTHCTL	<i>CNTHCTL, Counter-timer Hyp Control register on page G4-4209</i>
CNTHP_CTL	<i>CNTHP_CTL, Counter-timer Hyp Physical Timer Control register on page G4-4211</i>
CNTHP_CVAL	<i>CNTHP_CVAL, Counter-timer Hyp Physical CompareValue register on page G4-4213</i>
CNTHP_TVAL	<i>CNTHP_TVAL, Counter-timer Hyp Physical Timer TimerValue register on page G4-4214</i>
CNTKCTL	<i>CNTKCTL, Counter-timer Kernel Control register on page G4-4215</i>
CNTP_CTL	<i>CNTP_CTL, Counter-timer Physical Timer Control register on page G4-4217</i>
CNTP_CVAL	<i>CNTP_CVAL, Counter-timer Physical Timer CompareValue register on page G4-4219</i>

Table J-17 Alphabetical index of AArch32 Registers (continued)

Register	Description, see
CNTP_TVAL	<i>CNTP_TVAL</i> , Counter-timer Physical Timer TimerValue register on page G4-4221
CNTPCT	<i>CNTPCT</i> , Counter-timer Physical Count register on page G4-4223
CNTV_CTL	<i>CNTV_CTL</i> , Counter-timer Virtual Timer Control register on page G4-4224
CNTV_CVAL	<i>CNTV_CVAL</i> , Counter-timer Virtual Timer CompareValue register on page G4-4226
CNTV_TVAL	<i>CNTV_TVAL</i> , Counter-timer Virtual Timer TimerValue register on page G4-4227
CNTVCT	<i>CNTVCT</i> , Counter-timer Virtual Count register on page G4-4228
CNTVOFF	<i>CNTVOFF</i> , Counter-timer Virtual Offset register on page G4-4229
CONTEXTIDR	<i>CONTEXTIDR</i> , Context ID Register on page G4-3803
CP15DMB	<i>CP15DMB</i> , CP15 Data Memory Barrier operation on page G4-3805
CP15DSB	<i>CP15DSB</i> , CP15 Data Synchronization Barrier operation on page G4-3806
CP15ISB	<i>CP15ISB</i> , CP15 Instruction Synchronization Barrier operation on page G4-3807
CPACR	<i>CPACR</i> , Architectural Feature Access Control Register on page G4-3808
CPSR	<i>CPSR</i> , Current Program Status Register on page G4-3810
CSSELR	<i>CSSELR</i> , Cache Size Selection Register on page G4-3813
CTR	<i>CTR</i> , Cache Type Register on page G4-3815
DACR	<i>DACR</i> , Domain Access Control Register on page G4-3817
DBGAUTHSTATUS	<i>DBGAUTHSTATUS</i> , Debug Authentication Status register on page G4-4101
DBGBCR<n>	<i>DBGBCR<n></i> , Debug Breakpoint Control Registers, $n = 0 - 15$ on page G4-4103
DBGBVR<n>	<i>DBGBVR<n></i> , Debug Breakpoint Value Registers, $n = 0 - 15$ on page G4-4106
DBGBXVR<n>	<i>DBGBXVR<n></i> , Debug Breakpoint Extended Value Registers, $n = 0 - 15$ on page G4-4108
DBGCLAIMCLR	<i>DBGCLAIMCLR</i> , Debug Claim Tag Clear register on page G4-4110
DBGCLAIMSET	<i>DBGCLAIMSET</i> , Debug Claim Tag Set register on page G4-4112
DBGDCCINT	<i>DBGDCCINT</i> , DCC Interrupt Enable Register on page G4-4114
DBGDEVID	<i>DBGDEVID</i> , Debug Device ID register 0 on page G4-4116
DBGDEVID1	<i>DBGDEVID1</i> , Debug Device ID register 1 on page G4-4118
DBGDEVID2	<i>DBGDEVID2</i> , Debug Device ID register 2 on page G4-4119
DBGDIDR	<i>DBGDIDR</i> , Debug ID Register on page G4-4120
DBGDRAR	<i>DBGDRAR</i> , Debug ROM Address Register on page G4-4122
DBGDSAR	<i>DBGDSAR</i> , Debug Self Address Register on page G4-4124
DBGDSCRext	<i>DBGDSCRext</i> , Debug Status and Control Register, External View on page G4-4126
DBGDSCRint	<i>DBGDSCRint</i> , Debug Status and Control Register, Internal View on page G4-4130
DBGDTRRext	<i>DBGDTRRext</i> , Debug Data Transfer Register, Receive, External View on page G4-4132

Table J-17 Alphabetical index of AArch32 Registers (continued)

Register	Description, see
DBGDTRRXint	<i>DBGDTRRXint, Debug Data Transfer Register, Receive, Internal View</i> on page G4-4134
DBGDTRTXext	<i>DBGDTRTXext, Debug Data Transfer Register, Transmit, External View</i> on page G4-4136
DBGDTRTXint	<i>DBGDTRTXint, Debug Data Transfer Register, Transmit, Internal View</i> on page G4-4138
DBGOSDLR	<i>DBGOSDLR, Debug OS Double Lock Register</i> on page G4-4140
DBGOSECCR	<i>DBGOSECCR, Debug OS Lock Exception Catch Control Register</i> on page G4-4141
DBGOSLAR	<i>DBGOSLAR, Debug OS Lock Access Register</i> on page G4-4142
DBGOSLSR	<i>DBGOSLSR, Debug OS Lock Status Register</i> on page G4-4143
DBGPRCR	<i>DBGPRCR, Debug Power Control Register</i> on page G4-4145
DBGVCR	<i>DBGVCR, Debug Vector Catch Register</i> on page G4-4147
DBGWCR<n>	<i>DBGWCR<n>, Debug Watchpoint Control Registers, n = 0 - 15</i> on page G4-4153
DBGWFAR	<i>DBGWFAR, Debug Watchpoint Fault Address Register</i> on page G4-4156
DBGWVR<n>	<i>DBGWVR<n>, Debug Watchpoint Value Registers, n = 0 - 15</i> on page G4-4157
DCCIMVAC	<i>DCCIMVAC, Data Cache line Clean and Invalidate by VA to PoC</i> on page G4-3819
DCCISW	<i>DCCISW, Data Cache line Clean and Invalidate by Set/Way</i> on page G4-3820
DCCMVAC	<i>DCCMVAC, Data Cache line Clean by VA to PoC</i> on page G4-3822
DCCMVAU	<i>DCCMVAU, Data Cache line Clean by VA to PoU</i> on page G4-3823
DCCSW	<i>DCCSW, Data Cache line Clean by Set/Way</i> on page G4-3824
DCIMVAC	<i>DCIMVAC, Data Cache line Invalidate by VA to PoC</i> on page G4-3826
DCISW	<i>DCISW, Data Cache line Invalidate by Set/Way</i> on page G4-3827
DFAR	<i>DFAR, Data Fault Address Register</i> on page G4-3829
DFSR	<i>DFSR, Data Fault Status Register</i> on page G4-3831
DLR	<i>DLR, Debug Link Register</i> on page G4-4158
DSPSR	<i>DSPSR, Debug Saved Program Status Register</i> on page G4-4159
DTLBIALL	<i>DTLBIALL, Data TLB Invalidate All entries</i> on page G4-3836
DTLBIASID	<i>DTLBIASID, Data TLB Invalidate by ASID match</i> on page G4-3837
DTLBIMVA	<i>DTLBIMVA, Data TLB Invalidate entry by VA</i> on page G4-3838
ELR_hyp	<i>ELR_hyp, Exception Link Register (Hyp mode)</i> on page G4-3839
FCSEIDR	<i>FCSEIDR, FCSE Process ID register</i> on page G4-3840
FPEXC	<i>FPEXC, Floating-Point Exception Control register</i> on page G4-3841
FPSCR	<i>FPSCR, Floating-Point Status and Control Register</i> on page G4-3845
FPSID	<i>FPSID, Floating-Point System ID register</i> on page G4-3850
HACR	<i>HACR, Hyp Auxiliary Configuration Register</i> on page G4-3852

Table J-17 Alphabetical index of AArch32 Registers (continued)

Register	Description, see
HACTLR	<i>HACTLR, Hyp Auxiliary Control Register on page G4-3853</i>
HADFSR	<i>HADFSR, Hyp Auxiliary Data Fault Status Register on page G4-3854</i>
HAIFSR	<i>HAIFSR, Hyp Auxiliary Instruction Fault Status Register on page G4-3855</i>
HAMAIR0	<i>HAMAIR0, Hyp Auxiliary Memory Attribute Indirection Register 0 on page G4-3856</i>
HAMAIR1	<i>HAMAIR1, Hyp Auxiliary Memory Attribute Indirection Register 1 on page G4-3857</i>
HCPTR	<i>HCPTR, Hyp Architectural Feature Trap Register on page G4-3858</i>
HCR	<i>HCR, Hyp Configuration Register on page G4-3861</i>
HCR2	<i>HCR2, Hyp Configuration Register 2 on page G4-3867</i>
HDCR	<i>HDCR, Hyp Debug Control Register on page G4-4163</i>
HDFAR	<i>HDFAR, Hyp Data Fault Address Register on page G4-3869</i>
HIFAR	<i>HIFAR, Hyp Instruction Fault Address Register on page G4-3870</i>
HMAIR0	<i>HMAIR0, Hyp Memory Attribute Indirection Register 0 on page G4-3871</i>
HMAIR1	<i>HMAIR1, Hyp Memory Attribute Indirection Register 1 on page G4-3874</i>
HPFAR	<i>HPFAR, Hyp IPA Fault Address Register on page G4-3877</i>
HRMR	<i>HRMR, Hyp Reset Management Register on page G4-3878</i>
HSCTLR	<i>HSCTLR, Hyp System Control Register on page G4-3880</i>
HSR	<i>HSR, Hyp Syndrome Register on page G4-3885</i>
HSTR	<i>HSTR, Hyp System Trap Register on page G4-3900</i>
HTCR	<i>HTCR, Hyp Translation Control Register on page G4-3902</i>
HTPIDR	<i>HTPIDR, Hyp Thread Pointer / ID Register on page G4-3904</i>
HTTBR	<i>HTTBR, Hyp Translation Table Base Register on page G4-3905</i>
HVBAR	<i>HVBAR, Hyp Vector Base Address Register on page G4-3907</i>
ICC_AP0R0	<i>ICC_AP0R0, Interrupt Controller Active Priorities Register (0,0) on page G4-4230</i>
ICC_AP0R1	<i>ICC_AP0R1, Interrupt Controller Active Priorities Register (0,1) on page G4-4232</i>
ICC_AP0R2	<i>ICC_AP0R2, Interrupt Controller Active Priorities Register (0,2) on page G4-4234</i>
ICC_AP0R3	<i>ICC_AP0R3, Interrupt Controller Active Priorities Register (0,3) on page G4-4236</i>
ICC_APIR0	<i>ICC_APIR0, Interrupt Controller Active Priorities Register (1,0) on page G4-4238</i>
ICC_APIR1	<i>ICC_APIR1, Interrupt Controller Active Priorities Register (1,1) on page G4-4240</i>
ICC_APIR2	<i>ICC_APIR2, Interrupt Controller Active Priorities Register (1,2) on page G4-4242</i>
ICC_APIR3	<i>ICC_APIR3, Interrupt Controller Active Priorities Register (1,3) on page G4-4244</i>
ICC_ASGI1R	<i>ICC_ASGI1R, Interrupt Controller Alias Software Generated Interrupt group 1 Register on page G4-4246</i>
ICC_BPR0	<i>ICC_BPR0, Interrupt Controller Binary Point Register 0 on page G4-4248</i>

Table J-17 Alphabetical index of AArch32 Registers (continued)

Register	Description, see
ICC_BPR1	<i>ICC_BPR1, Interrupt Controller Binary Point Register 1 on page G4-4250</i>
ICC_CTLR	<i>ICC_CTLR, Interrupt Controller Control Register on page G4-4252</i>
ICC_DIR	<i>ICC_DIR, Interrupt Controller Deactivate Interrupt Register on page G4-4255</i>
ICC_EOIR0	<i>ICC_EOIR0, Interrupt Controller End Of Interrupt Register 0 on page G4-4256</i>
ICC_EOIR1	<i>ICC_EOIR1, Interrupt Controller End Of Interrupt Register 1 on page G4-4258</i>
ICC_HPPIR0	<i>ICC_HPPIR0, Interrupt Controller Highest Priority Pending Interrupt Register 0 on page G4-4260</i>
ICC_HPPIR1	<i>ICC_HPPIR1, Interrupt Controller Highest Priority Pending Interrupt Register 1 on page G4-4262</i>
ICC_HSRE	<i>ICC_HSRE, Interrupt Controller Hyp System Register Enable register on page G4-4263</i>
ICC_IAR0	<i>ICC_IAR0, Interrupt Controller Interrupt Acknowledge Register 0 on page G4-4265</i>
ICC_IAR1	<i>ICC_IAR1, Interrupt Controller Interrupt Acknowledge Register 1 on page G4-4267</i>
ICC_IGRPEN0	<i>ICC_IGRPEN0, Interrupt Controller Interrupt Group 0 Enable register on page G4-4268</i>
ICC_IGRPEN1	<i>ICC_IGRPEN1, Interrupt Controller Interrupt Group 1 Enable register on page G4-4270</i>
ICC_MCTLR	<i>ICC_MCTLR, Interrupt Controller Monitor Control Register on page G4-4271</i>
ICC_MGRPEN1	<i>ICC_MGRPEN1, Interrupt Controller Monitor Interrupt Group 1 Enable register on page G4-4274</i>
ICC_MSRE	<i>ICC_MSRE, Interrupt Controller Monitor System Register Enable register on page G4-4276</i>
ICC_PMR	<i>ICC_PMR, Interrupt Controller Interrupt Priority Mask Register on page G4-4278</i>
ICC_RPR	<i>ICC_RPR, Interrupt Controller Running Priority Register on page G4-4280</i>
ICC_SEIEN	<i>ICC_SEIEN, Interrupt Controller System Error Interrupt Enable register on page G4-4281</i>
ICC_SGI0R	<i>ICC_SGI0R, Interrupt Controller Software Generated Interrupt group 0 Register on page G4-4282</i>
ICC_SGI1R	<i>ICC_SGI1R, Interrupt Controller Software Generated Interrupt group 1 Register on page G4-4284</i>
ICC_SRE	<i>ICC_SRE, Interrupt Controller System Register Enable register on page G4-4286</i>
ICH_AP0R0	<i>ICH_AP0R0, Interrupt Controller Hyp Active Priorities Register (0,0) on page G4-4288</i>
ICH_AP0R1	<i>ICH_AP0R1, Interrupt Controller Hyp Active Priorities Register (0,1) on page G4-4290</i>
ICH_AP0R2	<i>ICH_AP0R2, Interrupt Controller Hyp Active Priorities Register (0,2) on page G4-4292</i>
ICH_AP0R3	<i>ICH_AP0R3, Interrupt Controller Hyp Active Priorities Register (0,3) on page G4-4294</i>
ICH_AP1R0	<i>ICH_AP1R0, Interrupt Controller Hyp Active Priorities Register (1,0) on page G4-4296</i>
ICH_AP1R1	<i>ICH_AP1R1, Interrupt Controller Hyp Active Priorities Register (1,1) on page G4-4298</i>
ICH_AP1R2	<i>ICH_AP1R2, Interrupt Controller Hyp Active Priorities Register (1,2) on page G4-4300</i>
ICH_AP1R3	<i>ICH_AP1R3, Interrupt Controller Hyp Active Priorities Register (1,3) on page G4-4302</i>
ICH_EISR	<i>ICH_EISR, Interrupt Controller End of Interrupt Status Register on page G4-4304</i>
ICH_ELSR	<i>ICH_ELSR, Interrupt Controller Empty List Register Status Register on page G4-4306</i>
ICH_HCR	<i>ICH_HCR, Interrupt Controller Hyp Control Register on page G4-4308</i>

Table J-17 Alphabetical index of AArch32 Registers (continued)

Register	Description, see
ICH_LRC<n>	<i>ICH_LRC<n></i> , Interrupt Controller List Registers, <i>n</i> = 0 - 15 on page G4-4311
ICH_LR<n>	<i>ICH_LR<n></i> , Interrupt Controller List Registers, <i>n</i> = 0 - 15 on page G4-4313
ICH_MISR	<i>ICH_MISR</i> , Interrupt Controller Maintenance Interrupt State Register on page G4-4314
ICH_VMCR	<i>ICH_VMCR</i> , Interrupt Controller Virtual Machine Control Register on page G4-4316
ICH_VSEIR	<i>ICH_VSEIR</i> , Interrupt Controller Virtual System Error Interrupt Register on page G4-4318
ICH_VTR	<i>ICH_VTR</i> , Interrupt Controller VGIC Type Register on page G4-4319
ICIALLU	<i>ICIALLU</i> , Instruction Cache Invalidate All to PoU on page G4-3908
ICIALLUIS	<i>ICIALLUIS</i> , Instruction Cache Invalidate All to PoU, Inner Shareable on page G4-3909
ICIMVAU	<i>ICIMVAU</i> , Instruction Cache line Invalidate by VA to PoU on page G4-3910
ID_AFR0	<i>ID_AFR0</i> , Auxiliary Feature Register 0 on page G4-3911
ID_DFR0	<i>ID_DFR0</i> , Debug Feature Register 0 on page G4-3912
ID_ISAR0	<i>ID_ISAR0</i> , Instruction Set Attribute Register 0 on page G4-3914
ID_ISAR1	<i>ID_ISAR1</i> , Instruction Set Attribute Register 1 on page G4-3916
ID_ISAR2	<i>ID_ISAR2</i> , Instruction Set Attribute Register 2 on page G4-3919
ID_ISAR3	<i>ID_ISAR3</i> , Instruction Set Attribute Register 3 on page G4-3922
ID_ISAR4	<i>ID_ISAR4</i> , Instruction Set Attribute Register 4 on page G4-3925
ID_ISAR5	<i>ID_ISAR5</i> , Instruction Set Attribute Register 5 on page G4-3928
ID_MMFR0	<i>ID_MMFR0</i> , Memory Model Feature Register 0 on page G4-3930
ID_MMFR1	<i>ID_MMFR1</i> , Memory Model Feature Register 1 on page G4-3933
ID_MMFR2	<i>ID_MMFR2</i> , Memory Model Feature Register 2 on page G4-3937
ID_MMFR3	<i>ID_MMFR3</i> , Memory Model Feature Register 3 on page G4-3940
ID_PFR0	<i>ID_PFR0</i> , Processor Feature Register 0 on page G4-3943
ID_PFR1	<i>ID_PFR1</i> , Processor Feature Register 1 on page G4-3945
IFAR	<i>IFAR</i> , Instruction Fault Address Register on page G4-3948
IFSR	<i>IFSR</i> , Instruction Fault Status Register on page G4-3950
ISR	<i>ISR</i> , Interrupt Status Register on page G4-3954
ITLBIALL	<i>ITLBIALL</i> , Instruction TLB Invalidate All entries on page G4-3956
ITLBIASID	<i>ITLBIASID</i> , Instruction TLB Invalidate by ASID match on page G4-3957
ITLBIMVA	<i>ITLBIMVA</i> , Instruction TLB Invalidate entry by VA on page G4-3958
JIDR	<i>JIDR</i> , Jazelle ID Register on page G4-3959
JMCR	<i>JMCR</i> , Jazelle Main Configuration Register on page G4-3960
JOSCR	<i>JOSCR</i> , Jazelle OS Control Register on page G4-3961

Table J-17 Alphabetical index of AArch32 Registers (continued)

Register	Description, see
MAIRO	<i>MAIRO, Memory Attribute Indirection Register 0</i> on page G4-3962
MAIR1	<i>MAIR1, Memory Attribute Indirection Register 1</i> on page G4-3965
MIDR	<i>MIDR, Main ID Register</i> on page G4-3968
MPIDR	<i>MPIDR, Multiprocessor Affinity Register</i> on page G4-3970
MVBAR	<i>MVBAR, Monitor Vector Base Address Register</i> on page G4-3972
MVFR0	<i>MVFR0, Media and VFP Feature Register 0</i> on page G4-3974
MVFR1	<i>MVFR1, Media and VFP Feature Register 1</i> on page G4-3977
MVFR2	<i>MVFR2, Media and VFP Feature Register 2</i> on page G4-3980
NMRR	<i>NMRR, Normal Memory Remap Register</i> on page G4-3982
NSACR	<i>NSACR, Non-Secure Access Control Register</i> on page G4-3984
PAR	<i>PAR, Physical Address Register</i> on page G4-3986
PMCCFILTR	<i>PMCCFILTR, Performance Monitors Cycle Count Filter Register</i> on page G4-4170
PMCCNTR	<i>PMCCNTR, Performance Monitors Cycle Count Register</i> on page G4-4172
PMCEID0	<i>PMCEID0, Performance Monitors Common Event Identification register 0</i> on page G4-4174
PMCEID1	<i>PMCEID1, Performance Monitors Common Event Identification register 1</i> on page G4-4176
PMCNTENCLR	<i>PMCNTENCLR, Performance Monitors Count Enable Clear register</i> on page G4-4178
PMCNTENSET	<i>PMCNTENSET, Performance Monitors Count Enable Set register</i> on page G4-4180
PMCR	<i>PMCR, Performance Monitors Control Register</i> on page G4-4182
PMEVCNTR<n>	<i>PMEVCNTR<n>, Performance Monitors Event Count Registers, n = 0 - 30</i> on page G4-4185
PMEVTYPER<n>	<i>PMEVTYPER<n>, Performance Monitors Event Type Registers, n = 0 - 30</i> on page G4-4187
PMINTENCLR	<i>PMINTENCLR, Performance Monitors Interrupt Enable Clear register</i> on page G4-4190
PMINTENSET	<i>PMINTENSET, Performance Monitors Interrupt Enable Set register</i> on page G4-4192
PMOVSr	<i>PMOVSr, Performance Monitors Overflow Flag Status Register</i> on page G4-4194
PMOVSSET	<i>PMOVSSET, Performance Monitors Overflow Flag Status Set register</i> on page G4-4196
PMSELR	<i>PMSELR, Performance Monitors Event Counter Selection Register</i> on page G4-4198
PMSWINC	<i>PMSWINC, Performance Monitors Software Increment register</i> on page G4-4200
PMUSERENR	<i>PMUSERENR, Performance Monitors User Enable Register</i> on page G4-4202
PMXEVCNTR	<i>PMXEVCNTR, Performance Monitors Selected Event Count Register</i> on page G4-4204
PMXEVTYPER	<i>PMXEVTYPER, Performance Monitors Selected Event Type Register</i> on page G4-4206
PRRR	<i>PRRR, Primary Region Remap Register</i> on page G4-3992
REVIDR	<i>REVIDR, Revision ID Register</i> on page G4-3995
RMR (at EL1)	<i>RMR (at EL1), Reset Management Register</i> on page G4-3996

Table J-17 Alphabetical index of AArch32 Registers (continued)

Register	Description, see
RMR (at EL3)	<i>RMR (at EL3), Reset Management Register</i> on page G4-3998
RVBAR	<i>RVBAR, Reset Vector Base Address Register</i> on page G4-4000
SCR	<i>SCR, Secure Configuration Register</i> on page G4-4001
SCTLR	<i>SCTLR, System Control Register</i> on page G4-4005
SDCR	<i>SDCR, Secure Debug Configuration Register</i> on page G4-4166
SDER	<i>SDER, Secure Debug Enable Register</i> on page G4-4168
SPSR	<i>SPSR, Saved Program Status Register</i> on page G4-4012
SPSR_abt	<i>SPSR_abt, Saved Program Status Register (Abort mode)</i> on page G4-4015
SPSR_fiq	<i>SPSR_fiq, Saved Program Status Register (FIQ mode)</i> on page G4-4019
SPSR_hyp	<i>SPSR_hyp, Saved Program Status Register (Hyp mode)</i> on page G4-4023
SPSR_irq	<i>SPSR_irq, Saved Program Status Register (IRQ mode)</i> on page G4-4027
SPSR_mon	<i>SPSR_mon, Saved Program Status Register (Monitor mode)</i> on page G4-4031
SPSR_svc	<i>SPSR_svc, Saved Program Status Register (Sup. Call mode)</i> on page G4-4035
SPSR_und	<i>SPSR_und, Saved Program Status Register (Undefined mode)</i> on page G4-4039
TCMTR	<i>TCMTR, TCM Type Register</i> on page G4-4043
TEECR	<i>TEECR, T32EE Configuration Register</i> on page G4-4045
TEEHBR	<i>TEEHBR, T32EE Handler Base Register</i> on page G4-4047
TLBIALL	<i>TLBIALL, TLB Invalidate All entries</i> on page G4-4048
TLBIALLH	<i>TLBIALLH, TLB Invalidate All entries, Hyp mode</i> on page G4-4049
TLBIALLHIS	<i>TLBIALLHIS, TLB Invalidate All entries, Hyp mode, Inner Shareable</i> on page G4-4050
TLBIALLIS	<i>TLBIALLIS, TLB Invalidate All entries, Inner Shareable</i> on page G4-4051
TLBIALLNSNH	<i>TLBIALLNSNH, TLB Invalidate All entries, Non-Secure Non-Hyp</i> on page G4-4052
TLBIALLNSNHIS	<i>TLBIALLNSNHIS, TLB Invalidate All entries, Non-Secure Non-Hyp, Inner Shareable</i> on page G4-4053
TLBIASID	<i>TLBIASID, TLB Invalidate entry by ASID match</i> on page G4-4054
TLBIASIDIS	<i>TLBIASIDIS, TLB Invalidate entry by ASID match, Inner Shareable</i> on page G4-4055
TLBIIPAS2	<i>TLBIIPAS2, TLB Invalidate entry by Intermediate Physical Address, Stage 2</i> on page G4-4056
TLBIIPAS2IS	<i>TLBIIPAS2IS, TLB Invalidate entry by Intermediate Physical Address, Stage 2, Inner Shareable</i> on page G4-4057
TLBIIPAS2L	<i>TLBIIPAS2L, TLB Invalidate entry by Intermediate Physical Address, Stage 2, Last level</i> on page G4-4058
TLBIIPAS2LIS	<i>TLBIIPAS2LIS, TLB Invalidate entry by Intermediate Physical Address, Stage 2, Last level, Inner Shareable</i> on page G4-4059
TLBIMVA	<i>TLBIMVA, TLB Invalidate entry by VA</i> on page G4-4060
TLBIMVAA	<i>TLBIMVAA, TLB Invalidate entry by VA, All ASID</i> on page G4-4061

Table J-17 Alphabetical index of AArch32 Registers (continued)

Register	Description, see
TLBIMVAAIS	<i>TLBIMVAAIS, TLB Invalidate entry by VA, All ASID, Inner Shareable on page G4-4062</i>
TLBIMVAAL	<i>TLBIMVAAL, TLB Invalidate entry by VA, All ASID, Last level on page G4-4063</i>
TLBIMVAALIS	<i>TLBIMVAALIS, TLB Invalidate entry by VA, All ASID, Last level, Inner Shareable on page G4-4064</i>
TLBIMVAH	<i>TLBIMVAH, TLB Invalidate entry by VA, Hyp mode on page G4-4065</i>
TLBIMVAHIS	<i>TLBIMVAHIS, TLB Invalidate entry by VA, Hyp mode, Inner Shareable on page G4-4066</i>
TLBIMVAIS	<i>TLBIMVAIS, TLB Invalidate entry by VA, Inner Shareable on page G4-4068</i>
TLBIMVAL	<i>TLBIMVAL, TLB Invalidate entry by VA, Last level on page G4-4069</i>
TLBIMVALH	<i>TLBIMVALH, TLB Invalidate entry by VA, Last level, Hyp mode on page G4-4070</i>
TLBIMVALHIS	<i>TLBIMVALHIS, TLB Invalidate entry by VA, Last level, Hyp mode, Inner Shareable on page G4-4072</i>
TLBIMVALIS	<i>TLBIMVALIS, TLB Invalidate entry by VA, Last level, Inner Shareable on page G4-4074</i>
TLBTR	<i>TLBTR, TLB Type Register on page G4-4075</i>
TPIDRPRW	<i>TPIDRPRW, Thread Pointer / ID Register, Privileged Read-Write on page G4-4076</i>
TPIDRURO	<i>TPIDRURO, Thread Pointer / ID Register, Unprivileged Read-Only on page G4-4077</i>
TPIDRURW	<i>TPIDRURW, Thread Pointer / ID Register, Unprivileged Read-Write on page G4-4078</i>
TTBCR	<i>TTBCR, Translation Table Base Control Register on page G4-4079</i>
TTBR0	<i>TTBR0, Translation Table Base Register 0 on page G4-4084</i>
TTBR1	<i>TTBR1, Translation Table Base Register 1 on page G4-4088</i>
VBAR	<i>VBAR, Vector Base Address Register on page G4-4091</i>
VMPIDR	<i>VMPIDR, Virtualization Multiprocessor ID Register on page G4-4093</i>
VPIDR	<i>VPIDR, Virtualization Processor ID Register on page G4-4095</i>
VTCR	<i>VTCR, Virtualization Translation Control Register on page G4-4097</i>
VTTBR	<i>VTTBR, Virtualization Translation Table Base Register on page G4-4099</i>

J.5 Functional index of AArch32 registers and system instructions

This section is an index of the AArch32 registers and system instructions, divided by functional group.

J.5.1 Special-purpose registers

This section is an index to the registers in the Processor state and Special-purpose functional groups.

Table J-18 Special-purpose registers

Register	Description, see
DLR	<i>DLR, Debug Link Register</i> on page G4-4158
DSPSR	<i>DSPSR, Debug Saved Program Status Register</i> on page G4-4159
ELR_hyp	<i>ELR_hyp, Exception Link Register (Hyp mode)</i> on page G4-3839
FPSCR	<i>FPSCR, Floating-Point Status and Control Register</i> on page G4-3845
SPSR_abt	<i>SPSR_abt, Saved Program Status Register (Abort mode)</i> on page G4-4015
SPSR_fiq	<i>SPSR_fiq, Saved Program Status Register (FIQ mode)</i> on page G4-4019
SPSR_hyp	<i>SPSR_hyp, Saved Program Status Register (Hyp mode)</i> on page G4-4023
SPSR_irq	<i>SPSR_irq, Saved Program Status Register (IRQ mode)</i> on page G4-4027
SPSR_mon	<i>SPSR_mon, Saved Program Status Register (Monitor mode)</i> on page G4-4031
SPSR_svc	<i>SPSR_svc, Saved Program Status Register (Sup. Call mode)</i> on page G4-4035
SPSR_und	<i>SPSR_und, Saved Program Status Register (Undefined mode)</i> on page G4-4039

J.5.2 VMSA-specific registers

This section is an index to the registers in the Virtual memory control functional group.

Table J-19 VMSA-specific registers

Register	Description, see
AMAIRO	<i>AMAIRO, Auxiliary Memory Attribute Indirection Register 0</i> on page G4-3780
AMAIR1	<i>AMAIR1, Auxiliary Memory Attribute Indirection Register 1</i> on page G4-3782
CONTEXTIDR	<i>CONTEXTIDR, Context ID Register</i> on page G4-3803
DACR	<i>DACR, Domain Access Control Register</i> on page G4-3817
HAMAIRO	<i>HAMAIRO, Hyp Auxiliary Memory Attribute Indirection Register 0</i> on page G4-3856
HMAIR1	<i>HMAIR1, Hyp Auxiliary Memory Attribute Indirection Register 1</i> on page G4-3857
HMAIRO	<i>HMAIRO, Hyp Memory Attribute Indirection Register 0</i> on page G4-3871
HMAIR1	<i>HMAIR1, Hyp Memory Attribute Indirection Register 1</i> on page G4-3874
HTCR	<i>HTCR, Hyp Translation Control Register</i> on page G4-3902
HTTBR	<i>HTTBR, Hyp Translation Table Base Register</i> on page G4-3905
MAIRO	<i>MAIRO, Memory Attribute Indirection Register 0</i> on page G4-3962
MAIR1	<i>MAIR1, Memory Attribute Indirection Register 1</i> on page G4-3965

Table J-19 VMSA-specific registers (continued)

Register	Description, see
NMRR	<i>NMRR, Normal Memory Remap Register on page G4-3982</i>
PRRR	<i>PRRR, Primary Region Remap Register on page G4-3992</i>
TTBCR	<i>TTBCR, Translation Table Base Control Register on page G4-4079</i>
TTBR0	<i>TTBR0, Translation Table Base Register 0 on page G4-4084</i>
TTBR1	<i>TTBR1, Translation Table Base Register 1 on page G4-4088</i>
VTCT	<i>VTCT, Virtualization Translation Control Register on page G4-4097</i>
VTBTR	<i>VTBTR, Virtualization Translation Table Base Register on page G4-4099</i>

J.5.3 ID registers

This section is an index to the registers in the Identification functional group.

Table J-20 ID registers

Register	Description, see
AIDR	<i>AIDR, Auxiliary ID Register on page G4-3777</i>
CCSIDR	<i>CCSIDR, Current Cache Size ID Register on page G4-3799</i>
CLIDR	<i>CLIDR, Cache Level ID Register on page G4-3801</i>
CSSELR	<i>CSSELR, Cache Size Selection Register on page G4-3813</i>
CTR	<i>CTR, Cache Type Register on page G4-3815</i>
FPSID	<i>FPSID, Floating-Point System ID register on page G4-3850</i>
ID_AFR0	<i>ID_AFR0, Auxiliary Feature Register 0 on page G4-3911</i>
ID_DFR0	<i>ID_DFR0, Debug Feature Register 0 on page G4-3912</i>
ID_ISAR0	<i>ID_ISAR0, Instruction Set Attribute Register 0 on page G4-3914</i>
ID_ISAR1	<i>ID_ISAR1, Instruction Set Attribute Register 1 on page G4-3916</i>
ID_ISAR2	<i>ID_ISAR2, Instruction Set Attribute Register 2 on page G4-3919</i>
ID_ISAR3	<i>ID_ISAR3, Instruction Set Attribute Register 3 on page G4-3922</i>
ID_ISAR4	<i>ID_ISAR4, Instruction Set Attribute Register 4 on page G4-3925</i>
ID_ISAR5	<i>ID_ISAR5, Instruction Set Attribute Register 5 on page G4-3928</i>
ID_MMFR0	<i>ID_MMFR0, Memory Model Feature Register 0 on page G4-3930</i>
ID_MMFR1	<i>ID_MMFR1, Memory Model Feature Register 1 on page G4-3933</i>
ID_MMFR2	<i>ID_MMFR2, Memory Model Feature Register 2 on page G4-3937</i>
ID_MMFR3	<i>ID_MMFR3, Memory Model Feature Register 3 on page G4-3940</i>
ID_PFR0	<i>ID_PFR0, Processor Feature Register 0 on page G4-3943</i>
ID_PFR1	<i>ID_PFR1, Processor Feature Register 1 on page G4-3945</i>

Table J-20 ID registers (continued)

Register	Description, see
MIDR	<i>MIDR, Main ID Register</i> on page G4-3968
MPIDR	<i>MPIDR, Multiprocessor Affinity Register</i> on page G4-3970
MVFR0	<i>MVFR0, Media and VFP Feature Register 0</i> on page G4-3974
MVFR1	<i>MVFR1, Media and VFP Feature Register 1</i> on page G4-3977
MVFR2	<i>MVFR2, Media and VFP Feature Register 2</i> on page G4-3980
REVIDR	<i>REVIDR, Revision ID Register</i> on page G4-3995
TCMTR	<i>TCMTR, TCM Type Register</i> on page G4-4043
TLBTR	<i>TLBTR, TLB Type Register</i> on page G4-4075
VMPIDR	<i>VMPIDR, Virtualization Multiprocessor ID Register</i> on page G4-4093
VPIDR	<i>VPIDR, Virtualization Processor ID Register</i> on page G4-4095

J.5.4 Performance monitors registers

This section is an index to the registers in the Performance Monitors functional group.

Table J-21 Performance monitors registers

Register	Description, see
PMCCFILTR	<i>PMCCFILTR, Performance Monitors Cycle Count Filter Register</i> on page G4-4170
PMCCNTR	<i>PMCCNTR, Performance Monitors Cycle Count Register</i> on page G4-4172
PMCEID0	<i>PMCEID0, Performance Monitors Common Event Identification register 0</i> on page G4-4174
PMCEID1	<i>PMCEID1, Performance Monitors Common Event Identification register 1</i> on page G4-4176
PMCNTENCLR	<i>PMCNTENCLR, Performance Monitors Count Enable Clear register</i> on page G4-4178
PMCNTENSET	<i>PMCNTENSET, Performance Monitors Count Enable Set register</i> on page G4-4180
PMCR	<i>PMCR, Performance Monitors Control Register</i> on page G4-4182
PMEVCNTR<n>	<i>PMEVCNTR<n>, Performance Monitors Event Count Registers, n = 0 - 30</i> on page G4-4185
PMEVTYPER<n>	<i>PMEVTYPER<n>, Performance Monitors Event Type Registers, n = 0 - 30</i> on page G4-4187
PMINTENCLR	<i>PMINTENCLR, Performance Monitors Interrupt Enable Clear register</i> on page G4-4190
PMINTENSET	<i>PMINTENSET, Performance Monitors Interrupt Enable Set register</i> on page G4-4192
PMOVSRR	<i>PMOVSRR, Performance Monitors Overflow Flag Status Register</i> on page G4-4194
PMOVSSET	<i>PMOVSSET, Performance Monitors Overflow Flag Status Set register</i> on page G4-4196
PMSELR	<i>PMSELR, Performance Monitors Event Counter Selection Register</i> on page G4-4198
PMSWINC	<i>PMSWINC, Performance Monitors Software Increment register</i> on page G4-4200

Table J-21 Performance monitors registers (continued)

Register	Description, see
PMUSERENR	<i>PMUSERENR, Performance Monitors User Enable Register on page G4-4202</i>
PMXEVCNTR	<i>PMXEVCNTR, Performance Monitors Selected Event Count Register on page G4-4204</i>
PMXEVTYPER	<i>PMXEVTYPER, Performance Monitors Selected Event Type Register on page G4-4206</i>

J.5.5 Debug registers

This section is an index to the registers in the Debug functional group.

Table J-22 Debug registers

Register	Description, see
DBGAUTHSTATUS	<i>DBGAUTHSTATUS, Debug Authentication Status register on page G4-4101</i>
DBGBCR<n>	<i>DBGBCR<n>, Debug Breakpoint Control Registers, n = 0 - 15 on page G4-4103</i>
DBGBVR<n>	<i>DBGBVR<n>, Debug Breakpoint Value Registers, n = 0 - 15 on page G4-4106</i>
DBGBXVR<n>	<i>DBGBXVR<n>, Debug Breakpoint Extended Value Registers, n = 0 - 15 on page G4-4108</i>
DBGCLAIMCLR	<i>DBGCLAIMCLR, Debug Claim Tag Clear register on page G4-4110</i>
DBGCLAIMSET	<i>DBGCLAIMSET, Debug Claim Tag Set register on page G4-4112</i>
DBGDCCINT	<i>DBGDCCINT, DCC Interrupt Enable Register on page G4-4114</i>
DBGDEVID	<i>DBGDEVID, Debug Device ID register 0 on page G4-4116</i>
DBGDEVID1	<i>DBGDEVID1, Debug Device ID register 1 on page G4-4118</i>
DBGDEVID2	<i>DBGDEVID2, Debug Device ID register 2 on page G4-4119</i>
DBGDIDR	<i>DBGDIDR, Debug ID Register on page G4-4120</i>
DBGDRAR	<i>DBGDRAR, Debug ROM Address Register on page G4-4122</i>
DBGDSAR	<i>DBGDSAR, Debug Self Address Register on page G4-4124</i>
DBGDSCRext	<i>DBGDSCRext, Debug Status and Control Register, External View on page G4-4126</i>
DBGDSCRint	<i>DBGDSCRint, Debug Status and Control Register, Internal View on page G4-4130</i>
DBGDTRRXext	<i>DBGDTRRXext, Debug Data Transfer Register, Receive, External View on page G4-4132</i>
DBGDTRRXint	<i>DBGDTRRXint, Debug Data Transfer Register, Receive, Internal View on page G4-4134</i>
DBGDTRTXext	<i>DBGDTRTXext, Debug Data Transfer Register, Transmit, External View on page G4-4136</i>
DBGDTRTXint	<i>DBGDTRTXint, Debug Data Transfer Register, Transmit, Internal View on page G4-4138</i>
DBGOSDLR	<i>DBGOSDLR, Debug OS Double Lock Register on page G4-4140</i>
DBGOSECCR	<i>DBGOSECCR, Debug OS Lock Exception Catch Control Register on page G4-4141</i>
DBGOSLAR	<i>DBGOSLAR, Debug OS Lock Access Register on page G4-4142</i>
DBGOSLSR	<i>DBGOSLSR, Debug OS Lock Status Register on page G4-4143</i>
DBGPRCR	<i>DBGPRCR, Debug Power Control Register on page G4-4145</i>

Table J-22 Debug registers (continued)

Register	Description, see
DBGVCR	<i>DBGVCR, Debug Vector Catch Register</i> on page G4-4147
DBGWCR<n>	<i>DBGWCR<n>, Debug Watchpoint Control Registers, n = 0 - 15</i> on page G4-4153
DBGWFAR	<i>DBGWFAR, Debug Watchpoint Fault Address Register</i> on page G4-4156
DBGWVR<n>	<i>DBGWVR<n>, Debug Watchpoint Value Registers, n = 0 - 15</i> on page G4-4157
DLR	<i>DLR, Debug Link Register</i> on page G4-4158
DSPSR	<i>DSPSR, Debug Saved Program Status Register</i> on page G4-4159
HDCCR	<i>HDCCR, Hyp Debug Control Register</i> on page G4-4163
SDCR	<i>SDCR, Secure Debug Configuration Register</i> on page G4-4166
SDER	<i>SDER, Secure Debug Enable Register</i> on page G4-4168

J.5.6 Generic timer registers

This section is an index to the registers in the Generic Timer functional group.

Table J-23 Generic timer registers

Register	Description, see
CNTFRQ	<i>CNTFRQ, Counter-timer Frequency register</i> on page G4-4208
CNTHCTL	<i>CNTHCTL, Counter-timer Hyp Control register</i> on page G4-4209
CNTHP_CTL	<i>CNTHP_CTL, Counter-timer Hyp Physical Timer Control register</i> on page G4-4211
CNTHP_CVAL	<i>CNTHP_CVAL, Counter-timer Hyp Physical CompareValue register</i> on page G4-4213
CNTHP_TVAL	<i>CNTHP_TVAL, Counter-timer Hyp Physical Timer TimerValue register</i> on page G4-4214
CNTKCTL	<i>CNTKCTL, Counter-timer Kernel Control register</i> on page G4-4215
CNTP_CTL	<i>CNTP_CTL, Counter-timer Physical Timer Control register</i> on page G4-4217
CNTP_CVAL	<i>CNTP_CVAL, Counter-timer Physical Timer CompareValue register</i> on page G4-4219
CNTP_TVAL	<i>CNTP_TVAL, Counter-timer Physical Timer TimerValue register</i> on page G4-4221
CNTPCT	<i>CNTPCT, Counter-timer Physical Count register</i> on page G4-4223
CNTV_CTL	<i>CNTV_CTL, Counter-timer Virtual Timer Control register</i> on page G4-4224
CNTV_CVAL	<i>CNTV_CVAL, Counter-timer Virtual Timer CompareValue register</i> on page G4-4226
CNTV_TVAL	<i>CNTV_TVAL, Counter-timer Virtual Timer TimerValue register</i> on page G4-4227
CNTVCT	<i>CNTVCT, Counter-timer Virtual Count register</i> on page G4-4228
CNTVOFF	<i>CNTVOFF, Counter-timer Virtual Offset register</i> on page G4-4229

J.5.7 Generic Interrupt Controller CPU interface registers

This section is an index to the registers in the GIC functional group.

Table J-24 Generic Interrupt Controller CPU interface registers

Register	Description, see
ICC_AP0R0	<i>ICC_AP0R0, Interrupt Controller Active Priorities Register (0,0) on page G4-4230</i>
ICC_AP0R1	<i>ICC_AP0R1, Interrupt Controller Active Priorities Register (0,1) on page G4-4232</i>
ICC_AP0R2	<i>ICC_AP0R2, Interrupt Controller Active Priorities Register (0,2) on page G4-4234</i>
ICC_AP0R3	<i>ICC_AP0R3, Interrupt Controller Active Priorities Register (0,3) on page G4-4236</i>
ICC_AP1R0	<i>ICC_AP1R0, Interrupt Controller Active Priorities Register (1,0) on page G4-4238</i>
ICC_AP1R1	<i>ICC_AP1R1, Interrupt Controller Active Priorities Register (1,1) on page G4-4240</i>
ICC_AP1R2	<i>ICC_AP1R2, Interrupt Controller Active Priorities Register (1,2) on page G4-4242</i>
ICC_AP1R3	<i>ICC_AP1R3, Interrupt Controller Active Priorities Register (1,3) on page G4-4244</i>
ICC_ASGI1R	<i>ICC_ASGI1R, Interrupt Controller Alias Software Generated Interrupt group 1 Register on page G4-4246</i>
ICC_BPR0	<i>ICC_BPR0, Interrupt Controller Binary Point Register 0 on page G4-4248</i>
ICC_BPR1	<i>ICC_BPR1, Interrupt Controller Binary Point Register 1 on page G4-4250</i>
ICC_CTLR	<i>ICC_CTLR, Interrupt Controller Control Register on page G4-4252</i>
ICC_DIR	<i>ICC_DIR, Interrupt Controller Deactivate Interrupt Register on page G4-4255</i>
ICC_EOIR0	<i>ICC_EOIR0, Interrupt Controller End Of Interrupt Register 0 on page G4-4256</i>
ICC_EOIR1	<i>ICC_EOIR1, Interrupt Controller End Of Interrupt Register 1 on page G4-4258</i>
ICC_HPPIR0	<i>ICC_HPPIR0, Interrupt Controller Highest Priority Pending Interrupt Register 0 on page G4-4260</i>
ICC_HPPIR1	<i>ICC_HPPIR1, Interrupt Controller Highest Priority Pending Interrupt Register 1 on page G4-4262</i>
ICC_HSRE	<i>ICC_HSRE, Interrupt Controller Hyp System Register Enable register on page G4-4263</i>
ICC_IAR0	<i>ICC_IAR0, Interrupt Controller Interrupt Acknowledge Register 0 on page G4-4265</i>
ICC_IAR1	<i>ICC_IAR1, Interrupt Controller Interrupt Acknowledge Register 1 on page G4-4267</i>
ICC_IGRPEN0	<i>ICC_IGRPEN0, Interrupt Controller Interrupt Group 0 Enable register on page G4-4268</i>
ICC_IGRPEN1	<i>ICC_IGRPEN1, Interrupt Controller Interrupt Group 1 Enable register on page G4-4270</i>
ICC_MCTLR	<i>ICC_MCTLR, Interrupt Controller Monitor Control Register on page G4-4271</i>
ICC_MGRPEN1	<i>ICC_MGRPEN1, Interrupt Controller Monitor Interrupt Group 1 Enable register on page G4-4274</i>
ICC_MSRE	<i>ICC_MSRE, Interrupt Controller Monitor System Register Enable register on page G4-4276</i>
ICC_PMR	<i>ICC_PMR, Interrupt Controller Interrupt Priority Mask Register on page G4-4278</i>
ICC_RPR	<i>ICC_RPR, Interrupt Controller Running Priority Register on page G4-4280</i>
ICC_SEIEN	<i>ICC_SEIEN, Interrupt Controller System Error Interrupt Enable register on page G4-4281</i>
ICC_SGI0R	<i>ICC_SGI0R, Interrupt Controller Software Generated Interrupt group 0 Register on page G4-4282</i>
ICC_SGI1R	<i>ICC_SGI1R, Interrupt Controller Software Generated Interrupt group 1 Register on page G4-4284</i>

Table J-24 Generic Interrupt Controller CPU interface registers (continued)

Register	Description, see
ICC_SRE	<i>ICC_SRE, Interrupt Controller System Register Enable register on page G4-4286</i>
ICH_AP0R0	<i>ICH_AP0R0, Interrupt Controller Hyp Active Priorities Register (0,0) on page G4-4288</i>
ICH_AP0R1	<i>ICH_AP0R1, Interrupt Controller Hyp Active Priorities Register (0,1) on page G4-4290</i>
ICH_AP0R2	<i>ICH_AP0R2, Interrupt Controller Hyp Active Priorities Register (0,2) on page G4-4292</i>
ICH_AP0R3	<i>ICH_AP0R3, Interrupt Controller Hyp Active Priorities Register (0,3) on page G4-4294</i>
ICH_AP1R0	<i>ICH_AP1R0, Interrupt Controller Hyp Active Priorities Register (1,0) on page G4-4296</i>
ICH_AP1R1	<i>ICH_AP1R1, Interrupt Controller Hyp Active Priorities Register (1,1) on page G4-4298</i>
ICH_AP1R2	<i>ICH_AP1R2, Interrupt Controller Hyp Active Priorities Register (1,2) on page G4-4300</i>
ICH_AP1R3	<i>ICH_AP1R3, Interrupt Controller Hyp Active Priorities Register (1,3) on page G4-4302</i>
ICH_EISR	<i>ICH_EISR, Interrupt Controller End of Interrupt Status Register on page G4-4304</i>
ICH_ELSR	<i>ICH_ELSR, Interrupt Controller Empty List Register Status Register on page G4-4306</i>
ICH_HCR	<i>ICH_HCR, Interrupt Controller Hyp Control Register on page G4-4308</i>
ICH_LRC<n>	<i>ICH_LRC<n>, Interrupt Controller List Registers, n = 0 - 15 on page G4-4311</i>
ICH_LR<n>	<i>ICH_LR<n>, Interrupt Controller List Registers, n = 0 - 15 on page G4-4313</i>
ICH_MISR	<i>ICH_MISR, Interrupt Controller Maintenance Interrupt State Register on page G4-4314</i>
ICH_VMCR	<i>ICH_VMCR, Interrupt Controller Virtual Machine Control Register on page G4-4316</i>
ICH_VSEIR	<i>ICH_VSEIR, Interrupt Controller Virtual System Error Interrupt Register on page G4-4318</i>
ICH_VTR	<i>ICH_VTR, Interrupt Controller VGIC Type Register on page G4-4319</i>

J.5.8 Cache maintenance system instructions

This section is an index to the system instructions in the Cache maintenance functional group.

Table J-25 Cache maintenance system instructions

Register	Description, see
BPIALL	<i>BPIALL, Branch Predictor Invalidate All on page G4-3796</i>
BPIALLIS	<i>BPIALLIS, Branch Predictor Invalidate All, Inner Shareable on page G4-3797</i>
BPIMVA	<i>BPIMVA, Branch Predictor Invalidate VA on page G4-3798</i>
DCCIMVAC	<i>DCCIMVAC, Data Cache line Clean and Invalidate by VA to PoC on page G4-3819</i>
DCCISW	<i>DCCISW, Data Cache line Clean and Invalidate by Set/Way on page G4-3820</i>
DCCMVAC	<i>DCCMVAC, Data Cache line Clean by VA to PoC on page G4-3822</i>
DCCMVAU	<i>DCCMVAU, Data Cache line Clean by VA to PoU on page G4-3823</i>
DCCSW	<i>DCCSW, Data Cache line Clean by Set/Way on page G4-3824</i>
DCIMVAC	<i>DCIMVAC, Data Cache line Invalidate by VA to PoC on page G4-3826</i>

Table J-25 Cache maintenance system instructions (continued)

Register	Description, see
DCISW	<i>DCISW, Data Cache line Invalidate by Set/Way</i> on page G4-3827
ICIALLU	<i>ICIALLU, Instruction Cache Invalidate All to PoU</i> on page G4-3908
ICIALLUIS	<i>ICIALLUIS, Instruction Cache Invalidate All to PoU, Inner Shareable</i> on page G4-3909
ICIMVAU	<i>ICIMVAU, Instruction Cache line Invalidate by VA to PoU</i> on page G4-3910

J.5.9 Address translation system instructions

This section is an index to the system instructions in the Address translation functional group.

Table J-26 Address translation system instructions

Register	Description, see
ATS12NSOPR	<i>ATS12NSOPR, Address Translate Stages 1 and 2 Non-secure Only PL1 Read</i> on page G4-3786
ATS12NSOPW	<i>ATS12NSOPW, Address Translate Stages 1 and 2 Non-secure Only PL1 Write</i> on page G4-3787
ATS12NSOUR	<i>ATS12NSOUR, Address Translate Stages 1 and 2 Non-secure Only Unprivileged Read</i> on page G4-3788
ATS12NSOUW	<i>ATS12NSOUW, Address Translate Stages 1 and 2 Non-secure Only Unprivileged Write</i> on page G4-3789
ATS1CPR	<i>ATS1CPR, Address Translate Stage 1 Current state PL1 Read</i> on page G4-3790
ATS1CPW	<i>ATS1CPW, Address Translate Stage 1 Current state PL1 Write</i> on page G4-3791
ATS1CUR	<i>ATS1CUR, Address Translate Stage 1 Current state Unprivileged Read</i> on page G4-3792
ATS1CUW	<i>ATS1CUW, Address Translate Stage 1 Current state Unprivileged Write</i> on page G4-3793
ATS1HR	<i>ATS1HR, Address Translate Stage 1 Hyp mode Read</i> on page G4-3794
ATS1HW	<i>ATS1HW, Address Translate Stage 1 Hyp mode Write</i> on page G4-3795

J.5.10 TLB maintenance system instructions

This section is an index to the system instructions in the TLB maintenance functional group.

Table J-27 TLB maintenance system instructions

Register	Description, see
DTLBIALL	<i>DTLBIALL, Data TLB Invalidate All entries</i> on page G4-3836
DTLBIASID	<i>DTLBIASID, Data TLB Invalidate by ASID match</i> on page G4-3837
DTLBIMVA	<i>DTLBIMVA, Data TLB Invalidate entry by VA</i> on page G4-3838
ITLBIALL	<i>ITLBIALL, Instruction TLB Invalidate All entries</i> on page G4-3956
ITLBIASID	<i>ITLBIASID, Instruction TLB Invalidate by ASID match</i> on page G4-3957
ITLBIMVA	<i>ITLBIMVA, Instruction TLB Invalidate entry by VA</i> on page G4-3958

Table J-27 TLB maintenance system instructions (continued)

Register	Description, see
TLBIALL	<i>TLBIALL, TLB Invalidate All entries on page G4-4048</i>
TLBIALLH	<i>TLBIALLH, TLB Invalidate All entries, Hyp mode on page G4-4049</i>
TLBIALLHIS	<i>TLBIALLHIS, TLB Invalidate All entries, Hyp mode, Inner Shareable on page G4-4050</i>
TLBIALLIS	<i>TLBIALLIS, TLB Invalidate All entries, Inner Shareable on page G4-4051</i>
TLBIALLNSNH	<i>TLBIALLNSNH, TLB Invalidate All entries, Non-Secure Non-Hyp on page G4-4052</i>
TLBIALLNSNHIS	<i>TLBIALLNSNHIS, TLB Invalidate All entries, Non-Secure Non-Hyp, Inner Shareable on page G4-4053</i>
TLBIASID	<i>TLBIASID, TLB Invalidate entry by ASID match on page G4-4054</i>
TLBIASIDIS	<i>TLBIASIDIS, TLB Invalidate entry by ASID match, Inner Shareable on page G4-4055</i>
TLBIIPAS2	<i>TLBIIPAS2, TLB Invalidate entry by Intermediate Physical Address, Stage 2 on page G4-4056</i>
TLBIIPAS2IS	<i>TLBIIPAS2IS, TLB Invalidate entry by Intermediate Physical Address, Stage 2, Inner Shareable on page G4-4057</i>
TLBIIPAS2L	<i>TLBIIPAS2L, TLB Invalidate entry by Intermediate Physical Address, Stage 2, Last level on page G4-4058</i>
TLBIIPAS2LIS	<i>TLBIIPAS2LIS, TLB Invalidate entry by Intermediate Physical Address, Stage 2, Last level, Inner Shareable on page G4-4059</i>
TLBIMVA	<i>TLBIMVA, TLB Invalidate entry by VA on page G4-4060</i>
TLBIMVAA	<i>TLBIMVAA, TLB Invalidate entry by VA, All ASID on page G4-4061</i>
TLBIMVAAIS	<i>TLBIMVAAIS, TLB Invalidate entry by VA, All ASID, Inner Shareable on page G4-4062</i>
TLBIMVAAL	<i>TLBIMVAAL, TLB Invalidate entry by VA, All ASID, Last level on page G4-4063</i>
TLBIMVAALIS	<i>TLBIMVAALIS, TLB Invalidate entry by VA, All ASID, Last level, Inner Shareable on page G4-4064</i>
TLBIMVAH	<i>TLBIMVAH, TLB Invalidate entry by VA, Hyp mode on page G4-4065</i>
TLBIMVAHIS	<i>TLBIMVAHIS, TLB Invalidate entry by VA, Hyp mode, Inner Shareable on page G4-4066</i>
TLBIMVAIS	<i>TLBIMVAIS, TLB Invalidate entry by VA, Inner Shareable on page G4-4068</i>
TLBIMVAL	<i>TLBIMVAL, TLB Invalidate entry by VA, Last level on page G4-4069</i>
TLBIMVALH	<i>TLBIMVALH, TLB Invalidate entry by VA, Last level, Hyp mode on page G4-4070</i>
TLBIMVALHIS	<i>TLBIMVALHIS, TLB Invalidate entry by VA, Last level, Hyp mode, Inner Shareable on page G4-4072</i>
TLBIMVALIS	<i>TLBIMVALIS, TLB Invalidate entry by VA, Last level, Inner Shareable on page G4-4074</i>

J.5.11 Legacy feature registers and system instructions

This section is an index to the registers and system instructions in the Legacy feature functional group.

Table J-28 Legacy feature registers and system instructions

Register	Description, see
CP15DMB	<i>CP15DMB, CP15 Data Memory Barrier operation on page G4-3805</i>
CP15DSB	<i>CP15DSB, CP15 Data Synchronization Barrier operation on page G4-3806</i>
CP15ISB	<i>CP15ISB, CP15 Instruction Synchronization Barrier operation on page G4-3807</i>
FCSEIDR	<i>FCSEIDR, FCSE Process ID register on page G4-3840</i>
JIDR	<i>JIDR, Jazelle ID Register on page G4-3959</i>
JMCR	<i>JMCR, Jazelle Main Configuration Register on page G4-3960</i>
JOSCR	<i>JOSCR, Jazelle OS Control Register on page G4-3961</i>
TEECR	<i>TEECR, T32EE Configuration Register on page G4-4045</i>
TEEHBR	<i>TEEHBR, T32EE Handler Base Register on page G4-4047</i>

J.5.12 Base system registers

This section is an index to the registers that are not a part of any of the other functional groups in this index.

Table J-29 Base system registers

Register	Description, see
ACTLR	<i>ACTLR, Auxiliary Control Register on page G4-3773</i>
ADFSR	<i>ADFSR, Auxiliary Data Fault Status Register on page G4-3775</i>
AIFSR	<i>AIFSR, Auxiliary Instruction Fault Status Register on page G4-3778</i>
APSR	<i>APSR, Application Program Status Register on page G4-3784</i>
CPACR	<i>CPACR, Architectural Feature Access Control Register on page G4-3808</i>
CPSR	<i>CPSR, Current Program Status Register on page G4-3810</i>
DFAR	<i>DFAR, Data Fault Address Register on page G4-3829</i>
DFSR	<i>DFSR, Data Fault Status Register on page G4-3831</i>
FPEXC	<i>FPEXC, Floating-Point Exception Control register on page G4-3841</i>
HACR	<i>HACR, Hyp Auxiliary Configuration Register on page G4-3852</i>
HACTLR	<i>HACTLR, Hyp Auxiliary Control Register on page G4-3853</i>
HADFSR	<i>HADFSR, Hyp Auxiliary Data Fault Status Register on page G4-3854</i>
HAIFSR	<i>HAIFSR, Hyp Auxiliary Instruction Fault Status Register on page G4-3855</i>
HCPTR	<i>HCPTR, Hyp Architectural Feature Trap Register on page G4-3858</i>
HCR	<i>HCR, Hyp Configuration Register on page G4-3861</i>
HCR2	<i>HCR2, Hyp Configuration Register 2 on page G4-3867</i>

Table J-29 Base system registers (continued)

Register	Description, see
HDFAR	<i>HDFAR, Hyp Data Fault Address Register on page G4-3869</i>
HIFAR	<i>HIFAR, Hyp Instruction Fault Address Register on page G4-3870</i>
HPFAR	<i>HPFAR, Hyp IPA Fault Address Register on page G4-3877</i>
HRMR	<i>HRMR, Hyp Reset Management Register on page G4-3878</i>
HSCTLR	<i>HSCTLR, Hyp System Control Register on page G4-3880</i>
HSR	<i>HSR, Hyp Syndrome Register on page G4-3885</i>
HSTR	<i>HSTR, Hyp System Trap Register on page G4-3900</i>
HTPIDR	<i>HTPIDR, Hyp Thread Pointer / ID Register on page G4-3904</i>
HVBAR	<i>HVBAR, Hyp Vector Base Address Register on page G4-3907</i>
IFAR	<i>IFAR, Instruction Fault Address Register on page G4-3948</i>
IFSR	<i>IFSR, Instruction Fault Status Register on page G4-3950</i>
ISR	<i>ISR, Interrupt Status Register on page G4-3954</i>
MVBAR	<i>MVBAR, Monitor Vector Base Address Register on page G4-3972</i>
NSACR	<i>NSACR, Non-Secure Access Control Register on page G4-3984</i>
PAR	<i>PAR, Physical Address Register on page G4-3986</i>
RMR (at EL1)	<i>RMR (at EL1), Reset Management Register on page G4-3996</i>
RMR (at EL3)	<i>RMR (at EL3), Reset Management Register on page G4-3998</i>
RVBAR	<i>RVBAR, Reset Vector Base Address Register on page G4-4000</i>
SCR	<i>SCR, Secure Configuration Register on page G4-4001</i>
SCTLR	<i>SCTLR, System Control Register on page G4-4005</i>
SPSR	<i>SPSR, Saved Program Status Register on page G4-4012</i>
TPIDRPRW	<i>TPIDRPRW, Thread Pointer / ID Register, Privileged Read-Write on page G4-4076</i>
TPIDRURO	<i>TPIDRURO, Thread Pointer / ID Register, Unprivileged Read-Only on page G4-4077</i>
TPIDRURW	<i>TPIDRURW, Thread Pointer / ID Register, Unprivileged Read-Write on page G4-4078</i>
VBAR	<i>VBAR, Vector Base Address Register on page G4-4091</i>

J.6 Alphabetical index of memory-mapped registers

This section is an index of memory-mapped registers in alphabetical order.

Table J-30 Alphabetical index of Memory-Mapped Registers

Register	Description, see
ASICCTL	<i>ASICCTL</i> , CTI External Multiplexer Control register on page H9-4554
CNTACR<n>	<i>CNTACR<n></i> , Counter-timer Access Control Registers, $n = 0 - 7$ on page I1-4648
CNTCR	<i>CNTCR</i> , Counter Control Register on page I1-4650
CNTCV	<i>CNTCV</i> , Counter Count Value register on page I1-4652
CNTELOACR	<i>CNTELOACR</i> , Counter-timer EL0 Access Control Register on page I1-4653
CNTFID0	<i>CNTFID0</i> , Counter Frequency ID on page I1-4655
CNTFID<n>	<i>CNTFID<n></i> , Counter Frequency IDs, $n = 1 - 23$ on page I1-4656
CNTFRQ	<i>CNTFRQ</i> , Counter-timer Frequency on page I1-4657
CNTNSAR	<i>CNTNSAR</i> , Counter-timer Non-secure Access Register on page I1-4658
CNTP_CTL	<i>CNTP_CTL</i> , Counter-timer Physical Timer Control on page I1-4660
CNTP_CVAL	<i>CNTP_CVAL</i> , Counter-timer Physical Timer CompareValue on page I1-4662
CNTP_TVAL	<i>CNTP_TVAL</i> , Counter-timer Physical Timer TimerValue on page I1-4663
CNTPCT	<i>CNTPCT</i> , Counter-timer Physical Count on page I1-4664
CNTSR	<i>CNTSR</i> , Counter Status Register on page I1-4665
CNTTIDR	<i>CNTTIDR</i> , Counter-timer Timer ID Register on page I1-4667
CNTV_CTL	<i>CNTV_CTL</i> , Counter-timer Virtual Timer Control on page I1-4669
CNTV_CVAL	<i>CNTV_CVAL</i> , Counter-timer Virtual Timer CompareValue on page I1-4671
CNTV_TVAL	<i>CNTV_TVAL</i> , Counter-timer Virtual Timer TimerValue on page I1-4673
CNTVCT	<i>CNTVCT</i> , Counter-timer Virtual Count on page I1-4674
CNTVOFF	<i>CNTVOFF</i> , Counter-timer Virtual Offset on page I1-4675
CNTVOFF<n>	<i>CNTVOFF<n></i> , Counter-timer Virtual Offsets, $n = 0 - 7$ on page I1-4676
CounterID<n>	<i>CounterID<n></i> , Counter ID registers, $n = 0 - 11$ on page I1-4677
CTIAPPCLEAR	<i>CTIAPPCLEAR</i> , CTI Application Trigger Clear register on page H9-4555
CTIAPPULSE	<i>CTIAPPULSE</i> , CTI Application Pulse register on page H9-4556
CTIAPPSET	<i>CTIAPPSET</i> , CTI Application Trigger Set register on page H9-4557
CTIAUTHSTATUS	<i>CTIAUTHSTATUS</i> , CTI Authentication Status register on page H9-4558
CTICHINSTATUS	<i>CTICHINSTATUS</i> , CTI Channel In Status register on page H9-4560
CTICHOUTSTATUS	<i>CTICHOUTSTATUS</i> , CTI Channel Out Status register on page H9-4561
CTICIDR0	<i>CTICIDR0</i> , CTI Component Identification Register 0 on page H9-4562
CTICIDR1	<i>CTICIDR1</i> , CTI Component Identification Register 1 on page H9-4563

Table J-30 Alphabetical index of Memory-Mapped Registers (continued)

Register	Description, see
CTICIDR2	<i>CTICIDR2, CTI Component Identification Register 2</i> on page H9-4564
CTICIDR3	<i>CTICIDR3, CTI Component Identification Register 3</i> on page H9-4565
CTICLAIMCLR	<i>CTICLAIMCLR, CTI Claim Tag Clear register</i> on page H9-4566
CTICLAIMSET	<i>CTICLAIMSET, CTI Claim Tag Set register</i> on page H9-4567
CTICONTROL	<i>CTICONTROL, CTI Control register</i> on page H9-4568
CTIDEVAFF0	<i>CTIDEVAFF0, CTI Device Affinity register 0</i> on page H9-4569
CTIDEVAFF1	<i>CTIDEVAFF1, CTI Device Affinity register 1</i> on page H9-4570
CTIDEVARCH	<i>CTIDEVARCH, CTI Device Architecture register</i> on page H9-4571
CTIDEVID	<i>CTIDEVID, CTI Device ID register 0</i> on page H9-4573
CTIDEVID1	<i>CTIDEVID1, CTI Device ID register 1</i> on page H9-4575
CTIDEVID2	<i>CTIDEVID2, CTI Device ID register 2</i> on page H9-4576
CTIDEVTYPE	<i>CTIDEVTYPE, CTI Device Type register</i> on page H9-4577
CTIGATE	<i>CTIGATE, CTI Channel Gate Enable register</i> on page H9-4578
CTIINEN<n>	<i>CTIINEN<n>, CTI Input Trigger to Output Channel Enable registers, n = 0 - 31</i> on page H9-4579
CTIINTACK	<i>CTIINTACK, CTI Output Trigger Acknowledge register</i> on page H9-4580
CTIITCTRL	<i>CTIITCTRL, CTI Integration mode Control register</i> on page H9-4582
CTILAR	<i>CTILAR, CTI Lock Access Register</i> on page H9-4583
CTILSR	<i>CTILSR, CTI Lock Status Register</i> on page H9-4584
CTIOUTEN<n>	<i>CTIOUTEN<n>, CTI Input Channel to Output Trigger Enable registers, n = 0 - 31</i> on page H9-4586
CTIPIDR0	<i>CTIPIDR0, CTI Peripheral Identification Register 0</i> on page H9-4587
CTIPIDR1	<i>CTIPIDR1, CTI Peripheral Identification Register 1</i> on page H9-4588
CTIPIDR2	<i>CTIPIDR2, CTI Peripheral Identification Register 2</i> on page H9-4589
CTIPIDR3	<i>CTIPIDR3, CTI Peripheral Identification Register 3</i> on page H9-4590
CTIPIDR4	<i>CTIPIDR4, CTI Peripheral Identification Register 4</i> on page H9-4591
CTITRIGINSTATUS	<i>CTITRIGINSTATUS, CTI Trigger In Status register</i> on page H9-4592
CTITRIGOUTSTATUS	<i>CTITRIGOUTSTATUS, CTI Trigger Out Status register</i> on page H9-4593
DBGAUTHSTATUS_EL1	<i>DBGAUTHSTATUS_EL1, Debug Authentication Status register</i> on page H9-4469
DBGBCR<n>_EL1	<i>DBGBCR<n>_EL1, Debug Breakpoint Control Registers, n = 0 - 15</i> on page H9-4471
DBGBVR<n>_EL1	<i>DBGBVR<n>_EL1, Debug Breakpoint Value Registers, n = 0 - 15</i> on page H9-4474
DBGCLAIMCLR_EL1	<i>DBGCLAIMCLR_EL1, Debug Claim Tag Clear register</i> on page H9-4477
DBGCLAIMSET_EL1	<i>DBGCLAIMSET_EL1, Debug Claim Tag Set register</i> on page H9-4478
DBGDTRRX_EL0	<i>DBGDTRRX_EL0, Debug Data Transfer Register, Receive</i> on page H9-4479

Table J-30 Alphabetical index of Memory-Mapped Registers (continued)

Register	Description, see
DBGDTRTX_EL0	<i>DBGDTRTX_EL0, Debug Data Transfer Register, Transmit on page H9-4480</i>
DBGWCR<n>_EL1	<i>DBGWCR<n>_EL1, Debug Watchpoint Control Registers, n = 0 - 15 on page H9-4481</i>
DBGWVR<n>_EL1	<i>DBGWVR<n>_EL1, Debug Watchpoint Value Registers, n = 0 - 15 on page H9-4484</i>
EDACR	<i>EDACR, External Debug Auxiliary Control Register on page H9-4486</i>
EDCIDR0	<i>EDCIDR0, External Debug Component Identification Register 0 on page H9-4487</i>
EDCIDR1	<i>EDCIDR1, External Debug Component Identification Register 1 on page H9-4488</i>
EDCIDR2	<i>EDCIDR2, External Debug Component Identification Register 2 on page H9-4489</i>
EDCIDR3	<i>EDCIDR3, External Debug Component Identification Register 3 on page H9-4490</i>
EDCIDSR	<i>EDCIDSR, External Debug Context ID Sample Register on page H9-4491</i>
EDDEVAFF0	<i>EDDEVAFF0, External Debug Device Affinity register 0 on page H9-4492</i>
EDDEVAFF1	<i>EDDEVAFF1, External Debug Device Affinity register 1 on page H9-4493</i>
EDDEVARCH	<i>EDDEVARCH, External Debug Device Architecture register on page H9-4494</i>
EDDEVID	<i>EDDEVID, External Debug Device ID register 0 on page H9-4496</i>
EDDEVID1	<i>EDDEVID1, External Debug Device ID register 1 on page H9-4498</i>
EDDEVID2	<i>EDDEVID2, External Debug Device ID register 2 on page H9-4499</i>
EDDEVTYPE	<i>EDDEVTYPE, External Debug Device Type register on page H9-4500</i>
EDECCECR	<i>EDECCECR, External Debug Exception Catch Control Register on page H9-4501</i>
EDECRCR	<i>EDECRCR, External Debug Execution Control Register on page H9-4503</i>
EDESRCR	<i>EDESRCR, External Debug Event Status Register on page H9-4505</i>
EDITCTRL	<i>EDITCTRL, External Debug Integration mode Control register on page H9-4507</i>
EDITRCR	<i>EDITRCR, External Debug Instruction Transfer Register on page H9-4508</i>
EDLRCR	<i>EDLRCR, External Debug Lock Access Register on page H9-4510</i>
EDLSRCR	<i>EDLSRCR, External Debug Lock Status Register on page H9-4511</i>
EDPCSRCR	<i>EDPCSRCR, External Debug Program Counter Sample Register on page H9-4513</i>
EDPIDR0	<i>EDPIDR0, External Debug Peripheral Identification Register 0 on page H9-4515</i>
EDPIDR1	<i>EDPIDR1, External Debug Peripheral Identification Register 1 on page H9-4516</i>
EDPIDR2	<i>EDPIDR2, External Debug Peripheral Identification Register 2 on page H9-4517</i>
EDPIDR3	<i>EDPIDR3, External Debug Peripheral Identification Register 3 on page H9-4518</i>
EDPIDR4	<i>EDPIDR4, External Debug Peripheral Identification Register 4 on page H9-4519</i>
EDPRCRCR	<i>EDPRCRCR, External Debug Power/Reset Control Register on page H9-4520</i>
EDPRSRCR	<i>EDPRSRCR, External Debug Processor Status Register on page H9-4523</i>
EDRCRCR	<i>EDRCRCR, External Debug Reserve Control Register on page H9-4529</i>

Table J-30 Alphabetical index of Memory-Mapped Registers (continued)

Register	Description, see
EDSCR	<i>EDSCR, External Debug Status and Control Register</i> on page H9-4531
EDVIDSR	<i>EDVIDSR, External Debug Virtual Context Sample Register</i> on page H9-4535
EDWAR	<i>EDWAR, External Debug Watchpoint Address Register</i> on page H9-4537
ID_AA64DFR0_EL1	<i>ID_AA64DFR0_EL1, Debug Feature Register 0</i> on page H9-4538
ID_AA64DFR1_EL1	<i>ID_AA64DFR1_EL1, Debug Feature Register 1</i> on page H9-4540
ID_AA64ISAR0_EL1	<i>ID_AA64ISAR0_EL1, Instruction Set Attribute Register 0</i> on page H9-4541
ID_AA64ISAR1_EL1	<i>ID_AA64ISAR1_EL1, Instruction Set Attribute Register 1</i> on page H9-4543
ID_AA64MMFR0_EL1	<i>ID_AA64MMFR0_EL1, Memory Model Feature Register 0</i> on page H9-4544
ID_AA64MMFR1_EL1	<i>ID_AA64MMFR1_EL1, Memory Model Feature Register 1</i> on page H9-4547
ID_AA64PFR0_EL1	<i>ID_AA64PFR0_EL1, Processor Feature Register 0</i> on page H9-4548
ID_AA64PFR1_EL1	<i>ID_AA64PFR1_EL1, Processor Feature Register 1</i> on page H9-4550
MIDR_EL1	<i>MIDR_EL1, Main ID Register</i> on page H9-4551
OSLAR_EL1	<i>OSLAR_EL1, OS Lock Access Register</i> on page H9-4553
PMAUTHSTATUS	<i>PMAUTHSTATUS, Performance Monitors Authentication Status register</i> on page I1-4599
PMCCFILTR_EL0	<i>PMCCFILTR_EL0, Performance Monitors Cycle Counter Filter Register</i> on page I1-4601
PMCCNTR_EL0	<i>PMCCNTR_EL0, Performance Monitors Cycle Counter</i> on page I1-4603
PMCEID0_EL0	<i>PMCEID0_EL0, Performance Monitors Common Event Identification register 0</i> on page I1-4604
PMCEID1_EL0	<i>PMCEID1_EL0, Performance Monitors Common Event Identification register 1</i> on page I1-4606
PMCFGR	<i>PMCFGR, Performance Monitors Configuration Register</i> on page I1-4608
PMCIDR0	<i>PMCIDR0, Performance Monitors Component Identification Register 0</i> on page I1-4610
PMCIDR1	<i>PMCIDR1, Performance Monitors Component Identification Register 1</i> on page I1-4611
PMCIDR2	<i>PMCIDR2, Performance Monitors Component Identification Register 2</i> on page I1-4612
PMCIDR3	<i>PMCIDR3, Performance Monitors Component Identification Register 3</i> on page I1-4613
PMCNTENCLR_EL0	<i>PMCNTENCLR_EL0, Performance Monitors Count Enable Clear register</i> on page I1-4614
PMCNTENSET_EL0	<i>PMCNTENSET_EL0, Performance Monitors Count Enable Set register</i> on page I1-4616
PMCR_EL0	<i>PMCR_EL0, Performance Monitors Control Register</i> on page I1-4618
PMDEVAFF0	<i>PMDEVAFF0, Performance Monitors Device Affinity register 0</i> on page I1-4620
PMDEVAFF1	<i>PMDEVAFF1, Performance Monitors Device Affinity register 1</i> on page I1-4621
PMDEVARCH	<i>PMDEVARCH, Performance Monitors Device Architecture register</i> on page I1-4622
PMDEVTYPE	<i>PMDEVTYPE, Performance Monitors Device Type register</i> on page I1-4624
PMEVCNTR<n>_EL0	<i>PMEVCNTR<n>_EL0, Performance Monitors Event Count Registers, n = 0 - 30</i> on page I1-4625
PMEVTYPER<n>_EL0	<i>PMEVTYPER<n>_EL0, Performance Monitors Event Type Registers, n = 0 - 30</i> on page I1-4626

Table J-30 Alphabetical index of Memory-Mapped Registers (continued)

Register	Description, see
PMINTENCLR_EL1	<i>PMINTENCLR_EL1, Performance Monitors Interrupt Enable Clear register on page I1-4628</i>
PMINTENSET_EL1	<i>PMINTENSET_EL1, Performance Monitors Interrupt Enable Set register on page I1-4630</i>
PMITCTRL	<i>PMITCTRL, Performance Monitors Integration mode Control register on page I1-4632</i>
PMLAR	<i>PMLAR, Performance Monitors Lock Access Register on page I1-4633</i>
PMLSR	<i>PMLSR, Performance Monitors Lock Status Register on page I1-4634</i>
PMOVSCLR_EL0	<i>PMOVSCLR_EL0, Performance Monitors Overflow Flag Status Clear register on page I1-4636</i>
PMOVSSET_EL0	<i>PMOVSSET_EL0, Performance Monitors Overflow Flag Status Set register on page I1-4638</i>
PMPIDR0	<i>PMPIDR0, Performance Monitors Peripheral Identification Register 0 on page I1-4640</i>
PMPIDR1	<i>PMPIDR1, Performance Monitors Peripheral Identification Register 1 on page I1-4641</i>
PMPIDR2	<i>PMPIDR2, Performance Monitors Peripheral Identification Register 2 on page I1-4642</i>
PMPIDR3	<i>PMPIDR3, Performance Monitors Peripheral Identification Register 3 on page I1-4643</i>
PMPIDR4	<i>PMPIDR4, Performance Monitors Peripheral Identification Register 4 on page I1-4644</i>
PMSWINC_EL0	<i>PMSWINC_EL0, Performance Monitors Software Increment register on page I1-4645</i>

J.7 Functional index of memory-mapped registers

This section is an index of the memory-mapped registers, divided by functional group.

J.7.1 ID registers

This section is an index to the registers in the Identification functional group.

Table J-31 ID registers

Register	Description, see
ID_AA64DFR0_EL1	<i>ID_AA64DFR0_EL1, Debug Feature Register 0</i> on page H9-4538
ID_AA64DFR1_EL1	<i>ID_AA64DFR1_EL1, Debug Feature Register 1</i> on page H9-4540
ID_AA64ISAR0_EL1	<i>ID_AA64ISAR0_EL1, Instruction Set Attribute Register 0</i> on page H9-4541
ID_AA64ISAR1_EL1	<i>ID_AA64ISAR1_EL1, Instruction Set Attribute Register 1</i> on page H9-4543
ID_AA64MMFR0_EL1	<i>ID_AA64MMFR0_EL1, Memory Model Feature Register 0</i> on page H9-4544
ID_AA64MMFR1_EL1	<i>ID_AA64MMFR1_EL1, Memory Model Feature Register 1</i> on page H9-4547
ID_AA64PFR0_EL1	<i>ID_AA64PFR0_EL1, Processor Feature Register 0</i> on page H9-4548
ID_AA64PFR1_EL1	<i>ID_AA64PFR1_EL1, Processor Feature Register 1</i> on page H9-4550
MIDR_EL1	<i>MIDR_EL1, Main ID Register</i> on page H9-4551

J.7.2 Performance monitors registers

This section is an index to the registers in the Performance Monitors functional group.

Table J-32 Performance monitors registers

Register	Description, see
PMAUTHSTATUS	<i>PMAUTHSTATUS, Performance Monitors Authentication Status register</i> on page I1-4599
PMCCFILTR_EL0	<i>PMCCFILTR_EL0, Performance Monitors Cycle Counter Filter Register</i> on page I1-4601
PMCCNTR_EL0	<i>PMCCNTR_EL0, Performance Monitors Cycle Counter</i> on page I1-4603
PMCEID0_EL0	<i>PMCEID0_EL0, Performance Monitors Common Event Identification register 0</i> on page I1-4604
PMCEID1_EL0	<i>PMCEID1_EL0, Performance Monitors Common Event Identification register 1</i> on page I1-4606
PMCFGR	<i>PMCFGR, Performance Monitors Configuration Register</i> on page I1-4608
PMCIDR0	<i>PMCIDR0, Performance Monitors Component Identification Register 0</i> on page I1-4610
PMCIDR1	<i>PMCIDR1, Performance Monitors Component Identification Register 1</i> on page I1-4611
PMCIDR2	<i>PMCIDR2, Performance Monitors Component Identification Register 2</i> on page I1-4612
PMCIDR3	<i>PMCIDR3, Performance Monitors Component Identification Register 3</i> on page I1-4613
PMCNTENCLR_EL0	<i>PMCNTENCLR_EL0, Performance Monitors Count Enable Clear register</i> on page I1-4614
PMCNTENSET_EL0	<i>PMCNTENSET_EL0, Performance Monitors Count Enable Set register</i> on page I1-4616
PMCR_EL0	<i>PMCR_EL0, Performance Monitors Control Register</i> on page I1-4618
PMDEVAFF0	<i>PMDEVAFF0, Performance Monitors Device Affinity register 0</i> on page I1-4620

Table J-32 Performance monitors registers (continued)

Register	Description, see
PMDEVAFF1	<i>PMDEVAFF1, Performance Monitors Device Affinity register 1</i> on page I1-4621
PMDEVARCH	<i>PMDEVARCH, Performance Monitors Device Architecture register</i> on page I1-4622
PMDEVTYPE	<i>PMDEVTYPE, Performance Monitors Device Type register</i> on page I1-4624
PMEVCNTR<n>_EL0	<i>PMEVCNTR<n>_EL0, Performance Monitors Event Count Registers, n = 0 - 30</i> on page I1-4625
PMEVTYPER<n>_EL0	<i>PMEVTYPER<n>_EL0, Performance Monitors Event Type Registers, n = 0 - 30</i> on page I1-4626
PMINTENCLR_EL1	<i>PMINTENCLR_EL1, Performance Monitors Interrupt Enable Clear register</i> on page I1-4628
PMINTENSET_EL1	<i>PMINTENSET_EL1, Performance Monitors Interrupt Enable Set register</i> on page I1-4630
PMITCTRL	<i>PMITCTRL, Performance Monitors Integration mode Control register</i> on page I1-4632
PMLAR	<i>PMLAR, Performance Monitors Lock Access Register</i> on page I1-4633
PMSLR	<i>PMSLR, Performance Monitors Lock Status Register</i> on page I1-4634
PMOVSCLR_EL0	<i>PMOVSCLR_EL0, Performance Monitors Overflow Flag Status Clear register</i> on page I1-4636
PMOVSSET_EL0	<i>PMOVSSET_EL0, Performance Monitors Overflow Flag Status Set register</i> on page I1-4638
PMPIDR0	<i>PMPIDR0, Performance Monitors Peripheral Identification Register 0</i> on page I1-4640
PMPIDR1	<i>PMPIDR1, Performance Monitors Peripheral Identification Register 1</i> on page I1-4641
PMPIDR2	<i>PMPIDR2, Performance Monitors Peripheral Identification Register 2</i> on page I1-4642
PMPIDR3	<i>PMPIDR3, Performance Monitors Peripheral Identification Register 3</i> on page I1-4643
PMPIDR4	<i>PMPIDR4, Performance Monitors Peripheral Identification Register 4</i> on page I1-4644
PMSWINC_EL0	<i>PMSWINC_EL0, Performance Monitors Software Increment register</i> on page I1-4645

J.7.3 Debug registers

This section is an index to the registers in the Debug functional group.

Table J-33 Debug registers

Register	Description, see
DBGAUTHSTATUS_EL1	<i>DBGAUTHSTATUS_EL1, Debug Authentication Status register</i> on page H9-4469
DBGBCR<n>_EL1	<i>DBGBCR<n>_EL1, Debug Breakpoint Control Registers, n = 0 - 15</i> on page H9-4471
DBGBVR<n>_EL1	<i>DBGBVR<n>_EL1, Debug Breakpoint Value Registers, n = 0 - 15</i> on page H9-4474
DBGCLAIMCLR_EL1	<i>DBGCLAIMCLR_EL1, Debug Claim Tag Clear register</i> on page H9-4477
DBGCLAIMSET_EL1	<i>DBGCLAIMSET_EL1, Debug Claim Tag Set register</i> on page H9-4478
DBGDTRRX_EL0	<i>DBGDTRRX_EL0, Debug Data Transfer Register, Receive</i> on page H9-4479
DBGDTRTX_EL0	<i>DBGDTRTX_EL0, Debug Data Transfer Register, Transmit</i> on page H9-4480
DBGWCR<n>_EL1	<i>DBGWCR<n>_EL1, Debug Watchpoint Control Registers, n = 0 - 15</i> on page H9-4481
DBGWVR<n>_EL1	<i>DBGWVR<n>_EL1, Debug Watchpoint Value Registers, n = 0 - 15</i> on page H9-4484

Table J-33 Debug registers (continued)

Register	Description, see
EDACR	<i>EDACR, External Debug Auxiliary Control Register on page H9-4486</i>
EDCIDR0	<i>EDCIDR0, External Debug Component Identification Register 0 on page H9-4487</i>
EDCIDR1	<i>EDCIDR1, External Debug Component Identification Register 1 on page H9-4488</i>
EDCIDR2	<i>EDCIDR2, External Debug Component Identification Register 2 on page H9-4489</i>
EDCIDR3	<i>EDCIDR3, External Debug Component Identification Register 3 on page H9-4490</i>
EDCIDSR	<i>EDCIDSR, External Debug Context ID Sample Register on page H9-4491</i>
EDDEVAFF0	<i>EDDEVAFF0, External Debug Device Affinity register 0 on page H9-4492</i>
EDDEVAFF1	<i>EDDEVAFF1, External Debug Device Affinity register 1 on page H9-4493</i>
EDDEVARCH	<i>EDDEVARCH, External Debug Device Architecture register on page H9-4494</i>
EDDEVID	<i>EDDEVID, External Debug Device ID register 0 on page H9-4496</i>
EDDEVID1	<i>EDDEVID1, External Debug Device ID register 1 on page H9-4498</i>
EDDEVID2	<i>EDDEVID2, External Debug Device ID register 2 on page H9-4499</i>
EDDEVTYPE	<i>EDDEVTYPE, External Debug Device Type register on page H9-4500</i>
EDECCR	<i>EDECCR, External Debug Exception Catch Control Register on page H9-4501</i>
EDECR	<i>EDECR, External Debug Execution Control Register on page H9-4503</i>
EDESR	<i>EDESR, External Debug Event Status Register on page H9-4505</i>
EDITCTRL	<i>EDITCTRL, External Debug Integration mode Control register on page H9-4507</i>
EDITR	<i>EDITR, External Debug Instruction Transfer Register on page H9-4508</i>
EDLAR	<i>EDLAR, External Debug Lock Access Register on page H9-4510</i>
EDLSR	<i>EDLSR, External Debug Lock Status Register on page H9-4511</i>
EDPCSR	<i>EDPCSR, External Debug Program Counter Sample Register on page H9-4513</i>
EDPIDR0	<i>EDPIDR0, External Debug Peripheral Identification Register 0 on page H9-4515</i>
EDPIDR1	<i>EDPIDR1, External Debug Peripheral Identification Register 1 on page H9-4516</i>
EDPIDR2	<i>EDPIDR2, External Debug Peripheral Identification Register 2 on page H9-4517</i>
EDPIDR3	<i>EDPIDR3, External Debug Peripheral Identification Register 3 on page H9-4518</i>
EDPIDR4	<i>EDPIDR4, External Debug Peripheral Identification Register 4 on page H9-4519</i>
EDPRCR	<i>EDPRCR, External Debug Power/Reset Control Register on page H9-4520</i>
EDPRSR	<i>EDPRSR, External Debug Processor Status Register on page H9-4523</i>
EDRCR	<i>EDRCR, External Debug Reserve Control Register on page H9-4529</i>
EDSCR	<i>EDSCR, External Debug Status and Control Register on page H9-4531</i>

Table J-33 Debug registers (continued)

Register	Description, see
EDVIDSR	<i>EDVIDSR, External Debug Virtual Context Sample Register on page H9-4535</i>
EDWAR	<i>EDWAR, External Debug Watchpoint Address Register on page H9-4537</i>
OSLAR_EL1	<i>OSLAR_EL1, OS Lock Access Register on page H9-4553</i>

J.7.4 Cross-trigger interface registers

This section is an index to the registers in the Cross-Trigger Interface functional group.

Table J-34 Cross-trigger interface registers

Register	Description, see
ASICCTL	<i>ASICCTL, CTI External Multiplexer Control register on page H9-4554</i>
CTIAPPCLEAR	<i>CTIAPPCLEAR, CTI Application Trigger Clear register on page H9-4555</i>
CTIAPPULSE	<i>CTIAPPULSE, CTI Application Pulse register on page H9-4556</i>
CTIAPPSET	<i>CTIAPPSET, CTI Application Trigger Set register on page H9-4557</i>
CTIAUTHSTATUS	<i>CTIAUTHSTATUS, CTI Authentication Status register on page H9-4558</i>
CTICHINSTATUS	<i>CTICHINSTATUS, CTI Channel In Status register on page H9-4560</i>
CTICHOUTSTATUS	<i>CTICHOUTSTATUS, CTI Channel Out Status register on page H9-4561</i>
CTICIDR0	<i>CTICIDR0, CTI Component Identification Register 0 on page H9-4562</i>
CTICIDR1	<i>CTICIDR1, CTI Component Identification Register 1 on page H9-4563</i>
CTICIDR2	<i>CTICIDR2, CTI Component Identification Register 2 on page H9-4564</i>
CTICIDR3	<i>CTICIDR3, CTI Component Identification Register 3 on page H9-4565</i>
CTICLAIMCLR	<i>CTICLAIMCLR, CTI Claim Tag Clear register on page H9-4566</i>
CTICLAIMSET	<i>CTICLAIMSET, CTI Claim Tag Set register on page H9-4567</i>
CTICONTROL	<i>CTICONTROL, CTI Control register on page H9-4568</i>
CTIDEVAFF0	<i>CTIDEVAFF0, CTI Device Affinity register 0 on page H9-4569</i>
CTIDEVAFF1	<i>CTIDEVAFF1, CTI Device Affinity register 1 on page H9-4570</i>
CTIDEVARCH	<i>CTIDEVARCH, CTI Device Architecture register on page H9-4571</i>
CTIDEVID	<i>CTIDEVID, CTI Device ID register 0 on page H9-4573</i>
CTIDEVID1	<i>CTIDEVID1, CTI Device ID register 1 on page H9-4575</i>
CTIDEVID2	<i>CTIDEVID2, CTI Device ID register 2 on page H9-4576</i>
CTIDEVTYPE	<i>CTIDEVTYPE, CTI Device Type register on page H9-4577</i>
CTIGATE	<i>CTIGATE, CTI Channel Gate Enable register on page H9-4578</i>
CTIINEN<n>	<i>CTIINEN<n>, CTI Input Trigger to Output Channel Enable registers, n = 0 - 31 on page H9-4579</i>
CTIINTACK	<i>CTIINTACK, CTI Output Trigger Acknowledge register on page H9-4580</i>

Table J-34 Cross-trigger interface registers (continued)

Register	Description, see
CTIITCTRL	<i>CTIITCTRL</i> , <i>CTI Integration mode Control register</i> on page H9-4582
CTILAR	<i>CTILAR</i> , <i>CTI Lock Access Register</i> on page H9-4583
CTILSR	<i>CTILSR</i> , <i>CTI Lock Status Register</i> on page H9-4584
CTIOUTEN<n>	<i>CTIOUTEN<n></i> , <i>CTI Input Channel to Output Trigger Enable registers, n = 0 - 31</i> on page H9-4586
CTIPIDR0	<i>CTIPIDR0</i> , <i>CTI Peripheral Identification Register 0</i> on page H9-4587
CTIPIDR1	<i>CTIPIDR1</i> , <i>CTI Peripheral Identification Register 1</i> on page H9-4588
CTIPIDR2	<i>CTIPIDR2</i> , <i>CTI Peripheral Identification Register 2</i> on page H9-4589
CTIPIDR3	<i>CTIPIDR3</i> , <i>CTI Peripheral Identification Register 3</i> on page H9-4590
CTIPIDR4	<i>CTIPIDR4</i> , <i>CTI Peripheral Identification Register 4</i> on page H9-4591
CTITRIGINSTATUS	<i>CTITRIGINSTATUS</i> , <i>CTI Trigger In Status register</i> on page H9-4592
CTITRIGOUTSTATUS	<i>CTITRIGOUTSTATUS</i> , <i>CTI Trigger Out Status register</i> on page H9-4593

Glossary

Note

The update of the Glossary from ARMv7 to ARMv8 has been started but remains work-in-progress.

- A32 instruction** A word that specifies an operation to be performed by a PE that is executing in an Exception level that is using AArch32 and is in A32 state. A32 instructions must be word-aligned.
- A32 instructions were previously called ARM instructions, and A32 state was previously called ARM state.
- See also* [A64 instruction](#), [T32 instruction](#)
- A64 instruction** A word that specifies an operation to be performed by a PE that is executing in an Exception level that is using AArch64. A64 instructions must be word-aligned.
- See also* [A32 instruction](#), [T32 instruction](#)
- AArch32** The 32-bit Execution state. In AArch32 state, addresses are held in 32-bit registers, and instructions in the base instruction sets use 32-bit registers for their processing. AArch32 state supports the T32 and A32 instruction sets
- See also* [AArch64](#), [A32 instruction](#), [T32 instruction](#).
- AArch64** The 64-bit Execution state. In AArch64 state, addresses are held in 64-bit registers, and instructions in the base instruction set can use 64-bit registers for their processing. AArch64 state supports the A64 instruction set.
- See also* [AArch32](#), [A64 instruction](#).
- Abort** An exception caused by an illegal memory access. Aborts can be caused by the external memory system or the MMU.
- Addressing mode** Means a method for generating the memory address used by a load/store instruction.

- Advanced SIMD** A feature of the ARM architecture that provides SIMD operations on a register file of SIMD and floating-point registers. Where an implementation supports both Advanced SIMD and floating-point instructions, these instructions operate on the same register file.
- Aligned** A data item stored at an address that is divisible by the highest power of 2 that divides into its size in bytes. Aligned halfwords, words and doublewords therefore have addresses that are divisible by 2, 4 and 8 respectively.
- An aligned access is one where the address of the access is aligned to the size of each element of the access.
- Architecturally executed** An instruction is architecturally executed only if it would be executed in a simple sequential execution of the program. When such an instruction has been executed and retired it has been *architecturally executed*. Any instruction that, in a simple sequential execution of a program, is treated as a NOP because it fails its condition code check, is an architecturally executed instruction.
- In a PE that performs speculative execution, an instruction is not architecturally executed if the PE discards the results of a speculative execution.
- See also [Condition code check](#).
- ARM core registers** Some older documentation uses *ARM core registers* to refer to the following set of registers for execution in AArch32 state:
- The thirteen general-purpose registers, R0-R12, that software can use for processing.
 - SP, the *stack pointer*, that can also be referred to as R13.
 - LR, the *link register*, that can also be referred to as R14.
 - PC, the *program counter*, that can also be referred to as R15.
- See also [General-purpose registers](#).
- ARM instruction** See [A32 instruction](#).
- Associativity** See [Cache associativity](#).
- Atomicity** Describes either single-copy atomicity or multi-copy atomicity. [Atomicity in the ARM architecture on page B2-79](#) defines these forms of atomicity for the ARM architecture.
- See also [Multi-copy atomicity](#), [Single-copy atomicity](#).
- Banked register** A register that has multiple instances, with the instance that is in use depending on the PE mode, Security state, or other PE state.
- Base register** A register specified by a load/store instruction that is used as the base value for the address calculation for the instruction. Depending on the instruction and its addressing mode, an offset can be added to or subtracted from the base register value to form the virtual address that is sent to memory.
- Base register writeback** Describes writing back a modified value to the base register used in an address calculation.
- Big-endian memory** Means that, for example:
- A byte or halfword at a word-aligned address is the most significant byte or halfword in the word at that address.
 - A byte at a halfword-aligned address is the most significant byte in the halfword at that address.
- Blocking** Describes an operation that does not permit following instructions to be executed before the operation completes.
- A non-blocking operation can permit following instructions to be executed before the operation completes, and in the event of encountering an exception does not signal an exception to the PE. This enables implementations to retire following instructions while the non-blocking operation is executing, without the need to retain precise PE state.

Branch prediction

Is where a PE selects a future execution path to fetch along. For example, after a branch instruction, the PE can choose to speculatively fetch either the instruction following the branch or the instruction at the branch target.

See also [Prefetching](#).

Breakpoint

A debug event triggered by the execution of a particular instruction, specified by one or both of the address of the instruction and the state of the PE when the instruction is executed.

Byte

An 8-bit data item.

Cache associativity

The number of locations in a cache set to which an address can be assigned. Each location is identified by its *way* value.

Cache level

The position of a cache in the cache hierarchy. In the ARM architecture, the lower numbered levels are those closest to the PE. For more information see [Terms used in describing the maintenance instructions on page D4-1680](#).

Cache line

The basic unit of storage in a cache. Its size in words is always a power of two, usually 4 or 8 words. A cache line must be aligned to a suitable memory boundary. A *memory cache line* is a block of memory locations with the same size and alignment as a cache line. Memory cache lines are sometimes loosely called cache lines.

Cache lockdown

Enables critical software and data to be loaded into the cache so that the cache lines containing them are not subsequently reallocated. It alleviates the delays caused by accessing a cache in a worst-case situation. This ensures that all subsequent accesses to the software and data concerned are cache hits and so complete quickly.

Cache miss

A memory access that cannot be processed at high speed because the data it addresses is not in the cache.

Cache sets

Areas of a cache, divided up to simplify and speed up the process of determining whether a cache hit occurs. The number of cache sets is always a power of two.

Cache way

A cache way consists of one cache line from each cache set. The cache ways are indexed from 0 to (Associativity-1). Each cache line in a cache way is chosen to have the same index as the cache way. For example, cache way *n* consists of the cache line with index *n* from each cache set.

Coherence order

See [Coherent](#).

Coherent

Data accesses from a set of observers to a memory location are coherent if accesses to that memory location by the members of the set of observers are consistent with there being a single total order of all writes to that memory location by all members of the set of observers. This single total order of all writes to that memory location is the *coherence order* for that location.

Condition code check

The process of determining whether a conditional instruction executes normally or is treated as a NOP. For an instruction that includes a condition code field, that field is compared with the condition flags to determine whether the instruction is executed normally. For a T32 instruction in an IT block, the value of the [ITSTATE](#) register determines whether the instruction is executed normally.

See also [Condition code field](#), [Condition flags](#), [Conditional execution](#).

Condition code field

A 4-bit field in an instruction that specifies the condition under which the instruction executes.

See also [Condition code check](#).

Condition flags

The N, Z, C, and V bits of PSTATE, or of the APSR, CPSR, SPSR, or FPSCR. See the register descriptions for more information.

See also [Condition code check](#), [PSTATE](#).

Conditional execution

When a conditional instruction starts executing, if the condition code check returns TRUE, the instruction executes normally. Otherwise, it is treated as a NOP.

See also [Condition code check](#).

CONSTRAINED UNPREDICTABLE

Where an instruction can result in UNPREDICTABLE behavior, the ARMv8 architecture specifies a narrow range of permitted behaviors. This range is the range of CONSTRAINED UNPREDICTABLE behavior. All implementations that are compliant with the architecture must follow the CONSTRAINED UNPREDICTABLE behavior.

See also [UNPREDICTABLE](#).

Context switch The saving and restoring of computational state when switching between different threads or processes. In this manual, the term context switch describes any situation where the context is switched by an operating system and might or might not include changes to the address space.

Context synchronization operation

One of:

- Performing an ISB operation. An ISB operation is performed when an ISB instruction is executed and does not fail its condition code check.
- Taking an exception.
- Returning from an exception.
- Exit from Debug state.
- Executing a DCPS instruction.
- Executing a DRPS instruction.

The architecture requires a context synchronization operation to guarantee visibility of any change to a system control register.

Digital signal processing (DSP)

Algorithms for processing signals that have been sampled and converted to digital form. DSP algorithms often use saturated arithmetic.

Direct Memory Access (DMA)

An operation that accesses main memory directly, without the PE performing any accesses to the data concerned.

DMA See [Direct Memory Access \(DMA\)](#).

DNM See [Do-Not-Modify \(DNM\)](#).

Domain In the ARM architecture, *domain* is used in the following contexts.

Shareability domain Defines a set of observers for which the shareability attributes make the data or unified caches transparent for data accesses.

Power domain Defines a block of logic with a single, common, power supply.

Memory regions domain

When using the Short-descriptor translation table format, defines a collection of Sections, Large pages and Small pages of memory, that can have their access permissions switched rapidly by writing to the *Domain Access Control Register (DACR)*. ARM deprecates any use of memory regions domains.

Do-Not-Modify (DNM)

Means the value must not be altered by software. DNM fields read as UNKNOWN values, and must only be written with the value read from the same field on the same PE.

Double-precision value

Consists of two consecutive 32-bit words that are interpreted as a basic double-precision floating-point number according to the IEEE 754 standard.

Deprecated

Something that is present in the ARM architecture for backwards compatibility. Whenever possible software must avoid using deprecated features. Features that are deprecated but are not optional are present in current implementations of the ARM architecture, but might not be present, or might be deprecated and OPTIONAL, in future versions of the ARM architecture.

See also [OPTIONAL](#).

Doubleword

A 64-bit data item. Doublewords are normally at least word-aligned in ARM systems.

- Doubleword-aligned**
Means that the address is divisible by 8.
- DSP**
See [Digital signal processing \(DSP\)](#).
- Endianness**
An aspect of the system memory mapping.
See also [Big-endian memory](#) and [Little-endian memory](#).
- Exception**
Handles an event. For example, an exception could handle an external interrupt or an undefined instruction.
- Exception vector**
A fixed address that contains the address of the first instruction of the corresponding exception handler.
- Execution stream**
The stream of instructions that would have been executed by sequential execution of the program.
- Explicit access**
A read from memory, or a write to memory, generated by a load or store instruction executed by the PE. Reads and writes generated by hardware translation table accesses are not explicit accesses.
- External abort**
An abort that is generated by the external memory system.
- Fast Context Switch Extension (FCSE)**
Modifies the behavior of an ARM memory system to enable multiple programs running on the ARM PE to use identical address ranges, while ensuring that the addresses they present to the rest of the memory system differ. From ARMv6, ARM deprecates any use of the FCSE. The FCSE is:
- Optional in an ARMv7 implementation that does not include the Multiprocessing Extensions.
 - Obsolete from the introduction of the Multiprocessing Extensions.
- FCSE**
See [Fast Context Switch Extension \(FCSE\)](#).
- Flat address mapping**
Is where the physical address for every access is equal to its virtual address.
- Flush-to-zero mode**
A special processing mode that optimizes the performance of some floating-point algorithms by replacing the denormalized operands and intermediate results with zeros, without significantly affecting the accuracy of their final results.
- General-purpose registers**
The registers that the base instructions use for processing:
- In AArch32 state the general-purpose registers are R0-R14, that can also be described as R0-R12, SP, LR.

———— **Note** —————

Older documentation defines the AArch32 general-purpose registers as R0-R12, and the ARM core registers as R0-R12, SP, LR, and PC.

—————
 - In AArch64 state the general-purpose registers are:
 - W0-W30 when accessed as 32-bit registers.
 - X0-X30 when accessed as 64-bit registers.
- See also* [High registers](#), [Low registers](#).
- Halfword**
A 16-bit data item. Halfwords are normally halfword-aligned in ARM systems.
- Halfword-aligned**
Means that the address is divisible by 2.

High registers	InAArch32 state, the general-purpose registers R8-R14. Most 16-bit T32 instructions cannot access the high registers.
	<p>———— Note ————</p> <ul style="list-style-type: none"> • In some contexts, <i>high registers</i> refers to R8-R15, meaning R8-R14 and the PC. <p>————</p>
	<i>See also</i> General-purpose registers , Low registers .
High vectors	An alternative location for the exception vectors. The high vector address range is near the top of the address space, rather than at the bottom.
Immediate and offset fields	Are unsigned unless otherwise stated.
Immediate value	A value that is encoded directly in the instruction and used as numeric data when the instruction is executed. Many A64, A32, and T32 instructions can be used with an immediate argument.
IMP	An abbreviation used in diagrams to indicate that one or more bits have IMPLEMENTATION DEFINED behavior.
IMPLEMENTATION DEFINED	Means that the behavior is not architecturally defined, but must be defined and documented by individual implementations. In body text, the term IMPLEMENTATION DEFINED is shown in SMALL CAPITALS.
Index register	A register specified in some load and store instructions. The value of this register is used as an offset to be added to or subtracted from the base register value to form the virtual address that is sent to memory. Some instruction forms permit the index register value to be shifted before the addition or subtraction.
Inline literals	These are constant addresses and other data items held in the same area as the software itself. They are automatically generated by compilers, and can also appear in assembler code.
Intermediate Physical Address (IPA)	An implementation of virtualization, the address to which an Guest OS maps a VA. A hypervisor might then map the IPA to a PA. Typically, the Guest OS is unaware of the translation from IPA to PA. <i>See also</i> Physical address (PA) , Virtual address (VA) .
Interworking	A method of working that permits branches between software using the A32 and T32 instruction sets.
IPA	<i>See</i> Intermediate Physical Address (IPA) .
Level	<i>See</i> Cache level .
Level of coherence (LoC)	The last level of cache that must be cleaned or invalidated when cleaning or invalidating to the point of coherency. For more information see Terms used in describing the maintenance instructions on page D4-1680 . <i>See also</i> Cache level , Point of coherency (PoC) .
Level of unification, Inner Shareable (LoUIS)	The last level of cache that must be cleaned or invalidated when cleaning or invalidating to the point of unification for the Inner Shareable shareability domain. For more information see Terms used in describing the maintenance instructions on page D4-1680 . <i>See also</i> Cache level , Point of unification (PoU) .
Level of unification, uniprocessor (LoUU)	For a PE, the last level of cache that must be cleaned or invalidated when cleaning or invalidating to the point of unification for that PE. For more information see Terms used in describing the maintenance instructions on page D4-1680 . <i>See also</i> Cache level , Point of unification (PoU) .
Line	<i>See</i> Cache line .

Little-endian memory

Means that:

- A byte or halfword at a word-aligned address is the least significant byte or halfword in the word at that address.
- A byte at a halfword-aligned address is the least significant byte in the halfword at that address.

Load/Store architecture

An architecture where data-processing operations only operate on register contents, not directly on memory contents.

LoC

See [Level of coherence \(LoC\)](#).

LoUIS

See [Level of unification, Inner Shareable \(LoUIS\)](#).

LoUU

See [Level of unification, uniprocessor \(LoUU\)](#).

Lockdown

See [Cache lockdown](#).

Low registers

InAArch32 state, general-purpose registers R0-R7. Unlike the high registers, all T32 instructions can access the Low registers.

See also [General-purpose registers](#). [High registers](#).

Memory barrier

See [Memory barriers on page B2-85](#)

Memory coherency

The problem of ensuring that when a memory location is read, either by a data read or an instruction fetch, the value actually obtained is always the value that was most recently written to the location. This can be difficult when there are multiple possible physical locations, such as main memory and at least one of a write buffer and one or more levels of cache.

Memory Management Unit (MMU)

Provides detailed control of the part of a memory system that provides a single stage of address translation. Most of the control is provided using translation tables that are held in memory, and define the attributes of different regions of the physical memory map.

Memory Protection Unit (MPU)

A hardware unit whose registers provide simple control of a limited number of protection regions in memory.

Miss

See [Cache miss](#).

MMU

See [Memory Management Unit \(MMU\)](#).

MPU

See [Memory Protection Unit \(MPU\)](#).

Multi-copy atomicity

The form of atomicity described in [Requirements for multi-copy atomicity on page B2-80](#).

See also [Atomicity](#), [Single-copy atomicity](#).

NaN

Special floating-point values that can be used when neither a numeric value nor an infinity is appropriate. NaNs can be *quiet* NaNs that propagate through most floating-point operations, or *signaling* NaNs that cause Invalid Operation floating-point exceptions when used. For more information, see the IEEE 754 standard.

Natural eviction

A natural eviction is an eviction that occurs in the course of the normal operation of the memory system, rather than because of an operation that explicitly causes an eviction from the cache, such as a cache maintenance operation. Typically, a natural eviction occurs when the caching algorithm requires data to be cached but the cache does not have room for that data.

Observer

A PE or mechanism in the system, such as a peripheral device, that can generate reads from or writes to memory.

Obsolete

Obsolete indicates something that is no longer supported by ARM. When an architectural feature is described as obsolete, this indicates that the architecture has no support for that feature, although an earlier version of the architecture did support it.

Offset addressing

Means that the memory address is formed by adding or subtracting an offset to or from the base register value.

OPTIONAL

When applied to a feature of the architecture, OPTIONAL indicates a feature that is not required in an implementation of the ARM architecture:

- If a feature is OPTIONAL and deprecated, this indicates that the feature is being phased out of the architecture. ARM expects such a feature to be included in a new implementation only if there is a known backwards-compatibility reason for the inclusion of the feature.
A feature that is OPTIONAL and deprecated might not be present in future versions of the architecture.
- A feature that is OPTIONAL but not deprecated is, typically, a feature added to a version of the ARM architecture after the initial release of that version of the architecture. ARM recommends that such features are included in all new implementations of the architecture.

In body text, these meanings of the term OPTIONAL are shown in SMALL CAPITALS.

Note: Do not confuse these ARM-specific uses of OPTIONAL with other uses of *optional*, where it has its usual meaning. These include:

- Optional arguments in the syntax of many instructions.
- Behavior determined by an implementation choice, for example the optional byte order reversal in an ARMv7-R implementation, where the `SCTLR.IE` bit indicates the implemented option.

See also [Deprecated](#).

PA

See [Physical address \(PA\)](#).

PE

See [Processing element \(PE\)](#).

Physical address (PA)

An address that identifies a location in the physical memory map.

See also [Intermediate Physical Address \(IPA\)](#), [Virtual address \(VA\)](#).

PoC

See [Point of coherency \(PoC\)](#).

PoU

See [Point of unification \(PoU\)](#).

Point of coherency (PoC)

For a particular MVA, the point at which all agents that can access memory are guaranteed to see the same copy of a memory location. For more information see [Terms used in describing the maintenance instructions on page D4-1680](#).

Point of unification (PoU)

For a particular PE, the point by which the instruction and data caches and the translation table walks of that PE are guaranteed to see the same copy of a memory location. For more information see [Terms used in describing the maintenance instructions on page D4-1680](#).

Post-indexed addressing

Means that the memory address is the base register value, but an offset is added to or subtracted from the base register value and the result is written back to the base register.

Prefetching

Prefetching refers to speculatively fetching instructions or data from the memory system. In particular, instruction prefetching is the process of fetching instructions from memory before the instructions that precede them, in simple sequential execution of the program, have finished executing. Prefetching an instruction does not mean that the instruction has to be executed.

In this manual, references to instruction or data fetching apply also to prefetching, unless the context explicitly indicates otherwise.

Note, in particular, that the Prefetch Abort exception can be generated on any instruction fetch, and is not limited to speculative instruction fetches.

Pre-indexed addressing

Means that the memory address is formed in the same way as for offset addressing, but the memory address is also written back to the base register.

Processing element (PE)

The abstract machine defined in the ARM architecture, as documented in an ARM Architecture Reference Manual. A PE implementation compliant with the ARM architecture must conform with the behaviors described in the corresponding ARM Architecture Reference Manual.

Protection region

A memory region whose position, size, and other properties are defined by Memory Protection Unit registers.

Protection Unit See [Memory Protection Unit \(MPU\)](#).

Pseudo-instruction

UAL assembler syntax that assembles to an instruction encoding that is expected to disassemble to a different assembler syntax, and is described in this manual under that other syntax. For example, `MOV <Rd>, <Rm>, LSL #<n>` is a pseudo-instruction that is expected to disassemble as `LSL <Rd>, <Rm>, #<n>`.

PSTATE

An abstraction of process state information. All of the instruction sets provide instructions that operate on elements of PSTATE.

See also [Condition flags](#).

Quadword

A 128-bit data item. Quadwords are normally at least word-aligned in ARM systems.

Quadword-aligned

Means that the address is divisible by 16.

Quiet NaN

A NaN that propagates unchanged through most floating-point operations.

RAO

See [Read-As-One \(RAO\)](#)

RAZ

See [Read-As-Zero \(RAZ\)](#).

RAO/SBOP

In versions of the ARM architecture before ARMv8, Read-As-One, Should-Be-One-or-Preserved on writes.

In ARMv8, RES1 replaces this description.

See also [UNK/SBOP](#), [Read-As-One \(RAO\)](#), [Should-Be-One-or-Preserved \(SBOP\)](#).

RAO/WI

Read-As-One, Writes Ignored.

Hardware must implement the field as read as Read-as-One, and must ignore writes to the field.

Software can rely on the field reading as all 1s, and on writes being ignored.

This description can apply to a single bit that reads as 1, or to a field that reads as all 1s.

See also [Read-As-One \(RAO\)](#).

RAZ/SBZP

In versions of the ARM architecture before ARMv8, Read-As-Zero, Should-Be-Zero-or-Preserved on writes.

In ARMv8, RES0 replaces this description.

See also [UNK/SBZP](#), [Read-As-Zero \(RAZ\)](#), [Should-Be-Zero-or-Preserved \(SBZP\)](#).

RAZ/WI

Read-As-Zero, Writes Ignored.

Hardware must implement the field as Read-as-Zero, and must ignore writes to the field.

Software can rely on the field reading as all 0s, and on writes being ignored.

This description can apply to a single bit that reads as 0, or to a field that reads as all 0s.

See also [Read-As-Zero \(RAZ\)](#).

Read-allocate cache

A cache in which a cache miss on reading data causes a cache line to be allocated into the cache.

Read-As-One (RAO)

Hardware must implement the field as reading as all 1s.

Software can rely on the field reading as all 1s.

This description can apply to a single bit that reads as 1, or to a field that reads as all 1s.

Read-As-Zero (RAZ)

Hardware must implement the field as reading as all 0s.

Software can rely on the field reading as all 0s.

This description can apply to a single bit that reads as 0, or to a field that reads as all 0s.

Read, modify, write

In a read, modify, write instruction sequence, a value is read to a general-purpose register, the relevant fields updated in that register, and the new value written back.

RES0

Hardware must implement the bit as Read-As-Zero, and must ignore writes to the field.

Software must not rely on the field reading as all 0s, and except for writing back to the register must treat the value as if it is UNKNOWN. Software must use an SBZP policy to write to the field.

This description can apply to a single bit that should be written as its preserved value or as 0, or to a field that should be written as its preserved value or as all 0s.

This definition of RES0 applies only to a bit or field that is RES0 in all contexts. In the ARM architecture a small number of fields are RES0 in one context, and have different behavior in another context. An extended definition of RES0 applies to these bits, see [Fixed values in instruction and register descriptions on page C4-230](#).

In body text, the term RES0 is shown in SMALL CAPITALS.

See also [Read-As-Zero \(RAZ\)](#), [Should-Be-Zero-or-Preserved \(SBZP\)](#), UNKNOWN.

RES1

Hardware must implement the field as Read-As-One, and must ignore writes to the field.

Software must not rely on the field reading as all 1s, and except for writing back to the register it must treat the value as if it is UNKNOWN. Software must use an SBOP policy to write to the field.

This description can apply to a single bit that should be written as its preserved value or as 1, or to a field that should be written as its preserved value or as all 1s.

This definition of RES1 applies only to a bit or field that is RES1 in all contexts. In the ARM architecture a small number of fields are RES1 in one context, and have different behavior in another context. An extended definition of RES1 applies to these bits, see [Fixed values in instruction and register descriptions on page C4-230](#).

In body text, the term RES1 is shown in SMALL CAPITALS.

See also [Read-As-One \(RAO\)](#), [Should-Be-One-or-Preserved \(SBOP\)](#), UNKNOWN.

Reserved

Unless otherwise stated:

- Instructions that are reserved or that access reserved registers have UNPREDICTABLE behavior.
- Bit positions described as reserved are:
 - In an RW register, RES0.
 - In an RO register, UNK.
 - In a WO register, RES0.

RISC

Reduced Instruction Set Computer.

Rounding error

The value of the rounded result of an arithmetic operation minus the exact result of the operation.

Rounding mode

Specifies how the exact result of a floating-point operation is rounded to a value that is representable in the destination format.

Round to Nearest (RN) mode

Means that the rounded result is the nearest representable number to the unrounded result.

Round towards Plus Infinity (RP) mode

Means that the rounded result is the nearest representable number that is greater than or equal to the exact result.

Round towards Minus Infinity (RM) mode

Means that the rounded result is the nearest representable number that is less than or equal to the exact result.

Round towards Zero (RZ) mode

Means that results are rounded to the nearest representable number that is no greater in magnitude than the unrounded result.

Saturated arithmetic

Integer arithmetic in which a result that would be greater than the largest representable number is set to the largest representable number, and a result that would be less than the smallest representable number is set to the smallest representable number. Signed saturated arithmetic is often used in DSP algorithms. It contrasts with the normal signed integer arithmetic used in ARM processors, in which overflowing results wrap around from $+2^{31}-1$ to -2^{31} or vice versa.

SBO See [Should-Be-One \(SBO\)](#).

SBOP See [Should-Be-One-or-Preserved \(SBOP\)](#).

SBZ See [Should-Be-Zero \(SBZ\)](#).

SBZP See [Should-Be-Zero-or-Preserved \(SBZP\)](#).

Security hole

A mechanism by which execution at the current level of privilege can achieve an outcome that cannot be achieved at the current or a lower level of privilege using instructions that are not UNPREDICTABLE. The ARM architecture forbids security holes.

Self-modifying code

Code that writes one or more instructions to memory and then executes them. When using self-modifying code you must use cache maintenance and barrier instructions to ensure synchronization. For more information see [Caches and memory hierarchy](#) on page B2-70.

Set See [Cache sets](#).

Should-Be-One (SBO)

Hardware must ignore writes to the field.

Software should write the field as all 1s. If software writes a value that is not all 1s, it must expect an UNPREDICTABLE result.

This description can apply to a single bit that should be written as 1, or to a field that should be written as all 1s.

Should-Be-One-or-Preserved (SBOP)

From the introduction of the ARMv7 Large Physical Address Extension the definition of SBOP is modified for register bits that are SBOP in some but not all contexts. For more information see [Meaning of fixed bit values in register diagrams](#) on page G3-3711. The generic definition of SBOP given here applies only to bits that are not affected by this modification.

Hardware must ignore writes to the field.

If software has read the field since the PE implementing the field was last reset and initialized, it should preserve the value of the field by writing the value that it previously read from the field. Otherwise, it should write the field as all 1s.

If software writes a value to the field that is not a value previously read for the field and is not all 1s, it must expect an UNPREDICTABLE result.

This description can apply to a single bit that should be written as its preserved value or as 1, or to a field that should be written as its preserved value or as all 1s.

Should-Be-Zero (SBZ)

Hardware must ignore writes to the field.

Software should write the field as all 0s. If software writes a value that is not all 0s, it must expect an UNPREDICTABLE result.

This description can apply to a single bit that should be written as 0, or to a field that should be written as all 0s.

Should-Be-Zero-or-Preserved (SBZP)

From the introduction of the ARMv7 Large Physical Address Extension, the definition of SBZP is modified for register bits that are SBZP in some but not all contexts. For more information see [Meaning of fixed bit values in register diagrams on page G3-3711](#). The generic definition of SBZP given here applies only to bits that are not affected by this modification.

Hardware must ignore writes to the field.

If software has read the field since the PE implementing the field was last reset and initialized, it must preserve the value of the field by writing the value that it previously read from the field. Otherwise, it must write the field as all 0s.

If software writes a value to the field that is not a value previously read for the field and is not all 0s, it must expect an UNPREDICTABLE result.

This description can apply to a single bit that should be written as its preserved value or as 0, or to a field that should be written as its preserved value or as all 0s.

Signaling NaNs Cause an Invalid Operation exception whenever any floating-point operation receives a signaling NaN as an operand. Signaling NaNs can be used in debugging, to track down some uses of uninitialized variables.

Signed immediate and offset fields

Are encoded in two's complement notation unless otherwise stated.

SIMD

Single-Instruction, Multiple-Data.

The SIMD instructions in AArch32 state are:

- The instructions summarized in [Parallel addition and subtraction instructions on page F1-2389](#).
- The Advanced SIMD instructions summarized in [Advanced SIMD and floating-point instructions on page E1-2303](#), when operating on vectors.

———— Note —————

In ARMv7, some VFP instructions can operate on vectors. However, ARM deprecates those instruction uses, and strongly recommends that Advanced SIMD instructions are always used for vector operations.

Simple sequential execution

The behavior of an implementation that fetches, decodes and completely executes each instruction before proceeding to the next instruction. Such an implementation performs no speculative accesses to memory, including to instruction memory. The implementation does not pipeline any phase of execution. In practice, this is the theoretical execution model that the architecture is based on, and ARM does not expect this model to correspond to a realistic implementation of the architecture.

Single-copy atomicity

The form of atomicity described in [Single-copy atomicity on page B2-79](#).

See also [Atomicity](#), [Multi-copy atomicity](#).

Single-precision value

A 32-bit word that is interpreted as a basic single-precision floating-point number according to the IEEE 754 standard.

Spatial locality

The observed effect that after a program has accessed a memory location, it is likely to also access nearby memory locations in the near future. Caches with multi-word cache lines exploit this effect to improve performance.

SUBARCHITECTURE DEFINED

Means that the behavior is expected to be specified by a subarchitecture definition. This definition might be shared by multiple implementations, but it must not be relied on by architecturally-portable software.

Subarchitecture definitions are used for:

- The interface between an ARMv7 VFP Extension implementation and its support code.
- The interface between an ARMv7 implementation of the Jazelle extension and an Enabled JVM.

In body text, the term SUBARCHITECTURE DEFINED is shown in SMALL CAPITALS.

T32 instruction One or two halfwords that specify an operation to be performed by a PE that is executing in an Exception level that is using AArch32 and is in T32 state. T32 instructions must be halfword-aligned.

T32 instructions were previously called Thumb instructions, and T32 state was previously called Thumb state.

See also [A32 instruction](#), [A64 instruction](#)

Temporal locality

The observed effect that after a program has accesses a memory location, it is likely to access the same memory location again in the near future. Caches exploit this effect to improve performance.

Thumb instruction

See [T32 instruction](#).

TLB

See [Translation Lookaside Buffer \(TLB\)](#).

TLB lockdown

A way to prevent specific translation table walk results being accessed. This ensures that accesses to the associated memory areas never cause a translation table walk.

Translation Lookaside Buffer (TLB)

A memory structure containing the results of translation table walks. They help to reduce the average cost of a memory access. Usually, there is a TLB for each memory interface of the ARM implementation.

Translation table

A table held in memory that defines the properties of memory areas of various sizes from 1KB to 1MB.

Translation table walk

The process of doing a full translation table lookup. It is performed automatically by hardware.

Trap enable bits

In VFPv2, VFPv3U, and VFPv4U, determine whether trapped or untrapped exception handling is selected. If trapped exception handling is selected, the way it is carried out is IMPLEMENTATION DEFINED.

Unaligned

An unaligned access is an access where the address of the access is not aligned to the size of an element of the access.

Unaligned memory accesses

Are memory accesses that are not, or might not be, appropriately halfword-aligned, word-aligned, or doubleword-aligned.

Unallocated

Except where otherwise stated, an instruction encoding is unallocated if the architecture does not assign a specific function to the entire bit pattern of the instruction, but instead describes it as UNDEFINED, UNPREDICTABLE, or an unallocated hint instruction.

A bit in a register is unallocated if the architecture does not assign a function to that bit.

UNDEFINED

Indicates an instruction that generates an Undefined Instruction exception.

In body text, the term UNDEFINED is shown in SMALL CAPITALS.

See also [Undefined Instruction exception on page G1-3476](#).

Unified cache

Is a cache used for both processing instruction fetches and processing data loads and stores.

Unindexed addressing

Means addressing in which the base register value is used directly as the virtual address to send to memory, without adding or subtracting an offset. In most types of load/store instruction, unindexed addressing is performed by using offset addressing with an immediate offset of 0. The LDC, LDC2, STC, and STC2 instructions have an explicit unindexed addressing mode that permits the offset field in the instruction to specify additional coprocessor options.

UNK

An abbreviation indicating that software must treat a field as containing an UNKNOWN value.

Hardware must implement the bit as read as 0, or all 0s for a bit field. Software must not rely on the field reading as zero.

See also [UNKNOWN](#).

UNK/SBOP

Hardware must implement the field as Read-As-One, and must ignore writes to the field.

Software must not rely on the field reading as all 1s, and except for writing back to the register it must treat the value as if it is UNKNOWN. Software must use an SBOP policy to write to the field.

This description can apply to a single bit that should be written as its preserved value or as 1, or to a field that should be written as its preserved value or as all 1s.

See also [Read-As-One \(RAO\)](#), [Should-Be-One-or-Preserved \(SBOP\)](#), [UNKNOWN](#).

UNK/SBZP

Hardware must implement the bit as Read-As-Zero, and must ignore writes to the field.

Software must not rely on the field reading as all 0s, and except for writing back to the register must treat the value as if it is UNKNOWN. Software must use an SBZP policy to write to the field.

This description can apply to a single bit that should be written as its preserved value or as 0, or to a field that should be written as its preserved value or as all 0s.

See also [Read-As-Zero \(RAZ\)](#), [Should-Be-Zero-or-Preserved \(SBZP\)](#), [UNKNOWN](#).

UNKNOWN

An UNKNOWN value does not contain valid data, and can vary from moment to moment, instruction to instruction, and implementation to implementation. An UNKNOWN value must not return information that cannot be accessed at the current or a lower level of privilege using instructions that are not UNPREDICTABLE and do not return UNKNOWN values.

An UNKNOWN value must not be documented or promoted as having a defined value or effect.

In body text, the term UNKNOWN is shown in SMALL CAPITALS.

See also [UNK](#).

UNPREDICTABLE

Means the behavior cannot be relied upon. UNPREDICTABLE behavior must not perform any function that cannot be performed at the current or a lower level of privilege using instructions that are not UNPREDICTABLE.

UNPREDICTABLE behavior must not be documented or promoted as having a defined effect.

An instruction that is UNPREDICTABLE can be implemented as UNDEFINED.

Execution in a Non-secure EL1 or EL0 mode of an instruction that is UNPREDICTABLE can be implemented as generating a Hyp Trap exception, provided that at least one instruction that is not UNPREDICTABLE causes a Hyp Trap exception.

In body text, the term UNPREDICTABLE is shown in SMALL CAPITALS.

See also [CONSTRAINED UNPREDICTABLE](#).

VA

See [Virtual address \(VA\)](#).

VFP

In ARMv7, an extension to the ARM architecture, that provides single-precision and double-precision floating-point arithmetic.

Virtual address (VA)

An address generated by an ARM PE. This means it is an address that might be held in the program counter of the PE. For a PMSA implementation, the virtual address is identical to the physical address.

See also [Intermediate Physical Address \(IPA\)](#), [Physical address \(PA\)](#).

Watchpoint

A debug event triggered by an access to memory, specified in terms of the address of the location in memory being accessed.

Way

See [Cache way](#).

Word

A 32-bit data item. Words are normally word-aligned in ARM systems.

Word-aligned

Means that the address is divisible by 4.

Write-allocate cache

A cache in which a cache miss on storing data causes a cache line to be allocated into the cache.

Write-back cache

A cache in which when a cache hit occurs on a store access, the data is only written to the cache. Data in the cache can therefore be more up-to-date than data in main memory. Any such data is written back to main memory when the cache line is cleaned or reallocated. Another common term for a write-back cache is a *copy-back cache*.

Write-through cache

A cache in which when a cache hit occurs on a store access, the data is written both to the cache and to main memory. This is normally done via a write buffer, to avoid slowing down the PE.

Write buffer

A block of high-speed memory that optimizes stores to main memory.

