



# CIVIC

31TBGG11  
 OG-05951  
 00X31-TBG-G110

[owners.honda.com](http://owners.honda.com) (U.S.)  
[myhonda.ca](http://myhonda.ca) (Canada)  
 2017 Honda Civic Coupe Owner's Guide  
 ©2017 Honda Motor Co., Ltd. — All Rights Reserved

Printed in U.S.A.



**2017**  
**Civic Coupe**  
**OWNER'S GUIDE**

# DISCLOSURES

## ■ Devices That Emit Radio Waves

The following products and systems on your vehicle emit radio waves when in operation:

- Audio system
- *Bluetooth*® Audio
- *Bluetooth* HandsFreeLink
- Collision Mitigation Braking System™ (CMBS™)\*
- Immobilizer system
- Remote transmitter
- Smart entry system\*
- Wireless charger\*

Each of the above complies with the appropriate requirements or the required standards of the FCC (Federal Communications Commission) and Industry Canada, described below:

*As required by the FCC:*

*This device complies with Part 15 of the FCC rules. Operation is subject to the following two conditions: (1) This device may not cause harmful interference, and (2) this device must accept any interference received, including interference that may cause undesired operation.*

*Changes or modifications not expressly approved by the party responsible for compliance could void the user's authority to operate the equipment.*

*As required by Industry Canada:*

*This device complies with Industry Canada licence-exempt RSS standard(s). Operation is subject to the following two conditions: (1) this device may not cause interference, and (2) this device must accept any interference, including interference that may cause undesired operation of the device.*

## ■ California Perchlorate Contamination Prevention Act

The airbags, seat belt tensioners, and CR-type batteries in this vehicle may contain perchlorate materials—special handling may apply. See [www.dtsc.ca.gov/hazardouswaste/perchlorate/](http://www.dtsc.ca.gov/hazardouswaste/perchlorate/) for more information.

## ■ California Proposition 65 Warning

**WARNING:** This product contains or emits chemicals known to the state of California to cause cancer and birth defects or other reproductive harm.

*\*if equipped*

## ■ Event Data Recorders

**This vehicle is equipped with an event data recorder (EDR).** The main purpose of an EDR is to record, in certain crash or near crash-like situations, such as an air bag deployment or hitting a road obstacle, data that will assist in understanding how a vehicle's systems performed. **The EDR is designed to record data related to vehicle dynamics and safety systems for a short period of time, typically 30 seconds or less. The EDR in this vehicle is designed to record such data as:**

- **How various systems in your vehicle were operating;**
- **Whether or not the driver and passenger safety belts were buckled/fastened;**
- **How far (if at all) the driver was depressing the accelerator and/or brake pedal; and,**
- **How fast the vehicle was traveling.**

These data can help provide a better understanding of the circumstances in which crashes and injuries occur. NOTE: EDR data are recorded by your vehicle only if a non-trivial crash situation occurs; no data are recorded by the EDR under normal driving conditions and no personal data (e.g., name, gender, age, and crash location) are recorded. However, other parties, such as law enforcement, could combine the EDR data with the type of personally identifying data routinely acquired during a crash investigation.

To read data recorded by an EDR, special equipment is required, and access to the vehicle or the EDR is needed. In addition to the vehicle manufacturer, other parties such as law enforcement that have the special equipment can read the information if they have access to the vehicle or the EDR.

The data belong to the vehicle owner and may not be accessed by anyone else except as legally required or with the permission of the vehicle owner.

## ■ Service Diagnostic Recorders

This vehicle is equipped with service-related devices that record information about powertrain performance. The data can be used to verify emissions law requirements and/or help technicians diagnose and solve service problems. It may also be combined with data from other sources for research purposes, but it remains confidential.

## ■ Privacy

The driver is responsible for the safe operation of the vehicle at all times. Use of the Android Display Audio and the Telematics Control Unit (TCU) should occur only when traffic conditions are safe. Your vehicle may share current location and vehicle usage information. To manage this setting or to obtain more details, press the LINK button in your vehicle (if equipped), visit [www.hondalink.com/vehicle-data-choices](http://www.hondalink.com/vehicle-data-choices), or see your Owner's Manual at [owners.honda.com](http://owners.honda.com) (U.S. owners) or [myhonda.ca](http://myhonda.ca) (Canadian owners).

# INTRODUCTION

This Owner's Guide is intended to help you quickly get acquainted with your **2017 Honda Civic Coupe**. It provides basic information and instructions on technology and convenience features, as well as emergency procedures and how to get assistance.

This guide is for vehicles sold in the United States and Canada. It covers all Civic Coupe models, so you may find descriptions of features and equipment that are not in your vehicle. Images throughout this guide are from U.S. vehicles and represent features and equipment that are available on some, but not all, models.

This guide is not intended to be a substitute for the Owner's Manual. The Owner Information CD enclosed in your glove box kit includes the Owner's Manual, Navigation Manual, and vehicle and tire warranties in electronic format. This information can be viewed on a computer (PC or Mac platform) and saved or printed for your reference. You can also visit [owners.honda.com](http://owners.honda.com) (U.S.) or [myhonda.ca](http://myhonda.ca) (Canada) to view the complete and most current information.

If you are the first registered owner of your vehicle, you may request a complimentary printed copy of the Owner's Manual, Navigation Manual, or Vehicle Warranty within the first six months of vehicle purchase. To request a copy, visit [owners.honda.com](http://owners.honda.com) (U.S.) and create or log in to your account. In Canada, please request a copy from your Honda dealer.

American Honda Motor Co., Inc. strives to be proactive in protecting our environment and natural resources. By using electronic delivery for a considerable portion of the information typically found in a vehicle owner's manual, we are further reducing our impact on the environment.

## Honda Automobile Customer Service

Your authorized Honda dealer should be able to answer any questions you have about your vehicle. However, if you are dissatisfied with the information you receive, you can call Honda Automobile Customer Service (see page 153).

**Phone (800) 999-1009 (U.S.) or (888) 946-6329 (Canada)**

## Honda Roadside Assistance

24-hour emergency road service is available to you in the United States and Canada throughout your 3-year/36,000-mile warranty term. Services include jump starting, flat tire and lockout assistance, towing, and more (limitations apply).

**Phone (866) 864-5211 (U.S.) or (800) 465-7587 (Canada)**

# TABLE OF CONTENTS

<b>VISUAL INDEX</b> .....	1	<b>AUDIO AND CONNECTIVITY</b> .....	54
Steering Wheel and Nearby Controls.....	1	Basic Audio Operation.....	54
Dashboard, Ceiling, and Other Controls.....	2	Models with Color Audio System.....	59
<b>SAFETY INFORMATION</b> .....	3	Color Audio System.....	59
Important Safety Information.....	3	FM/AM Radio.....	60
Seat Belts.....	5	iPod®.....	61
Airbags.....	8	USB Flash Drive.....	62
Child Safety.....	14	<i>Bluetooth</i> ® Audio.....	63
Safety Label Locations.....	21	Models with Display Audio.....	64
Reporting Safety Defects.....	22	Display Audio Operation.....	64
<b>INSTRUMENT PANEL</b> .....	23	HondaLink®.....	65
Malfunction Indicators.....	24	Wi-Fi Connection.....	66
Condition Indicators.....	26	Apple CarPlay™.....	67
On/Off Indicators.....	27	Android Auto™.....	68
Information Display*.....	28	FM/AM Radio.....	69
Driver Information Interface*.....	28	SiriusXM® Radio*.....	70
<b>VEHICLE CONTROLS</b> .....	32	iPod®.....	71
Using the Key or Remote Transmitter*.....	32	USB Flash Drive.....	72
Smart Entry System*.....	33	<i>Bluetooth</i> ® Audio.....	73
Door Operation.....	36	Pandora®*.....	74
Power Window Operation.....	37	<b>BLUETOOTH® HANDSFREELINK® (HFL)</b> .....	75
Power Moonroof Operation*.....	38	Models with color audio system.....	75
One-Touch Turn Signal.....	38	Basic HFL Operation.....	75
Interior and Exterior Lights.....	39	Pairing a Phone.....	76
Wiper Operation.....	40	Making a Call.....	77
Adjusting the Seats.....	42	Models with Display Audio.....	78
Adjusting the Steering Wheel.....	46	Basic HFL Operation.....	78
Adjusting the Mirrors.....	47	Pairing a Phone.....	80
Climate Control System.....	48	Making a Call.....	81
Seat Heaters*.....	51	SMS Text Messaging and E-Mail*.....	82
Customized Features.....	52	HondaLink® Assist.....	83
Setting the Clock.....	53	Siri® Eyes Free.....	84
		<b>NAVIGATION*</b> .....	85
		Basic Navigation Operation.....	85
		Entering a Destination.....	87
		Routing.....	90

\*if equipped

NAVIGATION

DRIVING

HANDLING THE UNEXPECTED

MAINTENANCE

SPECIFICATIONS

CUSTOMER INFORMATION

VOICE COMMAND INDEX

INDEX

TABLE OF CONTENTS

VISUAL INDEX

SAFETY INFORMATION

INSTRUMENT PANEL

VEHICLE CONTROLS

AUDIO AND CONNECTIVITY

BLUETOOTH® HANDSFREELINK®

HONDALINK®

# VISUAL INDEX

Quickly locate items in the vehicle's interior.

## Steering Wheel and Nearby Controls

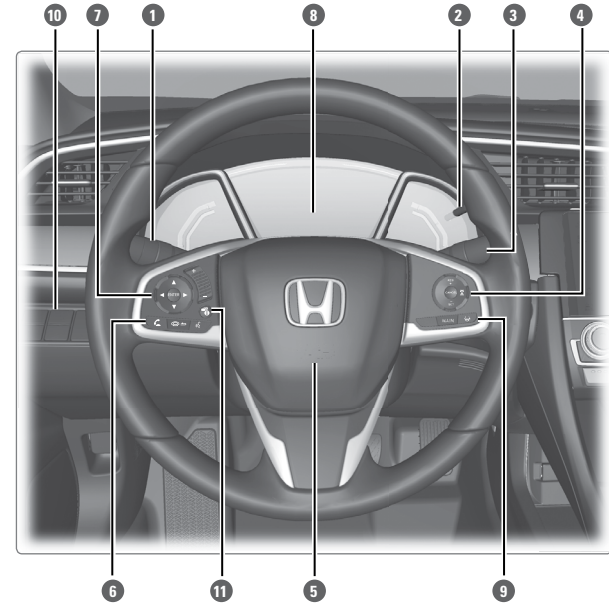

- 1 Lights/turn signals/LaneWatch button\* p. 39, p. 38, p. 110
- 2 TRIP knob p. 29  
Brightness control p. 39
- 3 Wipers/washers p. 40
- 4 Cruise control buttons\* p. 103  
Adaptive Cruise Control (ACC) with Low Speed Follow (LSF) buttons\* p. 104
- 5 Horn
- 6 Voice recognition/Bluetooth HandsFreeLink buttons p. 75, p. 78, p. 85
- 7 Audio controls p. 56
- 8 Instrument panel p. 23  
Information display\* p. 28  
Driver Information Interface\* p. 28
- 9 Lane Keeping Assist System (LKAS) button\* p. 106
- 10 Vehicle Stability Assist (VSA) OFF button p. 102  
Road Departure Mitigation (RDM) button\* p. 107  
Collision Mitigation Braking System (CMBS) button\* p. 108  
Tire Pressure Monitoring System (TPMS) button\* p. 120
- 11 Display/information button\* p. 28

\*if equipped

\*if equipped

**DRIVING**..... 92

- Before Driving..... 92
- Improving Fuel Economy and Reducing CO<sub>2</sub> Emissions..... 93
- Maximum Load Limit..... 94
- Remote Engine Start\*..... 96
- Starting to Drive..... 97
- Shifting..... 98
- Braking..... 100
- Eco Assist™ System\*..... 102
- SPORT Mode\*..... 102
- Vehicle Stability Assist (VSA®)..... 102
- Cruise Control\*..... 103
- Adaptive Cruise Control (ACC) with Low Speed Follow (LSF)\*..... 104
- Lane Keeping Assist System (LKAS)\*..... 106
- Road Departure Mitigation (RDM)\*..... 107
- Collision Mitigation Braking System™ (CMBS™)\*..... 108
- LaneWatch™\*..... 110
- Multi-View Rear Camera..... 111
- Refueling..... 113
- Turbocharger\* Precautions..... 114

**HANDLING THE UNEXPECTED**..... 115

- Smart Entry Remote Battery Strength\*..... 115
- Shift Lever Does Not Move\*..... 115
- Jump Starting..... 116
- Manually Opening the Trunk..... 117
- Overheating..... 118
- Emergency Engine Stop\*..... 119
- Emergency Towing..... 119
- Tire Pressure Monitoring System (TPMS)..... 120
- If You Get a Flat Tire..... 122
- Getting Ready to Change the Tire..... 122
- Fuse Locations..... 126

**MAINTENANCE**..... 129

- Safety Precautions..... 129
- Maintenance Minder™..... 130
- Under the Hood..... 133
- Engine Oil..... 135
- Engine Coolant..... 138
- Brake/Clutch\* Fluid..... 139
- Window Washer Fluid..... 139
- Checking the Battery..... 140
- Changing Wiper Blades..... 141
- Tire Information..... 142
- Tire Labeling..... 145
- DOT Tire Quality Grading..... 146
- Cold or Rainy Weather Driving..... 147
- Air Conditioning..... 147
- Testing of Readiness Codes..... 148

**SPECIFICATIONS**..... 149

**CUSTOMER INFORMATION**..... 152

- Frequently Asked Questions/Troubleshooting..... 152
- Contact Us..... 153
- Honda Roadside Assistance..... 153
- Warranty Coverages..... 154

**VOICE COMMAND INDEX**..... 155

**INDEX**..... 157

## Dashboard, Ceiling, and Other Controls

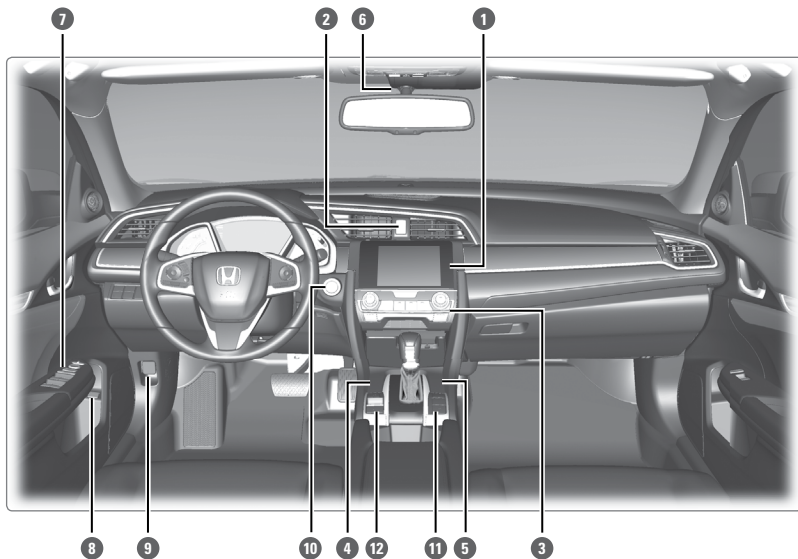

- 1 Color audio system\* p. 59  
Display Audio\* p. 64
- 2 Hazard warning button
- 3 Climate control system/seats heater buttons\* p. 48, p. 51
- 4 USB port p. 54
- 5 Accessory power socket p. 54
- 6 Moonroof switch\* p. 38  
Map lights p. 39  
Rearview mirror p. 47
- 7 Power window switches p. 37  
Door lock switches p. 36  
Door mirror controls p. 47
- 8 Trunk opener p. 36
- 9 Hood release handle p. 134
- 10 ENGINE START/STOP button\* p. 98
- 11 ECON button\* p. 102  
SPORT button\* page 102
- 12 Electric parking brake switch p. 100  
Automatic brake hold button p. 101

\*if equipped

## SAFETY INFORMATION

Your safety—and the safety of others—is very important, and operating this vehicle safely is an important responsibility. While we strive to help you make informed decisions about safety, it is not practical or possible to warn you about all the hazards associated with operating or maintaining your vehicle. Therefore, you must use your own good judgment.

### Important Safety Information

This guide explains many of your vehicle's safety features and how to use them. Please read this information carefully. Following the instructions below will also help to keep you and your passengers safe.

#### ■ Important Safety Precautions

- Always wear your seat belt.
- Secure all children in the proper restraint system.
- Be aware of airbag hazards.
- Don't drink and drive.
- Pay appropriate attention to the task of driving safely.
- Control your speed.
- Keep your vehicle in safe condition.

Engaging in cell phone conversation or other activities that keep you from paying close attention to the road, other vehicles, and pedestrians could lead to a crash. Remember, situations can change quickly, and only you can decide when it is safe to divert some attention away from driving.

#### ■ Safety Messages

When you see the following messages throughout this guide, pay close attention.

**⚠ DANGER** You WILL be KILLED or SERIOUSLY HURT if you don't follow instructions.

**⚠ WARNING** You CAN be KILLED or SERIOUSLY HURT if you don't follow instructions.

**⚠ CAUTION** You CAN be HURT if you don't follow instructions.

**NOTICE** This information is intended to help you avoid damage to your vehicle, other property, or the environment.

## ■ Carbon Monoxide Gas

The engine exhaust from this vehicle contains carbon monoxide, a colorless, odorless, and highly toxic gas. As long as you properly maintain your vehicle and follow the instructions set forth below, you will not accumulate dangerous levels of carbon monoxide gas in the vehicle interior.

Have the exhaust system inspected for leaks whenever:

- The exhaust system is making an unusual noise.
- The exhaust system may have been damaged.
- The vehicle is raised for an oil change.

When you operate a vehicle with the trunk open, airflow can pull exhaust gas into the interior and create a hazardous condition. If you must drive with the trunk open, open all the windows and set the climate control system as shown below.

1. Select the fresh air mode.
2. Select the  mode.
3. Set the fan speed to high.
4. Set the temperature control to a comfortable setting.

Adjust the climate control system in the same manner if you sit in your parked vehicle with the engine running.

### WARNING

Carbon monoxide gas is toxic. Breathing it can cause unconsciousness and even kill you.

Avoid any enclosed areas or activities that expose you to carbon monoxide.

An enclosed area such as a garage can quickly fill up with carbon monoxide gas. Do not run the engine with the garage door closed. Even when the garage door is open, drive out of the garage immediately after starting the engine.

## Seat Belts

A seat belt is your best protection in all types of collisions. Airbags are designed to supplement seat belts, not replace them. So even though your vehicle is equipped with airbags, make sure you and your passengers always wear your seat belts and wear them properly.

### ■ Lap/Shoulder Seat Belts

All five seating positions are equipped with lap/shoulder seat belts with emergency locking retractors. In normal driving, the retractor lets you move freely while keeping some tension on the belt. During a collision or sudden stop, the retractor locks to restrain your body. The front passenger's and rear seat belts also have a lockable retractor for use with child seats.

The front seats are equipped with automatic seat belt tensioners to enhance safety. The tensioners automatically tighten the front seat belts during a moderate to severe frontal collision, sometimes even if the collision is not severe enough to inflate the front airbags.

### ■ Proper Use of Seat Belts

Follow these guidelines for proper use:

- All occupants should sit upright, well back in the seat, and remain in that position for the duration of the trip. Slouching and leaning reduces the effectiveness of the belt and can increase the chance of serious injury in a crash.
- Never place the shoulder part of a lap/shoulder seat belt under your arm or behind your back. This could cause very serious injuries in a crash.
- Two people should never use the same seat belt. If they do, they could be very seriously injured in a crash.
- Do not put any accessories on the seat belts. Devices intended to improve comfort or reposition the shoulder part of a seat belt can reduce the protective capability and increase the chance of serious injury in a crash.
- No one should sit in a seat with an inoperative seat belt or one that does not appear to be working correctly. Using a seat belt that is not working properly may not protect the occupant in a crash. Have a dealer check the belt as soon as possible.
- If you extend the seat belt too quickly, it will lock in place. If this happens, slightly retract the seat belt, then extend it slowly.

### WARNING

Not wearing a seat belt properly increases the chance of a serious injury or death in a crash, even though your vehicle has airbags.

Be sure you and your passengers always wear seat belts and wear them properly.

## ■ Seat Belt Inspection

Regularly check the condition of your seat belts as follows:

- Pull each belt out fully, and look for frays, cuts, burns, and wear.
- Check that the latch plates and buckles work smoothly and the belts retract easily. If a belt does not retract easily, cleaning the belt may correct the problem. Use only mild soap and warm water. Do not use bleach or cleaning solvents. Make sure the belt is completely dry before allowing it to retract.

Any belt that is not in good condition or working properly will not provide proper protection and should be replaced as soon as possible.

A belt that has been worn during a crash may not provide the same level of protection in a subsequent crash. Have your seat belts inspected by a dealer after any collision.

### **⚠ WARNING**

Not checking or maintaining seat belts can result in serious injury or death if the seat belts do not work properly when needed.

Check your seat belts regularly and have any problem corrected as soon as possible.

## ■ Fastening a Seat Belt

Adjust your seat to the proper position (see page 42), and then follow the below steps.

1. Pull the seat belt out slowly.
2. Insert the latch plate into the buckle, then tug on the belt to make sure the buckle is secure. Make sure that the belt is not twisted or caught on anything.
3. Position the lap part of the belt as low as possible across your hips, then pull up on the shoulder part of the belt so the lap part fits snugly. This lets your strong pelvic bones take the force of a crash and reduces the chance of internal injuries.
4. If necessary, pull up on the belt again to remove any slack, then make sure that the belt rests across the center of your chest and over your shoulder. This spreads the forces of a crash over the strongest bones in your upper body.

To release the belt, push the red PRESS button then guide the belt by hand until it has retracted completely.

When exiting the vehicle, be sure the belt is properly stowed so that it will not get caught in the closing door.

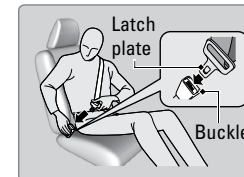
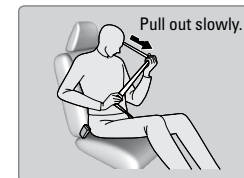

### **⚠ WARNING**

Improperly positioning the seat belts can cause serious injury or death in a crash.

Make sure all seat belts are properly positioned before driving.

## Airbags

Your vehicle is equipped with three types of airbags: front airbags, side airbags, and side curtain airbags.

### ■ Front Airbags (SRS)

The front SRS airbags inflate in a moderate-to-severe frontal collision to help protect the head and chest of the driver and/or front passenger. They are housed in the center of the steering wheel for the driver, and in the dashboard for the front passenger. Both airbags are marked **SRS AIRBAG**.

SRS (Supplemental Restraint System) indicates that the airbags are designed to supplement seat belts, not replace them. Seat belts are the occupant's primary restraint system.

### ■ Advanced Airbags

The airbags have advanced features to help reduce the likelihood of airbag-related injuries to smaller occupants.

The driver's advanced airbag system includes a seat position sensor. Based on information from this sensor and the severity of the impact, the advanced airbag system determines the optimal deployment of the driver's airbag.

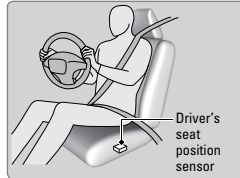

The front passenger's advanced airbag system has a weight sensor. We advise against allowing a child age 12 or under to ride in the front passenger's seat. However, *if you do allow a child age 12 or under to ride in the front passenger's seat*, note that the system will automatically turn off the front passenger's airbag if the sensors detect that the child is approximately 65 lbs (29 kg) or less.

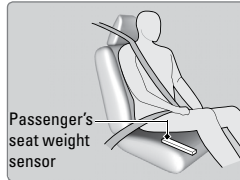

For the advanced airbags to work properly:

- Do not spill any liquid on or under the seats.
- Do not put any object under the passenger's seat.
- Make sure any objects are positioned properly on the floor. Improperly positioned objects can interfere with the advanced airbag sensors.
- All occupants should sit upright and wear their seat belts properly.
- Do not cover the passenger's side dashboard with a cloth, towel, cover, etc.
- Make sure the floor mat behind the front passenger's seat is hooked to the floor mat anchor. An improperly placed mat can interfere with the advanced airbag sensors.

### ■ Side Airbags

The side airbags help protect the torso and pelvis of the driver or a front passenger during a moderate-to-severe side impact. They are housed in the outside edge of the driver's and front passenger's seat-backs. Both are marked **SIDE AIRBAG**.

### ■ Side Curtain Airbags

Side curtain airbags help protect the heads of the driver and passengers in the outer seating positions during a moderate-to-severe side impact. The side curtain airbags equipped in this vehicle are also designed to help reduce the likelihood of partial and complete ejection of vehicle occupants through side windows in crashes, particularly rollover crashes.

The side curtain airbags are located in the ceiling above the side windows on both sides of the vehicle. Both are marked **SIDE CURTAIN AIRBAG**.

The side curtain airbags are designed to deploy in a rollover, moderate-to-severe side impact, or a moderate-to-severe angled frontal collision. If the SRS control unit senses that your vehicle is about to roll over, it immediately deploys both side curtain airbags and activates both front seat belt tensioners. If the impact is on the passenger's side, the passenger's side curtain airbag will inflate even if there are no occupants on that side of the vehicle. To get the best protection from the side curtain airbags, occupants should wear their seat belts properly and sit upright and well back in their seats.

Do not attach any objects to the side windows or roof pillars, as they can interfere with the proper operation of the side curtain airbags.

#### When side curtain airbags deploy in a frontal collision

One or both side curtain airbags may inflate in a severe frontal collision.

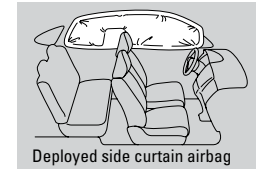
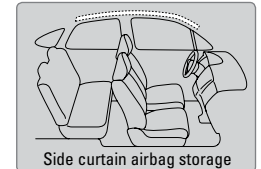



### ■ Important Facts About Your Airbags

Always wear your seat belt properly, and sit upright and as far back from the steering wheel as possible while allowing full control of the vehicle. A front passenger should move their seat as far back from the dashboard as possible.

**Do not place hard or sharp objects between yourself and a front airbag.** Carrying hard or sharp objects on your lap, or driving with a pipe or other sharp object in your mouth, can result in injuries if your front airbag inflates.

**Do not attach or place objects on the front airbag covers.** Objects on the covers marked **SRS AIRBAG** could interfere with the proper operation of the airbags or be propelled inside the vehicle and hurt someone if the airbags inflate.

**Do not attach accessories on or near the side airbags.** They can interfere with the proper operation of the airbags, or hurt someone if an airbag inflates.

**Do not attach any objects to the side windows or roof pillars.** They can interfere with the proper operation of the side curtain airbags.

**Do not cover or replace the front seat-back covers.** This can prevent your side airbags from properly deploying during a side impact

#### ⚠️ WARNING

An open glove box can cause serious injury to your passenger in a crash, even if the passenger is wearing the seat belt.

Always keep the glove box closed while driving.

### ■ Airbag System Indicators

If a problem occurs in the airbag system, the SRS indicator comes on and a message appears on the Driver Information Interface\*.

#### SRS (Supplemental Restraint System) indicator

If the indicator comes on at any other time besides vehicle start-up, or does not come on at all, have the system checked by a dealer as soon as possible. If you don't, your airbags and seat belt tensioners may not work properly when they are needed.



#### ⚠️ WARNING

Ignoring the SRS indicator can result in serious injury or death if the airbag systems or tensioners do not work properly.

Have your vehicle checked by a dealer as soon as possible if the SRS indicator alerts you to a possible problem.

\*if equipped

### Passenger Airbag Off indicator

The indicator comes on to alert you that the front passenger's front airbag has been turned off. This occurs when the front passenger's seat weight sensors detect 65 lbs (29 kg) or less, the weight of an infant or small child, on the seat.

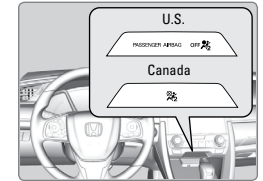

Infants and small children should always ride properly restrained in a back seat.

The indicator also will come on when the front passenger's seat is empty; the passenger's front airbag will not deploy in a crash.

To ensure the passenger is detected properly, check that:

- There is no child seat or other object pressing against the rear of the seat-back.
- There is no rear passenger pushing or pulling on the back of the front passenger's seat.
- The front seat or seat-back is not forced back against an object on the seat or floor behind it.
- There is no object placed under or beside the front passenger's seat.
- The occupant is sitting in an upright position and the seat back is not excessively reclined.
- The occupant is not leaning against the door or center console.
- The occupant's feet are placed on the floor in front of them.
- There are no objects hanging from the front passenger's seat.
- Only small, lightweight objects are in the seat-back pocket.

The passenger airbag off indicator may come on and go off periodically if the total weight on the seat is near the airbag cutoff threshold.

Have your vehicle checked by a dealer as soon as possible if:

- All of the above conditions exist, and the indicator comes on with an adult riding there.
- The seat is empty and the indicator is off.

Do not allow a passenger to ride in the front seat when the indicator is on.

### Airbag System Components

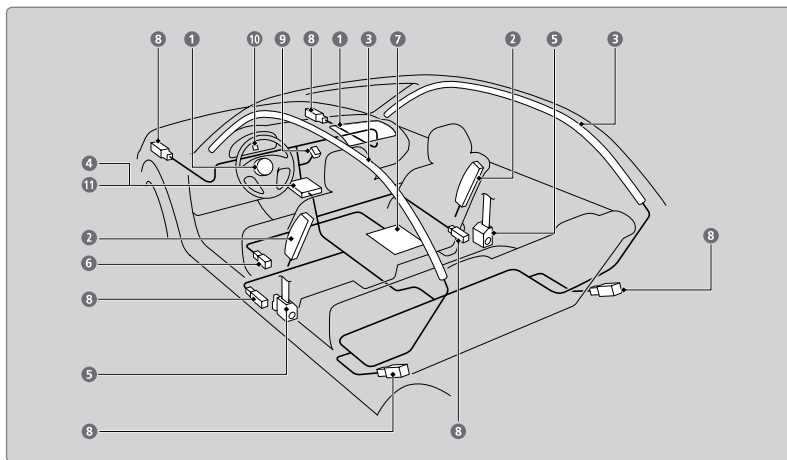

- 1 Two SRS (Supplemental Restraint System) front airbags. The driver's airbag is stored in the center of the steering wheel; the front passenger's airbag is stored in the dashboard. Both are marked **SRS AIRBAG**.
- 2 Two side airbags, one for the driver and one for the front passenger. The airbags are stored in the outer edges of the seat-backs. Both are marked **SIDE AIRBAG**.
- 3 Two side curtain airbags, one for each side of the vehicle. The airbags are stored in the ceiling, above the side windows. The front and rear pillars are marked **SIDE CURTAIN AIRBAG**.
- 4 An electronic control unit that, when the vehicle is on, continually monitors information about the various impact sensors, seat and buckle sensors, rollover sensor, airbag activators, seat belt tensioners, and other vehicle information. During a crash event, the unit can record such information.
- 5 Automatic front seat belt tensioners. In addition, the driver's and front passenger's seat belt buckles incorporate sensors that detect whether or not the belts are fastened.
- 6 A driver's seat position sensor. If the seat is too far forward, the airbag will inflate with less force.
- 7 Weight sensors in the front passenger's seat. The front passenger's airbag will be turned off if the weight on the seat is about 65 lbs (29 kg) or less (the weight of an infant or small child) or if the seat is empty.
- 8 Impact sensors that can detect a moderate-to-severe front or side impact.
- 9 An indicator on the dashboard that alerts you that the front passenger's front airbag has been turned off.

- 10 An indicator on the instrument panel that alerts you to a possible problem with the airbag system or seat belt tensioners.
- 11 A rollover sensor that detects whether the vehicle is about to roll over and signal the control unit to deploy both side curtain airbags.

### Airbag Care

You do not need to, and should not, perform any maintenance on or replace any airbag system components yourself. However, you should have your vehicle inspected by a dealer in the following situations:

#### When the airbags have deployed

If an airbag has inflated, the control unit and other related parts must be replaced. Similarly, once an automatic seat belt tensioner has been activated, it must be replaced.

You should always use new, genuine Honda parts to replace parts after an airbag deployment. Used, salvaged, aftermarket, or grey-market parts may not work correctly in a crash.

#### When the vehicle has been in a moderate-to-severe collision

Even if the airbags did not inflate, have your dealer inspect the following: the driver's seat position sensor, weight sensors in the passenger's seat, front seat belt tensioners, and each seat belt that was worn during the crash.

#### Do not remove or modify a front seat without first consulting a dealer

This would likely disable or affect the proper operation of the driver's seat position sensor or the weight sensors in the passenger's seat. If it is necessary to remove or modify a front seat to accommodate a person with disabilities, contact a Honda dealer, or for U.S. vehicles, call Honda Automobile Customer Service at (800) 999-1009. For Canadian vehicles, call Honda Canada Customer Relations at (888) 946-6329.

## Child Safety

Each year, many children are injured or killed in vehicle crashes because they are either unrestrained or not properly restrained. In fact, vehicle collisions are the number one cause of death of children ages 12 and under.

The National Highway Traffic Safety Administration and Transport Canada recommend that all children ages 12 and under be properly restrained in a rear seat. Some states or provinces/territories have laws restricting where children may ride.

To reduce the number of child deaths and injuries, every state, Canadian province and territory requires that infants and children be properly restrained when they ride in a vehicle.

### ■ Protecting Child Passengers

- An inflating front or side airbag can injure or kill a child sitting in the front seat.
- A child in the front seat is more likely to interfere with the driver's ability to safely control the vehicle.
- Statistics show that children of all sizes and ages are safer when they are properly restrained in a rear seat.
- Any child who is too small to wear a seat belt correctly must be restrained in an approved child seat that is properly secured to the vehicle using either the seat belt or the lower anchors of the LATCH system.
- Never put a seat belt over yourself and a child. During a crash, the belt would likely press deep into the child and cause serious or fatal injuries.
- Never let two children use the same seat belt. Both children could be very seriously injured in a crash.
- Do not allow children to operate the doors, windows, or seat adjusters.
- Do not leave children in the vehicle unattended, especially in hot weather when the inside of the vehicle can get hot enough to kill them. They could also activate vehicle controls, causing it to move unexpectedly.

### ⚠ WARNING

Children who are unrestrained or improperly restrained can be seriously injured or killed in a crash.

Any child too small for a seat belt should be properly restrained in a child seat. A larger child should be properly restrained with a seat belt, using a booster seat if necessary.

### ⚠ WARNING

Allowing a child to play with a seat belt or wrap one around their neck can result in serious injury or death.

Instruct children not to play with any seat belt and make sure any unused seat belt a child can reach is buckled, fully retracted, and locked.

### ■ Protecting Infants

An infant must be properly restrained in a rear-facing, reclining child seat until the infant reaches the seat manufacturer's weight or height limit for the seat, and the infant is at least one year old. Many experts recommend use of a rear-facing seat for a child up to two years old if the child's height and weight are appropriate for a rear-facing seat.

Child seats must be placed and secured in a rear seating position. Rear-facing child seats should never be installed in a forward-facing position. Many experts recommend use of a rear-facing seat for a child up to two years old if the child's height and weight are appropriate for a rear-facing seat.

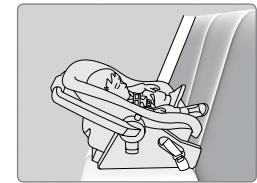

When properly installed, a rear-facing child seat may prevent the driver or a front passenger from moving their seat all the way back, or from locking their seat-back in the desired position. It can also interfere with proper operation of the passenger's advanced front airbag system. Make sure there is no contact between the child seat and the seat in front of it.

If this occurs, we recommend that you install the child seat directly behind the front passenger's seat, move the seat as far forward as needed, and leave it unoccupied. Or, you may wish to get a smaller rear-facing child seat.

Do not allow a front seat to rest against a child seat installed in a rear seating position: The weight sensor in the front seat may not correctly detect the actual weight of the occupant.

### ⚠ WARNING

Placing a rear-facing child seat in the front seat can result in serious injury or death during a crash.

Always place a rear-facing child seat in the rear seat, not the front.

## ■ Protecting Smaller Children

If a child is at least one year old and within the weight range indicated by the child seat manufacturer, the child should be properly restrained in a firmly secured forward-facing child seat.

We strongly recommend placing a forward-facing child seat in a rear seating position.

Placing a forward-facing child seat in the front seat can be hazardous, even with advanced front airbags that automatically turn the passenger's front airbag off. A rear seat is the safest place for a child.

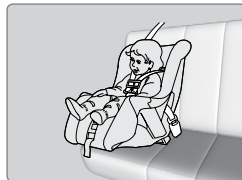

### ⚠️ WARNING

Placing a forward-facing child seat in the front seat can result in serious injury or death if the front airbag inflates.

If you must place a forward-facing child seat in front, move the vehicle seat as far back as possible, and properly restrain the child.

## ■ Selecting a Child Seat

Most child seats are LATCH-compatible (Lower Anchors and Tethers for CHildren). Some have a rigid-type connector, while others have a flexible-type connector. Both are equally easy to use. Some existing and previously owned child seats can be installed using only the seat belt. Whichever type you choose, follow the child seat manufacturer's use and care instructions as well as the instructions in your Owner's Manual, available at [owners.honda.com](http://owners.honda.com) (U.S. owners) or [myhonda.ca](http://myhonda.ca) (Canadian owners). Proper installation is key to maximizing your child's safety.

In seating positions and vehicles not equipped with LATCH, a LATCH-compatible child seat can be installed using the seat belt and a top tether for added security. This is because all child seats are required to be designed so that they can be secured with a lap belt or the lap part of a lap/shoulder belt. In addition, the child seat manufacturer may advise that a seat belt be used to attach a LATCH-compatible seat once a child reaches a specified weight. Please read the child seat owner's manual for proper installation instructions.

### Important considerations when selecting a child seat

Make sure the child seat meets the following four requirements:

- The child seat is the correct type and size for the child.
- The child seat is the correct type for the seating position.
- The child seat is compliant with Federal Motor Vehicle Safety Standard 213 or Canadian Motor Vehicle Safety Standard 213.
- The child seat is not older than the expiration date printed on the seat.

## ■ Installing a LATCH-Compatible Child Seat

A LATCH-compatible child seat can be installed in either of the two outer rear seats. A child seat is attached to the lower anchors with either the rigid or flexible type of connectors.

1. Locate the lower anchors under the marks.

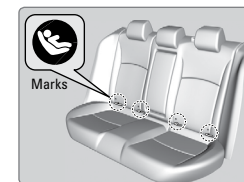

2. Place the child seat on the vehicle seat, then attach the child seat to the lower anchors according to the instructions that came with the child seat. Make sure that the lower anchors are not obstructed by the seat belt or any other object.

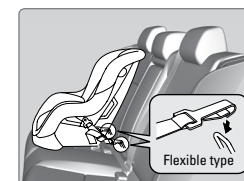
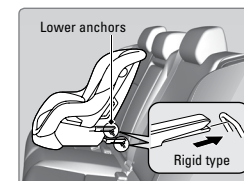

3. Open the tether anchor cover behind the head restraint.
4. Route the tether strap over the top of the head restraint, and secure the tether strap hook to the anchor. Make sure the strap is not twisted.
5. Tighten the tether strap as instructed by the child seat manufacturer.
6. Make sure the child seat is firmly secured by rocking it forward and back and side to side. Less than one inch of movement should occur near the seat belt.
7. Make sure any unused seat belt that a child can reach is buckled, the lockable retractor is activated, and the belt is fully retracted and locked.

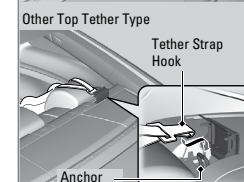
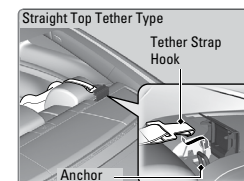

## ■ Installing a Child Seat with a Lap/Shoulder Seat Belt

1. Place the child seat on the vehicle seat.
2. Route the seat belt through the child seat according to the seat manufacturer's instructions, and insert the latch plate into the buckle. Insert the latch plate fully until it clicks.
3. Slowly pull the shoulder part of the belt all the way out until it stops. This activates the lockable retractor.
4. Let the seat belt completely wind up into the retractor, then try to pull it out to make sure the retractor is locked. If you are able to pull the shoulder belt out, the lockable retractor is not activated. Pull the seat belt all the way out, and repeat steps 3 – 4.
5. Grab the shoulder part of the seat belt near the buckle, and pull up to remove any slack from the lap part of the belt. When doing this, place your weight on the child seat and push it into the vehicle seat.
6. Make sure the child seat is firmly secured by rocking it forward and back and side to side; little movement should be felt.
7. Make sure any unused seat belt that a child can reach is buckled, the lockable retractor is activated, and the belt is fully retracted and locked.

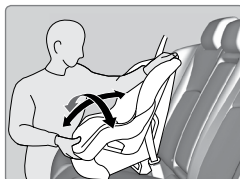
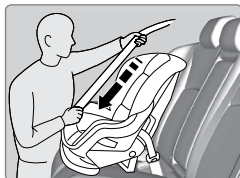

To deactivate a lockable retractor, release the buckle and allow the seat belt to wind up all the way.

## ■ Adding Security with a Tether

A tether anchorage point is provided behind each rear seating position. If you have a child seat that comes with a tether but can be installed with a seat belt, the tether may be used for additional security. Always use a tether for forward facing child seats when using the seat belt or lower anchors.

1. Locate the appropriate tether anchorage point and lift the cover.

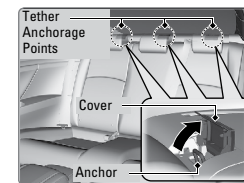

2. Route the tether strap over the head restraint. Make sure the strap is not twisted.

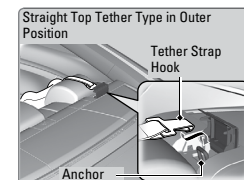

3. Secure the tether strap hook to the anchor.

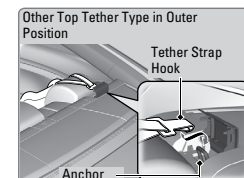

4. Tighten the tether strap as instructed by the child seat manufacturer.

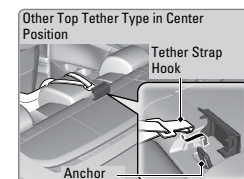
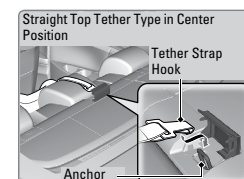

## Protecting Larger Children

When a child is too big for a child seat, secure the child in a rear seat using the lap/shoulder seat belt.

Have the child sit upright and all the way back, then ensure the following:

- The child's knees bend comfortably over the edge of the seat.
- The shoulder belt crosses between the child's neck and arm.
- The lap part of the seat belt is as low as possible, touching the child's thighs.
- The child can stay seated for the whole trip.



If a lap/shoulder seat belt cannot be used properly, position the child in a booster seat in the rear seat. For the child's safety, check that the child meets the booster seat manufacturer's recommendations.

Some U.S. states and Canadian provinces/territories require children to use a booster seat until they reach a given age or weight (e.g., 6 years or 60 lbs/27 kg). Be sure to check current laws in the state or province/territory where you intend to drive.

### WARNING

Allowing a child age 12 or under to sit in the front can result in injury or death if the passenger's front airbag inflates.

If a larger child must ride in front, move the vehicle seat as far to the rear as possible, then have the child sit up properly and wear the seat belt properly, using a booster seat if needed.

## Safety Label Locations

Safety labels are in the locations shown. They warn you of potential hazards that can cause serious injury or death. Read these labels carefully.

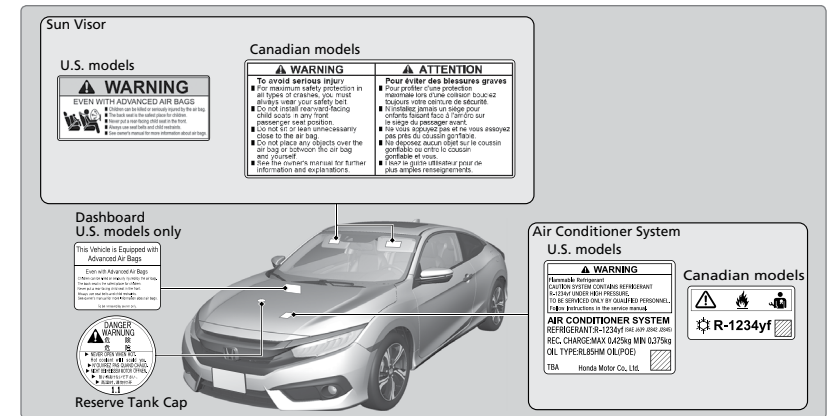

## Reporting Safety Defects

### In the U.S.

If you believe that your vehicle has a defect which could cause a crash or could cause injury or death, you should immediately inform the National Highway Traffic Safety Administration (NHTSA) in addition to notifying American Honda Motor Co., Inc.

If NHTSA receives similar complaints, it may open an investigation, and if it finds that a safety defect exists in a group of vehicles, it may order a recall and remedy campaign. However, NHTSA cannot become involved in individual problems between you, your dealer, or American Honda Motor Co., Inc.

To contact NHTSA, you may call the Vehicle Safety Hotline toll-free at 1-888-327-4236 (TTY: 1-800-424-9153); go to <http://www.safercar.gov>; or write to: Administrator, NHTSA, 1200 New Jersey Avenue, SE., Washington, DC 20590. You can also obtain other information about motor vehicle safety from <http://www.safercar.gov>.

### In Canada

If you believe that your vehicle has a defect which could cause a crash or could cause injury or death, you should immediately inform Honda Canada, Inc., and you may also inform Transport Canada.

If Transport Canada receives similar complaints, it may open an investigation, and if it finds that a safety defect exists in a group of vehicles, it may lead to a recall and remedy campaign. However, Transport Canada cannot become involved in individual problems between you, your dealer, or Honda Canada, Inc.

To contact Transport Canada's Defect Investigations and Recalls Division, you may call 1-800-333-0510. For more information on reporting safety defects or about motor vehicle safety, go to <http://www.tc.gc.ca/roadsafety>.

## INSTRUMENT PANEL

Learn about the indicators, gauges, and displays related to driving the vehicle.

### Models with information display

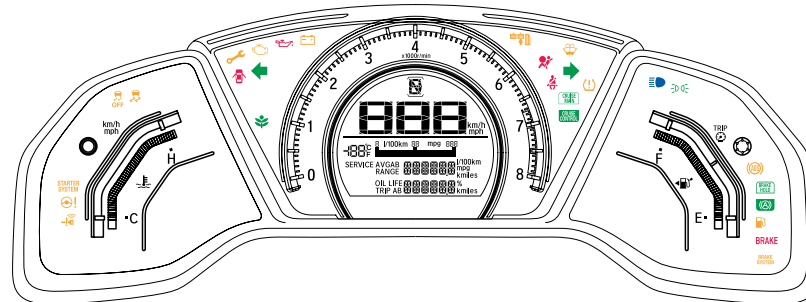

### Models with Driver Information Interface



Indicators briefly appear with each engine start and then go out. Red and amber indicators are most critical. Blue and green indicators are used for general information.

## Malfunction Indicators

These are the most critical indicators. If they come on and stay lit while driving or at any other time, there may be a problem. See your dealer if necessary.

### **BRAKE** Brake system

*U.S.*

- Brake fluid is low. Check the brake fluid (see page 139).



*Canada*

- The brake system has a problem. Press the brake pedal lightly to check pedal pressure. If normal, check the brake fluid level when you stop. If abnormal, take immediate action. If necessary, downshift the transmission to slow the vehicle using engine braking. Have your vehicle repaired immediately.
- If the indicator blinks (or comes on simultaneously with the amber brake system indicator), there is a problem with the electric parking brake system. Avoid using the parking brake and have your vehicle checked immediately.



### Low oil pressure

Engine oil pressure is low. Stop in a safe place. Open the hood. Check the oil level, and add oil if necessary (see page 135). If the indicator does not turn off, have your vehicle repaired immediately.



### Charging system

The battery is not charging. Turn off all electrical items, but do not turn off the vehicle to prevent further battery discharge. Have your vehicle repaired immediately.



### Supplemental Restraint System (SRS)

There is a problem with one of the airbag systems or seat belt tensioners.



### Smart Entry system\*

There is a problem with the smart entry system.

LKAS

### Lane Keeping Assist System (LKAS)\*

There is a problem with the system.



### Starter system\*

There is a problem with the starter system. Press and hold the ENGINE START/STOP button for up to 15 seconds while pressing the brake pedal to manually start the engine.

ACC

### Adaptive Cruise Control (ACC) with Low Speed Follow (LSF)\*

There is a problem with the system.



### Road Departure Mitigation (RDM)\*

There is a problem with the system.

*\*if equipped*



### Electric Power Steering (EPS)

There is a problem with the system.



### Malfunction indicator lamp (check engine light)

The emissions control system may have a problem, or the fuel cap is loose or missing. If the indicator blinks, a misfire in the engine's cylinders is detected. Stop in a safe place, and wait for the engine to cool down.



### Anti-lock Brake System (ABS)

There is a problem with the anti-lock brake system. Your vehicle still has normal braking ability, but no anti-lock function.



### Tire Pressure Monitoring System (TPMS) (U.S. models)

If the indicator blinks and remains on, there is a problem with the tire pressure monitoring system, or the vehicle is fitted with the compact spare tire. If the vehicle battery was disconnected, the system is temporarily deactivated. Drive a short distance at 12 mph (20 km/h) or more, and the indicator should go off.



### Vehicle Stability Assist (VSA)

There is a problem with the VSA system or hill start assist system. If the vehicle battery was disconnected, the system is temporarily deactivated. Drive a short distance at 12 mph (20 km/h) or more, and the indicator should go off.



### Vehicle Stability Assist (VSA) OFF

If the vehicle battery was disconnected, the system is temporarily deactivated. Drive a short distance at 12 mph (20 km/h) or more, and the indicator should go off.



### Collision Mitigation Braking System (CMBS)\*

There is a problem with the system, the temperature is too high, or the camera is blocked.



### Brake system

There is a problem with one of the braking systems, the electric parking brake system, or the automatic brake hold system.



*Canada*

*\*if equipped*



## Condition Indicators

These indicators may require you to perform an action.

### **BRAKE** Parking brake

*U.S.* Release the parking brake before driving. You will hear a beep if you drive with it not fully released.



*Canada*

### Seat belt reminder

Make sure seat belts are fastened for you and all passengers. The indicator blinks and beeps sound continuously if you or your front passenger has not fastened your seat belts when you begin driving. If the indicator remains on after seat belts are fastened, see your dealer.

### Door/trunk open

A door or the trunk is not closed. A beep sounds if open while driving.

### Low fuel

Refuel as soon as possible. If the indicator blinks, there is a problem with the fuel gauge. See your dealer.

### Low tire pressure\*

Stop in a safe place, check tire pressures, and inflate tire(s) if necessary. The indicator also appears if the system has not been calibrated (see page 120).

### Washer fluid level (Canadian models)\*

The washer fluid is low. Refill the washer fluid (see page 139).

### System message\*

When a condition or malfunction indicator comes on, a message also appears on the Driver Information Interface. Check the display for more information. Press the display/information button on the steering wheel to clear the message.

### Maintenance Minder\*

Scheduled maintenance for your vehicle is due.

### Immobilizer/security system

Your key or remote transmitter cannot be recognized by the vehicle. If the indicator blinks, you may not be able to start the engine. Turn the vehicle off, remove the key from the ignition\*, press and hold the brake pedal, and restart the vehicle. If it continues to blink, there may be a problem with the system. See your dealer.

*Canadian models:* To reset the immobilizer system, follow the steps above after the battery has been disconnected.

\*if equipped



CVT models  
MT models

### Brake depress

You must press the brake pedal before activating the electric parking brake or automatic brake hold. If the indicator blinks, automatic brake hold is canceled during operation. Immediately press the brake pedal.



### Transmission System Indicator\*

The indicated current gear selection or all the gear positions blink if there is a problem with the transmission system. Models without Auto Idle Stop may no longer move.

## On/Off Indicators

These indicators remind you when an item is on or off.



VSA off



VSA engaged (blinking)



CRUISE MAIN on



CRUISE CONTROL on



ACC\* on



CMBS\* off



LKAS\* on



Turn signals/hazards on



Fog lights\* on



High beams on



Exterior lights on



ECON mode\* on



Automatic brake hold on



Automatic brake hold activated



SPORT mode\* activated

\*if equipped

### Information Display\*

Consists of several displays that provide you with useful information.

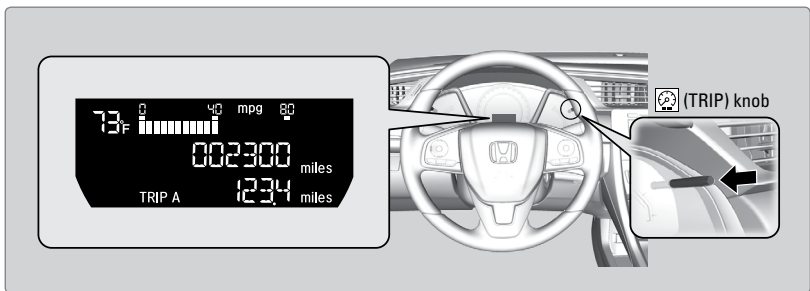

Press the TRIP knob to cycle through the displays shown below.

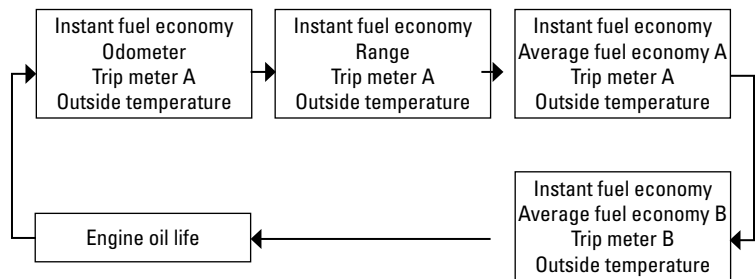

### Driver Information Interface\*

Consists of several displays that provide you with useful information.

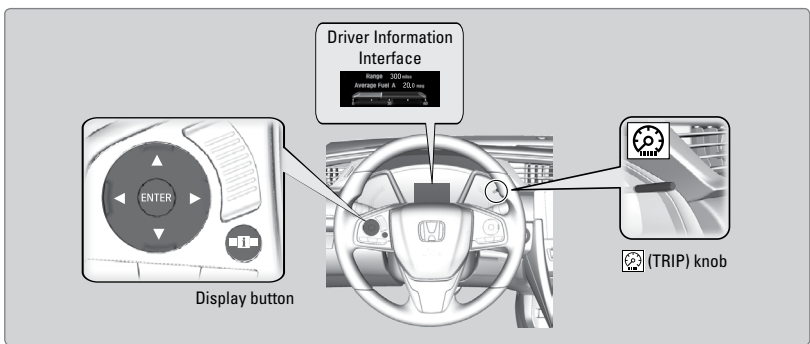

#### Main Displays

Press the Display button to scroll through the different icons shown below. Detailed information for the selected icon appears after a few seconds, or you can press the ENTER button to view it.

\*if equipped

You can customize the contents in the Driver Information Interface. For complete instructions, see the Owner's Manual at [owners.honda.com](http://owners.honda.com) (U.S.) or [myhonda.ca](http://myhonda.ca) (Canada).

#### Models without SPORT mode

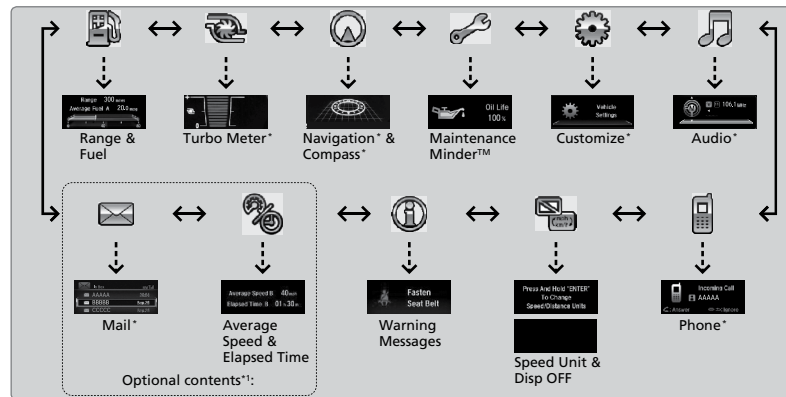

#### Models with SPORT mode

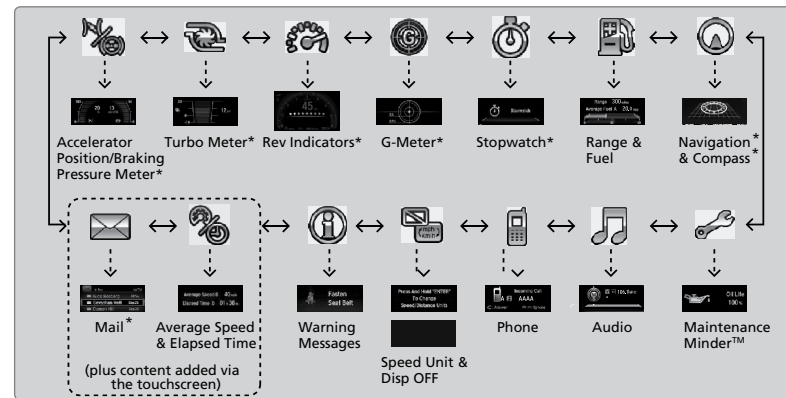

#### Trip Computer

Press the TRIP knob to cycle through the lower displays shown below.

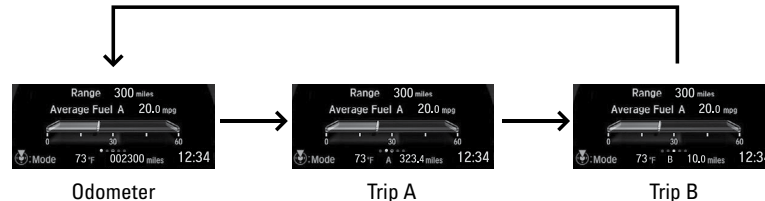

\*if equipped

■ **Stopwatch\***

Measure and show lap times.

- Press ENTER to show the lap time display.
- Press ENTER to start or stop the measurement.
- Press ▲ or ▼ to record a lap time split.
- Press the Back button to show the recorded times.



■ **Vehicle Settings\***

Use the Driver Information Interface to customize certain features. Use the steering wheel controls to select the Vehicle Settings screen when the vehicle is stopped.

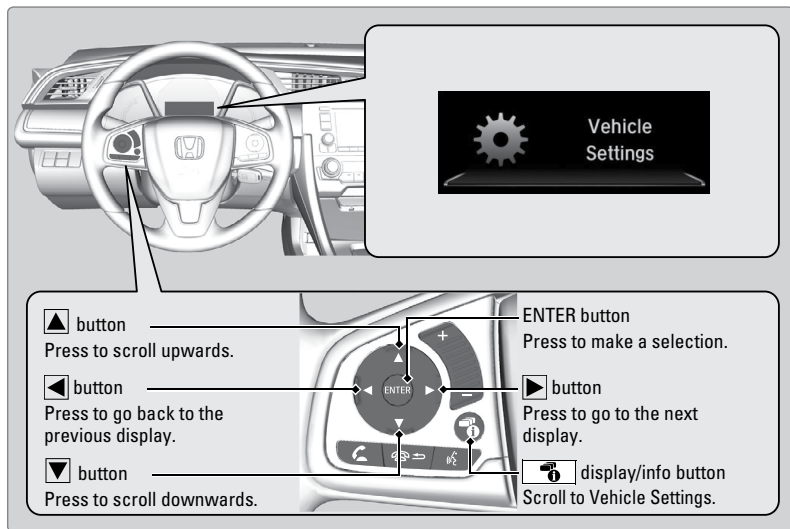

Below is an example of how to change a setting.

1. Press the display/info button until you see the Vehicle Settings screen. Press the ENTER button to select it.
2. Press the ▲ or ▼ button to scroll to Meter Setup, and select it.
3. Scroll to "Trip A" Reset Timing, and select it.
4. Scroll to the option you want, and select it.
5. Scroll to the Exit option, and select it. Repeat to exit the menus.



\*if equipped

■ **Vehicle Settings**

You can customize certain features when the vehicle is stopped.

**Models with Information Display**

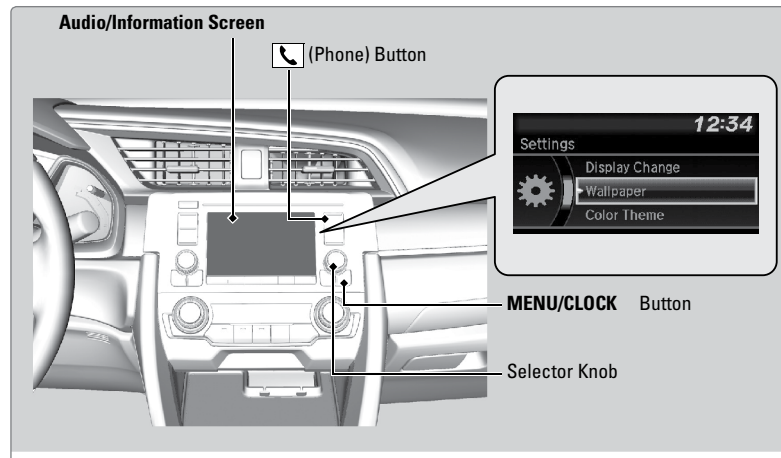

**Models with Driver Information Interface**

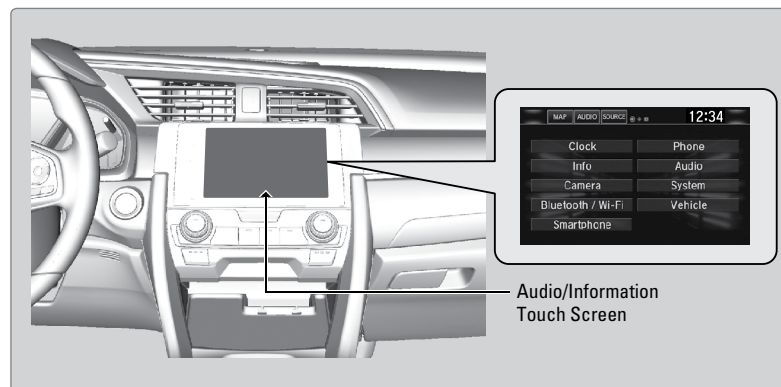

# VEHICLE CONTROLS

Learn about the various controls necessary for operating and driving the vehicle.

## Using the Key or Remote Transmitter\*

Lock or unlock the doors and trunk.

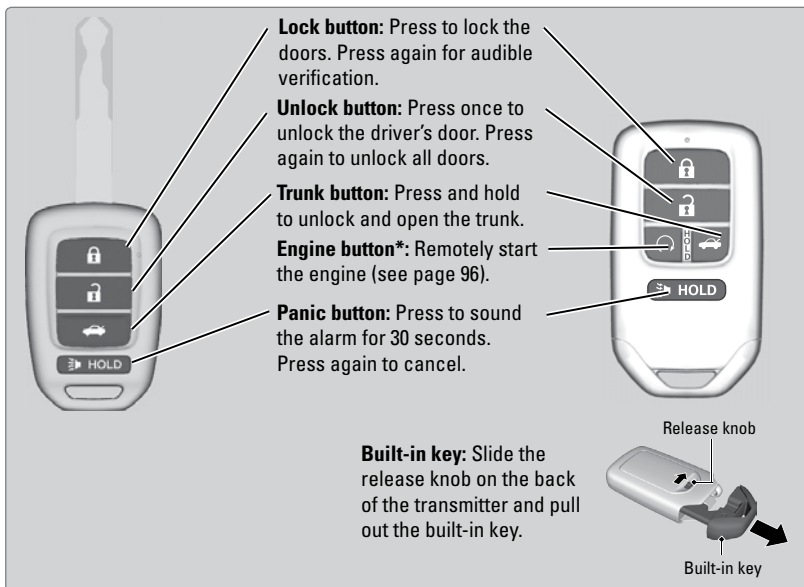

### NOTICE

Leaving the key or remote transmitter in the vehicle can result in theft or accidental movement of the vehicle. Always take it with you whenever you leave the vehicle unattended.

## Smart Entry System\*

When you carry the remote transmitter (for example, in a pocket or purse) and it is outside the vehicle and within range (about 32 inches or 80 cm), you can lock or unlock the doors and trunk without handling the transmitter.

### ■ Unlocking/Locking the Doors

**To unlock:** Grab the driver's door handle when the vehicle is off to unlock the driver's door. Grab the front passenger's door handle to unlock all doors.

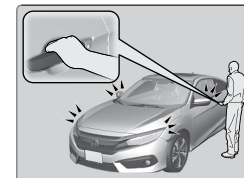

**To lock:** Press the door lock button on either door handle when the vehicle is off. If the remote transmitter is inside the vehicle, the doors will not lock.

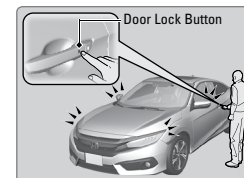

### ■ Unlocking the Trunk

Press the trunk release button to unlock and open the trunk.

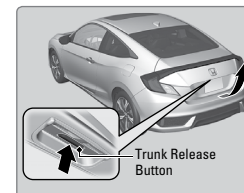

\*if equipped

\*if equipped

TABLE OF CONTENTS

VISUAL INDEX

SAFETY INFORMATION

INSTRUMENT PANEL

VEHICLE CONTROLS

AUDIO AND CONNECTIVITY

BLUETOOTH® HANDSFREELINK®

HONDALINK®

NAVIGATION

DRIVING

HANDLING THE UNEXPECTED

MAINTENANCE

SPECIFICATIONS

CUSTOMER INFORMATION

VOICE COMMAND INDEX

INDEX

■ **Customizing Door Lock Settings**

Customize the auto door-lock setting to your preference. Begin with the vehicle off.

**Models with information display**

1.	<b>Apply the parking brake</b>	
2.	<b>Position the driver's door</b>	
	<i>To enable auto door lock:</i> close the driver's door	<i>To disable auto door lock:</i> open the driver's door
3.	<b>Set your preference</b>	
	<p><b>Models with key ignition</b></p> <ol style="list-style-type: none"> <li>a. Set the ignition switch to ON</li> <li>b. Press the lock side of the master door lock switch until you hear a click (~ 5 sec.)</li> <li>c. Set the ignition switch to ACC</li> </ol>	<p><b>Models with Smart Entry</b></p> <ol style="list-style-type: none"> <li>a. Push ENGINE START/STOP twice (do not press the brake pedal)</li> <li>b. Press the lock side of the master door lock switch until you hear a click (~ 5 sec.)</li> <li>c. Push ENGINE START/STOP twice (do not press the brake pedal)</li> </ol>

**Models with driver information interface**

See Customized Features, page 52.

■ **Walk Away Auto Lock\***

When you walk away from the vehicle while carrying the remote transmitter, the doors can automatically lock if the following conditions are met:

- The remote transmitter is within a range of 5 feet (2.5 m).
- All doors and the hood are closed.
- There is not an additional remote transmitter inside the vehicle.

Follow these steps (see diagram):

1. Exit the vehicle, close the door and stay near it. Listen for a beep. The system is activated.
2. Walk at least 5 feet (2.5 m) away.
3. Listen for a beep and look for the lights to flash. The doors lock.

To turn on this feature, follow the steps below:

1. From the HOME screen, select Settings.
2. Select Vehicle. The vehicle must be in Park (P).
3. Select Door/Window Setup.
4. Select Walk Away Auto Lock.
5. Select On.
6. Select BACK to exit the menus.

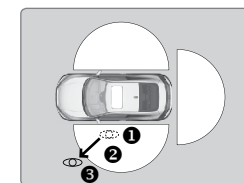

## Door Operation

Use several methods to lock or unlock the doors.

### ■ Using the Lock Tab

**To unlock:** Pull the lock tab rearward. When you unlock the door using the lock tab on the driver's door, only the driver's door unlocks.

**To lock:** Push the lock tab forward. When you lock the door using the lock tab on the driver's door, the other door locks at the same time.

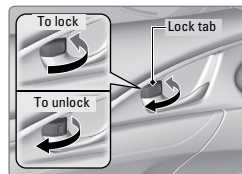

### ■ Using the Door Inner Handle

When you pull a door inner handle, the door unlocks and opens. Unlocking and opening the driver's door from the inner handle unlocks the other door.

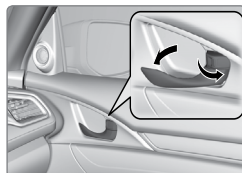

### ■ Using the Master Door Lock Switch

**To unlock:** Press the unlock side of the switch to unlock both doors.

**To lock:** Press the lock side of the switch to lock both doors.

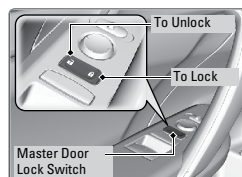

### ■ Using the Trunk Opener

Press the trunk opener on the driver's door to open the trunk.

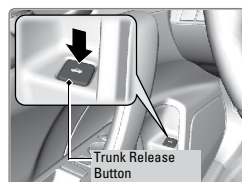

## Power Window Operation

The power windows can be opened and closed when the vehicle is on by using the switches on the doors. The switches on the driver's side can be used to open and close both windows.

### ■ Automatic Operation

**To open:** Push the switch down firmly.

**To close:** Pull the switch up firmly.

The window opens or closes completely. To stop the window at any time, push or pull the switch again briefly.

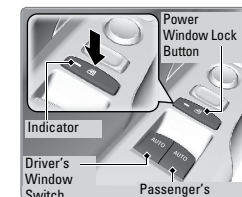

### ■ Manual Operation

**To open:** Push the switch down lightly.

**To close:** Pull the switch up lightly.

Release the switch when the windows reach the desired position.

### ■ Power Window Lock

Push in the power window lock button so only the driver's window can be operated.

## ⚠ WARNING

Closing a power window on someone's hands or fingers can cause serious injury.

Make sure your passengers are away from the windows before closing them.

## Power Moonroof Operation\*

The moonroof can be opened and closed when the vehicle is on by using the switch on the ceiling.

### Automatic Operation

**To open:** Push the switch back firmly to the second detent, then release.

**To close:** Push the switch forward firmly to the second detent, then release.

The moonroof opens or closes completely. To stop the moonroof at any time, push the switch briefly.

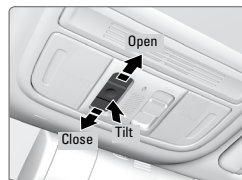

### Manual Operation

**To open:** Push and hold the switch back to the first detent until the desired position is reached.

**To close:** Push and hold the switch forward to the first detent until the desired position is reached.

### Moonroof Tilt

**To tilt:** Push the center of the switch.

**To close:** Push the switch forward firmly, then release.

### WARNING

Closing the moonroof on someone's hands or fingers can cause serious injury. Make sure your passengers are away from the moonroof before closing it.

### NOTICE

Opening the moonroof in below freezing temperatures or when it is covered with snow or ice can damage the moonroof panel or motor.

## One-Touch Turn Signal

Use this quick and convenient method to signal a lane change.

Lightly push the turn signal lever up or down for a three-blink sequence.

For a continuous signal, push the lever up or down until it locks into place.

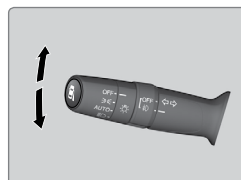

\*if equipped

## Interior and Exterior Lights

Operate interior and exterior lights when the vehicle is on or off.

### Brightness Control

Adjust instrument panel brightness when the vehicle is on.

**To brighten:** Turn the knob to the right.

**To dim:** Turn the knob to the left.

A beep sounds when the brightness reaches its minimum or maximum.

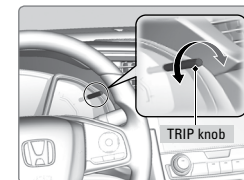

### Interior Lights

Change the interior light settings using the front and rear switches on the ceiling.

**ON position (rear):** Interior lights remain on.

**Door-activated position (front):** Interior lights come on when any of the doors are opened, the driver's door is unlocked, or the vehicle is turned off.

**OFF position:** Interior lights remain off.

**Map lights:** Press the map lights to turn on or off.

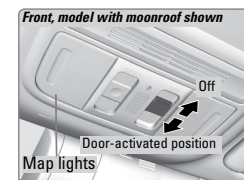

### Exterior Lights

Rotate the switches on the headlight lever to operate the exterior lights.

**OFF:** All exterior lights are off.

Turn on exterior lights except headlights.

**AUTO:** Turn on the automatic lighting feature.\* Headlights turn on or off depending on ambient brightness when the vehicle is on. Headlights automatically come on after the wipers are engaged for a certain time.

Turn on all exterior lights including headlights.

Turn fog lights\* on or off.

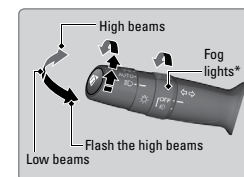

\*if equipped

## Wiper Operation

The windshield wipers and washers can be used when the vehicle is on. Move the wiper lever up or down to the desired position.

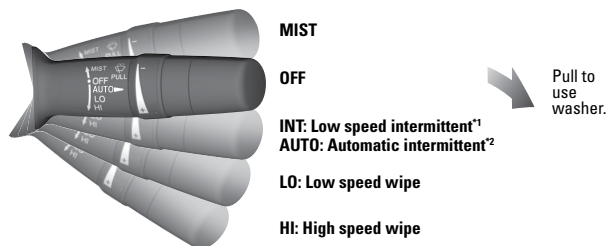

### Headlight-Wiper Integration\*

When the headlights are in the AUTO position, they automatically turn on when the front wipers operate several times within a certain interval. The headlights turn off shortly after the wipers are turned off, or if there is enough ambient light.

#### NOTICE

Do not use the wipers when the windshield is dry. The windshield will get scratched, or the rubber blades will get damaged.

In cold weather, the blades may freeze to the windshield, becoming stuck. Operating the wipers in this condition may damage the wipers. Use the defroster to warm the windshield, or manually clear the windshield of ice and snow before turning on the wipers.

*\* if equipped*

*\*1: models without automatic intermittent wipers; \*2: models with automatic intermittent wipers*

### Intermittent (INT) Wipers<sup>\*1</sup>

When you move the lever to the INT position, the wipers operate based on the delay adjustment.

Rotate the adjustment ring to adjust the wiper delay.

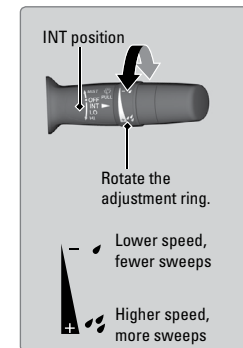

### Automatic (AUTO) Rain-Sensing Wipers<sup>\*2</sup>

When you move the lever to the AUTO position while driving in rainy weather, the wipers operate based on the amount of detected rainfall.

Put the lever in the AUTO position only when driving in rainy weather.

Rotate the adjustment ring to adjust the rainfall sensor sensitivity.

Return the lever to the OFF position when rain stops.

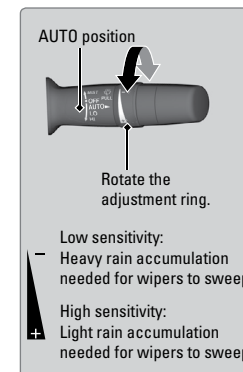

#### NOTICE

Always ensure the wiper lever is in the OFF position before cleaning the windshield or entering a car wash to prevent severe damage to the windshield wiper system.

*\*1: models without automatic intermittent wipers; \*2: models with automatic intermittent wipers*

TABLE OF CONTENTS  
VISUAL INDEX  
SAFETY INFORMATION  
INSTRUMENT PANEL  
VEHICLE CONTROLS  
AUDIO AND CONNECTIVITY  
BLUETOOTH® HANDSFREELINK®  
HONDALINK®

NAVIGATION  
DRIVING  
HANDLING THE UNEXPECTED  
MAINTENANCE  
SPECIFICATIONS  
CUSTOMER INFORMATION  
VOICE COMMAND INDEX  
INDEX



## Adjusting the Seats

Make seat adjustments before driving to ensure the best comfort and safety.

### ■ Adjusting the Seats

Adjust the driver's seat as far back as possible while allowing you to maintain full control of the vehicle. You should be able to sit upright and well back in the seat, adequately press the pedals without leaning forward, and grip the steering wheel comfortably. The passenger's seat should be adjusted in a similar manner, so that it is as far back from the front airbag in the dashboard as possible.

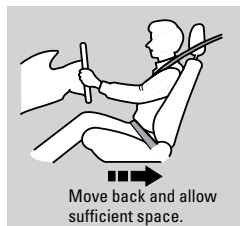

The National Highway Traffic Safety Administration and Transport Canada recommend that drivers allow at least 10 inches (25 cm) between the center of the steering wheel and their chest.

#### ⚠️ WARNING

Reclining the seat-back too far can result in serious injury or death in a crash. Adjust the seat-back to an upright position, and sit well back in the seat.

#### ⚠️ WARNING

Sitting too close to a front airbag can result in serious injury or death if the front airbags inflate. Always sit as far back from the front airbags as possible while maintaining control of the vehicle.

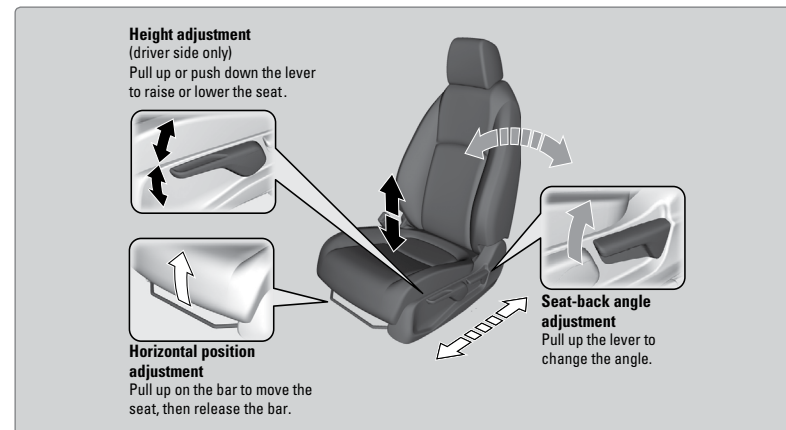

#### ⚠️ WARNING

Sitting improperly or out of position can result in serious injury or death in a crash. Always sit upright, well back in the seat, with your feet on the floor.

### ■ Floor Mats

Position the front seat floor mats properly, and anchor them. If they are not properly positioned, the floor mats can interfere with the front seat functions.

**Do not put additional floor mats on top of the anchored mats.**

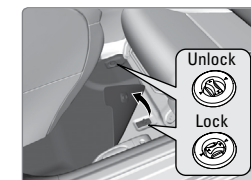

**■ Adjusting the Head Restraints**

Your vehicle is equipped with head restraints in all seating positions. Head restraints are most effective for protection against whiplash and other rear-impact crash injuries.

The center of the back of the occupant's head should rest against the center of the restraint. The tops of the occupant's ears should be level with the center height of the restraint.

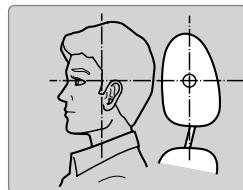

**Models without SPORT mode**

**To raise the head restraint:** Pull it upward.

**To lower the head restraint:** Push it down while pressing the release button.

**To remove the head restraint:** Pull the restraint up as far as it will go. Then push the release button, and pull the restraint up and out.

**To reinstall a head restraint:** Insert the legs back in place, then adjust the head restraint to an appropriate height while pressing the release button. Pull up on the restraint to make sure it is locked in position.

For the head restraint system to work properly:

- Do not hang any items on the head restraints, or from the restraint legs.
- Do not place any object between an occupant and the seat-back.
- Install each restraint in its proper location.

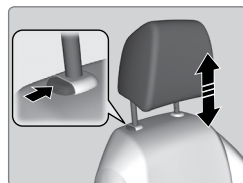

**⚠ WARNING**

Improperly positioning head restraints reduces their effectiveness and increases the likelihood of serious injury in a crash. Make sure head restraints are in place and positioned properly before driving.

**⚠ WARNING**

Failure to reinstall, or correctly reinstall, the head restraints can result in severe injury during a crash. Always replace the head restraints before driving.

**Models with SPORT mode**

The head restraints are not adjustable.

**■ Rear Seat Access**

Driver side: Pull up the seat-back lever to tilt the seat-back forward.



Passenger side: Pull up the seat-back lever, or push the seat-back release lever, to tilt the seat-back forward. Then move the seat forward.

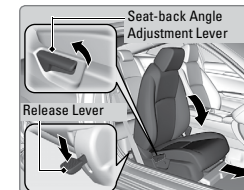

**■ Folding Down the Rear Seats**

The rear seat-backs can be folded down to make room for large items in the trunk.

1. Pull the release lever in the trunk to release the lock.

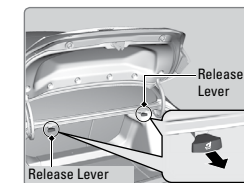

2. Fold down the seat-back.

Push the seat-back up firmly until it locks into place to return it to its original position.

Make sure all items in the trunk or items extending through the opening into the rear seats are properly secured. Loose items can fly forward if you have to brake hard.

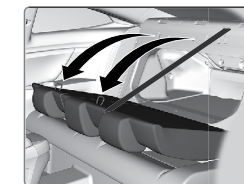

## Adjusting the Steering Wheel

The steering wheel height and distance from your body can be adjusted so that you can comfortably grip the steering wheel in an appropriate driving posture.

- Pull up the steering wheel adjustment lever.
- Move the steering wheel up or down, and in or out.
- Push down the steering wheel adjustment lever to lock the steering wheel in position.

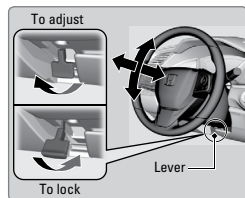

### ⚠ WARNING

Adjusting the steering wheel position while driving may cause you to lose control of the vehicle and be seriously injured in a crash.

Adjust the steering wheel only when the vehicle is stopped.

## Adjusting the Mirrors

Adjust the angle of the mirrors for the best visibility when you are sitting in the correct driving position.

### ■ Rearview Mirror with Day/Night Positions\*

Manually adjust the position to reduce headlight glare from vehicles behind you. Flip the tab to switch between day and night positions.

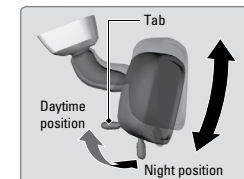

### ■ Automatic Dimming Rearview Mirror\*

When driving after dark, the automatic dimming function reduces the glare from headlights behind you based on the mirror sensor.

The function cancels when the shift lever is in Reverse (R).

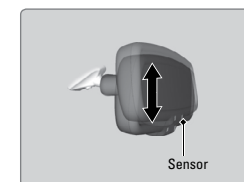

### ■ Power Door Mirrors

Adjust the power door mirrors when the vehicle is on.

**L/R selector switch:** Select the left or right mirror. After adjusting the mirror, return the switch to the center position.

**Mirror position adjustment switch:** Press the switch left, right, up, or down to move the mirror.

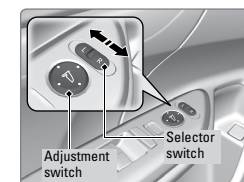

\*if equipped

## Climate Control System

Maintains your preferred interior temperature by selecting the proper mix of heated or cooled air and fan speed. Use the buttons on the dashboard to control the system.

### Models with color audio system

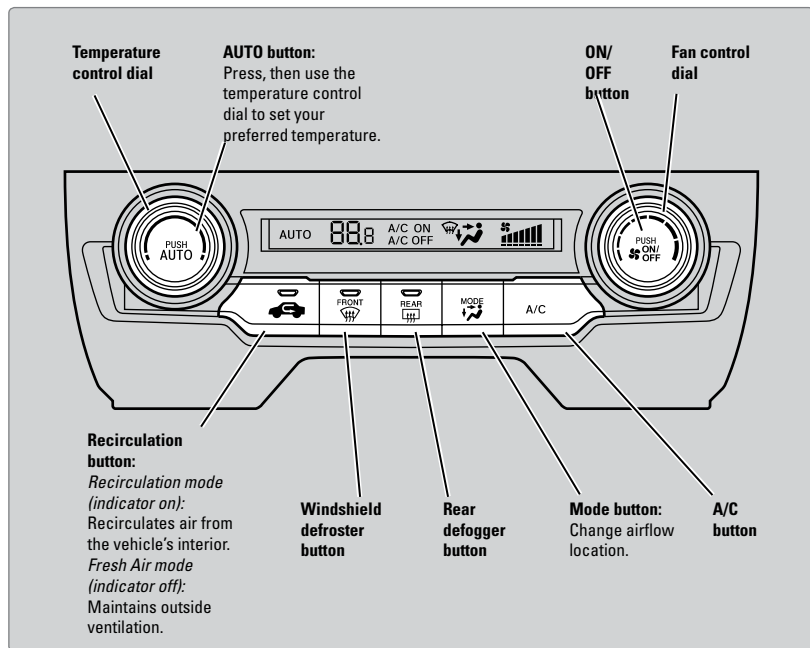

### Models with Display Audio

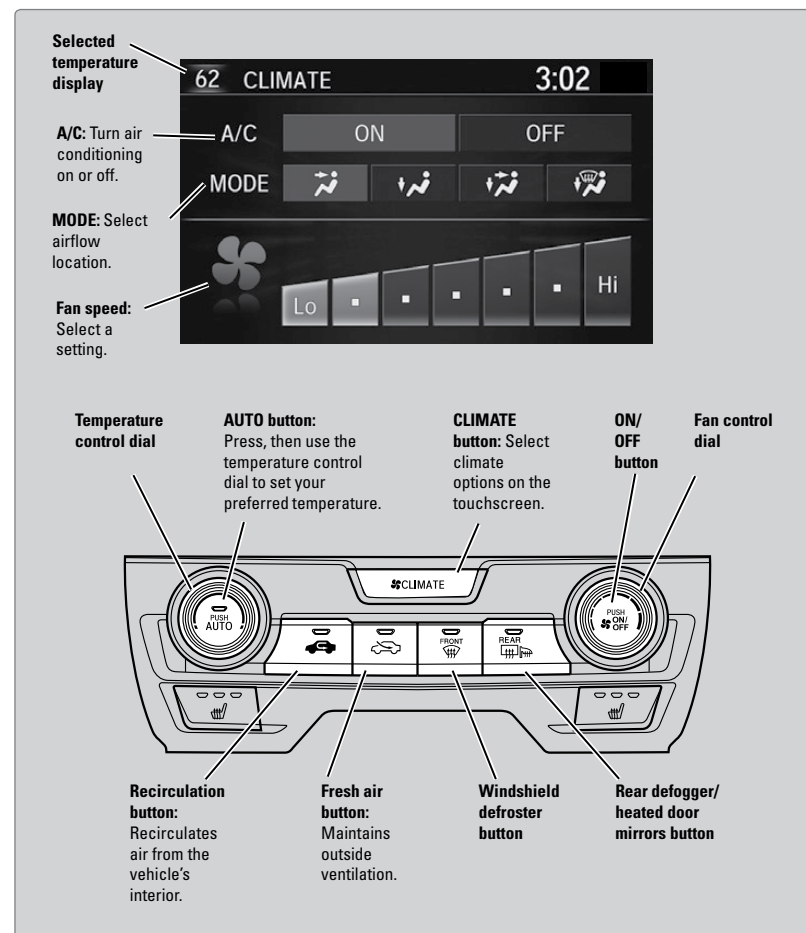

Models with Display Audio and SYNC button

**Selected temperature display** 62 CLIMATE 3:02 62

**A/C:** Turn air conditioning on or off. A/C ON OFF

**MODE:** Select airflow location. MODE [Icons for fan, defogger, front, rear]

**Fan speed:** Select a setting. Lo [Icons for fan speed] Hi

**Driver's temperature control dial**

**AUTO button:** Press, then use the temperature control dial to set your preferred temperature.

**CLIMATE button:** Select climate options on the touchscreen.

**SYNC button:** Set the passenger's side temperature to the same as the driver's side.

**Passenger's temperature control dial**

**ON/OFF button**

**Recirculation button:** *Recirculation mode (indicator on):* Recirculates air from the vehicle's interior. *Fresh air mode (indicator off):* Maintains outside ventilation.

**Windshield defroster button**

**Rear defogger/heated door mirrors button**

Seat Heaters\*

Quickly warm the seats when the vehicle is on.

■ Front Seat Heaters

Press the seat heater button in the front console to cycle through the heat settings.

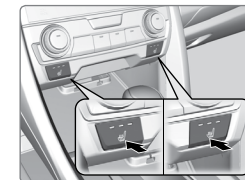

**WARNING**

Heat-induced burns are possible when using seat heaters.

Persons with a diminished ability to sense temperature (e.g., persons with diabetes, lower-limb nerve damage, or paralysis) or with sensitive skin should not use the seat heaters.

## Customized Features

Use the Settings menu to customize certain features when the vehicle is stopped.

### Models with color audio system

Use the selector knob to make and enter selections.

1. Press the MENU/CLOCK button.
2. Select Settings.
3. Select a setting option, and make your preferred changes.
4. Press the Back button to exit the menus.

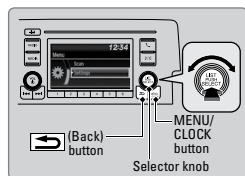

### Models with Display Audio

Select items on the touchscreen to make selections.

1. From the HOME screen, select SETTINGS.
2. Select an option (Phone, Audio, Bluetooth, Info, Camera, System, Vehicle, or Navi\*).
3. Select a setting option, and make your preferred changes.
4. Press BACK to exit the menus.

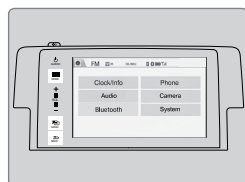

### ■ Customization Example: Door Lock Settings

For models with color audio, see page 34. For Display Audio, follow the steps below when the vehicle is stopped and the power mode is ON.

Auto Door Lock Choices	Auto Door Unlock Choices
With Vehicle Speed	All Doors When Driver's Door Opens
Shift from Park	All Doors When Shifted to Park
Off	All Doors When Ignition Switched Off
	Off

1. From the home screen, press Settings.
2. Press Vehicle.
3. Press Door/Window Setup:
  - To customize door lock settings, press Auto Door Lock.
  - To customize door unlock settings, press Auto Door Unlock.
4. Choose a setting:
  - The default lock setting is With Vehicle Speed.
  - The default unlock setting is All Doors when Driver's Door Opens.
5. Press BACK when you are done.

## Setting the Clock

Adjust the time using the steps described for your vehicle type.

### Models with color audio system

Use the selector knob to make and enter selections.

1. Press and hold the MENU/CLOCK button.
2. Select the hour and adjust as necessary.
3. Select the minutes and adjust as necessary.
4. Select Set when complete.

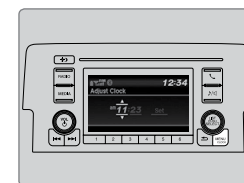

### Models with Display Audio

The time is automatically set using GPS signals.



# AUDIO AND CONNECTIVITY

Learn how to operate the vehicle's audio system.

## Basic Audio Operation

Connect audio devices and operate the audio system.

### ■ USB Port

Connect a USB flash drive or other audio device, such as an iPod or iPhone®. Install the flash drive or cable connector to the USB port.

#### Models with color audio system

The USB port (1.0A) is located in the front console and is for playing audio and charging devices.

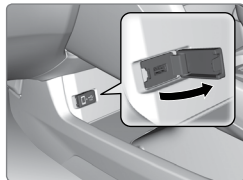

#### Models with Display Audio

The USB port (1.5A) is located in the front console and is for playing audio, charging devices, and connecting to Apple CarPlay (see page 67) or Android Auto (see page 68).



An additional port (1.0A) is located inside the center console. It can be used for playing audio and charging devices. You can use the sliding console tray to hold a phone or other small items.

*iPod and iPhone are trademarks of Apple, Inc.*

### ■ Accessory Power Socket

Open the socket cover in the front console to use power when the vehicle is on.

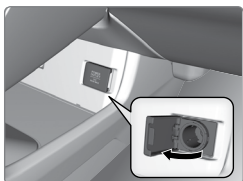

#### NOTICE

Do not insert an automotive-type cigarette lighter element. This can overheat the power socket.

### ■ Cable Management

Connect a cable to a port or socket in the lower front-console tray, then route the cable to the upper front-console tray via the cable guides molded into the rear of the upper tray.

### ■ Wireless Charger\*

Charge your Qi®-compatible device when the vehicle is on.

1. Press and hold the power button. A green indicator appears when the charger is on.
2. Place the chargeable side of the device on the charge area. The system begins charging the device when the amber indicator appears.
3. The green indicator appears when charging is complete. On some devices, the amber indicator may stay on even when charging is complete.

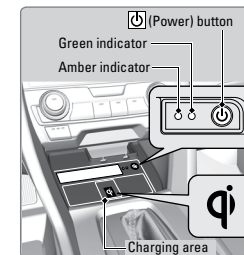

#### Notes:

- This system consumes a lot of power. It is best to charge your device when the engine is running.
- If the indicator light is blinking, there may be an obstacle between the device and charging area, the device may have moved, or the charger is malfunctioning.
- The device may not charge if you are near strong electromagnetic waves, such as at a gas station.
- The device and charging area may get warm during charging. This is normal.

#### ⚠ CAUTION

- Metal objects between the charger and the device to be charged will get hot and can burn you.
- Remove foreign objects from the charger before charging the device.

#### NOTICE

- Do not attach a metal object to the charger.
- Do not charge when the charger is covered with a towel, layer of dust, etc.
- Do not allow the charger to get wet from water, beverages, etc.
- Do not wipe the charger with oils, alcohol, benzene, thinners, etc. or expose it to aerosols.
- Do not use the charger if it is malfunctioning. In the unlikely event the charger emits smoke, abnormal odors or unusual sounds, stop use immediately.
- Do not place any magnetic devices, credit cards or watches within the charge area while charging. The data on credit cards can be lost and watches may stop working.

*\*if equipped. Qi is a registered trademark of the Wireless Power Consortium.*

## Steering Wheel Controls

You can operate certain functions of the audio system using the steering wheel controls.

### Models with color audio

**SOURCE button:** Cycle through available audio modes.

**+ / - buttons:** Adjust audio volume.

**◀ / ▶ buttons:** Change presets, tracks, albums, or folders.



### FM/AM Radio

Press **◀** or **▶** for the next or previous preset station.

Press and hold **◀** or **▶** to seek the next or previous strong station.

### iPod/USB/Bluetooth Audio

Press **◀** or **▶** for the next or previous track.

Press and hold **◀** or **▶** for the next or previous folder (USB).

### Models with Display Audio

**i button:** Press until the audio screen is displayed in the Driver Information Interface.

**+ / - bar:** Press the ends of the bar or slide to adjust audio volume. On models without SPORT mode, you can swipe up or down to adjust the volume.

**◀ / ▶ buttons:** Change presets, tracks, albums, or folders.



### FM/AM/SiriusXM Radio\*

Press **◀** or **▶** for the next or previous preset station.

Press and hold **◀** or **▶** to seek the next or previous strong station.

Press ENTER to display the list of preset stations.

### iPod/USB/Bluetooth Audio

Press **◀** or **▶** for the next or previous track.

Press and hold **◀** or **▶** for the next or previous folder (USB).

### Pandora\*

Press **▶** for the next song.

Press and hold **◀** or **▶** for the next or previous station.

\*if equipped

## Steering Wheel Controls (continued)

### Models with Display Audio (continued)

**▲ / ▼ buttons:** Cycle through available audio modes, or scroll through audio options in the Driver Information Interface.

**+ / - bar:** Swipe to scroll through the alphabet for the song library and phonebook.

**ENTER button:** Make audio selections in the Driver Information Interface.

From the audio screen in the Driver Information Interface:

### FM/AM/SiriusXM Radio\*

Press the ENTER button to display a preset list. Press **▲** or **▼** to scroll the list, and press the ENTER button to select a preset.

### USB Flash Drive

Press the ENTER button to display the folder list. Press or swipe **▲** or **▼** to scroll the list, and press the ENTER button to select a folder. Repeat to select a track.

### iPod

Press the ENTER button to display the iPod list. Press or swipe **▲** or **▼** to scroll the category, and press the ENTER button to select an item. Repeat to select a track.

### Bluetooth Audio

Press the ENTER button to display the track list. Press **▲** or **▼** to scroll the list, and press the ENTER button to select a track.

### Pandora\*

Press the ENTER button to display the station list. Press **▲** or **▼** to scroll the list, and press the ENTER button to select a station.

*Your vehicle comes equipped with software, which is governed by the End User License Agreement in this vehicle's Owner's Manual, and which contains a binding arbitration clause. Please refer to the End User License Agreement for the terms and conditions governing your use of the installed software, as well as the applications, services, functions, and content provided through the software. Your use of the installed software will serve as your consent to the terms and conditions of the End User License Agreement.*

*You may opt out of the arbitration provisions within 30 days of your initial use of the Software by sending a signed, written notice to HONDA at American Honda Motor Co., Inc. Honda Automobile Customer Services Mail Stop 100-5E-8A, 1919 Torrance Blvd. Torrance, CA 90501-2746*

\*if equipped



## ■ Adjusting the Sound

Adjust various sound settings.

### Models with color audio system

Use the selector knob to make and enter selections.

1. Press the Sound button.
2. Select a sound mode to change, and adjust it using the selector knob.
3. Press the Back button to exit the menu.

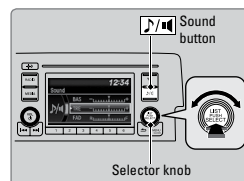

### Models with Display Audio

Make and enter selections using the touchscreen.

1. From the audio screen, select MENU.
2. Select Sound.
3. Select the tabs to change the sound mode and adjust the setting.
4. Select OK when complete.

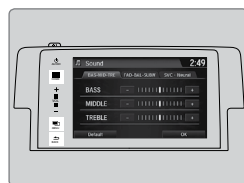

## Models with Color Audio System Color Audio System

Use the buttons to control the display and audio system.

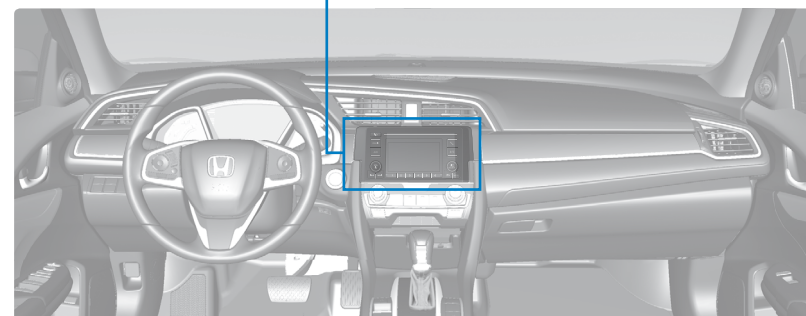
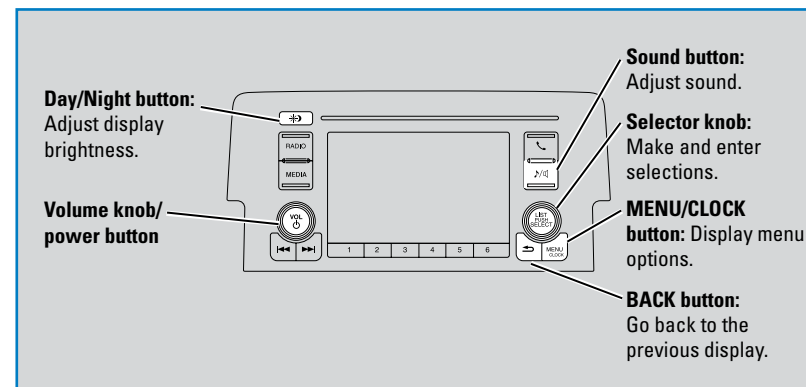

Models with color audio system

### FM/AM Radio

Play FM or AM radio stations.

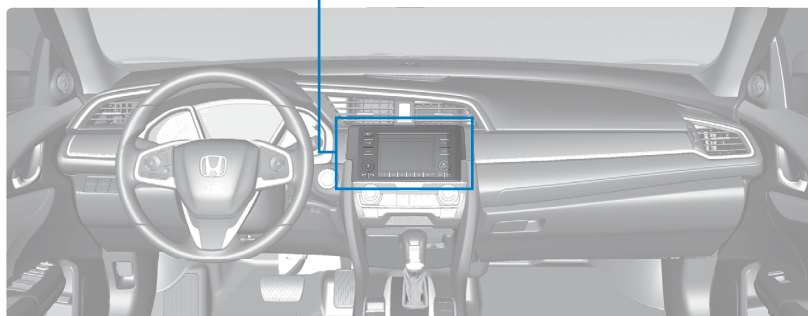
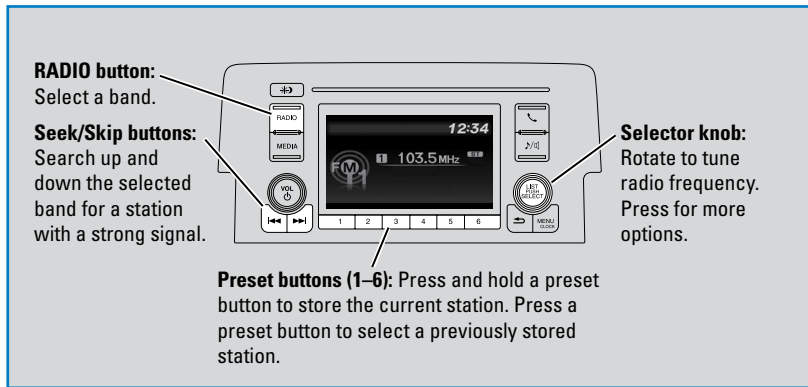

Models with color audio system

### iPod®

Play and operate an iPod through the vehicle's audio system. Connect your device to the USB port (see page 54).

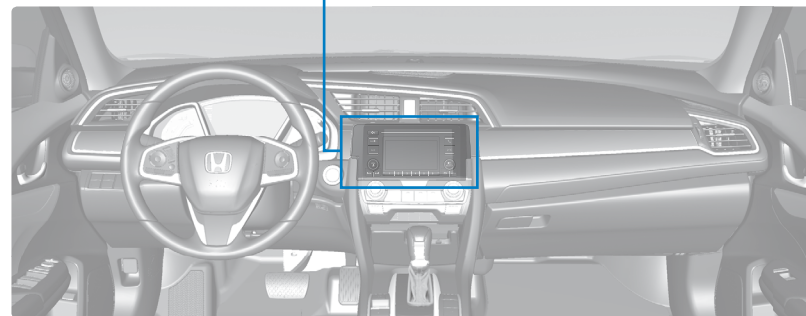
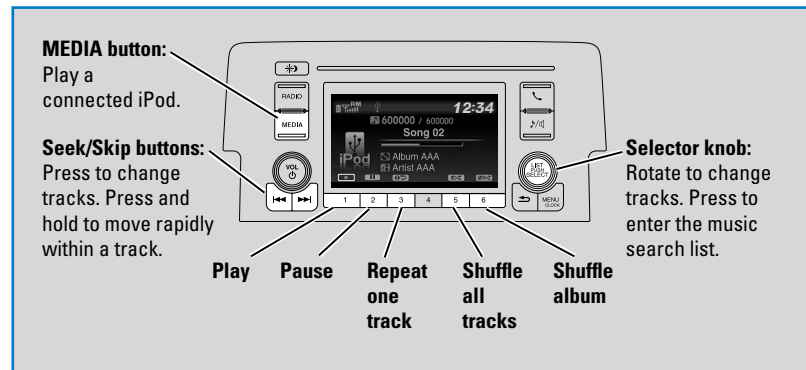

#### ■ Searching for Music

Use the selector knob to search for tracks stored on the iPod.

1. From the audio screen, press the selector knob.
2. Select a search option.
3. Select the track you want to play.

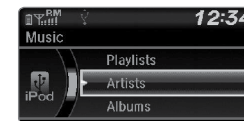

*iPod is a trademark of Apple, Inc.*

## Models with color audio system

**USB Flash Drive**

Play and operate a USB flash drive through the vehicle's audio system. Connect your device (see page 54).

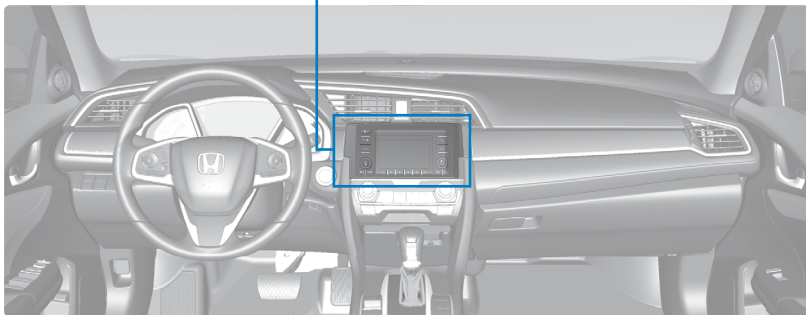
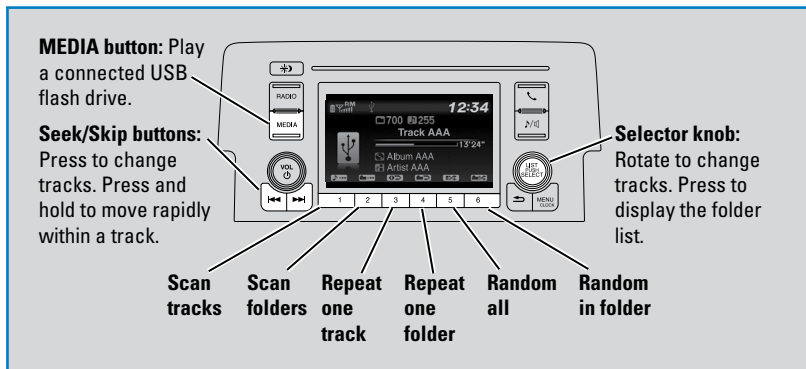
■ **Searching for Music**

Use the selector knob to search for tracks stored on the flash drive.

1. From the audio screen, press the selector knob.
2. Select a folder.
3. Select the track you want to play.



## Models with color audio system

**Bluetooth® Audio**

Play streaming or stored audio from your compatible phone through the vehicle's audio system. Visit [automobiles.honda.com/handsfreelink](http://automobiles.honda.com/handsfreelink) (U.S.) or [handsfreelink.ca](http://handsfreelink.ca) (Canada) to check phone compatibility. Standard data rates apply with your phone service provider. Connect your phone to *Bluetooth* HandsFreeLink (see page 76).

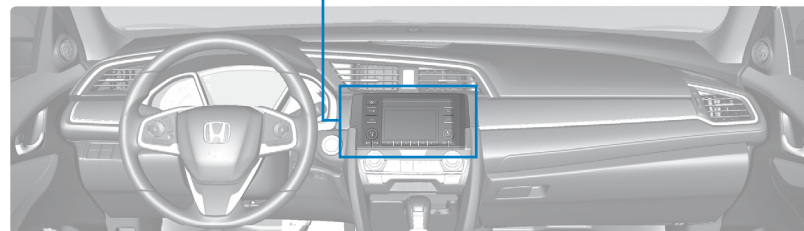
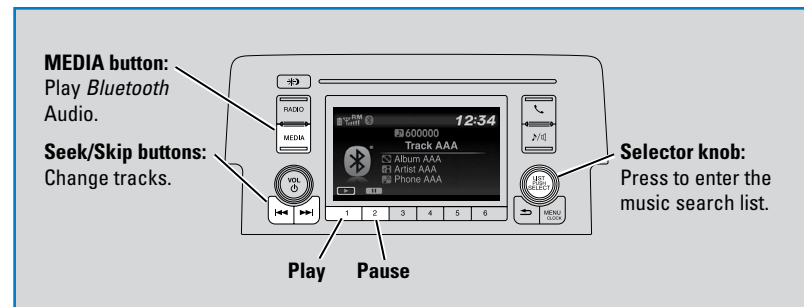
■ **Searching for Music**

Use the selector knob to search for tracks stored on the device.

1. From the audio screen, press the selector knob.
2. Select a category.
3. Select the track you want to play.

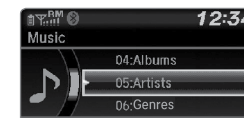
**Notes:**

- Make sure the volume on your phone is properly adjusted.
- You may need to enable additional settings on your phone for playback.
- The resume/pause function and remote audio controls are not supported on all phones.

*Applicable laws may prohibit the operation of handheld electronic devices while operating a vehicle. Launch streaming audio on your phone only when it is safe to do so.*

## Models with Display Audio

### Display Audio Operation

Use simple gestures—including touching, swiping, and scrolling—to operate certain audio functions.

Some items may be grayed out during driving to reduce the potential for distraction. You can select them when the vehicle is stopped.

Wearing gloves may limit or prevent touchscreen response.

You can use a microfiber cleaning cloth to remove dust or fingerprints from the touchscreen.

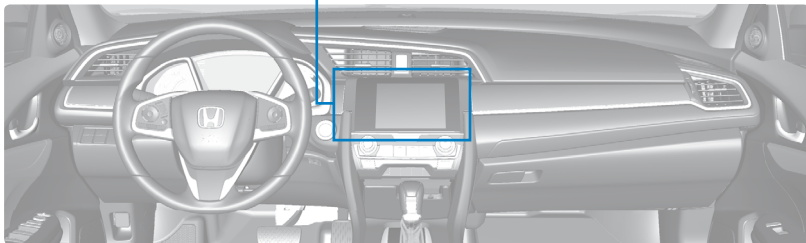
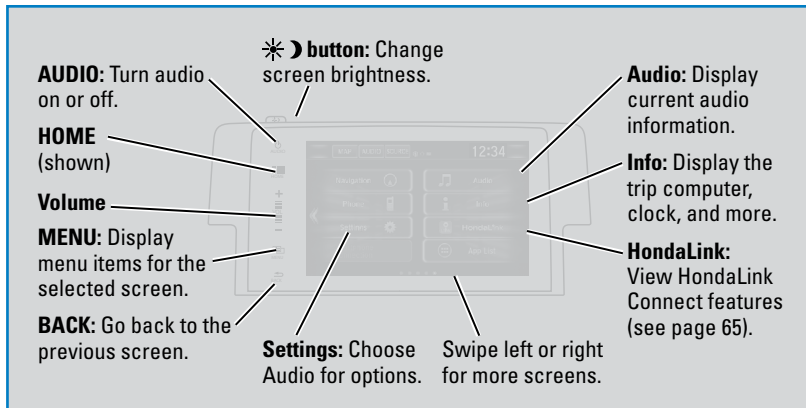

### Setting Touchscreen Sensitivity

You can adjust the touchscreen's sensitivity to your fingertip.

1. From the HOME screen, select Settings, then System.
2. Select Display, then Touch Panel Sensitivity.
3. Make your selection.

*Do not install apps other than those confirmed by a Honda dealer. Installation of unauthorized apps may introduce data corruption risks to your vehicle's information and your privacy.*

## Models with Display Audio

### HondaLink®\*

Provides you with useful information about your vehicle directly from Honda.

To check phone compatibility, visit [automobiles.honda.com/handsfreelink](http://automobiles.honda.com/handsfreelink) (U.S.) or [handsfreelink.ca](http://handsfreelink.ca) (Canada). Standard data rates may apply with your phone service provider.

To get more information on HondaLink, visit [www.hondalink.com](http://www.hondalink.com) (U.S.) or [honda.ca/hondalink](http://honda.ca/hondalink) (Canada).

If there is an active connection to Apple CarPlay (see page 67) or Android Auto (see page 68), HondaLink can be connected only through Wi-Fi.

### HondaLink Connection

Follow the steps below to connect to HondaLink and use its features.

1. Download the HondaLink Connect app to your compatible smartphone.
2. Pair your phone to *Bluetooth* HandsFreeLink (see page 80).
3. From the HOME screen, select HondaLink.
4. Certain features require you to send vehicle information to Honda. Select Enable Once, Always Enable, or Cancel.

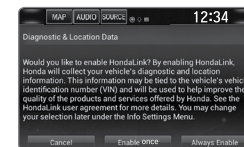

### HondaLink Menu

Select a menu option.

**Places\*:** Display restaurants, gas stations, and other locations. You can send a location to the navigation system and set a route.

**Vehicle:** Get instructional messages when your vehicle needs service.

**Help & Support:** Display tips for vehicle usage, get roadside assistance, or contact customer service.

**Messages from Honda:** Display helpful and important information from Honda. If you have a new message, a yellow envelope icon appears at the top of the screen and a beep sounds. You can swipe down to view the message from any screen.

**Weather:** Display a weekly five-day weather forecast for any location.

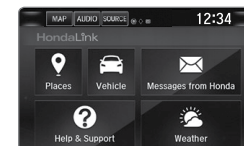

\*if equipped

## Models with Display Audio

## Wi-Fi Connection

You can connect the audio system to the internet using Wi-Fi and use online websites and services through the touchscreen. If your compatible phone has hotspot capabilities, the system can be tethered to the phone. Follow the steps below to set up Wi-Fi when the vehicle is stopped. Standard data rates apply with your phone service provider.

1. From the Home screen, select Settings.
2. Select Bluetooth/Wi-Fi. Select the Wi-Fi tab.
3. Select Wi-Fi On/Off Status, and select On.
4. Select Wi-Fi Device List. Make sure your phone's Wi-Fi setting is in access point (tethering) mode.
5. Select the phone you want to connect to the system. If the phone you want to connect does not appear, select Scan.
6. Select Connect.
7. Enter a password for your phone, if necessary. Select OK. The Wi-Fi symbol is displayed on the list when connection is successful.



## Models with Display Audio

## Apple CarPlay™

Connect an Apple CarPlay-compatible iPhone to the system. You can use the touchscreen to make a phone call, listen to music, and more. Visit the Apple CarPlay website for more information.

Park in a safe place before connecting your iPhone and launching any compatible apps.

1. Connect the iPhone to the front-console USB port (see page 54).
2. Apple CarPlay requires you to send vehicle information to Honda. Select Enable Once, Always Enable, or Cancel. Your phone may prompt you to allow access for CarPlay to be launched.
3. From the HOME screen, select Apple CarPlay.
4. Select a menu option.

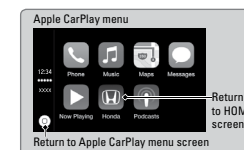
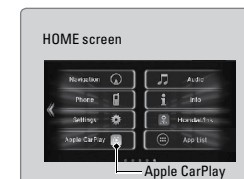

**Phone:** Access your contacts, make phone calls, or listen to voicemail. While connected to Apple CarPlay, calls can be made only through Apple CarPlay, not through *Bluetooth* HandsFreeLink.

**Music:** Play music stored on your iPhone.

**Maps:** View a map and operate navigation with routing guidance.

**Messages:** View and reply to text messages, or have messages read to you aloud by the system.

Once connected, press and hold the Talk button on the steering wheel (see page 78) to operate the system using voice commands with Siri Eyes Free.

*Depending on use, Apple CarPlay can share certain vehicle information (e.g., vehicle location, speed, and other operating conditions) with the connected iPhone. See Apple's privacy policy for details regarding Apple's use and handling of data uploaded by CarPlay. Use of CarPlay is at user's own risk, and is subject to agreement to the CarPlay terms of use, which are included as part of the Apple iOS terms of use. CarPlay vehicle integration is provided "as is," and Honda cannot guarantee CarPlay operability or functionality now or in the future due to, among other conditions, changes in CarPlay software/Apple iOS, service interruptions, or incompatibility or obsolescence of vehicle-integrated hardware or software. See dealer for details. Use CarPlay only when conditions allow you to do so safely. See your Owner's Manual on the Owner Information CD or at owners.honda.com (U.S.) or myhonda.ca (Canada) for further license and warranty terms.*

## Models with Display Audio

## Android Auto™

Connect a compatible Android phone to the system. You can use the touchscreen to make a phone call, listen to music, and more. Visit the Android Auto website for more information.

Park in a safe place before connecting your smartphone and launching any compatible apps.

1. Download the Android Auto app to your phone.
2. Connect the phone to the front-console USB port (see page 54). The phone is automatically paired. A tutorial also appears.
3. From the HOME screen, select Android Auto.
4. Android Auto requires you to send vehicle information to Honda. Select Enable Once, Always Enable, or Cancel.
5. Select a menu option.

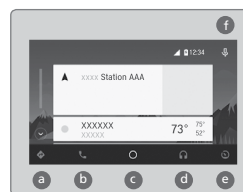
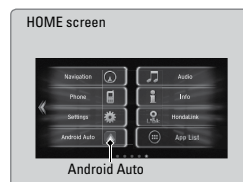

- Maps (Navigation):** View Google Maps and operate navigation with routing guidance. You cannot enter destinations using the keyboard while the vehicle is moving.
- Phone:** Make phone calls or listen to voicemail.
- Home (Google Now):** Display useful information organized by Android Auto into simple cards that appear only when needed.
- Music:** Play music from compatible apps. Select this icon to switch between music apps.
- Return to HOME screen:** Go back to the vehicle system HOME screen.
- Voice:** Use voice commands via Google Voice Search to operate Android Auto. You can also press and hold the Talk button on the steering wheel (see page 78) to say voice commands.

*Depending on use, Android Auto can share certain vehicle information (e.g., vehicle location, speed, and other operating conditions) with Google and its service providers. See Google privacy policy for details regarding Google's use and handling of data uploaded by Android Auto. Use of Android Auto is at user's own risk, and is subject to agreement to the Android Auto terms of use, which are presented to the user when the Android Auto application is downloaded to the user's Android phone. Android Auto vehicle integration is provided "as is," and Honda cannot guarantee Android Auto operability or functionality now or in the future due to, among other conditions, changes in Android Auto software/Android operating system, service interruptions, or incompatibility or obsolescence of vehicle-integrated hardware or software. See dealer for details. Use Android Auto only when conditions allow you to do so safely. See your Owner's Manual on the Owner Information CD or at owners.honda.com (U.S.) or myhonda.ca (Canada) for further license and warranty terms.*

## Models with Display Audio

## FM/AM Radio

Play FM or AM radio stations.

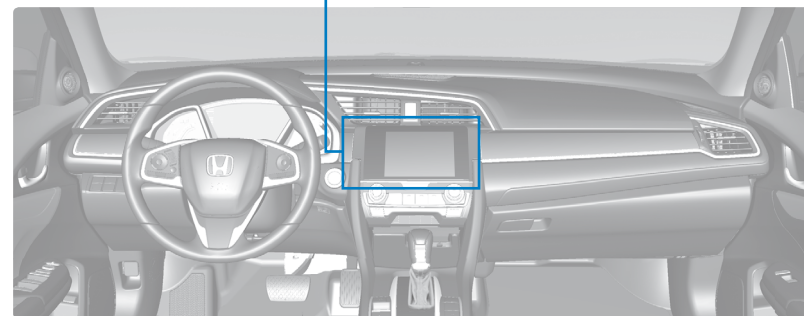
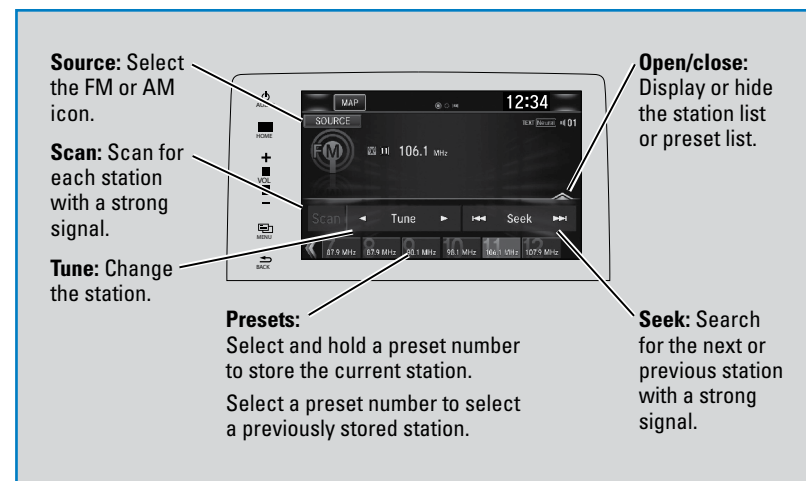

## Models with Display Audio

## SiriusXM® Radio\*

Available on a subscription basis only. For more information or to subscribe, contact your dealer, or visit [www.siriusxm.com](http://www.siriusxm.com) (U.S.) or [www.sirius.ca](http://www.sirius.ca) (Canada).

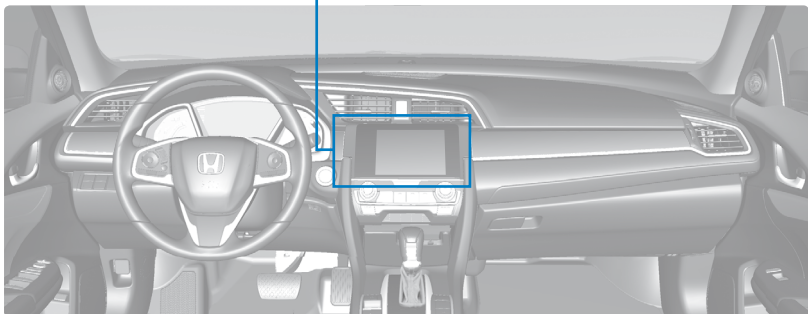
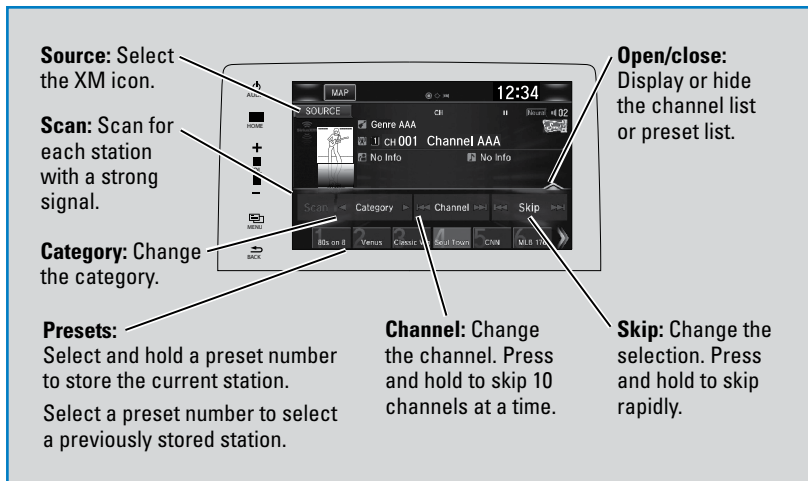

To learn about additional features—such as multi-channel preset, replay, or SportsFlash—see your Owner's Manual on the Owner Information CD or visit [owners.honda.com](http://owners.honda.com) (U.S.) or [myhonda.ca](http://myhonda.ca) (Canada).

Available in the U.S. and Canada, except Hawaii, Alaska, and Puerto Rico.  
XM® is a registered trademark of Sirius XM Radio, Inc.

\*if equipped

## Models with Display Audio

## iPod®

Play and operate an iPod through the vehicle's audio system. Connect your device to the USB port (see page 54).

If an iPhone is connected via Apple CarPlay (see page 67), the iPod source is unavailable and audio files on the phone can be played only within Apple CarPlay.

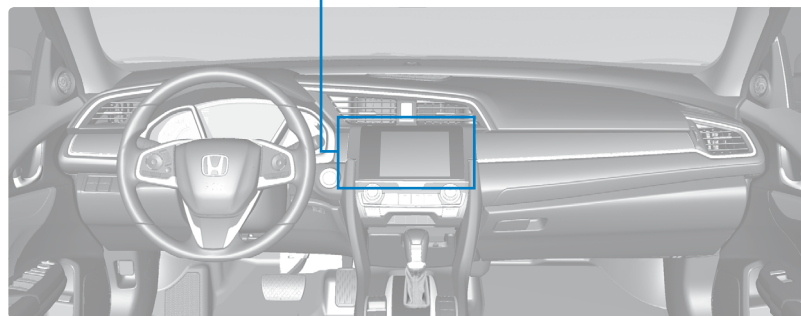
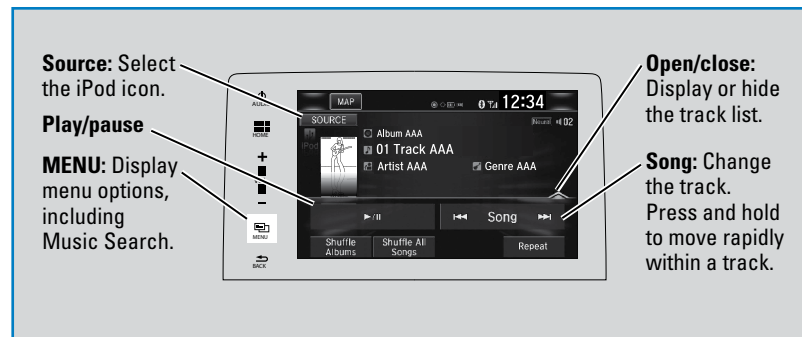

## ■ Searching for Music

Use the touchscreen to search for tracks stored on the iPod.

1. From the audio screen, press MENU.
2. Select Music Search.
3. Select a search option.
4. Select the track you want to play. On models without SPORT mode, you can swipe the + / - bar to scroll the list.

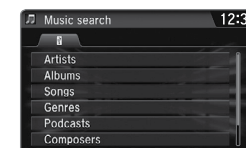

On vehicles with navigation, you can also search for and play iPod music using Song By Voice™ (see page 156).

iPod is a trademark of Apple, Inc.

Models with Display Audio

**USB Flash Drive**

Play and operate a USB flash drive through the vehicle's audio system. Connect your device to the USB port (see page 54).

If an iPhone is connected via Apple CarPlay (see page 67), the USB source is unavailable and audio files on the phone can be played only within Apple CarPlay.

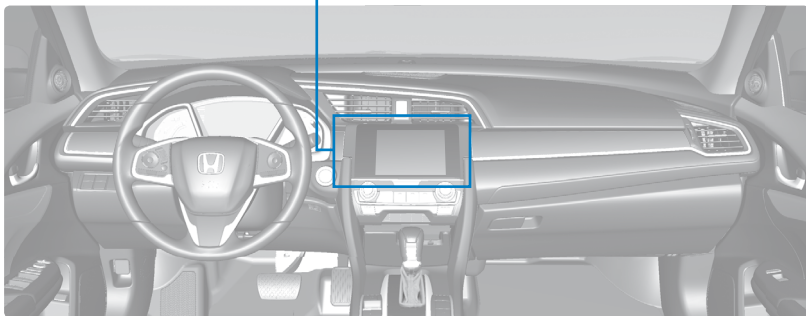

■ **Searching for Music**

Use the touchscreen to search for tracks stored on the USB flash drive.

1. From the audio screen, press MENU.
2. Select Music Search.
3. Select a folder.
4. Select the track you want to play.



On vehicles with navigation, you can also search for and play iPod music using Song By Voice (see page 156).

Models with Display Audio

**Bluetooth® Audio**

Play streaming or stored audio from your compatible phone through the vehicle's audio system. Visit [automobiles.honda.com/handsfreelink](http://automobiles.honda.com/handsfreelink) (U.S.) or [handsfreelink.ca](http://handsfreelink.ca) (Canada) to check phone compatibility. Standard data rates apply with your phone service provider. Connect your phone to *Bluetooth* HandsFreeLink (see page 80).

If a phone is currently connected via Apple CarPlay (see page 67) or Android Auto (see page 68), *Bluetooth* Audio from that phone is unavailable.

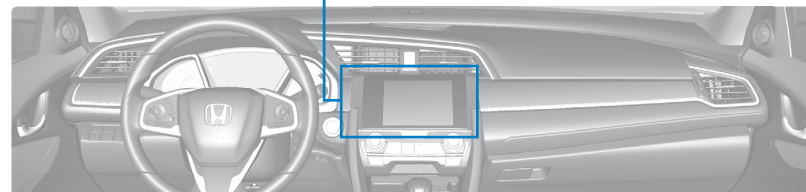

■ **Searching for Music**

Use the touchscreen to search for tracks stored on the device.

1. From the audio screen, press MENU.
2. Select Music Search.
3. Select a search category.
4. Select the track you want to play.

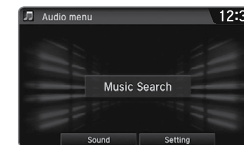

**Notes:**

- Make sure the volume on your phone is properly adjusted.
- You may need to enable additional settings on your phone for playback.
- Certain audio controls are not supported on all phones.

*Applicable laws may prohibit the operation of handheld electronic devices while operating a vehicle. Launch streaming audio on your phone only when it is safe to do so.*



Models with Display Audio

**Pandora®\***

Play and operate Pandora from your compatible phone through the vehicle's audio system. Visit [automobiles.honda.com/handsfreelink](http://automobiles.honda.com/handsfreelink) to check phone compatibility. Standard data rates apply with your phone service provider.

Connect your phone when the vehicle is stopped.

**For iPhone:**

- Connect via *Bluetooth* HandsFreeLink (see page 80) or USB port (see page 54).
- A pop-up may appear on your phone requesting you to allow access for Pandora to be launched.
- If you cannot operate Pandora through the audio system, it may be streaming through *Bluetooth* Audio. Make sure Pandora is selected on the audio system.
- If Pandora still does not operate, try rebooting the phone and reconnecting the cable if necessary.

**For other compatible smartphones:**

- Connect via *Bluetooth* HandsFreeLink (see page 80).
- If your phone is connected to Android Auto (see page 68), Pandora is available only through the Android Auto interface. Visit the Android Auto website to check compatibility.

**Source:** Select the Pandora icon.

**MENU:** Display menu options, including the Station List.

**Like/dislike song**

**Station:** Change the station.

**Skip:** Go to the next song.

**Play/Pause**

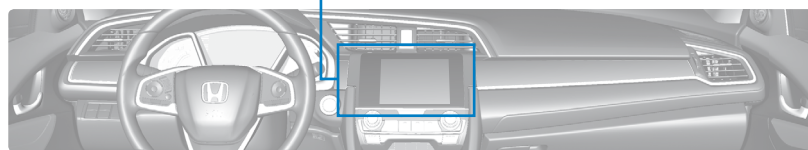

**BLUETOOTH® HANDSFREELINK® (HFL)**

Learn how to operate the vehicle's hands-free calling system.

**Models with color audio system**

**Basic HFL Operation**

Make and receive phone calls using the vehicle's audio system, without handling your phone. Visit [automobiles.honda.com/handsfreelink](http://automobiles.honda.com/handsfreelink) (U.S.) or [handsfreelink.ca](http://handsfreelink.ca) (Canada) to check phone compatibility.

**To reduce the potential for driver distraction, certain manual functions may be inoperable or grayed out while the vehicle is moving. Stop or pull over to perform the function.**

**HFL Controls**

Use the controls to enter information and make selections.

**Hang-Up/Back button:** End or decline a call, or cancel an operation.

**Pick-Up button:** Go to the phone screen, or answer an incoming call.

**Talk button:** Make a call using a stored voice tag.

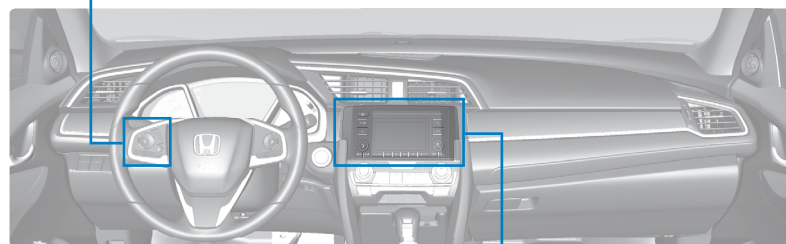

**PHONE button:** Display the phone screen.

**Selector knob:** Rotate and press to make selections.

**Back button:** Go back to the previous display.

\*Pandora is available only in certain countries. Visit the Pandora website for more information.

Applicable laws may prohibit the operation of handheld electronic devices while operating a vehicle. Launch streaming audio on your phone only when it is safe to do so.

Models with color audio system

Pairing a Phone

To use hands-free phone and streaming audio functions, you must first pair your phone to the system. This can be done only when the vehicle is stopped. Use the selector knob to make and enter selections.

Pairing the First Phone

1. Press the Phone button to go to the Phone screen. A prompt appears. Select Yes.
2. Make sure your phone is in discovery mode. Select OK.
3. The system searches for your phone. Select your phone when it appears on the list.  
*If your phone does not appear:* Select Phone Not Found? and search for HandsFreeLink from your phone. Connect to HFL.
4. The system gives you a pairing code. Compare it to the code that appears on your phone. Connect to HFL from your phone.

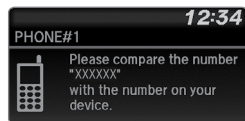
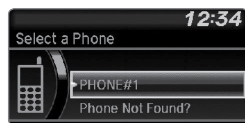
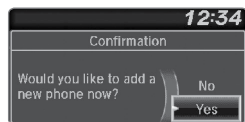

Pairing an Additional Phone

1. Press the Phone button to go to the Phone screen. If a prompt appears asking to connect to a phone, select No.
2. Select Phone Setup.
3. Select Bluetooth Setup.
4. Select Add New Device.
5. Make sure your phone is in discovery mode. Select OK.
6. The system searches for your phone. Select it when it appears on the list.  
*If your phone does not appear:* Select Phone Not Found?, and search for HandsFreeLink from your phone. Connect to HFL.
7. The system gives you a pairing code. Enter it on your phone when prompted.

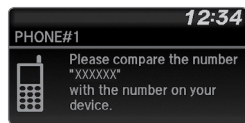

Applicable laws may prohibit the operation of handheld electronic devices while operating a vehicle.

Models with color audio system

Making a Call

You can make a call using several methods.

Dialing a Number

Enter a 10-digit phone number to call. Use the selector knob to make and enter selections. This method is inoperable while the vehicle is moving.

1. Press the Phone button.
2. Select Dial.
3. Enter the phone number. Select the green phone icon to call.



Using the Phonebook

When your phone is paired, its phonebook is automatically imported to the system. Use the selector knob to make and enter selections. This method is inoperable while the vehicle is moving.

1. Press the Phone button.
2. Select Phonebook.
3. Scroll through the list to find the name and number you want to call, and select it to call.



Storing Speed Dial Entries

Store up to 20 numbers for quick dialing. Use the selector knob to make and enter selections.

1. Press the Phone button.
2. Select Phone Setup.
3. Select Speed Dial, then select Add New.
4. Select an entry method.
5. If desired, you can create a voice tag for the number. Follow the prompts.



Using Speed Dial

Make calls quickly using stored speed dial entries. Use the selector knob to make and enter selections.

1. Press the Phone button.
2. Select Speed Dial.
3. Scroll through the list to find the entry you want to call, and select it to call.



Speed dial entries with stored voice tags can be called using the Talk button. Press the Talk button and follow the prompts.

## Models with Display Audio

### Basic HFL Operation

Make and receive phone calls using the vehicle's audio system, without handling your phone. Visit [automobiles.honda.com/handsfreelink](http://automobiles.honda.com/handsfreelink) (U.S.) or [handsfreelink.ca](http://handsfreelink.ca) (Canada) to check phone compatibility.

**To reduce the potential for driver distraction, certain manual functions may be inoperable or grayed out while the vehicle is moving. Stop or pull over to perform the function. Voice commands are also available.**

#### ■ HFL Controls

Use the controls to enter information and make selections.

**Hang-Up/Back button:** End or decline a call, or cancel an operation.

**Pick-Up button:** Answer an incoming call.

**Talk button:** Access the Voice Portal to make a call using a stored voice tag, or say voice commands\*.

**Phone button:** Press until the phone screen is displayed in the Driver Information Interface.

**▲ / ▼ buttons:** Press up or down to navigate the contact list in the Driver Information Interface. Swipe up or down to scroll through the contact list.

**ENTER button:** From the phone screen in the Driver Information Interface, select from Speed Dial, Call History, or Phonebook.

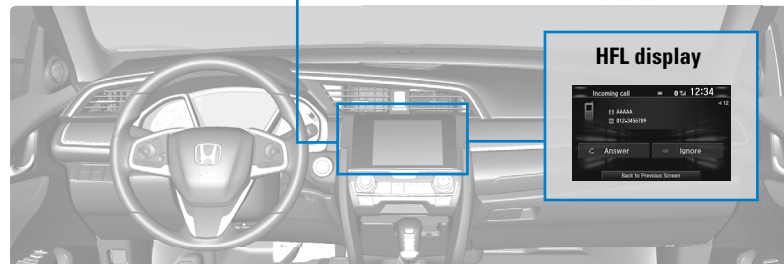
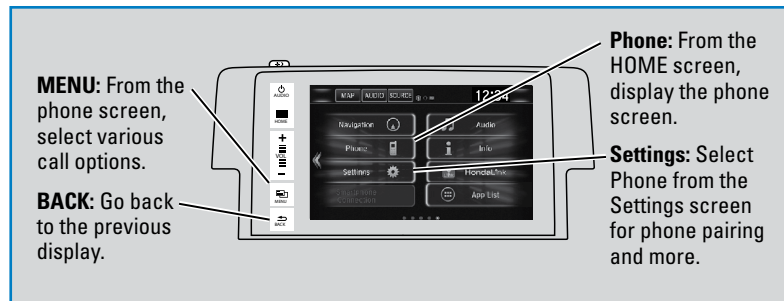
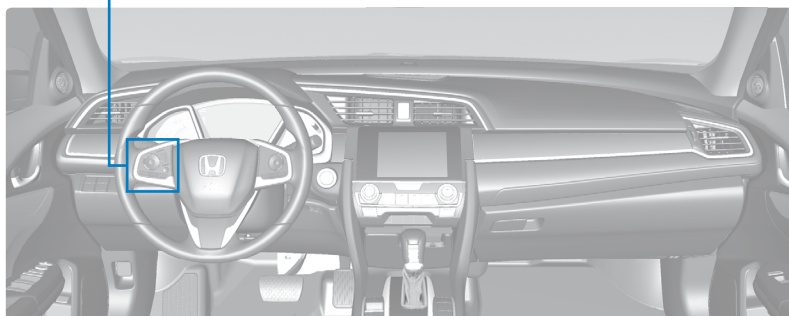

#### ■ Talk Button Tips

For a list of available phone commands, see page 155. The system recognizes only those commands.

- When using the Talk button, wait until you hear a beep before speaking.
- To bypass the system prompts, simply press the Talk button again to say your command.\*
- When the Talk button is pressed, all available voice commands are highlighted in yellow.\*
- Speak in a clear, natural voice.
- Reduce all background noise.
- Adjust the dashboard vents away from the microphone on the ceiling.
- Close the windows and moonroof.

\*models with navigation

\*models with navigation

Models with Display Audio

Pairing a Phone

To use hands-free phone and streaming audio functions, you must first pair your phone to the system. This can be done only when the vehicle is stopped. Use the touchscreen to make and enter selections.

If there is an active connection to Apple CarPlay (see page 67) or Android Auto (see page 68), pairing of additional *Bluetooth*-compatible devices is unavailable and Add Bluetooth Device is grayed out from the Bluetooth Device List screen.

1. From the Home screen, select Settings.
2. Select Phone.
3. Select Bluetooth Device List.
4. Select Add Bluetooth Device.
5. Make sure your phone is in discovery mode. Select Continue.
6. The system searches for your phone. Select your phone when it appears on the list.  
*If your phone does not appear:* Select Phone Not Found and search for HandsFreeLink from your phone. Connect to HFL.
7. The system gives you a pairing code. Compare it to the code that appears on your phone. Connect to HFL from your phone.
8. The system asks if you want to enable options:  
*HondaLink Assist:* Select On to enable emergency collision notification (see page 83).  
*Phone Synchronization:* Select On to automatically import contacts and call history from your phone.
9. Press BACK to exit the menu.

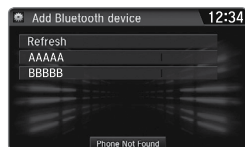

Applicable laws may prohibit the operation of handheld electronic devices while operating a vehicle.

Models with Display Audio

Making a Call

You can make a call using several methods.

Dialing a Number

Enter a 10-digit phone number to call.

Using voice commands

Press the Talk button before you say each command.

1. Say "Dial by number."
2. Say the phone number: For example, "3-1-0-5-5-1-2-3-4."
3. The system begins to dial.

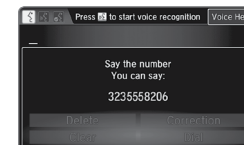

Using the touchscreen

Manual operation is limited while the vehicle is moving. Voice commands are always available.

1. From the Home screen, select Phone.
2. Select MENU.
3. Select Dial.
4. Enter the phone number. Select the green phone icon to call.



Using the Phonebook

When your phone is paired, its entire phonebook can be automatically imported to the system. Phone synchronization must be turned on.

Using voice commands

Press the Talk button before you say each command.

1. Say "Dial by name."
2. Say the phonebook name and phone type. For example, "John Smith mobile."



Using the touchscreen

Manual operation is limited while the vehicle is moving. Voice commands are always available.

1. From the Home screen, select Phone.
2. Select MENU.
3. Select Phonebook.
4. Scroll through the list to find the name and number you want to call, and select it to call.

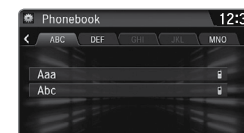

**Storing Speed Dial Entries**

Store up to 20 numbers for quick dialing.

1. From the Home screen, select Phone.
2. Select MENU.
3. Select Edit Speed Dial, then select New Entry.
4. Select an entry method.
5. If desired, you can create a voice tag for the number. Follow the prompts.



**Using Speed Dial**

Make calls quickly using stored speed dial entries.

**Using voice commands**

Press the Talk button before you say each command.

1. Say "Dial by name."
2. Say the stored voice tag name. For example, "John Smith."



**Using the touchscreen**

1. From the Home screen, select Phone.
2. Scroll through the list to find the entry you want to call, and select it to call.



**Models with Display Audio**

**SMS Text Messaging and E-Mail\***

Certain phones can receive and send messages from your paired and connected phone. Visit [automobiles.honda.com/handsfreelink](http://automobiles.honda.com/handsfreelink) (U.S.) or [handsfreelink.ca](http://handsfreelink.ca) (Canada) to check phone compatibility. Standard message rates apply with your phone service provider. This feature is limited while the vehicle is moving.

**Receiving and Responding to Messages**

When you receive a new message, a pop-up appears on the touchscreen. You can view the message when the vehicle is stopped. You can also reply to it using fixed phrases or call the sender.

1. When the prompt appears, select Read.



2. The message is displayed, and the system reads it aloud.

*To reply:* With the message open, select Reply, and choose one of the six available responses. Select Send to send the message. You cannot create a new text message.

*Call the sender:* With the message open, select Dial.



**Selecting an Account**

If your phone has both text message and e-mail accounts, you can select only one of them at a time to be active and receive notifications.

1. From the Home screen, select Settings.
2. Select Phone.
3. Select Select Account.
4. Select Text Message or an e-mail account.



**Models with Display Audio**

**HondaLink® Assist**

If your vehicle's airbags deploy or if the unit detects that the vehicle is severely impacted, your vehicle automatically attempts to connect to an operator. Your phone must be paired to the system and have good cellular connection. Visit [www.hondalink.com](http://www.hondalink.com) (U.S.) or [honda.ca/hondalinkassist](http://honda.ca/hondalinkassist) (Canada) for more information.

1. Make sure your phone is on and paired to Bluetooth HandsFreeLink (see page 80).
2. Select Call Now, or the system automatically connects after 10 seconds. The vehicle information and its position are sent to the operator.\*
3. Select Talk Now to immediately talk to the operator.
4. When the call is complete, select Hang Up or press the Hang-Up/Back button on the steering wheel.

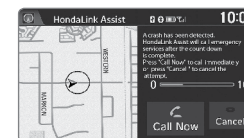

Honda reserves the right to terminate HondaLink Assist services at any time or for any reason, and in the future may not be able to provide services due to changes in or obsolescence of technology integral to the service or changes in governmental regulation.

\*Depending on your phone and cellular signal capability, your vehicle's location may not be sent to the operator.

Models with Display Audio

Siri® Eyes Free

Activate Siri through your vehicle when an iPhone is paired to the system. Visit [automobiles.honda.com/handsfreelink](http://automobiles.honda.com/handsfreelink) (U.S.) or [honda.ca/siri](http://honda.ca/siri) (Canada) to check phone

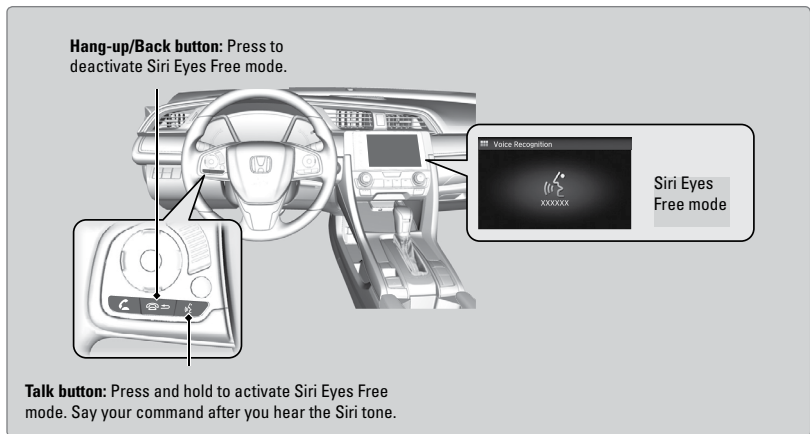

compatibility.

Here are some examples of Siri commands:

- "Call John Smith"
- "Read my new text message"
- "Find a nearby sushi restaurant"
- "Remind me to pick up dinner"
- "Set up a meeting today at 3 p.m."
- "Play song XYZ"

Notes:

- Any requests that include visual feedback from Siri on your phone are not displayed in the vehicle.
- Certain commands rely on the iPhone's features and existing apps.
- To hear turn-by-turn directions or songs through the vehicle, set the audio source to Bluetooth Audio.
- If using Siri Eyes Free through Apple CarPlay (see page 67), use the Talk button to activate and deactivate Siri Eyes Free mode.

Siri and iPhone are trademarks of Apple, Inc.

NAVIGATION\*

Learn how to enter a destination and operate the navigation system.

Basic Navigation Operation

A real-time navigation system uses GPS and a map database to show your current location and help guide you to a desired destination. You can operate the system using voice commands or the system controls.

**To reduce the potential for driver distraction, certain manual functions may be inoperable or grayed out while the vehicle is moving. Voice commands are always available.**

Steering Wheel Controls

Use the steering wheel controls to say voice commands.

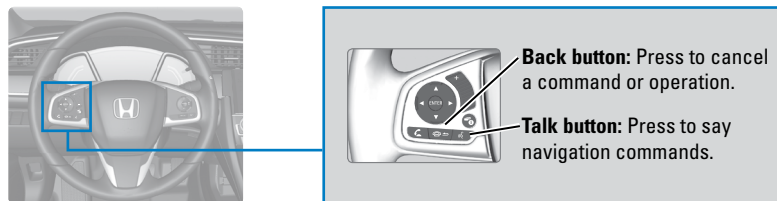

Talk Button Tips

- The system recognizes only those commands listed beginning on page 155.
- When using the Talk button, wait for a beep before saying a command.
- To bypass the system prompts, simply press the Talk button again to say your command.
- Speak in a clear, natural voice.
- Reduce all background noise.
- Adjust the dashboard vents away from the microphone in the ceiling.
- Close the windows and moonroof.

System Guidance Volume

Adjust the navigation system volume.

1. From the HOME screen, select Settings.
2. Select System.
3. Select the Sound/Beep tab.
4. Select Guidance Volume, and adjust the level. Select OK when complete.
5. Press BACK to exit the menus.

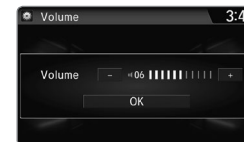

\*if equipped

TABLE OF CONTENTS

VISUAL INDEX

SAFETY INFORMATION

INSTRUMENT PANEL

VEHICLE CONTROLS

AUDIO AND CONNECTIVITY

BLUETOOTH® HANDSFREELINK®

HONDALINK®

NAVIGATION

DRIVING

HANDLING THE UNEXPECTED

MAINTENANCE

SPECIFICATIONS

CUSTOMER INFORMATION

VOICE COMMAND INDEX

INDEX

### Navigation Display and Controls

Touch icons on the screen to enter information and make selections.

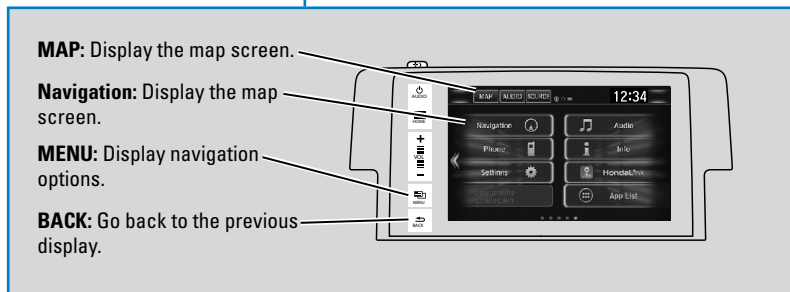
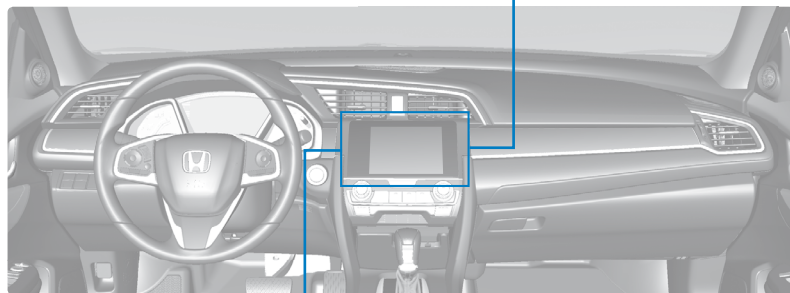
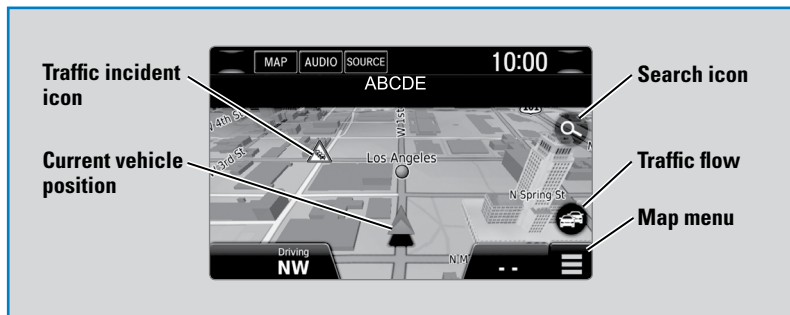

### Entering a Destination

Use several methods to enter a destination.

#### Home Address

Store your home address in the system so you can easily route to it.

1. From the map screen, select the Search icon.
2. Select MENU.
3. Select Set Home Location.
4. Select Enter My Address.
5. Select Search All.
6. Enter the street number and select Done.
7. Enter the street name and select Done. Select the street from the list.
8. Select the address from the list. A map of the address is shown. Select Select.

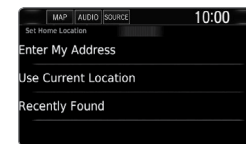

When your home address is stored, you can press the Talk button and say "Navigation" and then "Go home" at any time. You can also select Go Home from the Where To? menu.

#### Street Address

Enter a street address.

1. From the map screen, select the Search icon.
2. Select Address.
3. Select Search All.
4. Enter the street number and select Done.
5. Enter the street name and select Done. Select the street from the list.
6. Select the address from the list.
7. Select Go!.

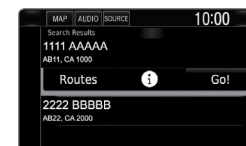

**Place Category**

Enter a destination using a point of interest or landmark.

1. From the map screen, select the Search icon.
2. Select Categories.
3. Select a category (and a subcategory if necessary).
4. Select a place from the list.
5. Select Go!.

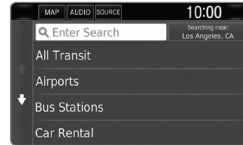
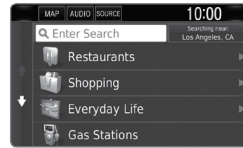

You can also enter a street address using voice commands. Press the Talk button and say "Navigation" and then "Find Place." Follow the prompts.

**Recent Places**

Select an address from a list of your 50 most recent destinations.

1. From the map screen, select the Search icon.
2. Select Recent.
3. Select a place from the list.
4. Select Go!.

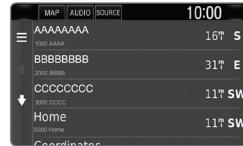

**Saved Places**

Save locations so you can quickly route to them.

**Saving a location**

1. From the map screen, select the Search icon.
2. Select Enter Search.
3. Enter the address or place name.
4. Select the destination name when it appears.
5. Select the info icon.
6. Select the menu icon.
7. Select Save.
8. Select OK.

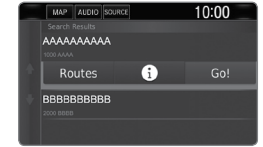

You can also save your current location. From the map screen, select the vehicle icon. Select Save. Enter a name for the location. Select Done. Select OK.

**Routing to a saved location**

1. From the map screen, select the Search icon.
2. Select Saved.
3. Select the destination from the list.
4. Select Go!.

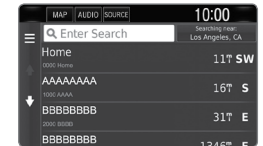



## Routing

After a destination is set, you can alter or cancel your route.

### Map Legend

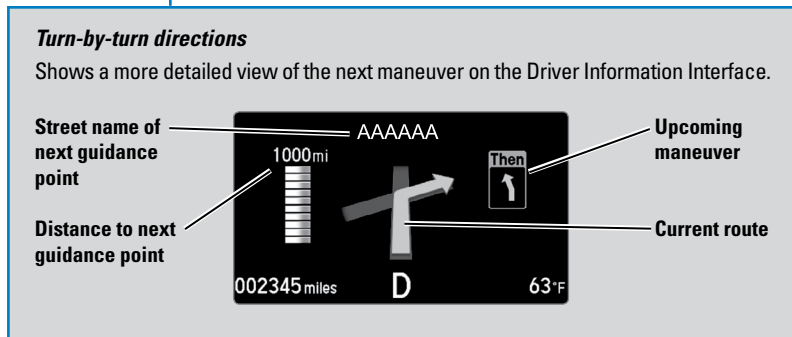
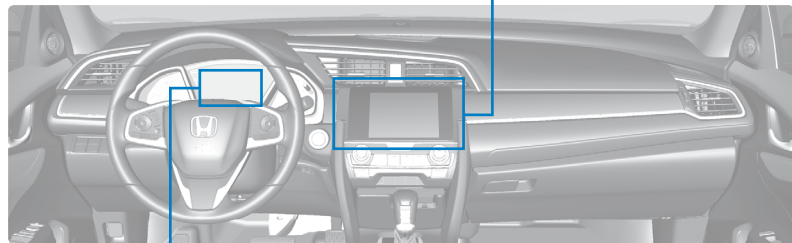
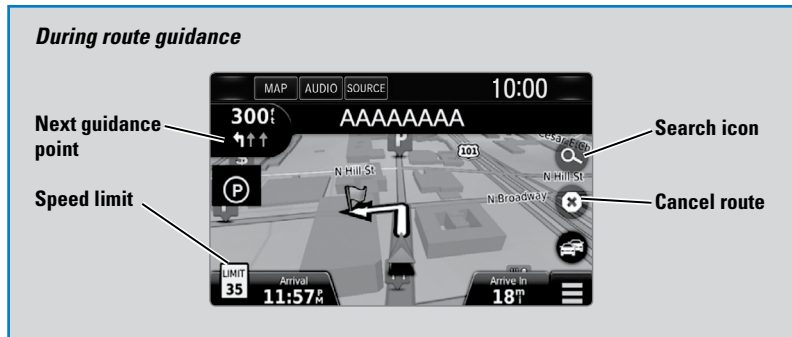

### ⚠ WARNING

Using the navigation system while driving can take your attention away from the road, causing a crash in which you could be seriously injured or killed.

Operate system controls only when the conditions permit you to safely do so.

## Traffic

View traffic flow and incidents in major metro areas. Traffic alerts are accompanied by an audible beep. Pop-up messages and traffic information can be viewed when you are on the map screen. You can also select traffic to avoid. Traffic coverage is limited in Canada.

### Viewing traffic

1. From the map screen, select the traffic icon.
2. Select Traffic Conditions.
3. Traffic icons are shown on the map. Select the magnifying glass icon to display a full list of traffic delays.

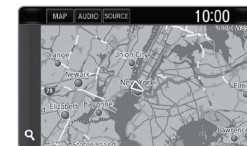

**To mute traffic alerts and voice guidance:** From the map screen, press MENU. Select Mute. To lower voice guidance volume, see page 85.

### Avoiding traffic on your route

1. From the map screen, select the traffic icon.
2. Select Traffic on Route.
3. Select an incident to avoid from the list.
4. Select the menu icon.
5. Select Avoid.

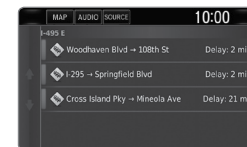

# DRIVING

Learn about preparation for driving, as well as other features.

## Before Driving

Check the following items before you begin driving.

### ■ Exterior Checks

- • Make sure there are no obstructions on the windows, door mirrors, exterior lights, or other parts of the vehicle.
- • Remove any frost, snow, or ice.
- • Make sure the hood is securely closed.
- • Heat from the engine and exhaust can ignite flammable materials left under the hood, causing a fire. If you've parked your vehicle for an extended period, inspect and remove any debris that may have collected, such as dried grass and leaves that have fallen or have been carried in for use as a nest by a small animal. Also check under the hood for leftover flammable materials after you or someone else has performed maintenance on your vehicle.
- • Make sure the tires are in good condition.
- • Make sure there are no people or objects behind or around the vehicle.

### NOTICE

If the doors are frozen shut, use warm water around the door edges to melt any ice. Do not try to force them open, as this can damage the rubber trim around the doors. When done, wipe dry to avoid further freezing.

### ■ Interior Checks

- • Store or secure all items on board properly.
- • Do not place anything in the front-seat footwells. Make sure to secure the floor mats.
- • If you have any animals on board, do not let them move freely around in the vehicle.
- • Securely close and lock all doors and the trunk.
- • Adjust your seating position, adjust the headrest\*, mirrors, and steering wheel properly.
- • Make sure items placed on the floor behind the front seats cannot roll under the seats.
- • Everyone in the vehicle must fasten their seat belt.
- • Make sure that the indicators in the instrument panel come on when you start the vehicle, and go off soon after.

In addition:

- • During the first 600 miles (1,000 km) of operation, avoid sudden acceleration or full throttle operation so as not to damage the engine or powertrain.
- • Avoid hard braking for the first 200 miles (300 km). You should also follow this when the brake pads are replaced.

### ⚠️ WARNING

Improper accessories or modifications can affect your vehicle's handling, stability, and performance, and cause a crash in which you can be seriously hurt or killed.

Follow all instructions in the vehicle owner's manual regarding accessories and modifications.

## Improving Fuel Economy and Reducing CO<sub>2</sub> Emissions

Achieving fuel economy and reducing CO<sub>2</sub> emissions is dependent on several factors, including driving conditions, load weight, idling time, driving habits, and vehicle condition. Depending on these and other factors, you may not achieve the rated fuel economy of this vehicle.

\*models without SPORT mode.

## Maximum Load Limit

Carrying too much cargo or improperly storing it can affect your vehicle's handling, stability, stopping distance, and tires, and make it unsafe.

The maximum load for your vehicle is 850 lbs (385 kg). See the Tire and Loading Information label on the driver's doorjamb.

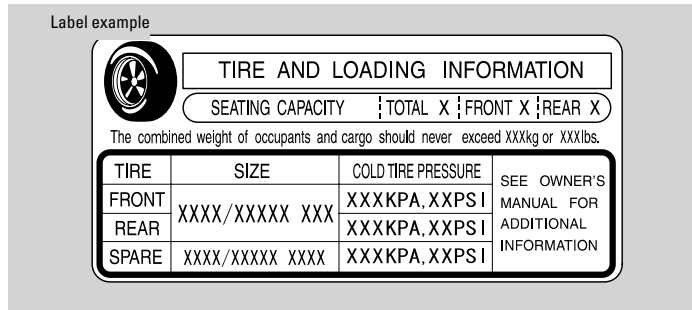

This figure includes the total weight of all occupants, cargo, and accessories, and the tongue load if you are towing a trailer. Below are the steps for determining the correct load limit:

1. Locate the statement "The combined weight of occupants and cargo should never exceed XXX kg or XXX lbs." on your vehicle's placard.
2. Determine the combined weight of the driver and passengers that will be riding in your vehicle.
3. Subtract the combined weight of the driver and passengers from XXX kg or XXX lbs.
4. The resulting figure equals the available amount of cargo and luggage load capacity. For example, if the "XXX" amount equals 1,400 lbs. and there will be five 150 lb. passengers in your vehicle, the amount of available cargo and luggage load capacity is 650 lbs. (1,400 - 750 (5 x 150) = 650 lbs.)
5. Determine the combined weight of luggage and cargo being loaded on the vehicle. That weight may not safely exceed the available cargo and luggage load capacity calculated in step 4.
6. If your vehicle will be towing a trailer, load from your trailer will be transferred to your vehicle. Consult this guide and the owner's manual to determine how this reduces the available cargo and luggage load capacity of your vehicle.

In addition, the total weight of the vehicle, all occupants, accessories, cargo, and trailer tongue load must not exceed the Gross Vehicle Weight Rating (GVWR) or the Gross Axle Weight Rating (GAWR). Both are on a label on the driver's doorjamb.

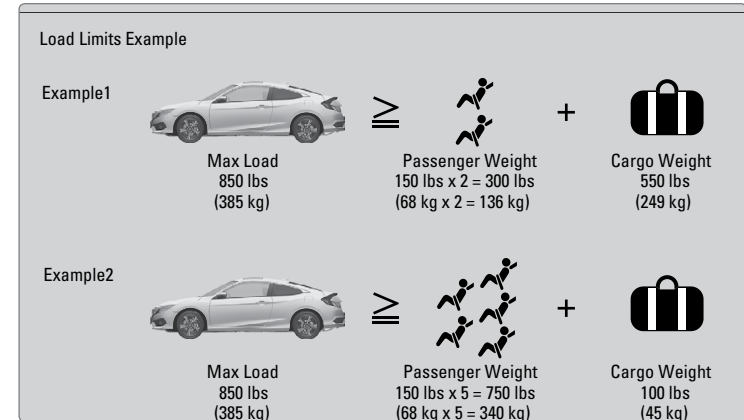

### ⚠️ WARNING

Overloading or improper loading can affect handling and stability and cause a crash in which you can be hurt or killed.

Follow all load limits and other loading guidelines in this guide.

The headlight aim on your vehicle was set by the factory, and does not need to be adjusted. However, if you regularly carry heavy items in the cargo area, have the aiming readjusted at your dealer or by a qualified technician.

**Your vehicle is not designed to tow a trailer. Attempting to do so can void your warranties.**

#### ■ Towing Behind a Motorhome

##### Models with continuously variable transmission

Your vehicle is not designed to be towed behind a motorhome. If your vehicle needs to be towed in an emergency, refer to the emergency towing information. See page 119.

##### Models with manual transmission

Your vehicle can be towed behind a motorhome. Perform the following procedure before towing your vehicle:

1. Shift to Neutral.
2. Release the parking brake.
3. Turn the ignition switch (or power mode) to ACCESSORY. Make sure the steering wheel does not lock.
4. Turn off all electrical devices. Do not use any accessory power sockets. This can prevent the battery from running down.

## Remote Engine Start\*

Start your vehicle's engine using the remote transmitter before you enter the vehicle.

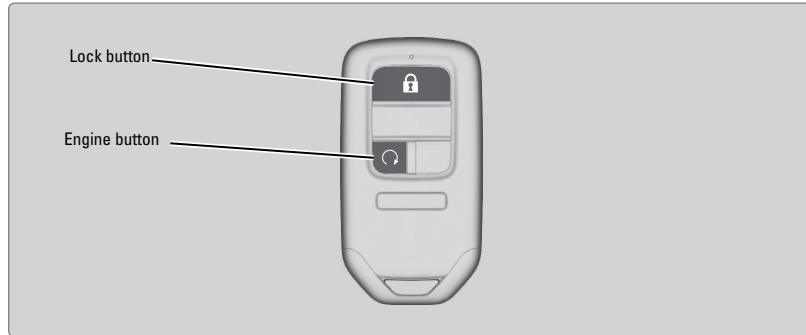

Make sure the vehicle is in a safe location when using remote engine start (i.e., a well ventilated, outside area, away from any flammable materials).

### Starting the Engine

Press the Lock button, then press and hold the Engine button within 5 seconds to remotely start the engine.

The engine runs for up to 10 minutes.

- If it is warm outside, the air conditioning is activated in recirculation mode.
- If it is cold outside, the defroster is activated at a moderately warm temperature, the rear defogger, door mirror heaters, and front seat heaters\* are activated.

To extend the run time for another 10 minutes, repeat the procedure during the initial 10 minutes.

### Stopping the Engine

Press and hold the Engine button.

The engine will also stop if it has been running for more than 10 minutes, or if any door is opened without using the remote or smart entry.

### **WARNING**

Engine exhaust contains toxic carbon monoxide gas.

Breathing carbon monoxide can kill you or cause unconsciousness.

Never use the remote engine starter when the vehicle is parked in a garage or other area with limited ventilation.

\*if equipped

## Starting to Drive

Turn on the vehicle and start the engine to begin driving.

### Before Starting the Engine

Make sure the parking brake is applied.

#### Continuously Variable Transmission (CVT)

Check that the shift lever is in Park (P), then press the brake pedal. Keep your foot firmly on the brake pedal when starting the engine.

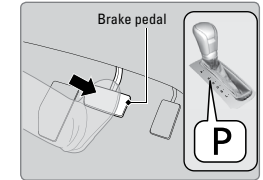

#### Manual transmission

Check that the shift lever is in Neutral (N). Press the brake pedal with your right foot, and press the clutch pedal all the way down with your left foot. Keep your foot firmly on the brake pedal when starting the engine.

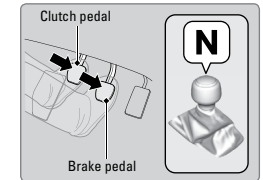

The engine is harder to start in cold weather and in thinner air found at altitudes above 8,000 feet (2,400 m). When starting the engine in cold weather, turn off all electrical accessories such as the lights, climate control system, and rear defogger in order to reduce battery drain.

### Starting the Ignition\*

Insert the key into the ignition and turn to turn on the vehicle or start the engine.

- Ⓘ **LOCK:** Insert and remove the key in this position.
- Ⓙ **ACCESSORY:** Operate the audio system and other accessories in this position.
- Ⓚ **ON:** This is the position when driving.
- Ⓛ **START:** This position is for starting the engine. The switch returns to ON when you release the key.

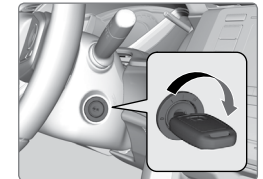

### Manual transmission models

### **WARNING**

Removing the key from the ignition switch while driving locks the steering. This can cause you to lose control of the vehicle.

Remove the key from the ignition switch only when parked.

\*if equipped

## ■ Starting and Stopping the Engine / Changing the Power Mode\*

Use the ENGINE START/STOP button to cycle through power modes or start the engine.

**Accessory or On mode:** Press ENGINE START/STOP once without pressing the brake pedal for Accessory mode. Press it again for On mode.

**Starting the engine:** Press and hold the brake pedal or clutch, then press ENGINE START/STOP. Keep your foot firmly on the brake pedal when starting the engine.

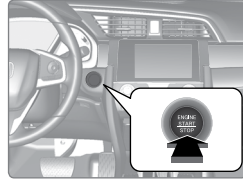

### Turning the vehicle off

#### Models with continuously variable transmission

Shift to Park (P) or apply the parking brake, then press ENGINE START/STOP. If you press the button and the shift lever is not in Park (P), the vehicle goes into Accessory mode.

#### Models with manual transmission

If the shift lever is in neutral, press the ENGINE START/STOP button. If the vehicle is in gear, depress the clutch pedal, then press the ENGINE START/STOP button.

## Shifting

Change the shift position based on your driving needs.

### ■ Continuously Variable Transmission (CVT)\*

**Park (P):** Used for parking or starting/stopping the engine. Press the brake pedal, then press the release button to shift.

**Reverse (R):** Used for reversing.

**Neutral (N):** Used for idling.

**Drive (D):** Used for normal driving.

**Drive (S):** Used for better acceleration, increased engine braking, or driving in hilly terrain.

**Low (L):** Used for stronger engine power and engine braking when driving in hilly terrain.

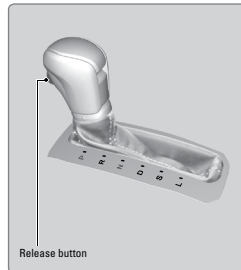

### NOTICE

When you change the shift lever from D to R and vice versa, come to a complete stop and keep the brake pedal depressed. Operating the shift lever before the vehicle has come to a complete standstill can damage the transmission.

Do not operate the shift lever while pressing the accelerator pedal. You could damage the transmission.

*\*if equipped*

### ■ Manual Transmission\*

Fully press the clutch pedal to operate the shift lever and change gears.

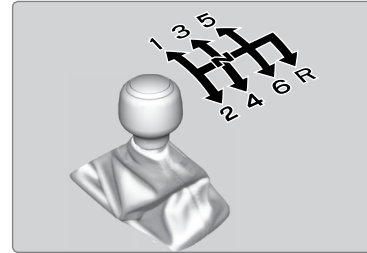

### NOTICE

Do not shift to Reverse (R) before the vehicle comes to a complete stop. This can damage the transmission.

### NOTICE

Before downshifting, make sure the engine will not go into the tachometer's red zone. This can severely damage your engine.

### ■ Shift Up Backlight\*

Blinks when the tachometer reading approaches the red zone.



### ■ Manual Shift Mode (CVT)\*

Use the paddle shifters to change sequentially between 1st and 7th speeds. Pull the right-hand paddle to upshift. Pull the left-hand paddle to downshift.

**Shift lever in (S):** The transmission switches to manual shift mode. The transmission will still automatically shift to prevent over or under revving. The transmission will automatically shift into 1<sup>st</sup> when you come to a stop. Cancel manual shift mode by returning the shift lever to (D).

**Shift lever in (D):** Pull the upshift paddle to temporarily engage manual shift mode. Manual shift mode will automatically cancel if the system detects you aren't actively shifting. Or, you can cancel by pulling and holding the upshift paddle.

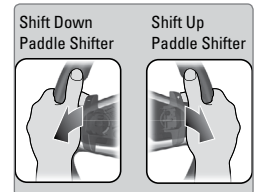

*\*if equipped*

## Braking

Slow down or stop your vehicle, and keep it from moving when parked.

### Foot Brake

Press the brake pedal to slow down or stop your vehicle from moving.

### Brake Assist System

During hard or emergency braking, the system increases braking force. The brake pedal may move slightly or make a noise; this is normal. Continue to hold the brake pedal firmly down.

### Anti-Lock Brake System (ABS)

During hard or emergency braking, the system rapidly pumps the brakes to prevent wheel lockup and help you maintain steering control. Do not pump the brake pedal, rather continue to hold it firmly down.

When ABS activates, you may notice vibrations through the brake pedal or the vehicle body, the brake pedal depressing further than usual, or hear a motor noise from the engine compartment. These are all normal.

In normal use, the ABS system will occasionally cause a motor sound from the engine compartment, especially when the engine is first started or after repeated use of the brakes.

#### NOTICE

The ABS may not function correctly if you use an incorrect tire type and size.

### Electric Parking Brake

Apply the electric parking brake as you're getting ready to step out of the vehicle once your drive is complete.

**To apply:** Pull up the switch. The BRAKE indicator appears in the instrument panel. Hold the switch up for emergency braking while the vehicle is moving.

**To release:** Press the brake pedal and make sure your seat belt is fastened. Press the switch down to release. Or, release by lightly pressing the accelerator pedal (and release the clutch pedal for manual transmission) while the vehicle is in gear.

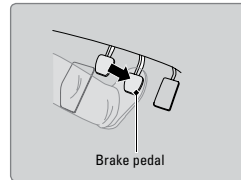
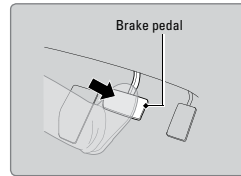

### Automatic Brake Hold

Use brake hold to make stop-and-go driving easier. It maintains rear brake hold even after the brake pedal is released. Make sure the vehicle is on and your seat belt is fastened when operating this feature.

1. Press the BRAKE HOLD button to the left of the shift lever. The BRAKE HOLD indicator appears in the instrument panel.
2. With the shift lever in Drive (D) or Neutral (N), press the brake pedal and come to a complete stop. The HOLD indicator appears, and brake hold is applied. Release the brake pedal.

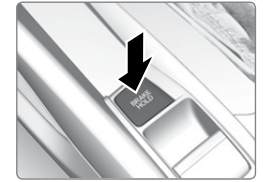

Press the accelerator pedal (or shift into a gear and release the clutch pedal for manual transmission) to cancel brake hold and start moving.

**To turn off brake hold:** Press the brake pedal and press the BRAKE HOLD button again.

Automatic brake hold cancels when:

- The engine stalls (manual transmission).
- The driver's seat belt is unfastened.
- The engine is turned off.
- The battery is disconnected.
- Braking is applied for more than 10 minutes.
- The electric parking brake is engaged.
- The foot brake is pressed and the shift lever is moved to P or R.

#### WARNING

Activating the automatic brake hold system on steep hills or slippery roads may still allow the vehicle to move if you remove your foot from the brake pedal.

If a vehicle unexpectedly moves, it may cause a crash resulting in serious injury or death.

Never use the automatic brake hold system or rely on it to keep a vehicle from moving when stopped on a steep hill or slippery roads.

#### WARNING

Using the automatic brake hold system to park the vehicle may result in the vehicle unexpectedly moving.

If a vehicle moves unexpectedly, it may cause a crash, resulting in serious injury or death.

Never leave the vehicle when braking is temporarily kept by automatic brake hold and always park the vehicle by putting the transmission in Park (P) and applying the parking brake.

## Eco Assist™ System\*

Can help improve fuel efficiency by adjusting the performance of the engine, transmission, climate control system, and cruise control.

### ■ ECON Button

Press the ECON button behind the shift lever to turn the system on or off. The ECON Mode indicator appears when the system is turned on.

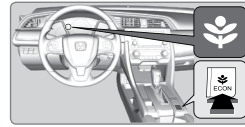

### ■ Ambient Meter

Color-coded bars change based on your driving style and brake or accelerator pedal operation.

**Green:** Fuel-efficient driving

**Light green:** Moderate acceleration/deceleration

**White:** Aggressive acceleration/deceleration

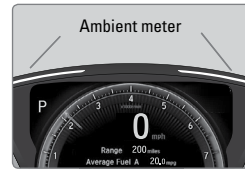

## SPORT Mode\*

Enhances the feelings of responsiveness and performance, for enjoying curving or hilly roads.

### ■ SPORT Button

Press the SPORT button behind the shift lever to turn the system on or off. The SPORT Mode indicator appears when the system is turned on. SPORT mode resets to off when you turn off the vehicle. The mode may not be changed under some driving conditions.

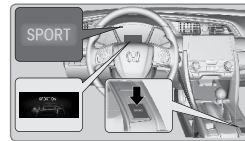

## Vehicle Stability Assist (VSA®)

Also known as Electronic Stability Control (ESC), VSA helps to stabilize the vehicle during cornering if the vehicle turns more or less than what was intended. It assists in maintaining traction on slippery surfaces by regulating engine output and selectively applying the brakes.

### ■ Turning VSA On or Off

Press and hold the VSA OFF button until you hear a beep to turn VSA on or off. The VSA OFF indicator appears when the system is off.

Traction control stops fully functioning, which may make it easier when trying to free your vehicle if it is stuck in mud or snow.

VSA is turned on every time you start the engine, even if you previously turned it off. If you turn VSA off, your vehicle has normal braking and cornering ability, but traction and stability enhancement become less effective.

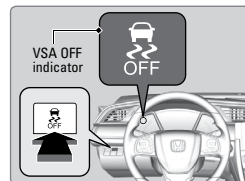

\*if equipped

## Cruise Control\*

Maintain a constant vehicle speed without having to keep your foot on the accelerator pedal. Use cruise control on highways or open roads where you can travel at a constant speed with little acceleration or deceleration.

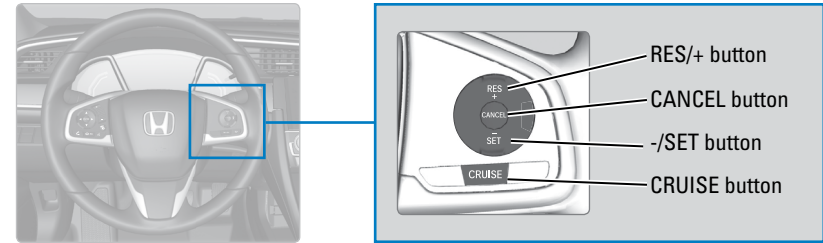

### ■ Activating and Setting the Vehicle Speed

1. Press the CRUISE button. The CRUISE MAIN indicator appears.
2. Accelerate to the desired speed (above 25 mph/40 km/h). Take your foot off the pedal and press the -/SET button to set the speed. The CRUISE CONTROL indicator appears.

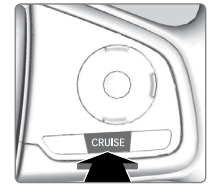

### ■ Adjusting the Vehicle Speed

Press the RES/+ button to increase speed, or the -/SET button to decrease speed.

Each time you press the button, the vehicle speed is increased or decreased by about 1 mph (1.6 km/h). If you keep the button pressed, the vehicle speed increases or decreases until you release it.

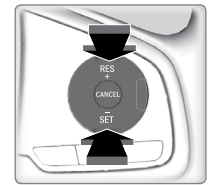

### ■ Canceling Cruise Control

Press the CRUISE or CANCEL button, or the brake pedal. The CRUISE CONTROL indicator goes off.

After cruise control has been canceled, you can still resume the prior set speed by pressing RES/+ while driving at a speed of at least 25 mph (40 km/h).

Press the CRUISE button to turn the system off.

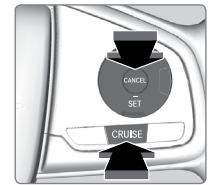

## ⚠ WARNING

Improper use of cruise control can lead to a crash.

Use cruise control only when traveling on open highways in good weather.

\*if equipped

## Adaptive Cruise Control (ACC) with Low Speed Follow (LSF)\*

Helps maintain a constant vehicle speed and a set following interval behind a vehicle detected ahead of yours.

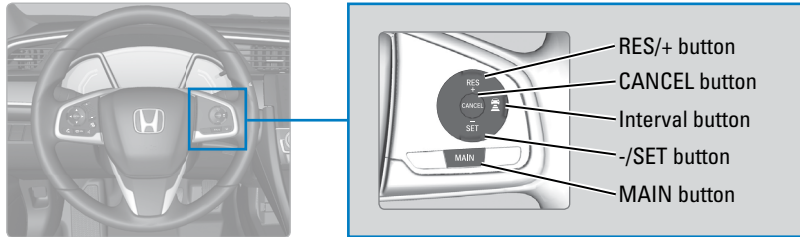

### ■ Activating and Setting the Vehicle Speed

1. Press the MAIN button. The ACC indicator appears.
2. Accelerate to the desired speed.

*Above 25 mph (40 km/h):* Take your foot off the pedal and press the -/SET button to set the speed.

*Below 25 mph (40 km/h) (Low Speed Follow):* Press the -/SET button to set the speed at 25 mph (40 km/h) if a vehicle is detected in front of you.



### ■ Adjusting the Vehicle Speed

Press the RES/+ button to increase speed, or the -/SET button to decrease speed.

Each time you press the switch up or down, the vehicle speed is increased or decreased by about 1 mph or 1 km/h. If you keep the switch pressed up or down, the vehicle speed increases or decreases by 5 mph or 5 km/h until you release it.

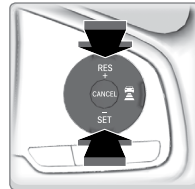

### ■ Adjusting the Following Interval

Press the Interval button to change the following interval. Each time you press the button, the following-interval setting cycles through short, middle, long, and extra long.



### ■ Switching to Standard Cruise Control

Press and hold the Interval button.

Cruise mode appears in the Driver Information Interface. Press and hold the button again to switch back to ACC.

\*if equipped

### ■ When in Operation

If a vehicle is detected ahead of you when ACC is turned on, the system maintains, accelerates, or decelerates your vehicle's set speed to keep the vehicle's set following interval from the vehicle ahead.

If a vehicle detected ahead of you slows down abruptly, or if another vehicle cuts in front of you, a beep sounds and BRAKE appears on the Driver Information Interface to alert you.

When a vehicle detected ahead is within range and slows to a stop, your vehicle also stops. The Stopped message appears on the Driver Information Interface.

When the vehicle ahead of you starts again, the vehicle icon on the Driver Information Interface blinks. Press the RES/+ button or the -/SET button, or press the accelerator pedal to resume the prior set speed.

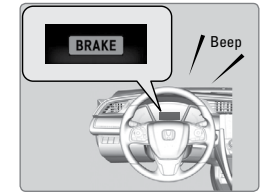

### ■ Canceling ACC

Press the CANCEL or MAIN button, or depress the brake pedal. The ACC indicator goes off.

Certain conditions may cause ACC to cancel automatically. When this happens, a message appears on Driver Information Interface.

After adaptive cruise control has been canceled, you can still resume the prior set speed by pressing the RES/+ button.

Press the MAIN button to turn the system off.

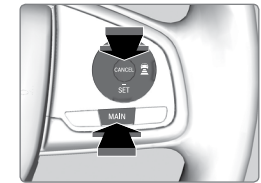

### ⚠ WARNING

Exiting a vehicle that has been stopped while the ACC with LSF system is operating can result in the vehicle moving without operator control.

A vehicle that moves without operator control can cause a crash, resulting in serious injury or death.

Never exit a vehicle when the vehicle is stopped by ACC with LSF.

### ⚠ WARNING

ACC with LSF has limited braking capability and may not stop your vehicle in time to avoid a collision with a vehicle that quickly stops in front of you.

Always be prepared to apply the brake pedal when conditions require.

### ⚠ WARNING

Improper use of ACC with LSF can lead to a crash.

Use ACC with LSF only when driving on expressways or freeways and in good weather conditions.



## Lane Keeping Assist System (LKAS)\*

Provides steering input to help keep the vehicle in the middle of a detected lane while driving between 45–90 mph (72–145 km/h).

If your vehicle is getting too close to detected left or right side lane markings without a turn signal activated, a message appears on the Driver Information Interface, and the steering wheel vibrates. Steering torque is also applied to help keep your vehicle within your driving lane.

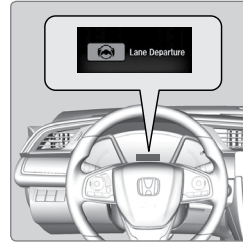

### Turning the System On or Off

1. Press the MAIN button. LKAS appears in the Driver Information Interface.

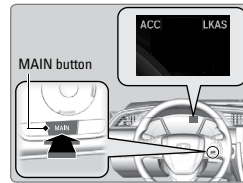

2. Press the LKAS button. Lane outlines appear in the Driver Information Interface. Dotted lane lines turn solid when the system starts operating.

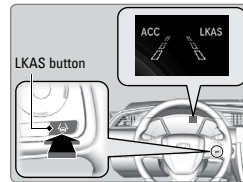

3. Press the MAIN button or the LKAS button to turn the system off.

### Important Safety Reminder

LKAS is for your convenience only. It is not a substitute for your vehicle control. The system does not work if you take your hands off the steering wheel or fail to steer the vehicle.

Do not place an object on the top of the instrument panel. It may reflect onto the windshield and prevent the system from detecting lane lines properly.

\*if equipped

## Road Departure Mitigation (RDM)\*

Alerts and helps to assist you if the system determines a possibility of your vehicle unintentionally crossing over detected lane markings and/or leaving the roadway altogether while driving between 45–90 mph (72–145 km/h).

If your vehicle is getting too close to detected lane markings without a turn signal activated, a message appears in the Driver Information Interface. Steering wheel torque and vibrations are applied to help your vehicle stay in the lane.

Braking may also be applied if the lane lines are solid and continuous.

If the system operates several times without detecting driver response, the system beeps to alert you.



### Turning the System On or Off

Press the RDM button to turn the system on or off. A green indicator appears on the button when the system is on.

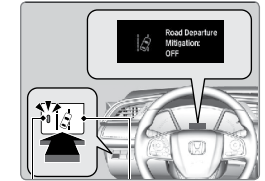

### Changing Settings

Determine the warning type.

1. From the HOME screen, select Settings.
2. Select Vehicle. The vehicle must be in Park (P).
3. Select Driver Assist System Setup.
4. Select Road Departure Mitigation Setting.
5. Select from the options.



*Normal (default):* Steering control starts from inside the lane edge.

*Wide:* Steering control starts from outside the lane edge.

*Warning Only:* The system provides only a BRAKE message and steering wheel vibrations, but does not apply steering torque or braking.

6. Press BACK to exit the menu.

### Important Safety Reminder

The RDM system has limitations. Over-reliance on it may result in a collision. It is always your responsibility to keep your vehicle within the driving lane.

\*if equipped

## Collision Mitigation Braking System™ (CMBS™)\*

Can assist you when there is a possibility of your vehicle colliding with a vehicle or a pedestrian detected in front of your vehicle.

The system can give you visual, audible, and tactile alerts when a potential collision is determined, and reduce your vehicle speed to help minimize collision severity when a collision is deemed unavoidable.

When a potential collision with a detected oncoming vehicle is determined, the system also alerts you with rapid vibrations on the steering wheel.

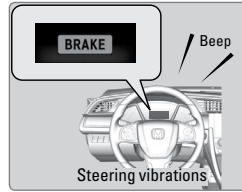

The system activates when:

- The speed difference between your vehicle and a vehicle or pedestrian detected in front of you is about 3 mph (5 km/h) and over with a chance of a collision.
- Your vehicle speed is about 62 mph (100 km/h) or less and there is a chance of a collision with an oncoming detected vehicle or a pedestrian in front of you.

### ■ Alert Stages

The system has three alert stages for a possible collision. Depending on the circumstances or CMBS settings, CMBS may not go through all of the stages before initiating the last stage.

**Stage 1:** Visual and audible warning, steering wheel vibrations

**Stage 2:** Visual and audible warning and light brake application

**Stage 3:** Visual and audible warning and strong brake application

### ■ Changing Settings

Determine the warning timing.

1. From the HOME screen, select Settings.
2. Select Vehicle. The vehicle must be in Park (P).
3. Select Driver Assist System Setup.
4. Select Forward Collision Warning Distance.
5. Select Long, Normal, or Short.
6. Press BACK to exit the menu.

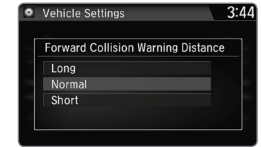

### ■ Turning CMBS On or Off

Press and hold the CMBS OFF button. A beep sounds and a message appears in the MID. The CMBS indicator appears when the system is off. CMBS retains its on/off state across ignition cycles.

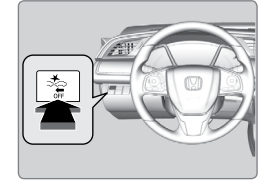

### Important Safety Reminder

CMBS is designed to reduce the severity of an unavoidable collision. It does not prevent collisions and may not completely stop the vehicle automatically. It is still your responsibility to operate the brake pedal and steering wheel appropriately according to the driving conditions.

*\*if equipped*

## LaneWatch™\*

Check the passenger-side rear areas in the audio/information screen when the right turn signal is activated.

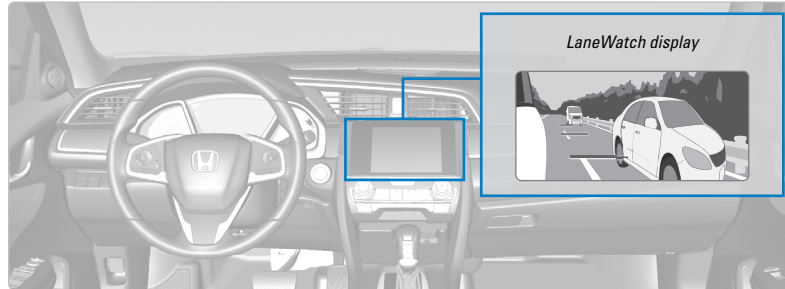

### ■ Activating LaneWatch

Activate the right turn signal. The LaneWatch display appears. Check the display for blind spots, and visually confirm that it is safe to change lanes.

You can also press the LaneWatch button on the end of the turn signal switch to view a constant real-time display. Press it again to turn the display off.

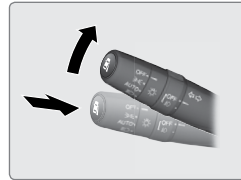

### ■ Changing Settings

Customize the display and how and when the display appears.

1. From the Home screen, select Settings.
2. Select Camera.
3. Select LaneWatch.
4. Select an option and make the preferred changes.
5. Press BACK to exit the menu.

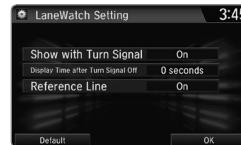

### Important Safety Reminder

LaneWatch has limitations. Over-reliance on the system may result in a collision.

## ⚠ WARNING

Failure to visually confirm that it is safe to change lanes before doing so may result in a crash and serious injury or death.

Do not rely only on LaneWatch while driving. Always look in your mirrors, to either side of your vehicle, and behind you for other vehicles before changing lanes.

\*if equipped

## Multi-View Rear Camera

When you shift into Reverse (R), a real-time image of the area behind your vehicle is shown in the display, along with helpful parking guidelines.

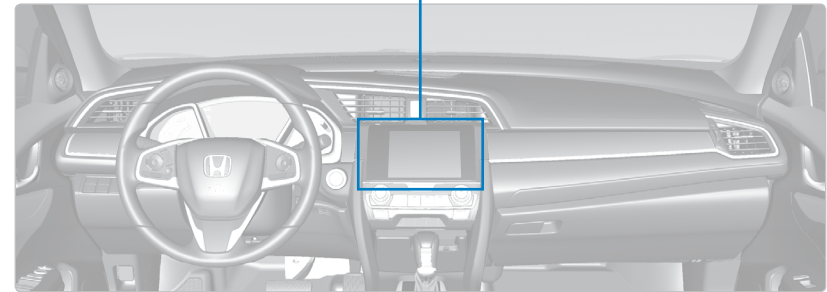
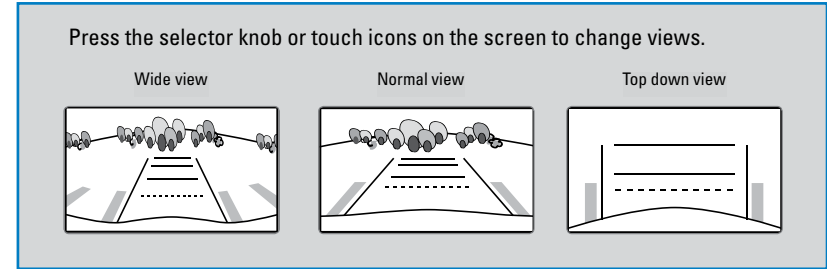

*The rear camera view is restricted. You cannot see the corner ends of the bumper or what is underneath the bumper. Its unique lens also makes objects appear closer or farther than they actually are.*

*Visually confirm that it is safe to drive before backing up. Certain conditions (such as weather, lighting, and high temperatures) may also restrict the rear view. Do not rely on the rearview display, which does not give you all the information about conditions at the rear of your vehicle.*

## ■ Changing Camera Settings

Turn the guidelines on or off.

### Models with color audio system

1. Press the MENU/CLOCK button.
2. Select Settings.
3. Select Rear Camera.
4. Select Camera Guideline.
5. Select On or Off.
6. Press the Back button to exit the menu.

### Models with Display Audio

1. From the Home screen, select Settings.
2. Select Camera.
3. Select Rear Camera.
4. Select an option:
  - Fixed Guideline:* Guidelines appear when you shift into Reverse.
  - Dynamic Guideline:* Guidelines move as you turn the steering wheel.
5. Select On or Off.
6. Press BACK to exit the menu.

## Refueling

Use the proper fuel and refueling procedure to ensure the best performance and safety of your vehicle.

### ■ Fuel Information

- Honda recommends TOP TIER Detergent Gasoline where available.
- Do NOT use gasoline containing more than 15% ethanol.
- Do NOT use gasoline containing methanol.
- Do NOT use gasoline containing MMT.

#### Models with SPORT mode

**Use of unleaded gasoline of 91 octane or higher is recommended.**

#### Models without SPORT mode

**Use of unleaded gasoline of 87 octane or higher is recommended.**

### NOTICE

We recommend quality gasoline containing detergent additives that help prevent fuel system and engine deposits. In addition, in order to maintain good performance, fuel economy, and emissions control, we strongly recommend the use of gasoline that does NOT contain harmful manganese-based fuel additives such as MMT, if such gasoline is available.

### ■ How to Refuel

Your fuel tank features a capless design. You can insert the filler nozzle directly into the filler pipe. The tank seals itself when you pull out the filler nozzle.

1. The fuel fill door is located at the left rear of the vehicle. Park next to the service pump that is most accessible.
2. Turn off the engine.
3. Press the area indicated by the arrow in the image to open the fuel fill door. The vehicle must be unlocked.
4. Insert the filler nozzle fully. When the tank is full, the nozzle clicks off automatically. Wait about 5 seconds before removing the filler nozzle.
5. Close the fuel fill door.

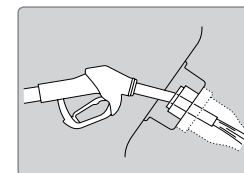
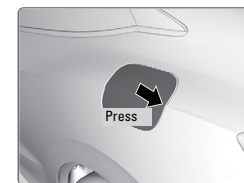

**WARNING**

Gasoline is highly flammable and explosive. You can be burned or seriously injured when handling fuel.

- Stop the engine, and keep heat, sparks, and flame away.
- Handle fuel only outdoors.
- Wipe up spills immediately.

**Refueling from a Portable Fuel Container**

If you need to refuel your vehicle from a portable fuel container, use the funnel provided with your vehicle.

1. Turn off the engine.
2. Press on the edge of the fuel fill door to open it. The vehicle must be unlocked.
3. Take the funnel out of the tool case in the trunk.
4. Place the end of the funnel on the lower part of filler opening, then insert it slowly and fully. Make sure that the end of the funnel goes down along with the filler pipe.
5. Fill the tank with fuel from the portable fuel container. Pour fuel carefully so you do not spill any.
6. Remove the funnel from the filler neck. Wipe up any fuel from the funnel before storing it.
7. Close the fuel fill door.

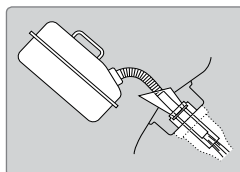
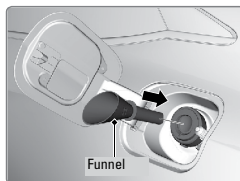
**NOTICE**

Do not insert the nozzle of a portable fuel container or any funnel other than the one provided with your vehicle. Doing so can damage the fuel system.

Do not try to pry open or push open the sealed fuel tank with foreign objects. This can damage the fuel system and its seal.

**Turbocharger\* Precautions**

The engine uses an exhaust-driven turbocharger to generate extra power. The turbocharger is a precision device that can spin at over 100,000 rpm and reach temperatures over 1,292F (700C). It is lubricated and cooled by engine oil. Be sure to follow these precautions to help prevent turbocharger damage.

- Always change the engine oil according to the Maintenance Minder.
- Always allow the engine to warm before revving it or accelerating in a spirited way.

*\*if equipped*

**HANDLING THE UNEXPECTED**

Learn about what to do in critical or emergency situations.

**Smart Entry Remote Battery Strength\***

If the battery life in your remote transmitter is weak, a message appears in the display with information on how to start the engine.

1. Touch the back of the remote transmitter to the ENGINE START/STOP button while the indicator is flashing.
2. With the brake pedal or clutch pedal pressed, press the ENGINE START/STOP button within 10 seconds.

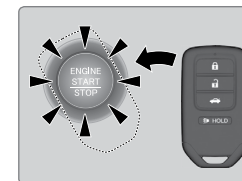
**Shift Lever Does Not Move\***

**Models with continuously variable transmission**

Follow the procedure below if you cannot move the shift lever out of Park (P).

1. Set the parking brake.
2. Remove the key from the ignition or remove the built-in key from the remote transmitter.
3. Move the removable beverage holder tray rearward. Remove the cover by pulling it with your fingers.
4. Wrap a cloth around the tip of a small flat-tip screwdriver to remove the cover of the shift lock release slot. Put the tip of the flat-tip screwdriver into the slot and remove it (see image).
5. Insert the key into the shift lock release slot.
6. While pushing the key in, press the shift lever release button and place the shift lever into Neutral (N). The lock is now released. Have the shift lever checked by a dealer as soon as possible.

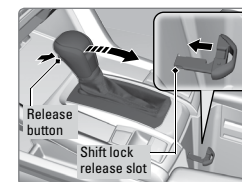
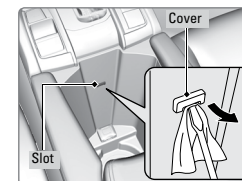

## Jump Starting

Turn off the power to electric devices, such as audio and lights. Turn off the engine, then open the hood.

1. Connect the first jumper cable to your vehicle's battery (+) terminal.
2. Connect the other end of the first jumper cable to the booster battery (+) terminal. Use a 12-volt booster battery only.
3. Connect the second jumper cable to the booster battery (-) terminal.
4. Connect the other end of the second jumper cable to the engine mounting bolt as shown. Do not connect this jumper cable to any other part.
5. If your vehicle is connected to another vehicle, start the assisting vehicle's engine and increase its rpm slightly.
6. *Canadian models only:* Before attempting to start your vehicle, the immobilizer system must be reset. To do this, press and hold the brake pedal firmly before turning the vehicle on.
7. Attempt to start your vehicle's engine. If it turns over slowly, make sure that the jumper cables have good metal-to-metal contact.

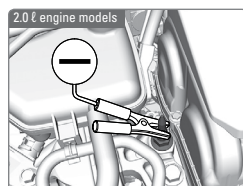
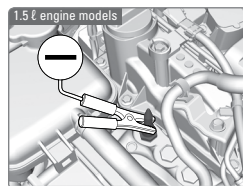
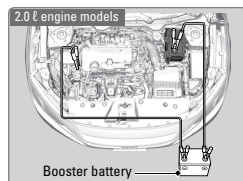
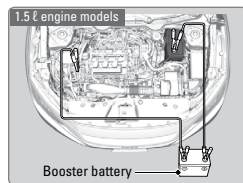

**WARNING:** Battery posts, terminals, and related accessories contain lead and lead compounds. **Wash your hands after handling.**

### ⚠ WARNING

A battery can explode if you do not follow the correct procedure, seriously injuring anyone nearby.

Keep all sparks, open flames, and smoking materials away from the battery.

## After the Engine Starts

Once your vehicle's engine has started, remove the jumper cables in the following order:

1. Disconnect the jumper cable from your vehicle's ground (engine mounting bolt).
2. Disconnect the other end of the jumper cable from the booster battery (-) terminal.
3. Disconnect the jumper cable from the booster battery (+) terminal.
4. Disconnect the other end of the jumper cable from your vehicle's (+) terminal.
5. Have your vehicle inspected by a nearby service station or a dealer.

If your vehicle's battery is disconnected or goes dead:

- Some systems are temporarily deactivated. Drive a short distance at 12 mph (20 km/h) or more, and the indicator(s) should go off.
- The immobilizer system needs to be reset (see page 26).\*

## Manually Opening the Trunk

Use the trunk release lever when other methods of opening the trunk do not work.

1. Remove the cover using a key wrapped within a cloth (to prevent scratches).
2. Pull the release lever.

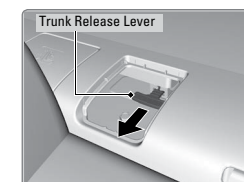

\*Canadian models only

## Overheating

If the temperature gauge pointer is at the H mark, the engine suddenly loses power, or steam or spray comes out from under the hood, your engine is overheating.

1. Immediately park the vehicle in a safe place. Turn off all accessories and turn on the hazard warning lights.
2. *If steam or spray is not present:* Keep the engine running and open the hood.  
*If steam or spray is present:* Turn off the engine and wait until it subsides. Then, open the hood.
3. Check that the cooling fan is operating and stop the engine once the temperature gauge needle comes down. If the cooling fan is not operating, immediately stop the engine.
4. Once the engine has cooled down, inspect the coolant level and check the cooling system components for leaks. If the coolant level in the reserve tank is low, or no coolant is in the tank, check that the radiator is cool. Cover the reserve tank cap with a heavy cloth and open the cap. Add coolant until it reaches the MAX mark and put the cap back on.

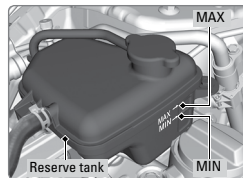

Once the engine has cooled sufficiently, restart it and check the temperature gauge. If the temperature gauge pointer has gone down, resume driving. If it has not gone down, contact a dealer for repairs.

### ⚠ WARNING

Steam and spray from an overheated engine can seriously scald you.  
Do not open the hood if steam is coming out.

### ⚠ WARNING

Removing the reserve tank cap while the engine is hot can cause the coolant to spray out, seriously scalding you.  
Always let the engine and radiator cool down before removing the reserve tank cap.

### NOTICE

Continuing to drive with the temperature gauge pointer at the H mark may damage the engine.

## Emergency Engine Stop\*

The ENGINE START/STOP button may be used to stop the engine due to an emergency situation even while driving. If you must stop the engine, choose one of the following operations:

- Press and hold the ENGINE START/STOP button for two seconds, or
- Firmly press the ENGINE START/STOP button two times (U.S. models) or three times (Canadian models).
- The steering wheel will not lock. The power mode changes to ACCESSORY, unless the shift lever is in Park (P), in which case the power mode changes to VEHICLE OFF. Because turning off the engine also disables the power assist the engine provides to the steering and braking systems, it will require significantly more physical effort and time to steer and slow the vehicle. Downshift gears and use both feet on the brake pedal, if necessary, to slow the vehicle and stop immediately in a safe place.



### NOTICE

Do not press the button while driving unless it is absolutely necessary for the engine to be switched off.

## Emergency Towing

Call a professional towing service if you need to tow your vehicle.

Flat bed equipment: The operator loads your vehicle on the back of a truck. **This is the best way to transport your vehicle.**

Wheel lift equipment: The tow truck uses two pivoting arms that go under the front tires and lift them off the ground. The rear tires remain on the ground. **This is an acceptable way to tow your vehicle.**

For CVT models: If you cannot shift the transmission or turn on the engine, your vehicle must be transported with the front wheels off the ground. Make sure the parking brake is released. If you cannot release the parking brake, your vehicle must be transported by flat bed equipment.

### NOTICE

Trying to lift or tow your vehicle by the bumpers will cause serious damage. The bumpers are not designed to support the vehicle's weight.

Improper towing such as towing behind a motorhome or other motor vehicle can damage the transmission.

\*if equipped

## Tire Pressure Monitoring System (TPMS)

Monitors the tire pressure while you are driving. If your vehicle's tire pressure becomes significantly low, the low tire pressure indicator comes on and a message appears on the display. **Available on U.S. models only.**

### What to Do

Stop your vehicle in a safe place. Check the tire pressure and adjust the pressure to the specified level on the label on the driver's doorjamb.



### TPMS Calibration

Any time you inflate, change, or rotate one or more of the tires, you need to recalibrate the system.

The calibration process requires approximately 30 minutes of cumulative driving at speeds between 30–65 mph (48–105 km/h). The vehicle must be stopped to begin calibration and the process finishes automatically.

#### Models with TPMS button

Press and hold the TPMS button until the low tire pressure indicator blinks twice, indicating the calibration process has begun.

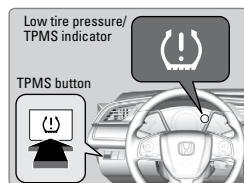

#### Models with color audio system and Driver Information Interface

Use the steering wheel buttons to make and enter selections in the Driver Information Interface (see page 28).

1. Scroll to the Vehicle Settings screen and select it.
2. Select TPMS Calibration.
3. Select Calibrate.

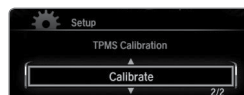

#### Models with Display Audio

Touch items on the screen to make and enter selections.

1. From the HOME screen, select Settings.
2. Select Vehicle.
3. Select TPMS Calibration.
4. Select Calibrate.



### NOTICE

Driving on an extremely underinflated tire can cause it to overheat. An overheated tire can fail. Always inflate your tires to the specified pressure.

### Tire Pressure Monitoring System (TPMS) - Required Federal Explanation

Each tire, including the spare (if provided), should be checked monthly when cold and inflated to the inflation pressure recommended by the vehicle manufacturer on the vehicle placard or tire inflation pressure label.

(If your vehicle has tires of a different size than the size indicated on the vehicle placard or tire inflation pressure label, you should determine the proper tire inflation pressure for those tires.)

As an added safety feature, your vehicle has been equipped with a tire pressure monitoring system (TPMS) that illuminates a low tire pressure telltale when one or more of your tires is significantly underinflated.



Accordingly, when the low tire pressure telltale illuminates, you should stop and check your tires as soon as possible, and inflate them to the proper pressure.

Driving on a significantly underinflated tire causes the tire to overheat and can lead to tire failure. Underinflation also reduces fuel efficiency and tire tread life, and may affect the vehicle's handling and stopping ability.

Please note that the TPMS is not a substitute for proper tire maintenance, and it is the driver's responsibility to maintain correct tire pressure, even if underinflation has not reached the level to trigger illumination of the TPMS low tire pressure telltale.

Your vehicle has also been equipped with a TPMS malfunction indicator to indicate when the system is not operating properly. The TPMS malfunction indicator is combined with the low tire pressure telltale. When the system detects a malfunction, the telltale will flash for approximately one minute and then remain continuously illuminated. This sequence will continue upon subsequent vehicle start-ups as long as the malfunction exists.

When the malfunction indicator is illuminated, the system may not be able to detect or signal low tire pressure as intended.

TPMS malfunctions may occur for a variety of reasons, including the installation of replacement or alternate tires or wheels on the vehicle that prevent the TPMS from functioning properly.

Always check the TPMS malfunction telltale after replacing one or more tires or wheels on your vehicle to ensure that the replacement or alternate tires and wheels allow the TPMS to continue to function properly.



## If You Get a Flat Tire

If a tire goes flat while driving, grasp the steering wheel firmly and brake gradually to reduce speed. Stop in a safe place. Replace the flat tire with the compact spare tire\* in the trunk or repair the flat tire using the tire repair kit\*. Go to a dealer as soon as possible to have the full-size tire repaired or replaced.

### Models with a temporary-use spare tire

#### ■ Getting Ready to Change the Tire

Park the vehicle on a firm, level, non-slippery surface. Apply the parking brake, shift to Park (P), and turn the vehicle off. Turn on the hazard warning lights.

1. Open the trunk floor lid.

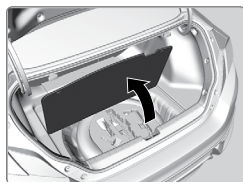

2. Take the tool case out of the trunk. Take the jack and wheel nut wrench out of the tool case.

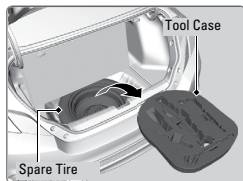

3. Unscrew the wing bolt, then remove the spacer cone. Remove the spare tire.

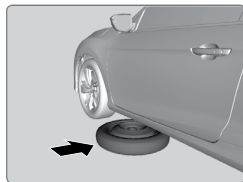

4. Place the compact spare tire (wheel side up) under the vehicle body, near the tire that needs to be replaced.

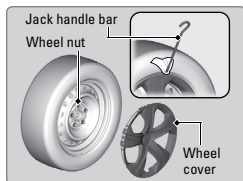

5. If necessary, put the flat tip of the jack handle bar into the edge of the wheel cover. Carefully pry the edge and remove the cover.



6. Loosen each wheel nut about one turn using the wheel nut wrench.

#### ■ Setting Up the Jack

1. Place the jack under the jacking point closest to the tire to be changed.

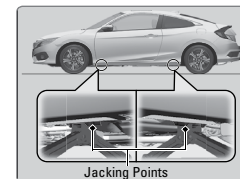

2. Turn the end bracket clockwise (as shown in the image) until the top of the jack contacts the jacking point. Make sure that the jacking point tab is resting in the jack notch.

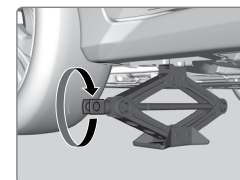

3. Raise the vehicle, using the jack handle and the jack handle, until the tire is off the ground.

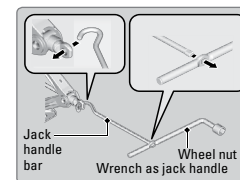

### ⚠ WARNING

The vehicle can easily roll off the jack, seriously injuring anyone underneath. Follow the directions for changing a tire exactly and never get under the vehicle when it is supported only by the jack.

The following instructions must be followed to use the jack safely:

- Do not use the jack with people or luggage in the vehicle.
- Use the jack provided in your vehicle. Other jacks may not support the weight ("load") or fit the jacking point.
- Do not use while the engine is running.
- Use only where the ground is firm and level.
- Use only at the jacking points.
- Do not get in the vehicle while using the jack.
- Do not put anything on top of or underneath the jack.

## ■ Replacing the Flat Tire

1. Remove the wheel nuts and flat tire.
2. Mount the compact spare tire. Replace the wheel nuts and lightly tighten them.
3. Lower the vehicle and remove the jack. Tighten the wheel nuts in the order indicated in the image. Go around, tightening the nuts, two to three times in this order. Do not overtighten the wheel nuts.

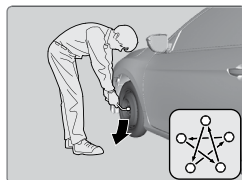
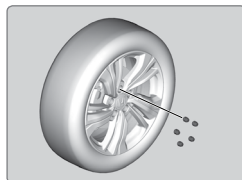

**Models with wheel covers:** Make sure the wire support ring is hooked into the clips around the edge of the wheel cover.

Align the valve mark on the wheel cover to the tire valve on the wheel, then install the wheel cover.

If you drive with the spare tire installed, the low tire pressure/TPMS indicator appears. The indicator stays on until a regular tire is installed.

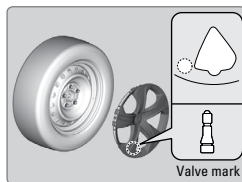
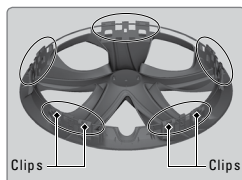

### NOTICE

Do not mount the compact spare on the front. If mounted on the front, the compact spare, smaller in size than the normal tire, may damage the differential. If either front tire goes flat, remove the rear tire on the same side, and mount the compact spare on the rear and the rear tire on the front.

## ■ Storing the Flat Tire

1. Remove the center cap, if necessary.
2. Open the trunk. Place the flat tire face down in the spare tire well.
3. Remove the spacer cone from the wing bolt, flip it over, and insert it back on the bolt. Secure the flat tire with the wing bolt.
4. **Models with wheel covers:** Make sure the wire support ring is hooked into the clips around the edge of the wheel cover.
5. Securely put the jack and wheel nut wrench back in the tool case. Store the case in the trunk.

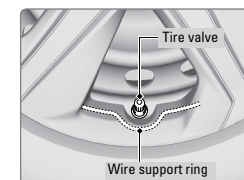
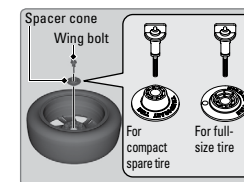

### ⚠ WARNING

Loose items can fly around the interior in a crash and can seriously injure the occupants.

Store the wheel, jack, and tools securely before driving.

## Models with a tire repair kit

If a tire has a small puncture, you can use the tire repair kit to temporarily repair it. The puncture must be smaller than 3/16-inch (4 mm) and not in the tire sidewall. Go to a dealer to have the full-size tire permanently repaired or replaced.

### Before Repairing the Tire

1. Park the vehicle on a firm, level, and non-slippery surface.
2. Make sure the vehicle is in Park (P) and apply the parking brake.
3. Turn on the hazard warning lights and turn the vehicle off.

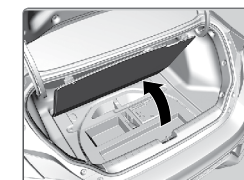

### Getting Ready to Repair the Tire

1. Open the trunk floor lid.
2. Remove the kit.
3. Place the kit face up on flat ground near the punctured tire and away from traffic. Do not place the kit on its side.
4. Follow the instructions in the kit to repair the tire.

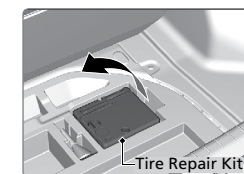

## Fuse Locations

If any electrical devices are not working, turn the vehicle off and check to see if any applicable fuse is blown. Fuse locations are shown on the fuse box cover. Locate the fuse in question by the fuse number and box cover number.

### ■ Engine Compartment Fuse Box

Located under the hood near the battery. Push the tabs to open the box.

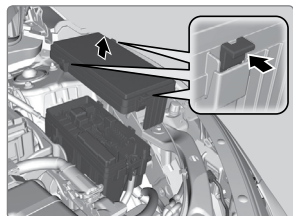

	Circuit Protected	Amps
1	— <sup>*2</sup>	(60 A)
	Adaptive Damper System <sup>*3</sup>	60 A
	Cooling Fan <sup>*4</sup>	(30 A)
	Cooling Fan <sup>*5</sup>	(50 A)
	—	—
2	IG Main <sup>*6</sup>	30 A
	— <sup>*7</sup>	—
	Headlight High Beam Main	30 A
	Battery	125 A
	EPS	70 A
3	IG Main	30 A <sup>*6</sup>
	—	50 A <sup>*7</sup>
	Fuse Box Option <sup>*</sup>	(40 A)
	Fuse Box	60 A
	Front Wiper Motor	30 A
4	Headlight Low Beam Main	30 A
	Rear Defroster	40 A
	Starter Motor <sup>*6</sup>	30 A
	— <sup>*7</sup>	—
	Fuse Box	40 A
5	ABS/VSA Motor	40 A
	ABS/VSA FSR	40 A
	Blower Motor	40 A
	—	—
	—	—

	Circuit Protected	Amps
5	Cooling Fan	5 A
6	Washer	15 A
7	FI Main	15 A
8	FI Sub	15 A
9	Stop Lights	10 A
10	Injector <sup>*5</sup>	(15 A)
11	LAF	5 A
12	FI ECU	10 A
13	Parking Lights	10 A
14	Hazard	15 A
15	IG Coil	15 A
16	Transmission <sup>*8</sup>	(15 A)
17	Daytime Running Lights	10 A
18	Back Up	10 A
19	Audio	15 A
20	Audio AMP <sup>*</sup>	(30 A)
21	Interior Lights	10 A
22	Front Fog Lights <sup>*</sup>	(15 A)
23	A/C Compressor	(10 A)
24	Horn	10 A
25	Left Headlight Low Beam	10 A
26	Right Headlight Low Beam	10 A
27	VB ACT <sup>*5</sup>	(10 A)
28	Left Headlight High Beam	10 A
29	Right Headlight High Beam	10 A
30	—	—
31	—	(15 A)
32	—	(20 A) <sup>*2</sup>
33	— <sup>*2</sup>	(20 A)
34	Adaptive Damper System <sup>*3</sup>	15 A
35	—	—
36	—	—

\*1: Models with the smart entry system have an **ENGINE START/STOP** button instead of an ignition switch.

\*2: Models without SPORT mode

\*3: Models with SPORT mode

\*4: 2.0L engine models

\*5: 1.5L engine models

\*6: Models with smart entry system

\*7: Models without smart entry system

\*8: Continuously variable transmission models

*\*if equipped*

### ■ Interior Fuse Box

Located under the dashboard on the driver's side.

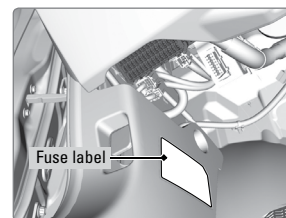

	Circuit Protected	Amps
1	Accessory	10 A
2	— <sup>*1</sup>	—
3	Key Lock <sup>*2</sup>	(5 A)
4	—	—
5	Front Sensor Camera <sup>*1, *3</sup>	(5 A)
6	Transmission <sup>*2, *4</sup>	(10 A)
7	Option	10 A
8	SRS Indicator	10 A
9	Meter	10 A
10	Fuel Pump	15 A

	Circuit Protected	Amps
9	AIRCON	10 A
10	—	—
11	Engine Control	5 A
12	Passenger Side Door Lock	10 A
13	—	(10 A)
14	—	(20 A)
15	Passenger's Side Power Window	20 A
16	Door Lock	20 A
17	Transmission <sup>*1, *4</sup>	(10 A)
18	Front Sensor Camera <sup>*2, *3</sup>	(5 A)
19	—	—
20	Moonroof <sup>*</sup>	(20 A)
21	—	—
22	ACG	10 A
23	Daytime Running Lights	10 A
24	—	—
25	Front Sensor Camera <sup>*</sup>	(5 A)
26	Driver's Door Lock	10 A
27	Passenger Side Door Unlock	10 A
28	—	(20 A)
29	Driver's Power Window	20 A
30	Front Accessory Power Socket	20 A
31	Smart Entry <sup>*1</sup>	10 A
32	— <sup>*2</sup>	—
33	—	(20 A)
34	Front Seat Heater <sup>*</sup>	(20 A)
35	—	(20 A)
36	VSA/ABS	10 A
37	SRS	10 A
38	—	—
39	—	—
40	Driver's Door Unlock	(10 A)
41	—	10 A

\*1: Models with smart entry system

\*2: Models without smart entry system

\*3: Models with CMBS™

\*4: Continuously variable transmission models

*\*if equipped*

## ■ Inspecting and Changing Fuses

1. Turn the vehicle off, including all lights and accessories.
2. Remove the fuse box cover.
3. Check the large fuse in the engine compartment.
4. If the fuse is blown, use a Phillips-head screwdriver to remove the screws and replace the fuse with a new one. Reinstall the screws.
5. Inspect the small fuses in the engine compartment and the vehicle interior.
6. If there is a burned out fuse, remove it with the fuse puller and replace it with a new one.

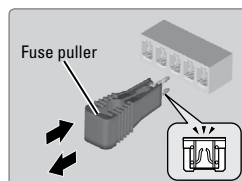
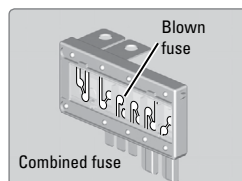

### NOTICE

Replacing a fuse with one that has a higher rating greatly increases the chances of damaging the electrical system.

## MAINTENANCE

Learn about basic maintenance that you can perform on the vehicle yourself, as well as information about how to best maintain the vehicle.

### Safety Precautions

Some of the most important safety precautions are listed below; however, we cannot warn you of every conceivable hazard that can arise in performing maintenance. Only you can decide whether or not you should perform a given task.

#### ■ Maintenance Safety

- To reduce the possibility of fire or explosion, keep cigarettes, sparks, and flames away from the battery and all fuel-related parts.
- Never leave rags, towels, or other flammable objects under the hood. Heat from the engine and exhaust can ignite them, causing a fire.
- To clean parts, use a commercially available degreaser or parts cleaner, not gasoline.
- Wear eye protection and protective clothing when working with the battery or compressed air.
- Do not run the engine in confined spaces where carbon monoxide gas can accumulate. Operate the engine only if there is sufficient ventilation.

#### ■ Vehicle Safety

- The vehicle must be stationary, and parked on level ground with the parking brake set and the engine off.
- Be aware that hot parts can burn you.
- Be aware that moving parts can injure you.

### ⚠ WARNING

Improperly maintaining this vehicle or failing to correct a problem before driving can cause a crash in which you can be seriously hurt or killed.

Always follow the inspection and maintenance recommendations according to the schedules in this guide.

### ⚠ WARNING

Failure to properly follow maintenance instructions and precautions can cause you to be seriously hurt or killed.

Always follow the procedures and precautions in this guide.

## Maintenance Minder™

Reminds you when indicated maintenance service is due.

### Models with information display

When maintenance is due, the Maintenance Minder indicator comes on and a message appears on the display every time you turn the vehicle on. Press the TRIP knob in the instrument panel to change displays (see page 28).

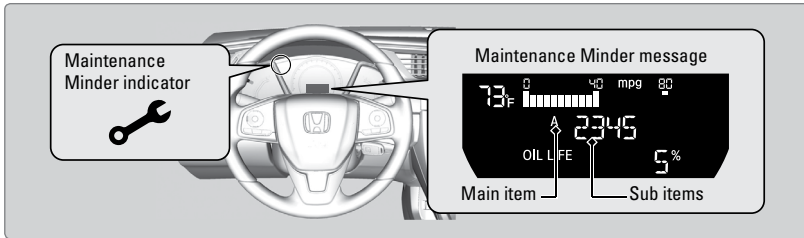

### Models with Driver Information Interface

When maintenance is due, the system message indicator comes on and a message appears on the display every time you turn the vehicle on. Press the display/information button on the steering wheel to change displays (see page 28).

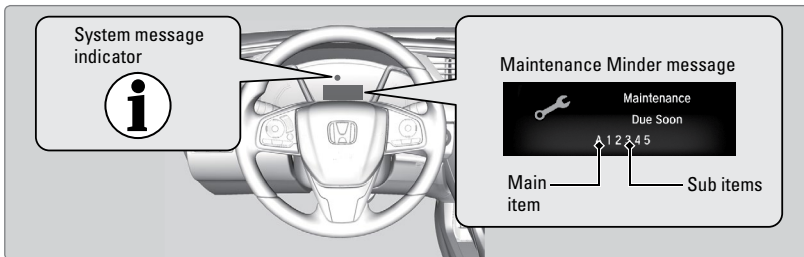

### U.S. models

**Maintenance, replacement, or repair of emissions control devices and systems may be done by any automotive repair establishment or individuals using parts that are certified to EPA standards.**

According to state and federal regulations, failure to perform maintenance on the maintenance main items marked with # will not void your emissions warranties. However, all maintenance services should be performed in accordance with the intervals indicated by the Maintenance Minder.

## Maintenance Minder Service Codes

These codes indicate what services are due on your vehicle.

### U.S. models

CODE	Maintenance Main Items
A	Replace engine oil* <sup>1</sup>
B	Replace engine oil* <sup>1</sup> and oil filter Inspect front and rear brakes Check expiration date for temporary tire repair kit bottle (if equipped) Inspect these items: <ul style="list-style-type: none"> <li>• Tie rod ends, steering gearbox, and boots</li> <li>• Suspension components</li> <li>• Driveshaft boots</li> <li>• Brake hoses and lines (including ABS/VSA)</li> <li>• All fluid levels and condition of fluids</li> <li>• Exhaust system<sup>#</sup></li> <li>• Fuel lines and connections<sup>#</sup></li> </ul>

\*1: If a Maintenance Minder message does not appear more than 12 months after the display is reset, change the engine oil every year.

#: See information on maintenance and emissions warranty.

\*2: If you drive in dusty conditions, replace the air cleaner element every 15,000 miles (24,000 km).

CODE	Maintenance Sub Items
1	Rotate tires
2	Replace air cleaner element* <sup>2</sup> Replace dust and pollen filter* <sup>3</sup> Inspect drive belt
3	Replace transmission fluid* <sup>4</sup>
4	Replace spark plugs Inspect valve clearance
5	Replace engine coolant
7	Replace brake fluid* <sup>5</sup>

\*3: If you drive primarily in urban areas that have high concentrations of soot in the air from industry and from diesel-powered vehicles, replace the dust and pollen filter every 15,000 miles (24,000 km).

\*4: Driving in mountainous areas at very low vehicle speeds results in higher transmission temperatures. This requires transmission fluid changes more frequently than recommended by the Maintenance Minder. If you regularly drive your vehicle under these conditions, have the transmission fluid changed every 25,000 miles (40,000 km).

\*5: If a Maintenance Minder message does not appear more than 36 months after the display for item 7 is reset, change the brake fluid every 3 years.

In addition:

- Inspect idle speed every 160,000 miles (256,000 km).
- Adjust the valves during services A, B, 1, 2, or 3 if they are noisy.

Canadian models

CODE	Maintenance Main Items
------	------------------------

A	Replace engine oil *1
0	Replace engine oil *1 and oil filter

CODE	Maintenance Sub Items
------	-----------------------

1	Rotate tires
2	Replace air cleaner element *2 Replace dust and pollen filter *3 Inspect drive belt
3	Replace transmission fluid *4
4	Replace spark plugs Inspect valve clearance
5	Replace engine coolant
7	Replace brake fluid *5
9	Service front and rear brakes Inspect these items: <ul style="list-style-type: none"> <li>• Tie rod ends, steering gearbox, and boots</li> <li>• Suspension components</li> <li>• Driveshaft boots</li> <li>• Brake hoses and lines (including ABS/VSA)</li> <li>• All fluid levels and condition of fluids</li> <li>• Exhaust system #</li> <li>• Fuel lines and connections #</li> </ul>

\*1: If a Maintenance Minder message does not appear more than 12 months after the display is reset, change the engine oil every year.  
 \*2: If you drive in dusty conditions, replace the air cleaner element every 24,000 km (15,000 miles).  
 \*3: If you drive primarily in urban areas that have high concentrations of soot in the air from industry and diesel-powered vehicles, replace the dust and pollen filter every 24,000 km (15,000 miles).  
 \*4: Driving in mountainous areas at very low vehicle speeds results in higher transmission temperatures. This requires transmission fluid changes more frequently than recommended by the Maintenance Minder. If you regularly drive your vehicle under these conditions, have the transmission fluid changed every 40,000 km (25,000 miles).  
 \*5: If a Maintenance Minder Indicator does not appear more than 36 months after the display for item 7 is reset, change the brake fluid every 3 years.  
 #: See information on maintenance and emissions warranty.

In addition:

- Inspect idle speed every 256,000 km (160,000 miles).
- Adjust the valves during services A, 0, 1, 2, 3, or 9 if they are noisy.

Under the Hood

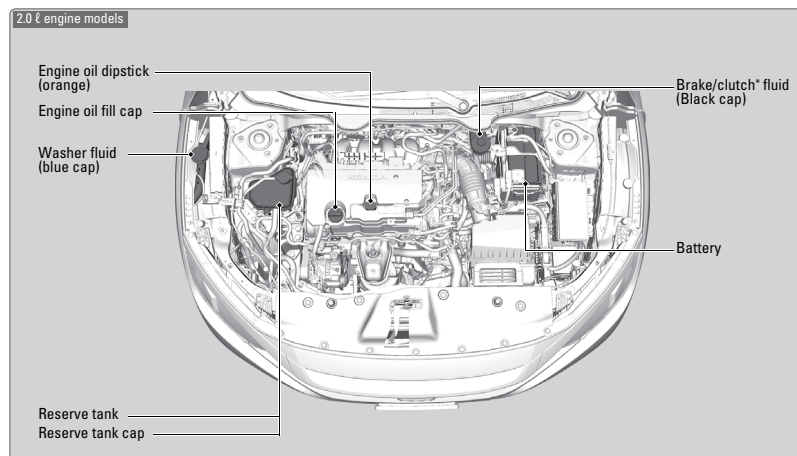
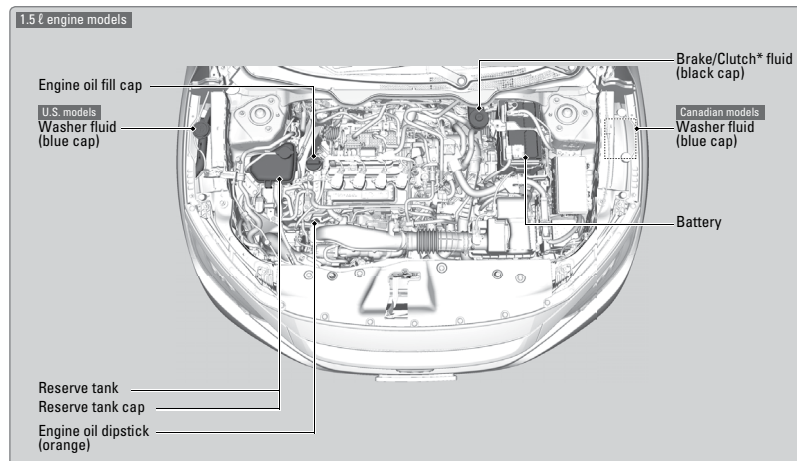

\*if equipped

■ Opening the Hood

1. Park the vehicle on a level surface and set the parking brake.
2. Pull the hood release handle under the lower left corner of the dashboard.
3. The hood latch lever is left of center. Slide the hood latch lever to the right to release the lock mechanism and open the hood.

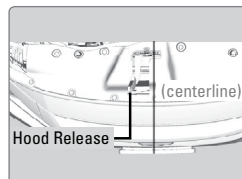
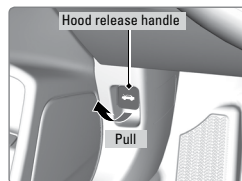

4. Remove the support rod from the clamp using the grip. Mount the support rod in the hood.

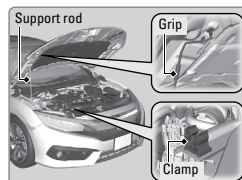

When closing, remove the support rod, and stow it in the clamp, then gently lower the hood. Remove your hand at a height of approximately 12 inches (30 cm) and let the hood close.

**NOTICE**

Do not open the hood when the wiper arms are raised. The hood will strike the wipers and may damage either the hood or the wipers.

**⚠ WARNING**

The hood support rod can become very hot due to heat from the engine. To ensure against possible burns, do not handle the metal section of the rod. Use the foam grip instead.

**Engine Oil**

Park the vehicle on level ground and wait approximately three minutes after turning the engine off before you check the oil.

■ Checking the Oil

1. Remove the dipstick (orange handle).

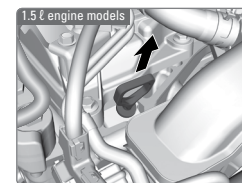

2. Wipe the dipstick with a clean cloth or paper towel.

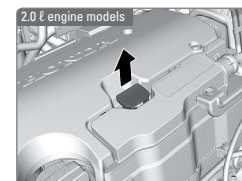

3. Insert the dipstick back all the way into its hole.

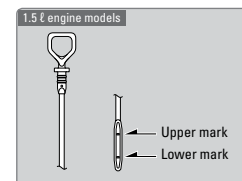

4. Remove the dipstick again and check the level. It should be between the upper and lower marks. Add oil if necessary.

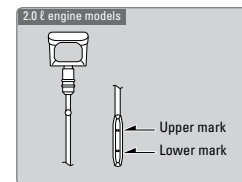

**Recommended Engine Oil**

- • **Honda Genuine Motor Oil**
- • **Premium-grade 0W-20 detergent oil with an API Certification Seal on the container**

This seal indicates the oil is energy conserving and that it meets the American Petroleum Institute's latest requirements.

Use Honda Genuine Motor Oil or another commercial engine oil of suitable viscosity for the ambient temperature as shown.

You may also use synthetic motor oil if it is labeled with the API Certification Seal and is of the specified viscosity grade.

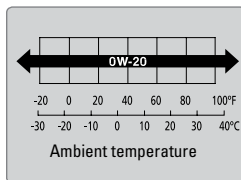

**Adding Oil**

1. Unscrew and remove the engine oil fill cap.
2. Add oil slowly.
3. Reinstall the engine oil fill cap and tighten it securely.
4. Wait for three minutes and recheck the engine oil dipstick.

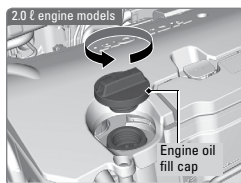
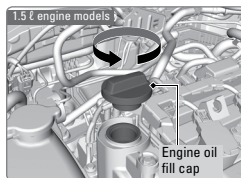

**NOTICE**

Do not fill the engine oil above the upper mark. Overfilling the engine oil can result in leaks and engine damage.

**Resetting the Engine Oil Life**

If you change or replace the vehicle's engine oil yourself, you must reset the engine oil life.

**Models with information display**

1. Press the TRIP knob in the instrument panel until the engine oil life appears in the display.
2. Press and hold the knob for 10 seconds or more, until the display begins to blink.
3. Press and hold the knob for 5 seconds or more. The engine oil life display returns to 100%.

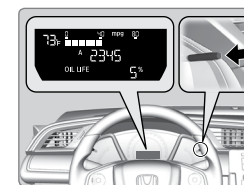

**Models with Driver Information Interface**

Use the steering wheel buttons to make and enter selections (see page 28).

1. Scroll to the Maintenance Minder screen and select it.
2. Press and hold the ENTER button for about 10 seconds to enter the reset mode.
3. Scroll to the maintenance item you want to reset (or All Due Items) and select it.

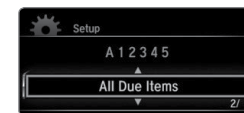

**Models with Display Audio**

Use the touchscreen to make and enter selections.

1. From the HOME screen, select Settings.
2. Select Vehicle.
3. Select Maintenance Info.
4. Select Select Reset Items.
5. Select an item on the list to reset.



**NOTICE**

Failure to reset the engine oil life after a maintenance service results in the system showing incorrect maintenance intervals, which can lead to serious mechanical problems.



## Engine Coolant

Park the vehicle on level ground. Check the reserve tank and the coolant level in the radiator. **We recommend Honda Long Life Antifreeze/Coolant Type 2.**

### ■ Checking the Coolant

1. Check the amount of coolant in the reserve tank.
2. If the coolant level is below the MIN mark, add the specified coolant until it reaches the MAX mark.
3. Inspect the cooling system for leaks.

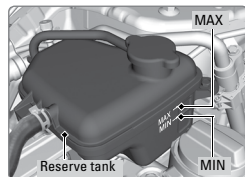

### ■ Adding Coolant

1. Make sure the engine and radiator are cool.
2. Turn the reserve tank cap counterclockwise and relieve any pressure in the coolant system. Do not push the cap down when turning.
3. Push down and turn the reserve tank cap counterclockwise to remove it.
4. Pour coolant into the reserve tank until it reaches the MAX mark.
5. Put the reserve tank cap back on and tighten it fully.

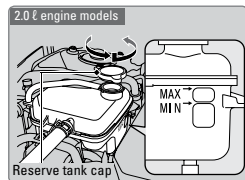
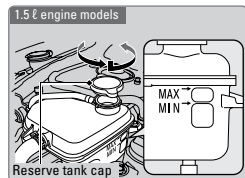

### ⚠ WARNING

Removing the radiator cap while the engine is hot can cause the coolant to spray out, seriously scalding you.

Always let the engine and radiator cool down before removing the radiator cap.

### NOTICE

If temperatures consistently below  $-31^{\circ}\text{F}$  ( $-35^{\circ}\text{C}$ ) are expected, the coolant mixture should be changed to a higher concentration. Consult a dealer for details for more information.

### NOTICE

Pour the fluid slowly and carefully so you do not spill any. Clean up any spills immediately; they can damage components in the engine compartment.

## Brake/Clutch\* Fluid

The fluid level should be between the MIN and MAX marks on the side of the reservoir. **We recommend using Honda Heavy Duty Brake Fluid DOT 3.**

Pour the fluid carefully.

If the fluid level is at or below the MIN mark, have a dealer inspect for leaks or worn brake pads as soon as possible.

The brake fluid reservoir is also used for your vehicle's clutch fluid. As long as you keep the brake fluid level as instructed above, there is no need for checking the clutch fluid level.

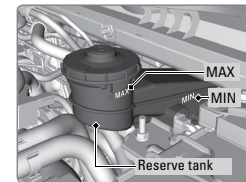

### NOTICE

Brake fluid marked DOT 5 is not compatible with your vehicle's braking system and can cause extensive damage.

## Window Washer Fluid

Check the amount of window washer fluid by looking at the reservoir. If the washer fluid level is low, fill the washer reservoir.

Pour the washer fluid carefully. Do not overflow the reservoir.

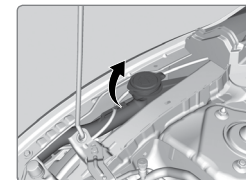

### Canadian models

If the washer fluid level is low, the washer level indicator or a message appears in the instrument panel.

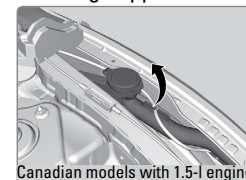

### NOTICE

Do not use engine antifreeze or a vinegar/water solution in the windshield washer reservoir. Antifreeze can damage your vehicle's paint. A vinegar/water solution can damage the windshield washer pump.

\*if equipped

## Checking the Battery

Check the battery terminals for corrosion monthly.  
For jump starting, see page 116.

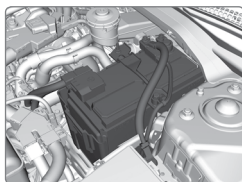

### ⚠ WARNING

The battery gives off explosive hydrogen gas during normal operation. A spark or flame can cause the battery to explode with enough force to kill or seriously hurt you. When conducting any battery maintenance, wear protective clothing and a face shield, or have a skilled technician do it.

After replacing or reconnecting the battery, keep in mind:

- Some systems are temporarily deactivated. Drive a short distance at 12 mph (20 km/h) or more and the indicator(s) should go off.
- The immobilizer system needs to be reset (see page 26).\*

### ⚠ WARNING

Battery posts, terminals, and related accessories contain lead and lead compounds. **Wash your hands after handling.**

\*Canadian models only

## Changing Wiper Blades

If the wiper blades leave streaks across the windshield, try cleaning them first with a paper towel or soft cloth and wiper fluid. If the wiper blade rubber has deteriorated, you should change the wiper blades.

1. Turn the vehicle off.
2. Hold the wiper switch in the MIST position, then turn the vehicle on. Both wiper arms lift up. Turn the vehicle off.
3. Lift both wiper arms.
4. Press and hold the tab, then slide the blade holder off the wiper arm.
5. Slide the wiper blade out from its holder by pulling the tabbed end out.
6. Slide the new wiper blade into the holder. The tab on the holder should fit in the indent of the wiper blade.
7. Slide the wiper blade holder onto the wiper arm until it locks.
8. Lower the passenger side wiper arm first, then the driver side.

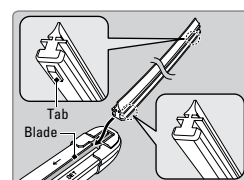
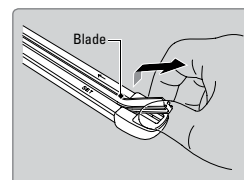
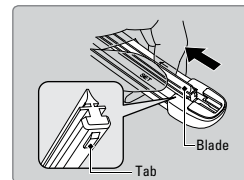
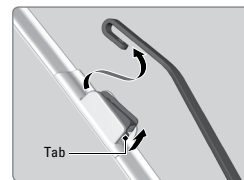
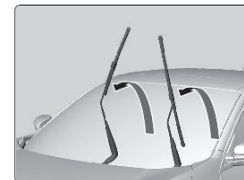
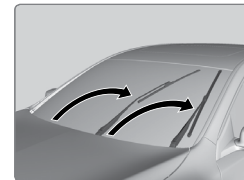

### NOTICE

Avoid dropping the wiper arm, as it may damage the windshield.

## Tire Information

To safely operate your vehicle, your tires must be of the proper type and size, in good condition with adequate tread, and properly inflated.

### Inflation Guidelines

- Properly inflated tires provide the best combination of handling, tread life, and comfort. Refer to the driver's doorjamb label or the specifications (see page 149) for the specified pressure.
- Underinflated tires wear unevenly, adversely affect handling and fuel economy, and are more likely to fail from overheating.
- Overinflated tires make your vehicle ride harshly, are more prone to road hazards, and wear unevenly.
- Every day before you drive, look at each of the tires. If one looks lower than the others, check the pressure with a tire gauge.
- Measure the air pressure when tires are cold. This means the vehicle has been parked for at least 3 hours or driven less than 1 mile (1.6 km). If necessary, add or release air until the specified pressure is reached, and then calibrate the system (see page 120). If checked when hot, tire pressure can be as much as 4–6 psi (30–40 kPa, 0.3–0.5 kgf/cm<sup>2</sup>) higher than checked when cold.
- At least once a month or before long trips, use a gauge to measure the pressure in all tires, including the spare. Even tires in good condition can lose 1–2 psi (10–20 kPa, 0.1–0.2 kgf/cm<sup>2</sup>) per month.

### Inspection Guidelines

Every time you inflate the tires, check for the following:

- Any damage to tires, including bumps, bulges, cuts, splits, or cracks in the side or tread. Remove any foreign objects and inspect for air leaks. Replace tires if you see fabric or cord.
- Uneven or excessive tread wear. Have a dealer check the wheel alignment.
- Cracks or other damage around the valve stems.

### Wear Indicators

The groove where the wear indicator is located is 1/16 inch (1.6 mm) shallower than elsewhere on the tire. If the tread has worn so low that the indicator is exposed, replace the tire. **Worn out tires have poor traction on wet roads.**

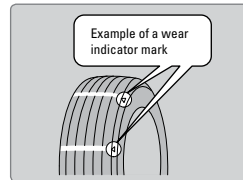

## ⚠ WARNING

Using tires that are excessively worn or improperly inflated can cause a crash in which you can be seriously hurt or killed.

Follow all instructions in this owner's manual regarding tire inflation and maintenance.

### Tire and Loading Information Label

The label attached to the driver's doorjamb provides necessary tire and loading information.

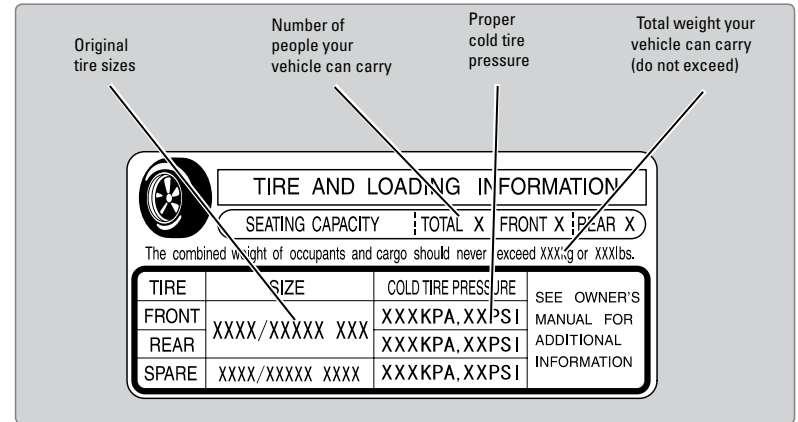

### Tire and Wheel Replacement

Replace your tires with radials of the same size, load range, speed rating, and maximum cold tire pressure rating (as shown on the tire's sidewall). Using tires of a different size or construction can cause certain vehicle systems such as ABS and Vehicle Stability Control (VSA) to work incorrectly. It is best to replace all four tires at the same time. If that isn't possible, replace the front or rear tires in pairs.

If you change or replace a wheel, make sure that the wheel's specifications match those of the original wheels.

## ⚠ WARNING

Installing improper tires on your vehicle can affect handling and stability.

This can cause a crash in which you can be seriously hurt or killed.

Always use the size and type of tires recommended in the Owner's Manual.

**Tire Service Life**

The life of your tires is dependent on many factors, including driving habits, road conditions, vehicle loading, inflation pressure, maintenance history, speed, and environmental conditions (even when the tires are not in use).

In addition to regular inspections and inflation pressure maintenance, it is recommended that you have annual inspections performed once the tires reach five years old. All tires, including the spare, should be removed from service after 10 years from the date of manufacture, regardless of their condition or state of wear.

**Winter Tires**

If driving on snowy or frozen roads, mount all season tires marked "M+S", snow tires, or tire chains; reduce speed and maintain sufficient distance between vehicles when driving. For winter tires, select the size and load ranges that are the same as the original tires and mount them to all four wheels.

**Tire Chains**

Because your vehicle has limited tire clearance, we strongly recommend using the following chains:

**For 215/55R16 tires:**

Cable-type: Autotrac 0154505

**For 215/50R17 tires:**

Cable-type: Autotrac 0154005

**For 235/40R18 tires:**

Chains not recommended.

Install tire chains on the front tires only. Mount chains as tightly as you can and make sure that they do not touch the brake lines or suspension.

**WARNING**

Using the wrong chains, or not properly installing chains, can damage the brake lines and cause a crash in which you can be seriously injured or killed. Follow all instructions in this guide regarding the selection and use of tire chains.

**NOTICE**

Traction devices that are the wrong size or improperly installed can damage your vehicle's brake lines, suspension, body, and wheels. Stop driving if they are hitting any part of the vehicle.

**Tire Labeling**

The tires that came on your vehicle have a number of markings. Those you should be aware of are described below.

Here is an example of what each marking means: P205/55R16 89H

- P: vehicle type (passenger)
- 205: tire width in millimeters
- 55: aspect ratio (tire section height as a percentage of its width)
- R: tire construction code (radial)
- 16: rim diameter in inches
- 89: load index (code indicating maximum load tire can carry)
- H: speed symbol (code indicating maximum speed rating)

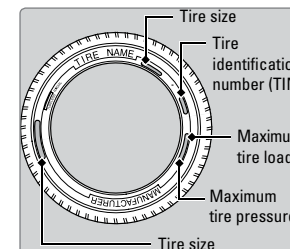

**Tire Identification Number (TIN)**

The tire identification number (TIN) is a group of numbers and letters that look like the example shown. TIN is located on the sidewall of the tire.

DOT B97R FW6X 2209

DOT: This indicates that the tire meets all requirements of the U.S. Department of Transportation.

B97R: Manufacturer's identification mark

FW6X: Tire type code

22 09: Date of Transportation

Year  
Week

**Glossary of Tire Terminology**

- Cold Tire Pressure** – The tire air pressure when the vehicle has been parked for at least three hours or driven less than 1 mile (1.6 km).
- Load Rating** – The maximum load that a tire is rated to carry for a given inflation pressure.
- Maximum Inflation Pressure** – The maximum tire air pressure that the tire can hold.
- Maximum Load Rating** – The load rating for a tire at the maximum permissible inflation pressure for that tire.
- Recommended Inflation Pressure** – The cold tire inflation pressure recommended by the manufacturer.
- Treadwear Indicators (TWI)** – The projections within the principal grooves designed to give a visual indication of the degrees of wear of the tread.

## DOT Tire Quality Grading

The tires on your vehicle meet all U.S. Federal Safety Requirements. All tires are also graded for treadwear, traction, and temperature performance according to Department of Transportation (DOT) standards. The following explains these gradings.

### ■ Uniform Tire Quality Grading

Quality grades can be found where applicable on the tire sidewall between tread shoulder and maximum section width.

For example:

**Treadwear 200**

**Traction AA**

**Temperature A**

All passenger car tires must conform to Federal Safety Requirements in addition to these grades.

### ■ Treadwear

The treadwear grade is a comparative rating based on the wear rate of the tire when tested under controlled conditions on a specified government test course. For example, a tire graded 150 would wear one and one-half (1 1/2) times as well on the government course as a tire graded 100. The relative performance of tires depends upon the actual conditions of their use and may depart significantly from the norm due to variations in driving habits, service practices, and differences in road characteristics and climate.

### ■ Traction

The traction grades, from highest to lowest, are AA, A, B, and C. Those grades represent the tire's ability to stop on wet pavement as measured under controlled conditions on specified government test surfaces of asphalt and concrete. A tire marked C may have poor traction performance.

**WARNING:** The traction grade assigned to this tire is based on straight-ahead braking traction tests and does not include acceleration, cornering, hydroplaning, or peak traction characteristics.

### ■ Temperature

The temperature grades are A (the highest), B, and C, representing the tire's resistance to the generation of heat and its ability to dissipate heat when tested under controlled conditions on a specified indoor laboratory test wheel. Sustained high temperature can cause the material of the tire to degenerate and reduce tire life, and excessive temperature can lead to sudden tire failure. The grade C corresponds to a level of performance which all passenger car tires must meet under the Federal Motor Vehicle Safety Standard No. 109. Grades B and A represent higher levels of performance on the laboratory test wheel than the minimum required by law.

**WARNING:** The temperature grade for this tire is established for a tire that is properly inflated and not overloaded. Excessive speed, underinflation, or excessive loading, either separately or in combination, can cause heat buildup and possible tire failure.

## Cold or Rainy Weather Driving

### Models having SPORT mode with summer tires

Summer-only and Ultra High Performance (UHP) tires are very sensitive to ambient temperatures and are designed to be used at temperatures above 45°F (7°C). Below that temperature, Summer-only and UHP tires provide decreasing amounts of grip and other performance attributes. At temperatures below -4°F (-20°C), the tire treads may become brittle, resulting in permanent damage to the tread. A damaged tire may fail during use. Therefore, if you will operate the vehicle when temperatures are below 45°F (7°C), we recommend you install other tires (e.g., mud+snow, winter) designed to perform under the expected conditions.

### WARNING

Use of Summer-only or Ultra High Performance tires at temperatures below 45°F (7°C) may lead to a loss of performance and control, which could result in a crash, serious injury, or death.

## Air Conditioning

To ensure proper and safe operation, the Society of Automotive Engineers (SAE J2845) recommends that the refrigerant system be serviced only by trained and certified technicians.

Never repair or replace the air conditioning evaporator (cooling coil) with one removed from a used or salvaged vehicle.

New replacement mobile air conditioning evaporators must be certified (and labeled) as meeting SAE Standard J2842.

### NOTICE

Vented refrigerant is harmful to the environment. To avoid refrigerant from venting, never replace the evaporator with one removed from a used or salvaged vehicle.

## Testing of Readiness Codes

Your vehicle has readiness codes as part of the onboard self-diagnostic system. Some states use these codes for testing to verify whether your vehicle's emissions components are working properly. The codes may not be read if you go through the testing just after the battery has gone dead or been disconnected.

To check if they are set, turn the vehicle on without starting the engine. The malfunction indicator lamp will come on for several seconds. If it goes off, the readiness codes are set. If it blinks five times, the readiness codes are not set.

If you are required to have your vehicle tested before the readiness codes are set, prepare the vehicle for retesting by doing the following:

1. Fill the gas tank to approximately 3/4 full.
2. Park the vehicle and leave the engine off for 6 hours or more.
3. Make sure the ambient temperature is between 40°F and 95°F (4°C and 35°C).
4. Start the engine without touching the accelerator pedal and let it idle for 20 seconds.
5. Keep the vehicle in Park (P) or Neutral for manual transmission. Increase the engine speed to 2,000 rpm, and hold it there for about 3 minutes.
6. Let the engine idle with your foot off the accelerator for 20 seconds.
7. Select a nearby, lightly traveled major highway where you can maintain a speed of 50 to 60 mph (80 to 97 km/h) for at least 20 minutes. Drive on the highway with the vehicle in Drive (D) or 5th gear. Do not use cruise control. When traffic allows, drive for 90 seconds without using the accelerator pedal. (Vehicle speed may vary slightly; this is OK.) If you cannot do this for a continuous 90 seconds because of traffic conditions, drive for at least 30 seconds, then repeat two more times (for a total of 90 seconds).
8. Drive in city or suburban traffic for at least 10 minutes. When traffic conditions allow, let the vehicle coast for several seconds without using the accelerator pedal or the brake pedal.
9. Park the vehicle and leave the engine off for 30 minutes.

The readiness codes are erased when the battery is disconnected and set again only after several days of driving under a variety of conditions.

If a testing facility determines that the readiness codes are not set, you may be requested to return at a later date to complete the test, or see your dealer.

## SPECIFICATIONS

### 1.5-L engine models

#### Vehicle

Model	Civic Coupe
No. of Passengers:	
Front	2
Rear	3
Total	5
Weights:	
Gross Vehicle Weight Rating	U.S.: 3,902 lbs (1,770 kg) <sup>*1</sup> Canada: 1,770 kg <sup>*1</sup>
	U.S.: 3,836 lbs (1,740 kg) <sup>*2</sup> Canada: 1,740 kg <sup>*2</sup>
Gross Axle Weight Rating (Front)	U.S.: 2,105 lbs (955 kg) <sup>*1</sup> Canada: 955 kg <sup>*1</sup>
	U.S.: 2,039 lbs (925 kg) <sup>*2</sup> Canada: 925 kg <sup>*2</sup>
Gross Axle Weight Rating (Rear)	U.S.: 1,808 lbs (820 kg) <sup>*1</sup> Canada: 820 kg <sup>*1</sup>
	U.S.: 1,808 lbs (820 kg) <sup>*2</sup> Canada: 820 kg <sup>*2</sup>

\*1: Models without SPORT mode

\*2: Models with SPORT mode

#### Fluids

##### Engine Oil

Recommended	-Genuine Honda Motor Oil 0W-20 -API Premium-grade 0W-20 detergent oil
Change	3.4 US qt (3.2 ℓ)
Capacity	Change including filter 3.7 US qt (3.5 ℓ)

##### Engine Coolant

Specified	Honda Long-Life Antifreeze/Coolant Type2
Ratio	50/50 with distilled water
	1.34 US gal (5.09 L) <sup>*1</sup> (change including the remaining 0.2 US gal (0.75 L) in the reserve tank)
Capacity	1.32 US gal (5.01 L) <sup>*2</sup> (change including the remaining 0.2 US gal (0.75 L) in the reserve tank)

\*1: Continuously variable transmission models

\*2: Manual transmission models

##### Brake Fluid

Specified	Honda Heavy Duty Brake Fluid DOT 3
-----------	------------------------------------

##### Continuously Variable Transmission Fluid\*

Specified	Honda HCF-2 Transmission Fluid
Capacity	Change 3.9 US qt (3.7 ℓ)

##### Manual Transmission Fluid\*

Specified	Honda Manual Transmission Fluid (MTF)
Capacity	Change 2.0 US qt (1.9 ℓ)

##### Washer Fluid

Tank Capacity	U.S.: 2.6 US qt (2.5 ℓ) Canada: 4.8 US qt (4.5 ℓ)
---------------	--

##### Air Conditioning

Refrigerant Type	HFO-1234yf (R-1234yf)
Charge Quantity	13.2 – 15.0 oz (375 – 425 g)
Lubricant Type	RL85HM (POE)
Quantity	4.7 – 6.3 oz (77 – 103 cm <sup>3</sup> )

\*if equipped

## Light Bulbs

Headlights (Low Beam)	55 W (H11) <sup>*1</sup> LED <sup>*2</sup>
Headlights (High Beam)	60 W (HB3) <sup>*1</sup> LED <sup>*2</sup>
Fog Lights	35 W (H8)
Parking/Daytime Running Lights	LED
Front Side Marker Lights	3 W
Front Turn Signal Lights	21 W (Amber) <sup>*1</sup> LED <sup>*2</sup>
Side Turn Signal Lights (on Door Mirrors) <sup>*</sup>	LED
Brake Lights	21 W
Rear Turn Signal Lights	21 W (Amber)
Tail/Rear Side Marker Lights	LED
Back-Up Lights	6 W
Taillight	LED
High-Mount Brake Light	LED
Rear License Plate Light	LED
Interior Lights	
Map Lights	8 W
Ceiling Light	8 W
Vanity Mirror Lights <sup>*</sup>	2 W
Trunk Light	5 W

\*1: Models with halogen headlights

\*2: Models with LED headlights

## Engine and Fuel

### Engine

Displacement	91.38 cu-in (1,498 cm <sup>3</sup> )
Spark Plugs	NGK ILZKAR8HS <sup>*1</sup> NGK ILZKAR8J8SY <sup>*2</sup>

\*1: Models without SPORT mode

\*2: Models with SPORT mode

### Fuel

Fuel:	Unleaded gasoline, Pump octane number of 87 or higher <sup>*1</sup>
Type	Unleaded gasoline, Pump octane number of 91 or higher <sup>*2</sup>
Fuel Tank Capacity	12.39 US gal (46.9 L)

\*1: Models without SPORT mode

\*2: Models with SPORT mode

## Tires

Regular	Size	215/50R17 91H <sup>*1</sup> 235/40R18 91W <sup>*2</sup> 235/40R18 95Y <sup>*3</sup>
	Front	
	Pressure psi (kPa [kgf/cm <sup>2</sup> ])	32 (220 [2.2]) <sup>*1</sup> 33 (225 [2.3]) <sup>*2, *3</sup> Rear 32 (220 [2.2]) <sup>*1, *2, *3</sup>
Compact Spare <sup>*</sup>	Size	T125/80D16 97M <sup>*1</sup> T125/70R17 98M <sup>*4, *5</sup>
	Pressure psi (kPa [kgf/cm <sup>2</sup> ])	60 (420 [4.2])
Wheel Size	Regular	17 x 7J <sup>*1</sup> 18 x 8J <sup>*2, *3</sup>
	Compact Spare <sup>*</sup>	16 x 4T <sup>*1</sup> 17 x 4T <sup>*4, *5</sup>

\*1: Models without SPORT mode

\*2: Models with SPORT mode

\*3: U.S. model with SPORT mode with optional summer tires

\*4: U.S. model with SPORT mode with optional spare tire

\*5: Canadian model with SPORT mode

## 2.0-L engine models

### Vehicle

Model	Honda Civic Coupe
No. of Passengers:	
Front	2
Rear	3
Total	5
Weights:	
Gross Vehicle Weight Rating	U.S.: 3,737 lbs (1,695 kg) Canada: 1,695 kg
Gross Axle Weight Rating (Front)	U.S.: 1,984 lbs (900 kg) Canada: 900 kg
Gross Axle Weight Rating (Rear)	U.S.: 1,786 lbs (810 kg) Canada: 810 kg

### Fluids

#### Engine Oil

Recommended	-Genuine Honda Motor Oil 0W-20 -API Premium-grade 0W-20 detergent oil
Change	4.2 US qt (4.0 ℓ)
Capacity	Change including filter 4.4 US qt (4.2 ℓ)

#### Engine Coolant

Specified	Honda Long Life Antifreeze/Coolant Type2
Ratio	50/50 with distilled water
Capacity	1.4 US gal (5.30 ℓ) (change including the remaining 0.2 US gal (0.75 ℓ) in the reserve tank)

#### Brake/Clutch<sup>\*</sup> Fluid

Specified	Honda Heavy Duty Brake Fluid DOT 3
-----------	------------------------------------

#### Continuously Variable Transmission Fluid<sup>\*</sup>

Specified	Honda HCF-2 Transmission Fluid
Capacity	Change 3.7 US qt (3.5 ℓ)

#### Manual Transmission Fluid<sup>\*</sup>

Specified	Honda Manual Transmission Fluid (MTF)
Capacity	Change 2.0 US qt (1.9 ℓ)

#### Washer Fluid

Tank Capacity	U.S.: 2.6 US qt (2.5 ℓ) Canada: 4.8 US qt (4.5 ℓ)
---------------	--

#### Air Conditioning<sup>\*</sup>

Refrigerant Type	HFO-1234yf (R-1234yf)
Charge Quantity	13.2 – 15.0 oz (375 – 425 g)
Lubricant Type	RL85HM (POE)
Quantity	4.7 – 6.3 cu.-in. (77 – 103 cm <sup>3</sup> )

### Light Bulbs

Headlights (Low Beam)	55 W (H11)
Headlights (High Beam)	60 W (HB3)
Parking/Daytime Running Lights	LED
Front Side Marker Lights	3 W
Front Turn Signal Lights	21 W (Amber)
Brake Lights	21 W
Rear Turn Signal Lights	21 W (Amber)
Tail/Rear Side Marker Lights	LED
Back-Up Lights	6 W
Taillight	LED
High-Mount Brake Light	LED
Rear License Plate Light	LED
Interior Lights	
Map Lights	8 W
Ceiling Light	8 W
Trunk Light	5 W

## Engine and Fuel

### Engine

Displacement	121.76 cu-in (1,996 cm <sup>3</sup> )
Spark Plugs	NGK DILKAR7H11GS DENSO DILKAR7G11GS DXE22HQR-D11S

### Fuel

Fuel:	Unleaded gasoline, Pump octane number of 87 or higher
Fuel Tank Capacity	12.39 US gal (46.9 ℓ)

### Tires

Regular	Size	215/55R16 93H
	Pressure psi (kPa [kgf/cm <sup>2</sup> ])	32 (220 [2.2])
Compact Spare <sup>*</sup>	Size	T125/80D16 97M
	Pressure psi (kPa [kgf/cm <sup>2</sup> ])	60 (420 [4.2])
Wheel Size	Regular	16 x 7J
	Compact Spare	16 x 4T

\*if equipped

# CUSTOMER INFORMATION

Learn about information specific to you as a Honda customer and how to get help.

## Frequently Asked Questions/Troubleshooting

Below are some frequently asked questions and troubleshooting items that you may have about the vehicle.

**Q:** *How do I set the vehicle clock?*

**A:** For vehicles without navigation, see page 53. For vehicles with navigation, the time is automatically set using GPS signals.

**Q:** *Why doesn't the vehicle start when I press the ENGINE START/STOP button\*?*

**A:** The brake pedal must be pressed to start the engine.

**Q:** *The amber indicator with a tire and an exclamation mark is on. What do I do?*

**A:** Either your tire pressure is low or you recently filled a tire. See page 120.

**Q:** *Why won't the driver's door unlock when I grab the door handle, even though the keyless access remote\* is within range?*

**A:** If you pull the handle too quickly, the system may not have time to confirm the door is unlocked. Wait to hear a beep to confirm the door is unlocked. If you are wearing gloves, the system may be slow to respond.

**Q:** *After my battery was disconnected or went dead, the audio system is asking for a code. Where do I find this?*

**A:** In most cases, you do not need to enter a code. Turn on the vehicle and the audio system, and press and hold the power button until the system reactivates.

**Q:** *Why can't I operate Pandora\* through the audio system?*

**A:** Audio may be streaming through *Bluetooth* Audio. Make sure Pandora mode is selected and the phone cable is properly connected to the USB adapter cable (if using). Some phones may prompt you to "Allow" a connection.

**Q:** *Is my phone compatible with Bluetooth features?*

**A:** Visit [automobiles.honda.com/handsfreelink](http://automobiles.honda.com/handsfreelink) (U.S.) or [www.handsfreelink.ca](http://www.handsfreelink.ca) (Canada) to check phone compatibility for *Bluetooth* Audio, *Bluetooth* HandsFreeLink, and SMS text messaging.

**Q:** *Every time I press the Talk button, the system gives me voice prompts\*. Can I turn these off?*

**A:** From the Home screen, select SETTINGS. Select System, then select Voice Prompt. Select Off.

\*if equipped

## Contact Us

Honda dealer personnel are trained professionals. They should be able to answer all your questions. If you encounter a problem that your dealership does not solve to your satisfaction, please discuss it with the dealership's service manager or general manager. If you are dissatisfied with the decision made by the dealership's management, contact Honda Automobile Customer Service.

### U.S. owners

American Honda Motor Co., Inc.  
Honda Automobile Customer Service  
1919 Torrance Blvd.  
Mail Stop 100-5E-8A  
Torrance, CA 90501-2746  
Tel: (800) 999-1009

### In Puerto Rico and the U.S. Virgin Islands

Bella International  
P.O. Box 190816  
San Juan, PR 00919-0816  
Tel: (787) 620-7546

### Canadian owners

Honda Canada, Inc.  
Customer Relations  
180 Honda Blvd.  
Markham, ON  
L6C 0H9  
Tel: (888) 946-6329  
Fax: (877) 939-0909  
e-mail: [honda\\_cr@ch.honda.com](mailto:honda_cr@ch.honda.com)

When you call or write, please give us the following information:

- Vehicle Identification Number
- Date of purchase
- Odometer reading of your vehicle
- Your name, address, and telephone number
- A detailed description of the problem
- Name of the dealer who sold the vehicle to you

## Honda Roadside Assistance

24-hour emergency road service is available to you in the United States and Canada throughout your 3-year/36,000-mile warranty term. Services include jump starting, flat tire and lockout assistance, towing, and more (limitations apply). Call (866) 864-5211 (U.S.) or (800) 465-7587 (Canada).

\*if equipped



## Warranty Coverages

Below is a brief summary of the warranties covering your new vehicle.

**New Vehicle Limited Warranty:** Covers your new vehicle, except for the emissions control system and accessories, against defects in materials and workmanship.

**Emissions Control Systems Defects Warranty and Emissions Performance Warranty:** Covers your vehicle's emissions control systems. Time, mileage, and coverage are conditional.

**Seat Belt Limited Warranty:** Covers seat belts that fail to function properly.

**Rust Perforation Limited Warranty:** Covers all exterior body panels that rust through from the inside.

**Accessory Limited Warranty:** Covers Honda accessories.

**Replacement Parts Limited Warranty:** Covers all Honda replacement parts against defects in materials and workmanship.

**Replacement Battery Limited Warranty:** Provides prorated coverage for a replacement battery purchased from a Honda dealer.

**Replacement Muffler Lifetime Limited Warranty:** Covers a replacement muffler for the duration of the ownership.

Restrictions and exclusions apply to all these warranties. See the Warranty Manual on the Owner Information CD or at [owners.honda.com](http://owners.honda.com) (U.S.) or [myhonda.ca](http://myhonda.ca) (Canada) for complete descriptions of each warranty, including time, mileage, and other conditional limitations.

Your vehicle's original tires are covered by their manufacturer. Tire warranty information can be found on the Owner Information CD or at [owners.honda.com](http://owners.honda.com) (U.S.) or [myhonda.ca](http://myhonda.ca) (Canada).

## EPA Contact Information

An owner may obtain further information concerning emission warranties or report violations of the terms of the emission warranties by contacting:

U.S. Environmental Protection Agency  
Office of Transportation and Air Quality  
Compliance Division,  
Light-Duty Vehicles Group  
Attn: Warranty Complaints  
2000 Traverwood Drive  
Ann Arbor, MI 48105  
**Email: [complianceinfo@epa.gov](mailto:complianceinfo@epa.gov)**

## VOICE COMMAND INDEX

Learn about all available voice commands to help you operate the vehicle. Available on vehicles with Display Audio.

Press the Talk button before you say a command. The system recognizes only the command listed here.

### ■ Voice Portal Commands

When you press the Talk button, the Voice Portal screen appears. Say one of the options, and follow the system prompts.

- Phone call
- Music search
- Audio
- Climate control
- Navigation\*
- Voice setting
- Voice help
- What is today's date?
- What time is it?

### ■ Navigation Commands\*

The system accepts these commands on most screens. You need to press the Talk button only once for navigation commands.

- View map
- Find place
- Find category
- Find intersection
- Recently found
- Go home
- Find address
- Find city
- Saved places

### ■ Climate Control Commands\*

The system accepts these commands on most screens.

- Climate control on\*\*
- Climate control off\*\*
- Air conditioner on\*\*
- Air conditioner off\*\*
- Defrost on\*\*
- Defrost off\*\*
- Fan speed # (#: 1 to 7)
- Temperature # degrees (#: 57 to 87°F)
- Temperature max heat
- Temperature max cool

### ■ Phone Commands

The system accepts these commands on most screens. Commands not available when Apple CarPlay is in use.

- Call by number
- Call by name
- Call (number)
- Call (name)

\*models with navigation

\*\*These commands toggle the function on and off, so the command may not match your intended action.

**Audio Commands\***

The system accepts these commands on most screens. Audio volume levels cannot be controlled using voice commands.

**FM/AM Radio Commands**

- Audio on\*\*
- Audio off\*\*
- Radio FM
- Radio AM
- Radio tune to # FM (#: frequency, e.g., 95.5)
- Radio tune to # AM (#: frequency, e.g., 1020)
- Radio FM preset # (#: 1 to 12)
- Radio AM preset # (#: 1 to 6)

**SiriusXM Radio Commands**

- Radio SXM
- SXM channel # (#: 0 to 255)
- SXM channel (channel name)
- Radio SXM preset # (#: 1 to 12)

**Song By Voice Commands**

Available for tracks stored on an iPod or USB device.

- Music search
- List album (specify album)
- List artist (specify artist)
- List composer (specify composer)
- List genre (specify genre)
- List playlist (specify playlist)
- Play album (specify album)
- Play artist (specify artist)
- Play composer (specify composer)
- Play genre (specify genre)
- Play playlist (specify playlist)
- Play song (specify song)
- What/Who am I listening to?
- Who is this?
- What's playing?
- Who's playing?
- What album is this?

**Pandora Commands (U.S. only)**

- Pandora
- Pandora play

**USB Commands**

- USB
- USB play
- USB play track # (#: 1 to 30)

**iPod Commands**

- iPod
- iPod play
- iPod play track # (#: 1-30)

**Bluetooth Audio Commands**

- Bluetooth audio play  
(may not work on all phones)

**INDEX**

ABS.....	25	Brake Assist System.....	99, 100
ACC.....	24, 27	Brake/Clutch* Fluid.....	139
Accessory Power Socket.....	54	Brake depress .....	27
Adaptive Cruise Control (ACC) with Low Speed Follow (LSF).....	24, 104	Brake system .....	24, 25
Address.....	87	Braking.....	100
Airbags.....	8	Brightness Control .....	39
Airbag Care .....	13	Carbon Monoxide Gas.....	4
Airbag System Components .....	12	Changing a Flat Tire .....	122
Airbag System Indicators .....	10	Changing Settings.....	51, 52
Ambient Meter.....	102	Charging system.....	24
Android Auto.....	68	Child Safety.....	14
Anti-Lock Brake System (ABS).....	25, 100	Protecting Child Passengers.....	14
Apple CarPlay.....	67	Protecting Infants.....	15
Audio Operation .....	54	Protecting Larger Children .....	20
Audio Commands .....	156	Protecting Smaller Children .....	16
Bluetooth Audio.....	63, 73	Child Seat.....	16
Color Audio System.....	59	Adding Security with a Tether.....	19
Display Audio .....	64	LATCH-Compatible Child Seat.....	17
FM/AM Radio .....	60, 69	With a Lap/Shoulder Seat Belt.....	18
HondaLink.....	65	Climate Control Commands.....	155
iPod.....	61, 71	Climate Control System.....	48
Pandora.....	74	Clock.....	53
Siri.....	84	Cold Weather Driving .....	147
SiriusXM Radio .....	70	Collision Mitigation Braking System (CMBS) .....	25, 108
Sound .....	58	Color Audio System .....	59
Steering Wheel Controls.....	56	Condition Indicators .....	26
USB Flash Drive.....	62, 72	Contact Us.....	153
USB Port .....	54	Continuously Variable Transmission.....	98
Wi-Fi Connection .....	66	Cruise Control.....	27, 103
Wireless Charger .....	55	Customer Information.....	152
Automatic (AUTO) Rain-Sensing Wipers.....	41	Customized Features.....	52
Automatic Brake Hold.....	27, 101	Dashboard, Ceiling, Other Controls.....	2
Automatic Dimming Rearview Mirror.....	47	Destination .....	87
Battery .....	140	Dialing a Number .....	77, 81
Bluetooth Audio.....	63, 73	Display Audio .....	64
Bluetooth Audio Commands.....	156	Door Mirrors .....	47
Bluetooth Handsfreelink (HFL).....	75	Door Operation .....	36
E-Mail .....	82	Doors.....	33
HFL Controls .....	75, 78	Door/trunk open .....	26
HondaLink Assist.....	83	DOT Tire Quality Grading .....	146
Making a Call .....	77, 81	Driver Information Interface .....	28
Pairing a Phone .....	76, 80		
Phonebook.....	77, 81		
Siri Eyes Free .....	84		
SMS Text Messaging.....	82		
Speed Dial .....	77, 82		
Talk Button Tips .....	79		

\*models with navigation

\*\*These commands toggle the function on and off, so the command may not match your intended action.

Driving ..... 92  
 Adaptive Cruise Control (ACC)  
 with Low Speed Follow (LSF) ..... 104  
 Braking ..... 100  
 Cold Weather Driving ..... 147  
 Collision Mitigation Braking System (CMBS) ..... 108  
 Continuously Variable Transmission (CVT) 98, 99  
 Cruise Control ..... 103  
 Eco Assist System ..... 102  
 ENGINE START/STOP button ..... 98  
 Exterior Checks ..... 92  
 Ignition ..... 97  
 Interior Checks ..... 93  
 Lane Keeping Assist System (LKAS) ..... 106  
 LaneWatch ..... 110  
 Manual Transmission ..... 99  
 Maximum Load Limit ..... 94  
 Multi-View Rear Camera ..... 111  
 Power Mode ..... 98  
 Refueling ..... 113  
 Remote Engine Start ..... 96  
 Road Departure Mitigation (RDM) ..... 107  
 Shifting ..... 98  
 Stopwatch ..... 30  
 Turbocharger Precautions ..... 114  
 Vehicle Stability Assist (VSA) ..... 102  
 Wiper Blades ..... 141  
 Eco Assist System ..... 102  
 ECON Button ..... 102  
 ECON mode ..... 27  
 Electric Parking Brake ..... 100  
 Electric Power Steering (EPS) ..... 25  
 E-Mail ..... 82  
 Emergency Engine Stop ..... 119  
 Emergency Towing ..... 119  
 Engine and Fuel ..... 150, 151  
 Engine Coolant ..... 138  
 Engine Oil ..... 135  
 ENGINE START/STOP button ..... 98  
 Exterior lights ..... 39  
 Exterior Lights ..... 27  
 Fastening a Seat Belt ..... 7  
 Flat Tire ..... 122  
 Floor Mats ..... 43  
 Fluids ..... 149, 151  
 FM/AM Radio ..... 60, 69  
 FM/AM Radio Commands ..... 156  
 Fog lights ..... 27  
 Foot Brake ..... 100  
 Frequently Asked Questions ..... 152  
 Fuel Information ..... 113  
 Refueling from a Portable Fuel Container ..... 114  
 Fuse Locations ..... 126  
 Hang-Up/Back button ..... 75, 78  
 Headlight-Wiper Integration ..... 40  
 Head Restraints ..... 44  
 HFL Controls ..... 75, 78

High beams ..... 27  
 Home Address ..... 87  
 HondaLink ..... 65  
 HondaLink Assist ..... 83  
 Honda Roadside Assistance ..... 153  
 Hood ..... 133  
 Ignition ..... 97  
 Immobilizer ..... 26  
 Information Display ..... 28  
 Instrument Panel ..... 23  
 Interior Lights ..... 39  
 Intermittent Wipers ..... 41  
 iPod ..... 61, 71  
 iPod Commands ..... 156  
 Jump Starting ..... 116  
 Key ..... 32  
 Lane Keeping Assist System (LKAS) ..... 24, 106  
 LaneWatch ..... 110  
 Lap/Shoulder Seat Belts ..... 5  
 LATCH-Compatible Child Seat ..... 17  
 Light Bulbs ..... 150, 151  
 Lights ..... 27, 39  
 LKAS ..... 27  
 Lock Tab ..... 36  
 Low fuel ..... 26  
 Low oil pressure ..... 24  
 Low tire pressure ..... 26  
 Maintenance ..... 129  
 Air Conditioning ..... 147  
 Battery ..... 140  
 Brake/Clutch\* Fluid ..... 139  
 Engine Coolant ..... 138  
 Engine Oil ..... 135  
 Maintenance Minder ..... 130  
 Service Codes ..... 131  
 Under the Hood ..... 133  
 Window Washer Fluid ..... 139  
 Making a Call ..... 77, 81  
 Malfunction indicator lamp ..... 25  
 Malfunction Indicators ..... 24  
 Manual Transmission ..... 99  
 Map Legend ..... 90  
 Master Door Lock Switch ..... 36  
 Maximum Load Limit ..... 94  
 Mirrors ..... 47  
 Moonroof ..... 38  
 Multi-View Rear Camera ..... 111  
 Music search ..... 156

Navigation ..... 85  
 Display and Controls ..... 86  
 Entering a Destination ..... 87  
 Home Address ..... 87  
 Map Legend ..... 90  
 Place Category ..... 88  
 Recent Places ..... 88  
 Routing ..... 90  
 Saved Places ..... 89  
 Steering Wheel Controls ..... 85  
 Street Address ..... 87  
 System Guidance Volume ..... 85  
 Talk Button Tips ..... 85  
 Traffic ..... 91  
 Turn-by-turn directions ..... 90  
 Navigation Commands ..... 155  
 On/Off Indicators ..... 27  
 Opening the Hood ..... 134  
 Overheating ..... 118  
 Pairing a Phone ..... 76, 80  
 Pandora ..... 74  
 Pandora Commands ..... 156  
 Parking Brake ..... 26, 100  
 Passenger Airbag Off Indicator ..... 11  
 Phone ..... 76, 80  
 Phonebook ..... 77, 81  
 PHONE button ..... 75  
 Phone Commands ..... 155  
 Pick-Up button ..... 75, 78  
 Place Category ..... 88  
 Power Door Mirrors ..... 47  
 Power Mode ..... 98  
 Power Moonroof Operation ..... 38  
 Power Window Operation ..... 37  
 Radio ..... 60, 69  
 Rain-Sensing Wipers ..... 41  
 Readiness Codes ..... 148  
 Rear Camera ..... 111  
 Rear Seats ..... 45  
 Rearview Mirror ..... 47  
 Recent Places ..... 88  
 Refueling ..... 113  
 Remote Battery Strength ..... 115  
 Remote Engine Start ..... 96  
 Remote Transmitter ..... 32  
 Reporting Safety Defects ..... 22  
 Road Departure Mitigation (RDM) ..... 24, 107  
 Roadside Assistance ..... 153  
 Routing ..... 90

Safety Information ..... 3  
 Airbags ..... 8  
 Child Safety ..... 14  
 Reporting Safety Defects ..... 22  
 Safety Label Locations ..... 21  
 Safety Messages ..... 3  
 Seat Belts ..... 5  
 Saved Places ..... 89  
 Seat belt reminder ..... 26  
 Seat Belts ..... 5  
 Fastening a Seat Belt ..... 7  
 Proper Use of Seat Belts ..... 5  
 Seat Belt Inspection ..... 6  
 Seat Heaters ..... 51  
 Seats ..... 42  
 Rear Seat Access ..... 45  
 Security system ..... 26  
 Selector knob ..... 75  
 Service Codes ..... 131  
 Settings ..... 30, 31, 52  
 Setting the Clock ..... 53  
 Shifting ..... 98  
 Shift Lever Does Not Move ..... 115  
 Siri Eyes Free ..... 84  
 SiriusXM Radio ..... 70  
 SiriusXM Radio Commands ..... 156  
 Smart Entry system ..... 24, 33  
 SMS Text Messaging ..... 82  
 Song By Voice Commands ..... 156  
 Sound ..... 58  
 Specifications ..... 149  
 Speed Dial ..... 77, 82  
 SRS (Supplemental Restraint System) Indicator ..... 10  
 Starter system ..... 24  
 Steering Wheel ..... 46  
 Steering Wheel and Nearby Controls ..... 1  
 Steering Wheel Controls ..... 56, 85  
 Stopwatch ..... 30  
 Street Address ..... 87  
 Supplemental Restraint System (SRS) ..... 24  
 System Guidance Volume ..... 85  
 System message ..... 26  
 Talk button ..... 75, 78  
 Talk Button Tips ..... 79, 85  
 Text Messaging ..... 82

Tire Information.....	142
DOT Tire Quality Grading.....	146
Inflation Guidelines .....	142
Tire and Loading Information Label.....	143
Tire Chains.....	144
Tire Identification Number (TIN).....	145
Tire Labeling.....	145
Tire Service Life.....	144
Tire Terminology.....	145
Wear Indicators.....	142
Winter Tires.....	144
Tire Pressure Monitoring System (TPMS)..	25, 120
Tires.....	150, 151
Ultra High Performance tires .....	147
Towing.....	95, 119
Traffic .....	91
Trip Computer .....	29
Troubleshooting.....	152
Trunk.....	33
Release lever .....	117
Trunk Release Button .....	36
Trunk release lever .....	117
Turbocharger Precautions .....	114
Turn-by-turn directions .....	90
Turn Signal .....	38
Turn signals.....	27
USB Commands.....	156
USB Flash Drive.....	62, 72
USB Port.....	54
Vehicle .....	149, 151
Vehicle Controls .....	32
Vehicle Settings .....	30, 31
Vehicle Stability Assist (VSA) .....	25, 102
Visual Index.....	1
Voice Command Index .....	155
Voice Portal Commands.....	155
VSA.....	25, 27
Walk Away Auto Lock .....	35
Warranty Coverages .....	154
Washer fluid level.....	26
Wear Indicators .....	142
Wi-Fi Connection.....	66
Windows.....	37
Window Washer Fluid.....	139
Winter Tires.....	144
Wiper Blades .....	141
Wiper Operation.....	40
Wireless Charger .....	55

TABLE OF CONTENTS

VISUAL INDEX

SAFETY INFORMATION

INSTRUMENT PANEL

VEHICLE CONTROLS

AUDIO AND CONNECTIVITY

BLUETOOTH® HANDSFREELINK®