

FEATURES

- ◆ Audible click and/or impulse when torque setting is reached.
- ◆ +/- 4% clockwise accuracy between 20% and 100% of range. Complies with:
 - American Standard ANSI/ASME B107.14M
 - International Standard ISO 6789
- ◆ Large easy to read torque scale.
- ◆ Ball bearing mechanism provides extended calibration accuracy.
- ◆ Anodized aluminum handle with no-slip diamond knurl.
- ◆ Detent style adjustment locking prevents accidental change of torque setting.
- ◆ Chrome plated, hardened steel body.
- ◆ Factory calibration tape supplied with each tool.
- ◆ Packaged in protective blow molded storage case.

SUGGESTIONS

Proper use of this professional torque wrench will give you complete satisfaction in its performance and reliability. Following are some helpful tips:

1. Accuracy is assured by gripping the wrench properly. Grasp the GRIP, not the SHAFT, and pull smoothly.
2. Each torque wrench is lubricated before leaving the factory. If it has not been used for some time, it should be operated several times to re-distribute the lubricant within the working mechanism.
3. Never attempt to turn the KNOB when the KNOB is in the "LOCK" position.
4. Never set for higher or lower torque values than those indicated on your wrench.
5. For greater accuracy, clean all thread surfaces and remove any burrs on the fasteners being used.
6. **WARNING**-never use your torque wrench to apply more torque than its rated capacity.
7. It is not necessary to return this wrench to its lowest calibrated value after use unless it is to be stored for an extended period of time.

DO NOT OVERTORQUE

CERTIFICATION

This torque wrench was calibrated prior to shipment from the factory within tolerance limits of +/- 4% clockwise (right-handed) accuracy of upper 80% of range

LIMITED WARRANTY

Until one year from the date of purchase, we will repair any defect in material or workmanship free of charge. Improper use of these products, including but not limited to the application of excessive force, will affect performance and may result in injury. The warranty does not apply to wrenches which do not function properly or within specified accuracy because of wear, improper or unreasonable use, damage not resulting from defect or malfunction, or which have been altered. Calibration is warranted for 90 days.

This warranty gives you specific legal rights, and you may also have other rights which vary from state to state.

For repair or calibration send wrench, postage prepaid, to:

IN THE U.S.A.

ATG Torque Repair
3000 West Kingsley Road
Garland, TX 75041
972-998-6585

IN CANADA

ATG Torque Repair
7631 Bath Road
Mississauga, ON L4T3T1
1-866-691-6212



ATD-109 MICROMETER ADJUSTING TORQUE WRENCH

OPERATING INSTRUCTIONS

ADJUSTING YOUR MICROMETER TORQUE WRENCH

Caution – Do not turn the adjusting knob with the knob in the locked position. Damage to the locking mechanism may occur.

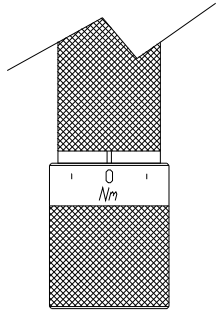

1. The minor scale is located on the adjusting knob. One revolution of the knob advances the major scale located in the grip window by one increment.

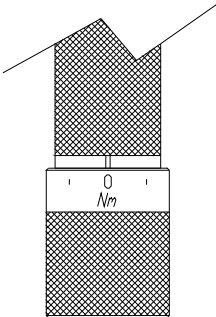

2. To adjust the torque setting, push the adjusting knob toward the grip until it unlocks and turn it to the right to increase the torque setting and to the left to reduce it.

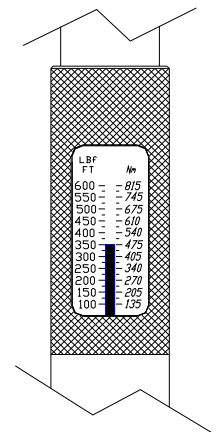

3. To set 362.5 ft-lbs for example, turn the adjusting knob until the red indicator in the major scale window is aligned with the closest major lbf-ft increment at or below the target torque setting and the knob is aligned on zero. Note: Lbf-ft units are on the right side of the window and Nm units are on the left side.

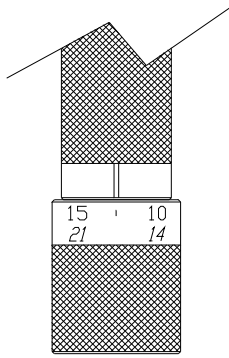

TORQUE UNIT CONVERSIONS

Torque values can be converted to other units very easily with simple multiplication.

To convert torque values from one unit to another, multiply the value of the given torque unit by the correct conversion factor to get the desired torque value.

$$\text{Inch Pounds} \times .08333 = \text{Foot Pounds}$$

$$\text{Meter Kilograms f} \times 7.233 = \text{Foot Pounds}$$

4. Turn the knob an additional 5 increments to set it on 12.5 and release it to lock the torque setting. The two scales added together give 362.5 ft-lbs. For Nm settings use the lower scale on the knob.

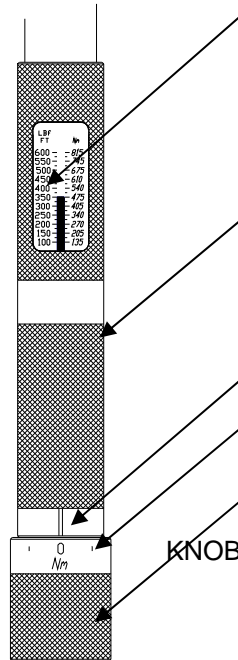

MAJOR SCALE

KNURLED GRIP

SCALE INDEX

MINOR SCALE

ADJUSTING

KNOB

HOW TO APPLY TORQUE

1. This Micrometer Adjustable Torque Wrench when properly used is designed to provide an audible signal and/or impulse feel to indicate the desired torque has been applied. **DO NOT** pull beyond this point.

CAUTION: The audible signal / or impulse feel is an indicator that the proper torque has been attained. Over torquing beyond these signals could cause fastener failure.

ADDITIONALLY: When the wrench is set at the low end of the torque range, the degree of signal and impulse will be less than when set at the high end of the range. Therefore, care must be taken at the low end of scale to hear the signal or feel the impulse.

2. To properly apply torque, attach a socket securely on the torque wrench square drive and position the socket on the fastener so that tilting will not occur. Grasp the center of the hand grip and apply a slow steadily increasing force perpendicular (90 degrees) to the torque wrench body and perpendicular to the center line of the square drive, socket, and fastener.
3. Turn the fastener down with a smooth and even force applied to the handle of the torque wrench. As turning resistance increases, pull more slowly. To assure accuracy, the fastener must be in motion when the torque measurement is made.

WARNING: Any change from the above procedure will result in a change of torque being applied. **DO NOT USE** universal joints or universal sockets due to the complexity of determining the associated error.

4. EXTENSIONS: When necessary to use an extension that changes the lever length of the torque wrench, torque being applied will change. To compute the wrench setting :

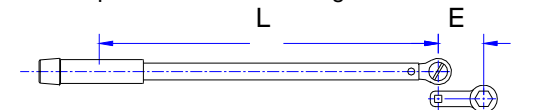

$$\text{Wrench Setting} = (\text{Desired Torque} \times L) / (L + E)$$

NOTE: Socket extension bars that are axially in line with the square drive do not cause error and need no adjustment.

ATD

ATD-109

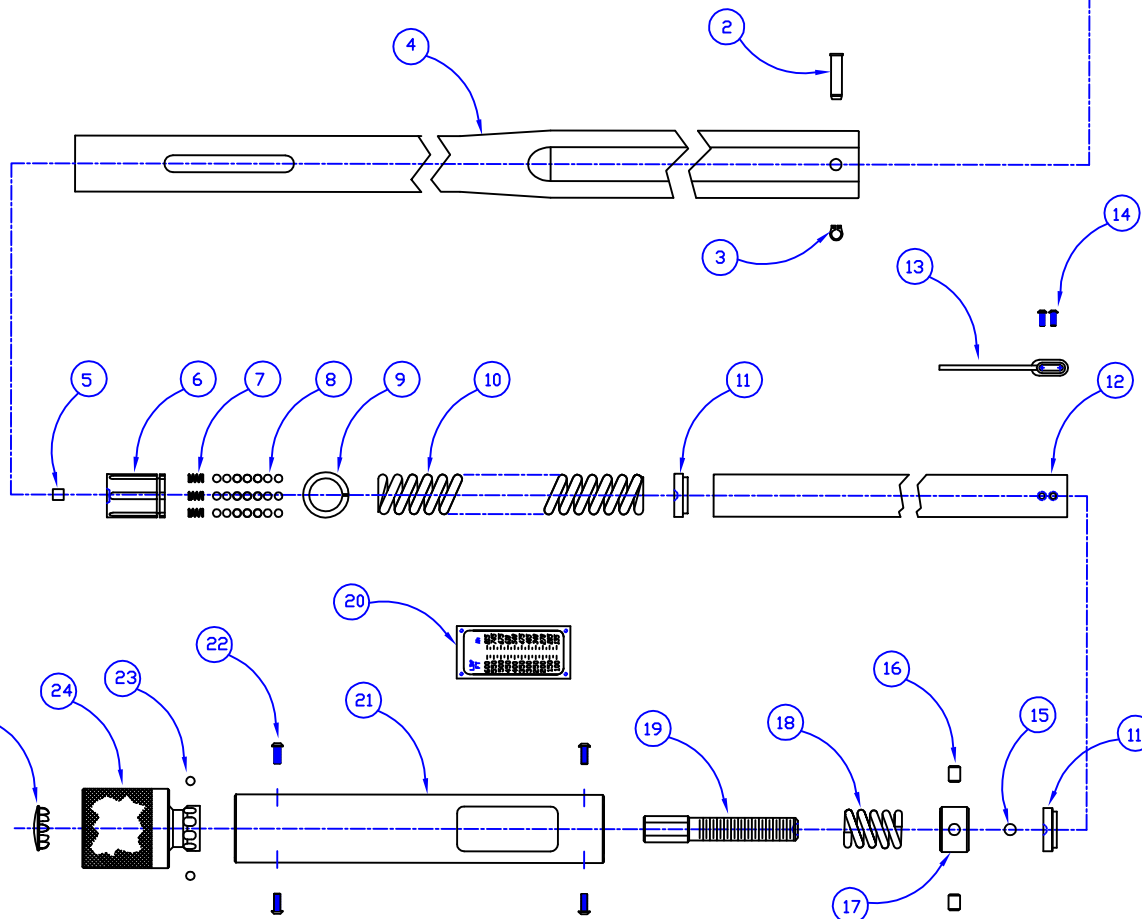
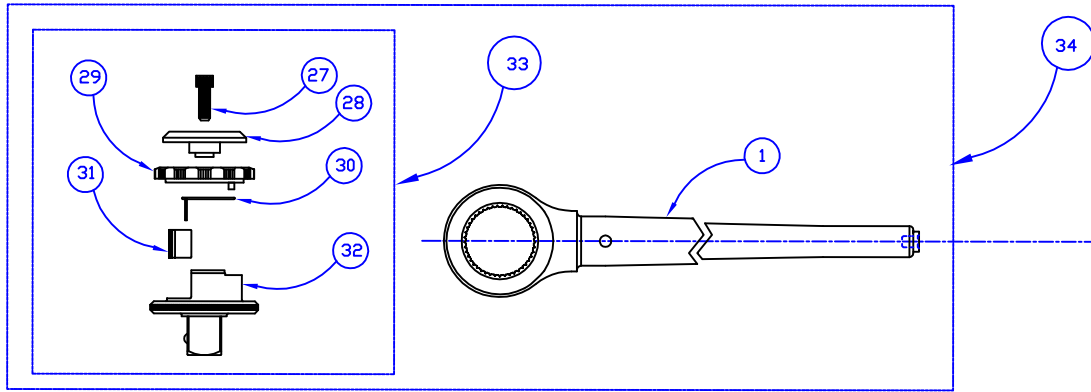

ITEM	QTY	PART #	DESCRIPTION
1	1	6356-01	HINGE #4
2	1	56354-23	PIN, HINGE
3	1	1390-01	RETAINING RING
4	1	54400-01	SPRING TUBE
5	1	51100-10	PIVOT BLOCK
6	1	54100-09	CAM
7	6	54100-06	CAM SPRING
8	30	01164-07	11/64 DIA BALL BEARING
9	1	5400C-29	WIRE RING
10	1	64600-08	LOAD SPRING
11	2	54400-28	THRUST WASHER
12	1	54400-44	SPACER
13	1	54400-10	POINTER
14	2	42000-15	SCREW, 4-40-UNC X 5/16
15	1	80023-15	BALL
16	2	6354-46	STOP PIN
17	1	6354-05	SPRING TUBE INSERT #4
18	1	64002-32	KNDB SPRING
19	1	54401-06	ADJUSTING SCREW
20	1	54402-24D	LENS
21	1	544AT-11	ALUMINUM HAND GRIP
22	4	54100-15	8-32-UNC X 3/16 18-8SS BHCS
23	2	01264-07	3/16 DIA BALL BEARING
24	1	640FN-03	ADJUSTING KNDB
25	1	31000-31	END CAP
27	1	80010-80	CAP SCREW
28	1	6355-25	RATCHET CAP #4
29	1	6355-73	REVERSING RING ASSEMBLY
30	1	6355-07	REVERSING SPRING #4
31	1	6356-06	RATCHET PAWL #4
32	1	6356-70	RETAINER DRIVE ASSEMBLY
33	1	6356-75	RATCHET REPAIR KIT
34	1	6356-60	RATCHET ASSEMBLY

MATERIAL		HEAT TREATMENT		TITLE	
UNLESS OTHERWISE SPECIFIED		FINISH		WRENCH ASSY	
DIMENSIONS ARE IN INCHES		SCALE 1:1		100-600 Ft-lb	
TOLERANCES:		DATE 09-19-06		SHEET	
XXX +/- .005		NOTICE		PART NO	
XX +/- .015		UNAUTHORIZED USE		CT4600FKK-ATB	
X +/- .030		OR POSSESSION OF		DF	
ANGULAR CONCERNTRICITY .005 TIR		THIS DOCUMENT WILL		APP'D	
63 MICRO MAX ROUGHNESS		BE PROSECUTED			
BREAK EDGES .005-.015					
DO NOT SCALE THIS DRAWING					

DRAWING NUMBER: CT4600FKKATB