

315-5250

118PIN MAX
120PIN FLAT
1 1/8"

許可ナク複写、複製厳禁
THIS DRAWING WILL IN NO WAY BE COPIED,
TO BE RETURNED ON DEMAND.
No. 0101 87.8.27
配布先 海外事業部
SEGA 第四研究開発部
第七期エンタープライゼス

SEGA SEGA ENTERPRISES, LTD.		APR 1987
THIS DRAWING WILL IN NO WAY BE COPIED, TO BE RETURNED ON DEMAND.		REV
* Thunder Blade		834-6335
GAME BD AFTER BURNER		DESCRIPTION
PART NO.		SHEET / OF 13

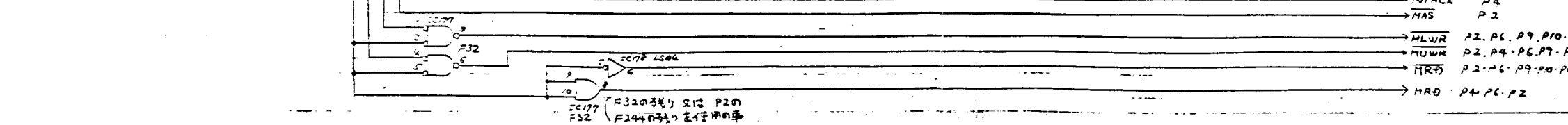

極秘
TOP SECRET

許可なく複製、複製厳禁
THIS DRAWING WILL NOT BE COPIED
TO BE RETURNED ON DEMAND

0101 87.3.27
海外事業部

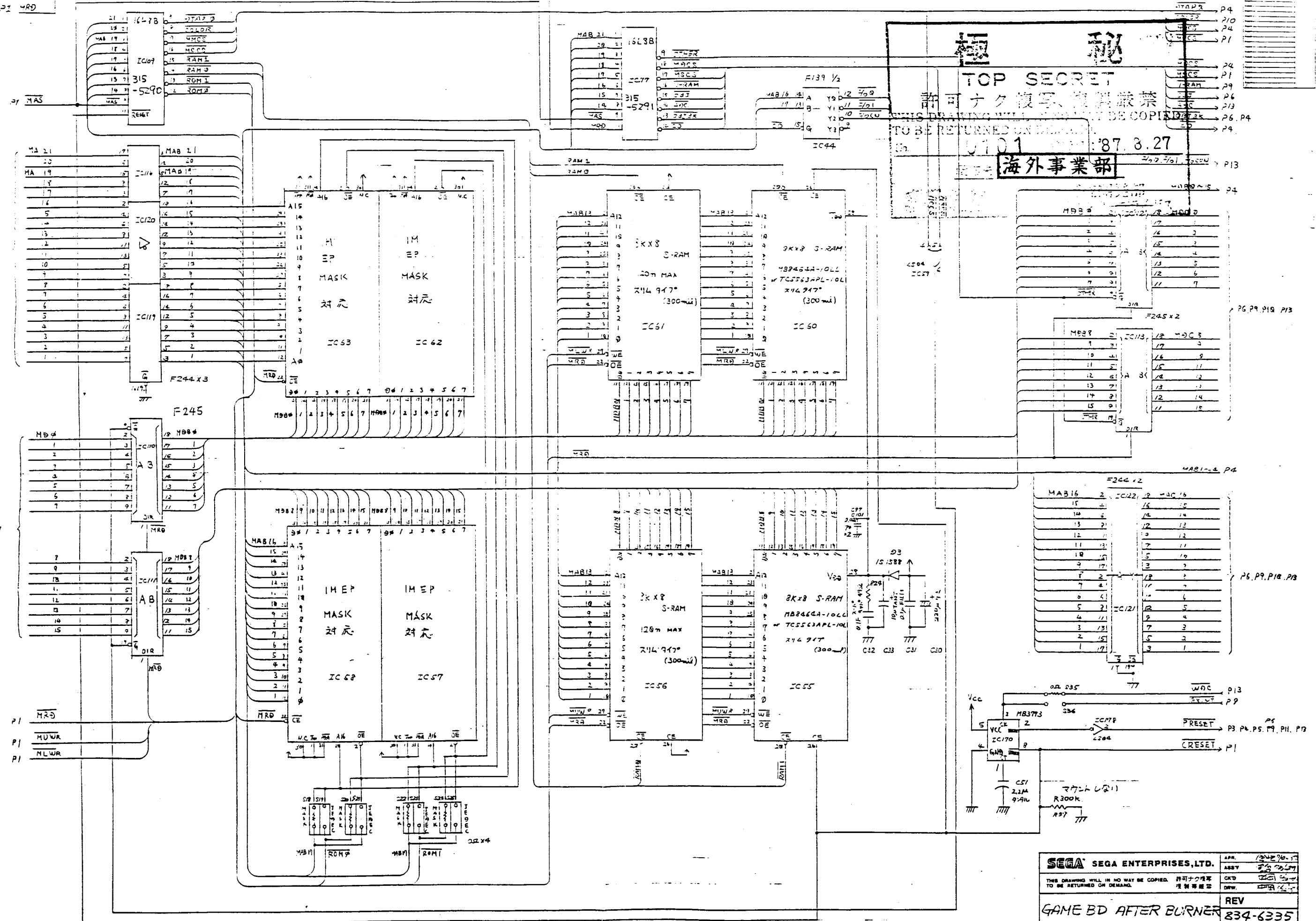

SEGA SEGA ENTERPRISES, LTD.

THIS DRAWING WILL IN NO WAY BE COPIED. 許可なく複製、複製厳禁
TO BE RETURNED ON DEMAND. 複製厳禁

GAME BD AFTER BURNER

DESCRIPTION

REV 834-6335

SHEET 2 OF 13

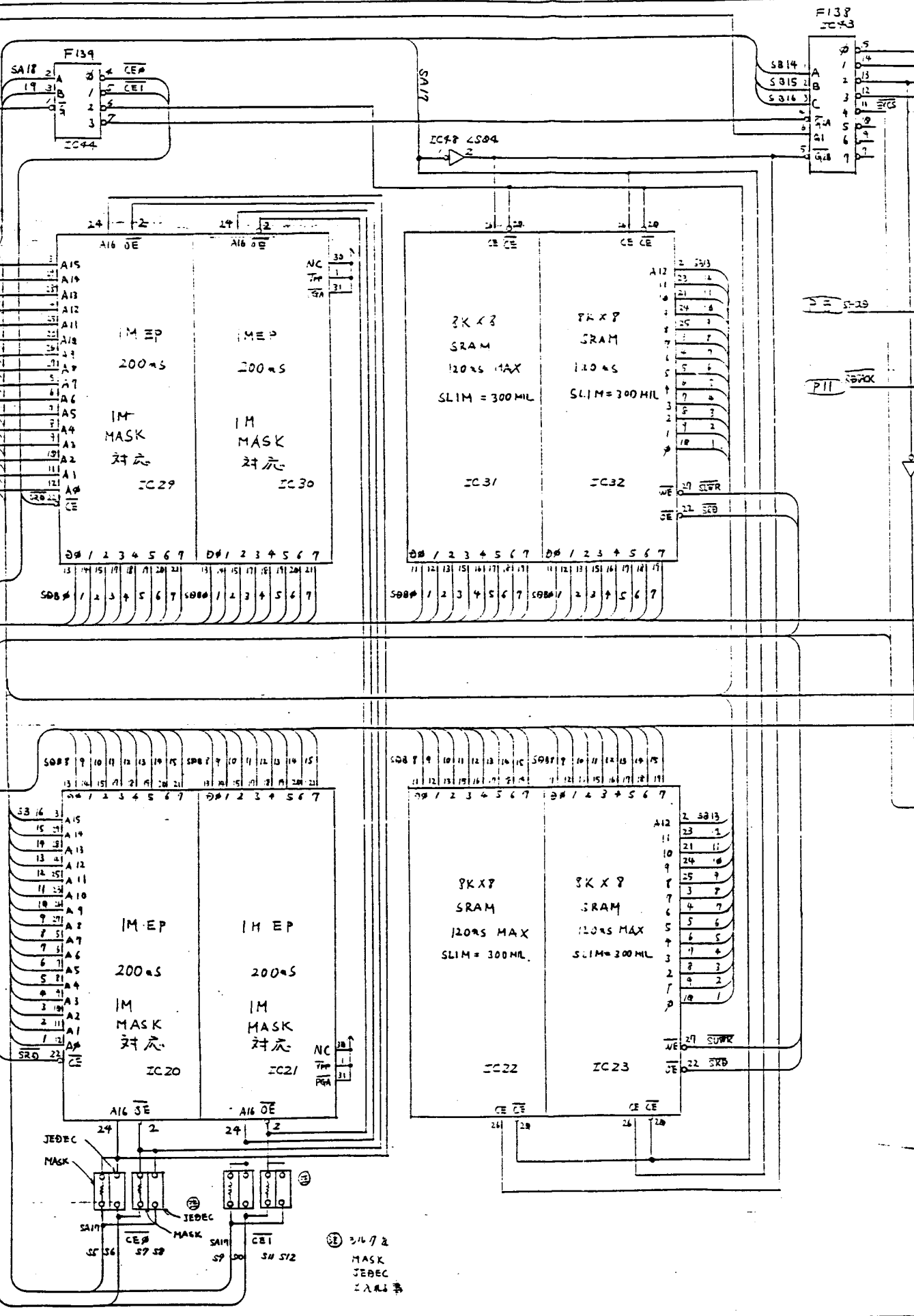
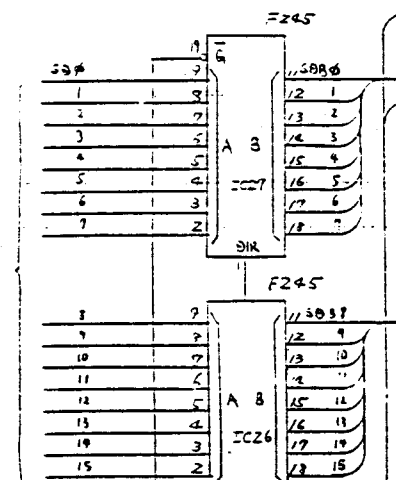
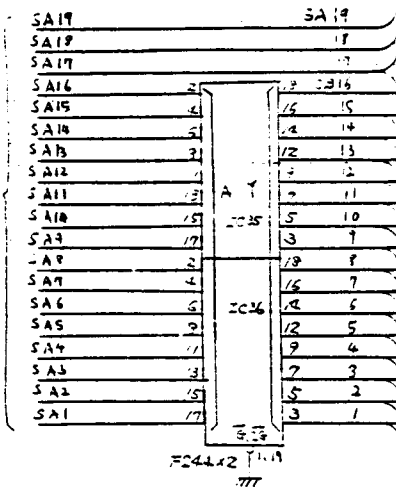

極秘

TOP SECRET

許可なく複写、複製厳禁

THIS DRAWING WILL IN NO WAY BE COPIED.
TO BE RETURNED ON DEMAND.

No. 0101

87. 8. 27

海外事業部

システム開発部

システムエンジニア

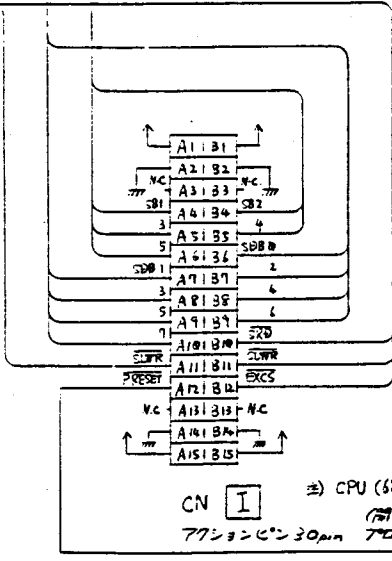

SEGA SEGA ENTERPRISES, LTD.	APR. 1987
THIS DRAWING WILL IN NO WAY BE COPIED. 許可なく複写、複製厳禁 TO BE RETURNED ON DEMAND. 複製厳禁	ASBY 2.2.76-4
DESCRIPTION	REV
GAME BD AFTER BURNER	834-6335
DESCRIPTION	PART NO.
Sub CPU Rom & Ram	SHEET 3 OF 13

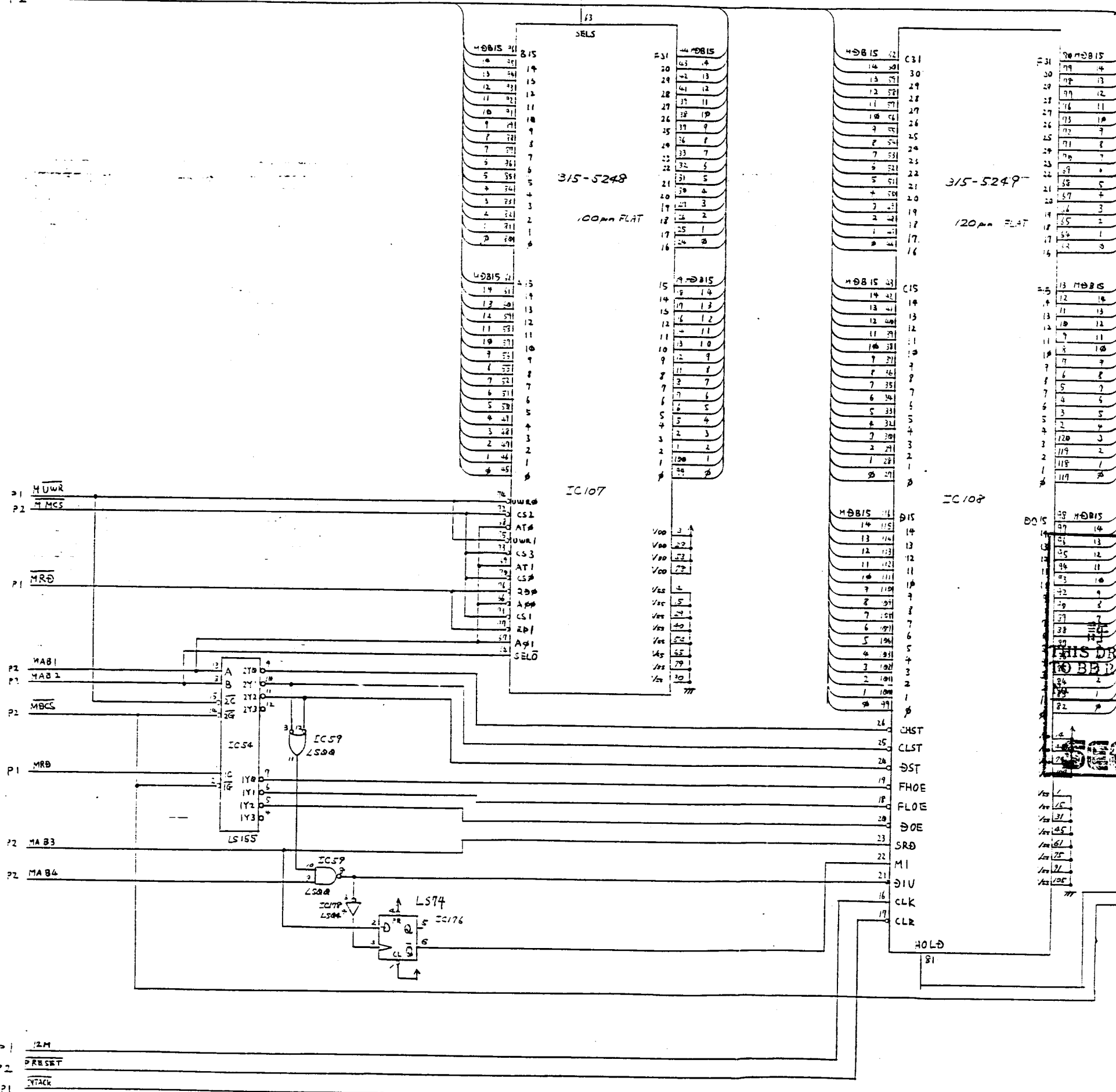

秘 秘
TOP SECRET
 許可なく複製、複製厳禁
 THIS DRAWING WILL IN NO WAY BE COPIED,
 NOR BE RETURNED ON DEMAND.
 0101 (Date: '87. 8. 27)
 配布先: 海外事業部

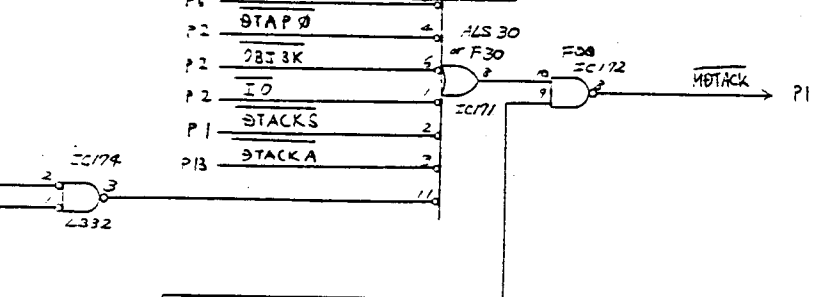

P1 12M
 P2 PRBSRT
 P1 STACK

SEGA SEGA ENTERPRISES, LTD.		APP.	27
THIS DRAWING WILL IN NO WAY BE COPIED, NOR BE RETURNED ON DEMAND. 許可なく複製、複製厳禁		ASBY	27
GAVIED AFTERBURNER		CHKD	27
DESCRIPTION		DRW.	27
		REV	
		PART NO.	
		SHEET 4	OF 12

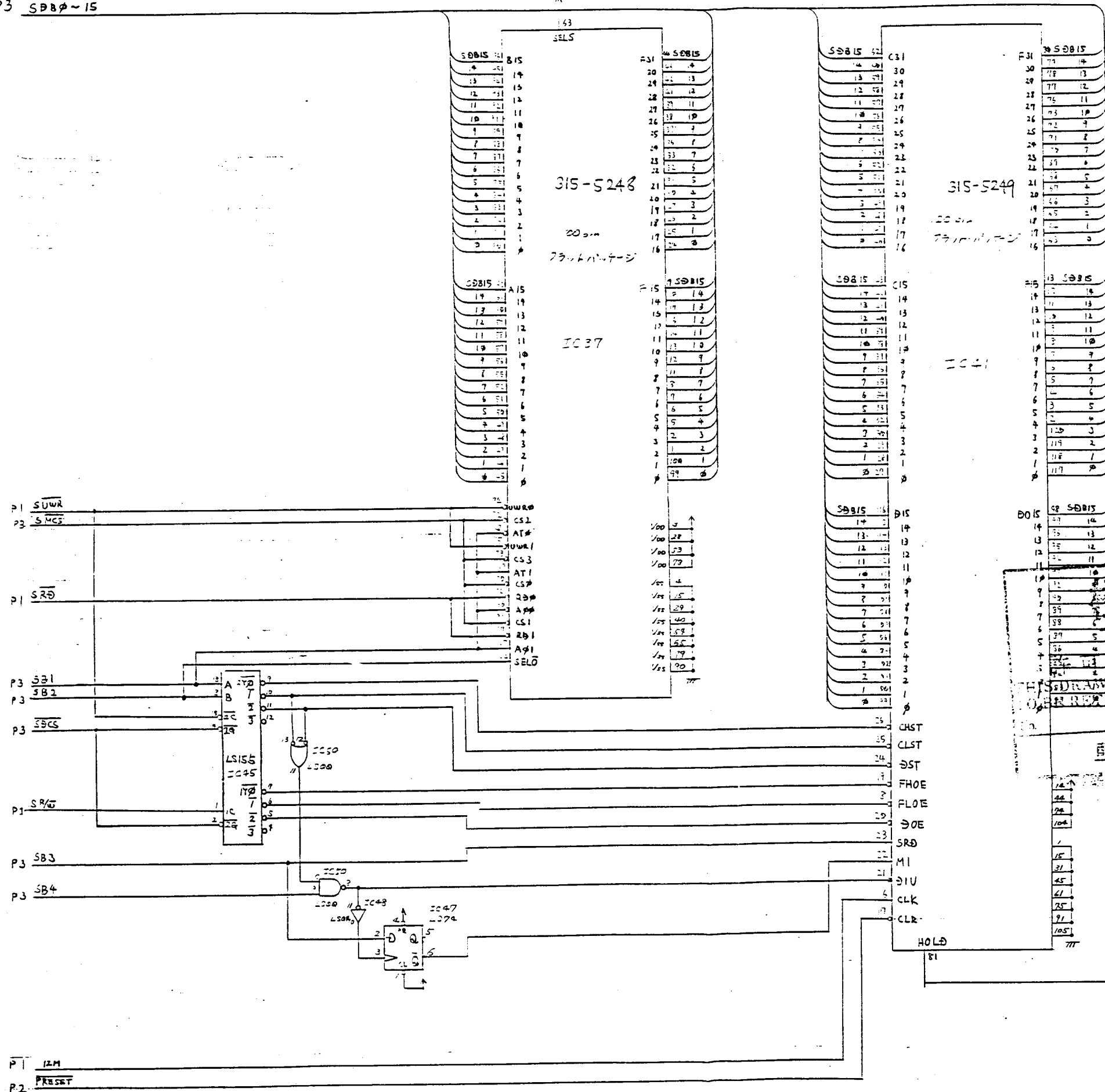
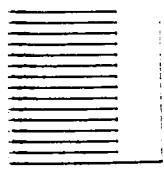

TOP SECRET
 ナク複写、複製厳禁
 THIS DRAWING WILL IN NO WAY BE COPIED,
 OR BE RETURNED ON DEMAND.
 0101 発行日 1978.8.27
 配前先: **海外事業部**
 第四研究開発部
 エンタープライゼス

SHOLD → P3

SEGA SEGA ENTERPRISES, LTD.		APP.	2001-17
THIS DRAWING WILL IN NO WAY BE COPIED, OR BE RETURNED ON DEMAND. 許可なく複製、複製厳禁		ASBY	2001-17
GAMEED AFTER BURNER		CKD	2001-17
		DRW.	2001-17
DESCRIPTION		REV	
PART NO.		PART	NO.
SHEET		3	3

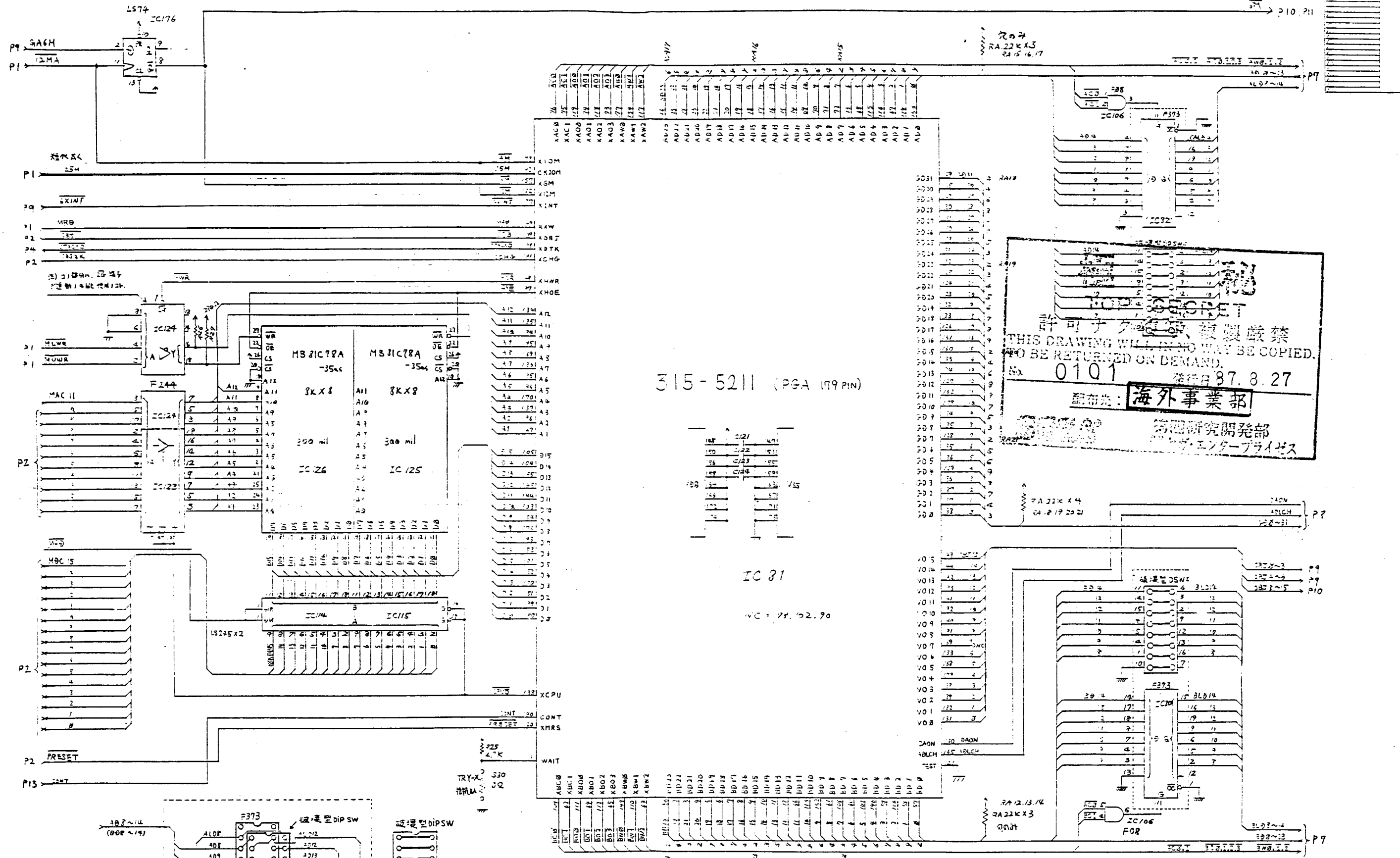

315-5211 (PGA 199 PIN)

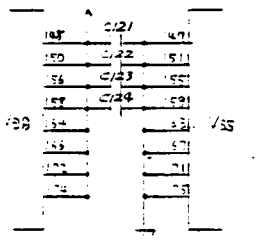

IC 81

VC = 74.02.90

許可なく複製厳禁
THIS DRAWING WILL IN NO WAY BE COPIED.
NO BE RETURNED ON DEMAND.
No. 0101 発行日 87. 8. 27
配布先: 海外事業部
第四研究開発部
エンタープライズ

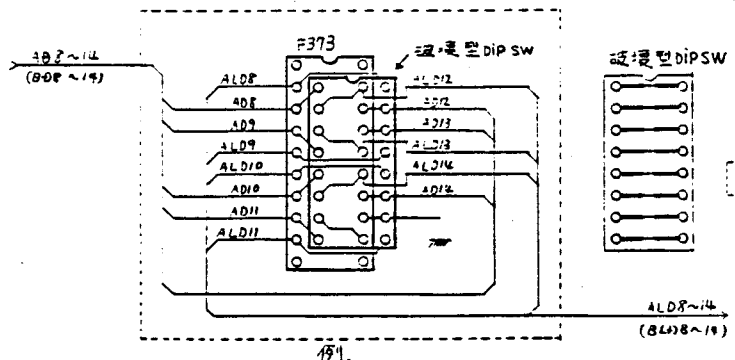

当該回路の回路は、F373 破損型 DIP SW の利し替えにより、ALD8~14 の出力が、ALD8~14 のみか、ALD8~14 の出力として使用できるようにアウトする。
③ 破損型 DIP SW が 0.2 x 2 で代用しても OK

SEGA SEGA ENTERPRISES, LTD.		APR. 1987
THIS DRAWING WILL IN NO WAY BE COPIED. 許可なく複製 TO BE RETURNED ON DEMAND. 複製厳禁		ASBY 〇〇〇〇〇
GAME BD AFTER BURNER		REV
DESCRIPTION		PART NO.
Motion Window CKT		SHEET 6 OF 8

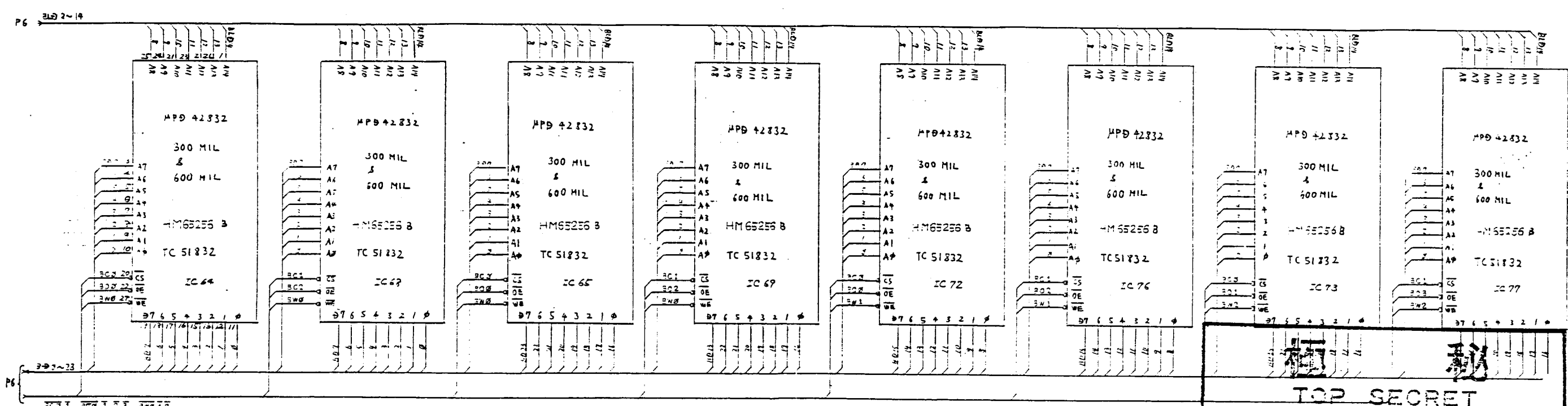
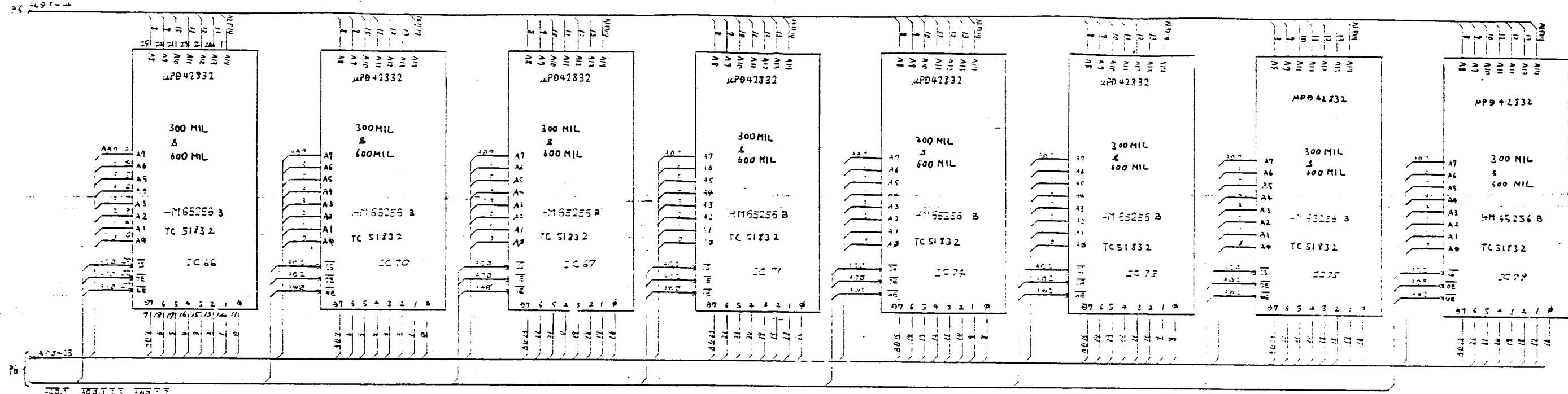

(191)

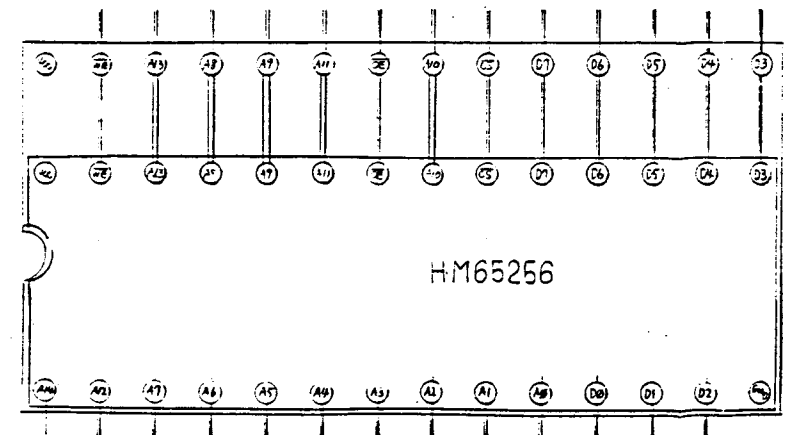

- HM65256 μ PD42832, TC51832 について
- HM65256を使用する場合は PSで DIP SW 2使用す
 - μ PD42832 or TC51832 を使用する場合は DIP SW 3使用す
 - 77C914 は Acc 6120a とす

TOP SECRET

許可ナク複製、複製厳禁
THIS DRAWING WILL IN NO WAY BE COPIED,
TO BE RETURNED ON DEMAND.

0101 0001 '87 8.27

配管先: **海外事業部**

研究開発部
システム部

SEGA SEGA ENTERPRISES, LTD.	APP. 1/22/87
THIS DRAWING WILL IN NO WAY BE COPIED, TO BE RETURNED ON DEMAND.	ASBY 22/87
許可ナク複製、複製厳禁	CHKD 中野 22/87
	DRW. 中野 22/87
GAME BD AFTER BURNER	REV
DESCRIPTION	PART NO.
Machine Guns	SHEET 17 of 13

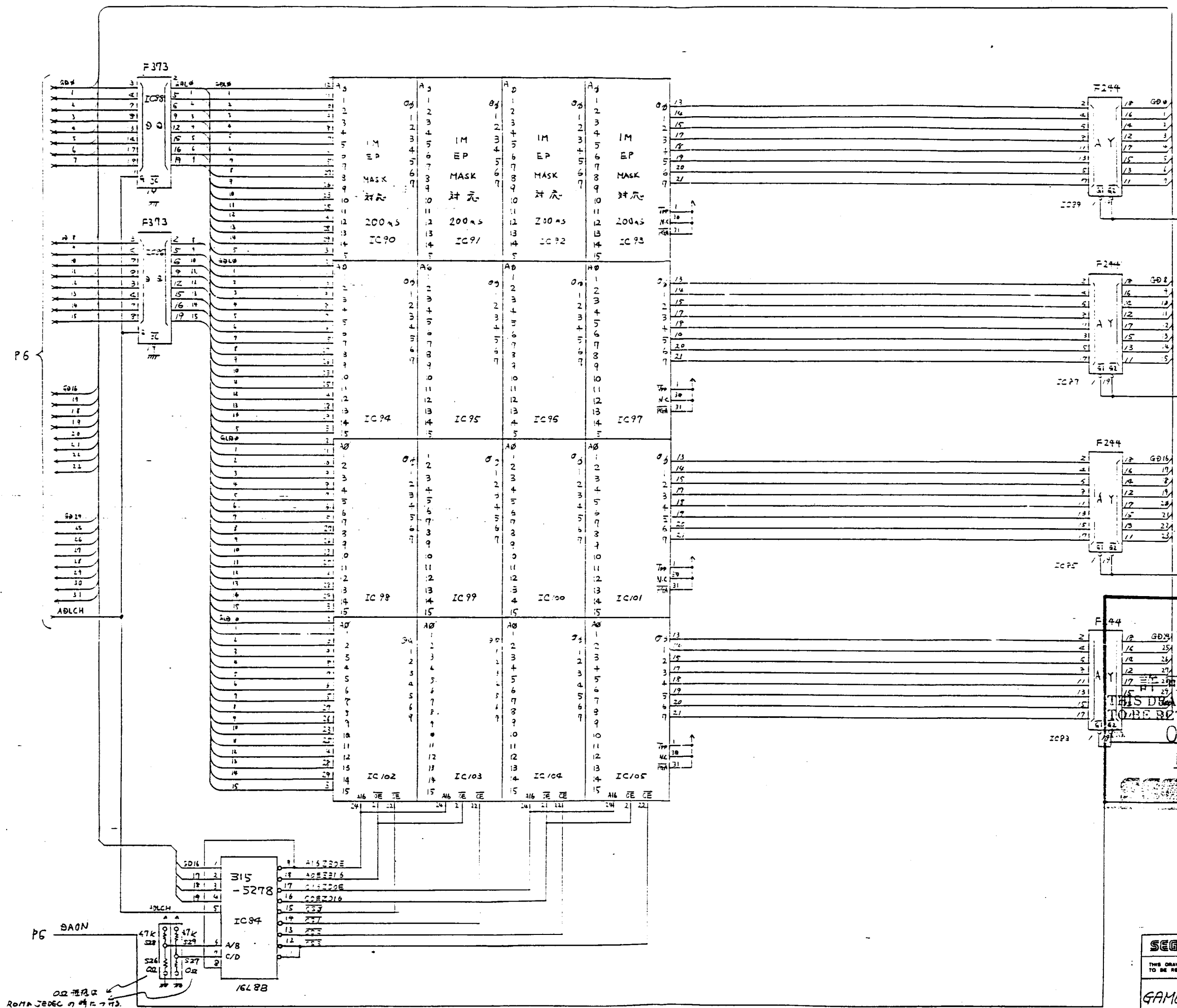

P6

9A0N

02 規格品
ROM JEDEC の時に付す。

極 秘
TOP SECRET

許可なく複製、複製厳禁
THIS DRAWING WILL IN NO WAY BE COPIED,
TO BE RETURNED ON DEMAND.

0101 発行日: '87. 8. 27

配布先: **海外事業部**

SEGA SEGA ENTERPRISES, LTD.	APP	2/2/87
THIS DRAWING WILL IN NO WAY BE COPIED, TO BE RETURNED ON DEMAND.	ASBY	2/2/87
GAME BD AFTER BURNER	CKD	中島
	DRW	中島
DESCRIPTION	REV	
	PART NO.	
Motion Picture Table	SHEET	2 of 13

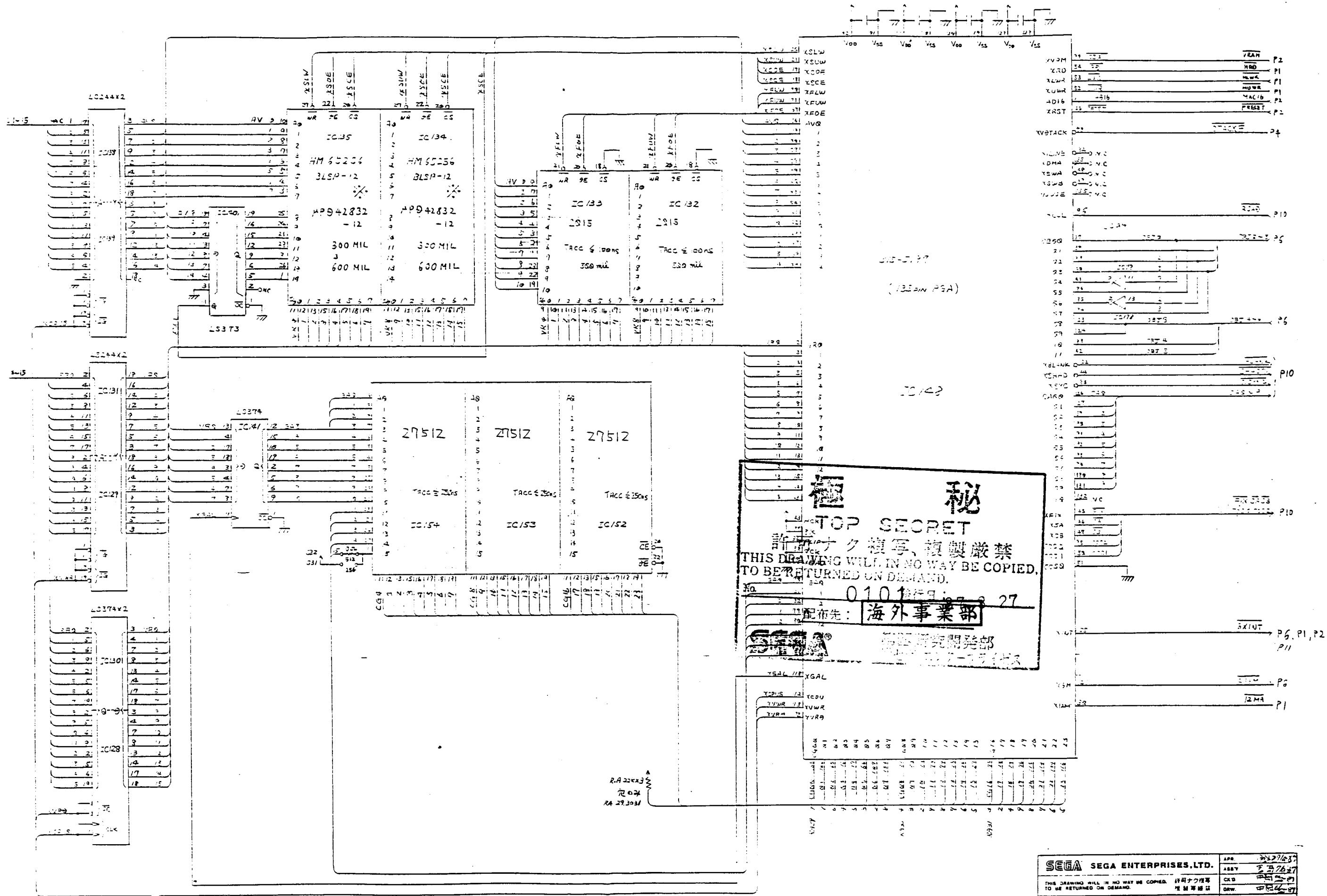

極 秘
TOP SECRET
 この図面は複製、転写、複製厳禁
 THIS DRAWING WILL IN NO WAY BE COPIED,
 TO BE RETURNED ON DEMAND.
 No. 0101
 配布先: 海外事業部
 SEGA 株式会社 開発部

HM 55254 X2 = 1987年 9月22日 作成

SEGA SEGA ENTERPRISES, LTD.	APR 20/87
THIS DRAWING WILL IN NO WAY BE COPIED, TO BE RETURNED ON DEMAND. 許可なく複製、転写、複製厳禁	ASBY 多田 26/87
SAME ED AFTER BURNER	CKD 多田 26/87
DESCRIPTION	DRW 多田 26/87
Background CRT	REV
	PART NO.
	SHEET 7 of 13

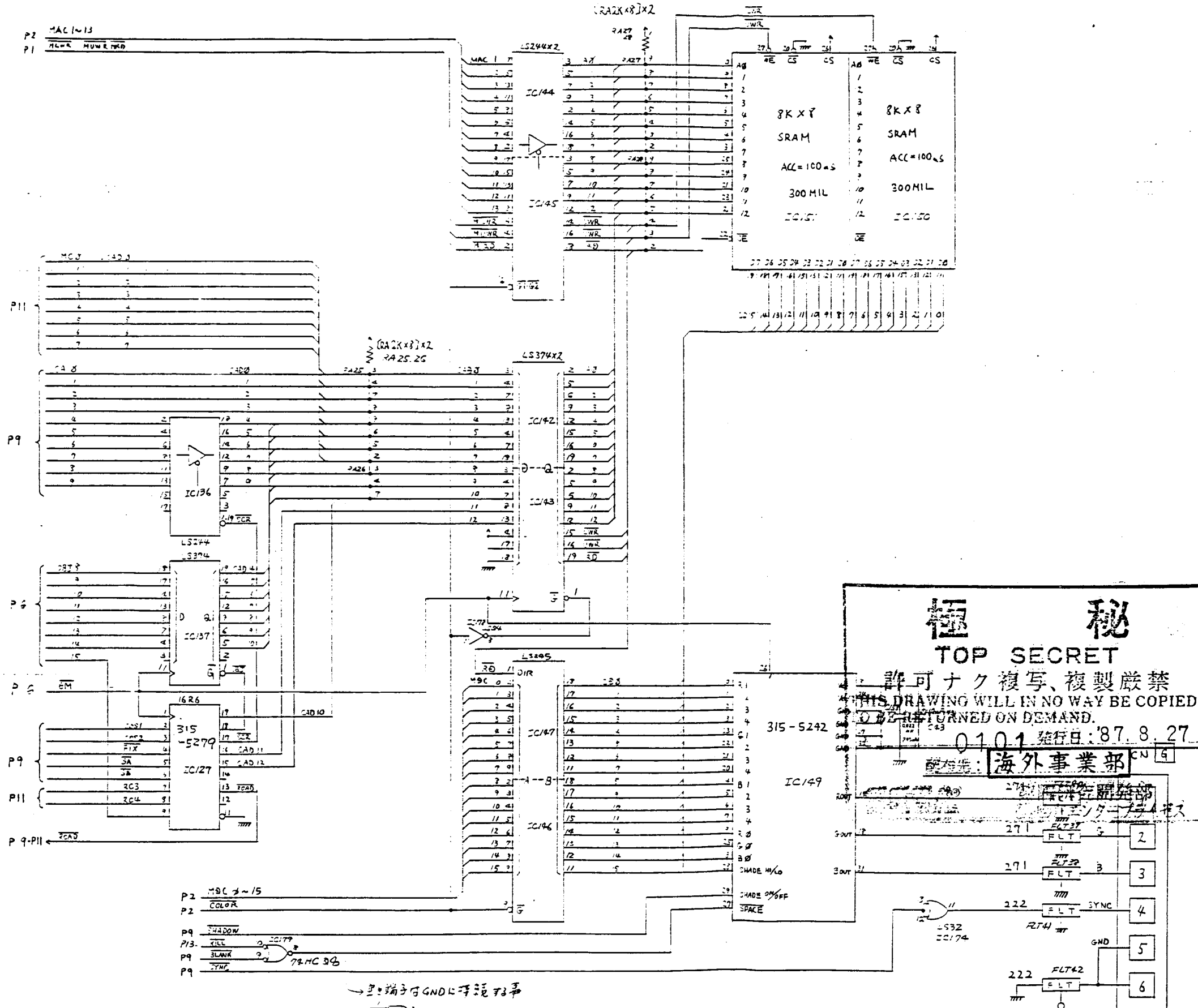
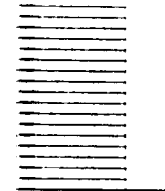

極 秘
TOP SECRET
 許可ナク複写、複製厳禁
 THIS DRAWING WILL IN NO WAY BE COPIED,
 REPRODUCED OR RETURNED ON DEMAND.
 0101 発行日: '87. 8. 27
 配付先: 海外事業部

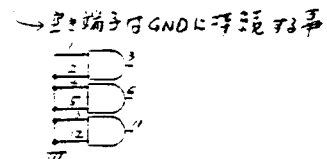

6pin JST

SEGA SEGA ENTERPRISES, LTD.		APP	2-2-3
THIS DRAWING WILL IN NO WAY BE COPIED, REPRODUCED OR RETURNED ON DEMAND. 許可ナク複写、複製厳禁		ASBY	2-5-17
GAME ED AFTER BURNER		CKD	2-5-17
DESCRIPTION		DRW	2-5-17
Color Output Pk		REV	
PART NO.		SHEET	10 of 12

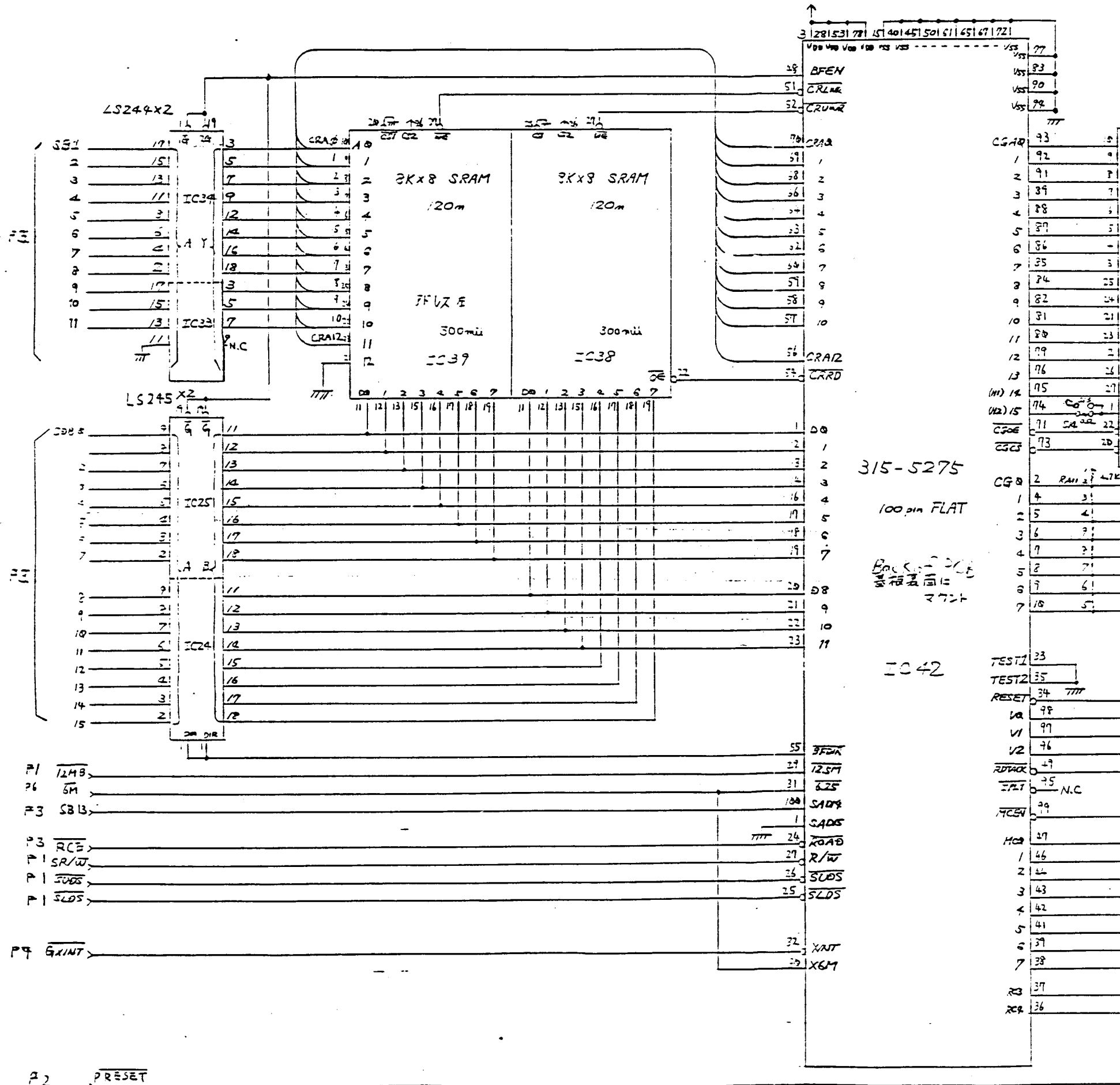

3 28 15 31 77 157 401 457 501 511 451 67 172 1

49 BFEN
51 CR2AR
52 CR2AR
70 CRA2
71
72
73
74
75
76
77
78
79
80
81
82
83
84
85
86
87
88
89
90
91
92
93
94
95
96
97
98
99
100

CG48 93
1 92
2 91
3 89
4 88
5 87
6 86
7 85
8 84
9 82
10 81
11 80
12 79
13 76
14 75
15 74
16 71
17 73
CG49 2
1 4
2 5
3 6
4 7
5 8
6 9
7 10

315-5275
100 pin FLAT

Back - 30E
372H

IC42

TEST1 33
TEST2 35
RESET 34
V0 98
V1 99
V2 96
RDACK 47
FRT 35
FCS 39
MCO 37
1 46
2 44
3 43
4 42
5 41
6 39
7 38
R3 37
R4 36

275/2

TOP SECRET

許可なく複製、複製厳禁
THIS DRAWING WILL IN NO WAY BE COPIED, TO BE RETURNED ON DEMAND.

No. 0101 発行日: '87. 8. 27

配前先: 海外事業部

SEGA

SEGA SEGA ENTERPRISES, LTD.		APP. 275/2
THIS DRAWING WILL IN NO WAY BE COPIED, TO BE RETURNED ON DEMAND.		ASBY 275/2
DESCRIPTION		CHKD 275/2
GAME BD AFTER BURNER		DRW. 275/2
REV	REV	
DESCRIPTION	REV	275-6335
PART NO.	PART NO.	
SHEET 11	SHEET 12	

Road CKT

P1 12A8
P6 5M
P3 SB13
P3 RC3
P1 SR/W
P1 SLD5
P1 SLD5
P9 GXINT

55 BFEN
27 12SM
31 625
100 SLD4
1 SADS
24 ROAD
27 R/W
26 SLD5
25 SLD5
32 XANT
29 X6M

P2 PRESET

V0 98 → V0 P1
V1 99 → V1 P1
V2 96 → V2 P1
RDACK 47 → RDACK P3
FRT 35 → N.C.
FCS 39 → ROAD P10
MCO 37 → MCO P10
1 46 → 1 P10
2 44 → 2 P10
3 43 → 3 P10
4 42 → 4 P10
5 41 → 5 P10
6 39 → 6 P10
7 38 → 7 P10
R3 37 → R3
R4 36 → R4

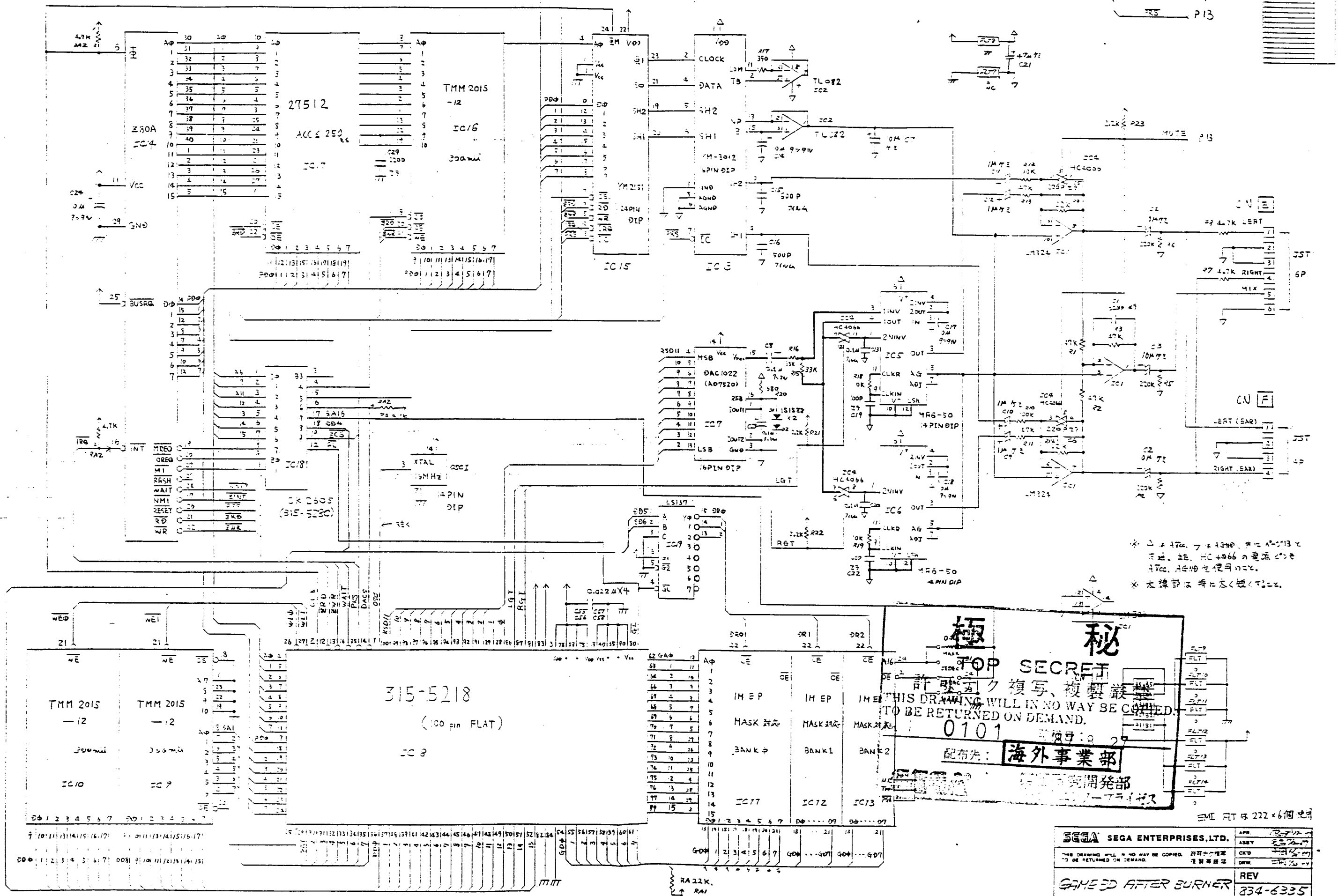

* この IC は AGND を使わずに AGND に接続して
 3ピン、2ピン、HC4066 の電源ピンを
 AGND、AGND を使用のこと。
 * 本線図は 手に 添く 趣く こと。

極 秘

TOP SECRET

計 画 書 複 写、複 製 厳 禁

THIS DRAWING WILL IN NO WAY BE COPIED,
 TO BE RETURNED ON DEMAND.

0101

配布先: **海外事業部**

開発部

SEGA SEGA ENTERPRISES, LTD.	APP. 2/27/87
THIS DRAWING WILL IN NO WAY BE COPIED, TO BE RETURNED ON DEMAND.	ASBY 2/27/87
GAME BOY AFTER BURNER	CKD 2/27/87
DESCRIPTION	REV 01
Sound Ckt	834-6335
	SHEET 12 OF 3

EMI FIT 係 222 x 6 個 使用

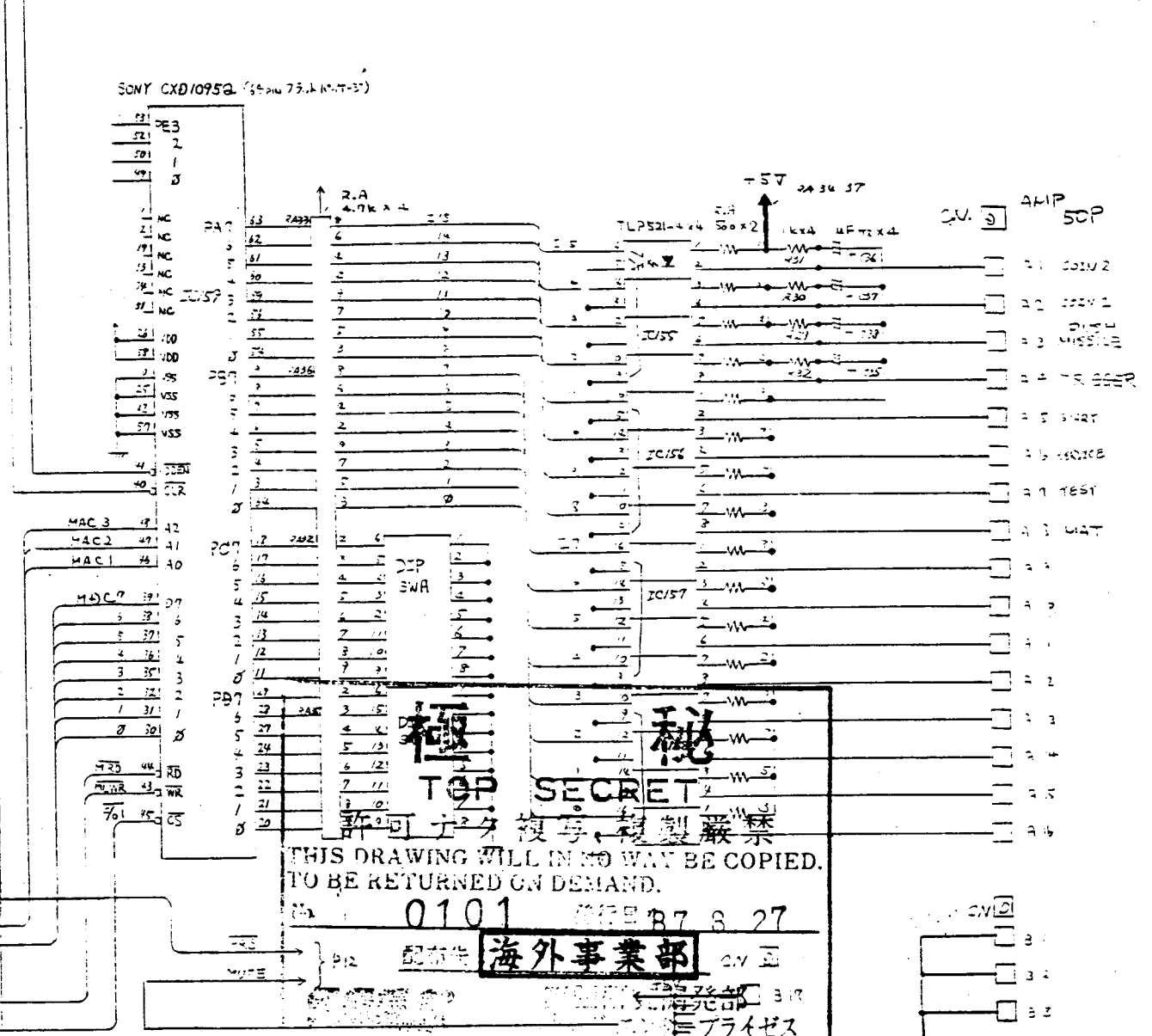
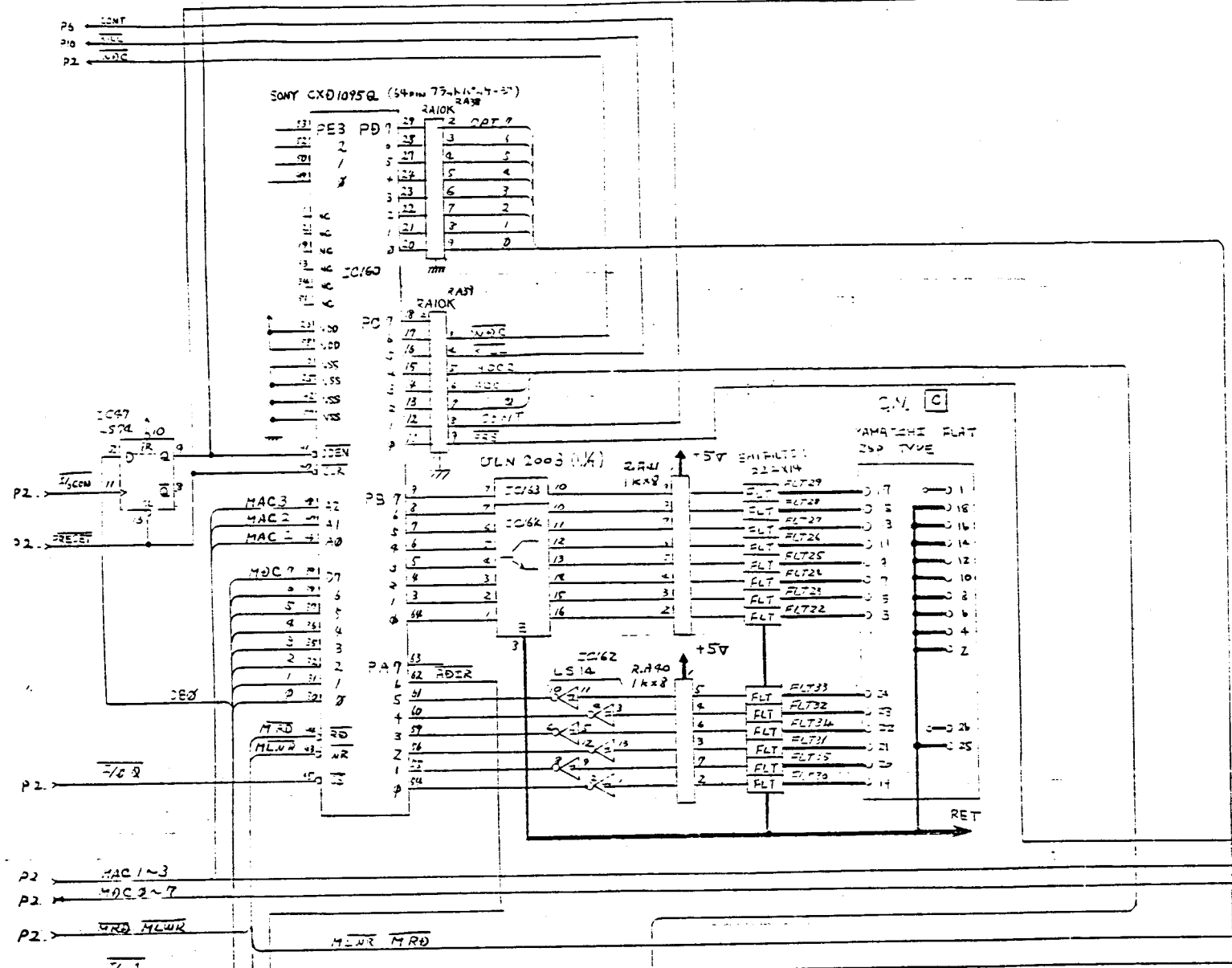

極 秘
TOP SECRET
許可なく複製・複製厳禁

THIS DRAWING WILL IN NO WAY BE COPIED.
TO BE RETURNED ON DEMAND.

0101 7878 27

海外事業部

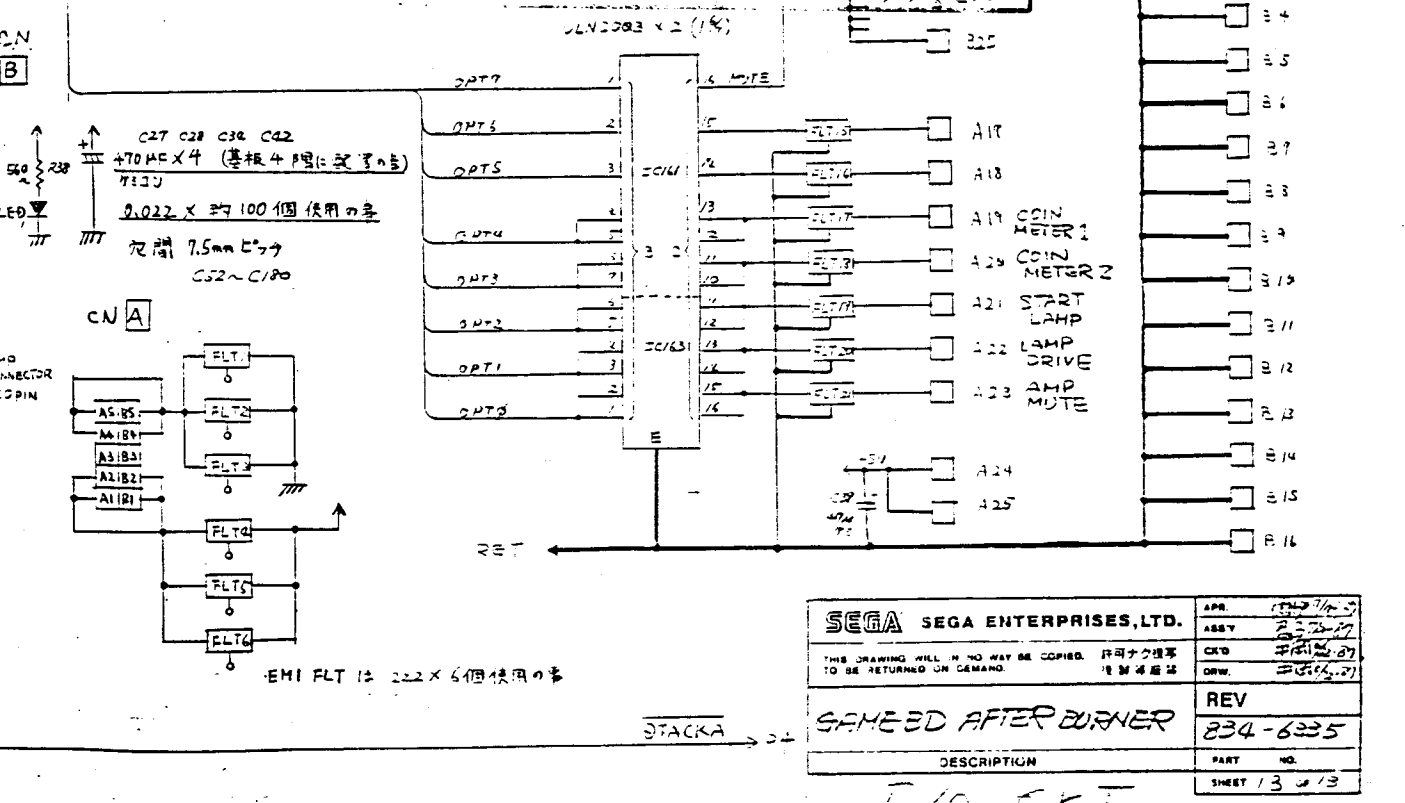
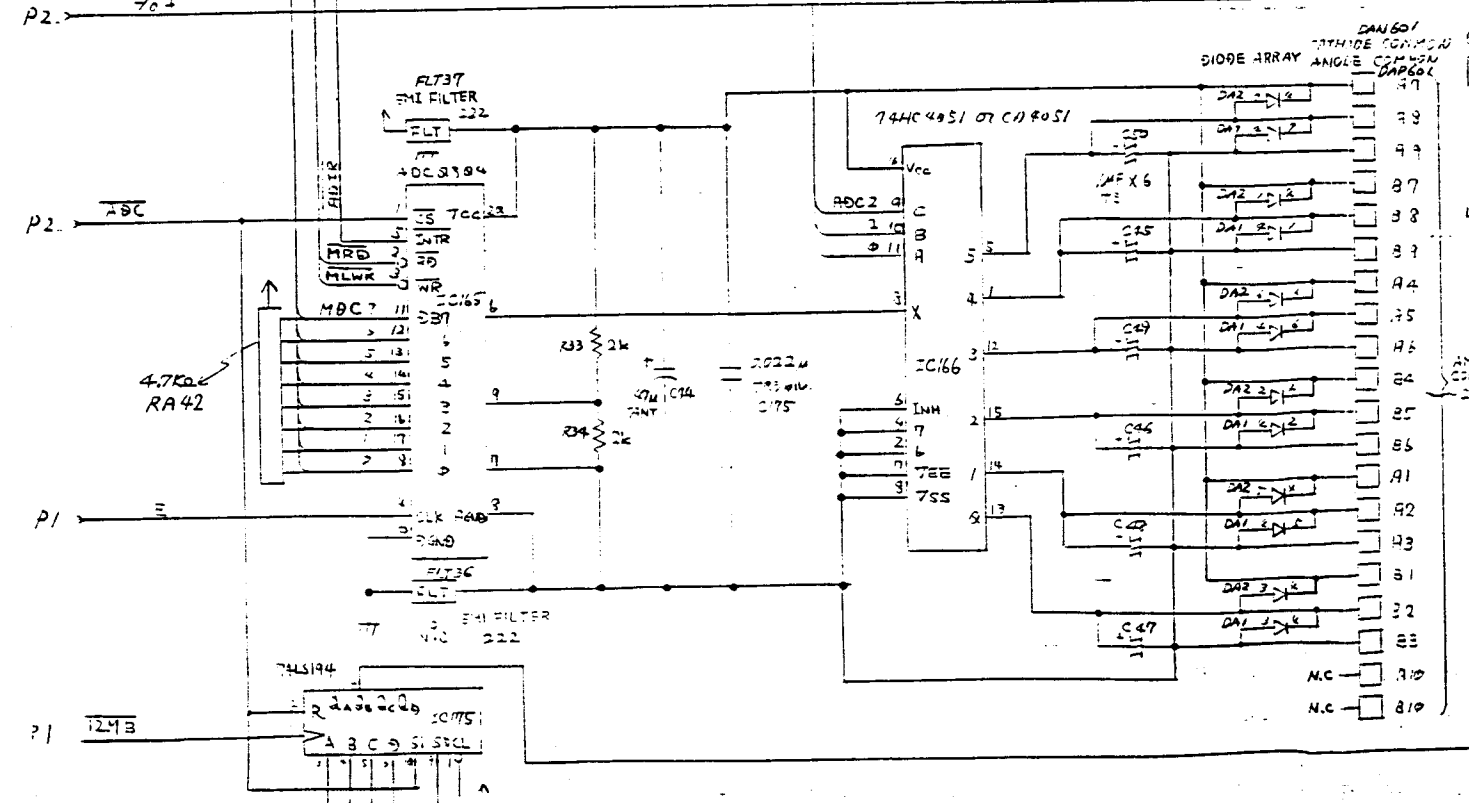

SEGA SEGA ENTERPRISES, LTD.		APP	REV
THIS DRAWING WILL IN NO WAY BE COPIED. 許可なく複製・複製厳禁		ASSY	834-6335
TO BE RETURNED ON DEMAND. 許可なく複製・複製厳禁		CHKD	834-6335
		DRW	834-6335
		REV	834-6335
DESCRIPTION		PART	NO.
SAME ED AFTER BURNER			
SHEET 13 of 13			

I/O CKT