



**Owner's Manual**

PERSONAL TELECOM, INC.  
[www.perstel.com](http://www.perstel.com)  
PMANWHF00040 (REV 1.0)

**DAB**  
*Digital Audio Broadcasting*

Portable Digital Audio  
**DR101**



## SAFETY PRECAUTIONS

To prevent injury and/or damage, take the following precautions:

- 1 Make sure you keep the antenna away from the mains or high voltage electricity source.
- 2 Make sure you keep the Power switch at OFF position when replacing batteries.
- 3 Make sure the batteries are NOT reversed.
- 4 If the unit becomes very hot, turn off the power immediately and consult your adapt™, dealer.
- 5 Do not drop the unit on the ground or subject to strong shock.
- 6 Do not attempt to dismantle the unit.
- 7 Keep the unit away from water or damp environments.
- 8 Keep away from direct sunlight or excessive heat or humidity.
- 9 Remove the batteries when you do not use the product for a long time.
- 10 Do not clean the unit with chemicals such as benzene and alcohol.



## WHAT IS DAB ?

The DAB system is a new digital format, which can provide crystal-clear, near CD-quality audio and good reception even when moving in cars or trains.

A DAB broadcast consists of a high speed data stream on a radio channel called an Ensemble.

An Ensemble is made up of several service components, which can be individual radio stations or data services. Each service, or station can carry other useful information in addition to the audio signal, such as the name of the station, news headlines or programme information. This is displayed on your DR101 when the station is selected.

A key feature of DAB radio is that stations can be added when additional channels are required for a particular time and events. For example, an extra secondary station or secondary service could be added for the commentary on a sports event. At the end of the event, the listener is automatically returned to the primary service or station.



## CONTENTS

## CONTENTS

### 1. PREPARATION

1 What is in the Box? .....	7
2 Controls Diagram .....	8
3 Keys and Buttons .....	9
4 LCD Display .....	10
5 Preparation to Use .....	11

### 2. GETTING STARTED

1 Power ON/OFF .....	13
2 Antenna Setting .....	13
3 Volume Control .....	14

### 3. DAB OPERATION

1 Ensemble Tuning .....	15
2 Service Component Selection .....	19
3 Display Other Service Information .....	19

### 4. DR101 SETTING

1 DR101 Other Modes and Settings .....	21
2 Adjustment of Display .....	23
3 Button Hold .....	24

### 5. FM OPERATION

1 Switching to FM Radio Mode .....	26
2 Frequency Tuning .....	26

### 6. BATTERY AND MAINS OPERATION

1 Battery Operation .....	29
2 Mains Operation .....	29

## APPENDICES

Appendix 1 Menu Tree - DAB Block .....	30
Appendix 2 Menu Tree - FM Radio Block .....	31
Appendix 3 Ensemble Information Example .....	32
Appendix 4 Regional Frequency Table .....	33
1 BAND-III (Europe) .....	33



## CONTENTS

## 1.PREPARATION

2 L-BAND (Europe) .....	34
3 L-BAND (Canada) .....	34
<b>Appendix 5</b> Troubleshooting .....	35
<b>Appendix 6</b> Specifications .....	37
<b>Appendix 7</b> Information on Digital Radio Services in the United Kingdom .....	38
<b>WARRANTY</b>	
1 About Warranty Service .....	48
2 Product Information .....	49
3 Warranty Exclusion .....	49
4 Warranty Statement .....	49

### 1 What is in the Box?

- DR101 DAB Digital Radio Receiver
- Stereo Earphone
- Owner's Manual
- 2 AA Alkaline Batteries
- Carrying Case
- Adaptor

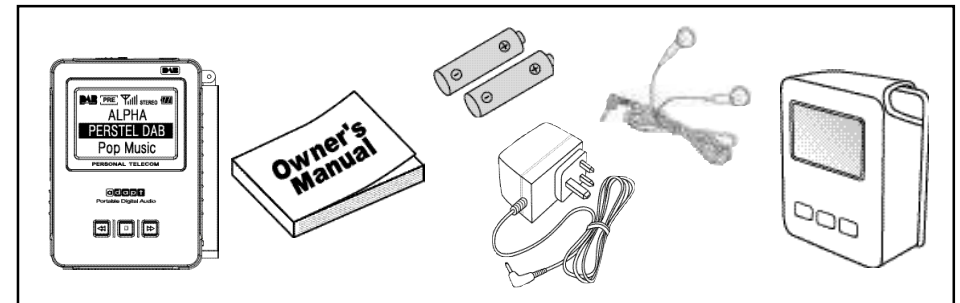



# 1.PREPARATION

# 1.PREPARATION

## 2 Controls Diagram

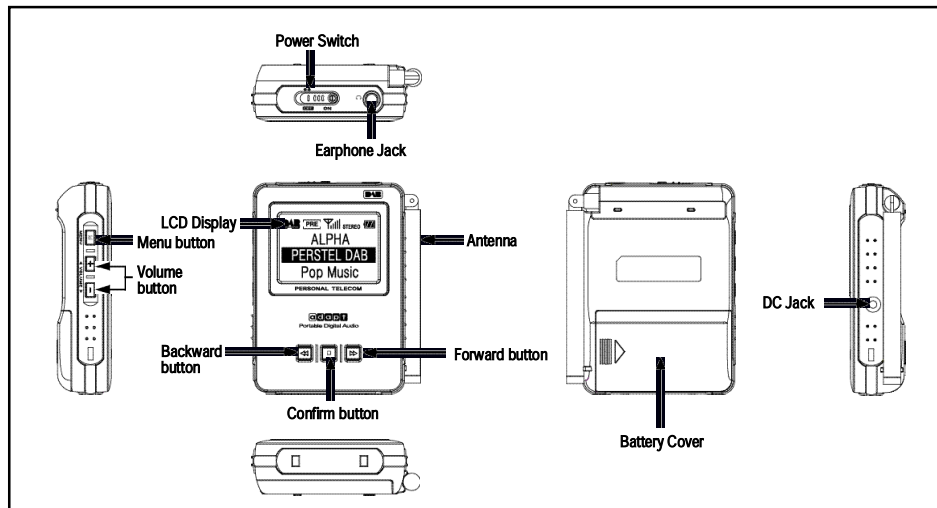

## 3 Keys and Buttons



Keys & Buttons	Name	Functionality
	Power ON /OFF	Slide to turn on / off
	Confirm	Push to select channel in [MENU] mode Push to select highlighted line DAB mode.
	Forward	Push to search next CHANNEL or MENU item Push and hold for auto forward search
	Backward	Push to search previous CHANNEL or MENU item Push and hold for auto backward search
	Volume up	Push to increase volume Push and hold for continuous control
	Volume down	Push to decrease volume Push and hold for continuous control
	Menu	Press to enter the [MENU] Press to exit the [MENU]



## 1.PREPARATION

## 1.PREPARATION

### 4 LCD Display

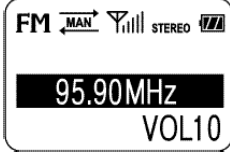
DAB Mode		FM Radio Mode
		
Fully Tuned	Volume Adjusting	Fully Tuned

### 5 Preparation to Use

#### · Battery insertion/replacement

Make sure the power switch is on "OFF" position before battery insertion or replacement.

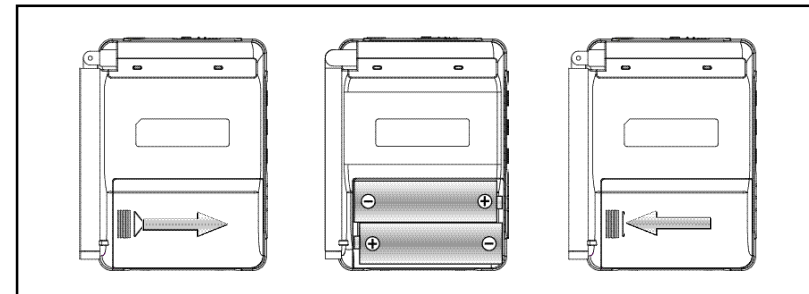

- ① Push the arrow marking on the battery cover stripe and slide the battery cover to the right to open the battery cover.
- ② Insert two (2) AA sized alkaline batteries into the compartment following the polarity indication.  
(Pull the ribbon to release old batteries for replacement.)
- ③ Place the battery cover on the original position and slide it to the left until it clicks.



## 1. PREPARATION

④ For safety purpose, remove batteries from the unit when not used for a long time.

### · Plug-in Earphone

Before use, plug in the Earphone gently into the Earphone jack on top of the unit. Make sure you use the earphone supplied or one designed for stereo portable voice systems to avoid possible damages.

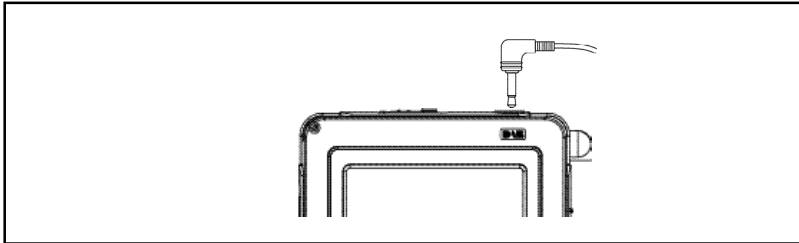

## 2. GETTING STARTED

### 1 Power ON/OFF

① Slide Power Switch to "ON" position. The display will turn on in few seconds.

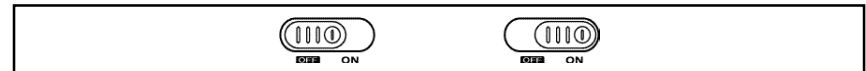

② DR101 saves last station and settings when powered off. When DR101 is powered on again, it automatically recalls and resumes operation at the last saved status.

③ To turn the unit off, slide the Power Switch to the "OFF" position.

### 2 Antenna Setting

Depending on the model and the country of use, the DR101 is designed to work either at Band-III or L-Band, or both.

In order to maximize receiving performance you may need to adjust antenna length.

For optimum reception in Band III the antenna should be fully extended.

In strong signal areas it is possible to reduce the antenna length without loss of quality.

· When reception is weak you may need to redirect antenna position for better reception.

· Refer to Regional Frequency Table at Appendix 4.



## 2.GETTING STARTED

## 3.DAB OPERATION

### 3 Volume Control

Adjust volume level to a desired position by pressing Volume (+ / -) button. DR101 has 21 steps of volume control. When volume control button is pressed and held volume level will gradually be raised or lowered. This volume control feature is common to DAB and FM Radio Mode.

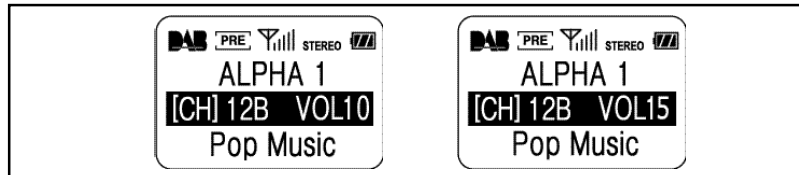

### 1 Ensemble Tuning

When DR101 is turned on in DAB Radio mode, it begins tuning to the last received channel.

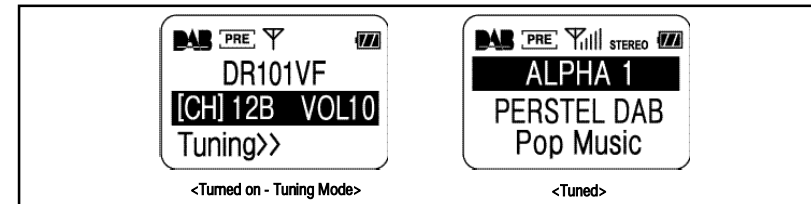

However when the incoming signal is weak or no signal is available, you will need to retune the receiver. The display will be as above <Tuned on - Tuning Mode>

#### Tuning an Ensemble: At Preset Tune mode (PRE appears as Tuning Icon)

- ① Press (▶) or (◀) repeatedly until the desired channel is displayed.
- ② When tuned to the desired channel, it may take 1 - 2 seconds for the receiver to capture the signal and the display will change to <Tuned> as shown above.
- ③ When tuned, the name of the Service Component or individual station is shown on the first line of the display, and this line is highlighted.





## 3.DAB OPERATION

- ④ The name of the Ensemble is shown on the second line of the display.
- ⑤ The third line of the display shows additional information called DLS. This will appear after 1 to 3 seconds and may show programme information, news headlines or other information depending on the station. It is possible to display other information on this line; (page 19).
- ⑥ Channel number and Volume level are replaced by the Ensemble name until next volume adjustment is made.

### · Tuning an Ensemble: At Manual Tune mode (MAN appears as Tuning Icon)

- ① Press (F2) or (F1) repeatedly until the desired channel is displayed.
- ② When tuned to the desired channel, it may take 1 - 2 seconds for the receiver to capture the signal and the display will change to <Tuned> as shown on previous page.
- ③ When tuned, the name of the Service Component or individual station is shown on the first line of the display, and this line is highlighted.
- ④ The name of the Ensemble is shown on the second line of the display.
- ⑤ The third line of the display shows additional information called DLS. This will appear after 1 to 3 seconds and may show programme information, news headlines or other information depending on the station. It is possible to display other information on this line; (page 19).
- ⑥ Channel number and Volume level are replaced by the Ensemble name until next volume adjustment is made.

## 3.DAB OPERATION

### · Changing the Ensemble (PRE or MAN appears as Tuning Icon)

- ① Press the Confirm (F1) button to highlight the second line of the display where the Ensemble name is displayed.
- ② Press (F2) or (F1) repeatedly until the desired channel is displayed.

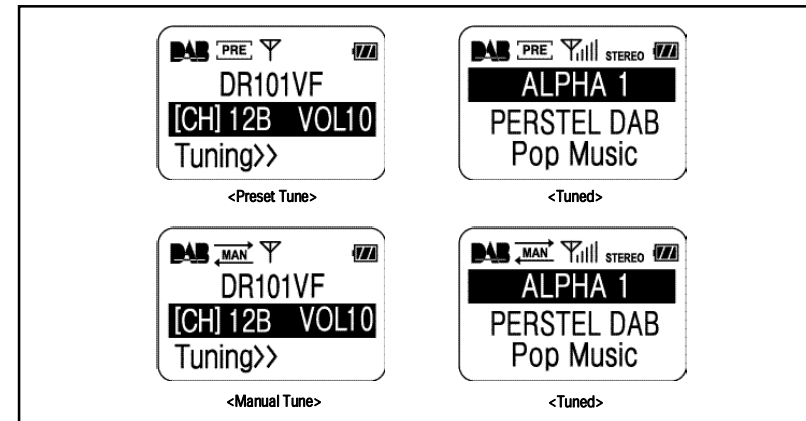



## 3.DAB OPERATION

### Automatic Tuning (AUTO appears as Tuning Icon)

- ① Press the Confirm (ENTER) button to highlight the second line of the display.
- ② Press and hold (RIGHT) or (LEFT) till AUTO appears as Tuning icon.

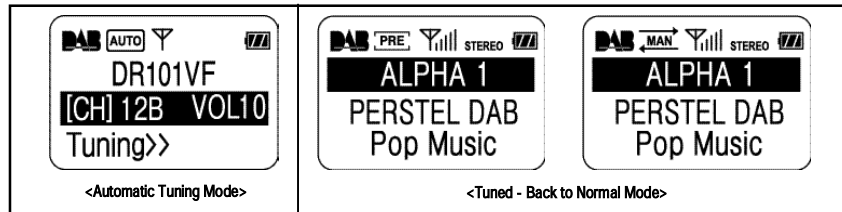

- ③ When signal is captured, the Ensemble name is displayed at second line while Primary Service Component name is on first line and other Service Information is on bottom line.
- ④ Tuning mode is then returned to normal mode displaying MAN or PRE as Tuning Icon.
- ⑤ When signal is not captured until the end of channel loop, the unit automatically moves to the first channel for tuning.

## 3.DAB OPERATION

### 2 Service Components Selection

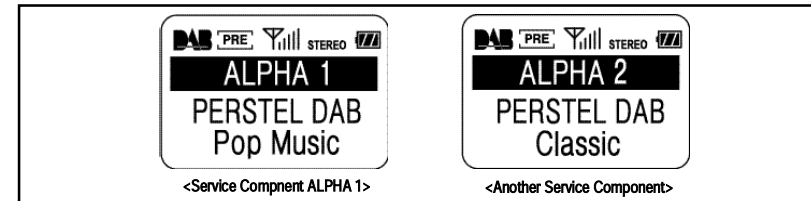

- ① When the unit is tuned, the highlighted line is the first line of the display where the Service Component name is displayed.
- ② Press (RIGHT) or (LEFT) button for other service components. Some Service components have "secondary service components" which may form an additional channel. These will be listed automatically after the primary component.

### 3 Displaying Other Service Information

When Ensemble and Service Component settings are done, you may wish to see other services provided by broadcasters.

- ① Press the Confirm (ENTER) button to highlight the third line of the display.



## 3.DAB OPERATION

## 4.DR101 SETTING

② Press (→) or (←) to see other available Service Information.

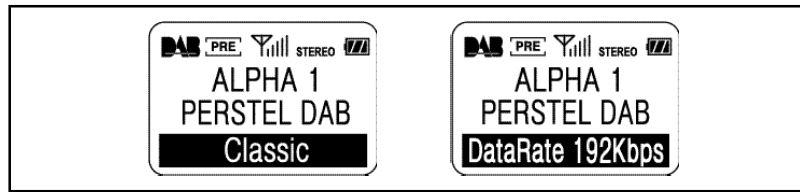

③ The following Service Information is available to be displayed.

Note that some of the information may not be available, depending on the station tuned.

- √ Dynamic Label
- √ Program type
- √ Data Rate Label
- √ Current Time (if transmitted by the service)
- √ DAB Mode information

**NOTE:** There are reserved preset channels with DR101 by region. DR101 works on preset channels at Preset Tune mode. Set DR101 at Manual Tune mode if you wish other channels than preset channels.

### 1 DR101 Other Modes And Settings: MENU Button (M)

DR101 has a FM Radio features in addition to the DAB receiver.

The mode of operation and other settings are controlled with the MENU button.

To change the DR101 mode ;

Press the MENU (M) button. The Menu will be displayed.

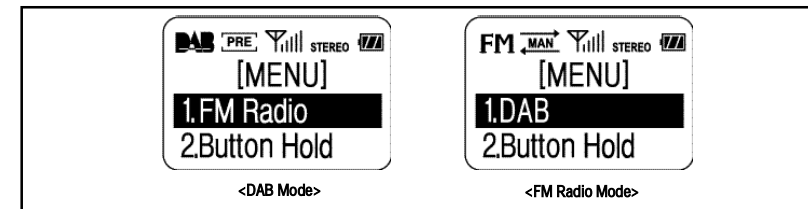

► The menu options are available in DAB mode

1. FM Radio
2. Button Hold
3. Backlight
4. Contrast
5. Preset Tune
6. Manual Tune



## 4.DR101 SETTING

## 4.DR101 SETTING

► These menu options are available in FM Radio mode

1. DAB
2. Button Hold
3. Backlight
4. Contrast

· Choose the desired Menu option by pressing ( ) or ( ) so that the desired selection is highlighted, and then press Confirm ( ) .

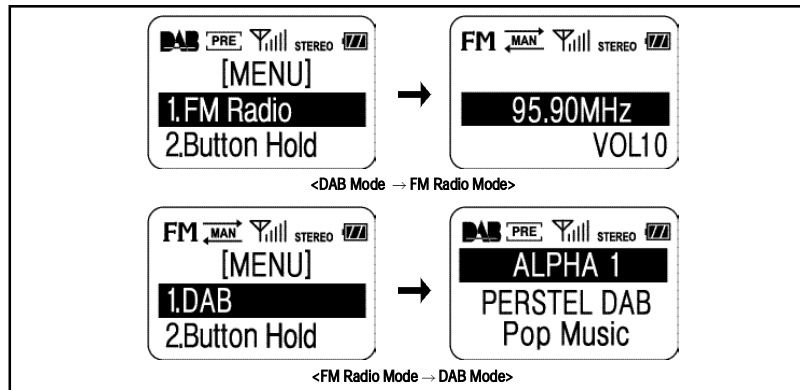

## 2 Adjustment of Display

It is possible to adjust the Backlight and Contrast level.

### · Backlight Setting

- ① Press the MENU ( ) button. The Menu is displayed.
- ② Press ( ) or ( ) so that the Backlight selection is highlighted, and then press Confirm ( ) .
- ③ Choose desired Backlight duration level by pressing ( ) or ( ) , and press Confirm ( ) .
- ④ To cancel and go back to the original setting, press the MENU ( ) button at anytime.

### · Contrast Setting

- ① Press the MENU ( ) button. The Menu is displayed.
- ② Press ( ) or ( ) so that the Contrast selection is highlighted, and then press Confirm ( ) .
- ③ Adjust Contrast level by pressing ( ) or ( ) , and press Confirm ( ) .
- ④ To cancel and go back to the original setting, press the MENU ( ) button at anytime.



## 4.DR101 SETTING

## 4.DR101 SETTING

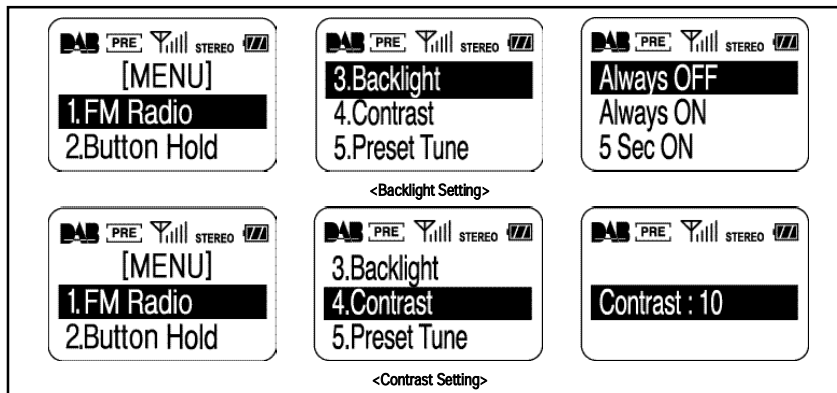

### 3 Button Hold

When DR101 is fully tuned and settings are personalised, you can lock the keys to prevent accidental button presses.

- ① Press the MENU ( ) button. The Menu is displayed.
- ② Press ( ) or ( ) button so that the **Button Hold** selection is highlighted, and then press Confirm ( ) to activate **Button Hold**.

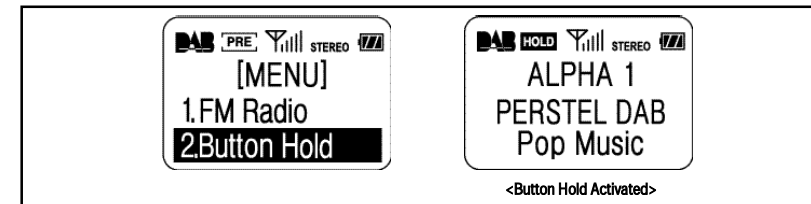

- ③ The HOLD icon appears when **Button Hold** is activated. No key operation is accepted.
- ④ To deactivate **Button Hold**, press the Confirm button ( ) for more than 2 seconds. HOLD icon disappears and key operation works normally.



## 5.FM OPERATION

### 1 Switching to FM Radio Mode

- ① Press the MENU ( ). The Menu is displayed.
- ② Choose the FM Radio option by pressing ( ) or ( ) so that the FM Radio selection is highlighted, and then press Confirm ( ).
- ③ The FM icon appears when the mode switching is done.



### 2 Frequency Tuning

#### · Manual Tuning

- ① To change the current frequency, press ( ) or ( ) until the desired frequency is displayed.
- ② When tuned in to a radio signal, the antenna signal bars and STEREO or MONO icons appear.

## 5.FM OPERATION

- ③ The tuning icon appears as (Normal mode + Manual Tuning mode).

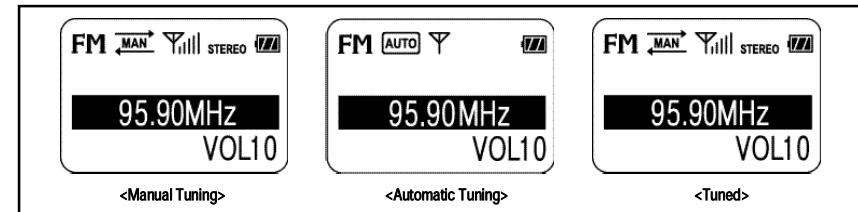

#### · Automatic Tuning

- ① When ( ) or ( ) is pressed and held the unit automatically searches next available frequencies.
- ② Tuning icon appears as (Automatic Tuning mode - Refer to above drawing).
- ③ The unit stops and stays tuned when next available channel is captured, and the Tuning icon switches back to .
- ④ Press ( ) or ( ) to stop Auto Tuning during Auto Tuning. Tuning stops and the unit returns to normal mode.
- ④ When the end of channels is reached, the unit continues tuning from the first channel.



## 5.FM OPERATION

## 6.BATRERY AND MAINS OPERATION

### Switching back to DAB Mode

- ① Press the MENU ( ) button. The Menu is displayed.
- ② Choose the DAB option by pressing ( ) or ( ) so that the DAB selection is highlighted, and then press Confirm ( ).
- ③ The DAB icon appears when Mode Switching is done.

NOTE :When switching to DAB or FM Radio modes, there is a time delay of a few seconds.

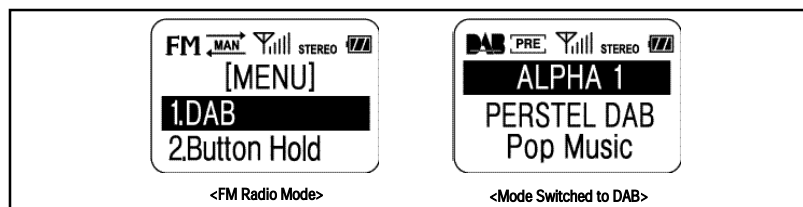

### 1 Battery Operation

DR101 is a battery operated radio, and the battery display icon displays the state of the battery. When battery icon blinks you must replace the batteries immediately.

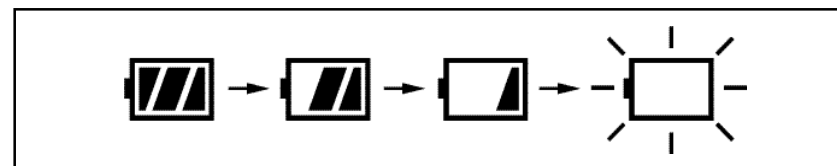

For battery replacement, refer to PREPARATION Guide at page 11. It is important to use high quality alkaline batteries for optimum performance.

NOTE : When the batteries are exhausted the display will show "Low Battery" and the DAB, FM Radio functions will not operate.

### 2 Mains Operation

The DR101 is supplied with a mains power adaptor. To connect, plug the adaptor into the socket on the side of the unit. The internal batteries are disconnected when the power adaptor is plugged in.



## APPENDICES

## APPENDICES

Appendix 1 Menu Tree - DAB Block

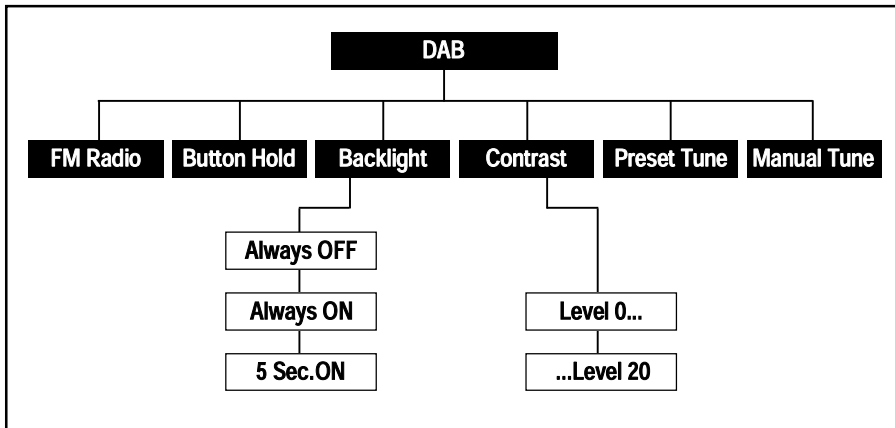

Appendix 2 Menu Tree - FM Radio Block

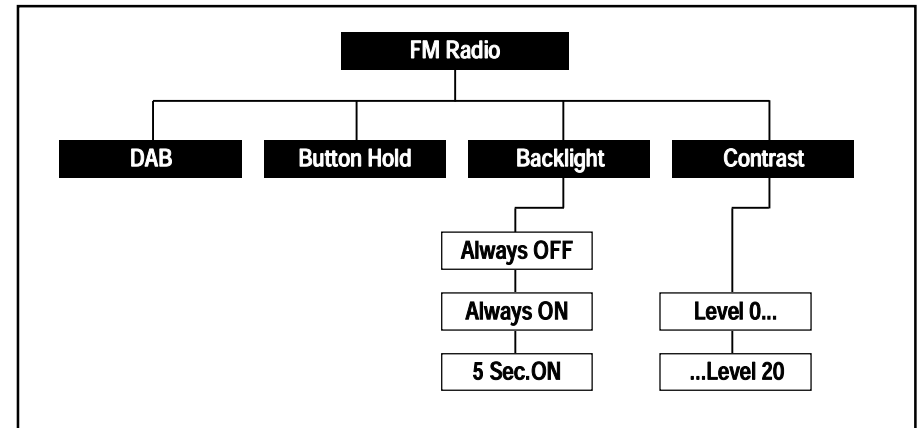





## APPENDICES

## APPENDICES

### Appendix 3 Ensemble Information Example

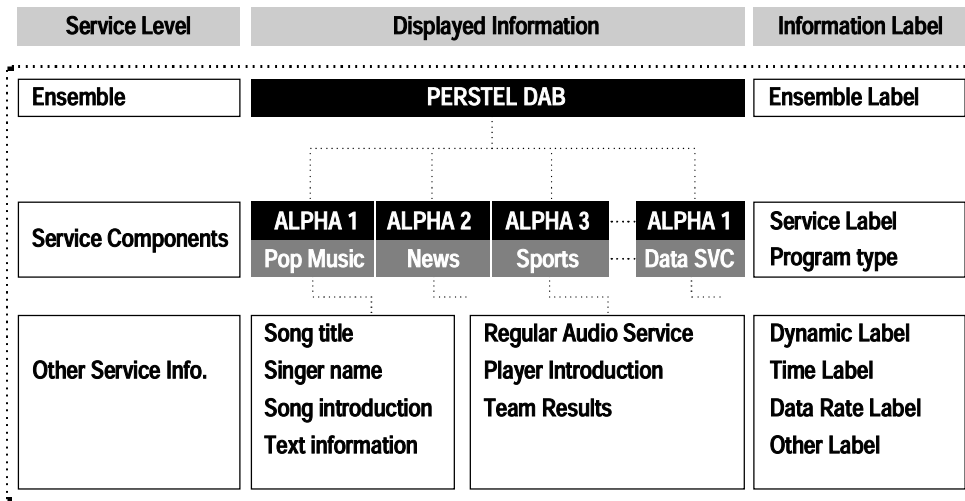

### Appendix 4 Regional Frequency Table

#### 1. BAND-III (Europe)

Frequency	Label	Frequency	Label	Frequency	Label
174.928MHz	5A	199.360MHz	8C	220.352MHz	11C
176.640MHz	5B	201.072MHz	8D	222.064MHz	11D
178.352MHz	5C	202.928MHz	9A	223.936MHz	12A
180.064MHz	5D	204.640MHz	9B	224.096MHz	12N
181.936MHz	6A	206.352MHz	9C	225.648MHz	12B
183.648MHz	6B	208.064MHz	9D	227.360MHz	12C
185.360MHz	6C	209.936MHz	10A	229.072MHz	12D
187.072MHz	6D	210.096MHz	10N	230.784MHz	13A
188.928MHz	7A	211.648MHz	10B	232.496MHz	13B
190.640MHz	7B	213.360MHz	10C	234.208MHz	13C
192.352MHz	7C	215.072MHz	10D	235.776MHz	13D
194.064MHz	7D	216.928MHz	11A	237.488MHz	13E
195.936MHz	8A	217.088MHz	11N	239.200MHz	13F
197.648MHz	8B	218.640MHz	11B		



## APPENDICES

## APPENDICES

### 2. L-BAND (Europe)

Frequency	Label	Frequency	Label	Frequency	Label
1452.960MHz	LA	1466.656MHz	LI	1480.352MHz	LQ
1454.672MHz	LB	1468.368MHz	LJ	1482.064MHz	LR
1456.384MHz	LC	1470.080MHz	LK	1483.776MHz	LS
1458.096MHz	LD	1471.792MHz	LL	1485.488MHz	LT
1459.808MHz	LE	1473.504MHz	LM	1487.200MHz	LU
1461.520MHz	LF	1475.216MHz	LN	1488.912MHz	LV
1463.232MHz	LG	1476.928MHz	LO	1490.624MHz	LW
1464.944MHz	LH	1478.640MHz	LP		

### 3. L-BAND (Canada)

Frequency	Label	Frequency	Label	Frequency	Label
1452.816MHz	LA	1466.768MHz	LI	1480.720MHz	LQ
1454.560MHz	LB	1468.512MHz	LJ	1482.464MHz	LR
1456.304MHz	LC	1470.256MHz	LK	1484.280MHz	LS
1458.048MHz	LD	1472.000MHz	LL	1485.952MHz	LT
1459.792MHz	LE	1473.744MHz	LM	1487.696MHz	LU
1461.536MHz	LF	1475.488MHz	LN	1489.440MHz	LV
1463.280MHz	LG	1477.232MHz	LO	1491.184MHz	LW
1465.024MHz	LH	1478.976MHz	LP		

### Appendix 5 Troubleshooting

Problems	Troubleshooting
· The unit does not turn on.	· Replace batteries. Battery might be exhausted. · Check battery polarity.
· A DAB signal cannot be received.	· Check if you are out of available DAB service area. · Adjust antenna length or redirect antenna. · Try other channels.
· The audio signal is intermittent or mutes	· The received signal strength is too weak. Try extending or re-positioning the antenna. It may be required to try another location. · Keep away from PC's or other possible interference sources
· The DAB signals received but no sound heard.	· Check audio format icon. If audio format shows "DATA", no audio service is provided. · Check data rate. (No sound is heard when data rate is over 256Kbps.) · Earphone is not properly plugged, or malfunctioning. Replace earphone or plug-in properly. · Volume is turned fully down



## APPENDICES

## APPENDICES

Problems	Troubleshooting
· Buttons do not work.	· Check if "HOLD" appears on Tuning Icon. Release Button Hold mode by pressing the Confirm button (  ) for more than 2 seconds.
· LCD dim	· Adjust the contrast of the LCD display.
· Backlight does not turn on	· Check the backlight setting and adjust. · Replace battery. (DR101 automatically turns off backlight when battery level is extremely low.)

### Appendix 6 Specifications

Classifications	Specifications	Options
Frequency Range	Band-III : 174MHz~240MHz L-BAND : 1452MHz~1492MHz FM : 87.50MHz~108MHz	V L (Not applicable) F
Power source	+3.0V +/-20%	
Battery	2AA size alkaline cells	
Adaptor	3V / 500mA	
Audio Output Power	5mW @ 16W	
Audio Frequency Range	20Hz-20KHz	
Dimension (W×H×D)	60×84×24 mm	
Operating Temperature	-5°C ~ +35°C	
Ambient temperature	-40°C ~ +80°C	

Information in this document is subject to change without notice.



### Appendix 7 Information on Digital Radio Services in the United Kingdom

This information is believed to be correct at October 2002. The situation in digital radio is evolving rapidly, and you are advised to check the operators or DRDB website for up to date information.

Details of regional service area licences and map can be found at:  
<http://www.radioauthority.org.uk>

More Information, news and links can be found at:  
<http://www.digitalradionow.com>

#### UK National Services:

##### BBC

Block 12B: 225.648 MHz  
Operator: BBC  
Ensemble Label: BBC National DAB  
<http://www.bbc.co.uk/digitalradio>

##### Digital One

England: Block 11D: 222.064MHz  
Scotland: Block 12A: 223.936MHz  
Ensemble Label: Digital1 Network  
<http://www.ukdigitalradio.com>

##### Regional Services

##### Aberdeen

Block 11C: 220.352 MHz, Operator: Switchdigital Scotland

##### Ayr

Block 11B: 218.640 MHz, Operator: Score Digital Ltd  
<http://www.scoredigital.co.uk/>

##### Bath & West Wilts

Block 12D: 229.072 MHz, Operator: Now Digital Ltd  
<http://www.now-digital.com/>



## APPENDICES

## APPENDICES

### **Birmingham**

Block 11C: 220.352 MHz, Operator: CE Digital

### **Bournemouth**

Block 11B: 218.640 MHz, Operator: Now Digital Ltd  
<http://www.now-digital.com/>

### **Bradford/Huddersfield**

Block 11B: 218.640 MHz, Operator: TWG Digital

### **Bristol and Bath**

Block 11B: 218.640 MHz, Operator: Now Digital  
<http://www.now-digital.com/>

### **Cardiff and Newport**

Block 11C: 220.352 MHz, Operator: Capital Radio Digital

### **Central Lancashire**

Block 12A: 223.936MHz, Operator: Emap Digital Radio

### **Coventry**

Block 12D: 229.072 MHz, Operator: Now Digital  
<http://www.now-digital.com/>

### **Dundee/Perth**

Block 11B: 218.640 MHz, Operator: Score Digital Ltd  
<http://www.scoredigital.co.uk/>

### **Edinburgh**

Block 12D: 229.072 MHz, Operator: Score Digital  
<http://www.scoredigital.co.uk/>

### **Exeter/Torbay**

Block 11C: 220.352 MHz, Operator: Now Digital  
<http://www.now-digital.com/>

### **Glasgow**

Block 11C: 220.352 MHz, Operator: Score Digital  
<http://www.scoredigital.co.uk/>



## APPENDICES

## APPENDICES

### Greater London 1

Block 12C: 227.360 MHz, Operator: CE Digital

### Greater London 2

Block 12A: 223.936 MHz, Operator: Switch Digital.

### Greater London 3

Block 11B: 218.640 MHz, Operator: The Digital Radio Group (London)  
<http://www.thedigitalradiogroup.co.uk/>

### Greater Manchester

Block 11C: 220.352 MHz, Operator: CE Digital

### Humberside

Block 11B: 218.640 MHz, Operator: Emap Digital Radio.

### Isle of Man

Block 11C: 220.352 MHz, Operator: mm02, Virgin Radio and Crown Castle International

### Leeds

Block 12D: 229.072 MHz, Operator: Emap Digital Radio

### Liverpool

Block 11B: 218.640 MHz, Operator: Emap Digital Radio

### Northern Ireland

Block 12D: 229.072 MHz, Operator: Score Digital  
<http://www.scoredigital.co.uk/>

### Southend/Chelmsford

Block 12D: 229.072 MHz, Operator: Now Digital  
<http://www.now-digital.com/>

### South Yorkshire

Block 11C: 220.352 MHz, Operator: Emap Digital Radio

### Teesside

Block 11B: 218.640 MHz, Operator: Emap Digital Radio Ltd



## APPENDICES

## MEMO

### **Tyne & Wear**

Block 11C: 220.352 MHz, Operator: Emap Digital Radio

### **Wolverhampton, Shrewsbury and Telford**

Block 11B: 218.640 MHz, Operator: Now Digital

<http://www.now-digital.com/>

The information given here is correct to the best of our knowledge, but is for guidance only, and is liable to change.  
Perstel Limited accepts no responsibility for any inaccuracy.



MEMO

---

---

---

---

---

---

---

---

---

---



**MEMO**

**MEMO**



**MEMO**

---

---

---

---

---

---

---

---

---

---

---

---



**MEMO**

---

---

---

---

---

---

---

---

---

---

---

---





## WARRANTY

## WARRANTY

### 1. About Warranty Service

Personal Telecom, Inc. Warrants that this product will be free from defects in materials and workmanship for a period of one(1) year from the date of purchase. Within this period, simply take the product and your proof of purchase to any local dealer and the product will be repaired without charge for parts and labor. Personal Telecom, Inc. reserves the right to charge for transportation. Any product which has been subject to misuse or accidental damage is excluded from this warranty.

This warranty is only applicable to a product purchased through right dealers and to a product that is presented for repair in a country where Personal Telecom, Inc. offers the product for sale.

While this warranty does not confer any legal rights other than those set out above, you may have additional statutory rights which will vary under the laws of the various countries, states, provinces and other governmental entities in which Personal Telecom, Inc.'s products are being sold. This warranty is subject to all statutory rights you may have in the country of purchase.

### 2. Product Information

Product type	<input type="checkbox"/> MP3 player		<input type="checkbox"/> Digital Voice Recorder		<input type="checkbox"/> DAB Receiver	
Product code						
Serial Number						
Date of purchase			/			
					(mm/dd/yy)	
Dealer						
Customer	Name					
	Contact					

### 3. Warranty Exclusion

- ① Any service request due to lack of knowledge of product; Read Owner's Manual carefully.
- ② Misuse or improper modification; Do not open the circuitry without Service Manual.
- ③ Majeur forces; Keep away from fire, salty water, flood etc.
- ④ Out of product life; Charged service for parts replacement.

### 4. Warranty Statement

This warranty Statement will not be reissued.  
Please keep with Owner's Manual with good care.