

Aspire 5739 Series Service Guide

Service guide files and updates are available on the ACER/CSD web; for more information, please refer to <http://csd.acer.com.tw>

PRINTED IN TAIWAN

Revision History

Please refer to the table below for the updates made to this service guide.

Date	Chapter	Updates

Copyright

Copyright © 2009 by Acer Incorporated. All rights reserved. No part of this publication may be reproduced, transmitted, transcribed, stored in a retrieval system, or translated into any language or computer language, in any form or by any means, electronic, mechanical, magnetic, optical, chemical, manual or otherwise, without the prior written permission of Acer Incorporated.

Disclaimer

The information in this guide is subject to change without notice.

Acer Incorporated makes no representations or warranties, either expressed or implied, with respect to the contents hereof and specifically disclaims any warranties of merchantability or fitness for any particular purpose. Any Acer Incorporated software described in this manual is sold or licensed "as is". Should the programs prove defective following their purchase, the buyer (and not Acer Incorporated, its distributor, or its dealer) assumes the entire cost of all necessary servicing, repair, and any incidental or consequential damages resulting from any defect in the software.

Acer is a registered trademark of Acer Corporation.

Intel is a registered trademark of Intel Corporation.

Pentium and Pentium II/III are trademarks of Intel Corporation.

Other brand and product names are trademarks and/or registered trademarks of their respective holders.

Conventions

The following conventions are used in this manual:

SCREEN MESSAGES	Denotes actual messages that appear on screen.
NOTE	Gives bits and pieces of additional information related to the current topic.
WARNING	Alerts you to any damage that might result from doing or not doing specific actions.
CAUTION	Gives precautionary measures to avoid possible hardware or software problems.
IMPORTANT	Reminds you to do specific actions relevant to the accomplishment of procedures.

Preface

Before using this information and the product it supports, please read the following general information.

1. This Service Guide provides you with all technical information relating to the BASIC CONFIGURATION decided for Acer's "global" product offering. To better fit local market requirements and enhance product competitiveness, your regional office MAY have decided to extend the functionality of a machine (e.g. add-on card, modem, or extra memory capability). These LOCALIZED FEATURES will NOT be covered in this generic service guide. In such cases, please contact your regional offices or the responsible personnel/channel to provide you with further technical details.
2. Please note WHEN ORDERING FRU PARTS, that you should check the most up-to-date information available on your regional web or channel. If, for whatever reason, a part number change is made, it will not be noted in the printed Service Guide. For ACER-AUTHORIZED SERVICE PROVIDERS, your Acer office may have a DIFFERENT part number code to those given in the FRU list of this printed Service Guide. You MUST use the list provided by your regional Acer office to order FRU parts for repair and service of customer machines.

System Specifications	1
Features	1
System Block Diagram	4
Your Acer Notebook tour	5
Front View	5
Hot Keys	7
Closed Front View	7
Rear View	8
Left View	8
Right View	9
Bottom View	10
Touchpad Basics (with fingerprint reader)	11
Using the Keyboard	12
Lock Keys and embedded numeric keypad	12
Windows Keys	13
Special Key	14
Using the System Utilities	15
Acer GridVista (dual-display compatible)	15
Hardware Specifications and Configurations	17
 System Utilities	 27
BIOS Setup Utility	27
Navigating the BIOS Utility	27
Information	28
Main	29
Security	30
Boot	33
Exit	34
BIOS Flash Utility	35
Using the Flash16 Utility to Update the BIOS	35
WinFlash Utility	36
DOS Flash Utility	37
Remove HDD/BIOS Password Utilities	40
Miscellaneous Utilities	43
 Machine Disassembly and Replacement	 47
Disassembly Requirements	47
General Information	48
Pre-disassembly Instructions	48
Disassembly Process	48
External Module Disassembly Process	49
External Modules Disassembly Flowchart	49
Removing the Battery Pack	49
Removing the SD dummy card	50
Removing the Lower Cover	51
Removing the WLAN Module	52
Removing the DIMM Modules	53
Removing the Hard Disk Drive Module	54
Removing the Optical Disk Drive Module	55
Removing the TV Tuner	57
Removing the Graphics Card	59
Removing the RTC Battery	59
Removing the CPU	60
Main Unit Disassembly Process	62

Table of Contents

Main Unit Disassembly Flowchart	62
Removing the Hinge Covers	63
Removing the Switch Cover	63
Removing the Power Save Board	66
Removing the Power Switch Board	67
Removing the Keyboard	67
Removing the LCD Module	68
Removing the Upper Base	72
Removing the Finger Print Reader	75
Removing the Multifunction Board	77
Removing the Modem Module	78
Removing the Bluetooth Module	80
Removing the Mainboard	80
Removing the Thermal Module	82
Removing the CPU (Alternate Procedure)	84
Removing the Speaker Modules	85
LCD Module Disassembly Process	88
LCD Module Disassembly Flowchart	88
Removing the LCD Bezel	88
Removing the Camera Module	90
Removing the LCD Panel	91
Removing the LCD Brackets and FPC Cable	92
Removing the Antennas	93
LCD Module Reassembly Procedure	95
Replacing the Antennas	95
Replacing the LCD Panel	96
Replacing the Camera Module	97
Replacing the LCD Bezel	98
Main Module Reassembly Procedure	99
Replacing the Speaker Modules	99
Replacing the CPU (Alternate Procedure)	100
Replacing the Thermal Module	101
Replacing the Mainboard	103
Replacing the Bluetooth Board	105
Replacing the Modem Module	107
Replacing the Finger Print Reader	109
Replacing the Upper Cover	109
Replacing the LCD Module	113
Replacing the Keyboard	116
Replacing the Power Switch Board	116
Replacing the Power Save Board	117
Replacing the Switch Cover	118
Replacing the Hinge Covers	120
External Unit Reassembly Process	122
Replacing the CPU	122
Replacing the RTC Battery	123
Replacing the Graphics Card	123
Replacing the ODD Module	125
Replacing the Hard Disk Drive Module	126
Replacing the DIMM Modules	126
Replacing the WLAN Module	128
Replacing the TV Tuner	128
Replacing the Lower Cover	130
Replacing the SD Card Dummy Tray	130
Replacing the Battery	131

Troubleshooting	133
Common Problems	133
Power On Issue	134
No Display Issue	136
Random Loss of BIOS Settings	138
LCD Failure	139
Built-In Keyboard Failure	139
Touchpad Failure	140
Internal Speaker Failure	140
Internal Microphone Failure	142
HDD Not Operating Correctly	144
ODD Failure	145
USB Failure (Rightside)	149
Modem Function Failure	149
Wireless Function Failure	150
Bluetooth Function Failure	150
EasyTouch Button Failure	151
Media Board Failure	151
Fingerprint Reader Failure	152
Thermal Unit Failure	152
External Mouse Failure	153
Other Failures	153
Intermittent Problems	154
Undetermined Problems	154
POST Codes Tables	155
Sec:	155
Memory:	155
BDS & Specific action:	157
Each PEIM entry point used in 80_PORT	158
Each Driver entry point used in 80_PORT	158
Each SmmDriver entry point used in 80_PORT	161
Jumper and Connector Locations	163
Top View	163
Bottom View	164
Clearing Password Check and BIOS Recovery	165
Clearing Password Check	165
BIOS Recovery by Crisis Disk	167
FRU (Field Replaceable Unit) List	169
Aspire 5739 Exploded Diagrams	170
Main Module	170
Aspire 5739 FRU List	171
Screw List	179
Model Definition and Configuration	181
Aspire 5739 Series	181
Test Compatible Components	209
Microsoft® Windows® Vista Environment Test	210
Online Support Information	215
Index	217

Table of Contents

System Specifications

Features

Below is a brief summary of the computer's many features:

NOTE: Items marked with * denote only selected models.

Operating System

- Genuine Windows® Vista™

Platform

- Intel® Centrino® 2 processor technology, featuring:
 - Intel® Core™2 Duo processor
 - Mobile Intel® PM45/GM45 Express Chipset*
 - Intel® Wireless WiFi Link 5100/5300*

System Memory

- Up to 2 GB of DDR3 1066 MHz memory, upgradeable
- to 4 GB using two soDIMM modules

Display

- Display
 - 16:9 aspect ratio
 - 14" HD 1366 x 768

TV-Tuner

- Digital TV-tuner supporting DVB-T*

Graphics

- Mobile Intel® GM45 Express Chipset*
- ATI Mobility™ Radeon HD 4570*
- NVIDIA® GeForce® GT 130M*

Storage subsystem

- 2.5" hard disk drive
- Optical drive options:
 - Blu-ray Disc™/DVD-Super Multi double-layer drive*
 - DVD-Super Multi double-layer drive*
- 5-in-1 card reader

Audio

- Dolby®-optimized surround sound system with two built-in stereo speakers
- True 5.1-channel surround sound output
- High-definition audio support
- S/PDIF (Sony/Philips Digital Interface) support for digital speakers
- Acer PureZone technology with two built-in stereo microphones
- MS-Sound compatible

Communication

- Acer Video Conference, featuring:
 - Integrated Acer Crystal Eye webcam*
 - Acer PureZone technology
- WLAN: Intel® Wireless WiFi Link 5100/5300*
- WPAN: Bluetooth® 2.0+Enhanced Data Rate (EDR)*
- LAN: Gigabit Ethernet; Wake-on-LAN ready
- Modem: 56K ITU V.92; Wake-on-Ring ready

Dimensions and Weight

- 372 (W) x 262 (D) x 26/38.8 (H) mm(16.14 x 11.25 x 1.37/1.63 inches)
- 2.8 kg (5.07 lbs.) withone HDD and 8-cell battery pack

Privacy control

- Acer Bio-Protection fingerprint solution*
- BIOS user, supervisor, HDD passwords
- Kensington lock slot

Power subsystem

- ACPI 3.0
- • 71 W 4800 mAh*
- 48.8 W 4400 mAh
- 3-pin 65 W AC adapter*
- 3-pin 90 W AC adapter*
- ENERGY STAR®*

Special keys and controls

- 103-/104-/107-key keyboard
- Touchpad pointing device

I/O interface

- Acer Bio-Protection fingerprint reader
- 5-in-1 card reader (SD/MMC/MS/MS PRO/xD)

-
- USB 2.0 ports•HDMI™ port with HDCP support
 - HDMI™ port with HDCP support
 - External display (VGA) port
 - Consumer infrared (CIR) port
 - RF-in jack*
 - eSATA port
 - Headphones/speaker/line-out jack with S/PDIF support
 - Microphone-in jack
 - Line-in jack
 - Ethernet (RJ-45) port
 - Modem (RJ-11) port
 - DC-in jack for AC adapter

Environment

- Temperature:
 - Operating: 5 °C to 35 °C
 - Non-operating: -20 °C to 65 °C
- Humidity (non-condensing):
 - Operating: 20% to 80%
 - Non-operating: 20% to 80%

NOTE: Items marked with * denote only selected models.

NOTE: The specifications listed above are for reference only. The exact configuration of your PC depends on the model purchased.

System Block Diagram

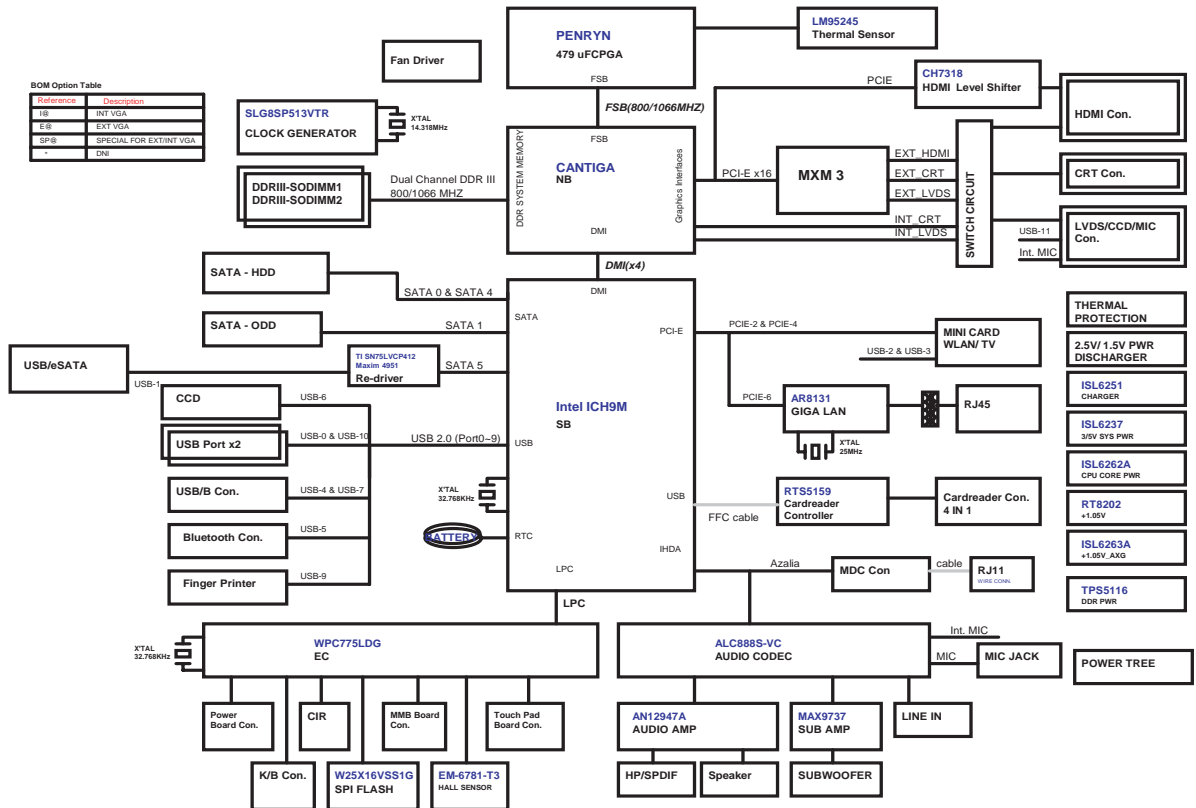







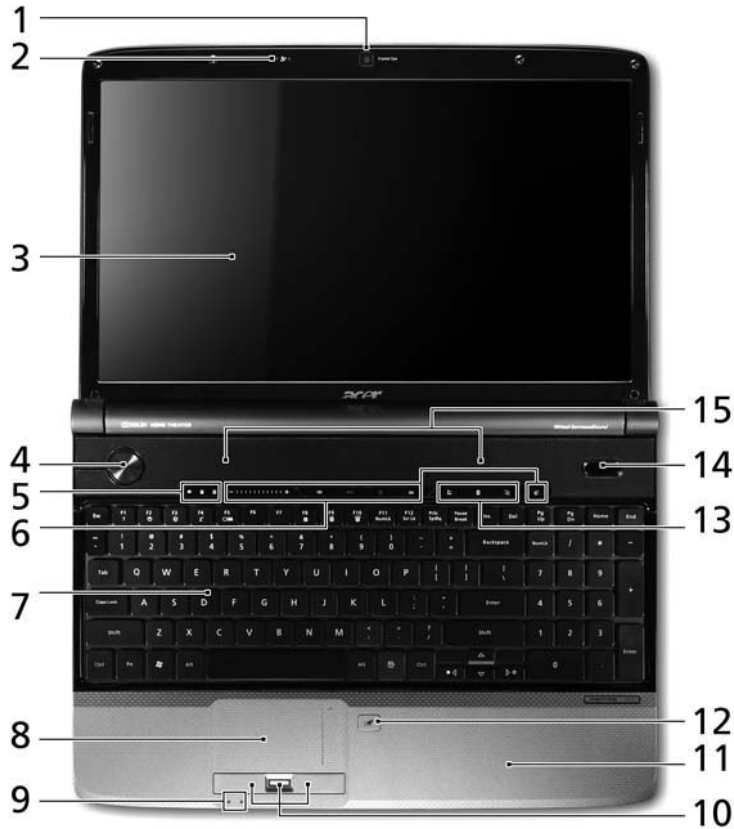





Your Acer Notebook tour

Following is a description of the functions and features available with this model.

Front View













No.	Icon	Item	Description
1.		Acer Crystal Eye webcam	Web camera for video communication (only for certain models).
2.		Microphone	Internal Microphone for sound recording
3.		Display screen	Also called Liquid-Crystal Display (LCD), displays computer output (Configuration may vary by models).
4.		Power button	Turns the computer on and off.
5.		HDD	Indicates when the hard disk drive is active.
		Num Lock	Lights up when Num Lock is activated.
		Caps Lock	Lights up when Caps Lock is activated.
6.		Acer MediaTouch	Touch sensitive controls for Acer Arcade, volume (up/down) and media (play/pause, stop, previous, next); with mute and hold keys

No.	Icon	Item	Description
7.		Keyboard	For entering data into your computer.
8.		Touchpad	Touch-sensitive pointing device which functions like a computer mouse.
9.		Power	Indicates the computer's power status.
		Battery	Indicates the computer's battery status. 1. Charging: The light shows amber when the battery is charging. 2. Fully charged: The light shows blue when in AC mode.
10.		Click buttons (left, center* and right)	The left and right buttons function like the left and right mouse buttons. *The center button serves as Acer Bio-Protection fingerprint reader supporting Acer FingerNav 4-way control function (only for certain models).
11.		Palmrest	Comfortable support area for your hands when you use the computer.
12.		Touchpad Toggle	Turns the internal touchpad on and off.
13.		Wireless LAN Communication button / Indicator	Enables/disables the wireless LAN function. Indicates the status of wireless LAN communication.
		Bluetooth Communication button/indicator	Enables/disables the Bluetooth function. Indicates the status of Bluetooth communication. (only for certain models)
		Backup key	Launches Acer Backup Management for three-step data backup.
14.		Acer PowerSmart key	Puts your computer into power-saving mode.
15.		Speakers	Left and right speakers deliver stereo audio output.

Hot Keys



The computer employs hotkeys or key combinations to access most of the computer's controls like screen brightness and volume output.

To activate hotkeys, press and hold the <Fn> key before pressing the other key in the hotkey combination.

Hotkey	Icon	Function	Description
<Fn> + <F2>		System Properties	Display the System Properties dialog box.
<Fn> + <F3>		Bluetooth	Enables/disables the Bluetooth function. (only for certain models)
<Fn> + <F4>		Sleep	Puts the computer in Sleep mode.
<Fn> + <F5>		Display toggle	Switches display output between the display screen, external monitor (if connected) and both.
<Fn> + <F6>		Screen blank	Turns the display screen backlight off to save power. Press any key to return.
<Fn> + <F8>		Speaker toggle	Turns the speakers on and off.
<Fn> + <D>		Brightness up	Increases the screen brightness.
<Fn> + <C>		Brightness down	Decreases the screen brightness.
<Fn> + <A>		Volume up	Increases the sound volume.
<Fn> + <V>		Volume down	Decreases the sound volume.

Closed Front View



No.	Icon	Item	Description
1		CIR Receiver	Receives signals from a remote control.
2		5-in-1 card reader	Accepts Secure Digital (SD), MultiMediaCard (MMC), Memory Stick (MS), Memory Stick PRO (MS PRO), xD-Picture Card (xD). Note: Push to remove/install the card. Only one card can operate at any given time.

Rear View



No.	Icon	Item	Description
1		Tuba	The dedicated Tuba CineBass subwoofer pumps out earthshaking movie-house audio.
2		Ventilation slots	Allows the computer to stay cool, even after prolonged use.





Left View



No.	Icon	Item	Description
1		DC-In jack	Connects to an AC adapter.
2		Ethernet (RJ-45) port	Connects to an Ethernet 10/100/1000-based network.
3		External display (VGA) port	Connects to a display device (e.g. external monitor, LCD projector).
	HDMI	HDMI port	Supports high definition digital video connections.
	eSATA	eSATA port	Connects to eSATA devices.
4		USB 2.0 port	Connect to USB 2.0 devices (e.g. USB mouse, USB camera)
5		Line-in jack	Accepts audio line-in devices (e.g., audio CD player, stereo walkman, mp3 player)
		Microphone jack	Accepts inputs from external microphones.
		Headphones/speaker/line-out jack with S/PDIF support	Connects to audio line-out devices (e.g., speakers, headphones).



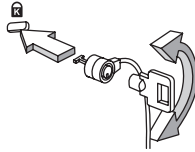

Right View

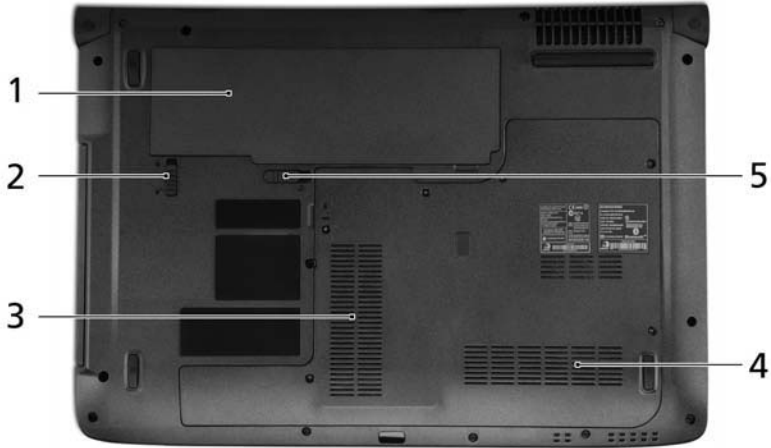

No.	Icon	Item	Description
1		USB 2.0 port	Connect to USB 2.0 devices (e.g. USB mouse, USB camera).
2		Optical drive	Internal optical drive; accepts CDs or DVDs.
3		Optical disk access indicator	Lights up when the optical drive is active.
4		Optical drive eject button	Ejects the optical disk from the drive.
5		Emergency eject hole	Ejects the optical drive tray when the computer is turned off. Note: Insert a paper clip into the emergency eject hole to eject the optical drive tray when the computer is off.
		RF-in port	Accepts input signals from digital TVtuner devices. (only for certain models)
		Modem (RJ-11) port	Connects to a phone line.
		Kensington lock slot 	Connects to a Kensington-compatible computer security lock. Note: Wrap the computer security lock cable around an immovable object such as a table or handle of a locked drawer. Insert the lock into the notch and turn the key to secure the lock. Some keyless models are also available.

Bottom View



No.	Icon	Item	Description
1		Battery bay	Houses the computer's battery pack.
2		Battery lock	Locks the battery in position.
3		Hard disk bay	Houses the computer's hard disk (secured with screws).
4		Memory compartment	Houses the computer's main memory.
5		Battery release latch	Releases the battery for removal.

Touchpad Basics (with fingerprint reader)

The following items show you how to use the touchpad with Acer Bio-Protection fingerprint reader:

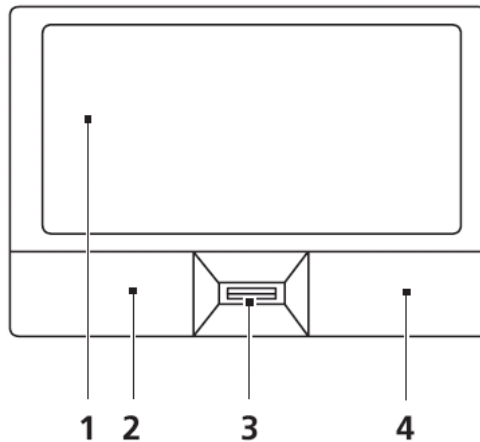

- Move your finger across the touchpad (1) to move the cursor.
- Press the left (2) and right (4) buttons located beneath the touchpad to perform selection and execution functions. These two buttons are similar to the left and right buttons on a mouse. Tapping on the touchpad is the same as clicking the left button.
- Use Acer Bio-Protection fingerprint reader (3) supporting Acer FingerNav 4-way control function (only for certain models) or the 4-way scroll (3) button (only for certain models) to scroll up or down and move left or right a page. This fingerprint reader or button mimics your cursor pressing on the right scroll bar of Windows applications.

Function	Left Button (2)	Right Button (4)	Main touchpad (1)
Execute	Quickly click twice.		Tap twice (at the same speed as double-clicking a mouse button).
Select	Click once.		Tap once.
Drag	Click and hold, then use finger on the touchpad to drag the cursor.		Tap twice (at the same speed as double-clicking a mouse button); rest your finger on the touchpad on the second tap and drag the cursor.
Access context menu		Click once.	

NOTE: When using the touchpad, keep it - and your fingers - dry and clean. The touchpad is sensitive to finger movement; hence, the lighter the touch, the better the response. Tapping too hard will not increase the touchpad's responsiveness.

Using the Keyboard

The keyboard has full-sized keys and an embedded numeric keypad, separate cursor, lock, Windows, function and special keys.

Lock Keys and embedded numeric keypad

The keyboard has three lock keys which you can toggle on and off.





















Lock key	Description
Caps Lock	When Caps Lock is on, all alphabetic characters typed are in uppercase.
Num Lock <Fn> + <F11>	When Num Lock is on, the embedded keypad is in numeric mode. The keys function as a calculator (complete with the arithmetic operators +, -, *, and /). Use this mode when you need to do a lot of numeric data entry. A better solution would be to connect an external keypad.
Scroll Lock <Fn> + <F12>	When Scroll Lock is on, the screen moves one line up or down when you press the up or down arrow keys respectively. Scroll Lock does not work with some applications.

The embedded numeric keypad functions like a desktop numeric keypad. It is indicated by small characters located on the upper right corner of the keycaps. To simplify the keyboard legend, cursor-control key symbols are not printed on the keys.

Desired access	Num Lock on	Num Lock off
Number keys on embedded keypad	Type numbers in a normal manner.	
Cursor-control keys on embedded keypad	Hold <Shift> while using cursor-control keys.	Hold <Fn> while using cursor-control keys.
Main keyboard keys	Hold <Fn> while typing letters on embedded keypad.	Type the letters in a normal manner.

Windows Keys

The keyboard has two keys that perform Windows-specific functions.

Key	Description
 Windows key	<p>Pressed alone, this key has the same effect as clicking on the Windows Start button; it launches the Start menu. It can also be used with other keys to provide a variety of functions:</p> <ul style="list-style-type: none"> <  >: Open or close the Start menu <  > + <D>: Display the desktop <  > + <E>: Open Windows Explore <  > + <F>: Search for a file or folder <  > + <G>: Cycle through Sidebar gadgets <  > + <L>: Lock your computer (if you are connected to a network domain), or switch users (if you're not connected to a network domain) <  > + <M>: Minimizes all windows <  > + <R>: Open the Run dialog box <  > + <T>: Cycle through programs on the taskbar <  > + <U>: Open Ease of Access Center <  > + <X>: Open Windows Mobility Center <  > + <BREAK>: Display the System Properties dialog box <  > + <SHIFT+M>: Restore minimized windows to the desktop <  > + <TAB>: Cycle through programs on the taskbar by using Windows Flip 3-D <  > + <SPACEBAR>: Bring all gadgets to the front and select Windows Sidebar <CTRL> + <  > + <F>: Search for computers (if you are on a network) <CTRL> + <  > + <TAB>: Use the arrow keys to cycle through programs on the taskbar by using Windows Flip 3-D <p>Note: Depending on your edition of Windows Vista, some shortcuts may not function as described.</p>
 Application key	<p>This key has the same effect as clicking the right mouse button; it opens the application's context menu.</p>

Special Key

You can locate the Euro symbol and the US dollar sign at the upper-center and/or bottom-right of your keyboard.



The Euro symbol

1. Open a text editor or word processor.
2. Hold <Alt Gr> and then press the <5> key at the upper-center of the keyboard.

NOTE: Note: Some fonts and software do not support the Euro symbol. Please refer to www.microsoft.com/typography/faq/faq12.htm for more information.

The US dollar sign

1. Open a text editor or word processor.
2. Hold <Shift> and then press the <4> key at the upper-center of the keyboard.

NOTE: This function varies by the operating system version.

Using the System Utilities

Acer Bio-Protection (only for certain models) Acer Bio-Protection Fingerprint Solution is a multi-purpose fingerprint software package integrated with the Microsoft Windows operating system. Utilizing the uniqueness of one's fingerprint features, Acer Bio-Protection Fingerprint Solution has incorporated protection against unauthorized access to your computer with centralized password management with Password Bank, easy music player launching with Acer MusicLaunch, secure Internet favorites via Acer MyLaunch, and fast application/website launching and login with Acer FingerLaunch, while Acer ProfileLaunch can launch up to three applications/websites from a single finger swipe.

Acer Bio-Protection Fingerprint Solution also allows you to navigate through web browsers and documents using Acer FingerNav. With Acer Bio-Protection Fingerprint Solution, you can now enjoy an extra layer of protection for your personal computer, as well as the convenience of accessing your daily tasks with a simple swipe of your finger!

For more information refer to the Acer Bio-Protection help files.

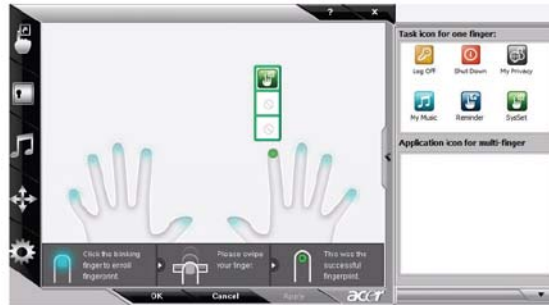

Acer GridVista (dual-display compatible)

NOTE: This feature is only available on certain models.

To enable the dual monitor feature of the notebook, first ensure that the second monitor is connected, then select **Start, Control Panel, Display** and click on **Settings**. Select the secondary monitor (**2**) icon in the display box and then click the check box **Extend my windows desktop onto this monitor**. Finally, click **Apply** to confirm the new settings and click **OK** to complete the process.

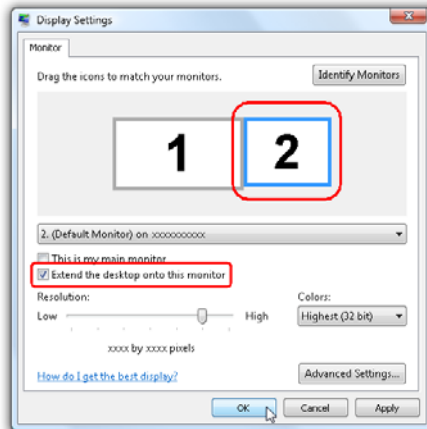

Acer GridVista is a handy utility that offers four pre-defined display settings so you can view multiple windows on the same screen. To access this function, please go to **Start → All Programs** and click on **Acer GridVista**. You may choose any one of the four display settings indicated below:



Double (vertical), Triple (primary at left), Triple (primary at right), or Quad Acer GridVista is dual-display compatible, allowing two displays to be partitioned independently.

Acer GridVista is dual-display compatible, allowing two displays to be partitioned independently.

AcerGridVista is simple to set up:

1. Run Acer GridVista and select your preferred screen configuration for each display from the task bar.
2. Drag and drop each window into the appropriate grid.
3. Enjoy the convenience of a well-organized desktop.

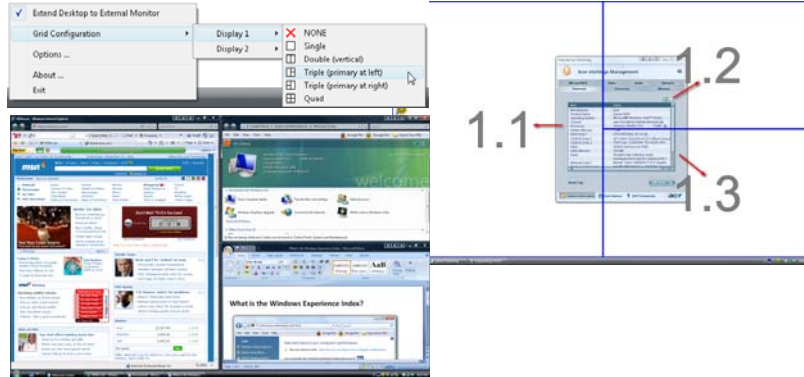

NOTE: Please ensure that the resolution setting of the second monitor is set to the manufacturer's recommended value.

Hardware Specifications and Configurations

Processor

Item	Specification
CPU Type	INTEL Penryn processor on 45-nanometer process technology
Core Logic	<ul style="list-style-type: none"> • Dual-core processor for mobile with enhanced performance • Supports Intel® architecture with IntelR Wide Dynamic Execution • Supports L1 cache-to-cache (C2C) transfer • On-die, primary 32-kB instruction cache and 32-kB write-back data cache in each core • The Penryn processor in XE, SV and LV have an On-die, up to 6-MB second-level shared cache with Advanced Transfer Cache architecture • The Penryn processor in ULV have an On-die, up to 3-MB second-levelshared cache with Advanced Transfer Cache architecture • Streaming SIMD extensions 2 (SSE2), streaming SIMD extensions 3 (SSE3), supplemental streaming SIMD extensions 3 (SSSE3) and SSE4.1 instruction sets • The Penryn processor in XE, SV and LV are offered at 667-MHz, 800-MHz and 1066-MHz source-synchronous front side bus (FSB) • The Penryn processor in ULV are offered at 667-MHz and 800-MHz source synchronous front side bus (FSB) • Advanced power management features including Enhanced Intel SpeedStep® Technology and dynamic FSB frequency switching • Digital thermal sensor (DTS) • IntelR 64 architecture • Supports enhanced Intel® Virtualization Technology • Intel® Dynamic Acceleration Technology and Enhanced Multi Threaded; Supports PSI2 functionality • The Penryn processor in XE, SV are offered in Micro-FCPGA and Micro-FCBGA packaging technologies • The Penryn SFF processor in LV and ULV are offered in Micro-FCBGA packaging technologies only • Execute Disable Bit support for enhanced security • C6 Low Power Feature with P_LVL6 I/O Support • Support for Intel® Trusted Execution Technology • Half ratio support (N/2) for Core to Bus ratio
CPU Package	479-ball Micro-FCBGA

Processor Specifications

Processor #	CPU Speed	Cores	Bus Speed	Mfg Tech	Cache Size	Package	Power	Acer P/N
P7450	2.4G	2	1066	45 nm	3M	FCBGA		
P8600	2.4G	2	1066	45 nm	3M	FCBGA		
P8600	2.4G	2	1066	45 nm	3M	FCBGA		
P8700	2.53G	2	1066	45 nm	3M	FCBGA		
P9500	2.53G	2	1066	45 nm	6M	FCBGA		
T6400	2.0G	2	800	45 nm	3M	FCBGA		
T6600	2.2G	2	800	45 nm	2M	FCBGA		

Processor #	CPU Speed	Cores	Bus Speed	Mfg Tech	Cache Size	Package	Power	Acer P/N
T9550	2.66G	2	1066	45 nm	6M	FCBGA		
T9600	2.8G	2	1066	45 nm	6M	FCBGA		
T9800	2.93G	2	1066	45 nm	6M	FCBGA		

System Board North / South Bridge

Item	Specifications
Core logic	<ul style="list-style-type: none"> Intel® ICH9M I/O controller. Intel CS GM45NB / Intel CS PM45NB (North Bridge)

CPU Fan True Value Table

CPU Temperature (°C)	Fan Speed (rpm)	SPL Spec (dBA)
40	2800	28
50	3100	31
65	3400	34
85	4000	37
105	4500	40

- Throttling 50%: On =105°C; Off=95°C
- OS Shut down: 108°C
- H/W Shut down: 110°C

BIOS ROM

Item	Specification
BIOS Vendor	Phoenix BIOS
BIOS Version	V0.3209
BIOS ROM Type	Flash ROM
BIOS ROM Size	2MB
Supported Protocols	SMBIOS 2.3
BIOS Password control	Yes
Features	<ul style="list-style-type: none"> • Support Acer UI • Support multi-boot • Suspend to RAM (S3)/Disk (S4) • Various hot-keys for system control • Support SMBIOS 2.3, PCI2.2 • DMI utility for BIOS serial number configurable/asset tag • Support PXE • Support Win Flash • Wake on LAN from S3 • Wake on LAN form S5 in AC mode • System information

System Memory

Item	Specifications
Memory Controller	Built-in
Memory Size	0MB (no on-board memory)
DIMM socket number	2
Supports Memory size per socket	2GB
Support maximum memory size	4GB
Support DIMM type	DDR II SDRAM
Support DIMM Speed	667/800MHz
Support DIMM voltage	+1.8V
Support DIMM package	200-pin
VGA Memory	64/128/256MB
Memory module combinations	You can install memory modules in any combinations as long as they match the above specifications.

Memory Combinations

Slot 1	Slot 2	Total Memory
0MB	512MB	512MB
0MB	1024MB	1024MB
0MB	2048MB	2048MB
512MB	512MB	1024MB
512MB	1024MB	1536MB
512MB	2048MB	2560MB
1024MB	0MB	1024MB
1024MB	512MB	1536MB
1024MB	1024MB	2048MB
1024MB	2048MB	3072MB
2048MB	0MB	2048MB
2048MB	512MB	2560MB
2048MB	1024MB	3072MB
2048MB	2048MB	4096MB

NOTE: Above table lists some system memory configurations. You may combine DIMMs with various capacities to form other combinations. On above table, the configuration of slot 1 and slot 2 could be reversed.

Hard Disk Drive Interface

Item	Specifications			
Vendor & Model Name	Hitachi HTS545050B9A300	Hitachi HTS545032B9A300	Hitachi HTS545025B9A300	Hitachi HTS545016B9A300
Capacity (MB)	500	320	250	160
Bytes per sector	512			
Data heads	4	3	2	2
Drive Format				
Disks	2	2	1	1
Spindle speed (RPM)	5400			
Performance Specifications				
Buffer size	8MB			
Interface	SATA			
Internal transfer rate (Mbits/sec, max)	3GB/s maximum			
I/O data transfer rate (Mbytes/sec max)	875 Mbits/s maximum			845 Mbits/s maximum
DC Power Requirements				
Voltage	+5.0V ± 5%.			

Item	Specifications			
Vendor & Model Name	Seagate ST9160310AS	Seagate ST9250315AS	Seagate ST9320320AS	Seagate ST9500325AS
Capacity (MB)	160	250	320	500
Bytes per sector	512	512	512	512
Data heads	2	2	4	4
Drive Format				
Disks	1	1	2	2
Spindle speed (RPM)	5400	5400	5400	5400
Performance Specifications				
Buffer size	8 MB	8 MB	8MB	8 MB
Interface	SATA	SATA	SATA	SATA
Internal transfer rate (Mbits/sec, max)	830	1175	830	1175
I/O data transfer rate (Mbytes/sec max)	875 Mbits/s maximum			845 Mbits/s maximum
DC Power Requirements				
Voltage	+5.0V ± 5%.			

Item	Specifications			
Vendor & Model Name	Toshiba MK1655GSX	Toshiba MK2555GSX	Toshiba MK3255GSX	Toshiba MK5055GSX
Capacity (MB)	160	250	320	500
Bytes per sector	512	512	512	512
Data heads	2	2	4	4
Drive Format				
Disks	1	1	2	2
Spindle speed (RPM)	5400			
Performance Specifications				
Buffer size	8MB			
Interface	SATA			
Internal transfer rate (Mbits/sec, max)	363 – 952 typical			
I/O data transfer rate (Mbytes/sec max)	300			
DC Power Requirements				
Voltage	5V ±5%			

Item	Specifications			
Vendor & Model Name	Western Digital WD1600BEVT-22ZCT0	Western Digital WD2500BEVT-22ZCT0	Western Digital WD3200BEVT-22ZCT0	Western Digital WD5000BEVT-22ZAT0
Capacity (MB)	160	250	320	500
Bytes per sector	512			
Data heads	2	4	3	4
Drive Format				
Disks	1	2	2	2
Spindle speed (RPM)	5400			
Performance Specifications				
Buffer size	8 MB			
Interface	SATA			
Internal transfer rate (Mbits/sec, max)	N/A			
I/O data transfer rate (Mbytes/sec max)	300			
DC Power Requirements				
Voltage	5V ±5%			

Optical Disk Drive

Item	Specification			
Vendor	PANASONIC	PLDS	SONY	TOSHIBA TS
Model	UJ880A	DS-8A3S	AD-7580S	TS-L633B
Type	Super-Multi	Super-Multi	Super-Multi	Super-Multi
Performance Specification				
Transfer rate (MB/sec)	10.8			
Buffer Memory	2MB			
Interface	SATA			
Applicable disc format	DVD+/-RW, CD +/-RW			
Loading mechanism	Drawer-Type			
Power Requirement				
Input Voltage	DC 5 V +/- 5%			

Item	Specification		
Vendor	PANASONIC	Pioneer	PLDS
Model	UJ-130A	BDC-TD01RS	DS-4E1S
Type	BD-ROM/DVD/CD WRITER		
Performance Specification			
Transfer rate (MB/sec)	9.3 MB/S (inner) - 22.5 MB/S (outer)		
Buffer Memory	4 MB		
Interface	SATA		
Applicable disc format	BD +/- RW, DVD+/-RW, CD +/-RW		
Loading mechanism	Drawer-Type		
Power Requirement			
Input Voltage	DC 5 V +/- 5%		

LCD 14"

Item	Specification
Vendor/model name	<ul style="list-style-type: none"> • Samsung LTN140AT01-G01 • AUO B140XW01 • LG LP140WH1 • CMO N140B6 - L02
Screen Diagonal (mm)	355.6 (14.0")
Display Area (mm)	309.399(H) X 173.952(V)
Display resolution (pixels)	1366 x 768
Pixel Pitch	0.2265(H) x 0.2265(V)
Display Mode	Normally white
Typical White Luminance (cd/m ²) (also called Brightness)	220 (typ.)
Contrast Ratio (typical)	500
Response Time (Optical Rise Time/Fall Time) msec	8 (typ.)

Item	Specification			
Input Voltage	3.3V ±0.3V			
Typical Power Consumption (watt)	5W (max.)			
Weight	375g (max.)			
Physical Size (mm)	324.0(H) x 192.5(V) x 5.2(D)			
Electrical Interface	LVDS			
Support Color	262,144			
Viewing Angle (degree)			Min.	Typ.
	Horizontal	CR => 10	40	45
			40	45
	Vertical		10	15
25			30	
Temperature Range (°C)				
Operating	0 to 50°C			
Storage (shipping)	-20 to 60°C			

VGA Graphic Controller

Item	Specification
Type	AMD M92XT
Manufacturing Tech.	55 nm
Form Factor	29mm*29mm
Package	M2

Keyboard

Item	Specification
Keyboard Controller	ENE KB926
Total number of keypads	86-/87-/91-key keyboard
Windows logo key	Yes
Internal & external keyboard work simultaneously	Yes

Audio Interface

Item	Specification
Audio Controller	Realtek ALC888 Azalia Codec
Features	<ul style="list-style-type: none">• HD Audio• 97dB SNR DACs & 90dB SNR ADCs• Ten DAC channels support 16/20/24-bit PCM format for 7.1 sound playback, plus 2channels of independent stereo sound output (multiple streaming) through the front panel output• Two stereo ADCs support 16/20/24-bit PCM format, one for stereo microphone, one for legacy mixer recording• All DACs supports 44.1k/48k/96k/192kHz sample rate• All ADCs support 44.1k/48k/96k sample rate• Two independent 16/20/24-bit S/PDIF-OUT converters support 44.1k/48k/96k/192kHzsample rate, one for nominal digital audio, the other one for digital audio output to HDMI transmitter• Enable VoIP function• Subwoofer support

LAN

Item	Specification
Type	Atheros AR8131-AL1E
Features	

Bluetooth

Item	Specification
Type	Foxconn Bluetooth FOX_BRM_2.0 F/W 300
Supported Protocols	1.1, 1.2 & 2.0 + EDR (Extended Data Rate)
Transfer Rate (max.)	3.0Mbps

Finger Print Reader

Item	Specification
Type	Authentec AES1610
Power	3.0V – 3.6V single supply
Detection Matrix	<ul style="list-style-type: none">• 128 x 8 pixels @ 500 ppi• 6.5mm x 0.41mm array size
Features	<ul style="list-style-type: none">• Advanced security• Next generation anti-spoofing protection• Fast Finger Motion Capture• TPM v1.2 support• Graphical or scroll navigation• Unequaled “ability to acquire”

WLAN

Item	Specification
Vendor and Model	Foxconn Atheros AR5B91
Protocol	
Interface	
Antenna	PIFA

Battery

Item	Specifications (3S2P)
Vendor & model name	<ul style="list-style-type: none">• SONY AS-2007A• Panasonic AS-2007A• Simplo AS-2007A• Sanyo AS-2007A
Battery Type	Li-ion
Pack capacity	4400 mAh
Number of battery cell	6
Package configuration	3S2P

System Utilities

BIOS Setup Utility

The BIOS Setup Utility is a hardware configuration program built into your computer's BIOS (Basic Input/Output System).

Your computer is already properly configured and optimized, and you do not need to run this utility. However, if you encounter configuration problems, you may need to run Setup. Please also refer to Chapter 4 Troubleshooting if a problem arises.

To activate the BIOS Utility, press **F2** during POST (when **Press <F2> to enter Setup** message is prompted on the bottom of screen).

Press **F2** to enter setup. The default parameter of F12 Boot Menu is set to "disabled". If you want to change boot device without entering BIOS Setup Utility, please set the parameter to "enabled".

Press **<F12>** during POST to enter multi-boot menu. In this menu, user can change boot device without entering BIOS SETUP Utility.

Navigating the BIOS Utility

There are six menu options: Information, Main, Advanced, Security, Power, Boot, and Exit.

Follow these instructions:

- To choose a menu, use the left and right arrow keys.
- To choose an item, use the up and down arrow keys.
- To change the value of a parameter, press **F5** or **F6**.
- A plus sign (+) indicates the item has sub-items. Press **Enter** to expand this item.
- Press **Esc** while you are in any of the menu options to go to the Exit menu.
- In any menu, you can load default settings by pressing **F9**. You can also press **F10** to save any changes made and exit the BIOS Setup Utility.

NOTE: You can change the value of a parameter if it is enclosed in square brackets. Navigation keys for a particular menu are shown on the bottom of the screen. Help for parameters are found in the Item Specific Help part of the screen. Read this carefully when making changes to parameter values. **Please note that system information is subject to different models.**

Information

The Information screen displays a summary of your computer hardware information.

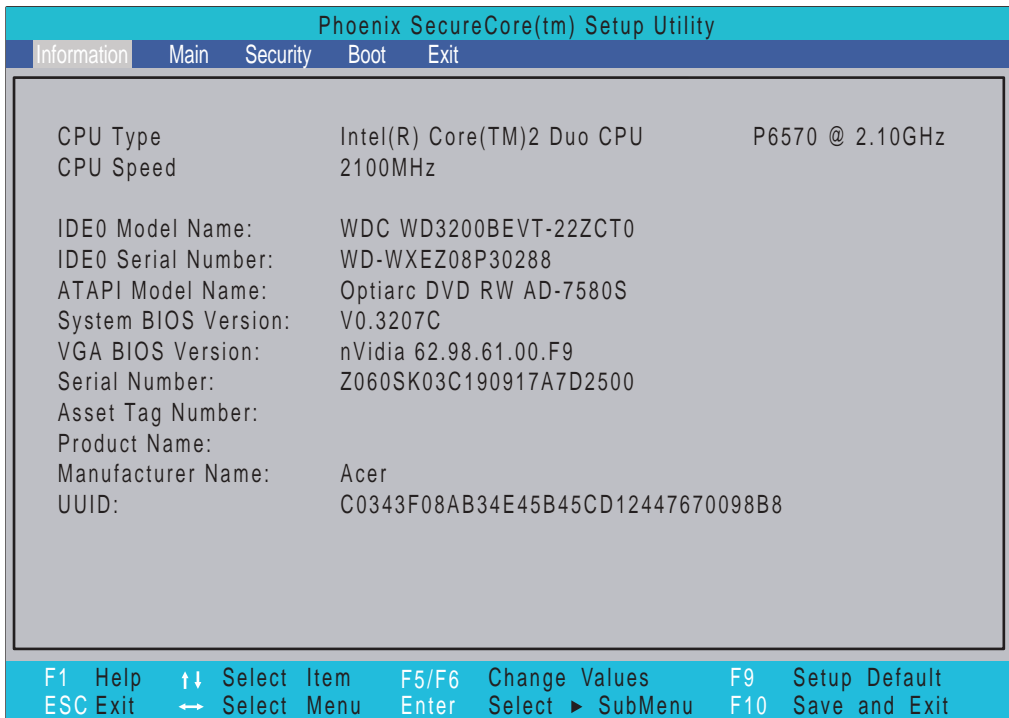

NOTE: The system information is subject to different models.

Parameter	Description
CPU Type	This field shows the CPU type of the system.
CPU Speed	This field shows the speed of the CPU.
IDE0 Model Name	This field shows the model name of HDD installed on primary IDE master.
IDE0 Serial Number	This field displays the serial number of HDD installed on primary IDE master.
System BIOS Version	Displays system BIOS version.
VGA BIOS Version	This field displays the VGA firmware version of the system.
Serial Number	This field displays the serial number of this unit.
Asset Tag Number	This field displays the asset tag number of the system.
Product Name	This field shows product name of the system.
Manufacturer Name	This field displays the manufacturer of this system.
UUID Number	Universally Unique Identifier (UUID) is an identifier standard used in software construction, standardized by the Open Software Foundation (OSF) as part of the Distributed Computing Environment (DCE).

Main

The Main screen allows the user to set the system time and date as well as enable and disable boot option and recovery.

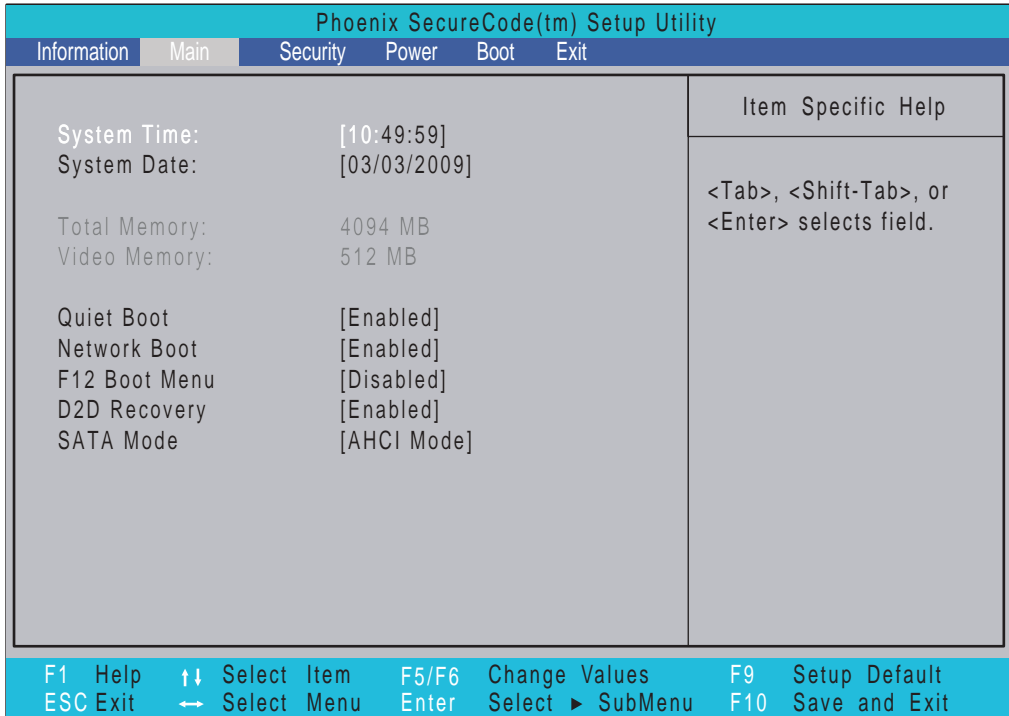

NOTE: The screen above is for your reference only. Actual values may differ.

The table below describes the parameters in this screen. Settings in **boldface** are the default and suggested parameter settings.

Parameter	Description	Format/Option
System Time	Sets the system time. The hours are displayed with 24-hour format.	Format: HH:MM:SS (hour:minute:second)
System Date	Sets the system date.	Format MM/DD/YYYY (month/day/year)
Total Memory	This field reports the memory size of the system. Memory size is fixed to 4094MB.	N/A
Video Memory	Shows the video memory size.	N/A
Quiet Boot	Allows startup to skip certain tests while booting, decreasing the time needed to boot the system.	Option: Enabled or Disabled
Network Boot	Enables, disables the system boot from LAN (remote server).	Option: Enabled or Disabled
F12 Boot Menu	Enables, disables Boot Menu during POST.	Option: Enabled or Disabled
D2D Recovery	Enables, disables D2D Recovery function. The function allows the user to create a hidden partition on hard disc drive to store operation system and restore the system to factory defaults.	Option: Enabled or Disabled
SATA Mode	Control the mode in which the SATA controller should operate.	Option: AHCI or IDE

Security

The Security screen contains parameters that help safeguard and protect your computer from unauthorized use.

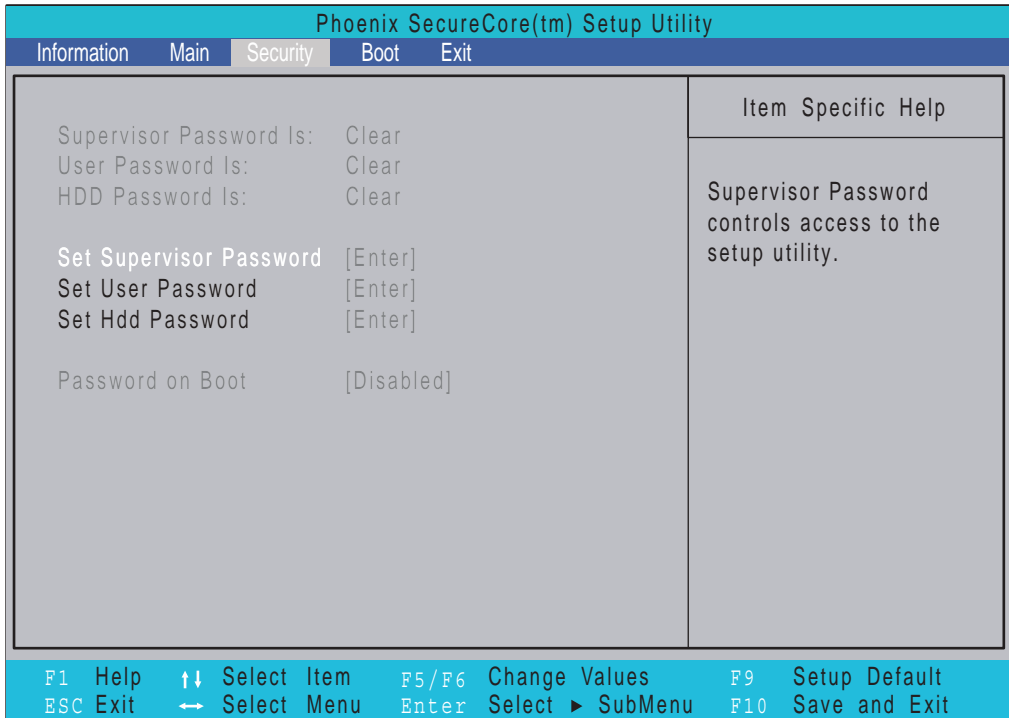

The table below describes the parameters in this screen. Settings in **boldface** are the default and suggested parameter settings.

Parameter	Description	Option
Supervisor Password Is	Shows the setting of the Supervisor password	Clear or Set
User Password Is	Shows the setting of the User password.	Clear or Set
HDD Password Is	Shows the setting of the HDD password.	Clear or Set
Set Supervisor Password	Press Enter to set the supervisor password. When set, this password protects the BIOS Setup Utility from unauthorized access. The user can not either enter the Setup menu nor change the value of parameters.	
Set User Password	Press Enter to set the user password. When user password is set, this password protects the BIOS Setup Utility from unauthorized access. The user can enter Setup menu only and does not have right to change the value of parameters.	
Set Hdd Password	Enter HDD password.	
Power on password	Defines whether a password is required or not while the events defined in this group happened. The following sub-options are all requires the Supervisor password for changes and should be grayed out if the user password was used to enter setup.	Enabled or Disabled

NOTE: When you are prompted to enter a password, you have three tries before the system halts. Don't forget your password. If you forget your password, you may have to return your notebook computer to your dealer to reset it.

Setting a Password

Follow these steps as you set the user or the supervisor password:

1. Use the ↑ and ↓ keys to highlight the Set Supervisor Password parameter and press the **Enter** key. The Set Supervisor Password box appears:

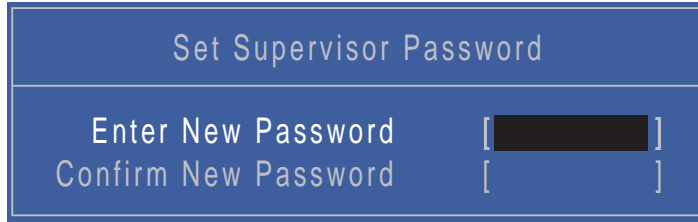

Set Supervisor Password	
Enter New Password	[██████████]
Confirm New Password	[]

2. Type a password in the “Enter New Password” field. The password length can not exceeds 8 alphanumeric characters (A-Z, a-z, 0-9, not case sensitive). Retype the password in the “Confirm New Password” field.

IMPORTANT: Be very careful when typing your password because the characters do not appear on the screen.

3. Press **Enter**. After setting the password, the computer sets the User Password parameter to “Set”.
4. If desired, you can opt to enable the Password on boot parameter.
5. When you are done, press F10 to save the changes and exit the BIOS Setup Utility.

Removing a Password

Follow these steps:

1. Use the ↑ and ↓ keys to highlight the Set Supervisor Password parameter and press the **Enter** key. The Set Password box appears:



Set Supervisor Password	
Enter Current Password	[██████████]
Enter New Password	[]
Confirm New Password	[]

2. Type the current password in the Enter Current Password field and press **Enter**.
3. Press **Enter** twice **without** typing anything in the Enter New Password and Confirm New Password fields. The computer then sets the Supervisor Password parameter to “Clear”.
4. When you have changed the settings, press u to save the changes and exit the BIOS Setup Utility.

Changing a Password

1. Use the ↑ and ↓ keys to highlight the Set Supervisor Password parameter and press the **Enter** key. The Set Password box appears.



The screenshot shows a blue BIOS screen titled "Set Supervisor Password". It contains three input fields: "Enter Current Password", "Enter New Password", and "Confirm New Password". The first field is filled with blacked-out characters, while the other two are empty. Each field has a pair of square brackets to its right.

2. Type the current password in the Enter Current Password field and press **Enter**.
3. Type a password in the Enter New Password field. Retype the password in the Confirm New Password field.
4. Press **Enter**. After setting the password, the computer sets the User Password parameter to "Set".
5. If desired, you can enable the Password on boot parameter.
6. When you are done, press **F10** to save the changes and exit the BIOS Setup Utility.
If the verification is OK, the screen will display as following.

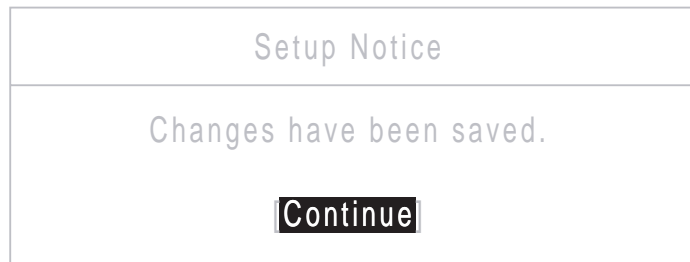

The screenshot shows a white BIOS screen titled "Setup Notice". Below the title, it says "Changes have been saved." At the bottom, there is a black button with the word "Continue" in white text.

The password setting is complete after the user presses **Enter**.

If the current password entered does not match the actual current password, the screen will show you the Setup Warning.



The screenshot shows a white BIOS screen with a red border titled "Setup Warning". Below the title, it says "Invalid Password." At the bottom, there is a black button with the word "Continue" in white text.

If the new password and confirm new password strings do not match, the screen displays the following message.



The screenshot shows a white BIOS screen with a red border titled "Setup Warning". Below the title, it says "Passwords do not match. Re-enter password." At the bottom, there is a black button with the word "Continue" in white text.

Boot

This menu allows the user to decide the order of boot devices to load the operating system. Bootable devices includes USB drives, the onboard hard disk drive and the DVD drive in the module bay.

Phoenix SecureCore(tm) Setup Utility				
Information	Main	Security	Boot	Exit
Boot priority order: 1. IDE0 : WDC WD3200BEVT-22ZCT0-(S1) 2. IDE CD : Optiarc DVD RW AD-7580S 3. PCI LAN: Atheros Boot Agent 4. USB HDD : 5. USB CDROM : 6. USB FDC : 7. USB KEY : 8: Excluded from boot order:		Item Specific Help Keys used to view or configure devices: Up and Down arrows select a device. <+> and <-> moves the device up or down. <f> and <r> specifies the device fixed or removable. <x> exclude or include the device to boot. <Shift+1> enables or disables a device. <1 - 4> Loads default boot sequence.		
F1 Help	↑↓ Select Item	F5/F6 Change Values	F9 Setup Default	
ESC Exit	←→ Select Menu	Enter Select ► SubMenu	F10 Save and Exit	

Exit

The Exit screen allows you to save or discard any changes you made and quit the BIOS Utility.

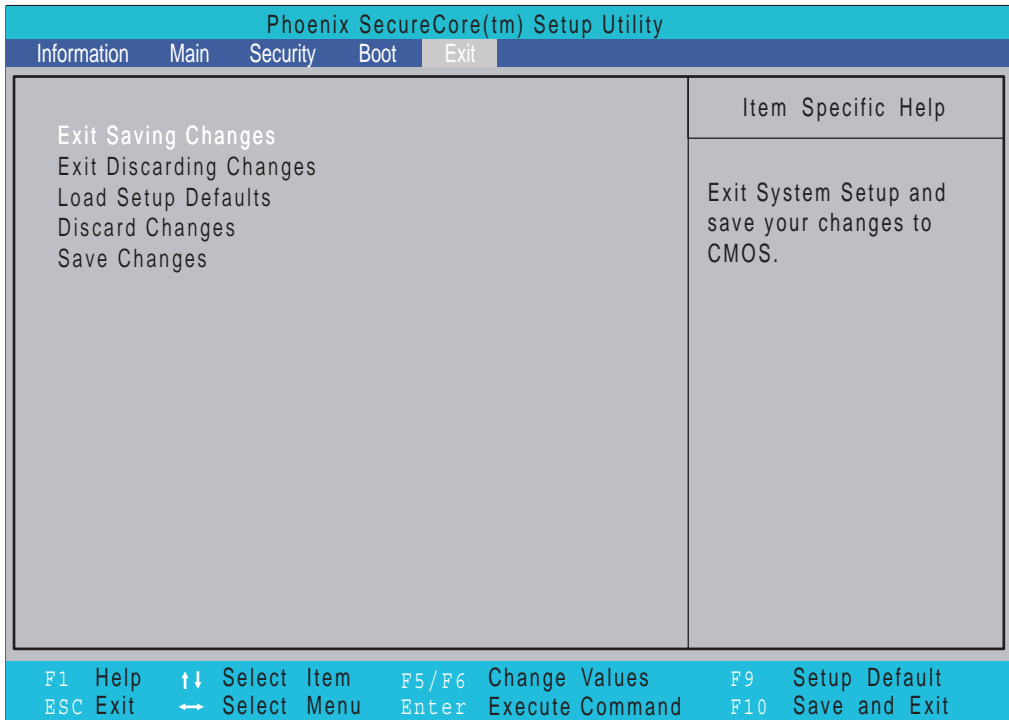

The table below describes the parameters in this screen.

Parameter	Description
Exit Saving Changes	Exit System Setup and save your changes to CMOS.
Exit Discarding Changes	Exit utility without saving setup data to CMOS.
Load Setup Default	Load default values for all SETUP item.
Discard Changes	Load previous values from CMOS for all SETUP items.
Save Changes	Save Setup Data to CMOS.

BIOS Flash Utility

The BIOS flash memory update is required for the following conditions:

- New versions of system programs
- New features or options
- Restore a BIOS when it becomes corrupted.

Use the Flash16 utility to update the system BIOS flash ROM.

NOTE: Do not install memory-related drivers (XMS, EMS, DPMS) when you use the Flash16 Utility.

NOTE: Please use the AC adaptor power supply when you run the flashit utility. If the battery pack does not contain enough power to finish the BIOS flash, you may not boot the system because the BIOS is not completely loaded.

Using the Flash16 Utility to Update the BIOS

Follow the steps below to run the Flash16 Utility.

1. Prepare a bootable diskette.
2. Copy the flash utilities to the bootable diskette.
3. Boot the system from the bootable diskette.
4. Run `Phlash16.exe z06_3106.wph /mode=3 /x`. After flashing the BIOS the system will restart.
5. During POST, press F2 to enter into the BIOS setup screen.
6. Navigate to the Exit page, choose Load Setup Defaults then press ENTER.
7. When a Setup Confirmation appears, choose 'Yes'. The system will restart with the BIOS settings included in the utility.

WinFlash Utility

Perform the following steps to use the WinFlash Utility:

1. The flash utility is stored on the hard drive and is based on BIOS V.3208.
2. The BIOS flash package includes the following files:
 - ZK6_3208.WPH is the BIOS rom
 - WinPhlash1.6.8.8 is the BIOS windows flash tool

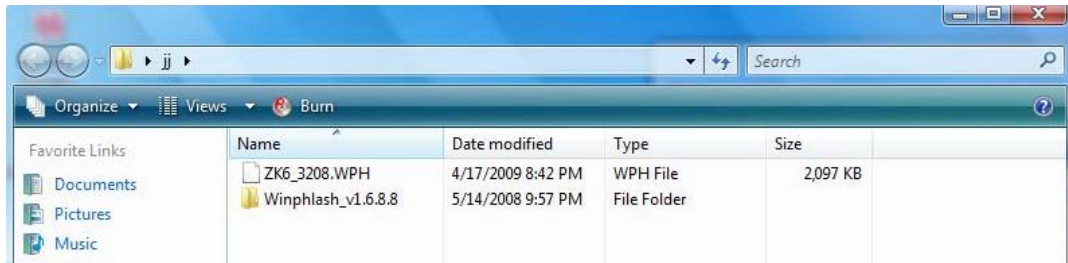

3. Execute " WinPhlash1.6.8.8" to update the BIOS, then choose " ZK6_3208.WPH " to continue.

NOTE: If the AC adapter is not plugged in the following message appears. Plug the AC source in and run the program again.

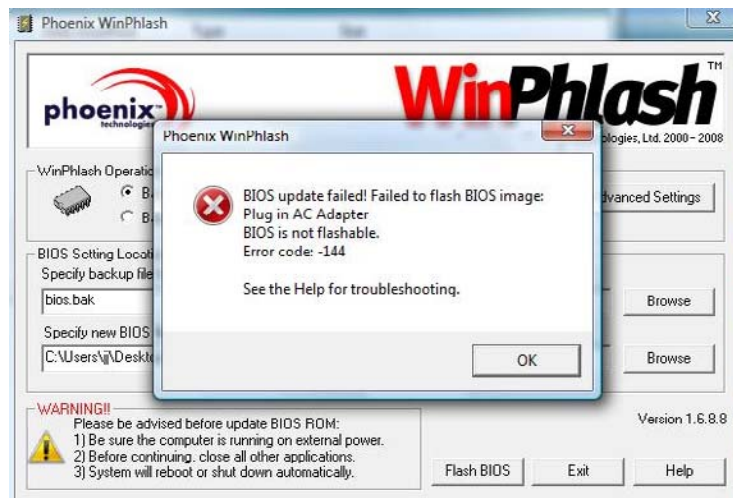

4. Please wait 5~10 seconds to launch BIOS Windows Flash application.
5. Click **Flash BIOS**.



6. Please wait while the BIOS is overwritten.

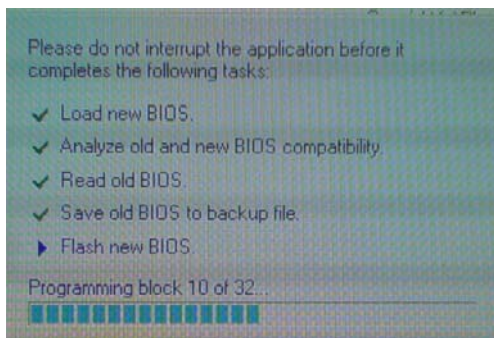

7. The system will auto restart after upgraded BIOS complete.

DOS Flash Utility

1. Press F2 while booting to enter the setup menu.
2. Select "Boot Menu" to change boot priority order, for example, Press F6 to set item 4: USB HDD: USB 2.0 Flash Drive to priority 1.

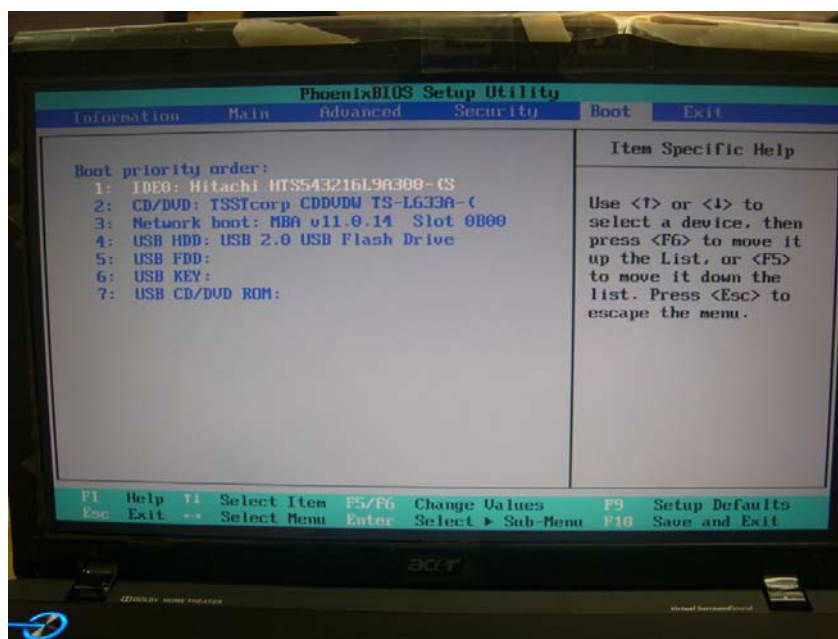

NOTE: Please use a USB KEY, USB HDD, DVD-RW, or HDD that can boot into DOS mode.

3. Execute the "BIOS.BAT" batch file to update BIOS

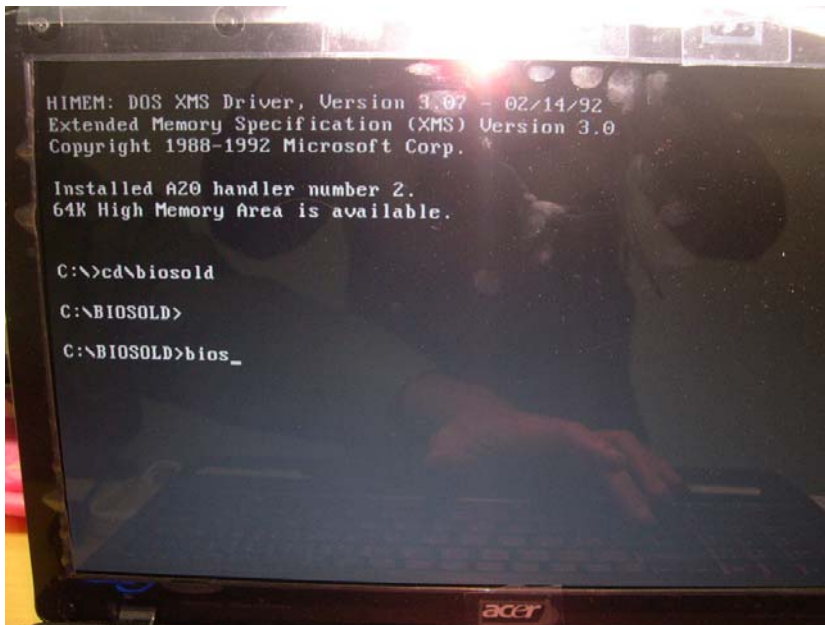

4. The image file automatically loads as shown below.

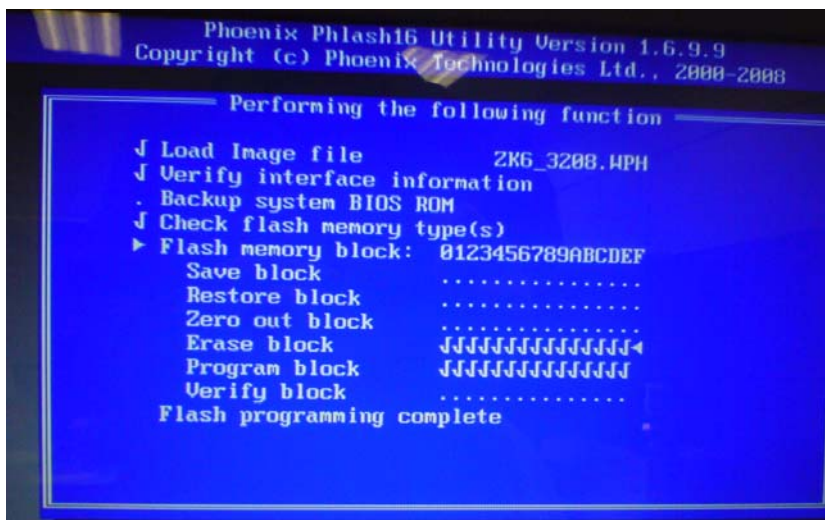

5. A "CAUTION : Please Do Not Remove AC Power Source." message displays

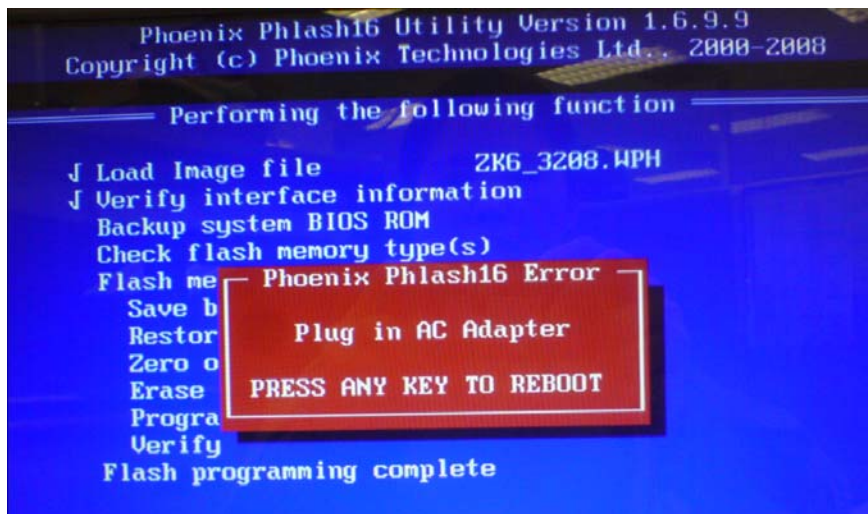

6. The BIOS updates as shown below.



Remove HDD/BIOS Password Utilities

To reset a hard drive or BIOS password you require an additional PC. The utilities run on a DOS prompt on the second machine.

This section provides instructions on how to remove a HDD password. If you enter the wrong hard drive password three times, the system reports the following error code:

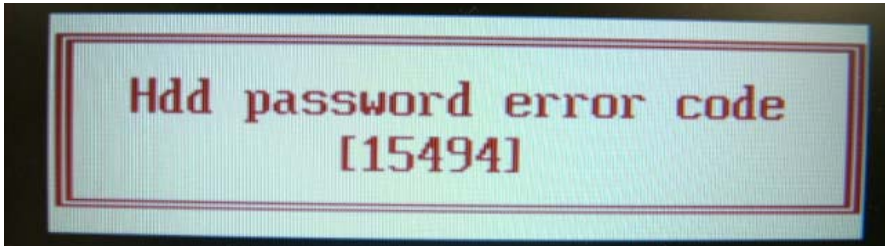

To reset the HDD password, run HDD_PW.EXE on a second machine as follows:

1. At a command prompt, type **hdd_pw 15494 0**
2. Type **2**.



3. Write down one of the two strings (in this example, **OKJFN42** or **UVEIQ96**).
4. Reboot the system and type the selected string (in this example **OKJFN42** or **UVEIQ96**) for the HDD user password.



Removing BIOS Passwords:

If you key in the wrong Supervisor Password three times, System Disabled displays on the screen as below.



To reset the BIOS password, run BIOS_PW.EXE on a second machine as follows:

1. At a command prompt, type **bios_pw 14452 0**.
2. Select one string from the list.

A screenshot of a Windows XP command prompt window. The title bar reads "C:\WINDOWS\system32\cmd.exe". The window content shows the following text:

```
Microsoft Windows XP [Version 5.1.2600]
(C) Copyright 1985-2001 Microsoft Corp.

C:\Documents and Settings\M54>d:
D:\>bios_pw 14452 0
unlock6.exe v1.0 1 July 1997
qjg9uy
07yqnd
cjl14tn
6mbzaj
```

The command "bios_pw 14452 0" is highlighted with a yellow box and a "1." next to it. The list of strings is highlighted with a yellow box and a "2." next to it.

3. Reboot the system and type the selected string (in this example qjig9vy or 07yqmjd etc.) for the BIOS user password.

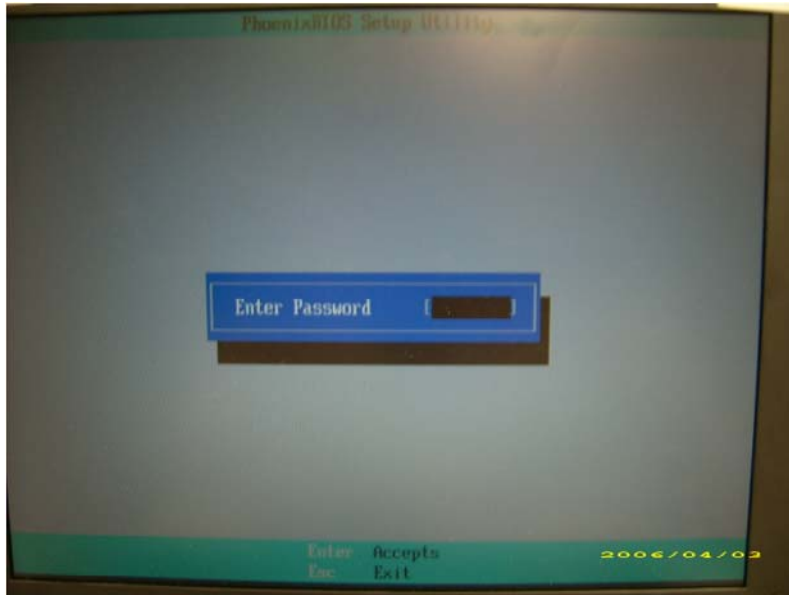

Cleaning BIOS Passwords

To clear the password, perform the following steps:

1. From a DOS prompt, Execute **clnpwd.exe**

```
d:\Clnpwd>clnpwd
ACER Clean Password Utility V1.00
Press 1 or 2 to clean any password shown as below
    1.User Password
    2.Supervisor Password

Clean User Password Successfully!
```

2. Press 1 or 2 to clean the desired password shown on the screen.
The onscreen message determines whether the function is successful or not.

Miscellaneous Utilities

Using Boot Sequence Selector

Boot Sequence Selector allows the boot order to be changed without accessing the BIOS. To use Boot Sequence Selector, perform the following steps:

1. Enter into DOS.
2. Execute BS.exe to display the usage screen.



```
d:\BOOTSEQ>bs

*** Boot Sequence Selector Version 0.03 ***
Create by Rockwell Chuang 10/01/2005.

Usage:
BS [ 1 | 2 | 3 | 4 ]

BS 1 : [ Floppy ] => [ HardDisk ] => [ CD-ROM ] => [ LAN ]
BS 2 : [ HardDisk ] => [ CD-ROM ] => [ LAN ] => [ Floppy ]
BS 3 : [ CD-ROM ] => [ HardDisk ] => [ LAN ] => [ Floppy ]
BS 4 : [ LAN ] => [ Floppy ] => [ HardDisk ] => [ CD-ROM ]

d:\BOOTSEQ>
```

3. Select the desired boot sequence by entering the corresponding sequence, for example, enter BS2 to change the boot sequence to HDD|CD ROM|LAN|Floppy.

Using DMITools

The DMI (Desktop Management Interface) Tool copies BIOS information to eeprom to be used in the DMI pool for hardware management.

When the BIOS displays **Verifying DMI pool data** it is checking the table correlates with the hardware before sending to the operating system (Windows, etc.).

To update the DMI Pool, perform the following steps:

1. Op[en a command prompt.
2. Execute **dmitools.exe**. The following messages show dmitools usage:

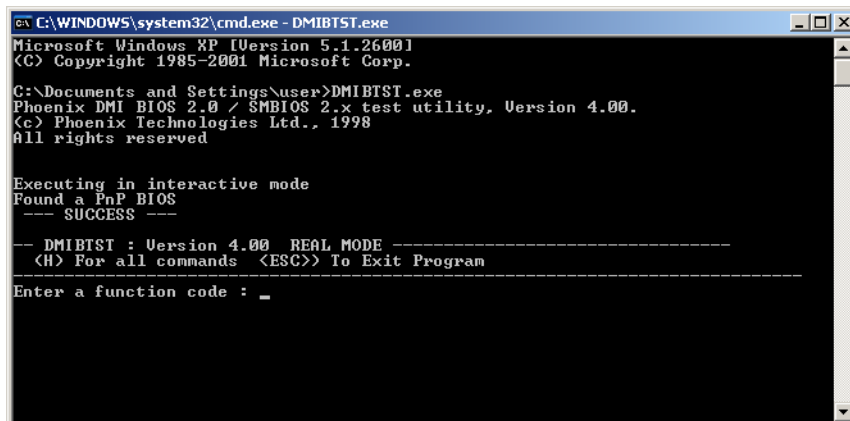

```
C:\WINDOWS\system32\cmd.exe - DMIBTST.exe
Microsoft Windows XP [Version 5.1.2600]
(C) Copyright 1985-2001 Microsoft Corp.

C:\Documents and Settings\user>DMIBTST.exe
Phoenix DMI BIOS 2.0 / SMBIOS 2.x test utility, Version 4.00.
(c) Phoenix Technologies Ltd., 1998
All rights reserved

Executing in interactive mode
Found a PnP BIOS
--- SUCCESS ---

--- DMIBTST : Version 4.00 REAL MODE -----
<H> For all commands <ESC> To Exit Program
-----
Enter a function code : _
```

IMPORTANT:The following write examples (2 to 5) require a system reboot to take effect

Example 1: Read DMI Information from Memory

Input:

```
dmitools /r
```

Output:

```
Manufacturer (Type1, Offset04h): Acer
```

```
Product Name (Type1, Offset05h): one xxxxx
```

```
Serial Number (Type1, Offset07h): 01234567890123456789
```

```
UUID String (Type1, Offset08h): xxxxxxxx-xxxx-xxxx-xxxx-xxxxxxxxxxxx
```

```
Asset Tag (Type3, Offset04h): Acer Asstag
```

Example 2: Write Product Name to EEPROM

Input:

```
dmitools /wp Acer
```

Example 3: Write Serial Number to EEPROM

Input:

```
dmitools /ws 01234567890123456789
```

Example 4: Write UUID to EEPROM

Input:

```
dmitools /wu
```

Example 5: Write Asset Tag to EEPROM

Input:

```
dmitools /wa Acer Asstag
```

Using the LAN MAC Utility

Perform the following steps to write MAC information to eeprom:

1. Use a text editor, for example Notepad, to edit the MAC.CFG file as shown:

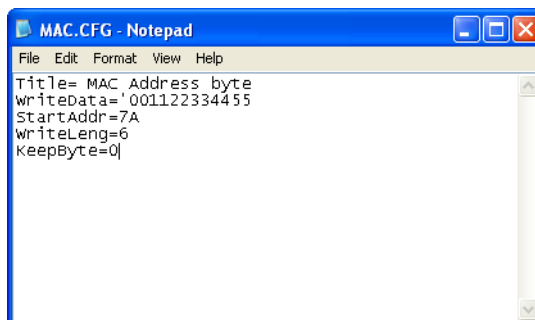

- WriteData= '001122334455' <----- MAC value
 - StartAddr=7A <----- MAC address
 - WriteLeng=6 <----- MAC value length
 - KeepByte=0 <----- can be any value
2. Boot into DOS.
 3. Execute **MAC.BAT** to write MAC information to eeprom.

Machine Disassembly and Replacement

This chapter contains step-by-step procedures on how to disassemble the notebook computer for maintenance and troubleshooting.

Disassembly Requirements

To disassemble the computer, you need the following tools:

- Wrist grounding strap and conductive mat for preventing electrostatic discharge
- Flat screwdriver
- Philips screwdriver
- Plastic flat screwdriver
- Plastic tweezers

NOTE: The screws for the different components vary in size. During the disassembly process, group the screws with the corresponding components to avoid mismatch when putting back the components.

General Information

Pre-disassembly Instructions

Before proceeding with the disassembly procedure, make sure that you do the following:

1. Turn off the power to the system and all peripherals.
2. Unplug the AC adapter and all power and signal cables from the system.



3. Place the system on a flat, stable surface.
4. Remove the battery pack.

Disassembly Process

The disassembly process is divided into the following stages:

- External module disassembly
- Main unit disassembly
- LCD module disassembly

The flowcharts provided in the succeeding disassembly sections illustrate the entire disassembly sequence. Observe the order of the sequence to avoid damage to any of the hardware components. For example, if you want to remove the main board, you must first remove the keyboard, then disassemble the inside assembly frame in that order.

Main Screw List

Description	Quantity	Acer P/N
M2.0D 3.0L K4.6D 0.8T ZK	17	86.AD302.001
M2.5D 3.0L K5.5D 0.8T ZK	15	86.AD302.002
M2.5D 5L K 5.5D ZK NL	21	86.AD302.003
M2.5D 10.0L K 5.5D 0.8T ZK	12	86.AD302.004
M3.0D 3.0L K 4.9D NI+	4	86.AD302.005
M2.5D 3.2L K 6D NI+	4	86.AD302.006

External Module Disassembly Process

External Modules Disassembly Flowchart

The flowchart below gives you a graphic representation on the entire disassembly sequence and instructs you on the components that need to be removed during servicing. For example, if you want to remove the main board, you must first remove the keyboard, then disassemble the inside assembly frame in that order.

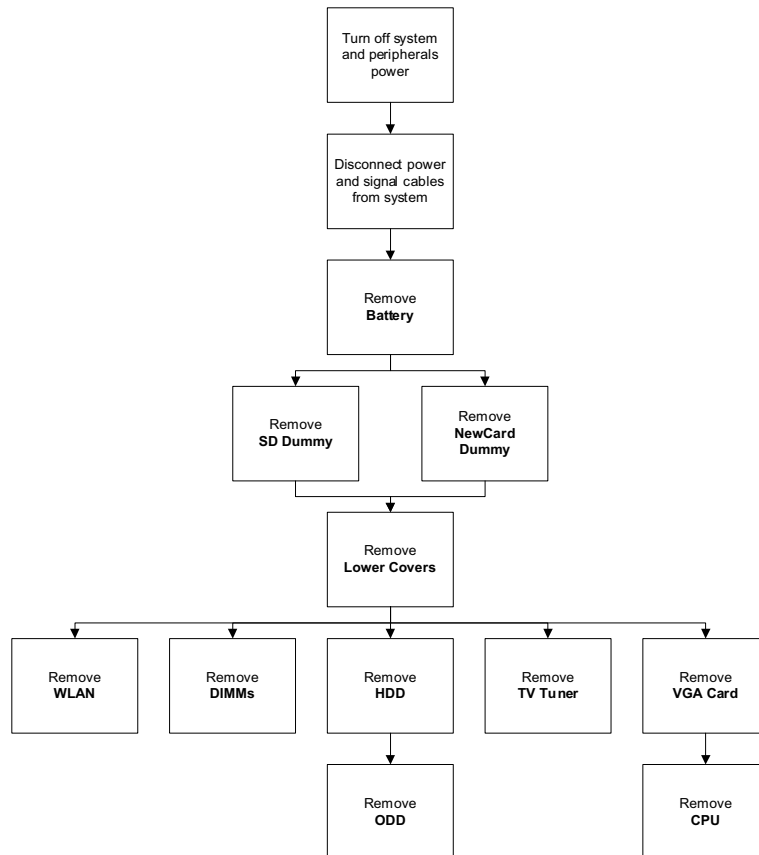

Screw List

Step	Screw	Quantity	Part No.
WLAN Module	M2*3	2	86.AD302.001
HDD Carrier	M3*3	4	86.AD302.005
ODD Module	M2.5*5	1	86.AD302.003
ODD Bracket	M2*3	2	86.AD302.001

Removing the Battery Pack

1. Turn computer over.

2. Slide the battery lock/unlock latch to the unlock position.



3. Slide and hold the battery release latch to the release position (1), then lift out the battery pack from the main unit (2).

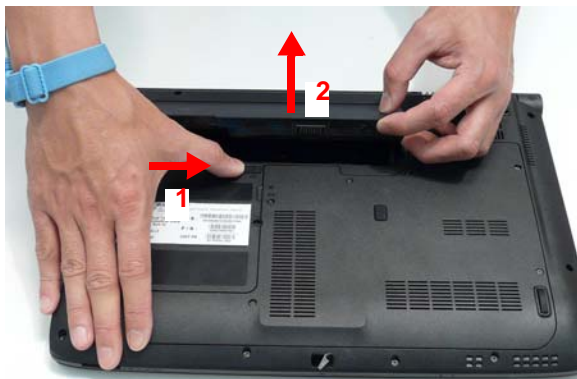

Removing the SD dummy card

1. Push the SD dummy card all the way in to eject it.



2. Pull it out from the slot.



Removing the Lower Cover

1. See "Removing the Battery Pack" on page 49.
2. See "Removing the SD dummy card" on page 50.
3. Loosen the six captive screws in the cover as shown.

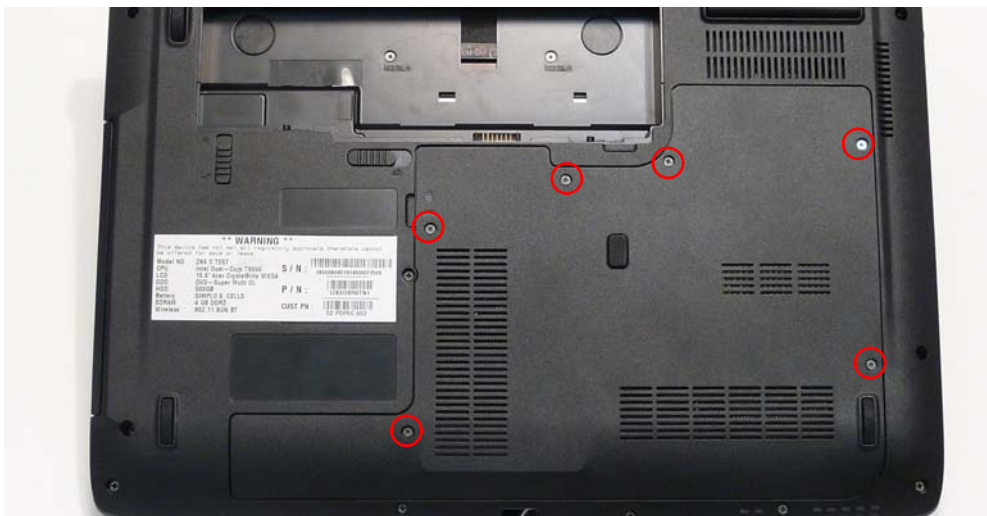

4. Carefully open the Lower Cover.



Removing the WLAN Module

NOTE: Systems are configured with two or three WAN antenna cables. The following procedure shows three antenna cables. The grey antenna cable is optional and may not appear in your system.

1. See "Removing the Lower Cover" on page 51.
2. Disconnect the three antenna cables.



3. Remove the single securing screw.



Step	Size	Quantity	Screw Type
WLAN Module	M2*3	1	

4. Remove the WLAN module as shown.



Removing the DIMM Modules

1. See "Removing the Lower Cover" on page 51.
2. Push out the release latches on both sides of the DIMM socket to release the DIMM module.



3. Remove the DIMM module.



4. Repeat steps 2 and 3 for the second DIMM module.

Removing the Hard Disk Drive Module

1. See "Removing the Lower Cover" on page 51.
2. Remove the single screw securing the hard disk bracket to the Lower Cover.

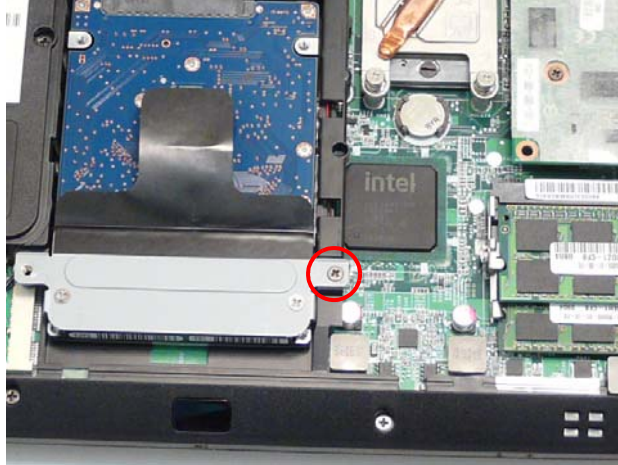

3. Hold the Pull Tab and slide the HDD away from the connector.

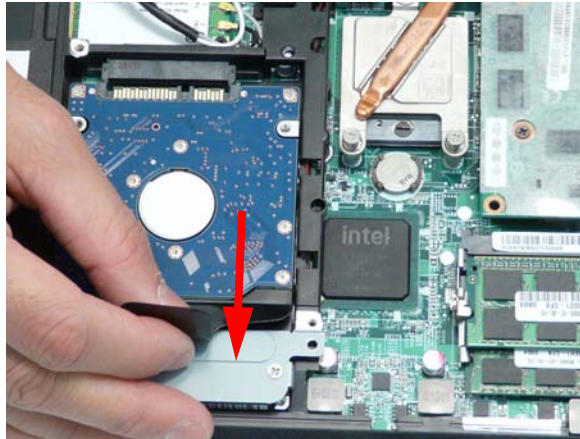



4. Pull the HDD up as shown to remove.

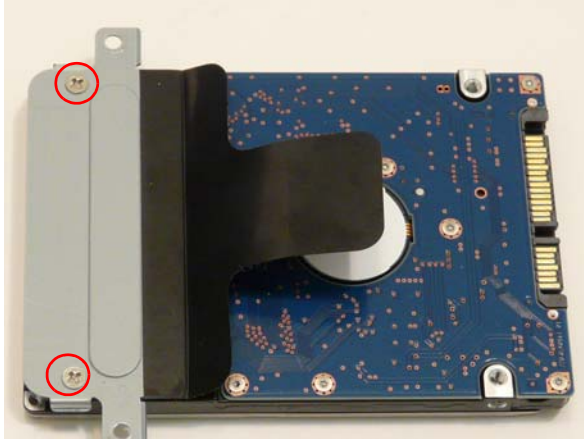

NOTE: To prevent damage to the HDD, avoid pressing down on it or placing heavy objects on top of it.

5. Remove the two screws (two each side) securing the HDD to the carrier.



Step	Size	Quantity	Screw Type
HDD Carrier	M3*3	2	

6. Lift the HDD carrier to remove.

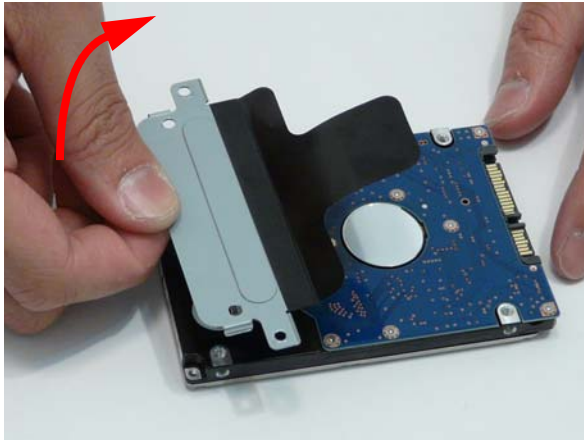

Removing the Optical Disk Drive Module

1. See "Removing the Hard Disk Drive Module" on page 54.

2. Remove the screw securing the ODD module.



Step	Size	Quantity	Screw Type
ODD Module	M2.5*6	1	

3. Insert a pen or other narrow plastic object as shown and push the ODD Module out of the bay.



- Remove the two screws securing the ODD bracket and remove the ODD bracket from the optical disk drive module.



Step	Size	Quantity	Screw Type
ODD Bracket	M2*3	2	

- Press down on the locking catch to release the ODD cover and remove.



Removing the TV Tuner

- See "Removing the Lower Cover" on page 51.

2. Disconnect the antenna cable.



3. Remove the single securing screw.



Step	Size	Quantity	Screw Type
TV Tuner Module	M2*3	1	

4. Remove the TV Tuner module as shown.

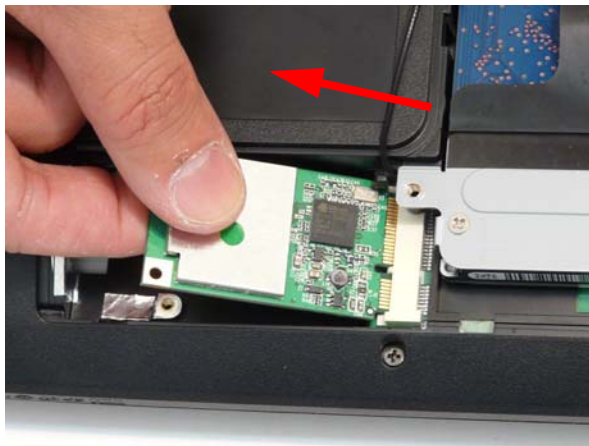

Removing the Graphics Card

1. See “Removing the Lower Cover” on page 51.
2. Remove the four screws securing the graphics card to the thermal unit underneath. The graphics card pops up.

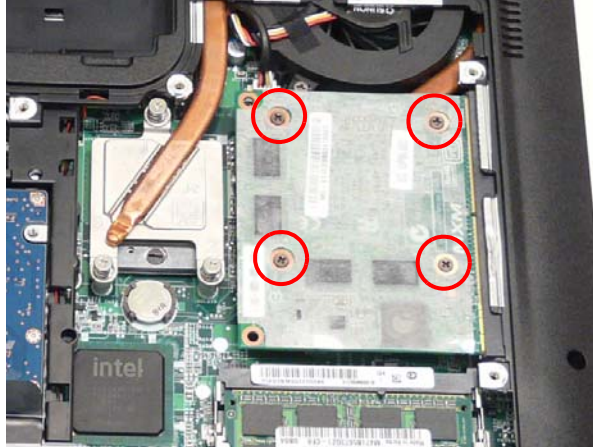

3. Remove the MXM card from the slot.

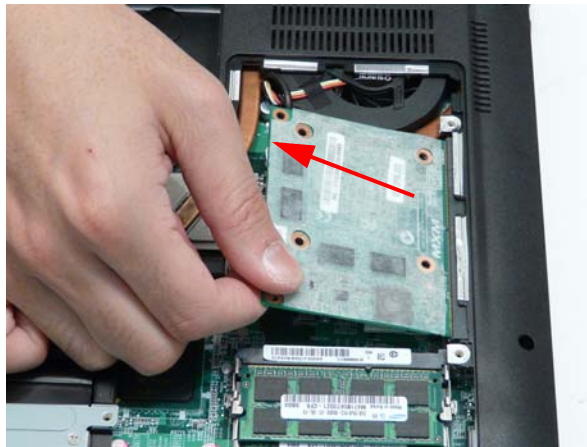

Removing the RTC Battery

1. See “Removing the Lower Cover” on page 51.
2. Remove the RTC battery from the mainboard.



Removing the CPU

1. See "Removing the Graphics Card" on page 59.

NOTE: With the graphics card removed, the GPU thermal pads are exposed. Do not allow any object to come into contact with the thermal pads as their performance will be seriously degraded if they are damaged. Replace the thermal pads if any object comes into contact with them.

2. Unscrew the three securing screws of the CPU heat sink in the indicated order: 3, 2, 1.

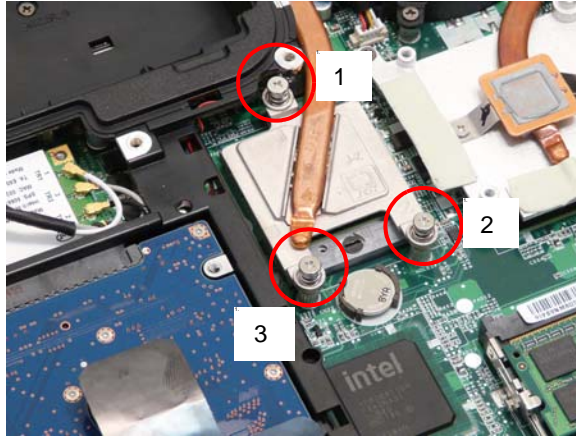

3. Using a flat screwdriver, turn the CPU socket latch counter-clockwise 180° to release the CPU.



4. Lift the CPU arm of the thermal unit. Keep the heat sink raised.



-
5. Clean the thermal pad off of the heat sink. Scrape the thermal pad off with a plastic implement and then use alcohol and a microfiber cloth to remove any residue from the heat sink.

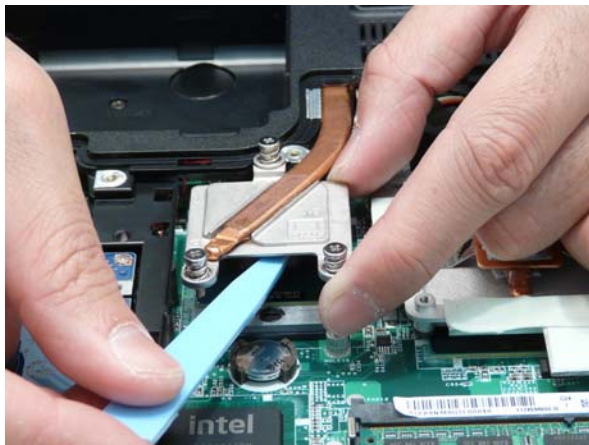

6. Lift the CPU clear of the socket by grasping from the corners and carefully ease the CPU out from under the heat sink.

WARNING: Take care to prevent the pins from becoming bent while removing the CPU. If you find it difficult to remove the CPU using this method, or lack the tools to properly remove the CPU clear of the socket, then remove the Thermal Module from the Mainboard first. See “Removing the Thermal Module” on page 82.

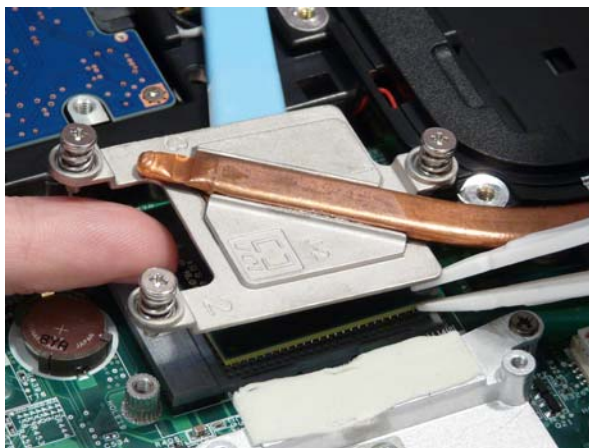

Main Unit Disassembly Process

Main Unit Disassembly Flowchart



Screw List

Step	Screw	Quantity	Part No.
Hinge Covers	M2*3	2	86.AD302.001
Switch Cover	M2.5*3	4	86.AD302.002
	M2.5*10	2	86.AD302.004
Function Board	M2.5*3	2	86.AD302.002
Speaker Module	M2.5*3	2	86.AD302.002
LCD Module	M2.5*5	6	86.AD302.003
Upper Cover	M2.5*10	10	86.AD302.004
	M2.5*5	6	86.AD302.003
	M2.5*3	1	86.AD302.002
Finger Print Reader	M2*3	1	86.AD302.001
TouchPad Bracket	M2*3	2	86.AD302.001
eKey Board	M2.5*3	1	86.AD302.002
USB Board	M2.5*3	1	86.AD302.002

Step	Screw	Quantity	Part No.
Modem Module	M2*3	2	86.AD302.001
BT Module	M2.5*3	1	86.AD302.002
Mainboard	M2.5*3	1	86.AD302.002
Thermal Module	M2.5*5*3.2	4	86.AD302.006

Removing the Hinge Covers

1. See "Removing the Battery Pack" on page 49.
2. Remove the two screw caps and screws from the Hinge Covers.



Step	Size	Quantity	Screw Type
Hinge Covers	M2.5*4	2	

3. Slide the covers off the hinges in the direction of the arrows.

IMPORTANT: The left and right Hinge Covers are shaped differently and marked **L** and **R** on the inside. Ensure that the correct cover is used during reassembly.



Removing the Switch Cover

CAUTION: Using tools to remove the Switch Cover may cause damage to the outer casing. It is recommended that only fingers are used to remove the Switch Cover.

1. See "Removing the Battery Pack" on page 49.

2. See "Removing the Hinge Covers" on page 63.
3. Locate and remove the six securing screws on the bottom of the computer.

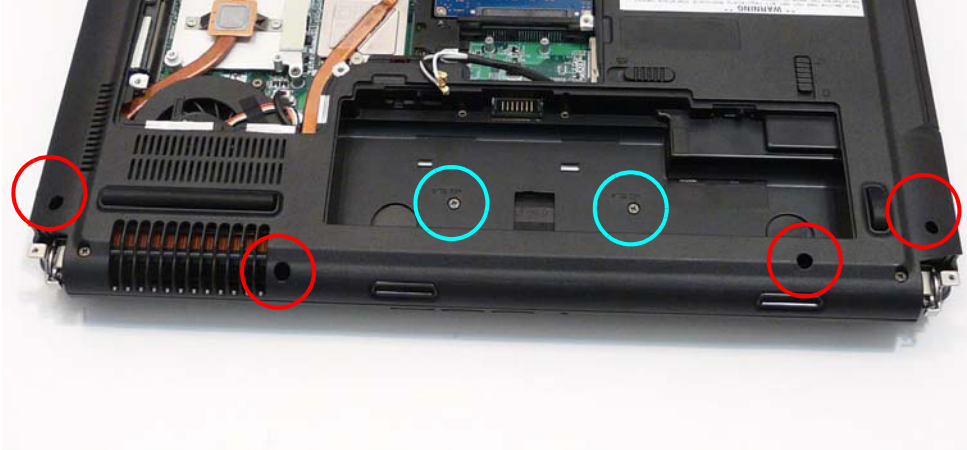

Step	Size	Quantity	Screw Type
Switch Cover (red callout)	M2.5*6	6	
Switch Cover (cyan callout)	M2.5*4	2	

4. Turn the computer over and open the LCD module to expose the Switch Cover.

IMPORTANT:The LCD module does not fully extend. Damage will occur if you attempt to extend the LCD module beyond the manufacturer's design.
5. Pull the switch cover up from the left or right corner, separating the back edge first.



6. Using both hands, lift both sides of the rear edge of the Switch Cover upward as shown.



7. Place the switch board on the keyboard.



8. Disconnect the function board from the main unit by lifting the FFC lock and removing the FFC as shown.



9. Disconnect the power board from the main unit by lifting the FFC lock and removing the FFC as shown.

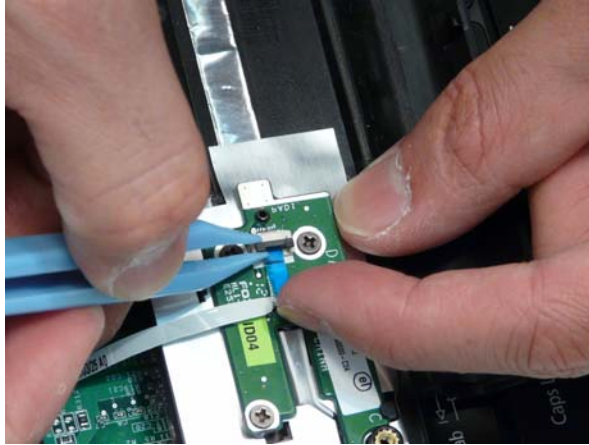

Removing the Power Save Board

1. See "Removing the LCD Module" on page 68.
2. Disconnect the Power Save Board from the Function Board by lifting the FFC lock and removing the FFC as shown.

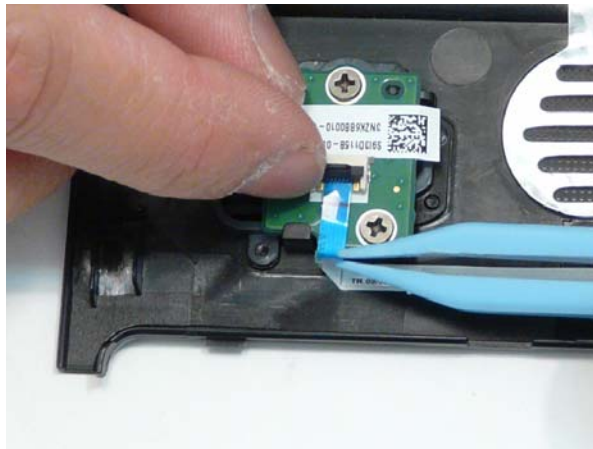

3. Remove the two screws securing the Power Save Board to the Switch Cover as shown.

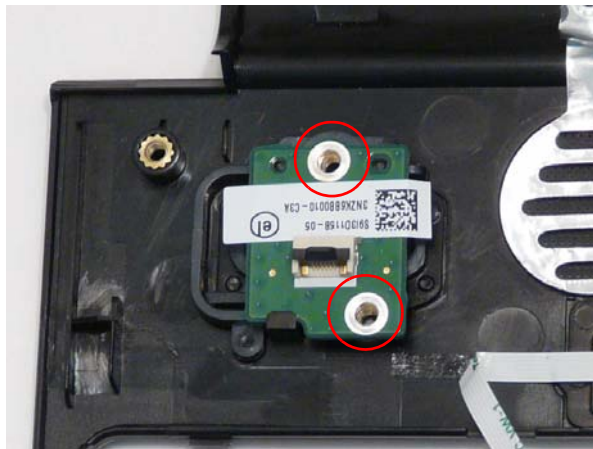

Step	Size	Quantity	Screw Type
Switch Cover (red callout)	M2.5*4	2	

4. Remove the Power Save Board from the Switch Cover.

Removing the Power Switch Board

1. See “Removing the LCD Module” on page 68.
2. Remove the three screws securing the Power Save Board to the Switch Cover as shown.

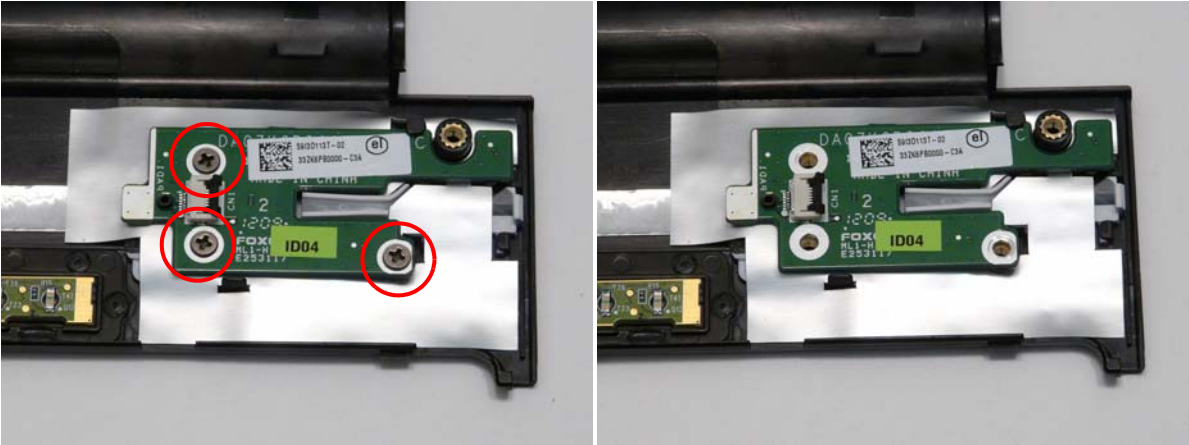

Step	Size	Quantity	Screw Type
Switch Cover (red callout)	M2.5*4	3	

3. Remove the power board by sliding it out from the securing tab as shown.

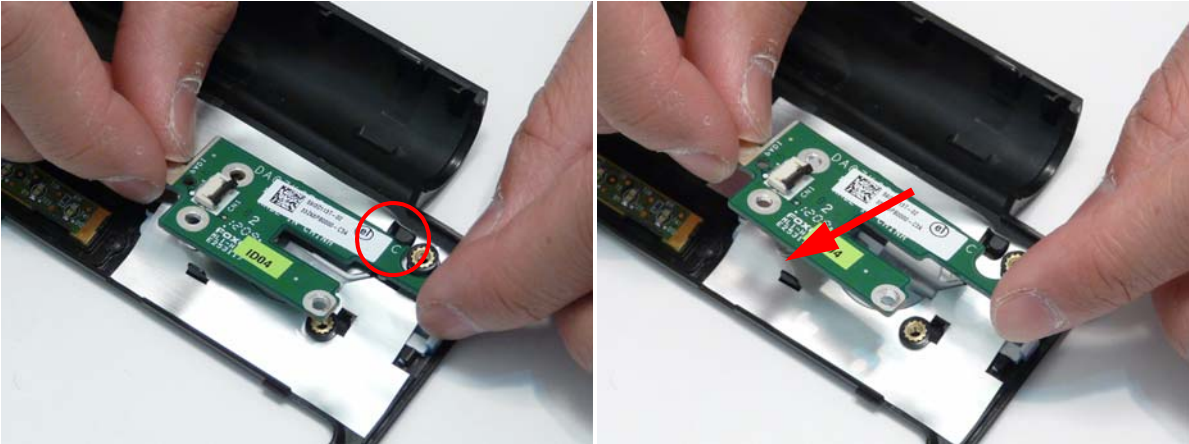

Removing the Keyboard

1. See “Removing the Switch Cover” on page 63.
2. Pull up on the center rear of the keyboard until the Keyboard snaps free of the securing tabs on both sides of the Keyboard.

IMPORTANT:The keyboard is still attached to the Mainboard FFC - do not pull on the keyboard.



3. Lay the keyboard face down on the touchpad.

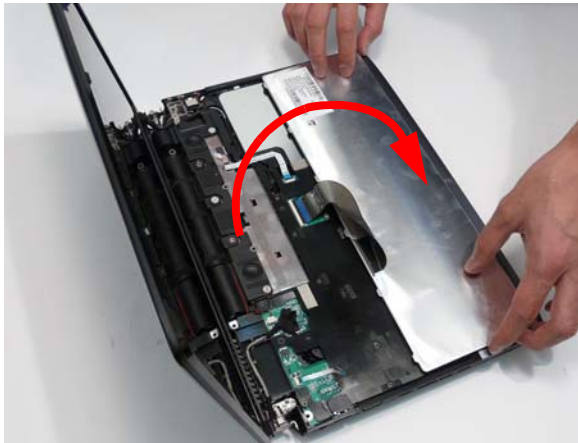

4. Unlock the connector and pull the FFC to remove it from the Mainboard.

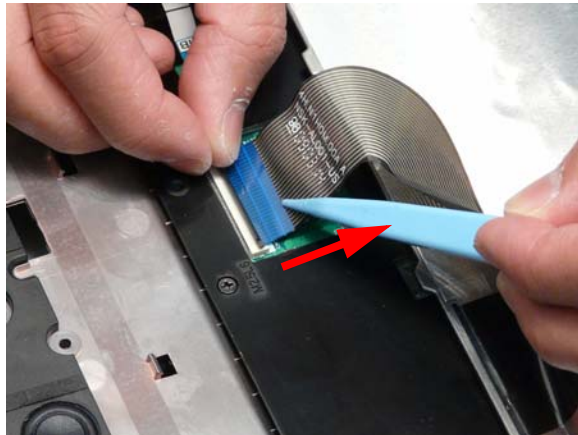



5. Remove the keyboard from the chassis.

Removing the LCD Module

1. See "Removing the WLAN Module" on page 52.
2. See "Removing the Keyboard" on page 67.

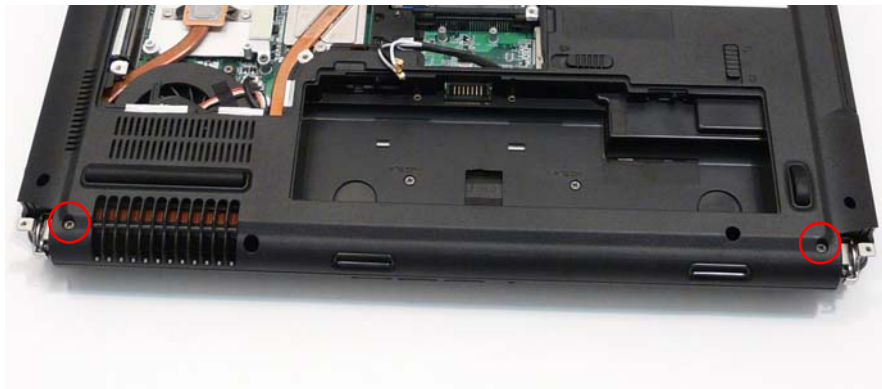
3. Turn the computer over. Remove the two securing screws as shown.



Step	Size	Quantity	Screw Type
LCD Module	M2.5*5	2	

4. Starting at the LCD module, completely remove the Antenna cable from the cable channel.

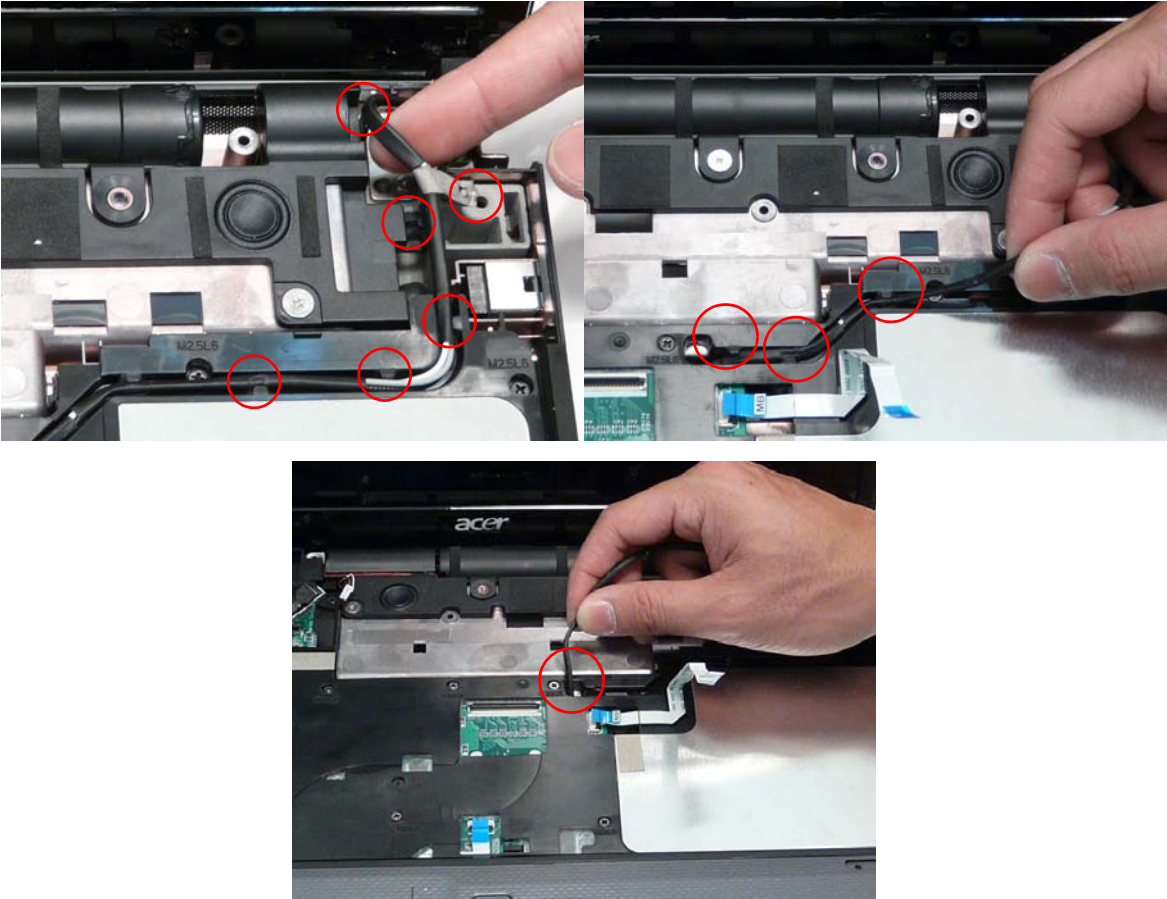

5. Rest the computer on its side with the LCD Module open and push the Antenna cable through the chassis as shown.



6. Disconnect the LCD cables from the Mainboard and remove the cable from the cable channel as shown.

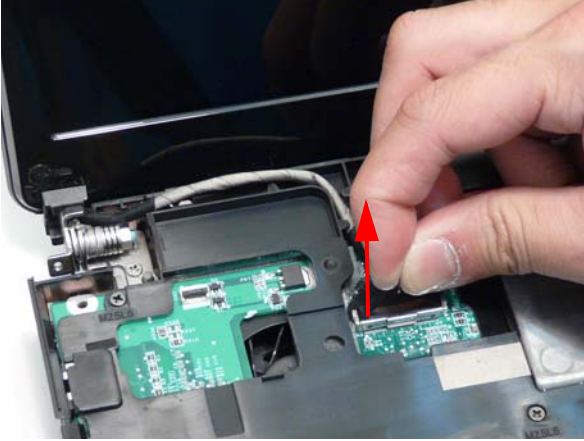

7. Remove the two securing screws from the left LCD hinge.

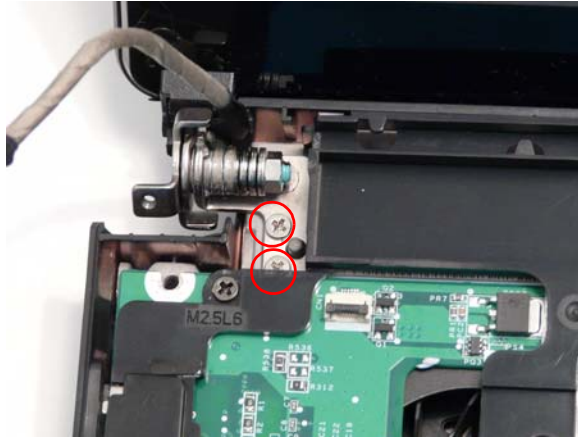

Step	Size	Quantity	Screw Type
LCD Module	M2.5*5	2	

8. Remove the two securing screws from the right LCD hinge.



Step	Size	Quantity	Screw Type
LCD Module	M2.5*5	2	

9. Carefully remove the LCD Module from the chassis.

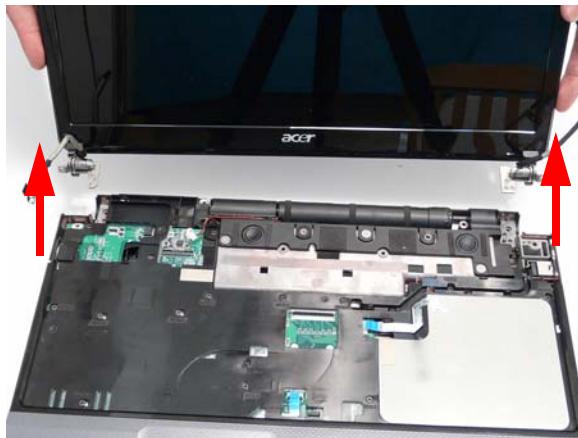

Removing the Upper Base

1. See "Removing the LCD Module" on page 68.

2. Turn the computer over. Remove the nine screws on the bottom panel.

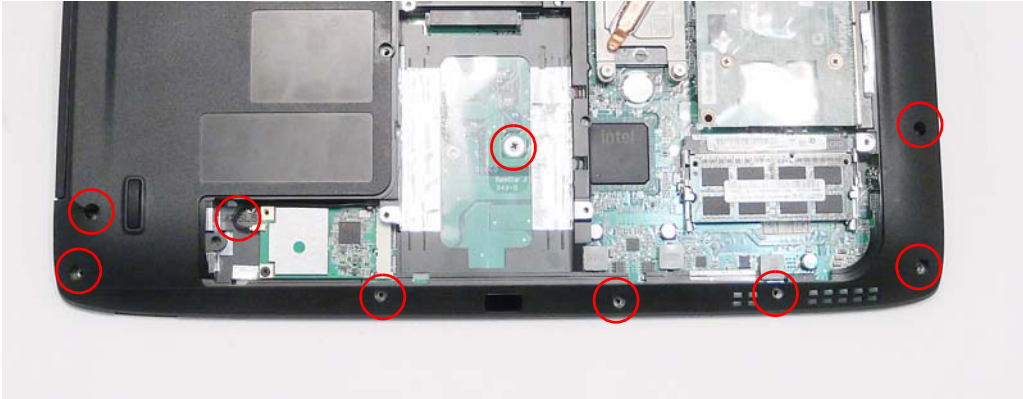

Step	Size	Quantity	Screw Type
Upper Cover	M2.5*6	9	

3. Turn the computer over. Remove the 13 securing screws on the top panel.



Step	Size	Quantity	Screw Type
Upper Cover (red callout)	M2.5*6	13	

4. Turn the computer over and disconnect the four cables from the mainboard.

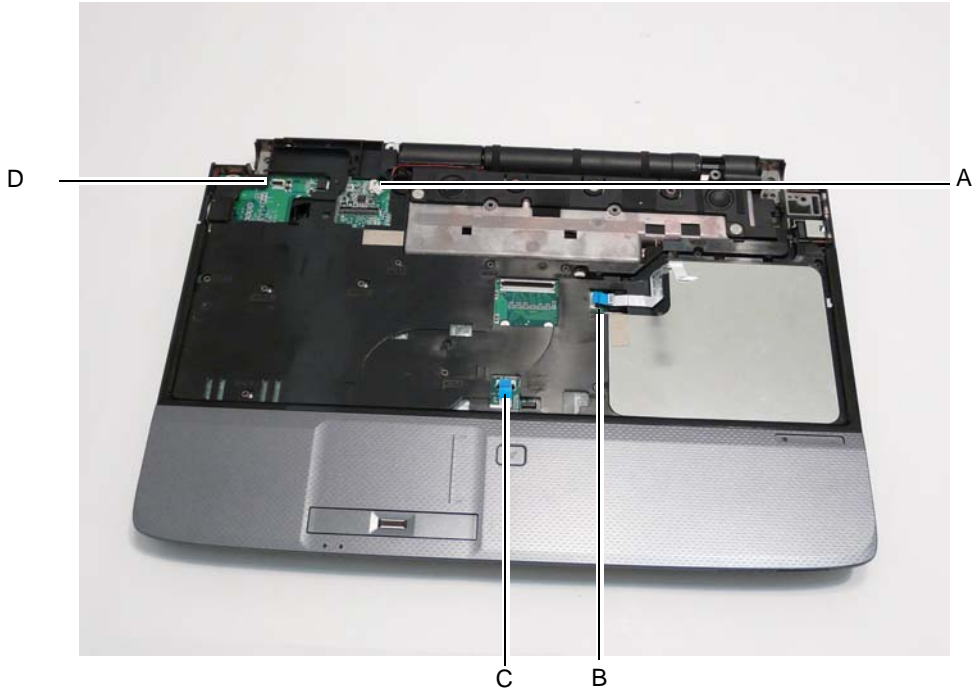

Unlock the connector and disconnect A as shown.

Unlock the connector and disconnect B as shown.

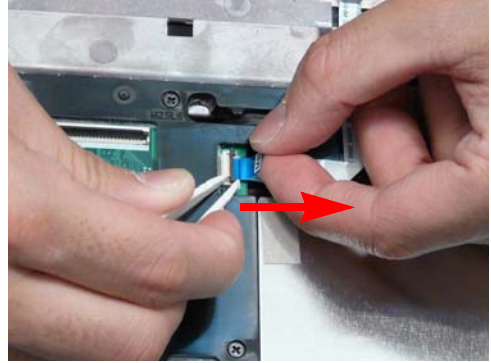
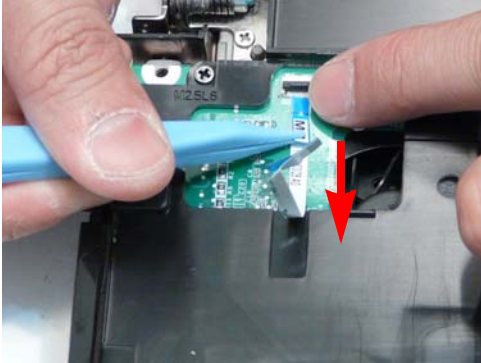

Unlock the connector and disconnect C as shown.

Unlock the connector and disconnect D as shown.

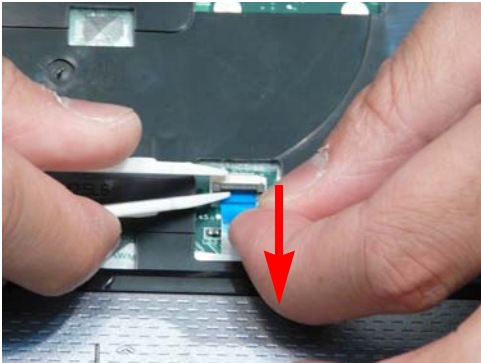

WARNING: Care must be taken when removing the Upper Base from the Lower Base to prevent damage or stress to the surface.

5. Ease the lower casing outward to clear the securing clips and pry apart the upper left side as shown, and lift the rear edge of the Upper Base upward.

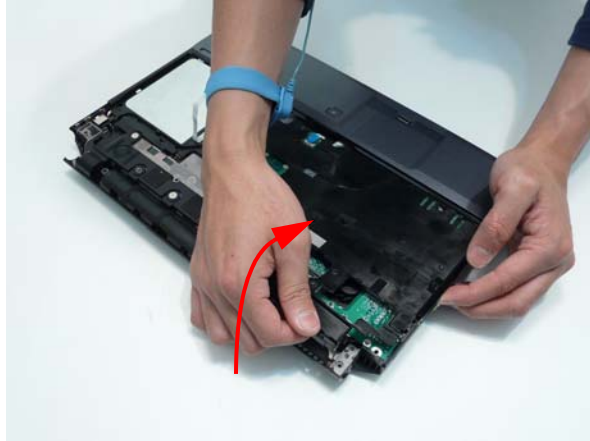

6. Ease the lower casing outward to clear the securing clips and pry apart the right side as shown. Lift the rear edge of the Upper Base upward.

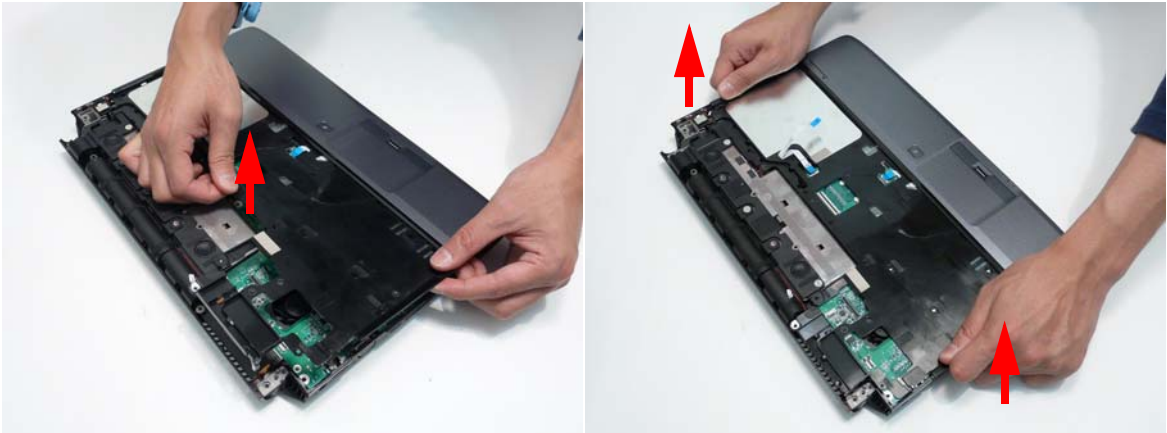

7. Completely remove the Upper Base from the Lower Base.

Removing the Finger Print Reader

NOTE: Only the Discrete SKU supports Finger Print Reader technology.

1. See "Removing the Upper Base" on page 72.

2. Lift the FFC locking latch, as shown, to disengage the cable and disconnect the main board FFC.

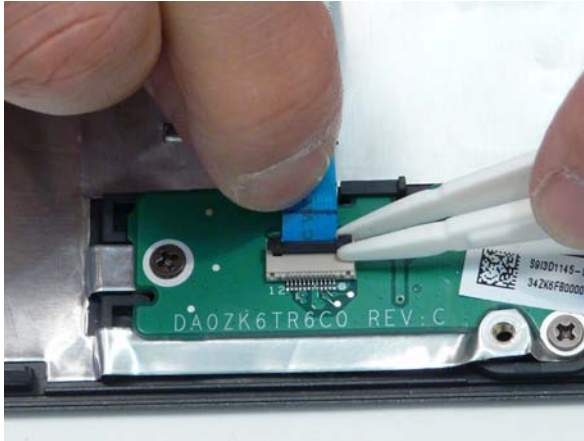

3. Open the FFC locking latch as shown and remove the FFC.

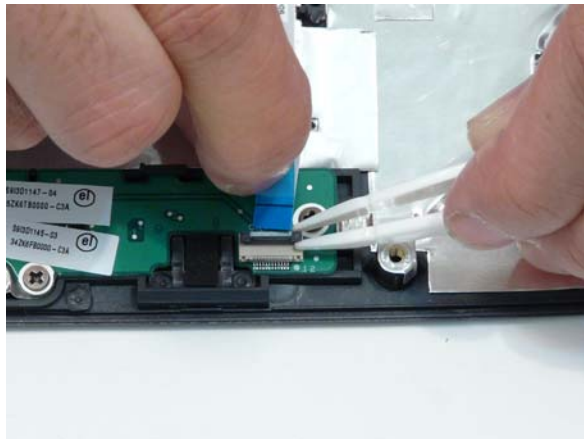

4. Remove the three securing screws on the bracket.

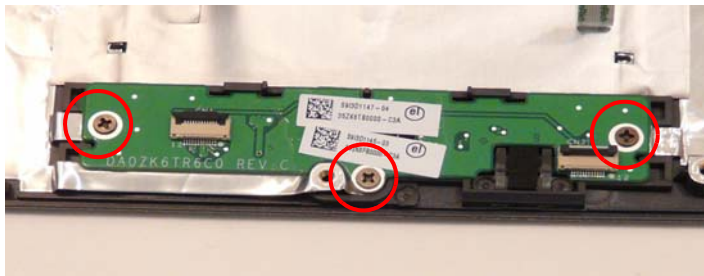

Step	Size	Quantity	Screw Type
Finger Print Reader	M2*3	1	

5. Pull the fingerprint reader out from under the securing brackets as shown.

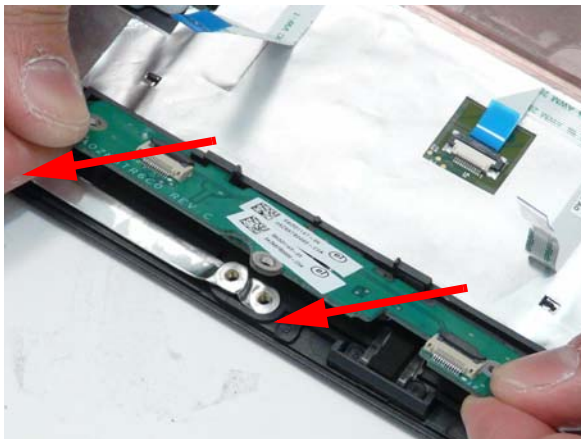

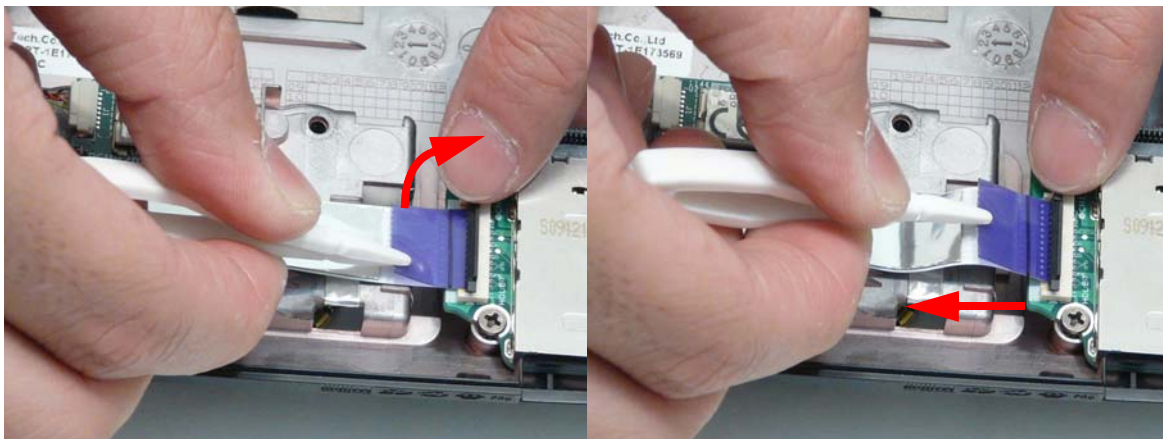

Removing the Multifunction Board

1. See “Removing the Upper Base” on page 72.
2. Open the FFC locking latch and remove the FFC from the Mainboard.

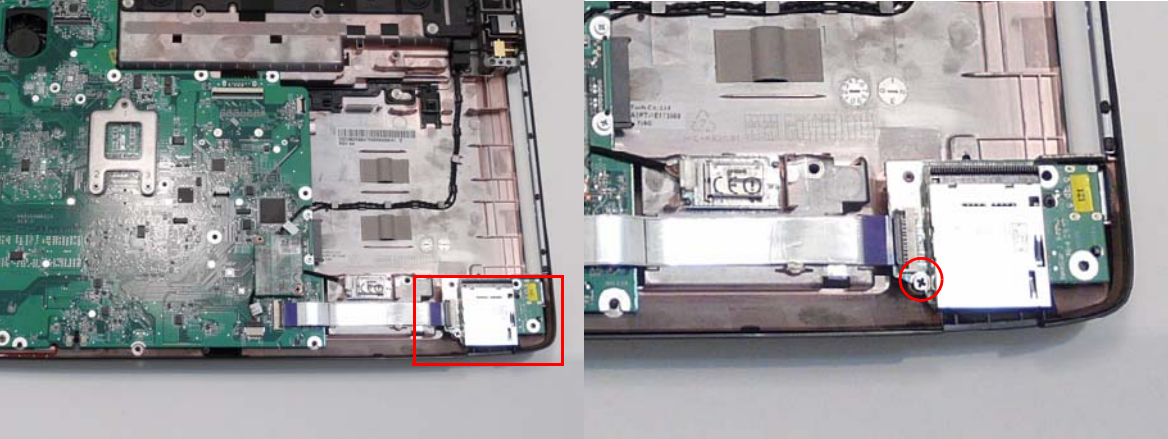

3. Remove the single securing screw from the Multifunction board.



Step	Size	Quantity	Screw Type
Multifunction Board	M2.5*3	1	

4. Lift the Multifunction Board clear of the casing.



Removing the Modem Module

1. Remove the Upper Base. See “Removing the Upper Base” on page 72.

2. Remove the two screws securing the Modem to the Mainboard.

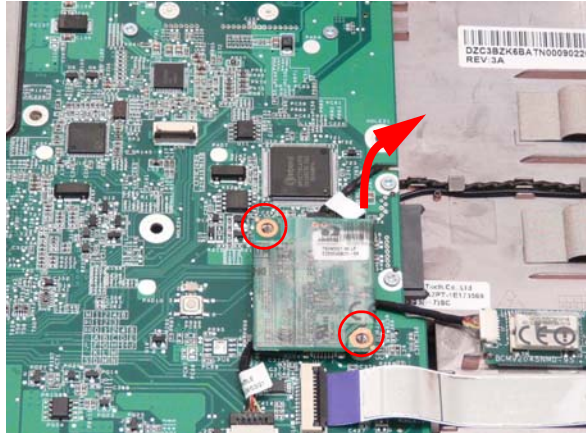

Step	Size	Quantity	Screw Type
Modem Module	M2*3	2	

3. Lift the Modem Module clear of the Mainboard as shown.

IMPORTANT:The back of the modem board is plugged into the mainboard. Be sure to lift straight up - do not twist the board or damage may result.

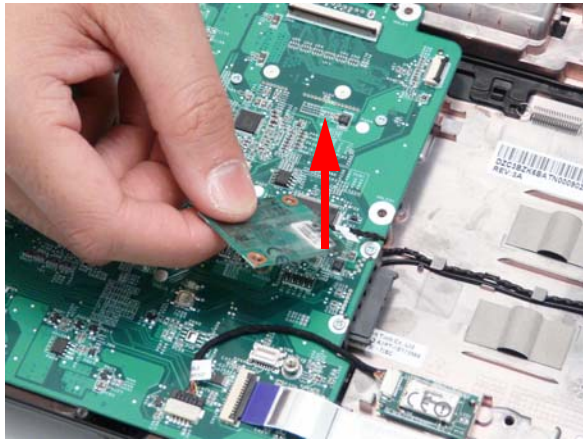

4. Turn the module over and disconnect the Modem cable. Remove the module from the casing.

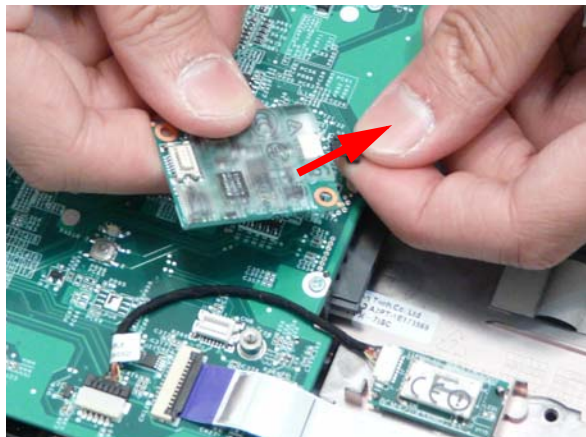

Removing the Bluetooth Module

1. See “Removing the Upper Base” on page 72.
2. Grasp the cable as shown and pull to disconnect from the Bluetooth module.

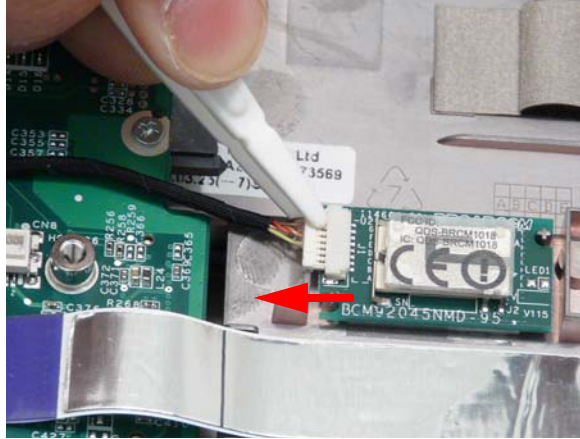

3. Lift the bluetooth board from the adhesive securing it to the Lower Cover.

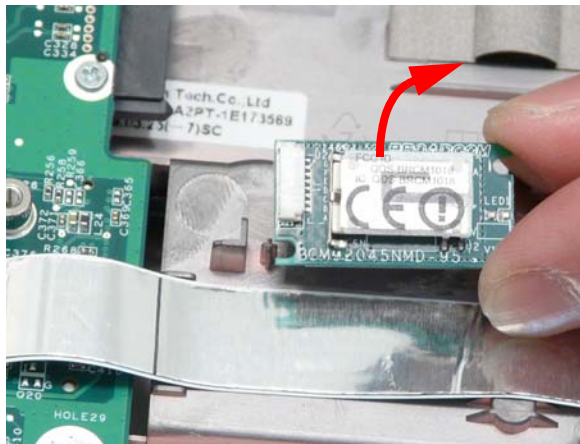

Removing the Mainboard

1. See “Removing the Upper Base” on page 72.
2. Disconnect the FFC connecting to the Multifunction board.

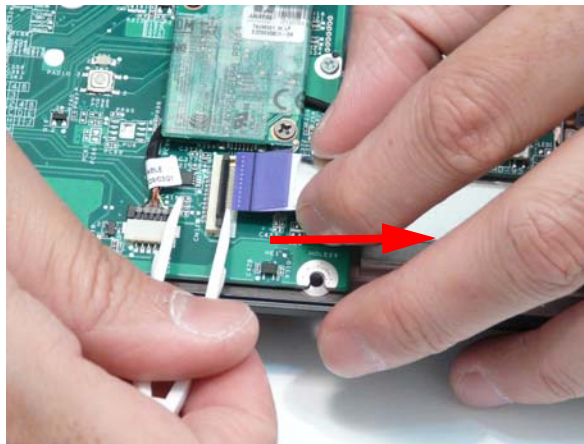

3. See “Removing the Modem Module” on page 78.

4. Disconnect the cable to the Bluetooth board.

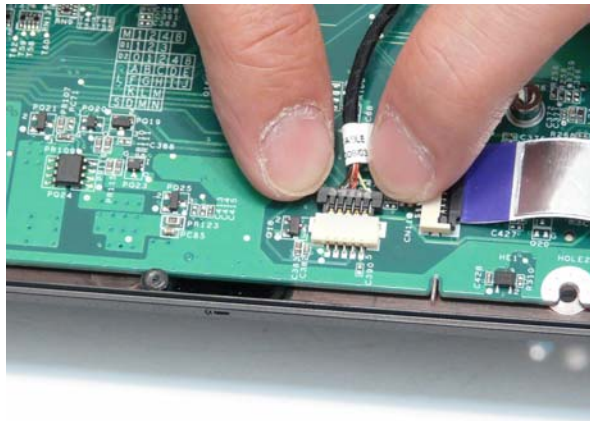

5. Disconnect the Speaker wires.

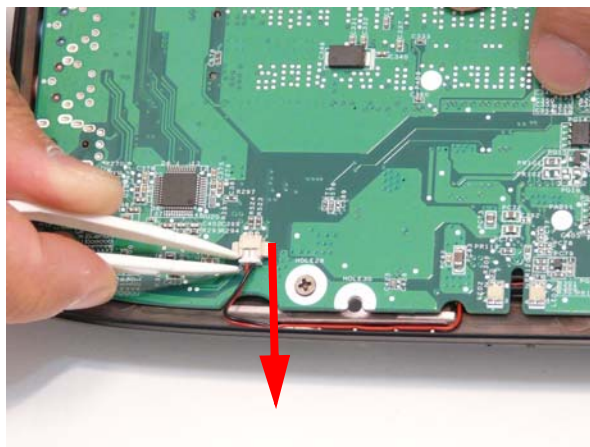

6. Grasp the RJ-11 cable and remove it from the Mainboard as shown.

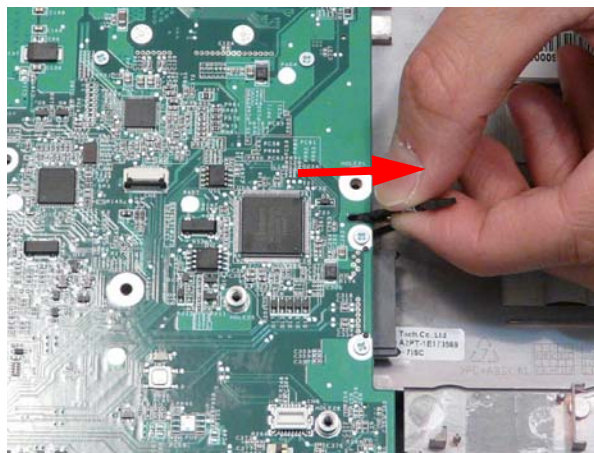

7. Remove the single securing screw.

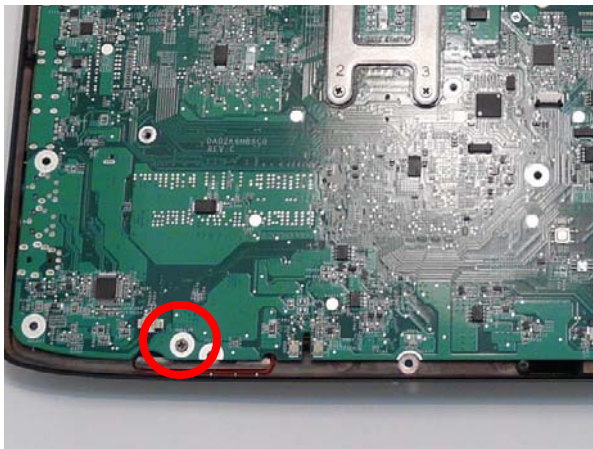

Step	Size	Quantity	Screw Type
Mainboard	M2.5*3	1	

8. Lift the mainboard right side first to remove from the base.

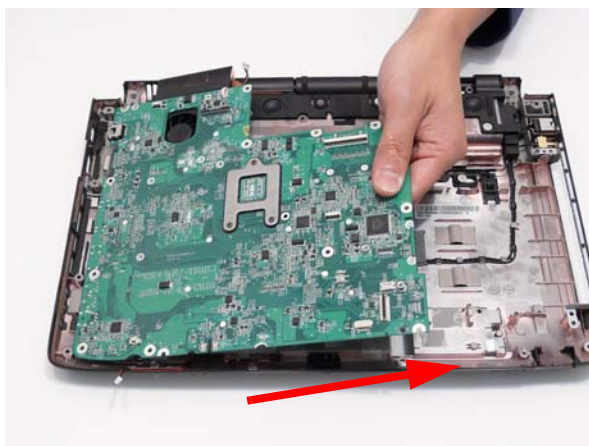

Removing the Thermal Module

1. See "Removing the Mainboard" on page 80.
2. Turn the Mainboard over and place on a clean surface.

3. Hold the fan cable connector and lift to disconnect from the mainboard.



4. Loosen the three captive screws from the Thermal Module CPU heat sink in reverse numerical order, from 3 to 1.

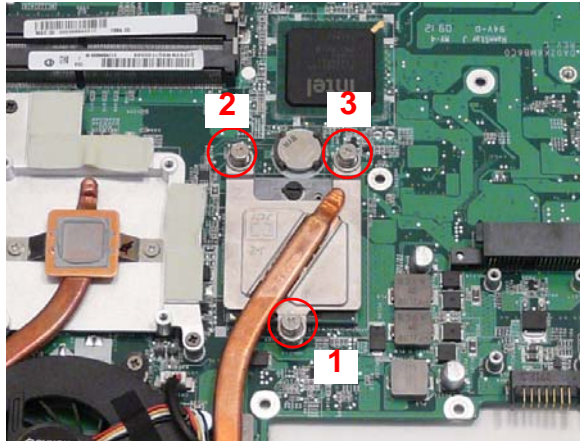

5. Remove the four screws from the Thermal Module.

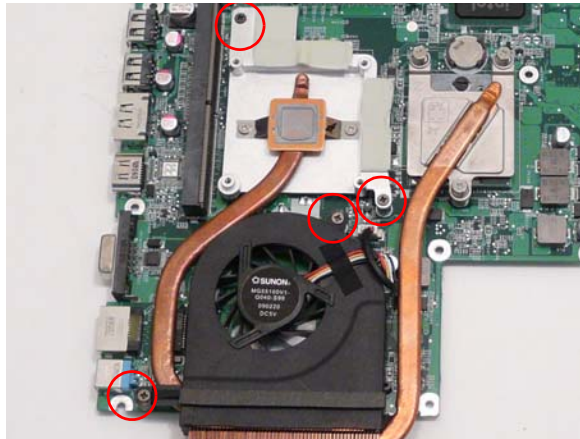

Step	Size	Quantity	Screw Type
CPU Thermal Module	M2.5*3	4	

WARNING: To prevent damage to the Thermal Module or the CPU, hold and lift the Thermal Module by lifting both ends up and away at the same time.

6. Hold the module on both sides and lift it clear of the Mainboard.

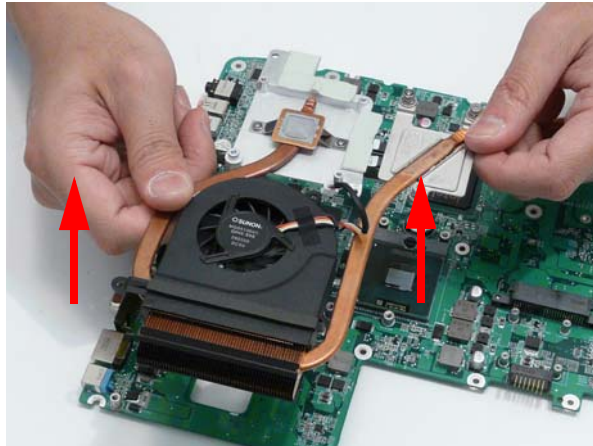

IMPORTANT: If the replacement Thermal Module does not include the thermal protection pads shown below, reuse the original thermal protection pad with the new Thermal Module.



Removing the CPU (Alternate Procedure)

NOTE: Use this procedure only if you are unable to remove the CPU safely as described in “Removing the CPU” on page 60.

1. See “Removing the Thermal Module” on page 82.

2. Turn the CPU socket latch 180 degrees counterclockwise to the Unlock position.



3. Lift the CPU clear of the socket.

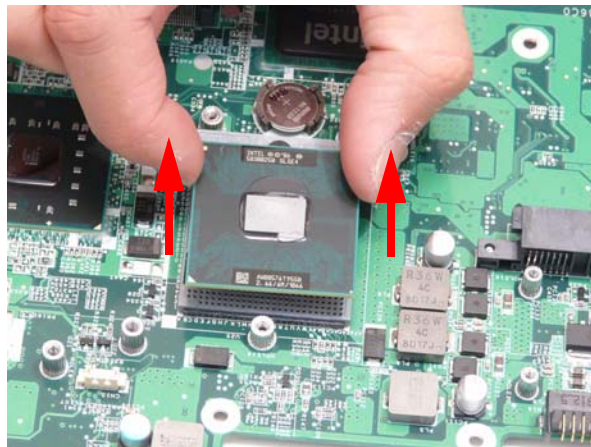

Removing the Speaker Modules

1. See "Removing the Mainboard" on page 80.

2. Remove the three securing screws from the Speaker Modules.

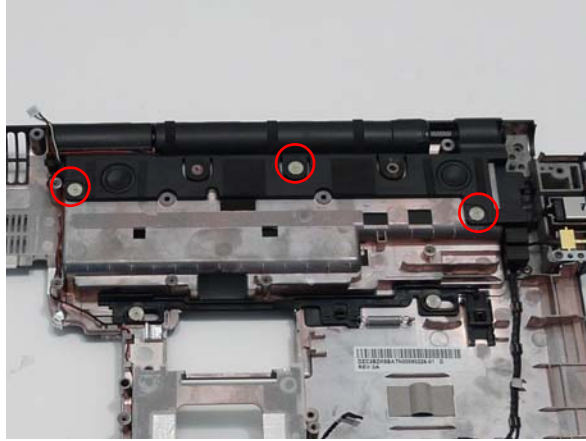

Step	Size	Quantity	Screw Type
Speaker Module	M2.5*2 x 6mm flat head	3	

3. Pull the subwoofer module up from the rubber dampers on the securing tabs as shown.

IMPORTANT: Do not lift the subwoofer out from the edges as contact with the speakers can damage the unit.

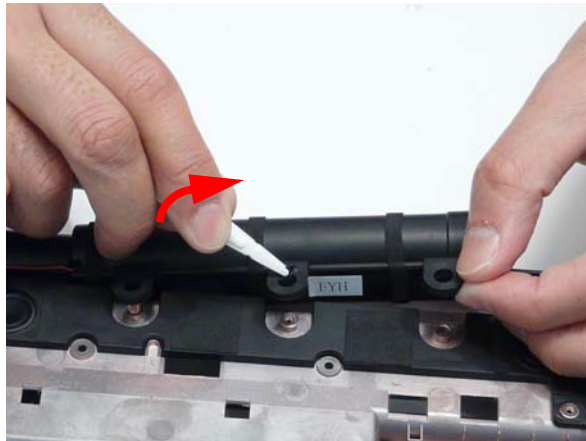

4. Lift the subwoofer away from the lower base as shown.

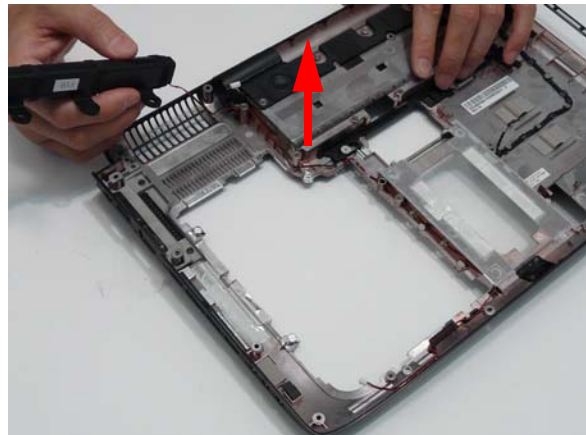

5. Lift the speaker module away from the lower base as shown

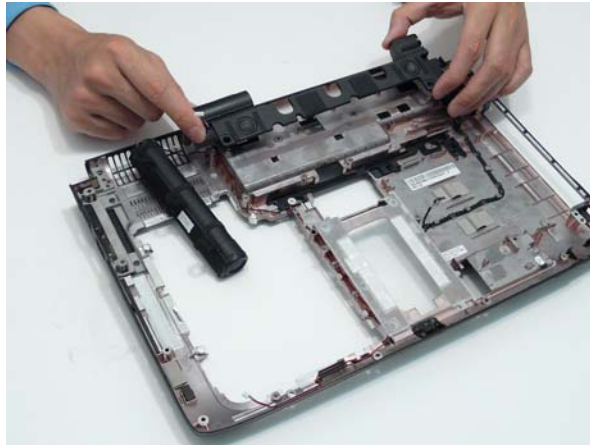

6. Remove the speaker wire from the channel as shown.

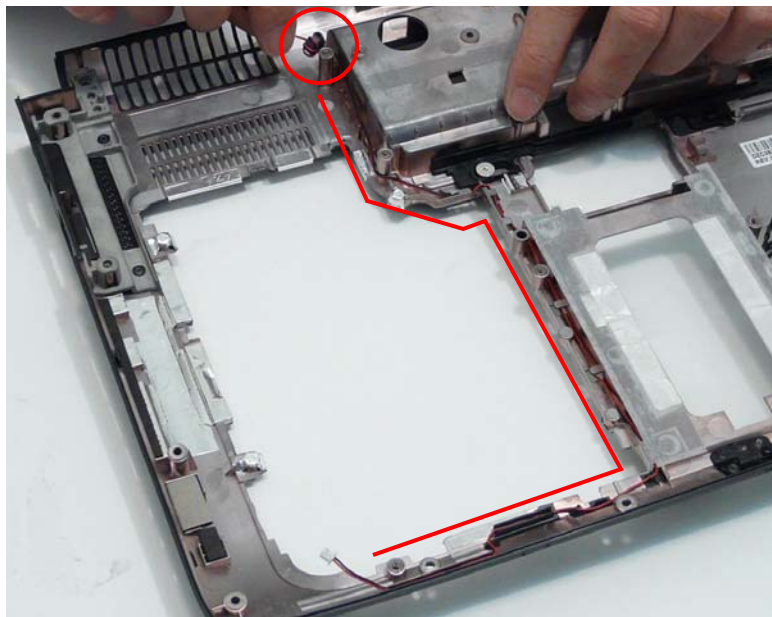

LCD Module Disassembly Process

LCD Module Disassembly Flowchart

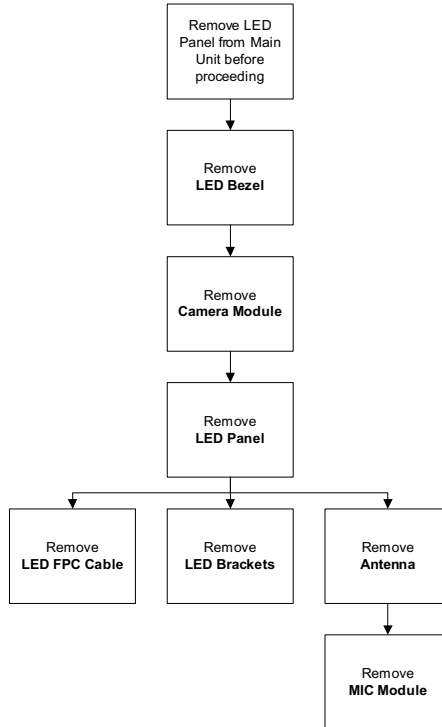

Screw List

Step	Screw	Quantity	Part No.
LCD Bezel	M2.5*5	6	86.AD302.003
Camera Module	M2.5*3	1	86.AD302.002
LCD Panel	M2.5*5	2	86.AD302.003
	M2.5*3	1	86.AD302.002
LCD Brackets	M2*3	6	86.AD302.001

Removing the LCD Bezel

1. See "Removing the LCD Module" on page 68.

2. Remove the six screw caps and screws as shown.



Step	Size	Quantity	Screw Type
LCD Bezel	M2.5*5	6	

3. Starting at the centre of the top edge, pry the inside of the bezel away from the screen. Work round the edges to pry the bezel away from the screen as shown.



4. Lift the bezel away from the panel and place it face down above the panel as shown.

IMPORTANT:The microphone cable still connects the bezel to the panel, take care not to pull the bezel away from the panel.



5. Disconnect the microphone cable from the panel assembly.

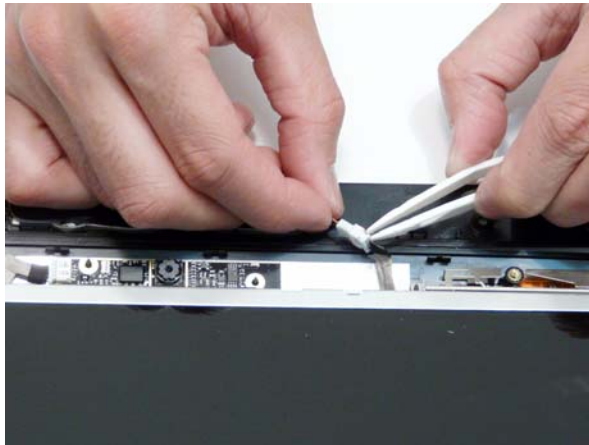

Removing the Camera Module

1. See "Removing the LCD Bezel" on page 88.
2. Disconnect the camera from the camera cable.

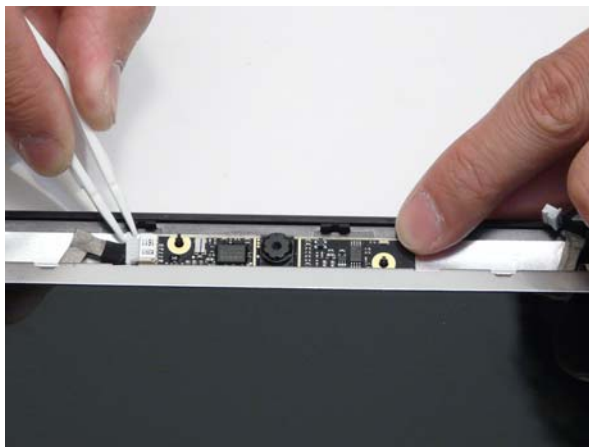



3. Lift the Camera Module out of the assembly. The Camera Module is secured in place with adhesive.

Removing the LCD Panel

1. See "Removing the Camera Module" on page 90.
2. Remove the two securing screws from the LCD hinges and the single LCD grounding screw.



Step	Size	Quantity	Screw Type
LCD Panel (red callout)	M2.5*5	2	
LCD Panel (green callout)	M2.5*3	1	

3. Lift the LCD Panel out of the casing as shown.



Removing the LCD Brackets and FPC Cable

1. See "Removing the LCD Panel" on page 91.
2. Remove the four securing screws (two on each side) from the LCD Panel brackets.



Step	Size	Quantity	Screw Type
LCD Brackets	M2*3	4	

3. Turn the LCD Panel over on a clean surface.
4. Remove the cable from the panel as shown (2).

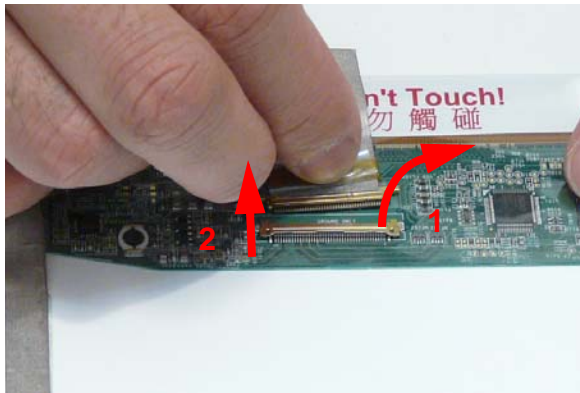

5. Lift the cable as shown to detach the adhesive.

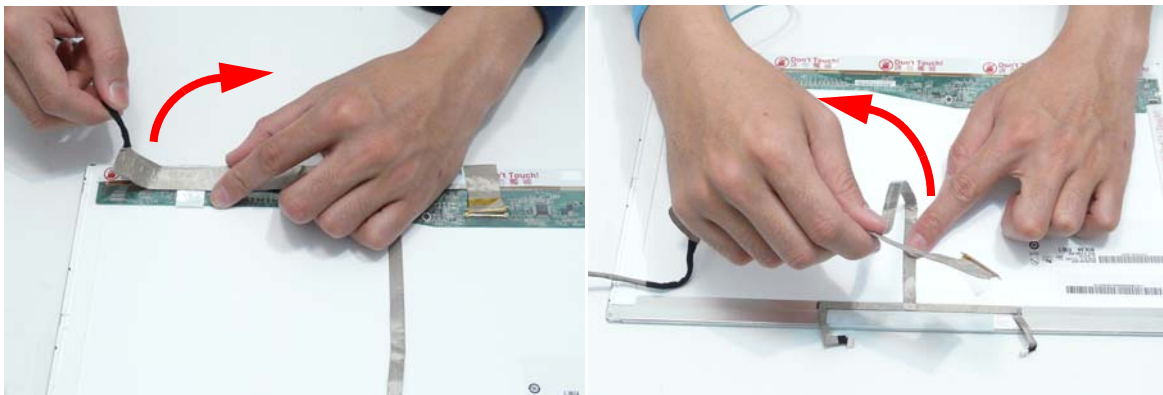

6. Grip the adhesive strip covering the LCD cable connector and pull it back (1).

7. Remove the LCD brackets by pulling them away from the LCD Panel.

Removing the Antennas

1. See "Removing the LCD Panel" on page 91.

2. Remove the screws holding the antennas in place.



3. Remove the strips holding the antenna cables in place. Ensure the cables are free from obstructions.

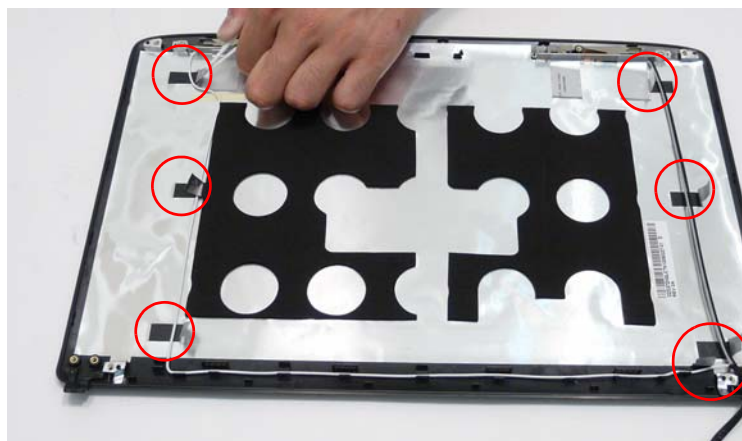

4. Remove the adhesive strips securing the left and right antennas to the LCD module and lift the antennas clear.

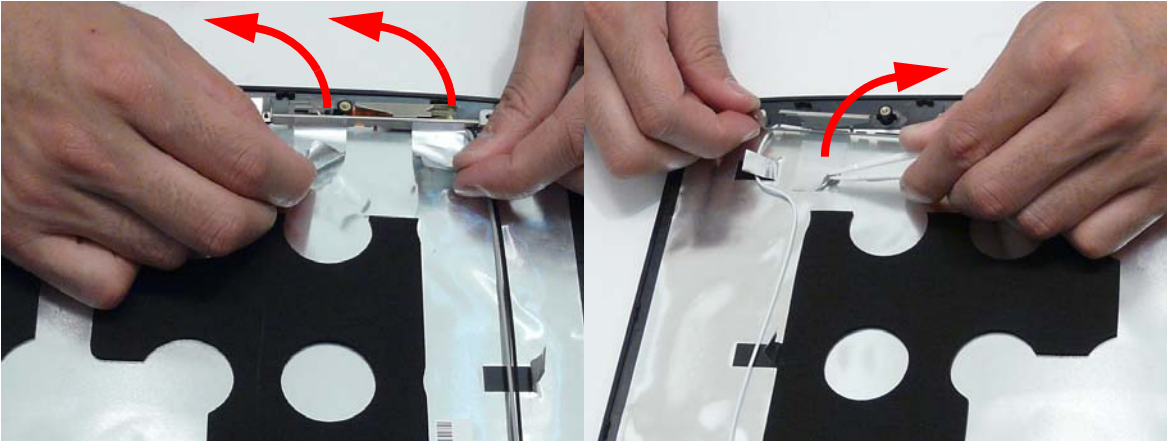

5. Remove the antenna cables and assembly from the LCD module.

LCD Module Reassembly Procedure

Replacing the Antennas

1. Replace the right Antenna in the LCD Cover as shown and secure it in place with the tape.

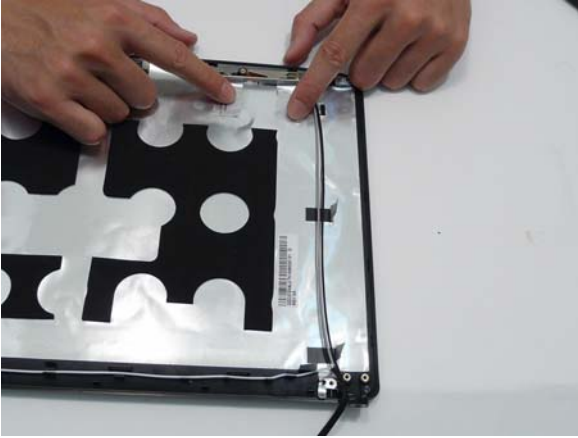

2. Replace the left Antenna in the LCD Cover as shown and secure it in place with the tape.

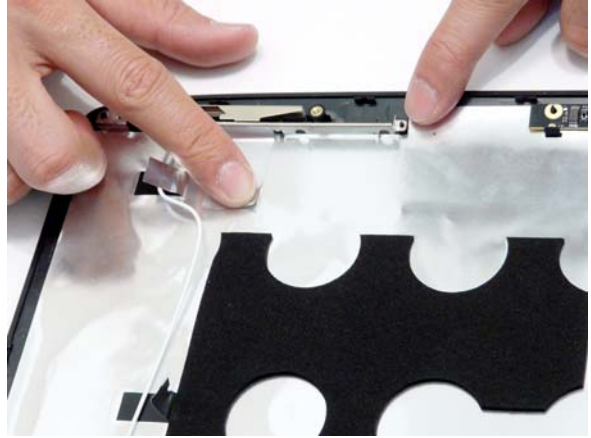

3. Run the cables under the adhesive strips.

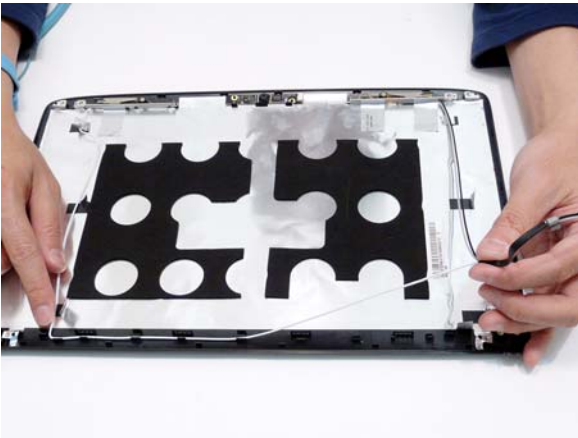

4. Insert the left antenna cable into the guides at the bottom of the LCD cover.

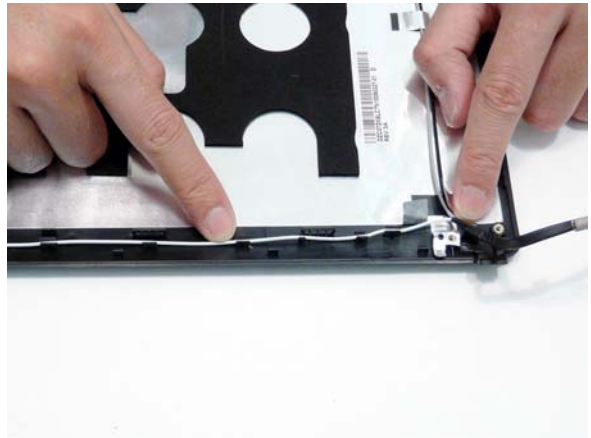

5. Replace the screws to secure the antennas in place.



Replacing the LCD Panel

1. Align the LCD brackets with the six screw holes (three on each side) on the LCD Panel as shown.
2. Replace the six securing screws in numeric order, from 1 to 3.

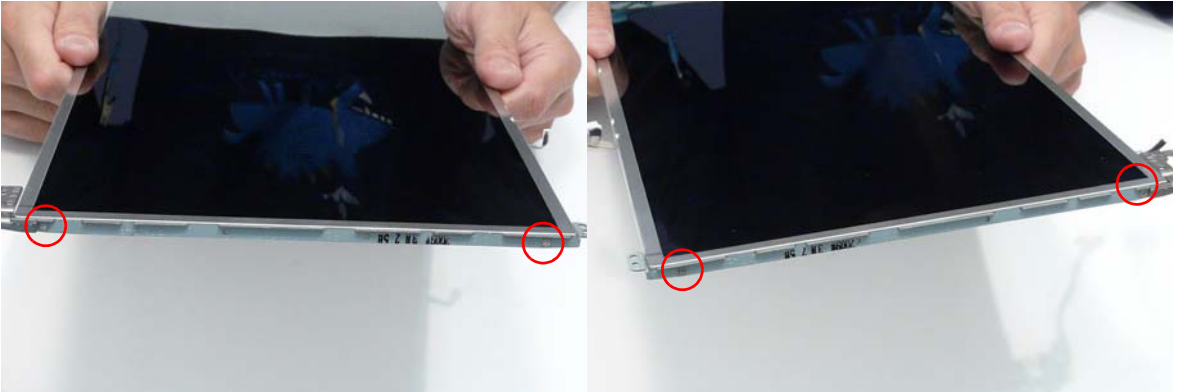

3. Turn the panel over. Insert the LCD Panel cable into the LCD Panel as shown (1). Secure the cable by replacing the securing strip (2).
4. Run the LCD cable as shown and press down along the length of the cable to secure it in place.

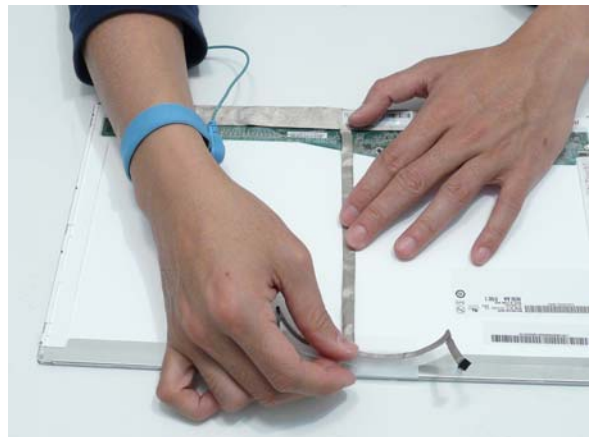
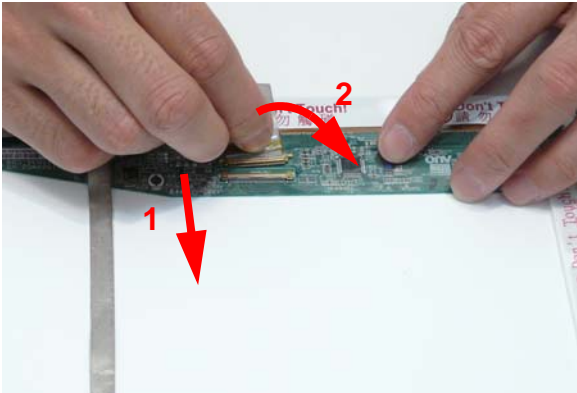

5. Insert the LCD panel into the casing back edge first as shown.
6. Ensure that the four locating pins are properly seated before continuing.

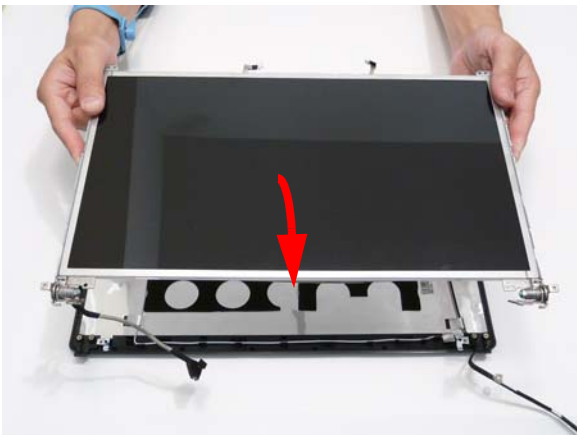

7. Ensure the WIFI Antenna Cables pass under the the bracket as shown.

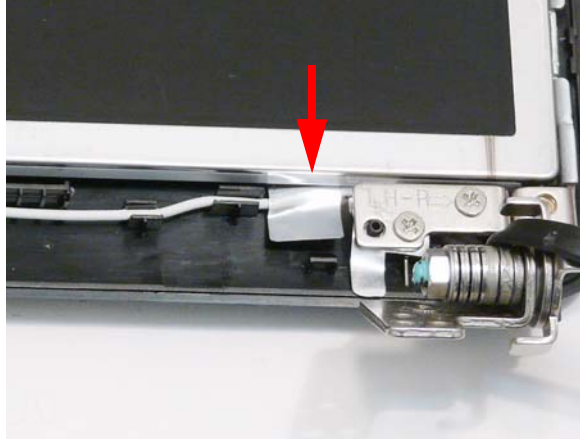

8. Replace the four screws to secure the panel within the LCD module.

IMPORTANT:When replacing the screws in the LCD brackets (red callout) do not use the screw holes marked with 'X'. These slots are reserved for the Bezel securing screws.

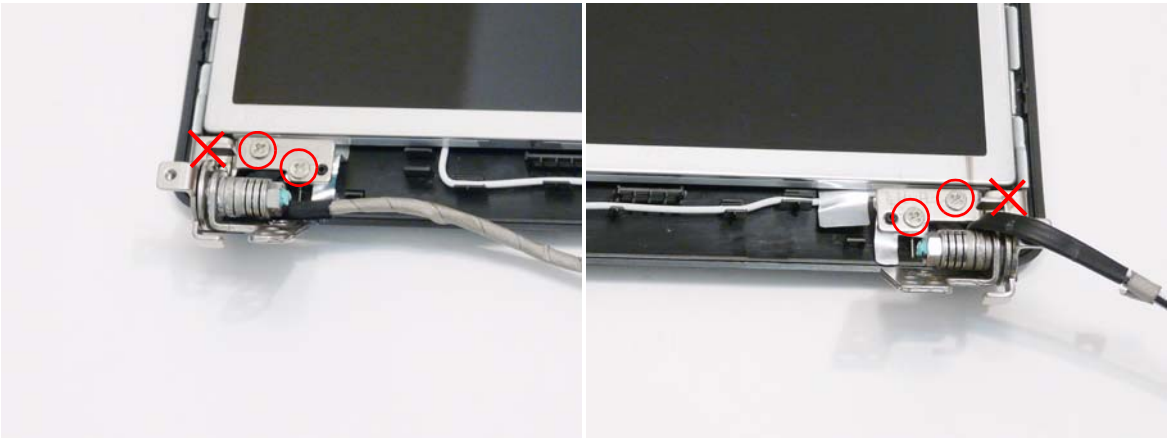

Replacing the Camera Module

1. Place the Camera Module into the assembly so the pins are aligned. Press down to secure the Camera Module in place with adhesive.
2. Reconnect the camera to the camera cable.

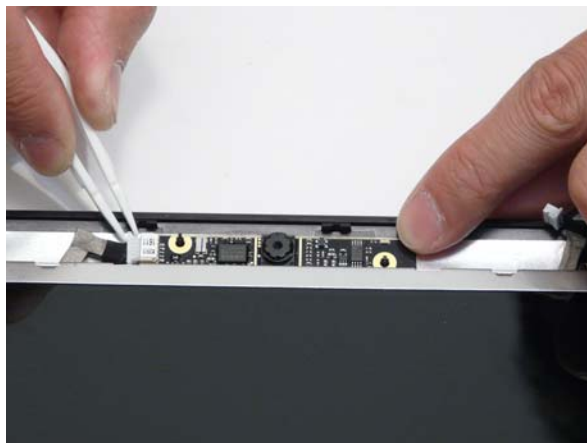

Replacing the LCD Bezel

1. Place the Bezel on the casing bottom edge first and press in the areas marked to snap it into place.
2. Press down the sides of the bezel, working toward the top edge.



3. Press down the top edge to complete the process.

IMPORTANT: Ensure there are no gaps between the LCD Cover and the Bezel.



4. Replace the six securing screws and screw caps on the LCD bezel.

IMPORTANT: Four of the screw caps are rubber pads. Be sure to replace them along the top edge of the LCD panel.



Main Module Reassembly Procedure

Replacing the Speaker Modules

5. Place the speaker module into the lower base as shown



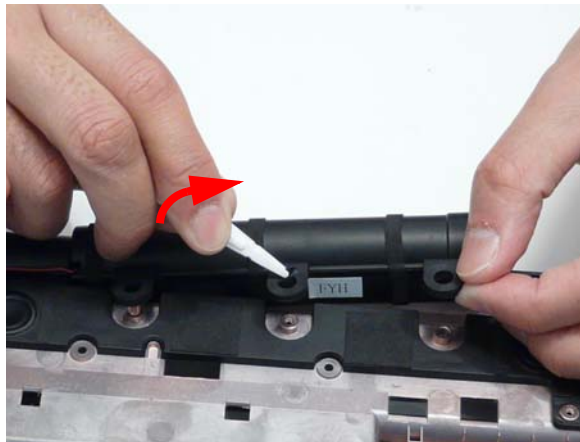

6. Push the subwoofer module onto the securing tabs as shown.

IMPORTANT: Do not hold the subwoofer by the edges as contact with the speakers can damage the unit.

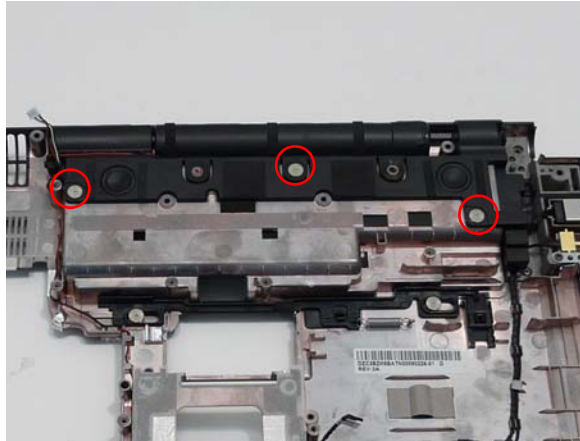

7. Replace the three screws to secure the Speaker Modules.



Step	Size	Quantity	Screw Type
Speaker Module	M2.5*2 x 6mm flat head	3	

8. Replace the speaker wire into the channel as shown.

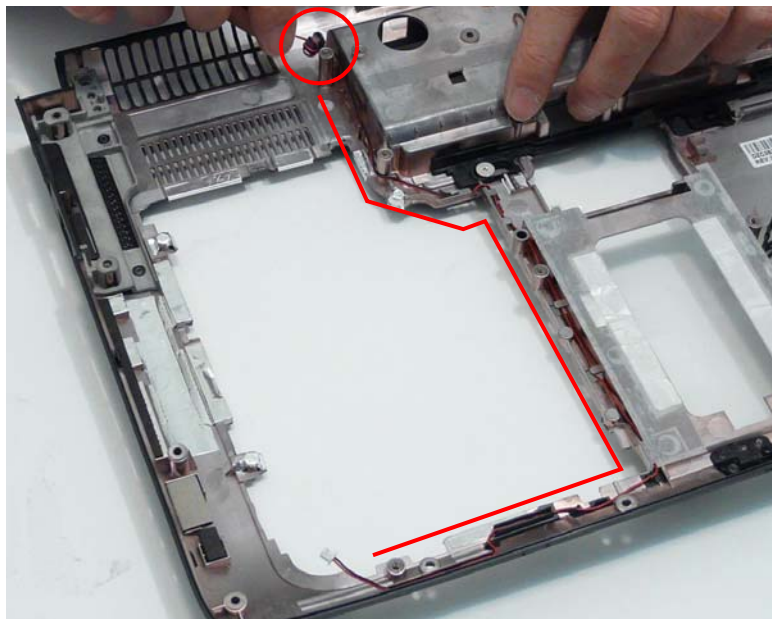

Replacing the CPU (Alternate Procedure)

IMPORTANT:The CPU has a Pin1 locator that must be positioned corresponding to the marker on the CPU socket

NOTE: Only use this procedure if you removed the thermal unit according to the instructions given in "Removing the CPU (Alternate Procedure)" on page 84.

IMPORTANT:Ensure all thermal pads are in place before replacing the Thermal Module.

The following thermal pads are approved for use:

- Silmore GP50
- Honeywell
- Jet Motor 7762

The following thermal compounds are approved for use:

- Eapus XR-PE

1. Remove all traces of thermal grease or pad adhesive from the Thermal Module using a lint-free cloth or cotton swab and Isopropyl Alcohol, Acetone, or other approved cleaning agent.
2. Apply a small amount of thermal grease or the supplied thermal pad to the centre of the heat sink. There is no need to spread grease manually, the force used during the installation of the Thermal Module is sufficient.
3. Place the CPU into the socket. Take note of the Pin 1 locator in the image below.

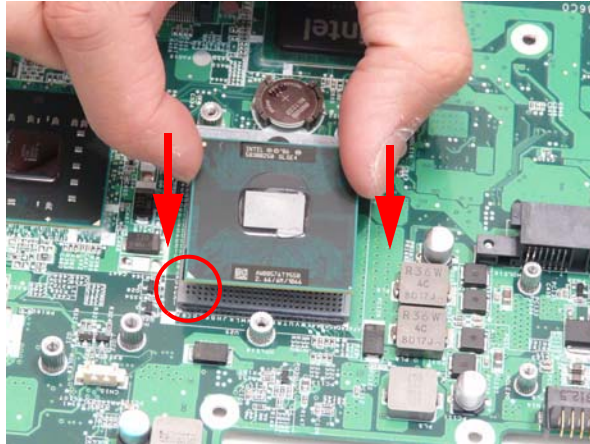

4. Turn the CPU socket latch 180 degrees clockwise to the Lock position.



Replacing the Thermal Module

IMPORTANT: Ensure all thermal pads are in place before replacing the Thermal Module.

The following thermal pads are approved for use:

- Silmore GP50
- Honeywell
- Jet Motor 7762

The following thermal compounds are approved for use:

- Eapus XR-PE

1. Remove all traces of thermal grease or pad adhesive from the Graphics Card and CPU using a lint-free cloth or cotton swab and Isopropyl Alcohol, Acetone, or other approved cleaning agent.

- Apply a small amount of thermal grease or the supplied thermal pad to the center of the heat sink and the indicated locations for the Graphics card. If using Thermal Grease, there is no need to spread it manually, the force used during the installation of the Thermal Module is sufficient



WARNING: To prevent damage to the Thermal Module or the CPU, place the Thermal Module onto the mainboard with both hands.

- Hold the module on both sides and place it onto the Mainboard.

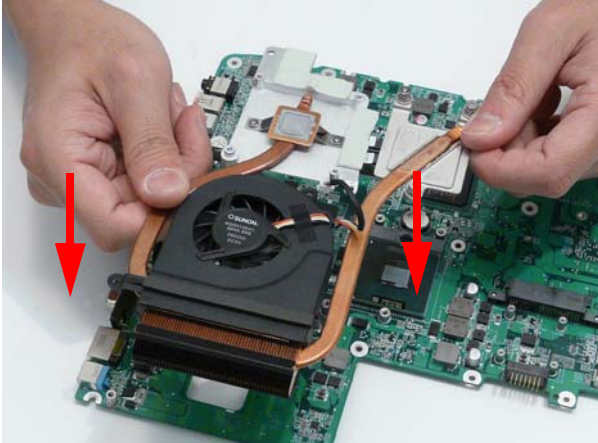

- Replace the four screws to secure the Thermal Module to the mainboard.

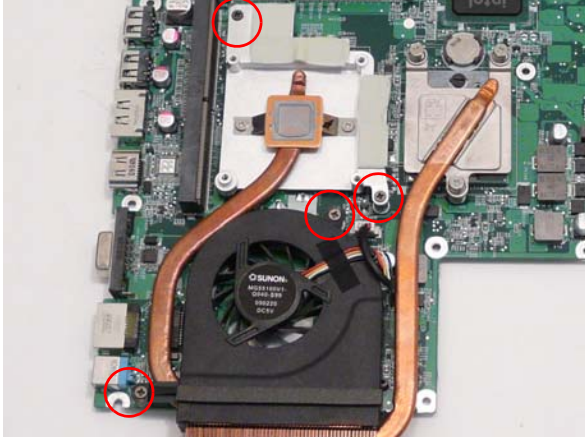

Step	Size	Quantity	Screw Type
CPU Thermal Module	M2.5*3	4	

5. Fasten the three captive screws to the Thermal Module CPU heat sink in numerical order, from 1 to 3.

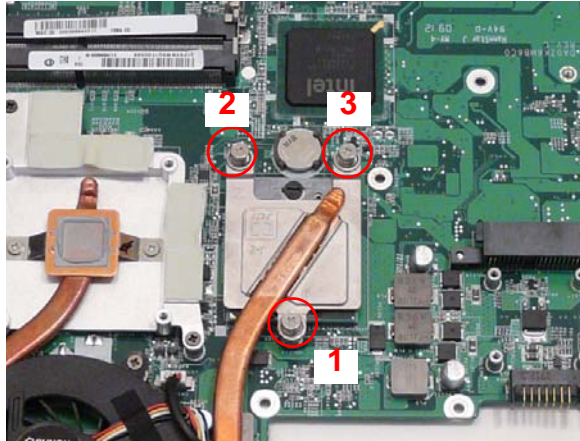

6. Connect the fan cable to the mainboard.

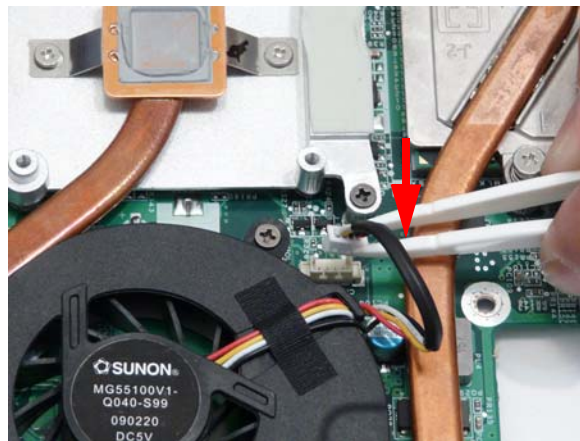

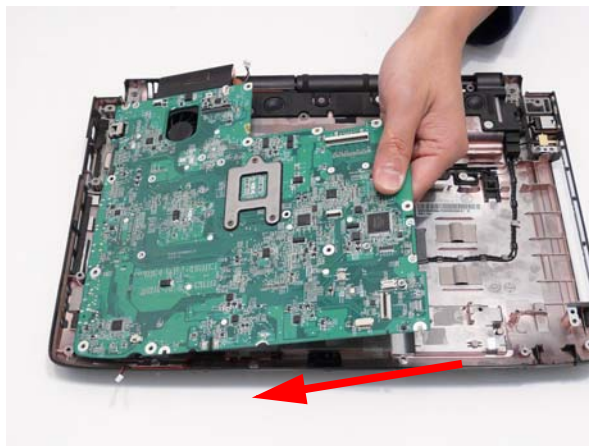

Replacing the Mainboard

1. Lift the mainboard right side first to remove from the base.

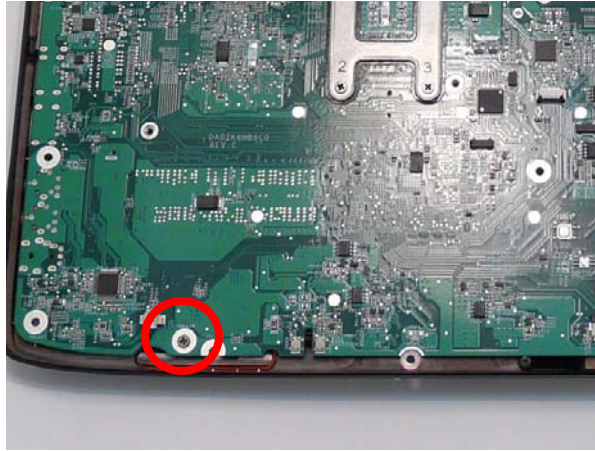

2. Replace the single securing screw.



Step	Size	Quantity	Screw Type
Mainboard	M2.5*3	1	

3. Grasp the RJ-11 cable and insert it into the Mainboard as shown.

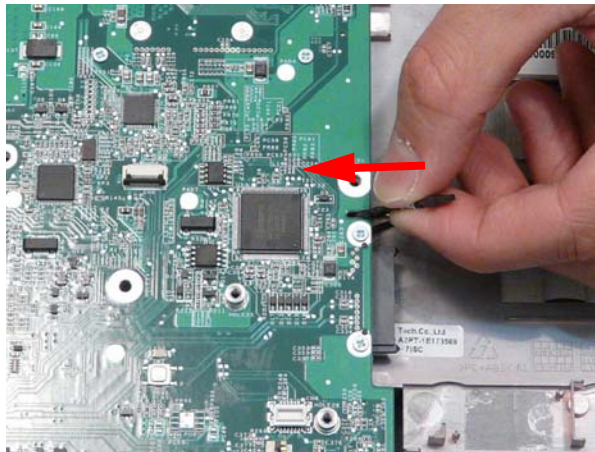

4. Connect the Speaker wires.

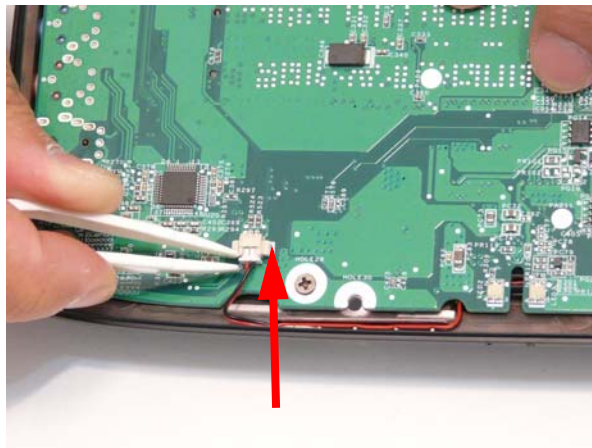

5. Connect the cable to the Bluetooth board.

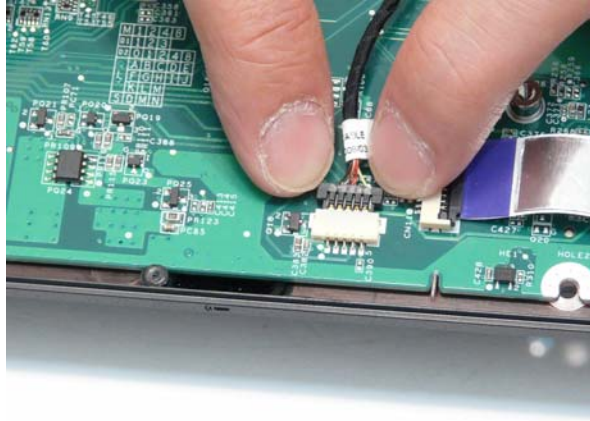

6. Connect the FFC connecting to the Multifunction board.

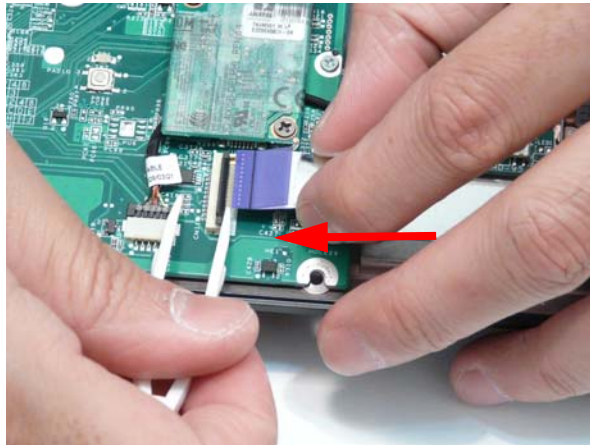

Replacing the Bluetooth Board

1. Place the bluetooth board onto the adhesive to secure it to the Lower Cover. Take care to align the mounting pin.

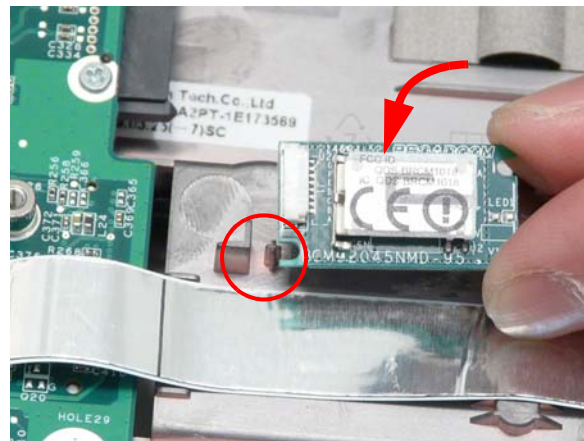

2. Connect the cable to the Bluetooth module.

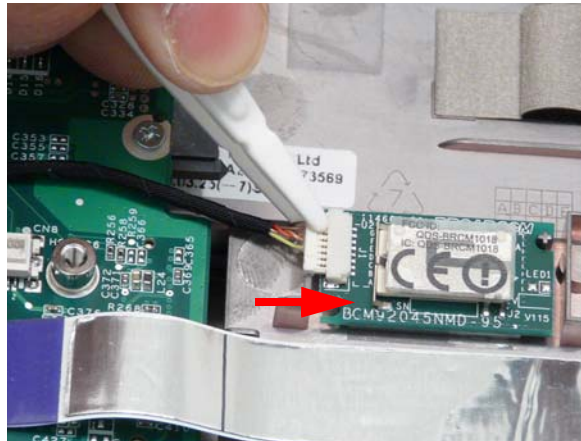

Replacing the Modem Module

1. Connect the modem cable as shown.

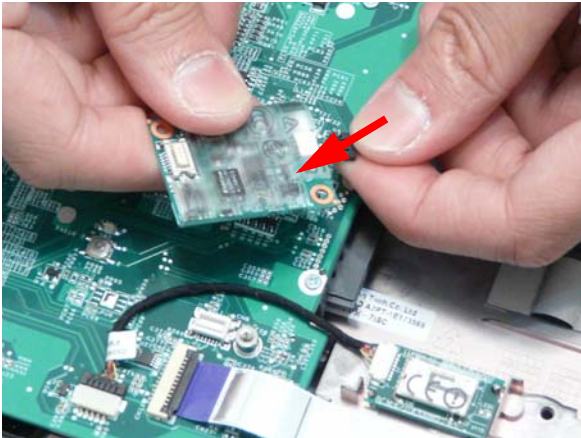

2. Replace the Modem Module on the Mainboard.

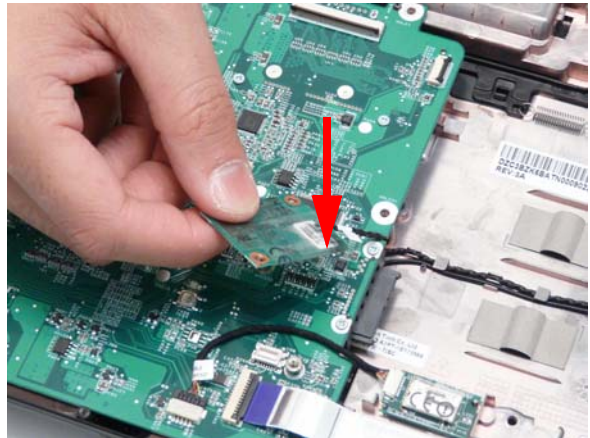

3. Align the screw sockets and replace the two screws.

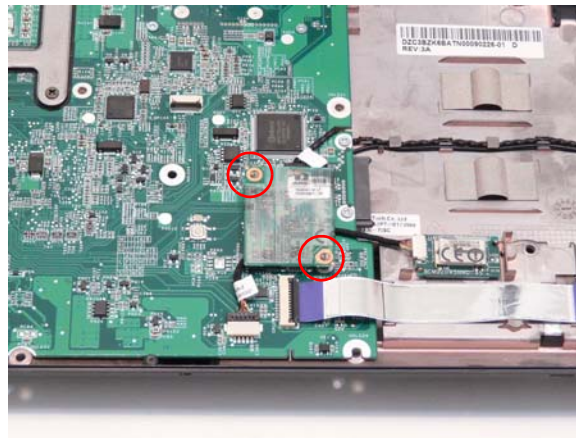

Step	Size	Quantity	Screw Type
Modem Module	M2*3	2	

Replacing the Multifunction Board

1. Insert the Multifunction Board into the casing, ensuring that the USB Port is accessible through the case.
2. Run the cable along the casing and insert it into the FFC connector.

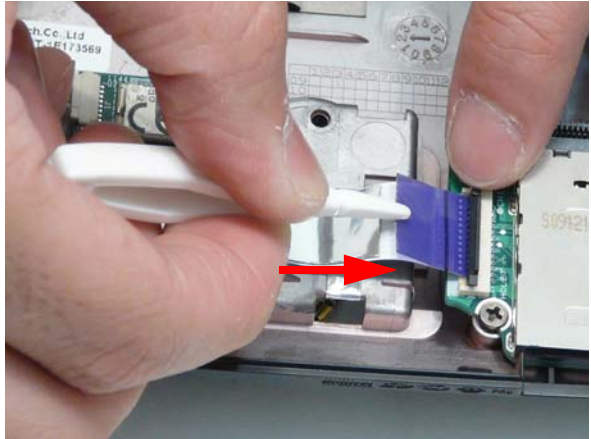

3. Lock the connector and press down on the FFC cable to secure it on the casing.
4. Ensure the locating pins is correctly seated and replace the single securing screw.

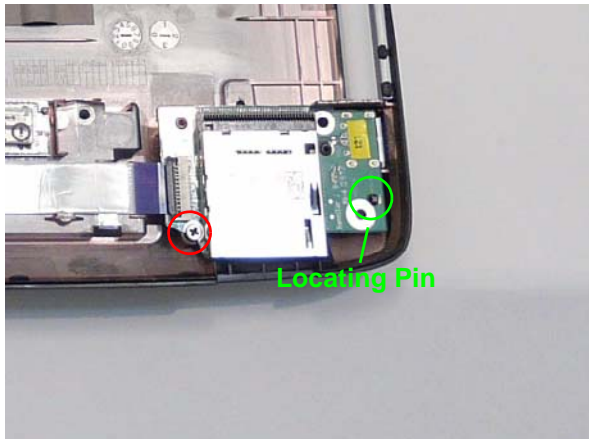
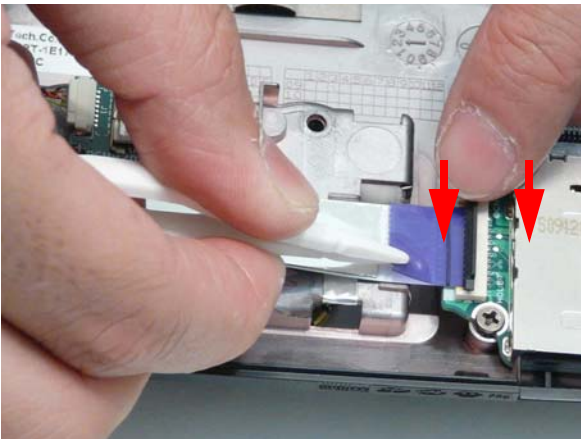

Replacing the Finger Print Reader

1. Replace the Finger Print Reader in the Upper Cover, making sure the tabs align with the slots in the upper cover.
2. Replace the three securing screws

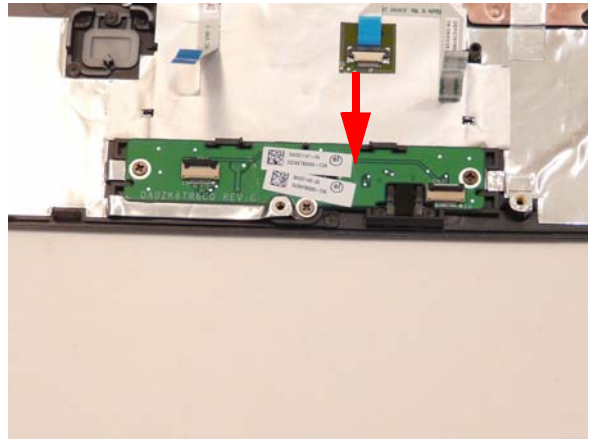
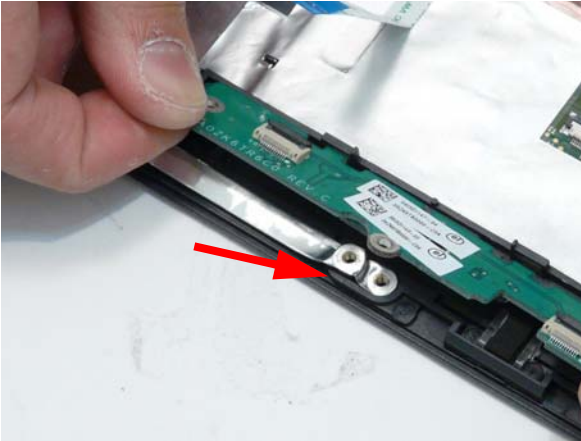

3. Replace the Touchpad FFC.
4. Replace the Mainboard FFC.

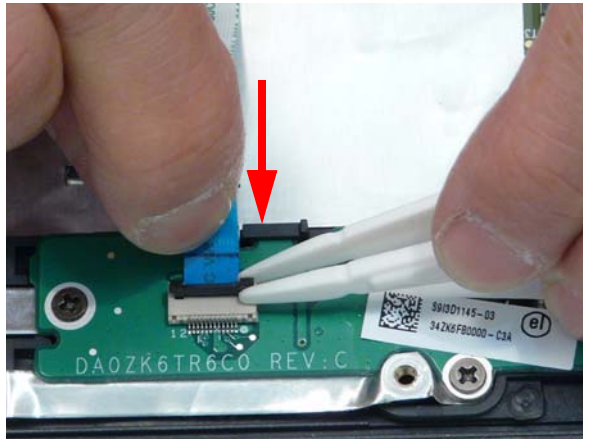
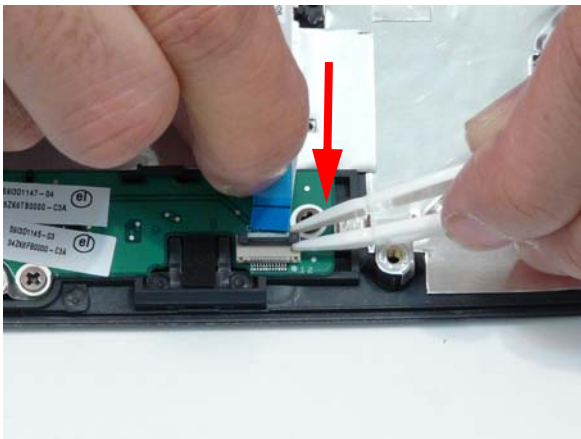

Replacing the Upper Cover

WARNING: Care must be taken when replacing the Upper Cover to prevent damage or stress to the surface.

5. Ease the lower casing outward to clear the securing clips and pry apart the right side as shown. Lift the rear edge of the Upper Base upward.

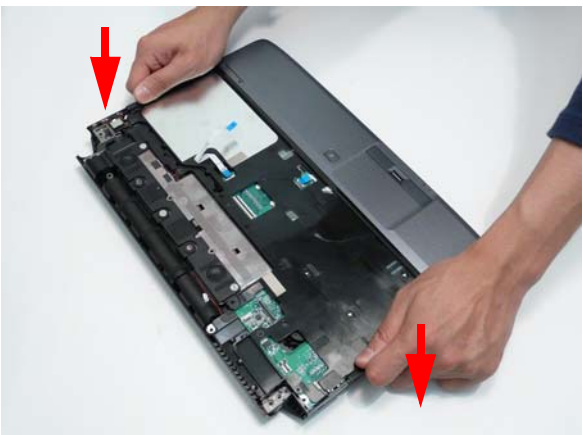
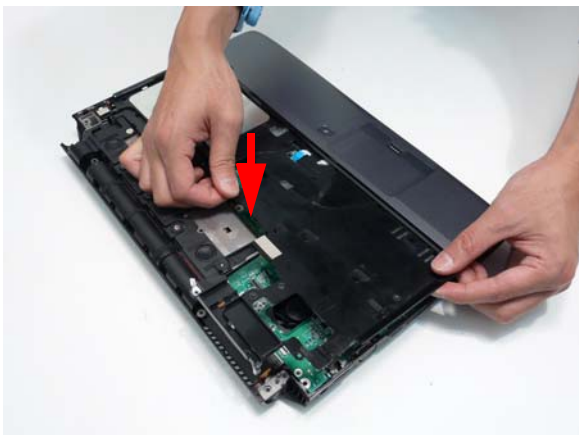

6. Starting with the sides, press down all around the perimeter of the cover to secure it in place.

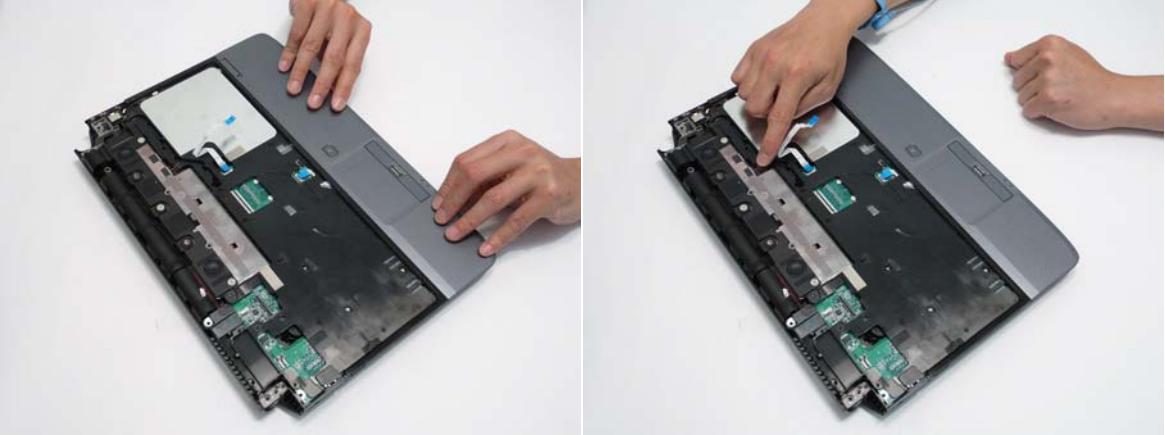

7. Reconnect the four FFC cables to the mainboard.

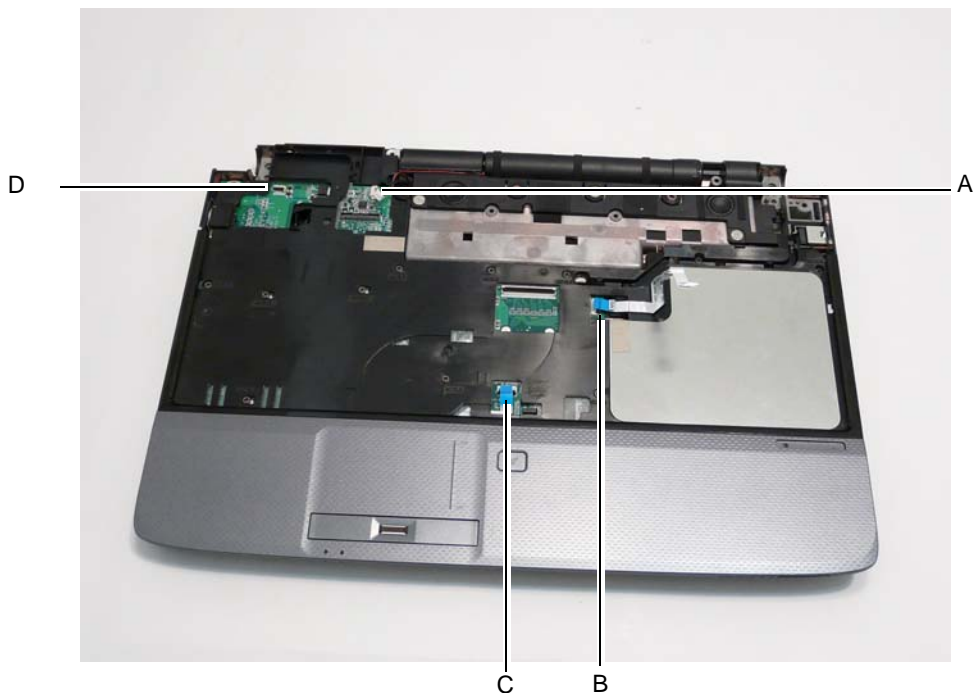

Connect A as shown and lock the connector.

Connect B as shown and lock the connector.

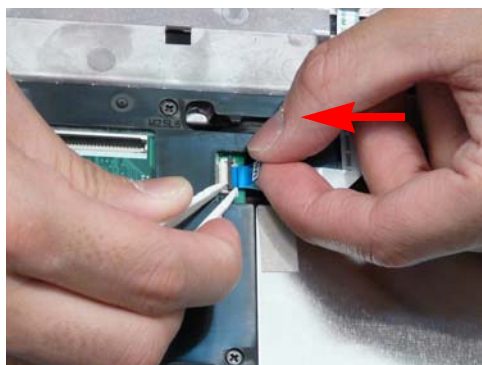
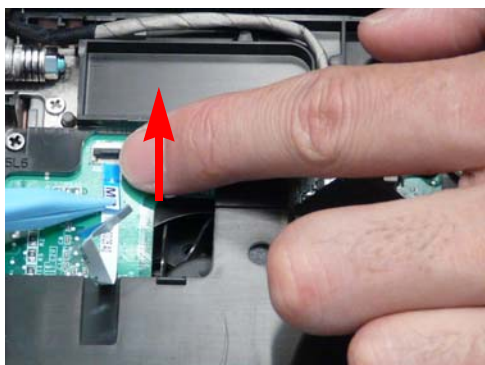

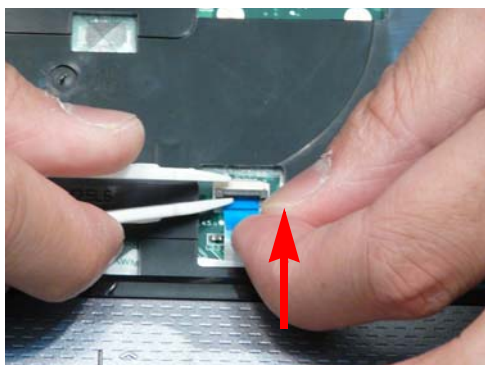

Connect C as shown and lock the connector.

Connect D as shown and lock the connector.



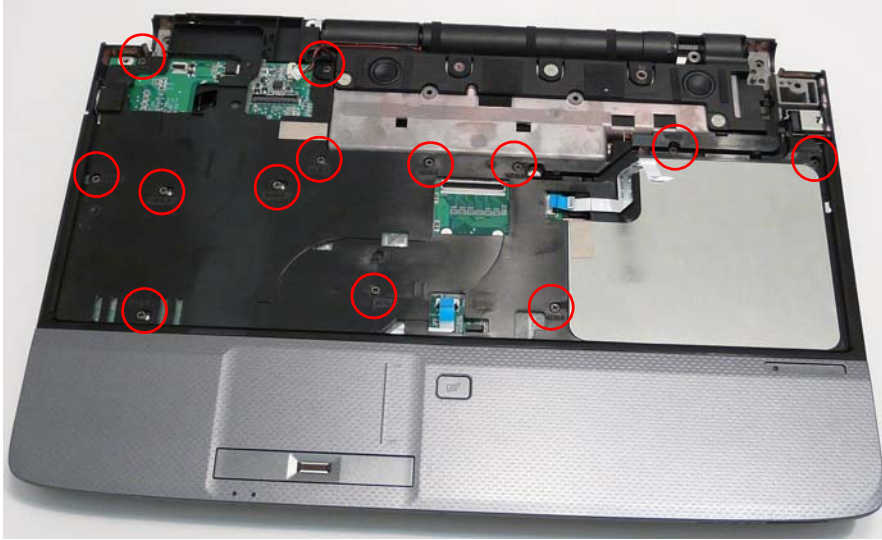

8. Replace the 13 securing screws on the top panel.

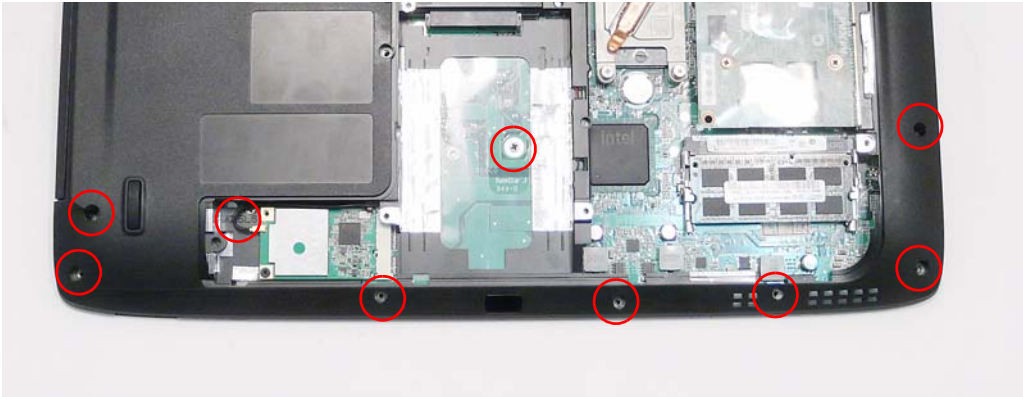

Step	Size	Quantity	Screw Type
Upper Cover (red callout)	M2.5*6	13	

9. Turn the computer over. Replace the nine screws on the bottom panel.



Step	Size	Quantity	Screw Type
Upper Cover	M2.5*6	9	

Replacing the LCD Module

10. Carefully place the LCD Module into the chassis, making sure to align the mounting pins on the LCD brackets with the well son the Lower Cover.

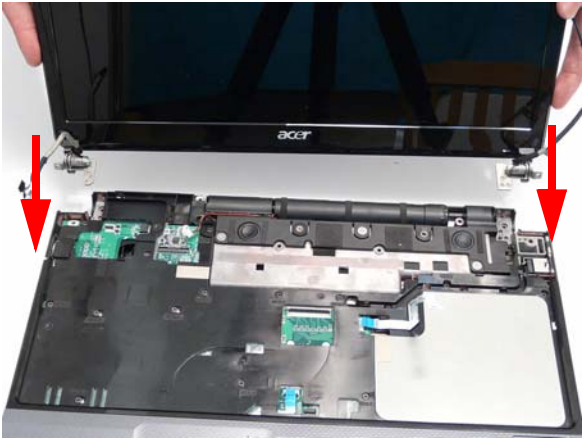



11. Replace the two securing screws for the left LCD hinge.

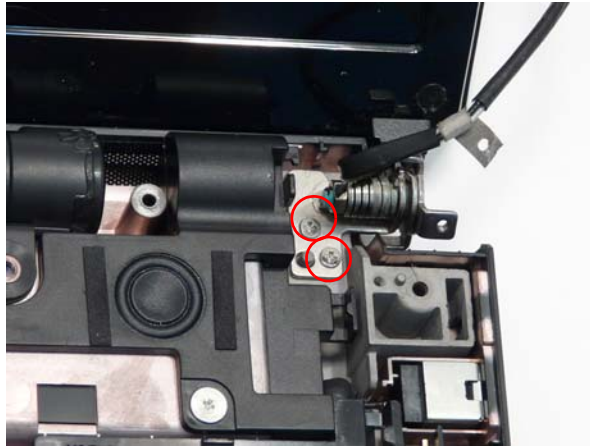

Step	Size	Quantity	Screw Type
LCD Module	M2.5*5	2	

12. Replace the two securing screws for the right LCD hinge.



Step	Size	Quantity	Screw Type
LCD Module	M2.5*5	2	

13. Connect the LCD cable to the Mainboard and insert the cable into the cable channel as shown.

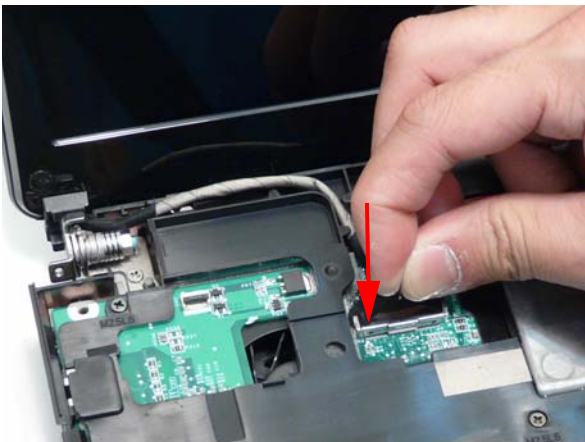

14. Rest the computer on its side with the LCD Module open and push the Antenna cable through the chassis as shown.

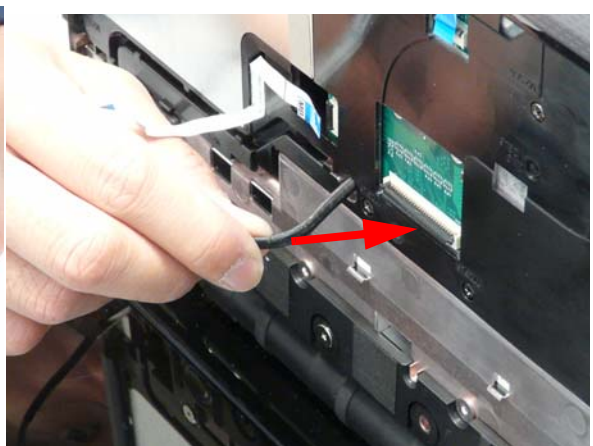

15. Starting from the LCD module, insert the Antenna cable into the cable channels as shown. Note how the cable hooks onto the cable channel in the speaker module, then is adhered to the pin on the Kensington Lock before passing into the cable channel on the upper cover

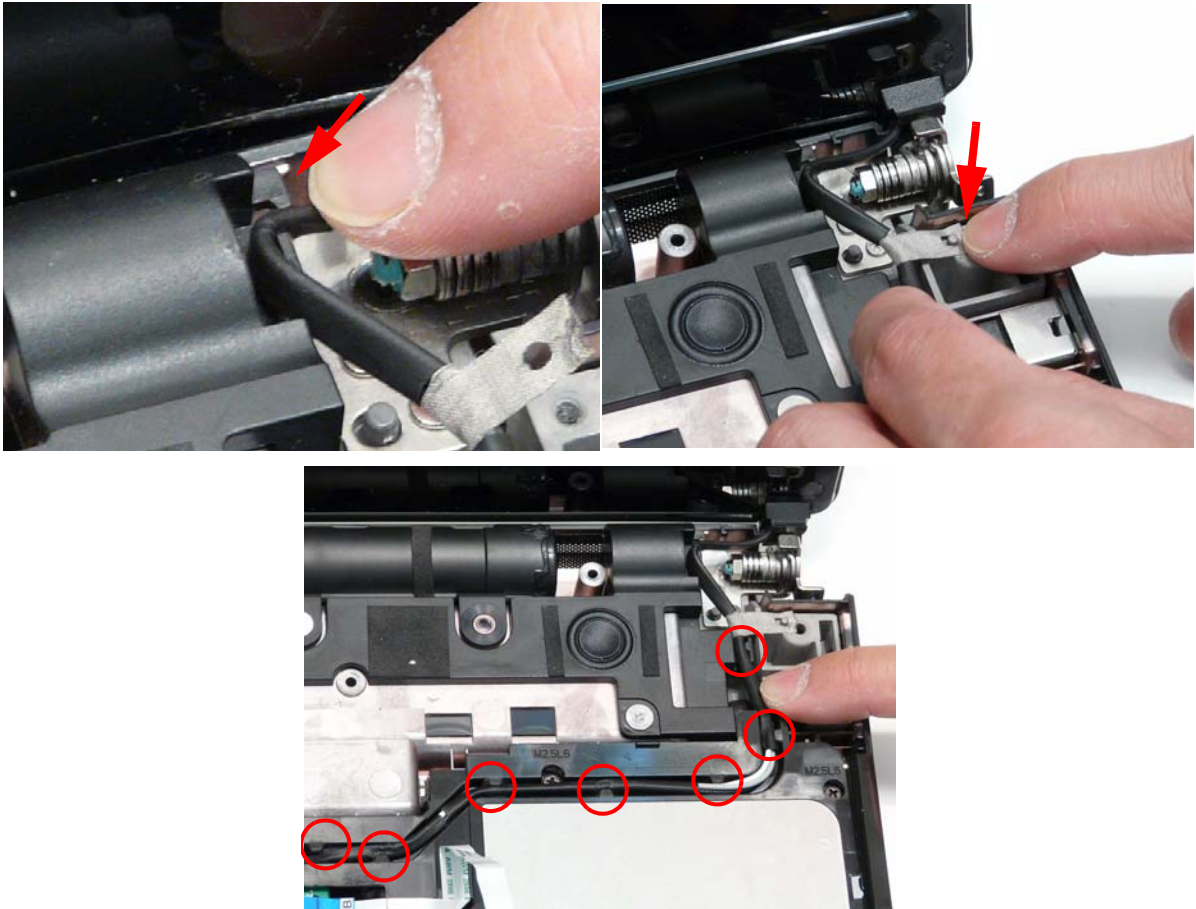

16. Close the lid, turn the computer over, and replace the two screws to secure the LCD panel as shown.



Step	Size	Quantity	Screw Type
LCD Module	M2.5*5	2	

Replacing the Keyboard

1. Place the Keyboard on the Upper Cover, face up and reconnect the FFC cable to the Mainboard.
2. Insert the Keyboard, front edge first, into the Upper Cover as shown. Ensure that the six tabs are correctly seated.

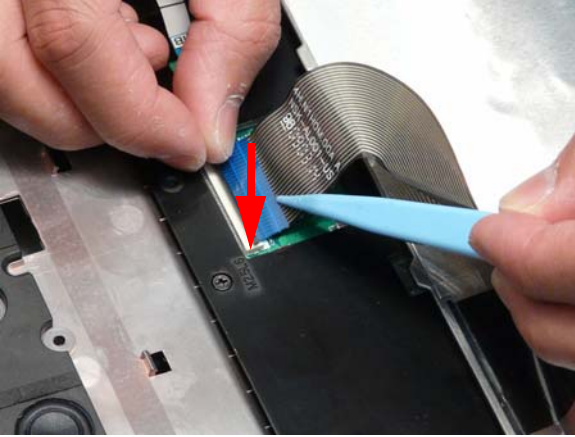

3. Press down both sides of the keyboard to secure it in place.



Replacing the Power Switch Board

1. Insert the the Power Board into the Switch Cover by sliding it under the securing tab as shown.



2. Replace the three screws to secure the Power Save Board to the Switch Cover as shown.

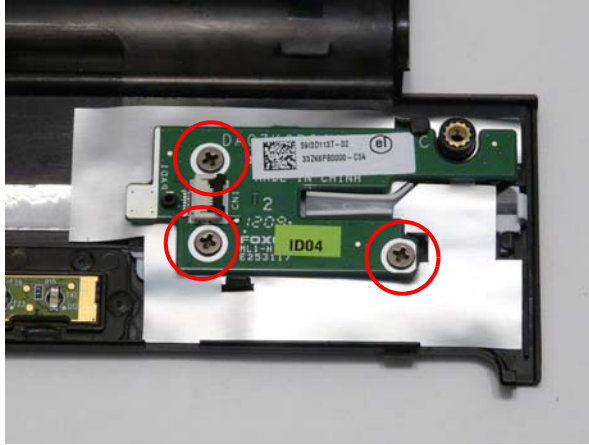

Step	Size	Quantity	Screw Type
Switch Cover (red callout)	M2.5*4	3	

Replacing the Power Save Board

3. Replace the two screws to secure the Power Save Board to the Switch Cover as shown.

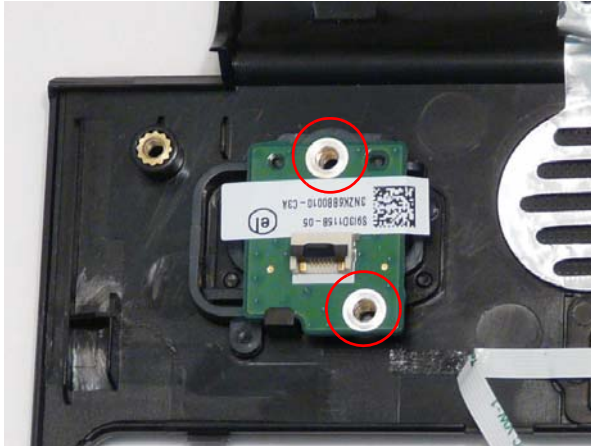

Step	Size	Quantity	Screw Type
Switch Cover (red callout)	M2.5*4	2	

-
4. Connect the Power Save Board to the Function Board by inserting the FFC and closing the FFC lock as shown.



Replacing the Switch Cover

CAUTION: Using tools to remove the Switch Cover may cause damage to the outer casing. It is recommended that only fingers are used to remove the Switch Cover.

1. See "Removing the Battery Pack" on page 49.
2. See "Removing the Hinge Covers" on page 63.
3. Place the switch board on the keyboard.



4. Connect the power board to the main unit by inserting the FFC and closing the FFC lock as shown.

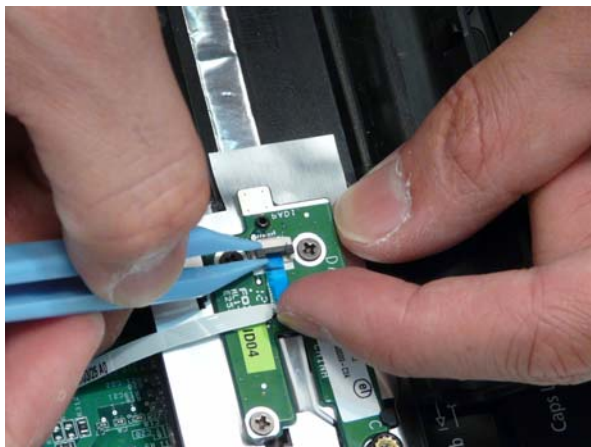

5. Connect the function board to the main unit by inserting the FFC and closing the FFC lock as shown.



6. Using both hands, rotate the Switch Cover into place, making sure the pins in the lower left and right corners are under the upper cover.

IMPORTANT: Make sure that the six tabs along the keyboard edge are on top of the keyboard and hold it in place.



7. Push the switch cover into place.



8. Close the LCD module and turn the computer over.

9. Replace the six screws on the bottom of the computer.

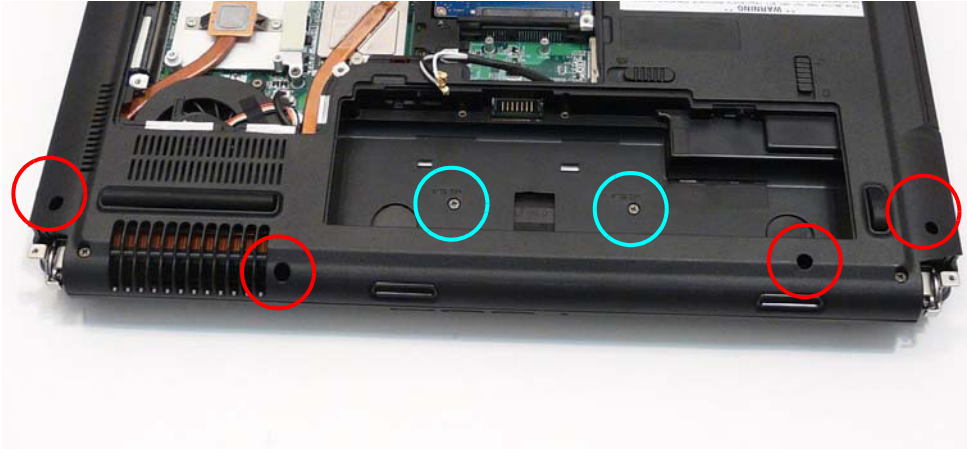

Step	Size	Quantity	Screw Type
Switch Cover (red callout)	M2.5*6	6	
Switch Cover (cyan callout)	M2.5*4	2	

Replacing the Hinge Covers

IMPORTANT:The left and right Hinge Covers are shaped differently and marked **L** and **R** on the inside. Ensure that the correct cover is used during reassembly.

1. Align the Hinge Covers screw hole side up and slide them onto the hinge assemblies.



2. Replace the two securing screws and caps.



Step	Size	Quantity	Screw Type
Hinge Covers	M2.5*4	2	

External Unit Reassembly Process

Replacing the CPU

IMPORTANT:The CPU has a Pin1 locator that must be positioned corresponding to the marker on the CPU socket

The following thermal pads are approved for use:

- Silmore GP50
- Honeywell
- Jet Motor 7762

The following thermal compounds are approved for use:

- Eapus XR-PE

1. Raise the heat sink and hold it in a raised position.
2. Remove all traces of thermal grease or pad adhesive from the heat sink using a lint-free cloth or cotton swab and Isopropyl Alcohol, Acetone, or other approved cleaning agent.
3. Place the CPU into the socket. Take note of the Pin 1 locator in the image below.

WARNING:Take care to prevent the pins from becoming bent while replacing the CPU. If you find it difficult to replace the CPU using this method, or lack the tools to properly insert the CPU into the socket, then follow the instructions provided in “Replacing the CPU (Alternate Procedure)” on page 100.

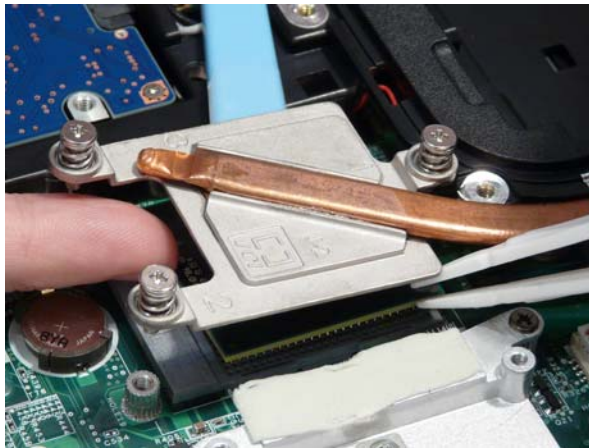

4. Apply a small amount of thermal grease or the supplied thermal pad to the centre of the heat sink. There is no need to spread grease manually, the force used during the installation of the Thermal Module is sufficient.
5. Using a flat screwdriver, turn the CPU socket latch clockwise 180° to lock the CPU in place.

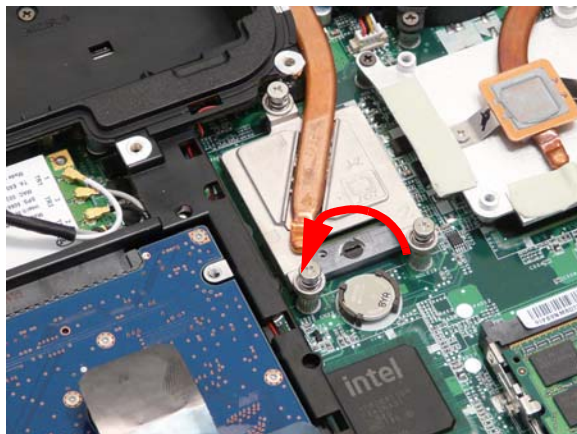

6. Lower the heat sink into place.

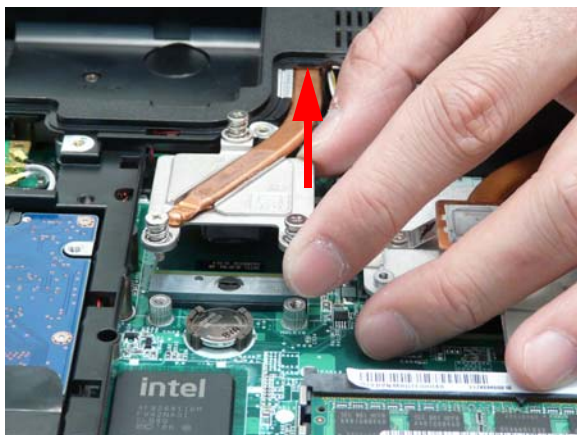

7. Tighten the three screws of the CPU heat sink in the indicated order: 1, 2, 3.

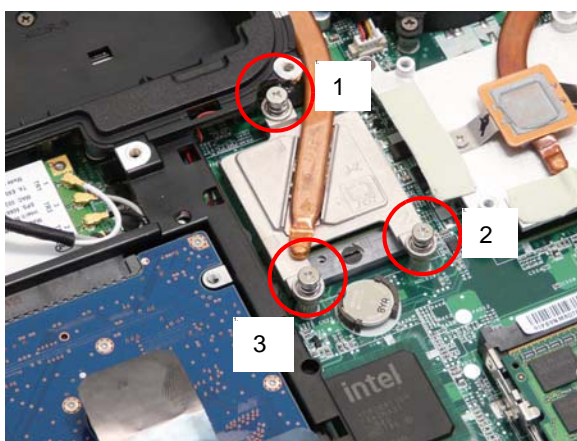

Replacing the RTC Battery

1. Insert the RTC battery into the socket in the mainboard.



Replacing the Graphics Card

The following thermal pads are approved for use:

- Silmore GP50
- Honeywell

- Jet Motor 7762

The following thermal compounds are approved for use:

- Eapus XR-PE
2. Remove all traces of thermal grease or pad adhesive from the heat sink using a lint-free cloth or cotton swab and Isopropyl Alcohol, Acetone, or other approved cleaning agent.
 3. Apply a small amount of thermal grease or the supplied thermal pads to the locations indicated below. There is no need to spread grease manually, the force used during the installation of the Thermal Module is sufficient.

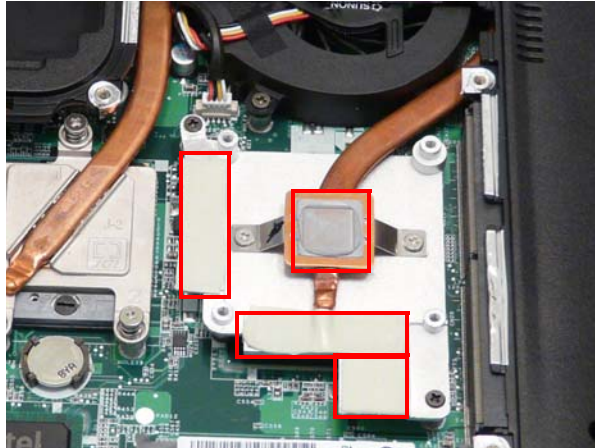

4. Insert the MXM card into the slot.

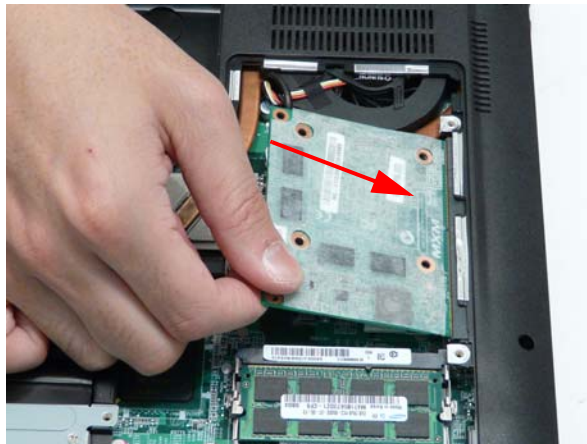

5. Push the graphics card into place and insert the four screws to secure the graphics card to the thermal unit underneath.

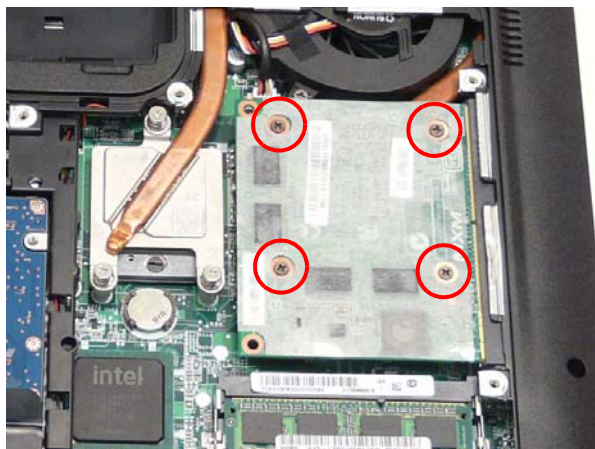

Replacing the ODD Module

1. Align the ODD Bezel as shown and press it into place.



2. Align the ODD Bracket as shown and replace the securing screws.



3. Push the ODD Module into the chassis as shown until the bezel is flush with the casing.
4. Replace the securing screw.



Replacing the Hard Disk Drive Module

1. Place the HDD carrier on the HDD.
2. Replace the two securing screws.

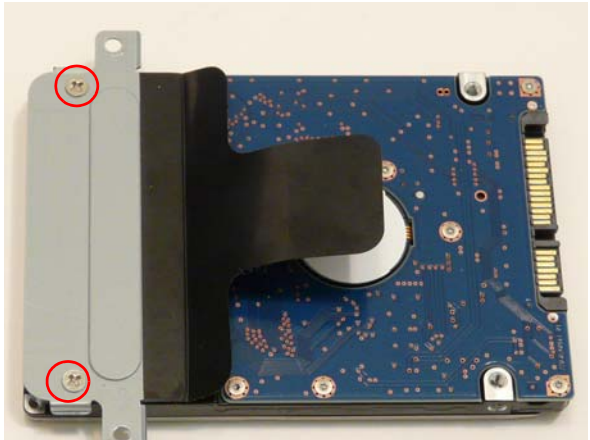
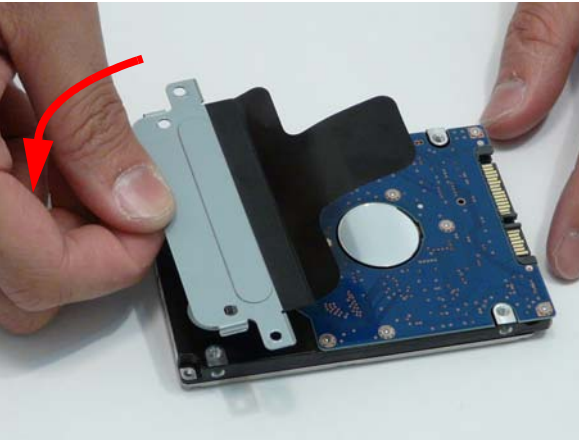

3. Place the HDD Module in the HDD bay as shown and slide it in the direction of the arrow to connect the interface.

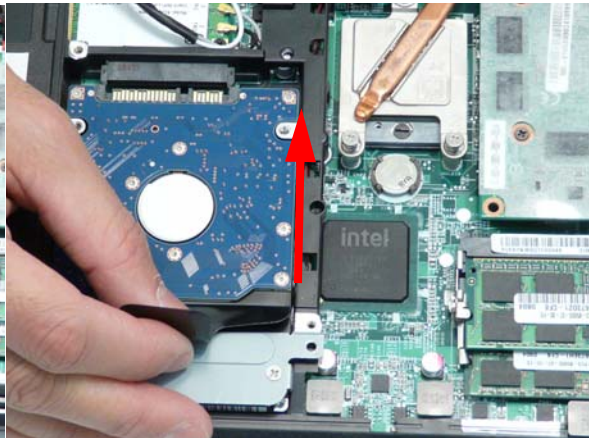
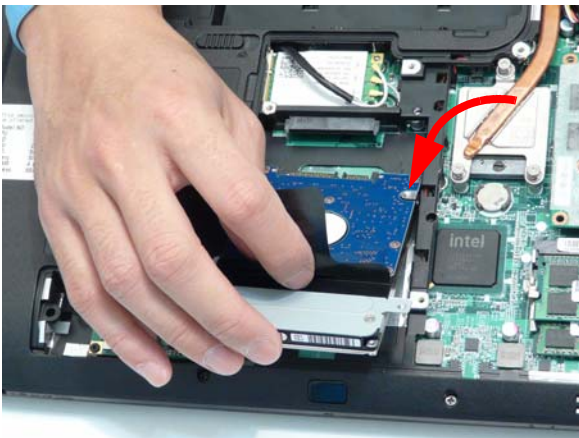

4. Replace the single screw to secure the hard disk bracket to the Lower Cover.

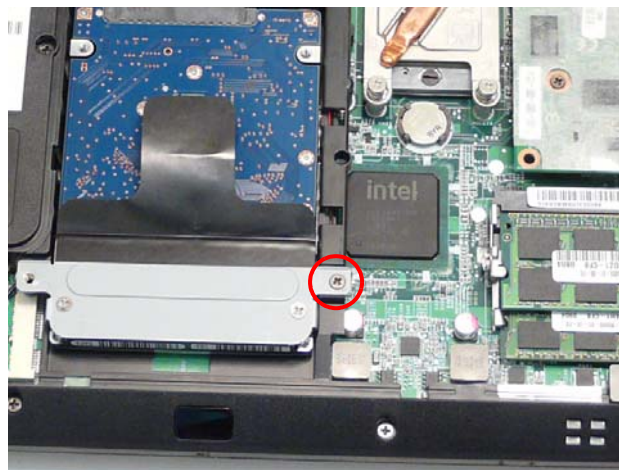

Replacing the DIMM Modules

NOTE: To replace DIMM Module 2, first remove DIMM Module 1. In this procedure, only DIMM Module 1 is

shown.

1. Insert the DIMM Module flush with the connector and press down to lock in place.

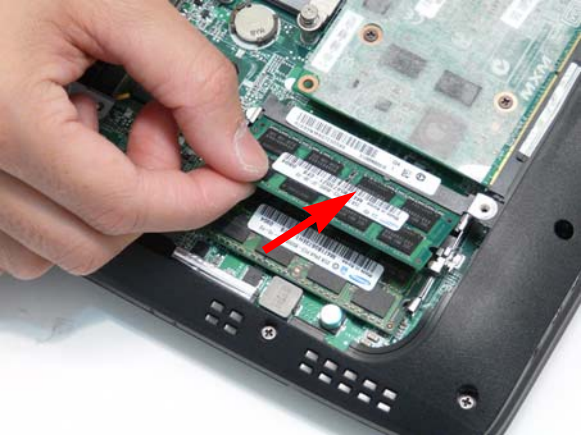

Replacing the WLAN Module

1. Insert the WLAN board into the WLAN socket.
2. Replace the single screw to secure the module.



3. Connect the three antenna cables to the module.

NOTE: The White cable goes to the upper terminal (TR 1), the black cable to the lower terminal (TR 2), and the grey cable to the middle terminal (TR 3).



Step	Size	Quantity	Screw Type
WLAN Module	M2*3	1	

Replacing the TV Tuner

1. Insert the TV Tuner module as shown.



2. Connect the antenna cable.

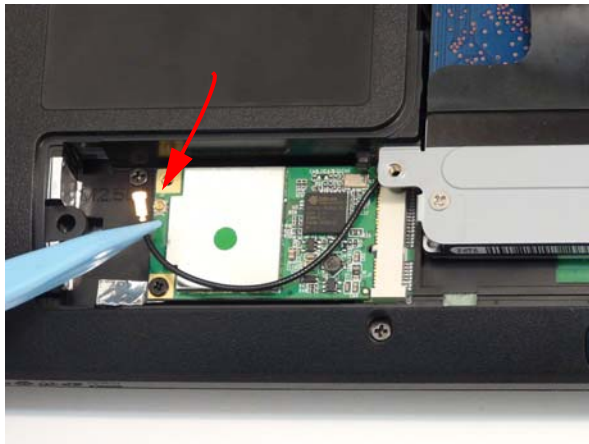

3. replace the single securing screw.



Step	Size	Quantity	Screw Type
TV Tuner Module	M2*3	1	

Replacing the Lower Cover

1. Replace the Lower Cover, inserting the tabs on the bottom edge first, as shown.



2. Tighten the six captive screws in the cover as shown.

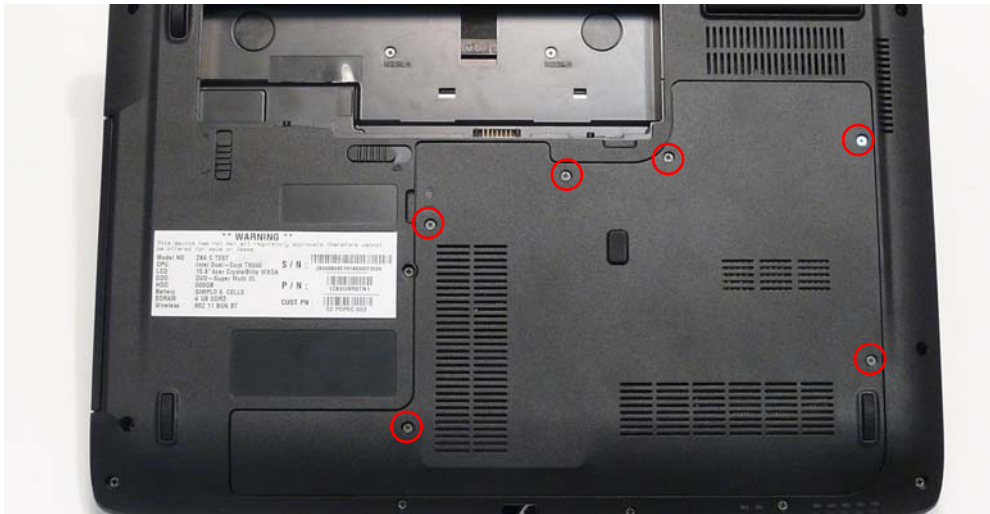

Replacing the SD Card Dummy Tray

1. Insert the SD Card and push into the slot until flush with the chassis cover.



Replacing the Battery

1. Slide and hold the battery release latch to the release position (1), then insert the battery and press down (2).

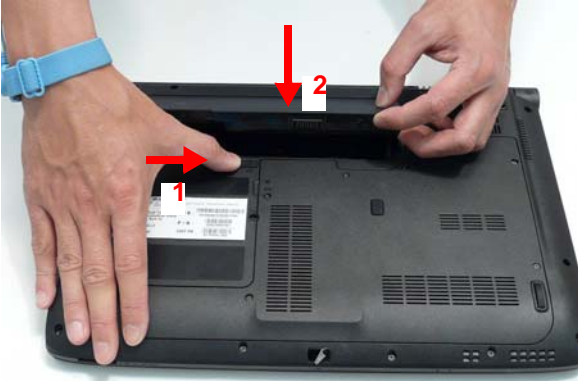

2. Slide the battery lock/unlock latch to the lock position.



Troubleshooting

Common Problems

Use the following procedure as a guide for computer problems.

NOTE: The diagnostic tests are intended to test only Acer products. Non-Acer products, prototype cards, or modified options can give false errors and invalid system responses.

1. Obtain the failing symptoms in as much detail as possible.
2. Verify the symptoms by attempting to re-create the failure by running the diagnostic test or by repeating the same operation.
3. Use the following table with the verified symptom to determine which page to go to.

Symptoms (Verified)	Go To
Power On Issue	Page 134
No Display Issue	Page 136
LCD Failure	Page 139
Internal Keyboard Failure	Page 139
Touchpad Failure	Page 140
Internal Speaker Failure	Page 140
Internal Microphone Failure	Page 142
ODD Failure	Page 145
Rightside USB Failure	Page 149
Modem Failure	Page 149
WLAN/WiMAX Failure	Page 150
Bluetooth Failure	Page 150
EasyTouch Button Failure	Page 151
Media Board Failure	Page 151
Finger Print Reader Failure	Page 152
Thermal Unit Failure	Page 152
Other Functions Failure	Page 153
Intermittent Failures	Page 154
Undetermined Failures	Page 154

4. If the Issue is still not resolved, see "Online Support Information" on page 215.

Power On Issue

If the system doesn't power on, perform the following actions one at a time to correct the problem. Do not replace a non-defective FRUs:

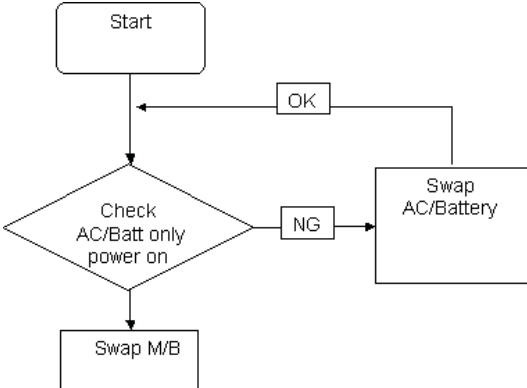

Computer Shutdown Intermittently

If the system powers off at intervals, perform the following actions one at a time to correct the problem.

1. Check the power cable is properly connected to the computer and the electrical outlet.
2. Remove any extension cables between the computer and the outlet.
3. Remove any surge protectors between the computer and the electrical outlet. Plug the computer directly into a known good electrical outlet.
4. Disconnect the power and open the casing to check the Thermal Unit and fan airways are free of obstructions.
5. Remove all external and non-essential hardware connected to the computer that are not necessary to boot the computer to the failure point.
6. Remove any recently installed software.
7. If the Issue is still not resolved, see "Online Support Information" on page 215.

No Display Issue

If the **Display** doesn't work, perform the following actions one at a time to correct the problem. Do not replace a non-defective FRUs:

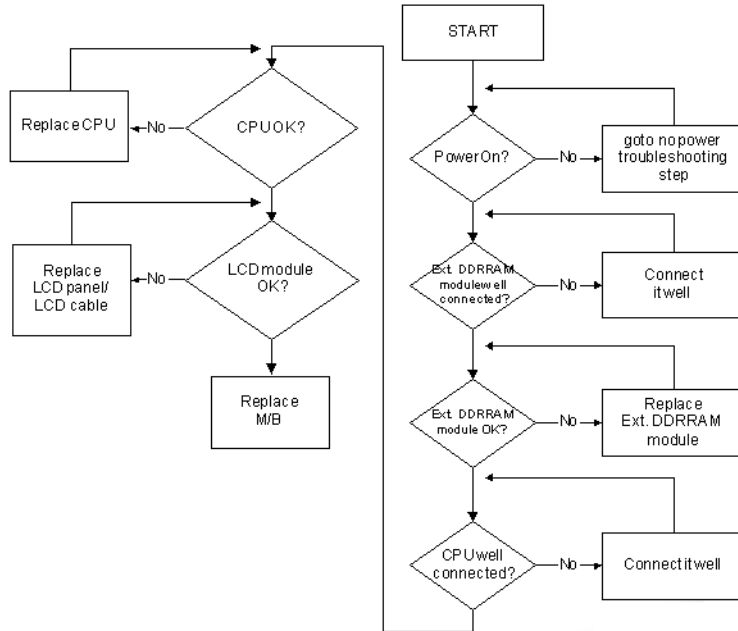

No POST or Video

If the POST or video doesn't display, perform the following actions one at a time to correct the problem.

1. Make sure that the internal display is selected. On this notebook model, switching between the internal display and the external display is done by pressing **Fn+F5**. Reference Product pages for specific model procedures.
2. Make sure the computer has power by checking at least one of the following occurs:
 - Fans start up
 - Status LEDs light up

If there is no power, see "Power On Issue" on page 134.

3. Drain any stored power by removing the power cable and battery and holding down the power button for 10 seconds. Reconnect the power and reboot the computer.
4. Connect an external monitor to the computer and switch between the internal display and the external display is by pressing **Fn+F5** (on this model).

If the POST or video appears on the external display, see "LCD Failure" on page 139.

5. Disconnect power and all external devices including port replicators or docking stations. Remove any memory cards and CD/DVD discs. Restart the computer.

If the computer boots correctly, add the devices one by one until the failure point is discovered.

6. Reseat the memory modules.
7. Remove the drives (see "Disassembly Process" on page 48).
8. If the Issue is still not resolved, see "Online Support Information" on page 215.

Abnormal Video Display

If video displays abnormally, perform the following actions one at a time to correct the problem.

1. Reboot the computer.
2. If permanent vertical/horizontal lines or dark spots display in the same location, the LCD is faulty and should be replaced. See “Disassembly Process” on page 48.
3. If extensive pixel damage is present (different colored spots in the same locations on the screen), the LCD is faulty and should be replaced. See “Disassembly Process” on page 48.
4. Adjust the brightness to its highest level. See the User Manual for instructions on adjusting settings.
NOTE: Ensure that the computer is not running on battery alone as this may reduce display brightness.
If the display is too dim at the highest brightness setting, the LCD is faulty and should be replaced. See “Disassembly Process” on page 48.
5. Check the display resolution is correctly configured:
 - a. Minimize or close all Windows.
 - b. If display size is only abnormal in an application, check the view settings and control/mouse wheel zoom feature in the application.
 - c. If desktop display resolution is not normal, right-click on the desktop and select **Personalize**→ **Display Settings**.
 - d. Click and drag the Resolution slider to the desired resolution.
 - e. Click **Apply** and check the display. Readjust if necessary.
6. Roll back the video driver to the previous version if updated.
7. Remove and reinstall the video driver.
8. Check the Device Manager to determine that:
 - The device is properly installed. There are no red Xs or yellow exclamation marks.
 - There are no device conflicts.
 - No hardware is listed under Other Devices.
9. If the Issue is still not resolved, see “Online Support Information” on page 215.
10. Run the Windows Memory Diagnostic from the operating system DVD and follow the onscreen prompts.
11. If the Issue is still not resolved, see “Online Support Information” on page 215.

Random Loss of BIOS Settings

If the computer is experiencing intermittent loss of BIOS information, perform the following actions one at a time to correct the problem.

1. If the computer is more than one year old, replace the CMOS battery.
2. Run a complete virus scan using up-to-date software to ensure the computer is virus free.
3. If the computer is experiencing HDD or ODD BIOS information loss, disconnect and reconnect the power and data cables between devices.
If the BIOS settings are still lost, replace the cables.
4. If HDD information is missing from the BIOS, the drive may be defective and should be replaced.
5. Replace the Motherboard.
6. If the Issue is still not resolved, see “Online Support Information” on page 215.

LCD Failure

If the **LCD** fails, perform the following actions one at a time to correct the problem. Do not replace a non-defective FRUs:

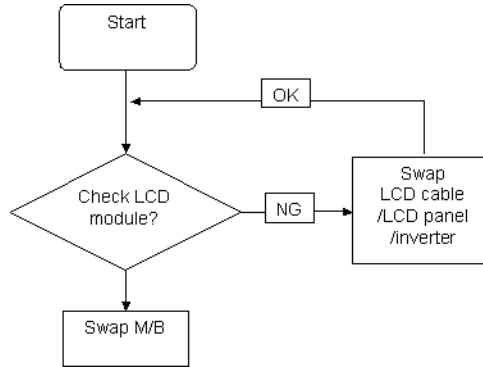

Built-In Keyboard Failure

If the built-in **Keyboard** fails, perform the following actions one at a time to correct the problem. Do not replace a non-defective FRUs:

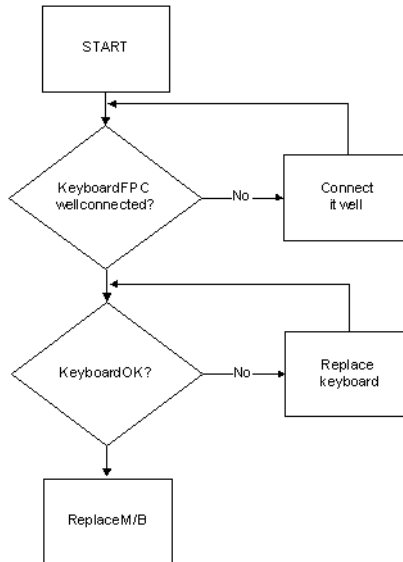

Touchpad Failure

If the **Touchpad** doesn't work, perform the following actions one at a time to correct the problem. Do not replace a non-defective FRUs:

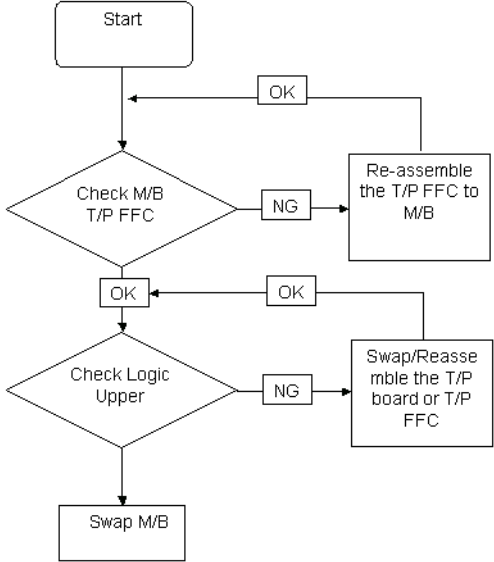

Internal Speaker Failure

If the internal **Speakers** fail, perform the following actions one at a time to correct the problem. Do not replace a non-defective FRUs:

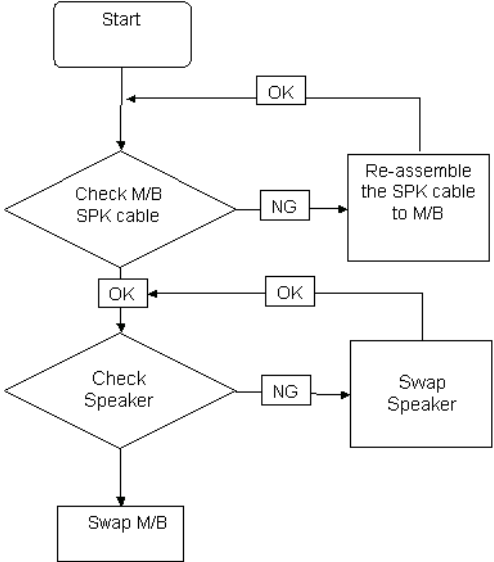

Sound Problems

If sound problems are experienced, perform the following actions one at a time to correct the problem.

1. Reboot the computer.
2. Navigate to **Start** → **Control Panel** → **System and Maintenance** → **System** → **Device Manager**. Check the Device Manager to determine that:
 - The device is properly installed.
 - There are no red Xs or yellow exclamation marks.
 - There are no device conflicts.
 - No hardware is listed under Other Devices.
3. Roll back the audio driver to the previous version, if updated recently.
4. Remove and reinstall the audio driver.
5. Ensure that all volume controls are set mid range:
 - a. Click the volume icon on the taskbar and drag the slider to 50. Ensure that the volume is not muted.
 - b. Click Mixer to verify that other audio applications are set to 50 and not muted.
6. Navigate to **Start** → **Control Panel** → **Hardware and Sound** → **Sound**. Ensure that Speakers are selected as the default audio device (green check mark).

NOTE: If Speakers does not show, right-click on the **Playback** tab and select **Show Disabled Devices** (clear by default).
7. Select Speakers and click **Configure** to start **Speaker Setup**. Follow the onscreen prompts to configure the speakers.
8. Remove and recently installed hardware or software.
9. Restore system and file settings from a known good date using **System Restore**.

If the issue is not fixed, repeat the preceding steps and select an earlier time and date.
10. Reinstall the Operating System.
11. If the Issue is still not resolved, see “Online Support Information” on page 215.

Internal Microphone Failure

If the internal **Microphone** fails, perform the following actions one at a time to correct the problem. Do not replace a non-defective FRUs:

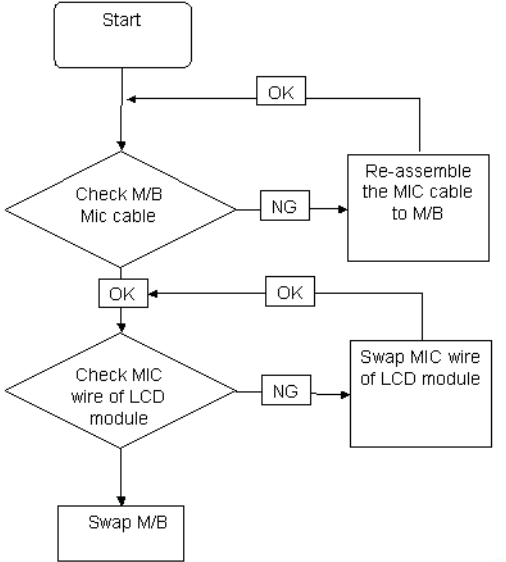

Microphone Problems

If internal or external **Microphones** do not operate correctly, perform the following actions one at a time to correct the problem.

1. Check that the microphone is enabled. Navigate to **Start** → **Control Panel** → **Hardware and Sound** → **Sound** and select the **Recording** tab.
2. Right-click on the **Recording** tab and select **Show Disabled Devices** (clear by default).
3. The microphone appears on the **Recording** tab.
4. Right-click on the microphone and select **Enable**.
5. Select the microphone then click **Properties**. Select the **Levels** tab.
6. Increase the volume to the maximum setting and click **OK**.
7. Test the microphone hardware:
 - a. Select the microphone and click **Configure**.
 - b. Select **Set up microphone**.
 - c. Select the microphone type from the list and click **Next**.
 - d. Follow the onscreen prompts to complete the test.
8. If the Issue is still not resolved, see "Online Support Information" on page 215.

HDD Not Operating Correctly

If the **HDD** does not operate correctly, perform the following actions one at a time to correct the problem.

1. Disconnect all external devices.
2. Run a complete virus scan using up-to-date software to ensure the computer is virus free.
3. Run the Windows Vista Startup Repair Utility:
 - a. insert the Windows Vista Operating System DVD in the ODD and restart the computer.
 - b. When prompted, press any key to start to the operating system DVD.
 - c. The **Install Windows** screen displays. Click **Next**.
 - d. Select **Repair your computer**.
 - e. The **System Recovery Options** screen displays. Click **Next**.
 - f. Select the appropriate operating system, and click **Next**.

NOTE: Click **Load Drivers** if controller drives are required.

- g. Select **Startup Repair**.
 - h. Startup Repair attempts to locate and resolve issues with the computer.
 - i. When complete, click **Finish**.
- If an issue is discovered, follow the onscreen information to resolve the problem.
4. Run the Windows Memory Diagnostic Tool. For more information see Windows Help and Support.
 5. Restart the computer and press F2 to enter the BIOS Utility. Check the BIOS settings are correct and that CD/DVD drive is set as the first boot device on the Boot menu.
 6. Ensure all cables and jumpers on the HDD and ODD are set correctly.
 7. Remove any recently added hardware and associated software.
 8. Run the Windows Disk Defragmenter. For more information see Windows Help and Support.
 9. Run Windows Check Disk by entering **chkdsk /r** from a command prompt. For more information see Windows Help and Support.
 10. Restore system and file settings from a known good date using **System Restore**.

If the issue is not fixed, repeat the preceding steps and select an earlier time and date.

11. Replace the HDD. See "Disassembly Process" on page 48.

ODD Failure

If the **ODD** fails, perform the following actions one at a time to correct the problem. Do not replace a non-defective FRUs:

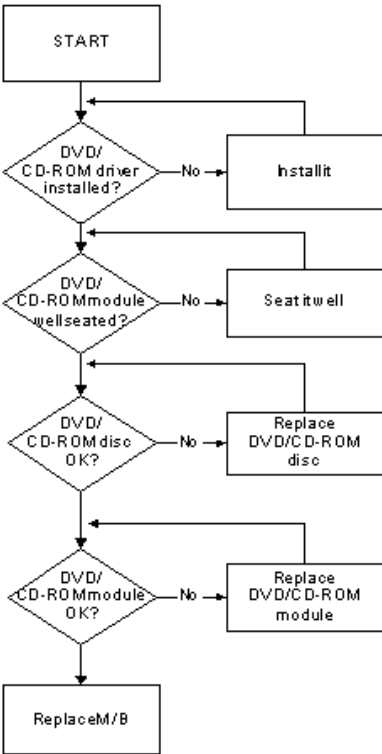

ODD Not Operating Correctly

If the **ODD** exhibits any of the following symptoms it may be faulty:

- Audio CDs do not play when loaded
- DVDs do not play when loaded
- Blank discs do not burn correctly
- DVD or CD play breaks up or jumps
- Optical drive not found or not active:
 - Not shown in My Computer or the BIOS setup
 - LED does not flash when the computer starts up
 - The tray does not eject
- Access failure screen displays
- The ODD is noisy

Perform the following general solutions one at a time to correct the problem.

1. Reboot the computer and retry the operation.
2. Try an alternate disc.
3. Navigate to **Start** → **Computer**. Check that the ODD device is displayed in the **Devices with Removable Storage** panel.
4. Navigate to **Start** → **Control Panel** → **System and Maintenance** → **System** → **Device Manager**.
 - a. Double-click **IDE ATA/ATAPI controllers**. If a device displays a down arrow, right-click on the device and click **Enable**.
 - b. Double-click **DVD/CD-ROM drives**. If the device displays a down arrow, right-click on the device and click **Enable**.
 - c. Check that there are no yellow exclamation marks against the items in **IDE ATA/ATAPI controllers**. If a device has an exclamation mark, right-click on the device and uninstall and reinstall the driver.
 - d. Check that there are no yellow exclamation marks against the items in **DVD/CD-ROM drives**. If a device has an exclamation mark, right-click on the device and uninstall and reinstall the driver.
 - e. If the exclamation marker is not removed from the item in the lists, try removing any recently installed software and retrying the operation.

Discs Do Not Play

If discs do not play when inserted in the drive, perform the following actions one at a time to correct the problem.

1. Check that the disc is correctly seated in the drive tray and that the label on the disc is visible.
2. Check that the media is clean and scratch free.
3. Try an alternate disc in the drive.
4. Ensure that **AutoPlay** is enabled:
 - a. Navigate to **Start** → **Control Panel** → **Hardware and Sound** → **AutoPlay**.
 - b. Select **Use AutoPlay for all media and devices**.
 - c. In the Audio CD and DVD Movie fields, select the desired player from the drop down menu.
5. Check that the Regional Code is correct for the selected media:

IMPORTANT: Region can only be changed a limited number of times. After Changes remaining reaches zero, the region cannot be changed even Windows is reinstalled or the drive is moved to another computer.

- a. Navigate to **Start** → **Control Panel** → **System and Maintenance** → **System** → **Device Manager**.
- b. Double-click **DVD/CD-ROM drives**.
- c. Right-click **DVD drive** and click **Properties**, then click the **DVD Region** tab.

-
- d. Select the region suitable for the media inserted in the drive.

Discs Do Not Burn Properly

If discs can not be burned, perform the following actions one at a time to correct the problem.

1. Ensure that the default drive is record enabled:
 - a. Navigate to **Start** → **Computer** and right-click the writable ODD icon. Click **Properties**.
 - b. Select the **Recording** tab. In the **Desktop disc recording** panel, select the writable ODD from the drop down list.
 - c. Click **OK**.
2. Ensure that the software used for burning discs is the factory default. If using different software, refer to the software's user manual.

Playback is Choppy

If playback is choppy or jumps, perform the following actions one at a time to correct the problem.

1. Check that system resources are not running low:
 - a. Try closing some applications.
 - b. Reboot and try the operation again.
2. Check that the ODD controller transfer mode is set to DMA:
 - a. Navigate to **Start** → **Control Panel** → **System and Maintenance** → **System** → **Device Manager**.
 - b. Double-click **IDE ATA/ATAPI controllers**, then right-click ATA Device 0.
 - c. Click **Properties** and select the **Advanced Settings** tab. Ensure that the **Enable DMA** box is checked and click **OK**.
 - d. Repeat for the other ATA Devices shown if applicable.

Drive Not Detected

If Windows cannot detect the drive, perform the following actions one at a time to correct the problem.

1. Restart the computer and press F2 to enter the BIOS Utility.
2. Check that the drive is detected in the **ATAPI Model Name** field on the Information page.

NOTE: Check that the entry is identical to one of the ODDs specified in “Hardware Specifications and Configurations” on page 17.
3. Turn off the power and remove the cover to inspect the connections to the ODD. See “Disassembly Process” on page 48.
 - a. Check for broken connectors on the drive, motherboard, and cables.
 - b. Check for bent or broken pins on the drive, motherboard, and cable connections.
 - c. Try an alternate cable, if available. If the drive works with the new cable, the original cable should be replaced.
4. Reseat the drive ensuring and all cables are connected correctly.
5. Replace the ODD. See “Disassembly Process” on page 48.

Drive Read Failure

If discs cannot be read when inserted in the drive, perform the following actions one at a time to correct the problem.

1. Remove and clean the failed disc.
2. Retry reading the CD or DVD.
 - d. Test the drive using other discs.
 - e. Play a DVD movie
 - f. Listen to a music CD

If the ODD works properly with alternate discs, the original disc is probably defective and should be replaced.

3. Turn off the power and remove the cover to inspect the connections to the ODD. See “Disassembly Process” on page 48.
 - a. Check for broken connectors on the drive, motherboard, and cables.
 - b. Check for bent or broken pins on the drive, motherboard, and cable connections.
 - c. Try an alternate cable, if available. If the drive works with the new cable, the original cable should be replaced.
4. Replace the ODD. See “Disassembly Process” on page 48.

USB Failure (Rightside)

If the rightside **USB** port fails, perform the following actions one at a time to correct the problem. Do not replace a non-defective FRUs:

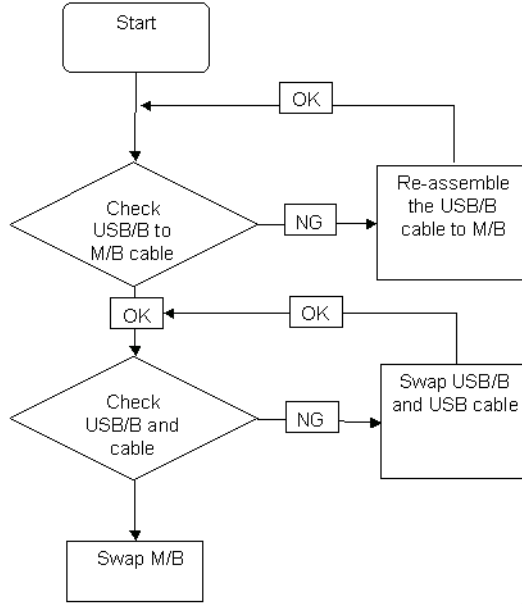

Modem Function Failure

If the internal **Modem** fails, perform the following actions one at a time to correct the problem. Do not replace a non-defective FRUs:

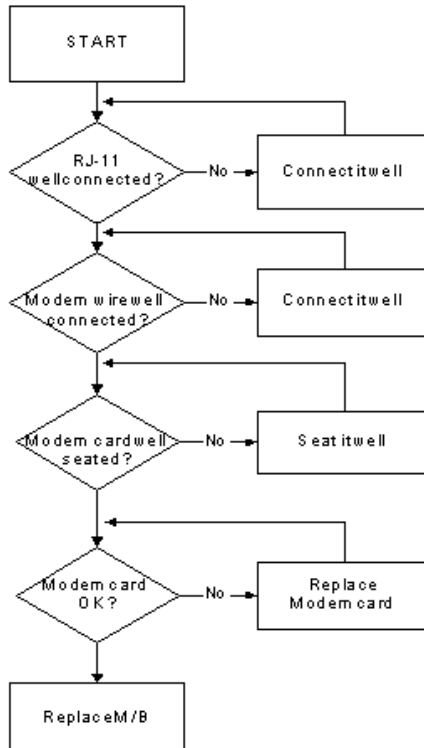

Wireless Function Failure

If the **WLAN/WiMAX** fails, perform the following actions one at a time to correct the problem. Do not replace a non-defective FRUs:

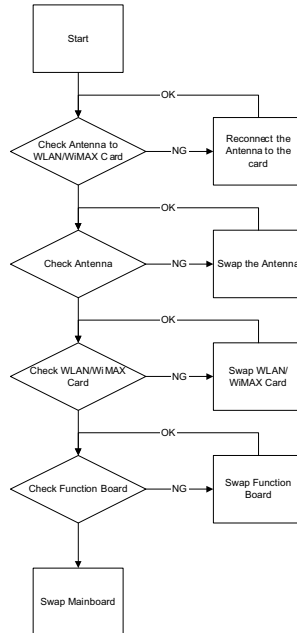

Bluetooth Function Failure

If the **Bluetooth** fails, perform the following actions one at a time to correct the problem. Do not replace a non-defective FRUs:

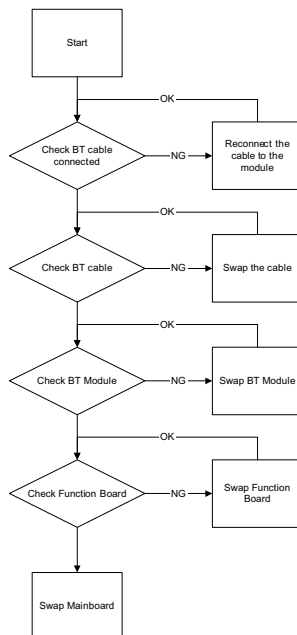

EasyTouch Button Failure

If the **Acer EasyTouch** buttons fail, perform the following actions one at a time to correct the problem. Do not replace a non-defective FRUs:

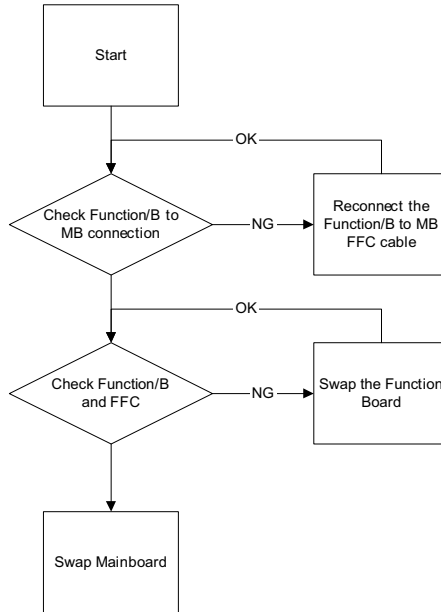

Media Board Failure

If the **Media Board** fails, perform the following actions one at a time to correct the problem. Do not replace a non-defective FRUs:

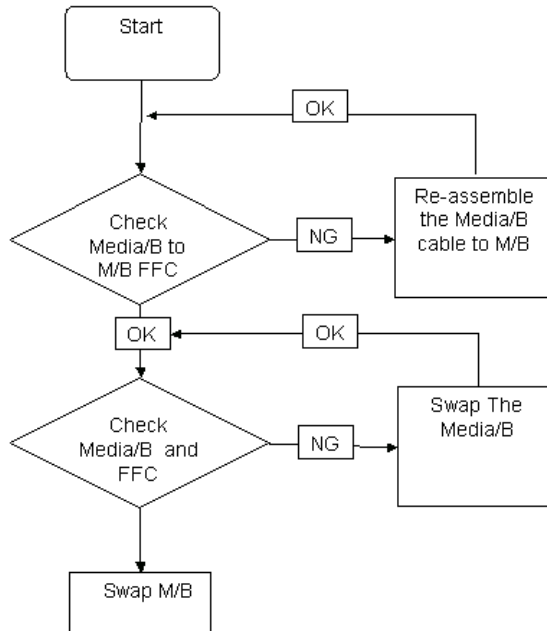

Fingerprint Reader Failure

If the **Fingerprint Reader** fails, perform the following actions one at a time to correct the problem. Do not replace a non-defective FRUs:

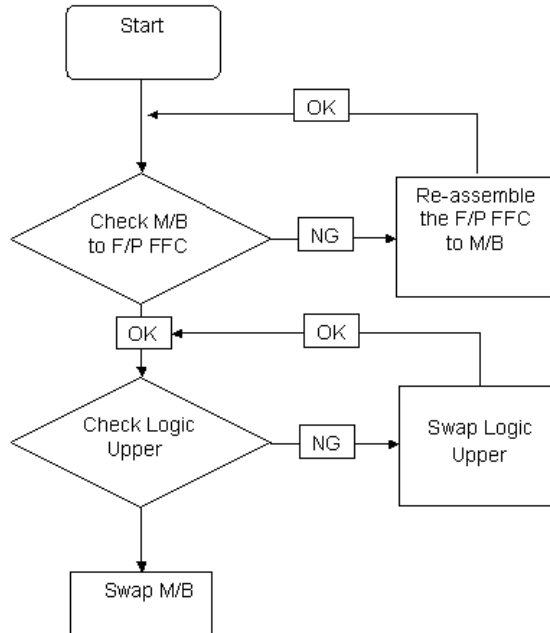

Thermal Unit Failure

If the **Thermal Unit** fails, perform the following actions one at a time to correct the problem. Do not replace a non-defective FRUs:

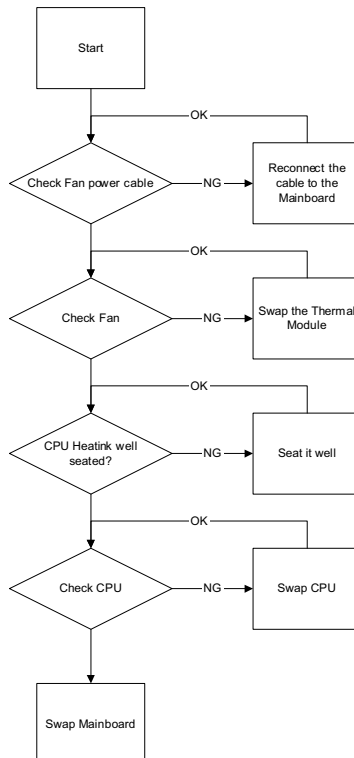

External Mouse Failure

If an external **Mouse** fails, perform the following actions one at a time to correct the problem.

1. Try an alternative mouse.
2. If the mouse uses a wireless connection, insert new batteries and confirm there is a good connection. See the mouse user manual.
3. If the mouse uses a USB connection, try an alternate USB port.
4. Try an alternative program to verify mouse operation. Reinstall the program experiencing mouse failure.
5. Restart the computer.
6. Remove any recently added hardware and associated software.
7. Remove any recently added software and reboot.
8. Restore system and file settings from a known good date using **System Restore**.

If the issue is not fixed, repeat the preceding steps and select an earlier time and date.

9. Run the Event Viewer to check the events log for errors. For more information see Windows Help and Support.
10. Roll back the mouse driver to the previous version if updated recently.
11. Remove and reinstall the mouse driver.
12. Check the Device Manager to determine that:
 - The device is properly installed. There are no red Xs or yellow exclamation marks.
 - There are no device conflicts.
 - No hardware is listed under Other Devices.
13. If the Issue is still not resolved, see “Online Support Information” on page 215.

Other Failures

If the CRT Switch, Dock, LAN Port, external MIC or Speakers, PCI Express Card, 5-in-1 Card Reader or Volume Wheel fail, perform the following general steps to correct the problem. Do not replace a non-defective FRUs:

1. Check Drive whether is OK.
2. Check Test Fixture is ok.
3. Swap M/B to Try.

Intermittent Problems

Intermittent system hang problems can be caused by a variety of reasons that have nothing to do with a hardware defect, such as: cosmic radiation, electrostatic discharge, or software errors. FRU replacement should be considered only when a recurring problem exists.

When analyzing an intermittent problem, do the following:

1. Run the advanced diagnostic test for the system board in loop mode at least 10 times.
2. If no error is detected, do not replace any FRU.
3. If any error is detected, replace the FRU. Rerun the test to verify that there are no more errors.

Undetermined Problems

The diagnostic problems does not identify which adapter or device failed, which installed devices are incorrect, whether a short circuit is suspected, or whether the system is inoperative.

Follow these procedures to isolate the failing FRU (do not isolate non-defective FRU).

NOTE: Verify that all attached devices are supported by the computer.

NOTE: Verify that the power supply being used at the time of the failure is operating correctly. (See "Power On Issue" on page 134.):

1. Power-off the computer.
2. Visually check them for damage. If any problems are found, replace the FRU.
3. Remove or disconnect all of the following devices:
 - Non-Acer devices
 - Printer, mouse, and other external devices
 - Battery pack
 - Hard disk drive
 - DIMM
 - CD-ROM/Diskette drive Module
 - PC Cards
4. Power-on the computer.
5. Determine if the problem has changed.
6. If the problem does not recur, reconnect the removed devices one at a time until you find the failing FRU.
7. If the problem remains, replace the following FRU one at a time. Do not replace a non-defective FRU:
 - System board
 - LCD assembly

POST Codes Tables

These tables describe the POST codes and descriptions during the POST.

Sec:

NO_EVICTION_MODE_DEBUG EQU 1 (CommonPlatform\sec\la32\SecCore.inc)

Code	Description
0xC2	MTRR setup
0xC3	Enable cache
0xC4	Establish cache tags
0xC5	Enter NEM, Place the BSP in No Fill mode, set CR0.CD = 1, CR0.NW = 0
0xCF	Cache Init Finished

Memory:

DEBUG_BIOS equ 1 (Chipset\Alviso\MemoryInitAsm\IA32\IMEMORY.INC)

Code	Description
0xA0	First memory check point
0x01	Enable MCHBAR
0x02	Check for DRAM initialization interrupt and reset fail
0x03	Verify all DIMMs are DDR or DDR2 and unbuffered
0x04	Detect an improper warm reset and handle
0x05	Detect if ECC SO-DIMMs are present in the system
0x06	Verify all DIMMs are single or double sided and not asymmetric
0x07	Verify all DIMMs are x8 or x16 width
0x08	Find a common CAS latency between the DIMMS and the MCH
0x09	Determine the memory frequency and CAS latency to program
0x10	Determine the smallest common TRAS for all DIMMs
0x11	Determine the smallest common TRP for all DIMMs
0x12	Determine the smallest common TRCD for all DIMMs
0x13	Determine the smallest refresh period for all DIMMs
0x14	Verify burst length of 8 is supported by all DIMMs
0x15	Determine the smallest tWR supported by all DIMMs
0x16	Determine DIMM size parameters
0x17	Program the correct system memory frequency
0x18	Determine and set the mode of operation for the memory channels
0x19	Program clock crossing registers
0x20	Disable Fast Dispatch
0x21	Program the DRAM Row Attributes and DRAM Row Boundary registers
0x22	Program the DRAM Bank Architecture register
0x23	Program the DRAM Timing & and DRAM Control registers
0x24	Program ODT
0x25	Perform steps required before memory init

Code	Description
0x26	Program the receive enable reference timing control register Program the DLL Timing Control Registers, RCOMP settings
0x27	Enable DRAM Channel I/O Buffers
0x28	Enable all clocks on populated rows
0x29	Perform JEDEC memory initialization for all memory rows
0x30	Perform steps required after memory init
0x31	Program DRAM throttling and throttling event registers
0x32	Setup DRAM control register for normal operation and enable
0x33	Enable RCOMP
0x34	Clear DRAM initialization bit in the SB
0x35	Initialization Sequence Completed, program graphic clocks
0x43	Program Thermal Throttling

BDS & Specific action:

Code	Description
0x00	Report the legacy boot is happening
0x12	Wake up the Aps
0x13	Initialize SMM Private Data and relocate BSP SMBASE
0x21	PC init begin at the stage1
0x27	Report every memory range do the hard ware ECC init
0x28	Report status code of every memory range
0x50	Get the root bridge handle
0x51	Notify pci bus driver starts to program the resource
0x58	Reset the host controller
0x5A	IdeBus begin initialization
0x79	Report that the remote terminal is being disabled
0x7A	Report that the remote terminal is being enabled
0x90	Keyboard reset
0x91	USB Keyboard disable
0x92	Keyboard detection
0x93	Report that the usb keyboard is being enabled
0x94	Clear the keyboard buffer
0x95	Init Keyboard
0x98	Mouse reset
0x99	Mouse disable
0x9A	Detect PS2 mouse
0x9B	Report that the mouse is being enabled
0xB8	Peripheral removable media reset (ex: IsaFloppy, USB device)
0xB9	Peripheral removable media disable
0xBB	Peripheral removable media enable
0xE4	Report Status Code here for DXE_ENTRY_POINT once it is available
0xF8	Report that ExitBootServices() has been called
0xF9	Runtime driver set virtual address map

Each PEIM entry point used in 80_PORT

Code	Description
0x00	
0x01	PEI_EVENT_LOG
0xA1	PEI_OEM_SERVICE
0xA2	PEI_SIO_INIT
0xA3	PEI_MONO_STATUS_CODE
0xA4	PEI_CPU_IO_PCI_CFG
0x06	PEI_CPU_IO
0x07	PEI_PCI_CFG
0xA5	PEI_CPU_PEIM
0xA6	PEI_PLATFORM_STAGE1
0xA7	PEI_VARIABLE
0xA8	PEI_SB_INIT
0x0C	PEI_CAPSULE
0xAA	PEI_PLATFORM_STAGE2
0xAC	PEI_SB_SMBUS_ARP_DISABLED
0x0F	PEI_HOST_TO_SYSTEM
0x40	PEI_MEMORY_INIT
0x41	PEI_S3_RESUME
0xAD	PEI_CLOCK_GEN
0xAB	PEI_OP_PRESENCE
0xAE	PEI_FIND_FV
0x16	PEI_H2O_DEBUG_IO
0x17	PEI_H2O_DEBUG_COMM
0x16~0x1F	PEI_RESERVED
0x20~0x2E	PEI_OEM_DEFINED
0xAF	PEI_DXE_IPL

Each Driver entry point used in 80_PORT

Code	Description
0x30	RESERVED
0xB6	DXE_CRC32_SECTION_EXTRACT
0xB8	SCRIPT_SAVE
0xB9	ACPI_S3_SAVE
0xBA	SMART_TIMER
0xBB	JPEG_DECODER
0xBC	PCX_DECODER
0xBE	HT_CPU / MP_CPU
0xBF	LEGACY_METRONOME
0xC0	FTWLITE
0xC1	RUN_RIME

Code	Description
0xC2	MONOTONIC_COUNTER
0xC3	WATCH_DOG_TIMER
0xC4	SECURITY_STUB
0xC5	DXE_CPU_IO
0xC6	CF9_RESET
0xC7	PC_RTC
0xC8	STATUS_CODE
0xC9	VARIABLE EMU_VARIABLE
0xD9	DXE_CHIPSET_INIT
0x45	DXE_ALERT_FORMAT
0xD6	PCI_HOST_BRIDGE
0xD7	PCI_EXPRESS
0xD5	DXE_SB_INIT
0xDA	IDE_CONTROLLER
0xDB	SATA_CONTROLLER
0xDD	SB_SM_BUS
0xE7	ISA_ACPI_DRIVER
0xE8	ISA_BUS
0xE9	ISA_SERIAL
0xED	BUS_PCI_UNDI
0xEC	PCI_BUS
0xF6	BOOT_PRIORITY
0xF7	FVB_SERVICE
0xF8	ACPI_PLATFORM
0xFB	PCI_HOT_PLUG
0xFC	DXE_PLATFORM
0xFD	PLATFORM_IDE
0x97	SMBIOS
0x98	MEMORY_SUB_CLASS
0x99	MISC_SUB_CLASS
0x82	CON_PLATFORM
0x83	SAVE_MEMORY_CONFIG
0x84	ACPI_SUPPORT
0x85	CON_SPLITTER_UGA_VGA / CON_SPLITTER
0x88	VGA_CLASS
0x89	DATA_HUB
0x60	DISK_IO
0x8B	MEMORY_TEST
0x62	CRISIS_RECOVERY
0x8D	LEGACY_8259
0x8E	LEGACY_REGION

Code	Description
0x8F	LEGACY_INTERRUPT
0x70	BIOS_KEYBOARD
0x71	BIOS_VEDIO
0x72	MONITER_KEY
0x73	LEGACY_BIOS
0x75	LEGACY_BIOS_PLATFORM
0x76	PCI_PLATFORM
0x6C	ISA_FLOOPY
0x6D	PS2_MOUSE
0x6E	USB_BOT
0x6F	USB_CBIO
0x74	USB_MOUSE
0xFA	SETUP_UTILITY
0x90	FW_BLOCK_SERVICE
0x78	SMM_USB_LEGACY
0x86	GRAPHICS_CONSOLE
0x87	TERMINAL
0x8A	DATA_HUB_STD_ERR
0x7C	FAT
0x7D	PARTITION
0x7E	ENGLISH
0x7F	FRENCH
0x9E	HII_DATABASE
0x9F	OEM_SETUP_BROWSER
0x8C	OEM_BADGING_SUPPORT
0xF9	SETUP_MOUSE
0x72	MONITOR_KEY
0xBD	PLATFORM_BDS
0x8D	RESERVED
0x8E	RESERVED
0x8F	RESERVED
0xA0	DXE_H2O_DEBUG_IO
0xB3	DXE_TPM_TCG
0xB4	DXE_TPM_PHYSICAL_PRESENCE
0xB7	DXE_OEM_SERVICE
0x9B	DXE_SECURITY_HDD_PASSWORD_SERVICE
0xA9	DXE_LAN_IDER_CONTROLLER
0x9C	DXE_SECURITY_SYSTEM_PASSWORD_SERVICE
0x9D	DXE_SECURITY_PASSWORD_CONSOLE
0xCB	DXE_DATA_HUB_RECORD_POLICY
0xB5	DXE_TPM_DRIVER
0x11	CHINESE

Code	Description
0xB0	JAPANESE
0xB1	DXE_UNICODE_COLLATION

Each SmmDriver entry point used in 80_PORT

Code	Description
0xD4	SMM_ACCESS
0xDE	SMM_CONTROL
0xCC	SMM_BASE
0xD2	SMM_RUNTIME
0xDF	SB_SMM_DISPATCH
0xD0	SMM_THUNK
0xCA	SMM_ACPI_SW_CHILD
0xFE	SMM_PLATFORM
0xD8	SMM_GMCH_MBI
0x90	SMM_FW_BLOCK_SERVICE
0x91	SMM_VARIABLE
0x92	SMM_IHISI
0x93	SMM_INT15_MICROCODE
0x94	SMM_PNP
0x95	SMM_INIT_PPM
0xD3	SMM_OEM_SERVICE

Jumper and Connector Locations

Top View

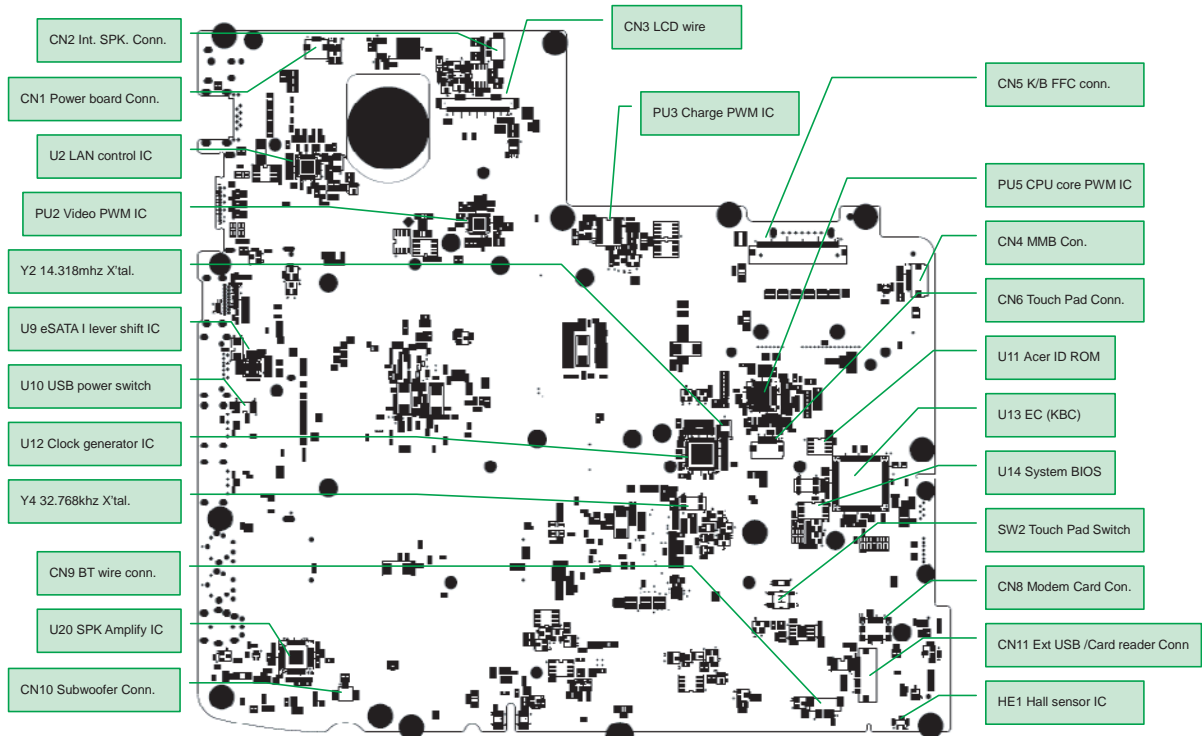

Pin	Description	Pin	Description
CN2	Internal Speaker Conn.	PU3	Charge PWM IC
CN1	Power Board Conn.	CN5	Keyboard FFC Conn.
U2	LAN Control IC	PU5	CPU Core PWM IC
PU2	Video PWM Conn.	CN4	MMB Conn.
Y2	14.318 MHz X'tal	CN6	TouchPad Conn.
U9	eSATA I Lever Shift IC	U11	Acer ID ROM
U10	USB Power Switch	U13	EC (KBC)
U12	Clock Generator IC	U14	System BIOS
Y4	32.768 KHz X'tal	SW2	TouchPad Switch
CN9	BT Wire Conn.	CN8	Modem Card Conn.
U20	Speaker Amplifier IC	CN11	Ext. USB/Card Reader Conn.
CN10	Subwoofer Conn.	HE1	Hall Sensor IC
CN3	LCD Wire		

Bottom View

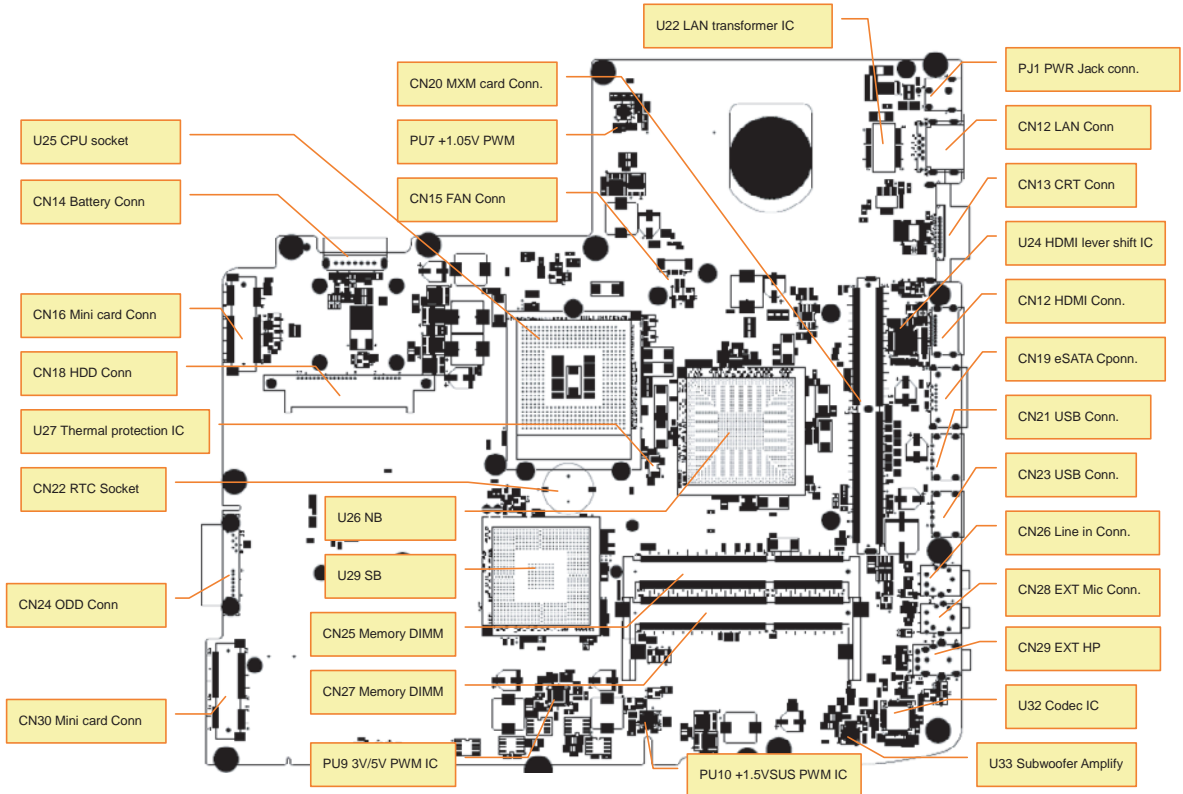

Pin	Description	Pin	Description
U25	CPU Socket	U22	LAN Transformer IC
CN14	Battery Conn.	PJ1	PWR Jack Conn.
CN16	Mini Card Conn.	CN12	LAN Conn.
CN18	HDD Conn.	CN13	CRT Conn.
U27	Thermal Protection IC	U24	HDMI Lever Shift IC
CN22	RTC Socket	CN12	HDMI Conn.
CN24	ODD Conn.	CN19	eSATA Conn.
CN30	Mini Card Conn.	CN21	USB Conn.
CN20	MXM Card Conn.	CN23	USB Conn.
PU7	+1.05V PWM	CN26	Line-in Conn.
CN15	Fan Conn.	CN28	External MIC Conn.
U26	Northbridge	CN29	External Headphones
U29	Southbridge	U32	Codec IC
CN25	Memory DIMM	U33	Subwoofer Amplifier
CN27	Memory DIMM	PU10	+1.5V SUS PWM IC
PU9	3V/5V PWM IC		

Clearing Password Check and BIOS Recovery

This section provide you the standard operating procedures of clearing password and BIOS recovery for Aspire 5739. Aspire 5739 provides one Hardware Open Gap on main board for clearing password check, and one Hotkey for enabling BIOS Recovery.

Clearing Password Check

Hardware Open Gap Description

Item	Description	Location
G1/G2	Clear CMOS Jumper	Adjacent to RTC Battery

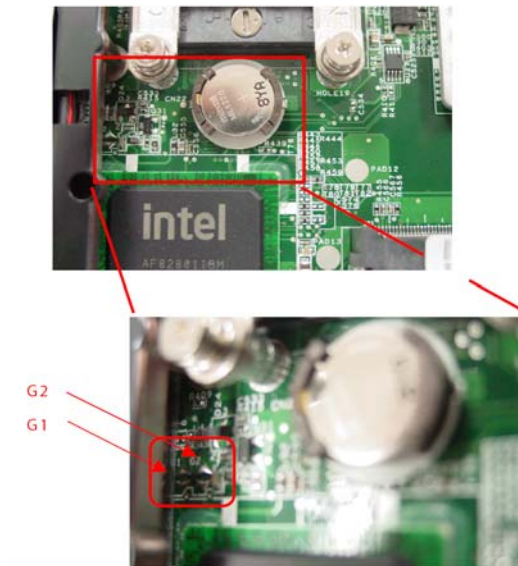

Steps for Clearing BIOS Password Check

If users set a BIOS Password (Supervisor Password and/or User Password) for security reasons, the BIOS will prompt for a password during system POST or when systems enter to BIOS Setup menu. However, if it is necessary to bypass the password check, users need to short the HW Gap to clear the password by performing the following procedure:

1. Power off the system, and unplug the AC and Battery from the machine.
2. Open the Hard Drive and RAM doors.
3. Remove the Hard drive.
4. Find the appropriate HW Gap on M/B as shown in the picture.
 - G1 is the RTC Reset. When asserted, this signal resets register bits in the RTC well. Unless the CMOS is being cleared (only to be done in the G3 power state), the RTCRST# input must always be high when all other RTC power planes are on. In the case where the RTC Battery is dead or missing on the platform, the RTCRST# pin must rise before the RSMRST# pin.
 - G2 is the Secondary RTC Reset. This signal resets the manageability register bits in the RTC well when the TRTC battery is removed. The SRTCST# input must always be high when all other RTC power planes are on. In the case where the RTC Battery is dead or missing on the platform, the SRTCST# pin must rise before the RSMRST# pin.
5. Use an electric conductivity tool to short the two points of the desired HW Gap.
6. Plug in AC, keeping the HW Gap shorted, and press Power Button to power on the system till BIOS POST finish. Then remove the tool from the HW Gap.

7. Restart system. Press F2 key to enter BIOS Setup menu.

If there is no Password request, the BIOS Password has been successfully cleared. Otherwise, please follow the steps and try again.

NOTE: The steps are only for clearing BIOS Password (Supervisor Password and User Password).

BIOS Recovery by Crisis Disk

BIOS Recovery Boot Block:

BIOS Recovery Boot Block is a special block of BIOS. It is used to boot up the system with minimum BIOS initialization. Users can enable this feature to restore the BIOS firmware to a successful one once the previous BIOS flashing process failed.

BIOS Recovery Hotkey:

The system provides a function hotkey: **Fn+Esc**, for enable BIOS Recovery process when system is powered on during BIOS POST. To use this function, it is strongly recommended to have the AC adapter and Battery present. If this function is enabled, the system will force the BIOS to enter a special BIOS block, called Boot Block.

Steps for BIOS Recovery by Crisis Disk:

Before doing this, one Crisis Disk should be prepared ready in hand. The Crisis Disk could be made by executing the Crisis Disk program in another system with Windows XP OS.

Follow the steps below:

1. Power Off failed system.
2. Attach a USB floppy drive to the failed system.
3. Insert the Crisis Disk in to the USB floppy drive attached to the BIOS flash failed system.
4. In the power-off state, press and hold **Fn+Esc** then press the Power button.

The system powers on and the Crisis BIOS Recovery process begins.

BIOS Boot Block begins restoring the BIOS code from the Crisis floppy disk to BIOS ROM on the failed systems.

When the Crisis flash process is finished, the system restarts with a workable BIOS.

5. Update to the latest version BIOS for the system using the regular BIOS flashing process.

FRU (Field Replaceable Unit) List

This chapter gives you the FRU (Field Replaceable Unit) listing in global configurations of the Aspire 5739. Refer to this chapter whenever ordering for parts to repair or for RMA (Return Merchandise Authorization).

Please note that WHEN ORDERING FRU PARTS, you should check the most up-to-date information available on your regional web or channel. For whatever reasons a part number change is made, it will not be noted on the printed Service Guide. For ACER AUTHORIZED SERVICE PROVIDERS, your Acer office may have a DIFFERENT part number code from those given in the FRU list of this printed Service Guide. You MUST use the local FRU list provided by your regional Acer office to order FRU parts for repair and service of customer machines.

NOTE: To scrap or to return the defective parts, you should follow the local government ordinance or regulations on how to dispose it properly, or follow the rules set by your regional Acer office on how to return it.

Aspire 5739 Exploded Diagrams



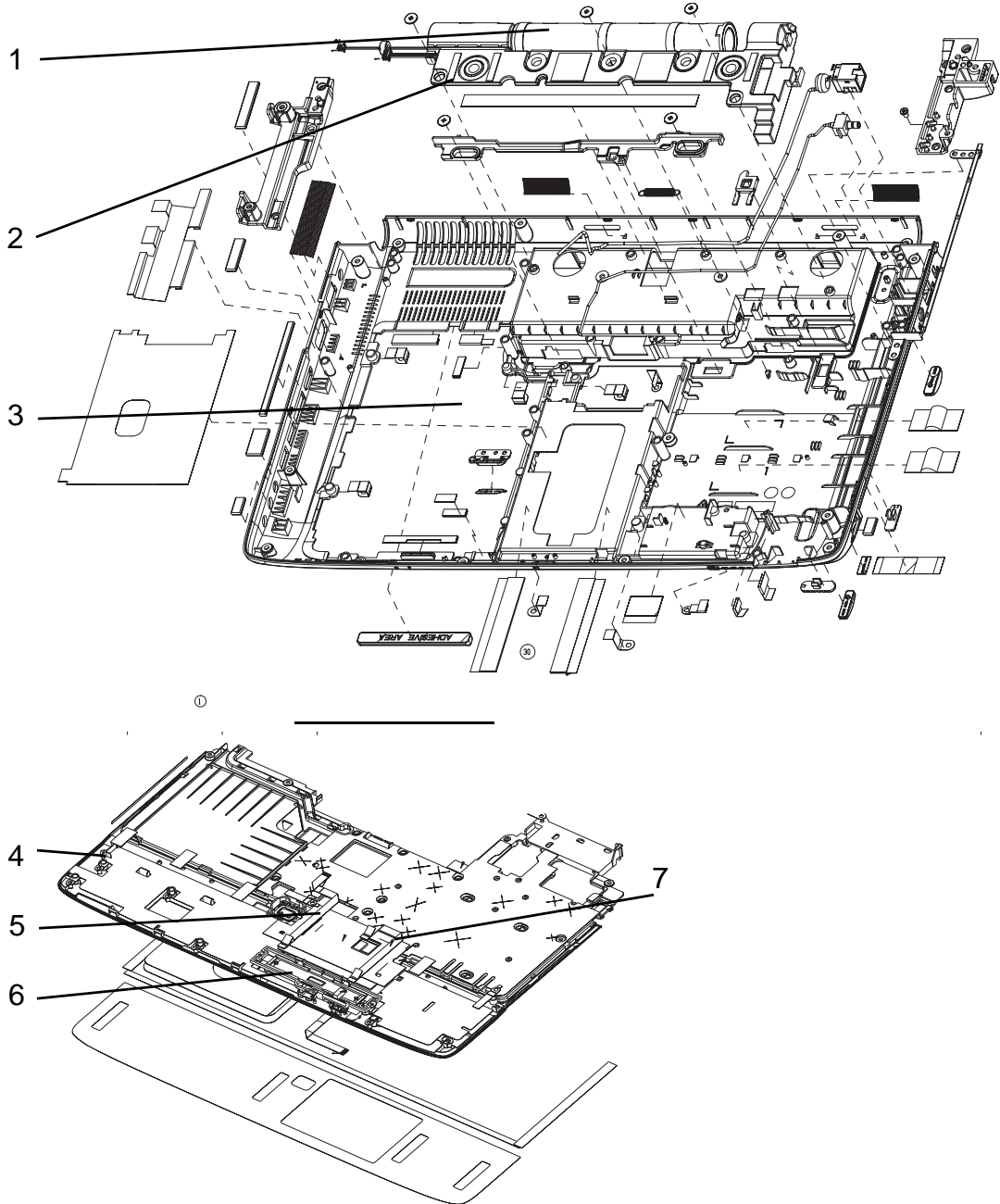



Main Module



Item	Description	Part No.	Item	Description	Part No.
1	Subwoofer	23.PDS07.001	5	FP Reader FFC	50.PDS07.007
2	Speaker	23.PDS07.002	6	FP Reader	55.PDS07.004
3	Lower Cover	60.PDP07.001	7	TP FFC	50.PDS07.006
4	Upper Cover	60.PDS07.001			



Aspire 5739 FRU List

Category	Description	ACER P/N
Adapter		
	Adapter DELTA 65W 19V 1.7x5.5x11 Yellow ADP-65JH DB A, LV5 LED LF	AP.06501.026
	Adapter DELTA 90W 19V 1.7x5.5x11 Blue ADP-90CD DB A, LV5 LED LF	AP.09001.027
	Adapter LITE-ON 90W 19V 1.7x5.5x11 Blue PA-1900-34AR, LV5 LED LF	AP.09003.021
	Adapter HIPRO 90W 19V 1.7x5.5x11 Blue HP-A0904A3 B1LF, LV5 LED LF	AP.0900A.005
	Adapter LITE-ON 65W 19V 1.7x5.5x11 Yellow PA-1650-22AC LV5 LED LF	AP.06503.024
	Adapter HIPRO 65W 19V 1.7x5.5x11 Yellow HP-A0652R3B 1LF, LV5 LED LF	AP.0650A.012
Battery		
	Battery SANYO AS-2007B Li-Ion 3S2P SANYO 6 cell 4400mAh Main COMMON Normal Type	BT.00603.042
	Battery PANASONIC AS-2007B Li-Ion 3S2P PANASONIC 6 cell 4400mAh Main COMMON PSS	BT.00605.021
	Battery SIMPLO AS-2007B Li-Ion 3S2P SAMSUNG 6 cell 4400mAh Main COMMON SDI 2.2F	BT.00606.001
	Battery SANYO AS-2007B Li-Ion 4S2P SANYO 8 cell 4800mAh Main COMMON	BT.00803.024
	Battery SONY AS-2007B Li-Ion 4S2P SONY 8 cell 4800mAh Main COMMON	BT.00804.020
	Battery SONY AS-2007B Li-Ion 3S2P SONY 6 cell 4400mAh Main COMMON Normal Type	BT.00604.025
	Battery SIMPLO AS-2007B Li-Ion 3S2P PANASONIC 6 cell 4400mAh Main COMMON PSS	BT.00607.016
Board		
	BLUETOOTH MODULE (T60H928.11)	BT.21100.005
	Foxconn Bluetooth FOX BRM 2046 BT2.1	BT.21100.006
	Foxconn Delphi-AM5 V2H 1.5_3.3v AUS T60M951	FX.22500.023
	Lan Intel WLAN 512AG_MMWG Shirley Peak 5100 MM#897004	KI.SPM01.005
	Lan Intel WLAN 512AN_MMWG2 Shirley Peak 5100 ME enable / MM#899541	KI.SPM01.008
	Lan Intel WLAN 512AN_MMWG Shirley Peak 5100 MM#895361 TA#E14718-014	KI.SPM01.003
	Lan Intel WLAN 533AN_MMWG2 Shirley Peak 5300 ME enable / MM#899545	KI.SPM01.009

Category	Description	ACER P/N
	DVB-T Mini-card TT-1260DA w/DiBCOM DIB7070P+DiB0700C rev.D	TU.23100.015
	Foxconn VGA Card AMD M92XT DDRII 512M 500MHz 64*16 MXM 3.0 Type A w/ Hynix H5PS1G63EFR-20L	VG.M920H.001
	Foxconn VGA Card AMD M92XT DDRII 512M 500MHz 64*16 MXM 3.0 Type A w/ Samsung K4N1G164QE-HC20	VG.M920H.002
	MSI VGA Card nVidia N10PGE1 DDRII 1024M 500MHz 64*16 MXM 3.0 Type A w/ Hynix H5PS1G63EFR-20L	VG.10P06.002
	MSI VGA Card nVidia N10PGE1 DDRII 1024M 500MHz 64*16 MXM 3.0 Type A w/ Samsung K4N1G164QE-HC20	VG.10P06.003
	MSI VGA Card AMD M92XT DDRII 512M 500MHz 64*16 MXM 3.0 Type A w/ Hynix H5PS1G63EFR-20L	
	MSI VGA Card AMD M92XT DDRII 512M 500MHz 64*16 MXM 3.0 Type A w/ Samsung K4N1G164QE-HC20	
	Yuan VGA Card nVidia N10PGE1 DDRII 1024M 500MHz 64*16 MXM 3.0 Type A w/ Hynix H5PS1G63EFR-20L	VG.10P0Y.002
	POWER BOARD	55.PDS07.001
	BATTERY SAVING BOARD	55.PDS07.002
	USB BOARD W/CARD READER	55.PDS07.003
	TP BOARD W/FP	55.PDS07.004
	TP BOARD W/O FP	55.PDT07.001
	CAPACITY BOARD	55.PDS07.005
Cable		
	PWR CORD V943B30001218008 DANISH 3P	27.A03V7.006
	PWR CORD(ISR)1.8M 3PBLK FZ010008-038	27.TATV7.005
	PWR CORD V50CB3T3012180QD TW-110V,3P	27.A99V7.002
	POWER CORD(SWI)1.8M 3PBLACK FZ010008-011	27.A99V7.004
	POWER CORD(IT) 1.8M 3PBLACK FZ010008-008	27.A99V7.005
	POWER CORD(S.A) 1.8M 3BLACK FZ010008-006	27.T48V7.001
	POWER CORD US 3PIN ROHS	27.TAXV7.001
	POWER CORD(EU) 1.8M 3PBLACK FM010008-010	27.TATV7.001
	POWER CORD(UK) 1.8M 3PBLACK FP010008-013	27.TATV7.003
	POWER CORD BRAZIL IMETRO 3 PIN	27.S0607.001
	POWER CORD(S.A) 1.8M 3BLACK FZ010008-006	27.T48V7.001

Category	Description	ACER P/N
	BLUETOOTH CABLE	50.PDS07.001
	FFC CABLE - USB/B TO MB	50.PDS07.002
	FFC CABLE - POWER/B TO MB	50.PDS07.003
	FFC CABLE - BATTERY/B TO MB	50.PDS07.004
	FFC CABLE - MMB TO MB IN MIDDLE COVER	50.PDS07.005
	FFC CABLE - TP TO TP/B IN UPPER CASE	50.PDS07.006
	FFC CABLE - TP/B TO MB IN UPPER CASE	50.PDS07.007
Case/Cover/Bracket Assembly		
	MIDDLE COVER W/MMB, FFC	42.PDS07.001
	UPPER CASE ASSY W/TP,FFC*3 FOR FP	60.PDS07.001
	UPPER CASE ASSY W/TP,FFC*3 FOR NON FP	60.PDT07.001
	LOWER CASE ASSY W/SPEAKER,SUB-WOOFER,RJ11 FOR TV	60.PDP07.001
	LOWER CASE ASSY W/SPEAKER,SUB-WOOFER,RJ11 FOR NON TV	60.PDS07.002
	THERMAL COVER	42.PDS07.002
	HINGE COVER - R	42.PDS07.003



Category	Description	ACER P/N
	HINGE COVER - L	42.PDS07.004
	DUMMY CARD READER	42.PDS07.005
	HEATSINK FOR UMA	33.PDS07.001
CPU/Processor		
	CPU Intel Core2Dual T9550 PGA 2.66G 6M 1066 35W E-0	KC.95501.DTP
	CPU Intel Core2Dual P8700 PGA 2.53G 3M 1066 25W R-0	KC.87R01.DPP
	CPU INTEL CORE2DUAL P9500 PGA 2.53G 6M 1066 25W	KC.95001.DPP
	CPU Intel Core2Dual T6400 PGA 2.0G 3M 800 35W R-0	KC.64001.DTP
	CPU Intel Core2Dual T6600 PGA 2.2G 2M 800 35W R-0	KC.66001.DTP
	CPU Intel Core2Dual P7450 PGA 2.13G 3M 1066 TJ, noVT	KC.74501.DPP
	CPU Intel Core2Dual P8600 PGA 2.4G 1066 25W 3M	KC.86001.DPP
	CPU Intel Pentium Dual-Core T4200 PGA 2.0G 1M 800 35W R-0 no VT	KC.42001.DTP
Optical Disk Drive		
	DVD/RW SUPER MULTI MODULE	6M.PDS07.001
	TOSHIBA Super-Multi DRIVE 12.7mm Tray DL 8X TS-L633B LF W/O bezel SATA	KU.00801.030
	PLDS Super-Multi DRIVE 12.7mm Tray DL 8X DS-8A3S LF W/O bezel SATA	KU.0080F.004
	SUPER-MULTI DRIVE 12.7MM SONY TRAY DL 8X AD-7580S LF W/O BEZEL SATA	KU.0080E.017
	ODD PANASONIC Super-Multi DRIVE 12.7mm Tray DL 8X UJ880A LF W/O bezel SATA	KU.00807.064
	BLUERAY COMBO MODULE	6M.PDS07.002
	PIONEER BD COMBO 12.7mm Tray DL 2X BDC-TD01RS LF W/O bezel SATA	KO.00205.001
	PANASONIC BD COMBO 12.7mm Tray DL 4X UJ-130A LF W/O bezel SATA 2X Single Layer, 4X Double Layer	KO.00407.002
	PLDS BD COMBO 12.7mm Tray DL 4X DS-4E1S LF W/O bezel SATA	KO.0040F.001
	OPTICAL BRACKET	33.PDS07.002
	ODD BEZEL - SUPER MULTI	42.PDS07.006
	BD COMBO BEZEL	42.PDS07.007

Category	Description	ACER P/N
HDD		
	HDD WD 2.5" 5400rpm 160GB WD1600BEVT-22ZCT0 ML160 SATA LF F/W:11.01A11	KH.16008.022
	HDD HGST 2.5" 5400rpm 250GB HTS545025B9A300 Panther B SATA LF F/W:C60F	KH.25007.015
	HDD WD 2.5" 5400rpm 250GB WD2500BEVT-22ZCT0 ML160 SATA LF F/W:11.01A11	KH.25008.021
	HDD HGST 2.5" 5400rpm 320GB HTS545032B9A300 Panther B SATA LF F/W: C60F	KH.32007.007
	HDD WD 2.5" 5400rpm 320GB WD3200BEVT-22ZCT0 ML160 SATA LF F/W:11.01A11	KH.32008.013
	HDD HGST 2.5" 5400rpm 500GB HTS545050B9A300 Panther B SATA LF F/W:C60F	KH.50007.009
	HDD WD 2.5" 5400rpm 500GB WD5000BEVT-22ZAT0 ML250 SATA LF F/W:01.01A01	KH.50008.013
	HDD BRACKET	33.PDS07.003
Keyboard		
	Keyboard ACER AC7G JM70 103KS Black Arabic Glossy	KB.1170A.059
	Keyboard ACER AC7G JM70 104KS Black Belgium Glossy	KB.1170A.060
	Keyboard ACER AC7G JM70 104KS Black Brazilian Portuguese Glossy	KB.1170A.061
	Keyboard ACER AC7G JM70 104KS Black CZ/SK Glossy	KB.1170A.062
	Keyboard ACER AC7G JM70 103KS Black Chinese Glossy	KB.1170A.063
	Keyboard ACER AC7G JM70 104KS Black Danish Glossy	KB.1170A.064
	Keyboard ACER AC7G JM70 104KS Black FR/Arabic Glossy	KB.1170A.065
	Keyboard ACER AC7G JM70 104KS Black French Glossy	KB.1170A.066
	Keyboard ACER AC7G JM70 104KS Black German Glossy	KB.1170A.067
	Keyboard ACER AC7G JM70 103KS Black Greek Glossy	KB.1170A.068
	Keyboard ACER AC7G JM70 104KS Black Hungarian Glossy	KB.1170A.069
	Keyboard ACER AC7G JM70 104KS Black Italian Glossy	KB.1170A.070
	Keyboard ACER AC7G JM70 107KS Black Japanese Glossy	KB.1170A.071
	Keyboard ACER AC7G JM70 104KS Black Nordic Glossy	KB.1170A.072
	Keyboard ACER AC7G JM70 104KS Black Norwegian Glossy	KB.1170A.073
	Keyboard ACER AC7G JM70 104KS Black Portuguese Glossy	KB.1170A.074
	Keyboard ACER AC7G JM70 103KS Black Russian Glossy	KB.1170A.075
	Keyboard ACER AC7G JM70 104KS Black SLO/CRO Glossy	KB.1170A.076
	Keyboard ACER AC7G JM70 104KS Black Spanish Glossy	KB.1170A.077
	Keyboard ACER AC7G JM70 104KS Black Sweden Glossy	KB.1170A.078
Keyboard ACER AC7G JM70 104KS Black Swiss/G Glossy	KB.1170A.079	
Keyboard ACER AC7G JM70 103KS Black Thailand Glossy	KB.1170A.080	

Category	Description	ACER P/N
	Keyboard ACER AC7G JM70 104KS Black Turkish Glossy	KB.1170A.081
	Keyboard ACER AC7G JM70 104KS Black UK Glossy	KB.1170A.082
	Keyboard ACER AC7G JM70 103KS Black US International Glossy	KB.1170A.083
	Keyboard ACER AC7G JM70 103KS Black US International w/ Hebrew Glossy	KB.1170A.084
	Keyboard ACER AC7G JM70 104KS Black US w/ Canadian French Glossy	KB.1170A.085
LCD		
	LCD MODULE 15.6 IN LED WXGA GLARE IMR W/ANTENNA *2	6M.PDS07.003
	LED LCD AUO 15.6"W WXGA Glare B156XW02 V0 LF 220nit 8ms 500:1	LK.15605.003
	LED LCD SAMSUNG 15.6"W WXGA Glare LTN156AT02-A01 LF 220nit 8ms 500:1	LK.15606.003
	LED LCD LPL 15.6"W WXGA Glare LP156WH2-TLE1 LF 220nit 8ms 400:1	LK.15608.002
	LED LCD CMO 15.6"W WXGA Glare N156B6-L04 LF 220nit 8ms 500:1	LK.1560D.005
	LCD CABLE 15.6 IN. FOR CCD	50.PDS07.008
	LCD COVER ASSY IMR W/ANTENNA *2	60.PDS07.003
	LCD BEZEL ASSY FOR CCD	60.PDS07.004
	LCD BRACKET W/HINGE - R	33.PDS07.004
	LCD BRACKET W/HINGE - L	33.PDS07.005
	CCD MODULE SUYIN 1.0M	57.PDA07.001
	CCD MODULE CN1014-S36B-OV01-1 CHICONY 1.0M	57.PDA07.002

Category	Description	ACER P/N
	LCD MODULE 15.6 IN LED WXGA GLARE IMR W/ANTENNA *3	6M.PDS07.004
	LED LCD AUO 15.6"W WXGA Glare B156XW02 V0 LF 220nit 8ms 500:1	LK.15605.003
	LED LCD SAMSUNG 15.6"W WXGA Glare LTN156AT02-A01 LF 220nit 8ms 500:1	LK.15606.003
	LED LCD LPL 15.6"W WXGA Glare LP156WH2-TLE1 LF 220nit 8ms 400:1	LK.15608.002
	LED LCD CMO 15.6"W WXGA Glare N156B6-L04 LF 220nit 8ms 500:1	LK.1560D.005
	LCD CABLE 25.6 IN. FOR CCD	50.PDS07.008
	LCD COVER ASSY IMR W/ANTENNA *3	60.PDS07.005
	LCD BEZEL ASSY FOR CCD	60.PDS07.004
	LCD BRACKET W/HINGE - R	33.PDS07.004
	LCD BRACKET W/HINGE - L	33.PDS07.005
	CCD MODULE SUYIN 1.0M	57.PDA07.001
	CCD MODULE CN1014-S36B-OV01-1 CHICONY 1.0M	57.PDA07.002
Mainboard		
	MAINBOARD UMA GM45 ICH9M W/CARD READER W/O CPU RAM	MB.PDT06.001
	MAINBOARD DIS PM45 ICH9M W/CARD READER W/O CPU RAM	MB.PDS06.001

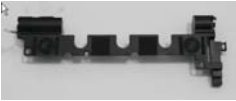
Category	Description	ACER P/N
Memory		
	Memory SAMSUNG SO-DIMM DDRIII 1066 1GB M471B2873EH1-CF8 LF 64*16 0.055um	KN.1GB0B.028
	Memory SAMSUNG SO-DIMM DDRIII 1066 2GB M471B5673EH1-CF8 LF 128*8 0.055um	KN.2GB0B.012
	Memory HYNIX SO-DIMM DDRIII 1066 2GB HMT125S6AFP8C-G7N0 LF 128*8 0.065um	KN.2GB0G.009
	Memory SAMSUNG SO-DIMM DDRIII 1066 1GB M471B2874DZ1-CF8 LF	KN.1GB0B.019
	Memory HYNIX SO-DIMM DDRIII 1066 1GB HMT112S6AFP6C-G7N0 LF 64*16 0.065um	KN.1GB0G.019
	Memory SAMSUNG SO-DIMM DDRIII 1066 2GB M471B5673DZ1-CF8 LF	KN.2GB0B.005
	Memory MICRON SO-DIMM DDRIII 1066 1GB MT8JSF12864HY-1G1D1 LF 64*16 0.07um	KN.1GB04.003
	Memory ELPIDA SO-DIMM DDRIII 1066 1GB EBJ11UE6BBS0-AE-F LF 64*16 0.065um	KN.1GB09.011
	Memory MICRON SO-DIMM DDRIII 1066 2GB MT16JSF25664HY-1G1D1 LF 128*8 0.07um	KN.2GB04.004
	Memory ELPIDA SO-DIMM DDRIII 1066 2GB EBJ21UE8BBS0-AE-F LF 128*8 0.065um	KN.2GB09.004
	Memory ELPIDA SO-DIMM DDRIII 1066 1GB EBJ11UE6BAU0-AE-E LF	KN.1GB09.009
	Memory ELPIDA SO-DIMM DDRIII 1066 2GB EBJ21UE8BAU0-AE-E LF 128*8 0.07um	KN.2GB09.002
	Memory HYNIX SO-DIMM DDRIII 1066 2GB HMT125S6BFR8C-G7 N0 LF 128*8 0.055um	KN.2GB0G.014
Heatsink		
	THERMAL MODULE FOR N10P	60.PDP07.002
	THERMAL MODULE FOR UMA	60.PDT07.002
	THERMAL MODULE FOR M96	60.PDS07.006
Miscellaneous		
	NAME PLATE - AS5739	40.PDS07.001
	POWER BUTTON RUBBER	47.PDS07.001
	HINGE COVER RUBBER	47.PDS07.002
	LCD RUBBER CIRCLE	47.PDS07.003
	LCD SIDE RUBBER	47.PDS07.004
	RUBBER FOOT - FRONT	47.PDS07.005
	RUBBER FOOT - BLACK L	47.PDS07.006
	RUBBER FOOT - BLACK R	47.PDS07.007
	THERMAL COVER RUBBER	47.PDS07.008

Category	Description	ACER P/N
Speaker		
	SPEAKER	23.PDS07.001
	SUB-WOOFER	23.PDS07.002

Screw List

Category	Description	Acer P/N.
Screw		
	SCREW M2.5*4.0-I(NYLOK)EU	86.T23V7.009
	SCREW M2.5*6-I(BNI)(NYLOK)	86.A08V7.004
	SCREW M3*0.5+3.5I	86.TDY07.003
	SCREW M2.0*3.0-I-NI-NYLOK IRON	86.A08V7.005
	SCREW M2.0*3.0-I(NI)(NYLOK)IRON	86.PDS07.001
	SCREW M2.0*3.0-I(BKAG)(NYLOK) IRON	86.EDM07.002

Model Definition and Configuration

Aspire 5739 Series

Model	RO	Country	Acer Part No	Description	CPU
AS5739G-642G32Mn	TWN	GCTWN	LX.PDS0X.0 43	AS5739G-642G32Mn VHP32ATTW1 MC M92XT512CFbk 1*2G/320/BT/ 6L/5R/CB_n2_FP_1.0D_GEb_TC11	C2DT6400
AS5739G-654G50Mn	EME A	Italy	LX.PDS0X.0 42	AS5739G-654G50Mn VHP32ATIT1 MC M92XT512CFbk 2*2G/500_L/6L/ 5R/CB_n2_FP_1.0D_GEb_IT12	C2DT6500
AS5739G-754G32Mn	EME A	Eastern Europe	LX.PDS0X.0 40	AS5739G-754G32Mn VHP32ATEU5 MC M92XT512CFbk 2*2G/320/6L/ 5R/CB_n2_FP_1.0D_GEb_PL13	C2DP755 0
AS5739G-754G32Mn	EME A	Eastern Europe	LX.PDS0X.0 39	AS5739G-754G32Mn VHP32ATEU5 MC M92XT512CFbk 2*2G/320/6L/ 5R/CB_n2_FP_1.0D_GEb_RO12	C2DP755 0
AS5739G-754G32Mn	EME A	Eastern Europe	LX.PDS0X.0 41	AS5739G-754G32Mn VHP32ATEU7 MC M92XT512CFbk 2*2G/320/6L/ 5R/CB_n2_FP_1.0D_GEb_ENR2	C2DP755 0
AS5739G-754G32Mn	EME A	Eastern Europe	LX.PDS0X.0 38	AS5739G-754G32Mn VHP32ATEU7 MC M92XT512CFbk 2*2G/320/6L/ 5R/CB_n2_FP_1.0D_GEb_SL11	C2DP755 0
AS5739G-754G32Mn	EME A	Eastern Europe	LX.PDS0X.0 34	AS5739G-754G32Mn VHP32ATEU4 MC M92XT512CFbk 2*2G/320/6L/ 5R/CB_n2_FP_1.0D_GEb_SV22	C2DP755 0
AS5739G-754G32Mn	EME A	Hungary	LX.PDS0X.0 35	AS5739G-754G32Mn VHP32ATHU1 MC M92XT512CFbk 2*2G/320/6L/ 5R/CB_n2_FP_1.0D_GEb_HU13	C2DP755 0
AS5739G-754G32Mn	EME A	Greece	LX.PDS0X.0 37	AS5739G-754G32Mn VHP32ATGR1 MC M92XT512CFbk 2*2G/320/6L/ 5R/CB_n2_FP_1.0D_GEb_EL32	C2DP755 0
AS5739G-754G32Mn	EME A	Finland	LX.PDS0X.0 36	AS5739G-754G32Mn VHP32ATFI2 MC M92XT512CFbk 2*2G/320/6L/ 5R/CB_n2_FP_1.0D_GEb_FI11	C2DP755 0
AS5739G-754G32Mn	EME A	Israel	LX.PDS0X.0 30	AS5739G-754G32Mn VHP32ATIL1 MC M92XT512CFbk 2*2G/320/6L/ 5R/CB_n2_FP_1.0D_GEb_HE12	C2DP755 0
AS5739G-754G32Mn	EME A	Eastern Europe	LX.PDS0X.0 24	AS5739G-754G32Mn VHP32ATEU3 MC M92XT512CFbk 2*2G/320/6L/ 5R/CB_n2_FP_1.0D_GEb_RU23	C2DP755 0
AS5739G-754G32Mn	EME A	Spain	LX.PDS0X.0 25	AS5739G-754G32Mn VHP32ATES1 MC M92XT512CFbk 2*2G/320/6L/ 5R/CB_n2_FP_1.0D_GEb_ES22	C2DP755 0
AS5739G-754G32Mn	EME A	Austria	LX.PDS0X.0 29	AS5739G-754G32Mn VHP32ATAT1 MC M92XT512CFbk 2*2G/320/6L/ 5R/CB_n2_FP_1.0D_GEb_DE11	C2DP755 0

Model	RO	Country	Acer Part No	Description	CPU
AS5739G-754G32Mn	EME A	Belgium	LX.PDS0X.033	AS5739G-754G32Mn VHP32ATBE1 MC M92XT512CFbk 2*2G/320/6L/5R/CB_n2_FP_1.0D_GEb_NL13	C2DP7550
AS5739G-754G32Mn	EME A	Switzerland	LX.PDS0X.028	AS5739G-754G32Mn VHP32ATCH1 MC M92XT512CFbk 2*2G/320/6L/5R/CB_n2_FP_1.0D_GEb_IT42	C2DP7550
AS5739G-754G32Mn	EME A	Denmark	LX.PDS0X.027	AS5739G-754G32Mn VHP32ATDK1 MC M92XT512CFbk 2*2G/320/6L/5R/CB_n2_FP_1.0D_GEb_NO13	C2DP7550
AS5739G-754G32Mn	EME A	Germany	LX.PDS0X.026	AS5739G-754G32Mn VHP32ATDE1 MC M92XT512CFbk 2*2G/320/6L/5R/CB_n2_FP_1.0D_GEb_DE13	C2DP7550
AS5739G-754G32Mn	EME A	UK	LX.PDS0X.032	AS5739G-754G32Mn VHP32ATGB1 MC M92XT512CFbk 2*2G/320/6L/5R/CB_n2_FP_1.0D_GEb_EN14	C2DP7550
AS5739G-754G32Mn	EME A	France	LX.PDS0X.031	AS5739G-754G32Mn VHP32ATFR1 MC M92XT512CFbk 2*2G/320/6L/5R/CB_n2_FP_1.0D_GEb_FR23	C2DP7550
AS5739G-754G32Mn	EME A	Portugal	LX.PDS0X.020	AS5739G-754G32Mn VHP32ATPT1 MC M92XT512CFbk 2*2G/320/6L/5R/CB_n2_FP_1.0D_GEb_PT12	C2DP7550
AS5739G-754G32Mn	EME A	Turkey	LX.PDS0X.019	AS5739G-754G32Mn EM VHP32ATTR1 MC M92XT512CFbk 2*2G/320/6L/5R/CB_n2_FP_1.0D_GEb_TR33	C2DP7550
AS5739G-754G32Mn	EME A	South Africa	LX.PDS0X.015	AS5739G-754G32Mn EM VHP32ATZA1 MC M92XT512CFbk 2*2G/320/6L/5R/CB_n2_FP_1.0D_GEb_FR23	C2DP7550
AS5739G-754G32Mn	EME A	South Africa	LX.PDS0X.014	AS5739G-754G32Mn EM VHP32ATZA2 MC M92XT512CFbk 2*2G/320/6L/5R/CB_n2_FP_1.0D_GEb_EN16	C2DP7550
AS5739G-754G32Mi	EME A	Ukraine	LX.PDS0X.016	AS5739G-754G32Mi VHP32ATUK1 MC M92XT512CFbk 2*2G/320/6L/5R/CB_abg_FP_1.0D_GEb_RU11	C2DP7550
AS5739G-754G32Mi	EME A	Russia	LX.PDS0X.017	AS5739G-754G32Mi VHP32ATRU1 MC M92XT512CFbk 2*2G/320/6L/5R/CB_abg_FP_1.0D_GEb_RU11	C2DP7550
AS5739G-754G32Mn	EME A	Italy	LX.PDS0X.023	AS5739G-754G32Mn VHP32ATIT1 MC M92XT512CFbk 2*2G/320/6L/5R/CB_n2_FP_1.0D_GEb_IT12	C2DP7550
AS5739G-754G32Mn	EME A	Middle East	LX.PDS0X.021	AS5739G-754G32Mn EM VHP32ATME2 MC M92XT512CFbk 2*2G/320/6L/5R/CB_n2_FP_1.0D_GEb_AR13	C2DP7550
AS5739G-754G32Mn	EME A	Luxembourg	LX.PDS0X.022	AS5739G-754G32Mn VHP32ATLU3 MC M92XT512CFbk 2*2G/320/6L/5R/CB_n2_FP_1.0D_GEb_IT41	C2DP7550
AS5739G-754G32Mn	EME A	Sweden	LX.PDS0X.018	AS5739G-754G32Mn VHP32ATSE1 MC M92XT512CFbk 2*2G/320/6L/5R/CB_n2_FP_1.0D_GEb_FI13	C2DP7550

Model	RO	Country	Acer Part No	Description	CPU
AS5739G-754G32Mn	EME A	Middle East	LX.PDS0X.0 13	AS5739G-754G32Mn EM VHP32ATME4 MC M92XT512CFbk 2*2G/320/6L/5R/ CB_n2_FP_1.0D_GEb_EN11	C2DP755 0
AS5739G-754G32Mn	EME A	South Africa	LX.PDS0X.0 03	AS5739G-754G32Mn EM VHP32ATZA4 MC M92XT512CFbk 2*2G/320/6L/5R/ CB_n2_FP_1.0D_GEb_ENI1	C2DP755 0
AS5739G-754G32Mn	EME A	Middle East	LX.PDS0X.0 08	AS5739G-754G32Mn EM VHP32ATME9 MC M92XT512CFbk 2*2G/320/6L/5R/ CB_n2_FP_1.0D_GEb_FR22	C2DP755 0
AS5739G-754G32Mn	EME A	Norway	LX.PDS0X.0 05	AS5739G-754G32Mn VHP32ATNO1 MC M92XT512CFbk 2*2G/320/6L/ 5R/CB_n2_FP_1.0D_GEb_NO12	C2DP755 0
AS5739G-754G32Mn	EME A	Poland	LX.PDS0X.0 04	AS5739G-754G32Mn VHP32ATPL1 MC M92XT512CFbk 2*2G/320/6L/ 5R/CB_n2_FP_1.0D_GEb_PL11	C2DP755 0
AS5739G-754G32Mn	EME A	Holland	LX.PDS0X.0 06	AS5739G-754G32Mn VHP32ATNL1 MC M92XT512CFbk 2*2G/320/6L/ 5R/CB_n2_FP_1.0D_GEb_NL12	C2DP755 0
AS5739G-754G32Mn	EME A	Middle East	LX.PDS0X.0 07	AS5739G-754G32Mn EM VHP32ATME6 MC M92XT512CFbk 2*2G/320/6L/5R/ CB_n2_FP_1.0D_GEb_EN15	C2DP755 0
AS5739G-754G32Mn	EME A	Middle East	LX.PDS0X.0 12	AS5739G-754G32Mn EM VHP32ATME3 MC M92XT512CFbk 2*2G/320/6L/5R/ CB_n2_FP_1.0D_GEb_FR23	C2DP755 0
AS5739G-754G32Mn	EME A	Middle East	LX.PDS0X.0 09	AS5739G-754G32Mn EM VHP32ATME4 MC M92XT512CFbk 2*2G/320/6L/5R/ CB_n2_FP_1.0D_GEb_RU61	C2DP755 0
AS5739G-754G32Mn	EME A	Middle East	LX.PDS0X.0 10	AS5739G-754G32Mn EM VHP32ATME2 MC M92XT512CFbk 2*2G/320/6L/5R/ CB_n2_FP_1.0D_GEb_AR23	C2DP755 0
AS5739G-754G32Mn	EME A	Middle East	LX.PDS0X.0 11	AS5739G-754G32Mn EM VHP32ATME2 MC M92XT512CFbk 2*2G/320/6L/5R/ CB_n2_FP_1.0D_GEb_EN15	C2DP755 0
AS5739G-742G32Mn	CHI NA	China	LX.PDS0C.0 02	AS5739G-742G32Mn LINPUSACN1 M92XT512CFbk 1*2G/320/BT/6L/ 5R/CB_n2_FP_1.0D_GEb_EN91	C2DP745 0
AS5739G-742G32Mn	CHI NA	Hong Kong	LX.PDS0C.0 01	AS5739G-742G32Mn LINPUSAHK2 M92XT512CFbk 1*2G/320/BT/6L/ 5R/CB_n2_FP_1.0D_GEb_EN91	C2DP745 0
AS5739G-873G32Bn	AAP	Japan	LX.PDS0X.0 02	AS5739G-873G32Bn VHP32AJP1 MC M92XT512CFbk 2G+1G/320/BT/ 6L/ CB_n2_FP_1.0D_GEb_JA11_M33	C2DP870 0

Model	RO	Country	Acer Part No	Description	CPU
AS5739G-873G32Bn	AAP	Japan	LX.PDS0X.0 01	AS5739G-873G32Bn VHP32APJP1 MC M92XT512CFbk 2G+1G/320/BT/ 6L/ CB_n2_FP_1.0D_GEb_JA11_M33F	C2DP870 0
AS5739G-754G32Mn	EME A	South Africa	LX.PEM0X.0 42	AS5739G-754G32Mn EM VHP32ATZA2 MC M92XT512Cbk 2*2G/320/6L/5R/ CB_n2_1.0D_GEb_EN16	C2DP755 0
AS5739G-754G32Mn	EME A	South Africa	LX.PEM0X.0 41	AS5739G-754G32Mn EM VHP32ATZA1 MC M92XT512Cbk 2*2G/320/6L/5R/ CB_n2_1.0D_GEb_FR23	C2DP755 0
AS5739G-754G32Mn	EME A	Denmark	LX.PEM0X.0 39	AS5739G-754G32Mn VHP32ATDK1 MC M92XT512Cbk 2*2G/320/6L/5R/ CB_n2_1.0D_GEb_NO13	C2DP755 0
AS5739G-754G32Mn	EME A	South Africa	LX.PEM0X.0 40	AS5739G-754G32Mn EM VHP32ATZA4 MC M92XT512Cbk 2*2G/320/6L/5R/ CB_n2_1.0D_GEb_EN11	C2DP755 0
AS5739G-754G32Mn	EME A	France	LX.PEM0X.0 38	AS5739G-754G32Mn VHP32ATFR1 MC M92XT512Cbk 2*2G/320/6L/5R/ CB_n2_1.0D_GEb_FR23	C2DP755 0
AS5739G-754G32Mn	EME A	Belgium	LX.PEM0X.0 36	AS5739G-754G32Mn VHP32ATBE1 MC M92XT512Cbk 2*2G/320/6L/5R/ CB_n2_1.0D_GEb_NL13	C2DP755 0
AS5739G-754G32Mn	EME A	Holland	LX.PEM0X.0 35	AS5739G-754G32Mn VHP32ATNL1 MC M92XT512Cbk 2*2G/320/6L/5R/ CB_n2_1.0D_GEb_NL12	C2DP755 0
AS5739G-754G32Mn	EME A	Germany	LX.PEM0X.0 37	AS5739G-754G32Mn VHP32ATDE1 MC M92XT512Cbk 2*2G/320/6L/5R/ CB_n2_1.0D_GEb_DE13	C2DP755 0
AS5739G-754G32Mn	EME A	Luxembo urg	LX.PEM0X.0 34	AS5739G-754G32Mn VHP32ATLU3 MC M92XT512Cbk 2*2G/320/6L/5R/ CB_n2_1.0D_GEb_IT41	C2DP755 0
AS5739G-754G32Mn	EME A	Eastern Europe	LX.PEM0X.0 25	AS5739G-754G32Mn VHP32ATEU5 MC M92XT512Cbk 2*2G/320/6L/5R/ CB_n2_1.0D_GEb_PL13	C2DP755 0
AS5739G-754G32Mn	EME A	Eastern Europe	LX.PEM0X.0 26	AS5739G-754G32Mn VHP32ATEU7 MC M92XT512Cbk 2*2G/320/6L/5R/ CB_n2_1.0D_GEb_ENR2	C2DP755 0
AS5739G-754G32Mn	EME A	Eastern Europe	LX.PEM0X.0 27	AS5739G-754G32Mn VHP32ATEU5 MC M92XT512Cbk 2*2G/320/6L/5R/ CB_n2_1.0D_GEb_RO12	C2DP755 0
AS5739G-754G32Mn	EME A	Eastern Europe	LX.PEM0X.0 28	AS5739G-754G32Mn VHP32ATEU4 MC M92XT512Cbk 2*2G/320/6L/5R/ CB_n2_1.0D_GEb_SV22	C2DP755 0
AS5739G-754G32Mn	EME A	Eastern Europe	LX.PEM0X.0 29	AS5739G-754G32Mn VHP32ATEU7 MC M92XT512Cbk 2*2G/320/6L/5R/ CB_n2_1.0D_GEb_SL11	C2DP755 0
AS5739G-754G32Mi	EME A	Russia	LX.PEM0X.0 32	AS5739G-754G32Mi VHP32ATRU1 MC M92XT512Cbk 2*2G/320/6L/5R/ CB_abg_1.0D_GEb_RU11	C2DP755 0

Model	RO	Country	Acer Part No	Description	CPU
AS5739G-754G32Mn	EME A	Austria	LX.PEM0X.0 31	AS5739G-754G32Mn VHP32ATAT1 MC M92XT512Cbk 2*2G/320/6L/5R/ CB_n2_1.0D_GEb_DE11	C2DP755 0
AS5739G-754G32Mn	EME A	Norway	LX.PEM0X.0 33	AS5739G-754G32Mn VHP32ATNO1 MC M92XT512Cbk 2*2G/320/6L/5R/ CB_n2_1.0D_GEb_NO12	C2DP755 0
AS5739G-754G32Mn	EME A	Sweden	LX.PEM0X.0 30	AS5739G-754G32Mn VHP32ATSE1 MC M92XT512Cbk 2*2G/320/6L/5R/ CB_n2_1.0D_GEb_FI13	C2DP755 0
AS5739G-754G32Mn	EME A	Eastern Europe	LX.PEM0X.0 24	AS5739G-754G32Mn VHP32ATEU3 MC M92XT512Cbk 2*2G/320/6L/5R/ CB_n2_1.0D_GEb_RU23	C2DP755 0
AS5739G-754G32Mn	EME A	Finland	LX.PEM0X.0 23	AS5739G-754G32Mn VHP32ATFI2 MC M92XT512Cbk 2*2G/320/6L/5R/ CB_n2_1.0D_GEb_FI11	C2DP755 0
AS5739G-754G32Mn	EME A	Hungary	LX.PEM0X.0 22	AS5739G-754G32Mn VHP32ATHU1 MC M92XT512Cbk 2*2G/320/6L/5R/ CB_n2_1.0D_GEb_HU13	C2DP755 0
AS5739G-754G32Mn	EME A	Spain	LX.PEM0X.0 20	AS5739G-754G32Mn VHP32ATES1 MC M92XT512Cbk 2*2G/320/6L/5R/ CB_n2_1.0D_GEb_ES22	C2DP755 0
AS5739G-754G32Mn	EME A	Israel	LX.PEM0X.0 18	AS5739G-754G32Mn VHP32ATIL1 MC M92XT512Cbk 2*2G/320/6L/5R/ CB_n2_1.0D_GEb_HE12	C2DP755 0
AS5739G-754G32Mn	EME A	Middle East	LX.PEM0X.0 16	AS5739G-754G32Mn EM VHP32ATME9 MC M92XT512Cbk 2*2G/320/6L/5R/ CB_n2_1.0D_GEb_FR22	C2DP755 0
AS5739G-754G32Mn	EME A	Middle East	LX.PEM0X.0 15	AS5739G-754G32Mn EM VHP32ATME6 MC M92XT512Cbk 2*2G/320/6L/5R/ CB_n2_1.0D_GEb_EN15	C2DP755 0
AS5739G-754G32Mn	EME A	Italy	LX.PEM0X.0 17	AS5739G-754G32Mn VHP32ATIT1 MC M92XT512Cbk 2*2G/320/6L/5R/ CB_n2_1.0D_GEb_IT12	C2DP755 0
AS5739G-754G32Mn	EME A	Greece	LX.PEM0X.0 19	AS5739G-754G32Mn VHP32ATGR1 MC M92XT512Cbk 2*2G/320/6L/5R/ CB_n2_1.0D_GEb_EL32	C2DP755 0
AS5739G-754G32Mn	EME A	Portugal	LX.PEM0X.0 21	AS5739G-754G32Mn VHP32ATPT1 MC M92XT512Cbk 2*2G/320/6L/5R/ CB_n2_1.0D_GEb_PT12	C2DP755 0
AS5739G-754G32Mn	EME A	Middle East	LX.PEM0X.0 14	AS5739G-754G32Mn EM VHP32ATME2 MC M92XT512Cbk 2*2G/320/6L/5R/ CB_n2_1.0D_GEb_EN15	C2DP755 0
AS5739G-754G32Mn	EME A	Middle East	LX.PEM0X.0 12	AS5739G-754G32Mn EM VHP32ATME4 MC M92XT512Cbk 2*2G/320/6L/5R/ CB_n2_1.0D_GEb_RU61	C2DP755 0

Model	RO	Country	Acer Part No	Description	CPU
AS5739G-754G32Mn	EME A	Middle East	LX.PEM0X.010	AS5739G-754G32Mn EM VHP32ATME3 MC M92XT512Cbk 2*2G/320/6L/5R/ CB_n2_1.0D_GEb_FR23	C2DP7550
AS5739G-754G32Mn	EME A	Poland	LX.PEM0X.008	AS5739G-754G32Mn VHP32ATPL1 MC M92XT512Cbk 2*2G/320/6L/5R/ CB_n2_1.0D_GEb_PL11	C2DP7550
AS5739G-754G32Mn	EME A	Turkey	LX.PEM0X.006	AS5739G-754G32Mn EM VHP32ATTR1 MC M92XT512Cbk 2*2G/320/6L/5R/ CB_n2_1.0D_GEb_TR33	C2DP7550
AS5739G-754G32Mi	EME A	Ukraine	LX.PEM0X.005	AS5739G-754G32Mi VHP32ATUK1 MC M92XT512Cbk 2*2G/320/6L/5R/ CB_abg_1.0D_GEb_RU11	C2DP7550
AS5739G-754G32Mn	EME A	Switzerland	LX.PEM0X.007	AS5739G-754G32Mn VHP32ATCH1 MC M92XT512Cbk 2*2G/320/6L/5R/ CB_n2_1.0D_GEb_IT42	C2DP7550
AS5739G-754G32Mn	EME A	Middle East	LX.PEM0X.009	AS5739G-754G32Mn EM VHP32ATME2 MC M92XT512Cbk 2*2G/320/6L/5R/ CB_n2_1.0D_GEb_AR23	C2DP7550
AS5739G-754G32Mn	EME A	Middle East	LX.PEM0X.011	AS5739G-754G32Mn EM VHP32ATME2 MC M92XT512Cbk 2*2G/320/6L/5R/ CB_n2_1.0D_GEb_AR13	C2DP7550
AS5739G-754G32Mn	EME A	Middle East	LX.PEM0X.013	AS5739G-754G32Mn EM VHP32ATME4 MC M92XT512Cbk 2*2G/320/6L/5R/ CB_n2_1.0D_GEb_EN11	C2DP7550
AS5739G-754G32Mn	EME A	UK	LX.PEM0X.004	AS5739G-754G32Mn VHP32ATGB1 MC M92XT512Cbk 2*2G/320/6L/5R/ CB_n2_1.0D_GEb_EN14	C2DP7550
AS5739G-742G32Mn	PA	Canada	LX.PEM0X.003	AS5739G-742G32Mn VHP64ATCA2 MC M92XT512Cbk 1*2G/320/BT/6L/5R/CB_n2_1.0D_GEb_FR82	C2DP7450
AS5739G-742G32Mn	PA	USA	LX.PEM0X.002	AS5739G-742G32Mn VHP64ATUS1 MC M92XT512Cbk 1*2G/320/BT/6L/5R/CB_n2_1.0D_GEb_EN33	C2DP7450
AS5739G-742G32Mn	PA	USA	LX.PEM0X.001	AS5739G-742G32Mn VHP64ATUS1 MC M92XT512Cbk 1*2G/320/BT/6L/5R/CB_n2_1.0D_GEb_ENP2	C2DP7450
AS5739G-662G25Bn	WW	WW	S2.PDQ0C.001	AS5739G-662G25Bn LINPUSAWW1 M92XT512TCFbk 2*1G/250/BT/6L/ CB_n2_DVBT U/ VHF_FP_1.0D_GEb_EN11	C2DT6600
AS5739G-654G25Mn	PA	USA	LX.PDR0X.051	AS5739G-654G25Mn VHP64ATUS1 MC N10PGE11GBCFbk 2*2G/250/6L/5R/CB_n2_FP_1.0D_GEb_EN11	C2DT6500
AS5739G-742G32Mn	CHI NA	China	LX.PDR0X.045	AS5739G-742G32Mn VHP32ATCN1 MC N10PGE11GBCFbk 1*2G/320/BT/6L/5R/ CB_n2_FP_1.0D_GEb_SC11	C2DP7450

Model	RO	Country	Acer Part No	Description	CPU
AS5739G-734G50Mn	EME A	UK	LX.PDR0X.0 47	AS5739G-734G50Mn VHP32ATGB1 MC N10PGE11GBCFbk 2*2G/ 500_L/6L/5R/ CB_n2_FP_1.0D_GEb_EN14	C2DP735 0
AS5739G-644G50Mn	EME A	France	LX.PDR0X.0 50	AS5739G-644G50Mn VHP32ATFR1 MC N10PGE11GBCFbk 2*2G/ 500_L/6L/5R/ CB_n2_FP_1.0D_GEb_FR23	C2DT6400
AS5739G-654G32Mn	EME A	UK	LX.PDR0X.0 49	AS5739G-654G32Mn VHP32ATGB1 MC N10PGE11GBCFbk 2*2G/320/ 6L/5R/CB_n2_FP_1.0D_GEb_EN14	C2DT6500
AS5739G-654G50Bn	EME A	UK	LX.PDR0X.0 48	AS5739G-654G50Bn VHP32ATGB1 MC N10PGE11GBCFbk 2*2G/ 500_L/6L/5R/ CB_n2_FP_1.0D_GEb_EN14	C2DT6500
AS5739G-734G32Mn	EME A	France	LX.PDR0X.0 46	AS5739G-734G32Mn VHP32ATFR1 MC N10PGE11GBCFbk 2*2G/320/ 6L/5R/CB_n2_FP_1.0D_GEb_FR23	C2DP735 0
AS5739G-664G50Mi	EME A	Russia	LX.PDR0C.0 03	AS5739G-664G50Mi LINPUSARU1 N10PGE11GBCFbk 2*2G/500_L/BT/ 8L/5R/ CB_abg_FP_1.0D_GEb_EN71	C2DT6600
AS5739G-734G50Mn	EME A	France	LX.PDR0X.0 44	AS5739G-734G50Mn VHP32ATFR1 MC N10PGE11GBCFbk 2*2G/ 500_L/6L/5R/ CB_n2_FP_1.0D_GEb_FR23	C2DP735 0
AS5739G-874G50Mn	EME A	Middle East	LX.PDR0X.0 43	AS5739G-874G50Mn EM VHP32ATME4 MC N10PGE11GBCFbk 2*2G/500_L/6L/ 5R/CB_n2_FP_1.0D_GEb_RU61	C2DP870 0
AS5739G-654G32Mn	EME A	Italy	LX.PDR0X.0 42	AS5739G-654G32Mn VHP32ATIT1 MC N10PGE11GBCFbk 2*2G/320/ 6L/5R/CB_n2_FP_1.0D_GEb_IT12	C2DT6500
AS5739G-734G50Mn	EME A	Italy	LX.PDR0X.0 41	AS5739G-734G50Mn VHP32ATIT1 MC N10PGE11GBCFbk 2*2G/ 500_L/6L/5R/ CB_n2_FP_1.0D_GEb_IT12	C2DP735 0
AS5739G-874G50Mn	EME A	Belgium	LX.PDR0X.0 38	AS5739G-874G50Mn VHP32ATBE1 MC N10PGE11GBCFbk 2*2G/ 500_L/6L/5R/ CB_n2_FP_1.0D_GEb_NL13	C2DP870 0
AS5739G-874G50Mn	EME A	Eastern Europe	LX.PDR0X.0 40	AS5739G-874G50Mn VHP32ATEU5 MC N10PGE11GBCFbk 2*2G/ 500_L/6L/5R/ CB_n2_FP_1.0D_GEb_RO12	C2DP870 0
AS5739G-874G50Mn	EME A	Austria	LX.PDR0X.0 33	AS5739G-874G50Mn VHP32ATAT1 MC N10PGE11GBCFbk 2*2G/ 500_L/6L/5R/ CB_n2_FP_1.0D_GEb_DE11	C2DP870 0
AS5739G-874G50Mn	EME A	Germany	LX.PDR0X.0 32	AS5739G-874G50Mn VHP32ATDE1 MC N10PGE11GBCFbk 2*2G/ 500_L/6L/5R/ CB_n2_FP_1.0D_GEb_DE13	C2DP870 0

Model	RO	Country	Acer Part No	Description	CPU
AS5739G-874G50Mn	EME A	Israel	LX.PDR0X.0 34	AS5739G-874G50Mn VHP32ATIL1 MC N10PGE11GBCFbk 2*2G/ 500_L/6L/5R/ CB_n2_FP_1.0D_GEb_HE12	C2DP870 0
AS5739G-874G50Mn	EME A	Hungary	LX.PDR0X.0 35	AS5739G-874G50Mn VHP32ATHU1 MC N10PGE11GBCFbk 2*2G/ 500_L/6L/5R/ CB_n2_FP_1.0D_GEb_HU13	C2DP870 0
AS5739G-874G50Mn	EME A	Eastern Europe	LX.PDR0X.0 36	AS5739G-874G50Mn VHP32ATEU5 MC N10PGE11GBCFbk 2*2G/ 500_L/6L/5R/ CB_n2_FP_1.0D_GEb_PL13	C2DP870 0
AS5739G-874G50Mn	EME A	Switzerla nd	LX.PDR0X.0 37	AS5739G-874G50Mn VHP32ATCH1 MC N10PGE11GBCFbk 2*2G/ 500_L/6L/5R/ CB_n2_FP_1.0D_GEb_IT42	C2DP870 0
AS5739G-874G50Mn	EME A	Eastern Europe	LX.PDR0X.0 39	AS5739G-874G50Mn VHP32ATEU4 MC N10PGE11GBCFbk 2*2G/ 500_L/6L/5R/ CB_n2_FP_1.0D_GEb_SV22	C2DP870 0
AS5739G-874G50Mn	EME A	Denmark	LX.PDR0X.0 28	AS5739G-874G50Mn VHP32ATDK1 MC N10PGE11GBCFbk 2*2G/ 500_L/6L/5R/ CB_n2_FP_1.0D_GEb_NO13	C2DP870 0
AS5739G-874G50Mn	EME A	France	LX.PDR0X.0 25	AS5739G-874G50Mn VHP32ATFR1 MC N10PGE11GBCFbk 2*2G/ 500_L/6L/5R/ CB_n2_FP_1.0D_GEb_FR23	C2DP870 0
AS5739G-874G50Mn	EME A	Greece	LX.PDR0X.0 23	AS5739G-874G50Mn VHP32ATGR1 MC N10PGE11GBCFbk 2*2G/ 500_L/6L/5R/ CB_n2_FP_1.0D_GEb_EL32	C2DP870 0
AS5739G-874G50Mn	EME A	Italy	LX.PDR0X.0 22	AS5739G-874G50Mn VHP32ATIT1 MC N10PGE11GBCFbk 2*2G/ 500_L/6L/5R/ CB_n2_FP_1.0D_GEb_IT12	C2DP870 0
AS5739G-874G50Mn	EME A	UK	LX.PDR0X.0 24	AS5739G-874G50Mn VHP32ATGB1 MC N10PGE11GBCFbk 2*2G/ 500_L/6L/5R/ CB_n2_FP_1.0D_GEb_EN14	C2DP870 0
AS5739G-874G50Mn	EME A	Finland	LX.PDR0X.0 31	AS5739G-874G50Mn VHP32ATFI2 MC N10PGE11GBCFbk 2*2G/ 500_L/6L/5R/ CB_n2_FP_1.0D_GEb_FI11	C2DP870 0
AS5739G-874G50Mn	EME A	Spain	LX.PDR0X.0 29	AS5739G-874G50Mn VHP32ATES1 MC N10PGE11GBCFbk 2*2G/ 500_L/6L/5R/ CB_n2_FP_1.0D_GEb_ES22	C2DP870 0
AS5739G-874G50Mn	EME A	Eastern Europe	LX.PDR0X.0 27	AS5739G-874G50Mn VHP32ATEU3 MC N10PGE11GBCFbk 2*2G/ 500_L/6L/5R/ CB_n2_FP_1.0D_GEb_RU23	C2DP870 0

Model	RO	Country	Acer Part No	Description	CPU
AS5739G-874G50Mn	EME A	Eastern Europe	LX.PDR0X.0 26	AS5739G-874G50Mn VHP32ATEU7 MC N10PGE11GBCFbk 2*2G/ 500_L/6L/5R/ CB_n2_FP_1.0D_GEb_SL11	C2DP870 0
AS5739G-874G50Mn	EME A	Eastern Europe	LX.PDR0X.0 30	AS5739G-874G50Mn VHP32ATEU7 MC N10PGE11GBCFbk 2*2G/ 500_L/6L/5R/ CB_n2_FP_1.0D_GEb_ENR2	C2DP870 0
AS5739G-874G50Mn	EME A	Middle East	LX.PDR0X.0 20	AS5739G-874G50Mn EM VHP32ATME2 MC N10PGE11GBCFbk 2*2G/500_L/6L/ 5R/CB_n2_FP_1.0D_GEb_AR23	C2DP870 0
AS5739G-874G50Mn	EME A	Middle East	LX.PDR0X.0 21	AS5739G-874G50Mn EM VHP32ATME3 MC N10PGE11GBCFbk 2*2G/500_L/6L/ 5R/CB_n2_FP_1.0D_GEb_FR23	C2DP870 0
AS5739G-874G50Mi	EME A	Russia	LX.PDR0X.0 18	AS5739G-874G50Mi VHP32ATRU1 MC N10PGE11GBCFbk 2*2G/ 500_L/6L/5R/ CB_abg_FP_1.0D_GEb_RU11	C2DP870 0
AS5739G-874G50Mn	EME A	Middle East	LX.PDR0X.0 16	AS5739G-874G50Mn EM VHP32ATME2 MC N10PGE11GBCFbk 2*2G/500_L/6L/ 5R/CB_n2_FP_1.0D_GEb_EN15	C2DP870 0
AS5739G-874G50Mn	EME A	Middle East	LX.PDR0X.0 14	AS5739G-874G50Mn EM VHP32ATME6 MC N10PGE11GBCFbk 2*2G/500_L/6L/ 5R/CB_n2_FP_1.0D_GEb_EN15	C2DP870 0
AS5739G-874G50Mn	EME A	Middle East	LX.PDR0X.0 13	AS5739G-874G50Mn EM VHP32ATME9 MC N10PGE11GBCFbk 2*2G/500_L/6L/ 5R/CB_n2_FP_1.0D_GEb_FR22	C2DP870 0
AS5739G-874G50Mn	EME A	Middle East	LX.PDR0X.0 15	AS5739G-874G50Mn EM VHP32ATME4 MC N10PGE11GBCFbk 2*2G/500_L/6L/ 5R/CB_n2_FP_1.0D_GEb_EN11	C2DP870 0
AS5739G-874G50Mn	EME A	Middle East	LX.PDR0X.0 17	AS5739G-874G50Mn EM VHP32ATME2 MC N10PGE11GBCFbk 2*2G/500_L/6L/ 5R/CB_n2_FP_1.0D_GEb_AR13	C2DP870 0
AS5739G-874G50Mn	EME A	Luxembo urg	LX.PDR0X.0 19	AS5739G-874G50Mn VHP32ATLU3 MC N10PGE11GBCFbk 2*2G/ 500_L/6L/5R/ CB_n2_FP_1.0D_GEb_IT41	C2DP870 0
AS5739G-874G50Mn	EME A	Holland	LX.PDR0X.0 09	AS5739G-874G50Mn VHP32ATNL1 MC N10PGE11GBCFbk 2*2G/ 500_L/6L/5R/ CB_n2_FP_1.0D_GEb_NL12	C2DP870 0
AS5739G-874G50Mn	EME A	Portugal	LX.PDR0X.0 11	AS5739G-874G50Mn VHP32ATPT1 MC N10PGE11GBCFbk 2*2G/ 500_L/6L/5R/ CB_n2_FP_1.0D_GEb_PT12	C2DP870 0

Model	RO	Country	Acer Part No	Description	CPU
AS5739G-874G50Mn	EME A	Sweden	LX.PDR0X.0 07	AS5739G-874G50Mn VHP32ATSE1 MC N10PGE11GBCFbk 2*2G/ 500_L/6L/5R/ CB_n2_FP_1.0D_GEb_FI13	C2DP870 0
AS5739G-874G50Mi	EME A	Ukraine	LX.PDR0X.0 06	AS5739G-874G50Mi VHP32ATUK1 MC N10PGE11GBCFbk 2*2G/ 500_L/6L/5R/ CB_abg_FP_1.0D_GEb_RU11	C2DP870 0
AS5739G-874G50Mn	EME A	South Africa	LX.PDR0X.0 04	AS5739G-874G50Mn EM VHP32ATZA2 MC N10PGE11GBCFbk 2*2G/500_L/6L/ 5R/CB_n2_FP_1.0D_GEb_EN16	C2DP870 0
AS5739G-874G50Mn	EME A	South Africa	LX.PDR0X.0 03	AS5739G-874G50Mn EM VHP32ATZA4 MC N10PGE11GBCFbk 2*2G/500_L/6L/ 5R/CB_n2_FP_1.0D_GEb_ENI1	C2DP870 0
AS5739G-874G50Mn	EME A	South Africa	LX.PDR0X.0 05	AS5739G-874G50Mn EM VHP32ATZA1 MC N10PGE11GBCFbk 2*2G/500_L/6L/ 5R/CB_n2_FP_1.0D_GEb_FR23	C2DP870 0
AS5739G-874G50Mn	EME A	Turkey	LX.PDR0X.0 12	AS5739G-874G50Mn EM VHP32ATTR1 MC N10PGE11GBCFbk 2*2G/500_L/6L/ 5R/CB_n2_FP_1.0D_GEb_TR33	C2DP870 0
AS5739G-874G50Mn	EME A	Norway	LX.PDR0X.0 10	AS5739G-874G50Mn VHP32ATNO1 MC N10PGE11GBCFbk 2*2G/ 500_L/6L/5R/ CB_n2_FP_1.0D_GEb_NO12	C2DP870 0
AS5739G-874G50Mn	EME A	Poland	LX.PDR0X.0 08	AS5739G-874G50Mn VHP32ATPL1 MC N10PGE11GBCFbk 2*2G/ 500_L/6L/5R/ CB_n2_FP_1.0D_GEb_PL11	C2DP870 0
AS5739G-742G32Mn	CHI NA	China	LX.PDR0C.0 02	AS5739G-742G32Mn LINPUSACN1 N10PGE11GBCFbk 1*2G/320/BT/ 6L/5R/CB_n2_FP_1.0D_GEb_EN91	C2DP745 0
AS5739G-742G32Mn	CHI NA	Hong Kong	LX.PDR0C.0 01	AS5739G-742G32Mn LINPUSAHK2 N10PGE11GBCFbk 1*2G/320/BT/ 6L/5R/CB_n2_FP_1.0D_GEb_EN91	C2DP745 0
AS5739G-874G50Bn	AAP	Japan	LX.PDR0X.0 02	AS5739G-874G50Bn VHP32AJP1 MC N10PGE11GBCFbk 2*2G/ 500_L/BT/6L/ CB_n2_FP_1.0D_GEb_JA11_MX1	C2DP870 0
AS5739G-874G50Bn	AAP	Japan	LX.PDR0X.0 01	AS5739G-874G50Bn VHP32APJP1 MC N10PGE11GBCFbk 2*2G/ 500_L/BT/6L/ CB_n2_FP_1.0D_GEb_JA11_MX1F	C2DP870 0
AS5739G-874G50Mn	EME A	South Africa	LX.PEL0X.03 9	AS5739G-874G50Mn EM VHP32ATZA2 MC N10PGE11GBCbk 2*2G/500_L/6L/ 5R/CB_n2_1.0D_GEb_EN16	C2DP870 0

Model	RO	Country	Acer Part No	Description	CPU
AS5739G-874G50Mn	EME A	South Africa	LX.PELOX.04 0	AS5739G-874G50Mn EM VHP32ATZA1 MC N10PGE11GBCbk 2*2G/500_L/6L/ 5R/CB_n2_1.0D_GEb_FR23	C2DP870 0
AS5739G-874G50Mn	EME A	South Africa	LX.PELOX.04 1	AS5739G-874G50Mn EM VHP32ATZA4 MC N10PGE11GBCbk 2*2G/500_L/6L/ 5R/CB_n2_1.0D_GEb_ENI1	C2DP870 0
AS5739G-874G50Mn	EME A	Denmark	LX.PELOX.04 2	AS5739G-874G50Mn VHP32ATDK1 MC N10PGE11GBCbk 2*2G/500_L/ 6L/5R/CB_n2_1.0D_GEb_NO13	C2DP870 0
AS5739G-874G50Mn	EME A	Belgium	LX.PELOX.03 6	AS5739G-874G50Mn VHP32ATBE1 MC N10PGE11GBCbk 2*2G/500_L/ 6L/5R/CB_n2_1.0D_GEb_NL13	C2DP870 0
AS5739G-874G50Mn	EME A	Luxembo urg	LX.PELOX.03 8	AS5739G-874G50Mn VHP32ATLU3 MC N10PGE11GBCbk 2*2G/500_L/ 6L/5R/CB_n2_1.0D_GEb_IT41	C2DP870 0
AS5739G-874G50Mi	EME A	Russia	LX.PELOX.03 4	AS5739G-874G50Mi VHP32ATRU1 MC N10PGE11GBCbk 2*2G/500_L/ 6L/5R/CB_abg_1.0D_GEb_RU11	C2DP870 0
AS5739G-874G50Mn	EME A	Austria	LX.PELOX.03 3	AS5739G-874G50Mn VHP32ATAT1 MC N10PGE11GBCbk 2*2G/500_L/ 6L/5R/CB_n2_1.0D_GEb_DE11	C2DP870 0
AS5739G-874G50Mn	EME A	Norway	LX.PELOX.03 5	AS5739G-874G50Mn VHP32ATNO1 MC N10PGE11GBCbk 2*2G/500_L/ 6L/5R/CB_n2_1.0D_GEb_NO12	C2DP870 0
AS5739G-874G50Mn	EME A	Holland	LX.PELOX.03 7	AS5739G-874G50Mn VHP32ATNL1 MC N10PGE11GBCbk 2*2G/500_L/ 6L/5R/CB_n2_1.0D_GEb_NL12	C2DP870 0
AS5739G-874G50Mn	EME A	Sweden	LX.PELOX.02 9	AS5739G-874G50Mn VHP32ATSE1 MC N10PGE11GBCbk 2*2G/500_L/ 6L/5R/CB_n2_1.0D_GEb_FI13	C2DP870 0
AS5739G-874G50Mn	EME A	Eastern Europe	LX.PELOX.03 0	AS5739G-874G50Mn VHP32ATEU7 MC N10PGE11GBCbk 2*2G/500_L/ 6L/5R/CB_n2_1.0D_GEb_SL11	C2DP870 0
AS5739G-874G50Mn	EME A	Eastern Europe	LX.PELOX.03 1	AS5739G-874G50Mn VHP32ATEU4 MC N10PGE11GBCbk 2*2G/500_L/ 6L/5R/CB_n2_1.0D_GEb_SV22	C2DP870 0
AS5739G-874G50Mn	EME A	Eastern Europe	LX.PELOX.03 2	AS5739G-874G50Mn VHP32ATEU5 MC N10PGE11GBCbk 2*2G/500_L/ 6L/5R/CB_n2_1.0D_GEb_RO12	C2DP870 0
AS5739G-874G50Mn	EME A	Eastern Europe	LX.PELOX.02 6	AS5739G-874G50Mn VHP32ATEU5 MC N10PGE11GBCbk 2*2G/500_L/ 6L/5R/CB_n2_1.0D_GEb_PL13	C2DP870 0
AS5739G-874G50Mn	EME A	Finland	LX.PELOX.02 7	AS5739G-874G50Mn VHP32ATFI2 MC N10PGE11GBCbk 2*2G/500_L/ 6L/5R/CB_n2_1.0D_GEb_FI11	C2DP870 0
AS5739G-874G50Mn	EME A	Portugal	LX.PELOX.02 8	AS5739G-874G50Mn VHP32ATPT1 MC N10PGE11GBCbk 2*2G/500_L/ 6L/5R/CB_n2_1.0D_GEb_PT12	C2DP870 0

Model	RO	Country	Acer Part No	Description	CPU
AS5739G-874G50Mn	EME A	Greece	LX.PELOX.02 5	AS5739G-874G50Mn VHP32ATGR1 MC N10PGE11GBCbk 2*2G/500_L/6L/5R/CB_n2_1.0D_GEb_EL32	C2DP870 0
AS5739G-874G50Mn	EME A	Italy	LX.PELOX.02 4	AS5739G-874G50Mn VHP32ATIT1 MC N10PGE11GBCbk 2*2G/500_L/6L/5R/CB_n2_1.0D_GEb_IT12	C2DP870 0
AS5739G-874G50Mn	EME A	Middle East	LX.PELOX.02 3	AS5739G-874G50Mn EM VHP32ATME9 MC N10PGE11GBCbk 2*2G/500_L/6L/5R/CB_n2_1.0D_GEb_FR22	C2DP870 0
AS5739G-874G50Mn	EME A	Middle East	LX.PELOX.02 2	AS5739G-874G50Mn EM VHP32ATME4 MC N10PGE11GBCbk 2*2G/500_L/6L/5R/CB_n2_1.0D_GEb_EN11	C2DP870 0
AS5739G-874G50Mn	EME A	Middle East	LX.PELOX.02 1	AS5739G-874G50Mn EM VHP32ATME3 MC N10PGE11GBCbk 2*2G/500_L/6L/5R/CB_n2_1.0D_GEb_FR23	C2DP870 0
AS5739G-874G50Mn	EME A	Poland	LX.PELOX.01 7	AS5739G-874G50Mn VHP32ATPL1 MC N10PGE11GBCbk 2*2G/500_L/6L/5R/CB_n2_1.0D_GEb_PL11	C2DP870 0
AS5739G-874G50Mn	EME A	Turkey	LX.PELOX.01 5	AS5739G-874G50Mn EM VHP32ATTR1 MC N10PGE11GBCbk 2*2G/500_L/6L/5R/CB_n2_1.0D_GEb_TR33	C2DP870 0
AS5739G-874G50Mn	EME A	UK	LX.PELOX.01 3	AS5739G-874G50Mn VHP32ATGB1 MC N10PGE11GBCbk 2*2G/500_L/6L/5R/CB_n2_1.0D_GEb_EN14	C2DP870 0
AS5739G-874G50Mi	EME A	Ukraine	LX.PELOX.01 4	AS5739G-874G50Mi VHP32ATUK1 MC N10PGE11GBCbk 2*2G/500_L/6L/5R/CB_abg_1.0D_GEb_RU11	C2DP870 0
AS5739G-874G50Mn	EME A	Switzerland	LX.PELOX.01 8	AS5739G-874G50Mn VHP32ATCH1 MC N10PGE11GBCbk 2*2G/500_L/6L/5R/CB_n2_1.0D_GEb_IT42	C2DP870 0
AS5739G-874G50Mn	EME A	Middle East	LX.PELOX.01 6	AS5739G-874G50Mn EM VHP32ATME2 MC N10PGE11GBCbk 2*2G/500_L/6L/5R/CB_n2_1.0D_GEb_AR23	C2DP870 0
AS5739G-874G50Mn	EME A	Middle East	LX.PELOX.02 0	AS5739G-874G50Mn EM VHP32ATME2 MC N10PGE11GBCbk 2*2G/500_L/6L/5R/CB_n2_1.0D_GEb_AR13	C2DP870 0
AS5739G-874G50Mn	EME A	Middle East	LX.PELOX.01 9	AS5739G-874G50Mn EM VHP32ATME4 MC N10PGE11GBCbk 2*2G/500_L/6L/5R/CB_n2_1.0D_GEb_RU61	C2DP870 0
AS5739G-874G50Mn	EME A	France	LX.PELOX.00 4	AS5739G-874G50Mn VHP32ATFR1 MC N10PGE11GBCbk 2*2G/500_L/6L/5R/CB_n2_1.0D_GEb_FR23	C2DP870 0
AS5739G-874G50Mn	EME A	Germany	LX.PELOX.00 5	AS5739G-874G50Mn VHP32ATDE1 MC N10PGE11GBCbk 2*2G/500_L/6L/5R/CB_n2_1.0D_GEb_DE13	C2DP870 0

Model	RO	Country	Acer Part No	Description	CPU
AS5739G-874G50Mn	EME A	Eastern Europe	LX.PELOX.007	AS5739G-874G50Mn VHP32ATEU3 MC N10PGE11GBCbk 2*2G/500_L/6L/5R/CB_n2_1.0D_GEb_RU23	C2DP8700
AS5739G-874G50Mn	EME A	Middle East	LX.PELOX.011	AS5739G-874G50Mn EM VHP32ATME2 MC N10PGE11GBCbk 2*2G/500_L/6L/5R/CB_n2_1.0D_GEb_EN15	C2DP8700
AS5739G-874G50Mn	EME A	Middle East	LX.PELOX.012	AS5739G-874G50Mn EM VHP32ATME6 MC N10PGE11GBCbk 2*2G/500_L/6L/5R/CB_n2_1.0D_GEb_EN15	C2DP8700
AS5739G-874G50Mn	EME A	Israel	LX.PELOX.010	AS5739G-874G50Mn VHP32ATIL1 MC N10PGE11GBCbk 2*2G/500_L/6L/5R/CB_n2_1.0D_GEb_HE12	C2DP8700
AS5739G-874G50Mn	EME A	Spain	LX.PELOX.009	AS5739G-874G50Mn VHP32ATES1 MC N10PGE11GBCbk 2*2G/500_L/6L/5R/CB_n2_1.0D_GEb_ES22	C2DP8700
AS5739G-874G50Mn	EME A	Hungary	LX.PELOX.008	AS5739G-874G50Mn VHP32ATHU1 MC N10PGE11GBCbk 2*2G/500_L/6L/5R/CB_n2_1.0D_GEb_HU13	C2DP8700
AS5739G-874G50Mn	EME A	Eastern Europe	LX.PELOX.006	AS5739G-874G50Mn VHP32ATEU7 MC N10PGE11GBCbk 2*2G/500_L/6L/5R/CB_n2_1.0D_GEb_ENR2	C2DP8700
AS5739G-743G25Mn	PA	Canada	LX.PELOX.002	AS5739G-743G25Mn VHP32ATCA2 MC N10PGE11GBCbk 2G+1G/250/BT/6L/5R/CB_n2_1.0D_GEb_FR81	C2DP7450
AS5739G-743G25Mn	PA	USA	LX.PELOX.001	AS5739G-743G25Mn VHP32ATUS1 MC N10PGE11GBCbk 2G+1G/250/BT/6L/5R/CB_n2_1.0D_GEb_EN34	C2DP7450
AS5739G-742G32Mn	CHI NA	China	LX.PELOX.003	AS5739G-742G32Mn VHP32ATCN1 MC N10PGE11GBCbk 1*2G/320/BT/6L/5R/CB_n2_1.0D_GEb_SC11	C2DP7450
AS5739G-9A4G50Mn	WW	WW	S2.PDP0C.002	AS5739G-9A4G50Mn LINPUSAWW1 N10PGE11GBTCFbk 2*2G/500_L/BT/6L/CB_n3_DVBT U/ VHF_FP_1.0D_GEb_EN11	C2DT9550
AS5739G-872G32Mn	WW	WW	S2.PDP0C.001	AS5739G-872G32Mn LINPUSAWW1 N10PGE11GBTCFbk 1*2G/320/BT/6L/CB_n3_DVBT U/ VHF_FP_1.0D_GEb_EN11	C2DP8700
AS5739G-9A4G50Mn	WW	WW	S2.PDP0X.001	AS5739G-9A4G50Mn VHP32AWW1 MC N10PGE11GBTCFbk 2*2G/500_L/BT/6L/CB_n3_DVBT U/ VHF_FP_1.0D_GEb_EN11	C2DT9550
AS5739-661G25Mn	CHI NA	China	LX.PDT0C.002	AS5739-661G25Mn LINPUSACN1 UMACbk 1*1G/250/BT/6L/5R/CB_n2_1.0D_GEb_EN91	C2DT6600
AS5739-661G25Mn	CHI NA	Hong Kong	LX.PDT0C.001	AS5739-661G25Mn LINPUSAHK2 UMACbk 1*1G/250/BT/6L/5R/CB_n2_1.0D_GEb_EN91	C2DT6600

Model	RO	Country	Acer Part No	Description	CPU
AS5739-872G32Mn	AAP	Japan	LX.PDT0X.0 02	AS5739-872G32Mn VHP32APJP1 MC UMACbk 1*2G/320/BT/6L/ CB_n2_1.0D_GEb_JA11_D72F	C2DP870 0
AS5739-872G32Mn	AAP	Japan	LX.PDT0X.0 01	AS5739-872G32Mn VHP32AJJP1 MC UMACbk 1*2G/320/BT/6L/ CB_n2_1.0D_GEb_JA11_D72	C2DP870 0
AS5739-642G16Mi	WW	WW	S2.PDT0C.0 02	AS5739-642G16Mi LINPUSAWW1 UMACbk 2*1G/160/BT/6L/ CB_abg_1.0D_GEb_EN11	C2DT6400
AS5739-641G16Mi	WW	WW	S2.PDT0C.0 01	AS5739-641G16Mi LINPUSAWW1 UMACbk 1*1G/160/BT/6L/ CB_abg_1.0D_GEb_EN11	C2DT6400

Model	LCD	VGA Chip	VRAM 1	Memory 1	Memory 2
AS5739G-642G32Mn	NLED15.6WGXGAG	M92XT	512M-DDR2(64*16*4)	SO2GBIII10	N
AS5739G-654G50Mn	NLED15.6WGXGAG	M92XT	512M-DDR2(64*16*4)	SO2GBIII10	SO2GBIII10
AS5739G-754G32Mn	NLED15.6WGXGAG	M92XT	512M-DDR2(64*16*4)	SO2GBIII10	SO2GBIII10
AS5739G-754G32Mn	NLED15.6WGXGAG	M92XT	512M-DDR2(64*16*4)	SO2GBIII10	SO2GBIII10
AS5739G-754G32Mn	NLED15.6WGXGAG	M92XT	512M-DDR2(64*16*4)	SO2GBIII10	SO2GBIII10
AS5739G-754G32Mn	NLED15.6WGXGAG	M92XT	512M-DDR2(64*16*4)	SO2GBIII10	SO2GBIII10
AS5739G-754G32Mn	NLED15.6WGXGAG	M92XT	512M-DDR2(64*16*4)	SO2GBIII10	SO2GBIII10
AS5739G-754G32Mn	NLED15.6WGXGAG	M92XT	512M-DDR2(64*16*4)	SO2GBIII10	SO2GBIII10
AS5739G-754G32Mn	NLED15.6WGXGAG	M92XT	512M-DDR2(64*16*4)	SO2GBIII10	SO2GBIII10
AS5739G-754G32Mn	NLED15.6WGXGAG	M92XT	512M-DDR2(64*16*4)	SO2GBIII10	SO2GBIII10
AS5739G-754G32Mn	NLED15.6WGXGAG	M92XT	512M-DDR2(64*16*4)	SO2GBIII10	SO2GBIII10
AS5739G-754G32Mn	NLED15.6WGXGAG	M92XT	512M-DDR2(64*16*4)	SO2GBIII10	SO2GBIII10
AS5739G-754G32Mn	NLED15.6WGXGAG	M92XT	512M-DDR2(64*16*4)	SO2GBIII10	SO2GBIII10
AS5739G-754G32Mn	NLED15.6WGXGAG	M92XT	512M-DDR2(64*16*4)	SO2GBIII10	SO2GBIII10
AS5739G-754G32Mn	NLED15.6WGXGAG	M92XT	512M-DDR2(64*16*4)	SO2GBIII10	SO2GBIII10
AS5739G-754G32Mn	NLED15.6WGXGAG	M92XT	512M-DDR2(64*16*4)	SO2GBIII10	SO2GBIII10
AS5739G-754G32Mn	NLED15.6WGXGAG	M92XT	512M-DDR2(64*16*4)	SO2GBIII10	SO2GBIII10
AS5739G-754G32Mn	NLED15.6WGXGAG	M92XT	512M-DDR2(64*16*4)	SO2GBIII10	SO2GBIII10
AS5739G-754G32Mn	NLED15.6WGXGAG	M92XT	512M-DDR2(64*16*4)	SO2GBIII10	SO2GBIII10
AS5739G-754G32Mn	NLED15.6WGXGAG	M92XT	512M-DDR2(64*16*4)	SO2GBIII10	SO2GBIII10
AS5739G-754G32Mn	NLED15.6WGXGAG	M92XT	512M-DDR2(64*16*4)	SO2GBIII10	SO2GBIII10
AS5739G-754G32Mi	NLED15.6WGXGAG	M92XT	512M-DDR2(64*16*4)	SO2GBIII10	SO2GBIII10
AS5739G-754G32Mi	NLED15.6WGXGAG	M92XT	512M-DDR2(64*16*4)	SO2GBIII10	SO2GBIII10
AS5739G-754G32Mn	NLED15.6WGXGAG	M92XT	512M-DDR2(64*16*4)	SO2GBIII10	SO2GBIII10
AS5739G-754G32Mn	NLED15.6WGXGAG	M92XT	512M-DDR2(64*16*4)	SO2GBIII10	SO2GBIII10
AS5739G-754G32Mn	NLED15.6WGXGAG	M92XT	512M-DDR2(64*16*4)	SO2GBIII10	SO2GBIII10
AS5739G-754G32Mn	NLED15.6WGXGAG	M92XT	512M-DDR2(64*16*4)	SO2GBIII10	SO2GBIII10
AS5739G-754G32Mn	NLED15.6WGXGAG	M92XT	512M-DDR2(64*16*4)	SO2GBIII10	SO2GBIII10
AS5739G-754G32Mn	NLED15.6WGXGAG	M92XT	512M-DDR2(64*16*4)	SO2GBIII10	SO2GBIII10
AS5739G-754G32Mn	NLED15.6WGXGAG	M92XT	512M-DDR2(64*16*4)	SO2GBIII10	SO2GBIII10
AS5739G-754G32Mn	NLED15.6WGXGAG	M92XT	512M-DDR2(64*16*4)	SO2GBIII10	SO2GBIII10

Model	HDD 1(GB)	ODD	Extra SW1	Card Reader
AS5739G-754G32Mn	N320GB5.4KS	NSM8XS	McAfee	5 in 1-Build in
AS5739G-754G32Mn	N320GB5.4KS	NSM8XS	McAfee	5 in 1-Build in
AS5739G-754G32Mn	N320GB5.4KS	NSM8XS	McAfee	5 in 1-Build in
AS5739G-754G32Mi	N320GB5.4KS	NSM8XS	McAfee	5 in 1-Build in
AS5739G-754G32Mn	N320GB5.4KS	NSM8XS	McAfee	5 in 1-Build in
AS5739G-754G32Mn	N320GB5.4KS	NSM8XS	McAfee	5 in 1-Build in
AS5739G-754G32Mn	N320GB5.4KS	NSM8XS	McAfee	5 in 1-Build in
AS5739G-754G32Mn	N320GB5.4KS	NSM8XS	McAfee	5 in 1-Build in
AS5739G-754G32Mn	N320GB5.4KS	NSM8XS	McAfee	5 in 1-Build in
AS5739G-754G32Mn	N320GB5.4KS	NSM8XS	McAfee	5 in 1-Build in
AS5739G-754G32Mn	N320GB5.4KS	NSM8XS	McAfee	5 in 1-Build in
AS5739G-754G32Mn	N320GB5.4KS	NSM8XS	McAfee	5 in 1-Build in
AS5739G-754G32Mn	N320GB5.4KS	NSM8XS	McAfee	5 in 1-Build in
AS5739G-754G32Mn	N320GB5.4KS	NSM8XS	McAfee	5 in 1-Build in
AS5739G-754G32Mn	N320GB5.4KS	NSM8XS	McAfee	5 in 1-Build in
AS5739G-754G32Mn	N320GB5.4KS	NSM8XS	McAfee	5 in 1-Build in
AS5739G-754G32Mn	N320GB5.4KS	NSM8XS	McAfee	5 in 1-Build in
AS5739G-754G32Mi	N320GB5.4KS	NSM8XS	McAfee	5 in 1-Build in
AS5739G-754G32Mn	N320GB5.4KS	NSM8XS	McAfee	5 in 1-Build in
AS5739G-754G32Mn	N320GB5.4KS	NSM8XS	McAfee	5 in 1-Build in
AS5739G-754G32Mn	N320GB5.4KS	NSM8XS	McAfee	5 in 1-Build in
AS5739G-754G32Mn	N320GB5.4KS	NSM8XS	McAfee	5 in 1-Build in
AS5739G-754G32Mn	N320GB5.4KS	NSM8XS	McAfee	5 in 1-Build in
AS5739G-754G32Mn	N320GB5.4KS	NSM8XS	McAfee	5 in 1-Build in
AS5739G-754G32Mn	N320GB5.4KS	NSM8XS	McAfee	5 in 1-Build in
AS5739G-754G32Mn	N320GB5.4KS	NSM8XS	McAfee	5 in 1-Build in
AS5739G-754G32Mn	N320GB5.4KS	NSM8XS	McAfee	5 in 1-Build in
AS5739G-742G32Mn	N320GB5.4KS	NSM8XS	McAfee	5 in 1-Build in
AS5739G-742G32Mn	N320GB5.4KS	NSM8XS	McAfee	5 in 1-Build in
AS5739G-742G32Mn	N320GB5.4KS	NSM8XS	McAfee	5 in 1-Build in
AS5739G-662G25Bn	N250GB5.4KS	NBDCB4XS	N	5 in 1-Build in
AS5739G-654G25Mn	N250GB5.4KS	NSM8XS	McAfee	5 in 1-Build in
AS5739G-742G32Mn	N320GB5.4KS	NSM8XS	McAfee	5 in 1-Build in
AS5739G-734G50Mn	N500GB5.4KS	NSM8XS	McAfee	5 in 1-Build in
AS5739G-644G50Mn	N500GB5.4KS	NSM8XS	McAfee	5 in 1-Build in
AS5739G-654G32Mn	N320GB5.4KS	NSM8XS	McAfee	5 in 1-Build in
AS5739G-654G50Bn	N500GB5.4KS	NBDCB4XS	McAfee	5 in 1-Build in
AS5739G-734G32Mn	N320GB5.4KS	NSM8XS	McAfee	5 in 1-Build in
AS5739G-664G50Mi	N500GB5.4KS	NSM8XS	N	5 in 1-Build in
AS5739G-734G50Mn	N500GB5.4KS	NSM8XS	McAfee	5 in 1-Build in
AS5739G-874G50Mn	N500GB5.4KS	NSM8XS	McAfee	5 in 1-Build in

Model	HDD 1(GB)	ODD	Extra SW1	Card Reader
AS5739G-743G25Mn	N250GB5.4KS	NSM8XS	McAfee	5 in 1-Build in
AS5739G-742G32Mn	N320GB5.4KS	NSM8XS	McAfee	5 in 1-Build in
AS5739G-9A4G50Mn	N500GB5.4KS	NSM8XS	N	5 in 1-Build in
AS5739G-872G32Mn	N320GB5.4KS	NSM8XS	N	5 in 1-Build in
AS5739G-9A4G50Mn	N500GB5.4KS	NSM8XS	McAfee	5 in 1-Build in
AS5739-661G25Mn	N250GB5.4KS	NSM8XS	N	5 in 1-Build in
AS5739-661G25Mn	N250GB5.4KS	NSM8XS	N	5 in 1-Build in
AS5739-872G32Mn	N320GB5.4KS	NSM8XS	McAfee	5 in 1-Build in
AS5739-872G32Mn	N320GB5.4KS	NSM8XS	McAfee	5 in 1-Build in
AS5739-642G16Mi	N160GB5.4KS	NSM8XS	N	5 in 1-Build in
AS5739-641G16Mi	N160GB5.4KS	NSM8XS	N	5 in 1-Build in

Model	Wireless LAN	Wireless LAN1	Bluetooth	Finger Print
AS5739G-642G32Mn	SP1x2MMW	SP1x2MMW	BT 2.1	TCS4E
AS5739G-654G50Mn	SP1x2MMW	SP1x2MMW	N	TCS4E
AS5739G-754G32Mn	SP1x2MMW	SP1x2MMW	N	TCS4E
AS5739G-754G32Mn	SP1x2MMW	SP1x2MMW	N	TCS4E
AS5739G-754G32Mn	SP1x2MMW	SP1x2MMW	N	TCS4E
AS5739G-754G32Mn	SP1x2MMW	SP1x2MMW	N	TCS4E
AS5739G-754G32Mn	SP1x2MMW	SP1x2MMW	N	TCS4E
AS5739G-754G32Mn	SP1x2MMW	SP1x2MMW	N	TCS4E
AS5739G-754G32Mn	SP1x2MMW	SP1x2MMW	N	TCS4E
AS5739G-754G32Mn	SP1x2MMW	SP1x2MMW	N	TCS4E
AS5739G-754G32Mn	SP1x2MMW	SP1x2MMW	N	TCS4E
AS5739G-754G32Mn	SP1x2MMW	SP1x2MMW	N	TCS4E
AS5739G-754G32Mn	SP1x2MMW	SP1x2MMW	N	TCS4E
AS5739G-754G32Mn	SP1x2MMW	SP1x2MMW	N	TCS4E
AS5739G-754G32Mn	SP1x2MMW	SP1x2MMW	N	TCS4E
AS5739G-754G32Mn	SP1x2MMW	SP1x2MMW	N	TCS4E
AS5739G-754G32Mn	SP1x2MMW	SP1x2MMW	N	TCS4E
AS5739G-754G32Mn	SP1x2MMW	SP1x2MMW	N	TCS4E
AS5739G-754G32Mn	SP1x2MMW	SP1x2MMW	N	TCS4E
AS5739G-754G32Mi	SP1x2MMW	SP1x2MABG	N	TCS4E
AS5739G-754G32Mi	SP1x2MMW	SP1x2MABG	N	TCS4E
AS5739G-754G32Mn	SP1x2MMW	SP1x2MMW	N	TCS4E
AS5739G-754G32Mn	SP1x2MMW	SP1x2MMW	N	TCS4E
AS5739G-754G32Mn	SP1x2MMW	SP1x2MMW	N	TCS4E

Model	Wireless LAN	Wireless LAN1	Bluetooth	Finger Print
AS5739G-754G32Mn	SP1x2MMW	SP1x2MMW	N	N
AS5739G-754G32Mn	SP1x2MMW	SP1x2MMW	N	N
AS5739G-754G32Mn	SP1x2MMW	SP1x2MMW	N	N
AS5739G-754G32Mn	SP1x2MMW	SP1x2MMW	N	N
AS5739G-754G32Mn	SP1x2MMW	SP1x2MMW	N	N
AS5739G-754G32Mn	SP1x2MMW	SP1x2MMW	N	N
AS5739G-754G32Mn	SP1x2MMW	SP1x2MMW	N	N
AS5739G-754G32Mi	SP1x2MMW	SP1x2MABG	N	N
AS5739G-754G32Mn	SP1x2MMW	SP1x2MMW	N	N
AS5739G-754G32Mn	SP1x2MMW	SP1x2MMW	N	N
AS5739G-754G32Mn	SP1x2MMW	SP1x2MMW	N	N
AS5739G-754G32Mn	SP1x2MMW	SP1x2MMW	N	N
AS5739G-754G32Mn	SP1x2MMW	SP1x2MMW	N	N
AS5739G-742G32Mn	SP1x2MMW	SP1x2MMW	BT 2.1	N
AS5739G-742G32Mn	SP1x2MMW	SP1x2MMW	BT 2.1	N
AS5739G-742G32Mn	SP1x2MMW	SP1x2MMW	BT 2.1	N
AS5739G-662G25Bn	SP1x2MMW	SP1x2MMW	BT 2.1	TCS4E
AS5739G-654G25Mn	SP1x2MMW	SP1x2MMW	N	TCS4E
AS5739G-742G32Mn	SP1x2MMW	SP1x2MMW	BT 2.1	TCS4E
AS5739G-734G50Mn	SP1x2MMW	SP1x2MMW	N	TCS4E
AS5739G-644G50Mn	SP1x2MMW	SP1x2MMW	N	TCS4E
AS5739G-654G32Mn	SP1x2MMW	SP1x2MMW	N	TCS4E
AS5739G-654G50Bn	SP1x2MMW	SP1x2MMW	N	TCS4E
AS5739G-734G32Mn	SP1x2MMW	SP1x2MMW	N	TCS4E
AS5739G-664G50Mi	SP1x2MMW	SP1x2MABG	BT 2.1	TCS4E
AS5739G-734G50Mn	SP1x2MMW	SP1x2MMW	N	TCS4E
AS5739G-874G50Mn	SP1x2MMW	SP1x2MMW	N	TCS4E
AS5739G-654G32Mn	SP1x2MMW	SP1x2MMW	N	TCS4E
AS5739G-734G50Mn	SP1x2MMW	SP1x2MMW	N	TCS4E
AS5739G-874G50Mn	SP1x2MMW	SP1x2MMW	N	TCS4E
AS5739G-874G50Mn	SP1x2MMW	SP1x2MMW	N	TCS4E
AS5739G-874G50Mn	SP1x2MMW	SP1x2MMW	N	TCS4E
AS5739G-874G50Mn	SP1x2MMW	SP1x2MMW	N	TCS4E
AS5739G-874G50Mn	SP1x2MMW	SP1x2MMW	N	TCS4E
AS5739G-874G50Mn	SP1x2MMW	SP1x2MMW	N	TCS4E
AS5739G-874G50Mn	SP1x2MMW	SP1x2MMW	N	TCS4E
AS5739G-874G50Mn	SP1x2MMW	SP1x2MMW	N	TCS4E
AS5739G-874G50Mn	SP1x2MMW	SP1x2MMW	N	TCS4E
AS5739G-874G50Mn	SP1x2MMW	SP1x2MMW	N	TCS4E
AS5739G-874G50Mn	SP1x2MMW	SP1x2MMW	N	TCS4E
AS5739G-874G50Mn	SP1x2MMW	SP1x2MMW	N	TCS4E
AS5739G-874G50Mn	SP1x2MMW	SP1x2MMW	N	TCS4E
AS5739G-874G50Mn	SP1x2MMW	SP1x2MMW	N	TCS4E
AS5739G-874G50Mn	SP1x2MMW	SP1x2MMW	N	TCS4E
AS5739G-874G50Mn	SP1x2MMW	SP1x2MMW	N	TCS4E
AS5739G-874G50Mn	SP1x2MMW	SP1x2MMW	N	TCS4E

Model	Wireless LAN	Wireless LAN1	Bluetooth	Finger Print
AS5739G-874G50Mn	SP1x2MMW	SP1x2MMW	N	N
AS5739G-874G50Mn	SP1x2MMW	SP1x2MMW	N	N
AS5739G-874G50Mn	SP1x2MMW	SP1x2MMW	N	N
AS5739G-874G50Mn	SP1x2MMW	SP1x2MMW	N	N
AS5739G-874G50Mn	SP1x2MMW	SP1x2MMW	N	N
AS5739G-874G50Mn	SP1x2MMW	SP1x2MMW	N	N
AS5739G-874G50Mn	SP1x2MMW	SP1x2MMW	N	N
AS5739G-874G50Mn	SP1x2MMW	SP1x2MMW	N	N
AS5739G-874G50Mn	SP1x2MMW	SP1x2MMW	N	N
AS5739G-874G50Mn	SP1x2MMW	SP1x2MMW	N	N
AS5739G-874G50Mn	SP1x2MMW	SP1x2MMW	N	N
AS5739G-874G50Mi	SP1x2MMW	SP1x2MABG	N	N
AS5739G-874G50Mn	SP1x2MMW	SP1x2MMW	N	N
AS5739G-874G50Mn	SP1x2MMW	SP1x2MMW	N	N
AS5739G-874G50Mn	SP1x2MMW	SP1x2MMW	N	N
AS5739G-874G50Mn	SP1x2MMW	SP1x2MMW	N	N
AS5739G-874G50Mn	SP1x2MMW	SP1x2MMW	N	N
AS5739G-874G50Mn	SP1x2MMW	SP1x2MMW	N	N
AS5739G-874G50Mn	SP1x2MMW	SP1x2MMW	N	N
AS5739G-874G50Mn	SP1x2MMW	SP1x2MMW	N	N
AS5739G-874G50Mn	SP1x2MMW	SP1x2MMW	N	N
AS5739G-874G50Mn	SP1x2MMW	SP1x2MMW	N	N
AS5739G-874G50Mn	SP1x2MMW	SP1x2MMW	N	N
AS5739G-874G50Mn	SP1x2MMW	SP1x2MMW	N	N
AS5739G-874G50Mn	SP1x2MMW	SP1x2MMW	N	N
AS5739G-874G50Mn	SP1x2MMW	SP1x2MMW	N	N
AS5739G-874G50Mn	SP1x2MMW	SP1x2MMW	N	N
AS5739G-874G50Mn	SP1x2MMW	SP1x2MMW	N	N
AS5739G-874G50Mn	SP1x2MMW	SP1x2MMW	N	N
AS5739G-874G50Mn	SP1x2MMW	SP1x2MMW	N	N
AS5739G-874G50Mn	SP1x2MMW	SP1x2MMW	N	N
AS5739G-874G50Mn	SP1x2MMW	SP1x2MMW	N	N
AS5739G-874G50Mn	SP1x2MMW	SP1x2MMW	N	N
AS5739G-874G50Mn	SP1x2MMW	SP1x2MMW	N	N
AS5739G-874G50Mn	SP1x2MMW	SP1x2MMW	N	N
AS5739G-874G50Mn	SP1x2MMW	SP1x2MMW	N	N
AS5739G-743G25Mn	SP1x2MMW	SP1x2MMW	BT 2.1	N
AS5739G-743G25Mn	SP1x2MMW	SP1x2MMW	BT 2.1	N
AS5739G-742G32Mn	SP1x2MMW	SP1x2MMW	BT 2.1	N
AS5739G-9A4G50Mn	SP3x3MMW	SP3x3MMW	BT 2.1	TCS4E
AS5739G-872G32Mn	SP3x3MMW	SP3x3MMW	BT 2.1	TCS4E
AS5739G-9A4G50Mn	SP3x3MMW	SP3x3MMW	BT 2.1	TCS4E
AS5739-661G25Mn	SP1x2MMW	SP1x2MMW	BT 2.1	N
AS5739-661G25Mn	SP1x2MMW	SP1x2MMW	BT 2.1	N
AS5739-872G32Mn	SP1x2MMW	SP1x2MMW	BT 2.1	N
AS5739-872G32Mn	SP1x2MMW	SP1x2MMW	BT 2.1	N
AS5739-642G16Mi	SP1x2MABG	SP1x2MABG	BT 2.1	N
AS5739-641G16Mi	SP1x2MABG	SP1x2MABG	BT 2.1	N

Test Compatible Components

This computer's compatibility is tested and verified by Acer's internal testing department. All of its system functions are tested under Windows® XP Home, Windows® XP Pro environment.

Refer to the following lists for components, adapter cards, and peripherals which have passed these tests. Regarding configuration, combination and test procedures, please refer to the Aspire 5739 series Compatibility Test Report released by the Acer Mobile System Testing Department.

Microsoft® Windows® Vista Environment Test

BRAND	Type	Description
Adapter		
DELTA	65W	Adapter DELTA 65W 19V 1.7x5.5x11 Yellow ADP-65JH DB A, LV5 LED LF
DELTA	90W	Adapter DELTA 90W 19V 1.7x5.5x11 Blue ADP-90CD DB A, LV5 LED LF
HIPRO	65W	Adapter HIPRO 65W 19V 1.7x5.5x11 Yellow HP-A0652R3B 1LF, LV5 LED LF
HIPRO	90W	Adapter HIPRO 90W 19V 1.7x5.5x11 Blue HP-A0904A3 B1LF, LV5 LED LF
LITE-ON	65W	Adapter LITE-ON 65W 19V 1.7x5.5x11 Yellow PA-1650-22AC LV5 LED LF
LITE-ON	90W	Adapter LITE-ON 90W 19V 1.7x5.5x11 Blue PA-1900-34AR, LV5 LED LF
Audio Codec		
Realtek	ALC888S	ALC888S
Battery		
PANASONIC	6CELL2.2	Battery PANASONIC AS-2007B Li-Ion 3S2P PANASONIC 6 cell 4400mAh Main COMMON PSS
SAMSUNG	6CELL2.2	Battery SAMSUNG AS-2007B Li-Ion 3S2P SAMSUNG 6 cell 4400mAh Main COMMON SDI 2.2F
SANYO	6CELL2.2	Battery SANYO AS-2007B Li-Ion 3S2P SANYO 6 cell 4400mAh Main COMMON Normal Type
SANYO	8CELL2.4	Battery SANYO AS-2007B Li-Ion 4S2P SANYO 8 cell 4800mAh Main COMMON
SIMPLO	6CELL2.2	Battery SIMPLO AS-2007B Li-Ion 3S2P PANASONIC 6 cell 4400mAh Main COMMON PSS
SONY	6CELL2.2	Battery SONY AS-2007B Li-Ion 3S2P SONY 6 cell 4400mAh Main COMMON Normal Type
SONY	8CELL2.4	Battery SONY AS-2007B Li-Ion 4S2P SONY 8 cell 4800mAh Main COMMON
Bluetooth		
Foxconn	BT 2.1	Foxconn Bluetooth FOX BRM 2046 BT2.1
Camera		
Chicony	1.0M DV	Chicony 1.0M DV Daisy_G
Suyin	1.0M DV	Suyin 1.0M DV Tulip_G
Card Reader		
N/A	5 in 1-Build in	5 in 1-Build in MS, MS Pro, SD, SC, XD
CPU		
INTEL	C2DP7350	CPU Intel Core2Dual P7350 PGA 2.0G 3M 1066 25W
INTEL	C2DP7450	CPU Intel Core2Dual P7450 PGA 2.13G 3M 1066 TJ, noVT
INTEL	C2DP7550	CPU Intel Core2Dual P7550 PGA 2.26G 3M 1066 R-0
INTEL	C2DP8600	CPU Intel Core2Dual P8600 PGA 2.4G 1066 25W 3M
INTEL	C2DP8600	CPU Intel Core2Dual P8600 PGA 2.4G 3M 1066 25W R-0
INTEL	C2DP8700	CPU Intel Core2Dual P8700 PGA 2.53G 3M 1066 25W R-0

BRAND	Type	Description
INTEL	C2DP8800	CPU Intel Core2Dual P8800 PGA 2.66G 3M 1066 25W R-0
INTEL	C2DP9500	CPU Intel Core2Dual P9500 PGA 2.53G 6M 1066 25W E-0
INTEL	C2DT6400	CPU Intel Core2Dual T6400 PGA 2.0G 2M 800 35W R-0 TJ, no VT
INTEL	C2DT6500	CPU Intel Core2Dual T6500 PGA 2.1G 2M 800 R-0
INTEL	C2DT6600	CPU Intel Core2Dual T6600 PGA 2.2G 2M 800 35W R-0
INTEL	C2DT9550	CPU Intel Core2Dual T9550 PGA 2.66G 6M 1066 35W E-0
INTEL	C2DT9600	CPU Intel Core2Dual T9600 PGA 2.8G 6M 1066 35W E-0
INTEL	C2DT9800	CPU Intel Core2Dual T9800 PGA 2.93G 6M 1066 35W E-0
Finger Print		
Upek	TCS4E	Upek Finger Print TCS4E
HDD		
HGST	N160GB5.4K S	HDD HGST 2.5" 5400rpm 160GB HTS545016B9A300 Panther B SATA LF F/W:C60F
HGST	N250GB5.4K S	HDD HGST 2.5" 5400rpm 250GB HTS545025B9A300 Panther B SATA LF F/W:C60F
HGST	N320GB5.4K S	HDD HGST 2.5" 5400rpm 320GB HTS545032B9A300 Panther B SATA LF F/W: C60F
HGST	N500GB5.4K S	HDD HGST 2.5" 5400rpm 500GB HTS545050B9A300 Panther B SATA LF F/W:C60F
SEAGATE	N160GB5.4K S	HDD SEAGATE 2.5" 5400rpm 160GB ST9160310AS Crockett SATA LF F/W:0303
SEAGATE	N250GB5.4K S	HDD SEAGATE 2.5" 5400rpm 250GB ST9250315AS Wyatt SATA LF F/W:0001SDM1
SEAGATE	N320GB5.4K S	HDD SEAGATE 2.5" 5400rpm 320GB ST9320320AS Crockett SATA LF F/W:0303
SEAGATE	N500GB5.4K S	HDD SEAGATE 2.5" 5400rpm 500GB ST9500325AS Wyatt SATA LF F/W:0001SDM1
TOSHIBA	N160GB5.4K S	HDD TOSHIBA 2.5" 5400rpm 160GB MK1655GSX Libra SATA LF F/W: FG011J
TOSHIBA	N250GB5.4K S	HDD TOSHIBA 2.5" 5400rpm 250GB MK2555GSX Libra SATA LF F/W:FG001J
TOSHIBA	N320GB5.4K S	HDD TOSHIBA 2.5" 5400rpm 320GB MK3255GSX Libra SATA LF F/W:FG011J
TOSHIBA	N500GB5.4K S	HDD TOSHIBA 2.5" 5400rpm 500GB MK5055GSX Libra SATA LF F/W:FG001J
WD	N160GB5.4K S	HDD WD 2.5" 5400rpm 160GB WD1600BEVT-22ZCT0 ML160 SATA LF F/W:11.01A11
WD	N250GB5.4K S	HDD WD 2.5" 5400rpm 250GB WD2500BEVT-22ZCT0 ML160 SATA LF F/W:11.01A11
WD	N320GB5.4K S	HDD WD 2.5" 5400rpm 320GB WD3200BEVT-22ZCT0 ML160 SATA LF F/W:11.01A11
WD	N500GB5.4K S	HDD WD 2.5" 5400rpm 500GB WD5000BEVT-22ZAT0 ML250 SATA LF F/W:01.01A01
Keyboard		
ACER	AC7G	Keyboard ACER AC7G JM70 Internal 17 Standard Black UV glossy

BRAND	Type	Description
LAN		
Atheros	AR8131L	Atheros AR8131L
LCD		
AUO	NLED15.6WX GAG	LED LCD AUO 15.6"W WXGA Glare B156XW02 V0 LF 220nit 8ms 500:1
CMO	NLED15.6WX GAG	LED LCD CMO 15.6"W WXGA Glare N156B6-L04 LF 220nit 8ms 500:1
CMO	NLED15.6WX GAG	LED LCD CMO 15.6"W WXGA Glare N156B6-L06 LF 220nit 8ms 500:1
LPL	NLED15.6WX GAG	LED LCD LPL 15.6"W WXGA Glare LP156WH2-TLE1 LF 220nit 8ms 400:1
SAMSUNG	NLED15.6WX GAG	LED LCD SAMSUNG 15.6"W WXGA Glare LTN156AT02-A01 LF 220nit 8ms 500:1
MEM		
ELPIDA	SO1GBIII10	Memory ELPIDA SO-DIMM DDRIII 1066 1GB EBJ11UE6BAU0-AE-E LF 64*16 0.07um
ELPIDA	SO1GBIII10	Memory ELPIDA SO-DIMM DDRIII 1066 1GB EBJ11UE6BBS0-AE-F LF 64*16 0.065um
ELPIDA	SO2GBIII10	Memory ELPIDA SO-DIMM DDRIII 1066 2GB EBJ21UE8BAU0-AE-E LF 128*8 0.07um
ELPIDA	SO2GBIII10	Memory ELPIDA SO-DIMM DDRIII 1066 2GB EBJ21UE8BBS0-AE-F LF 128*8 0.065um
HYNIX	SO1GBIII10	Memory HYNIX SO-DIMM DDRIII 1066 1GB HMT112S6AFP6C-G7N0 LF 64*16 0.065um
HYNIX	SO1GBIII10	Memory HYNIX SO-DIMM DDRIII 1066 1GB HMT112S6BFR6C-G7N0 LF 64*16 0.055um
HYNIX	SO2GBIII10	Memory HYNIX SO-DIMM DDRIII 1066 2GB HMT125S6BFR8C-G7N0 LF 128*8 0.055um
MICRON	SO1GBIII10	Memory MICRON SO-DIMM DDRIII 1066 1GB MT8JSF12864HY-1G1D1 LF 64*16 0.07um
MICRON	SO2GBIII10	Memory MICRON SO-DIMM DDRIII 1066 2GB MT16JSF25664HY-1G1D1 LF 128*8 0.07um
NANYA	SO1GBIII10	Memory NANYA SO-DIMM DDRIII 1066 1GB NT1GC64BH8A1PS-BE LF 64*16 0.07um
NANYA	SO2GBIII10	Memory NANYA SO-DIMM DDRIII 1066 2GB NT2GC64B8HA1NS-BE LF 128*8 0.07um
SAMSUNG	SO1GBIII10	Memory SAMSUNG SO-DIMM DDRIII 1066 1GB M471B2873EH1-CF8 LF 64*16 0.055um
SAMSUNG	SO1GBIII10	Memory SAMSUNG SO-DIMM DDRIII 1066 1GB M471B2874DZ1-CF8 LF 64*16 0.065um
SAMSUNG	SO2GBIII10	Memory SAMSUNG SO-DIMM DDRIII 1066 2GB M471B5673DZ1-CF8 LF 128*8 0.065um
SAMSUNG	SO2GBIII10	Memory SAMSUNG SO-DIMM DDRIII 1066 2GB M471B5673EH1-CF8 LF 128*8 0.055um
Modem		
Foxconn	Fox+LSI AM5 V2H 1.5_3.3V Aus	Foxconn Delphi-AM5 V2H 1.5_3.3v AUS T60M951

BRAND	Type	Description
NB Chipset		
INTEL	GM45	NB Chipset Intel CS GM45NB
INTEL	PM45	NB Chipset Intel CS PM45NB
ODD		
PANASONIC	NBDCB4XS	ODD PANASONIC BD COMBO 12.7mm Tray DL 4X UJ-130A LF W/O bezel SATA 2X Single Layer, 4X Double Layer
PANASONIC	NSM8XS	ODD PANASONIC Super-Multi DRIVE 12.7mm Tray DL 8X UJ880A LF W/O bezel SATA
PIONEER	NBDCB4XS	ODD PIONEER BD COMBO 12.7mm Tray DL 4X BDC-TD01RS LF W/O bezel SATA
PLDS	NBDCB4XS	ODD PLDS BD COMBO 12.7mm Tray DL 4X DS-4E1S LF W/O bezel SATA
PLDS	NSM8XS	ODD PLDS Super-Multi DRIVE 12.7mm Tray DL 8X DS-8A3S LF W/O bezel SATA
SONY	NSM8XS	ODD SONY Super-Multi DRIVE 12.7mm Tray DL 8X AD-7580S LF W/O bezel SATA
TOSHIBA	NSM8XS	ODD TOSHIBA Super-Multi DRIVE 12.7mm Tray DL 8X TS-L633B LF W/O bezel SATA
Remote Controller		
Fomosa21	RC804V-B	Fomosa21 Remote Controller RC804V-B EU
Formosa21	RC804V-B	Formosa21 Remote Controller RC804V-B EN
Formosa21	RC804V-B	Formosa21 Remote Controller RC804V-B SC
Formosa21	RC804V-B	Formosa21 Remote Controller RC804V-B TC
SB Chipset		
INTEL	ICH9M	SB Chipset Intel CS ICH9M
Software		
N/A	McAfee	Antivirus application McAfee
TV Antenna		
WNC	Passive Antenna	WNC Passive Antenna
TV Tuner		
N/A	DVB-T Mini-card	DVB-T Mini-card TT-1260DA w/DiBCOM DIB7070P+DiB0700C rev.D
AVerMedia	DVB-T Mini-card	AVerMedia TV-tuner card DVB-T Mini-card A310 w/ Intel+MaxLinear Rev 1.0
VGA Chip		
AMD	M92XT	AMD M92XT 55nm 29mm*29mm M2 package
None	UMA	UMA (Intel)
NVIDIA	N10PGE1	NVIDIA N10PGE1 55nm 29mm*29mm GB1-128 package
VRAM		
N/A	1G-DDR2 (64*16*8)	1G-DDR2 64*16*8
N/A	512M-DDR2 (64*16*4)	512M-DDR2 64*16*4

BRAND	Type	Description
WiFi Antenna		
WNC	PIFA	PIFA
Wireless LAN		
Foxconn	3rd WiFi 1x2 BGN	Foxconn Wireless LAN Atheros AR5B91 1x2 BGN
INTEL	SP1x2MABG	Lan Intel WLAN 512AG_MMWG Shirley Peak 5100 MM#897004
INTEL	SP1x2MMW	Lan Intel WLAN 512AN_MMWG Shirley Peak 5100 MM#895361
INTEL	SP1x2MMW	Lan Intel WLAN 512AN_MMWG2 Shirley Peak 5100 ME enable / MM#899541
INTEL	SP3x3MMW	Lan Intel WLAN 533AN_MMWG2 Shirley Peak 5300 ME enable / MM#899545

Online Support Information

This section describes online technical support services available to help you repair your Acer Systems.

If you are a distributor, dealer, ASP or TPM, please refer your technical queries to your local Acer branch office. Acer Branch Offices and Regional Business Units may access our website. However some information sources will require a user i.d. and password. These can be obtained directly from Acer CSD Taiwan.

Acer's Website offers you convenient and valuable support resources whenever you need them.

In the Technical Information section you can download information on all of Acer's Notebook, Desktop and Server models including:

- Service guides for all models
- User's manuals
- Training materials
- Bios updates
- Software utilities
- Spare parts lists
- TABs (Technical Announcement Bulletin)

For these purposes, we have included an Acrobat File to facilitate the problem-free downloading of our technical material.

Also contained on this website are:

- Detailed information on Acer's International Traveler's Warranty (ITW)
- Returned material authorization procedures
- An overview of all the support services we offer, accompanied by a list of telephone, fax and email contacts for all your technical queries.

We are always looking for ways to optimize and improve our services, so if you have any suggestions or comments, please do not hesitate to communicate these to us.

A

Antennas 93

B

Battery Pack 49

BIOS Utility 27–35

 Advanced 30

 Boot 33

 Exit 34

 Navigating 27

 Save and Exit 34

 Security 30

 System Security 34

Bluetooth module 80

Board Layout

 Top View 163

brightness

 hotkeys 7

C

Camera Module 90

Common Problems 134

CPU 60

D

DIMM Module 53

Display 4

display

 hotkeys 7

E

EasyTouch Failure 151

Euro 14

External Module Disassembly

 Flowchart 49

F

Features 1, 5

Fingerprint Reader Failure 152

FLASH Utility 35

Flash Utility 35

FPC Cable 92

FRU (Field Replaceable Unit) List 169

H

Hard Disk Drive Module 54

Hibernation mode

 hotkey 7

Hinge Covers 63

Hot Keys 12

I

Intermittent Problems 154

Internal Microphone Failure 142

Internal Speaker Failure 140

J

Jumper and Connector Locations 163

 Top View 163

K

Keyboard 67

Keyboard Failure 139

L

LCD Bezel 88

LCD Brackets 92

LCD Failure 139

LCD Module Disassembly

 Flowchart 88

LCD Panel 91

lower cover 51

M

Main Unit Disassembly

 Flowchart 62

Mainboard 80

MediaTouch Button Failure 151

Memory Check 134

Model Definition 181

Modem Module 78

N

No Display Issue 136

O

Online Support Information 215

optical drive module 55

P

Panel 5

 Bottom 10

Power On Failure 134

S

speakers

 hotkey 7

System

 Block Diagram 4

T

Test Compatible Components 209

Thermal Unit Failure 152

Top 163

Touchpad Failure 140

Troubleshooting

 Built-in KB Failure 139

 EasyTouch Buttons 151

 Fingerprint Reader 152

 Internal Microphone 142

 Internal Speakers 140

 LCD Failure 139

 MediTouch Buttons 151

 No Display 136

 Other Failures 153

 Power On 134

 Thermal Unit 152

 Touchpad 140

 USB 149

 WLAN 150

U

Undetermined Problems 154

USB Failure (Rightside) 149

utility

 BIOS 27–35

V

volume

hotkeys 7

W

Windows 2000 Environment Test 210

Wireless Function Failure 150

